

JAMECO®

ELECTRONICS
Brand Names & Generic Equivalents
Quality Components For Less

Catalog 242
May 2004

Sourcing List

Approved Mfg & PIN	Jameco	Digi-Key	Mouser	Newark
 MICROCHIP PIC12C504A45 PIC Processors	\$1.49	\$2.28	\$1.59	\$2.29
 BOURNS 329K1-4-102 Potentiometers	\$2.10	\$2.50	\$2.20	\$2.49
 FLUKE Fluke 73 III Test Equipment	\$148.95	N/A	\$159.00	\$159.00
 AMP 205208-1 Connectors	\$1.19	\$1.30	\$1.30	\$1.31
 Belden 1419A-090-1000 Cable & Wire	\$147.49	N/A	\$176.00	\$172.53

SAVE! SAVE! SAVE!
Great Savings Off Market Prices:

10% Off TI 74HC & 74HCT
See pages 9-11

20% Off Connectors
See pages 70-85

20% Off Most IC's
See pages 4-20

& Great
Discounts
Throughout!

Just Added: 1,300
New Products!
For detailed index
See page 3

* Terms and Conditions
These are single-unit prices taken from each party's website on 3/19/04 and do not include shipping and handling charges, volume discounts or any other discounts. Pricing does fluctuate, so please be sure to check when making purchases.

Bottom Line: Big Savings at Jameco!

1-800-831-4242
www.Jameco.com

Guaranteed to Provide You the Lowest Prices!

Featured Products

Unbeatable Prices On Artesyn Power Supplies!

The time is now to stock up on high-quality, super-reliable open-frame Artesyn power supplies, at prices that really put the power in your hands!

Artesyn is one of the top names in US-designed power supplies, and it's our goal to be your #1 source for these outstanding products. We offer a broad range of the most popular power supplies as well as DC/DC converters in both

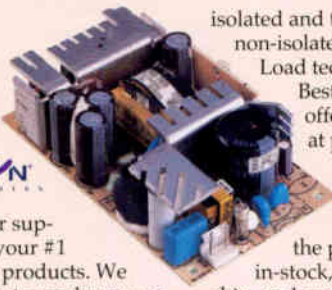

isolated and the innovative non-isolated Point-of-Load technologies.

Best of all, we're offering them to you in this catalog at prices well below even the lowest "street" prices.

Remember, when you buy from Jameco, you can rest assured that the power supplies you need are in-stock, unbeatably priced, ready to ship, and are backed by Artesyn's full 2-year warranty!

For details see pages 124-132.

Add High-Quality Video Security at a Super-Low Price!

Now, your business can benefit from the safety and protection of a full-featured video security system, for a tiny fraction of the price you might expect to pay!

Just slip this revolutionary PCI card into your Windows® 2000 or XP-based computer and install the point-and-click software package. Connect up to four security cameras to its industry-standard connectors and your PC has become a state-of-the-art video security monitor! With a few clicks of your mouse, you can configure the system to monitor four locations in your business, warehouse, parking lot, or anywhere else you need to enhance security. Plus, you can install



up to four cards in the same PC for monitoring of 16 locations.

And there's more! You can digitally record full-motion or time-lapse video from all locations. Advanced features include motion-detection recording, scheduling, time/date stamping, and simultaneous, multi-camera on-screen monitoring. With a voice modem, your new system will even call you on the phone to report a system error or possible intrusion!

See part number 262019CL on page 174. At just \$237.50, now is the time to add a versatile, expandable video security system card to your business!

See page 174 for complete details.

See page 147 for complete selection.

Quality Components For Less

Jameco Electronics is committed to saving you significant money on quality electronic components. We're constantly looking for new and creative money-saving ideas that will benefit your bottom line.

So what do we mean by significant amounts of money? Our goal is to typically save you 10-20% off market price. Yes, that means for every hundred you spend, you could be adding \$10-\$20 to your bottom line.

While other catalogs make it difficult for you to compare prices between manufacturers, we're doing just the opposite. Check out our 74HCT and 74HC product lines on pages 9-11. You can save up to 10% off market prices on Texas Instruments products. If you prefer savings closer to 20%, then select our Mixed Major



Brands. We have placed each side-by-side, so it's easier for you to compare.

If you need to make a spot buy, we also offer many terrific deals! Be sure to consider our special offers, especially those at the bottom of the power supply pages 112-138. You can save up to 70% off the manufacturer's list price on new products.

Not convinced you'll save more at Jameco? Then go to pages 235 & 236. You'll find dozens and dozens of price comparisons, just like those on the front cover. Each was compared on March 19, 2004 to help further illustrate how much you can save when shopping at Jameco.

For even more price comparisons, be sure to check out page 3. We're here to save you money, and we guarantee it!

The Latest Thing in Wall Adaptors: Slim Is In!

New



Now you can power your products with an innovative new design in wall adaptors! These small, lightweight, efficient switching power supplies are designed with both convenience and customer satisfaction in mind. They're oriented horizontally, so they take up only a single AC plug in a wall plate or power strip. Plus, they feature built-in regulation and are designed to handle a range of input voltages from 100 to 240 VAC.

Private Labeling

When you place your order for 500 or more, we can private-label the above wall adaptors for you at no extra charge. Branding them with your company name and phone number will give them a more professional finish. You won't find a lower price on a switching wall adaptor, and in this space-saving, customer-friendly format, these small wonders are a powerful bargain you should not pass up!



New Motors and Solenoids

When you think motors, think Jameco! We're constantly adding new categories and families of motors and solenoids to bring our customers the greatest possible selection at the very best prices, in large or small quantities.

In this catalog, we've rounded out our line in three key categories: DC gearhead motors, vibrator motors and solenoids. And remember, all of our motors are in-stock and available off-the-shelf. There's no need for an expensive custom design or a massive stocking order for your prototypes.

With this new, broader line, we're ready to meet the motor-related needs of everyone from individual experimenters to large manufacturers. And with our unmatched tech support and product management teams at work for you, rest assured that when it comes to motors, if we don't have it, we can get it!

For details see pages 87-91.

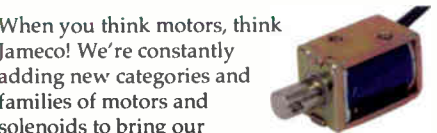

Take Your PIC! Announcing the Broadest Line of Microcontrollers We've Ever Offered!

You asked for more PIC MCUs, and we heard you loud and clear! In this catalog, we've added 150 more microcontrollers from Microchip, the #1 MCU supplier in the world. Our experts have improved this newly-expanded area to provide a versatile foundation for your designs, including the most-needed components with the most-requested features!

We'll continue adding new MCUs with each new catalog, with the goal of bringing



you toll-free, one-stop access to all the microcontrollers you need. That means more

Expanded line on pages 6-8.

flash-memory MCUs, more package varieties, and a wider range of features and capabilities. And as always, Jameco provides unparalleled tech support, 99% in-stock inventory, and our low-price

guarantee to ensure that our customers always get the best deal on the best products.

MICROCHIP

There's a New Look to Logic at Jameco!

Take a look at the new way we're presenting our extensive line of HC and HCT logic products, and we think you'll like what you see!

First, we've combined the entire range of surface mount and DIP products into a single, more convenient listing format. Second, you'll see that all products are cross-referenced to allow you to match any chip we offer with an equivalent IC from another manufacturer. But the biggest change can be summed up in two big letters: TI!

Jameco is proud to add a great line from Texas Instruments to our product portfolio, and we've made this new addition in a special way that's focused on you, the customer. For every selection, we'll present two pin-for-pin compatible choices: one will be from TI, and the other from a group



of specific major manufacturers. So, when you need to ensure a specific manufacturer for your BOM, or to comply with your approved vendor list, you can now choose the standard-setting quality of a world-trusted brand like TI. And when value is your primary need, you can choose

our corresponding Mixed Major Brands product for even greater savings.

With either choice, whether from TI or our Mixed Major Brands equivalents, you can

be assured that you're getting the best price, superior service, and in-stock availability from Jameco. And with each new catalog, you'll notice that we're adding even more

new families of components to better meet your needs!

HC and HCT line on pages 9-11.

Now, Tune Into NTE's Top 200 Greatest Hits!

When you think of replacement semiconductors, you naturally think of NTE. And now, Jameco Electronics is proud to provide the top 200 NTE products, all in-stock and at unbeatable prices!

As an authorized NTE franchise distributor, you have a direct line to this outstanding provider of high-quality, broad-tolerance components. Whatever your application, this top 200 listing of logic and linear ICs, voltage regulators, transistors, rectifiers, diodes,



thermal fuses and other popular components will meet your need for a one-stop, ready-to-ship resource. And if by chance you don't find what you need, a Jameco representative is a phone call away at 1-800-831-4242 to hook you up with the full line of quality NTE products.

New, offered on pages 24-25.



Be sure to watch this space! In the next Jameco catalog, we'll be more than doubling this popular line to include the top 500 most wanted NTE components!

Great Deals & Late Additions.....235-237

Semiconductors4-25

Analog, Discretes, Linear, Logic, Memory, MCUs, etc.

Electronic Design.....26-34

Programmable, Prototyping Systems, Breadboards, etc.

Optos & Illumination.....35-42

Optoelectronic Components, LEDs, Lamps, Displays, etc.

Passives.....43-55

Caps, Resistors, Potentiometers, Inductors, Crystals, etc.

Wire & Cable56-69

Bulk Wire & Cable, Assemblies, Wire & Cable Management, etc.

Interconnects70-85

Adapters, Connectors, Terminal Blocks, Sockets, etc.

Electromechanical.....86-111

Motors, Switches, Relays, Fans, Knobs, etc.

Power Products112-155

Switching Power Supplies, Wall Adapters, Batteries, etc.

Computer Products.....156-172

Cards, Storage, Memory, Motherboards, Networking, etc.

Security173-175

Cameras, Monitors, Video Capture, etc.

Test, Tools & Supplies.....176-214

Test & Measurement, Tools, Soldering Equipment, etc.

Educational & Hobbyist215-228

Robotics, Solar, Educational Kits, Books, etc.

Order Info, Order Form, Product & Manufacturer Indices 229-234

PRICES

Prices are effective 4-19-04. Prices and discounts are subject to change without notice.

Committed to Convenience and Availability

Our Low-Price Guarantee Doesn't Get Much Use...

... and we like it that way! But it is offered for a good reason. We take our pricing and product sourcing seriously, searching around the world to identify sources for the lowest prices and highest quality products.



Help Avoid Duplicate Catalogs



While we don't intend to send multiple catalogs to the same person, on occasion we do make mistakes. If you're incorrectly receiving multiple catalogs, please visit our web site at www.Jameco.com/DupCats and

we'll remove the duplicates. Alternatively, you can mail the duplicate back-covers/mailing label(s) to us:

Jameco Electronics - Duplicate Catalogs
1355 Shoreway Rd., Belmont, CA 94002

Open an Account Today!

It's easy to open an account at Jameco. Simply call us and we'll take the information over the phone or visit www.Jameco.com. If it's more convenient, we can fax you a credit application right away. And don't worry about delays. Most applications are processed within minutes.



Just in Time Fast Delivery – Get It at Jameco

Take advantage of our "Just In Time" fast delivery. Jameco has stocking levels that guarantee 99% in-stock availability, without the exceptions others may impose. Place your order any business day before 6:00 PM EST, and you can be assured your order is on its way that day!



We've Added Resources

Many of the products we offer have free technical documents online, so you don't have to wait for snail mail. And in addition to placing orders on the web, you can also request RMAs. For more information visit www.Jameco.com today!

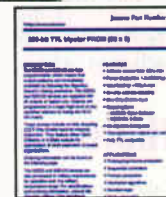

Find Products and Savings Faster!

Looking for great savings or new products? Our simplified legend helps you identify both quickly and easily, and now you can see which prices we reduced since the last catalog!

Find New Savings Faster

We're proud to show you our latest price reductions. You'll find nearly 700 prices reduced from our previous catalog just by looking for the **orange** prices in this catalog.

Jameco Price Reductions Are Substantial!

Rest assured your savings are not just numerous, they're significant too! Look for former first column prices slashed out to the left.

Save with Quantity Discounts

Quantity SAVE Buy in quantity and save! Corporate buyers will especially appreciate savings up to 54% off single unit prices. Look for products highlighted in **green**.

Save on Sale Items!

Sale products are highlighted in **yellow**, so you can identify items whose prices have been reduced in all quantities for a limited time.

Find New Products Quickly

New Look for the part numbers in **magenta**. We've expanded our IC and motor selections, as well as hundreds of other products.

Last Chance Opportunities

Unfortunately we're not always able to restock certain hard-to-find products. In this case we'll print **blue** part numbers, so if we know there's limited stock, you'll also know.

Out-Of-Production Products

Some products are no longer produced, and yet we know you need them. That's why we occasionally offer pulled or refurbished products. Pulled part numbers are clearly printed in **purple** and refurbished in **brown**. Each is backed by our standard Jameco warranty.



Part No.	Description	1	10	100	1000
152741CA	Straight header	\$45	\$30	\$35	\$29
152752CA	Right angle header	55	35	40	35
152753CA	Single w/ notch	45	37	32	16

Part No.	Description	1	10	25
190718CA	33-key PS/2	\$49.95	\$44.95	\$38.95
114086CA	64-key AT	59.95	49.95	38.95

Part No.	Description	1	10
156705	Shielding material	\$64.95	\$42.95
136814	Shielding tape	4.95	4.49
134831	Replacement sponge	2.99	2.00

Part No.	Product No.	Qty	Description	1	10
14072	1407	10	Quad 2 input NOR gate	\$1.49	\$1.29
13824	1382	10	Quad 2 input NOR gate	19	14
14421	1442	10	Hex inverter (CMOS)	39	35

Part No.	Product No.
182991	RMH08LP

Part No.	Product No.
155643	DC603F1

Part No.	Product No.
25101	MC146818

Part No.	Product No.
121232	AW10D1GA

Contact Information

Order Desk 24/7, 365 Days a Year

Phone: 1-800-831-4242

Fax: 1-800-237-6948

E-mail: sales@jameco.com

Website www.Jameco.com

International Order Desk

Phone: 650-592-8097

Fax: 650-592-2503

E-mail: international@jameco.com

Technical Support

Phone: 1-800-831-4242

E-mail: tech@jameco.com

Customer Service

Phone: 1-800-831-4242

E-mail: custservice@jameco.com

Credit Department

Phone: 650-592-8097

E-mail: credit@jameco.com

International Toll-Free Fax

Columbia: 980-9-136748

Mexico: 001-800-593-1449

Indonesia: 1-803-015-237-6948

Brazil: 000-817-455-6119

New Zealand: 080-044-0470

Jameco Electronics is a trademark of James Electronics, LTD.
Other product names and logos are used for identification purposes only and are trademarks of their respective companies.
©2004 James Electronics. All rights reserved.

Check Out These Sample Price Comparisons*

Product Description	Jameco Part No.	Jameco Page #	Jameco Price	Digi-Key Corp.	Mouser Electronics	Newark InOne	Minimum Savings
PIC, PIC12C509-04/P, DIP	144258CL	6	\$1.49	\$2.28	\$1.59	\$2.29	6.3%
Logic, 74AC244, DIP	211908CL	14	\$3.30	\$0.50	\$0.77	\$0.63	40.0%
Logic, 74AHC374, DIP	214210CL	14	\$2.26	\$0.50	\$0.49	\$0.40	35.0%
Logic, 74ALS240A, DIP	245753CL	14	\$3.39	\$0.64	\$0.80	\$0.48	18.8%
Logic, 74HCT240, DIP	45014CL	11	\$2.21	\$0.50	\$0.39	—	46.1%
TI logic, SN74HCT240N, DIP	250827CL	11	\$3.35	\$0.50	\$0.39	—	10.3%
Linear, LM317LM, SOIC	193551CL	16	\$2.22	\$0.72	\$0.53	\$0.64	58.3%
EEPROM, 93C46, DIP	102058CL	4	\$3.35	\$0.43	\$0.39	\$0.45	10.2%
MOSFET, IRF830	210585CL	22	\$7.77	\$1.50	\$1.06	\$1.50	27.4%
Ligitek LSD5111-11, 7-Seg LED	199531CL	40	\$9.99	\$2.31	\$4.05	—	57.1%
MOC3010 Opto-isolator	26278CL	35	\$4.49	\$0.87	\$0.87	\$0.836	41.3%
P6KE16CA Trans. Volt. Sup.	255935CL	22	\$2.25	\$0.44	\$0.30	\$0.48	16.7%
Cap, Tantalum, 10uF, 10V	87020CL	43	\$5.50	\$0.73	\$0.79	\$0.80	31.5%
Cap, Elect, 470uF, 63V, Radial	158465CL	44	\$3.30	\$1.50	\$1.23	\$0.92	67.3%
Cermet Pot, 50k, 3362P-503	254027CL	51	\$5.59	\$0.83	\$0.83	\$0.81	27.1%
Molex plug, 03-06-2044	224514CL	72	\$3.39	\$0.54	\$0.52	—	25.0%
Term Block, 12 pos, 10mm	215028CL	83	\$1.89	\$8.64	\$4.53	\$4.57	58.3%
DC Fan, 43CFM, 12VDC, 3.15"	172460CL	109	\$9.95	\$13.08	\$11.15	—	10.8%
Switcher, Mean Well, 150W	123393CL	117	\$69.95	\$169.14	\$154.13	—	54.6%
Coax Cable, 6', BNCM, 50Ω	256760CL	81	\$12.19	\$13.21	\$15.79	\$20.66	7.7%

* These are single unit prices taken from each party's website on March 19, 2004 and do not include shipping & handling charges, volume discounts or any other discounts. Pricing does fluctuate, so please be sure to check when making purchases.

Just Added! Over 1,300 New Products!

Product Line	Page #
Integrated Circuits	
Interface	15
Linear	17-20
Logic	9-11, 14
Microcontrollers	5-8
Microchip PIC	6-8, 237
NTE Replacements	24-25
Texas Instruments	9-11
Voltage Regulators	17
Semiconductors	
Diodes	22-25
Rectifiers	23, 25
Transistors	20-22, 24-25
Batteries	154-155, 237
Connectors	82
Knobs	106
LEDs	38
Motors & Solenoids	91
Potentiometers	48-51
Prototyping Boards	30
Soldering Equipment	211-213
Tools	179-180, 182-183
Wall Adapters	147

Yes! Both the Lowest Prices & Great Service.

You're probably aware of companies that advertise a few low prices, and you probably know of companies that purport to offer the best service levels. But in most cases you must choose between service and savings.

At Jameco, we take a different approach. We strive to provide you with the best of both worlds by offering a truly unique combination of the lowest prices and great service.



Save with the Lowest Prices...

Whether you need a name brand product or a generic equivalent, Jameco is committed to helping you save money. Look for the items with **orange** prices throughout this catalog

Part No.	Description	1	10	100	1000
152741CA	Straight header	\$.45	\$.39	\$.35	\$.29
152752CA	Right angle header	.45	.39	.35	.29
152733CA	Single w/ latch	.43	.37	.22	.16

which means their prices have been reduced. Nearly 700 items have been lowered since we published our previous catalog just three months ago.

We truly stand behind our efforts to provide the best price. That's why long ago we instituted our Low-Price Guarantee. So if you manage to find a print ad with a lower price, just give us a call with the information. Our sales representatives will be happy to

adjust the price, and they'll be sure to communicate the information to our pricing specialists. Be sure to look below at some of the price comparisons we have found. All were updated on March 19, 2004.

Of course, another company may lower a few of their printed prices after we publish our catalog. Rest assured we'll still honor our low-price guarantee!

...And Great Service

We're also committed to providing the best service in the industry. With Jameco, you can place your order anytime of day or night by phone, fax, web or email. Orders placed by 6 PM EST will ship out the same business day, so you can have your products tomorrow. And since



over 99% of our products are in stock, backorders are few and far between.

Frequent buyers can benefit even more. We'll assign a personal rep who understands your needs, product requirements, logistical issues and more. Our customers have told us this personalized service saves them time, reduces costs and eliminates the headaches they have experienced elsewhere. We think you'll appreciate it too.

You'll also find a host of other valuable services available throughout this catalog and our website. For instance, detailed manufacturer's specifications for most of our products are at www.Jameco.com, and the download is FREE. Use it today and bookmark it for tomorrow!

Call for pricing on quantities over 100 - we carry major manufacturers. We will special order any IC - \$100 minimum.

EPROM



Part No.	Cross Ref.	Pkg.	Description	1	10	100
39706CL	2708	DIP-24	1k x 8 450ns (±5V, +12V)	\$4.95	\$4.25	\$3.19
40002CL	2716	DIP-24	2k x 8 450ns (25V)	3.99	3.59	3.19
39706CL	27C16	DIP-24	2k x 8 450ns (25V) CMOS	7.25	6.55	5.99
40011CL	2716-1	DIP-24	2k x 8 350ns (25V)	6.49	5.89	5.39
40096CL	2732	DIP-24	4k x 8 450ns (25V)	6.49	5.49	4.10
39765CL	27C32	DIP-24	4k x 8 450ns (25V) CMOS	5.49	4.15	2.89
40133CL	2732A-45	DIP-24	4k x 8 450ns (21V)	3.99	3.69	3.29
33591CL	TMS2532A	DIP-24	4k x 8 450ns (21V)	3.95	3.55	3.19
114876CL	2732B	DIP-24	4k x 8 450ns (12.5V)	4.15	3.75	3.39
40125CL	2732A-25	DIP-24	4k x 8 250ns (21V)	4.99	4.49	3.99
40109CL	2732A-20	DIP-24	4k x 8 200ns (21V)	6.49	5.99	5.49
40205CL	2764-25	DIP-28	8k x 8 250ns (21V)	5.25	4.75	4.25
40248CL	2764A-25	DIP-28	8k x 8 250ns (12.5V)	3.49	3.15	2.85
39845CL	27C64-25	DIP-28	8k x 8 250ns (12.5V) CMOS	4.49	4.09	3.79
40192CL	2764-20	DIP-28	8k x 8 200ns (21V)	5.25	4.75	4.25
40230CL	2764A-20	DIP-28	8k x 8 200ns (12.5V)	4.49	4.05	3.65
74608CL	27C64-20	DIP-28	8k x 8 200ns (12.5V) CMOS	4.69	4.29	3.79
39829CL	27C64-15	DIP-28	8k x 8 150ns (12.5V) CMOS	3.79	3.49	2.99
105304CL	27C64-12	DIP-28	8k x 8 120ns (12.5V) CMOS	6.49	5.99	5.49
39933CL	27128-25	DIP-28	16k x 8 250ns (21V)	5.95	5.09	3.85
39984CL	27128A-25	DIP-28	16k x 8 250ns (12.5V)	4.49	4.05	3.69
39685CL	27C128-25	DIP-28	16k x 8 250ns (12.5V) CMOS	3.99	3.59	3.25
39688CL	27128A-20	DIP-28	16k x 8 200ns (12.5V)	4.69	4.19	3.79
101101CL	27C128-20	DIP-28	16k x 8 200ns (12.5V) CMOS	4.69	4.29	3.79
39950CL	27128A-15	DIP-28	16k x 8 150ns (12.5V)	4.49	3.95	3.55
39677CL	27C128-15	DIP-28	16k x 8 150ns (12.5V) CMOS	4.29	3.85	3.45
87935CL	27C128-12	DIP-28	16k x 8 120ns (12.5V) CMOS	4.49	3.99	3.59
40061CL	27256-25	DIP-28	32k x 8 250ns (12.5V)	3.15	2.95	2.65
39731CL	27C256-25	DIP-28	32k x 8 250ns (12.5V) CMOS	3.15	2.95	2.65
40045CL	27256-20	DIP-28	32k x 8 200ns (12.5V)	3.75	3.35	3.05
39722CL	27C256-20	DIP-28	32k x 8 200ns (12.5V) CMOS	2.59	2.49	2.19
40037CL	27256-15	DIP-28	32k x 8 150ns (12.5V)	3.25	3.09	2.75
39714CL	27C256-15	DIP-28	32k x 8 150ns (12.5V) CMOS	2.05	1.75	1.55
65904CL	27C256-12	DIP-28	32k x 8 120ns (12.5V) CMOS	2.05	1.90	1.75
112740CL	27C256-10	DIP-28	32k x 8 100ns (12.5V) CMOS	3.35	3.15	2.85
140476CL	27C256-70	DIP-28	32k x 8 70ns (12.5V) CMOS	3.59	3.39	3.09
40168CL	27512-25	DIP-28	64k x 8 250ns (12.5V)	3.79	3.45	3.15
39802CL	27C512-25	DIP-28	64k x 8 250ns (12.5V) CMOS	4.75	4.39	3.95
40150CL	27512-20	DIP-28	64k x 8 200ns (12.5V)	2.75	2.45	2.25
39790CL	27C512-20	DIP-28	64k x 8 200ns (12.5V) CMOS	3.15	2.95	2.65
39781CL	27C512-15	DIP-28	64k x 8 150ns (12.5V) CMOS	2.09	1.99	1.79
39773CL	27C512-12	DIP-28	64k x 8 120ns (12.5V) CMOS	2.09	1.79	1.49
131959CL	27C512-10	DIP-28	64k x 8 100ns (12.5V) CMOS	3.39	3.15	2.85
175206CL	27C512-90	DIP-28	64k x 8 90ns (12.5V) CMOS	\$2.45	2.29	2.09
203625CL	27C512-70	DIP-28	64k x 8 70ns (12.5V) CMOS	2.89	2.49	1.89
203617CL	27C512-45	DIP-28	64k x 8 45ns (12.5V) CMOS	4.09	3.79	3.49
118148CL	27C1024-15	DIP-40	64k x 16 150ns (12.5V) CMOS	5.69	5.25	4.79
203641CL	27C1024-12	DIP-40	64k x 16 120ns (12.5V) CMOS	\$6.05	5.29	4.59
203633CL	27C1024-80	DIP-40	64k x 16 80ns (12.5V) CMOS	4.99	4.49	3.99
39669CL	27C010-20	DIP-32	128k x 8 200ns (12.5V) CMOS	\$2.89	2.39	1.99
39651CL	27C010-15	DIP-32	128k x 8 150ns (12.5V) CMOS	2.59	2.19	1.89
74624CL	27C010-12	DIP-32	128k x 8 120ns (12.5V) CMOS	\$2.89	3.59	2.79
79231CL	27C010-10	DIP-32	128k x 8 100ns (12.5V) CMOS	\$4.09	3.49	2.97
137699CL	27C010-80	DIP-32	128k x 8 80ns (12.5V) CMOS	5.12	4.61	4.09
146149CL	27C010-70	DIP-32	128k x 8 70ns (12.5V) CMOS	2.39	2.15	2.05
137701CL	27C010-45	DIP-32	128k x 8 45ns (12.5V) CMOS	\$6.09	5.39	4.99
65681CL	27C020-20	DIP-32	256k x 8 200ns (12.5V) CMOS	5.63	5.22	4.71
65699CL	27C020-15	DIP-32	256k x 8 150ns (12.5V) CMOS	\$6.63	5.29	4.99
78852CL	27C020-12	DIP-32	256k x 8 120ns (12.5V) CMOS	\$6.63	5.29	4.89
156267CL	27C020-10	DIP-32	256k x 8 100ns (12.5V) CMOS	\$6.63	3.85	3.49
203650CL	27C020-80	DIP-32	256k x 8 80ns (12.5V) CMOS	7.15	6.09	4.59
127933CL	27C04096-12	DIP-40	256k x 16 120ns (12.5V) CMOS	9.22	8.60	7.85
85462CL	27C040-15	DIP-32	512k x 8 150ns (12.5V) CMOS	6.59	6.09	5.59
102293CL	27C040-12	DIP-32	512k x 8 120ns (12.5V) CMOS	6.59	6.09	5.59
111780CL	27C040-10	DIP-32	512k x 8 100ns (12.5V) CMOS	6.92	6.41	5.90
203676CL	27C040-80	DIP-32	512k x 8 80ns (12.5V) CMOS	7.15	6.45	5.90
203668CL	27C040-45	DIP-32	512k x 8 45ns (12.5V) CMOS	\$12.29	12.65	10.75

EPROM (Continued)



Part No.	Cross Ref.	Pkg.	Description	1	10	100
140003CL	27C080-12	DIP-32	1M x 8 120ns (12.5V) CMOS	\$12.99	\$11.99	\$10.99
156273CL	27C080-10	DIP-32	1M x 8 100ns (12.5V) CMOS	12.91	10.97	8.23
203684CL	27C080-90	DIP-32	1M x 8 90ns (12.5V) CMOS	12.91	11.99	10.96
156283CL	27C160-10	DIP-42	2M x 8 100ns (12.5V) CMOS	20.45	18.95	17.31

See EPROM programmers and erasers on pages 26 & 27

EPROM Accessories

Part No.	Cross Ref.	Description	1	5
206922CL	EP1D	1.1" x 0.46" EPROM & DIP window labels UV opaque, accepts ink or pencil (168 labels per pack)	\$6.95	\$5.95
13864CL	CF2	Conductive foam (12" x 24" x .25") hard black	7.95	6.95
66042CL	DE1	UVP portable EPROM eraser, pg 28	\$64.95	44.95
15712CL	DE4	8-chip UV-EPROM eraser, pg 28	119.95	109.95

EEPROM



Part No.	Cross Ref.	Pkg.	Description	1	10	100
200627CL	24C44	DIP-8	16 x 16 Serial (CMOS)	\$	\$1.29	\$
102058CL	93C46	DIP-8	64 x 16 Serial (5V)	\$.35	.30
108855CL	93C56	DIP-8	128 x 16 Serial (5V)	\$.47	.37
108839CL	24C02P	DIP-8	256 x 8 Serial (CMOS)	\$.79	.43
200598CL	93C66	DIP-8	256 x 16 Serial (5V)	.69	.62	.55
108847CL	24C04P	DIP-8	512 x 8 Serial (CMOS)	.89	.79	.69
200547CL	24C08-10	DIP-8	1k x 8 Serial (CMOS)	\$.77	.77
200601CL	93C86	DIP-8	1k x 16 Serial (5V)	\$1.39	.71	.71
200555CL	24C16-10	DIP-8	2k x 8 Serial (CMOS)	1.19	1.05	.79
74691CL	28C16A-25	DIP-24	2k x 8 250ns (5V) CMOS	3.99	3.69	3.39
40416CL	2817A-25	DIP-28	2k x 8 250ns 5V read/write	7.95	7.15	6.49
200563CL	24C32-10	DIP-8	4k x 8 Serial (CMOS)	1.79	1.69	1.39
200619CL	24C65	DIP-8	8k x 8 Serial (CMOS)	1.89	1.69	1.49
74827CL	28C64A-25	DIP-28	8k x 8 250ns (5V) CMOS	4.49	4.05	3.65
40475CL	2865A	DIP-28	8k x 8 250ns 5V read/write	4.95	4.49	4.05
200571CL	24C128-10	DIP-8	16k x 8 Serial (CMOS)	\$2.75	1.79	1.49
200580CL	24C256-10	DIP-8	32k x 8 Serial (CMOS)	2.19	2.39	2.15
74878CL	28C256-25	DIP-28	32k x 8 250ns CMOS	8.75	7.45	5.59
74843CL	28C256-15	DIP-28	32k x 8 150ns CMOS	8.89	8.89	8.19
242253CL	28C010-15	DIP-32	128k x 8 150ns (5V) CMOS	29.41	28.00	27.00

OTP/PROM

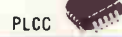

Part No.	Cross Ref.	Pkg.	Description	1	10	100
48531CL	74S188	DIP-16	32 x 8 Open collector (27S18)	\$4.35	\$3.91	\$3.19
48717CL	74S288	DIP-16	32 x 8 Tri-st. (27S19/TBP18S030N)	\$7.95	6.99	6.00
27844CL	N82S23	DIP-16	32 x 8 PROM (OC) (27S18)	5.95	5.39	4.85
27764CL	N82S123	DIP-16	32 x 8 PROM tri-state (27S19)	8.95	8.50	8.09
48696CL	74S287	DIP-16	256 x 4 Tri-state (TBP24S10N)	6.95	6.25	5.65
48805CL	74S387	DIP-16	256 x 4 Open collector (TBP24A10N)	4.29	3.89	3.59
27772CL	N82S126	DIP-16	256 x 4 PROM (OC) (27S20)	10.95	10.39	9.85
27781CL	N82S129	DIP-16	256 x 4 PROM tri-state (27S21)	7.95	6.95	6.25
48910CL	74S571	DIP-16	512 x 4 Tri-state (27S13)	\$6.99	5.69	5.49
27799CL	N82S131	DIP-16	512 x 4 PROM tri-state (27S13)	7.99	6.99	5.99
48928CL	74S573	DIP-18	1k x 4 Tri-state (27S33)	3.55	3.15	2.83
27801CL	N82S137	DIP-18	1k x 4 PROM tri-state (27S33)	4.95	4.25	3.19
27810CL	N82S181	DIP-24	1k x 8 Bipolar PROM tri-state	6.95	5.95	5.39
27828CL	N82S185	DIP-18	2k x 4 PROM tri-state	\$4.99	4.74	3.77
27836CL	N82S191	DIP-24	2k x 8 PROM tri-state	6.95	6.25	5.65
203730CL	27C512-10 PLCC	PLCC-32	64k x 8 100ns (12.5V) CMOS	2.08	1.79	1.59
203692CL	27C512-12 OTP	DIP-28	64k x 8 100ns (12.5V) CMOS	2.25	1.89	1.79
203705CL	27C010-10 OTP	DIP-32	128k x 8 100ns (12.5V) CMOS	2.55	2.19	1.65
203748CL	27C010-10 PLCC	PLCC-32	128k x 8 100ns (12.5V) CMOS	\$2.99	2.79	2.39
203713CL	27C020-10 OTP	DIP-32	256k x 8 100ns (12.5V) CMOS	3.99	3.39	2.54
203756CL	27C020-10 PLCC	PLCC-32	256k x 8 100ns (12.5V) CMOS	3.79	3.22	2.42
203764CL	27C040-10 PLCC	PLCC-32	512k x 8 100ns (12.5V) CMOS	5.49	4.67	3.50
203721CL	27C040-12 OTP	DIP-32	512k x 8 100ns (12.5V) CMOS	\$6.99	5.12	3.99

30-Day Money-Back Guarantee

Call for pricing on quantities over 100 - we carry major manufacturers.

We will special order any IC - \$100 minimum.

Flash Memory

Part No.	Cross Ref.	Pkg.	Description	DIP		
				1	10	100
242552CL	29C512-12	DIP-32	64k x 8 120ns (5V) CMOS	\$4.59	\$3.69	\$3.19
242561CL	29F512-90	DIP-32	64k x 8 90ns (5V) CMOS	4.70	3.80	3.36
242579CL	29F512-70	DIP-32	64k x 8 70ns (5V) CMOS	6.31	4.39	4.39
74771CL	28F010-15	DIP-32	128k x 8 150ns (12V) CMOS	6.95	6.25	5.65
242587CL	29F010-120	DIP-32	128k x 8 120ns (5V) CMOS	2.59	2.49	2.19
242595CL	29F010-90	DIP-32	128k x 8 90ns (5V) CMOS	4.39	4.09	3.79
242608CL	29F010-70	DIP-32	128k x 8 70ns (5V) CMOS	6.09	4.99	4.49
74835CL	28F020-15	DIP-32	256k x 8 150ns (12V) CMOS	7.95	7.15	6.45
242616CL	29F020-12	DIP-32	256k x 8 120ns (5V) CMOS	6.19	4.79	4.49
242624CL	29F020-90	DIP-32	256k x 8 90ns (5V) CMOS	8.69	6.99	6.09
242659CL	29F040-120	DIP-32	512k x 8 120ns (5V) CMOS	11.79	8.69	7.99
242667CL	29F040-90	DIP-32	512k x 8 90ns (5V) CMOS	11.79	7.19	6.79

Dynamic and Video RAM

Part No.	Cross Ref.	Pkg.	Description	DIP			SDJ		
				1	10	100	1	10	100
41339CL	4116-15	DIP-16	16k x 1 150ns (MM5290J-1R)	\$9.99	\$8.99	\$8.80			
41662CL	4164-150	DIP-16	64k x 4 150ns (MCM6665-15)	59	53	48			
41574CL	41464-10	DIP-18	64k x 4 100ns (HY53C464S-10)	1.69	1.65	1.59			
41427CL	41256-150	DIP-16	256k x 1 150ns (P21256-15)	69	59	49			
41398CL	41256-120	DIP-16	256k x 1 120ns (MB81256-12)	73	65	59			
42315CL	514256P-80	DIP-20	256k x 4 80ns (UPD424256-80)	2.49	2.25	2.05			
93374CL	514256P-70	DIP-20	256k x 4 70ns (TC514256P-70)	2.79	2.49	2.19			
128688CL	HM514260	SOJ	256k x 16 70ns	3.39	2.89	2.19			
42219CL	511000P-10	DIP-18	1M x 1 100ns (M5M4C1000-10)	2.25	1.99	1.79			

Static RAM

Part No.	Cross Ref.	Pkg.	Description	DIP		
				1	10	100
38931CL	2111-1	DIP-18	256 x 4 500ns (AM9111APC)	\$1.89	\$1.39	\$1.49
42198CL	5101	DIP-22	256 x 4 450ns (CMOS)	7.99	7.19	6.49
38957CL	2114N	DIP-18	1k x 4 450ns (91148PC)	2.29	1.99	1.79
43238CL	6514	DIP-18	1k x 4 350ns CMOS (M58981P)	3.95	3.65	3.35
38973CL	2114N-2	DIP-18	1k x 4 200ns (9114EPC) (U214D20)	2.29	2.09	1.89
38981CL	2114N-2L	DIP-18	1k x 4 200ns low power	2.29	2.09	1.89
243475CL	MBM104174A-10	DIP-24	1k x 4 10ns ECL asynchronous	3.49	2.99	2.49
38746CL	2016-20	DIP-24	2k x 8 200ns (MB8128-20)	3.39	2.89	2.49
114260CL	OS1220Y-150	DIP-24	2k x 8 150ns, 4.25V WP	11.95	10.95	9.85
25911CL	MK48202B-15	DIP-24	2k x 8 150ns (16kB) zero-power RAM	50.99	38.99	33.99
42809CL	6116P-3	DIP-24	2k x 8 150ns (16kB) CMOS	1.39	1.29	1.19
42753CL	6116LP-3	DIP-24	2k x 8 150ns (16kB) LP CMOS	1.95	1.75	1.59
38738CL	2016-12	DIP-24	2k x 8 120ns (AM9128-12)	1.42	1.25	1.19
42796CL	6116P-2	DIP-24	2k x 8 120ns (16kB) CMOS	1.59	1.39	1.29
42788CL	6116P-1	DIP-24	2k x 8 100ns (16kB) CMOS	1.48	1.49	1.38
42737CL	6116LP-1	DIP-24	2k x 8 100ns (16kB) LP CMOS	1.39	1.29	1.28
242675CL	6116-70	DIP-24	2k x 8 70ns (5V) CMOS async.	2.09	1.99	1.89
242683CL	CY7C128A-45	DIP-24	2k x 8 45ns (5V) CMOS async.	3.39	3.19	2.99
242691CL	CY7C128A-35	DIP-24	2k x 8 35ns (5V) CMOS async.	4.59	3.79	3.38
242704CL	CY7C128A-25	DIP-24	2k x 8 25ns (5V) CMOS async.	4.69	3.79	2.99
242712CL	CY7C128A-15	DIP-24	2k x 8 15ns (5V) CMOS async.	5.19	4.19	3.19
114307CL	DS1225Y-200	DIP-28	8k x 8 200ns, 4.25V WP	15.95	14.49	11.65
114278CL	DS1225AB-150	DIP-28	8k x 8 150ns, 4.62V WP	17.29	14.49	9.89
42930CL	6264P-12	DIP-28	8k x 8 120ns (64kB) CMOS	2.65	2.09	1.89
42892CL	6264LP-12	DIP-28	8k x 8 120ns (64kB) LP CMOS	2.79	2.49	2.19
42921CL	6264P-10	DIP-28	8k x 8 100ns (64kB) CMOS	2.59	2.29	1.99
42884CL	6264LP-10	DIP-28	8k x 8 100ns (64kB) LP CMOS	2.75	2.49	2.25
85121CL	6264LP-70	DIP-28	8k x 8 70ns (64kB) LP CMOS	3.39	2.99	2.19
242721CL	6264-55	DIP-28	8k x 8 55ns (5V) CMOS async.	3.29	2.59	2.09
242333CL	CY7C185-35	DIP-28	8k x 8 35ns (5V) CMOS async.	3.39	2.99	1.99
242341CL	CY7C185-25	DIP-28	8k x 8 25ns (5V) CMOS async.	3.39	2.99	1.99
242350CL	7C185-20	DIP-28	8k x 8 20ns 5V asynchronous	2.89	2.29	1.79
114323CL	DS1230Y-150	DIP-28	32k x 8 150ns, 4.37V WP	19.95	18.95	15.15
41988CL	43256-12L	DIP-28	32k x 8 120ns low power (NEC)	4.99	4.49	4.09
42850CL	62256LP-12	DIP-28	32k x 8 120ns low power CMOS	3.89	3.49	3.19
177113CL	DS1230Y-100	DIP-28	32k x 8 100ns, 4.37V WP	21.95	17.75	12.85
41970CL	43256-10L	DIP-28	32k x 8 100ns low power (NEC)	5.49	4.99	4.49
42833CL	62256LP-10	DIP-28	32k x 8 100ns low power CMOS	4.19	3.89	3.59
82472CL	62256LP-70	DIP-28	32k x 8 70ns low power CMOS	5.49	4.99	4.49

Static RAM (Continued)

Part No.	Cross Ref.	Pkg.	Description	DIP		
				1	10	100
242499CL	DS1230Y-70	DIP-28	32k x 8 70ns nonvol. 4.5V WP	\$16.59	\$15.29	\$13.99
242376CL	7C199-35	DIP-28	32k x 8 35ns 5V asynchronous	1.99	1.59	1.19
75037CL	UM61M256K-15	DIP-28	32k x 8 15ns high speed CMOS (3W)	3.39	2.99	2.69
103982CL	628128LP-85	DIP-32	128k x 8 85ns low power CMOS	8.49	7.49	6.79
131810CL	628128LP-70	DIP-32	128k x 8 70ns low power CMOS	8.49	7.39	6.69
157358CL	628512LP-70	DIP-32	512k x 8 70ns low power CMOS	14.99	11.99	10.79

CPUs/MPUs

Part No.	Description	MHz	Socket	DIP		
				1	10	25
183118CL	Pentium III processor	600	Slot 1	\$159.95	\$153.79	\$147.49
183100CL	Pentium II processor	400	Slot 1	124.99	109.99	99.99
151651CL	Pentium II processor	300	Slot 1	109.99	99.99	89.99
190060CL	Pentium II processor w/ heat sink	233	Slot 1	89.95	79.95	72.95
150501CL	Pentium MMX processor	233	376/PGA	69.95	62.95	54.95
140054CL	Pentium MMX processor	200	376/PGA	23.35	21.25	19.29
196912CL	Pentium MMX processor	166	296/PGA	26.29	23.89	21.75
130841CL	Pentium processor	166	296/PGA	26.69	24.25	21.95
130833CL	Pentium processor	133	296/PGA	11.49	10.11	8.81
118421CL	486 speed doubler, 80486DX2	66	168/PGA	19.95	17.95	16.15
76531CL	Math coprocessor, 80387-25SX	25	68PLCC	27.95	22.20	21.15

Z80 Series

Part No.	Cross Ref.	Pkg.	MHz	Description	DIP		
					1	10	100
35561CL	Z80	DIP-40	2.5	CPU (MK3880N/780C)	\$1.39	\$1.19	\$1.09
35596CL	Z80A	DIP-40	4	CPU (MK3880N-4/780C-1)	1.99	1.79	1.59
35609CL	Z80A-CTC	DIP-28	4	Counter timer circuit (MK3882-4)	1.99	1.79	1.59
35625CL	Z80A-DART	DIP-40	4	Dual asynchronous receiver/transmitter	3.49	3.19	2.89
35641CL	Z80A-PIO	DIP-40	4	Parallel I/O interf. contr. (MK3881-4)	1.49	1.29	1.15
35668CL	Z80A-SIO/O	DIP-40	4	Serial I/O (TxCB & RxCB bond.) MK3884-4	2.19	1.79	1.59
35705CL	Z80B	DIP-40	6	CPU (MK3880N-6)	2.59	2.39	2.09
35781CL	Z84C00-4	DIP-40	4	CPU (Z84C0004PEC) CMOS	4.15	3.49	2.55
35799CL	Z8530	DIP-40	2	Serial communications controller	1.49	1.19	1.09

6500 Series/Commodore

Part No.	Cross Ref.	Pkg.	Description	DIP		
				1	10	100
43191CL	6502	DIP-40	MPU with internal clock (1MHz)	\$7.95	\$6.95	\$6.25
43166CL	65C02	DIP-40	MPU with internal clock (CMOS)	6.95	5.25	3.65
43254CL	6522	DIP-40	VIA (versatile interface adapter) 1MHz	2.39	2.15	1.94
43297CL	6532	DIP-40	128 x 8 RAM, I/O timer array	7.95	6.99	6.49
43318CL	6551	DIP-28	ACIA (asynch. comm. interface adptr)	3.95	3.49	3.15

6800/68000 Series

Part No.	Cross Ref.	Pkg.	Description	DIP			PLCC		
				1	10	100	1	10	100
43481CL	6800	DIP-40	8-bit MCU	\$6.95	\$5.25	\$3.65			
43502CL	6802	DIP-40	8-bit MPU with clock and RAM (1MHz)	8.50	7.65	6.89			
43529CL	6803	DIP-40	8-bit MCU with 128k RAM	7.79	6.99	6.29			
43537CL	MC6808	DIP-40	8-bit MPU with clock and 128k RAM	8.95	8.06	7.25			
43545CL	6809E	DIP-40	MPU with external clock (1MHz)	3.95	3.59	3.25			
43561CL	6810	DIP-24	128x8 static RAM (1MHz)	1.95	1.69	1.49			
43596CL	6821	DIP-40	Peripheral interface adapter (1MHz)	3.95	3.59	3.25			
43414CL	68B21	DIP-40	Peripheral interface adapter (2MHz)	4.95	4.49	4.05			
43617CL	6840	DIP-28	Programmable timer (1MHz)	2.49	2.25	1.99			
43633CL	6850	DIP-24	Asynch. comm. int. adapter (ACIA)	2.39	2.09	1.89			
25304CL	MC68000L8	DIP-64	MPU 16-bit (8MHz)	8.95	7.95	7.25			
25291CL	MC68000L10	DIP-64	MPU 16-bit (10MHz)	14.95	11.20	7.85			
25355CL	MC68701	DIP-40	8-bit EPROM MPU w/ 128B RAM & I/O	15.95	13.95	12.55			
25363CL	MC68705P3S	DIP-28	8-bit EPROM MPU w/ 112B RAM & I/O	24.95	22.95	20.65			
25371CL	MC68705U3S	DIP-40	8-bit EPROM MPU w/ 112B RAM & I/O	29.95	25.49	19.09			
248591CL	MC68HC11E0CFN2	PLCC-52	MCU w/ 512 EPROM & 38 I/O, A/D	10.95	9.85	8.87			
248604CL	MC68HC11E1CFN2	PLCC-52	MCU w/ 512 EPROM & 38 I/O, A/D	8.85	7.25	6.55			
191863CL	MC68HC11E1CP2	DIP-48	8-bit micro cntl. w/ A/D conv. (512B RAM)						

Microprocessors - Microcontrollers

Color Code Legend
New Sale Qty. Save Returnished Pull Closeout

Call for pricing on quantities over 100 - we carry major manufacturers. We will special order any IC - \$100 minimum.

6800/68000 Series (Continued)

Part No.	Cross Ref.	Pkg.	Description	1	10	100
248639CL	MC68HC7051ACDW	SOIC-20	MCU, OTP 1.2k ROM, 14 I/O	\$3.45	\$3.09	\$2.79
1089272CL	MC68HC705K1P	DIP-16	8-bit HCMOS MCU, 504B, OTPROM, 10 I/O tm	5.52	5.02	4.58
248612CL	MC68HC705P6ACP	DIP-28	MCU, OTP 4.5k ROM, 21 I/O A/D	3.95	2.75	2.49
248621CL	MC68HC705P6ADW	SOIC-28	MCU, OTP 4.5k ROM, 21 I/O A/D	3.95	2.75	2.49
248655CL	MC68HC705C9ACFN	PLCC-44	MCU, OTP 16k ROM, 31 I/O	11.75	10.55	9.50
248567CL	MC68HC711D3CFN2	PLCC-44	MCU, OTP 4k ROM, 26 I/O	10.75	9.69	8.71
248575CL	MC68HC711E9CFN2	PLCC-52	MCU, OTP 12k ROM, 38 I/O A/D	13.59	10.49	9.89
248356CL	MC68HC908GP32CP	DIP-40	MCU, flash 32k ROM, 33 I/O	12.69	11.39	10.29
248410CL	MC68HC908JB8ADW	SOIC-28	MCU, flash 8k ROM, 21 I/O USB	6.69	5.99	5.45
248401CL	MC68HC908JB8JP	DIP-20	MCU, flash 8k ROM, 37 I/O USB	5.49	5.45	4.65
248372CL	MC68HC908JK3CDW	SOIC-20	MCU, flash 4k ROM, 15 I/O	3.75	3.45	3.09
248364CL	MC68HC908JK3CP	DIP-20	MCU, flash 4k ROM, 15 I/O	3.75	3.45	3.09
248399CL	MC68HC908JL3CDW	SOIC-28	MCU, flash 4k ROM, 23 I/O, A/D	5.45	4.95	4.45
248381CL	MC68HC908JL3CP	DIP-28	MCU, flash 4k ROM, 23 I/O, A/D	4.55	4.35	3.95
248436CL	MC68HC908K3CDW	SOIC-16	MCU, flash 8k ROM, 13 I/O, A/D	6.29	5.69	5.15
248428CL	MC68HC908K3CP	DIP-16	MCU, flash 8k ROM, 13 I/O, A/D	5.65	5.45	5.05
248495CL	MC68HC908Q1CDW	SOIC-8	MCU, flash 1.5k ROM, 6 I/O	1.89	1.45	1.30
248487CL	MC68HC908Q1CP	DIP-8	MCU, flash 1.5k ROM, 6 I/O	1.89	1.45	1.30
248479CL	MC68HC908Q2CDW	SOIC-8	MCU, flash 1.5k ROM, 6 I/O, A/D	2.39	2.29	2.09
248461CL	MC68HC908Q2CP	DIP-8	MCU, flash 1.5k ROM, 6 I/O, A/D	2.85	2.55	2.29
248452CL	MC68HC908Q4CDW	SOIC-8	MCU, flash 4k ROM, 6 I/O, A/D	2.69	2.05	1.85
248444CL	MC68HC908Q4CP	DIP-8	MCU, flash 4k ROM, 6 I/O, A/D	2.69	1.65	1.43
248559CL	MC68HC908QY1CDT	TSSOP-16	MCU, flash 1.5k ROM, 14 I/O	2.49	2.39	2.19
248541CL	MC68HC908QY1CP	DIP-16	MCU, flash 1.5k ROM, 14 I/O	2.15	1.65	1.49
248532CL	MC68HC908QY2CDT	TSSOP-16	MCU, flash 1.5k ROM, 13 I/O, A/D	2.85	2.69	2.45
248524CL	MC68HC908QY2CP	DIP-16	MCU, flash 1.5k ROM, 13 I/O, A/D	2.55	1.95	1.75
248516CL	MC68HC908QY4CDW	TSSOP-16	MCU, flash 4k ROM, 13 I/O A/D	2.89	2.49	2.25
248508CL	MC68HC908QY4CP	DIP-16	MCU, flash 4k ROM, 13 I/O A/D	2.89	2.49	2.25

8000 Series

Part No.	Cross Ref.	Pkg.	Description	1	10	100
51844CL	8031	DIP-40	CPU with 128 x 8 RAM and I/O	\$3.29	\$2.99	\$2.69
51676CL	80C31	DIP-40	CPU with 128 x 8 RAM and I/O (CMOS)	3.39	2.89	2.19
102197CL	8032	DIP-40	8-bit MCU 256 x 8 RAM	3.95	3.59	3.25
108804CL	80C32-1	DIP-40	8-bit MCU 256 x 8 RAM (CMOS)	4.49	3.85	2.89
51861CL	8035	DIP-40	MPU 8-bit	3.95	3.59	3.25
51959CL	8039	DIP-40	CPU single chip 8-bit (128 bytes RAM)	4.49	3.99	3.59
51692CL	80C39	DIP-40	CPU sgle chip 8-bit (128 bytes RAM) CMOS	3.99	3.59	3.25
51983CL	8049*	DIP-40	CPU sgle chip 8-bit (can be used as 8039*)	1.95	1.75	1.59
51991CL	8051AP**	DIP-40	MCU w/128x8 RAM (book 161402CL, pg 228)	5.49	4.99	4.49
52003CL	8052AH**	DIP-40	CPU 8-bit 256 bytes RAM, tmr/countr & I/O	7.99	7.19	6.49
125647CL	80C52BASIC	DIP-40	CPU 8-bit CMOS w/ basic interpreter	32.09	28.89	25.99
52046CL	8080A	DIP-40	CPU 8-bit N-channel (1MHz)	4.49	3.95	3.59
52062CL	8085A	DIP-40	CPU 8-bit N-channel (3MHz)	4.99	4.25	3.19
52071CL	8085A-2	DIP-40	CPU 8-bit N-channel (5MHz)	5.49	4.99	4.49
51705CL	80C85	DIP-40	CPU 8-bit N-channel (3MHz)(CMOS)	6.95	5.95	4.45
52100CL	8086-2	DIP-40	CPU 16-bit (8MHz)	1.95	1.75	1.59
52142CL	8088	DIP-40	CPU 16-bit (8-bit data bus) 5MHz	2.49	2.25	1.99
52169CL	8088-2	DIP-40	CPU 16-bit (8-bit data bus) 8MHz	5.95	5.39	4.85
34358CL	UPD7D108-8	DIP-40	V20 chip (replaces the 8088-2) 8MHz	10.99	9.99	8.99
52290CL	8155	DIP-40	HMOS RAM I/O port/timer (3MHz)	4.49	3.39	2.39
52302CL	8155-2	DIP-40	HMOS RAM I/O port/timer (5MHz)	5.95	5.39	4.85
52193CL	81C55	DIP-40	256x8 RAM I/O port/tmr (CMOS) 3MHz	4.49	3.59	3.19
52329CL	8156	DIP-40	RAM with I/O port and timer	6.95	6.29	5.69
52468CL	8212	DIP-24	8-bit input/output (74S412)	6.49	5.99	5.49
52484CL	8216	DIP-16	Bi-directional bus driver (non-invert.)	3.95	3.39	2.55
52492CL	8224	DIP-16	Clock generator/driver	2.95	2.49	2.25
52513CL	8228	DIP-28	System contr./bus driver (74S428)	2.95	2.55	1.89
52581CL	8243	DIP-24	I/O expander for 48 series	5.49	4.99	4.49
52610CL	8250A	DIP-40	Asynchronous comm. element	4.95	4.25	3.19
52644CL	8251	DIP-40	Prog. comm. I/O (USART)	2.99	2.69	2.39
52652CL	8251A	DIP-28	Prog. comm. interface (USART)	3.99	3.69	3.39
52370CL	82C51A	DIP-28	Prog. comm. interface (USART) CMOS	4.49	3.99	3.49
52679CL	8253	DIP-24	Prog. interval timer	3.19	2.89	2.59

* 8049 (ROM not available for I/O) Tie pin 7 high to bypass the internal ROM to convert 8049 to 8039

** Tie pin 31 low to bypass the internal ROM

8000 Series (Continued)

Part No.	Cross Ref.	Pkg.	Description	1	10	100
52687CL	8253-5	DIP-24	Prog. interval timer (2MHz)	\$4.99	\$4.49	\$3.99
52388CL	82C53-5	DIP-24	Prog. interval timer (CMOS) 2MHz	4.95	4.25	3.19
52708CL	8254	DIP-24	Prog. interval timer (UPD71054)	4.49	3.99	3.59
52716CL	8254-2	DIP-24	Prog. interval timer (10MHz)	7.35	6.65	5.95
52396CL	82C54	DIP-24	Prog. interval timer (CMOS)	3.95	3.39	2.55
52409CL	82C54-2	DIP-24	Prog. interval timer (CMOS) 10MHz	4.49	3.85	2.89
52724CL	8255	DIP-40	Prog. periph. I/O (PPI) 71055 (2MHz)	4.49	3.99	3.49
52732CL	8255A-5	DIP-40	Prog. peripheral I/O (PPI) 5MHz	4.89	4.39	2.89
52417CL	82C55A	DIP-40	Prog. peripheral I/O (PPI) CMOS	4.99	4.49	3.99
52425CL	82C55A-5	DIP-40	Prog. periph. I/O (PPI) CMOS (5MHz)	4.49	3.99	3.49
52759CL	8256	DIP-40	Multif. universal asynch. rec./trans.	19.99	17.99	16.19
52775CL	8259	DIP-28	Prog. interrupt controller (UPD71059)	1.75	1.55	1.45
52783CL	8259-5	DIP-28	Prog. interrupt controller (8259A-2)	2.49	2.19	1.99
52821CL	8275	DIP-40	Prog. CRT controller	12.95	11.05	8.29
52839CL	8279	DIP-40	Prog. keyboard/display interface	12.99	11.99	10.99
52847CL	8279-5	DIP-40	Prog. keybrd/display interface (5MHz)	12.95	11.69	10.49
52855CL	8282	DIP-20	Octal latch (UPD71082)	6.49	5.85	5.29
52871CL	8284A	DIP-18	Clock gen. and driver (UPD71084)	4.49	3.99	3.59
52898CL	8286	DIP-20	Octal bus transceiver (UPD71086)	3.95	3.59	3.25
52901CL	8287	DIP-20	Octal bus transceiver (inverted)	10.99	9.99	8.99
52919CL	8288	DIP-20	Bus controller (UPD71088) 82C88-2	1.95	1.65	1.25
53006CL	8741	DIP-40	8-bit univ. periph. interface (EPROM)	7.99	7.19	6.49
53014CL	8742	DIP-40	8-bit univ. peripheral interface	9.95	8.49	6.35
53022CL	8748	DIP-40	CPU 8-bit, EPROM, RAM & I/O (21V)	13.95	11.89	8.89
53031CL	8748H	DIP-40	CPU 8-bit, EPROM, RAM & I/O HMOS (21V)	15.95	14.49	12.99
53057CL	8749H	DIP-40	MPU 8-bit (EPROM version 8049)	22.99	19.99	17.95
53073CL	8751	DIP-40	CPU w/4k EPROM & 128x8 RAM (3.5-8MHz)	19.99	17.99	16.19
53081CL	8751H	DIP-40	CPU w/4k EPROM & 128x8 RAM (1.2-12MHz)	28.49	24.25	18.19
52978CL	87C51	DIP-40	CPU w/4k EPROM & 128x8 RAM(3.5-12MHz)	21.99	18.69	13.99
196120CL	P87C51	DIP-40	CPU w/4k EPROM & 128x8 RAM(3.5-12MHz)OTP	8.99	8.09	7.29
53090CL	8755	DIP-40	16k EPROM with I/O	8.95	8.09	7.29
248701CL	T89C51R82	PLCC-44	MCU, flash 16k ROM, 32 I/O	8.65	7.79	7.05
248719CL	T89C51R2	PLCC-44	MCU, flash 32k ROM, 32 I/O	10.25	9.19	8.29
248727CL	T89C51R22	PLCC-44	MCU, flash 64k ROM, 32 I/O	13.45	12.15	10.89

MICROCHIP PIC Microcontrollers

Part No.	Product No.	Pkg.	Memory	Speed (MHz)	ROM Words	RAM Bytes	I/O Pins	1	25
145040CL	PIC12C508-04/P	DIP-8	OTP	4	512	25	5	\$1.49	\$9.99
145058CL	PIC12C509/JW	DIP-8	OTP	4	1k	41	5	13.95	12.59
144258CL	PIC12C509-04/P	DIP-8	OTP	4	1k	41	5	1.49	1.09
200475CL	PIC12CE518-04/P	DIP-8	OTP	4	512	25	6	1.89	1.49
200483CL	PIC12CE519-04/P	DIP-8	OTP	4	1k	41	6	1.97	1.69
193455CL	PIC12CG71-04/P	DIP-8	OTP	4	1k	128	6	2.79	2.25
193463CL	PIC12CE672-04/P	DIP-8	OTP	4	2k	128	6	2.79	2.19
248137CL	PIC12CE673-10/P	DIP-8	OTP	10	1k	128	5	3.41	3.19
248145CL	PIC12CE674-10/P	DIP-8	OTP	10	2k	128	5	3.41	2.89
223790CL	PIC12F629-I/P	DIP-8	Flash	20	1k	64	6	1.59	1.39
247193CL	PIC12F629-I/SN	SOIC-8	Flash	20	1k	64	6	1.59	1.29
223781CL	PIC12F675-I/P	DIP-8	Flash	20	1k	64	6	1.99	1.69
247206CL	PIC12F675-I/SN	SOIC-8	Flash	20	1k	64	6	1.99	1.29
247361CL	PIC14000-4/S/P	DIP-28	OTP	4	4k	192	22	9.74	9.47
247370CL	PIC14000-4/SO	SOIC-28	OTP	4	4k	192	22	9.93	9.66
200459CL	PIC16C505-04/P	DIP-14	OTP	20	1k	72	12	1.99	1.29
247329CL	PIC16C505-20/P	DIP-14	OTP	20	1k	72	11	2.00	1.69
247337CL	PIC16C505-20I/SL	SOIC-14	OTP	20	1k	72	11	1.99	1.69
128338CL	PIC16C54A-04/P	DIP-18	OTP	4	512	25	12	3.59	2.59
247214CL	PIC16C54C-20I/P	DIP-18	OTP	20	512	25	12	2.33	2.00
247222CL	PIC16C54C-20I/SO	SOIC-18	OTP	20	512	25	12	2.33	1.91
247231CL	PIC16C54C-20I/SS	SSOP-20	OTP	20	512	25	12	2.57	2.18
247345CL	PIC16HV540-20/P	DIP-18	OTP	20	512	25	12	2.30	1.95
247353CL	PIC16HV540-20/SO	SSOP-20	OTP	20	512	25	12	2.35	2.00
200416CL	PIC16C55A-04/P	DIP-28	OTP	4	512	24	20	2.69	2.19
247249CL	PIC16C55A-20								



Call for pricing on quantities over 100 - we carry major manufacturers.

We will special order any IC - \$100 minimum.

MICROCHIP PIC Microcontrollers

Part No.	Product No.	Pkg.	Memory	Speed (MHz)	ROM Words	RAM Bytes	I/O Pins	Price	
								1	25
247396CL	PIC16C554-4/SO	SOIC-18	OTP	4	512	80	13	\$3.57	\$3.34
247409CL	PIC16C558-20/P	DIP-18	OTP	20	2k	128	13	4.59	3.87
247417CL	PIC16C558-20/SO	SOIC-18	OTP	20	2k	128	13	4.68	4.31
134172CL	PIC16C56-RC/P	DIP-18	OTP	20	1k	25	12	4.49	3.69
247265CL	PIC16C56A-20/P	DIP-18	OTP	20	1k	25	12	2.87	2.44
247273CL	PIC16C56A-20/SO	SOIC-18	OTP	20	1k	25	12	2.66	2.56
213495CL	PIC16C57C/JW	DIP-28	OTP	40	2k	72	20	13.95	12.95
193341CL	PIC16C57C-04/P	DIP-28	OTP	4	2k	72	20	3.19	2.09
247281CL	PIC16C57C-20/P	DIP-28	OTP	20	2k	72	20	3.46	2.75
247290CL	PIC16C57C-20/SO	SOIC-28	OTP	20	2k	72	20	3.60	3.06
247302CL	PIC16C58B-20/P	DIP-18	OTP	20	2k	73	12	2.77	2.22
247311CL	PIC16C58B-20/SO	SOIC-18	OTP	20	2k	73	12	2.82	2.41
247343CL	PIC16C62B-20/SO	SOIC-28	OTP	20	2k	128	22	4.42	3.75
247425CL	PIC16C62B-20/SP	DIP-28	OTP	20	2k	128	22	4.42	3.75
247505CL	PIC16C620A-20/P	DIP-18	OTP	20	512	96	13	2.26	1.92
247513CL	PIC16C620A-20/SO	SOIC-18	OTP	20	512	96	13	2.30	1.95
247521CL	PIC16C621A-20/P	DIP-18	OTP	20	1k	96	13	2.54	2.15
247530CL	PIC16C621A-20/SO	SOIC-18	OTP	20	1k	96	13	2.59	2.19
193383CL	PIC16C622A-04/P	DIP-18	OTP	4	2k	128	13	2.09	2.29
247548CL	PIC16C622A-20/P	DIP-18	OTP	20	2k	128	13	3.15	2.69
247556CL	PIC16C622A-20/SO	SOIC-18	OTP	20	2k	128	13	3.20	2.72
193439CL	PIC16F627-20/P	DIP-18	Flash	20	1k	224	16	3.29	2.39
193447CL	PIC16F628-20/P	DIP-18	Flash	20	2k	224	16	3.69	2.69
246730CL	PIC16F628-20/SO	SOIC-18	Flash	20	2k	224	16	3.71	2.73
246748CL	PIC16F628-20/SS	SSOP-20	Flash	20	2k	224	16	4.02	2.97
246756CL	PIC16F628-20/P	DIP-18	Flash	20	2k	224	16	4.02	2.97
246764CL	PIC16F628-20/SO	SOIC-18	Flash	20	2k	224	16	4.09	3.02
193324CL	PIC16C63A-20/SP	DIP-28	OTP	20	4k	192	22	5.49	4.49
223749CL	PIC16F630-I/P	DIP-14	Flash	20	1k	64	12	1.89	1.59
247126CL	PIC16F630-I/SL	SOIC-14	Flash	20	1k	128	12	1.86	1.58
247134CL	PIC16F630-I/ST	TSSOP-14	Flash	20	1k	128	12	2.07	1.77
247142CL	PIC16F648A-I/P	DIP-18	Flash	20	4k	256	16	3.27	1.92
247151CL	PIC16F648A-I/SO	SOIC-18	Flash	20	4k	256	16	3.34	2.46
247169CL	PIC16F648A-I/SS	SSOP-20	Flash	20	4k	256	16	3.59	2.66
247450CL	PIC16C65B-20/L	PLCC-44	OTP	20	4k	192	33	7.60	7.49
247441CL	PIC16C65B-20/P	DIP-40	OTP	20	4k	192	33	6.79	5.69
247476CL	PIC16C66-20/SO	SOIC-28	OTP	20	8k	368	22	8.68	7.39
247468CL	PIC16C66-20/SP	DIP-28	OTP	20	8k	368	22	8.68	7.39
247492CL	PIC16C67-20/L	PLCC-44	OTP	20	8k	368	33	9.10	8.55
247484CL	PIC16C67-20/P	DIP-40	OTP	20	8k	368	33	8.68	7.31
223757CL	PIC16F676-I/P	DIP-14	Flash	20	1k	64	12	2.19	1.79
247177CL	PIC16F676-I/SL	SOIC-14	Flash	20	1k	64	12	2.14	1.81
247185CL	PIC16F676-I/ST	TSSOP-14	Flash	20	1k	64	12	2.35	2.00
247581CL	PIC16C710-20/P	DIP-18	OTP	20	512	36	13	3.88	2.86
193359CL	PIC16C711-04/P	DIP-18	OTP	4	1k	68	13	3.99	2.29
247599CL	PIC16C711-20/P	DIP-18	OTP	20	1k	68	13	4.65	3.42
247601CL	PIC16C711-20/SO	SOIC-18	OTP	20	1k	68	13	4.75	3.49
247610CL	PIC16C712-20/P	DIP-18	OTP	20	1k	128	13	3.41	2.51
247628CL	PIC16C712-20/SO	SOIC-18	OTP	20	1k	128	13	3.48	2.57
247636CL	PIC16C715-20/P	DIP-18	OTP	20	2k	68	13	4.75	3.49
247644CL	PIC16C715-20/SO	SOIC-18	OTP	20	2k	68	13	4.84	4.00
247652CL	PIC16C716-20/P	DIP-18	OTP	20	2k	128	13	4.18	3.09
247661CL	PIC16C716-20/SO	SOIC-18	OTP	20	2k	128	13	4.62	3.14
247679CL	PIC16C717-I/P	DIP-20	OTP	20	2k	256	16	6.72	3.04
247687CL	PIC16C717-SO	SOIC-20	OTP	20	2k	256	16	3.74	2.75
200432CL	PIC16C72A-04/SP	DIP-28	OTP	4	2k	128	22	4.99	4.09
247695CL	PIC16C72A-20/P	DIP-28	OTP	20	2k	128	22	5.78	4.92
247708CL	PIC16C72A-20/SO	SOIC-28	OTP	20	2k	128	22	5.26	4.92
193391CL	PIC16F73-I/SP	DIP-28	Flash	20	4k	192	5	5.19	4.19
246801CL	PIC16F73-I/SO	SOIC-28	Flash	20	4k	192	22	5.06	4.30
246810CL	PIC16F73-I/SS	SSOP-28	Flash	20	4k	192	22	5.20	4.41
145091CL	PIC16C74A/JW	DIP-40	OTP	20	14k	192	33	19.95	17.99
246772CL	PIC16F74-I/L	PLCC-44	Flash	20	4k	192	33	6.86	6.12
193404CL	PIC16F74-I/P	DIP-40	Flash	20	4k	192	8	6.19	5.19
246781CL	PIC16F74-I/P	TOFP-44	Flash	20	4k	192	33	7.36	6.26
247804CL	PIC16C745-I/SO	SOIC-28	OTP	24	8k	256	22	5.10	3.79

MICROCHIP PIC Microcontrollers

Part No.	Product No.	Pkg.	Memory	Speed (MHz)	ROM Words	RAM Bytes	I/O Pins	Price	
								1	25
247791CL	PIC16C745-I/SP	DIP-28	OTP	24	8k	256	22	\$5.10	\$3.79
246828CL	PIC16F76-I/SO	SOIC-28	Flash	20	8k	368	22	6.34	5.39
193412CL	PIC16F76-I/SP	DIP-28	Flash	20	8k	368	5	5.29	6.49
246836CL	PIC16F76-I/SS	SSOP-28	Flash	20	8k	368	22	6.49	5.52
247821CL	PIC16C765-I/L	PLCC-44	OTP	24	8k	256	33	6.39	5.42
247812CL	PIC16C765-I/P	DIP-40	OTP	24	8k	256	33	6.09	4.49
246799CL	PIC16F77-I/L	PLCC-44	Flash	20	8k	368	33	7.85	6.99
193421CL	PIC16F77-I/P	DIP-40	Flash	20	8k	368	8	5.19	7.09
247716CL	PIC16C770-I/P	DIP-20	OTP	20	2k	256	16	4.07	2.99
247724CL	PIC16C770-I/SO	SOIC-20	OTP	20	2k	256	16	3.69	2.72
247732CL	PIC16C771-I/P	DIP-20	OTP	20	2k	256	16	4.42	3.29
247741CL	PIC16C771-I/SO	SOIC-20	OTP	20	2k	256	16	4.48	3.31
247759CL	PIC16C773-I/SP	DIP-28	OTP	20	4k	256	22	6.98	5.93
247767CL	PIC16C773-I/SO	SOIC-28	OTP	20	4k	256	22	6.98	5.93
247783CL	PIC16C774-I/L	PLCC-44	OTP	20	4k	256	33	9.05	8.52
247775CL	PIC16C774-I/P	DIP-40	OTP	20	4k	256	33	8.49	7.21
223765CL	PIC16F818-I/P	DIP-18	Flash	20	1k	128	16	3.09	2.29
247054CL	PIC16F818-I/SO	SOIC-18	Flash	20	1k	128	16	3.10	2.28
247062CL	PIC16F818-I/SS	SSOP-20	Flash	20	1k	128	16	3.37	2.39
223773CL	PIC16F819-I/P	DIP-18	Flash	20	2k	256	16	3.39	2.59
247089CL	PIC16F819-I/SO	SOIC-18	Flash	20	2k	256	16	3.53	2.60
247071CL	PIC16F819-I/SS	SSOP-20	Flash	20	2k	256	16	3.81	2.81
145111CL	PIC16F84-04/P	DIP-18	Flash	4	1k	68	13	6.59	4.39
145120CL	PIC16F84-10/P	DIP-18	Flash	10	1k	68	13	7.09	5.99
193332CL	PIC16F84A-20/P	DIP-18	Flash	20	1k	68	13	5.36	4.69
246844CL	PIC16F84A-20/SO	SOIC-18	Flash	20	1k	68	13	5.73	4.87
246852CL	PIC16F84A-20/SP	SSOP-20	Flash	20	1k	68	13	6.11	5.19
246861CL	PIC16F84A-20/P	DIP-18	Flash	20	1k	68	13	6.20	5.24
246879CL	PIC16F84A-20/SO	SOIC-18	Flash	20	1k	68	13	6.30	5.35
246887CL	PIC16F84A-20/SS	SSOP-20	Flash	20	1k	68	13	6.66	5.65
247097CL	PIC16F87-I/P	DIP-18	Flash	20	4k	368	16	4.02	2.97
247100CL	PIC16F87-I/SO	SOIC-18	Flash	20	4k	368	16	4.12	3.04
247118CL	PIC16F87-I/SS	SSOP-20	Flash	20	4k	368	16	4.42	3.26
246908CL	PIC16F870-I/SO	SOIC-28	Flash	20	2k	128	22	4.35	3.69
246895CL	PIC16F870-I/SP	DIP-28	Flash	20	2k	128	22	4.35	3.69
246916CL	PIC16F870-I/SS	SSOP-28	Flash	20	2k	128	22	4.49	3.81
246932CL	PIC16F871-I/L	PLCC-44	Flash	20	2k	128	33	5.76	5.40
246924CL	PIC16F871-I/P	DIP-40	Flash	20	2k	128	33	5.15	4.65
246959CL	PIC16F872-I/SO	SOIC-28	Flash	20	2k	128	22	4.35	3.69
246941CL	PIC16F872-I/SP	DIP-28	Flash	20	2k	128	22	4.35	3.69
246967CL	PIC16F872-I/SS	SSOP-28	Flash	20	2k	128	22	4.49	3.81
246983CL	PIC16F873A-I/SO	SOIC-28	Flash	20	4k	192	22	6.16	5.22
246975CL	PIC16F873A-I/SP	DIP-28	Flash	20	4k	192	22	6.29	5.19
247003CL	PIC16F874A-I/L	PLCC-44	Flash	20	4k	192	33	7.55	6.73
246991CL	PIC16F874A-I/P	DIP-40	Flash	20	4k	192	33	6.72	5.72
247020CL	PIC16F876A-I/SO	SOIC-28	Flash	20	8k	368	22	6.63	5.64
247011CL	PIC16F876A-I/SP	DIP-28	Flash	20	8k	368	22	6.63	5.64
193367CL	PIC16F876-20/SP	DIP-28	Flash	20	256	368	22	7.88	6.60
247046CL	PIC16F877A-I/L	PLCC-44	Flash	20	8k	368	33	8.11	7.24
247038CL	PIC16F877A-I/P	DIP-40	Flash	20	8k	368	33	7.24	6.15
176882CL	PIC16F877-20/P	DIP-40	Flash	20	256	368	33	9.49	8.49
247847CL	PIC16C923-04/L	PLCC-68	OTP	4	4k	176	52	6.29	6.11
247839CL	PIC16C923-04/PT	TQFP-64	OTP	4	4k	176	52	6.29	6.10
247880CL	PIC17C42A-16/L	PLCC-44	OTP	16	2k	232	33	10.39	9.64
247871CL	PIC17C42A-16/P	DIP-40	OTP	16	2k	232	33	9.39	8.29
247901CL	PIC17C43-25/L	PLCC-44	OTP	25	4k	454	33	12.31	11.55
247898CL	PIC17C43-25/P	DIP-40	OTP	25	4k	454	33	11.90	10.00
247927CL	PIC17C44-33/L	PLCC-44	OTP	33	8k	454</			

Microcontrollers – Programmable Logic

Color Code Legend
New Sale Qty Save

Call for pricing on quantities over 100 – we carry major manufacturers. We will special order any IC – \$100 minimum.

MICROCHIP PIC Microcontrollers

Part No.	Product No.	Pkg.	Memory	Speed (MHz)	ROM Words	RAM Bytes	I/O Pins	1	10	25
248129CL	PIC18F1320-I/SO	SOIC-18	Flash	40	4k	256	16	\$4.87	\$4.14
247986CL	PIC18F242-I/SO	SOIC-28	Flash	40	8k	768	23	7.31	6.21
247978CL	PIC18F242-I/SP	DIP-28	Flash	40	8k	768	23	7.31	6.21
248006CL	PIC18F252-I/SO	SOIC-28	Flash	40	16k	1536	23	7.97	6.79
247994CL	PIC18F252-I/SP	DIP-28	Flash	40	16k	1536	23	7.97	6.79
200504CL	PIC18C252-I/SP	DIP-28	OTP	40	32k	1536	23	8.29	7.09
248022CL	PIC18F258-I/SO	SOIC-28	Flash	40	16k	1536	23	9.65	8.11
248014CL	PIC18F258-I/SP	DIP-28	Flash	40	16k	1536	23	9.65	8.11
248081CL	PIC18F442-I/L	PLCC-44	Flash	40	8k	768	34	9.10	8.12
248073CL	PIC18F442-I/P	DIP-40	Flash	40	8k	768	34	8.13	6.91
200512CL	PIC18C452-I/P	DIP-40	OTP	40	32k	1536	23	9.19	7.49
200521CL	PIC18C452/JW	DIP-40	EPROM	40	32k	1536	23	22.85	20.85
248049CL	PIC18F452-I/L	PLCC-44	Flash	40	16k	1536	34	9.86	8.71
248031CL	PIC18F452-I/P	DIP-40	Flash	40	16k	1536	34	8.82	7.49
248065CL	PIC18F458-I/L	PLCC-44	Flash	40	16k	1536	34	10.69	9.41
248057CL	PIC18F458-I/P	DIP-40	Flash	40	16k	1536	34	9.68	8.22

ATMEL AT89C Series

Part No.	Product No.	Pkg.	Description	1	25
248330CL	ATMEGA8-16PI	DIP-28	8-bit MCU, 16MHz 8kB flash	\$5.25 \$4.41
248153CL	ATTINY11-6PC	DIP-8	8-bit MCU, 6MHz 1kB flash	1.66 1.41
248161CL	ATTINY11-6SI	SOIC-8	8-bit MCU, 6MHz 1kB flash	1.79 1.51
248170CL	ATTINY12-8PC	DIP-8	8-bit MCU, 8MHz 1kB flash	1.85 1.59
248188CL	ATTINY12-8SI	SOIC-8	8-bit MCU, 8MHz 1kB flash	1.99 1.69
248196CL	ATTINY15L-1PC	DIP-8	8-bit MCU, 1.6MHz 1kB flash	2.99 2.53
248209CL	ATTINY15L-1SI	SOIC-8	8-bit MCU, 1.6MHz 1kB flash	2.99 2.53
248217CL	ATTINY26-16PC	DIP-20	8-bit MCU, 16MHz 2kB flash	2.49 2.11
248225CL	ATTINY26-16SI	SOIC-20	8-bit MCU, 16MHz 2kB flash	2.58 2.25
248233CL	ATTINY28L-4PC	DIP-28	8-bit MCU, 4MHz 2kB flash	2.25 1.88
248348CL	ATMEGA8515-16JI	PLCC-44	8-bit MCU, 16MHz 8kB flash	5.19 4.52
168866CL	AT89C1051-24PC	DIP-20	8-bit MCU, 24MHz 1kB flash mem.	2.65 2.15
168874CL	AT89C2051-24PC	DIP-20	8-bit MCU, 24MHz 2kB flash mem.	3.59 2.39
204089CL	AT89C4051-24PC	DIP-20	8-bit MCU, 24MHz 4kB flash mem. 8-bit	4.49 2.95
168903CL	AT89C51-24PC	DIP-40	8-bit MCU, 24MHz 4kB flash memory	4.49 3.99
168920CL	AT89C52-24PC	DIP-40	8-bit MCU, 24MHz 8kB flash memory	4.39 2.85
168938CL	AT89C52-24JC	DIP-44	8-bit MCU, 24MHz 8kB flash PLCC	4.35 2.83
168946CL	AT89C55WD-24PC	DIP-40	8-bit MCU, 24MHz 20kB flash memory	7.99 6.79
204097CL	AT89S8252-24PC	DIP-40	8-bit MCU, 24MHz 8kB flash mem. 2kB EEPROM	6.75 4.49
204100CL	AT90S1200-12PC	DIP-20	20 AVR 8-bit RISC MCU, 12MHz 1kB prog. flash	2.95 1.95
248241CL	AT90S1200A-12SC	SOIC-20	8-bit AVR MCU, 12MHz 1kB prog. flash	2.89 2.45
248250CL	AT90S2313-10PC	DIP-20	8-bit AVR MCU, 10MHz 2kB prog. flash	3.25 2.69
248268CL	AT90S2313-10SI	SOIC-20	8-bit AVR MCU, 10MHz 2kB prog. flash	2.65 2.39
248276CL	AT90S2323-10SI	SOIC-8	8-bit AVR MCU, 10MHz 2kB prog. flash	3.25 2.79
248284CL	AT90S2343-10PC	DIP-8	8-bit AVR MCU, 10MHz 2kB prog. flash	2.99 2.63
248292CL	AT90S2343-10SI	SOIC-8	8-bit AVR MCU, 10MHz 2kB prog. flash	3.49 2.74
204126CL	AT90S8515-8PC	DIP-40	8-bit AVR MCU, 8MHz 8kB prog. flash	7.95 5.49

IC Test Clip Series

- For temporary connections to DIP package components
- Heavy-duty spring loaded hinge provides positive contact
- 20 AWG insulated gold contacts
- Color: white



Part No.	Cross Ref.	Description	1	10	25
22103CL	JTC16	16-pin (for 8, 14 and 16-pin ICs)	\$6.95	\$6.25 \$5.59
22120CL	JTC20	20-pin (for 18 and 20-pin ICs)	8.95	6.50 5.35
22162CL	JTC28	28-pin	10.95	9.95 8.95
22189CL	JTC40	40-pin	11.95	11.35 10.75

We'll Find Any IC!

Call us with your 100 piece minimum order.

1-800-831-4242

TEXAS INSTRUMENTS Microcontrollers

Part No.	Product No.	Pkg.	Description	1	10	100
248663CL	MSP430F1121AIPW	SSOP-20	MCU, flash 8MHz 4k ROM, 15 I/O	\$3.55	\$3.45 \$3.09
248680CL	MSP430F1231PW	SSOP-20	MCU, flash 8MHz 4k ROM, 15 I/O	4.79	4.69 4.25

Stamp Microcontrollers

80C52-BASIC Microcontroller
The 80C52-BASIC chip is a custom-masked 80C52 microcontroller with a full-featured 8k-byte ROM-resident BASIC-52 interpreter.

- Hardware:**
- On-chip oscillator and clock circuit
 - Operates DC to 12MHz
 - 256 x 8-bit RAM
- Software:**
- Full BASIC interpreter in ROM on a single chip
 - "Stand-alone" software development
 - Interrupts can be handled by BASIC or Assembly Language

Part No.	Product No.	Description	1	10	100
125647CL	80C52BASIC	40-pin CPU 8-bit CMOS w/ BASIC interpreter	\$32.09	\$28.89 \$25.99

PARALLAX SX 50MIPS SX Microcontroller

Part No.	Parallax No.	Description	1	10	100
162931CL	SX28AC/DP	28-pin 50MIPS SX microcontroller	\$6.49	\$4.99 \$4.89 \$4.79

Voice Chips

Single-Chip Voice Record/Playback Devices

10 to 240 Second Durations (28-pin DIP)

- Easy-to-use single-chip voice recording and playback
- Manual switch or microprocessor controllable
- Directly cascadable for longer durations
- Fully addressable to handle multiple messages
- Zero-power message storage – eliminates battery backup circuits
- Single voltage operation: +5V (4.5V to 5.5V operating range)
- Automatic power-down (push-button mode)
- Playback can be edge or level-activated
- 1 µA standby current (typical)
- 100-year message retention (typical)
- On-chip clock source
- 100k record cycles (typical)
- On-chip automatic gain control (AGC)



Part No.	Product No.	Description	1	10	50
141671CL	ISD1110P	Voice record/playback (10 sec.)	\$4.29	\$3.99 \$3.79
107334CL	ISD1420P	Voice record/playback (20 sec.)	5.39	5.09 4.89
120643CL	ISD2560P	Voice record/playback (60 sec.)	9.19	8.59 7.79
120660CL	ISD2590P	Voice record/playback (90 sec.)	9.29	8.69 7.89
141655CL	ISD25120P	Voice record/playback (120 sec.)	9.39	8.79 7.99

FPLA, PALs and GALs

Part No.	Cross Ref.	Pkg.	Description	1	10	100
27748CL	N82S100	DIP-28	16 x 48 x 8 field-prog. logic array, tri-state	\$14.95	\$13.49 \$12.15
28020CL	PAL16L8	DIP-20	Octal 16-input AND-OR-INVERT gate array	2.25	1.75 1.66
88399CL	16V8-10*	DIP-20	10ns 64 x 32 AND array	2.59	2.35 2.10
37452CL	16V8-15*	DIP-20	15ns 64 x 32 AND array	1.39	1.25 1.12
37461CL	16V8-25*	DIP-20	25ns 64 x 32 AND array	1.25	1.09 .99
88292CL	20V8-10**	DIP-24	10ns 64 x 40 AND array	2.29	1.85 1.60 1.43
38658CL	20V8-15**	DIP-24	15ns 64 x 40 AND array	1.74	1.41 1.19
38666CL	20V8-25**	DIP-24	25ns 64 x 40 AND array	1.75	1.63 1.46 1.23
235352CL	20VP8-25LJ	PLCC-28	15ns 64 x 40 AND array	1.85	1.63 1.46 1.23
123801CL	22V10-10	DIP-24	10ns 132 x 44 AND array	5.49	4.99 4.49
39159CL	22V10-15	DIP-24	15ns 132 x 44 AND array	4.49	3.95 3.55
39167CL	22V10-25	DIP-24	25ns 132 x 44 AND array	3.99	3.49 3.09

GALs are electrically erasable PLDs that can be used in place of numerous PALs

- * Replaces PALs: 10H8, 10L8, 10P8, 12H6, 12L6, 12P6, 14H4, 14L4, 14P4, 16H2, 16H8, 16L2, 16L8, 16P2, 16P8, 16R4, 16R6, 16R8, 16RP4, 16RP6, 16RP8
- ** Replaces PALs: 14H8, 14L8, 14P8, 16H6, 16L6, 16P6, 18H4, 18L4, 18P4, 20H2, 20H8, 20L2, 20L8, 20P2, 20P8, 20R4, 20R6, 20R8, 20RP4, 20RP6, 20RP8

PEEL™ Devices (CMOS)

Programmable Electrically Erasable Logic (PEEL) devices allow for supersets replacement of over 40 standard 20-pin and 24-pin PLDs (PAL, GAL, EPLD, etc.). They also offer additional architectural features so more logic can be put into every design.

Part No.	Cross Ref.	Pkg.	Description	1	10	100
105953CL	18CV8P-25	DIP-20	PLD superset 12 config. I/O pins (8) 25ns	\$2.25	\$1.95 \$1.45
105996CL	22CV10AP-25	DIP-24	PLD superset 4/12 config. I/O pins (10) 25ns	2.59	2.10 1.85

Call for pricing on quantities over 100 – we carry major manufacturers. We will special order any IC – \$100 minimum.

74HC(T)XXX CMOS Logic Competitive Cross Reference Guide

Family	Package	TI	Jameco	Fairchild	On Semi	ST Micro	Philips	Toshiba
HC(T)	DIP	SN74HC(T)XXXN	74HC(T)XXXN	MM74HC(T)XXXN	MC74HC(T)XXXN	M74HC(T)XXXBIR	74HC(T)XXXN	TC74HC(T)XXXAP
	DIP	CD74HC(T)XXXE	74HC(T)XXXN	MM74HC(T)XXXN	MC74HC(T)XXXN	M74HC(T)XXXBIR	74HC(T)XXXN	TC74HC(T)XXXAP
	SOIC	SN74HC(T)XXXD/DW	74HC(T)XXXM/WM	MM74HC(T)XXXM/WM	MC74HC(T)XXXD	M74HC(T)XXXMIR	74HC(T)XXXD	TC74HC(T)XXXAF/AFW
	SOIC	CD74HC(T)XXXM	74HC(T)XXXM/WM	MM74HC(T)XXXM/WM	MC74HC(T)XXXD	M74HC(T)XXXMIR	74HC(T)XXXD	TC74HC(T)XXXAF/AFW

74HC Series – HC family offers CMOS inputs with CMOS outputs

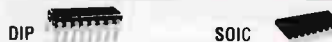

Save When Purchasing Texas Instruments and Mixed Major Brands!

Jameco now offers two ways to save! Our NEW selection of Texas Instruments products will save you about 6-10% off market prices. And if your project doesn't require a specific brand, select from the functionally equivalent Mixed Major Brands column to save up to 20%! You'll get the best price on products guaranteed to be from Fairchild†, National Semi, On Semi†, Philips†, ST Micro, TI†, and/or Toshiba.



* Prepackaged: order in increments of 10 or 100

Texas Instruments – Save 6-10%

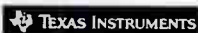

Part No.	T.I. Product No.	Package	Description	1	10	100
251889CL	SN74HC00D	SOIC-14	Quad 2-input NAND gate	\$.23	\$.15	\$.10
250966CL	SN74HC00N	DIP-14	Quad 2-input NAND gate (6231581)	.24	.23	.16
251926CL	SN74HC02D	SOIC-14	Quad 2-input NOR gate	.23	.22	.20
250974CL	SN74HC02N	DIP-14	Quad 2-input NOR gate	.23	.22	.20
251934CL	SN74HC04D	SOIC-14	Hex inverter (buffered)	.22	.17	.16
250982CL	SN74HC04N	DIP-14	Hex inverter (buffered)	.25	.22	.17
251942CL	SN74HC08D	SOIC-14	Quad 2-input AND gate	.23	.20	.19
251002CL	SN74HC08N	DIP-14	Quad 2-input AND gate	.20	.16	.11
251951CL	SN74HC10D	SOIC-14	Triple 3-input NAND gate	.31	.28	.20
251011CL	SN74HC10N	DIP-14	Triple 3-input NAND gate	.25	.20	.14
251037CL	SN74HC11N	DIP-14	Triple 3-input AND gate	.31	.28	.20
251969CL	SN74HC14D	SOIC-14	Hex inverter Schmitt trigger	.24	.22	.20
251045CL	SN74HC14N	DIP-14	Hex inverter Schmitt trigger	.24	.21	.18
251985CL	CD74HC30M	SOIC-14	8-input NAND gate	.31	.28	.20
251070CL	CD74HC30E	DIP-14	8-input NAND gate	.31	.28	.20
251993CL	SN74HC32D	SOIC-14	Quad 2-input OR gate	.16	.12	.12
251088CL	SN74HC32N	DIP-14	Quad 2-input OR gate	.30	.25	.22
252030CL	SN74HC74D	SOIC-14	Dual D flip-flop	.22	.18	.17
251096CL	SN74HC74N	DIP-14	Dual D flip-flop	.38	.35	.31
252048CL	CD74HC85M	SOIC-16	4-bit magnitude comparator	.47	.45	.40
251109CL	CD74HC85E	DIP-16	4-bit magnitude comparator	.47	.45	.40
252056CL	SN74HC86D	SOIC-14	Quad Exclusive OR gate	.16	.15	.15
251133CL	SN74HC86N	DIP-14	Quad Exclusive-OR gate	.27	.24	.22
252064CL	CD74HC123M	SOIC-16	Dual retriggerable monostable multivibrator	.41	.34	.23
251184CL	CD74HC123E	DIP-16	Dual retriggerable monostable multivibrator	.40	.33	.23
252072CL	SN74HC125D	SOIC-14	Quad bus buffer tri-state	.15	.15	.14
251192CL	SN74HC125N	DIP-14	Quad bus buffer tri-state	.33	.29	.24
252081CL	SN74HC132D	SOIC-14	Quad 2-input NAND Schmitt trigger	.23	.19	.17
251205CL	SN74HC132N	DIP-14	Quad 2-input NAND Schmitt trigger	.35	.29	.20
252099CL	SN74HC138D	SOIC-16	3-to-8 decoder/demultiplexer	.32	.27	.20
251213CL	SN74HC138N	DIP-16	3-to-8 decoder/demultiplexer	.33	.29	.20
252101CL	SN74HC139D	SOIC-16	2 to 4 decoder/demultiplexer	.35	.29	.20
251221CL	SN74HC139N	DIP-16	2-to 4 decoder/demultiplexer	.40	.34	.25
252110CL	CD74HC154M	SOIC-24	4/16 line decoder	.45	.34	.255
251230CL	CD74HC154E	DIP-24	4/16 line decoder (.3"W)	.88	.72	.65
251248CL	CD74HC154EN	DIP-24	4/16 line decoder (.6"W)	.81	.70	.63
252136CL	SN74HC157D	SOIC-16	Quad 2-input multiplexer	.23	.19	.17
251299CL	SN74HC157N	DIP-16	Quad 2-input multiplexer	.40	.33	.25
252144CL	SN74HC161D	SOIC-16	Synchronous 4-bit counter	.30	.23	.20
251301CL	SN74HC161N	DIP-16	Synchronous 4-bit counter	.39	.33	.25
251310CL	SN74HC163N	DIP-16	Synchronous 4-bit counter	.30	.25	.24
252152CL	SN74HC164D	SOIC-14	8-bit serial shift register	.40	.33	.25
251328CL	SN74HC164N	DIP-14	8-bit serial shift register	.41	.33	.25
252161CL	SN74HC165D	SOIC-16	Parallel load 8-bit serial shift register	.36	.29	.22
251336CL	SN74HC165N	DIP-16	Parallel load 8-bit serial shift register	.35	.30	.22
252179CL	SN74HC174D	SOIC-16	Hex D flip-flop with clear	.27	.23	.21
251352CL	SN74HC174N	DIP-16	Hex D flip-flop with clear	.41	.33	.25
251395CL	CD74HC192E	DIP-16	Decade up/down counter with clear	1.72	1.57	1.39
252187CL	SN74HC193D	SOIC-16	Binary up/down counter with clear	.30	.26	.23
251387CL	SN74HC193N	DIP-16	Binary up/down counter with clear	.34	.27	.25
252259CL	CD74HC221M	SOIC-16	Dual mono. multivibrator Schmitt trigger	.48	.45	.42

Mixed Major Brands – Save up to 20%

Part No.	Cross Ref.	1	10	100
197106CL	74HC00M	\$.21	\$.13	\$.09
45161CL	74HC00N	.22	.18	.15
197114CL	74HC02M	.21	.20	.18
45188CL	74HC02N	.15	.11	.11
197122CL	74HC04M	.20	.16	.15
45209CL	74HC04N	.23	.19	.18
197131CL	74HC08M	.21	.15	.17
45225CL	74HC08N	.15	.10	.10
243272CL	74HC10M	.29	.26	.18
45233CL	74HC10N	.25	.18	.17
45268CL	74HC11N	.29	.26	.18
197149CL	74HC14M	.22	.20	.18
45364CL	74HC14N	.22	.19	.17
243281CL	74HC30M	.28	.26	.16
45786CL	74HC30N	.29	.26	.18
197157CL	74HC32M	.13	.11	.11
45794CL	74HC32N	.28	.23	.22
197165CL	74HC74M	.20	.17	.16
46130CL	74HC74N	.35	.32	.29
243299CL	74HC85M	.42	.41	.37
46172CL	74HC85N	\$.49	.45	.44
243301CL	74HC86M	.15	.14	.14
46181CL	74HC86N	\$.39	.25	.22
243310CL	74HC123M	.38	.31	.21
45292CL	74HC123N	\$.39	.37	.30
243328CL	74HC125M	.14	.14	.13
45305CL	74HC125N	\$.33	.30	.27
243731CL	74HC132M	\$.23	.18	.18
45321CL	74HC132N	\$.35	.27	.18
197173CL	74HC138M	\$.35	.29	.25
45330CL	74HC138N	\$.35	.30	.27
243740CL	74HC139M	.32	.27	.18
45356CL	74HC139N	\$.35	.37	.31
243758CL	74HC154WM	\$.105	.08	.08
45401CL	74HC154N	\$.85	.78	.72
111739CL	74HC154WN	\$.109	.08	.08
243766CL	74HC157M	\$.27	.21	.16
45428CL	74HC157N	.37	.30	.23
243774CL	74HC161M	.28	.21	.18
45452CL	74HC161N	\$.39	.36	.31
45479CL	74HC163N	\$.49	.43	.42
197181CL	74HC164M	\$.39	.37	.30
45487CL	74HC164N	\$.39	.38	.30
197190CL	74HC165M	\$.35	.30	.27
45495CL	74HC165N	.32	.28	.25
243782CL	74HC174M	.25	.21	.19
45508CL	74HC174N	\$.49	.45	.42
45541CL	74HC192N	1.59	1.45	1.29
243791CL	74HC193M	.28	.25	.23
45559CL	74HC193N	\$.35	.31	.25
243803CL	74HC221AM	\$.56	.43	.41

† Note: TI now owns GE, Harris & RCA logic; Fairchild now owns National Semi logic; Philips now owns Signetics; and On Semi is also known as Motorola.

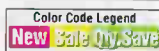

Call for pricing on quantities over 100 - we carry major manufacturers.

We will special order any IC - \$100 minimum.

74HC Series (Continued) - HC family offers CMOS inputs with CMOS outputs



Save When Purchasing Texas Instruments and Mixed Major Brands!

Jameco now offers two ways to save! Our NEW selection of Texas Instruments products will save you about 6-10% off market prices. And if your project doesn't require a specific brand, select from the functionally equivalent Mixed Major Brands column to save up to 20%! You'll get the best price on products guaranteed to be from Fairchild†, National Semi, On Semi†, Philips†, ST Micro, TI†, and/or Toshiba.



PHILIPS

ON Semiconductor

TOSHIBA

Texas Instruments - Save 6-10%



Part No.	T.I. Product No.	Package	Description	1	10	100
251408CL	CD74HC221E	DIP-16	Dual mono. multivibrator Schmitt trigger	\$.48	\$.40	\$.30
252267CL	SN74HC240DW	SOIC-20	Octal inverting line driver tri-state	.34	.29	.22
251416CL	SN74HC240N	DIP-20	Octal inverting line driver tri-state	.41	.37	.34
252275CL	SN74HC244DW	SOIC-20	Octal driver tri-state	.34	.29	.22
251424CL	SN74HC244N	DIP-20	Octal driver tri-state	.49	.42	.31
252291CL	SN74HC245DW	SOIC-20	Octal transceiver tri-state	.34	.29	.22
251432CL	SN74HC245N	DIP-20	Octal transceiver tri-state	.49	.41	.31
252304CL	SN74HC273DW	SOIC-20	Octal D-type flip-flops with clear	.35	.29	.22
251459CL	SN74HC273N	DIP-20	Octal D-type flip-flop with clear	.26	.23	.19
252312CL	SN74HC373DW	SOIC-20	Octal D-type flip-flop tri-state	.34	.29	.22
251475CL	SN74HC373N	DIP-20	Octal D-type flip-flop tri-state	.49	.42	.38
252321CL	SN74HC374DW	SOIC-20	Octal D-type flip-flop edge-trig tri-state	.34	.29	.22
251483CL	SN74HC374N	DIP-20	Octal D-type flip-flop edge-trig tri-state	.53	.42	.31
252339CL	SN74HC393D	SOIC-14	Dual 4-bit binary counter	.32	.29	.275
251504CL	SN74HC393N	DIP-14	Dual 4-bit binary counter	.36	.29	.22
252347CL	SN74HC540DW	SOIC-20	Octal invert. buffer/line driver tri-state	.32	.28	.24
251512CL	SN74HC540N	DIP-20	Octal invert. buffer/line driver tri-state	.36	.29	.22
252355CL	SN74HC541DW	SOIC-20	Octal buffer/line driver tri-state	.36	.29	.22
251521CL	SN74HC541N	DIP-20	Octal buffer/line driver tri-state	.36	.29	.22
252363CL	SN74HC573ADW	SOIC-20	Octal D-type flip-flop tri-state	.36	.29	.22
251547CL	SN74HC573AN	DIP-20	Octal D-type flip-flop tri-state	.36	.29	.22
252371CL	SN74HC574DW	SOIC-20	Octal D-type flip-flop tri-state	.30	.25	.18
251558CL	SN74HC574N	DIP-20	Octal D-type flip-flop tri-state	.36	.29	.22
251838CL	SN74HC590AN	DIP-16	8-bit binary counter w/ output reg. tri-state	.33	.26	.24
252523CL	SN74HC595D	SOIC-16	8-bit serial-to-parallel shift reg. tri-state	.34	.29	.27
251643CL	SN74HC595N	DIP-16	8-bit serial-to-parallel shift reg. tri-state	.67	.48	.42
252531CL	SN74HC688DW	SOIC-20	8-bit mag. comparator	.52	.46	.43
251651CL	SN74HC688N	DIP-20	8-bit mag. comparator	.57	.49	.46
251660CL	CD74HC4017E	DIP-16	Decade ctr./div. with 10 decoded outputs	.56	.51	.39
252540CL	SN74HC4020D	SOIC-16	14-stage binary counter	.45	.20	.18
251678CL	CD74HC4020E	DIP-16	14-stage binary counter	.47	.38	.285
252558CL	SN74HC4040D	SOIC-16	12-stage binary counter	.27	.25	.22
251686CL	SN74HC4040N	DIP-16	12-stage binary counter	.26	.21	.18
252460CL	CD74HC4046AM	SOIC-16	Phase lock loop	.45	.36	.28
251694CL	CD74HC4046AE	DIP-16	Phase lock loop	.39	.34	.285
252478CL	CD74HC4049M	SOIC-16	HEX inverting buffers	.36	.33	.30
252486CL	CD74HC4050M	SOIC-16	HEX non-inverting buffers	.36	.33	.285
252380CL	CD74HC4051M	SOIC-16	Single 8-channel multi/demultiplexer	.39	.36	.285
251707CL	CD74HC4051E	DIP-16	Single 8-channel multi/demultiplexer	.34	.26	.245
252494CL	CD74HC4052M	SOIC-16	High speed analog multiplexer/demultiplexer	.40	.34	.255
252515CL	CD74HC4053M	SOIC-16	High speed analog multiplexer/demultiplexer	.38	.35	.28
252419CL	SN74HC4060D	SOIC-16	14-stage binary counter	.43	.33	.25
251803CL	SN74HC4060N	DIP-16	14-stage binary counter	.43	.33	.25
252435CL	SN74HC4066D	SOIC-14	Quad analog switch	.33	.30	.28
251811CL	SN74HC4066N	DIP-14	Quad analog switch	.57	.51	.46
252566CL	CD74HC4316M	SOIC-16	High speed quad analog switches w/ level translation	.45	.41	.30
251820CL	CD74HC4514E	DIP-24	4/16-line decoder with latch (.3" W)	1.79	1.61	1.45
252443CL	CD74HC4538M	SOIC-16	Dual retrig. mono. multivibrator	.46	.42	.39
251838CL	CD74HC4538E	DIP-16	Dual retrig. mono. multivibrator	.37	.34	.30

Mixed Major Brands - Save up to 20%

Part No.	Cross Ref.	1	10	100
45604CL	74HC221N	\$.43	\$.35	\$.27
243811CL	74HC240WM	.31	.27	.20
45612CL	74HC240N	\$.37	.30	.22
197202CL	74HC244M	\$.42	.31	.27
45655CL	74HC244N	.45	.39	.29
197211CL	74HC245M	\$.42	.31	.27
45671CL	74HC245N	.45	.38	.29
243820CL	74HC273WM	.32	.27	.20
45743CL	74HC273N	\$.28	.24	.18
197229CL	74HC373M	\$.39	.31	.27
45831CL	74HC373N	.45	.39	.35
197237CL	HC374M	\$.42	.31	.27
45858CL	74HC374N	.49	.39	.29
243838CL	74HC393M	.29	.27	.20
45874CL	74HC393N	\$.39	.33	.27
243846CL	74HC540WM	.29	.27	.22
109760CL	74HC540N	\$.65	.33	.27
243854CL	74HC541WM	.33	.27	.22
46050CL	74HC541N	\$.69	.33	.27
197245CL	74HC573M	\$.42	.33	.27
46076CL	74HC573N	\$.49	.33	.27
197253CL	74HC574M	\$.42	.28	.23
46084CL	74HC574N	\$.39	.33	.27
88090CL	74HC590N	\$.69	.30	.25
245075CL	74HC595M	.31	.27	.25
46105CL	74HC595N	.62	.44	.39
245083CL	74HC688WM	.48	.42	.40
46113CL	74HC688N	\$.65	.52	.42
45891CL	74HC4017N	\$.59	.50	.42
245091CL	74HC4020M	.41	.20	.17
45903CL	74HC4020N	\$.59	.41	.33
245104CL	74HC4040M	.25	.23	.18
45920CL	74HC4040N	\$.41	.24	.19
243900CL	74HC4046M	.41	.33	.26
45938CL	74HC4046N	\$.49	.35	.30
243918CL	74HC4049M	.32	.29	.27
243926CL	74HC4050M	.32	.29	.25
243862CL	74HC4051M	.35	.32	.26
88102CL	74HC4051N	.30	.24	.22
245059CL	74HC4052M	.36	.30	.23
245067CL	74HC4053M	.35	.32	.26
243871CL	74HC4060M	.40	.30	.23
45962CL	74HC4060N	\$.57	.40	.30
243889CL	74HC4066M	.30	.28	.26
45971CL	74HC4066N	\$.43	.35	.32
245112CL	74HC4316M	.40	.35	.27
46009CL	74HC4514N	\$.99	.81	.79
243897CL	74HC4538M	.42	.39	.36
46017CL	74HC4538N	.33	.31	.27

74HCT Series - HCT family offers TTL inputs with CMOS outputs



Texas Instruments - Save 6-10%



Part No.	T.I. Product No.	Package	Description	1	10	100
246393CL	SN74HCT00D	SOIC-14	Quad 2-input NAND gate	*	\$.16	\$.15
246406CL	SN74HCT00N	DIP-14	Quad 2-input NAND gate	.26	.23	.20
246414CL	SN74HCT02N	DIP-14	Quad 2-input NOR gate	.35	.29	.20
246369CL	SN74HCT04D	SOIC-14	Hex inverter	.20	.16	.14

Mixed Major Brands - Save up to 20%

Part No.	Cross Ref.	1	10	100
246027CL	74HCT00M	*	\$.15	\$.14
44871CL	74HCT00N	.24	.21	.18
44880CL	74HCT02N	.32	.27	.18
246035CL	74HCT04M	*	.15	.13

† Note: TI now owns GE, Harris & RCA logic; Fairchild now owns National Semi logic; Philips now owns Signetics; and On Semi is also known as Motorola.

Call for pricing on quantities over 100 - we carry major manufacturers.

We will special order any IC - \$100 minimum.

74HCT Series (Continued) - HCT family offers TTL inputs with CMOS outputs

Save When Purchasing Texas Instruments and Mixed Major Brands!

Jameco now offers two ways to save! Our NEW selection of Texas Instruments products will save you about 6-10% off market prices. And if your project doesn't require a specific brand, select from the functionally equivalent Mixed Major Brands column to save up to 20%! You'll get the best price on products guaranteed to be from Fairchild†, National Semi, On Semi†, Philips†, ST Micro, TI†, and/or Toshiba.

Texas Instruments - Save 6-10%

Part No.	T.I. Product No.	Package	Description	1	10	100
246422CL	SN74HCT04N	DIP-14	Hex inverter	\$.25	\$.22	\$.20
246078CL	SN74HCT08D	SOIC-14	Quad 2-input AND gate	.16	.14	.14
246431CL	SN74HCT08N	DIP-14	Quad 2-input AND gate	.20	.16	.14
246377CL	SN74HCT14D	SOIC-14	Hex inverter Schmitt trigger	.21	.18	.16
246449CL	SN74HCT14N	DIP-14	Hex inverter Schmitt trigger	.22	.20	.175
246318CL	SN74HCT32D	SOIC-14	Quad 2-input OR gate	.14	.13	.13
246457CL	SN74HCT32N	DIP-14	Quad 2-input OR gate	.23	.20	.19
246262CL	SN74HCT74D	SOIC-14	Dual D flip-flop	.17	.16	.16
246465CL	SN74HCT74N	DIP-14	Dual D flip-flop	.27	.23	.20
246473CL	CD74HCT86E	DIP-14	Quad 2-input exclusive DR gate	.24	.22	.20
246481CL	CD74HCT123E	DIP-16	Quad retrigg. monostable multivibrator w/ reset	.26	.24	.20
246490CL	SN74HCT125N	DIP-14	Quad 3-state bus buffer	.24	.21	.17
246385CL	SN74HCT138D	SOIC-16	3 to 8 decoder/demultiplexer	.29	.25	.21
246502CL	74HCT138N	DIP-16	3 to 8 decoder/demultiplexer	.36	.29	.22
246289CL	SN74HCT139D	SOIC-16	2 to 4 decoder/demultiplexer	.27	.245	.23
246511CL	SN74HCT139N	DIP-16	2 to 4 decoder/demultiplexer	.33	.29	.27
246521CL	CD74HCT154E	DIP-24	4 to 16 decoder/demultiplexer	1.19	.99	.88
246300CL	SN74HCT157D	SOIC-16	Quad 2 to 1 data selectors/multiplexers	.43	.33	.25
253016CL	CD74HCT164M	SOIC-14	8-bit serial in/parallel out shift register	.34	.31	285
250819CL	CD74HCT164E	DIP-14	8-bit serial in/parallel out shift register	.39	.33	.28
246351CL	SN74HCT240DW	SOIC-20	Octal inverting line driver w/ 3-state outputs	.34	.31	.25
250827CL	SN74HCT240N	DIP-20	Octal inverting line driver w/ 3-state outputs	.35	.32	.25
246342CL	SN74HCT244DW	SOIC-20	Octal driver tri-state	.41	.33	.25
250835CL	SN74HCT244N	DIP-20	Octal driver tri-state	.33	.31	.25
246334CL	SN74HCT245DW	SOIC-20	Octal transceiver w/ 3-state outputs	.34	.31	.25
250843CL	SN74HCT245N	DIP-20	Octal transceiver w/ 3-state outputs	.41	.33	.25
246326CL	SN74HCT273DW	SOIC-20	Octal D-type flip-flop with clear	.31	.28	.25
250851CL	SN74HCT273N	DIP-20	Octal D-type flip-flop with clear	.41	.33	.25
246140CL	SN74HCT373DW	SOIC-20	Octal D-type flip-flop w/ 3-state outputs	.34	.31	.29
250878CL	SN74HCT373N	DIP-20	Octal D-type flip-flop w/ 3-state outputs	.36	.29	.22
246166CL	SN74HCT374DW	SOIC-20	Octal D-type flip-flop edge-trig. w/ 3-state outputs	.34	.31	.25
250894CL	SN74HCT374N	DIP-20	Octal D-type flip-flop edge-trig. w/ 3-state outputs	.37	.33	.25
250907CL	CD74HCT393E	DIP-14	Dual 4-stage binary counter	.41	.33	.25
246182CL	SN74HCT540DW	SOIC-20	Octal 3-state buffer	.45	.42	.38
250915CL	SN74HCT540N	DIP-20	Octal 3-state buffer	.41	.33	.25
246203CL	SN74HCT541DW	SOIC-20	Octal buffer/line driver w/ 3-state outputs	.41	.33	.25
250923CL	SN74HCT541N	DIP-20	Octal buffer/line driver w/ 3-state outputs	.41	.33	.25
246211CL	SN74HCT573DW	SOIC-20	Octal D-type latched flip-flop w/ 3-state outputs	.41	.33	.25
250931CL	SN74HCT573N	DIP-20	Octal D-type latched flip-flop w/ 3-state outputs	.38	.33	.25
246246CL	SN74HCT574DW	SOIC-20	Octal D-type flip-flop edge-trigger w/ 3-state outputs	.38	.33	.25
250940CL	SN74HCT574N	DIP-20	Octal D-type flip-flop edge-trigger w/ 3-state outputs	.41	.33	.25
250958CL	CD74HCT688E	DIP-20	8-bit magnitude comparator	.60	.48	.43

† Note: TI now owns GE, Harris & RCA logic; Fairchild now owns National Semi logic; Philips now owns Signetics; and On Semi is also known as Motorola.

New



PHILIPS

ON Semiconductor

ON

TOSHIBA

Prepackaged: order in increments of 10 or 100

Mixed Major Brands - Save up to 20%

Part No.	Cross Ref.	1	10	100
44898CL	74HCT04N	\$.23	\$.20	\$.18
246043CL	74HCT08M	.15	.14	.14
44901CL	74HCT08N	.15	.13	.13
246060CL	74HCT14M	.17	.16	.16
44935CL	74HCT14N	\$.30	.18	.18
246123CL	74HCT32M	.13	.12	.12
45057CL	74HCT32N	\$.26	.18	.17
246254CL	74HCT74M	.16	.15	.15
45137CL	74HCT74N	.25	.21	.18
45145CL	74HCT86N	.17	.17	.17
88049CL	74HCT123N	\$.26	.18	.18
243192CL	74HCT125N	\$.24	.18	.18
246051CL	74HCT138M	.27	.24	.19
44927CL	74HCT138N	\$.34	.27	.20
246271CL	74HCT139M	.25	.23	.19
63773CL	74HCT139N	.30	.27	.23
88057CL	74HCT154N	1.06	.85	.78
246297CL	74HCT157M	.40	.30	.23
253024CL	74HCT164M	.30	.28	.25
44978CL	74HCT164N	\$.44	.28	.25
246086CL	74HCT240WM	.31	.29	.27
45014CL	74HCT240N	\$.49	.21	.18
246094CL	74HCT244WM	.38	.30	.23
45022CL	74HCT244N	\$.39	.30	.29
246107CL	74HCT245WM	.31	.29	.25
45031CL	74HCT245N	\$.39	.38	.30
246115CL	74HCT273WM	.29	.26	.23
45049CL	74HCT273N	\$.46	.38	.30
246131CL	74HCT373WM	.31	.29	.27
45065CL	74HCT373N	\$.49	.31	.23
246158CL	74HCT374WM	.31	.29	.23
45073CL	74HCT374N	\$.42	.31	.23
243205CL	74HCT393N	\$.40	.33	.23
246174CL	74HCT540WM	.38	.30	.23
109778CL	74HCT540N	\$.40	.33	.23
246191CL	74HCT541WM	.38	.30	.23
99303CL	74HCT541N	\$.69	.38	.23
246220CL	74HCT573WM	.38	.30	.23
45090CL	74HCT573N	\$.69	.35	.30
246238CL	74HCT574WM	.34	.32	.23
45102CL	74HCT574N	\$.69	.38	.23
45129CL	74HCT688N	\$.69	.48	.43

74LS Series

Part No.	Cross Ref.	Pkg.	Description	1	10	100
46252CL	74LS00N**	DIP-14	Quad 2-input NAND gate	\$.29	\$.27	\$.24
198361CL	74LS00M	SOIC-14	Quad 2-input NAND gate	.30	.27	.23
46287CL	74LS02N**	DIP-14	Quad 2-input NOR gate	.29	.25	.21
198379CL	74LS02M	SOIC-14	Quad 2-input NOR gate	.28	.25	.21
46308CL	74LS03N	DIP-14	Quad 2-input NAND gate (O.C.)	.34	.28	.23
46316CL	74LS04N**	DIP-14	Hex inverter	.29	.26	.23
198387CL	74LS04M	SOIC-14	Hex inverter	.28	.25	.21
46341CL	74LS05N*	DIP-14	Hex inverter (O.C.)	.34	.28	.21
198395CL	74LS05M	SOIC-14	Hex inverter (O.C.)	.28	.19	.15
46359CL	74LS06N	DIP-14	Hex inverter buffer/driver (O.C.)	.57	.53	.44
46367CL	74LS07N	DIP-14	Hex buffer/driver (O.C. hi-voltage)	.84	.79	.74
198408CL	74LS07M	SOIC-14	Hex buffer/driver (O.C. hi-voltage)	.66	.49	.42
46375CL	74LS08N**	DIP-14	Quad 2-input AND gate	.36	.31	.22
198416CL	74LS08M	SOIC-14	Quad 2-input AND gate	.34	.25	.19
46391CL	74LS09N	DIP-14	Quad 2-input AND gate (O.C.)	.29	.22	.15
46404CL	74LS10N*	DIP-14	Triple 3-input NAND gate	.38	.33	.23

*10 pcs. in 74LS series IC cabinet kit, pg 33

**20 pcs. in 74LS series IC cabinet kit, pg 33

74LS Series (Continued)

Part No.	Cross Ref.	Pkg.	Description	1	10	100
198424CL	74LS10M	SOIC-14	Triple 3-input NAND gate	\$.29	\$.19	\$.15
46439CL	74LS11N*	DIP-14	Triple 3-input AND gate	.36	.27	.18
198432CL	74LS11M	SOIC-14	Triple 3-input AND gate	.33	.28	.22
46640CL	74LS14N*	DIP-14	Hex inverter Schmitt trigger	.29	.25	.18
198441CL	74LS14M	SOIC-14	Hex inverter Schmitt trigger	.33	.19	.15
47095CL	74LS20N*	DIP-14	Dual 4-input NAND gate	.25	.19	.17
198459CL	74LS20M	SOIC-14	Dual 4-input NAND gate	.33	.28	.22
47108CL	74LS21N	DIP-14	Dual 4-input AND gate	.22	.19	.16
47378CL	74LS27N	DIP-14	Triple 3-input NOR gate	.23	.20	.15
47458CL	74LS30N*	DIP-14	8-input NAND gate	.33	.29	.21
198467CZ	74LS30M	SOIC-14	8-input NAND gate	.33	.28	.22
47466CL	74LS32N**	DIP-14	Quad 2-input OR gate	.29	.26	.23
198475CL	74LS32M	SOIC-14	Quad 2-input OR gate	.33	.24	.19
47597CL	74LS37N	DIP-14	Quad 2-input NAND gate buffer	.54	.50	.40
47693CL	74LS38N	DIP-14	Quad 2-input NAND gate buffer (O.C.)	.29	.23	.19
47773CL	74LS42N	DIP-16	BCD-to-decimal decoder/driver	.69	.59	.49

*10 pcs. in 74LS series IC cabinet kit, pg 33

**20 pcs. in 74LS series IC cabinet kit, pg 33

Call for pricing on quantities over 100 - we carry major manufacturers.

We will special order any IC - \$100 minimum.

74LS Series (Continued)

DIP SOIC

Part No.	Cross Ref.	Pkg.	Description	1	10	100
47790CL	74LS47N*	DIP-16	BCD to 7-seg. decoder/driver (O.C.)	\$.72	\$.52	\$.45
47811CL	74LS48N	DIP-16	BCD to 7-seg. decoder/driver	4.99	4.49	3.59
47992CL	74LS73M*	DIP-14	Dual JK flip-flop with clear	\$.30 .32	.29	.25
48004CL	74LS74N*	DIP-14	Dual D flip-flop	.29	.25	.22
198491CL	74LS74M	SOIC-14	Dual D flip-flop	.33	.24	.19
48021CL	74LS75M*	DIP-16	4-bit bi-stable latch	.63	.49	.40
198504CL	74LS75M	SOIC-16	4-bit bi-stable latch	.45	.40	.33
48039CL	74LS76N	DIP-16	Dual JK flip-flop with preset and clear	.69	.62	.55
48063CL	74LS83N	DIP-16	4-bit binary full adder	.52	.45	.40
48071CL	74LS85M*	DIP-16	4-bit magnitude comparator	.43	.33	.29
198512CL	74LS85M	SOIC-16	4-bit magnitude comparator	.45	.40	.33
48098CL	74LS86N*	DIP-14	Quad EXCLUSIVE-OR gate	.35	.30	.22
198521CL	74LS86M	SOIC-14	Quad EXCLUSIVE-OR gate	.45	.35	.29
48119CL	74LS90N*	DIP-14	Decade counter	.49	.45	.39
198539CL	74LS90M	SOIC-14	Decade counter	.50	.39	.29
48143CL	74LS92N	DIP-14	Divide-by-12 counter	.56	.49	.44
48151CL	74LS93N*	DIP-14	4-bit binary counter	.89	.79	.70
198547CL	74LS93M	SOIC-14	4-bit binary counter	.99	.89	.75
48178CL	74LS95N	DIP-14	4-bit parallel-access shift register	.89	.79	.69
46412CL	74LS107N	DIP-14	Dual JK flip-flop with clear	.49	.36	.25
46421CL	74LS109N	DIP-16	Dual JK pos. edge-trig. flip-flop	.36	.28	.19
46447CL	74LS112N	DIP-16	Dual JK neg. edge-trig. flip-flop	.41	.37	.33
46471CL	74LS122N	DIP-14	Retrig. mono. multivibrator comm. CLK	.41	.30	.27
46480CL	74LS123N*	DIP-16	Dual mono. multivibrator with clear	.39	.30	.23
198555CL	74LS123M	SOIC-16	Dual mono. multivibrator with clear	.56	.45	.33
46501CL	74LS125M*	DIP-16	Quad bus buffer neg. enable tri-state	.46	.35	.27
243168CL	74LS125AM	SOIC-14	Quad 3-state buffer	.42	.32	.25
46527CL	74LS126N	DIP-14	Quad bus buffer tri-state	\$.35 .32	.30	.22
46551CL	74LS132N	DIP-14	Quad 2-input NAND Schmitt trigger	.46	.35	.24
46586CL	74LS136N	DIP-14	Quad EXCLUSIVE-OR gate (O.C.)	.53	.40	.30
46607CL	74LS138N**	DIP-16	3 to 8 decoder/demultiplexer	.38	.35	.26
198563CL	74LS138M	SOIC-16	3 to 8 decoder/demultiplexer	.45	.40	.33
46623CL	LS139N*	DIP-16	2 to 4 decoder/demultiplexer	.34	.31	.26
46666CL	74LS145N	DIP-16	BCD-to-decimal decoder/driver	.49	.45	.39
46682CL	74LS148N	DIP-16	8 to 3 priority encoder	.79	.68	.55
46703CL	74LS151N*	DIP-16	8-input multiplexer	.39	.35	.31
198571CL	74LS151M	SOIC-16	8-input multiplexer	\$.39 .32	.28	.26
46720CL	74LS153N	DIP-16	Dual 4-to-1 selector/multiplexer	.36	.31	.23
46738CL	74LS154N	DIP-24	4 to 16 line decoder/demultiplexer	4.45	3.99	3.49
46754CL	74LS155N*	DIP-16	Dual 2/4 demultiplexer	.49	.41	.31
46762CL	74LS156N	DIP-16	Dual 2/4 demultiplexer (O.C.)	.24	.21	.19
46771CL	74LS157N*	DIP-16	Quad 2/1 data selector	.36	.31	.23
198580CL	74LS157M	SOIC-16	Quad 2/1 data selector	\$.39 .31	.25	.19
46800CL	74LS160N	DIP-16	Decade counter with asynch. clear	1.95	1.85	1.75
46818CL	74LS161N	DIP-16	Synch 4-bit counter	.44	.38	.28
46842CL	74LS163N	DIP-16	Fully synch. 4-bit counter	.44	.36	.28
46851CL	74LS164N	DIP-14	8-bit serial shift register	.37	.31	.24
46877CL	74LS165N	DIP-16	8-bit serial shift register, parallel load	.49	.42	.31
46885CL	74LS166N	DIP-16	8-bit shift register, parallel load	.38	.36	.25
46906CL	74LS169N	DIP-16	Synch. binary up/down counter	.61	.47	.35
46922CL	74LS173N	DIP-16	4-bit D-type reg. tri-state	.99	.95	.89
46931CL	74LS174N*	DIP-16	Hex D flip-flop with clear	.34	.29	.27
46957CL	74LS175N*	DIP-16	Quad D flip-flop with clear	.40	.31	.23
46973CL	74LS181N	DIP-24	Arithmetic logic unit/function generator	1.56	1.31	.89
46990CL	74LS190N	DIP-16	Synchronous up/down counter	1.71	1.54	1.37
47001CL	74LS191N	DIP-16	Up/down binary counter	.45	.38	.29
47010CL	74LS192N	DIP-16	Decade up/down counter with clear	3.95	3.59	3.25
47036CL	74LS193N*	DIP-16	Binary up/down counter with clear	.59	.49	.45
198598CL	74LS193M	SOIC-16	Binary up/down counter with clear	.56	.52	.45
47052CL	74LS194N	DIP-16	4-bit bi-directional shift register	.59	.49	.45
47061CL	74LS195N	DIP-16	4-bit parallel-access shift register	.49	.40	.28
47124CL	74LS221N	DIP-16	Dual mono. multivibrator Schmitt trigger	.49	.44	.36
243176CL	74LS221M	SOIC-16	Dual monostable multivibrator	.75	.57	.44
47141CL	74LS240N*	DIP-20	Octal invert. line driver tri-state	\$.44 .41	.31	.24
198619CL	74LS240M	SOIC-20	Octal invert. line driver tri-state	\$.49 .41	.31	.24

*10 pcs. in 74LS series IC cabinet kit, pg 33

**20 pcs. in 74LS series IC cabinet kit, pg 33

74LS Series (Continued)

DIP SOIC

Part No.	Cross Ref.	Pkg.	Description	1	10	100
47167CL	74LS241N	DIP-20	Octal bus/line driver tri-state	\$.39 .27	\$.25	\$.22
47183CL	74LS244N*	DIP-20	Octal driver tri-state	.44	.37	.28
198627CL	74LS244M	SOIC-20	Octal driver tri-state	.45	.39	.33
47212CL	74LS245N*	DIP-20	Octal bus transceiver tri-state	.45	.39	.35
198635CL	74LS245M	SOIC-20	Octal bus transceiver tri-state	\$.39 .27	.25	.21
47247CL	74LS247N	DIP-16	BCD to 7-segment decoder/driver (O.C.)	.94	.80	.62
47271CL	74LS251N	DIP-16	8-channel multiplexer tri-state	.45	.35	.29
47298CL	74LS257N	DIP-16	Quad 2-input multiplexer tri-state	.26	.24	.21
47327CL	74LS259N	DIP-16	8-bit addressable latch	.49	.41	.31
47360CL	74LS266N	DIP-14	Quad EXCLUSIVE-NOR gate (O.C.)	.49	.36	.31
47386CL	74LS273N*	DIP-20	Octal D-type flip-flop with clear	.39	.31	.24
198643CL	74LS273M	SOIC-20	Octal D-type flip-flop with clear	.45	.34	.29
47407CL	74LS279N	DIP-16	Quad set-reset latches	.49	.41	.31
47423CL	74LS283N	DIP-16	4-bit binary full add with fast carry	.45	.34	.24
47440CL	74LS299N	DIP-20	8-bit universal shift/storage register	\$.19 .82	.70	.51
47546CL	74LS365N	DIP-16	Hex buffer with logical OR tri-state	.69	.62	.47
47562CL	74LS367N	DIP-16	Hex buffer tri-state	.45	.38	.28
47600CL	74LS373N*	DIP-20	Octal D flip-flop tri-state	.45	.39	.35
198651CL	74LS373M	SOIC-20	Octal D flip-flop tri-state	.41	.31	.24
47634CL	74LS374N*	DIP-20	Octal D F/F edge-trig tri-state	.45	.39	.34
198660CL	74LS374M	SOIC-20	Octal D F/F edge-trig tri-state	.41	.31	.24
47669CL	74LS377N	DIP-20	Octal D register common enable	.14	.13	.13
47722CL	74LS390N	DIP-16	Dual 4-bit decade counter	.69	.59	.44
47731CL	74LS393N	DIP-14	Dual 4-bit binary counter	\$.49 .45	.39	.30
243184CL	74LS393M	SOIC-16	Dual 4-bit binary counter	.84	.65	.50
47861CL	74LS540N	DIP-20	Octal invert. buffer/line driver tri-state	.86	.74	.55
47870CL	74LS541N	DIP-20	Octal buffer/line driver tri-state	.69	.59	.49
64418CL	74LS573N	DIP-20	Octal D-type F/F latch tri-state	2.06	1.81	1.23
64426CL	74LS574N	DIP-20	Octal D-type F/F edge-trig. tri-state	2.11	1.81	1.36
47909CL	74LS590N	DIP-16	8-bit binary counter w/o reg. tri-state	\$.49 4.55	4.23	3.55
103974CL	74LS595N	DIP-16	8-bit serial-to-parallel shift reg. tri-state	4.49	3.99	3.49
47950CL	74LS645N	DIP-20	Octal bus transceiver tri-state	1.69	1.45	1.09
47984CL	74LS688N	DIP-20	8-bit magnitude comparator	1.19	1.02	.79

*10 pcs. in 74LS series IC cabinet kit, pg 33

4000 Series

New Lower Prices

DIP SOIC

Part No.	Cross Ref.	Pkg.	Description	1	10	100
12562CL	CD4001N**	DIP-14	Quad 2-input NOR gate	\$.29	\$.24	\$.19
197261CL	CD4001M	SOIC-14	Quad 2-input NOR gate	\$.29 .25	.21	.16
12597CL	CD4007N	DIP-14	Dual comp. pair with inverter	.29	.25	.22
12634CL	CD4011N**	DIP-14	Quad 2-input NAND gate	.29	.24	.19
197270CL	CD4011M	SOIC-14	Quad 2-input NAND gate	\$.29 .23	.22	.14
12677CL	CD4013N**	DIP-14	Dual D flip-flop with set/reset	.35	.25	.22
197288CL	CD4013M	SOIC-14	Dual D flip-flop with set/reset	\$.29 .18	.17	.14
12706CL	CD4015N*	DIP-16	Dual 4-stage static shift register	.45	.37	.28
12722CL	CD4016N*	DIP-14	Quad bilateral switch	.28	.24	.18
12749CL	CD4017N*	DIP-16	Decade counter/divider	.39	.35	.31
197296CL	CD4017M	SOIC-16	Decade counter/divider	.56	.45	.33
12773CL	CD4018N	DIP-16	Presettable divide-by-N counter	\$.39 .30	.25	.23
12802CL	CD4020N*	DIP-16	14-stage binary/ripple counter	.49	.39	.29
197309CL	CD4020M	SOIC-16	14-stage binary/ripple counter	.56	.39	.29
12829CL	CD4021N	DIP-16	8-stage static shift register	\$.35 .32	.27	.18
54666CL	CD4022N	DIP-16	Div. by 8-cnt./driver w/ 8-decoded outputs	\$.39 .32	.31	.29
12845CL	CD4023N*	DIP-14	Triple 3-input NAND gate	.29	.25	.19
12853CL	CD4024N*	DIP-14	7-stage binary counter	\$.35 .32	.27	.18
12888CL	CD4027N*	DIP-16	Dual JK master-slave flip-flop	\$.39 .32	.27	.18
197317CL	CD4027M	SOIC-16	Dual JK master-slave flip-flop	\$.39 .31	.25	.18
12909CL	CD4028N	DIP-16	BCD-to-decimal decoder	\$.35 .32	.27	.18
12925CL	CD4029N	DIP-16	Presettable up/down counter	\$.39 .32	.27	.18
197325CL	CD4029M	SOIC-16	Presettable up/down counter	.56	.51	.45
12950CL	CD4040N*	DIP-16	12-stage binary/ripple counter	\$.35 .32	.27	.18
197333CL	CD4040M	SOIC-16	12-stage binary/ripple counter	.33	.25	.19
12984CL	CD4042N	DIP-16	Quad clocked D latch	\$.39 .25	.21	.15
12992CL	CD4043N	DIP-16	Quad NOR R-S latch tri-state	.31	.25	.23
13004CL	CD4044N	DIP-16	Quad 3-state NAND R-S latch tri-state	\$.45 .32	.29	.23

*10 pcs. in 4000 series IC cabinet kit, pg 33

**20 pcs. in 4000 series IC cabinet kit, pg 33

Call for pricing on quantities over 100 - we carry major manufacturers. We will special order any IC - \$100 minimum.

4000 Series (Continued)

Part No.	Cross Ref.	Pkg.	Description	New Lower Prices		
				DIP	SOIC	100
13012CL	CD4046N*	DIP-16	Micropower phase-locked loop	\$.41	\$.32	\$.25
13039CL	CD4047N	DIP-14	Monostable/astable multivibrator	.31	.27	.29
13055CL	CD4049N**	DIP-16	Hex/buffer/converter (inverting)	.29	.24	.21
197341CL	CD4049M	SOIC-16	Hex/buffer/converter (inverting)	\$.35 .33	.27	.24
13071CL	CD4050N*	DIP-16	Hex/buffer/converter (N-inverting)	.29	.25	.23
197350CL	CD4050M	SOIC-16	Hex/buffer/converter (N-inverting)	.29	.13	.12
13098CL	CD4051N*	DIP-16	Single 8-channel multi/demultiplexer	.45	.39	.35
197368CL	CD4051M	SOIC-16	Single 8-channel multi/demultiplexer	\$.39 .29	.23	.21
13119CL	CD4052N	DIP-16	Diff. 4-channel multi/demultiplexer	\$.35 .31	.28	.17
13127CL	CD4053N	DIP-16	Triple 2-channel multi/demultiplexer	.33	.28	.29
13151CL	CD4060N	OIP-16	14-stage ripple-carry binary	.33	.21	.29
13186CL	CD4066N**	OIP-14	Quad bilateral switch	.35	.25	.19
197376CL	CD4066M	SOIC-14	Quad bilateral switch	\$.29 .25	.21	.16
13215CL	CD4067N	DIP-24	16-channel analog multi/demultiplexer	\$.29 .24	.23	.20
13231CL	CD4069N*	DIP-14	Hex inverter (74C04)	.29	.24	.17
197384CL	CD4069M	SOIC-14	Hex inverter (74C04)	\$.29 .25	.21	.16
13258CL	CD4070N*	DIP-14	Quad EXCLUSIVE-OR gate (74C86)	.28	.24	.17
13274CL	CD4071N*	DIP-14	Quad 2-input OR gate	\$.29 .24	.19	.13
197392CL	CD4071M	SOIC-14	Quad 2-input OR gate	.31	.26	.18
13354CL	CD4081N*	DIP-14	Quad 2-input AND gate	.29	.24	.17
197405CL	CD4081M	SOIC-14	Quad 2-input AND gate	.31	.26	.18
13400CL	CD4093N*	DIP-14	Quad 2-input NAND Schmitt trigger	.29	.25	.19
197413CL	CD4093M	SOIC-14	Quad 2-input NAND Schmitt trigger	\$.29 .29	.18	.16
13426CL	CD4094N	DIP-16	8-stage shift-and-store bus register	\$.49 .41	.39	.27
13434CL	CD4098N	DIP-16	CMOS/MOS dual mono. multivibrator	.45	.38	.23
13442CL	CD4099N	DIP-16	8-bit addressable latch	\$.49 .41	.34	.19
13469CL	CD4503N	DIP-16	Tri-state hex buffer (74C367) 80C97	\$.39 .31	.26	.17
13485CL	CD4510N	DIP-16	BCD up/down counter	.69	.59	.45
13493CL	CD4511N*	DIP-16	BCD to 7-seg. latch/decoder/driver	.69	.59	.49
197421CL	CD4511M	SOIC-16	BCD to 7-seg. latch/decoder/driver	.47	.38	.29
13514CL	CD4512N	DIP-16	8-channel data selector	.59	.50	.38
13522CL	CD4514N	DIP-24	4-bit latch/4-16 line decoder	.89	.79	.69
13549CL	CD4516N	DIP-16	Binary up/down counter	.54	.46	.34
13565CL	CD4518N	DIP-16	Dual BCD up counter	.49	.42	.31
13581CL	CD4520N	DIP-16	Dual binary up counter	.45	.35	.25
13590CL	CD4522N	DIP-16	Program. BCD divide-by-N counter	.89	.76	.57
13602CL	CD4526N	DIP-16	Divide-by-N counter (binary)	.55	.47	.42
13611CL	CD4528N	DIP-16	Dual monostable multivibrator	.69	.49	.39
13653CL	CD4538N*	DIP-16	Dual precision monostable multivibrator	.59	.49	.39
197430CL	CD4538M	SOIC-16	Dual precision monostable multivibrator	\$.69 .59	.48	.39
13688CL	CD4541N	DIP-14	Oscillator/programmable timer	.39	.33	.25
13696CL	CD4543N*	DIP-16	BCD to 7-segment decoder (LCD)	.59	.45	.29
13709CL	CD4553N	DIP-16	3-digit BCD counter	2.95	2.75	2.49
13768CL	CD4584N*	DIP-14	Hex Schmitt trigger (74C14) 40106	.39	.35	.29
197448CL	CD4584M	SOIC-14	Hex Schmitt trigger (74C14) 40106	.33	.28	.22
44257CL	CD40106N	DIP-14	Hex inverter Schmitt trigger (74C14)	\$.39 .31	.27	.21

* 10 pcs. in 4000 series IC cabinet kit, pg 33 ** 20 pcs. in 4000 series IC cabinet kit, pg 33

7400 Series

Part No.	Cross Ref.	Pkg.	Description	DIP		
				1	10	100
48979CL	7400N*	DIP-14	Quad 2-input NAND gate	\$.65	\$.55	\$.45
49007CL	7401N	DIP-14	Quad 2-input NAND gate (O.C.)	.59	.55	.49
49015CL	7402N*	DIP-14	Quad 2-input NOR gate	.59	.49	.45
49040CL	7404N*	DIP-14	Hex inverter	.59	.49	.45
49074CL	7405N*	DIP-14	Hex inverter (O.C.)	.56	.43	.30
49091CL	7406N*	DIP-14	Hex inverter buffer/driver (O.C.)	.45	.39	.35
49120CL	7407N*	DIP-14	Hex buffer/driver (O.C.)	.35	.32	.28
49146CL	7408N*	DIP-14	Quad 2-input AND gate	.82	.63	.48
49189CL	7410N*	DIP-14	Triple 3-input NAND gate	.33	.30	.21
49402CL	7413N	DIP-14	Dual 4-input NAND gate Schmitt trigger	.89	.76	.57
49437CL	7414N*	DIP-14	Hex inverter Schmitt trigger	.59	.54	.50
49630CL	7416N*	DIP-14	Hex inverter buffer/driver (O.C.)	\$.69 .52	.46	.44
49728CL	7417N*	DIP-14	Hex buffer/driver (O.C. hi-voltage)	.91	.77	.58
50008CL	7420N*	DIP-14	Dual 4-input NAND gate	.49	.45	.39
50083CL	7425N	DIP-14	Dual 4-input NOR gate with strobe	\$.69 .49	.45	.39
50139CL	7427N	DIP-14	Triple 3-input NOR gate	.59	.50	.38

* 10 pcs. in 7400 series IC cabinet kit, pg 33 ** 20 pcs. in 7400 series IC cabinet kit, pg 33

7400 Series (Continued)

Part No.	Cross Ref.	Pkg.	Description	DIP		
				1	10	100
50198CL	7428N	DIP-14	Quad 2-input NOR buffer	\$.79	\$.69	\$.59
50235CL	7432N*	DIP-14	Quad 2-input OR gate	.59	.49	.45
50315CL	7438N*	DIP-14	Quad 2-input NAND buffer (O.C.)	.56	.48	.37
50358CL	7440N	DIP-14	Dual 4-input NAND buffer	.59	.47	.33
50374CL	7442N	DIP-16	BCD-to-decimal decoder	1.14	.97	.73
50403CL	7445N	DIP-16	BCD-to-decimal decoder/driver (30V)	1.02	.91	.79
50411CL	7446N	DIP-16	BCD-to-7 segment decoder/driver (30V)	2.09	1.95	1.89
50420CL	7447N*	DIP-16	BCD-to-7 segment decoder/driver (15V)	1.49	1.29	.99
50518CL	7470N*	DIP-14	Edge-triggered JK flip-flop	.81	.77	.73
50526CL	7472N	DIP-14	AND gated JK master/slave flip-flop	1.24	.94	.76
50534CL	7473N	DIP-14	Quad JK flip-flop with clear	.85	.75	.59
50551CL	7474N**	OIP-14	Dual D flip-flop	.59	.49	.39
50577CL	7475N	DIP-16	4-bit bi-stable latch	2.95	2.75	2.49
50593CL	7476N	DIP-16	Quad JK flip-flop with preset and clear	1.79	1.51	1.08
50631CL	7483N	DIP-16	4-bit binary full adder	.89	.79	.69
50657CL	7485N*	DIP-16	4-bit magnitude comparator	.74	.61	.45
50227CL	7430N*	DIP-14	8-input NAND gate	.56	.48	.37
50665CL	7486N	DIP-14	Quad EXCLUSIVE-OR gate	.89	.75	.56
50681CL	7489N	DIP-16	64-bit RAM P 50ns	3.49	3.19	2.99
50690CL	7490N	DIP-14	Decade counter	1.49	1.15	.78
50737CL	7492N	DIP-14	Divide-by-12 counter	1.49	1.29	.95
50745CL	7493N	DIP-14	4-bit binary counter	1.49	1.34	1.19
50770CL	7495N*	DIP-14	4-bit parallel-access shift reg. (K155N)	.79	.68	.45
50796CL	7497N	DIP-16	Synch. 6-bit binary rate multipliers	1.99	1.69	1.24
49234CL	74107N*	DIP-14	Dual JK flip-flop with clear	.45	.38	.28
49293CL	74116N	DIP-24	Dual 4-bit latches with clear	1.24	1.11	.99
49322CL	74121N	DIP-14	Monostable multivibrator	.99	.89	.79
49349CL	74122N	DIP-14	Retriggerable mono. multivibrator w/ clear	1.02	1.00	.98
49357CL	74123N*	DIP-16	Dual retriggerable mono. multivibrator	.79	.74	.66
49373CL	74125N	DIP-14	Quad bus buffer tri-state (DM8093N)	1.11	.99	.86
49411CL	74132N*	DIP-14	Quad 2-input NAND Schmitt trigger	1.02	.79	.56
49496CL	74148N	DIP-16	8 to 3 line octal priority encoder	1.24	1.11	.99
49509CL	74150N	DIP-24	16 to 1 line multiplexer	1.95	1.75	1.55
49525CL	74151N*	DIP-16	8-input multiplexer	.49	.44	.36
49550CL	74153N*	DIP-16	Dual 4/1 data selector/multiplexer	.49	.36	.25
49568CL	74154N	DIP-24	4 to 16 line decoder/demultiplexer	2.25	1.95	1.75
49605CL	74157N*	DIP-16	Quad 2/1 data selector	.61	.46	.33
49648CL	74160N*	DIP-16	Decade counter with asynch. clear	.45	.38	.29
49664CL	74161N	DIP-16	Synchronous 4-bit counter	.61	.53	.40
49672CL	74163N	DIP-16	Synchronous 4-bit counter	.61	.53	.39
49681CL	74164N	DIP-14	8-bit serial shift register	.74	.63	.48
49699CL	74165N	DIP-16	8-bit serial shift register, parallel load	.86	.74	.56
49779CL	74174N*	DIP-16	Hex D-type flip-flop with clear	.86	.74	.56
49795CL	74175N*	DIP-16	Quad D-type flip-flop with clear	.74	.63	.48
49832CL	74180N	DIP-14	9-bit odd/even parity generator/checker	2.49	2.34	1.99
49841CL	74181N	DIP-24	Arithmetic logic unit/function generator	2.86	2.49	2.24
49883CL	74189N	DIP-16	64-bit RAM tri-state (DM8599N)	\$.99 .89	.81	.73
49904CL	74191N	DIP-16	Binary up/down counter	1.61	1.44	1.09
49912CL	74192N	DIP-16	Decade up/down counter with clear	3.69	3.39	3.19
49939CL	74193N	DIP-16	Binary up/down counter with clear	1.60	1.37	1.25
49955CL	74194N	DIP-16	4-bit bi-directional shift register	1.39	1.25	1.15
49963CL	74195N	DIP-16	4-bit parallel-access shift register	1.89 1.38	1.28	1.10
50171CL	74279N*	DIP-16	Quad set-reset latch	1.74	1.56	1.44
88225CL	SDLD001A	—	Texas Instruments TTL Data Book	34.95	31.49	29.95

* 10 pcs. in 7400 series IC cabinet kit, pg 33 ** 20 pcs. in 7400 series IC cabinet kit, pg 33

74AC Series

Part No.	Cross Ref.	Pkg.	Description	DIP		
				1	10	100
211801CL	74AC00N	DIP-14	Quad 2-input NAND gate	\$.20	\$.18	\$.155
211810CL	74AC02N	DIP-14	Quad 2-input NOR gate	.17	.14	.13
211828CL	74AC04N	DIP-14	Hex inverter	.16	.13	.12
211836CL	74AC08N	DIP-14	Quad 2-input AND gate	.19	.17	.16
238887CL	74AC10N	DIP-14	Triple 3-input NAND gate	.20	.19	.16
238895CL	74AC11N	DIP-14	Triple 3-input AND gate	\$.41 .38	.35	.31
211844CL	74AC14N	DIP-14	Hex inverter with Schmitt trigger input	.24	.21	.17
238836CL	74AC20N	DIP-14	4-input NAND gate	.41	.36	.26
211852CL	74AC32N	DIP-14	Quad 2-input OR gate	.20	.19	.15
211861CL	74AC74N	DIP-14	Dual D-type pos. edge-triggered flip-flop	.20	.19	.15

Prepackaged: order in increments of 10 or 100

Call for pricing on quantities over 100 - we carry major manufacturers. We will special order any IC - \$100 minimum.

74AC Series (Continued)

DIP

Part No.	Cross Ref.	Pkg.	Description	* Prepackaged: order in increments of 10 or 100		
				1	10	100
211879CL	74AC86N	DIP-14	Quad 2-input exclusive OR gate	*	\$.17	\$.14
238908CL	74AC109N	DIP-16	Dual JK positive edge triggered flip-flop	.55	.42	.32
238916CL	74AC125N	DIP-14	Quad buffer with 3-state outputs	.46	.39	.29
211887CL	74AC138N	DIP-16	1 of 8 decoder/demultiplexer	.34	.30	.26
238730CL	74AC139N	DIP-16	Dual 1 of 4 decoder/demultiplexer	.55	.42	.32
238748CL	74AC151N	DIP-16	8-input multiplexer	.49	.42	.32
238756CL	74AC153N	DIP-16	Dual 4-input multiplexer	.49	.42	.32
238764CL	74AC157N	DIP-16	Quad 2-input multiplexer	.46	.35	.27
238772CL	74AC161N	DIP-16	Synchronous presettable binary counter	.59	.45	.35
238781CL	74AC163N	DIP-16	Binary counter	.59	.45	.35
238799CL	74AC169N	DIP-16	4-stage synchronous bidirectional counter	.93	.84	.75
238801CL	74AC174N	DIP-16	HEX D-type flip-flop w/ master reset	.49	.38	.29
238810CL	74AC175N	DIP-16	Quad D-type flip-flop	.59	.45	.35
238828CL	74AC191N	DIP-16	Up/down counter w/ preset & ripple clock	1.25	1.06	.87
211895CL	74AC240N	DIP-20	Octal buffer/line driv. w/ 3-st. outputs (2-6V)	.31	.28	.23
238844CL	74AC241N	DIP-20	Octal buffer/line driver w/ 3-state outputs	.44	.36	.28
211908CL	74AC244N	DIP-20	Octal bidirectional trans. w/ 3-st. outputs (4.5-5.5V)	\$.35	.30	.25
211916CL	74AC245N	DIP-20	Octal bidirectional trans. w/ 3-state I/O	\$.37	.30	.24
238852CL	74AC251N	DIP-16	8-input multiplexer w/ 3-state output	.41	.38	.34
238861CL	74AC253N	DIP-16	Dual 4-input multiplexer w/ 3-state outputs	.36	.33	.30
238879CL	74AC257N	DIP-16	Quad 2-input multiplexer	.40	.35	.32
238924CL	74AC299N	DIP-20	8-input univ. shift/storg. reg. w/ com. parallel I/O pins	1.35	1.29	1.16
211924CL	74AC273N	DIP-20	Octal D-type flip-flop	.42	.38	.35
211932CL	74AC373N	DIP-20	Octal transparent latch w/ 3-state outputs	.42	.37	.32
211941CL	74AC374N	DIP-20	Octal D-type flip-flop w/ 3-state outputs	.33	.30	.25
242763CL	74AC377N	DIP-20	Octal D-type flip flop w/ clock enable	\$.71	.60	.46
238941CL	74AC399N	DIP-16	Quad 2-port register	2.04	1.76	1.53
238959CL	74AC521N	DIP-20	8-bit identity comparator	.83	.65	.54
238967CL	74AC540N	DIP-20	Octal buffer/line driver w/ 3-state outputs	.43	.39	.37
238975CL	74AC541N	DIP-20	Octal buffer/line driver w/ 3-state outputs	.47	.41	.36
238983CL	74AC573N	DIP-20	Octal latch w/ 3-state outputs	.34	.29	.26
238991CL	74AC574N	DIP-20	Octal D-type flip-flop w/ 3-state outputs	.77	.66	.48

74ACT Series

DIP

Part No.	Cross Ref.	Pkg.	Description	* Prepackaged: order in increments of 10 or 100		
				1	10	100
211959CL	74ACT00N	DIP-14	Quad 2-input NAND gate	\$.20	\$.19	\$.15
211967CL	74ACT02N	DIP-14	Quad 2-input NOR gate	\$.27	.23	.17
211975CL	74ACT04N	DIP-14	Hex inverter	.24	.22	.18
211983CL	74ACT08N	DIP-14	Quad 2-input AND gate	.20	.19	.15
239046CL	74ACT10N	DIP-14	Triple 3-input NAND gate	.21	.20	.16
211991CL	74ACT14N	DIP-14	Hex inverter with Schmitt trigger input	.22	.21	.17
212003CL	74ACT32N	DIP-14	Quad 2-input OR gate	.20	.20	.20
212011CL	74ACT74N	DIP-14	Dual D-type pos. edge-triggered flip-flop	.20	.17	.16
212020CL	74ACT86N	DIP-14	Quad 2-input exclusive OR gate	.20	.16	.16
239003CL	74ACT125N	DIP-14	Quad buffer with 3-state outputs	.34	.32	.27
212038CL	74ACT138N	DIP-16	1 of 8 decoder/demultiplexer	\$.52	.24	.20
239011CL	74ACT139N	DIP-16	Dual 1 of 4 decoder/demultiplexer	.40	.33	.23
239020CL	74ACT151N	DIP-16	8-input multiplexer	.55	.42	.32
239038CL	74ACT157N	DIP-16	Quad 2-input multiplexer	.55	.42	.32
239071CL	74ACT161N	DIP-16	Synchronous binary counter	.42	.35	.29
239062CL	74ACT163N	DIP-16	Synchronous presettable binary counter	.55	.45	.35
239054CL	74ACT174N	DIP-16	HEX D-type flip-flop with master reset	.46	.39	.34
239089CL	74ACT175N	DIP-16	Quad D-type flip flop	.43	.37	.27
212046CL	74ACT240N	DIP-20	Octal buffer/line driv. w/ 3-st. outputs (2-6V)	.31	.28	.23
239097CL	74ACT241N	DIP-20	Octal buffer/line driver with 3-state outputs	.44	.36	.28
212054CL	74ACT244N	DIP-20	Octal buffer/line driv. w/ 3-st. outputs (4.5-5.5V)	.40	.35	.26
212062CL	74ACT245N	DIP-20	Octal bidirectional trans. w/ 3-state I/O	.39	.36	.33
239100CL	74ACT251N	DIP-16	8-input multiplexer	\$.46	.35	.27
239126CL	74ACT257N	DIP-16	Quad 2-input multiplexer with 3-st. outputs	.39	.32	.29
212071CL	74ACT273N	DIP-20	Octal D-type flip-flop	\$.83	.38	.32
212089CL	74ACT373N	DIP-20	Octal transparent latch w/ 3-st. outputs	\$.55	.43	.35
212097CL	74ACT374N	DIP-20	Octal D-type flip-flop w/ 3-state outputs	.31	.28	.23
235230CL	74ACT521N	DIP-20	8-bit identity comparator	.71	.54	.41
235248CL	74ACT533N	DIP-20	Octal transparent latch w/ 3-state outputs	.44	.40	.36
235264CL	74ACT541N	DIP-20	Octal buffer/line driver with 3-state outputs	.65	.55	.40
235272CL	74ACT573N	DIP-20	Octal latch with 3-state outputs	.55	.48	.35
235281CL	74ACT574N	DIP-20	Octal D-type flip-flop	.73	.59	.45
235299CL	74ACT715N	DIP-20	Programmable video sync. generator	\$12.99	10.15	9.12 7.56

74AHC Series

DIP

Part No.	Cross Ref.	Pkg.	Description	* Prepackaged: order in increments of 10 or 100		
				1	10	100
214092CL	74AHC00N	DIP-14	Quad 2-input positive NAND gate	\$.32	\$.27	\$.19
214105CL	74AHC02N	DIP-14	Quad 2-input positive NOR gate	.34	.27	.19
214113CL	74AHC04N	DIP-14	Hex inverter	\$.46	.34	.27
214121CL	74AHC08N	DIP-14	Quad 2-input positive AND gate	.34	.27	.19
214130CL	74AHC14N	DIP-14	Hex inverter with Schmitt trigger input	.34	.29	.19
214148CL	74AHC32N	DIP-14	Quad 2-input positive OR gate	*	.16	.13
214156CL	74AHC74N	DIP-14	Dual D-type pos. edge-trigg. flip-flop	\$.29	.27	.26
214164CL	74AHC86N	DIP-14	Quad 2-input exclusive OR gate	\$.37	.34	.27
243213CL	74AHC138N	DIP-16	3-line to 8-line decoders/demultiplexers	.22	.19	.17
243221CL	74AHC139N	DIP-16	Dual 2-line to 4-line decoders/demultiplexers	.21	.20	.19
214172CL	74AHC240N	DIP-20	Octal buffer/driver w/ 3-st. outputs	\$.57	.42	.34
214181CL	74AHC244N	DIP-20	Octal buffer/driver w/ 3-st. outputs	\$.49	.27	.25
214199CL	74AHC245N	DIP-20	Octal bus transceiver w/ 3-st. outputs	\$.52	.42	.34
214201CL	74AHC373N	DIP-20	Octal transprt. D-type latch w/ 3-st. outputs	\$.42	.27	.25
214210CL	74AHC374N	DIP-20	Octal edge-trig. D-type flip-flop w/ 3-st. outputs	\$.49	.26	.24
214228CL	74AHC541N	DIP-20	Octal buffer/driver w/ 3-state outputs	.39	.34	.24
214236CL	74AHC574N	DIP-20	Octal edge-trig. D-type flip-flop w/ 3-st. outputs	\$.55	.42	.34

74AHC Series

DIP

Part No.	Cross Ref.	Pkg.	Description	* Prepackaged: order in increments of 10 or 100		
				1	10	100
43844CL	74AHC00N	DIP-14	Quad 2-input positive NAND gate	\$.21	\$.15	\$.10
43852CL	74AHC02N	DIP-14	Quad 2-input positive NOR gate	\$.25	.15	.12
43861CL	74AHC04N	DIP-14	Hex inverter	\$.25	.13	.09
63431CL	74AHC08N	DIP-14	Quad 2-input positive AND gate	\$.24	.17	.09
63458CL	74AHC14N	DIP-14	Hex inverter with Schmitt trigger input	.24	.23	.22
43924CL	74AHC174N	DIP-14	Dual D-type pos. edge-triggered flip-flop	.34	.27	.13
43932CL	74AHC86N	DIP-14	Quad 2-input exclusive OR gate	\$.24	.21	.19
243248CL	74AHC138N	DIP-16	3-line to 8-line decoders/demultiplexers	.34	.28	.19
243256CL	74AHC139N	DIP-16	Dual 2-line to 4-line decoders/demultiplexers	.32	.27	.21
214244CL	74AHC240N	DIP-20	Octal buffer/driver w/ 3-st. outputs (2-6V)	\$.46	.27	.25
63466CL	74AHC244N	DIP-20	Octal buffer/driver w/ 3-st. outputs (4.5-5.5V)	.26	.21	.17
43887CL	74AHC245N	DIP-20	Octal bus transceiver w/ 3-state outputs	.41	.39	.35
43908CL	74AHC373N	DIP-20	Octal transparent D-type latch w/ 3-st. outputs	.39	.37	.35
43916CL	74AHC374N	DIP-20	Octal edge-trig. D-type flip-flop w/ 3-st. outputs	.49	.45	.36
214252CL	74AHC574N	DIP-20	Octal edge-trig. D-type flip-flop w/ 3-st. outputs	\$.46	.42	.34

74ALS Series

New

DIP

Part No.	Cross Ref.	Pkg.	Description	* Prepackaged: order in increments of 10 or 100		
				1	10	100
245294CL	74ALS00AN	DIP-14	Quad 2-input NAND gate	\$.38	\$.33	\$.23
43959CL	74ALS02N	DIP-14	Quad 2-input NOR gate	.30	.27	.22
245307CL	74ALS04BN	DIP-14	Hex inverters	.38	.33	.23
245286CL	74ALS05AN	DIP-14	Hex inverters w/ open collector outputs	.38	.33	.23
43983CL	74ALS08N	DIP-14	Quad 2-input AND gate	.37	.32	.23
245315CL	74ALS10AN	DIP-14	Triple 3-input NAND gate	.25	.24	.23
245323CL	74ALS11AN	DIP-14	Triple 3-input AND gate	.38	.33	.24
63503CL	74ALS27N	DIP-14	Triple 3-input NOR gate	.21	.19	.18
245796CL	74ALS30AN	DIP-14	8-input NAND gate	.40	.33	.23
245753CL	74ALS240AN	DIP-20	Octal 3-state bus driver	.39	.30	.23
245761CL	74ALS244AN	DIP-20	Octal 3-state bus driver	.56	.47	.35
245770CL	74ALS245AN	DIP-20	Octal 3-state bus transceiver	.39	.30	.23
44100CL	74ALS251N	DIP-16	3-st. 1 of 8 line data selector/multiplexer	.47	.42	.43
245788CL	74ALS258N	DIP-20	3-st. quad 1 of 2 line data selector/multiplex. (inverting)	.67	.64	.57
44118CL	74ALS273N	DIP-20	Octal D-type edge trig. flip-flops w/ clear inputs	.79	.60	.45
44142CL	74ALS373N	DIP-20	Octal D-type 3-st. transparent latches	.71	.49	.36
245809CL	74ALS374AN	DIP-20	Octal 3-st. D-type edge trigg. flip-flops	.39	.30	.23
245817CL	74ALS520N	DIP-20	8-bit comparator	1.12	.95	.76
245825CL	74ALS521N	DIP-20	8-bit comparator	1.37	1.16	.82
245833CL	74ALS533N	DIP-20	Octal D-type transparent latches w/ 3-st. outputs	1.21	1.02	.73
245841CL	74ALS540N	DIP-20	Octal inverting buffers & line driv. w/ 3-st. outputs	.80	.67	.54
245850CL	74ALS541N	DIP-20	Octal buffers & line drivers w/ 3-st. outputs	.74	.62	.50
245868CL	74ALS573BN	DIP-20	Extend. temp. octal D-type transp. latch w/ 3-st. outputs	.34	.29	.23
245876CL	74ALS574AN	DIP-20	Octal D-type edge trig. flip-flops w/ 3-st. outputs	.34	.32	.28
245884CL	74ALS845AN	DIP-20	Octal bus transceivers	1.00	.84	.67

Call for pricing on quantities over 100 - we carry major manufacturers. We will special order any IC - \$100 minimum.

74C Series

Part No.	Cross Ref.	Pkg.	Description	DIP		
				1	10	100
44222CL	74C00N	DIP-14	Quad 2-input NAND gate	\$.79	\$.59	\$.41
44231CL	74C04N	DIP-14	Hex inverter (CD4069)	.79	.59	.41
44257CL	74C14N	DIP-14	Hex inverter Schmitt trigger (CD40106)	\$.39	.27	.18
44441CL	74C74N	DIP-14	Dual D flip-flop	1.59	1.35	1.05
44361CL	74C221N	DIP-16	Dual monostable multivibrator	3.95	3.59	3.25
13469CL	74C367N	DIP-16	Hex buffer tri-state (80C97/CD4503)	\$.39	.28	.21
44396CL	74C373N	DIP-20	Octal D-type flip-flop with clear tri-state	3.75	3.25	2.49
44409CL	74C374N	DIP-20	Octal D-type flip-flop tri-st. (INS82C06N)	1.69	1.49	1.35
44564CL	74C922N	DIP-18	16-key keyboard encoder (INS8245N)	6.29	5.05	4.26
44572CL	74C923N	DIP-20	20-key keyboard encoder (INS8246N)	5.99	4.95	4.09
44581CL	74C925N	DIP-16	4-digit CTR w/ MUX D segment driver	13.99	11.49	10.49
44599CL	74C926N	DIP-18	4-digit CTR w/ MUX D segment driver	6.95	6.25	5.65

74S Series

Part No.	Cross Ref.	Pkg.	Description	DIP		
				1	10	100
48531CL	74S188N	DIP-16	256-bit (32 x 8) PROM O.C. (27S18)	\$4.35	\$3.91	\$3.19
48557CL	74S189N	DIP-16	64-bit (16 x 4) RAM tri-state (27S03)	4.15	4.05	3.65
48696CL	74S287N	DIP-16	1k-bit (256 x 4) PROM tri-state (T8P24S10)	6.95	6.25	5.65
48717CL	74S288N	DIP-16	256-bit (32 x 8) PROM tri-st. (TBP18S030N)	6.99	6.00	5.25
48805CL	74S387N	DIP-16	1k-bit (256 x 4) PROM O.C. (TBP24SA10N)	4.29	3.89	3.59
52513CL	74S428N	DIP-28	System contr./bus driver (8228)	2.95	2.55	1.89
48864CL	74S472N	DIP-20	4k-bit (512 x 8) PROM tri-st. (TBP28S42N)	12.95	11.65	10.49
48910CL	74S571N	DIP-16	2k-bit (512 x 4) PROM tri-st. (AM27S13)	\$6.99	5.69	5.29
48928CL	74S573N	DIP-18	4k-bit (1024 x 4) PROM tri-st. (53S441J)	3.55	3.15	2.83

9000 Series

Part No.	Cross Ref.	Pkg.	Description	DIP		
				1	10	100
53663CL	9368	DIP-16	FND70 driver/latch	\$4.49	\$3.95	\$3.55
10567CL	AM9513ACP	DIP-40	System timing controller	39.95	33.99	25.49

Dallas Semiconductor

Part No.	Product No.	Pkg.	Description	DIP		
				1	10	100
114198CL	DS1210	DIP-8	Nonvolatile controller chip	\$3.95	\$3.59	\$3.25
114219CL	DS1213C	DIP-28	SmartSocket 64K/256k	16.95	15.29	12.19
133410CL	DS1216C	DIP-28	Smartwatch/RAM 64K/256k	31.85	27.69	19.99
114331CL	DS1232	DIP-8	Micromonitor chip	1.89	1.42	1.25
133444CL	DS1286	DIP-28	Watchdog timekeeper (50-Byte RAM)	23.09	19.05	13.79
76646CL	DS1287	DIP-24	Real time clock with RAM (MC146818A)	5.95	5.09	3.79
176778CL	DS1302	DIP-8	Trickle charge time keeping IC	2.49	2.25	2.05
114374CL	DS1387	DIP-24	RAMified real time clock 4kx8	\$2.55	2.18	1.71
114382CL	DS1620	DIP-8	Digital thermometer and thermostat	6.29	5.05	3.49
245500CL	DS1705ESA	SOIC-8	3V and 5V micromonitor	2.05	1.56	1.09
133452CL	DS12887	DIP-24	Real time clock chip	6.95	6.25	5.65
114403CL	DS80C320-MCG	DIP-40	High speed micro 25MHz	13.69	9.59	6.69

Maxim-Type Interface Series

Part No.	Cross Ref.	Pkg.	Description	DIP		
				1	10	100
142535CL	HIN202CP	DIP-16	+5V RS-232 trans. requires 0.1µF caps	\$2.49	\$2.25	\$2.05
244232CL	MAX202CSE	SOIC-16	+5V RS-232 trans. w/ 0.1µF int. caps	1.17	1.02	.90
244241CL	MAX202EPE	DIP-16	+5V RS-232 transceivers	1.13	.99	.88
244259CL	MAX202ESE	SOIC-16	+5V RS-232 trans. w/ 0.1µF ext. caps	1.13	.99	.88
24811CL	MAX232CPE	DIP-16	+5V powered, dual RS-232 transmitter/receiver (0°C to +70°C)	2.19	1.75	1.45
106147CL	MAX232CWE	SOIC-16	+5V powered, dual RS-232 trans./receiver	1.95	1.75	1.59
256401CL	MAX232DR	DIP-16	Dual EIA-232 driver/receiver	.99	.89	.81
106155CL	MAX232EPE	DIP-16	+5V powered, dual RS-232 transmitter/receiver (-40°C to +85°C)	2.49	2.25	2.05
106163CL	MAX233CPP	DIP-20	+5V powered, multichannel RS-232 drivers/receivers (no ext. components)	5.75	5.18	4.66
106171CL	MAX235CPG	DIP-24	+5V powered, five RS-232 transmitter/receiver (no ext. components)	9.95	8.45	6.35
106180CL	MAX238CNG	DIP-24	+5V powered, quad RS-232 transmitter and receiver	6.39	4.70	3.59
242085CL	MAX626CPA	DIP-8	Dual 1.5A-peak low-side MOSFET driver	1.14	.93	.86
242093CL	MAX627CPA	DIP-8	Dual MOSFET driver	1.10	.91	.83

Maxim-Type Interface Series (Cont'd)

Part No.	Cross Ref.	Pkg.	Description	SDT-23		
				1	10	100
106219CL	MAX690CPA	DIP-8	Microprocessor watchdog/battery switchover/reset generator	\$6.15	\$4.49	\$3.25
106227CL	MAX691CPE	DIP-16	Microprocessor watchdog/battery switchover/reset generator	6.99	4.35	3.59
243627CL	MAX705CPA	DIP-8	MPU supervisory circuit	4.91	3.79	3.35
243635CL	MAX705CSA	SOIC-8	Low cost MPU supervisory circuit	4.91	3.79	3.35
251758CL	MAX707CPA	DIP-8	Low cost MPU supervisory circuit	6.38	5.74	5.17
251774CL	MAX707CSA	SOIC-8	Low cost MPU supervisory circuit	5.55	4.97	4.47
245391CL	MAX810S	SOT-23	3-pin microprocessor reset circuit	.91	.82	.74
245497CL	MAX813CSA	SOIC-8	Low cost MPU supervisory circuit	4.55	4.07	3.66
106260CL	MAX1232CPA	DIP-8	Microprocessor monitor	2.79	2.35	1.88
244195CL	MAX1487CPA	DIP-8	RS-485/RS-422 low-power transceivers	2.45	1.89	1.29
244208CL	MAX1487CSA	SOIC-8	RS-485/RS-422 low-power transceivers	2.45	1.59	1.32
252128CL	MAX3221CAE	SSOP-16	RS-232 transceiver with auto shutdown	3.45	3.10	2.79

Interface Series

Part No.	Cross Ref.	Pkg.	Description	SDIC & SDP		
				1	10	100
24811CL	MAX232CPE	DIP-16	Dual RS-232 receiver/transmitter	\$2.19	\$1.75	\$1.45
39571CL	26LS30	DIP-16	Dual diff RS422 party line Qd RS423 line driv.	2.49	2.25	1.95
39589CL	26LS31CN	DIP-16	Quad diff line driver	.79	.69	.62
243555CL	AM26LV31CD	SOP-16	RS-422 quad differential line transceivers	\$.92	.77	.59
39600CL	26LS32CN	DIP-16	Quad diff line receiver	.59	.50	.39
242051CL	AM26LV32CD	SOP-16	RS-422 quad differential line receivers	\$.92	.77	.59
244179CL	ADM1485JN	DIP-8	RS-485 differential bus transceivers	1.79	1.63	1.49
244187CL	ADM1485JR	SOIC-8	RS-485 differential bus transceivers	\$1.79	1.55	1.06
235310CL	DS1487N	DIP-8	Low pwr RS-485 1/4 unit load multiptr recvr.	\$2.59	1.88	1.87
193691CL	DS1488D	SOIC-14	Quad line driver RS-232 (75188)	.29	.25	.18
16361CL	DS14C88N	DIP-14	Quad CMOS line driver RS-232	.45	.40	.35
193703CL	DS1489D	SOIC-14	Quad line receiver RS-232 (75189)	.29	.25	.22
23181CL	DS1489N	DIP-14	Quad line receiver RS-232 (75189)	.29	.20	.18
16379CL	DS14C89N	DIP-14	Quad CMOS line receiver RS-232	.75	.54	.53
252427CL	MC3486D	SOIC-16	Quad EIA-422/423 line rec. w/ 3-st. outputs	.66	.50	.38
25232CL	MC3486P	DIP-16	Quad EIA-422/423 line rec. w/ 3-st. outputs	.59	.49	.45
252961CL	MC3487D	SOIC-16	Quad EIA-422 differential line driver	.65	.50	.38
25259CL	MC3487P	DIP-16	Quad EIA-422 line driver w/ 3-state outputs	.69	.59	.45
144039CL	DS3695N	DIP-8	Multipoint RS-485/422 trans. w/ 3-st. outputs	1.85	1.38	1.02
235336CL	DS3696N	DIP-8	Multipoint RS-485/RS-422 trans./repeaters	1.89	1.39	1.09
251029CL	TC4420COA	SOIC-8	6A high speed MOSFET drivers	1.59	1.57	1.41
213170CL	UA9636A	DIP-8	Dual differential line receiver (MC3488A)	.79	.69	.55
235301CL	DS14C232CN	DIP-16	Low pwr +5V pwr'd TIA/EIA 232 dual driv/recvr	1.25	1.12	.83
235344CL	DS36C278N	DIP-8	Low pwr multipoint EIA RS-485 transceiver	2.69	2.15	2.05
256727CL	SN65LVDS31D	SOIC-16	High speed differential line drivers	3.32	2.68	2.10
256719CL	SN65LVDS048AD	SOIC-16	LVDS quad differential line receiver	4.49	4.04	3.26
50884CL	75154N	DIP-16	Quad line receiver	.69	.59	.45
241980CL	SN75LBC172N	DIP-16	RS-485 differential line drivers	\$2.99	1.76	1.32
245331CL	75173D	SOIC-16	Quadruple differential line receivers	1.15	.92	.70
50930CL	75173N	DIP-16	Quadruple differ. line receiver	1.99	1.59	1.19
241998CL	SN75LBC173N	DIP-16	RS-422/RS-423/RS-485 diff. line rec.	\$2.75	1.65	1.23
50948CL	75174N	DIP-16	Quad diff. RS-422 line driver w/ 3-st. out.	\$1.09	.91	.62
245340CL	75175D	SOIC-16	Quad differential line receivers	.56	.40	.34
50956CL	75175N	DIP-16	Quad diff. EIA 422A/423A line rec. w/3-st. out.	\$1.05	.69	.49
243707CL	SN75LBC175D	SOIC-16	Quadruple low power diff. line receiver	1.24	1.08	.90
243715CL	SN75LBC175N	DIP-16	RS-422/RS-423 RS-485 diff. line receivers	2.40	2.25	1.98
50964CL	75176BN	DIP-8	Differential bus transceiver	.65	.55	.45
251053CL	SN75LBC176A0	SOIC-8	Differential bus transceiver	3.29	2.98	2.68
244136CL	SN75LBC176AP	DIP-8	RS-485 differential bus transceivers	\$2.99	1.76	1.48
251846CL	SN75LBC176D	SOIC-8	Differential bus transceiver	1.62	1.31	.86
243723CL	SN75LBC176P	DIP-8	RS-485 differential bus transceivers	2.88	1.89	1.78
256081CL	SN75185N	DIP-20	Multiple RS-232 drivers & receivers	.69	.62	.56
23157CL	75188N	DIP-14	Quad line driver RS-232 (DS1488N)	.29	.25	.22
245366CL	SN75C188D	SOIC-14	Quad low power line driver	.56	.42	.32
23181CL	75189N	DIP-14	Quad line rec. RS-232 (DS1489N)	.29	.20	.18
245374CL	SN75C189D	SOIC-14	Quad low power line receiver	.79	.61	.45
51027CL	75451AN	DIP-8	Dual peripheral AND driver	.49	.44	.39
51035CL	75452N	DIP-8	Dual peripheral NAND driver	.39	.34	.32
51131CL	75492	DIP-14	Hex digit driver (492)	3.29	3.19	2.99

*10 pcs. in Linear series IC cabinet kit, pg 33

Call for pricing on quantities over 100 - we carry major manufacturers. We will special order any IC - \$100 minimum.

Interface Series (Continued)

Part No.	Cross Ref.	Pkg.	Description	1	10	100
235387CL	DS96172CN	DIP-16	RS-485/RS-422 quad diff. line drivers	\$3.80	\$3.60	\$3.45
235361CL	DS96173CN	DIP-16	RS-485/RS-422 quad diff. line recvr.	\$2.87 2.59	2.35	2.05
235395CL	DS96174CN	DIP-16	RS-485/RS-422 quad diff. line drivers	2.49	1.89	1.49
235379CL	DS96175CN	DIP-16	RS-485/RS-422 quad diff. line receivers	2.49	1.89	1.49
235408CL	DS96176CN	DIP-8	RS-485/RS-422 diff. bus transceivers	1.79	1.59	1.19
250998CL	MC145406P	DIP-16	RS232-C/V.28 drv./rec. (CMOS) (75C1406N)	1.95	1.75	1.59
253083CL	SN751730N	DIP-16	Triple line driver/receiver	2.35	1.90	1.50

Digital Interface ICs

Stepper Motor Controllers

Designed to interface a logic level input byte to a stepper motor.

Part No.	Product No.	Pkg.	Description	1	10	50
141532CL	EDE1200	DIP-18	Unipolar stepper motor controller	\$8.95	\$7.95	\$6.95
157526CL	EDE1204	DIP-18	Bipolar stepper motor controller	8.95	7.95	6.95

Keypad Encoder

Designed to interface a matrix type 4 row x 4 column (16-key or less) keypad to a microcontroller or other host processor.

Part No.	Product No.	Pkg.	Description	1	10	50
171969CL	EDE1144	DIP-18	Keypad Encoder	\$6.95	\$6.25	\$5.59

Serial LCD Interface

Provides a cost-effective LCD control solution for a wide variety of embedded designs. Allows nearly any text-based LCD module to be controlled via a simple one-wire data link.

Part No.	Product No.	Pkg.	Description	1	10	50
171951CL	EDE702	DIP-18	Serial LCD Interface	\$8.95	\$7.95	\$6.95

5000 Series and Clock Chips

Part No.	Cross Ref.	Pkg.	Description	1	10	50
32803CL	TCM5089N	DIP-16	Integrated tone dialer chip	\$4.95	\$4.49	\$4.05
26091CL	MMS5321N	DIP-16	TV camera synchronous generator	7.95	6.79	5.19
26171CL	MM5450N	DIP-40	34-segment LED display driver	4.95	4.49	4.05
243395CL	DP8573AN	DIP-24	5V real time clock chip	11.29	9.69	8.59
26201CL	MM58167AN	DIP-24	Microprocessor real time clock	4.95	4.25	3.19
95530CL	RTC72421B	DIP-18	Real time clock module	6.79	5.69	4.05
25101CL	MC146818	DIP-24	Real time clock plus RAM	4.95	3.75	3.19

UARTs

Part No.	Cross Ref.	Pkg.	Description	1	10	100
43158CL	6402	DIP-40	CMOS/LSI UART (TR1863)	\$4.95	\$4.49	\$4.05
27570CL	NS16C450N	DIP-40	CMOS ACE (IBM-AT compat.) (82C450)	\$6.95 3.49	2.69	2.09
27596CL	NS16550AN	DIP-40	UART w/ FIFO (PC16550DN)	5.89	4.49	3.39

Encoders/Decoders

Part No.	Cross Ref.	Pkg.	Description	1	10	100
243942CL	HCS300	DIP-8	2-6.3V, Code hopping decoder	\$1.75	\$1.65	\$1.55
243483CL	HCS512	DIP-18	3-6V, Code hopping decoder	7.15	6.85	6.50
243934CL	HCS515	DIP-14	3-6V, Code hopping decoder	\$2.27 2.90	2.74	2.60
243951CL	HCS2000	DIP-8	3.5-13V, Code hopping decoder	1.52	1.45	1.40
123730CL	HT12E	DIP-18	Encoder 12-bit	1.69	1.49	1.35
123748CL	HT12D	DIP-18	Decoder 8-bit address/4-bit data	1.69	1.49	1.35
126594CL	HT640	DIP-24	Encoder 10-bit address/8-bit address/data	2.95	2.55	1.89
126607CL	HT648L	DIP-24	Decoder 10-bit address/8-bit latch data	3.29	2.99	2.69
243441CL	MCP2120	DIP-14	IrDA encoder/decoder	2.10	1.90	1.80
243459CL	MCP2150	DIP-18	IrDA standard protocol stack controller	7.29	7.05	6.70
243408CL	TP3054	DIP-16	5V serial PCM u-Law	2.39	1.79	1.49
243416CL	TP3057	DIP-16	5V serial PCM A-Law	2.49	1.75	1.49
243424CL	TP3064	DIP-20	5V serial PCM u-Law	3.20	3.05	2.90
243432CL	TP3067	DIP-20	5V serial PCM A-Law	2.39	1.95	1.49

Call us with your 100 piece minimum order

We'll Find Any IC!

1-800-831-4242

KAE Servo and Stepper Motor Controllers

Controllers operate from standard 8-bit serial interface (RS232 or RS485). Using RS485, any mix of up to 32 controllers may be operated from a single serial port. Complete documentation.

146472CL: PIC-SERVO Motion Control Chipset for DC Motors

- PIC servo control for DC motors with digital encoders
- 32-bit position, velocity, and acceleration resolution
- PWM and direction outputs connect to servo amplifier
- Two chip set (PIC-SERVO 28-pin and PIC-ENC 18-pin)



175901CL: PIC-STEP Motion Control Chip for Stepper Motors

- Step rates up to 50,000 steps/sec. - suitable for use with microstepping drivers
- Trapezoidal positioning and profiled velocity modes
- Programmable current limits automatically switch between holding and running currents
- Programmable accelerations and minimum step rates

Part No.	Description	Package	1	10	50
146472CL	PIC-SERVO chip set	DIP-28/18, 0.3"	\$34.95	\$29.95	\$27.95
175901CL	PIC-STEP chip	DIP-28, 0.3"	32.95	29.69	26.69

A/D & D/A Converters

Part No.	Cross Ref.	Pkg.	Description	1	10	100
43748CL	7106CPL	DIP-40	A/D with 3 1/2-digit LCD control	\$3.39	\$2.99	\$2.49
43756CL	7107CPL	DIP-40	A/D with 3 1/2-digit LED control	3.49	2.79	2.59
116100CL	ADC0831CCN	DIP-8	8-bit A/D w/ mux. diff. input (± 1 LSB), 32 μ s	1.95	1.75	1.59
251176CL	TL0831CP	DIP-8	8-bit A/D w/ serial control (± 1 LSB), 32 μ s	2.17	1.97	1.61
10145CL	ADC0803LCN	DIP-20	8-bit A/D 1-input ($\pm 1/2$ LSB), 100 μ s	\$6.95 4.59	4.09	3.49
10153CL	ADC0804LCN	DIP-20	8-bit A/D 1-input (± 1 LSB), 100 μ s	\$2.87 2.49	1.89	1.39
10225CL	ADC0820CCN	DIP-20	8-bit high speed (1/2 μ s) A/D w/ track&hold	3.19	2.75	2.55
10170CL	ADC0808CCN	DIP-28	8-bit A/D w/ 8-ch. mux. ($\pm 1/2$ LSB), 100 μ s	4.99	4.15	3.89
10188CL	ADC0809CCN	DIP-28	8-bit A/D w/ 8-ch. mux. (± 1 LSB), 100 μ s	2.95	2.75	2.49
10209CL	ADC0817CCN	DIP-40	8-bit A/D w/ 16-ch. mux. ($\pm 1/2$ LSB), 100 μ s	\$8.45 3.30	6.65	6.05
242296CL	TLC1543	DIP-20	10-bit A/D 11-inputs (± 1 LSB), 38Ksps	3.39	2.89	2.33
242309CL	TLC1549	DIP-20	10-bit A/D 1-input (± 1 LSB), 38Ksps	3.69	2.99	2.29
43764CL	109CPL	DIP-40	12-bit A/D 1-input (± 2 LSB), 30sps	7.99	6.79	5.99
242325CL	ADS7813	DIP-16	16-bit A/D 1-input (± 2 LSB), 40Ksps	\$14.79 8.83	35.25	31.55
242317CL	ADS7805	DIP-28	16-bit A/D 1-input (± 3 LSB), 100Ksps	\$14.79 36.05	34.60	32.95
239417CL	ADS7825	DIP-28	16-bit A/D 4-inputs (± 2 LSB), 40Ksps	\$6.79 46.58	43.47	40.36
115158CL	AD558JN	DIP-16	8-bit D/A 1-input ($\pm 1/2$ LSB), 200ns	\$14.99 15.99	12.75	11.49
54025CL	AD7523JN	DIP-16	8-bit D/A 1-input (± 1 LSB), 150ns	2.69	2.58	2.54
14904CL	DAC0800LCN	DIP-16	8-bit D/A (± 1 LSB), 100ns	1.79	1.59	1.45
14912CL	DAC0806LCN	DIP-16	8-bit D/A (± 1 LSB), 150ns (MC1408P6)	1.89	1.85	1.82
14947CL	DAC0808LCN	DIP-16	8-bit D/A (± 1 LSB), 150ns (MC1408P8)	1.59	1.39	1.09
14963CL	DAC0830LCN	DIP-20	8-bit D/A double buffer (.05% Lin.), 1 μ s	5.95	4.49	4.35
128186CL	DAC0832LCN	DIP-20	8-bit D/A double buffer (.20% Lin.), 1 μ s	3.95	3.59	3.25
239425CL	TLC5615	DIP-8	10-bit D/A 1-input (± 1 LSB), 12 μ s	3.49	2.79	2.29
14980CL	DAC1222LCN	DIP-18	12-bit D/A (.20% Lin.), 500ns	9.95	8.95	8.05
243344CL	DAC716	DIP-16	16-bit D/A w/ serial interf. (± 1 LSB), 10 μ s	27.38	25.55	23.72
239433CL	DAC712	DIP-28	16-bit D/A 1-input (± 1 LSB), 10 μ s	\$26.78 18.69	17.49	16.19
243336CL	DAC715	DIP-28	16-bit D/A w/ bus interface (± 1 LSB), 10 μ s	34.60	32.90	31.35
243352CL	DAC725	DIP-28	16-bit D/A 2-input (± 1 LSB), 8 μ s	136.39	127.29	118.19

Voltage Regulators

Part No.	Cross Ref.	Pkg.	Description	1	10	100
23499CL	LM309K	TO-3/2	5V 1A regulator (0°C to +125°C)	\$6.99 4.99	\$3.85	\$2.98
192268CL	LM317AT	TO-220/3	3-terminal adjustable reg. (1.2V-37V)	\$1.95 1.75	1.25	.95
192276CL	LM317HVT	TO-220/3	3-terminal adjustable reg. (1.2V-57V)	\$2.75 2.35	1.75	1.29
23544CL	LM317K	TO-3/2	1.5A adj. pos. reg. (1.2V-37V)	\$1.79 1.61	1.49	1.23
193551CL	LM317LM	SOIC-8	100mA adj. pos. regulator (1.2V to 37V)	\$1.82 .22	.17	.14
23552CL	LM317LZ	TO-92	100mA adj. pos. reg. (1.2V-37V)	23	22	20
23579CL	LM317T**	TO-220/3	1.5A adj. pos. reg. (1.2V-37V)	\$4.49 .45	.39	.34
23798CL	LM337K	TO-3/2	1.5A/3 term. adj. neg. reg.	\$3.49 2.89	2.34	1.89
193586CL	LM337LM	SOIC-8	1.5A adj. neg. regulator (-1.2V to -37V)	.79	.69	.49
23819CL	LM337*	TO-220/3	1.5A/adj. neg. reg. (-1.2V-37V)	.69	.59	.49
23835CL	LM338T	TO-3/2	5A adj. pos. reg. (1.2V-32V)	4.95	3.89	3.25
192284CL	LM338T	TO-220/3	5A adjustable regulator	1.99	1.49	.99
23931CL	LM350K	TO-3/2	3A/3 term. adj. pos. reg. (1.2V-33V)	4.73	3.85	2.98
23940CL	LM350T	TO-220/3	3 amp. adj. power regulator	\$1.75 1.15	.95	.79
239134CL	LM431ACM	SOIC-8	Programmable shunt regulator	.29	.25	.22
239142CL	LM431BCM	SOIC-8	Programmable shunt regulator	.31	.26	.25

*10 pieces included in Linear kit on page 33

**20 pieces included in Linear kit on page 33

Call for pricing on quantities over 100 – we carry major manufacturers. We will special order any IC – \$100 minimum.

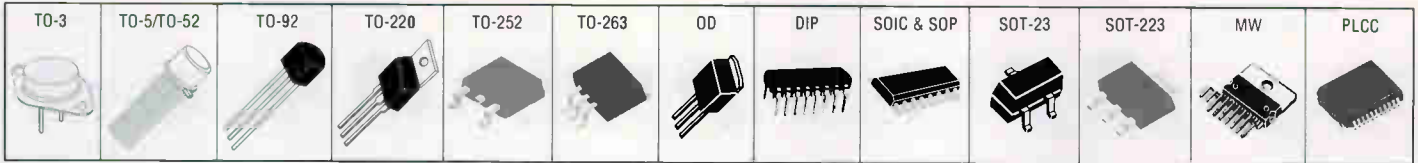

Semiconductors

Voltage Regulators (Continued)



Package (see above)

Part No.	Cross Ref.	Pkg.	Description	1	10	100
251862CL	LM431CIM	SOIC-8	Adj. precision zener shunt regulator	\$.37	\$.32	\$.28
214050CL	LM723CD	DIP-14	High precision voltage regulator	\$.34 .32	.28	.26
24467CL	LM723CN*	DIP-14	Voltage regulator (2V-37V)	\$.29 .26	.24	.23
244304CL	LO108602M	TO-263/3	adjustable, low dropout voltage reg.	1.08	.97	.89
244312CL	LD1086D2M33	TO-263/3	3.3V, low dropout voltage regulator	\$ 1.15 .97	.96	.89
245585CL	LD1086D2M50	TO-263/3	5.0V, low drop positive voltage reg.	1.12	1.01	.91
245526CL	LM1086CS-AQJ	TO-263/3	1.5A low dropout positive regulator	1.65	1.48	1.33
192305CL	LM1086CT-3.3	TO-220/3	1.5A low dropout positive reg. (3.3V)	\$ 1.49 1.18	.87	.64
192313CL	LM1086CT-5.0	TO-220/3	1.5A low dropout positive reg. (5V)	\$ 1.29 1.18	.87	.64
192292CL	LM1086CTADJ	TO-220/3	1.5A low dropout positive reg.	\$ 1.23 1.18	.87	.64
242042CL	LM1117DT-3.3	TO-252/3	800mA low dropout linear reg.	\$.79 .74	.54	.40
242069CL	LM1117DT-5.0	TO-252/3	800mA, 5V, low dropout voltage reg.	\$.74 .74	.54	.40
251782CL	LM1117MPX-AQJ	SOT-223/3	800mA low drop out linear regulator	.60	.54	.49
242114CL	LM1117T-3.3	TO-220/3	800mA, 3.3V, low dropout voltage reg.	.73	.68	.63
243539CL	LM1117T-AQJ	TO-220/3	800mA, adj., low dropout voltage reg.	\$.69 .62	.71	.52
244216CL	LT1585ACT-3.3	TO-220/3	5A, 3.3V, low dropout voltage reg.	\$ 4.69 4.40	3.97	3.57
244224CL	LT1585ACT-AQJ	TO-220/3	5A, adjustable, low dropout volt. reg.	4.75	4.20	3.60
244144CL	LT1587CM	OD/3	3A, low dropout voltage regulator	\$ 6.59 6.43	4.88	3.45
244152CL	LT1587CT-3.3	TO-220/3	3A, 3.3V, low dropout voltage reg.	\$ 1.99 .82	.79	.76
244161CL	LM1587CT-ADJ	TO-220/3	3A low dropout fast response reg.	.79	.73	.63
192330CL	LM2574HN-5.0	DIP-8	Simple Switcher 0.5A step-down volt. reg.	3.50	2.69	2.09
245551CL	LM2574N-ADJ	DIP-8	Simple Switcher 0.5A step-down volt. reg.	1.39	1.26	1.13
156566CL	LM2574N-5	DIP-8	Step-down 5-voltage regulator	\$ 1.49 1.30	1.11	.77
192399CL	LM2576HVT-12	TO-220/5	Simple Switcher 3A step down volt. reg.	5.89	4.53	3.49
192381CL	LM2576HVT-5.0	TO-220/5	Simple Switcher 3A step down volt. reg.	5.90	4.53	3.49
192372CL	LM2576HVT-AQJ	TO-220/5	Simple Switcher 3A step down volt. reg.	\$ 3.95 3.95	3.65	3.04
245569CL	LM2576T-5.0	TO-220/5	Simple Switcher 3A step down volt. reg.	2.30	1.76	1.36
120977CL	LM2576T-ADJ	TO-220/5	Simple Switcher 3A step down volt. reg.	2.85	2.55	2.30
192410CL	LM2587T-ADJ	TO-220/5	Simple Switcher 5A flyback regulator	\$ 6.99 5.60	5.25	4.85
192428CL	LM2594N-AQJ	DIP-8	Simple Switcher pwr. conv. 150kHz 0.5A	2.65	2.05	1.59
192452CL	LM2595T-5.0	TO-220/5	Simple Switcher pwr. conv. 150kHz 1A	3.49	2.89	2.19
121030CL	LM2931AZ-5.0	TO-92	5V low dropout regulator	.85	.75	.67
23368CL	LM2931CT	TO-220/5	3V-24V low dropout regulator	.68	.64	.59
256612CL	LM2931Z-5.0	SOIC-8	5V low dropout regulator	.46	.40	.35
121048CL	LM2931Z-5.0	TO-92	5V low dropout regulator	.69	.62	.56
245649CL	LM2936MP-3.3	SOT-223	Ultra-low quiescent current 3.3V reg.	3.05	2.74	2.47
107166CL	LM2936Z-5	TO-92	Ultra-low quiescent current 5V reg.	1.76	1.60	1.18
192495CL	LM2940CT-12	TO-220/3	12V low dropout reg. (max 45Vin)	1.27	1.02	.75
107182CL	LM2940CT-5	TO-220/3	5V low dropout reg. (max. 45Vin)	\$ 1.86 1.15	1.15	1.09
245657CL	LM2941CS	TO-263/5	1A low dropout adjustable regulator	1.80	1.33	.99
121064CL	LM2941CT	TO-220/5	1A low dropout adjust. reg. (45Vin)	\$ 1.31 .85	.82	.66
23376CL	LM2941T	TO-220/5	1A low dropout adjust. reg. (60Vin)	\$ 1.31 1.10	1.10	.89
121101CL	LP2950ACZ-5.0	DIP-8	100mA low pwr. low dropout volt. reg.	1.02	.76	.56
239151CL	LP2951CM	SOIC-8	Adjustable micropower voltage regulator	.91	.68	.49
246545CL	LM3480IM3-3.3	SOT-23/3	100mA quasi low dropout linear volt. reg.	1.39	1.24	1.12
246553CL	LM3480IM3-5.0	SOT-23/3	100mA quasi low dropout linear volt. reg.	1.39	1.24	1.12
192524CL	LM3940IT-3.3	TO-220/3	1A low dropout reg. for 5V to 3.3V conv.	\$ 2.24 1.55	1.55	1.09
51174CL	7660CPA	DIP-8	CMOS volt convtr. (+5 to ±5V) (M660AN)	1.25	.79	.73
51246CL	7805K	TO-3/2	5V 1A pos. voltage reg. (LM340K-5)	4.35	3.50	2.85
51262CL	7805T**	TO-220/3	5V 1A pos. voltage reg. (LM340T-5)	.35	.32	.28
51182CL	78L05**	TO-92	5V 100mA pos. voltage regulator	.27	.24	.22
193754CL	78L05ACM	SOIC-8	5V 100mA pos. voltage regulator	.30	.26	.24
192233CL	78M05	TO-220/3	5V 500mA pos. voltage regulator	.35	.30	.22
51297CL	7806T	TO-220/3	6V 1A pos. voltage reg. (LM340T-6)	\$.35 .30	.25	.23
193762CL	78L06ACM	SOIC-8	6.2V 100mA pos. voltage regulator	.29	.25	.18
51300CL	7808T*	TO-220/3	8V 1A pos. voltage reg. (LM340T-8)	.46	.35	.28
192225CL	78L09	TO-92	9V 100mA pos. voltage regulator	\$.24 .24	.23	.17
51318CL	7812K	TO-3/2	12V 1A pos. voltage reg. (LM340K-12)	1.69	1.55	1.39
51334CL	7812T**	TO-220/3	12V 1A pos. voltage reg. (LM340T-12)	.35	.32	.28

*10 pieces included in Linear kit on page 33 **20 pieces included in Linear kit on page 33

Voltage Regulators (Continued)



Package (see above)

Part No.	Cross Ref.	Pkg.	Description	1	10	100
51203CL	78L12*	TO-92	12V 100mA pos. voltage regulator	\$.29 .28	.28	.24
193771CL	78L12ACM	SOIC-8	12V 100mA pos. voltage regulator	.38	.29	.19
192241CL	TO-220/3	12V 500mA pos. voltage regulator	\$.24 .24	.22	.185	
51369CL	7815K	TO-3/2	15V 1A pos. voltage reg. (LM340K-15)	1.30	1.20	1.12
51377CL	7815T*	TO-220/3	15V 1A pos. voltage reg. (LM340T-15)	.28	.25	.22
193789CL	78L15ACM	SOIC-8	15V 100mA pos. voltage regulator	\$.25 .20	.19	.14
192250CL	78M15	TO-220/3	15V 500mA pos. voltage regulator	\$.35 .28	.25	.23
194634CL	7818T	TO-220/3	18V 1A pos. voltage reg. (LM340T-18)	.46	.35	.27
51414CL	7824T	TO-220/3	24V 1A pos. voltage reg. (LM340T-24)	.36	.34	.31
51238CL	78S40	OIP-16	1.25V-40V 1.5A switching regulator	\$ 1.69 1.05	.94	.84
51457CL	7905T*	TO-220/3	5V 1A neg. voltage reg. (LM320T-5)	.42	.38	.36
51422CL	79L05	TO-92	5V 100mA neg. voltage regulator	.78	.71	.71
193797CL	79L05ACM	SOIC-8	-5V 100mA neg. voltage regulator	\$.85 .28	.27	.24
51449CL	79M05	TO-220/3	3-terminal negative regulator	.39	.26	.20
51481CL	7912T*	TO-220/3	12V 1A neg. voltage reg. (LM320T-12)	\$.39 .30	.25	.23
51431CL	79L12	TO-92	12V 100mA neg. voltage regulator	\$.28 .17	.14	.12
193800CL	79L12ACM	SOIC-8	-12V 100mA neg. voltage regulator	.35	.30	.22
51502CL	7915T*	TO-220/3	15V 1A neg. voltage reg. (LM320T-15)	\$.34 .32	.27	.22
194749CL	79L15	TO-92	15V 100mA neg. voltage regulator	.21	.16	.14
193818CL	79L15ACM	SOIC-8	-15V 100mA neg. voltage regulator	\$.20 .18	.17	.14
252241CL	MC29152BU	TO-263/5	1.5A high current low dropout regulators	2.75	2.59	2.27
251344CL	TP76201DBVR	SOT-23/5	100mA low pwr low output adj. LOO linear reg.	.98	.90	.81

*10 pieces included in Linear kit on page 33

Linear Series



Package (see above)

Part No.	Cross Ref.	Pkg.	Description	1	10	100
23051CL	LH0002CN	DIP-10	General purpose buffer	\$9.95	\$8.95	\$7.95
27852CL	OP07	DIP-8	Ultra-low-offset-voltage op amp.	.99	.89	.79
193471CL	OP07CS	SOIC-8	Very low offset single bipolar op amp.	.62	.56	.47
252988CL	OP07O	OIP-8	Very low offset single bipolar op amp.	.62	.52	.42
120715CL	LM10CN	OIP-8	Op amp and voltage reference	\$ 3.88 2.55	1.98	1.38
23106CL	LM10CLN	OIP-8	Low voltage (1.1 volt) op amp.	\$ 2.49 1.79	1.40	1.36
25751CL	MF10CN	OIP-20	General purpose dual active filter	\$ 2.25 2.85	2.19	1.89
120723CL	LM12CLK	TO-3/4	80W op amp.	\$ 20.99 19.05	17.85	15.95
213090CL	TL022CP	DIP-8	Dual low power op amp.	\$ 1.59 1.06	.89	.69
16301CL	OS0026CN	OIP-8	Dual mos clk. driver (5MHz)(TC426CPA)	2.91	2.62	1.90
252996CL	OP27EZ	OIP-8	Low noise high speed precision op amp.	20.69	18.64	16.78
115300CL	OP27EP	OIP-8	Low noise precision op amp.	4.95	4.52	4.06
115318CL	OP27GP	OIP-8	Low noise prec. op amp. (-40°C to 80°C)	\$ 1.95 1.45	1.32	1.11
253032CL	TL031CO	SOIC-8	Enhanced JFET low pwr low offset op amp.	1.05	.93	.84
213102CL	TL031CP	DIP-8	Enhanced JFET low pwr. low offset op amp.	.71	.67	.49
253059CL	TL032CD	SOIC-8	Enhanced JFET low pwr low offset op amp.	1.45	1.30	1.17
213111CL	TL032CP	DIP-8	Enhanced JFET low pwr. low offset op amp.	\$.90 .86	.62	.57
253235CL	TL034CO	SOIC-14	Enhanced JFET low pwr low offset op amp.	1.12	.91	.69
214068CL	TL034CN	OIP-14	Enhanced low pwr low offset op amp.	\$ 1.45 .83	.83	.63
107094CL	LM34CZ	TO-92	Prec. F temp. sensor (-40°F to +230°F)	\$ 5.59 4.80	4.26	3.45
193480CL	LM340M	SOIC-8	Prec. F temp. sensor (-55°F to 300°F)	1.49	1.27	.95
155192CL	LM340Z	TO-92	Prec. F temp. sensor (+32°F to +212°F)	1.99	1.67	1.23
193498CL	LM35DM	SOIC-8	Prec. C temp. sensor (-55°C to 150°C)	1.99	1.49	1.10
192217CL	LM35DT	TO-220/3	Prec. C temp. sensor (-55°C to 150°C)	\$ 2.79 .57	1.02	1.44
107107CL	LM35CZ	TO-92	Prec. C temp. sensor (-40°C to 110°C)	5.79	4.39	3.19
155740CL	LM35DZ	TO-92	Prec. C temp. sensor (0°C to +100°C)	1.75	1.55	1.35
213129CL	TL052ACP	OIP-8	Enhanced JFET low offset op amp.	\$ 4.59 1.63	1.30	.98
253243CL	TL054ACD	SOIC-14	Enhanced JFET low offset op amp.	6.19	5.58	5.02
213153CL	TL054ACN	OIP-14	Enhanced JFET low offset op amp.	\$ 4.99 .87	3.70	2.92
213145CL	TL054CN	DIP-14	Enhanced JFET low offset op amp.	\$ 1.49 1.49	1.10	.91
213137CL	TL061ACP	OIP-8	Low power JFET input op amp.	\$.69 .51	.51	.42
242106CL	TL061IP	DIP-8	Low power JFET op amp.	.72	.53	.45

*10 pcs. in Linear series IC cabinet kit, pg 33 **20 pcs. in Linear series IC cabinet kit, pg 33

Call for pricing on quantities over 100 - we carry major manufacturers. We will special order any IC - \$100 minimum.

Semiconductors

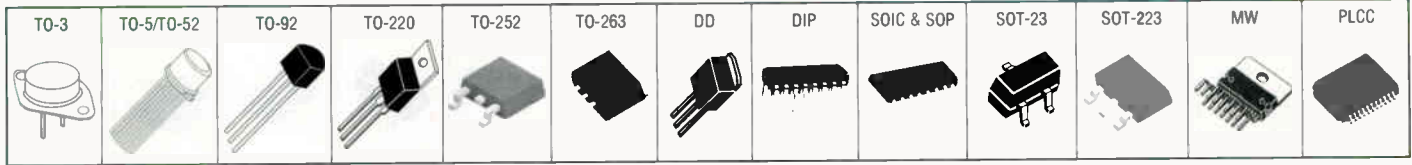

Linear Series (Continued)

Part No.	Cross Ref.	Pkg.	Description	Package (see above)		
				1	10	100
252283CL	TL062ACD	SOIC-8	Low power JFET input op amp.	\$.74	\$.59	\$.54
33161CL	TL082CP	DIP-8	Low power JFET op amp. (VCC 8-pin)	\$.29	.21	.20
253104CL	TL064BCD	SOIC-14	Low power JFET input op amp.	.69	.58	.47
253139CL	TL064BCN	DIP-14	Low power JFET input op amp.	.97	.87	.78
33179CL	TL064CN	DIP-14	Low power JFET input op amp.	\$.63	.43	.35
213081CL	TL071ACP	DIP-8	Low noise JFET input op amp.	\$.63	.59	.45
33187CL	TL071CP	DIP-8	Low noise JFET op amp.	.39	.30	.23
213073CL	TL072ACP	DIP-8	Low noise JFET input op amp.	.52	.39	.29
253147CL	TL072BCP	DIP-8	Low noise JFET input op amp.	.56	.42	.32
193501CL	TL072CD	SOIC-8	Low noise JFET dual op amp.	.45	.39	.25
33195CL	TL072CP*	DIP-8	Low noise JFET dual op amp.	\$.20	.26	.25
213065CL	TL074BCN	DIP-14	Low noise JFET input op amp.	\$.78	.69	.59
193519CL	TL074CD	SOIC-8	Low noise JFET quad op amp.	\$.44	.40	.32
33216CL	TL074CN*	OIP-14	Low noise JFET quad op amp.	\$.47	.37	.30
213057CL	TL081ACP	DIP-8	JFET input op amp.	.66	.50	.39
253155CL	TL081CD	SOIC-8	JFET input op amp.	.39		.23
33232CL	TL081CP	DIP-8	JFET input op amp.	\$.39	.31	
214076CL	TL082ACP	OIP-8	JFET input op amp.	\$.59	.39	
253198CL	TL082BCP	DIP-8	JFET input op amp.	.51	.48	.43
193527CL	TL082CD	SOIC-8	JFET input dual op amp.	\$.27	.29	.27
33241CL	TL082CP*	DIP-8	JFET input dual op amp.	.38	.33	.29
214084CL	TL084ACN	DIP-14	JFET input op amp.	.72	.55	.42
253219CL	TL084BCN	SOIC-14	JFET input op amp.	.73	.65	.60
193535CL	TL084CD	SOIC-14	JFET input quad op amp.	\$.49	.46	.40
33267CL	TL084CN*	DIP-14	JFET input quad op amp.	\$.46	.43	.39
243686CL	OPA137PA	DIP-8	FET op-amp.	\$ 1.59	1.46	1.31
243694CL	OPA137UA	SOIC-8	FET input op-amp.	\$ 1.55	1.45	1.31
239281CL	DG201BDJ	DIP-16	Quad analog switch	1.47	1.35	1.18
239302CL	NJU201AD	DIP-16	CMOS quad SPST analog switch	.83	.78	.70
239290CL	DG202BDJ	DIP-16	Quad analog switch	2.30	2.07	1.94
239311CL	DG211BDJ	DIP-16	Quad analog switch	\$ 1.23	1.14	1.11
239329CL	DG221CJ	DIP-16	SPST quad channel analog switch	1.97	1.64	1.49
212118CL	LM224N	DIP-14	Low power quad op amp.	\$.49	.35	.28
212126CL	LM239N	DIP-14	Low pwr. low offset volt quad comp.	\$.29	.26	.19
212142CL	LM258N	DIP-8	Low power dual op amp.	.27	.22	.18
242000CL	TLC274ACN	DIP-14	Quad precision op-amp.	.85	.63	.53
242018CL	TLC274BCN	DIP-14	Quad precision op-amp.	\$ 1.15	.89	.79
242026CL	TLC274CN	DIP-14	CMOS Precision quad op-amp.	\$.74	.55	.43
242034CL	TLC274IN	DIP-14	Quad CMOS op-amp.	\$.79	.75	.62
243678CL	OP275GP	DIP-8	Dual JFET audio op-amp.	3.00	2.60	2.25
243660CL	OP275GS	SOIC-8	Dual JFET audio op-amp.	1.58	1.19	1.02
245403CL	L298N	MW-15	Dual full-bridge driver (MULTIWATT-15 pkg.)	5.35	4.81	4.33
245665CL	LM301AH	TO-5/8	Operational amplifier	2.14	1.64	1.27
212151CL	LM301AN	DIP-8	Operational amplifier	.47	.42	.30
23392CL	LM301N*	DIP-8	Improved op amp.	.47	.42	.30
245446CL	MAX301CPE	DIP-16	Precision dual high speed analog switch	5.99	5.37	4.83
245456CL	MAX301CSE	SOIC-16	Precision dual high speed analog switch	7.19	6.46	5.81
245462CL	MAX303CPE	DIP-16	Precision dual high speed analog switch	12.55	11.29	10.16
213188CL	LM306N	DIP-8	Differential comparator w/ strobes	\$.89	.69	.62
245673CL	LM308AH	TO-5/8	Precision op amp.	2.99	2.29	1.78
23464CL	LM308N*	DIP-8	Precision op amp.	4.49	3.99	3.49
23499CL	LM309K	TO-3/2	5V 1A regulator (0°C to +125°C)	\$ 5.99	4.99	3.85
193543CL	LM311D	SOIC-8	Voltage comparator	\$.24	.22	.19
23528CL	LM311N*	DIP-8	Voltage comparator	.35	.25	.19
251918CL	LP311D	SOIC-8	Voltage comparator	.76	.64	.52
239193CL	LP311P	DIP-8	Differential comparator	.69	.58	.47
245681CL	LM318M	SOIC-8	Precision high speed op amp.	1.15	.85	.64
23608CL	LM318N	DIP-8	Precision hi-speed op amp.	.56	.52	.46
245690CL	LM319M	SOIC-14	High speed dual comparator	.80	.59	.44

*10 pcs. in Linear series IC cabinet kit, pg 33

Linear Series (Continued)

Part No.	Cross Ref.	Pkg.	Description	Package (see above)		
				1	10	100
23632CL	LM319N	DIP-14	Hi-speed dual comparator	\$.30	\$.25	\$.22
23667CL	LM323K	TO-3/2	5V 3A positive regulator	3.19	2.78	2.12
245702CL	LM324AM	SOIC-14	Low power quad op amp.	.27	.23	.20
212169CL	LM324AN	DIP-14	Low power quad op amp.	\$.27	.22	.21
86721CL	LM324D	SOIC-14	Low power quad op amp.	.29	.21	.18
236833CL	LM324N*	DIP-14	Low power quad op amp.	.25	.23	.21
192559CL	LP324N	DIP-14	Micropower quad op amp.	.79	.59	.45
241963CL	LMV324M	SOIC-14	Low-voltage, general purpose op-amp	.91	.75	.58
23721CL	LM331*	DIP-8	Prec. volt to freq. convtr. (150ppm/°C)	\$ 2.55	1.75	1.55
245729CL	LM334M	SOIC-8	3-terminal adjustable current source	1.12	.83	.61
23739CL	LM334Z	TO-92	Adjust current source	.72	.65	.47
120820CL	LM335AZ	TO-92	Precision temperature sensor	.89	.72	.67
193560CL	LM335M	SOIC-8	Precision temperature sensor	1.25	.92	.55
23755CL	LM335Z	TO-92	Volt mode temperature sensor	\$.75	.67	.61
193578CL	LM336M-2.5	SOIC-8	Precision 2.5V shunt regulator diode	.69	.59	.44
23771CL	LM336Z	TO-92	Voltage reference (2.5V)	\$.69	.57	.49
246537CL	LM339AM	SOIC-14	Low pwr low offset volt. quad comparator	.37	.32	.24
143888CL	LM339AN	DIP-14	Low power quad comparator	\$.90	.24	.22
193594CL	LM339M	SOIC-14	Low pwr low offset volt quad comparator	\$.29	.23	.20
23851CL	LM339N*	OIP-14	Quad comparator	\$.25	.21	.18
251977CL	LP339M	SOIC-14	Ultra low power quad comparator	.74	.54	.40
121099CL	LP339N	DIP-14	Quad low-power comparator	.44	.34	.26
245438CL	LF347BD	SOIC-14	Quad JFET input op amp. (wide bandwidth)	1.49	1.40	1.26
245420CL	LF347M	SOIC-14	Quad JFET input op amp. (wide bandwidth)	.54	.47	.35
22904CL	LF347N	DIP-14	Quad JFET input op amp. (wide band)	\$.63	.36	.30
246570CL	LM348M	SOIC-14	Quad 741 op amp.	.59	.43	.31
23915CL	LM348N	DIP-14	Quad 741 op amp. (UPC4741C)	.35	.29	.26
22912CL	LF351N	DIP-8	BIFET op amp.	.39	.35	.29
245518CL	LF353D	SOIC-8	Dual JFET input op amp. (wide bandwidth)	.37	.30	.23
22939CL	LF353N*	DIP-8	Dual BIFET op amp. (comp. w/ TL082CP)	.39	.35	.29
193607CL	LF356M	SOIC-8	JFET input op amp. (wide band)	\$.59	.56	.51
22971CL	LF356N*	DIP-8	JFET input op amp. (wide band)	.79	.69	.59
22998CL	LF357N	DIP-8	JFET input op amp. (wide band decomp.)	\$ 2.92	2.35	1.91
246588CL	LM358AM	SOIC-8	Low power dual op amp.	.23	.22	.20
210862CL	LM358AN	DIP-8	Low power dual op amp. (elect improv.)	\$.55	.45	.37
193615CL	LM358D	SOIC-8	Low power dual op amp.	.23	.20	.18
23966CL	LM358N*	DIP-8	Low power dual op amp.	.20	.17	.16
24037CL	LM380N	DIP-14	2-watt audio power amp.	.85	.79	.57
24088CL	LM383T	TO-220/5	7-watt audio high power amp.	5.95	5.39	4.95
24096CL	LM384N	DIP-14	5-watt audio amp.	\$ 1.70	1.21	1.15
120871CL	LM385BZ-1.2	TO-92	Volt. ref. diode (1.2 ±1.5%)	.51	.45	.39
120889CL	LM385BZ2.5	TO-92	Volt. ref. diode (2.5V ±1.5%)	\$.60	.45	.43
24117CL	LM385Z12	TO-92	Micropower volt. ref. diode (1.2V)	\$.52	.45	.41
24109CL	LM385Z-2.5	TO-92	Volt. ref. diode (2.5V ±3%)	\$.49	.43	.41
193623CL	LM386M	SOIC-8	Low volt. audio power amp. 250mW/12V	.82	.74	.69
24125CL	LM386N-1*	DIP-8	Low voltage audio amp. 250mW/6V	.39	.35	.29
24133CL	LM386N-3*	DIP-8	Low voltage audio amp. 500mW/9V	.69	.59	.49
246633CL	LM392M	SOIC-8	Low power op amp./volt. comparator	1.53	1.13	.63
120900CL	LM392N	DIP-8	Low pwr op amp./voltage comparator	1.38	1.14	.84
246641CL	LM393AM	SOIC-8	Low pwr low offset volt. dual comparator	.30	.25	.21
212177CL	LM393AN	DIP-8	Low pwr low offset volt dual comparator	.27	.26	.24
193631CL	LM393D	SOIC-8	Low pwr offset voltage dual comparator	\$.29	.23	.20
24281CL	LM393N*	DIP-8	Dual comparator	\$.29	.20	.17
23000CL	LF398N	DIP-8	Sample and hold circuit	1.59	1.45	1.15
245454CL	DG403DY	SOIC-16	Improved dual hi-speed analog switches	1.83	1.48	1.22
245489CL	DG405DJ	DIP-16	Improved dual hi-speed analog switches	2.99	2.85	2.74
256541CL	DG406DJ	DIP-16	Imprvd 16-ch./dual 8-ch. CMOS analog mux.	8.29	7.47	6.72
256532CL	DG408DJ	DIP-16	Imprvd 8-ch./dual 4-ch. CMOS analog mux.	1.79	1.73	1.68
119941CL	LF411ACN	DIP-8	Low offset low drift JFET input op amp.	3.95	3.59	3.29

*10 pcs. in Linear series IC cabinet kit, pg 33

**20 pcs. in Linear series IC cabinet kit, pg 33

Call for pricing on quantities over 100 - we carry major manufacturers. We will special order any IC - \$100 minimum.

Linear Series (Continued)



Package (see pg 18)

Part No.	Cross Ref.	Pkg.	Description	1	10	100
23018CL	LF411CN*	DIP-8	Low offset drift JFET input op amp.	\$1.21	\$.90	\$.66
243643CL	DG411DJ	DIP-16	Quad precision analog switch	1.33	1.48	1.35
243651CL	DG411DY	SOIC-16	Quad analog switch	1.63	1.58	1.54
256516CL	DG412DJ	DIP-16	Improved quad SPST analog switch	1.83	1.61	1.06
245358CL	DG412DY	SOIC-16	Improved quad SPST analog switch	1.51	1.37	1.16
193640CL	LF412CD	SOIC-8	Low offset drift JFET input dual op amp.	.79	.66	.53
119950CL	LF412ACN	DIP-8	Dual JFET op-amp.	2.85	2.55	2.19
23026CL	LF412CN*	DIP-8	Low offset drift JFET input dual op amp.	\$1.35	.78	.66
246561CL	DG419DY	SOIC-8	Improved SPST/SPDT analog switch	1.18	1.13	1.08
116206CL	TC426PCA	DIP-8	Dual 1.5A high speed pwr MOSFET driver	1.59	1.45	1.30
245593CL	TC426EOA	SOIC-8	Dual 1.5A high speed pwr MOSFET driver	1.67	1.50	1.35
242077CL	TC428PCA	DIP-8	Dual MOSFET 1.5A driver	1.61	.98	.78
241955CL	LM431ACZ	TO-92	Adj. precision zener shunt regulator	.42	.37	.31
33347CL	TL431CLP	TO-92	Program precision reference	.27	.22	.15
256495CL	DG442DJ	DIP-16	Improved quad SPST analog switch	1.65	1.49	1.22
256508CL	DG442DY	SOIC-16	Improved quad SPST analog switch	1.75	1.56	1.40
106681CL	LF442CN	DIP-8	Dual low power JFET input op amp.	.88	.79	.57
256487CL	DG444DJ	DIP-16	Improved quad SPST analog switch	2.69	2.40	2.16
256479CL	DG444DY	SOIC-16	Improved quad SPST analog switch	2.45	2.19	1.97
119984CL	LF444ACN	DIP-14	Quad low power JFET input op amp.	\$2.25	1.78	1.51
119992CL	LF444CN	DIP-14	Quad low power JFET input op amp.	1.45	1.09	.79
256452CL	DG445DJ	DIP-16	Improved quad SPST analog switch	2.59	2.32	2.09
256444CL	DG445DY	SOIC-16	Improved quad SPST analog switch	1.37	1.31	1.24
33355CL	TL494CN	DIP-16	Control. ckt. pulse width modulated	.79	.69	.59
86799CL	LM555CM	SOIC-8	Timer (NE555D)	.29	.25	.22
27422CL	LM555CN*	DIP-8	Timer (MC1455P/NE555V)	.27	.23	.17
246676CL	LMC555CM	SOIC-8	CMOS 555 timer	.50	.43	.27
126797CL	LMC555CN*	DIP-8	CMOS 555 timer	.54	.49	.44
34930CL	XRL555	DIP-8	Micro power 555 timer	.89	.79	.69
193658CL	LM556CM	SOIC-14	Dual 555 timer	.49	.29	.21
24328CL	LM556N*	DIP-14	Dual 555 timer (MC3456P)	.49	.45	.39
27457CL	NE558N	DIP-16	Quad timer (NE558C)	.69	.52	.36
27473CL	NE564N	DIP-16	High frequency phase locked loop	1.95	1.49	1.05
24352CL	LM565N	DIP-14	Phased locked loop	1.49	1.29	1.19
193666CL	LM567CM	SOIC-8	Tone decoder	.39	.35	.29
24395CL	LM567CN	DIP-8	Tone decoder	.49	.40	.37
246650CL	LMC567CN	DIP-8	Tone decoder	1.39	1.16	.88
243387CL	LMC568CN	DIP-8	Low power phase-locked loop	2.09	1.85	1.53
27490CL	NE571N	DIP-16	Companion, subscriber	3.29	2.99	2.69
241939CL	AD590JH	TO-52/3	Two terminal IC temperature transducer	5.85	4.55	3.88
115174CL	AD620AN	DIP-8	Low cost instrument amplifier	17.95	15.95	14.35
115182CL	AD633JN	DIP-8	Low cost analog multiplier	7.95	7.55	7.15
241912CL	TC646VOA	SOIC-8	3-5V, PWM fan controller	2.82	2.33	1.85
242131CL	TC648VPA	DIP-8	3-5V, PWM fan controller	2.29	2.10	2.00
143976CL	LMC660CN	DIP-14	CMOS quad operational amplifier	1.65	1.23	.91
120926CL	LM675T	TO-220/5	Power op amplifier	6.95	5.25	4.39
214041CL	TL712CP	DIP-8	Differential comparator	1.10	.89	.67
24483CL	LM725CN	DIP-8	Instrumentation op amplifier	2.75	1.99	1.45
24491CL	LM733CN	DIP-14	Differential amplifier	.99	.89	.79
24521CL	LM741CH	TO-5/8	Op amplifier	2.69	2.07	1.59
24539CL	LM741CN**	DIP-8	Op amplifier (ULN2151)	.29	.25	.19
24563CL	LM747CN	DIP-14	Dual 741 op amplifier	3.99	3.49	2.99
246668CL	LM837M	SOIC-14	Low noise quad operational amp.	1.02	.80	.75
143896CL	LM837N	DIP-14	Low-noise quad operational amp.	\$1.49	1.35	1.12
25435CL	MC846P	DIP-14	Quad 2-input gate	3.95	2.95	2.25
239222CL	LT1001CN8	DIP-8	Precision op amplifier	3.19	2.87	2.58
239231CL	LT1002CN	DIP-14	Dual, matched precision op amplifier	4.73	3.19	2.71
239257CL	LT1004CZ-1.2	TO-92	1.2V, micropower voltage reference	\$.92	.48	.38
239265CL	LT1004CZ-2.5	TO-92	2.5V, micropower voltage reference	.68	.52	.40
239214CL	LT1006CN8	DIP-8	Precision op-amplifier	\$2.99	2.39	1.99
239273CL	LT1012CN8	DIP-8	Picoamp input curr. microvolt offset, low noise op amp.	4.50	3.05	2.55
239169CL	LT1013CP	DIP-8	Dual precision op amplifier	1.20	1.01	.90
252005CL	LT1013DD	SOIC-8	Dual precision op amplifier	.87	.78	.70
239177CL	LT1014DN	DIP-14	Quad precision op amplifier	\$4.89	3.25	2.85
246692CL	LT1030N	DIP-14	Quad low power line driver	1.11	.93	.76
24942CL	MC1350P	DIP-8	Video IF amp (12V operation)	1.95	1.85	1.75

*10 pcs. in Linear series IC cabinet kit, pg 33

**20 pcs. in Linear series IC cabinet kit, pg 33

Linear Series (Continued)



Package (see pg 18)

Part No.	Cross Ref.	Pkg.	Description	1	10	100
193682CL	LM1458M	SOIC-8	Dual op amplifier	\$2.29	\$ 2.26	\$ 2.22
23131CL	LM1458N*	DIP-8	Dual op amplifier (RC4558)	.29	.26	.20
118578CL	MC1495L	DIP-14	Linear four quadrant multiplier	9.95	8.95	8.05
23211CL	LM1496N	DIP-14	Balanced mod./demodulator (MC1496P)	.79	.59	.49
23270CL	LM1875T	TO-220/5	20-watt power audio amplifier	1.95	1.55	1.25
245534CL	LM1877M-9	SOIC-14	Dual audio power amplifier	1.41	1.06	.79
23288CL	LM1877N-9	DIP-14	Dual power audio amplifier	\$1.65	1.45	1.09
245642CL	LM1881M	SOIC-8	Video synchronous separator	2.67	2.04	1.57
107140CL	LM1881N	DIP-8	Video synchronous separator	2.69	2.05	1.55
243547CL	LM1894N	DIP-14	DNR noise reduction	2.77	2.14	1.67
32897CL	TDA2002V	TO-220/5	8-watt audio high power amp.	\$1.65	1.45	1.28
34278CL	ULN2003A*	DIP-16	Hi-volt/curr. darl. transistor array	.39	.35	.29
193826CL	ULN2003AD	SOIC-16	Hi-volt/curr. darl. transistor array	.39	.35	.29
34294CL	ULN2004A	DIP-16	Hi-volt/curr. darl. trans. array (XR2204CP)	.32	.29	.25
241891CL	ML2035CP	DIP-8	Serial input prog. sine wave generator	8.29	6.59	5.29
241883CL	ML2036CP	DIP-14	5V, 50kHz prog. sine wave generator	4.33	3.33	2.83
34972CL	XR2206CP	DIP-16	Monolithic function generator	3.59	3.29	2.99
34999CL	XR2211N	DIP-14	FSK demodulator/tone decoder	1.79	1.59	1.39
34315CL	ULN2803A*	DIP-18	Hi-volt. hi-curr. darl. transistor array	.69	.59	.49
245577CL	LM2901M	SOIC-14	Low pwr low offset volt. quad comparator	.30	.22	.19
23296CL	LM2901N	DIP-14	Quad comparator	.26	.24	.18
245606CL	LM2902M	SOIC-14	Low power quad op amplifier	.27	.24	.19
57007CL	LM2902N	DIP-14	Low power quad op amplifier	.285	.259	.19
245614CL	LM2903M	SOIC-14	Low power low offset volt. dual comp.	.27	.25	.19
23309CL	LM2903N	DIP-8	Low power low offset volt. dual comp.	.25	.23	.19
245622CL	LM2904M	SOIC-8	Low power dual op amplifier	.25	.23	.20
121005CZ	LM2904N	DIP-8	Low power dual op amplifier	.22	.20	.19
123625CL	LM2907N-8	DIP-8	Frequency to volt converter	\$1.95	1.79	1.56
23317CL	LM2907N	DIP-14	Frequency to volt converter	1.59	1.39	1.08
245631CL	LM2917M	SOIC-14	Frequency to voltage converter	2.75	2.48	2.23
23350CL	LM2917N-8	DIP-8	Frequency to volt converter	2.45	1.75	1.25
23341CL	LM2917N-14	DIP-14	Frequency to volt converter	1.79	1.49	1.29
12079CL	CA3046N	DIP-14	NPN transistor array (ULN2046)	\$.42	.45	.40
12116CL	CA3080E	DIP-8	Op transconductance amp. (100135)	\$.58	.51	.44
12124CL	CA3081N	DIP-16	Common emitter NPN array (ULN2081)	.69	.59	.54
12159CL	CA3086N	DIP-14	Transistor array NPN (ULN2086)	.49	.49	.37
12183CL	CA3130E	DIP-8	CMOS op amplifier	.81	.78	.71
12204CL	CA3140E	DIP-8	Bi-MOS op amplifier	\$.72	.68	.65
12239CL	CA3161E	DIP-16	BCD to 7-seg. decoder driver	\$2.19	2.11	1.95
12247CL	CA3162E	DIP-16	Dual slope & rate analog/digital convert	6.95	5.95	5.25
245711CL	LM3302D	SOIC-14	Low pwr low offset volt. quad comparator	.45	.42	.38
107238CL	LM3302N	DIP-14	Low pwr low offset volt. quad comparator	.32	.22	.13
246721CL	MC3303D	SOIC-14	Quad op amplifier	.43	.35	.31
212185CL	MC3303N	DIP-14	Quad bipolar op amplifier	\$.43	.35	.31
212193CL	MC3403N	DIP-14	Quad bipolar op amplifier	.45	.38	.29
25216CL	MC3479P	DIP-16	Biphase stepper motor driver	5.75	5.18	4.65
31974CL	SG3524N	DIP-16	Regulating pulse width modulator	\$.65	.45	.41
235328CL	UC3525AN	DIP-8	SMPS Controller	.62	.58	.55
243521CL	JC3842AN	DIP-8	30V, current mode PWM controller	.49	.46	.38
243504CL	UC3843AN	DIP-8	30V, current mode PWM controller	.49	.37	.29
243512CL	UC3844N	DIP-8	30V, current mode PWM controller	.48	.42	.34
243491CL	UC3845N	DIP-8	30V, current mode PWM controller	.46	.41	.36
252013CL	LM3875T	TO-220/11	56W high perf. audio power amp.	7.45	6.71	6.04
126834CL	LM3876T	TO-220/11	40W high perf. audio amp. with mute	4.95	3.95	3.25
192516CL	LM3886T	TO-220/11	68W high perf. audio amp. with mute	5.19	3.95	2.95
246617CL	LM3900D	SOIC-14	Quad amplifier	1.03	.93	.84
24168CL	LM3900N	DIP-14	Quad amplifier	.77	.65	.53
24230CL	LM3914N	DIP-18	Bar-graph display driver	2.25	2.02	1.82
246625CL	LM3914V	PLCC-20	Dot/bar display driver	2.58	2.18	1.68
24256CL	LM3915N	DIP-18	3 dB steps bar-graph disp. driver	2.49	1.99	1.55
24272CL	LM3916N	DIP-18	VU meter display driver	2.25	1.95	1.75
239185CL	THS4031CD	SOIC-8	100MHz op-amp	5.15	4.64	4.19
243571CL	LM4040AIZ-10	TO-92	Precision micropower shunt volt. ref.	1.95	1.29	.97
243598CL	LM4040AIZ-2.5	TO-92	2.5V, precision micropower volt. ref.	\$1.99	1.14	.84
243580CL	LM4040AIZ-5.0	TO-92	5.0V, precision micropower volt. ref.	1.87	1.56	1.16
243619CL	LM4040CIZ-2.5	TO-92	2.5V, precision micropower volt. ref.	1.14	.84	.62

*10 pcs. in Linear series IC cabinet kit, pg 33

Analog - Transistors

Color Code Legend
New Sale Qty. Save Pull Closeout

Call for pricing on quantities over 100 - we carry major manufacturers. We will special order any IC - \$100 minimum.

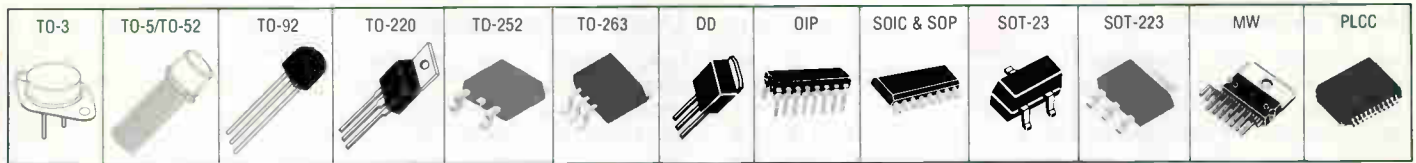

Semiconductor

Linear Series (Continued)



Package (see above)

Part No.	Cross Ref.	Pkg.	Description	1	10	100
243601CL	LM4040C1Z-5.0	TO-92	5.0V, precision micropower volt. ref.	\$1.14	\$.84	\$.62
25275CL	MC4044P	DIP-14	Frequency phase detector	9.99	7.49	5.25
29356CL	RC4136N	DIP-14	Quad op amp (XR4136)	.77	.71	.66
29372CL	RC4151NB	DIP-8	Volt to freq. converter (XR4151)	1.29	1.19	1.09
251256CL	TLC4501ACD	SOIC-8	Precision CMOS rail to rail output op amp	3.75	3.38	3.04
251264CL	TLC4501CD	SOIC-8	Precision CMOS rail to rail output op amp	3.55	3.21	2.89
251281CL	TLC4502AIO	SOIC-8	Precision CMOS rail to rail output op amp	5.59	5.04	4.54
251272CL	TLC4502IO	SOIC-8	Precision CMOS rail to rail output op amp	5.15	4.63	4.17
251150CL	MC4558CO	SOIC-8	Wide bandwidth dual bipolar op amp	.56	.50	.45
251125CL	NE5534	OIP-8	Wide bandwidth dual bipolar op amp	.31	.29	.27
243379CL	MM5453N	OIP-40	Liquid crystal display driver	2.79	2.29	2.09
252970CL	NE5532AP	OIP-8	Quad low noise op amp	.69	.58	.47
27385CL	NE5532N*	DIP-8	Dual low noise op amp	.49	.43	.39
27406CL	NE5534	OIP-8	Low noise op amp	.79	.69	.59
193746CL	NE5534D	SOIC-8	Low noise op amp	.43	.37	.26
126893CL	LMC6482AIN	OIP-8	CMOS dual rail to rail input/output op amp	2.06	1.56	1.17
251168CL	LMC6482AIM	SOIC-8	CMOS dual rail to rail input/output op amp	2.06	1.56	1.17
251871CL	LMC7101AM5	SOT-23/5	Tiny low power op amp w/ rail to rail I/O	1.67	1.25	.93
251900CL	LMC7111AIN	DIP-8	Tiny CMOS op amp w/ rail to rail I/O	1.55	1.40	1.26
51140CL	7555IPA	OIP-8	CMOS timer (LM555CN)	\$.49	.36	.28
241808CL	ICL7665SCPA	DIP-8	2-16V voltage detector	2.55	2.19	1.69
241816CL	ICL7673CPA	OIP-8	Auto battery backup switch, 2.5V to 15V	1.29	1.19	.89
51879CL	8038CCPO	OIP-14	Precision wave form generator	3.19	2.49	2.39

*10 pcs. in Linear series IC cabinet kit, pg 33

Linear Series (Continued)



Package (see above)

Part No.	Cross Ref.	Pkg.	Description	1	10	100
241875CL	FAN8082	DIP-8	Bi-directional, 18V dc motor driver	\$.85	\$.60	\$.50
255257CL	AD8091AR	SOIC-8	Low cost high speed rail to rail amplifier	1.55	1.25	1.13
255231CL	AD8092ARM	SOIC-8	Low cost high speed rail to rail amplifier	2.15	1.95	1.76
241867CL	FAN8200	DIP-14	Bi-directional, 2-ch, 9V stepper motor driver	.39	.39	.39
255206CL	AD8510AR	SOIC-8	Prec. low noise low input bias curr. JFET input op amp	2.55	2.30	2.11
192532CL	LM13700N	OIP-16	Quad op transcon. amp. w/ diodes & buffer	1.49	1.19	.79
25021CL	MC14411P	DIP-24	Bit rate frequency generator	6.95	5.95	4.45
241841CL	MC14467	DIP-16	Smoke detector	1.59	.97	.85
241824CL	MC14489	OIP-20	5V, LED display/lamp driver	\$.55	\$.35	\$.30
25064CL	MC14490P	OIP-16	Hex contact bounce eliminator	6.95	6.25	5.59
251117CL	MC34072D	SOIC-8	Single supply 3V-44V op amp	.90	.78	.70
251061CL	MC34072P	OIP-8	Single supply 3V-44V op amp	.91	.85	.79
241744CL	MCP41010-I/P	DIP-8	10k Ω , 256 steps, SPI digital pot	1.59	1.30	1.25
241761CL	MCP41050-I/P	OIP-8	50k Ω , 256 steps, SPI digital pot	1.86	1.75	1.69
241787CL	MCP41100-I/P	DIP-8	100k Ω , 256 steps, SPI digital pot	1.61	1.41	1.35
241752CL	MCP42010-I/P	DIP-14	10k Ω , 256 steps, 2-ch, SPI digital pot	2.38	1.89	1.78
241779CL	MCP42050-I/P	DIP-14	50k Ω , 256 steps, 2-ch, SPI digital pot	2.28	1.80	1.69
241832CL	MC145012	OIP-16	Smoke detector	2.78	2.80	2.80
118586CL	MC145151P	OIP-28	Parallel input PLL freq. synthesizer	5.95	5.05	3.79



See page 33 for 7400, 74LS, 4000 and Linear Series IC Cabinet Kits.

Transistors



Package (see pg 21)

* Prepackaged: order in increments of 10, 100 or 1000

Part No.	Product No.	Mfr.	Pkg.	Desc.	Vceo	Min. (h _{FE} @ Ic)	1	10	100	1000
214834CL	MMBTA05	♦	SOT-23	NPN	60	—	\$.067	\$.045	\$.03	
214842CL	MMBTA06	♦	SOT-23	NPN	80	100 @ .01A	\$.057	\$.048	\$.038	
26462CL	MPSA06	♦	TO-92	NPN	30	50 @ .01A	\$.44	\$.32	\$.28	
214851CL	MMBTA13	♦	SOT-23	NPN	30	5k @ .01A	\$.057	\$.039	\$.026	
26489CL	MPSA13	♦	TO-92	NPN	30	5k @ .01A	\$.75	\$.55	\$.47	
214869CL	MMBTA14	♦	SOT-23	NPN	30	10k @ .01A	\$.059	\$.039	\$.024	
210593CL	MPSA14	♦	TO-92	NPN	30	20k @ .10A	\$.05	\$.035	\$.025	
210681CL	MPSA18	♦	TO-92	NPN	45	500 @ .001A	\$.06	\$.05	\$.031	
33021CL	TIP29A	♦	TO-220	NPN	60	15 @ 1A	\$.45	\$.38	\$.27	
33030CL	TIP30A	♦	TO-220	PNP	60	15 @ 1A	\$.54	\$.50	\$.45	\$.37
179346CL	TIP30C	FSC	TO-220	PNP	100	15 @ 1A	\$.39	\$.32	\$.27	\$.25
33048CL	TIP31A	♦	TO-220	NPN	60	10 @ 3A	\$.49	\$.39	\$.35	\$.29
179354CL	TIP31C	FSC	TO-220	NPN	100	10 @ 3A	\$.42	\$.37	\$.36	\$.27
33064CL	TIP32A	♦	TO-220	PNP	60	10 @ 3A	\$.49	\$.37	\$.35	\$.27
181841CL	TIP32C	♦	TO-220	PNP	100	10 @ 3A	\$.48	\$.37	\$.36	\$.27
179371CL	TIP41C	FSC	TO-220	NPN	100	15 @ 3A	\$.47	\$.36	\$.34	\$.28
33081CL	TIP41A	♦	TO-220	NPN	60	15 @ 3A	\$.55	\$.48	\$.38	\$.31
214885CL	MMBTA42	♦	SOT-23	PNP	300	40 @ .01A	\$.065	\$.057	\$.047	
178546CL	MPSA42	♦	TO-92	NPN	30	40 @ .03A	\$.89	\$.69	\$.64	
33101CL	TIP42A	♦	TO-220	PNP	60	15 @ 3A	\$.48	\$.42	\$.35	\$.29
139580CL	TIP42C	♦	TO-220	PNP	100	15 @ 3A	\$.49	\$.39	\$.35	\$.28
179389CL	TIP42C	FSC	TO-220	PNP	100	15 @ 3A	\$.52	\$.41	\$.35	\$.28
214906CL	MMBTA55	♦	SOT-23	PNP	60	100 @ .01A	\$.056	\$.038	\$.024	
214914CL	MMBTA56	♦	SOT-23	PNP	80	100 @ .01A	\$.085	\$.058	\$.04	
210606CL	MPSA56	♦	TO-92	PNP	80	100 @ .10A	\$.05	\$.04	\$.034	
214922CL	MMBTA63	♦	SOT-23	PNP	30	5k @ .01A	\$.056	\$.038	\$.025	
214931CL	MMBTA64	♦	SOT-23	PNP	30	10k @ .01A	\$.056	\$.038	\$.025	
120221CL	BPW77NA	♦	TO-18	NPN	70	—	1.95	1.75	1.49	1.39
178554CL	MPSA92	♦	TO-92	PNP	300	25 @ .003A	\$.067	\$.048	\$.029	
214957CL	MMBTA92	♦	SOT-23	PNP	300	40 @ .01A	\$.06	\$.05	\$.045	

♦ Manufacturer varies FSC = Fairchild Semiconductor

Transistors (Continued)



Package (see pg 21)

* Prepackaged: order in increments of 10, 100 or 1000

Part No.	Product No.	Mfr.	Pkg.	Desc.	Vceo	Min. (h _{FE} @ Ic)	1	10	100	1000
214033CL	MPSA93	♦	TO-92	PNP	200	25 @ .03A	\$.85	\$.65	\$.54	
32977CL	TIP102	♦	TO-220	NPN	100	1k @ 3A	\$.45	\$.39	\$.35	\$.29
179240CL	TIP102	FSC	TO-220	NPN	100	1k @ 3A	\$.67	\$.53	\$.47	\$.37
32985CL	TIP106	♦	TO-220	PNP	80	1k @ 3A	\$.59	\$.54	\$.49	\$.39
179258CL	TIP107	FSC	TO-220	PNP	100	1k @ 3A	\$.67	\$.53	\$.47	\$.37
32993CL	TIP120	♦	TO-220	NPN	60	1k @ 3A	\$.49	\$.45	\$.39	\$.35
179291CL	TIP120	FSC	TO-220	NPN	60	1k @ 3A	\$.58	\$.47	\$.46	\$.37
120416CL	TIP122	♦	TO-220	NPN	100	1k @ 3A	\$.38	\$.32	\$.22	\$.17
179303CL	TIP122	FSC	TO-220	NPN	100	1k @ 3A	\$.47	\$.37	\$.34	\$.25
33013CL	TIP125	♦	TO-220	PNP	60	1k @ 3A	\$.55	\$.49	\$.45	\$.29
179320CL	TIP127	FSC	TO-220	PNP	100	1k @ 3A	\$.45	\$.42	\$.38	\$.28
254772CL	BC237	♦	TO-126	NPN	80	40 @ .15A	\$.41	\$.40	\$.38	\$.28
254810CL	BC337	♦	TO-92	NPN	45	100 @ .10A	\$.12	\$.059	\$.042	\$.039
211529CL	MJE340	♦	TO-225	NPN	300	30 @ .05A	\$.30	\$.28	\$.23	\$.216
211537CL	MJE350	♦	TO-225	PNP	300	30 @ .05A	\$.37	\$.33	\$.31	\$.25
255994CL	BU406	♦	TO-220	NPN	200	—	1.17	1.02	.89	.83
256073CL	BC438	♦	TO-225	PNP	45	30 @ .01A	\$.39	\$.36	\$.34	\$.27
254801CL	BC547B	♦	TO-92	NPN	45	330 @ .002A	\$.07	\$.078	\$.075	\$.05
254799CL	BC547C	♦	TO-92	NPN	45	600 @ .002A	\$.09	\$.08	\$.07	
254781CL	BC548B	♦	TO-92	NPN	30	110 @ .002A	\$.085	\$.075	\$.05	
256065CL	BD682	♦	TO-225	PNP	100	750 @ 1.5A	\$.39	\$.38	\$.36	\$.21
211545CL	MJE700	♦	TO-225	PNP	60	750 @ 1.5A	\$.37	\$.34	\$.32	\$.28
211553CL	MJE800	♦	TO-225	NPN	60	750 @ 1.5A	\$.29	\$.28	\$.27	\$.18
213920CL	MMBT918	♦	SOT-23	NPN	15	20 @ .003A	\$.043	\$.029	\$.018	
194327CL	2N2102	♦	TO-39	NPN	65	40 @ .15A	\$.39	\$.35	\$.28	\$.21
38228CL	2N219A	♦	TO-39	NPN	40	100 @ .15A	\$.59	\$.49	\$.45	\$.39
94941CL	MMBT2222	♦	SOT-23	NPN	30	100 @ .15A	\$.22	\$.19	\$.15	\$.12
26446CL	MPQ2222	♦	OIP-14	NPN	40	100 @ .15A	2.25	1.95	1.79	1.65
28628CL	PN2222	♦	TO-92	NPN	30	100 @ .15A	\$.045	\$.027	\$.025	
213938CL	MMBT2222A	♦	SOT-23	NPN	40	100 @ .15A	\$.054	\$.045	\$.029	

♦ Manufacturer varies FSC = Fairchild Semiconductor

Call for pricing on quantities over 5000 - we carry major manufacturers.

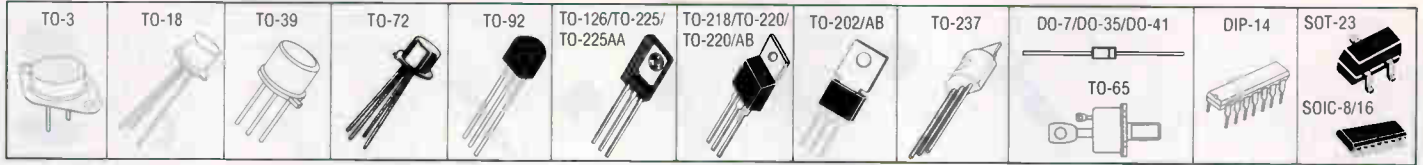

Semiconductors

Transistors (Continued)



Package (see above)

Prepackaged: order in increments of 10, 100 or 1000

Part No.	Product No.	Mfr.	Pkg.	Desc.	V _{ceo} Min.	(h _{FE} @ I _c)	1	10	100	1000
213997CL	MMPQ2222A	◆	SOIC-16	NPN	40	100 @ .15A	\$.87	\$.81	\$.75	\$.57
210673CL	MPS2222A	◆	TO-92	NPN	40	40 @ .50A
178511CL	PN2222A	◆	TO-92	NPN	40	100 @ .15A
38236CL	2N2222A	◆	TO-18	NPN	40	100 @ .15A
214658CL	MMBT2369	◆	SOT-23	PNP	25	60 @ .05A
213946CL	MMBT2369A	◆	SOT-23	NPN	15	40 @ .01A
26526CL	MPS2369	◆	TO-92	NPN	15	20 @ .10A
211334CL	MPS2369A	◆	TO-92	NPN	15	20 @ .10A
194378CL	2N2905A	◆	TO-39	PNP	60	100 @ .15A
94959CL	MMBT2907	◆	SOT-23	PNP	40	100 @ .15A
26454CL	MPQ2907	◆	DIP-14	PNP	40	100 @ .15A	1.55	1.45	1.35	1.10
28644CL	PN2907	◆	TO-92	PNP	40	100 @ .15A
213954CL	MMBT2907A	◆	SOT-23	PNP	60	100 @ .01A
214009CL	MMPQ2907A	◆	SOIC-16	PNP	60	100 @ .01A
211342CL	MPS2907A	◆	TO-92	PNP	60	100 @ .15A
178520CL	PN2907A	◆	TO-92	PNP	60	100 @ .15A
38279CL	2N2907A	◆	TO-18	PNP	60	100 @ .15A
211377CL	TIP2955	◆	TO-218	PNP	60	5 @ .001A
211502CL	MJ2955A	◆	TO-3	NPN	60	20 @ 4A
25831CL	MJE2955T	◆	TO-220	PNP	60	20 @ 4A
38295CL	2N3053	◆	TO-39	NPN	40	25 @ .15A
211385CL	TIP3055	◆	TO-218	NPN	60	5 @ .001A	1.10	.95	.85	.79
38308CL	2N3055	◆	TO-3	NPN	60	15 @ 10A
211406CL	2N3055A	◆	TO-3	NPN	60	20 @ 4A
25857CL	MJE3055T	◆	TO-220	PNP	60	20 @ 4A
194415CL	2N3439	◆	TO-39	NPN	350	40 @ .02A
194423CL	2N3440	◆	TO-39	NPN	250	40 @ .02A
211561CL	MPS3646	◆	TO-92	NPN	15	30 @ .003A
194458CL	2N3700	◆	TO-18	NPN	80	100 @ .15A
209242CL	2N3771	◆	TO-3	NPN	40	15 @ 15A
38324CL	2N3772	◆	TO-3	NPN	40	15 @ 10A	1.49	1.35	1.19	.99
140151CL	2N3773	◆	TO-3	NPN	140	15 @ 8A	2.35	2.19	1.99	1.69
62279CL	2N3903	◆	TO-92	NPN	40	50 @ .01A
94967CL	MMBT3904	◆	SOT-23	NPN	40	100 @ .01A
211351CL	MPS3904	◆	TO-92	NPN	40	100 @ .001A
38359CL	2N3904	◆	TO-92	NPN	40	100 @ .01A
178597CL	2N3904	FSC	TO-92	NPN	40	100 @ .01A
62287CL	2N3905	◆	TO-92	PNP	40	50 @ .01A
94975CL	MMBT3906	◆	SOT-23	PNP	40	100 @ .01A
214017CL	MMPQ3906	◆	SOIC-16	PNP	40	75 @ .01A
211369CL	MPS3906	◆	TO-92	PNP	40	100 @ .001A
38375CL	2N3906	◆	TO-92	PNP	40	100 @ .01A
178618CL	2N3906	FSC	TO-92	PNP	40	100 @ .01A
194466CL	2N4033	◆	TO-39	PNP	80	100 @ .10A
38404CL	2N4123	◆	TO-92	NPN	30	25 @ .05A
214674CL	MMBT4124	◆	SOT-23	NPN	25	60 @ .05A
62295CL	2N4124	◆	TO-92	NPN	25	60 @ .05A
214682CL	MMBT4126	◆	SOT-23	PNP	25	60 @ .05A
253411CL	2N4400	◆	TO-92	NPN	40	50 @ .15A
214703CL	MMBT4401	◆	SOT-23	NPN	40	80 @ .01A
38421CL	2N4401	◆	TO-92	NPN	40	100 @ .15A
214720CL	MMBT4403	◆	SOT-23	PNP	40	60 @ .001A
38447CL	2N4403	◆	TO-92	PNP	40	100 @ .15A
211511CL	2N4410	◆	TO-92	NPN	80	60 @ .01A
211449CL	2N4918	◆	TO-225	PNP	40	30 @ .50A
211457CL	2N4919	◆	TO-225	PNP	60	30 @ .50A

◆ Manufacturer varies FSC = Fairchild Semiconductor

Transistors (Continued)



Package (see above)

Prepackaged: order in increments of 10, 100 or 1000

Part No.	Product No.	Mfr.	Pkg.	Desc.	V _{ceo} Min.	(h _{FE} @ I _c)	1	10	100	1000
211465CL	2N4920	◆	TO-225	PNP	80	30 @ .50A	\$.33	\$.30	\$.30	\$.29
211473CL	2N4921	◆	TO-225	NPN	40	30 @ .50A
211481CL	2N4922	◆	TO-225	NPN	60	30 @ .50A
214623CL	2N4126	◆	TO-92	PNP	25	60 @ .05A
211490CL	2N4923	◆	TO-225	NPN	80	30 @ .50A
213962CL	MMBT5087	◆	SOT-23	PNP	50	250 @ .01A
210631CL	2N5087	◆	TO-92	PNP	50	250 @ .10A
213971CL	MMBT5088	◆	SOT-23	NPN	30	300 @ .01A
62316CL	2N5088	◆	TO-92	NPN	30	300 @ .10A
214746CL	MMBT5089	◆	SOT-23	NPN	25	400 @ .01A
62324CL	2N5089	◆	TO-92	NPN	25	400 @ .10A
38480CL	PN5179	◆	TO-92	NPN	15	25 @ .003A
140373CL	2N5179	◆	TO-72	NPN	12	25 @ .003A
209251CL	2N5191	◆	TO-225	NPN	60	25 @ 1.5A
38498CL	2N5192	◆	TO-225	NPN	80	20 @ 1.5A
209269CL	2N5194	◆	TO-225	PNP	60	25 @ 1.5A
38501CL	2N5195	◆	TO-225	PNP	80	20 @ 1.5A
253930CL	2N5400	◆	TO-92	PNP	120	40 @ .010A
214754CL	MMBT5401	◆	SOT-23	PNP	150	40 @ .001A
210649CL	2N5401	◆	TO-92	PNP	150	60 @ .01A
214762CL	MMBT5550	◆	SOT-23	NPN	140	60 @ .01A
253569CL	2N5550	◆	TO-92	NPN	140	60 @ .010A
214771CL	MMBT5551	◆	SOT-23	NPN	140	80 @ .01A
210657CL	2N5551	◆	TO-92	NPN	160	80 @ .01A
209277CL	2N5657	◆	TO-126	NPN	350	30 @ .10A
253438CL	2N5884	◆	TO-3	PNP	80	4 @ 25A	2.35	2.18	1.63	1.56
254764CL	2N5886	◆	TO-3	NPN	80	20 @ 10A	2.25	2.09	1.59	1.28
194571CL	2N6042	◆	TO-220	PNP	100	1k @ 3A
194589CL	2N6045	◆	TO-220	NPN	100	1k @ 3A
194597CL	2N6052	◆	TO-3	PNP	100	750 @ 6A
194600CL	2N6059	◆	TO-3	NPN	100	750 @ 6A
255011CL	2N6292	◆	TO-220	NPN	70	30 @ 2A
213989CL	MMBT6427	◆	SOT-23	NPN	40	10k @ .01A
255003CL	2N6427	◆	TO-92	NPN	40	10k @ .01A
214789CL	MMBT6428	◆	SOT-23	NPN	50	250 @ .01A
194618CL	2N6547	◆	TO-3	NPN	400	12 @ 5A
194626CL	2N6678	◆	TO-3	NPN	400	8 @ 15A	6.79	6.15	5.75	4.49
214025CL	MMPQ6700	◆	SOIC-16	NPN/PNP	40	70 @ .01A
140134CL	2N6725	◆	TO-237	NPN	50	25k @ .2A

◆ Manufacturer varies

J-FETs

Package (see above)

Prepackaged: order in increments of 10, 100 or 1000

Part No.	Product No.	Mfr.	Pkg.	Desc.	BV _{GS} @ I _{GU} A	Loss (mA) @ V _{DS}	1	10	100	1000
210622CL	2N3819	◆	TO-92	N-Ch	25 @ 1	20 @ 15
38341CL	2N3823	◆	TO-72	N-Ch	30 @ 1	20 @ 15
38527CL	2N5951	◆	TO-92	N-Ch	30 @ 1	13 @ 15
26403CL	MPF102	◆	TO-92	N-Ch	25 @ 1	20 @ 15
211393CL	J111	◆	TO-92	N-Ch	35 @ 1	20 @ 15
140450CL	J112	◆	TO-92	N-Ch	35 @ 1	5 @ 15
140142CL	J176	◆	TO-92	P-Ch	30 @ 1	2 @ 25
211414CL	J177	◆	TO-92	P-Ch	30 @ 1	20 @ 15

◆ Manufacturer varies

30-Day Money-Back Guarantee

Transistors - Diodes - Voltage Suppressors

Color Code Legend
New Sale by Same Closeout

Call for pricing on quantities over 5000 - we carry major manufacturers.

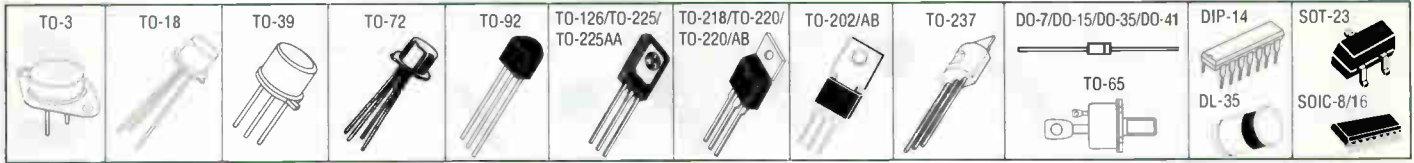

N-Channel/P-Channel MOSFETs

Package (see above)

Prepackaged: order in increments of 10, 100 or 1000

Part No.	Product No.	Mfr.	Pkg.	Desc.	Min. On-St.					
					BV _{DS}	DS Current	1	10	100	1000
209058CL	BUZ72L	◆	TO-220	N-Ch	100V	10.0A	\$.69	\$.55	\$.45	\$.39
256014CL	BSS138	◆	SOT-23	N-Ch	50V	0.2A	.11	.075	.055	
256031CL	BS170	◆	TO-92	N-Ch	60V	—	.21	.07	.06	
256057CL	BS250	◆	TO-92	P-Ch	45V	—	.23	.21	.20	.16
209234CL	IRF510	◆	TO-220	N-Ch	100V	5.6A	\$.46	.43	.39	.34
209226CL	IRF520	◆	TO-220	N-Ch	100V	10.0A	\$.55	.52	.48	.39
210500CL	IRF530	◆	TO-220	N-Ch	100V	14.0A	\$.66	.57	.52	.49
210518CL	IRF540	◆	TO-220	N-Ch	100V	27.0A	\$.81	.73	.54	.51
210526CL	IRF620	◆	TO-220	N-Ch	200V	6.0A	\$.56	.49	.44	.29
210534CL	IRF630	◆	TO-220	N-Ch	200V	9.0A	\$.75	.65	.58	.43
210542CL	IRF640	◆	TO-220	N-Ch	200V	18.0A	\$.99	.92	.85	.69
210551CL	IRF730	◆	TO-220	N-Ch	400V	5.5A	\$.79	.69	.56	.52
210569CL	IRF740	◆	TO-220	N-Ch	400V	10.0A	1.25	1.10	.89	.80
210577CL	IRF820	◆	TO-220	N-Ch	500V	4.0A	\$.65	.60	.55	.45
210585CL	IRF830	◆	TO-220	N-Ch	500V	4.5A	\$.77	.70	.62	.58
184719CL	IRF840	◆	TO-220	N-Ch	500V	8.0A	1.49	1.29	.99	.89
253948CL	2N5457	◆	TO-92	N-Ch	-25V	—	.20	.18	.126	.102
253921CL	2N5458	◆	TO-92	N-Ch	25V	0.1A	.29	.23	.18	.16
253913CL	2N5460	◆	TO-92	P-Ch	40V	—	.34	.28	.22	.19
253905CL	2N5461	◆	TO-92	P-Ch	40V	—	.26	.19	.16	.13
253892CL	2N5462	◆	TO-92	P-Ch	40V	—	.091	.083	.075	
253884CL	2N5484	◆	TO-92	N-Ch	-25V	—	.13	.12	.08	
253585CL	2N5485	◆	TO-92	N-Ch	-25V	—	.23	.20	.18	.13
253577CL	2N5486	◆	TO-92	N-Ch	-25V	—	.18	.15	.11	
253542CL	2N5639	◆	TO-92	N-Ch	30V	0.05A	.20	.175	.125	.065
178669CL	2N7000	FSC	TO-92	N-Ch	60V	0.2A	—	.12	.11	.10
119423CL	2N7000	◆	TO-92	N-Ch	60V	0.3A	.21	.17	.12	.10
140169CL	2N7002	◆	SOT-23	N-Ch	60V	0.5A	—	.063	.056	.029
255020CL	SI4410DY	◆	SOIC-8	N-Ch	30V	20A	.89	.73	.52	.50
255038CL	SI4420DY	◆	SOIC-8	N-Ch	30V	30A	2.99	2.67	2.55	2.40
255046CL	SI4435DY	◆	SOIC-8	P-Ch	-30V	-40A	.85	.71	.52	.42
255054CL	SI4463DY	◆	SOIC-8	P-Ch	-20V	-30A	1.66	1.55	1.49	1.17
255062CL	SI4467DY	◆	SOIC-8	P-Ch	-12V	-20A	1.59	1.45	1.24	1.02
255071CL	SI4884DY	◆	SOIC-8	N-Ch	30V	40A	1.15	1.02	.95	.85
255089CL	SI4963DY	◆	SOIC-8	Dual P-Ch	-20V	-20A	1.29	1.20	1.07	.98

◆ Manufacturer varies FSC = Fairchild Semiconductor

Diodes

Package (see above)

Prepackaged: order in increments of 10, 100 or 1000

Part No.	Product No.	Mfr.	Pkg.	Description				
					1	10	100	1000
140185CL	BAS16	◆	SOT-23	70PRV, 1A (Switching)	\$.06	\$.04	\$.034	
254852CL	BAT54	◆	SOT-23	30PRV, 0.6A (Schottky)	.16	.125	.09	
254844CL	BAT54A	◆	SOT-23	30PRV, 0.6A (Schottky)	.08	.05	.043	
254836CL	BAT54C	◆	SOT-23	30PRV, 0.6A (Schottky)	.08	.05	.043	
254828CL	BAT54S	◆	SOT-23	30PRV, 0.6A (Schottky)	.21	.19	.16	.11
140177CL	BAW56	◆	SOT-23	70PRV, 0.25A (Switching)	.065	.06	.053	
140206CL	BAV70	◆	SOT-23	70PRV, 0.25A (Switching)	.075	.06	.035	
140193CL	BAV99	◆	SOT-23	70PRV, 1A (Switching)	.075	.06	.035	
35941CL	1N270	◆	DO-7	80 PRV (Germanium)	.75	.69	.59	.49
179207CL	1N914	VSH	DO-35	100 PRV (Switching)	.04	.032	.019	
36311CL	1N914	◆	DO-35	75 PRV, .01A (Switching)	.027	.017	.009	
35967CL	1N3600	◆	DO-35	50 PRV, .20A (Switching)	.07	.055	.045	
179215CL	1N4148	VSH	DO-35	100 PRV (Switching)	.03	.025	.018	
36038CL	1N4148	◆	DO-35	75 PRV, .01A (Switching)	.04	.03	.025	
94908CL	1N4148SM	◆	DL-35	75 PRV @ 50µA, 10mA	.03	.024		
151247CL	1N4148T	◆	DO-35	75 PRV, .01A (Switching)	#	#	#	.02

◆ Manufacturer varies VSH = Vishay # Taped-ammo style: order in increments of 1000

Zener Diodes

Package (see above)

Prepackaged: order in increments of 10, 100 or 1000

Part No.	Product No.	Mfr.	Pkg.	V _{Znom}	Pwr Dissipation				
						10	100	500	1000
36290CL	1N751	◆	DO-35	5.1V	0.5W	\$.09	\$.06	\$.05	\$.04
178765CL	1N4730A	◆	DO-41	3.9V	1W	.09	.06	.05	.04
178773CL	1N4732A	VSH	DO-41	4.7V	1W	.09	.06	.05	.04
36089CL	1N4732A	◆	DO-41	4.7V	1W	.09	.06	.05	.05
178781CL	1N4733A	VSH	DO-41	5.1V	1W	.09	.06	.05	.04
36097CL	1N4733A	◆	DO-41	5.1V	1W	.09	.06	.05	.04
178790CL	1N4734A	VSH	DO-41	5.6V	1W	.09	.06	.05	.04
36118CL	1N4734A	◆	DO-41	5.6V	1W	.09	.06	.05	.04
178802CL	1N4735A	VSH	DO-41	6.2V	1W	.09	.06	.05	.04
36126CL	1N4735A	◆	DO-41	6.2V	1W	.09	.06	.05	.04
178811CL	1N4737A	◆	DO-41	7.5V	1W	.09	.06	.05	.04
178829CL	1N4738A	◆	DO-41	8.2V	1W	.09	.06	.05	.04
178837CL	1N4739A	◆	DO-41	9.1V	1W	.09	.06	.05	.04
178845CL	1N4740A	◆	DO-41	10V	1W	.09	.06	.05	.04
178853CL	1N4742A	VSH	DO-41	12V	1W	.09	.06	.05	.04
36169CL	1N4742A	◆	DO-41	12V	1W	.09	.06	.05	.04
178861CL	1N4744A	VSH	DO-41	15V	1W	.09	.06	.05	.04
36185CL	1N4744A	◆	DO-41	15V	1W	.09	.06	.05	.04
178888CL	1N4747A	◆	DO-41	20V	1W	.09	.059	.049	.039
178896CL	1N4748A	◆	DO-41	22V	1W	.09	.059	.049	.039
178909CL	1N4749A	◆	DO-41	24V	1W	.09	.06	.05	.04
183450CL	1N4750A	◆	DO-41	27V	1W	.09	.075	.062	.049
179004CL	1N5225B	◆	DO-35	3.0V	0.5W	.04	.035	.03	.027
179021CL	1N5229B	◆	DO-35	4.3V	0.5W	.04	.035	.029	.022
179039CL	1N5230B	◆	DO-35	4.7V	0.5W	.04	.035	.03	.027
179047CL	1N5231B	◆	DO-35	5.1V	0.5W	.04	.035	.03	.027
179055CL	1N5232B	◆	DO-35	5.6V	0.5W	.04	.035	.03	.027
179063CL	1N5234B	◆	DO-35	6.2V	0.5W	.04	.035	.029	.025
179098CL	1N5242B	◆	DO-35	12V	0.5W	.04	.035	.029	.025
179135CL	1N5250B	◆	DO-35	20V	0.5W	.04	.035	.029	.025

◆ Manufacturer varies VSH = Vishay

Transient Voltage Suppressors

Package (see above)

Prepackaged: order in increments of 10, 100 or 1000

Part No.	Product No.	Mfr.	Pkg.	Min. Brkdw Volt. (V _{BR})	Stand-Off Voltage				
						1	10	100	1000
255935CL	P6KE16CA	◆	DO-15	15.2	13.6	\$.25	\$.24	\$.225	\$.19
255943CL	P6KE16A	◆	DO-15	15.2	13.6	.21	.20	.195	.13
255901CL	P6KE18CA	◆	DO-15	17.1	15.3	.23	.22	.20	.136
255919CL	P6KE18A	◆	DO-15	17.1	15.3	.23	.22	.20	.135
255863CL	P6KE20A	◆	DO-15	19.0	17.1	.26	.25	.24	.15
255847CL	P6KE24CA	◆	DO-15	22.8	20.5	.17	.16	.15	.15
255855CL	P6KE24A	◆	DO-15	22.8	20.5	.23	.22	.20	.135
255812CL	P6KE27CA	◆	DO-15	25.7	23.1	.24	.23	.22	.16
255821CL	P6KE27A	◆	DO-15	25.7	23.1	.26	.25	.24	.17
255791CL	P6KE30CA	◆	DO-15	28.5	25.6	.26	.25	.23	.19
255804CL	P6KE30A	◆	DO-15	28.5	25.6	.26	.25	.23	.19
255755CL	P6KE33CA	◆	DO-15	31.4	28.2	.25	.24	.23	.16
255783CL	P6KE33A	◆	DO-15	31.4	28.2	.25	.24	.23	.18
255767CL	P6KE36A	◆	DO-15	34.2	30.8	.23	.22	.20	.136
255741CL	P6KE39CA	◆	DO-15	37.1	33.3	.17	.16	.15	.15
255759CL	P6KE39A	◆	DO-15	37.1	33.3	.26	.24	.23	.19
255951CL	P6KE150CA	◆	DO-15	143.0	128.0	.36	.33	.28	.17
255927CL	P6KE180A	◆	DO-15	171.0	154.0	.26	.23	.15	.135
255871CL	P6KE200A	◆	DO-15	190.0	171.0	.38	.35	.33	.27
255839CL	P6KE250CA	◆	DO-15	237.0	214.0	.26	.23	.15	.14

◆ Manufacturer varies

Call for pricing on quantities over 5000 - we carry major manufacturers.

Diac/Triacs/Quadrac

Package (see left)

Prepackaged: order in increments of 10, 100 or 1000

Part No.	Product No.	Mfr.	Pkg.	Type	Rating	1	10	100
140425CL	2N6071A	♦	TO-225AA	Triac	200 V _{DRM} , 4A	\$.49	\$.39	\$.32
160098CL	HT-32	TEC	DO-35	Diac	27.37 V _{BO} , 2A	♦	♦	♦
160178CL	L401E3	TEC	TO-92	Triac	400 V _{DRM} , 1A	.73	.65	.58
220468CL	L4004F31	TEC	TO-220AB	Triac	400 V _{DRM} , 4A	1.03	.92	.82
160186CL	L4004F51	TEC	TO-220AB	Triac	400 V _{DRM} , 4A	.95	.85	.76
220450CL	L4004L3	TEC	TO-220AB	Triac	400 V _{DRM} , 4A	1.30	1.20	1.08
31819CL	SC146B	♦	TO-220	Triac	200 V _{DRM} , 10A (2N6342)	1.69	1.52	1.37
31827CL	SC146M	♦	TO-220	Triac	600 V _{DRM} , 10A (2N6344)	1.99	1.69	1.49
160194CL	Q401E3	TEC	TO-92	Triac	400 V _{DRM} , 1A	.66	.61	.54
160240CL	Q4004LT	TEC	TO-220AB	Quadrac	400 V _{DRM} , 4A	1.25	1.12	.99
160207CL	Q4008L4	TEC	TO-220AB	Triac	400 V _{DRM} , 8A	1.34	1.19	1.07
220492CL	Q4008R4	TEC	TO-220AB	Triac	400 V _{DRM} , 8A	1.23	1.04	.99
139336CL	Q4015L5	♦	TO-220AB	Triac	400 V _{DRM} , 15A	\$1.75	1.59	1.45
160143CL	Q4025L6	TEC	TO-220AB	Triac	400 V _{DRM} , 25A	2.59	2.29	2.08
160215CL	Q6008L3	TEC	TO-220AB	Triac	600 V _{DRM} , 8A	1.49	1.33	1.19
160231CL	Q6015L5	TEC	TO-220AB	Triac	600 V _{DRM} , 15A	2.07	1.84	1.65
220513CL	Q6025P5	TEC	TO-3	Triac	600 V _{DRM} , 25A	8.29	7.39	6.59
220505CL	Q6025R6	TEC	TO-220AB	Triac	600 V _{DRM} , 25A	2.59	2.29	2.06
220521CL	Q6035P5	TEC	TO-3	Triac	600 V _{DRM} , 35A	10.99	9.89	8.89

♦ Manufacturer varies TEC = Teccor

Silicon Controlled Rectifiers (SCR)

Package (see left)

Prepackaged: order in increments of 10, 100 or 1000

Part No.	Product No.	Mfr.	Pkg.	Rating	1	10	100	1000
119802CL	2N5060	♦	TO-92	25 PRV, 0.8A	\$.29	\$.18	\$.14	\$.12
211422CL	2N5061	♦	TO-92	60 PRV, 0.8A	\$.29	.16	.15	.115
120070CL	2N5062	♦	TO-92	100 PRV, 0.8A	.35	.20	.16	.13
211431CL	2N5064	♦	TO-92	200 PRV, 0.8A	\$.35	.20	.14	.11
140417CL	2N6507	♦	TO-220AB	400 PRV, 25A	1.59	1.45	1.29	1.15
14859CL	C38M	♦	TO-65	600 PRV, 35A (2N3899)	6.89	6.19	5.59	5.05
14736CL	C106B1	♦	TO-202	200 PRV, 4A (2N6239)*	.65	.43	.36	.35
14752CL	C122B	♦	TO-220	200 PRV, 8A*	.99	.89	.79	.65
14761CL	C122M	♦	TO-220	600 PRV, 8A*	1.35	1.25	1.05	.69
220484CL	EC103B	TEC	TO-92	200 V _{DRM} , 0.8A	.37	.35	.31	.31
160101CL	EC103D	TEC	TO-92	400 V _{DRM} , 0.8A	.41	.37	.33	.33
220530CL	T106B1	TEC	TO-220AB	200 V _{DRM} , 4A	.59	.53	.48	.48
160119CL	T106D1	TEC	TO-220AB	400 V _{DRM} , 4A	.65	.59	.53	.53
160127CL	S401E	TEC	TO-92	400 V _{DRM} , 1A	.58	.51	.46	.46
220548CL	S4025L	TEC	TO-220AB	400 V _{DRM} , 25A	1.73	1.54	1.38	1.38
160135CL	S6025L	TEC	TO-220AB	600 V _{DRM} , 25A	1.84	1.63	1.47	1.47

* Isolated ♦ Manufacturer varies TEC = Teccor

Rectifiers



Prepackaged: order in increments of 10, 100 or 1000

Part No.	Product No.	Mfr.	Pkg.	Rating	1	10	100	1000
35924CL	1N1188	♦	DO-5	400 PRV 35A	\$2.89	\$2.59	\$2.35	\$2.10
35975CL	1N4001	♦	DO-41	50 PRV, 1A	♦	.03	.025	.02
76961CL	1N4002	♦	DO-41	100 PRV, 1A	♦	.03	.025	.02
76970CL	1N4003	♦	DO-41	200 PRV, 1A	♦	.04	.025	.02
35991CL	1N4004	♦	DO-41	400 PRV, 1A	♦	.04	.025	.02
76988CL	1N4005	♦	DO-41	600 PRV, 1A	♦	.04	.025	.02
76996CL	1N4006	♦	DO-41	800 PRV, 1A	♦	.026	.018	.015
36011CL	1N4007	♦	DO-41	1000 PRV, 1A	♦	.04	.03	.025
227846CL	1N5059	♦	SOD57	200 V _R , 2A	.135	.125	.095	
227854CL	1N5060	♦	SOD57	400 V _R , 2A	.135	.125	.095	
227862CL	1N5061	♦	SOD57	600 V _R , 2A	.135	.125	.095	
227871CL	1N5062	♦	SOD57	800 V _R , 2A	.16	.156	.115	
214543CL	1N5399	♦	DO-15	1000 PRV, 1.5A	♦	.054	.038	.028
77075CL	1N5400	♦	DO-27A	50 PRV, 3A	♦	.08	.06	.053
36249CL	1N5401	♦	DO-27A	100 PIV, 3A	♦	.14	.11	.06
77083CL	1N5402	♦	DO-27A	200 PRV, 3A	♦	.11	.07	.06

♦ Manufacturer varies

Rectifiers (Continued)

Prepackaged: order in increments of 10, 100 or 1000

Part No.	Product No.	Mfr.	Pkg.	Rating	1	10	100	1000
36265CL	1N5404	♦	DO-27A	400 PRV, 3A	\$.11	\$.07	\$.055	
36273CL	1N5408	♦	DO-27A	1000 PRV, 3A	♦	.15	.11	.08
177949CL	1N5817	♦	DO-204AL	20 PIV, 1A	.19	.17	.16	.13
177957CL	1N5818	♦	DO-204AL	30 PIV, 1A	♦	.09	.07	.065
177965CL	1N5819	♦	DO-204AL	40 PIV, 1A	♦	.095	.078	.051
177973CL	1N5820	♦	DO-201AD	20 PIV, 3A	\$.29	.22	.20	.16
177981CL	1N5821	♦	DO-201AD	30 PIV, 3A	\$.29	.20	.17	.16
177990CL	1N5822	♦	DO-201AD	40 PIV, 3A	\$.49	.23	.19	.17
177754CL	T6A05L	♦	T6L	50 PIV, 6A	♦	.31	.28	.25
177762CL	T6A10L	♦	T6L	100 PIV, 6A	♦	.31	.28	.23
177818CL	T6A100L	♦	T6L	1000 PIV, 6A	♦	.49	.44	.40
177885CL	UF4002	♦	DO-41	100 PIV, 1A	♦	.21	.18	.16
177906CL	UF4004	♦	DO-41	400 PIV, 1A	♦	.27	.24	.21
177922CL	UF4006	♦	DO-41	800 PIV, 1A	♦	.33	.30	.27

♦ Manufacturer varies

Bridge Rectifiers

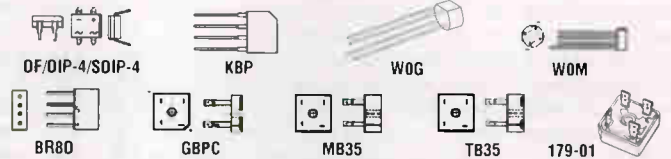

Prepackaged: order in increments of 10, 100 or 1000

Part No.	Product No.	Mfr.	Pkg.*	Rating	1	10	100	1000
178001CL	DF005M	♦	DF	50 PIV, 1A	\$.29	\$.26	\$.23	\$.19
103000CL	DF01M	♦	DF	100 PIV, 1A	\$.39	.35	.27	.19
103042CL	DF02M	♦	DF	200 PIV, 1A	.30	.24	.22	.19
102971CL	DF04M	♦	DF	400 PIV, 1A	.29	.27	.25	.17
103034CL	DF06M	♦	DF	600 PIV, 1A	\$.35	.29	.26	.21
103026CL	DF10M	♦	DF	1000 PIV, 1A	.30	.26	.22	.18
256559CL	DF10S	♦	SDIP-4	1000 PIV, 1A	.31	.26	.23	.19
256575CL	DF08M	♦	DIP-4	800 PIV, 1.5A	.34	.27	.24	.20
255960CL	DF005S	♦	SDIP-4	50 PIV, 1.5A	.30	.26	.22	.18
256604CL	DF01S	♦	SDIP-4	100 PIV, 1.5A	.29	.23	.21	.18
256591CL	DF02S	♦	SDIP-4	200 PIV, 1.5A	.30	.25	.22	.16
256583CL	DF04S	♦	SDIP-4	400 PIV, 1.5A	.32	.28	.24	.20
256567CL	DF08S	♦	SDIP-4	800 PIV, 1.5A	.29	.25	.19	.17
145429CL	KBP02M	♦	KBP	200 PIV, 1.5A	\$.49	.46	.35	.31
119562CL	KBP04M	♦	KBP	400 PIV, 1.5A	\$.49	.45	.32	.23
103018CL	W02G	♦	WOG	200 PIV, 1.5A	.32	.30	.22	.19
102980CL	W04G	♦	WOG	400 PIV, 1.5A	\$.49	.36	.27	.18
102998CL	W06G	♦	WOG	600 PIV, 1.5A	.45	.35	.25	.19
179469CL	W08G	♦	WOG	800 PIV, 1.5A	\$.69	.40	.30	.21
178124CL	W005M	♦	WOM	50 PIV, 1.5A	\$.49	.30	.26	.21
178132CL	W01M	♦	WOM	100 PIV, 1.5A	.36	.27	.20	.17
178141CL	W02M	♦	WOM	200 PIV, 1.5A	\$.29	.27	.23	.18
178175CL	W08M	♦	WOM	800 PIV, 1.5A	.39	.30	.21	.19
178183CL	BR805D	♦	BR8D	50 PIV, 2A	.55	.49	.39	.35
178204CL	BR82D	♦	BR8D	200 PIV, 2A	.85	.77	.69	.62
178247CL	BR810D	♦	BR8D	1000 PIV, 2A	.69	.59	.49	.39
253260CL	2KBP06M	♦	KBP	600 PIV, 2A	.66	.57	.48	.39
253286CL	2KBP10M	♦	KBP	1000 PIV, 2A	.40	.35	.29	.24
179477CL	GBPC25-01	♦	GBPC	100 PIV, 25A	2.65	2.13	1.75	1.51
179485CL	GBPC25-02	♦	GBPC	200 PIV, 25A	3.59	2.70	1.89	1.65
178280CL	MB254	♦	MB35	400 PIV, 25A	2.49	2.19	1.89	1.69
178335CL	TB252	♦	TB35	200 PIV, 25A	2.10	1.85	1.69	1.50
25574CL	MDA990-3	♦	179-01	200 PIV, 30A	4.49	3.99	3.39	2.89
25591CL	MDA990-6	♦	179-01	600 PIV, 30A	4.95	4.49	3.99	3.59
178431CL	MB358	♦	MB35	800 PIV, 35A	2.95	2.74	2.47	2.22
178440CL	TB3505	♦	TB35	50 PIV, 35A	2.39	2.10	1.89	1.69
178503CL	TB3510	♦	TB35	1000 PIV, 35A	\$.29	.29	.29	.29

♦ Manufacturer varies
* DF/KBP/WOG/WOM/179-01 - plastic case; GBPC/TB35 - plastic case, metal base; MB35 - metal case

Please call our sales rep. if you cannot find the NTE product replacement you are trying to find or for special pricing on large quantity orders.

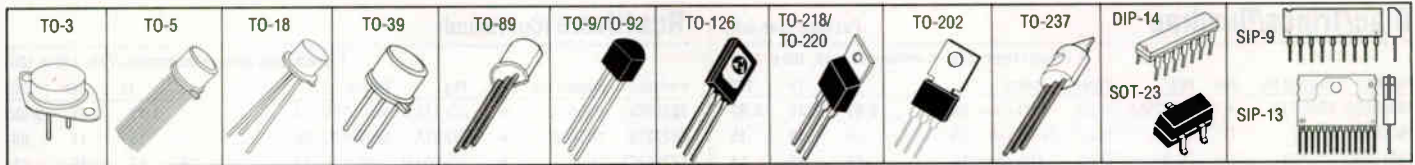

Integrated Circuits

Part No.	Cross Ref.	Pkg.	Description	1	10	25
260161CL	NTE778A	DIP-8	Dual operational amplifier	\$2.38	\$2.29	\$2.21
260179CL	NTE823	DIP-8	Low voltage audio amplifier	1.52	1.49	1.45
260187CL	NTE858M	DIP-8	Dual low noise JFET input op amp.	2.62	2.41	2.15
260195CL	NTE859	DIP-14	Quad low noise JFET input op amp.	3.73	3.55	3.39
260216CL	NTE941	TO-5/8	Operational amplifier	5.78	5.75	5.69
260224CL	NTE941M	DIP-8	Operational amplifier	.92	.88	.85
260232CL	NTE947D	DIP-14	Dual operational amplifier	4.93	4.58	4.07
260241CL	NTE955M	DIP-8	Timing circuit	1.29	1.25	1.20
260347CL	NTE987	DIP-14	Quad low power operational amplifier	1.96	1.85	1.80
260355CL	NTE999	TO-92	Adjustable precision shunt regulator	1.02	.99	.95
260228CL	NTE1714M	DIP-8	Remote control amplifier/driver	4.99	4.19	4.11
260136CL	NTE2014	DIP-16	7-channel darlington array drivers	2.84	2.69	2.59
260144CL	NTE2018	DIP-18	8-channel darlington array drivers	3.29	3.15	3.09
259291CL	NTE4001B	DIP-14	Quad 2-input NOR gate	.68	.65	.62
259303CL	NTE4006B	DIP-14	18 stage static shift register	2.82	2.77	2.71
259311CL	NTE4013B	DIP-14	Dual D flip-flop w/ set/reset	1.10	1.06	1.02
259320CL	NTE4049	DIP-16	Hex buffer/converter (inverting)	1.22	1.18	1.14
259338CL	NTE4066B	DIP-14	Quad bilateral switch	1.42	1.37	1.31
259346CL	NTE4093B	DIP-14	Quad 2-input NAND Schmitt trigger	1.05	1.02	.99
260152CL	NTE7039	SIP-13	Vert. deflection output circuit w/ drive circuit	3.19	3.09	2.99
259354CL	NTE7407	DIP-14	Hex buffer/driver	1.29	1.25	1.20
259362CL	NTE7408	DIP-14	Quad 2-input AND gate	1.06	1.03	.99
259389CL	NTE7475	DIP-16	4-bit bi-stable latch	3.89	3.71	3.54
259371CL	NTE74121	DIP-14	Monostable multivibrator	2.29	2.21	1.97
259397CL	NTE75189	DIP-14	Quad line receiver	1.22	1.18	1.14

Voltage Regulators

Part No.	Cross Ref.	Pkg.	Description	1	10	25
261358CL	NTE309K	TO-3	+5V, 1A voltage regulator	\$8.02	\$7.85	\$7.65
260208CL	NTE931	TO-3	+5V, 3A voltage regulator	11.60	11.02	9.86
260259CL	NTE960	TO-220	+5V, 1A voltage regulator	1.65	1.59	1.53
260267CL	NTE961	TO-220	-5V, 1A voltage regulator	1.65	1.59	1.53
260275CL	NTE962	TO-220	+6V, 1A voltage regulator	1.32	1.28	1.23
260283CL	NTE964	TO-220	+8V, 1A voltage regulator	1.29	1.25	1.19
260291CL	NTE966	TO-220	+12V, 1A voltage regulator	1.65	1.59	1.53
260304CL	NTE967	TO-220	-12V, 1A voltage regulator	1.65	1.59	1.53
260312CL	NTE968	TO-220	+15V, 1A voltage regulator	1.65	1.59	1.53
260321CL	NTE971	TO-220	-24V, 1A voltage regulator	4.65	4.39	4.15
260339CL	NTE972	TO-220	+24V, 1A voltage regulator	1.65	1.59	1.53
261331CL	NTE1914	TO-3	+12V, 1A voltage regulator	3.75	3.72	3.69
261340CL	NTE1915	TO-3	-12V, 1A voltage regulator	3.89	3.85	3.79

Transistors

Part No.	Cross Ref.	Pkg.	Description	1	10	25
261083CL	NTE47	TO-92	NPN high gain, low noise	\$.61	\$.59	\$.57
261104CL	NTE48	TO-92	NPN darlington, high current	.95	.92	.89
261112CL	NTE55	TO-220	PNP complimentary trans., high freq. driver	3.56	3.39	3.25
261139CL	NTE85	TO-92	NPN general purpose	.84	.79	.76
260507CL	NTE100	TO-18	PNP germanium comp. trans. oscillator	3.15	3.09	3.04
260515CL	NTE102	TO-18	PNP germanium comp. trans. pwr output driver	3.69	2.49	3.35
260523CL	NTE108	TO-92	NPN high frequency amp.	1.34	1.29	1.24
260531CL	NTE123	TO-18	NPN general purpose audio amp., switch	.75	.73	.71
260540CL	NTE123A	TO-18	NPN comp. transistor, general purpose	1.07	1.04	.99
260558CL	NTE123AP	TO-92	NPN audio amplifier switch	.86	.79	.74
260566CL	NTE128	TO-39	NPN comp. trans., audio output, video driver	1.19	1.15	1.07
260574CL	NTE128P	TO-237	NPN comp. transistor, general purpose	1.29	1.25	1.20
260582CL	NTE129	TO-237	PNP comp. transistor, general purpose	2.26	2.19	2.09
260591CL	NTE130	TO-3	NPN audio pwr amp., medium speed switch	2.76	2.52	2.29
260603CL	NTE154	TO-39	NPN high voltage video output	2.82	2.65	2.56
260611CL	NTE159	TO-92	PNP audio amplifier switch	.96	.91	.87
260620CL	NTE172A	TO-92	NPN darlington pre-amp., med. sp. switch	.62	.61	.58

Transistors (Continued)

Part No.	Cross Ref.	Pkg.	Description	1	10	25
260638CL	NTE175	TO-3	NPN comp. trans., hi volt. med. pwr switch	\$3.30	\$3.25	\$3.19
260646CL	NTE181	TO-3	NPN high power audio amplifier	6.60	6.29	6.01
260654CL	NTE184	TO-126	NPN comp. trans. audio pwr amp., switch	1.81	1.75	1.69
260662CL	NTE185	TO-126	PNP comp. trans. audio pwr amp., switch	1.90	1.85	1.77
260671CL	NTE196	TO-220	NPN comp. trans. audio pwr output&med. pwr switch	2.43	2.39	2.13
260689CL	NTE199	TO-92	NPN low noise, high gain amplifier	.67	.65	.62
260697CL	NTE211	TO-202	PNP comp. trans. gen. purpose output driver	1.83	1.74	1.66
260777CL	NTE234	TO-92	PNP low noise, high gain amplifier	.89	.85	.81
260822CL	NTE238	TO-3	PNP color TV horizontal output	5.55	5.49	5.45
260857CL	NTE247	TO-3	NPN comp. trans. darlington power amp.	5.27	4.99	4.80
260865CL	NTE253	TO-126	NPN comp. trans. darlington power amp.	1.53	1.49	1.43
260881CL	NTE261	TO-220	NPN comp. trans. darlington power amp.	2.28	2.22	2.15
260890CL	NTE262	TO-220	PNP comp. trans. darlington power amp.	2.52	2.49	2.40
260902CL	NTE263	TO-220	NPN comp. trans. darlington power amp.	2.52	2.39	2.30
260911CL	NTE264	TO-220	PNP comp. trans. darlington power amp.	2.91	2.85	2.75
260929CL	NTE265	TO-220	NPN darlington power amplifier	3.76	3.74	3.65
260937CL	NTE287	TO-92	NPN comp. trans. hi volt., general purpose	.87	.85	.80
260945CL	NTE288	TO-92	PNP comp. trans. hi volt., general purpose	.80	.74	.65
260953CL	NTE289A	TO-92	NPN comp. transistor audio power amp.	1.22	1.19	1.14
260961CL	NTE290A	TO-92	PNP comp. transistor audio power amp.	1.38	1.34	1.28
260970CL	NTE291	TO-220	NPN comp. trans. medium power amp., switch	2.16	2.09	2.01
260988CL	NTE311	TO-39	NPN frequency multiplier driver, VHF/UHF	2.78	2.75	2.67
260996CL	NTE316	TO-39	NPN high gain, low noise amp.	3.10	3.02	2.95
261008CL	NTE331	TO-220	NPN comp. trans. audio power amp., switch	2.89	2.74	2.61
261016CL	NTE332	TO-220	PNP comp. trans. audio power amp., switch	2.89	2.75	2.62
261024CL	NTE373	TO-126	NPN comp. transistor audio amp. driver	1.68	1.64	1.57
261032CL	NTE374	TO-126	PNP comp. transistor audio amp. driver	1.73	1.65	1.61
261041CL	NTE378	TO-220	PNP comp. trans. pwr amp. driver output switch	2.72	2.55	2.46
261059CL	NTE379	TO-220	NPN power amp. high voltage switch	7.14	7.09	6.99
261067CL	NTE397	TO-39	PNP power amp. & high speed switch	2.74	2.51	2.23
261075CL	NTE399	TO-92	NPN high voltage video amp.	2.75	2.64	2.52
261091CL	NTE473	TO-39	NPN RF power driver	5.17	5.15	5.09
260700CL	NTE2300	TO-3	NPN high voltage horizontal output	5.12	5.15	4.99
260718CL	NTE2311	TO-218	NPN high voltage high speed switch	14.24	13.45	12.82
260726CL	NTE2312	TO-220	NPN high voltage high speed switch	4.74	4.49	4.30
260734CL	NTE2322	DIP-14	PNP quad general purpose	2.82	2.57	2.28
260742CL	NTE2324	TO-220	NPN color TV horiz. deflection output	8.55	8.15	7.96
260751CL	NTE2329	TO-126	PNP comp. trans. audio power output	5.75	5.69	5.65
260769CL	NTE2331	TO-220	NPN color TV horiz. deflection output w/ damper diode	6.85	6.79	6.75
260785CL	NTE2343	TO-220	NPN comp. trans. darlington pwr amp., switch	2.07	1.95	1.92
260793CL	NTE2344	TO-220	PNP comp. trans. darlington pwr amp., switch	1.65	1.55	1.51
260806CL	NTE2349	TO-3	NPN darlington trans., hi curr. gen. purpose	15.62	15.39	15.25
260814CL	NTE2353	TO-220	NPN TV horiz. deflection output w/ damper diode	5.73	5.69	5.65
260831CL	NTE2408	SOT-23	NPN general purpose amp. (2/pk.)	1.25	1.19	1.15
260849CL	NTE2409	SOT-23	PNP general purpose amp. (2/pk.)	1.25	1.19	1.15
260873CL	NTE2543	TO-220	NPN darlington motor/relay driver	3.29	3.25	3.19
261121CL	NTE6410	TO-92	Unijunction transistor	4.79	4.75	4.69

JFETs

Part No.	Cross Ref.	Pkg.	Description	1	10	25
260427CL	NTE457	TO-92	N-ch JFET general purpose	\$1.04	\$.99	\$.95
260435CL	NTE458	TO-92	N-ch JFET low noise, audio freq. amp.	1.70	1.65	1.59

MOSFETs

Part No.	Cross Ref.	Pkg.	Description	1	10	25
260443CL	NTE222	TO-39	Dual gate N-channel MOSFET	\$10.56	\$9.59	\$8.95
260451CL	NTE2389	TO-220	N-ch enhancement mode hi speed switch	5.35	5.15	4.91
260460CL	NTE2394	TO-126	N-ch enhancement mode hi speed switch	11.25	11.19	11.09
260478CL	NTE2395	TO-220	N-ch enhancement mode high speed switch	5.60	5.39	5.15
260486CL	NTE2397	TO-220	N-ch enhancement mode high speed switch	5.60	5.39	5.15
260494CL	NTE2398	TO-220	N-ch enhancement mode high speed switch	3.75	3.69	3.65



Please call our sales rep. if you cannot find the NTE product replacement you are trying to find or for special pricing on large quantity orders.

Semiconductors

Diodes

Part No.	Cross Ref.	Pkg.	Description	Package (see pg 22)		
				1	10	25
259418CL	NTE109	DO-7	Germanium fast switching	\$1.18	\$1.14	\$1.10
259426CL	NTE112	DO-35	Silicon small signal schottky	1.48	1.34	1.20
259434CL	NTE177	DO-35	Silicon general purpose	.30	.28	.26
259442CL	NTE519	DO-7	Silicon ultra fast switch	.34	.31	.29
259451CL	NTE570	DO-7	Silicon controlled avalanche diode	1.23	1.19	1.15
259469CL	NTE583	DO-7	Schottky RF switch	1.27	1.22	1.19
259477CL	NTE588	DO-7	Silicon 200V, 3A fast switch	1.25	1.21	1.16
259485CL	NTE618	Non-Std	Silicon tuning diode for AM radio, varactor	1.79	1.75	1.69

Zener Diodes

Part No.	Cross Ref.	Pkg.	Voltage	Wattage	Qty.			
						1	10	25
259565CL	NTE5010A	DO-35	5.1V	1/2W	1/pk.	\$.39	\$.36	\$.33
259573CL	NTE5021A	DO-35	12V	1/2W	1/pk.	.49	.45	.40
259581CL	NTE5024A	DO-35	15V	1/2W	1/pk.	.49	.48	.47
259493CL	NTE135A	DO-35	5.1V	1W	2/pk.	.53	.51	.49
259506CL	NTE136A	DO-35	5.6V	1W	2/pk.	.44	.41	.39
259514CL	NTE138A	DO-35	7.5V	1W	2/pk.	.53	.50	.47
259522CL	NTE142A	DO-35	12V	1W	2/pk.	.56	.55	.53
259531CL	NTE143A	DO-35	13V	1W	2/pk.	.44	.41	.39
259549CL	NTE145A	DO-35	15V	1W	2/pk.	.44	.41	.39
259557CL	NTE147A	DO-35	33V	1W	2/pk.	.44	.41	.39
259590CL	NTE5077A	DO-35	18V	1W	2/pk.	1.42	1.38	1.32
259602CL	NTE5105A	DO-35	200V	1W	2/pk.	1.86	1.78	1.70
259611CL	NTE5130A	DO-35	15V	5W	1/pk.	1.46	1.39	1.32
259629CL	NTE5141A	DO-35	30V	5W	1/pk.	2.05	2.01	1.97
259637CL	NTE5164A	DO-35	180V	5W	1/pk.	2.05	2.01	1.97

Rectifiers

Part No.	Cross Ref.	Pkg.	Description	PRV	AFC	Package (see pg 23)		
						1	10	25
259813CL	NTE116	DO-41	Rectifier	600V	1A	\$.49	\$.45	\$.42
259821CL	NTE125	DO-41	Rectifier	1000V	2.5A	.50	.48	.45
259830CL	NTE156	DO-41	Rectifier	1000V	3A	.67	.63	.60
259645CL	NTE506	DO-41	Rectifier	1400V	2A	1.10	1.06	1.02
259848CL	NTE541	DO-35	Rectifier	8.4kV	50A	8.37	8.29	8.25
259856CL	NTE552	DO-41	Rectifier	600V	1A	.93	.90	.87
259864CL	NTE558	DO-41	Rectifier	1500V	1A	1.68	1.63	1.57
259872CL	NTE569	DO-41	Rectifier	600V	3A	1.12	1.03	.95
259881CL	NTE574	DO-41	Rectifier	400V	1A	.58	.53	.48
259899CL	NTE576	DO-41	Rectifier	400V	5A	1.86	1.79	1.73
259901CL	NTE577	DO-41	Rectifier	1000V	5A	3.58	3.45	3.33
259910CL	NTE580	SOD57	Rectifier	600V	3A	2.71	2.59	2.47
260021CL	NTE598	TO-220	Rectifier	600V	8A	2.16	2.11	2.08
259928CL	NTE5800	DO-41	Rectifier	50V	3A	.33	.31	.30
259936CL	NTE5801	DO-41	Rectifier	100V	3A	.48	.45	.44
259944CL	NTE5804	DO-41	Rectifier	400V	3A	.60	.56	.54
259952CL	NTE5806	DO-41	Rectifier	600V	3A	.94	.92	.88
259961CL	NTE5809	DO-41	Rectifier	1000V	3A	1.39	1.31	1.25
259979CL	NTE5812	T6L	Rectifier	100V	6A	.91	.87	.84
259987CL	NTE5814	T6L	Rectifier	400V	6A	1.52	1.45	1.40
259995CL	NTE5815	T6L	Rectifier	600V	6A	2.49	2.27	2.15
260005CL	NTE5817	T6L	Rectifier	1000V	6A	2.28	2.14	2.04
260013CL	NTE5870	DO-4	Rectifier	50V	12A	2.60	2.49	2.38
260030CL	NTE6013	TO-220	Rectifier	600V	12.7A isolated	3.77	3.69	3.61
260048CL	NTE6240	TO-220	Rectifier	200V	16A	3.94	3.77	3.59
259653CL	NTE166	BR80	Bridge rectifier	100V	2A	1.10	1.06	1.02
259661CL	NTE167	BR80	Bridge rectifier	200V	2A	1.75	1.69	1.62
259670CL	NTE168	BR80	Bridge rectifier	400V	2A	1.93	1.86	1.79
259688CL	NTE170	BR80	Bridge rectifier	1000V	2A	2.82	2.79	2.75
259696CL	NTE5304	WOM	Bridge rectifier	400V	1.5A	1.32	1.28	1.23
259709CL	NTE5305	WOM	Bridge rectifier	600V	1.5A	1.47	1.42	1.39
259717CL	NTE5312	GBPC	Bridge rectifier	100V	8A	3.88	3.70	3.53
259725CL	NTE5313	GBPC	Bridge rectifier	200V	8A	3.82	3.65	3.48
259733CL	NTE5314	GBPC	Bridge rectifier	400V	8A	3.93	3.74	3.59
259741CL	NTE5322	TB35	Bridge rectifier	200V	25A	5.64	5.38	5.13
259750CL	NTE5326	TB35	Bridge rectifier	600V	25A	7.59	7.20	6.90
259768CL	NTE5329	BR80	Bridge rectifier	200V	6A	3.63	3.46	3.30
259776CL	NTE5332	DIP-4	Bridge rectifier	600V	1A	1.52	1.45	1.39
259784CL	NTE5340	Non-Std	Bridge rectifier	200V	40A	9.00	8.57	8.17
259792CL	NTE5342	Non-Std	Bridge rectifier	600V	40A	11.37	10.79	10.24
259805CL	NTE5344	Non-Std	Bridge rectifier	1000V	40A	12.78	12.29	11.80

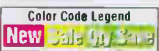

Silicon Controlled Rectifiers (SCR)

Part No.	Cross Ref.	Pkg.	Description			
				1	10	25
260056CL	NTE5401	TO-92	60 VRM 0.8A	\$.97	\$.91	\$.87
260064CL	NTE5402	TO-92	100 VRM 0.8A	.97	.89	.78
260072CL	NTE5404	TO-92	200 VRM 0.8A	1.33	1.29	1.25
260081CL	NTE5457	TO-202	400 VRM 4A	1.33	1.29	1.25
260099CL	NTE5458	TO-202	600 PRV 4A	2.03	1.99	1.94

Diacs/Triacs/Sidacs/TVS

Part No.	Cross Ref.	Pkg.	Description			
				1	10	25
261278CL	NTE4900	DO-35	TVS, 5.0V	\$2.18	\$2.15	\$2.09
260110CL	NTE6404	TO-89	SUS, Si, 1.0A	8.86	8.79	8.75
259400CL	NTE6408	DO-35	Diac	.94	.90	.87
260101CL	NTE6419	Non-Std	Sidac, 110-125V	2.06	1.99	1.91
261147CL	NTE5629	TO-202	Triac, 400 VRM, 4A	1.98	1.89	1.81
261155CL	NTE5656	TO-9	Triac, 400 VRM, 0.8A	1.08	1.05	.99

Varistors (MOV)

Part No.	Cross Ref.	Pkg.	Description			
				1	10	25
261286CL	NTE1V020	8.5mm	20V _{RMS} , 20VDC, 1.5 joules	\$1.03	\$.99	\$.95
261294CL	NTE1V130	8.5mm	135V _{RMS} , 180VDC, 10 joules	1.08	1.03	.99
261307CL	NTE2V130	16mm	135V _{RMS} , 180VDC, 39 joules	1.85	1.79	1.75
261315CL	NTE2V250	16mm	240V _{RMS} , 320VDC, 70 joules	2.66	2.54	2.41
261323CL	NTE524V25	23mm	240V _{RMS} , 320VDC, 129 joules	2.40	2.35	2.29

Thermal Fuses

Part No.	Cross Ref.	Description	Dimensions			
				1	10	25
261163CL	NTE8076	TCO 77°C, 171°F	3.2"L x 1.6"Dia	\$1.13	\$1.09	\$1.05
261171CL	NTE8085	TCO 87°C, 189°F	3.2"L x 1.6"Dia	1.27	1.23	1.18
261180CL	NTE8090	TCO 93°C, 200°F	3.2"L x 1.6"Dia	1.13	1.09	1.05
261198CL	NTE8096	TCO 98°C, 208°F	3.2"L x 1.6"Dia	1.13	1.09	1.05
261201CL	NTE8098	TCO 100°C, 212°F	3.2"L x 1.6"Dia	1.13	1.09	1.05
261219CL	NTE8103	TCO 104°C, 220°F	3.2"L x 1.6"Dia	1.13	1.09	1.05
261227CL	NTE8118	TCO 121°C, 250°F	3.2"L x 1.6"Dia	1.13	1.09	1.05
261235CL	NTE8139	TCO 141°C, 286°F	3.2"L x 1.6"Dia	1.27	1.23	1.18
261243CL	NTE8181	TCO 184°C, 364°F	3.2"L x 1.6"Dia	1.13	1.09	1.05
261251CL	NTE8213	TCO 216°C, 421°F	3.2"L x 1.6"Dia	1.13	1.09	1.05
261260CL	NTE8242	TCO 240°C, 464°F	3.2"L x 1.6"Dia	1.13	1.09	1.05

LEDs

Part No.	Cross Ref.	Pkg.	Description			
				1	10	25
260363CL	NTE1866	SIP-9	5-point LED VU scale bar level meter driver	\$2.01	\$1.96	\$1.93
260371CL	NTE3024*	T1 1/4	Green 5mm, 2.1Vf@20mA, 8.7mcd@10mA, 565nm	1.31	1.24	1.19

* 2 ea. per pack

Optoisolators

Part No.	Cross Ref.	Pkg.	Description			
				1	10	25
260380CL	NTE3040	OIP-6	NPN transistor output, 1.5V @ 10mA	\$1.73	\$1.68	\$1.61
260398CL	NTE3041	OIP-6	NPN transistor output, 1.15V @ 10mA	1.75	1.69	1.63
260401CL	NTE3044	OIP-6	NPN darl. trans. output, 1.15V @ 10mA	2.33	2.25	2.19
260419CL	NTE3047	OIP-6	Triac driver output, 1.15V @ 10mA	2.41	2.04	1.95

NTE Hardware

Part No.	Cross Ref.	Description			
			1	10	25
259151CL	NTE303	1 gram tube heat sink compound (5/pk.)	\$1.63	\$1.55	\$1.48
259194CL	TP0001	TO-3 Thermo pad (5/pk.)	1.39	1.29	1.25
259282CL	TP0002	TO-66 Thermo pad (5/pk.)	1.15	1.12	1.09
259207CL	TP0003	DO-5 Thermo pad (5/pk.)	.82	.78	.75
259215CL	TP0004	TO-126 Thermo pad (5/pk.)	.69	.65	.63
259223CL	TP0005	TO-218 Thermo pad (5/pk.)	1.36	1.33	1.27
259231CL	TP0006	TO-220 Thermo pad (5/pk.)	1.01	.95	.91
259240CL	TP0007	DO-5 Thermo pad (5/pk.)	1.03	.98	.95
259258CL	TP0008	TO-3 Thermo pad (5/pk.)	1.15	1.12	1.09
259266CL	TP0009	TO-36 Thermo pad (5/pk.)	1.38	1.35	1.29
259274CL	TP0010	TO-3PML Thermo pad (5/pk.)	2.41	2.20	1.95
259178CL	NTE416	DIP-16 16-pin DIP socket	2.11	1.85	1.60
259186CL	NTE423	DIP-8 8-pin DIP socket	1.10	1.06	1.02
259160CL	NTE422	TO-220 Insulator kit	1.01		

XELTEK

48 & 100-Pin High-Performance Universal Parallel Programmiers

- SuperPro-680 features a 48-Pin ZIF socket with universal pin-drivers. By adding the optional PEP600 pin-driver expansion pack, it can be expanded to 100-pins
- High-speed embedded CPU generates more accurate and reliable algorithm timing
- Supports devices down to 1.8V
- Supports 9000+ devices, E/EPROM, FLASH, BPROM, Micros, Classic PLD, EPLD, CPLD
- Tests TTL/CMOS logic ICs and Dynamic/Static RAM
- Device insertion and poor-pin-contact check
- PC interface through printer port
- Supports Windows® 95/98/2000/NT/ME/XP
- Size: 11.3"L x 6.8"W x 1.7"H
- Weight: 4.9 lbs.

Includes: Power adapter, parallel cable, user's guide, CD-ROM software



Speed Comparison

Device Type	Program (seconds)	Verify (seconds)	Pieces in 8 hour day
28F320B3	88	80	169
28F800B	20	18	720
28F008	30	24	514
29F080B	48	23	389
28C64B	1	0.8	7578
94E255	3	8	2215
W78E58	13	3	1600
PIC12C508	1	0.8	7578

Part No.	Description	1	5
231204CL	SuperPro-680 universal programmer	\$889.95	\$845.49
231212CL	SuperPro-680-100 programmer w/ 100-pin PEP600	994.95	945.25
231239CL	PEP600 100-pin programmer expander for 231204CL	154.95	147.25

XELTEK

Ultra-Fast 48-Pin USB & Stand-Alone Universal Programmer

- Fastest low-cost programmer in the market; programs high-density FLASH memory at near theoretical minimum programming time: (Intel 28F320W18 - 1.8 volts 32Mbit at 18 sec.; 13 sec. for programming & 5 sec. for verifying)
- Standard universal 48 pin-drivers support devices down to 1.5 volts; optional 100-pin expander module
- Currently 4,000 devices supported from 100+ manufacturers including memory, MCU, and PLD; 11,000+ by 1/1/2004
- Supports: EPROM, Paged EPROM, Parallel/Serial EEPROM, FPGA Configuration Serial PROM, FLASH Memory (NOR and NAND), BPROM, NOVRAM, SPLD, CPLD, EPLD, Firmware HUB, Microcontroller, MCU, Standard Logic
- Reliable programming of low voltage devices down to 1.5 volts
- Three modes of operation are supported: standard PC hosted operation via USB, stand-alone operation for manufacturing or service and built-in terminal mode to operate via an external instrument
- Over-current/over-voltage protection for safety of the chip & programmer hardware
- Microsoft® Windows® 98/ME/NT/2000/XP compatible
- Size: 9.4"L x 5.9"W x 2.0"H • Weight: 5.0 lbs.

Includes: 12VDC@2.5A AC adapter, Program CD, USB Cable, user's guide

Part No.	Description	1	5
231211CL	SuperPro-3000 USB universal programmer	\$989.95	\$940.45



48-Pin Advanced, Low-Cost Universal Programmer

- Provides a 48-pin ZIF socket that accepts any number of pins
- Programmable I/O level supports low voltage devices down to 1.8V
- Device insertion and pin contact check protect chips from damaging
- Supports 5000+ devices including E/EPROM, FLASH, Microcontrollers, PLD & tests standard logic devices & SRAM
- High-speed embedded CPU generates more accurate & reliable algorithm timing
- Supports Windows® 95/98/2000/NT/ME/XP
- Connect to PC via printer port
- Size: 7.8"L x 5.5"W x 1.0"H • Wt.: 4.0 lbs.

Includes: Power adapter, parallel cable, user's guide & CD-ROM software



Speed Comparison

Device Type	Program (seconds)	Verify (seconds)	Pieces in 8 hour day
28C64B	1	0.8	7578
94E256	3	8	2215
W78E58	13	3	1600
PIC12C508	1	0.8	7578

Part No.	Description	1	5
231191CL	SuperPro-280 advanced universal programmer	\$444.95	\$422.69

Universal EPROM/Flash Programmer w/ USB Interface

- Supports low voltage components up to 2.5V; user selectable verify Vcc with one or two-pass verify voltage
- High speed: 30 sec. to process 16Mbits memory
- Auto detect device pin insertion and contact check
- Select device brand & number by prompt & convenient cross search, FLASH memory auto detection
- Supports EPROMs, EEPROMs, FLASH EPROMs, Serial E/EPROMs, NV RAMs, Microcontrollers, DSPs & PLDs
- Supports file formats JEDEC, binary, Intel 80/86 HEX, Motorola HEX, Tektronic HEX

Includes: USB cable, 12V@1.5A power adapter and CD-ROM software

System requirements: Pentium® II or higher, 32MB RAM minimum, 30MB hard disk space, Windows® 98/ME/2000 operating system

Part No.	Description	1	5
225939CL	Leaper 48	\$589.95	\$529.95



XELTEK 40-Pin Low-Cost Universal Programmer

- Supports 2500+ devices, including most E(EP)ROM, Series E(EP)ROM & FLASH
- Programs GALs, PEELs, PALCE, Microcontrollers, PIC16Cxx/17Cxx, COP87xx, and PSD3XX
- Tests TTL/CMOS Test, Memory Test, Vector Test, Test Pattern Edit, Auto Identify TTL/CMOS Device
- Features a universal ZIF socket that accepts up to 40 pins
- High-speed programming, cost-effective hardware and flexible software
- Load and save file in binary, Intel (extended) Hex, Motorola S or Tektronics (extended) Hex format. Multiple load, format conversion, relocation etc.
- HEX-ASCII Edit, Fuse Map Edit, Checksum, Swap, Vector Table edit
- Supports Windows® 95/98/ME • Printer Port Interface
- Size: 7.8"L x 5.5"W x 0.8"H • Weight: 4.0 lbs.

Includes: Power adapter, parallel cable, user's guide and CD-ROM software



Part No.	Description	1	5
231183CL	SuperPro-Z universal programmer	\$244.95	\$232.69

512k E(EP)ROM/Flash Programmer w/ USB Interface

Compact, portable, and lightweight stand-alone E(EP)ROM flash programmer. Also interfaces with your PC through the USB port.

- Programs EPROMs, EEPROMs, Flash EPROMs & more
- 2 sockets for master/slave operation
- Stand-alone mode uses two 9V batteries
- IC parameters are adjustable such as programming algorithm, Vpp voltage, and pulse width
- Supports file formats binary and machine code, INTEL HEX, Motorola HEX
- Supports Windows® 95/98/NT/2000/ME/XP • Size: 6.3"L x 4.3"W x 1.8"H

Includes: USB cable, 12VDC@500mA power adapter and CD-ROM

Part No.	Description	1	5
220636CL	Leaper-3C	\$275.95	\$249.95



XELTEK SMD Adapters for SuperPro 280/680/3000



Part No.	Product No.	Description	1	5
231247CL	A008A	28-pin PLCC adapter	\$84.95	\$80.75
231255CL	A015A	32-pin PLCC adapter	94.95	90.25
231263CL	A244A	44-pin PLCC adapter	109.95	104.45
231271CL	A247A	48-pin TSOP adapter	174.95	166.25

MCS-51 Programmer with USB Interface

- Programs 8-bit MCS-51 serial ICs via USB cable
- High-speed, high performance programming: ATMEL AT89S52 takes 4 seconds to erase, blank check, program & verify
- Supports file formats binary and machine code, Intel HEX, Motorola HEX, Tektronix, ATMEL; Hyundai; Intel 87C; ISSI, Philips, SST, TEMIC, and Winbond ICs

Includes: USB cable, 12V@500mA adapter, CD-ROM

System requirements: Pentium III 500 or higher, Windows® 98/2000/XP, 20MB hard disk space, USB port

Part No.	Product No.	1	10
225921CL	Leaper 5E	\$249.95	\$236.95



Flash Writer/Programmer w/ USB Interface

- Programs 8-bit FLASH serial ICs via USB cable on Windows® 9x/2000/XP
- High speed: Only 22 seconds to blank check, program, and verify MXIC MX29F040
- File formats supported: binary and machine code, Intel HEX, Motorola HEX, Tektronix
- Type, read, load, edit, checksum, erase, blank check, program, verify, protect functions • Supports Flash EPROM, EPROM & EEPROM



Includes: USB cable, 12V @ 500mA adapter, CD-ROM software and manual

Part No.	Description	1	5
225947CL	Leaper 3D	\$249.95 \$199.95	\$179.95

High-Speed Universal Device Programmer/Tester

Parallel Port Interface

- Programs Flash memory, PROM, EPROM/EEPROM, Serial (E)EPROM, Bipolar PROM, PAL, PALCE, GAL, NVRAM, PEEL, EPLD, SPLD, CPLD, PIC & Microcontrollers
- 5000+ device types supported
- Hardware diagnostic program examines all 48-pin drivers
- On-board FPGA for speed; 4X faster than offshore brands
- Tests TTL, CMOS, DRAM and Static RAM ICs
- Detects pin locations for poor or damaged contacts
- Current limiting protects hardware circuits from improperly inserted or defective chips • Supports POF and JEDEC formats
- High-speed device function tests and user creatable test library
- Read, blank check, program, verify, checksum, data compare, security, auto (erase, blank check, program, verify), and option bit program function
- Built-in editor for both buffer date and test vectors • CE/CUL/CSA quality certified



Includes: Parallel cable, installation diskette, power cord and manual

System Requirements: IBM PC, XT, AT, 386, 486, Pentium®, hard drive, 512K RAM, Windows® 95/98/2000/NT, and parallel port

Part No.	Description	Socket	1	5
207765CL	TOPMAX	48-pin universal ZIF	\$875.95 \$832.95	

Versatile, Production Quality Universal Programmers

Parallel Port Interface

- 3000+ device types supported
- Supports EPROM, flash, microcontroller, Serial (E)EPROM, EPLD, PALCE, GAL, PEEL
- Auto search device select function
- Fast programming speed with IC vendor approved algorithms
- Built-in editor for both buffer date and test vectors
- Supports JEDEC, Intel Hex, Motorola S Records, Binary and ASCII file formats with File LOAD/SAVE command
- Built-in macro commands for programming



207781CL

Includes: 01/02/03 personality modules, parallel cable, wall adapter, disk & manual

System requirements: IBM PC, XT, AT, 386, 486, Pentium®, hard disk, 512K RAM, standard parallel port, MS-DOS 2.11 or higher

Part No.	Description	Sockets	1	5
207773CL	MEGAMAX programmer	48-pin ZIF	\$379.95 \$349.95	
207781CL	MEGAMAX4G prog.	48-pin ZIF (1)/32-pin ZIF (3)	\$429.95 \$399.95	

Fast, Low-Cost Universal Device Programmer

Parallel Port Interface

- 2000+ device types supported
- Menu driven software
- Programs (E)EPROM, PROM, Serial PROM, PALCE, GAL, flash memory, microcontrollers, ATF
- On-board FPGA for speed; 4X faster than offshore brands
- Auto search device select function supports (E)EPROM and microcontrollers
- Auto programming for production programming
- Device insertion test identifies improperly inserted device before programming
- Auto programming for production programming
- Read, blank check, program, verify, checksum, data compare, security, auto function



Includes: Parallel cable, wall adapter, diskette & manual

System Requirements: IBM PC, XT, AT, 386, 486, Pentium® or compatibles, DOS 2.11 or greater, Windows® 95/98/2000/NT/XP; hard disk, 512K RAM & parallel port

Part No.	Description	Socket	1	5
207731CL	CHIPMAX	40-pin ZIF	\$349.95 \$332.95	

16kB-256MB Universal IC Programmer/Tester

Parallel Port Interface

HI-LO SYSTEMS

Supports over 7,000 devices including EPROM, EEPROM, Serial PROM, FLASH, PLD/ CPLD/ FPGA, MPU/MCU & much more. Most devices in various package types can be programmed with the on-board 40-pin ZIF socket or through an appropriate adapter/ converter. Modular pin drivers program at high speed & provide high reliability & expansion capability.



- Functions of load file, read master, program, verify, auto, ID check, checksum, blank check, erase, secure, protect/unprotect, edit, file transfer, function configuration & self test

Includes: External power supply, DB25 M/F cable, manual & software CD-ROM
System Requirements: Intel Pentium, 32MB of RAM, parallel port, Windows® 95/98/NT/2000/XP, 5MB free hard disk space, CD-ROM drive
206922CL: UV opaque EPROM window labels (168 per pack)

Part No.	Description	1	5
216039CL	ALL-11C2 programmer	\$799.95 \$379.95	\$799.95
206922CL	1.1" x .046" window label	6.95 6.95	5.95

Universal Programmer – Pocket Size & Battery Powered

Parallel Port Interface

A unique ASIC pin driver was designed specifically for this latest generation programmer, enabling the first true universal input/output capability. Along with basic functions the software permits setting specially designated functions for any selected device.



GALEP-4

- Supports 5200+ devices: 8-bit and 16-bit EPROM, EEPROM, FLASH EPROM, Serial EEPROMs, all Microcontrollers, GAL/PAL/CE without adaptors
- Support for ultra-low voltage devices down to 1.3V
- High speed data transfer: 27C256 read/verify = 2 seconds; program = 8 seconds
- Three separately adjustable voltages for all 40-pins
- Fully compatible with Windows® 95/98/ME/NT/2000/XP
- Integrated editor's many features allow user to edit device data, which can be loaded or saved in INTEL HEX, Motorola S or binary format
- Operates on AC power adapter or 6 NiMH batteries
- Size: 4.5"L x 3.1"W x 1.3"H • Weight: 7.5 oz.

Includes: Printer port data cable, power adapter & CD

System requirements: PC with Pentium® CPU

Part No.	Description	1	5
226309CL	GALEP-4	\$369.95 \$369.95	\$351.49

Flash Writer/Programmer with USB Interface

- Programs 8-bit Flash serial IC's via USB cable on Windows® 9x/ME/2000/XP
- High-speed, high-performance programming: programs a 16MB flash device in just 30 seconds
- File formats supported: Binary, Motorola HEX, Intel HEX, Tektronix HEX
- Read, program, verify, blank check, erase, secure, memory edit functions
- EPROM auto ID, device insertion check
- File loading & saving w/ automatic format detection
- Project functionality to save device type, file and used procedures
- Adjustable IC parameters: voltage, algorithm, and pulse width
- Supports flash, EPROM, and EEPROM devices
- Powered by power adapter or two 9V batteries



Includes: USB cable, CD-ROM (software and users manual), installation manual, and power adapter

System Requirements: Pentium® II, 32MB of RAM, 30MB hard disk space, USB 1.1 compliant port or higher

Part No.	Description	1	10
236988CL	EPP3 flash writer/programmer w/ USB interface	\$219.95 \$219.95	\$208.95

30-Day Money-Back Guarantee

If you're not satisfied, we'll take it back!
Details on page 229.

EPROM Erasers and Accessories

66042CL: Erases 1 chip in 7 minutes

- Conductive foam liner eliminates static build-up
- UV intensity: 6.5mW/cm²
- Size: 6.8"L x 1.5"W x 2.3"H
- One-year warranty
- Weight: 0.8 lbs.

Requires: Four AA batteries (not included), recommend P/N 244515CL (pg 154)



66042CL 15712CL

15712CL: Erases 1 chip in 15 min. or 8 chips in 21 min.

- Conductive foam liner eliminates static build-up
- Maintains constant exposure distance of 1"
- Built-in safety lock to prevent UV exposure
- Complete with holding tray for 8 chips
- UV intensity: 6.8mW/cm²
- Size: 9.0"L x 3.7"W x 2.6"H
- Weight: 2.3 lbs.



Part No.	Description	1	5
66042CL	Portable eraser	\$54.95	\$49.95
15712CL	8-chip eraser	119.95	109.95
34382CL	Lamp for 15712CL	39.95	39.95
13864CL	Foam (12" x 24" x 0.25")	7.95	6.95

HI-LO SYSTEMS EPROM Eraser

- Erases all UV erasable EPROMs (32-pin)
- Upper & lower erasing chambers hold a total of 16 EPROMs
- Conductive foam liner eliminates static build-up
- One-year warranty
- Size: 8.5"L x 2.8"W x 2.8"H
- Weight: 1.6 lbs.

Includes: AC adapter - 9VDC @ 600mA and a timer which turns eraser off at the end of the selected time period - 10 to 60 minutes



Part No.	Description	1	5
121267CL	EPROM eraser	\$159.95	\$143.95

microEngineering Labs

"PICProto" Prototyping Boards

- High quality blank prototyping boards for PICmicro microcontrollers
- Holds microcontroller, 5V regulator, oscillator, capacitors and DB9-25 connector
- Double-sided board with plated-through holes
- Solder mask on both sides makes soldering easy
- Large prototyping area
- Silkscreen legend

Includes: Documentation sheet with schematic, suggested parts and placement

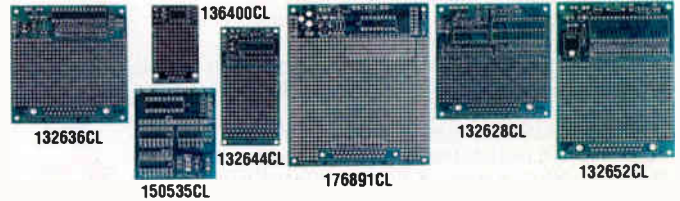

PICProto 18, 18L: For all 18-pin PICs including PIC16C52, 54, 56, 58, 554, 558, 61, 620, 621, 622, 71, 710, 711, 712, 715, 716, 84, 16CE623, 624, 625, 16F627, 628, 83, and 84

Part No.	Description	Size (L" x W")	1	10
132644CL	PICProto 18	3.0 x 1.5	\$9.95	\$8.95
176891CL	PICProto 18L	3.6 x 4.1	19.95	17.95

PICProto 3: For the 28-pin PIC16C62, 63, 642, 66, 72, 76, 773, 16F73, 76, 870, 872, 873, 876, 18C242, and 252

132636CL	PICProto 3	3.0 x 3.0	\$14.95	\$13.49
----------	------------	-----------	---------	---------

PICProto 64: For the 40-pin PIC16C64, 65, 662, 67, 74, 77, 774, 16F74, 77, 871, 874, 18C422, and 452

132652CL	PICProto 64	4.0 x 3.0	\$16.95	\$14.95
----------	-------------	-----------	---------	---------

PICProto 8: For all 8-pin PIC12Cxxx and 12CExxx

136400CL	PICProto 8	2.0 x 1.2	\$8.95	\$7.95
----------	------------	-----------	--------	--------

PICProto Dual: For 18-pin PIC16C52, 54, 56, 58, 554, 558, 61, 620, 621, 622, 71, 710, 711, 712, 715, 716, 84, 16CE623, 624, 625, 16F627, 628, 83, & 84, as well as 28-pin PIC16C55, & 57. Accepts standard 0.6" 28-pin device or 0.3" skinny DIP

132628CL	PICProto Dual 18/28	3.0 x 3.0	\$14.95	\$13.49
----------	---------------------	-----------	---------	---------

PICProto S1: For working with circuits in "Easy Microcontrol'n" (pg 228) and "Microcontrol'n Apps" (pg 220). Holds 18-pin PICmicro, oscillator, 5-volt power supply, DIP switches, & socket to solderless breadboard

150535CL	PICProto S1	1 x 1.9	\$13.50	\$12.95
----------	-------------	---------	---------	---------

microEngineering Labs

EPIC Plus PICmicro Programmer

The EPIC Plus Programmer quickly and easily programs the PIC12Cxxx, 12CExxx, 16C505, 16C55x, 6xx, 7xx, 84, 9xx, 16CE62x, 16F62X, 7x, 8x, 87x, 14C000, 17C7xx, 18Cxxx microcontrollers from Microchip. The basic programmer includes an 18-pin socket for programming 8, 14 and 18-pin PICmicro MCUs. Devices available separately on page 6.

- Simple installation with parallel port (printer) interface
- Interactive software for Windows and DOS
- Command line operation for automated, non-interactive programming
- PICmicro Assembler software included

Requires: Two 9V batteries or AC adapter (below)

Part No.	Description	1	10
132679CL	EPIC Plus PICmicro programmer	\$59.95	\$53.95
136397CL	8/18/20-pin ZIF adapter	34.95	31.95
132610CL	40/28-pin ZIF adapter	34.95	31.95
162317CL	AC wall adapter (16VDC/500mA, details on page 146)	7.95	6.95
67256CL	6' DB25 cable (details on page 66)	6.45	5.79



microEngineering Labs

PICBasic and PICBasic Pro Compiler

PICBasic converts your BASIC programs into files that can be programmed directly into a PICmicro MCU.

- Compatible with most PICmicro MCU programmers including EPIC plus
- Use in DOS or Windows (includes Windows editor/DE software)
- I2C instructions to access external EEPROMs
- In-line assembler and call support

132661CL: PICBasic Compiler

- Expanded BASIC Stamp I compatible instruction set
- PEEK and POKE instructions to access any register from BASIC
- Serial speeds to 9600 baud
- Supports PC12C67x, PIC14Cxxx, PIC16C55x, 66x, 7xx, 84, 92x, and PIC16CF8xx microcontrollers
- May use up to 2k of code space

150543CL: PICBasic Pro Compiler

- Direct and library routine access to any pin or register
- Automation page boundary handling past 2k
- Real If...Then...Else...Endif
- Interrupts in BASIC and assembler
- Built-in LCD support
- Supports 12C5xx, 12C67x, 12CE67x, 14C000, 16C5x, 16C55x, 6xx, 7xx, 84, 92x, 16CE62x, 16F62x, 7x, 8x, 87x, 17Cxxx, and 18Cxxx microcontrollers
- Bit, byte, word arrays
- Hierarchical expression handling
- BASIC Stamp I and II library
- MPLAB/MPASM/ICE compatibility



132661CL

Part No.	Description	1	10
132661CL	PICBasic compiler	\$99.95	\$89.95
150543CL	PICBasic Pro compiler	249.95	224.95

microEngineering Labs

LAB-X1 Experimenter's Module Board

The LAB-X1 is a pre-assembled experimenter's platform. It provides an assembled testbed containing most of the circuitry commonly used with PICmicro microcontrollers (MCUs). Many different projects may be created using the LAB-X1, including calculator, voltmeter, LCD backpack, tone dialer, and RC servo controller.

- 40-pin ZIF socket for PICmicro MCU (not included, PIC16F877-20/P recommended)
- Jumper selectable oscillator from 4MHz to 20MHz
- Reset button
- 16 switch keypad
- 3 potentiometers
- LED bargraph
- 2 lines x 20 characters LCD module
- Speaker
- 2 RC servo connectors
- RS232 interface
- Socket for RS485 interface (device not included)
- Socket for I2C & SPI serial EEPROM (device not included)
- Socket for Microwire serial EEPROM (device not included)
- Socket for real time clock/serial analog to digital converter (devices not included)
- EPIC in-circuit programming connector
- Prototyping area for additional circuit
- Wiring for microchip in-circuit debug connector
- Size: 5.5" x 5.6"

Requires: AC adapter (below)

Part No.	Description	1	10
169113CL	LAB-X1 Experimenter Board	\$199.95	\$189.95
176903CL	LAB-X1 Experimenter Board Kit (unassembled)	139.95	132.95
198168CL	LAB-X2 for 28 and 40-pin MCUs	69.00	65.00
198176CL	LAB-X3 for 18-pin MCUs	119.95	107.95
176882CL	PIC16F877-20/P microcontroller (pg 7)	9.49	8.49
127976CL	AC adapter (details on page 145)	4.75	4.25



General Purpose Prototyping Boards

Select the prototype board that fits your needs from our comprehensive product listing. Prototyping boards with punched holes are convenient, economical tools for assembling circuit components and trying cost-effective alternatives to custom designs.

- 0.062" board thickness
- 0.1" hole spacing
- 0.08" pad size
- Plated through pads are double-sided
- PCB material epoxy glass

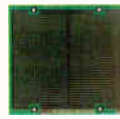

206578CL



21434CL



52943CL



21477CL

Circuit Patterns

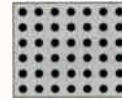

A
Holes Only

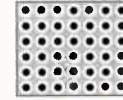

B
Pad Per Hole



C
Power/Ground Perimeter Bus with Pad Per Hole



D
3 Hole Solder Pad and Bus

Board Outline



Now Lower Prices

NEW

SALE

See pg 104 for PCB mounting enclosures and hardware (recommend P/N 106551CL)

Part Number	Product Number	Size (W" x L")	Fits Enclosure(s) (see page 104)	Circuit Pattern	Hole Pads	# Holes x Dia. †	Power/Ground Busses	Connector I/O or Edge	# Mounting Holes x Dia.	Weight (lbs.)	Pricing			
											1	10	50	100
105099CL	2855PCB	1.60 x 2.70	18921CL	B	Single-sided	288 x .035"	None	None	2 x .115"	.02	\$5.25	\$4.73	\$4.25	\$3.83
105101CL	5002PCB	1.50 x 3.50	11957CL	C	Single-sided	365 x .038"	4	None	2 x .140"	.02	6.95	6.25	5.59	4.95
263185CL	PCB-403	1.80 x 3.10	18921CL	B	Plated through	300 x .042"	None	None	4 x .115"	.03	6.95	6.25	5.63	5.09
105128CL	2853PCB	2.00 x 4.40	18913CL, 11965CL	C	Single-sided	669 x .038"	4	None	4 x .140"	.03	7.95	6.95	6.25	5.59
105110CL	2300PCB	2.40 x 3.40	11869CL	C	Single-sided	637 x .038"	4	None	2 x .140"	.03	7.95	6.95	6.25	5.59
263206CL	PCB-463	2.40 x 4.10	N/A	B	Plated through	640 x .042"	None	None	4 x .120"	.05	8.95	8.09	7.25	6.55
28177CL	PCB1	2.42 x 4.10	18913CL	C	Plated through	674 x .040"	None	None	4 x .120"	.04	5.95	5.35	4.79	4.29
263214CL	PCB-858	2.50 x 4.50	18913CL	B	Plated through	640 x .042"	None	None	4 x .120"	.05	8.95	8.09	7.25	6.55
105152CL	2851PCB	3.10 x 5.50	18892CL	C	Single-sided	1450 x .035"	7	None	4 x .140"	.07	9.95	8.95	7.95	6.95
263222CL	PCB-69	3.30 x 3.70	N/A	B	Single-sided	900 x .042"	None	None	4 x .120"	.05	8.95	8.09	7.25	6.55
105136CL	2320PCB	3.30 x 4.50	11885CL	C	Single-sided	1266 x .035"	4	None	4 x .140"	.06	9.95	8.95	7.95	6.95
105161CL	2852PCB	3.60 x 7.00	18905CL, 11973CL	B	Single-sided	2225 x .035"	4	None	4 x .140"	.10	14.95	13.45	11.95	10.95
206586CL	2746APCB	4.30 x 6.80	209349CL	C	Single-sided	2550 x .042"	5	None	4 x .140"	.07	10.95	9.86	8.87	7.98
21434CL	JE401(8001)	4.50 x 6.50	18868CL	B/D	Single-sided	2360 x .042"	2	None	None	.12	21.95	19.76	17.78	16.00
21451CL	JE405(8003)	4.50 x 6.50	18868CL	C	Single-sided	2360 x .042"	1	None	None	.12	19.95	17.95	14.36	10.77
43140CL	64P44XXX*	4.50 x 6.50	18868CL	A	Drilled only	2860 x .042"	None	None	None	.09	9.95	5.99	5.65	5.49
52943CL	84P44WE	4.50 x 8.50	18876CL	A	Drilled only	3740 x .042"	None	None	None	.15	9.39	8.79	8.49	8.29
37604CL	169P44WE	4.50 x 17.0	N/A	A	Drilled only	7524 x .042"	None	None	None	.31	16.19	14.19	13.99	13.69
37612CL	169P44XXX*	4.50 x 17.0	N/A	A	Drilled only	7524 x .042"	None	None	None	.25	11.19	10.39	9.99	9.69
206578CL	2743APCB	4.60 x 4.30	208910CL	C	Single-sided	1684 x .042"	5	None	4 x .140"	.07	7.49	6.74	6.07	5.46
105179CL	2505PCB	5.00 x 6.50	11893CL, 18868CL	C	Single-sided	2829 x .035"	7	None	8 x .120"	.13	14.95	13.49	11.95	10.95
28193CL	PCB3	5.00 x 8.00	18876CL	C	Plated through	3705 x .042"	4	Mounting area-I/O	4 x .120"	.17	21.95	19.76	17.78	16.00
21477CL	JE407(8006)	5.00 x 13.25	N/A	B	Plated through	6063 x .038"	None	None	8 x .120"	.28	41.19	37.07	33.36	30.03
206594CL	2747APCB	5.50 x 8.00	209357CL	C	Single-sided	3906 x .042"	5	None	4 x .140"	1.0	14.99	13.49	12.14	10.93
105187CL	2507PCB	6.10 x 8.80	18876CL	C	Single-sided	4771 x .035"	7	None	8 x .140"	.21	29.95	26.95	23.95	21.95
263231CL	PCB-7038	8.30 x 11.9	N/A	B	Plated through	8819 x .042"	10	5	4 x .115"	.40	55.95	52.19	49.59	47.09
37621CL	169P84WE	8.50 x 17.0	N/A	A	Drilled only	14,448 x .042"	None	None	None	.53	22.85	21.19	20.29	19.79
263249CL	PCB-6088	9.20 x 13.0	N/A	B	Plated through	11,000 x .042"	10	None	13 x .115"	.50	55.95	52.19	49.59	47.09

* PCB material: phenolic

† All 0.042" diameter hole boards use terminals T44, T49, and T421 (see below)

Wire Wrap and Push-In Terminals

For .042" Diameter Holes

Specifications:

- Material: copper alloy • Prebagged 100 pcs.
- 34147CL: Push-In Micro-Klip Terminals**
- Overall length: .36" • Post size: .032" x .045"
- 34155CL: Miniwrap Wiring Terminals • Shoulder: .045"**
- Two-prong with square tail for wire wrapping
- Overall length: .69" • Post size: .025" Sq.
- 34163CL: Klipwrap Wiring Terminals • Shoulder: .045"**
- Three-prong with square tail for wire wrapping
- Overall length: .83" • Post size: .025" Sq.

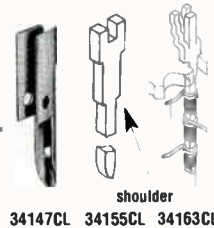

Part Number	Mfr. Cross Ref. No.	Height Above .062" Ref.	Length Below .062" Board	100 pc. units	
				1	10
34147CL	T421	.200	.097	\$7.29	\$6.95
34155CL	T44	.065	.530	7.99	7.49
34163CL	T49	.200	.530	11.79	11.19

Copper-Plated Blank Circuit Boards

Ideal for hobbyists and students doing prototypes of circuits. Copper plating on board for either single-sided or double-sided boards.

- 1.6mm thickness



Fig. 1



Fig. 2



Fig. 3

Single-Sided							
Part No.	Product No.	Size (L" x W")	Fig.	Wt. (lbs.)	1	10	50
169279CL	PCBS3X6	3.0 x 6.0	3	0.1	\$3.49	\$3.15	\$2.85
169287CL	PCBS6X6	6.0 x 6.0	2	0.2	4.95	4.49	3.95
169295CL	PCBS12X12	12.0 x 12.0	1	0.5	13.49	12.14	10.93
Double-Sided							
Part No.	Product No.	Size (L" x W")	Fig.	Wt. (lbs.)	1	10	50
169308CL	PCBD3X6	3.0 x 6.0	3	0.1	\$5.25	\$4.73	\$4.25
169316CL	PCBD6X6	6.0 x 6.0	2	0.2	7.95	7.15	6.45
169324CL	PCBD12X12	12.0 x 12.0	1	0.7	17.95	15.95	14.49

PT Series Prototyping Boards

Designed to accommodate any mixture of 0.3" to 0.6" wide IC's with any number of pins, as well as any combination of resistors, capacitors, diodes, transistors, etc.

- 4 power busses that connect to a power jack (recommended P/Ns 101178CL & 101186CL, pg 152)

Part No.	Mfr. Cross Ref. No.	Size	Hold Pads	# Holes x Dia.	# Mntg Holes x Dia.	1	5	10
262511CL	PT-5X37	5"L x 3.7"W	Double-sided	1267 x .036"	4 x .140"	\$24.75	\$22.95	\$21.79
262537CL	PT-6X49	6"L x 4.9"W	Double-sided	1267 x .036"	4 x .140"	32.49	30.89	29.35

NEW

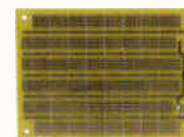

262511CL

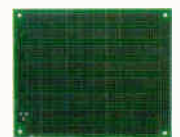

262537CL

These long-lasting solderless breadboards feature screen-printed color coordinates suitable for many types of digital and analog prototyping and circuit design. Larger models feature a heavy-duty aluminum backing with binding posts. Use Jameco's AC/DC breadboard power supply, P/N 77681CL (pg 32).

- Accepts most electronic components, including integrated circuits and transistors for digital and/or analog circuitry • 0.1" hole spacing
- Pins are identified by numbered rows and columns
- Ideal for high frequency and low noise circuits
- One-year warranty • WBU5 and JE series do not interconnect



20757CL

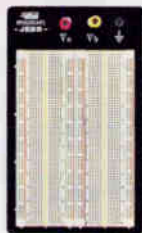

20773CL



20790CL



20811CL

Attention Educators! Buy jumper wire (pg 32) in bulk and SAVE! (see Hook-up Wire on page 60)

WBU5 Series Key Features:

- Horizontal assembly corresponds to the operation flow design of the PC boards for handy operation
- Round hole design makes the electric connection better
- Formed with V-shaped cross-sectional groove, which allows DIP IC pins to be inserted across two parts and to increase the rate of utilization due to small pitch
- Dovetail protrusions and recesses designed to connect two adjacent parts tightly together

JE Series Key Features:

- Use to breadboard and debug circuit designs
- Low static, plastic body - CMOS safe
- Nickel-plated clips designed to withstand up to 5,000 insertion cycles
- Breadboard strips connect together to form larger working areas
- Components are easily interconnected using 20-28 AWG wire (P/N 19289CL & 20079CL, pg 32)
- Some models feature heavy-duty aluminum backings (JE24, JE27, WBU504)

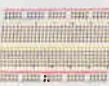

20600CL

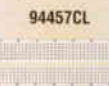

94457CL



20669CL



136901CL



77825CL

Part Number	Product Number*	Terminal Strips	Bus Strips	Contact Points	Binding Posts	Breadboard Size L" x W"	Baseplate Size L" x W"	Weight (lbs.)	Pricing			
									1	10	50	100
94457CL	JE19	0	1	100	0	6.5 x 0.4	—	0.04	\$2.95	\$2.65	\$2.39	\$2.15
20600CL	JE21	1	2	400	0	3.3 x 2.1	—	0.13	5.25	4.73	4.25	3.83
20669CL	JE22	1	0	630	0	6.5 x 1.4	—	0.20	5.49	4.95	4.49	3.95
194280CL	JE35	1	1	740	0	6.9 x 2.1	—	0.23	9.95	8.99	8.09	7.25
194298CL	JE37	1	2	840	0	6.9 x 2.4	—	0.25	9.95	8.95	7.95	7.25
194255CL	JE38	1	2	970	4	2.9 x 5.6	4.9 x 6.3	0.50	16.95	15.25	13.75	12.35
20722CL	JE23	1	2	830	0	6.5 x 4.0	6.5 x 2.1	0.30	9.39	8.45	7.61	6.85
194271CL	JE34	2	3	1,560	3	6.5 x 4.0	8.5 x 4.7	0.73	15.95	14.39	12.95	11.65
20757CL	JE24	2	1	1,360	2	6.5 x 3.1	8.5 x 4.0	0.60	13.65	12.28	11.06	9.95
136901CL	WBU504*	2	3	1,855	4	5.5 x 5.5	7.4 x 6.3	0.90	22.99	20.99	18.99	16.99
20773CL	JE25	2	4	1,660	3	6.5 x 4.3	8.5 x 5.1	0.80	19.95	17.95	16.16	14.54
20790CL	JE26	3	5	2,390	4	6.9 x 5.8	9.1 x 6.9	1.10	27.29	24.56	22.10	19.89
20811CL	JE27	4	7	3,220	4	7.3 x 7.5	9.5 x 8.3	1.40	33.59	30.23	27.21	24.49

Part No.	Description	1	10	25
77825CL	Breadboard pin to breadboard pin test leads (20 pk), 4 each color-coded (red, yellow, blue, black, white), 20 AWG wire, 5.9" (15cm)	\$12.95	\$11.69	\$10.49

PLCC Prototype Adapters

PLCC socket mounted on a circuit board for easy wire wrap or design prototyping. Solder masked PCB with 0.25" long leads.

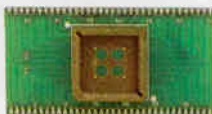

73550CL

- PCB construction
- Silkscreen numbers identify pin numbers in groups of 5 and 10 • Gold-plated round pins
- Tin-plated PLCC connector
- PLCC socket identifies pin 1 and orientation key
- PLCC socket slotted for PLCC chip remover

Part No.	Pins	Size (L x W)	1	10	100
73541CL	44	2.3" x 1.6" ...	\$11.95	\$10.79	\$9.69
73550CL	68	3.4" x 1.6" ...	\$15.95	\$14.49	\$12.95
73568CL	84	4.3" x 1.9" ...	\$23.95	\$21.59	\$19.45

PCI-Bus Extender Card

- PCI Bus
- Extends life of motherboard connectors
- Gold-plated fingers for long life
- Size: 5.9"L x 5.4"W



Part No.	Description	1	10
141381CL	PCI-bus extender card	\$74.95	\$67.49

BestProto AT/ISA Prototyping Board

- Can accommodate a PGA package with a 31 x 31mm footprint
- Twenty-one 1206 surface-mount bypass capacitor sites and 142 unconnected sites
- Size: 8.2"L x 4.2"W

Includes: Signal definition chart

Part No.	Description	1	10
136469CL	AT/ISA board	\$22.50	\$19.95

PCI-Bus Prototype Board

- All plated through holes
- 0.1" hole spacing
- 50 Mil power and ground grids
- Provision for wire wrap and bypass caps
- Impedance matched to bus specifications
- Easy access to every signal on the bus
- Size: 12.4"L x 5.0"W • Weight: 0.6 lbs.



Part No.	Description	1	10
141372CL	PCI prototype bus board	\$74.95	\$68.46

8/16-Bit PC/XT/AT Solderless Plug-In Breadboard

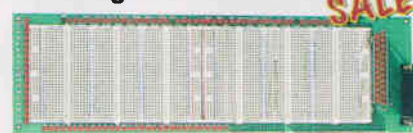

- IBM PC/XT/AT and higher compatible
- 62 data I/O lines and a DB25 female connector for interfacing to peripherals
- Twenty-four 14-pin IC capacity
- Clearly labeled bus lines • 2,352 contact points
- Durable construction • One-year warranty
- Size: 13.8"L x 5.0"W • Weight: 1.0 lb.

Part No.	Description	1	10	25
81672CL	8/16-bit breadboard	\$7.95	\$52.16	\$46.94

See page 29 for Jameco's surface mount prototyping boards.



Digital/Analog Design Labs

- Two 7-Segment Displays (digit height: 0.3")
- One-year warranty

Solderless Breadboard

- Interconnected nickel-plated tie points, fitting all DIP sizes and all components with AWG #22-30 (0.3-0.8mm) solid leads

DC Power Supplies

- DC supplies equipped with short circuit protection
- Variable DC power: 0 to +15V & 0 to -15V @ 0.5A

Function Generator (5 ranges)

- Frequency range: 1Hz-10Hz, 10Hz-100Hz, 100Hz-1kHz, 1kHz-10kHz, 10kHz-100kHz
- Sine wave output: 0-8 Vp-p variable • Triangle wave output: 6Vp-p fixed • Square wave output: ±5V fixed



Part No.	Tie Points	Fixed Power Supply	Pulse Generator	Frequency Counter	Multimeter	Includes
75838CL	1580	±5VDC @ 1.0A	No	No	DCV (Digital)	Power cord, manual
201890CL	2960	±5VDC @ 0.5A	1Hz to 1MHz switchable	Yes	ACV, DCV, DCmA, resistance (analog)	Power cord, enclosed case, test lead, jumper wire kit, DB25 serial adapter, manual

Part No.	Description	Size (W" x D" x H")	Weight (lbs.)	1	10	25
75838CL	Digital lab	10.6 x 13.3 x 5.0	8.1	\$276.95	\$249.95	\$226.95
201890CL	Digital/analog lab	13.9 x 12.8 x 4.9 (back panel)	11.8	\$429.95	\$389.95	\$349.95

Digital-Analog Design Lab

Solderless Breadboard

- 2712 interconnected nickel-plated tie points, fitting all DIP sizes and all components with AWG #22-30 (0.3-0.8mm) solid leads

DC Power Supplies

- Variable DC output: 0 to +15V & 0 to -15V @ 500mA
- Fixed DC output: +5VDC, 1A; -5VDC, 300mA
- Input power: 120/220VAC @ 50-60Hz (switchable)

- Function Generator • Frequency ranges: 1Hz-10Hz, 10Hz-100Hz, 100Hz-1kHz, 1kHz-10kHz, 10kHz-100kHz
- Sine wave output: 0-8 Vpp variable • Triangle wave output: 0-6 Vpp variable • Square wave output: 0-8 Vpp variable

Other features:

- 2 variable resistors: VR1=1kΩ, VR2=100kΩ • 8 data switches • 2.5" dia. 8Ω, 25W speaker
- 2 pulse switches (2 sets of outputs: A, A, B, B) • 2 banana sockets, 2 BNC jacks • One-year warranty
- Two 7-segment LED displays (digit height: 0.3") • 8 red LEDs with separate input terminals

Includes: Power cord and manual

Part No.	Description	Size (W" x D" x H")	Weight (lbs.)	1	10	25
136266CL	Digital-analog lab	12.8 x 9.8 x 3.7	8.5	\$379.95	\$341.99	\$307.79

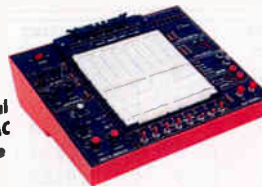

AC/DC Power Supply

Ideal for Breadboards on page 31



Output Specifications:
+5VDC @ 1A;
-5V @ 300mA fixed;
0 to +15VDC @ 500mA variable,
0 to -15VDC @ 300mA variable;
12-6-0-6-12 tapped VAC,
300mA fixed

With built-in short-proof regulated power supplies.

- Input power: 120/220VAC @ 50-60Hz (switchable)
- Indicator lamps and power fuses
- Just plug-in and start to use
- Compact & lightweight
- For both digital and analog circuits
- Compatible with test leads P/N 77841CL, pg 202
- Size: 7.4"W x 5.5"D x 2.6"H • Color: beige
- Weight: 5.5 lbs. • One-year warranty

Part No.	Description	1	10	25
77681CL	Power supply ...	\$119.95	\$109.95	\$99.95

Powered Project Board

- Solderless breadboard with 2420 tie points
- DC power supplies: +5V @ 1A; variable power 0 to +15VDC and 0 to -15VDC @ 500mA
- Back panel has ground terminal
- Outputs are short-circuit protected
- Edge plate for non-DIP size components
- Input power: 120/220VAC @ 50-60Hz (switchable)
- Replacement fuse: P/N 103907CL, pg 54
- Power switch with light
- Breadboard size: 7.4"L x 6.8"W
- Enclosure size: 9.8"L x 8.0"W x 2.6"H
- Weight: 6.8 lbs. • One-year warranty

Includes: Power cord

Part No.	Description	1	10	25
136258CL	Powered breadboard	\$99.95	\$89.95	\$87.95



International 120/220VAC Switchable

Wire Jumper Kit (350 pcs.)

- 25 each of lengths 0.1" through 5.0" (14 sizes)
- 350 assorted lengths in 13 colors
- Pre-stripped/preformed 22 AWG solid wire jumpers



Part No.	Description	1	10	50	100
19289CL	Wire jumper kit ..	\$15.95	\$14.39	\$12.95	\$11.65
20079CL	Refill for 19289CL ..	10.99	9.89	8.90	8.01

Reinforced Jumper Wires

- 24 AWG-300 volts
- Reinforced pin ends for durability
- 10 pack assortment: 2 each yellow, white, red, black & blue



Part Number	Mfr. Ref. No.	Length (mm / inch)	126341CL	1	10	100
126359CL	JW50	50 / 1.97	...	\$3.95	\$3.49	\$2.95
126341CL	JW100	100 / 3.94	...	4.95	4.49	4.05
126324CL	JW200	200 / 7.87	...	5.19	4.69	4.25

Resistance and Capacitance Decade Substitution Boxes

Wide-range decade substitution boxes for product design or calibration checks.

EXTECH

- Light durable construction
- Case may be grounded separately
- Three binding posts permit isolated substitutions
- Size: 4.7"W x 5.7"H x 1.4"D
- Weight: 0.7 lbs.
- 211668CL: 1% resistance substitution from 1Ω to 11.111110MΩ
- 7 decade ranges of resistance
- Values can be changed in 1Ω increments
- 211676CL: 5% capacitance substitution from 100pF to 11,111µF
- 5 decade ranges of capacitance



211668CL



211676CL

Part No.	Description	1	10
211668CL	Resistance	\$98.95	\$93.95
211676CL	Capacitance	128.95	122.45

Over 99% of our products are in stock!

Just place your order by 6PM EST for same business day shipment.



We'll Send It Today!

For Banana Plugs, Binding Posts and Test Leads see pages 202 - 203.

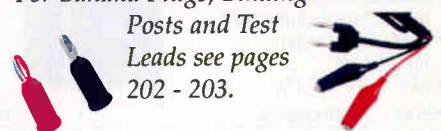

Kits include the Most Popular Components and a Cabinet with extra drawers for your Customized Expansion



84970CL (IC kit)



84996CL (LED Kit)



81832CL
(Resistor kit)



Each Kit includes a 20-Drawer Component Cabinet (81701CL), 20 clear plastic drawers (85454CL), 20 clear dividers (85446CL), 30 adhesive labels for drawers to identify parts in kit, and all the Electronic Components listed in each kit.

• Cabinet size: 6.0"L x 15.0"W x 7.9"H • Drawer size: 5.5"L x 2.7"W x 1.5"H • Weight: 4.6–6.4 lbs. • Cabinet: ABS-Black • Cabinet is wall-mountable or free standing

Each Refill Package includes all Electronic Components listed in each kit; each type is separately packaged.

4000 Series CMOS IC Kit

Includes 300 pcs. (25 types) CD4000 Series Integrated Circuits

SAVE \$28

10 each	10 each	10 each	10 each	20 each
CD4015	CD4024	CD4051	CD4093	CD4001
CD4016	CD4027	CD4069	CD4511	CD4011
CD4017	CD4040	CD4070	CD4538	CD4013
CD4020	CD4046	CD4071	CD4543	CD4049
CD4023	CD4050	CD4081	CD4584	CD4066

Part No.	Description	Wt. (lbs.)	1	10
84970CL	300 pcs. 4000 series CMOS IC kit	6.1	\$79.95	\$71.95
130403CL	Refill for 84970CL (300 pcs.)	1.4	58.95	52.95

7400 Series IC Kit

Includes 350 pcs. (30 types) 7400 (TTL) Integrated Circuits

SAVE \$75

10 each	10 each	10 each	10 each	10 each	20 each
7402	7416	7438	74107	74157	7400
7405	7417	7447	74123	74160	7404
7408	7420	7470	74132	74174	7406
7410	7430	7485	74151	74175	7407
7414	7432	7495	74153	74279	7474

Part No.	Description	Wt. (lbs.)	1	10
84953CL	350 pcs. 7400 IC kit	6.2	\$149.95	\$134.95

74LS Series IC Kit

Includes 420 pcs. (35 types) 74LS (TTL) Integrated Circuits

SAVE \$48

10 each	10 each	10 each	10 each	20 each
74LS05	74LS73	74LS125	74LS193	74LS00
74LS10	74LS75	74LS139	74LS240	74LS02
74LS11	74LS85	74LS151	74LS244	74LS04
74LS14	74LS86	74LS155	74LS245	74LS08
74LS20	74LS90	74LS157	74LS273	74LS32
74LS30	74LS93	74LS174	74LS373	74LS74
74LS47	74LS123	74LS175	74LS374	74LS138

Part No.	Description	Wt. (lbs.)	1	10
84961CL	420 pcs. 74LS IC kit	6.7	\$119.95	\$107.95
130391CL	Refill for 84961CL (420 pcs.)	2.0	99.99	89.99

Linear Series IC Kit

Includes 480 pcs. (40 types) Linear Series Integrated Circuits

SAVE \$53

10 each	10 each	10 each	10 each	20 each
TL072CP	LM337T	LF412CN	ULN2803A	LM317T
TL074CN	LF353N	LMC555CN	NE5532	LM324N
TL082CP	LF356N	LM556N	7808T	LM339N
TL084CN	LM358N	LM723CN	78L12	LM741CN
MAX232CPE	LM386N-1	LM1458N	7815T	LM555CN
LM301N	LM386N-3	LM1488N	7905T	7805T
LM308N	LM393N	DS1489N	7912T	78L05
LM311N	LF411CN	ULN2003A	7915T	7812T

Part No.	Description	Wt. (lbs.)	1	10
84988CL	480 pcs. Linear IC kit	6.0	\$182.95	\$164.95
130411CL	Refill for 84988CL (480 pcs.)	1.3	169.95	145.95

Low Profile IC Socket Kit

Includes 300 pcs. (10 types) Solder tail (Tin) IC Sockets

SAVE \$13

10 each	20 each	20 each	50 each	50 each
22LP	18LP	28LP	8LP	16LP
24SLP	24LP	40LP	14LP	20LP

Part No.	Description	Wt. (lbs.)	1	10
85075CL	300 pcs. LP IC Socket kit	5.5	\$36.95	\$33.25

LEDs & LED Mounting Hardware Kit

See pages 36 & 42 for photos and specs.

SAVE \$27

Includes 560 pcs. (20 types) LEDs and mounting hardware

10 each	10 each	10 each	10 each	100 each
LVG2043	HPQLMPD141	LSG2040	LG3330	LMH100
LH2043	CLF280CTP	LY2040	LY3330	LMH200
LT0333-41	LTL-425B	LA93B/G-1	LFH3360	LR2040
LG3333	LHG3392	LA93B/H-1	LEG3362	LR3330

Part No.	Description	Wt. (lbs.)	1	10
84996CL	560 pcs. LED & Hardware kit	5.0	\$66.95	\$60.25

1/8-Watt Carbon Film Resistor Kit

Includes 540 pcs. (30 values) 1/8-watt 5% Resistors

10 each	10 each	10 each	10 each	10 each	10 each	50 each	50 each
10Ω	330Ω	1.5kΩ	3.3kΩ	15kΩ	47kΩ	100Ω	4.7kΩ
47Ω	390Ω	2Ω	5.1kΩ	22kΩ	470kΩ	220Ω	10kΩ
150Ω	470Ω	2.2kΩ	5.6kΩ	27kΩ	1MΩ	1kΩ	100kΩ
270Ω	680Ω	2.7kΩ	6.8kΩ	33kΩ	10MΩ		

Part No.	Description	Wt. (lbs.)	1	10
108329CL	540 pcs. 1/8-watt Resistor kit	4.9	\$24.95	\$22.49
108302CL	Refill for 108329CL (540 pcs.)	0.2	12.95	11.49

1/4-Watt Carbon Film Resistor Kit

Includes 540 pcs. (30 values) 1/4-watt 5% Resistors

10 each	10 each	10 each	10 each	10 each	10 each	50 each	50 each
10Ω	330Ω	1.2kΩ	2.7kΩ	15kΩ	47kΩ	100Ω	4.7kΩ
47Ω	390Ω	1.5kΩ	3.3kΩ	20kΩ	470kΩ	220Ω	10kΩ
150Ω	470Ω	2kΩ	5.1kΩ	22kΩ	1MΩ	1kΩ	100kΩ
270Ω	680Ω	2.2kΩ	5.6kΩ	33kΩ	10MΩ		

Part No.	Description	Wt. (lbs.)	1	10
81832CL	540 pcs. 1/4-watt Resistor kit	4.9	\$27.95	\$24.95
103165CL	Refill for 81832CL (540 pcs.)	0.2	12.95	11.49

1/2-Watt Carbon Film Resistor Kit

Includes 540 pcs. (30 values) 1/2-watt 5% Resistors

10 each	10 each	10 each	10 each	10 each	10 each	50 each	50 each
10Ω	330Ω	1.5kΩ	3.3kΩ	15kΩ	47kΩ	100Ω	4.7kΩ
47Ω	390Ω	2kΩ	5.1kΩ	22kΩ	470kΩ	220Ω	10kΩ
150Ω	470Ω	2.2kΩ	5.6kΩ	27kΩ	1MΩ	1kΩ	100kΩ
270Ω	680Ω	2.7kΩ	6.8kΩ	33kΩ	10MΩ		

Part No.	Description	Wt. (lbs.)	1	10
107879CL	540 pcs. 1/2-watt Resistor kit	5.1	\$29.95	\$26.95
107852CL	Refill for 107879CL (540 pcs.)	0.4	14.95	13.49

Kits include the Most Popular Components and a Cabinet with extra drawers for your Customized Expansion



Each Kit includes a 20-Drawer Component Cabinet (81701CL), 20 clear plastic drawers (85454CL), 20 clear dividers (85446CL), 30 adhesive labels for drawers to identify parts in kit, and all the Electronic Components listed in each kit.

20-drawer component cabinet with every kit!

- Cabinet size: 6.0"L x 15.0"W x 7.9"H
- Cabinet: ABS-Black
- Drawer size: 5.5"L x 2.7"W x 1.5"H
- Weight: 4.6 to 6.4 lbs.
- Cabinet is wall-mountable or free standing

Each Refill Package includes all Electronic Components listed in each kit; each type is separately packaged.

Need a refill? Just call 1-800-831-4242



108433CL (Hardware Kit)

81875CL (Capacitor Kit)

1/2-Watt Single Turn Cermet Pot Kit

See page 52 (63P Series) for photos and specs.

Includes 100 pcs. (10 values) 1/2-watt Linear Taper Potentiometer

10 each	10 each	10 each	10 each	10 each
63P500Ω	63P5kΩ	63P500kΩ	63P1kΩ	63P50kΩ
63P2kΩ	63P20kΩ	63P1MΩ	63P10kΩ	63P100kΩ
Part No.	Description	Wt. (lbs.)	1	10
85032CL	100 pcs. single turn Pot kit	4.9	\$65.95	\$59.35

SAVE \$28

3/4-Watt 15 Turn Cermet Pot Kit

See page 52 (43P Series) for photos and specs.

Includes 100 pcs. (10 values) 3/4-watt Linear Taper Potentiometer

10 each	10 each	10 each	10 each	10 each
43P500Ω	43P5kΩ	43P500kΩ	43P1kΩ	43P50kΩ
43P2kΩ	43P20kΩ	43P1MΩ	43P10kΩ	43P100kΩ
Part No.	Description	Wt. (lbs.)	1	10
85041CL	100 pcs. 15 turn Pot kit	4.9	\$82.95	\$74.65

SAVE \$32

Switch Assortment Kit

See pages 93, 94, 96 & 97 for photos and specs.

Includes 150 pcs. (15 types) Pushbutton, Slide, Dip & Toggle Switches

10 each	10 each	10 each	10 each	10 each
206-4	JMT121	JMT223	MPC221	MS103
206-8	JMT123	MPC121	MPC223	SDTX620K
JMT113	JMT221	MPC123	MS102	SW153
Part No.	Description	Wt. (lbs.)	1	10
85059CL	150 pcs. Switch kit	5.0	\$98.95	\$89.06

SAVE \$52

Hardware and Spacer Assortment Kit

Includes 2300 pcs. (23 types) Spacers, Nuts, Flat, Tooth & Lock Washers and Slotted PH Screws

100 each	100 each	100 each	100 each	100 each	100 each
Spacers	Hex nuts	Flat	Int. tooth	Split lock	PH machine screws
—	2-56	—	—	#2	2-56 x 1/4, —
4-40	4-40	#4	#4	#4	4-40 x 1/4, 1/2
6-32	6-32	#6	#6	#6	6-32 x 1/4, 1/2
8-32	8-32	#8	#8	#8	8-32 x 1/2, —
Part No.	Description	Wt. (lbs.)	1	10	
108433CL	2300 pcs. Hardware kit	7.5	\$55.95	\$50.36	
130497CL	Refill for 108433CL (2300 pcs.)	2.7	39.95	35.95	

SAVE \$7

Ceramic Disc Capacitor Kit

Includes 520 pcs. (10 values) 50V ±20% Ceramic Disc Capacitors

20 each	20 each	20 each	100 each	100 each
10pF	47pF	470pF	.022μF	.01μF
22pF	100pF	.001μF	.047μF	.1μF
Part No.	Description	Wt. (lbs.)	1	10
81859CL	520 pcs. Ceramic Capacitor kit	5.0	\$35.95	\$32.35
130232CL	Refill for 81859CL (520 pcs.)	0.3	17.95	16.49

SAVE \$16

Monolithic Ceramic Capacitor Kit

Includes 280 pcs. (10 types) 50V ±20% Monolithic Ceramic Capacitors

10 each	10 each	10 each	10 each	100 each
22pF	.001μF	.047μF	.47μF	.01μF
100pF	.0022μF	.22μF	1μF	.1μF
Part No.	Description	Wt. (lbs.)	1	10
171475CL	280 pcs. Monolithic Capacitor kit	5.0	\$29.95	\$26.95
171483CL	Refill for 171475CL (280 pcs.)	0.3	17.95	15.95

SAVE \$10

Radial Electrolytic Capacitor Kit

Includes 240 pcs. (15 values) ±20% Radial Electrolytic Capacitors

10 each	10 each	20 each	20 each	20 each
100μF @ 50V	1000μF @ 16V	1μF @ 50V	3.3μF @ 50V	22μF @ 50V
220μF @ 25V	2200μF @ 25V	1μF @ 100V	4.7μF @ 50V	47μF @ 50V
470μF @ 25V	3300μF @ 25V	2.2μF @ 50V	10μF @ 50V	100μF @ 25V
Part No.	Description	Wt. (lbs.)	1	10
81867CL	240 pcs. Radial Capacitor kit	5.3	\$29.95	\$26.95
130331CL	Refill for 81867CL (240 pcs.)	0.5	17.95	16.49

SAVE \$11

Axial Electrolytic Capacitor Kit

Includes 140 pcs. (10 values) ±20% Axial Electrolytic Capacitors

10 each	10 each	10 each	20 each	20 each
47μF @ 50V	220μF @ 50V	1000μF @ 25V	1μF @ 50V	10μF @ 50V
100μF @ 50V	470μF @ 50V	2200μF @ 16V	4.7μF @ 50V	2.2μF @ 50V
Part No.	Description	Wt. (lbs.)	1	10
81875CL	140 pcs. Axial Capacitor kit	5.3	\$37.95	\$34.15
130340CL	Refill for 81875CL (140 pcs.)	0.6	24.95	22.49

SAVE \$13

Mylar Capacitor Kit

Includes 280 pcs. (10 values) 100V ±10% Mylar Capacitors

10 each	10 each	10 each	10 each	100 each
.001μF	.022μF	.047μF	.47μF	.01μF
.0047μF	.033μF	.22μF	1μF	.1μF
Part No.	Description	Wt. (lbs.)	1	10
81883CL	280 pcs. Mylar Capacitor kit	5.1	\$37.95	\$34.15
130358CL	Refill for 81883CL (280 pcs.)	0.3	19.95	17.95

SAVE \$11

Dipped Tantalum Capacitor Kit

Includes 150 pcs. (15 values) ±20% Dipped Tantalum Capacitors

10 each	10 each	10 each	10 each	10 each
.1μF @ 35V	1μF @ 25V	3.3μF @ 35V	10μF @ 16V	22μF @ 16V
.22μF @ 35V	1μF @ 35V	4.7μF @ 35V	10μF @ 35V	33μF @ 25V
.47μF @ 35V	2.2μF @ 16V	6.8μF @ 35V	15μF @ 25V	47μF @ 25V
Part No.	Description	Wt. (lbs.)	1	10
81841CL	150 pcs. Tantalum Capacitor kit	4.8	\$79.95	\$71.95
130260CL	Refill for 81841CL (150 pcs.)	0.3	59.95	53.95

SAVE \$40

Transistor Assortment Kit

See pages 20-21 for photos and specs.

Includes 560 pcs. (20 types) NPN, PNP (High/Medium/Low Power) Transistors

10 each	10 each	10 each	10 each	100 each
2N2222A	2N4401	MJE3055T	TIP31A	2N3904
2N2907A	2N4403	MPF102	TIP32A	2N3906
2N3053	2N5951	MPSA06	TIP102	PN2222
2N3055	2N7000	MPSA13	TIP120	PN2907
Part No.	Description	Wt. (lbs.)	1	10
82595CL	560 pcs. Transistor kit	5.1	\$82.95	\$74.65
130374CL	Refill for 82595CL (560 pcs.)	0.4	69.95	62.95

SAVE \$12

Diode Assortment Kit

See pages 23-22 for photos and specs.

Includes 420 pcs. (15 types) Zener, Switching and Silicon Rectifiers

10 each	10 each	10 each	10 each	100 each
1N270	1N4001	1N4735	1N5408	1N914
1N751	1N4007	1N4742	C106B1	1N4004
1N3600	1N4733	1N5404	KBPO4M	1N4148
Part No.	Description	Wt. (lbs.)	1	10
82587CL	420 pcs. Diode kit	5.0	\$39.95	\$35.95
130366CL	Refill for 82587CL (420 pcs.)	0.3	25.95	21.95

SAVE \$4

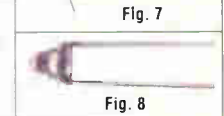
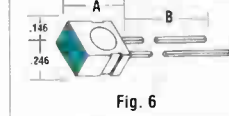
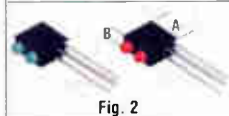
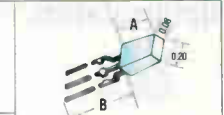
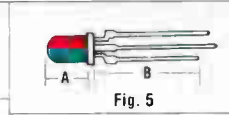
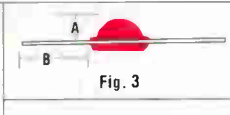
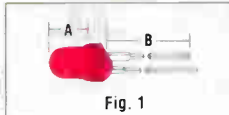
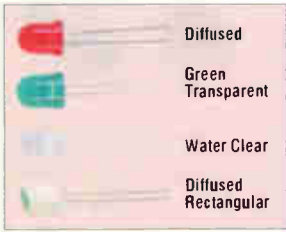

Standard-Output LEDs

Quantity **SAVE**

Call for OEM PRICING - we carry major manufacturers.

Prepackaged: order in increments of 100 or 1000
 * Prepackaged: order in increments of 10, 100 or 1000

Part No.	Mfr. Cross Ref. No.	Fig.	Emitting Color	Lens/Feature Description	LED Size	Diameter inch/mm	Dimensions		Lead Spacing	Typical VI @ II (mA)	Typical mcd @ mA	Wavelength n.m	Pricing			
							A"	B"					1	10	100	1000
206480CL	LVY2041	1	Yellow	Yellow transparent	T1	.119/3	0.17	0.69	0.08	2.3 @ 20	450 @ 20	595	\$.14	\$.12	\$.10	
136493CL	LT0333-41	1	Yellow	Water clear (BY209)	T1	.119/3	0.20	0.95	0.10	2.3 @ 20	38 @ 20	589	.19	.11	.09	
202489CL	MVL-301Y	1	Yellow	Yellow diffused	T1	.119/3	0.14	1.12	0.10	2.1 @ 20	9.0 @ 10	585	.19	.15	.11	
34657CL	LY2040	1	Yellow	Yellow diffused (XC209Y)	T1	.119/3	0.16	0.68	0.08	2.3 @ 20	15 @ 10	585	.13	.11	.075	
206498CL	LHR2041	1	Red	Red transparent	T1	.119/3	0.17	0.69	0.08	2.0 @ 20	350 @ 20	660	.15	.12	.09	
114673CL	LH2043	1	Red	Water clear (BR209)	T1	.119/3	0.14	0.98	0.07	2.3 @ 20	12 @ 10	697	.19	.15	.12	
94529CL	LH2040	1	Red	Red diffused (XC209RB)	T1	.119/3	0.18	1.04	0.07	2.3 @ 20	4.5 @ 10	697	.19	.15	.12	
175679CL	LVG2041	1	Green	Green transparent	T1	.119/3	0.17	0.69	0.08	2.2 @ 20	129 @ 20	565	.15	.11	.08	
114681CL	LVG2043	1	Green	Water clear (BG209)	T1	.119/3	0.14	0.98	0.07	2.2 @ 20	129 @ 20	565	.09	.07	.055	
34606CL	LSG2040	1	Green	Green diffused (XC209G)	T1	.119/3	0.13	1.05	0.08	2.2 @ 20	15 @ 10	560	.15	.11	.08	
211086CL	LTL-4231N-022	1	Green	Green diffused	T1	.119/3	0.13	1.10	0.10	2.1 @ 20	12.6 @ 10	565	#	#	#	
202471CL	MVL-301HR	1	Orange Red	Red diffused	T1	.119/3	0.14	1.12	0.10	2.0 @ 20	9.0 @ 10	640	.19	.15	.11	
94553CL	LHG2062	1	Red/Green	White diffused bi-color/bi-state ¹	T1	.119/3	0.18	1.06	0.08	2.3 @ 20	3 & 15 @ 10	697/565	.27	.25	.21	
137411CL	LVB2040	1	Blue	Blue diffused	T1	.119/3	0.21	0.98	0.10	4.8 @ 20	10 @ 20	430	2.49	2.25	1.95	
123941CL	521-9478	1	Green/Yellow	White diffused bi-color/bi-state ¹	T1	.119/3	0.18	0.86	0.08	2.1 @ 10	6.3 & 4.3 @ 10	565/585	.29	.19	.15	
210825CL	BVU-5MIQ1N1	1	Orange Red	Red diffused	T1 3/4	.197/5	0.30	1.07	0.08	2.1 @ 20	600 @ 20	615	.49	.45	.39	
135597CL	LTL307E	1	Orange Red	Red diffused	T1 3/4	.197/5	0.34	1.00	0.07	2.0 @ 20	19 @ 10	635	.16	.10	.09	
107393CL	LE3330	1	Orange Red	Orange diffused (XC556A)	T1 3/4	.197/5	0.30	1.02	0.08	2.3 @ 20	12 @ 10	635	.11	.07	.06	
206501CL	LVY3331	1	Yellow	Yellow transparent	T1 3/4	.197/5	0.24	1.07	0.07	2.2 @ 20	700 @ 20	595	.19	.15	.12	
175695CL	LVY3333	1	Yellow	Water clear	T1 3/4	.197/5	0.30	1.07	0.08	2.1 @ 20	60 @ 10	585	.19	.15	.12	
34825CL	LY3330	1	Yellow	Yellow diffused (XC556Y)	T1 3/4	.197/5	0.30	0.82	0.07	2.3 @ 20	12 @ 10	585	.19	.15	.12	
206519CL	LHR3331	1	Red	Red transparent	T1 3/4	.197/5	0.24	1.07	0.07	2.0 @ 20	660 @ 20	550	.19	.15	.12	
138860CL	LFH3363	1	Red	Water clear/flashing [†]	T1 3/4	.197/5	0.35	1.06	0.10	3-12V	9	697	.49	.45	.39	
34745CL	LH3333	1	Red	Water clear (XC554R)	T1 3/4	.197/5	0.30	1.00	0.08	2.3 @ 20	7.5 @ 10	697	.15	.11	.065	
94511CL	LH3330	1	Red	Red diffused (XC556RB)	T1 3/4	.197/5	0.31	0.81	0.08	2.3 @ 20	3 @ 10	697	.17	.13	.10	
34690CL	LFH3360	1	Red	Red diffused/flashing (XC5410) [†]	T1 3/4	.197/5	0.30	0.94	0.07	3-12V	2.8	697	.49	.45	.39	
134332CL	LT1883-81UR	1	Blue	Water clear	T1 3/4	.197/5	0.30	0.93	0.10	3.8 @ 20	350 @ 20	428	2.65	2.45	2.25	
137613CL	LSB13333	1	Blue	Water clear	T1 3/4	.197/5	0.34	0.98	0.08	3.8 @ 20	160 @ 20	430	2.27	2.05	1.65	
138691CL	LVB3330	1	Blue	Blue diffused	T1 3/4	.197/5	0.34	0.98	0.08	4.8 @ 20	10 @ 20	430	2.14	2.04	1.95	
153154CL	LVG3333	1	Green	Water clear	T1 3/4	.197/5	0.36	0.90	0.10	2.3 @ 20	500 @ 20	565	.14	.10	.08	
11359CL	LG3333	1	Green	Water clear (BG5704)	T1 3/4	.197/5	0.30	1.04	0.07	2.3 @ 20	100 @ 20	565	.22	.20	.16	
175687CL	LT0524-81	1	Green	Green transparent	T1 3/4	.197/5	0.24	1.07	0.07	2.1 @ 20	44 @ 20	567	.16	.12	.09	
94561CL	LVG3360	1	Green	Green diff./flashing (XC5408) [†]	T1 3/4	.197/5	0.30	1.05	0.08	3-12V	17	565	.59	.53	.48	
34761CL	LG3330	1	Green	Green diffused (XC556G)	T1 3/4	.197/5	0.31	0.79	0.09	2.3 @ 20	12 @ 10	565	.15	.14	.10	
34711CL	LEG3362	1	Red/Green	White diffused bi-color/bi-state ¹	T1 3/4	.197/5	0.30	1.01	0.09	2.3 @ 20	7.5 & 8 @ 20	635/565	.33	.28	.22	
119634CL	LHR3930	1	Red	Red diffused Jumbo	T2 1/2	.315/8	0.44	0.84	0.07	2.0 @ 20	100 @ 20	660	.23	.20	.15	
137621CL	LVG3930	1	Green	Green diffused Jumbo	T2 1/2	.315/8	0.43	1.04	0.07	2.3 @ 20	40 @ 20	565	.25	.22	.18	
138683CL	LHR3630	1	Red	Red diffused XJumbo (XC10R)	T3 1/4	.394/10	0.40	1.04	0.10	2.0 @ 20	100 @ 20	660	.29	.26	.22	
98984CL	LVG3630	1	Green	Green diffused XJumbo (XC10G)	T3 1/4	.394/10	0.40	1.07	0.08	2.3 @ 20	40 @ 20	565	.27	.26	.19	
98992CL	LY3630	1	Yellow	Yellow diff. XJumbo (XC10Y)	T3 1/4	.394/10	0.54	1.04	0.08	2.3 @ 20	15 @ 20	585	.29	.25	.19	
235416CL	LA45B/2G	2	Green	Green diffused (dual)	T1	.119/3	0.40	0.18	0.10	1.7 @ 20	15 @ 10	565	1.29	1.15	.89	
136274CL	LA44B/2G	2	Green	Green diffused (dual)	T1	.119/3	0.38	0.17	0.10	2.3 @ 20	15 @ 10	565	.49	.45	.39	
235424CL	LA45B/2I	2	Red	Red diffused (dual)	T1	.119/3	0.40	0.18	0.10	1.7 @ 20	12 @ 10	630	1.29	1.15	.89	
136282CL	LA44B/2I	2	Red	Red diffused (dual)	T1	.119/3	0.38	0.17	0.10	2.3 @ 20	12 @ 10	630	.49	.45	.39	
26745CL	MCDL-170EC	3	Red	Water clear	T 3/4	.083/2.1	0.06	0.25	0.11	2.1 @ 20	7 @ 10	635	.25	.22	.18	
134869CL	RRL5621	3	Orange Red	Red diffused (5V) [†]	T 3/4	.083/2.1	0.09	0.37	0.10	3.0-5.5V	1.2	650	.19	.15	.12	
104248CL	LA93B/H-1	4	Red	Red diffused (XC410R)	T1 3/4	.197/5	0.35	0.89	0.08	2.3 @ 20	6.5 @ 10	697	.23	.19	.17	
104256CL	LA93B/G-1	4	Green	Green diffused (XC410G)	T1 3/4	.197/5	0.35	0.89	0.08	2.3 @ 20	30 @ 10	565	.23	.19	.17	
104264CL	LA93B/Y-1	4	Yellow	Yellow diffused (XC410Y)	T1 3/4	.197/5	0.35	0.89	0.08	2.3 @ 20	25 @ 10	585	.35	.29	.25	
34673CL	LHG3392	5	Red/Green	White diff. bi-color/tri-state	T1 3/4	.197/5	0.30	1.02	0.03	2.3 @ 20	3 & 12 @ 10	697/565	.24	.22	.20	
34850CL	LT7341R-81*	6	Orange Red	Red diffused rectangular	3.5 x 6	—	0.27	0.85	0.07	2.0 @ 20	5.2 @ 20	635	.26	.22	.16	
94545CL	LEG25030*	6	Green	Green diff. rect. (XC57124G)	3.5 x 6	—	0.26	1.06	0.08	2.3 @ 20	5.2 @ 20	565	.19	.16	.15	
104889CL	LEG5292*	7	Red/Green	White diff. bi-color rectangular	2 x 5	—	0.27	1.02	0.08	2.3 @ 20	6.6 @ 10	695/565	.17	.14	.14	
176532CL	MV50G	8	Green	Water clear	T 3/4	.069/1.7	0.06	0.40	0.08	2.1 @ 20	300 @ 20	568	.10	.08	.055	

¹ Reverse polarity to change color

[†] Voltage shown is operating voltage range; no current limiting resistor required

* For Mounting Hardware see pg 42

High-Output LEDs

• Typical DC forward current 20mA

See page 42 for LED Mounting Hardware



Part No.	Mr. Cross Reference No.	Fig.	Emitting Color	Lens/Feature Description	LED Size	Diameter inch/mm	Dimensions		Lead Spacing	Typical Vf @ If (mA)	Typical mcd @ mA	Wavelength nm	Pricing			
							A"	B"					1	10	100	1000
217525CL	MCDPW-3004C	1	White	Water clear	T1	.119/3	0.18	1.00	0.10	3.8 @ 20	3000 @ 20	—	\$2.99	\$2.85	\$2.69	\$2.55
142893CL	BVU-5E1WK4-B	1	White	Water clear	T1 3/4	.197/5	0.34	0.79	0.08	3.5 @ 20	3700 @ 20	—	3.95	3.59	2.95	2.75
183231CL	BVU-5C14WK4-B	1	White	Water clear	T1 3/4	.197/5	0.30	1.06	0.08	3.5 @ 20	3000 @ 20	—	2.95	2.65	2.39	2.15
183222CL	MCDL-513SBC4	1	Blue	Water clear	T1 3/4	.197/5	0.29	1.02	0.08	3.6 @ 20	3000 @ 20	470	3.25	2.95	2.65	2.39
183214CL	MCDPE-503PC1	1	Green	Water clear	T1 3/4	.197/5	0.30	1.04	0.08	3.5 @ 20	2200 @ 20	515	2.95	2.65	2.39	2.15
131895CL	TLSH180P	1	Orange	Water clear	T1 3/4	.197/5	0.39	0.80	0.10	2.1 @ 20	10000 @ 20	623	2.49	2.19	1.95	1.79
153138CL	LT2KJ3-UR-S14	1	Orange	Water clear	T1 3/4	.197/5	0.36	0.90	0.10	2.1 @ 20	2500 @ 20	621	.49	.44	.39	.35
197683CL	BVT-5E1QT4ER	1	Orange Red	Water clear	T1 3/4	.197/5	0.29	1.08	0.08	2.3 @ 20	4650 @ 20	634	.69	.59	.49	.39
197616CL	BVU-5E1QH4E	1	Red	Water clear	T1 3/4	.197/5	0.30	1.05	0.08	1.8 @ 20	2180 @ 20	630	.39	.35	.29	.25
152864CL	BVU-501RD4	2	Red Super Bright	Water clear	T1 3/4	.197/5	0.34	0.89	0.10	1.9 @ 20	1000 @ 20	660	.29	.24	.19	.15
215597CL	LT2K33-81-UC9T	1	Yellow	Water clear	T1 3/4	.197/5	0.31	0.89	0.10	2.2 @ 20	5000 @ 20	592	.59	.55	.49	.45
197675CL	BVT-5E1TT4E	1	Yellow	Water clear	T1 3/4	.197/5	0.30	1.08	0.08	2.3 @ 20	2800 @ 20	592	.45	.36	.29	.27
197641CL	BVT-529T3E	2	Yellow	Yellow transparent	Oval	.170/.220	0.29	1.04	0.08	2.3 @ 20	7800 @ 20	592	.69	.62	.55	.49
197659CL	BVT-529QT3F	2	Orange Red	Red transparent	Oval	.170/.220	0.30	1.05	0.08	2.3 @ 20	3600 @ 20	634	.49	.44	.39	.35

Optus

LEDTECH LEDs

• Typical DC forward current 20mA

Ledtech is a QS9000 and ISO-9000 Certified Company

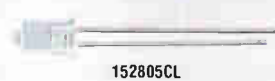
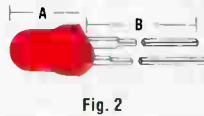
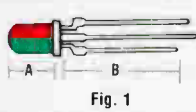

151415CL

Prepackaged: order in increments of 10, 100 or 1000

Part Number	Product Number	Fig.	Emitting Color	Lens/Feature Description	LED Size	Diameter (in./mm)	Dimensions		Lead Spacing	Typical Vf @ If (mA)	Typical mcd @ mA	Wavelength nm	Pricing			
							A"	B"					1	10	100	1000
261622CL	LT1873-81-UR-P22	2	Red	Water clear	T1 3/4	.197/5	0.34	0.89	0.10	1.9 @ 20	1200 @ 20	660	\$2.21	\$2.20	\$1.19	\$1.15
152805CL	LT1873-81-UR	2	Red Ultra Bright	Water clear	T1 3/4	.197/5	0.34	0.89	0.10	1.9 @ 20	2000 @ 20	660	.29	.25	.19	.15
156953CL	LT0373-41	2	Red Super Bright	Water clear	T1	.119/3	0.21	1.07	0.08	1.7 @ 20	600 @ 20	660	.24	.22	.17	.14
156945CL	LT0362-25-D61	1	Red/Green	White diff. bi-color tri-state	T1	.119/3	0.16	0.87	0.08	2.1 @ 20	2.7/13.3 @ 20	700/567	.29	.25	.19	.15
152750CL	LT0344R-41	2	Orange Red	Red clear	T1	.119/3	0.20	0.89	0.10	2.1 @ 20	52.9 @ 10	635	.19	.16	.12	.12
152784CL	LT0341R-41	2	Orange Red	Red diffused	T1	.119/3	0.20	0.89	0.10	2.1 @ 20	15.5 @ 10	635	.17	.15	.12	.12
152856CL	LT1841R-81	2	Orange Red	Red diffused	T1 3/4	.197/5	0.34	0.89	0.10	2.1 @ 20	23 @ 20	635	.17	.15	.13	.13
152768CL	LT0324-41	2	Green	Green clear	T1	.119/3	0.20	0.89	0.10	2.1 @ 20	45 @ 20	567	.12	.09	.07	.07
156929CL	LT0321-41-HE	2	Green	Green diffused	T1	.118/3	0.16	0.88	0.10	2.1 @ 20	32 @ 20	567	.18	.11	.10	.10
242843CL	LT1811-81	2	Red	Red diffused	T1 3/4	.197/5	0.30	0.88	0.10	2.1 @ 20	4.1 @ 20	700	.12	.10	.06	.06
156961CL	LT1823-81-HE	2	Green	Water clear	T1 3/4	.197/5	0.34	0.87	0.10	2.1 @ 20	500 @ 20	567	.17	.15	.12	.12
152821CL	LT1821-81-HE	2	Green	Green diffused	T1 3/4	.197/5	0.34	0.89	0.10	2.1 @ 20	96 @ 20	567	.16	.12	.09	.09
152792CL	LT1833-81-M1	2	Ylw Super Bright	Water clear	T1 3/4	.197/5	0.34	0.89	0.10	2.1 @ 20	1040 @ 20	593	.26	.24	.19	.14
152830CL	LT1831-81-UR	2	Ylw Ultra Bright	Yellow diffused	T1 3/4	.197/5	0.34	0.89	0.10	2.0 @ 20	424 @ 20	593	.26	.24	.20	.14
156937CL	LT0331-41	2	Yellow	Yellow diffused	T1	.118/3	0.16	0.88	0.10	1.7 @ 20	1.8 @ 20	655	.14	.10	.07	.07

White Diffused Backlight

151415CL	LT1F24-A2-S1	-	Green	Backlight, white diffused	2.05" L x 0.78" H x 0.09" T	8-pin	4.2 @ 20	140 @ 20	567	\$2.95	\$2.65	\$2.39	\$1.95
----------	--------------	---	-------	---------------------------	-----------------------------	-------	----------	----------	-----	--------	--------	--------	--------

Infrared and Visible Light Emitters and Detectors

• Use for remote control and/or for fiber optics

• P/N 133946CL:

Can be used with cameras, see page 175 (peak emission wavelength: 940nm @ 20mA)

SALE

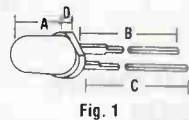

Fig. 1

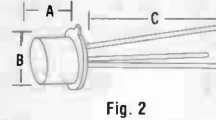

Fig. 2

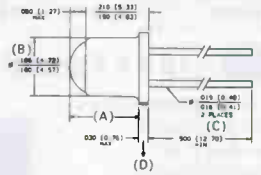
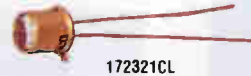

Fig. 3



106526CL



172321CL

Part No.	Mr. Cross Ref. No.	Fig.	Description	Size	Diameter inch/mm	Dimensions (inches)				Vf @ If	nm	mWatts	Pricing			
						A	B	C	D				1	10	100	1000
112150CL	L1R2043	1	Infrared emitter diode (GaAs)	T1	0.125/3	0.18	0.95	0.98	0.03	1.2V @ 20mA	940	5	\$2.22	\$1.18	\$1.14	\$1.12
133946CL	SLI-0308CP	1	Infrared emitter diode (GaAs)	T1	0.12/3	0.22	0.98	1.00	0.03	1.3V @ 50mA	940	4	.62	.53	.40	.31
112176CL	LPT2023	1	Infrared phototransistor	T1	0.12/3	0.18	0.95	0.98	0.03	—	940	—	.39	.29	.19	.15
106526CL	LVR3333	1	Infrared emitter diode (GaAs)	T1 3/4	0.200/5	0.34	0.78	0.84	0.04	1.2V @ 20mA	940	8	.39	.29	.19	.15
112168CL	LPT3313	1	Infrared photo:ransistor	T1 3/4	0.200/5	0.31	1.05	1.10	0.04	—	940	—	.36	.30	.24	.20
120221CL	BPW77NA	2	Visible light phototransistor	TO-18	—	.24	0.19	0.52	—	—	850	—	1.95	1.75	1.49	1.39
172321CL	OP133	3	Infrared emitter diode (GaAs)	TO-46	—	0.22	0.18	1.05	0.20	1.4V @ 100mA	935	5	2.15	1.95	1.45	1.42

Color Code Legend

New Sale Qty Save Closeout

Order 24/7 Toll Free 1-800-831-4242

World Radio History

HLMP Series LEDs



New



* Prepackaged: order in increments of 10, 100 or 1000

Part No.	Mfr. Cross Ref. No.	Emitting Color	Lens/Feature Description	LED Size	Diameter inch/mm	Dimensions		Lead Spacing	Typical Vf @ If (mA)	Typical mcd @ mA	Wavelength nm	Pricing			
						A"	B"					1	10	100	1000
253278CL	HLMP-1301	Red	Diffused	T1	.119/3	0.19	1.00	0.10	1.9 @ 10	5.4 @ 10	635	137	112	098	
253366CL	HLMP-1321	Red	Tinted	T1	.119/3	0.19	1.00	0.10	1.9 @ 10	30 @ 10	635	167	13	10	
253551CL	HLMP-1340	Red	Clear	T1	.119/3	0.19	1.00	0.10	1.9 @ 20	55 @ 10	635	122	105	076	
253690CL	HLMP-1700	Red	Diffused	T1	.119/3	0.19	1.00	0.10	1.7 @ 2	2.1 @ 2	635	132	105	086	
253702CL	HLMP-K101	Red	Diffused	T1	.119/3	0.19	1.00	0.10	1.8 @ 20	45 @ 20	645	203	133	106	
253711CL	HLMP-K105	Red	Clear	T1	.119/3	0.19	1.00	0.10	2.2 @ 20	65 @ 20	645	169	152	113	
253729CL	HLMP-K150	Red	Diffused	T1	.119/3	0.19	1.00	0.10	1.8 @ 1	2.0 @ 1	645	216	171	097	
253631CL	HLMP-1503	Green	Diffused	T1	.119/3	0.19	1.00	0.10	2.1 @ 10	1.0 @ 10	565	103	076	061	
253649CL	HLMP-1521	Green	Tinted	T1	.119/3	0.19	1.00	0.10	2.7 @ 10	6.7 @ 10	565	216	171	095	
253657CL	HLMP-1523	Green	Diffused	T1	.119/3	0.19	1.00	0.10	2.1 @ 10	7.0 @ 10	565	316	244	171	
253665CL	HLMP-1540	Green	Clear	T1	.119/3	0.19	1.00	0.10	45 @ 20	2.2 @ 20	565	132	105	086	
253681CL	HLMP-1790	Green	Diffused	T1	.119/3	0.19	1.00	0.10	2.2 @ 2	2.3 @ 2	565	132	105	099	
253673CL	HLMP-1719	Yellow	Diffused	T1	.119/3	0.19	1.00	0.10	2.5 @ 2	2.1 @ 2	583	132	105	086	
253614CL	HLMP-1401	Yellow	Diffused	T1	.119/3	0.19	1.00	0.10	2.0 @ 10	2.2 @ 10	583	137	112	098	
253622CL	HLMP-1440	Yellow	Clear	T1	.119/3	0.19	1.00	0.10	2.1 @ 20	45 @ 20	583	122	105	076	
253745CL	HLMP-3300	Red	Diffused	T1 1/2	.197/5	0.36	1.00	0.10	2.2 @ 10	3.5 @ 10	635	335	263	188	
253753CL	HLMP-3301	Red	Diffused	T1 1/2	.197/5	0.36	1.00	0.10	2.4 @ 10	5.4 @ 10	635	16	143	095	
253788CL	HLMP-3750	Red	Clear	T1 1/2	.197/5	0.36	0.90	0.10	1.9 @ 20	125 @ 20	635	141	105	07	
253817CL	HLMP-4700	Red	Diffused	T1 1/2	.197/5	0.36	1.00	0.10	1.7 @ 2	2.3 @ 2	626	31	244	171	
253841CL	HLMP-D101	Red	Diffused	T1 1/2	.197/5	0.36	1.00	0.10	2.2 @ 20	7.0 @ 20	645	207	171	119	
253850CL	HLMP-D150	Red	Diffused	T1 1/2	.197/5	0.36	1.00	0.10	1.8 @ 1	3.0 @ 1	645	31	244	171	
11797CL	QLMP-D141	Red	Water Clear	T1 1/2	.197/5	0.29	1.05	0.07	2.0 @ 20	350 @ 20	660	19	13	10	
253868CL	HLMP-D401	Orange Red	Diffused	T1 1/2	.197/5	0.36	1.00	0.10	2.4 @ 10	5.4 @ 10	600	14	127	126	
203553CL	HLMP-4100	Orange Red	Water Clear	T1 1/2	.197/5	0.33	1.07	0.08	2.1 @ 20	600 @ 20	615	29	25	20	
253770CL	HLMP-3507	Green	Diffused	T1 1/2	.197/5	0.36	1.00	0.10	2.1 @ 10	4.2 @ 10	565	169	143	095	
253809CL	HLMP-3950	Green	Clear	T1 1/2	.197/5	0.36	0.90	0.10	1.5 @ 20	265 @ 20	565	244	171	095	
253833CL	HLMP-4740	Green	Diffused	T1 1/2	.197/5	0.36	1.00	0.10	2.2 @ 2	2.3 @ 2	565	244	171	124	
253761CL	HLMP-3401	Yellow	Diffused	T1 1/2	.197/5	0.36	1.00	0.10	2.0 @ 10	5.7 @ 10	583	29	244	171	
253796CL	HLMP-3850	Yellow	Clear	T1 1/2	.197/5	0.36	0.90	0.10	2.1 @ 20	140 @ 20	583	244	171	098	
253825CL	HLMP-4719	Yellow	Diffused	T1 1/2	.197/5	0.36	1.00	0.10	2.5 @ 2	2.1 @ 2	585	226	171	096	

Optos

Parallel LCD Displays

Point Six 16 x 4 Parallel LCD Display

- 16 x 4 character display (.78"H)
- Character font: 5 x 8 dots
- Input data: 4-bit or 8-bit interface available
- Display size: 2.4"L x 1.0"W x 0.06"T
- Module size: 3.4"L x 2.4"W x 0.25"T



Requires: 4.5V @ 2mA wall transformer (recommend P/N 164101CL, pg 144)

Part No.	Description	1	10	25
151933CL	16 x 4 parallel LCD ..	\$24.95	\$22.49	\$19.95

20 x 1 Parallel LCD Display



- Built-in controller: HD44780
- Character font size: 0.45"W x 0.26"H
- Maximum input voltage: 5.5VDC
- 14-pin terminal
- Operating input voltage: 5VDC
- Display size: 6.5"L x 1.3"W
- Module size: 7.2"L x 1.6"W x 0.4"T
- Weight: 0.3 lbs.

SALE

Part No.	Description	1	10	25
206615CL	LCD Module ..	\$21.05	\$19.00	\$17.35

Parallel LCD Displays

- 8-bit interface data bus
- Controller: KS0066U or equivalent
- Character font size: 0.125"W x 0.200"H
- Maximum input voltage: 5.3VDC
- Operating input voltage: 5VDC (recommend P/N 164101CL, pg 144)



- 171715CL: 16 Characters x 2 Lines
 - Display size: 2.5"L x 0.7"W
 - Module size: 3.4"L x 1.2"W x 0.5"T
- 171723CL: 20 Characters x 2 Lines
 - Display size: 3.3"L x 0.7"W
 - Module size: 4.6"L x 1.5"W x 0.4"T

Part No.	Prod. No.	Description	1	10	25
171715CL	AC162A	14-pin/term	\$19.95	\$17.95	\$15.95
171723CL	AC2 02A	16-pin/term ..	24.95	22.49	20.25

16 x 4 Parallel LCD Display

- 16 characters x 4 lines
- 5 x 8 dot matrix
- 4-bit or 8-bit parallel interface
- Clear/reflective type LCD display
- Control LSI HD44780 or equivalent and column driver MSM5259 or equivalent
- Display size: 2.4"L x 1.0"H
- Module size: 3.4"L x 2.4"W x 0.3"T



Part No.	Description	1	10	25
210761CL	16 x 4 LCD display ..	\$22.95	\$19.95	\$18.69

40 x 2 Parallel LCD Display with Backlight



- 40 x 2 lines character display
- Control chip HCD44780
- Character font: 5 x 8 dots
- Column driver: KS0063B
- Backlight: yellow-green
- Supply voltage (logic): 5VDC @ 5mA
- Display size: 5.81"L x 0.45"W
- Module size: 7.2"L x 1.4"W x 0.4" Thick

Part No.	Description	1	10	25
215159CL	40 x 2 parallel LCD ..	\$29.99	\$26.99	\$24.29

Jameco's Low-Price Guarantee

We'll match the print advertised price of any like product.

It's that simple!

Scott Edwards Electronics, Inc.

Serial LCD Displays

- Includes instruction codes for character generation, cursor control, printing, etc. Examples for Stamps in PBASIC included.
- One-year warranty

Ideal for use w/ BASIC Stamps (pg 221), 80C52-BASIC controllers (pg 8) and PCs!

16 characters x 2 lines Integrated Display

- 1200-9600bps serial input with 16-byte input buffer
- Four inputs for switches/buttons that can be read via the serial connection
- EEPROM storage of settings, six custom characters, and a text screen that can be automatically displayed at startup (splash screen)
- Serial control of the standard LED backlight
- Low current draw; 5mA (backlight off) to 40mA (backlight on and bright)
- Power requirement: 4.8 - 5.5VDC @ 5mA (recommend P/N 164101CL, pg 144)
- Module size: 3.2"L x 2.0"W x 0.5"T



Part No.	Description	1	10	25
150990CL	LCD module	\$48.95	\$44.09	\$39.65

20 Characters x 4 Lines Graphics LCD

- 120 x 32 pixel graphics screen
- 2400 or 9600 bps serial input
- EEPROM stores text font and 6 full-screen images
- Supports multiple fonts and font sizes
- Included utility program lets you create and download pictures and fonts
- Power requirement: 9V battery or 5V power supply (recommend P/N 164101CL, pg 144)
- Module size: 3.1"L x 1.9"W x 0.8"T



Includes: Battery snap connectors, sample programs and manual on disk

Part No.	Description	1	10
158166CL	20 x 4 serial LCD display ...	\$119.95	\$107.99

40 characters x 4 lines LCD Serial Backpack®

- High-contrast supertwist display with unique "big character"; backlit mode - prints 1" numbers and letters automatically
- Serial input at 1200, 2400, 4800 or 9600bps
- Power requirement: 5VDC @ <10mA (recommend P/N 164101CL, pg 144)
- Module size: 7.5"L x 2.2"W x 0.9"T



Part No.	Description	1	10
136485CL	40 x 4 serial LCD display ...	\$169.95	\$152.95

16 characters x 2 lines LCD Serial Backpack®

- High-contrast supertwist display
- Serial "backpack" accepts RS232, or inverted CMOS, TTL at 2400 or 9600bps
- Power requirement: 4.8 - 5.5VDC @ 3mA (recommend P/N 164101CL, pg 144)
- Connector: 5-pin header (recommend P/N 163686CL, pg 78) • Module size: 3.1"L x 1.4"W x 0.7"T



Part No.	Description	1	10	25
133129CL	LCD module	\$59.95	\$53.99	\$48.99

Serial Graphics LCD Display

40 characters x 8 lines Maximum

- 40 characters x 8 lines max. display with 5 x 7 font
- Backlight control, bar graphs, large digits, multiple displays, software contrast control, auto line wrapping, and auto scroll feature
- Pixel layout: 240 x 64 pixels
- Serial input: 1200-19,200bps (jumper configurable)
- Backlight supply current: 160mA typical
- Power requirement: 5VDC @ 31mA typical (recommend P/N 164101CL, pg 144)
- Display size: 5.2"L x 1.5"W • Weight: 0.9 lbs.
- Module size: 7.1"L x 2.6"W x 0.7"T



Includes: Manual and software

Part No.	Description	1	10
174182CL	Graphic display	\$165.99	\$161.69

VL 0.5" High 4-Digit Field Effect LCD Display

- Compatible with socket P/N 78641CL (2), pg 77
- Pin spacing: 0.1" centers
- 40-pin package (no connector required)
- Size: 2.0"L x 1.2"H x 0.1"D
- Digital multimeters, thermometers, pressure gauges, timers, clocks (12 or 24 hour format) and frequency counters

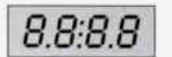

Part No.	Description	1	10	25
17110CL	4-digit LCD w/ pins	\$14.95	\$13.49	\$12.15

0.6" High 3 1/2-Digit & 4 1/2-Digit LCD Digital Panel Meters



- Input Ranges: 200mV, 20V, 200V, 500V
- Supply voltage: 8-12VDC (recommend 9V battery P/N 151095CL, pg 154)
- Automatic polarity indication
- Input impedance: >100MΩ
- Accuracy: ±0.5% • Size: 2.7"L x 1.7"W
- 146835CL: Backlit display



Includes: Bezel

Part No.	Prod. No.	Digits	1	10	25
108388CL	PM-428	3 1/2	\$12.95	\$11.95	\$10.95
175951CL	PM-128	3 1/2	12.95	11.95	10.95
146835CL	PM-188BL	3 1/2	19.95	17.99	16.19
123140CL	PM-328	4 1/2	27.95	24.95	22.49

See pages 143-148 for our complete selection of Wall Adapters



16 Characters x 2 Lines Serial LCD Display

- Backlight control, bar graphs, large digits, multiple displays, software contrast control, auto line wrapping, and auto scroll feature
- Serial input at 1200-19,200bps (jumper selectable)
- Connect 16 modules using same two wire interface
- Backlight supply current: 40mA typical
- Power requirement: 5VDC @ 9mA (recommend P/N 164101CL, pg 144)
- Display size: 2.5"L x 0.7"W • Weight: 0.6 lbs.
- Module size: 3.2"L x 1.5"W x 0.8"T



Includes: Manual and software

Part No.	Description	1	10	25
174166CL	16 x 2 w/ interface ..	\$52.39	\$51.19	\$49.95

20 x 4 Serial LCD Display

- 20 characters x 4 line display with large digit mode
- Backlight control, bar graphs, large digits, multiple displays, software contrast control, auto line wrapping and auto scroll feature
- Backlight supply current: 90mA typical
- Serial input at 1200-19,200bps (jumper selectable)
- Connect 16 modules using the same 2 wire interface
- Display size: 3.0"L x 1.0"W • One-year warranty



Includes: Manual and software

Part No.	Description	1	10	25
150957CL	20 x 4 Serial LCD Module	\$54.19	\$52.69	\$51.19
157323CL	20x4 Serial LCD Module with keypad interface	72.95	71.15	68.99

Serial LCD Interface Module

For Parallel LCD Displays with Hitachi 44780 Chipset

- Supports 1 x 8 thru 4 x 20 LCD display formats
- Provides word wrap, control character processing for display blanking, cursor blanking, up-down-left-right cursor controls
- Compatible with P/Ns 151933CL and 171715CL, pg 38 • Size: 1.5"L x 1.0"W



SALE

Part No.	Description	1	10	25
157981CL	LCD serial module ..	\$19.70	\$17.91	\$16.20

We'll Send It Today!

Just place your order by 6PM EST for same business day shipment.

LED Displays

The general advantages of LED displays compared to incandescent types include:

- Lower power consumption
- Longer lifetime (averaged more than 300,000 hours)
- Compact size suitable for instrumentation and graphic representations

Soldering:

- Soldering bath: not more than 5 seconds @ 260°C
- Soldering iron: not more than 3 seconds @ 300°C under 30W



Quantity
SAVE



7-Segment Displays

Part No.	Mfr. Cross Reference No.	Character Height	Illuminated Color	Buss Polarity*	Pins/Leads	Typical Vi @ If (mA)	Typical mcd @ mA	Wavelength nm	Decimal Point #	Pricing			
										1	10	100	1000
24731CL	LSD3021-11	.300"	Red	CA	11	1.9 @ 20	0.3 @ 20	697	RHDP	\$.87	\$.70	\$.50	\$.47
24740CL	LSD3221-11	.300"	Red	CA	11	2.1 @ 20	2.5 @ 20	697	LHDP	\$.89 .79	.72	.64	.58
151976CL	LTS312AY	.300"	Yellow	CA	11	2.8 @ 20	2.0 @ 10	585	LHDP	.34	.31	.28	.26
24782CL	LSD3211-11	.300"	Red	CC	10	2.1 @ 20	2.5 @ 20	697	RHDP	.89	.75	.65	.49
17187CL	LSD5051-11	.500"	Red	CC	10	2.1 @ 20	0.9 @ 20	697	RHDP	.89	.80	.72	.65
17208CL	LSD5061-11	.500"	Red	CA	10	2.1 @ 20	0.9 @ 20	697	RHDP	.89	.75	.65	.49
104213CL	LSD5124-10	.560"	Orange Red	CA	10	2.0 @ 20	2.4 @ 20	635	RHDP	.89	.80	.71	.55
199531CL	LSD5111-11	.560"	Red	CC	10	2.1 @ 20	0.8 @ 20	697	RHDP	.89	.80	.71	.55
24715CL	LDD5121-20	.560"	Red	2-digit CA	18	2.1 @ 20	0.8 @ 20	697	RHDP	1.25	1.05	.89	.75
24723CL	LDD5111-11	.560"	Red	2-digit CC	18	2.1 @ 20	0.8 @ 20	697	RHDP	1.25	1.05	.89	.75
200379CL	LB602VAGI	.560"	Red	2-digit CA	18	2.0 @ 10	16 @ 10	650	RHDP	1.25	.99	.90	.68
24694CL	LDD5124	.560"	Orange Red	2-digit CA	18	2.0 @ 20	2.4 @ 20	635	RHDP	1.39	1.14	1.06	.99
24707CL	LDD5114-20	.560"	Orange Red	2-digit CC	18	2.0 @ 20	2.4 @ 20	635	RHDP	1.35	1.15	.99	.89
200539CL	ELD556YWA	.560"	Yellow	2-digit CA	18	2.0 @ 20	1.9 @ 10	590	RHDP	1.25	1.05	.99	.89
225963CL	KW3-562A2B	.560"	Green	3-digit CA	28	2.2 @ 20	15 @ 20	568	RHDP	2.39	2.15	1.95	1.25
199582CL	LC56311	.560"	Yellow	CC	8	2.1 @ 20	5.2 @ 20	589	RHDP	1.49	.99	.89	.79
196787CL	LB602VA	.560"	Orange Red	2-digit CA	18	2.0 @ 20	16.0 @ 20	650	RHDP	\$1.45 .99	.89	.69	.55
18737CL	LSD816-11	.800"	Orange Red	CA	13	1.6 @ 20	0.9 @ 20	655	RHDP	1.45	1.20	.99	.74
18753CL	LSD8151-10	.800"	Red	CC	13	2.1 @ 20	1.0 @ 20	697	RHDP	1.49	1.35	1.19	.99
206017CL	SC08-11HWA	.800"	Red	CC	13	2.0 @ 20	.36 @ 10	700	RHDP	\$.95 .85	.74	.66	.44
176559CL	C8021-1	.800"	Green	CC	13	2.0 @ 20	0.9 @ 20	568	RHDP	.49	.39	.35	.29
97172CL	LSD10061-10	1.0"	Red	CA	10	2.1 @ 20	2.0 @ 20	697	RHDP	1.39	1.25	1.12	.99
97199CL	LSD23265-10	2.24"	Red	CA	10	1.7 @ 20	21 @ 20	660	RHDP	5.75	5.19	4.69	4.19
97201CL	LSD23255-10	2.24"	Red	CC	10	1.7 @ 20	21 @ 20	660	RHDP	4.49	3.95	3.25	2.95
202518CL	LSD30165-20	3.0"	Orange Red	CA	10	8 @ 20	4.5 @ 10	635	RHDP	7.39	6.99	6.65	6.29
202542CL	LSD30155-20	3.0"	Orange Red	CC	10	8 @ 20	4.5 @ 10	635	RHDP	5.49	4.95	4.45	4.05
105591CL	LSD40054-20†	4.0"	Orange Red	CC	10	2.0 @ 20	18 @ 20	635	RHDP	9.49	8.29	7.49	6.49
202500CL	LSD40064-20	4.0"	Orange Red	CA	10	2.0 @ 20	18 @ 10	635	RHDP	10.49	9.49	8.59	7.79
202526CL	LSD50065-20	5.0"	Red	CA	10	17 @ 20	45 @ 10	660	RHDP	34.99	27.89	25.29	22.79
202534CL	LSD50055-20	5.0"	Red	CC	10	17 @ 20	45 @ 10	660	RHDP	17.95	14.35	12.95	11.65

† 5 diodes per segment

Dot Matrix Displays

Part No.	Mfr. Cross Reference No.	Jameco Socket Number	Character Height	Illuminated Color	Buss Polarity*	Pins/Leads	Typical Vi @ If (mA)	Typical mcd @ mA	Wavelength nm	Decimal Point #	Pricing			
											1	10	100	1000
173833CL	HP5082-7300	—	.290"	Red	4x7 Numeric	8	5.0 @ 170	.03 @ 20	660	RHDP	\$2.95 \$4.95	\$4.46	\$3.56	\$2.67
32951CL	TIL311	37161CL	.300"	Red	4x7 Hex character	11	5.0 @ 5	0.1 @ 5	660	—	16.95	14.35	12.92	11.62
118906CL	LTP747R	37161CL	.680"	Orange Red	5 x 7 AC/CR	12	1.7 @ 20	0.2 @ 20	655	—	1.95	1.79	1.45	1.05
218843CL	CSM57041T-11	—	.700"	Red	5 x 7 CC/AR	12	1.8 @ 20	8 @ 20	660	—	1.95	1.55	1.17	.82
206560CL	LTP2157AG	—	2.0"	Green	5 x 7 CC/AR	14	3.7 @ 80	4.8 @ 80	565	—	4.49	3.55	3.27	3.09
183265CL	LMD5821ASR-20	—	2.3"	Red	5 x 8 CC/AR	14	1.7 @ 20	12 @ 20	660	—	4.95	4.45	3.55	2.69

* CA-Common Anode/CC-Common Cathode/AC-Anode Column/CR-Cathode Row/AR-Anode Row

† LHDP-Left Hand Decimal Point / RHDP-Right Hand Decimal Point



Cluster-Type T1 1/4 LED Lamps

- Cluster-type red/green T1 1/4 LEDs
- 660nm for red/570nm for green
- Lens: water clear • Common anode • 3 lead wires

Quantity
SAVE

150914CL

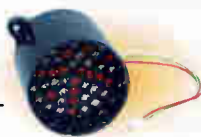

150914CL: 50 Cluster (30 green/20 red)

150922CL: 14 Cluster (8 green/6 red)

Part No.	Product No.	Vi @ If	mcd @ mA	Lead Wire	Mounting Hole Dia.	Dimensions (Dia. " x L")	Pricing		
							1	10	100
150914CL	LCR5250A-79	20.5V @ 40mA	12,000 @ 40	16"	M4	2.07 x 1.98	\$21.95	\$16.96	\$12.72
150922CL	LGR2614B-79	10V @ 20mA	1950 @ 20	7"	M3	1.02 x 1.51	4.95	4.49	3.95

See page 35 for our complete selection of Optoisolators.

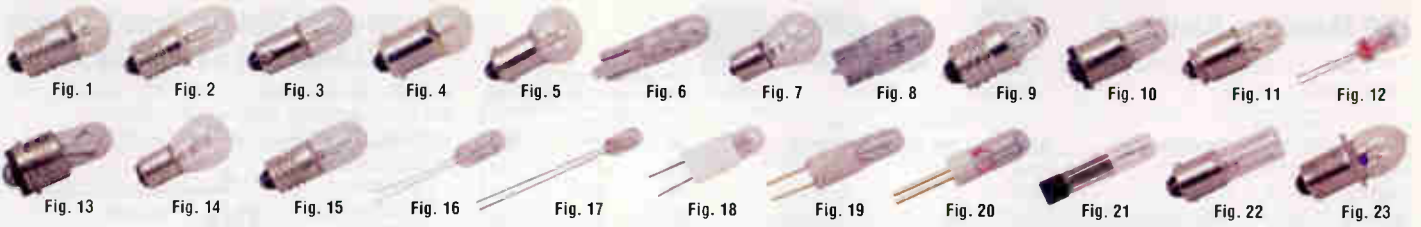

Incandescent Lamps

Part No.	Mfr. Cross Ref. No.	Fig.	Description	Volts (VDC)	Current (A)	MSCP	Pricing		
							1	10	100
209381CL	13	1	G3 1/2 miniature screw	3.7	.30	.98	\$.79	\$.69	\$.59
209390CL	14	1	G3 1/2 miniature screw	2.47	.30	.50	.55	.50	.45
209402CL	40	2	T3 1/4 miniature screw	6.3	.15	.50	.29	.19	.15
209411CL	44	3	T3 1/4 miniature bayonet	6.3	.25	.90	.22	.17	.13
209429CL	46	2	T3 1/4 miniature screw	6.3	.25	.90	.37	.32	.27
209437CL	47	3	T3 1/4 miniature bayonet	6.3	.15	.50	.22	.17	.13
209445CL	50	1	G3 1/2 miniature bayonet	7.5	.22	1.0	.64	.57	.51
210403CL	51	4	G3 1/2 miniature bayonet	7.5	.22	1.0	.39	.29	.25
209453CL	53	4	G3 1/2 miniature bayonet	14.4	.12	1.0	.49	.39	.29
210411CL	55	5	G4 1/2 miniature bayonet	7.0	.41	2.0	\$.23	.20	.14
209461CL	73	6	T1 3/4 wedge	14.0	.08	.30	.29	.21	.17
209470CL	85	6	T1 3/4 wedge	28.0	.04	.30	.29	.21	.17
209488CL	86	6	T1 3/4 wedge	6.3	.20	.40	.29	.21	.17
209496CL	93	7	S-8 sngl contact bayonet	12.8	1.04	15.0	\$.75	.59	.49
209509CL	161	8	T3 1/4 wedge	4.0	.19	1.0	.25	.19	.15
209517CL	168	8	T3 1/4 wedge	14.0	.35	3.0	.29	.20	.16
209525CL	194	8	T3 1/4 wedge	14.0	.27	2.0	.29	.22	.17
209533CL	222	9	GTL-3 miniature screw	2.25	.25	—	.29	.25	.23
209541CL	259	8	T3 1/4 wedge	6.3	.25	.65	.29	.22	.17
209550CL	313	3	T3 1/4 miniature bayonet	28.0	.17	3.5	.29	.24	.18
209568CL	327	10	T1 3/4 midget flange	28.0	.04	.34	.35	.30	.25
209576CL	328	10	T1 3/4 midget flange	6.0	.20	.60	.55	.47	.35
209584CL	330	10	T1 3/4 midget flange	14.0	.08	.50	.39	.34	.29
209592CL	334	11	T1 3/4 midget groove	28.0	.04	.34	.49	.40	.33
209605CL	335	15	T1 3/4 midget screw	28.0	.04	.34	.59	.48	.36
209613CL	344	10	T1 3/4 midget flange	10.0	.014	.002	.99	.89	.79
209621CL	345	10	T1 3/4 midget flange	6.0	.04	.03	.79	.64	.46
209630CL	370	10	T1 3/4 midget flange	18.0	.04	.15	.99	.89	.79
209648CL	376	10	T1 3/4 midget flange	28.0	.06	.34	.69	.59	.49
209656CL	379	11	T1 3/4 midget groove	6.3	.20	.40	.99	.89	.74
209664CL	381	10	T1 3/4 midget flange	6.3	.20	.40	.59	.44	.34
209672CL	382	10	T1 3/4 midget flange	14.0	.08	.30	.49	.40	.34
209681CL	385	10	T1 3/4 midget flange	28.0	.04	.15	.49	.41	.34
209699CL	386	11	T1 3/4 midget groove	14.0	.08	.30	.39	.33	.27
209701CL	387	10	T1 3/4 midget flange	28.0	.04	.30	.39	.27	.26
209710CL	388	11	T1 3/4 midget groove	28.0	.04	.30	.39	.31	.28
209728CL	394	10	T1 3/4 midget flange	12.0	.04	.12	.49	.44	.38
209736CL	656	8	T3 1/4 wedge	28.0	.06	.62	.29	.19	.15
209752CL	657	8	T3 1/4 wedge	28.0	.08	.62	.29	.21	.16
202100CL	683	12	T1 wire terminal	5.0	.06	.05	.59	.39	.29
209761CL	685	13	T1 sub midget flange	5.0	.06	.05	1.29	1.19	.99
209779CL	715	12	T1 wire terminal	5.0	.115	.15	.99	.89	.79
209787CL	755	3	T3 1/4 miniature bayonet	6.3	.15	.33	.59	.47	.35
209795CL	756	3	T3 1/4 miniature bayonet	14.0	.08	.31	.69	.59	.49
209808CL	757	3	T3 1/4 miniature bayonet	28.0	.08	.62	.39	.35	.29
210438CL	1156	7	S-8 sngl contact bayonet	12.8	2.1	32	.49	.39	.35
210446CL	1157	14	S-8 double contact index	12.8/14	21/.59	32/3	.39	.35	.29
209816CL	1450	4	G3 1/2 miniature bayonet	24.0	.035	.23	.99	.89	.79
209824CL	1813	3	T3 1/4 miniature bayonet	14.4	.10	.86	.29	.24	.22
209832CL	1815	3	T3 1/4 miniature bayonet	14.0	.20	1.4	.49	.39	.29
209841CL	1816	3	T3 1/4 miniature bayonet	13.0	.33	3.0	.29	.24	.19
209859CL	1818	3	T3 1/4 miniature bayonet	24.0	.17	3.3	.99	.89	.79
209867CL	1819	3	T3 1/4 miniature bayonet	28.0	.04	.34	.29	.25	.19
209875CL	1820	3	T3 1/4 miniature bayonet	28.0	.10	1.6	.49	.34	.24
209883CL	1821	15	T3 1/4 screw	28.0	.17	3.4	.99	.89	.79
209891CL	1822	3	T3 1/4 miniature bayonet	36.0	.10	2.1	.49	.33	.29
209904CL	1829	3	T3 1/4 miniature bayonet	28.0	.07	1.0	.29	.24	.19

Incandescent Lamps (Continued)

Part No.	Mfr. Cross Ref. No.	Fig.	Description	Volts (VDC)	Current (A)	MSCP	Pricing		
							1	10	100
209912CL	1835	3	T3 1/4 miniature bayonet	55.0	.05	1.1	\$.49	\$.39	\$.34
209921CL	1847	3	T3 1/4 miniature bayonet	6.3	.15	.38	.59	.49	.44
209939CL	1850	3	T3 1/4 miniature bayonet	5.0	.09	.25	\$.38	\$.24	\$.20
209947CL	1864	3	T3 1/4 miniature bayonet	28.0	.17	3.0	\$.54	\$.47	\$.38
209955CL	1866	3	T3 1/4 miniature bayonet	6.3	.25	.65	.39	.29	.25
209963CL	1891	3	T3 1/4 miniature bayonet	14.0	.24	2.0	.49	.34	.29
209971CL	1893	3	T3 1/4 miniature bayonet	14.0	.33	2.0	.59	.45	.39
141073CL	2182	16	T1 3/4 wire terminal	14.0	.08	.30	.59	.53	.48
141065CL	2200	16	T1 3/4 wire terminal	5.0	.06	.05	.59	.53	.48
141057CL	6833	17	T 3/4 wire terminal	5.0	.06	.05	1.29	1.16	.93
209998CL	7219	12	T1 wire terminal	12.0	.06	.15	.29	.26	.23
210008CL	7328	18	T1 3/4 bi-pin	6.0	.20	.60	.99	.89	.69
210016CL	7335	10	T1 3/4 midget flange	5.0	.115	.15	.79	.69	.59
210024CL	7341	10	T1 3/4 midget flange	28.0	.065	.65	.89	.73	.69
141006CL	7361	18	T1 3/4 bi-pin	5.0	.06	.05	1.29	1.15	.99
210032CL	7382	18	T1 3/4 bi-pin	14.0	.08	.30	.49	.39	.35
210041CL	7387	18	T1 3/4 bi-pin	28.0	.04	.30	.59	.49	.39
210059CL	7632	19	T1 1/4 bi-pin	28.0	.04	.32	1.49	1.29	.99
210067CL	7683	20	T1 bi-pin	5.0	.06	.05	1.39	1.19	1.09
210075CL	7715	20	T1 bi-pin	5.0	.115	.15	1.39	1.29	1.19
210083CL	7839	20	T1 bi-pin	28.0	.024	.15	1.39	1.29	1.09
210227CL	6PSB	21	T2 tel. slide base type 5	6.0	.14	550	.79	.69	.59
210112CL	12ESB	21	T2 tel. slide base type 5	12.0	.04	650	.79	.64	.55
210121CL	12PSB	21	T2 tel. slide base type 5	12.0	.17	2000	.89	.75	.59
210139CL	24ESB	21	T2 tel. slide base type 5	24.0	.04	850	.79	.64	.55
210147CL	24MB	22	T2 miniature bayonet	24.0	.073	3000	1.19	.99	.89
210155CL	24PSB	21	T2 tel. slide base type 5	24.0	.073	3000	.69	.59	.49
210163CL	28ESB	21	T2 tel. slide base type 5	28.0	.04	1500	.79	.64	.55
210171CL	28MB	22	T2 miniature bayonet	28.0	.04	1600	.99	.89	.79
210180CL	28PSB	21	T2 tel. slide base type 5	28.0	.04	1600	.79	.59	.49
210198CL	48PSB	21	T2 tel. slide base type 5	48.0	.053	1800	.99	.79	.59
210201CL	60MB	22	T2 miniature bayonet	60.0	.05	2200	.99	.89	.79
210219CL	60PSB	21	T2 tel. slide base type 5	60.0	.05	2200	.69	.59	.49
210091CL	120MB	22	T2 miniature bayonet	120	.025	1200	.99	.69	.65
210104CL	120PSB	21	T2 tel. slide base type 5	120	.025	1200	.89	.74	.68
210340CL	PR2	23	B3 1/2 sngl cont. mini flange	2.38	.50	.80	\$.59	.24	.20
210358CL	PR3	23	B3 1/2 sngl cont. mini flange	3.57	.50	1.5	\$.59	.24	.20
210366CL	PR4	23	B3 1/2 sngl cont. mini flange	2.33	.27	.40	\$.55	.24	.20
210374CL	PR6	23	B3 1/2 sngl cont. mini flange	2.47	.30	.45	\$.59	.24	.20

Neon Lamps

New Lower Prices



Part No.	Mfr. Cross Ref. No.	Fig.	Description	Voltage (VAC)	Current (mA)	Pricing		
						1	10	100
27351CL	A1A (NE-2)	1	Wire terminal	65-120	0.5	\$.49	\$.35	\$.31
210243CL	A1B	1	Wire terminal	65-120	0.3	.33	.25	.24
210251CL	A1C	1	Wire terminal	65-120	1.2	.39	.29	.25
210260CL	A9A (NE-2E)	1	Wire terminal	65-120	0.7	.29	.25	.19
210278CL	B1A (NE-51)	2	T3 1/4 miniature bayonet	65-120	0.3	.79	.69	.59
210286CL	B2A (NE-51H)	2	T3 1/4 miniature bayonet	65-120	1.2	.69	.49	.39
210294CL	B7A (NE-45)	3	T4 1/2 candelabra screw	65-120	2.0	\$.49	\$.33	\$.30
210307CL	B9A (NE-48)	4	T4 1/2 D.C. bayonet	65-120	2.0	3.99	3.49	2.99
210315CL	C2A (NE-2H)	1	Wire terminal	65-120	1.9	.39	.35	.26

LED Mounting Hardware

- P/N 95521CL: for use with P/N 94545CL and 34850CL, pg 36



Prepackaged: order in increments of 10, 100 or 1000

Part No.	Mfr. Cross Ref. No.	Description	Color	Mounting Hole Dia.	Panel Thickness	Pricing		
						10	100	1000
95513CL	LMH100	T1 snap-in	Black	.185"	Up to .070"	\$.08	\$.07	\$.04
23077CL	LMH200	T1 3/4 ring & clip	Black	.257"	Up to .125"	.15	.135	.12
95521CL	LMH250	Rect. snap-in	Black	.306" x .202"	Up to .092"	.20	.17	.13



T1 3/4 Ciplite® LED Lens Mount

- Requires no assembly tools, just snap in
- Material: lens - polycarbonate; spacer - nylon
- Increases viewing angle to 180°
- Devices mount on .375" centers
- Helps guard against electrostatic discharge up to 16kV while affording the LED physical protection

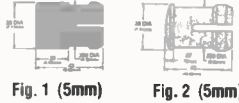

Part No.	Product No.	Description	Color	Fig.	Mounting Hole Dia.	Panel Thickness	Pricing			
							1	10	100	1000
14277CL	CLF280CTP	T1 3/4	Clear	1	.25"	.063" - .125"	\$.25	\$.19	\$.16	\$.14
29612CL	CLF280RTP	T1 3/4	Red	1	.25"	.063" - .125"	.25	.19	.16	.14
124927CL	CLB300CTP	T1 3/4	Clear	2	.25"	.031" - .25"	.25	.19	.16	.14



T1 & T1 3/4 Ciplite® Lens and Conxrite® Cable Assembly

- Ciplite® Lens:**
- Material: (lens) polycarbonate; (ring) polypropylene (UL Listed)
 - Mounts through front panel in 0.171" hole diameter, panel thickness: 1/32" to 3/32"
- Conxrite® Cable Assembly:**
- Terminals: phosphor bronze, tin-plated
 - Connector socket and ring/header connector: thermoplastic (UL Listed)
 - Wire: 22AWG, 7 strand copper, insulated



Part No.	Product No.	Size	Description	1	10	100	1000
143183CL	SMC170CTP	T1	Clear Ciplite® lens	\$.22	\$.20	\$.15	\$.13
143132CL	CMC321CTP	T1 3/4	Clear Ciplite® lens	.25	.22	.19	.16
143087CL	BE2108	T1	8.5" cable assembly	1.25	1.13	.93	.86
143036CL	CE2108	T1 3/4	8.5" cable assembly	1.29	1.25	1.19	1.15
143052CL	CE2118	T1 3/4	18" cable assembly	1.55	1.39	1.20	1.09

LED Panel-Mount Indicators

- Easy panel installation
- Panel/status/instrument indicators
- Vf @ If: 2V @ 20mA
- Chrome housing
- Color: red
- 236427CL: Color: green
- 236427CL/236419CL: Color: green
- Vf @ If: 12V @ 15mA
- Black nylon housing

Quantity SAVE



Part No.	Mfr. Cross Ref. No.	LED Size	Dimensions (In.)			Mounting Hole	Pricing			
			L	A	B		1	10	100	1000
236427CL	5102H5-12V	T1 3/4	.53	6.0	6.0	.25"	\$ 1.49	\$ 1.34	\$ 1.07	\$.80
236419CL	5102H1-12V	T1 3/4	.53	6.0	6.0	.25"	1.19	1.07	.86	.64
141111CL	L922SRD	T1	.56	.34	.25	.23"	.79	.60	.52	.45
141129CL	L913RD	T1	.56	.39	.32	.24"	1.09	.81	.69	.61
141137CL	L917RD	T1 3/4	.70	.55	.47	.31"	.89	.79	.71	.55

Incandescent and Neon Panel Mount Indicators

Incandescent Panel Mount Lamps

- 215781CL/215790CL/215773CL: wire length - 3.9" (100mm)
- 215749CL/215757CL/215765CL: wire length - 4.9" (125mm)
- 215714CL/215722CL/215731CL: solder terminals - 0.196" (5mm)



215790CL
Fig. 1



215757CL
Fig. 2



215714CL
Fig. 3

Part No.	Product No.	Fig.	Voltage	Color	Mounting Hole	Pricing		
						1	10	100
215773CL	R9-46B-W100-12V-R	1	12	Red	1/2" (13mm)	\$ 1.79	\$ 1.59	\$ 1.35
215781CL	R9-46B-W100-12V-Y	1	12	Yellow	1/2" (13mm)	1.79	1.59	1.35
215790CL	R9-46B-W100-12V-G	1	12	Green	1/2" (13mm)	1.79	1.59	1.35
215749CL	R9-55B-W130-12V-R	2	12	Red	9/32" (7mm)	1.79	1.59	1.35
215757CL	R9-55B-W130-12V-Y	2	12	Yellow	9/32" (7mm)	1.79	1.59	1.35
215765CL	R9-55B-W130-12V-G	2	12	Green	9/32" (7mm)	1.79	1.59	1.35
215714CL	R9-71B-05-12V-R	3	12	Red	5/8" (16mm)	1.79	1.59	1.35
215722CL	R9-71B-05-12V-Y	3	12	Yellow	5/8" (16mm)	1.79	1.59	1.35
215731CL	R9-71B-05-12V-G	3	12	Green	5/8" (16mm)	1.79	1.59	1.35

Neon Panel Mount Lamps

- Output voltage: 120V
- Mounting hole diameter: 5/8" (16mm)
- Solder terminals: 0.196" (5mm)

215802CL: Red

215811CL: Yellow

215829CL: Green



215802CL

Part No.	Product No.	1	10	100
215802CL	R9-71N-05-120V-R...	\$ 1.79	\$ 1.59	\$ 1.35
215811CL	R9-71N-05-120V-Y...	1.79	1.59	1.35
215829CL	R9-71N-05-120V-G...	1.79	1.59	1.35

Don't worry about backorders.
Over 99% of our products are in stock!

We'll Send It Today!

Just place your order by 6PM EST
for same business day shipment.



193009CL Tape and Reel 193009CL

Aluminum Electrolytic Capacitors

Operating temperature range	-40°C to +85°C
Leakage Current (20°C) after 2 minutes	≤ .01CV or 3µA

Quantity
SAVE



Side View

Bottom View

Prepackaged: order in increments of 10, 100 or 500

Prepackaged: order in increments of 10, 100 or 500

Part No.	Mfr. Cross Ref. No.†	Value (µF)	Voltage	Dia. (mm)	Pricing			
					1	10	100	500
193228CL	SE1/50	1	50	4.0	\$.15	\$.13	\$.115	
193236CL	SE2.2/50	2.2	50	4.0	.15	.13	.11	
193244CL	SE3.3/50	3.3	50	4.0	.15	.13	.10	
193076CL	SE427/25	4.7	25	4.0	.16	.15	.125	
193252CL	SE4.7/50	4.7	50	5.0	.17	.14	.105	
192997CL	SE10/16	10	16	4.0	.16	.12	.115	
193084CL	SE10/25	10	25	5.0	.16	.14	.115	
193164CL	SE10/35	10	35	5.0	.18	.17	.14	
193261CL	SE10/50	10	50	6.3	.23	.18	.16	
192891CL	SE22/6.3	22	6.3	4.0	.18	.12	.10	
193009CL	SE22/16	22	16	5.0	.14	.12	.10	
193092CL	SE22/25	22	25	6.3	.18	.16	.13	
193172CL	SE22/35	22	35	6.3	.17	.11	.10	
193279CL	SE22/50	22	50	6.3	.26	.19	.15	
193017CL	SE33/16	33	16	5.0	.17	.14	.115	
193105CL	SE33/25	33	25	6.3	.22	.19	.14	
193181CL	SE33/35	33	35	8.0	.24	.22	.195	
193287CL	SE33/50	33	50	8.0	.27	.24	.20	
193025CL	SE47/16	47	16	6.3	.17	.14	.115	
193113CL	SE47/25	47	25	6.3	.39	.24	.21	
193199CL	SE47/35	47	35	6.3	.19	.13	.105	

Part No.	Mfr. Cross Ref. No.†	Value (µF)	Voltage	Dia. (mm)	Pricing			
					1	10	100	500
193295CL	SE47/50	47	50	10.0	\$.28	\$.26	\$.23	
192903CL	SE100/6.3	100	6.3	6.3	.24	.17	.115	
192954CL	SE100/10	100	10	6.3	.19	.16	.12	
193033CL	SE100/16	100	16	8.0	.26	.23	.21	
193121CL	SE100/25	100	25	8.0	.33	.24	.185	
193201CL	SE100/35	100	35	10.0	.39	.35	.29	
193308CL	SE100/50	100	50	10.0	.40	.34	.33	
192911CL	SE220/6.3	220	6.3	6.3	.27	.19	.14	
192962CL	SE220/10	220	10	8.0	.29	.27	.23	
193041CL	SE220/16	220	16	8.0	.36	.31	.26	
193130CL	SE220/25	220	25	10.0	.52	.46	.46	
193210CL	SE220/35	220	35	8.0	.55	.50	.40	
193316CL	SE220/50	220	50	10.0	.59	.49	.37	
193050CL	SE330/16	330	16	10.0	.49	.36	.31	
193148CL	SE330/25	330	25	8.0	.43	.40	.35	
192920CL	SE470/6.3	470	6.3	8.0	.69	.39	.37	
192971CL	SE470/10	470	10	10.0	.39	.33	.25	
193068CL	SE470/16	470	16	10.0	.55	.45	.39	
193156CL	SE470/25	470	25	10.0	.55	.49	.43	
192938CL	SE1000/6.3	1000	6.3	10.0	.56	.45	.42	
192989CL	SE1000/10	1000	10	10.0	.49	.43	.35	
192946CL	SE1500/6.3	1500	6.3	10.0	.69	.55	.49	

† Cross Reference: Panasonic: VS Series

Multilayer Ceramic Chip Capacitors

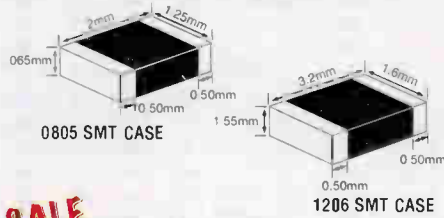

SALE X7R SERIES (±10%)

Part No.	Capacitance	Volt.	100 pc. Incremnt	Pricing per each		
				500	1000	3000
87311CL	.01µF	50	\$12	\$.07	\$.04	\$.03
87370CL	1µF	25	\$14	.09	.06	.053

Part No.	Capacitance	Volt.	100 pc. Incremnt	Pricing per each		
				500	1000	3000
87329CL	.01µF	50	\$15	\$.07	\$.04	\$.022
87388CL	1µF	50	\$19	.13	.05	.045
87396CL	22µF	25	.25	.22	.19	.15

Z5U SERIES (±20%)

Quantity **SAVE**

Part No.	Capacitance	Voltage	100 pc. Incremnt	Pricing per each		
				500	1000	5000
87177CL	1µF	50	\$.037	\$.029	\$.025	\$.019

Part No.	Capacitance	Voltage	100 pc. Incremnt	Pricing per each		
				500	1000	5000
87185CL	1µF	50	\$.08	\$.069	\$.049	\$.039
87206CL	.22µF	50	.09	.059	.049	.039
87222CL	.47µF	50	.25	.22	.19	.17

Resin Molded Chip Tantalum Electrolytic Capacitors (±20%)



Case Size (Dimensions in mm)

EIA CASE CODE	L ±0.2	W ±0.2	H ±0.2	P ±0.3	a ±0.2	h(min)
A (3216)	3.2	1.6	1.7	0.8	1.2	0.7
B (3528)	3.5	2.8	1.9	0.8	2.0	0.7
C (6032)	6.0	3.2	2.5	1.3	2.0	1.0
D (7343)	7.3	4.3	2.9	1.3	2.4	1.0

Part No.	Capacitance	Case Size	10 pc. Incremnt	Pricing per each		
				100	500	1000
87020CL	10µF	B	\$.50	\$.44	\$.37	\$.32
87118CL	100µF	D	\$.84	\$.64	\$.57	\$.52

Part No.	Capacitance	Case Size	10 pc. Incremnt	Pricing per each		
				100	500	1000
86932CL	1µF	A	\$.39	\$.19	\$.15	\$.11
87038CL	10µF	C	.60	.50	.39	.35
87100CL	47µF	D	.95	.85	.79	.69

See page 103 for Plastic Flip-top Case for SMDs.

See page 76 for PLCC Surface Mount Sockets.

0805 Resistor Assortment (±5%)

144 Values, 50 pcs. each; 7,200 Pieces Total

Resistance Value Chart:

1.2	10	75	430	2.0k	10k	51k	270k	2.2M
1.6	16	85	470	2.2k	11k	56k	300k	2.4M
2.2	18	91	510	2.4k	12k	62k	360k	2.7M
2.4	20	110	560	2.7k	13k	68k	390k	3.0M
2.7	22	120	620	3.0k	15k	75k	430k	3.3M
3.0	24	130	680	3.3k	16k	82k	470k	3.6M
3.3	27	150	750	3.6k	18k	91k	510k	3.9M
4.3	30	160	820	3.9k	20k	100k	560k	4.3M
4.7	33	180	910	4.3k	22k	110k	620k	4.7M
5.1	39	200	1.0k	4.7k	24k	120k	750k	5.1M
5.6	43	220	1.1k	5.6k	27k	150k	820k	5.6M
6.2	47	240	1.2k	6.2k	30k	160k	910k	6.8M
6.8	51	270	1.3k	6.8k	33k	180k	1.0M	7.5M
7.5	56	300	1.5k	7.5k	36k	200k	1.6M	8.2M
8.2	62	360	1.6k	8.2k	39k	220k	1.8M	9.1M
9.1	68	390	1.8k	9.1k	43k	240k	2.0M	10M

- Size (mm): 2.0L x 1.25W x 0.5Thick
- Max. overload voltage: 200V
- 1/8 watts
- Operating temperature: -50°C to 120°C
- Case size (two cases): 10.5"L x 6.7"W x 1.7"H
- Weight: 1.9 lbs.

Includes: Case with labels

Part No.	Mfr. Cross Ref. No.	1	10	25
172806CL	16-500	\$79.95	\$71.95	\$64.79

1206 Resistor Assortment (±1%)

56 Values, 200 pcs. each; 11,200 pcs. Total

Value Chart (Dhms)

10	200	3.92k	75k
12.1	243	4.99k	90.9k
15	301	6.19k	100k
20	392	7.5k	121k
24.3	499	9.09k	150k
30.1	619	10k	200k
39.2	750	12.1k	243k
49.9	909	15k	301k
61.9	1k	20k	392k
75	1.21k	24.3k	499k
90.9	1.5k	30.1k	619k
100	2k	39.2k	750k
121	2.43k	49.9k	909k
150	3.01k	61.9k	1M

Packaged in strips of 200 pcs. each

- Max. working voltage: 200V
- Power: 1/8W
- Operating temperature: -55°C to +125°C
- Temp. coefficient: ±100 ppm/°C
- Resistor dimensions (mm): 3.10L x 1.5 W x 0.55H

Part No.	Mfr. Cross Ref. No.	1	10	25
156881CL	SMR1206SB	\$99.99	\$89.99	\$79.99



SALE



Aluminum Radial-Lead Electrolytic Capacitors

General purpose low voltage 85°C (A); HT Type 105°C (B) ±20%

Quantity **SAVE**

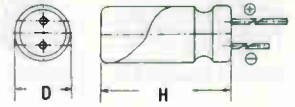

Operating temperature range	-40°C to +85°C (A); -40°C to +105°C (B)	
Leakage Current (20°C)	After 1 min.	0.03CV or 4µA, whichever is greater
	After 2 min.	0.01CV or 3µA, whichever is greater

† CRDSS REFERENCES: Elna: RC2/RE2; IC: RAR/RSS; Marcon: SEM/SSM; Nichicon: LB/VX/USA/SR/SA; Rubycon: MS7/TWSS; Sprague: 501D/513D; UCC: SME/SRE/SRA/SRG; Panasonic: KA/KS/SU

Prepackaged: order in increments of 10, 100 or 500

Prepackaged: order in increments of 10, 100 or 500

Part No.	Mfr. Cross Ref. No. †	Op. Temp	Value (µF)	Voltage	Size (mm) D x H	Pricing			
						1	10	100	500
158481CL	R0.47B100	B	0.47	100V	5 x 11	0.05	0.04	0.03	
94160CL	5R1/50	A	1	50V	4 x 5	.12	.08	.05	
29831CL	R1/50	A	1	50V	5 x 11	.057	.048	.038	
158490CL	R1B100	B	1	100V	5 x 11	.06	.05	.04	
93729CL	R2.2/50	A	2.2	50V	5 x 11	.038	.033	.026	
199021CL	R2.2J/100	A	2.2	100V	5 x 11	.035	.03	.025	
135183CL	R3.3/50	A	3.3	50V	5 x 11	.05	.04	.025	
31000CL	R4.7/50	A	4.7	50V	5 x 11	.038	.033	.026	
198838CL	R10J/16	A	10	16V	5 x 11	.045	.03	.025	
94211CL	5R10/25	A	10	25V	4 x 5	.13	.08	.05	
94220CL	5R10/35	A	10	35V	5 x 5	.09	.07	.065	
94369CL	7R10/35	A	10	35V	5 x 7	.11	.06	.04	
29891CL	R10/50	A	10	50V	5 x 11	.06	.05	.04	
199048CL	R10J/100	A	10	100V	6 x 11	.08	.07	.055	
158529CL	R10B100	B	10	100V	6 x 11	.08	.07	.055	
158326CL	R22B35	B	22	35V	5 x 11	.07	.05	.03	
198846CL	R22J/16	A	22	16V	5 x 11	.04	.035	.026	
189918CL	R22J/25	A	22	25V	5 x 11	.045	.032	.024	
207870CL	R22B/25	B	22	25V	5 x 11	.045	.036	.027	
198942CL	R22J/35	A	22	35V	5 x 11	.035	.03	.025	
93737CL	R22/50	A	22	50V	5 x 11	.06	.05	.035	
199056CL	R22J/100	A	22	100V	6 x 11	.15	.09	.06	
198854CL	R33J/16	A	33	16V	5 x 11	.04	.034	.023	
198926CL	R33J/25	A	33	25V	5 x 11	.045	.035	.025	
93745CL	R33/50	A	33	50V	5 x 11	.055	.05	.045	
199064CL	R33J/100	A	33	100V	8 x 11	.108	.09	.081	
135301CL	R47/10	A	47	10V	5 x 12	.04	.03	.025	
198862CL	R47J/16	A	47	16V	5 x 11	.04	.032	.023	
93753CL	R47/25	A	47	25V	5 x 11	.048	.033	.026	
198951CL	R47J/35	A	47	35V	5 x 11	.05	.04	.03	
199072CL	R47J/100	A	47	100V	10 x 12	.15	.09	.06	
158246CL	R47B25	B	47	25V	5 x 11	.06	.04	.035	
31114CL	R47/50	A	47	50V	6 x 11	.06	.05	.045	
207811CL	R100/10	A	100	10V	5 x 11	.08	.06	.05	
94289CL	5R100/16	A	100	16V	6 x 5	.15	.12	.09	
94431CL	7R100/16	A	100	16V	6 x 7	.09	.075	.055	
93761CL	R100/25	A	100	25V	6 x 11	.07	.05	.035	
198969CL	R100J/35	A	100	35V	6 x 11	.07	.06	.05	
29962CL	R100/50	A	100	50V	8 x 11	.07	.06	.05	
158393CL	R100B50	B	100	50V	8 x 11	.09	.07	.055	

Part No.	Mfr. Cross Ref. No. †	Op. Temp	Value (µF)	Voltage	Size (mm) D x H	Pricing			
						1	10	100	500
207845CL	R180/16	B	180	16V	6 x 15	0.07	0.06	0.045	
135124CL	7R220/10	A	220	10V	6 x 11	.26	.20	.15	.105
198871CL	R220J/16	A	220	16V	6 x 11	.11	.07	.06	
30496CL	R220/25	A	220	25V	8 x 11	.08	.06	.05	
158262CL	R220B25	B	220	25V	8 x 11	.12	.09	.07	
93770CL	R220/35	A	220	35V	10 x 12	.09	.08	.07	
93778CL	R220/50	A	220	50V	10 x 12	.15	.12	.09	
158406CL	R220B50	B	220	50V	10 x 12	.11	.08	.06	
199081CL	R220J/100	A	220	100V	12 x 25	.75	.55	.49	.39
198889CL	R330J/16	A	330	16V	8 x 11	.14	.07	.06	
93796CL	R330/25	A	330	25V	10 x 12	.13	.09	.08	
198977CL	R330J/35	A	330	35V	10 x 12	.45	.29	.22	.16
199099CL	R330J/100	A	330	100V	12 x 25	1.15	.85	.65	.52
93809CL	R470/16	A	470	16V	8 x 11	.11	.095	.076	
158203CL	R470B16	B	470	16V	8 x 11	.12	.10	.09	
31181CL	R470/25	A	470	25V	10 x 12	.12	.10	.09	
158289CL	R470B25	B	470	25V	10 x 12	.15	.12	.10	
93817CL	R470/35	A	470	35V	10 x 16	.17	.15	.13	
93825CL	R470/50	A	470	50V	12 x 20	.29	.27	.19	.13
158465CL	R470B63	B	470	63V	12 x 20	.30	.27	.22	.17
199101CL	R470J/100	A	470	100V	16 x 25	1.15	.78	.69	.58
30015CL	R1000/16	A	1000	16V	10 x 16	.16	.14	.12	
93833CL	R1000/25	A	1000	25V	10 x 20	.25	.23	.18	
158297CL	R1000B25	B	1000	25V	10 x 20	.35	.29	.25	.19
158377CL	R1000B35	B	1000	35V	12 x 20	.49	.45	.35	.28
93841CL	R1000/50	A	1000	50V	12 x 25	.52	.46	.41	.34
199110CL	R1000J/100	A	1000	100V	18 x 40	3.19	2.49	1.88	1.41
133145CL	R2200/16	A	2200	16V	12 x 20	.32	.28	.24	.22
30533CL	R2200/25	A	2200	25V	12 x 25	.55	.49	.40	.30
198985CL	R2200J/35	A	2200	35V	16 x 25	1.39	1.25	.99	.74
158431CL	R2200B50	B	2200	50V	16 x 35	.99	.89	.70	.61
198897CL	R3300J/16	A	3300	16V	12 x 25	.49	.39	.33	.29
30891CL	R3300/25	A	3300	25V	16 x 25	.71	.65	.49	.43
198993CL	R3300J/35	A	3300	35V	16 x 35	.99	.88	.77	.65
199013CL	R3300J/50	A	3300	50V	18 x 35	2.15	1.95	1.71	1.46
198900CL	R4700J/16	A	4700	16V	16 x 25	.79	.69	.51	.45
93850CL	R4700/25	A	4700	25V	16 x 31	.99	.85	.70	.55
199005CL	R4700J/35	A	4700	35V	18 x 35	1.35	1.25	1.15	1.05
163301CL	R4700/50	A	4700	50V	22 x 42	1.99	1.79	1.50	1.31
31510CL	R6800/16	A	6800	16V	16 x 35	.99	.78	.68	.59
198934CL	R6800J/25	A	6800	25V	18 x 35	2.55	1.96	1.49	1.15

Snap Mount Large Can Aluminum Electrolytic Capacitors (±20%)

- Designed as input filter for switched mode power supply; standard 10mm (.400") snap-in spacing
- Operating temperature range: -40°C to +85°C max. leakage current: 0.02CV (µA) or 3mA whichever is smaller
- Can-Top safety vent

Quantity **SAVE**

Snap-Ins!



† CRDSS REFERENCES: Aero M: LP/LPR; Elna: LP3/LP4; Illinois Capacitor: LBA/LPR; Mallory: LPX; Marcon: CEAWF; Nichicon: LLK/LLQ; Panasonic: TS-UP/TS-U; Phillips (MEPCO): 3487/3489; Rubycon: RSP; Sprague: 80D/82D; United Chemicon: SMG(VN)/SMH(VN)

Part No.	Mfr. Cross Ref. No. †	Capacitance	Voltage	Size (mm) D x H	Pricing		
					1	10	100
203211CL	SN220/400/2	220µF	400V	22 x 51	4.45	3.75	2.65
203220CL	SN220/400/3	220µF	400V	30 x 30	4.99	3.99	2.99
203238CL	SN270/350	270µF	350V	25 x 40	4.99	3.99	2.55
203246CL	SN330/400	330µF	400V	30 x 46	5.05	4.35	2.69
115377CL	SN470/200	470µF	200V	30 x 41	2.49	2.25	1.99
203254CL	SN470/400/4	470µF	400V	35 x 41	6.99	5.69	4.45
203262CL	SN470/400/5	470µF	450V	35 x 51	8.25	7.60	5.69

Capacitor dimensions and styles may vary

Part No.	Mfr. Cross Ref. No. †	Capacitance	Voltage	Size (mm) D x H	Pricing		
					1	10	100
155889CL	SN560/200	560µF	200V	23 x 41	3.20	2.69	1.90
203271CL	SN680/200/2	680µF	200V	35 x 25	3.49	2.95	2.09
203289CL	SN680/200/3	680µF	200V	30 x 31	2.35	2.19	1.99
203297CL	SN820/200/4	820µF	200V	30 x 41	3.99	3.35	2.39
203300CL	SN820/200/2	820µF	200V	35 x 25	4.19	3.19	2.25
115422CL	SN4700/50	4,700µF	50V	30 x 41	3.19	2.69	1.99
115431CL	SN6800/50	6,800µF	50V	30 x 51	3.15	2.90	2.39
157737CL	SN10000/50	10,000µF	50V	35 x 40	4.95	4.10	3.99



SALE

Aluminum Axial-Lead Electrolytic Capacitors

General purpose low voltage 85°C maximum

Operating temperature range	-40°C to +85°C
Leakage Current (After 2 minutes 20°C)	0.02CV or 2µA, whichever is greater

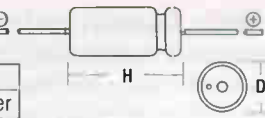

Quantity **SAVE**

† CROSS REFERENCES: Elna: RE2; IC: RAR; Marcon: SEM; Nichicon: LB/VX; Rubycon: TWSS; Sprague: 501D/513D; UCC: SME; Panasonic: SU

Prepackaged: order in increments of 10, 100 or 500

Prepackaged: order in increments of 10, 100 or 500

Part No.	Mfr. Cross Ref. No.†	Value (µF)	Voltage	Size (mm)* DxH	Pricing			
					1	10	100	500
10866CL	A1.50	1	50V	5 x 13	\$.15	\$.115	\$.09	
199128CL	A2.2J/16	2.2	16V	6 x 13	.225	.099	.085	.06
93569CL	A2.2.50	2.2	50V	6 x 13	.11	.11	.10	.09
199136CL	A3.3J/16	3.3	16V	6 x 12	.059	.054	.049	
199419CL	A3.3J/50	3.3	50V	6 x 12	.19	.12	.09	
11076CL	A4.7/50	4.7	50V	6 x 13	.18	.13	.11	
199427CL	A6.8J/50	6.8	50V	6 x 12	.19	.12	.09	
199144CL	A10J/16	10	16V	6 x 12	.20	.14	.10	
199259CL	A10J/25	10	25V	5 x 12	.15	.10	.085	
93577CL	A10/35	10	35V	6 x 13	.12	.10	.09	
10882CL	A10/50	10	50V	6 x 12	.15	.12	.08	
199152CL	A22J/16	22	16V	6 x 12	.17	.12	.09	
199267CL	A22J/25	22	25V	6 x 12	.20	.14	.10	
10997CL	A22/50	22	50V	6 x 12	.19	.14	.10	
199161CL	A33J/16	33	16V	6 x 13	.13	.115	.095	
199275CL	A33J/25	33	25V	6.3 x 12	.18	.12	.09	
199347CL	A33J/35	33	35V	6.3 x 16	.19	.13	.09	
199435CL	A33J/50	33	50V	6.3 x 16	.18	.12	.09	
199179CL	A47J/16	47	16V	6.3 x 12	.14	.10	.085	
135319CL	A47/25	47	25V	8 x 16	.15	.14	.09	
199355CL	A47J/35	47	35V	6.3 x 16	.20	.14	.10	
11105CL	A47/50	47	50V	8 x 16	.19	.14	.10	
199443CL	A68J/50	68	50V	8 x 15	.25	.21	.17	.12
199187CL	A100J/16	100	16V	6.3 x 16	\$.28 \$.29	.21	.18	.14
199283CL	A100J/25	100	25V	8 x 16	.25	.20	.18	.15
93551CL	A100/35	100	35V	8 x 16	.21	.17	.13	
10911CL	A100/50	100	50V	8 x 20	.22	.18	.14	
199195CL	A220J16	220	16V	8 x 16	.17	.13	.11	
199291CL	A220J/25	220	25V	8 x 16	.25	.21	.18	.12
199363CL	A220J/35	220	35V	10 x 17	\$.35	.31	.25	.18

* Capacitor dimensions and styles may vary

Part No.	Mfr. Cross Ref. No.†	Value (µF)	Voltage	Size (mm)* DxH	Pricing			
					1	10	100	500
11017CL	A220/50	220	50V	10 x 20	\$.35	\$.29	\$.25	\$.19
199208CL	A330J/16	330	16V	8 x 16	.25	.15	.14	.12
199304CL	A330J/25	330	25V	10 x 17	.29	.23	.21	.15
199371CL	A330J/35	330	35V	10 x 17	.29	.24	.185	
199451CL	A330J/50	330	50V	13 x 22	.39	.33	.25	.22
199216CL	A470J/16	470	16V	8 x 16	\$.35 \$.45	.25	.23	.18
199312CL	A470J/25	470	25V	10 x 17	.35	.30	.26	.21
199380CL	A470J/35	470	35V	10 x 21	\$.51	.46	.37	.34
11121CL	A470/50	470	50V	13 x 31	.59	.49	.42	.34
199460CL	A680J/50	680	50V	16 x 25	.79	.68	.53	.44
93631CL	A1000/16	1000	16V	13 x 27	\$.51	.46	.41	.38
10954CL	A1000/25	1000	25V	13 x 31	.59	.49	.44	.34
93649CL	A1000/35	1000	35V	13 x 26	.85	.75	.59	.49
147256CL	A1000/50	1000	50V	16 x 31	.79	.69	.59	.49
213356CL	A1000/50-1	1000	50V	22 x 41	.69	.59	.55	.49
11033CL	A2200/16	2200	16V	16 x 40	.79	.71	.65	.59
199321CL	A3300J/25	2200	25V	16 x 28	\$ 1.11	.99	.83	.72
93657CL	A2200/35	2200	35V	16 x 30	1.25	1.10	.99	.85
199478CL	A2200J/50	2200	50V	18 x 42	\$ 2.55	2.29	1.93	1.79
199224CL	A3300J/16	3300	16V	16 x 26	.79	.71	.57	.43
93665CL	A3300/25	3300	25V	16 x 32	.99	.89	.79	.69
199398CL	A3300J/35	3300	35V	18 x 37	\$ 3.39	3.15	2.69	2.12
199486CL	A3300J/50	3300	50V	22 x 43	\$ 4.29	3.95	3.15	2.35
199232CL	A4700J/16	4700	16V	16 x 30	1.55	1.37	1.09	.95
93673CL	A4700/25	4700	25V	22 x 39	1.69	1.49	1.29	.99
199401CL	A4700J/35	4700	35V	18 x 40	\$ 4.85	2.50	2.13	1.75
158810CL	A4700A50	4700	50V	25 x 43	2.79	2.29	2.09	1.79
199241CL	A6800J/16	6800	16V	16 x 33	\$ 2.15	1.99	1.35	1.12
199339CL	A6800J/25	6800	25V	18 x 40	1.59	1.45	1.35	1.19
93681CL	A10000/16	10000	16V	22 x 51	2.25	2.05	1.65	1.19

Ceramic Disc Capacitors (±20%)

25, 50 and 1000 Volt,
Z5U Temperature Coefficient

Quantity **SAVE**



Operating temperature range	+10°C to +85°C
Cap. change over temp. range	+22% to -56%
Dielectric withstanding voltage	2.5 times rated volt. for not < 1 sec.

Low Voltage
50VDC Ceramic

Prepackaged: order in increments of 10, 100 or 1000

Part No.	Mfr. Cross Ref. No.	Capacitance	Voltage	Dia. (mm)	Pricing			
					10	100	1000	5000
135141CL	DC2.2	2.2pF	50V	5	\$.915	\$.715	\$.515	\$.315
15333CL	DC10	10pF	50V	5	.07	.05	.02	.015
15405CL	DC22	22pF	50V	6	.07	.05	.025	.02
15510CL	DC47	47pF	50V	5	.05	.035	.02	.015
15341CL	DC100	100pF	50V	5	.05	.035	.025	.02
15413CL	DC220	220pF	50V	5	.05	.035	.025	.015
15528CL	DC470	470pF	50V	5	.08	.065	.025	.022
207853CL	DC820/1000	820pF	1000V	14	.07	.05	.038	.038
15190CL	DC.001	.001µF	50V	6	.06	.05	.025	.022
97341CL	DC.0022/1K20	.0022µF	1000V	11	.22	.18	.16	.11
15211CL	DC.0047	.0047µF	50V	6	.05	.035	.03	.02
15229CL	DC.01	.01µF	50V	6	.06	.04	.03	.02
97375CL	DC.01/1K20	.01µF	1000V	12	.18	.12	.084	.066
15245CL	DC.022	.022µF	50V	8	.07	.05	.04	.03
15253CL	DC.047	.047µF	50V	8	.084	.069	.057	.04
151116CL	DC.1/25	.1µF	25V	6	.14	.13	.08	.07
15270CL	DC.1	.1µF	50V	8	.15	.13	.115	.095

* Capacitor dimensions and styles may vary

Monolithic Ceramic Capacitors (±20%) (Z5U Series)

Applications:
• Data processing
• Communications engineering

Quantity **SAVE**



Operating temperature range:
-10°C to +85°C

Prepackaged: order in increments of 10, 100 or 1000

Part No.	Mfr. Cross Ref. No.	Capacitance	Volt.	Size (mm)* W x T x H	Pricing			
					1	10	100	5000
81541CL	MD10	10pF	50V	3.5 x 2.0 x 3.0	\$.10	\$.065	\$.045	\$.03
81533CL	MD22	22pF	50V	4.0 x 2.0 x 4.0	.095	.073	.045	.04
81525CL	MD100	100pF	50V	3.5 x 2.0 x 3.0	.09	.07	.045	.035
81517CL	MD.001	.001µF	50V	4.5 x 2.0 x 3.0	.09	.07	.05	.035
138181CL	MD.0022	.0022µF	50V	4.0 x 2.0 x 5.5	.07	.06	.05	.04
138202CL	MD.0047	.0047µF	50V	5.0 x 2.0 x 5.5	.07	.045	.039	.035
25507CL	MD.01	.01µF	50V	3.5 x 2.0 x 3.0	.09	.06	.04	.035
57621CL	MD.047	.047µF	50V	2.5 x 2.5 x 3.0	.08	.07	.05	.03
25523CL	MD.1	.1µF	50V	6.0 x 2.0 x 4.0	.07	.06	.04	.035
25540CL	MD.22	.22µF	50V	6.0 x 2.0 x 4.5	.17	.12	.08	.06
138237CL	MD.33	.33µF	50V	6.0 x 2.0 x 8.0	.20	.15	.15	.11
25558CL	MD.47	.47µF	50V	4.5 x 2.5 x 4.5	.25	.19	.13	.12
81509CL	MD1	1µF	50V	6.0 x 3.0 x 7.0	.48	.43	.32	.21

* Capacitor dimensions and style may vary



See page 34 for Axial Electrolytic
Capacitor Cabinet Kit.

Mylar Capacitors (±10%) Metalized Polyester Film Capacitors

- High performance at low cost • Non-inductive construction

Operating temperature range	-40°C to +85°C
Dissipation factor	≤.01 (at 1kHz)
Dielectric strength	150% of rated voltage for 5 sec.



Quantity **SAVE**

New Lower Prices

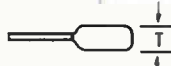

†Cross References:

Panasonic: ECQ-E Series; **Sprague:** DF/450P/451P/453P; **Westlake:** 160/168/185/167/184/186; **Rubycon:** MC/MN; **Mepeco:** 713A1/719A1/C280; **TRW:** X601PE/X601CPE; **Packtron:** MF/RB; **Secor:** MMKS/MMKR/MMDR; **RIFA:** PHE353/PHE354; **Roederstein:** MKT 1818/MKT 1822; **WIMA:** MKS; **CSF Thompson:** MD/M; **Siemens:** B325X-XX; **NIC:** NEM/NRM; **Nichicon:** DDXM; **Phillips:** 712 A1 series

* Prepackaged: order in increments of 10, 100 or 1000

Part No.	Mfr. Cross Ref. No. †	Capacitance	Volt. (V)	Size (mm)* L x T x H	Pricing			
					1	10	100	1000
26833CL	MY.001	.001µF	100	7.0 x 3.0 x 7.0	+	\$.10	\$.07	\$.05
207802CL	MY.0015/1000	.0015µF	1000	23.5 x 5.1 x 10.7	+	.11	.06	.05
26868CL	MY.0022	.0022µF	100	6.0 x 3.0 x 10.0	+	.09	.06	.04
26876CL	MY.0047	.0047µF	100	6.0 x 3.0 x 9.0	+	.14	.13	.11
207829CL	MY.0068/220	.0068µF	220	18.0 x 5.5 x 10.0	+	.12	.07	.05
26884CL	MY.01	.01µF	100	6.0 x 3.0 x 7.0	+	.10	.06	.04
207837CL	MY.018/50	.018µF	50	6.1 x 2.6 x 11.3	+	.37	.34	.31
26905CL	MY.022	.022µF	100	6.0 x 3.0 x 10.0	+	.15	.10	.06
26921CL	MY.033	.033µF	100	8.0 x 4.0 x 11.0	+	.15	.10	.06
207861CL	MY.033/400	.033µF	400	11.0 x 4.0 x 8.0	+	.10	.06	.04
26930CL	MY.047	.047µF	100	8.0 x 4.0 x 12.0	+	.15	.10	.06
135562CL	MY.1/50	.1µF ††	50	14.0 x 6.0 x 12.0	+	.09	.05	.05
26956CL	MY.1	.1µF	100	12.5 x 5.0 x 9.5	+	.17	.12	.07
93921CL	MY.1/250	.1µF	250	12.5 x 5.5 x 10	+	.19	.16	.13
26972CL	MY.22	.22µF	100	12.5 x 5.5 x 10	+	.19	.12	.085
93964CL	MY.33/250	.33µF	250	18.0 x 7.0 x 12.5	.32	.25	.21	.19
26999CL	MY.47	.47µF	100	18.0 x 6.0 x 11.5	.39	.29	.20	.17
27001CL	MY1	.1µF	100	18.0 x 7.5 x 14.0	.49	.39	.33	.29
93981CL	MY1/250	.1µF	250	26.0 x 9.0 x 16.0	.50	.41	.36	.31
93999CL	MY2.2/250	2.2µF	250	26.0 x 9.0 x 16.0	.89	.69	.59	.45

†† ±20% tolerance * Capacitor dimensions and styles may vary

Dipped Tantalum Capacitors (±10%) Resin Dipped Solid Tantalum Capacitors

- Flame retardant coating • Exceptional temperature stability
- Low leakage current • Moisture-resistant
- Designed for entertainment and commercial equipment

Operating temp. range	-55°C to +85°C (+125°C with derating)
Rated voltage DC	≤ +85°C



†Cross References:

Panasonic: EF Series; **AVX:** Tap Series; **Sprague:** 196D and 199D; **Matsuo:** 202; **Kemet:** T350/ T360; **Metco:** 49GS; **NEC:** DN; **Nichicon:** 599; **NIC:** NDTM; **Hitachi:** TSD-3

* Prepackaged: order in increments of 10, 100 or 1000

Part No.	Mfr. Cross Ref. No. †	Capacitance	Voltage (V)	Size (mm)* D x H	Pricing				
					1	10	100	1000	
33486CL	TM.1	.1µF	35	4.5 x 7.0	+	\$.25	\$.19	\$.15	
33507CL	TM.22	.22µF	35	4.5 x 7.0	+	.25	.19	.15	
33523CL	TM.33	.33µF	35	4.5 x 7.0	+	.25	.19	.15	
33531CL	TM.47	.47µF	35	4.5 x 7.0	+	.20	.15	.14	
61102CL	TM.68	.68µF	35	2.9 x 5.1	+	.25	.19	.17	
154860CL	TM1/25	.1µF	25	3.0 x 6.0	+	.29	.25	.22	
33662CL	TM1	.1µF	35	4.5 x 7.0	+	.29	.25	.22	
94001CL	TM2.2/16	2.2µF	16	4.5 x 7.0	+	.19	.15	.12	
94019CL	TM2.2/25	2.2µF	25	4.5 x 7.0	+	.35	.29	.25	
33734CL	TM2.2	2.2µF	35	4.5 x 7.5	.39	.35	.29	.22	
33769CL	TM3.3	3.3µF	35	4.5 x 7.5	.55	.36	.33	.31	
94035CL	TM4.7/16	4.7µF	16	4.5 x 7.5	.47	.38	.28	.20	
94043CL	TM4.7/25	4.7µF	25	5.0 x 8.5	.49	.44	.33	.20	
33806CL	TM4.7	4.7µF	35	5.5 x 9.0	\$.55	.45	.42	.37	.27
33873CL	TM6.8	6.8µF	35	6.0 x 10.0	.59	.45	.36	.32	
94060CL	TM10/16	10µF	16	5.0 x 9.0	.45	.39	.29	.25	
94078CL	TM10/25	10µF	25	5.5 x 9.0	.59	.50	.40	.36	
33689CL	TM10	10µF	35	6.0 x 10.0	.89	.79	.69	.59	
33718CL	TM15	15µF	25	6.0 x 10.0	.89	.80	.65	.49	
33751CL	TM22	22µF	6.3	5.0 x 9.0	.45	.37	.26	.22	
94094CL	TM22/16	22µF	16	6.0 x 10.0	.69	.59	.49	.45	
94107CL	TM22/25	22µF	25	7.0 x 10.5	1.79	1.59	.99	.85	
33785CL	TM33	33µF	25	8.0 x 13.0	2.31	2.09	1.62	1.05	
94123CL	TM47/16	47µF	16	8.0 x 13.0	1.69	1.55	1.35	.95	
33822CL	TM47	47µF	25	9.0 x 14.5	3.39	3.05	2.35	1.85	
33700CL	TM100	100µF	6.3	7.0 x 10.5	1.19	1.09	.95	.85	

* Capacitor dimensions and styles may vary

5mm Ceramic Trimmer Capacitor

- Working voltage: 200VDC
- Withstand voltage: 400VDC
- Turning torque: 35-200 g-cm
- Operating temperature range: -30°C~+85°C
- Insulation resistance: >10MΩ min. @ 250VDC

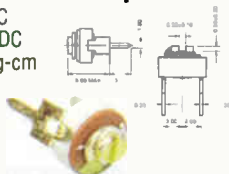

Part No.	Capacitance Range (pF)	Q Factor @ 1MHz	Color Codes	Pricing			
				1	10	100	1000
136979CL	9.0-50.0	> 200	Green	\$.89	\$.79	\$.69	\$.59

8mm .315" Ceramic Trimmer Capacitors (250WVDC) Thru Hole

- Working voltage: 250VDC
- Withstand voltage: 550VDC
- Turning torque: 40-200 g-cm
- Operating temperature range: -55°C~+85°C
- Insulation resistance: 10MΩ min. @ 250VDC

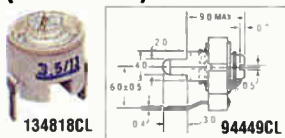

Part No.	Capacitance Range (pF)	Q Factor @ 1MHz	Color Codes	Pricing			
				1	10	100	1000
134818CL	3.5-13.0	> 300	Ivory	\$.69	\$.65	\$.50	\$.39
32838CL	4.0-34.0	> 300	Yellow	.90	.77	.62	.59
32854CL	6.0-70.0	> 200	Nil	.92	.78	.72	.68
94449CL	8.5-100	> 200	Purple	1.05	.93	.81	.77
94465CL	8.5-120	> 200	Nil	.99	.79	.65	.59

Memory Back-Up Capacitors

Applications:

- Back-up on CMOS microcomputers, static RAM, DTSs (digital tuning systems)
- Memory back-up of remote controllers



Features:

- Excellent voltage holding characteristics for low back-up currents
- Small size vs. capacitance • Voltage: 5.5VDC
- Capacitance ranges from .047 to 1F

Capacitor dimensions and lead spacing may vary

Part No.	Mfr. Cross Ref. No.	Capacitance (Farad)	Pricing		
			1	10	100
142922CL	MBC.047/5.5	.047µF	1.50	\$1.34	\$.99
142949CL	MBC.22/5.5	.22µF	2.09	1.79	1.41
143010CL	MBC.47/5.5	.47µF	3.49	2.89	2.09
142957CL	MBC1.0/5.5	1.0µF	4.75	4.29	3.49
227811CL	S5R5V105	1.0µF	4.99	3.99	3.29



See page 34 for Mylar & Dipped Tantalum Capacitor Cabinet Kits.

Dipped Silver Mica Capacitors (±5%)

Metalized Polyester Film Capacitors

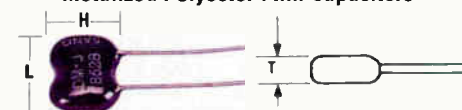

Case type	DM15
Lead space (in.)	.23
Tolerance	±5%
Operating temperature range	-55°C to +125°C
Size (mm) - L x T x H*	11 x 4 x 9

* Capacitor dimensions and style may vary

Part No.	Mfr. Cross Ref. No.	Capacitance	Volt. (V)	Pricing			
				1	10	100	1000
15991CL	DM100	10pF	500	\$.49	\$.38	\$.31	\$.30
16037CL	DM220	22pF	500	.49	.39	.29	.23
16070CL	DM330	33pF	500	.49	.38	.31	.29
16096CL	DM470	47pF	500	.49	.39	.29	.25
16002CL	DM101	100pF	500	.49	.39	.31	.27
16088CL	DM331	330pF	500	.89	.73	.55	.45
16109CL	DM471	470pF	500	1.05	.95	.79	.65
16011CL	DM102	1000pF	100	1.19	.99	.89	.79



See page 43 for Surface Mount Capacitors



1/4-Watt Carbon Film Resistors (±5%)



Single Resistor Value Pricing: 1/4-Watt Carbon Film Resistors (±5%)

To order: Use 5-digit part number adjacent to ohms in chart below
Values may not be combined for quantity price breaks

99¢/bag 100 piece bags

Specify Part No. & Resistor Value	1 Bag	10 Bags	50 Bags	100 Bags
(see Standard Resistor Values Chart below)	\$.99/bag	\$.57/bag	\$.49/bag	\$.46/bag

Assortment Pricing: 1/4-Watt Carbon Film Resistor (±5%)

Assortments may not be combined for quantity price breaks

Part No.	Description (Including bulk pack values)	1	10	25
10719CL	5 ea. 70 values (every other value from 10kΩ-5.6MΩ) (350 pcs.)	\$9.95	\$8.95	\$7.95
103165CL	10 ea. 24 values marked (●) and 50 ea. 6 values marked (✖) (540 pcs.)	12.95	11.49	9.95
10663CL	100 ea. 27 values marked (▲) (2,700 pcs.)	24.95	22.49	20.49
10655CL	100 ea. 160 values (all resistor values in the chart below) (16,000 pcs.)	119.95	107.95	96.95
81832CL	1/4-watt resistor component cabinet kit - 30 values (540 pcs.), pg 33	27.95	24.95	22.49

Standard Resistor Values Chart

*▲● see above

Part No.	Ohms	Part No.	Ohms	Part No.	Ohms	Part No.	Ohms	Part No.	Ohms	Part No.	Ohms	Part No.	Ohms	Part No.	Ohms							
30293CL	2.2	59192CL	15	29946CL	▲✖	100	31499CL	▲●	680	31026CL	▲✖	4.7k	30841CL	▲●	33k	30525CL	220k	29778CL	1.5M			
30349CL	2.4	30197CL	16	30040CL		110	31561CL		750	31237CL	▲●	5.1k	30912CL		36k	30576CL	240k	29794CL	1.6M			
30373CL	2.7	30234CL	18	30082CL		120	31624CL		820	31270CL	▲●	5.6k	30955CL		39k	30613CL	270k	29815CL	1.8M			
30621CL	3.0	30411CL	20	30120CL		130	31691CL		910	31405CL		6.2k	31077CL		43k	30808CL	300k	30285CL	2.0M			
30656CL	3.3	65736CL	22	30162CL	▲●	150	29663CL	▲✖	1.0k	31430CL		6.8k	31149CL	▲●	47k	30883CL	330k	30331CL	2.2M			
30699CL	3.6	30541CL	24	59248CL		160	29719CL		1.1k	31536CL		7.5k	31309CL		51k	30939CL	360k	30355CL	2.4M			
30728CL	3.9	30584CL	27	59281CL		180	29735CL	●	1.2k	31595CL		8.2k	31350CL		56k	30971CL	390k	30402CL	2.7M			
30980CL	4.3	30752CL	30	59424CL		200	58931CL		1.3k	60353CL		9.1k	31456CL		62k	31093CL	430k	30648CL	3.0M			
59811CL	4.7	30824CL	33	30470CL	▲✖	220	29760CL	▲●	1.5k	29911CL	▲✖	10k	31481CL		68k	31202CL	▲●	470k	30681CL	3.3M		
31211CL	5.1	30904CL	36	30568CL		240	29786CL		1.6k	30031CL		11k	31552CL		75k	31325CL	510k	30710CL	3.6M			
31253CL	5.6	59723CL	39	30605CL	▲●	270	29807CL		1.8k	30074CL		12k	31616CL		82k	31384CL	560k	30744CL	3.9M			
31392CL	6.2	31069CL	43	30795CL		300	30277CL	▲●	2.0k	30111CL		13k	31683CL		91k	31472CL	620k	31051CL	4.7M			
31421CL	6.8	31106CL	▲●	47	30867CL	▲●	330	30314CL	▲●	2.2k	30146CL	▲●	15k	29997CL	▲✖	100k	31501CL	680k	31245CL	5.1M		
31528CL	7.5	31296CL		51	30921CL		360	30357CL		2.4k	30200CL		16k	30058CL		110k	31579CL	750k	59934CL	5.6M		
31587CL	8.2	31341CL		56	30963CL	●	390	30390CL	▲●	2.7k	30242CL		18k	30091CL		120k	31632CL	820k	31413CL	6.2M		
31641CL	9.1	60089CL		62	31085CL		430	30630CL		3.0k	30429CL	●	20k	30138CL		130k	31704CL	910k	31448CL	6.8M		
29882CL	▲●	10	60134CL		68	31165CL	▲●	470	30672CL	▲●	3.3k	30453CL	▲●	22k	30171CL		150k	29698CL	▲●	1.0M	60206CL	7.5M
59061CL		11	60222CL		75	31317CL		510	30701CL		3.6k	30550CL		24k	30226CL		160k	29727CL		1.1M	31608CL	8.2M
30066CL		12	60302CL		82	31376CL		560	30736CL		3.9k	30592CL		27k	30269CL		180k	29743CL		1.2M	31667CL	9.1M
30103CL		13	31675CL		91	31464CL		620	59782CL		4.3k	30779CL		30k	30437CL		200k	29751CL	1.3M	29938CL	▲●	10M

1/8-Watt Carbon Film Resistor (±5%) Assortments

Any 1/8 or 1/2-Watt Resistor value (below) can be special ordered - 1000 pc minimum
• 1/8-W - \$12.95/k (bulk) • 1/2-W - \$15.95/k (bulk)

SALE

Part No.	Cross Ref. No.	Values included	Description (see chart below)	Pricing	
				1	10
108302CL	ASST1830	✖	10 ea. of 24 values marked by ✖ and 50 ea. of 6 values marked below by # (540 pcs.)	\$12.95	\$11.49
108290CL	ASST1827	✓	100 ea. of 27 values marked by ✓ (2,700 pcs.)	29.95	26.95
108329CL	CAB182R	-	1/8-watt resistor component cabinet kit - 30 values (540 pcs.), see page 33	24.95	22.49

1/8 & 1/2-Watt Resistor Assortments Value Chart (Ohms)

10 ✓✖	150 ✓✖	330 ✓✖	680 ✓✖	2.0k ✓✖	3.3k ✓✖	5.6k ✓✖	15k ✓✖	33k ✓✖	470k ✓✖
47 ✓✖	220 ✓✖	390 ✓✖	1.0k ✓✖	2.2k ✓✖	4.7k ✓✖	6.8k ✓✖	22k ✓✖	47k ✓✖	1.0M ✓✖
100 ✓✖	270 ✓✖	470 ✓✖	1.5k ✓✖	2.7k ✓✖	5.1k ✓✖	10k ✓✖	27k ✓✖	100k ✓✖	10M ✓✖

(✓), (✖), (#) symbols indicate Resistor values included in Assortments above and below.

1/2-Watt Carbon Film Resistor (±5%) Assortments

Any 1/8 or 1/2-Watt Resistor value (above) can be special ordered - 1000 pc minimum
• 1/8-W - \$12.95/k (bulk) • 1/2-W - \$15.95/k (bulk)

Part No.	Cross Ref. No.	Values included	Description (see chart above)	Pricing	
				1	10
107852CL	ASST1230	✖	10 ea. of 24 values marked by ✖ and 50 ea. of 6 values marked by # (540 pcs.)	\$14.95	\$13.49
107844CL	ASST1227	✓	100 ea. of 27 values marked by ✓ (2,700 pcs.)	34.95	31.49
107836CL	ASST1270	-	5 ea. of 70 values (every other value from 10Ω - 5.6MΩ) (350 pcs.) (see chart above)	10.95	9.95
107879CL	CAB12R	-	1/2-watt resistor component cabinet kit - 30 values (540 pcs.), see page 33	29.95	26.95

Single-In-Line "SIP" Resistor Networks (±2%)

8 and 10-Pin Bussed (125mW/Resistor) ±2%

Features (8BRN/10BRN):

- 8-pin package (7 resistors) = 8BRN
- 10-pin package (9 resistors) = 10BRN
- Rated power per resistor at 70°C: 125mW/resistor
- Operating temperature range: -55°C to +125°C
- Resistance temperature coefficient: 200ppm/°C
- Max. working voltage: 100V or rated power x resistance, whichever is smaller
- Insulation resistance: 10,000MΩ min. at 100V
- Solderability: per MIL-R-83401
- Low profile 5mm (.200" body ht.)
- Low profile is compatible w/ DIPs
- Cermet thick film construction



Part No.	Pins	Ohms
97826CL	8	10k
97851CL	10	330
97869CL	10	470
97877CL	10	1.0k
97893CL	10	2.2k
24660CL	10	4.7k
24643CL	10	10k
98087CL	10	47k
98095CL	10	100k

Dual-In-Line "DIP" Resistor Networks (±2%)

16-Pin Isolated (140mW/Resistor) ±2%

Features (161RN):

- Maximum operating voltage: 100V • Tolerance: ±2%
- Temperature coefficient: ±100ppm/°C
- Operating temp.: -55°C to +125°C
- Insulation resistance: 10,000MΩ min.
- Lead solderability/solvent resistance: meets requirements of MIL-R-83401
- Power rating at 70°C: 2.25 watts
- Compatible with automatic insertion equipment
- Copper leads for excellent heat dissipation

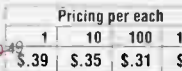
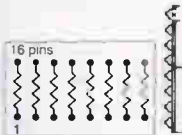

Part No.	Ohms
164005CL	33
108556CL	100
108564CL	220
108572CL	330
108581CL	470
108599CL	1.0k
108610CL	4.7k
108628CL	10k
108644CL	100k

SIP and DIP Resistor Network Cross Reference Chart

Jameco	CTS	A-B	Bourms	Dale	Beckman	Sprague	MEPCO
8BRN	770-81-R...	708A	4608X-101...	CSC08A01	L08-1-R	356CF X2P0	9S08 GL002
10BRN	770-101-R	710A	4610X-101...	CSC10A01	L10-1-R	256CX X2P0	9S10 GL002
161RN	761-3-R	316B	4116R-001...	MDP16-03	898-3-R	916C X5SR	016H 12-J

1/2-Watt 24mm Linear Taper ($\pm 20\%$)



- Maximum voltage: 500V
- Rotational angle: 300° ($\pm 5^\circ$)
- Withstanding voltage for 1 minute: 500VAC

0.335" L shaft; solder lugs

Part No.	Product No.	Ohms	1	10	100	500
255476CL	RV24A-10-15R1-B52	500	\$1.18	\$.91	\$.83	\$.76
255484CL	RV24A-10-15R1-B13	1k	1.18	.91	.83	.76
255492CL	RV24A-10-15R1-B23	2k	1.18	.91	.83	.76
255505CL	RV21A-10-15R1-BF3	2.5k	1.18	.91	.83	.76
255513CL	RV24A-10-15R1-B53	5k	1.18	.91	.83	.76
255521CL	RV24A-10-15R1-B14	10k	1.18	.91	.83	.76
255530CL	RV24A-10-15R1-BF4	25k	1.18	.91	.83	.76
255548CL	RV24A-10-15R1-B54	50k	1.18	.91	.83	.76
255556CL	RV24A-10-15R1-B15	100k	1.18	.91	.83	.76
255564CL	RV24A-10-15R1-BF5	250k	1.18	.91	.83	.76
255572CL	RV24A-10-15R1-B55	500k	1.18	.91	.83	.76
255581CL	RV24A-10-15R1-B16	1M	1.18	.91	.83	.76
255599CL	RV24A-10-15R1-B26	2M	1.18	.91	.83	.76
255601CL	RV24A-10-15R1-B56	5M	1.18	.91	.83	.76

0.531" L knurled shaft; solder lugs

Part No.	Product No.	Ohms	1	10	100	500
264372CL	RV24A-10-20K-B52	500	\$1.18	\$.91	\$.83	\$.76
264381CL	RV24A-10-20K-B13	1k	1.18	.91	.83	.76
264399CL	RV24A-10-20K-B23	2k	1.18	.91	.83	.76
264401CL	RV24A-10-20K-B53	5k	1.18	.91	.83	.76
264410CL	RV24A-10-20K-B14	10k	1.18	.91	.83	.76
264428CL	RV24A-10-20K-B54	50k	1.18	.91	.83	.76
264436CL	RV24A-10-20K-B15	100k	1.18	.91	.83	.76
264444CL	RV24A-10-20K-BF5	250k	1.18	.91	.83	.76
264452CL	RV24A-10-20K-B55	500k	1.18	.91	.83	.76
264461CL	RV24A-10-20K-B16	1M	1.18	.91	.83	.76
264479CL	RV24A-10-20K-B26	2M	1.18	.91	.83	.76

1.32" L shaft; solder pins

Part No.	Product No.	Ohms	1	10	100	500
255610CL	RV24A-10-40R1-B52	500	\$1.13	\$.95	\$.86	\$.79
255628CL	RV24A-10-40R1-B13	1k	1.13	.95	.86	.79
255636CL	RV24A-10-40R1-B23	2k	1.13	.95	.86	.79
255644CL	RV24A-10-40R1-BF3	2.5k	1.13	.95	.86	.79
255652CL	RV24A-10-40R1-B53	5k	1.13	.95	.86	.79
255661CL	RV24A-10-40R1-B14	10k	1.13	.95	.86	.79
255679CL	RV24A-10-40R1-BF4	25k	1.13	.95	.86	.79
255687CL	RV24A-10-40R1-B54	50k	1.13	.95	.86	.79
255695CL	RV24A-10-40R1-B15	100k	1.13	.95	.86	.79
255708CL	RV24A-10-40R1-BF5	250k	1.13	.95	.86	.79
255716CL	RV24A-10-40R1-B55	500k	1.13	.95	.86	.79
255724CL	RV24A-10-40R1-B16	1M	1.13	.95	.86	.79
255732CL	RV24A-10-40R1-B56	5M	1.13	.95	.86	.79

1/2-Watt Linear Taper ($\pm 10\%$)

- Temperature range: -55°C to +125°C
- Non-rotational key
- Non-slotted shaft end
- Mounting hole: 0.3125"
- Shaft diameter: 0.25"
- Shaft length: 0.50"
- Maximum panel thickness: 0.1875"

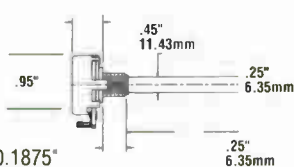

29081CL

Includes: Mounting hardware

Part No.	Mfr. Cross Ref. No.	Ohms	1	10	100	500
29049CL	P1K	1k	\$.99	\$.79	\$.65	\$.55
29196CL	P5K	5k	.99	.79	.65	.55
29081CL	P10K	10k	.99	.79	.65	.55
29102CL	P100K	100k	.99	.79	.65	.55
29065CL	P1MEG	1M	.99	.79	.65	.55

1/2-Watt 24mm Linear Taper with Switch ($\pm 20\%$)



- Shaft length: 0.335"
- Maximum voltage: 500V
- Switch circuit: SPST
- Switch rating: 125VAC, 1A
- Rotational angle: 300° ($\pm 5^\circ$)
- Terminal type: solder lugs

Part No.	Product No.	Ohms	1	10	100	500
263759CL	RV24A01-10-15R1-B52	500	\$1.62	\$1.36	\$1.24	\$1.13
263767CL	RV24A01-10-15R1-B13	1k	1.62	1.36	1.24	1.13
263775CL	RV24A01-10-15R1-BF3	2.5k	1.62	1.36	1.24	1.13
263783CL	RV24A01-10-15R1-B53	5k	1.62	1.36	1.24	1.13
263791CL	RV24A01-10-15R1-B14	10k	1.62	1.36	1.24	1.13
263804CL	RV24A01-10-15R1-BF4	25k	1.62	1.36	1.24	1.13
263812CL	RV24A01-10-15R1-B54	50k	1.62	1.36	1.24	1.13
263821CL	RV24A01-10-15R1-B15	100k	1.62	1.36	1.24	1.13
263839CL	RV24A01-10-15R1-BF5	250k	1.62	1.36	1.24	1.13
263847CL	RV24A01-10-15R1-B55	500k	1.62	1.36	1.24	1.13
263855CL	RV24A01-10-15R1-B16	1M	1.62	1.36	1.24	1.13

1/4-Watt 24mm Audio Taper ($\pm 20\%$)



- Shaft length: 0.335"
- Rotational angle: 300° ($\pm 5^\circ$)
- Insulation resistance: >100M Ω @ 500VDC
- Terminal type: solder lugs
- Maximum voltage: 250V

Part No.	Product No.	Ohms	1	10	100	500
255396CL	RV24A-10-15R1-A13	1k	\$1.18	\$.90	\$.83	\$.76
255417CL	RV24A-10-15R1-A53	5k	1.18	.90	.83	.76
255425CL	RV24A-10-15R1-A14	10k	1.18	.90	.83	.76
255433CL	RV24A-10-15R1-A54	50k	1.18	.90	.83	.76
255441CL	RV24A-10-15R1-A15	100k	1.18	.90	.83	.76
255450CL	RV24A-10-15R1-A55	500k	1.18	.90	.83	.76
255468CL	RV24A-10-15R1-A16	1M	1.18	.90	.83	.76

1/4-Watt 24mm Audio Taper with Switch ($\pm 20\%$)



- Shaft length: 0.590"
- Switch circuit: SPST
- Switch rating: 125VAC, 1A
- Rotational angle: 300° ($\pm 5^\circ$)
- Voltage rating: 250V

Part No.	Product No.	Ohms	1	10	100	500
263601CL	RV24A01-10-15R1-A13	1k	\$1.62	\$1.36	\$1.24	\$1.13
263610CL	RV24A01-10-15R1-A53	5k	1.62	1.36	1.24	1.13
263636CL	RV24A01-10-15R1-A14	10k	1.62	1.36	1.24	1.13
263644CL	RV24A01-10-15R1-A54	50k	1.62	1.36	1.24	1.13
263652CL	RV24A01-10-15R1-A15	100k	1.62	1.36	1.24	1.13
263661CL	RV24A01-10-15R1-A55	500k	1.62	1.36	1.24	1.13
263679CL	RV24A01-10-15R1-A16	1M	1.62	1.36	1.24	1.13

2-Watt Linear Taper ($\pm 10\%$)

- Military No.: RV4N-AYSD___A
- 2W @ 70°C ambient
- Conductive plastic element
- Temp. range: -55°C to +120°C
- Non-rotational key
- Shaft: dia.: 0.25"; length: 0.875"
- Mounting hole: 0.375"
- Maximum panel thickness: 0.25"

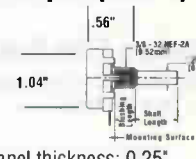

95417CL

Includes: Mounting hardware

Part No.	Product No.	Ohms	1	10	50	100
183610CL	53C3-500	500	\$7.95	\$6.95	\$5.95	\$5.25
13936CL	53C3-1k	1k	7.95	6.95	5.95	5.25
13995CL	53C3-5k	5k	7.95	6.95	5.95	5.25
13952CL	53C3-10k	10k	7.95	6.95	5.99	5.25
95417CL	53C3-50k	50k	7.95	6.95	5.95	5.25
13979CL	53C3-100k	100k	7.95	6.95	5.95	5.25



2-Watt Linear Taper (10-turn)

- Resistance tolerance: $\pm 10\%$
- 10-turn; wirewound
- Load life: 1000 hours, 2W
- Insulation resistance: (500VDC) 1000M Ω minimum
- Absolute minimum resistance: 1 Ω or 0.1% maximum



183548CL

Part No.	Product No.	Ohms	1	10	50
183548CL	3540S-1-502	5k	\$12.79	\$12.35	\$11.89
183521CL	3540S-1-103	10k	12.79	12.35	11.89

2-Watt Linear Taper ($\pm 20\%$)

- Temp. range: -10°C to +70°C
- Shaft diameter: 0.25"
- Mounting hole: 0.375"
- Non-rotational key
- Length: 0.825"
- Base length: 0.25"



123959CL

Includes: Mounting hardware

Part No.	Mr. Cross Ref. No.	Ohms	1	10	100	500
123959CL	PT1K	1k	\$3.29	\$2.99	\$2.65	\$2.39
123967CL	PT5K	5k	3.29	2.99	2.65	2.39

0.2-Watt Linear Taper ($\pm 20\%$)

Quantity **SAVE**

- Number of detents: 10
- Shaft diameter: 0.235"
- Shaft length: 0.605"
- Mounting hole: 0.27"
- Insulation resistance: 100M Ω @ 500VDC
- Maximum panel thickness: 0.15"
- Maximum operating voltage: 150VAC
- Rotational life: 15,000 cycles

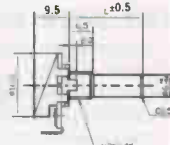

Includes: Mounting hardware

Part No.	Mr. Cross Ref. No.	Ohms	1	10	100	500
163563CL	PMD401	10k	\$1.65	\$1.49	\$1.19	\$0.85

5-Watt Linear Taper Wire Wound ($\pm 20\%$)

- Temp. range: -10°C to 70°C
- Shaft diameter: 0.23" (6mm)
- Shaft length: 0.67", except P/N 140521CL (0.25")
- Mounting hole: 0.32"
- Non-rotational key
- Maximum panel thickness: 0.1"



Includes: Mounting hardware

Part No.	Mr. Cross Ref. No.	Ohms	1	10	50	100
140513CL	PW5B100	100	\$2.79	\$2.35	\$2.25	\$2.10
140521CL	PW5B500	500	2.79	2.35	2.25	2.10

Aluminum Instrumentation Knobs

(1/8" and 1/4" Shaft Diameters)

Includes: Set screw for secure attachment

- 138384CL: • Coarse surface for sensitive control
• 1/8" shaft diameter



Part No.	Mr. Cross Ref. No.	Body Color	Pointer Color	Size (H" x Dia.)	1	10	100
162481CL	K5-1/4S	Chrome	Silver	.50 x .56	\$1.19	\$1.09	\$.96
138384CL	KD500G	Silver	Silver	.50 x .63	1.39	1.25	.99
162499CL	K5-1/4B	Black	White	.50 x .56	1.55	1.39	1.07
138481CL	KN031	Aluminum	Black	.61 x .65	1.49	1.29	.95
138501CL	KN032	Aluminum	Black	.87 x .75	1.95	1.71	1.55
138510CL	KN033	Aluminum	Black	1.18 x .87	2.49	2.24	1.95

3/4-Watt, 3/4" Rectangular, 15-Turn Cermet Potentiometer Side Adjustment ($\pm 10\%$)

3006P Series Value Equivalents

- Low PC board profile
- Temperature range: -55°C to 125°C
- Absolute minimum resistance: 1% or 2 Ω
- Contact resistance variation: 1% or 1 Ω maximum
- Power rating: 0.75W @ 70°C (400V maximum)

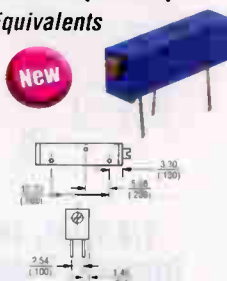

Part No.	Mr. Cross Ref. No.	Ohms	1	10	50	100
241234CL	3006P-101	100	\$1.25	\$1.15	\$.99	\$.89
241242CL	3006P-201	200	1.25	1.15	.99	.89
241251CL	3006P-501	500	1.25	1.15	.99	.89
241269CL	3006P-102	1k	1.25	1.15	.99	.89
241277CL	3006P-202	2k	1.25	1.15	.99	.89
241285CL	3006P-502	5k	1.25	1.15	.99	.89
241293CL	3006P-103	10k	1.25	1.15	.99	.89
241306CL	3006P-203	20k	1.25	1.15	.99	.89
241314CL	3006P-253	25k	1.25	1.15	.99	.89
241322CL	3006P-503	50k	1.25	1.15	.99	.89
241331CL	3006P-104	100k	1.25	1.15	.99	.89
241349CL	3006P-204	200k	1.25	1.15	.99	.89
241357CL	3006P-254	250k	1.25	1.15	.99	.89
241365CL	3006P-504	500k	1.25	1.15	.99	.89
241373CL	3006P-105	1M	1.25	1.15	.99	.89

Instrumentation Knobs

(1/4" Shaft Diameters)

102787CL/104176CL/202286CL:

- Brass insert and set screw for strength and durability
- Compatible with all rotary switches

136240CL: • Used with 1/2-watt and 2-watt linear taper potentiometers

138392CL: • Brass insert, dual set screws • Black knob with inset chrome top



Part No.	Mr. Cross Ref. No.	Body Color	Pointer Color	Size (H" x Dia.)	1	10	100
102787CL	KN141	Black	White	.54 x 1.25	\$.64	\$.41	\$.39
104176CL	KN143	Black	White	.49 x .75	.99	.85	.65
202286CL	K14SM	Black/Alum	White	.60 x .80	.79	.69	.64
136240CL	KN145	Black/Alum	White	.52 x .54	.65	.55	.49
138392CL	PKG90B	Black/Alum	White	.56 x .85	.79	.59	.54

New

See page 106 for our complete selection of
Plastic Instrumentation Knobs



See the yellow and green highlighted items.

Jameco Special Values!

Details on page 2.

1/2-Watt, 3/8" Square, Multi-Turn Trimming Potentiometers, Top Adjustment ($\pm 10\%$)

3296Y, 3299W, and 3299Y Series

- Resistance tolerance: $\pm 10\%$
- 25-turns nominal
- Insulation resistance: (500VDC) 1000M Ω minimum
- Contact resistance variation: 1% or 3 Ω maximum
- Absolute minimum resistance: 1% or 2 Ω maximum
- Power rating: 0.5W @ 70°C (300V maximum)

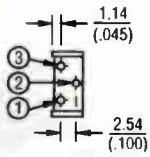

3296Y Series

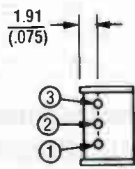

3299W Series

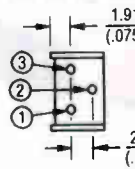

3299Y Series

1/4-Watt, 1/4" Square Trimming Potentiometers, Top Adjustment ($\pm 10\%$)

NEW

3266W Series Value Equivalents

- Resistance tolerance: $\pm 10\%$
- 12-turns nominal
- Insulation resistance: (500VDC) 1,000M Ω minimum
- Contact resistance variation: 3% or 3 Ω maximum (whichever is greater)
- Absolute min. resistance: 1% or 2 Ω maximum (whichever is greater)
- Power rating: 0.25W @ 70°C (300V maximum)

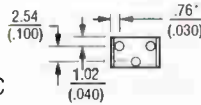

Part No.	Mfr. Cross Ref.	Ohms	1	10	50	100
254609CL	3266W-500	50	\$2.29	\$1.99	\$1.93	\$1.83
254617CL	3266W-101	100	2.29	1.99	1.93	1.83
254625CL	3266W-201	200	2.29	1.99	1.93	1.83
254633CL	3266W-501	500	2.29	1.99	1.93	1.83
254641CL	3266W-102	1k	2.29	1.99	1.93	1.83
254650CL	3266W-202	2k	2.29	1.99	1.93	1.83
254668CL	3266W-502	5k	2.29	1.99	1.93	1.83
254676CL	3266W-103	10k	2.29	1.99	1.93	1.83
254684CL	3266W-203	20k	2.29	1.99	1.93	1.83
254692CL	3266W-253	25k	2.29	1.99	1.93	1.83
254705CL	3266W-503	50k	2.29	1.99	1.93	1.83
254713CL	3266W-104	100k	2.29	1.99	1.93	1.83
254721CL	3266W-204	200k	2.29	1.99	1.93	1.83
254730CL	3266W-504	500k	2.29	1.99	1.93	1.83
254748CL	3266W-105	1M	2.29	1.99	1.93	1.83

Attention Budget-Minded Buyers!

Jameco now offers high-quality Bourns equivalents below, and they're priced to save you money. You'll get consistent form, fit and function, without paying the added surcharge for brand name components.

3296Y Series Value Equivalents

Part No.	Mfr. Cross Ref.	Ohms	1	10	50	100
240696CL	3296Y-100	10	\$1.89	\$1.69	\$1.49	\$1.35
240709CL	3296Y-200	20	1.89	1.69	1.49	1.35
240717CL	3296Y-500	50	1.89	1.69	1.49	1.35
240725CL	3296Y-101	100	1.89	1.69	1.49	1.35
240733CL	3296Y-201	200	1.89	1.69	1.49	1.35
240741CL	3296Y-501	500	1.89	1.69	1.49	1.35
240750CL	3296Y-102	1k	1.89	1.69	1.49	1.35
240768CL	3296Y-202	2k	1.89	1.69	1.49	1.35
240776CL	3296Y-502	5k	1.89	1.69	1.49	1.35
240784CL	3296Y-103	10k	1.89	1.69	1.49	1.35
240792CL	3296Y-203	20k	1.89	1.69	1.49	1.35
240805CL	3296Y-253	25k	1.89	1.69	1.49	1.35
240813CL	3296Y-503	50k	1.89	1.69	1.49	1.35
240821CL	3296Y-104	100k	1.89	1.69	1.49	1.35
240830CL	3296Y-254	250k	1.89	1.69	1.49	1.35
240848CL	3296Y-504	500k	1.89	1.69	1.49	1.35
240856CL	3296Y-105	1M	1.89	1.69	1.49	1.35
240864CL	3296Y-205	2M	1.89	1.69	1.49	1.35

3299W Series Value Equivalents

Part No.	Mfr. Cross Ref.	Ohms	1	10	50	100
241058CL	3299W-100	10	\$2.09	\$1.99	\$1.75	\$1.55
241066CL	3299W-200	20	2.09	1.99	1.75	1.55
241074CL	3299W-500	50	2.09	1.99	1.75	1.55
241082CL	3299W-101	100	2.09	1.99	1.75	1.55
241091CL	3299W-201	200	2.09	1.99	1.75	1.55
241103CL	3299W-501	500	2.09	1.99	1.75	1.55
241111CL	3299W-102	1k	2.09	1.99	1.75	1.55
241120CL	3299W-202	2k	2.09	1.99	1.75	1.55
241138CL	3299W-502	5k	2.09	1.99	1.75	1.55
241146CL	3299W-103	10k	2.09	1.99	1.75	1.55
241154CL	3299W-203	20k	2.09	1.99	1.75	1.55
241162CL	3299W-253	25k	2.09	1.99	1.75	1.55
241171CL	3299W-503	50k	2.09	1.99	1.75	1.55
241189CL	3299W-104	100k	2.09	1.99	1.75	1.55
241197CL	3299W-254	250k	2.09	1.99	1.75	1.55
241200CL	3299W-504	500k	2.09	1.99	1.75	1.55
241218CL	3299W-105	1M	2.09	1.99	1.75	1.55
241226CL	3299W-205	2M	2.09	1.99	1.75	1.55

3299Y Series Value Equivalents

Part No.	Mfr. Cross Ref.	Ohms	1	10	50	100
240872CL	3299Y-100	10	\$2.09	\$1.99	\$1.75	\$1.55
240881CL	3299Y-200	20	2.09	1.99	1.75	1.55
240899CL	3299Y-500	50	2.09	1.99	1.75	1.55
240901CL	3299Y-101	100	2.09	1.99	1.75	1.55
240910CL	3299Y-201	200	2.09	1.99	1.75	1.55
191417CL	3299Y-501	500	2.09	1.99	1.75	1.55
191396CL	3299Y-102	1k	2.09	1.99	1.75	1.55
240944CL	3299Y-202	2k	2.09	1.99	1.75	1.55
191425CL	3299Y-502	5k	2.09	1.99	1.75	1.55
240961CL	3299Y-103	10k	2.09	1.99	1.75	1.55
240979CL	3299Y-203	20k	2.09	1.99	1.75	1.55
240987CL	3299Y-253	25k	2.09	1.99	1.75	1.55
240995CL	3299Y-503	50k	2.09	1.99	1.75	1.55
191409CL	3299Y-104	100k	2.09	1.99	1.75	1.55
241015CL	3299Y-254	250k	2.09	1.99	1.75	1.55
241023CL	3299Y-504	500k	2.09	1.99	1.75	1.55
241031CL	3299Y-105	1M	2.09	1.99	1.75	1.55
241040CL	3299Y-205	2M	2.09	1.99	1.75	1.55

Bourns® Potentiometers Below

Jameco now offers a broad selection of industry-renowned Bourns multi-turn potentiometers below. They're ideal for integration into devices requiring high-precision pots.



3296Y – Y Layout Solder Pins

Part No.	Product No.	Ohms	1	10	50	100
240338CL	3296Y-1-100	10	\$2.10	\$1.89	\$1.69	\$1.49
240346CL	3296Y-1-200	20	2.10	1.89	1.69	1.49
240354CL	3296Y-1-500	50	2.10	1.89	1.69	1.49
240362CL	3296Y-1-101	100	2.10	1.89	1.69	1.49
240371CL	3296Y-1-201	200	2.10	1.89	1.69	1.49
240389CL	3296Y-1-501	500	2.10	1.89	1.69	1.49
240397CL	3296Y-1-102	1k	2.10	1.89	1.69	1.49
240400CL	3296Y-1-202	2k	2.10	1.89	1.69	1.49
240418CL	3296Y-1-502	5k	2.10	1.89	1.69	1.49
240426CL	3296Y-1-103	10k	2.10	1.89	1.69	1.49
240434CL	3296Y-1-203	20k	2.10	1.89	1.69	1.49
240442CL	3296Y-1-253	25k	2.10	1.89	1.69	1.49
240451CL	3296Y-1-503	50k	2.10	1.89	1.69	1.49
240469CL	3296Y-1-104	100k	2.10	1.89	1.69	1.49
240477CL	3296Y-1-254	250k	2.10	1.89	1.69	1.49
240485CL	3296Y-1-504	500k	2.10	1.89	1.69	1.49
240493CL	3296Y-1-105	1M	2.10	1.89	1.69	1.49
240506CL	3296Y-1-205	2M	2.10	1.89	1.69	1.49

3299W – In-Line Solder Pins

Part No.	Product No.	Ohms	1	10	50	100
238553CL	3299W-1-100	10	\$2.39	\$2.25	\$1.99	\$1.79
238561CL	3299W-1-200	20	2.39	2.25	1.99	1.79
238570CL	3299W-1-500	50	2.39	2.25	1.99	1.79
238588CL	3299W-1-101	100	2.39	2.25	1.99	1.79
238596CL	3299W-1-201	200	2.39	2.25	1.99	1.79
238609CL	3299W-1-501	500	2.39	2.25	1.99	1.79
183556CL	3299W-1-102	1k	2.39	2.25	1.99	1.79
238617CL	3299W-1-202	2k	2.39	2.25	1.99	1.79
238625CL	3299W-1-502	5k	2.39	2.25	1.99	1.79
183564CL	3299W-1-103	10k	2.39	2.25	1.99	1.79
238633CL	3299W-1-203	20k	2.39	2.25	1.99	1.79
238641CL	3299W-1-253	25k	2.39	2.25	1.99	1.79
238650CL	3299W-1-503	50k	2.39	2.25	1.99	1.79
183572CL	3299W-1-104	100k	2.39	2.25	1.99	1.79
238668CL	3299W-1-254	250k	2.39	2.25	1.99	1.79
238676CL	3299W-1-504	500k	2.39	2.25	1.99	1.79
238684CL	3299W-1-105	1M	2.39	2.25	1.99	1.79
238692CL	3299W-1-205	2M	2.39	2.25	1.99	1.79

3299Y – Y Layout Solder Pins

Part No.	Product No.	Ohms	1	10	50	100
240514CL	3299Y-1-100	10	\$2.39	\$2.19	\$1.79	\$1.59
240522CL	3299Y-1-200	20	2.39	2.19	1.79	1.59
240531CL	3299Y-1-500	50	2.39	2.19	1.79	1.59
240549CL	3299Y-1-101	100	2.39	2.19	1.79	1.59
240557CL	3299Y-1-201	200	2.39	2.19	1.79	1.59
240565CL	3299Y-1-501	500	2.39	2.19	1.79	1.59
240573CL	3299Y-1-102	1k	2.39	2.19	1.79	1.59
240581CL	3299Y-1-202	2k	2.39	2.19	1.79	1.59
240590CL	3299Y-1-502	5k	2.39	2.19	1.79	1.59
240602CL	3299Y-1-103	10k	2.39	2.19	1.79	1.59
240611CL	3299Y-1-203	20k	2.39	2.19	1.79	1.59
240629CL	3299Y-1-253	25k	2.39	2.19	1.79	1.59
240637CL	3299Y-1-503	50k	2.39	2.19	1.79	1.59
240645CL	3299Y-1-104	100k	2.39	2.19	1.79	1.59
240653CL	3299Y-1-254	250k	2.39	2.19	1.79	1.59
240661CL	3299Y-1-504	500k	2.39	2.19	1.79	1.59
240670CL	3299Y-1-105	1M	2.39	2.19	1.79	1.59
240688CL	3299Y-1-205	2M	2.39	2.19	1.79	1.59

1/2-Watt, 1/4" Round, Cermet Potentiometers Top Adjustment ($\pm 10\%$)

NEW

3329P Series Value Equivalents

- Sealed to withstand wave soldering and immersion cleaning process
- Extended temperature range: -55°C to $+150^{\circ}\text{C}$
- TO-5 grid
- Terminals: solderable pins

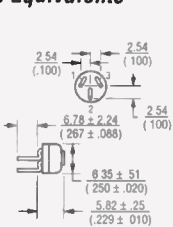

Part No.	Mfr. Cross Ref.	Ohms	1	10	50	100
254457CL	3329P-500	50	1.70	1.53	1.29	1.21
254465CL	3329P-101	100	1.70	1.53	1.29	1.21
254473CL	3329P-201	200	1.70	1.53	1.29	1.21
254481CL	3329P-501	500	1.70	1.53	1.29	1.21
254490CL	3329P-102	1k	1.70	1.53	1.29	1.21
254502CL	3329P-202	2k	1.70	1.53	1.29	1.21
254511CL	3329P-502	5k	1.70	1.53	1.29	1.21
254529CL	3329P-103	10k	1.70	1.53	1.29	1.21
254537CL	3329P-203	20k	1.70	1.53	1.29	1.21
254545CL	3329P-253	25k	1.70	1.53	1.29	1.21
254553CL	3329P-503	50k	1.70	1.53	1.29	1.21
254561CL	3329P-104	100k	1.70	1.53	1.29	1.21
254570CL	3329P-204	200k	1.70	1.53	1.29	1.21
254588CL	3329P-504	500k	1.70	1.53	1.29	1.21
254596CL	3329P-105	1M	1.70	1.53	1.29	1.21

1/2-Watt, 1/4" Square, Single-Turn Cermet Potentiometers Top Adjustment ($\pm 10\%$)

NEW

3362P Series Value Equivalents

- Resistance tolerance: $\pm 10\%$
- Insulation resistance: (500VDC) 1,000M Ω
- Absolute minimum resistance: 1% or 2 Ω (whichever is greater)
- Contact resistance variation: 1% or 3 Ω maximum (whichever is greater)
- Power rating: 0.5W @ 70 $^{\circ}\text{C}$ (300V max.)

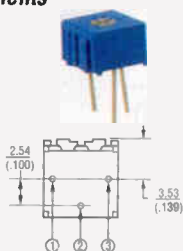

Part No.	Mfr. Cross Ref.	Ohms	1	10	50	100
253964CL	3362P-101	100	.59	.55	.45	.42
253972CL	3362P-201	200	.59	.55	.45	.42
254078CL	3362P-501	500	.59	.55	.45	.42
253981CL	3362P-102	1k	.59	.55	.45	.42
253999CL	3362P-202	2k	.59	.55	.45	.42
254086CL	3362P-502	5k	.59	.55	.45	.42
254094CL	3362P-103	10k	.59	.55	.45	.42
254001CL	3362P-203	20k	.59	.55	.45	.42
254019CL	3362P-253	25k	.59	.55	.45	.42
254027CL	3362P-503	50k	.59	.55	.45	.42
254035CL	3362P-104	100k	.59	.55	.45	.42
254107CL	3362P-204	200k	.59	.55	.45	.42
254043CL	3362P-504	500k	.59	.55	.45	.42
254115CL	3362P-105	1M	.59	.55	.45	.42

1/2-Watt, 1/4" Square, Single-Turn Cermet Potentiometers Side Adjustment ($\pm 10\%$)

NEW

3362W Series Value Equivalents

- Resistance tolerance: $\pm 10\%$
- Insulation resistance: (500VDC) 1,000M Ω
- Absolute minimum resistance: 1% or 2 Ω (whichever is greater)
- Contact resistance variation: 1% or 3 Ω maximum (whichever is greater)
- Power rating: 0.5W @ 70 $^{\circ}\text{C}$ (300V max.)

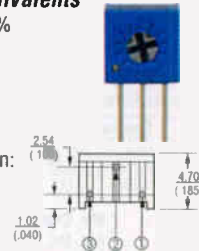

Part No.	Mfr. Cross Ref.	Ohms	1	10	50	100
254140CL	3362W-101	100	.60	.54	.45	.41
254158CL	3362W-201	200	.60	.54	.45	.41
254166CL	3362W-501	500	.60	.54	.45	.41
254174CL	3362W-102	1k	.60	.54	.45	.41
254182CL	3362W-202	2k	.60	.54	.45	.41
254191CL	3362W-502	5k	.60	.54	.45	.41
254203CL	3362W-103	10k	.60	.54	.45	.41
254211CL	3362W-203	20k	.60	.54	.45	.41
254220CL	3362W-253	25k	.60	.54	.45	.41
254238CL	3362W-503	50k	.60	.54	.45	.41
254246CL	3362W-104	100k	.60	.54	.45	.41
254254CL	3362W-204	200k	.60	.54	.45	.41
254262CL	3362W-504	500k	.60	.54	.45	.41
254271CL	3362W-105	1M	.60	.54	.45	.41

1/2-Watt, 3/8" Square, Single-Turn Trimming Potentiometers Top Adjustment ($\pm 10\%$)

NEW

3386P Series Value Equivalents

- Resistance tolerance: $\pm 10\%$
- Absolute minimum resistance: 2 Ω maximum
- Insulation resistance: (500VDC) 1,000M Ω minimum
- Contact resistance variation: 2% or 3 Ω maximum (whichever is greater)
- Power rating: 0.5W @ 85 $^{\circ}\text{C}$ (300V maximum)

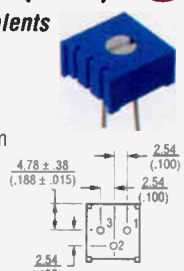

Part No.	Mfr. Cross Ref.	Ohms	1	10	50	100
254289CL	3386P-500	50	.85	.76	.67	.64
254297CL	3386P-101	100	.85	.76	.67	.64
254300CL	3386P-201	200	.85	.76	.67	.64
254318CL	3386P-501	500	.85	.76	.67	.64
254326CL	3386P-102	1k	.85	.76	.67	.64
254334CL	3386P-202	2k	.85	.76	.67	.64
254342CL	3386P-502	5k	.85	.76	.67	.64
254351CL	3386P-103	10k	.85	.76	.67	.64
254369CL	3386P-203	20k	.85	.76	.67	.64
254377CL	3386P-253	25k	.85	.76	.67	.64
254385CL	3386P-503	50k	.85	.76	.67	.64
254393CL	3386P-104	100k	.85	.76	.67	.64
254406CL	3386P-204	200k	.85	.76	.67	.64
254414CL	3386P-254	250k	.85	.76	.67	.64
254422CL	3386P-504	500k	.85	.76	.67	.64
254431CL	3386P-105	1M	.85	.76	.67	.64
254449CL	3386P-205	2M	.85	.76	.67	.64

1/2-Watt, 3/8" Square, Single-Turn Trimming Potentiometers Side Adjustment ($\pm 10\%$)

3386W Series Value Equivalents

- Resistance tolerance: $\pm 10\%$
- Insulation resistance: (500VDC) 1,000M Ω minimum
- Absolute minimum resistance: 2 Ω maximum
- Contact resistance variation: 2% or 3 Ω maximum (whichever is greater)
- Adjustment angle: 280 $^{\circ}$ nominal

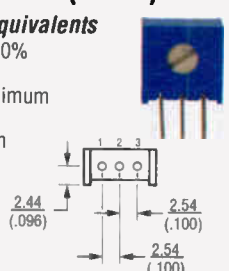

Part No.	Mfr. Cross Ref.	Ohms	1	10	50	100
241381CL	3386W-500	50	.89	.79	.69	.65
241390CL	3386W-101	100	.89	.79	.69	.65
241402CL	3386W-201	200	.89	.79	.69	.65
241411CL	3386W-501	500	.89	.79	.69	.65
241429CL	3386W-102	1k	.89	.79	.69	.65
241437CL	3386W-202	2k	.89	.79	.69	.65
241445CL	3386W-502	5k	.89	.79	.69	.65
241453CL	3386W-103	10k	.89	.79	.69	.65
241461CL	3386W-203	20k	.89	.79	.69	.65
241470CL	3386W-253	25k	.89	.79	.69	.65
241488CL	3386W-503	50k	.89	.79	.69	.65
241496CL	3386W-104	100k	.89	.79	.69	.65
241509CL	3386W-204	200k	.89	.79	.69	.65
241517CL	3386W-254	250k	.89	.79	.69	.65
241525CL	3386W-504	500k	.89	.79	.69	.65
241533CL	3386W-105	1M	.89	.79	.69	.65
241541CL	3386W-205	2M	.89	.79	.69	.65

1/2-Watt, 3/8" Square, Single-Turn Trimming Potentiometers Side Adjustment ($\pm 10\%$)

NEW

3386X Series Value Equivalents

- Resistance tolerance: $\pm 10\%$
- Insulation resistance: (500VDC) 1,000M Ω minimum
- Absolute minimum resistance: 2 Ω maximum
- Contact resistance variation: 2% or 3 Ω maximum (whichever is greater)
- Power rating: 0.5W @ 85 $^{\circ}\text{C}$ (300V max.)

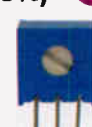
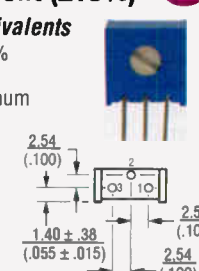

Part No.	Mfr. Cross Ref.	Ohms	1	10	50	100
264604CL	3386X-500	50	.85	.76	.67	.64
264612CL	3386X-101	100	.85	.76	.67	.64
264621CL	3386X-201	200	.85	.76	.67	.64
264639CL	3386X-501	500	.85	.76	.67	.64
264647CL	3386X-102	1k	.85	.76	.67	.64
264655CL	3386X-202	2k	.85	.76	.67	.64
264663CL	3386X-502	5k	.85	.76	.67	.64
264671CL	3386X-103	10k	.85	.76	.67	.64
264680CL	3386X-203	20k	.85	.76	.67	.64
264698CL	3386X-253	25k	.85	.76	.67	.64
264701CL	3386X-503	50k	.85	.76	.67	.64
264719CL	3386X-104	100k	.85	.76	.67	.64
264727CL	3386X-204	200k	.85	.76	.67	.64
264735CL	3386X-254	250k	.85	.76	.67	.64
264743CL	3386X-504	500k	.85	.76	.67	.64
264751CL	3386X-105	1M	.85	.76	.67	.64
264760CL	3386X-205	2M	.85	.76	.67	.64

30-Day Money-Back Guarantee

If you're not satisfied, we'll take it back! Details on page 229.

1/4-Watt Miniature Linear ($\pm 20\%$)

X201 (19/32") Vertical Mount

- 15mm thick
- Power rating: below 5k Ω - 1/4 watt @ 40°C, 5k Ω & above - 1/4 watt @ 55°C
- Total rotation: 260° $\pm 5^\circ$
- Voltage rating: 350 VDC

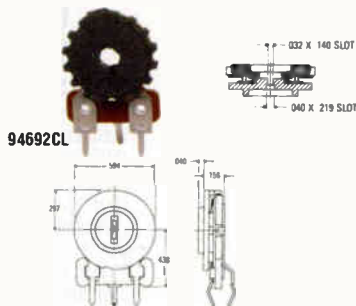

Cross Reference Chart

Equivalent to:	
CTS	X201R
Bourns	3355X
PIHER	PT15

Part No.	Mfr. Cross Ref. No.	Ohms	1	10	100	500
94692CL	X201R1K	1k	\$.45	\$.39	\$.35	\$.29
35502CL	X201R252B	2.5k	.45	.39	.35	.29
94705CL	X201R5K	5k	.45	.39	.35	.29
94713CL	X201R10K	10k	.45	.39	.35	.29
172136CL	X201R25K	25k	.45	.39	.35	.29
94721CL	X201R50K	50k	.45	.39	.35	.29
94730CL	X201R100K	100k	.45	.39	.35	.29

1/2-Watt, 3/8" Square, Single-Turn Cermet ($\pm 10\%$)

- Top adjustment
- 1/2 watt linear taper @ 70°C
- PC pins: .100" grid (2.54mm)
- Sealed to guard against contaminants
- Pin spacing: 0.1" (\uparrow P/N 43060CL & P/N 105216CL: 0.2")
- Temperature range: -55°C to +125°C

Now Lower Prices



Quantity SAVE

Cross Ref. Chart

Equivalent to:	
Allen Bradley	E2B
Beckman	72PR
Bourns	3386P
Mecopcal	8038
Murata	3104P
Spectrol	63P
VRN	780-12P
Weston	840P

Part No.	Mfr. Cross Ref. No.	Ohms	1	10	100	500
43123CL	63P500	500	\$.85	\$.79	\$.69	\$.49
42964CL	63P1K	1k	.85	.79	.69	.49
43043CL	63P2K	2k	.85	.79	.69	.49
43078CL	63P5K	5k	.85	.79	.69	.49
43001CL	63P10K	10k	.85	.79	.69	.49
43051CL	63P20K	20k	.85	.76	.61	.46
43107CL	63P50K	50k	.85	.76	.61	.42
43027CL	63P100K	100k	.85	.79	.69	.49
43060CL	63P300K \uparrow	300k	.85	.76	.61	.46
63212CL	63P500K	500k	.85	.76	.61	.42
42981CL	63P1MEG	1M	.85	.79	.69	.49
105216CL	63P2MEG \uparrow	2M	.85	.76	.61	.42

1/2-Watt Trimming Potentiometers ($\pm 10\%$)

3362P Series

- Linear taper
- Insulation resistance: 500VDC, 1,000M Ω minimum
- Absolute minimum resistance: 1% or 2 Ω maximum
- Contact resistance variation: 1% or 3 Ω maximum
- Rotational life: 200 cycles
- Terminals: solderable pins
- Top adjustment: 240° nominal

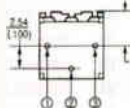

Cross Reference Chart

Equivalent to:	
Bourns	3362P
Copal	CT-6P
Murata	PVC6
Vishay	76

Part No.	Mfr. Cross Ref. No.	Ohms	1	10	100	500
191644CL	3362P-200	20	\$.69	\$.62	\$.47	\$.42
189341CL	3362P-500	50	\$.69	\$.62	\$.47	\$.42
182810CL	3362P-501	500	\$.69	\$.62	\$.47	\$.42
182828CL	3362P-502	5k	\$.69	\$.62	\$.47	\$.42
182836CL	3362P-103	10k	\$.69	\$.62	\$.47	\$.42
182844CL	3362P-204	200k	\$.69	\$.62	\$.47	\$.42
182852CL	3362P-105	1M	\$.69	\$.62	\$.47	\$.42

1/2-Watt, 1/4" Round, Cermet ($\pm 10\%$)

3329P Series Value Equivalents

- Sealed to withstand wave soldering and immersion cleaning process
- Extended temperature range: -55°C to +150°C
- TO-5 grid
- Top adjustment
- Terminals: solderable pins

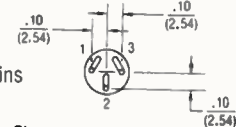

Cross Ref. Chart

Equivalent to:	
Beckman	82M
Bourns	3329P
Mecopcal	8050
MEC	471
Murata	3321P
Spectrol	62-3
VRN	171
Weston	567

Part No.	Mfr. Cross Ref. No.	Ohms	1	10	100	500
95441CL	3329P-102	1k	\$1.89	\$1.59	\$1.29	\$1.19
95450CL	3329P-502	5k	1.89	1.59	1.29	1.19
96719CL	3329P-103	10k	1.89	1.59	1.29	1.19
95484CL	3329P-104	100k	1.89	1.59	1.29	1.19

3/4-Watt, 3/4" Rectangular 15-Turn Linear Cermet ($\pm 10\%$)

- PC pins: .100" grid (2.54mm)
- Temperature range: -55°C to +125°C
- Sealed to guard against contaminants
- Side adjustment

Quantity SAVE

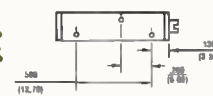

Cross Ref. Chart

Equivalent to:	
Allen Bradley	94P
Beckman	89PR
Bourns	3006P
Litton	6034Y
Mecopcal	8034
Murata	2101P
Spectrol	43P
VRN	961-20
Weston	830P

Part No.	Mfr. Cross Ref. No.	Ohms	1	10	100	500
181972CL	43P201	200	\$1.05	\$.94	\$.76	\$.57
41937CL	43P500	500	1.05	.99	.89	.75
41785CL	43P1K	1k	1.05	.99	.89	.75
41865CL	43P2K	2k	1.05	.99	.89	.75
41890CL	43P5K	5k	1.05	.99	.89	.75
41822CL	43P10K	10k	1.05	.99	.89	.75
41873CL	43P20K	20k	1.05	.99	.89	.75
41911CL	43P50K	50k	1.05	.99	.89	.75
41849CL	43P100K	100k	1.05	.99	.89	.75
63001CL	43P200K	200k	1.05	.99	.89	.75
41953CL	43P500K	500k	1.05	.99	.89	.75
41806CL	43P1MEG	1M	1.05	.99	.89	.75

1/2 and 3/4-Watt Potentiometer Kits



20-drawer component cabinet with every kit!

- Kit includes: 20-drawer component cabinet (81701CL), 20 clear plastic drawers (85454CL), 20 clear dividers (85446CL)
- Cabinet size: 6.0"L x 15.0"W x 7.9"H
- Drawer size: 5.5"L x 2.7"W x 1.5"H
- Cabinet is wall-mountable or free standing

For more kits, see pages 33-34

1/2-Watt Single Turn Cermet Pot Kit

See left (63P Series) for photos and specs.

Includes 100 pcs. (10 values) 1/2-watt Linear Taper Potentiometer

SAVE \$28

Part No.	Description	Wt. (lbs.)	1	10
85032CL	100 pcs. single turn Pot kit	4.9	\$65.95	\$58.95

3/4-Watt 15 Turn Cermet Pot Kit

See above (43P Series) for photos and specs.

Includes 100 pcs. (10 values) 3/4-watt Linear Taper Potentiometer

SAVE \$32

Part No.	Description	Wt. (lbs.)	1	10
85041CL	100 pcs. 15 turn Pot kit	4.9	\$87.95	\$78.95

Axial Leaded RF Chokes

4600 Series

- Inductive tolerance: 10%
- Test frequency: 7.9MHz
- Size: A = 6.8mm max.; B = 19.0mm max.
C = 25.0±2.0mm; D = 0.65±0.5mm



Part No.	L (µH)	Q (min.)	Res. Freq. Min. (MHz)	DCR Max. (µ)	Max. DC Current (mA)	Pricing		
						1	10	100
208063CL	1.0	60	190	.050	2000	.69	.62	.55
208071CL	1.5	58	149	.093	1800	.69	.62	.55
208080CL	2.4	56	120	.190	1500	.69	.62	.55
208098CL	3.9	60	93	.450	1000	.69	.62	.55
208101CL	5.5	57	80	.670	850	.69	.62	.55
208119CL	6.2	57	76	.830	700	.69	.62	.55
208127CL	8.2	57	65	1.2	600	.69	.62	.55
208135CL	10	36	61	1.5	500	.69	.62	.55

NTC Thermistors

- Typical applications: temperature measurement/control/compensation; power supply fan control; PCB temperature monitoring
- Operating temperature range: -30°C ~ +130°C
- Maximum allowable power (@ 250°C): 0.55W
- Thermal dissipation factor: 6.5mW/OC (@ 250°C)
- Resistance value allowable difference: 10%



Part No.	Mfr. Cross Ref. No.	Resistance (Ω @ 25°C)	B Constant (25/50°C >10%)	Temp. Coef. @ 25°C (%/°C)	Pricing			
					1	10	100	500
207520CL	NTC-101	100	3100	-3.5	.59	.49	.39	.32
207511CL	NTC-201	200	3100	-3.5	.59	.39	.32	.27
207503CL	NTC-301	300	3100	-3.5	.59	.49	.39	.32
207491CL	NTC-501	500	3100	-3.5	.59	.49	.39	.32
207482CL	NTC-102	1k	3800	-4.3	.59	.49	.39	.32
207474CL	NTC-202	2k	3800	-4.3	.59	.49	.39	.32
207466CL	NTC-302	3k	3900	-4.4	.59	.49	.39	.32
207458CL	NTC-402	4k	3900	-4.4	.59	.49	.39	.32
207440CL	NTC-502	5k	3900	-4.4	.59	.49	.39	.32
207036CL	NTC-103	10k	4100	-4.6	.59	.49	.39	.32
207028CL	NTC-153	15k	4100	-4.6	.59	.39	.32	.27
207010CL	NTC-203	20k	4200	-4.7	.59	.49	.39	.32
207001CL	NTC-503	50k	4200	-4.7	.59	.49	.39	.32
206990CL	NTC-104	100k	4400	-4.9	.59	.49	.39	.32
206981CL	NTC-204	200k	4500	-5.1	.59	.49	.39	.32

Epoxy Conformal Coated Chokes

- Operating temperature: -25°C to +85°C
- Tolerance: 5%
- Size: A = 3.2mm max.
B = 7.0mm max.
C = 0.48±0.5mm
(except P/N 208143CL: 0.50±0.05mm)
D = 63±3mm



New Lower Prices
Quantity SAVE

Part No.	L (µH)	Q (min.)	Test. Freq (MHz)	Res. Freq. Min. (MHz)	DCR Max. (µ)	Max. DC Curr. (mA)	Pricing		
							1	10	100
208143CL	10	60	7.96	28.7	1.56	670	.49	.45	.39
208151CL	27	50	2.52	10.2	2.39	410	.49	.44	.35
208160CL	33	50	2.52	8.4	2.71	380	.49	.45	.39
208178CL	47	50	2.52	6.9	3.3	330	.49	.45	.39
208186CL	82	45	2.52	5.4	4.62	240	.49	.44	.35
208194CL	100	45	2.52	5.0	4.98	240	.49	.45	.39
208207CL	220	45	0.796	3.3	9.23	180	.49	.45	.39
208215CL	330	45	0.796	2.7	13.2	140	.49	.44	.35
208223CL	470	45	0.796	2.2	21.4	120	.49	.45	.39
208231CL	820	45	0.796	1.7	28.4	90	.49	.44	.35
208240CL	1000	45	0.796	1.5	31.3	80	.49	.45	.39

High Current Toroid Inductors

- Low radiation • Low core loss
- High current capacity
- Size: A = 22.22mm max.; B = 11.09mm max.
C = 15.0±1.0mm; D = 1.2±0.5mm
- See page 151 for EMI suppression cores
- See technical datasheets on www.jameco.com for complete specifications

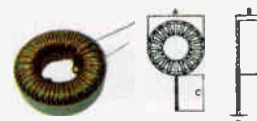

Part No.	Mfr. Cross Ref. No.	L (µH)	IDC max. (A)	L min. @ IDC	Pricing				
					1	10	25	50	100
208258CL	5701	10	11.0	5	\$3.99	\$3.05	\$2.74	\$2.26	\$2.06
208266CL	5702	25	5.5	12	3.99	3.05	2.74	2.26	2.06
208311CL	5711	50	9.5	25	4.93	3.75	3.37	2.78	2.53
208303CL	5707	75	5.0	40	4.32	3.28	2.95	2.44	2.21
208274CL	5703	125	2.75	70	3.99	3.05	2.74	2.26	2.06
208320CL	5712	150	4.75	85	4.93	3.75	3.37	2.78	2.53
208282CL	5704	275	2.0	150	3.99	3.05	2.74	2.26	2.06
208291CL	5705	450	1.5	250	4.32	3.28	2.95	2.44	2.21

Varistors

LA Series Varistors (Radial Lead)

- AC power line applications • Power supplies • High energy absorption
- UL recognized as "transient voltage surge suppressors"
- UL recognized as "across-the-line components"

Part No.	Mfr. Cross Ref. No.	Size (mm)	Max. Ratings (+85°C)			Characteristics at 25°C		Pricing				
			V _{m(ac)} Volts	V _{m(dc)} Volts	W _{tm} Joules	V	I _{pk} =2.0A Amps	1	10	100	500	
34446CL	V130LA10A	14	130	175	38	340	50	50	.29	.25	.22	.20
34471CL	V250LA20A	14	250	330	72	650	50	50	.39	.35	.32	.30
34462CL	V130LA20A	20	130	175	70	340	100	100	.59	.56	.54	.52

ZA Series Varistor (Radial Lead)

- Low DC voltage applications
- UL recognized as "transient voltage surge suppressors"
- Used for highly sensitive devices • Low transient energy
- Printed circuit board designs
- Computer equipment • Alarm systems

Part No.	Mfr. Cross Ref. No.	Size (mm)	Characteristics at 25°C			Pricing					
			Min. V _{N(dc)} Volts	Max. V Volts	I _{pk} =2.0A Amps	1	10	100	500		
190449CL	V18ZA1	7	16.0	18.0	20.0	35	2.5	.21	.17	.15	.13

NTE Varistors (Metal Oxide)

- High transient current capability—up to 6500A
- Fast response time—less than 35ns
- Excellent voltage clamping characteristics
- Very low temperature coefficient
- Low standby current
- High energy capability
- Very low leakage current
- Low capacitance • Low overshoot characteristics

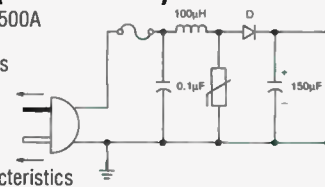

Part No.	Product No.	Size (mm)	Max. Ratings (T _a =25°C)			Characteristics at 25°C		Pricing		
			RMS Volt.	DC Volt.	Energy (10/1000µs)	V	I _{pk} =1mA Amps	1	10	25
261286CL	NTE1V020	8.5	20	26	1.5	70	250	1.03	\$.99	\$.95
261294CL	NTE1V130	8.5	30	38	2.3	95	250	1.08	1.03	.99
261307CL	NTE2V130	16.0	135	180	39.0	355	4500	1.85	1.79	1.75
261315CL	NTE2V250	16.0	240	320	70.0	630	4500	2.66	2.54	2.41
261323CL	NTE524V25	23.0	240	320	129.0	630	6500	2.40	2.35	2.29

Jameco's Low-Price Guarantee

We'll match the print advertised price of any like product. It's that simple!

Resettable Fuses

Resettable fuses improve reliability and lower costs. Polymer Positive Temperature Coefficient (PPTC) fuses have provided designers in numerous industries a new tool in their battle to improve product quality and performance. As PPTC fuses are resettable, warranty costs and service calls are largely avoided.

RA Series

- Rated voltage: (V_{MAX} , V): 60
- Max. current: (I_{MAX} , A): 40
- Lead length (D): 7.6mm (min.)
- Thickness (E): 3.1mm (min.)

Quantity
SAVE

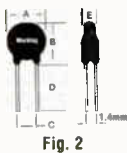

RB Series

- Rated voltage: (V_{MAX} , V): 30
- Max. current: (I_{MAX} , A): 40
- Lead length (D): 7.6mm (min.)
- Thickness (E): 3.0mm (min.)

SALE
Quantity
SAVE

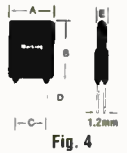
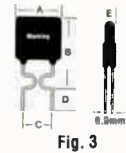

Part No.	Mfr. Cross Ref. No.	Hold Curr. (I_H , A)	Trip Curr. (I_T , A)	Fig.	Size (mm)			Pricing			
					A	B	C	1	10	100	500
199814CL	RA010-60	0.10	0.20	1	7.4	12.7	5.1	.43	\$.41	\$.39	\$.31
199822CL	RA017-60	0.17	0.34	1	7.4	12.7	5.1	.43	\$.39	\$.29	\$.25
199831CL	RA020-60	0.20	0.40	1	7.4	12.2	5.1	.43	\$.41	\$.39	\$.31
199849CL	RA025-60	0.25	0.50	1	7.4	12.7	5.1	.43	\$.41	\$.39	\$.31
199857CL	RA030-60	0.30	0.60	1	7.4	13.0	5.1	.43	\$.41	\$.39	\$.31
199865CL	RA040-60	0.40	0.80	1	7.6	13.5	5.1	.47	\$.44	\$.41	\$.31
199873CL	RA050-60	0.50	1.00	1	7.9	13.7	5.1	.49	\$.46	\$.43	\$.32
199881CL	RA065-60	0.65	1.30	1	9.7	14.5	5.1	.50	\$.47	\$.43	\$.34
199890CL	RA075-60	0.75	1.50	1	10.4	15.2	5.1	.50	\$.47	\$.43	\$.34
199902CL	RA090-60	0.90	1.80	1	11.7	15.8	5.1	.52	\$.49	\$.45	\$.30
199911CL	RA110-60	1.10	2.20	2	13.0	18.0	5.1	.57	\$.55	\$.52	\$.40
199929CL	RA135-60	1.35	2.70	2	14.5	19.6	5.1	.58	\$.56	\$.53	\$.41
199937CL	RA160-60	1.60	3.20	2	16.3	21.3	5.1	.60	\$.57	\$.54	\$.42
199945CL	RA185-60	1.85	3.70	2	17.8	22.9	5.1	.59	\$.55	\$.45	\$.39
199953CL	RA250-60	2.50	5.00	2	21.3	26.4	10.2	.70	\$.65	\$.49	\$.39
199961CL	RA300-60	3.00	6.00	2	24.9	30.0	10.2	.74	\$.67	\$.53	\$.40
199970CL	RA375-60	3.75	7.50	2	28.5	33.5	10.2	.74	\$.67	\$.53	\$.40

Part No.	Mfr. Cross Ref. No.	Hold Curr. (I_H , A)	Trip Curr. (I_T , A)	Fig.	Size (mm)			Pricing			
					A	B	C	1	10	100	500
199988CL	RB090-30	0.90	1.80	3	7.4	12.2	5.1	.48	\$.43	\$.35	\$.26
199996CL	RB110-30	1.10	2.20	3	7.4	14.2	5.1	.48	\$.43	\$.35	\$.25
200002CL	RB135-30	1.35	2.70	3	8.9	13.5	5.1	.48	\$.46	\$.43	\$.34
200011CL	RB160-30	1.60	3.20	3	8.9	15.2	5.1	.53	\$.45	\$.42	\$.31
200029CL	RB185-30	1.85	3.70	3	10.2	15.7	5.1	.48	\$.43	\$.35	\$.26
200037CL	RB250-30	2.50	5.00	3	11.4	18.3	5.1	.52	\$.48	\$.43	\$.34
200045CL	RB300-30	3.00	6.00	4	11.4	17.3	5.1	.57	\$.52	\$.48	\$.37
200053CL	RB400-30	4.00	8.00	4	14.0	20.1	5.1	.62	\$.57	\$.52	\$.40
200061CL	RB500-30	5.00	10.00	4	14.0	24.9	10.2	.67	\$.59	\$.49	\$.35
200070CL	RB600-30	6.00	12.00	4	16.5	24.9	10.2	.73	\$.67	\$.61	\$.48
200088CL	RB700-30	7.00	14.00	4	19.1	26.7	10.2	.80	\$.73	\$.67	\$.52
200096CL	RB800-30	8.00	16.00	4	21.6	29.2	10.2	.87	\$.78	\$.63	\$.47
200109CL	RB900-30	9.00	18.00	4	24.1	29.7	10.2	.89	\$.79	\$.69	\$.59

Fuse Clips

- Low contact resistance
- Low profile
- Withstands shock and vibration

Prepackaged: order in increments of 10, 100 or 1000

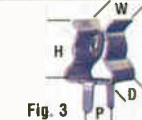

Part No.	Description	Fig.	Size (H" x W" x D" x P")	10	100	1000
102859CL	5mm, front leads	1	.37 x .25 x .21 x .19	\$.12	\$.09	\$.05
119280CL	5mm, side leads	2	.33 x .25 x .20 x .21	\$.09	\$.08	\$.07
102841CL	1/4", front leads (10A)	3	.32 x .27 x .25 x .23	\$.09	\$.08	\$.07
220732CL	5mm, front leads (10A)	3	.33 x .27 x .25 x .29	\$.15	\$.10	\$.07

1/4" x 1/4" Standard Fuses

Fast Acting Fuses (250V) AGC/3AG Fuses



• Prepackaged: order in increments of 10, 100 or 1000

Part No.	Amps	Mfr.	10	100	1000
69403CL	250mA	Various	\$.20	\$.18	\$.16
10410CL	500mA	Various	\$.20	\$.18	\$.16
197510CL	630mA	Various	\$.20	\$.18	\$.16
10372CL	1 amp	Various	\$.20	\$.12	\$.11
197528CL	1.6 amp	Various	\$.20	\$.12	\$.11
10381CL	2 amp	Various	\$.20	\$.12	\$.11
197536CL	2.5 amp	Various	\$.21	\$.12	\$.09
69438CL	3 amp	Various	\$.20	\$.12	\$.11
197544CL	4 amp	Various	\$.22	\$.20	\$.18
10401CL	5 amp	Various	\$.22	\$.20	\$.18
197552CL	6.3 amp	Various	\$.22	\$.20	\$.18
69462CL	10 amp	Various	\$.25	\$.22	\$.20
186301CL	16 amp	Various	\$.25	\$.22	\$.20

Slow Blow Fuses (250V) MDL/3AG Fuses



Part No.	Amps	Mfr.	1	10	100	1000
25654CL	250mA	Various	\$.74	\$.59	\$.50	\$.40
25689CL	500mA	Various	\$.71	\$.59	\$.50	\$.37
25638CL	1 amp	Various	\$.71	\$.59	\$.50	\$.37
25646CL	2 amp	Various	\$.54	\$.43	\$.39	\$.28
69534CL	3 amp	Various	\$.54	\$.44	\$.34	\$.28
25671CL	5 amp	Various	\$.54	\$.44	\$.34	\$.28
69569CL	10 amp	Various	\$.74	\$.65	\$.51	\$.40

5mm x 20mm Miniature Fuses

Fast Acting Fuses (250V) GMA Fuses



• Recommended for new designs
• Prepackaged: order in increments of 10, 100, 500 or 1000

Part No.	Amps	Mfr.	10	100	500	1000
103886CL	250mA	Various	\$.20	\$.15	\$.11	\$.10
102040CL	500mA	Various	\$.19	\$.15	\$.10	\$.09
103907CL	1 amp	Various	\$.20	\$.15	\$.11	\$.10
103915CL	2 amp	Various	\$.20	\$.15	\$.11	\$.10
103923CL	3 amp	Various	\$.20	\$.15	\$.11	\$.10
103931CL	5 amp	Various	\$.20	\$.15	\$.11	\$.10

Slow Blow Fuses (250V) GMA Fuses



• Prepackaged: order in increments of 10, 100 or 1000

Part No.	Amps	Mfr.	10	100	1000
197501CL	500mA	Various	\$.29	\$.26	\$.23
197464CL	1 amp	Various	\$.20	\$.15	\$.19
197472CL	2 amp	Various	\$.35	\$.32	\$.29
197481CL	3.15 amp	Various	\$.35	\$.32	\$.29
197499CL	5 amp	Various	\$.35	\$.32	\$.29

1 Amp Fuse with Pigtail

- 5mm x 20mm fuse
- 250V @ 1A
- Lead length: 1.5"
- Prepackaged: order in increments of 10 or 100



Part No.	Description	10	100
215431CL	1 Amp fuse w/ pigtail	\$.13	\$.12

Panel Mount Fuse Holders

1/4" x 1/4" Standard Thumbscrew Cap

- Straight solder terminal; 10A @ 250VAC



Part No.	Approvals	Size	Mounting Hole	1	10	100	1000
120993CL	—	1.95"L x .71"Dia. .58"Dia. (Double D-style)	.79	\$.69	\$.55	\$.49	
18702CL	UL/CSA	2.05"L x .71"Dia. .58"Dia. x .52"Flat (D-style)	1.59	1.35	1.15	.99	

5mm x 20mm Miniature Thumbscrew Cap

- Straight solder terminal; Size: 1.5" x 0.6"Dia.

Part No.	Approvals	Current	Mounting Hole	1	10	100	1000
150463CL	—	6A @ 250VAC	.50"Dia. x .43"Flat	\$.99	\$.86	\$.75	\$.57
102824CL	UL/CSA	10A @ 250VAC	.50"Dia.	.99	.85	.72	.59

In-Line Fuse Holders

- Built-in spring ensures good fuse connection
- Vinyl covered wire with stranded copper center
- Wire color: red; except for P/N 108783CL orange



1/4" x 1/4" Standard

Part No.	AWG	Wire Lgths	Body Size(L)	Body Color	1	10	100
109321CL	22	3.5/3"	2.4"	Black	\$.65	\$.58	\$.52
102867CL	20	3/3"	2.2"	White	\$.65	\$.58	\$.48
151917CL	18	6/6"	2.4"	White	\$.99	\$.85	\$.65
108783CL	16	21/26"	2.2"	Black	\$.99	\$.87	\$.68
108791CL	14	19/25"	2.5"	Black	1.59	1.19	.83

5mm x 20mm Miniature

Part No.	AWG	Wire Color	Body Size (L)	1	10	100
109330CL	20	Red	1.8"	\$.69	\$.56	\$.45

5mm x 20mm Miniature Low Profile Fuse Holder

- Accepts 5 x 20mm fuses
- 10A @ 250VAC
- Size: 1.4"L x 0.6"Dia.
- D Style mounting hole: 1 ea. 0.5"Dia x .46" flat



Part No.	Description	1	10	100
102832CL	Fuse holder UL/CSA	\$1.95	\$1.79	\$1.59

Crystals

SALE

Dimensions in millimeters

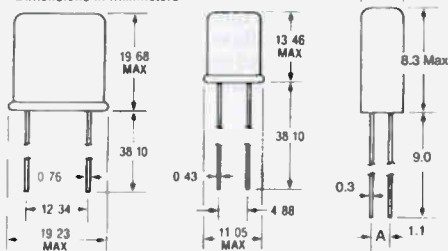

HC33/U Case HC49/U (HC18/U) Case TF Case

- Frequency calibration tolerance: $\pm 50\text{ppm}$ @ 25°C
- Operating temperature: -10°C to $+60^\circ\text{C}$
- Drive level: 4.0 mW maximum
- Frequency stability tolerance: $\pm 50\text{ppm}$ from -10°C to $+60^\circ\text{C}$
- Shunt capacitance: 7pF maximum

Quantity
SAVE

Application Reference (4-14MHz) (Parallel Resonance)

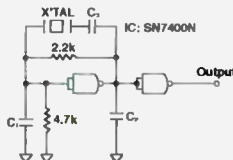

C1: 150-470 pF
C2: 220-820 pF
C3: Match crystal impedance

HC33/U Case

Part No.	Mfr. Cross Ref. No.	Frequency (MHz)	Impedance	Microprocessor	Pricing			
					1	10	100	1000
14349CL	CY1	1.0	13pF	MC6800/6808/6809E/6500 series	\$4.95	\$4.49	\$3.95	\$3.49

HC49/U (HC18/U) Case

Part No.	Mfr. Cross Ref. No.	Frequency (MHz)	Impedance	Microprocessor	Pricing			
					1	10	100	1000
102613CL	CY1.843	1.8432	18pF	MC14411/MC6802	\$0.99	\$0.72	\$0.51	\$0.39
102621CL	CY2.0	2.0	Series	2650/F-8	\$1.49 \$0.81	.79	.75	.69
101274CL	CY2.457	2.4576	32pF	CDP1702/1802C/1804/1804C	\$0.99 \$0.79	.65	.59	.49
14525CL	CY3.27	3.2768	18pF	IM6100C/CDP1802/CDP1804	.99	.89	.79	.69
14533CL	CY3.57	3.579545	18pF	MC6801.2.3/MM5369	.59	.54	.42	.39
14568CL	CY3.68	3.6864	18pF	8748/8035-8	.89	.79	.69	.59
14592CL	CY4	4.0	20pF	MCS-40/MC6802.8.9/CDP1802	.59	.54	.41	.39
14621CL	CY4.91	4.9152	Series	CDP1802C/1804/1804C	.89	.79	.69	.59
14681CL	CY6	6.0	18pF	MCS-48/IM8048	.79	.70	.59	.40
14699CL	CY6.14	6.144	30pF	MCS-85/8085	\$0.79 \$0.37	.34	.30	.25
14710CL	CY7.37	7.3728	30pF	8051/8031	.89	.80	.65	.45
14728CL	CY8	8.0	Series	IM6100A/MC68809	.89	.79	.69	.54
14381CL	CY10	10.0	Series	MCS-85/8085A-2	.79	.69	.59	.49
120061CL	CY11.05	11.0592	Series	General purpose	.89	.79	.69	.59
14402CL	CY12	12.0	Series	MCS-86/8086/8284/8202	.89	.75	.55	.39
14453CL	CY16	16.0	Series	8080/8224/general purpose	.62	.56	.45	.35
14517CL	CY20	20.0	Series	MCS-80/8080A/8224	.79	.69	.59	.39

TF Case

14584CL	CY32.76	32.768kHz	10.5pF	Tuning fork	\$0.89	\$0.79	\$0.69	\$0.59
---------	---------	-----------	--------	-------------	--------	--------	--------	--------

Low Profile Crystals

SALE

- Frequency range: 3.5 to 70.0MHz
- Operating temp.: -10°C to $+60^\circ\text{C}$
- Drive level: 0.5mW (fundamental frequency)
- Aging: $\pm 5\text{ppm/year}$ maximum
- Frequency stability tolerance: $\pm 50\text{ppm}$

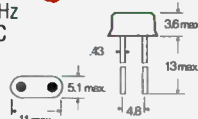

HC49/S Case

HC49/S Case (Low Profile)

Part No.	Mfr. Cross Ref. No.	Frequency (MHz)	Imped.	Max. Resist.	Microprocessor	Pricing			
						1	10	100	1000
137816CL	CY3.57LP	3.579545	17pF	150 Ω	MC6801.2.3/MM5369	\$0.95	\$0.75	\$0.59	\$0.49
137832CL	CY4LP	4.000	17pF	120 Ω	MCS-40/MC6802.8.9/CDP1802	.99	.89	.79	.69
137859CL	CY8LP	8.000	Series	60 Ω	IM6100A/MC68809	.75	.67	.59	.53
137875CL	CY11.05LP	11.0592	Series	50 Ω	General purpose	1.05	.81	.66	.52
137891CL	CY16LP	16.000	Series	40 Ω	8080/8224/general purpose	.39	.36	.29	.27

TTL Crystal Oscillators

Quantity
SAVE

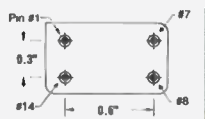

Full Can

Pin #	Function
1	N/C
7	GND
8	Output
14	+5VDC



Half Can

Pin #	Function
1	N/C
4	GND
5	Output
8	+5VDC



102779CL

Specifications:

- Input voltage: +5VDC $\pm 0.5\text{VDC}$
- OSC series oscillators fit into a 14-pin DIP socket P/N 133006CL, below
- Frequency stability $\pm 100\text{ppm}$
- Operating temperature: 0°C to 70°C

Part No.	Mfr. Cross Ref. No.	Frequency (MHz)	Size	Max Input Current	Rise Fall Time	Input Current	Pricing			
							1	10	100	1000
27861CL	OSC1	1.0	Full	7mA	15ns	45mA	\$2.75	\$2.45	\$1.59	\$1.39
27879CL	OSC1.84	1.8432	Full	7mA	15ns	45mA	2.39	2.15	1.75	1.29
27924CL	OSC2	2.0	Full	7mA	15ns	30mA	1.99	1.79	1.59	1.39
27967CL	OSC4	4.0	Full	7mA	10ns	50mA	1.99	1.79	1.59	1.39
27991CL	OSC8	8.0	Full	15mA	15ns	30mA	1.99	1.79	1.59	1.39
27887CL	OSC10	10.0	Full	15mA	10ns	20mA	1.99	1.79	1.59	1.39
102779CL	OSC10H	10.0	Half	45mA	6ns	30mA	1.45	1.05	.96	.79
144207CL	OSC11.05	11.0592	Full	50mA	10ns	30mA	\$1.99 \$1.35	1.19	.95	.89
27895CL	OSC12	12.0	Full	15mA	10ns	50mA	1.99	1.79	1.49	1.05
108652CL	OSC14.31	14.31818	Full	15mA	10ns	50mA	1.99	1.79	1.45	1.09
27908CL	OSC16	16.0	Full	15mA	10ns	50mA	1.59	1.45	1.15	.85
27932CL	OSC20	20.0	Full	17mA	10ns	20mA	1.79	1.59	1.45	1.29
27941CL	OSC32	32.0	Full	18mA	7ns	15mA	1.59	1.45	1.15	.85
76822CL	OSC33	33.0	Full	18mA	6ns	15mA	1.99	1.79	1.43	1.07
153226CL	OSC40	40.0	Full	18mA	6ns	15mA	1.79	1.59	1.45	1.29
76831CL	OSC50	50.0	Full	25mA	6ns	25mA	1.99	1.79	1.43	1.07
76857CL	OSC100	100.0	Full	25mA	3ns	90mA	2.49	2.25	1.95	1.75

14-Pin Crystal Oscillator Socket

- Can be PCB mounted without the modifications that would be needed with DIP-IC sockets
- Low profile solder tail; machine tooled on 4 pins
- Good for prototyping and PCB mounting



Part No.	Description	1	10	100	1000
133006CL	Oscillator socket	\$0.55	\$0.46	\$0.34	\$0.31

Typical Crystal Oscillator Design

An oscillator is an amplifier with a feedback loop from output to input. Barkhausen criteria states that for oscillation to occur, the product of the gains around a loop must be equal to or greater than unity and that the sum of the phase shifts around the loop must be a multiple of 360° .

These parameters will determine the crystal specifications:

- On what crystal frequency do you wish to operate?
- How much can the frequency be off at room temperature (25°C)?
- At what temperature range will the crystal operate?
- How much can the crystal change frequency over the temperature range?
- Will the crystal operate in series or parallel resonance modes?
- If operated at parallel, what is the parallel capacitance in picofarads (pF)?
- Is pullability important? • What holder type or can size do you require?

Belden Coaxial Cables

Compare Belden coaxial cables with the other companies who produce them and you will discover the obvious: Belden has no equal. That's because Belden coaxial cables are time-tested for performance. Performance that guarantees outstanding value. Belden guarantees this level of performance because every cable is tested with equipment that simulates every known environmental and electrical performance condition. As a result, Belden coaxial cable can be counted on for positive, reliable, and trouble-free operation. Engineered in a wide selection of sizes and materials, with each offering the benefits needed for physical, electrical and cost-requirement applications. Cable choices include broadband, standard analog, precision video for analog and digital, and more. For our complete line of Belden products, please visit www.jameco.com/Belden.

50Ω Transmission and Computer Cable RG8/U Type

16 AWG stranded (19x29) .058" bare copper

- 95% bare copper braid shield
- Foam polyethylene insulation and black PVC jacket
- Nominal capacitance: 81.4pF/m • Nominal impedance: 50Ω
- Nominal outer diameter: .042" • Color: black - 10



Part No.	Product No.	Description	1	5	10
234254CL	9258-100-10	100' reel	\$58.34	\$54.60	\$43.17
234256CL	9258-500-10	500' reel	216.53	212.10	198.74
234255CL	9258-1000-10	1000' reel	433.13	424.19	338.37
234258CL	9258-U500-10	500' unreel box	216.53	212.10	198.74
234257CL	9258-U1000-10	1000' unreel box	433.13	424.19	338.37

13 AWG stranded (7 x 21) .085" bare copper

- 97% bare copper braid shield
- Polyethylene insulation and black PVC jacket
- Nominal capacitance: 93.5pF/m • Nominal impedance: 52Ω
- Nominal outer diameter: .405" • Color: black - 10



Part No.	Product No.	Description	1	5	10
232848CL	8237-100-10	100' reel	\$115.43	\$103.93	\$94.02
232856CL	8237-500-10	500' reel	432.67	392.31	380.59
232864CL	8237-1000-10	1000' reel	801.73	717.63	661.56

11 AWG stranded (7 x 19) .108" bare copper

- 97% bare copper braid shield
- Foam polyethylene insulation and black PVC jacket
- Nominal capacitance: 85.3pF/m • Nominal impedance: 50Ω
- Nominal outer diameter: .285" • Color: black - 10



Part No.	Product No.	Description	1	5	10
232750CL	8214-100-10	100' reel	\$120.71	\$108.91	\$99.89
232768CL	8214-500-10	500' reel	523.46	475.85	436.24
232776CL	8214-1000-10	1000' reel	953.80	874.24	805.22

50Ω Transmission and Computer Cable RG58A/U Type

20 AWG solid .032" bare copper

- 95% tinned copper braid shield
- Polyethylene insulation and black PVC jacket
- Nominal capacitance: 93.5pF/m • Nominal impedance: 51.5Ω
- Nominal outer diameter: .193" • Color: black - 10



Part No.	Product No.	Description	1	5	10
232872CL	8240-100-10	100' reel	\$41.26	\$36.39	\$33.03
232881CL	8240-500-10	500' reel	139.12	124.97	113.61
232899CL	8240-1000-10	1000' reel	261.25	237.71	214.51
234175CL	8240-U500-10	500' unreel box	140.68	127.52	115.96
234174CL	8240-U1000-10	1000' unreel box	281.25	255.11	242.35

20 AWG stranded (19 x 33) .035" tinned copper

- 95% tinned copper braid shield
- Polyethylene insulation and black PVC jacket
- Nominal capacitance: 101pF/m • Nominal impedance: 50Ω
- Nominal outer diameter: .192" • Color: black - 10



Part No.	Product No.	Description	1	5	10
232936CL	8259-100-10	100' reel	\$43.45	\$38.57	\$35.32
232944CL	8259-500-10	500' reel	137.30	131.46	119.60
232952CL	8259-1000-10	1000' reel	238.95	215.99	194.49

20 AWG stranded (19 x 32) .037" tinned copper

- 96% tinned copper braid shield
- Foam polyethylene insulation and black PVC jacket
- Nominal capacitance: 86.9pF/m • Nominal impedance: 53.5Ω
- Nominal outer diameter: .194" • Color: black - 10



Part No.	Product No.	Description	1	5	10
232813CL	8219-100-10	100' reel	\$36.84	\$34.99	\$33.26
232821CL	8219-500-10	500' reel	159.96	151.55	143.13
232830CL	8219-1000-10	1000' reel	269.75	254.75	242.15

50Ω Transmission and Computer Cable RG174/U Type

26 AWG stranded (7 x 34) .019" bare copper-covered steel

- 90% tinned copper braid shield
- Polyethylene insulation and black PVC jacket
- Nominal capacitance: 101pF/m • Nominal impedance: 50Ω
- Nominal outer diameter: .110" • Color: black - 10



Part No.	Product No.	Description	1	5	10
232784CL	8216-100-10	100' reel	\$35.46	\$32.17	\$29.37
232792CL	8216-500-10	500' reel	123.06	111.60	102.24
232805CL	8216-1000-10	1000' reel	221.64	209.37	197.03

75Ω Broadband Coax CATV Cable RG6/U Type

18 AWG solid .040" bare copper-covered steel

- Duobond® II +60% aluminum braid shield
- Gas injected foam polyethylene insulation and black PVC jacket
- Nominal capacitance: 53.1pF/m • Nominal impedance: 75Ω
- Nominal outer diameter: .270" • Color: black - 10



Part No.	Product No.	Description	1	5	10
233269CL	9116-100-10	100' reel	\$21.39	\$17.97	\$16.23
233277CL	9116-500-10	500' reel	58.56	51.40	48.73
233285CL	9116-1000-10	1000' reel	102.56	92.21	83.00

18 AWG solid .040" bare copper-covered steel

- DuoBond® IV quad shield
- Gas injected foam polyethylene insulation and black PVC jacket
- Nominal capacitance: 53.1pF/m • Nominal impedance: 75Ω
- Nominal outer diameter: .298" • Color: black - 10



Part No.	Product No.	Description	1	5	10
232733CL	1189A-100-10	100' reel	\$24.61	\$20.67	\$18.62
233402CL	1189A-500-10	500' reel	87.14	76.27	68.68
232741CL	1189A-1000-10	1000' reel	152.58	137.34	123.60
234052CL	1189A-U500-10	500' unreel box	87.14	76.27	68.68

Precision Video Cable for Analog and Digital RG6 Type

18 AWG solid .040" bare copper

- DuoFoil® +95% tinned copper braid shield
- Gas injected foam HDPE insulation, PVC jacket
- Nominal capacitance: 53.1pF/m • Nominal impedance: 75Ω
- Nominal outer diameter: .275" • Color: black - 10



Part No.	Product No.	Description	1	5	10
234099CL	1694A-100-10	100' reel	\$67.26	\$63.76	\$60.60
234155CL	1694A-500-10	500' reel	225.99	205.15	186.29
234154CL	1694A-1000-10	1000' reel	483.63	443.31	391.29

Direct Broadcast Satellite RG6 Type Cable

18 AWG solid .040" bare copper

- DuoBond® II +60% aluminum braid
- Gas injected foam polyethylene insulation, PVC jacket
- Nominal capacitance: 16.2pF/m
- Nominal impedance: 75Ω
- Nominal outer diameter: .270"



Part No.	Product No.	Description	1	5	10
234156CL	1829AC-100-10	100' reel	\$12.23	\$11.65	\$11.04
234177CL	1829AC-500-10	500' reel	58.66	55.56	52.86
234157CL	1829AC-1000-10	1000' reel	111.53	105.94	100.70

Composite Data, Audio, Video, Security and Control Cable

Two RG6 18 AWG solid bare copper conductor and two 4-pair UTP 24 AWG solid bare copper conductor

- Banana Peel™ jacketless cables
- Gas injected FPR insulation coax cable, polyolefin insulation CAT5e cable and F-R PVC jackets
- Component nominal outer diameter: .200"



Part No.	Product No.	Description	1	5	10
234163CL	7913S-500	500' reel	\$290.69	\$276.18	\$262.33
234162CL	7913S-1000	1000' reel	553.66	525.96	499.72

Belden Coaxial Cables (Continued)

75Ω Standard Analog Video Cable RG59/U Type

23 AWG solid .023" bare copper

- 95% bare copper braid shield
- Polyethylene insulation and black PVC jacket
- Nominal capacitance: 67.3pF/m • Nominal impedance: 75Ω
- Nominal outer diameter: .242" • Color: black - 10



Part No.	Product No.	Description	1	5	10
232901CL	8241-100-10	100' reel	\$44.55	\$40.25	\$36.62
232910CL	8241-500-10	500' reel	118.81	107.71	97.91
232928CL	8241-1000-10	1000' reel	233.26	211.92	192.49

22 AWG stranded (7 x 30) .030" bare copper

- 95% bare copper braid shield
- Foam polyethylene insulation and black PVC jacket
- Nominal capacitance: 56.7pF/m • Nominal impedance: 75Ω
- Nominal outer diameter: .241" • Color: black - 10



Part No.	Product No.	Description	1	5	10
232653CL	9259-100-10	100' reel	\$50.25	\$40.63	\$39.12
232661CL	9259-500-10	500' reel	131.65	107.70	102.36
232670CL	9259-1000-10	1000' reel	264.56	216.71	204.74
234070CL	9259-U500-10	500' unreel box	172.60	156.49	151.17
234069CL	9259-U1000-10	1000' unreel box	327.95	297.30	287.19

RG59 Type Security Coaxial Cable

20 AWG solid bare copper conductor

- 95% bare copper braid shield
- Nominal impedance: 75Ω
- Foam polyolefin insulation and black UV resistant PVC jacket
- Impregnated with CoreGuard® flame retardant flooding compound
- Shielded or flooded for use in underground ducts
- Surveillance and CCTV applications • Color: black - 10



Part No.	Product No.	Description	1	5	10
234158CL	543945-100-10	100' reel	\$13.83	\$13.18	\$12.51
234160CL	543945-500-10	500' reel	64.94	61.98	58.92
234159CL	543945-1000-10	1000' reel	129.61	103.70	97.73

Standard Analog Video Cable 75Ω Miniature Coax

27 AWG stranded (7x35) .017" bare copper-covered steel

- Polyethylene insulation and black PVC jacket
- Nominal capacitance: 67.3pF/m
- Nominal impedance: 75Ω
- Nominal outer diameter: .100" • Color: black - 10



Part No.	Product No.	Description	1	5	10
234173CL	8218-U500-10	500' unreel box	\$179.71	\$162.83	\$148.01
234172CL	8218-U1000-10	1000' unreel box	359.24	325.95	309.66

Broadband Coax (Headend/Video Cables)

20 AWG solid .031" bare copper

- 98% tinned copper double braid shield
- Polyethylene insulation and jacket
- Nominal capacitance 68.9pF/m • Nominal impedance: 75Ω
- Nominal outer diameter: .305" • Color: black - 10



Part No.	Product No.	Description	1	5	10
232961CL	8281-100-10	100' reel	\$96.23	\$80.49	\$72.44
232979CL	8281-500-10	500' reel	373.83	339.21	305.29
232987CL	8281-1000-10	1000' reel	679.79	623.13	575.19

20 AWG solid .032" solid bare copper

- Duofoil™ +95% tinned copper braid shield
- Gas injected foam HDPE insulation and PVC jacket
- Nominal capacitance: 53.5pF/m • Nominal impedance: 75Ω
- Nominal outer diameter: .234" • Color: black - 10



Part No.	Product No.	Description	1	5	10
234086CL	1505A-100-10	100' reel	\$51.38	\$48.86	\$46.39
234088CL	1505A-500-10	500' reel	210.95	184.73	174.84
234087CL	1505A-1000-10	1000' reel	399.10	362.14	342.82

Belden Speaker Cables

These speaker cables are used to connect receivers or power amplifiers to speakers and are also used for the internal wiring of the speakers. All Belden speaker cables utilize only high-conductivity copper produced by a process called Electrolytic Tough Pitch (ETP). This refining process produces a conductor that is 99.95% pure copper resulting in high-conductivity per ASTM B115.

Electrolytic Tough Pitch (ETP) High Conductivity Copper Speaker Cables

- 2-conductor stranded
- ETP high conductivity copper
- Parallel (1) tinned (1) bare
- PVC insulation • Clear PVC jacket - 368



18 AWG Stranded (16 x 30)

Part No.	Product No.	Description	1	5	10
232573CL	9708-100-368	100' reel	\$32.59	\$29.48	\$26.79
232581CL	9708-500-368	500' reel	119.86	113.82	107.51
232590CL	9708-1000-368	1000' reel	227.62	214.99	202.33
234153CL	9708-U500-368	500' unreel box	119.50	113.22	106.98
234080CL	9708-U1000-368	1000' unreel box	227.62	213.79	202.33

14 AWG Stranded (19 x 27)

Part No.	Product No.	Description	1	5	10
232602CL	9717-100-368	100' reel	\$65.51	\$55.09	\$49.45
233429CL	9717-500-368	500' reel	255.71	242.25	218.04
232611CL	9717-1000-368	1000' reel	459.27	433.66	390.41

12 AWG Stranded (65 x 30)

Part No.	Product No.	Description	1	5	10
232629CL	9718-100-368	100' reel	\$153.08	\$128.60	\$115.73
232637CL	9718-500-368	500' reel	405.25	358.42	310.77
232645CL	9718-1000-368	1000' reel	813.00	728.00	664.72

Belden Hook-up Wire

UL AWM Style 1007

Belden hook-up and lead wire products are manufactured in a variety of materials, sizes, and designs to meet rigid industry and government specifications. Used in a wealth of applications including inter-connection circuits, internal wiring of computer and data processing equipment, appliances, and automotive. AWM, or Appliance Wiring Material, is Underwriter Laboratories' recognized covering of insulated wires and cables intended for internal wiring of appliances and equipment.

- Tinned copper • PVC insulated
- Rated 105°C, 300V; 600V peak for electronic circuits and electrical equipment
- Increments of 100' reels



Use the color code chart below to replace the "xx" when ordering

01 - Brown	02 - Red	03 - Orange	04 - Yellow	05 - Green
07 - Violet	08 - Gray	09 - White	10 - Black	13 - Dark blue

e.g. 234601CL - 2346 is the Jameco designation for 28 AWG stranded wire and 01 is for color brown

Part No.	Product No.	Description	1	5	10
2346xxCA	9928-100-xx	28 AWG (7 x 36) stranded	\$11.46	\$10.37	\$9.45
2345xxCA	9926-100-xx	26 AWG (7 x 34) stranded	12.29	11.13	10.10
2344xxCA	9923-100-xx	24 AWG (7 x 32) stranded	12.88	11.72	10.61
2343xxCA	9921-100-xx	22 AWG (7 x 30) stranded	14.77	13.51	12.26
2342xxCA	9919-100-xx	20 AWG (7 x 28) stranded	18.26	16.59	15.10
2341xxCA	9918-100-xx	18 AWG (16 x 30) stranded	20.40	19.20	16.79
2340xxCA	9916-100-xx	16 AWG (26 x 30) stranded	29.35	26.70	24.25

Bus Bar Hook Up Wire

Made in accordance with the performance requirements of Federal Specifications QQ-W343G.

- Solid tinned copper, single conductor
- Nominal outer diameter: 24 AWG - .021"; 22 AWG - .026"; 20 AWG - .033"



Part No.	Product No.	Description	1	5	10
234168CL	8022-100	24 AWG, 100' reel	\$10.68	\$9.68	\$8.79
234169CL	8022-1000	24 AWG, 1000' reel	57.12	46.52	42.96
234166CL	8021-100	22 AWG, 100' reel	11.77	9.43	8.54
234167CL	8021-1000	22 AWG, 1000' reel	72.14	65.53	59.52
234164CL	8020-100	20 AWG, 100' reel	13.56	12.34	11.22
234165CL	8020-1000	20 AWG, 1000' reel	93.29	80.16	71.76

Belden Paired Cables

Belden cable products are manufactured in a variety of gauge sizes, dimensions, insulation materials, shielding configurations, and jacketing materials including PVC, PLENUM and High-Temperature versions to meet the technical requirements of many different types of systems. Paired cables allow balanced signal transmission, which results in lower crosstalk through common mode rejection. Due to the improved noise immunity of twisted pairs, they generally permit higher data speeds than other multi-conductor cables. For our complete line of Belden products, please visit www.Jameco.com/Belden.

- Chrome PVC jacket • Tinned copper • Twisted pairs • Tinned copper drain wire • Overall 100% BELDFOIL® shield (for shielded cables)

High-Temperature Control, Instrumentation Cables and Computer Cables

24 AWG stranded (7 x 32) shielded with 24 AWG stranded TC drain wire

- Semi-rigid PVC insulation • Nominal DCR: 24Ω/m
- Nominal impedance: 75Ω • Color: chrome – 60



9501 Series



9502 Series			9503 Series			9504 Series		
Part No.	Product No.	No. of Pairs	Description	1	5	10		
232709CL	9501-100-60	1	100' reel	\$13.00	\$12.04	\$10.92		
232717CL	9501-500-60	1	500' reel	61.34	57.95	54.60		
232725CL	9501-1000-60	1	1000' reel	121.42	114.22	107.75		
234073CL	9501-U500-60	1	500' unreel box	64.98	61.52	58.17		
234072CL	9501-U1000-60	1	1000' unreel box	123.10	116.22	109.49		
232451CL	9502-100-60	2	100' reel	21.67	19.60	17.83		
232469CL	9502-500-60	2	500' reel	100.01	94.75	89.51		
232477CL	9502-1000-60	2	1000' reel	194.48	181.38	173.02		
234075CL	9502-U500-60	2	500' unreel box	100.01	94.75	89.51		
234074CL	9502-U1000-60	2	1000' unreel box	194.48	181.38	173.02		
232485CL	9503-100-60	3	100' reel	25.70	23.77	21.54		
232493CL	9503-500-60	3	500' reel	114.75	108.69	102.65		
232506CL	9503-1000-60	3	1000' reel	253.22	239.04	226.90		
234077CL	9503-U500-60	3	500' unreel box	130.19	123.31	116.46		
234076CL	9503-U1000-60	3	1000' unreel box	233.19	210.69	199.99		
232514CL	9504-100-60	4	100' reel	32.07	26.29	24.09		
232522CL	9504-500-60	4	500' reel	159.12	150.73	142.39		
232531CL	9504-1000-60	4	1000' reel	293.47	239.85	226.74		
232549CL	9505-100-60	5	100' reel	35.94	29.33	26.98		
232557CL	9505-500-60	5	500' reel	178.21	168.80	159.41		
232565CL	9505-1000-60	5	1000' reel	347.36	327.20	310.84		
234078CL	9505-U500-60	5	500' unreel box	177.67	168.29	158.93		
234079CL	9505-U1000-60	5	1000' unreel box	344.67	325.52	309.24		

Low Capacitance Computer Cables

24 AWG stranded (7 x 32) shielded with 24 AWG stranded TC drain wire

- Datalene® insulation, chrome PVC jacket
- Nominal DCR: 24Ω/m
- Nominal impedance: 100Ω
- Color: chrome – 60



Part No.	Product No.	No. of Pairs	Description	1	5	10
234178CL	1419A-100-60	2	100' reel	\$20.14	\$18.46	\$16.67
234085CL	1419A-500-60	2	500' reel	95.78	87.75	79.85
234084CL	1419A-1000-60	2	1000' reel	147.49	134.95	122.95

Audio, Control, and Instrumentation Cables Non-Plenum

22 AWG stranded (7 x 30) shielded with 22 AWG stranded TC drain wire

- Polypropylene insulation
- Paper wrap
- Black PVC jacket
- Nominal capacitance: 111pF/m
- Nominal outer diameter: .138" • Color: black – 10



Part No.	Product No.	No. of Pairs	Description	1	5	10
233111CL	8451-100-10	1	100' reel	\$19.44	\$17.68	\$16.08
233120CL	8451-500-10	1	500' reel	86.55	78.55	71.38
233138CL	8451-1000-10	1	1000' reel	135.99	124.65	115.15
234062CL	8451-U500-10	1	500' unreel box	88.61	78.92	72.86
234061CL	8451-U1000-10	1	1000' unreel box	174.95	158.76	144.20

Audio, Control, and Instrumentation Cables Non-Plenum (Cont'd)

22 AWG stranded (7 x 30) shielded with 22 AWG stranded TC drain wire

- Polypropylene insulation • PVC jacket
- Nominal capacitance: 111pF/m
- Nominal outer diameter: .135"
- Color: gray – 08



Part No.	Product No.	No. of Pairs	Description	1	5	10
232688CL	9451-100-08	1	100' reel	\$23.93	\$22.53	\$20.97
232696CL	9451-500-08	1	500' reel	90.29	79.09	71.19
233411CL	9451-T1000-08	1	1000' reel	144.77	131.45	123.09

22 AWG stranded (7 x 30) shielded with 22 AWG stranded TC drain wire

- Polyethylene insulation and chrome PVC jacket
- Nominal capacitance: 79pF/m
- Nominal outer diameter: .175"
- Color: chrome – 60



Part No.	Product No.	No. of Pairs	Description	1	5	10
234190CL	8761-500-60	1	500' reel	\$95.57	\$86.69	\$78.89
234189CL	8761-1000-60	1	1000' reel	173.74	159.25	147.65
234192CL	8761-U500-60	1	500' unreel box	95.57	86.69	78.89
234191CL	8761-U1000-60	1	1000' unreel box	148.56	137.39	135.16

22 AWG stranded (7 x 30) shielded with 24 AWG stranded TC drain wire

- Polypropylene insulation
- Nominal capacitance: 115pF/m
- Nominal outer diameter: .168"
- Color: chrome – 60



Part No.	Product No.	No. of Pairs	Description	1	5	10
234179CL	8723-100-60	2	100' reel	\$21.96	\$19.93	\$18.13
234181CL	8723-500-60	2	500' reel	95.94	86.12	79.42
234180CL	8723-1000-60	2	1000' reel	200.07	183.32	169.19
234183CL	8723-U500-60	2	500' unreel box	87.56	82.77	77.98
234182CL	8723-U1000-60	2	1000' unreel box	169.49	139.95	132.95

20 AWG stranded (7 x 28) unshielded

- Chrome PVC jacket
- Color: chrome – 60



Part No.	Product No.	No. of Pairs	Description	1	5	10
234171CL	8205-U500-60	1	500' unreel box	\$63.49	\$53.04	\$51.96
234170CL	8205-U1000-60	1	1000' unreel box	104.49	102.66	101.70

20 AWG stranded (7 x 28) shielded with 22 AWG stranded TC drain wire

- Semi-rigid PVC insulation and overall chrome PVC jacket
- Nominal capacitance: 180pF/m
- Nominal outer diameter: .300"
- Color: chrome – 60



Part No.	Product No.	No. of Pairs	Description	1	5	10
234259CL	9402-100-60	2	100' reel	\$59.12	\$56.76	\$53.21
234261CL	9402-U500-60	2	500' unreel box	236.53	227.96	212.87
234260CL	9402-1000-60	2	1000' reel	473.06	455.91	432.85

18 AWG stranded (16 x 30) shielded with 20 AWG stranded TC drain wire

- Tinned copper, twisted pair
- Polyethylene insulation with chrome PVC jacket
- Nominal capacitance: 79pF/m
- Nominal outer diameter: .222"
- Color: chrome – 60



Part No.	Product No.	No. of Pairs	Description	1	5	10
234184CL	8760-100-60	1	100' reel	\$43.45	\$36.46	\$34.80
234186CL	8760-500-60	1	500' reel	120.27	109.09	98.39
234185CL	8760-1000-60	1	1000' reel	218.55	200.45	184.92
234188CL	8760-U500-60	1	500' unreel box	120.22	109.27	100.49
234187CL	8760-U1000-60	1	1000' unreel box	225.72	199.39	184.06

Belden Paired Line Level Analog Audio Cable

20 AWG stranded (7 x 28) with 20 AWG stranded TC drain wire

- Polyethylene insulation with chrome PVC jacket
- Nominal capacitance: 89pF/m
- Nominal outer diameter: .204"
- Color: chrome - 60



Part No.	Product No.	No. of Pairs	Description	1	5	10
234194CL	8762-100-60	1	100' reel	\$23.95	\$21.70	\$19.71
234196CL	8762-500-60	1	500' reel	79.99	77.55	74.95
234195CL	8762-1000-60	1	1000' reel	210.03	198.39	186.70
234198CL	8762-U500-60	1	500' unreel box	99.19	94.29	89.49
234197CL	8762-U1000-60	1	1000' unreel box	187.91	175.78	169.72

16 AWG stranded (19 x 29) shielded with 18 AWG stranded TC drain wire

- Polyethylene insulation
- Nominal capacitance: 75pF/m
- Nominal outer diameter: .313"
- Color: chrome - 60



Part No.	Product No.	No. of Pairs	Description	1	5	10
233146CL	8719-100-60	1	100' reel	\$62.86	\$52.77	\$47.48
233154CL	8719-500-60	1	500' reel	198.65	180.24	163.88
233162CL	8719-1000-60	1	1000' reel	362.09	331.16	305.62
234064CL	8719-U500-60	1	500' unreel box	202.83	184.06	167.08
234063CL	8719-U1000-60	1	1000' unreel box	362.09	331.16	305.62

14 AWG stranded (19 x 27) shielded with 16 AWG stranded TC drain wire

- Polyethylene insulation
- Nominal capacitance: 79pF/m
- Nominal outer diameter: .355"
- Color: chrome - 60



Part No.	Product No.	No. of Pairs	Description	1	5	10
233171CL	8720-100-60	1	100' reel	\$61.38	\$51.52	\$46.38
233189CL	8720-500-60	1	500' reel	237.17	215.15	195.46
233197CL	8720-1000-60	1	1000' reel	431.14	395.33	364.81
234065CL	8720-U500-60	1	500' unreel box	237.17	215.15	195.46

Belden Paired DataTwist® Category 5e UTP Cable

TIA/EIA - 568-B.2, unbonded-pair cable

- 4 pair unshielded
- 24 AWG solid
- Maximum DCR per 100m - 9.38Ω
- Input impedance: 100Ω



1585A series:

- Plenum, FEP Teflon® insulation, Flamarrrest® jacket
- Nominal outer diameter: .200"

1583A series:

- Non-plenum, polyolefin insulation, PVC jacket,
- Nominal outer diameter: .214"

Part No.	Product No.	Color	Description	1	5	10
234092CL	1585A-100-877	Natural	100' reel	\$32.19	\$30.61	\$29.07
234094CL	1585A-500-877	Natural	500' reel	153.04	145.61	138.31
234093CL	1585A-1000-877	Natural	1000' reel	292.79	278.19	266.75
234095CL	1585A-U1000-877	Natural	1000' unreel box	206.83	170.32	161.80
234096CL	1585A-U100-D15	Blue	100' unreel box	32.24	30.66	29.15
234098CL	1585A-U500-D15	Blue	500' unreel box	153.69	146.03	138.72
234097CL	1585A-U1000-D15	Blue	1000' unreel box	292.79	278.14	264.27
234089CL	1583A-100-06	Blue	100' reel	9.93	9.03	8.09
234176CL	1583A-500-06	Blue	500' reel	47.32	42.32	38.99
234090CL	1583A-1000-06	Blue	1000' reel	90.08	81.76	74.26
234091CL	1583A-U1000-06	Blue	1000' unreel box	90.08	81.76	74.26

Belden Multi-Conductor Audio, Control, and Instrumentation Cables Non-Plenum

22 AWG stranded (7 x 30) shielded with 22 AWG stranded TC drain wire

- Polyethylene insulation
- Nominal capacitance: 75pF/m
- Nominal outer diameter: .199"
- Color: chrome - 60

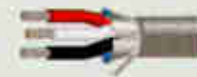

Part No.	Product No.	Conductors	Description	1	5	10
233234CL	8771-100-60	3	100' reel	\$36.36	\$30.55	\$27.49
233242CL	8771-500-60	3	500' reel	99.53	94.53	89.10
233251CL	8771-1000-60	3	1000' reel	193.82	182.80	172.09
234067CL	8771-U500-60	3	500' unreel box	99.53	94.35	89.10
234066CL	8771-U1000-60	3	1000' unreel box	193.82	182.80	172.09

22 AWG stranded (7 x 30) unshielded

- PVC insulation
- Color: chrome - 60



Part No.	Product No.	Conductors	Description	1	5	10
232995CL	8442-100-60	2	100' reel	\$11.21	\$10.10	\$9.22
233007CL	8442-500-60	2	500' reel	51.62	48.91	46.21
233015CL	8442-1000-60	2	1000' reel	99.00	94.80	89.21
234054CL	8442-U500-60	2	500' unreel box	52.73	49.97	47.13
234053CL	8442-U1000-60	2	1000' unreel box	99.00	94.80	89.21
233023CL	8443-100-60	3	100' reel	15.69	14.23	12.96
233031CL	8443-500-60	3	500' reel	72.78	68.96	65.14
233040CL	8443-1000-60	3	1000' reel	141.46	133.63	125.75
234056CL	8443-U500-60	3	500' unreel box	74.29	70.40	66.46
234055CL	8443-U1000-60	3	1000' unreel box	141.46	133.63	125.75
233058CL	8444-100-60	4	100' reel	20.10	18.22	16.58
233066CL	8444-500-60	4	500' reel	92.98	88.06	83.19
233074CL	8444-1000-60	4	1000' reel	180.79	170.72	160.71
234058CL	8444-U500-60	4	500' unreel box	92.98	88.06	83.19
234057CL	8444-U1000-60	4	1000' unreel box	180.79	170.72	160.71
233082CL	8445-100-60	5	100' reel	25.11	22.76	20.69
233091CL	8445-500-60	5	500' reel	124.79	113.45	103.97
233103CL	8445-1000-60	5	1000' reel	226.06	213.48	200.96
234060CL	8445-U500-60	5	500' unreel box	128.62	104.86	96.63
234059CL	8445-U1000-60	5	1000' unreel box	256.13	232.37	210.02

20 AWG stranded (7 x 28) shielded with 20 AWG stranded TC drain wire

- Polyethylene insulation and chrome PVC jacket
- Nominal capacitance: 89pF/m
- Nominal outer diameter: .218"
- Color: chrome - 60



Part No.	Product No.	Conductors	Description	1	5	10
234253CL	8772-U500-60	3	500' unreel box	\$110.58	\$104.44	\$98.29
234252CL	8772-U1000-60	3	1000' unreel box	245.75	226.04	203.48

18 AWG stranded (16 x 30) shielded with 20 AWG stranded TC drain wire

- Polyethylene insulation
- Nominal capacitance: 79pF/m
- Nominal outer diameter: .246"
- Color: chrome - 60



Part No.	Product No.	Conductors	Description	1	5	10
233200CL	8770-100-60	3	100' reel	\$61.49	\$51.63	\$38.08
233218CL	8770-500-60	3	500' reel	165.65	150.32	136.56
233226CL	8770-1000-60	3	1000' reel	306.87	290.73	265.35
234083CL	8770-U500-60	3	500' unreel box	169.10	153.45	139.47
234082CL	8770-U1000-60	3	1000' unreel box	313.51	297.00	282.13

Belden® Cable Now at Jameco!

Professionals don't take chances when it comes to cables, so here's great news. Now you can get your Belden cables from Jameco. The undisputed leader in quality cabling, Belden is the cable of choice for critical applications like Internet, intranet and communication network backbones. We offer the Belden cable of your choice in reels ranging from 100' to 1,000'. You'll find a wide variety of cable types, stranded and solid core, single and multi-conductor, coax, and more. And you'll find them all at very competitive prices, with our fast, efficient service at no extra charge.

Due to extraordinary copper market price fluctuations, cable and wire prices are subject to change.

Color Code Legend
New Sale Qty. Save Closeout

Call for DEM pricing

RG Type Bulk Coaxial Cable

RG58/U & RG58A/U (50Ω): Nom. cap.: 27pF/ft.; center resist.: 10.4Ω/1kft. @ 77°F
RG59/U (75Ω): Nominal capacitance: 19pF/ft.; center resist.: 16.5Ω/kft. @ 77°F
RG174/U (50Ω): Nominal capacitance: 30.8pF/ft.; center resist.: 97Ω/kft. @ 77°F

• Prepackaged and priced in increments of 100' or 1000'

Part No.	Cross Ref. No.	Description	100 ft.	1000 ft.
102226CL	RG58/U	For ethernet, oscilloscopes (solid 20AWG)	\$12.00	\$90.00
116898CL	RG58A/U	For ethernet, oscilloscopes (stranded 20AWG)	19.00	150.00
102218CL	RG59/U	For CATV & video patch cords (solid 22AWG)	13.00	110.00
112037CL	RG174/U	For ethernet, oscilloscopes (stranded 26AWG)	19.00	169.00

Gray Flat Ribbon Cable – 28 AWG

103481CL
 • Single edge red stripe for pin 1 orientation
 • Insulation: polyvinyl chloride (PVC) • 28 AWG (7 x 36) • Center spacing: 0.05"
 • Voltage rating: 300V • Stranded copper wire • Temp. rating: -20°C to +80°C
 • Prepackaged and priced in increments of 10', 25', 100' or 500'

Part No.	Cross Ref. No.	Conductors	10 ft.	25 ft.	100 ft.	500 ft.
135538CL	171-10	10	\$1.49	\$3.20	\$11.50	\$47.50
37671CL	171-16	16	2.20	5.00	16.00	70.00
37719CL	171-20	20	4.00	6.25	16.00	65.00
37760CL	171-25	25	3.90	8.75	25.00	110.00
37807CL	171-26	26	3.49	8.00	25.00	120.00
37840CL	171-34	34	4.25	9.25	32.00	120.00
37911CL	171-37	37	5.90	11.75	32.00	125.00
37920CL	171-40	40	7.40	17.50	48.00	215.00
37954CL	171-50	50	6.75	14.50	49.00	210.00
103481CL	171-60	60	8.95	19.75	65.00	285.00

Multicolor Flat Ribbon Cable – 28 AWG

105718CL
 • Standard 10-color repeat sequence • 28 AWG (7 x 36)
 • Center spacing: 0.05" • Voltage rating: 300V
 • Temp. rating: -20°C to +80°C • Stranded copper wire
 • Prepackaged and priced in increments of 10', 25', 100' or 500'

Part No.	Cross Ref. No.	Conductors	10 ft.	25 ft.	100 ft.	500 ft.
112547CL	28RC10	10	\$1.95	\$4.50	\$17.50	\$70.00
105671CL	28RC16	16	3.25	7.25	24.00	100.00
105689CL	28RC20	20	3.95	9.00	30.00	125.00
105697CL	28RC25	25	6.29	14.25	49.95	219.95
105700CL	28RC34	34	6.50	13.00	43.00	195.00
105726CL	28RC40	40	8.69	19.55	69.49	299.95
105718CL	28RC50	50	10.95	24.95	85.95	384.95

Solid Hook-Up Wire – 22 AWG

• Temp. range: -55°C to +105°C • Passes UL VW-1 flame test
 • MIL-W-16878D type B • Wt.: 100' (0.3 lbs.); 1000' (3.8 lbs.)
 • For use with breadboards such as the JE20 series, pg 31

Part No.	Cross Ref. No.	Color	100 ft.	1000 ft.
36767CL	122BE/C	Blue	\$5.49	\$39.99
36791CL	122BK/C	Black	5.49	39.99
36821CL	122G/C	Green	5.49	39.99
36855CL	122R/C	Red	5.49	39.99
36880CL	122W/C	White	5.49	39.99
36919CL	122Y/C	Yellow	5.49	39.99

Modular Telephone Cable – 28 AWG

103430CL
 • Color coded conductors • Flat modular cable
 • PVC jacket • Gray • 7 x 43 stranded

Part No.	Cross Ref. No.	Conductors	100 ft.	1000 ft.	10000 ft.
103430CL	MTC4	4	\$3.30	\$30.00	\$0.25
103448CL	MTC6	6	7.00	50.00	.043
103450CL	MTC8	8	10.00	62.00	.045

2-Conductor Stranded Power/Spaker Cable – 24 AWG

• Black wire with white polarity stripe
 • Temperature rating: 20°C to 60°C
 • Stranded copper wire (7 x 32) • Operating voltage: 300V

Part No.	Cross Ref. No.	Wt. (lbs.)	100 ft.	Part No.	Cross Ref. No.	Wt. (lbs.)	1000 ft.
100280CL	224BK/C	0.8	\$5.59	100298CL	224BK/K	7.8	\$39.95

Category 5 Network Cable

118130CL
 • 100MHz • 8C • 4 twisted pairs • UTP
 • Insulation: polyethylene • Nom. OD.: 0.189"
 • Nom. impedance: 100Ω
Solid: uses modular plug P/N 119343CL, pg 79
Stranded: uses modular plug P/N 79281CL, pg 79
 • Prepackaged and priced in increments of 25', 100' or 1000'

24 AWG UTP Category 5 Enhanced – 350MHz

Part No.	Description	25 ft.	100 ft.	1000 ft.
176225CL	Solid (gray)	\$5.00	\$17.00	\$100.00
176233CL	Stranded (gray)	6.00	21.00	180.00
201582CL	Stranded (blue)	6.00	18.00	160.00

24 AWG UTP Category 5 – 100MHz

Part No.	Description	25 ft.	100 ft.	1000 ft.
118113CL	Solid (gray)	\$4.59	\$16.49	\$129.50
118130CL	Stranded (gray) (7/32 AWG)	5.95	19.35	164.50

Multiconductor Shielded Computer Communication Cable – 24 AWG

31843CL
 • Stranded copper wire, multi-colored insulation
 • Insulated with polyvinyl chloride (PVC)
 • Voltage rating: 300V • Color: gray • Drain wire
 • 24 AWG (7 x 32 AWG) • Shielded 100% w/ aluminum mylar
 • Prepackaged and priced in increments of 25', 100' or 1000'

Part No.	Cross Ref. No.	Conductors	Diameter	25 ft.	100 ft.	1000 ft.
31860CL	SC4	4	0.20"	\$4.75	\$17.00	\$140.00
31878CL	SC9	9	0.23"	11.25	35.00	270.00
31843CL	SC15	15	0.28"	14.75	49.00	430.00
31851CL	SC25	25	0.37"	22.25	71.00	590.00

Stranded Hook-Up Wire – 18/20/22 AWG

300 Volts
 • 80°C • PVC insulation • CSA: TR-64 • UL style: 1007
 • Temperature range: -40°C to +80°C • Sold in 100' rolls

Part No.	Cross Ref. No.	AWG	Strands (No. x AWG)	Color	Wt. (lbs.)	1	10
126084CL	223SBK/C	22	7 x 30	Black	0.4	\$3.39	\$2.99
126033CL	223SR/C	22	7 x 30	Red	0.4	3.39	2.99
126076CL	223SW/C	22	7 x 30	White	0.4	3.39	2.99
125840CL	203SBK/C	20	10 x 30	Black	0.6	4.95	4.49
125794CL	203SR/C	20	10 x 30	Red	0.5	4.95	4.49
125831CL	203SW/C	20	10 x 30	White	0.5	4.95	4.49
125786CL	183SBK/C	18	16 x 30	Black	0.8	5.79	5.25
125735CL	183SR/C	18	16 x 30	Red	0.8	5.79	5.25
125751CL	183SW/C	18	16 x 30	White	0.8	5.79	5.25

Twisted Pair Cable – 24 AWG

• PVC insulation • Use for hook up wire • Stranded tinned wire (7 x 32)
 • Reduced EMI • Wt.: 100' (0.5 lbs.); 1000' (4.7 lbs.) • 80°C • 300 V

Part No.	Cross Ref. No.	Color	100 ft.	Part No.	Cross Ref. No.	Color	1000 ft.
105911CL	224GW/C	Green/white	\$5.49	105806CL	224GW/K	Green/white	\$44.95
173147CL	224RW/C	Red/white	5.49	173155CL	224RW/K	Red/white	44.95
173163CL	224BW/C	Black/white	5.49	173171CL	224BW/K	Black/white	44.95

Kynar™ Wire Wrap Wire – 30 AWG

• Assorted color coded insulation • Used for prototyping
 • Color coded Kynar™ (Polyvinidene Fluoride) insulation
 • Silver plated copper (solid conductor) • UL 1423
 • Temperature: -40°C to +125°C • See pg 76 for sockets
 • Wire wrap tools, pg 183 • Passes UL VW-1 flame test

Part No.	Color	Wt. (lbs.)	100 ft.	Part No.	Color	Wt. (lbs.)	1000 ft.
22541CL	Blue	0.1	\$4.95	22550CL	Blue	0.6	\$29.95
22576CL	Black	0.1	4.95	22584CL	Black	0.6	29.95
22630CL	Red	0.1	4.95	22648CL	Red	0.6	29.95
22664CL	White	0.1	4.95	22672CL	White	0.6	29.95
22605CL	Green	0.1	4.95	22613CL	Green	0.6	29.95
22699CL	Yellow	0.1	4.95	22701CL	Yellow	0.6	29.95

Call for OEM pricing

New Lower Prices

Nylon Cable Ties

Standard

70560CL

- Cable ties made from UL approved Nylon 66
- Temperature range: -40°C to +85°C
- Flammability rating: UL 94V-2
- Color: clear (except P/N 182676CL)
- Sold in increments of 100 or 1000

Quantity **SAVE**

Part No.	Tensile Strength (lbs.)	Dimensions (L" x W")	100	1000
70560CL	18	3.1 x 0.10	.025	\$.015
126543CL	18	4.0 x 0.10	.02	.014
182676CL	18*	4.75 x 0.13	.043	.025
182650CL	18	5.5 x 0.13	.035	.025
139150CL	18	8.0 x 0.10	.06	.04
182668CL	18	8.0 x 0.13	.075	.05
182684CL	18	8.0 x 0.18	.036	.033
70906CL	40	5.8 x 0.10	.035	.029
190756CL	40	10.0 x 0.14	.099	.069
190772CL	40	11.0 x 0.19	.10	.086
190764CL	40	13.0 x 0.14	.10	.075

* Black

Weather Resistant

104141CL

- Contain Carbonate A for greater resistance to ultra violet rays in outdoor use
- Color: black
- Sold in increments of 100 or 1000

UV Resistant

Part No.	Tensile Strength (lbs.)	Dimensions (L" x W")	100	1000
139125CL	18	3.0 x 0.90	\$.045	\$.029
104141CL	18	4.0 x 0.10	.044	.029
104133CL	40	5.8 x 0.10	.047	.031
190781CL	40	8.0 x 0.13	.085	.065
190799CL	40	10.0 x 0.14	.10	.09
190801CL	40	13.0 x 0.14	.113	.088

Cable Tie Assortments

- Tensile strength: 18-50 lbs.
- 145701CL: 1000 pcs. (4"L); 10 colors
- 150412CL: 500 pcs. (4"L); 300 pcs. (8"L); 50 pcs. (11"L), 5 colors



Part No.	Weight (lbs.)	1	10	50
145701CL	0.7	\$9.49	\$8.49	\$7.39
150412CL	1.7	13.95	11.49	9.95

AC Cord Cable Tie

- Reusable
- Length: 6"
- Color: black
- Sold in increments of 100 or 1000

Part No.	Description	100	1000
183185CL	Cable tie	\$.09	\$.08

Cable Tie Tool

- 2.5 - 5mm width (of cable)
- Tension adjustable
- Twist to cut surplus tie end
- Spring return action
- Plastic



Part No.	Description	1	10	100
182297CL	Cable tie tool	\$15.95	\$13.95	\$12.65

Cable Tie Mounts and Cable Clamps

- Tie mount and screw tab cable clamps
- Material: UL approved nylon 66, 94V-2
- Sold in increments of 10, 100 or 1000



182941CL/171213CL
71407CL/71394CL
71386CL



70594CL



182300CL/173761CL



182318CL/182376CL



182334CL/182342CL



173711CL/173729CL
173737CL/134754CL
173753CL

SALE

Quantity **SAVE**

Part No.	Mfr. Cross Reference No.	Description	10	100	1000
182941CL	0505HC-101S	4-way cable tie mount, self adhesive, .75"D	\$.07	\$.055	\$.042
171213CL	HC-100	4-way cable tie mount, self adhesive, use w/ 0.1"W max., 0.5" square	.15	.13	.094
71407CL	HC-101	4-way cable tie mount, self adhesive, use w/ 0.1"W max., 0.9" square	.18	.16	.13
71394CL	HC-102	4-way cable tie mount, self adhesive, use w/ 0.2"W max., 1.1" square	.23	.19	.14
71386CL	HC-103	4-way cable tie mount, self adhesive, use w/ 0.4"W max., 1.1" square	.25	.19	.13
70594CL	HC-0	4-way cable tie, screw type, use w/ 0.2"W max., 0.8"L x 0.4"W	.15	.09	.05
182300CL	0510HC-2	Cable tie mount, 1/4" screw hole, 0.5"D	.17	.15	.14
173761CL	HC-1	Cable tie, saddle type, 0.6"L x 0.4"W	.15	.125	.075
182318CL	0519ATC-17	2-way adjustable tie mount, #6 flat head screw, 0.7"D	\$.59	.39	.32
182376CL	0519ATC-22	2-way adjustable tie mount, #6 flat head screw, 0.9"D	\$.25	.17	.14
182334CL	0520FC-1	Cable tie mount, self adhesive, 0.1"D	.17	.15	.12
182342CL	0520FC-2	Cable tie mount, self adhesive, 0.2"D	.15	.13	.08
173711CL	UC0	Cable clamp for 1/8" cable	.08	.027	.018
173729CL	UC0.5	Cable clamp for 3/16" cable	.035	.032	.019
173737CL	UC1	Cable clamp for 1/4" cable	.14	.09	.063
134754CL	BO375	Cable clamp for 3/8" cable	.08	.029	.018
173753CL	UC3	Cable clamp for 1/2" cable	.09	.033	.025

Nylon Cable ID Ties and Tabs



71061CL



135175CL

- 71061CL: Clear ID tab (0.98" x 0.31")
- 135175CL: Nylon cable tie ID marker

- Sold in increments of 10, 100 or 1000

Part No.	Size	10	100	1000
71061CL	4.0"L x 0.1"W	\$.085	\$.08	\$.072
135175CL	2.0"L x 0.8"W x .02"T	.22	.11	.08

TECHFLEX Cable Sleeve

Clean Cut Expandable Sleeving

- Flame resistant
- Applications: protecting wires, cables and hoses
- Operating temp.: -70°C to 125°C
- Sold in spools of 25'

162157CL



Part No.	Product No.	Actual/Expanded Dia.	1	10
162157CL	CCPT2X	.250"/.440"	\$15.95	\$14.95
162165CL	CCPT3X	.500"/.750"	17.95	14.49

30-Day Money-Back Guarantee

If you're not satisfied we'll take it back!

Details on page 229.

Pressure Sensitive Wire Marker

Easy release vinyl cloth markers feature a strong, pressure-sensitive adhesive, for long lasting bond on a wire or cable. Black non-smear legends on white background for easy identification.

- Convenient pocket-size booklet
- 10 sheets numbered 1 to 45 each sheet

Quantity **SAVE**

Part No.	Product No.	1	10	100
216813CL	TCWM-3	\$12.95	\$11.05	\$8.25

Self Adhesive Wire Marker

- 90 markers per number
- Stick to wires for permanent identification
- Cloth tape label numbered 0-9
- Used after or before terminal



Part No.	Product No.	1	10
182262CL	0215WMB-1	\$9.95	\$8.95

3M Tape Wire Marker

- For marking wires with numerical sequence
- Self adhesive tapes numbered 0-9
- Size: (tape) 96"L x 0.25"W



Part No.	Description	1	10
159231CL	Numerical tape dispenser	\$.30.95	\$27.95

Cable Markers

- UL approved natural nylon
- 10 piece minimum



Part No.	Size	10	100	1000
182705CL	1.5"L x .75"W	\$.10	\$.09	\$.08
182713CL	2.5"L x 1.76"W	.27	.19	.15

Category 5e Network Cables



- 4 pair
- 24 AWG (7 x 43) stranded
- UTP • 8P8C
- "Snagless" boot
- Color coded for easy wire tracing
- High-flexibility
- Achieve optimum system performance

Category 5e (350MHz)

Part No.	Description	Color	1	10	100
168292CL	3ft. cable RJ45	Gray	\$1.79	\$1.49	\$1.39
168305CL	7ft. cable RJ45	Gray	2.99	2.59	2.39
168313CL	15ft. cable RJ45	Gray	5.29	4.39	3.99
168321CL	25ft. cable RJ45	Gray	7.99	6.79	6.39
201777CL	3ft. cable RJ45	Red	1.79	1.49	1.39
201785CL	7ft. cable RJ45	Red	2.99	2.59	2.39
201793CL	15ft. cable RJ45	Red	6.95	5.95	4.45
201806CL	25ft. cable RJ45	Red	7.99	6.79	6.39
201697CL	3ft. cable RJ45	Black	1.79	1.49	1.39
201700CL	7ft. cable RJ45	Black	2.99	2.59	2.39
201718CL	15ft. cable RJ45	Black	5.29	4.39	3.99
201726CL	25ft. cable RJ45	Black	7.99	6.79	6.39
201734CL	3ft. cable RJ45	Blue	1.79	1.49	1.39
201742CL	7ft. cable RJ45	Blue	2.99	2.59	2.39
201751CL	15ft. cable RJ45	Blue	5.29	4.39	3.99
201769CL	25ft. cable RJ45	Blue	7.99	6.79	6.39
201814CL	3ft. cable RJ45	Yellow	1.79	1.49	1.39
201822CL	7ft. cable RJ45	Yellow	2.99	2.59	2.39
201831CL	15ft. cable RJ45	Yellow	5.29	4.39	3.99
201849CL	25ft. cable RJ45	Yellow	7.99	6.79	6.39

Category 5 (100MHz)

Part No.	Description	Color	1	10	100
203051CL	10ft. cable RJ45	Blue	\$1.95	\$1.69	\$1.25
170190CL	25ft. cable RJ45	Blue	3.35	3.05	2.99

Bulk Modular Network Cables

- 8 Conductor • UTP
- 4 twisted pairs
- Insulation: polyethylene
- Nom. OD.: 189"
- Nominal impedance: 100Ω
- Solid:** uses modular plug P/N 119343CL, pg 79
- Stranded:** uses modular plug P/N 79281CL, pg 79
- 118130CL/201646CL:** 7/32 AWG
- Prepackaged and priced in increments of 25', 100' or 1000'

24 AWG UTP Category 5e - 350MHz

Part No.	Description	25 ft.	100 ft.	1000 ft.
176225CL	Solid (gray)	\$5.00	\$17.00	\$100.00
201603CL	Solid (blue)	5.00	14.00	90.00
176233CL	Stranded (gray)	6.00	21.00	180.00
201574CL	Stranded (red)	6.00	18.00	160.00
201591CL	Stranded (black)	6.00	18.00	160.00
201582CL	Stranded (blue)	6.00	18.00	160.00
201566CL	Stranded (yellow)	6.00	18.00	160.00

24 AWG UTP Category 5 - 100MHz

Part No.	Description	25 ft.	100 ft.	1000 ft.
118113CL	Solid (gray)	\$4.59	\$16.49	\$129.50
118130CL	Stranded (gray)	5.95	19.35	164.50
201646CL	Stranded (black)	5.50	15.00	140.00

CAT 5e Crossover Cable

- Connect 2 PCs without a hub
- 24AWG (7 x 43) stranded
- Strain relief RJ45 connectors
- 4-pair • 8P8C • UTP
- Color: gray

Part No.	Description	1	10	100
169261CL	10' cable RJ45	\$6.95	\$6.25	\$5.59

Keystone-Type Wall Plates

• Size: 2.8"W x 4.5"H

Quantity **SAVE**

Part No.	No. of ports	Color	1	10	100
195549CL	1	Ivory	\$1.25	\$1.15	\$0.99
195557CL	2	Ivory	1.25	1.15	.99
195565CL	3	Ivory	1.25	1.05	.79
195573CL	4	Ivory	1.25	1.06	.80
212978CL	1	White	1.25	1.15	.99
212994CL	2	White	1.25	1.15	.99
212986CL	3	White	1.25	1.15	.99
212960CL	4	White	1.25	1.15	.99
213508CL	Hole Filler	White	.28	.25	.23

Modular Jacks

Punchdown Keystone Type

- Removable jacks used in wall plates (clip in)
- CAT 5e classification
- Punchdown type wiring connections with color coding
- Size: 0.57"W x 0.63"H x 1.23"D
- RJ45:** 8P8C **RJ11:** 6P6C

Quantity **SAVE**

Part No.	Color	1	10	100
195590CL	Red	\$3.75	\$3.55	\$3.19
195602CL	Yellow	3.75	3.55	3.19
195611CL	Green	3.75	3.55	2.99
195629CL	Black	3.75	3.55	3.19
195637CL	Ivory	3.75	3.55	2.99
212951CL	Blue	3.75	3.55	3.19
212943CL	White	3.75	3.55	3.19

RJ11

Part No.	Color	1	10	100
213524CL	Black	\$3.75	\$3.55	\$2.99
213516CL	White	3.75	3.55	3.19

BNC/F-Type Jacks

SALE

Part No.	Description	Color	1	10	100
195645CL	F-Type F to F	Ivory	\$1.39	\$1.29	\$1.19
224645CL	F-Type F to F	White	1.39	1.29	1.19
224637CL	BNC F to F	White	2.29	2.05	1.89

- Removable jacks used in wall plates (see above)
- Clip on for easy installation on wall plates
- Keystone type

Part No.	Description	Color	1	10	100
195645CL	F-Type F to F	Ivory	\$1.39	\$1.29	\$1.19
224645CL	F-Type F to F	White	1.39	1.29	1.19
224637CL	BNC F to F	White	2.29	2.05	1.89

Token Ring-to-RJ45 Adapter

- Easy connection to UTP cabling
- Use type A or B style data connector with RJ45 jack
- Determine cable length (flexibility)
- Dimensions: 2.5"L x 1.0"W

SALE

Part No.	Description	1	10	100
125461CL	Token ring	\$6.55 \$4.75	\$4.35	\$3.99

Category 6 Network Cables



- With RJ45 plugs and molded strain reliefs
- Assembled using ETL verified 24AWG stranded cable
- Gold over nickel contacts
- Exceeds performance levels as specified in TIA/EIA 568B.2-1 Category 6 draft 8

Category 6

Part No.	Length	Color	1	10	100
219707CL	3ft.	Gray	\$6.29	\$5.79	\$5.29
219715CL	7ft.	Gray	7.99	7.39	6.79
219723CL	14ft.	Gray	8.99	8.29	7.59
219731CL	25ft.	Gray	13.49	12.39	11.39
219740CL	50ft.	Gray	22.49	20.69	18.99
219854CL	3ft.	Blue	6.29	5.79	5.29
219862CL	7ft.	Blue	7.99	7.39	6.79
219871CL	14ft.	Blue	8.99	8.29	7.59
219889CL	25ft.	Blue	13.49	12.39	11.39
219897CL	50ft.	Blue	22.49	20.69	18.99
220003CL	3ft.	White	6.29	5.79	5.29
220011CL	7ft.	White	7.99	7.39	6.79
220020CL	14ft.	White	8.99	8.29	7.59
220038CL	25ft.	White	13.49	12.39	11.39
220046CL	50ft.	White	22.49	20.69	18.99
219900CL	3ft.	Red	6.29	5.79	5.29
219918CL	7ft.	Red	7.99	7.39	6.79
219926CL	14ft.	Red	8.99	8.29	7.59
219934CL	25ft.	Red	13.49	12.39	11.39
219942CL	50ft.	Red	22.49	20.69	18.99
219803CL	3ft.	Green	6.29	5.79	5.29
219811CL	7ft.	Green	7.99	7.39	6.79
219820CL	14ft.	Green	8.99	8.29	7.59
219838CL	25ft.	Green	13.49	12.39	11.39
219846CL	50ft.	Green	22.49	20.69	18.99
219758CL	3ft.	Black	6.29	5.79	5.29
219766CL	7ft.	Black	7.99	7.39	6.79
219774CL	14ft.	Black	8.99	8.29	7.59
219782CL	25ft.	Black	13.49	12.39	11.39
219791CL	50ft.	Black	22.49	20.69	18.99
219951CL	3ft.	Yellow	6.29	5.79	5.29
219969CL	7ft.	Yellow	7.99	7.39	6.79
219977CL	14ft.	Yellow	8.99	8.29	7.59
219985CL	25ft.	Yellow	13.49	12.39	11.39
219993CL	50ft.	Yellow	22.49	20.69	18.99

CAT5e RJ45 Modular Jack

A unique and simple CAT5e hardware component (TIA/EIA-568 B.2) utilizing the universally accepted keystone mount. It offers a quick and reliable connection as the eight conductors are effortlessly terminated in a single operation.

- UL verified TIA/EIA-568 B.2 CAT5e
- Tool-less connector
- Keystone mount
- Integral shutter
- Top or bottom cable insertion
- Self-stripping contacts

New

Part No.	Product No.	1	10	100
263071CL	VOL-OCK5E-U-W	\$6.89	\$6.55	\$6.25

Modular Jack Boxes & Wall Plate



Fig. 1 W: 2.8" H: 4.5" (72311CL)
Fig. 2 W: 2.0" H: 2.2" D: 0.9" (71651CL)
Fig. 3 W: 1.5" H: 2.4" D: 1.1" (213031CL)
Fig. 4 W: 2.4" H: 2.4" D: 1.1" (213049CL)

Part No.	Description	Fig.	1	10	100
72311CL	6P6C & 8P8C double wall jack plate w/ jacks (beige)	1	\$1.95	\$1.75	\$1.57
103464CL	6P4C adhesive jack RJ11 (beige)	2	1.39	1.19	1.09
71984CL	6P6C adhesive jack RJ11 (beige)	2	1.39	1.19	.99
71651CL	8P8C adhesive jack RJ45 (beige)	2	1.95	1.65	1.45
213031CL	8P8C adhesive jack RJ45 (single, white) (CAT 5e)	3	3.29	2.99	2.69
213049CL	8P8C adhesive jack RJ45 (dual, white) (CAT 5e)	4	4.15	3.75	3.39

Surface Mount Boxes

Category 5 and 5e

- RJ45 • 8P8C
- 100MHz
- Size: 2.6"L x 3.2"W x 1.2"H
- CAT 5e (except P/N 176073CL)



176073CL

213014CL

Part No.	Description	1	10	100
176073CL	Single jack (beige)	\$6.95	\$6.25	\$5.59
213022CL	Single jack (white)	6.95	6.25	5.59
176081CL	Dual jack (beige)	9.99	8.99	7.64
213014CL	Dual jack (white)	9.99	8.49	7.59

Telecom Splice Connectors

- Provides clean, solid, and rapid connection of wires to keep communication lines free of noise
- Available to handle a wide range of conductor sizes



169754CL

169746CL

- 169754CL: Y-Type
- Prepackaged: order in increments of 10, 100 or 1000

Part No.	Color	Wire Gauge	No. of Conductors	10	100	1000
169746CL	Yellow	22-26	2	\$1.10	\$1.00	\$0.80
169754CL	Red	19-26	3Y	.15	.14	.12

Wire Connectors



182449CL

182511CL

140716CL

- Material: UL approved nylon 66, 94V2
- Quick and secure method to splice control wires
- Strip wire before application • Twist on type
- Material: PVC with metal spring, except P/N 182449CL nylon 66, 94-2 and P/N 140716CL PE - metal inside
- 182449CL: UL/CSA approved
- Sold in increments of 10, 100 or 1000

Part No.	Description	Color	10	100	1000
182449CL	Crimp 16-14 AWG*	Nat.	\$.06	\$.055	\$.049
182511CL	Wire-nut 16 AWG	Blue	.045	.04	.035
140716CL	Wire IDC 22-18 AWG	Red	.15	.11	.083

* Requires crimping tool (P/N 72995CL, pg 180)

Call for OEM pricing - we carry major manufacturers.

Heat Shrink Tubing

- 2:1 uniform shrink ratio • Color: black
- Temperature range: -45°C to +125°C

PVC Heat Shrink Flat Film

- Shrink temperature: 175°C
- Precut 39" length; sold as 1 increment

Quantity
SAVE

Part No.	Unshrunk		Shrunk		1*	10*	100*
	Flat	Cir. Dia.	Cir. Dia.	Cir. Dia.			
70631CL	5/16"	1/4"	1/8"	1/8"	\$1.69	\$1.55	\$1.39
70623CL	1/2"	5/16"	3/16"	3/16"	1.69	1.45	1.09
70666CL	13/16"	9/16"	1/4"	1/4"	1.69	1.45	1.09

Polyolefin Heat Shrink Tubing

- Dielectric strength: 1300V
- Flexible
- Flame retardant
- Shrink temp.: 121°C
- Precut 39" length; sold as 1 increment



72063CL

Part No.	Before	After (Dia.)	1*	10*	100*
71327CL	1/16"	1/32"	\$.55	\$.46	\$.41
71870CL	3/32"	3/64"	.55	.45	.39
71280CL	1/8"	1/16"	.69	.59	.54
72063CL	1/4"	1/8"	.89	.72	.65
226245CL	3/8"	3/16"	1.09	.98	.88
216477CL	1/2"	1/4"	.99	.89	.89

PVC Heat Shrink Tubing

- 2:1 uniform shrink ratio
- Color: black
- Shrink temp: 125°C
- Sold in 10" and 100" increments

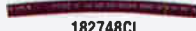

182748CL

182772CL



Part No.	Dia. before (mm)	10 ft.	100 ft.
184721CL	.12" (3)	\$1.19	\$10.50
182730CL	.16" (4)	1.39	12.50
182748CL	.20" (5)	1.45	13.00
182756CL	.24" (6)	1.49	13.50
182764CL	.31" (8)	1.79	16.00
182772CL	.43" (11)	2.80	19.00
182781CL	.59" (15)	3.50	30.00

Round-Type Strain Relief Bushings

- Material: UL approved nylon 66, 94V-2
- Color: black
- Used extensively for protecting cords and to prolong cord life
- Sold in increments of 10, 100 or 1000

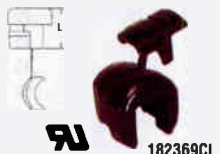

182369CL

Part No.	Cable Type	Lgth (in.)	10	100	1000
182351CL	SVI/SVT	.43	\$.05	\$.043	\$.04
182369CL	SJ/SJT; 16 AWG	.58	.18	.10	.085
182377CL	SJC; 18 AWG	.58	.27	.23	.17

Bushing Assembly Tool

- For use with strain relief bushings, above



Part No.	Description	1	10	100
73470CL	Bushing tool	\$31.95	\$28.75	\$25.85

Jameco Special Values!

See the yellow and green highlighted items.
Details on page 2.

Nail-In Cable Clips

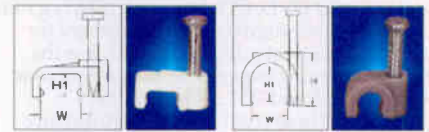

190810CL

190861CL

- Material: impact resistant PE
- With nails inserted
- Sold in increments of 100 or 1000

Now Lower Prices

For telephone cords; white

SALE

Part No.	Mfr. Ref. No.	Cross W x H x H1 (in.)	100	1000
190810CL	NF0.7	.22 x .22 x .12	\$.006	\$.005
190828CL	NF1.2	.24 x .21 x .15	.05	.02
190836CL	NF1.6	.31 x .31 x .20	.05	.02
190844CL	NF2.0	.33 x .31 x .20	.007	.006
190852CL	NF2.8	.59 x .50 x .34	.016	.014

For general round cables; gray

Part No.	Mfr. Ref. No.	Cross W x H x H1 (in.)	100	1000
190861CL	NCO.35N	.14 x .23 x .15	\$.085	\$.035
190879CL	NCO.5N	.20 x .30 x .21	.05	.02
190887CL	NC1N	.24 x .35 x .26	.085	.029
190895CL	NC2N	.31 x .45 x .34	.05	.02
190908CL	NC3N	.39 x .53 x .41	.05	.02

Insulated Solderless Terminals

- Insulation thickness: .030"
- Funnel ramp entry • Temperature to 105°C
- Use with crimping tool P/N 72995CL, pg 180
- Sold in increments of 10, 100 or 1000

Ring Solderless

Part No.	Color	Wire Gauge	Stud	10	100	1000
103683CL	Red	16-22	#6	\$.11	\$.07	\$.05

Spade Solderless

Part No.	Color	Wire Gauge	Stud	10	100	1000
103587CL	Red	16-22	#6	\$.13	\$.06	\$.05
103595CL	Blue	14-16	#8	.12	.068	.06

Disconnect Solderless

Part No.	Descrip.	Color	Gauge	Blade	10	100	1000
106921CL	Female	Red	16-22	.187"	\$.12	\$.07	\$.05
103667CL	Female	Red	16-22	.25"	.12	.07	.05
109111CL	Female†	Red	16-22	.25"	.17	.11	.055

† includes hood

171-Pc. Solderless Terminal Kit

- Clear, hinged plastic box
- Use crimping tool P/N 72995CL, pg 180

170 Terminals and Connectors!



Qty.	Description	Wire Gauge	Blade Size	Qty.	Description	Wire Gauge	Blade Size
10	Male spade	16-22	1/4"	10	Ring term.	14-16	#10
10	Male spade	14-16	1/4"	5	Ring term.	10-12	#10
10	Fem. spade	16-22	1/4"	5	Ring term.	10-12	#14
10	Fem. spade	14-16	1/4"	10	Spade term.	16-22	#6
10	Ring term.	16-22	#6	10	Spade term.	16-22	#8
10	Ring term.	16-22	#8	10	Spade term.	14-16	#10
10	Ring term.	16-14	#10	10	Butt conn.	16-22	-
15	Ring term.	14-16	#6	10	Butt conn.	14-16	-
10	Ring term.	14-16	#8	5	Butt conn.	10-12	-

Part No.	Description	1	10	25
10989CL	Terminal kit	\$8.95	\$7.95	\$7.25

Digital Audio Optical Cables and Adapters

Connect your DVD, CD, Mini Disc, DAT, game console or other digital audio equipment for clear, full and richly detailed sound. For the ultimate listening experience, connect to your Dolby Digital™ or DTS™ home theater equipment. These cost effective performance TOSLINK type cables give you the cleanest possible signal, even at extreme volume levels for today's audio and home theater applications. They are manufactured with high-quality P.M.M.A. optical fiber and highly-polished lenses. The durable connectors ensure long lasting, corrosion-free connections. The stylish PVC jacket adds flexibility and durability for years of listening pleasure.

- Low-loss core provides low distortion and high signal-to-noise ratio
- Clad reflecting layer prevents phase error and noise, achieving high-fidelity transmission effect
- Corrosion-resistant, precise collar to ensure long lasting quality
- Non-slip rubber grip connector provides for easy installation
- Ultra flexible PVC jacket makes installation, even in hard to reach areas a snap



Cables

Part No.	Description	1	2	5
228654CL	3' TOSLINK-TOSLINK	\$3.79	\$3.35	\$2.85
228689CL	3' TOSLINK-mini plug	9.95	8.95	7.95
228662CL	6' TOSLINK-TOSLINK	4.75	4.29	3.79
228697CL	6' TOSLINK-mini plug	16.65	14.99	13.49
228671CL	12' TOSLINK-TOSLINK	7.29	6.59	5.95
228700CL	12' TOSLINK-mini plug	23.29	20.95	18.85

Adapters

230615CL	TOSLINK - mini plug adapter	\$2.79	\$2.59	\$2.49
230607CL	TOSLINK - TOSLINK coupler	1.89	1.79	1.69

Component Video and Audio Cables

Component video cables connect the latest video equipment like DVD players equipped with component video output jacks to LCD or plasma televisions, projector, and other component video devices. By using component video cables, you bypass the TV's Y/C separator and color decoder, routing the color (Y Pr Pb) information directly into the TV's matrix decoder. By sending the pure DVD component signal directly to a component video input-equipped display device, the DVD signal forgoes the extra processing that normally would degrade the image. Python™ component video cables provide you maximum picture and sound quality compared to ordinary "out of the box" cables.

- Low-loss 75Ω oxygen-free copper center conductors and foam dielectric provide maximum signal transfer bandwidth for improved picture quality and performance
- Corrosion resistant, precise 24k gold-plated connectors ensure long lasting quality
- Fully molded color coded connectors attached to an ultra-flexible PVC jacket provides excellent strain relief, easy installation, and identification
- 100% .012mm aluminum-polyester foil shielding and spiral-wound copper-braid shielding provides clear, noise-free, vivid picture quality
- Bonded construction design for neat, easy connection of component video and audio



Part No.	Description	1	2	5
228620CL	6' component video RGB cable	\$12.35	\$11.15	\$9.99
228638CL	12' component video RGB cable	23.75	21.39	19.25
228646CL	25' component video RGB cable	33.95	30.59	27.49
229403CL	6' component video RGB and stereo audio cable	17.29	15.59	13.99
229411CL	12' component video RGB and stereo audio cable	33.25	29.95	26.95
229420CL	25' component video RGB and stereo audio cable	47.55	42.79	38.55

Audio Adapters and Cables

RCA Audio Adapters

SALE

Best Lowest Prices

Part No.	Description	1	10	25	100
228283CL	RCA female jack to mono 1/4" male plug	\$.99	\$.89	\$.69	\$.55
228312CL	RCA male plug to 1/4" mono female jack	1.25	1.10	.79	.69
228267CL	RCA female to female jack coupler, gold plated	.95	.79	.55	.45
159441CL	RCA female to female jack coupler, metal	1.15	.99	.75	.65
228259CL	RCA male to male plug adapter	1.59	1.25	.99	.85
228339CL	RCA F jack to 3.5mm mono M plug, gold plated	1.49	1.29	1.09	.90
228291CL	RCA F jack to 3.5mm mono M plug, nickel plated	1.25	1.09	.89	.75
215458CL	RCA male plug to 3.5mm mono female jack	.89	.75	.69	.59

RCA Y-Cables

139037CL	5' Y-cable 1/8" stereo M plug to (2) RCA M plugs	\$2.25	\$1.99	\$1.79	\$1.61
228371CL	6" Y-cable (2) RCA M plugs to RCA F jack	.99	.89	.80	.72
228355CL	6" Y-cable RCA M plug to (2) RCA F jacks	1.15	.99	.85	.79
228380CL	6" Y-cable (2) RCA F jacks to 3.5mm stereo plug	1.65	1.35	1.25	1.19
215466CL	8" Y-cable RCA M plug to (2) RCA M plugs	1.89	1.69	1.53	1.38

3.5mm Audio Adapters

228275CL	3.5mm stereo female to female jack	\$.55	\$.49	\$.44	\$.365
215440CL	3.5mm mono female jack to 1/4" mono male plug	\$.45 \$.39	\$.28 \$.24	\$.24 \$.21	\$.21 \$.18
196082CL	3.5mm stereo female jack to 1/4" stereo male plug	\$.69 \$.61	\$.47 \$.41	\$.41 \$.35	\$.35 \$.29
228321CL	3.5mm mono M plug to 1/4" stereo F jack	1.39	1.15	.99	.75
228304CL	3.5mm stereo M plug to (2) 1/4" stereo F jacks	2.05	1.85	1.25	1.15
228339CL	3.5mm mono M plug to RCA F jack, gold plated	1.49	1.29	1.09	.90
228291CL	3.5mm mono M plug to RCA F jack, nickel plated	1.25	1.09	.89	.75
215458CL	3.5mm mono female jack to RCA male plug	.89	.75	.69	.59

3.5mm Y-Cables

139037CL	5' Y-cable 1/8" stereo M plug to (2) RCA M plugs	\$2.25	\$1.99	\$1.79	\$1.61
228398CL	6" Y-cable (2) 3.5mm stereo female jacks to 3.5mm stereo male plugs	1.95	1.65	1.35	1.25
228380CL	6" Y-cable (2) RCA F jacks to 3.5mm stereo M plug	1.65	1.35	1.25	1.19



SALE

Quantity
SAVE

Now Lower
Prices

Audio/Video Cables and Adapters

RCA Cables

Part No.	Description	1	10	25
215474CL	3' RCA male plug - female jack (gray)	\$1.15	\$.61	\$.50
228443CL	3' stereo RCA (2) male to (2) male plugs, gold plated	1.49	1.39	1.29
183311CL	4' RCA male to male plug (black)	.99	.85	.65
206973CL	4' RCA male to male plug (yellow)	.99	.89	.79
183302CL	4' RCA (2) male to (2) male plugs (red/black)	1.75	1.45	1.35
106374CL	6' RCA male to male plug	1.19	.98	.81
228419CL	6' mono RCA male plug to female jack	1.65	1.45	1.25
228486CL	6' RCA stereo (2) male plugs to (2) female jacks	1.25	1.15	1.05
228451CL	6' RCA stereo (2) male to (2) male plugs, gold plated	1.79	1.69	1.59
228401CL	6' RCA stereo (2) male plugs to 3.5mm stereo male plug	1.55	1.39	1.25
238865CL	6' RCA (3) male to (3) male plugs, gold plated	2.39	2.05	1.55
184882CL	6' RCA (3) male to (3) male plugs, low loss	1.95	1.79	1.59
228427CL	10' RCA female jack to male plug	2.35	1.95	1.79
29348CL	10' RCA male to male plug (yellow)	1.69	1.49	.29
228460CL	12' RCA stereo (2) male to (2) male plugs, gold plated	2.10	1.89	1.75
225980CL	12' RCA (3) male to (2) male plugs, gold plated	4.49	3.89	2.89
225998CL	20' RCA (3) male to (2) male plugs, gold plated	7.99	6.79	5.09
228435CL	25' mono RCA male to male plug, nickel plated	2.19	2.09	1.99
228478CL	25' RCA stereo (2) male to (2) male plugs, gold plated	2.39	2.29	2.19

3.5mm Audio Patch Cables

228494CL	6' 3.5mm stereo male to male plug	\$1.39	\$1.19	\$.99
228515CL	6' 3.5mm stereo male plug to female jack	1.49	1.35	1.25
228507CL	12' 3.5mm stereo male to male plug	1.69	1.49	1.29
228523CL	12' 3.5mm stereo male plug to female jack	1.65	1.49	1.35



Video/Audio Patch Cables

Part No.	Description	1	10	25
228216CL	3' stereo video patch cable, gold plated	\$1.19	\$1.13	\$1.07
228574CL	25' stereo video patch cable, gold plated	6.99	6.29	5.65
228582CL	50' stereo video patch cable, gold plated	12.59	11.35	10.19

VCR Cable

228224CL	6' stereo VCR cable	\$2.39	\$2.29	\$2.15
----------	---------------------	--------	--------	--------

S-VHS Cables and Adapters

Low-loss fully shielded Super-VHS cables, 4-contact mini DIN plus S-VHS cable and dual-RCA plug stereo cables.

- Fully-molded color coded gold RCA connectors
- Flexible black PVC jacket
- Applications: home theaters, DSS receivers, Super-VHS VCRs, camcorders, and DVD players

228558CL/228566CL: 95% spiral wound shield S-VHS/audio conductors

Part No.	Description	1	10	25
228591CL	6' S-VHS video cable, gold plated	\$2.15	\$1.95	\$1.79
228558CL	6' S-VHS audio-video cable, gold plated	12.95	11.65	10.49
228566CL	12' S-VHS audio-video cable, gold plated	14.95	13.45	12.15
228603CL	12' S-VHS video cable, gold plated	2.65	2.35	2.10
228611CL	25' S-VHS video cable, gold plated	4.05	3.85	3.65
229809CL	S-video 4-pin mini DIN female to female jack	2.85	2.59	2.29
229391CL	S-video male plug to RCA video female jack	5.39	4.85	4.39



3.5mm Female Jacks and Male Plugs



- Threaded screw on housing
- 1mm diameter solder eyelets
- Shield crimp tabs

231159CL/231167CL: With spring strain relief

Part No.	Mfr. Cross Ref. No.	Description	1	10	100	1000
109495CL	PJ035PM	Mono F jack, 3.5mm hole size	\$.45	\$.40	\$.36	\$.32
165729CL	PJ035A	Mono F jack, 3.5mm hole size	.69	.59	.49	.39
101151CL	PJ1035	Mono male plug, plastic	.69	.62	.49	.39
147344CL	PJ1035L	Mono male plug, plastic	.64	.58	.46	.35
231159CL	AP-336	Mono male plug, metal	1.25	1.19	1.09	.95
231175CL	AP-340	Stereo male plug, plastic	.45	.41	.35	.27
231167CL	AP-343	Stereo male plug, metal	1.79	1.60	1.45	1.30

RCA Plugs

- High-quality plastic and metal housing RCA plugs

Gold plated metal housing w/ spring strain relief for 6.7mm cables

Part No.	Description	1	10	25	100
229876CL	Black	\$1.89	\$1.69	\$1.55	\$1.39
229868CL	Red	1.89	1.69	1.55	1.39
229884CL	White	1.89	1.69	1.55	1.39
230287CL	Yellow	1.89	1.69	1.55	1.39

Plastic screw-on cover w/ integral cable protection

229921CL	Black (5 pk)	\$1.15	\$1.05	\$.91	\$.85
229930CL	Red (5 pk)	1.15	1.05	.91	.85
229913CL	White (5 pk)	1.19	1.09	.95	.89
229892CL	Yellow (5 pk)	1.19	1.09	.95	.89

RCA Jacks

- Standard RCA jacks for audio and video signals
- P/N 237016CL: 2x3 grid; † Red/white/yellow

Part No.	Dimensions	Color	1	10	100	1000
237016CL	2.0"W x .45"D x 1.1"H	†	\$.89	\$.79	\$.69	\$.65
220581CL	.44"W x .56"D x .48"H	Wht	.45	.31	.28	.22
220556CL	.44"W x .56"D x .48"H	Red	.45	.31	.28	.22
220572CL	.44"W x .56"D x .48"H	Blk	.45	.31	.28	.22
220564CL	.44"W x .56"D x .48"H	Yel	.45	.31	.28	.22
112475CL	.44"W x .58"D x .48"H	Red	.39	.35	.31	.19
169501CL	.40"W x .85"D x .50"H	Blk	.39	.35	.28	.21
159484CL	.84"W x .38"H	Blk	.49	.39	.33	.24
172339CL	.84"W x .38"H	Red	.49	.39	.31	.23



Jameco's Low Price Guarantee

We'll match the print advertised price of any of any like product. It's that simple!

RGB Video Cables

- 75Ω coaxial cable; 6' or 10'
- Pin 1 red, pin 2 green, pin 3 blue, pin 14 white/black vertical, pin 13 gray horizontal
- 5 BNCs to HDDB15-pin male
- Weight: 0.9 lbs.



73648CL
Quantity SAVE

Part No.	Description	1	10	25
73648CL	6' cable (black)	\$19.95	\$16.99	\$12.75
118068CL	10' cable (black)	31.95	27.15	20.39

Serial Null Modem Cables

- Molded type connectors
- Color: gray
- 181403CL/180697CL Pin outs:**
1 & 6-4, 2-3, 3-2, 4-6 & 1, 5-5, 7-8, 8-7
- 181438CL Pin outs:** 2-2; 3-3; 5 & 6-4; 7-5; 8-7; 20-6 & 8 (Serial Printer Null Modem)
- 180582CL Pin outs:** 2-2; 3-3; 4-5 & 6; 5-7; 6 & 8-20; 7-8; (Serial Printer Null Modem)
- 180742CL Pin outs:** 1-4 & 5; 2-2; 3-3; 4-6; 5-7; 6-20; 7-8; 8-8



180697CL



180582CL



180742CL

Part No.	Description	Wt. (lbs.)	1	10	50
181403CL	6' DB9 F to DB9 F	0.3 ...	\$5.69	\$5.09	\$4.59
180697CL	10' DB9 F to DB9 F	0.4 ...	6.79	6.09	5.49
181438CL	6' DB25 M to DB9 F	0.4 ...	4.95	4.49	3.95
180582CL	10' DB25 M to DB9 F	0.4 ...	6.69	6.05	5.45
180742CL	10' DB25 F to DB9 F	0.5 ...	7.39	6.65	5.99

VGA Monitor Cables

- Connects video card to VGA monitor
- IBM PC/XT and higher compatibles
- HDDB15 male to male



66173CL

Part No.	Description	1	10	100
66173CL	6' monitor cable	\$6.49	\$5.89	\$5.29
148523CL	10' monitor cable	6.95	6.25	5.59

9-Pin Monitor Cable

- For monochrome, RGB, EGA and multisync monitors
- Connects video card to monitor
- IBM PC/XT and higher compatibles



Part No.	Description	1	10	100
66157CL	6' DB9 M-M	\$4.45	\$3.95	\$3.55

VGA Monitor Extension Cables

- Extends VGA monitor cable; HDDB15 male-to-female
- IBM PC/XT and higher compatibles
- 134041CL:** • HDDB15 female with hex nuts and HDDB15 male with thumbscrews
- 66165CL/148531CL:** • Thumbscrews on each end



66165CL



134041CL

Part No.	Description	1	10	100
134041CL	6' screws/hex nuts ...	\$4.49	\$3.95	\$3.49
66165CL	6' thumbscrews	6.59	5.95	5.35
148531CL	10' thumbscrews	7.49	6.79	5.99

DA15 Extension Cables

- Molded connectors
- Straight through
- Thumbscrews
- Color: gray (237032CL: black)

New Lower Prices



181286CL

Part No.	Description	Length	1	10	100
181286CL	DA15 M-M	6'	\$5.49	\$4.95	\$4.45
181358CL	DA15 M-F	6'	5.49	4.95	4.45
237032CL	DA15 M-F	8'	6.99	5.95	4.45

DB25-to-Centronics Parallel Printer Cables

- Molded and fully shielded DB25 male and 36-pin Centronics male connectors
- IBM PC/XT and higher compatibles

Quantity SAVE



28716CL

SALE



164777CL

Part No.	Description	Wt. (lbs.)	1	10	100
28716CL	6' straight	0.4 ...	\$4.69	\$4.25	\$3.85
223845CL	6' straight	0.6 ...	11.95	10.95	10.95
123781CL	10' straight	0.6 ...	5.95	5.09	3.79
164777CL	10' right angle*	0.7 ...	4.95	4.45	3.95
28708CL	15' straight	0.8 ...	5.95	5.09	3.79
101899CL	25' straight	1.1 ...	5.95	5.09	3.79
184786CL	50' straight	2.1 ...	2.00	1.82	1.65

* Centronics right angle

37-Pin Straight Through Cable Adapters



180611CL

181294CL

Part No.	Description	1	10	100
180611CL	6' DC37 M-M	\$6.95	\$6.29	\$5.65
181294CL	6' DC37 M-F	5.95	5.49	4.95

Monitor/Mouse/Keyboard Cables

- 6' or 32'
- HDDB15 male/female for monitor, 5-pin DIN male/female for keyboard, and DB9 male/female for mouse



141284CL

Part No.	Description	Wt. (lbs.)	1	10
141284CL	6' cable	1.6	\$22.95	\$19.95
141276CL	32' cable	4.8	39.95	35.95

Switch Box Adapter Cables

- 177261CL:** Male to male non-coiled cable for P/N 79177CL switch box, pg 169
- 114913CL:** Male to male coiled cable for P/N 114155CL switch box, pg 169
- 174772CL:** Male to male
- 174908CL/205655CL:** Male to male non-coiled
- 112627CL:** Male to male non-coiled cable for P/N 79177CL switch box, pg 169

Quantity SAVE



174772CL



205655CL

Part No.	Description	Length	1	10	50
114913CL	5-pin DIN	5' (gray)	\$4.95	\$4.49	\$3.95
177261CL	6-pin mini DIN	2' (gray)	2.95	2.55	1.89
174772CL	6-pin mini DIN	6' (black)	4.95	4.25	3.19
174908CL	6-pin mini DIN	6' (gray)	5.75	5.15	4.65
112627CL	6-pin mini DIN	10' (beige)	7.95	7.25	6.49
205655CL	6-pin mini DIN	25' (beige)	8.95	7.95	6.95

DB9 Extension Cables



132345CL

25700CL

- All lines connected straight through
- 132345CL/196365CL:**
- DB9 female to DB9 female cable with thumbscrews
- 220661CL/25700CL/148515CL/199638CL:**
- DB9 male to DB9 female cable with thumbscrews
- 181665CL:** • DB9 male to DB9 male cable

Part No.	Description	1	10	100	1000
220661CL	5' M-F	\$4.39	\$3.89	\$3.35	\$2.89
132345CL	6' F-F	4.95	4.49	3.95	3.49
199638CL	6' M-F (black)	4.49	3.95	3.49	2.95
25700CL	6' M-F	4.95	4.49	3.95	3.49
196365CL	10' F-F	6.95	6.25	5.95	4.95
148515CL	10' M-F	7.49	6.79	5.99	4.95
181665CL	10' M-M	6.95	6.25	5.59	4.95

9-Pin Test Cable

- DB9 M to DB9 F (6')
- Pin outs: 1-3, 2-2, 4-5

Quantity SAVE



Part No.	Description	1	10	100
162915CL	DB9 male to DB9 female	\$2.95	\$2.51	\$1.88

DB9-to-DB25 AT-Adapter Serial Cables

- For DB9 serial ports which need to be converted to DB25 serial
- AT and compatibles
- Molded DB9 female to DB25 male connectors

Quantity SAVE



31721CL

Part No.	Description	1	10	100
109583CL	1' serial, beige	\$4.35	\$3.95	\$3.49
189333CL	3' serial, beige	3.95	3.39	2.55
207790CL	4' serial, beige	\$2.95	2.35	2.15
31721CL	6' serial, beige	3.89	3.55	3.15
191361CL	6' serial, gray	4.39	3.99	3.15
155521CL	10' serial, beige	\$4.49	3.95	3.36

DB25 Extension Cables

- All lines connected straight through
- Use to lengthen your standard serial cable or for switch box applications
- Thumbscrews to secure connectors
- Color: gray; except P/Ns 174001CL/175290CL: black*

Quantity SAVE



67256CL

Part No.	Description	Wt. (lbs.)	1	10	50	100
174001CL	3' M-M*	0.6	\$4.79	\$4.35	\$3.89	\$3.49
65787CL	6' M-M	0.5	6.49	5.89	5.29	4.89
39538CL	10' M-M	0.7	6.95	6.29	5.05	3.69
179979CL	15' M-M	1.2	6.95	6.29	5.05	3.65
67070CL	25' M-M	1.4	10.95	9.95	8.95	7.95
180435CL	50' M-M	3.6	14.95	13.49	11.95	9.95
164291CL	3' M-F	0.4	4.29	3.89	3.09	2.35
175290CL	3' M-F*	0.4	2.95	2.69	2.25	1.59
163133CL	5' M-F	0.6	5.29	4.75	4.29	3.85
67256CL	6' M-F	0.6	6.45	5.79	5.25	4.69
39511CL	10' M-F	0.7	6.95	6.29	5.05	3.69
177279CL	15' M-F	1.0	9.49	8.55	7.69	6.25
101995CL	25' M-F	1.4	11.95	10.79	8.65	6.35
181201CL	50' M-F	3.2	17.95	14.39	10.79	7.55
224266CL	6' F-F	0.7	4.95	3.95	2.95	2.09
181331CL	10' F-F	0.9	6.69	5.55	4.15	2.89

USB-A Female Cables & Bracket

- Supports data transfer rates of 12Mbps
- Allows connection of two devices
- Dual USB-A female connectors • 8" long

Part No.	Description	1	10	25
144813CL	USB-A panel mount ...	\$6.95	\$6.25	\$5.59

ATEN USB-to-Centronics Printer Cable

- Full compliance with the USB spec V.1.0
- USB-A male to 36-pin male centronics connector
- Supports true bidirectional communication
- Applicable to standard and bidirectional printers

Part No.	Description	1	10	25
155352CL	6' USB cable	\$29.95	\$26.95	\$23.95

USB Cable Extenders

- Extends distance between USB devices by up to 16'
- Complies with USB electrical and timing specifications
- Compatible with high and low speed USB devices
- Interface: USB-A male to USB-A female
- Size: (adapter): 2.8"L x 1.5"W x 0.6"H • Wt.: 1.0 lb.

Part No.	Description	1	10	25
191433CL	8' USB extender	\$12.95	\$11.65	\$10.49
191441CL	16' USB extender	29.50	25.09	18.79

USB to Serial Adapter with Prolific Chipset

- This USB serial adapter provides an external Plug-and-Play RS-232 port for computers, notebooks, laptops, and handheld held computing devices. Provides high-quality serial connections at transfer rates of more than 500kbps for cell phones, PDAs, digital cameras, modems and ISDN terminal adapters. Since it is a USB connection it eliminates the hassles of traditional serial port connections and IRQ conflicts.
- Frees existing RS-232 ports for other uses
 - Supports RS-232 serial interface, automatic handshake mode, remote wake-up & power management
 - Provides a 96-byte buffer for each upstream and downstream data transfer • Weight: 1.5 lbs.
 - Full compliance with USB specification v 1.1
 - 7' cable with DB25 male connector and 14" cable with USB-A connector • Size: 2.7"L x 1.6"W x 0.7"H

System requirements: Windows®98/2000, USB host controlled installed in the system

Includes: 3.5" software and manual

Part No.	Description	1	5
213006CL	USB-A to serial converter	\$29.95	\$27.95

USB Gender Adapters

USB-A to USB-B

169383CL: USB-A (M) to USB-B (F)
169375CL: USB-A (F) to USB-B (M)

Part No.	Dimensions	1	10	25
169383CL	1.3"L x 0.4"W	\$6.95	\$6.35	\$5.59
169375CL	1.7"L x 0.6"W	6.95	6.35	5.59

Retractable USB and Firewire Cables

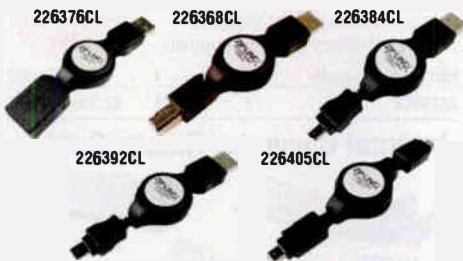

Carrying all those extra cables for your computer peripherals such as printers, cameras, zip drives, external hard drives, adds weight and gets tangled in your computer bag. With these retractable USB and Firewire cables, you can easily store them in an inside pocket of your bag, plus they are tangle free. Just pull the cable on both ends of the spool and you have a high quality cable that extends to over 2'. Simply pull again and it retracts back into its housing.

USB cables

Part No.	Description	1	5
226376CL	USB A male to female	\$9.95	\$10.95
226368CL	USB A - B	9.95	10.95
226384CL	USB A - Mini 4-pin	9.95	10.95
226392CL	USB A - Mini 5-pin	9.95	10.95

Firewire cables

Part No.	Description	Price
226405CL	4-pin M - M, 400Mbps	\$11.95
227424CL	6-pin M - 4-pin M 400Mbps	11.95
227459CL	6-pin M - M 400Mbps	11.95

IEEE 1394 Firewire Cables



- Connect your computer to the latest high speed Firewire peripherals.
- IEEE-1394 compliant
 - UL approved
 - Molded connectors

4-pin Male to 4-pin Male

Part No.	Description	1	10	25
222631CL	3' cable black	\$5.99	\$5.39	\$4.99
175821CL	6' cable black	7.99	6.99	5.99
222244CL	10' cable black	9.99	7.19	6.49
222252CL	15' cable black	12.99	11.69	10.49

4-pin Male to 6-pin Male

Part No.	Description	1	10	25
222623CL	3' cable black	\$5.99	\$5.39	\$4.99
175839CL	6' cable black	7.99	6.99	5.99
222228CL	10' cable black	9.99	8.99	7.99
222236CL	15' cable black	12.99	11.69	10.49

6-pin Male to 6-pin Male

Part No.	Description	1	10	25
222615CL	3' cable black	\$5.99	\$5.39	\$4.99
175847CL	6' cable black	7.99	6.99	5.99
222201CL	10' cable black	9.99	8.99	7.99
222210CL	15' cable black	12.99	11.69	10.49

USB 2.0 Cables



- Higher transfer rate up to 480Mbps
- USB-A Male to USB-A Male**
- | Part No. | Description | 1 | 10 | 25 |
|----------|-----------------------|--------|--------|--------|
| 229681CL | 6' cable beige | \$1.49 | \$1.49 | \$1.39 |
| 222033CL | 6' cable black | 6.49 | 5.99 | 5.69 |
| 229551CL | 6' cable clear | 6.49 | 5.99 | 5.69 |
| 229690CL | 10' cable beige | 1.75 | 1.75 | 1.65 |
| 222041CL | 10' cable black | 7.99 | 7.19 | 6.49 |
| 229569CL | 10' cable clear | 7.99 | 7.19 | 6.49 |
| 229702CL | 15' cable beige | 2.85 | 2.59 | 2.49 |
| 222050CL | 15' cable black | 12.99 | 11.69 | 10.49 |
| 229577CL | 15' cable clear | 12.99 | 11.69 | 10.49 |

USB-A Male to USB-B Male

Part No.	Description	1	10	25
229711CL	3' cable beige	\$1.39	\$1.39	\$1.29
222607CL	3' cable black	5.99	5.39	4.99
229585CL	3' cable clear	5.99	5.39	4.99
229729CL	6' cable beige	1.65	1.49	1.39
222009CL	6' cable black	6.49	5.99	5.69
229593CL	6' cable clear	6.49	5.99	5.69
229737CL	10' cable beige	1.89	1.75	1.65
222017CL	10' cable black	7.99	7.19	6.49
229606CL	10' cable clear	7.99	7.19	6.49
229761CL	15' cable beige	2.85	2.59	2.49
222025CL	15' cable black	12.99	11.69	10.49
229614CL	15' cable clear	12.99	11.69	10.49

USB-A Male to USB-A Female

Part No.	Description	1	10	25
229770CL	6' cable beige	\$1.65	\$1.49	\$1.39
222068CL	6' cable black	7.99	7.19	6.49
229622CL	6' cable clear	7.99	7.19	6.49
229788CL	10' cable beige	1.89	1.75	1.65
222076CL	10' cable black	9.99	8.99	7.99
229631CL	10' cable clear	9.99	8.99	7.99
229796CL	15' cable beige	2.85	2.85	2.49
222084CL	15' cable black	14.99	13.49	11.99
229649CL	15' cable clear	2.85	2.59	2.49

USB 1.1 Cables

USB-A Male to USB-A Male

Part No.	Description	1	10	25
196904CL	2' cable	\$1.85	\$0.68	\$0.62
175425CL	3' cable	\$2.95	1.92	1.74

USB-A Male to USB-B Male

Part No.	Description	1	10	25
175417CL	3' cable	\$4.49	\$3.99	\$3.59
169359CL	6' cable	4.95	4.49	3.95

Jameco Special Values!

See the yellow and green highlighted items.
Details on page 2.

ATX Power Supply 15" Extension Cable

- For use with ATX power supplies
- 20-pin ATX male and female connectors
- Color coded to ATX power supply code
- 15" L x 18 AWG (wires)



Part No.	Mfr. Cross Ref. No.	1	10	100
170237CL	ATX-400-RV	\$6.49	\$5.85	\$5.29

3.5" & 5.25" Disk Drive Power Splitters

- IBM PC/XT and higher compatibles
- Splits 4-line Molex male into 2 females



Part No.	Drive	AWG	Length	1	10	100
28353CL	5.25"	18	5'	\$2.95	\$2.69	\$2.15
72303CL	3.5"	22	5'	2.75	2.49	2.19

3.5" Disk Drive Power Adapter Cable

- IBM PC/XT and higher compatibles
- Allows connection of standard 3.5" disk drives to power supplies



Part No.	Length	AWG	1	10	100
28396CL	3.5'	22	\$2.49	\$2.25	\$1.95

Internal Computer Ribbon Cables



Part No.	Conductors	Length	1	10	100
185068CL	34	9.0'	\$2.95	\$2.66	\$2.36
185076CL	40	14.0'	.79	.65	.49
32686CL	40	18.0'	3.95	3.49	2.95

Ribbon Cable Assemblies

- Metal connector
- 300V rating
- 105°C rating
- 28 AWG flat cable
- Tin-plated contacts



Part No.	Description	1	10	100
12407CL	4' DB25 M-F	\$4.49	\$3.95	\$3.59
208581CL	6' DB9 M-F	3.95	3.55	3.19

Computer Card Brackets



- For securing cards into bus slots
- Fits standard PC/XT/AT cases
- Length: 4.75"
- See pg 71 for DB connectors

Part No.	Description	Fig.	1	10	100
11754CL	Blank back panel	1	\$1.79	\$1.59	\$1.45
101717CL	For DB9 connector	2	1.79	1.59	1.45
101733CL	For DB25 connector	3	1.79	1.59	1.45
101741CL	For DC37 connector	4	1.79	1.59	1.45
101830CL	For DB9/DB25 conn.	5	1.79	1.59	1.45

Panel Bracket Cable Assemblies

- Standard computer back panel brackets
- Length: 12"
- Ribbon cable with header connector



- 149614CL: 2 serial ports
- 149622CL: 1 parallel port
- 179995CL: 1 parallel & 2 serial ports

Part No.	Description	1	10	25
149614CL	DB9M to 10-pin header			
	DB25M to 10-pin header	\$4.95	\$3.75	\$2.65
149622CL	DB25 to 26-pin header	4.95	3.75	2.65
179995CL	DB9M to 10-pin header			
	DB25M to 10-pin header			
	DB25F to 26-pin header	1.19	.99	.79

Now Lower Prices

Disk Drive Cables

Quantity SAVE



Part No.	Description	Cable Length	1	10	100
185084CL	34-pin header socket ribbon cable for floppy drive	25'	\$1.19	\$.99	\$.75
32918CL	34-pin header socket ribbon cable for floppy to card	23'	3.49	2.99	2.25
72805CL	Two 40-pin header socket ribbon cable for IDE drive	18'	3.69	3.14	2.35
175492CL	40-pin header socket ribbon cable for ultra DMA66/100	17'	6.95	6.25	5.49

Internal and External SCSI Cables for Complete Connectivity



- For PC/XT/AT and compatibles
- All lines connected

SALE

Now Lower Prices

Part No.	Description	1	10	100
32715CL	50-pin header socket ribbon cable SCSI-I (18")	\$3.95	\$3.49	\$2.95
72848CL	50-pin header socket ribbon cable SCSI-I (24")	1.95	1.79	1.65
137550CL	68-pin header internal ribbon cable SCSI-III (27")	\$12.49	12.49	11.25
118084CL	Male 50-pin Centronics to male HPDB50 cable SCSI-I to SCSI-II (6')	14.95	13.49	11.95
118914CL	Male HPDB50 to male HPDB50 SCSI-II to SCSI-II (3')	\$14.95	9.34	8.49
118076CL	Male HPDB50 to male HPDB50 SCSI-II to SCSI-II (6')	17.95	15.95	13.95
137568CL	Male HPDB68-pin to male HPDB50-pin SCSI-III to SCSI-II (3')	\$12.95	7.19	6.80

† Also Macintosh® compatibles, see right for SCSI type connector guide

PC/XT/AT & PS/2 Keyboard Extension Cables

- Color: beige
- 114981CL/112045CL/:
- 5-pin DIN male-to-female
- 28548CL/111053CL:
- 6-pin mini DIN female-to-male



Part No.	Description	1	10	100
114981CL	PC/XT/AT 6' non-coiled	\$1.99	\$1.79	\$1.65
112045CL	PC/XT/AT 10' non-coiled	3.95	3.36	2.52
28548CL	PS/2 6' non-coiled	4.35	3.89	3.49
111053CL	PS/2 10' non-coiled	5.49	4.99	4.39

AT-to-PS/2 and PS/2-to-AT Keyboard Adapter Cables

- 28003CL:
- Connects AT-type keyboards to PS/2
- 5-pin female DIN to 6-pin male mini DIN



Part No.	Length	Color	Wt. (lbs.)	1	10	100
28003CL	6.5'	Beige	0.6	\$3.95	\$3.49	\$3.15
85500CL	11.3'	Beige	0.8	5.39	4.85	4.39

SCSI Adapters



- See below for SCSI-type connector guide

Part No.	Description	1	10	50
133920CL	50-pin ribbon header			
	SCSI-I to DB25 female	\$8.95	\$6.95	\$5.25
125241CL	50-pin ribbon header to HPDB50 SCSI-II female	9.95	8.45	6.35
167370CL	DB25 female to HPDB50 male SCSI-II	\$9.95	3.55	3.20

SCSI TYPE / CONNECTOR REFERENCE TABLE

SCSI type	50-pin Centronics		Half pitch DB50		HPDB50 Centronics	
	DB25	DB25	DB25	DB25	DB25	DB25
SCSI-I	✓	✓	✓	✓		
SCSI-II			✓	✓		
SCSI-II wide					✓	
SCSI-III					✓	✓
RAID: SCA, SCA-2						✓

Jameco's Low-Price Guarantee

We'll match the print advertised price of any like product. It's that simple!

- Molded connectors
- Excellent resistance to jacket abrasion
- Temperature: -20°C to +60°C
- Voltage rating: 300 volts



AWG	Volts	Amps	VA
18	125	10	1250
16	125	12	1500
14	125	15	1875



Quantity **SAVE**

SALE

Part Number	Mfr. Cross Reference No.	Description	Weight (lbs.)	Agency Approvals	Plug Fig.	Length	Color	AWG	Cord Type*	Pricing			
										1	10	100	250
152186CL	17106BG	2-conductor power cord with pigtail	.20	UL/CSA	1	6'	Beige	18/2	SPT-2	\$1.09	\$.98	\$.78	\$.59
124433CL	ST008	2-conductor power cord with pigtail	.16	UL/CSA	1	6'	Black	18/2	SPT-2	1.15	.99	.89	.79
42041CL	17106	2-conductor power cord with pigtail with strain relief	.25	UL/CSA	1	6'	Black	18/2	SPT-2	1.15	.99	.89	.79
146309CL	PC182J6	2-conductor power cord with pigtail (round)	.31	UL/CSA	1	6'	Black	18/2	SJT	.99	.79	.59	.42
189587CL	VW-1	2-conductor "8" style power cord for laptops and power supplies	.30	UL/CSA	2	6'	Black	18/2	SPT-2	2.95 2.49	2.15	1.94	1.74
200791CL	LL114039	2-conductor "D" style power cord for laptops and power supplies	.30	UL/CSA	3	6'	Black	18/2	SPT-2	2.95	2.69	2.15	1.15
38009CL	17237	3-conductor power cord with pigtail	.31	UL/CSA	4	6'	Gray	18/3	SVT	2.39	2.15	1.94	1.74
173809CL	17405	3-conductor power cord with pigtail	.39	UL/CSA	4	6'	Gray	18/3	SJT	\$2.95 2.39	2.15	1.72	1.29
37997CL	17236	3-conductor power cord with pigtail	.30	UL/CSA	4	6'	Black	18/3	SVT	2.79	2.32	2.11	1.99
159409CL	17405B	3-conductor power cord with pigtail	.37	UL/CSA	4	6'	Black	18/3	SJT	2.59	2.15	1.95	1.79
38025CL	17238	3-conductor power cord with pigtail	.39	UL/CSA	4	8'	Black	18/3	SVT	3.29	2.75	2.45	2.25
102007CL	17535B	3-conductor power cord with pigtail	.49	UL/CSA	4	10'	Black	18/3	SVT	3.25	2.75	2.49	2.25
196285CL	LL40378	3-conductor power cord with pigtail	.80	UL/CSA	4	10'	Black	16/3	SJT	3.49	3.15	2.79	2.49
166924CL	17516	3-conductor power cord with pigtail	.67	UL/CSA	4	6' 7"	Black	14/3	SJT	3.95	3.55	3.19	2.79
100271CL	17629B	3-conductor power cord with pigtail	.88	UL/CSA	4	9'	Black	14/3	SJT	4.25	3.55	3.25	2.89
160995CL	17720	3-conductor power cord with pigtail (shielded)	.44	UL/CSA	5	8'	Black	18/3	SVT	2.49	2.25	2.05	1.85
184815CL	17629BR	3-conductor right angle power cord with pigtail	.77	UL/CSA	6	7'	Black	14/3	SJT	2.15	1.89	1.69	1.55
103747CL	17248	3-conductor power supply cord	.34	UL/CSA	7	6'	Gray	18/3	SVT	2.59	2.39	2.19	2.09
213874CL	17660BG	3-conductor power supply cord (shielded)	.40	UL/CSA	7	6'	Beige	18/3	SVT	\$2.59 2.39	2.15	1.95	1.77
38041CL	17249	3-conductor power supply cord	.37	UL/CSA	7	6'	Beige	18/3	SVT	3.49	3.15	2.79	2.49
38050CL	17250	3-conductor power supply cord	.36	UL/CSA	7	6'	Black	18/3	SVT	3.79	3.45	3.19	2.95
161761CL	17742	3-conductor power supply cord (shielded)	.40	UL/CSA	7	6'	Black	18/3	SVT	4.49	4.05	3.65	3.29
132118CL	17500	3-conductor power supply cord	.44	UL/CSA	7	6'	Black	18/3	SJT	4.49	4.05	3.25	2.45
117583CL	17502	3-conductor power supply cord	.37	UL/CSA	7	8'	Gray	18/3	SVT	3.49	3.15	2.55	1.89
171096CL	17758	3-conductor power supply cord	.60	UL/CSA	7	8'	Black	18/3	SJT	3.95	3.55	3.19	2.89
229219CL	9350819	3-conductor power supply cord (shielded)	.45	UL/CSA	7	8'	Black	18/3	SJT	4.49 4.05	3.25	2.45	
102023CL	17501V	3-conductor power supply cord	.55	UL/CSA	7	10'	Black	18/3	SVT	3.95	3.39	3.09	2.79
192727CL	17501J	3-conductor power supply cord	.64	UL/CSA	7	10'	Black	18/3	SJT	3.95	3.59	2.89	2.15
190625CL	37805	3-conductor power supply cord (shielded)	.75	UL/CSA	7	10'	Beige	18/3	SJT	3.49	3.15	2.85	2.59
163361CL	6952299	3-conductor power supply cord	.33	UL/CSA	7	14'	Black	18/3	SJT	5.39	4.85	4.39	3.95
159361CL	17602	3-conductor power supply cord	.57	UL/CSA	7	6'	Black	16/3	SJT	3.79	3.15	2.79	2.49
142607CL	17502	3-conductor power supply cord (shielded)	.63	UL/CSA	7	6'	Black	16/3	SJT	4.19	3.79	3.39	3.05
125541CL	17504	3-conductor power supply cord	.71	UL/CSA	7	6' 7"	Black	14/3	SJT	4.95	4.25	3.35	2.50
117356CL	8120-6177	3-conductor right angle power supply cord	.41	UL/CSA	8	6'	Gray	18/3	SVT	3.95	3.19	2.39	1.69
38076CL	17250R	3-conductor right angle power supply cord	.54	UL/CSA	8	6'	Black	18/3	SVT	3.49	3.15	2.85	2.55
173251CL	17250RS	3-conductor right angle power supply cord (shielded)	.40	UL/CSA	8	6'	Black	18/3	SVT	3.29	2.99	2.69	2.39
177383CL	17507	3-conductor right angle power supply cord	.66	UL/CSA	8	10'	Black	18/3	SJT	3.95	3.59	2.89	2.15
84937CL	17669-6	3-conductor piggy backed computer power cord	.47	UL/CSA	9	6'	Black	18/3	SJT	6.95	6.29	5.05	3.79
28468CL	PEC	3-conductor computer power supply extension cord	.36	UL/CSA	10	6'	Black	18/3	SVT	4.39 4.05	3.45	2.75	2.95
121291CL	PEC2	3-conductor computer power supply extension cord	.55	UL/CSA	10	8'	Black	18/3	SJT	\$3.95 3.45	2.95	2.35	1.75
175855CL	PECUL10	3-conductor computer power supply extension cord	.53	UL/CSA	10	10'	Black	18/3	SVT	2.95	2.39	1.79	1.25
177447CL	MPC1	3-conductor monitor power adapter cord	.16	UL/CSA	11	1'	Black	18/3	SVT	2.95	2.49	2.15	1.79
132011CL	17006G	3-conductor power cord w/ hospital grade male (green dot)	.82	UL/CSA	12	10'	Gray	16/3	SJT	8.45	7.65	6.15	4.59
115078CL	17006	3-conductor power cord w/ hospital grade male (green dot)	.84	UL/CSA	12	10'	Black	16/3	SJT	8.95	8.05	6.45	4.89
173884CL	3472WJ698G	3-conductor power cord w/ hospital grade male rt ang (green dot)	.85	UL/CSA	13	9'	Gray	16/3	SJT	7.95	7.19	5.75	4.35
199777CL	PSS-1	3-conductor power cord (power strip saver)	.16	UL/CSA	14	1'	Black	18/3	SVT	1.69	1.55	1.39	1.25
208338CL	SY0527BG	3-conductor power cord (power strip saver)	.16	UL/CSA	14	1'	Beige	18/3	SVT	\$1.69 1.35	.95	.85	.75
208346CL	GPR-2006	3-conductor power cord ("Y" type power strip saver)	.38	UL/CSA	15	2'	Black	18/3	SVT	2.89	2.75	2.59	2.59

* Thermoplastic Cord Jacket Type: SPT-2 (Flat); Junior duty. SVT (Round); Light service, SJT (Round); Junior service

D-Subminiature Connectors

- Dielectric withstanding voltage: 1000VAC (one minute)
- Nylon, flame retardant, 94V-0 rated, glass filled
- Low-cost, high-performance, precision formed crimp contacts
- Standard mounting method with 0.120" diameter mounting holes
- Insulation resistance: 5000MΩ
- UL/CSA recognized and certified

Crimp-Type Contacts

- Current rating: 1.2A to 3.7A
- Intermateable with any size 20 D-sub dimensionally complying with MIL-C-24308
- Crimp snap-in contacts allows loading of only the number of contacts being used

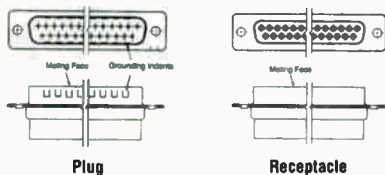

Zinc-Plated Shell

Now Lower Prices



Part No.	Product No.	Cont.	Description	1	10	100
222640CL	205204-1	9	Plug	\$.95	\$.85	\$.63
222658CL	205206-1	15	Plug	1.39	1.24	.92
222666CL	205208-1	25	Plug	1.05	.92	.82
222674CL	205210-1	37	Plug	1.69	1.49	1.10
222682CL	205212-1	50	Plug	2.10	1.79	1.35
222691CL	205203-1	9	Receptacle	1.10	.99	.77
222703CL	205205-1	15	Receptacle	1.25	1.10	.82
222711CL	205207-1	25	Receptacle	1.05	.95	.71
222720CL	205209-1	37	Receptacle	1.69	1.49	1.10
222738CL	205211-1	50	Receptacle	2.10	1.79	1.69

Tin-Plated Shell



Part No.	Product No.	Cont.	Description	1	10	100
222754CL	205204-3	9	Plug	\$1.29	\$1.15	\$.85
222762CL	205206-2	15	Plug	1.49	1.29	.95
222771CL	207464-1	25	Plug	.94	.80	.61
222789CL	205210-2	37	Plug	1.69	1.49	1.10
222797CL	205204-4	9	Plug*	.83	.75	.55
222800CL	205206-3	15	Plug*	.99	.89	.65
222818CL	207464-2	25	Plug*	.88	.78	.58
222826CL	205210-3	37	Plug*	1.68	1.49	1.12
222834CL	205212-3	50	Plug*	1.79	1.59	1.19
222842CL	205203-3	9	Receptacle	.69	.59	.52
222914CL	205205-2	15	Receptacle	.88	.78	.58
222922CL	207463-1	25	Receptacle	.99	.89	.68
222931CL	205209-2	37	Receptacle	1.19	1.05	.78
222949CL	205211-2	50	Receptacle	2.10	1.79	1.35

* With grounding indents

D-Sub Pin Insertion/Extraction Tools

19094CL: Plastic body; metal tips
223327CL: Handle with .050" hex wrench & exchangeable tips



Part No.	Description	1	10	100
19094CL	Red/white plastic body	\$2.79	\$2.49	\$2.15
223327CL	AMP# 91285-1	19.99	18.99	17.99

Solder-Cup Contacts

- Current rating: 1.2A to 3.0A
- Intermateable with other D-sub connectors
- One-piece 94V-0 rated plastic insert
- Preloaded duplex-plated solder-cup contacts
- Shields offer full EMI shielding and ESD insulation
- Anti-solderwicking contact design

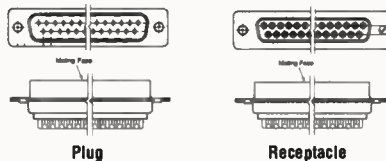

Zinc-Plated Shell



Part No.	Product No.	Cont.	Description	1	10	100
222957CL	747904-4	9	Plug	\$1.89	\$1.59	\$1.32
222965CL	747908-4	15	Plug	2.65	2.19	1.75
222973CL	747912-4	25	Plug	3.69	3.10	2.49
222981CL	747916-4	37	Plug	5.45	4.56	3.79
223036CL	747905-4	9	Receptacle	2.65	2.23	1.76
223044CL	747913-4	25	Receptacle	4.75	3.99	3.19

Tin-Plated Shell



Part No.	Product No.	Cont.	Description	1	10	100
222990CL	747904-2	9	Plug	\$1.69	\$1.55	\$1.15
223001CL	747908-2	15	Plug	2.79	2.49	1.85
223010CL	747912-2	25	Plug	3.29	2.95	2.19
223028CL	747916-2	37	Plug	5.29	4.29	3.49
223052CL	747905-2	9	Receptacle	2.35	2.09	1.55
223061CL	747909-2	15	Receptacle	3.45	2.99	2.19
223079CL	747913-2	25	Receptacle	4.10	3.69	2.72
223087CL	747912-2	37	Receptacle	6.65	5.69	4.19

D-Sub Plastic Hoods for AMP D-Sub Connectors

- Cable clamp type: clam shell
- Cable exit angle: straight
- Standard clam shell length
- Body material, cable support gate, and cable clamp: thermoplastic
- Screw material: steel
- Screw plating: zinc



Part No.	Product No.	Positions	1	10	100
230893CL	205729-1	9	\$2.25	\$1.85	\$1.46
230906CL	205730-1	15	2.34	2.10	1.85
230914CL	205718-1	25	2.05	1.69	1.32
230922CL	205731-1	37	2.88	2.63	2.29
230931CL	205732-1	50	3.21	2.65	2.19

D-Sub Crimp and Solder Contacts

- Pin material: brass; socket material: phosphor bronze
- Contact plating
- *A: Select - gold flash over nickel on entire contact, with additional gold (.000030) on mating end;
- *B: Duplex - gold (.000030) on mating end, tin-lead on termination end, with entire contact nickel underplated;
- *C: gold flash over nickel on entire contact;
- *D: gold flash on mating end, tin-lead on termination end, with entire contact nickel underplated
- For use with AMP D-sub connectors (see left)
- Prepackaged: order in increments of 10, 100 or 1000

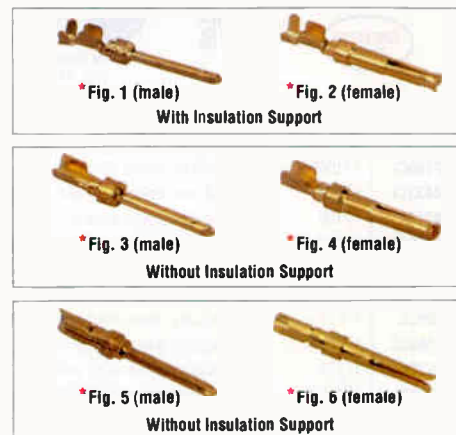

Male Crimp Contacts

Part No.	Product No.	Desc.*	AWG	10	100	1000
223095CL	1-66507-0	1C	28-24 ...	\$.24	\$.17	\$.12
223124CL	66682-4	1A	28-24	.28	.19	.14
223108CL	66507-9	1A	28-24	.18	.12	.09
223132CL	745254-7	1C	26-22	.25	.18	.128
223141CL	745254-6	1A	26-22	.28	.20	.14
223159CL	1-745254-6	1B	26-22	.25	.18	.13
223167CL	1-66506-0	1C	24-20	.16	.15	.12
223175CL	205202-7	3C	24-20	.24	.17	.14
223183CL	5-66506-9	1D	24-20	.21	.15	.13
223191CL	66506-9	1A	24-20	.16	.15	.10
223204CL	5-66506-7	1B	24-20	.24	.17	.12
223212CL	745229-4	3A	22-18	.26	.24	.19

Female Crimp Contacts

Part No.	Product No.	Desc.*	AWG	10	100	1000
223221CL	1-66505-0	2C	28-24 ...	\$.18	\$.12	\$.09
223239CL	66683-4	2A	28-24	.31	.22	.15
223247CL	745253-6	2A	26-22	.30	.20	.14
223255CL	1-66504-0	2C	24-20	.17	.15	.11
223263CL	205201-7	4C	24-20	.28	.23	.18
223271CL	5-66504-7	2D	24-20	.16	.12	.10
223280CL	205201-5	4A	24-20	.32	.26	.20
223298CL	66504-9	2A	24-20	.17	.15	.13
223301CL	6-66504-0	2B	24-20	.27	.18	.13

Male Solder Contact

Part No.	Product No.	Desc.*	AWG	10	100	1000
234982CL	66570-3	5A	28-24 ...	\$.22	\$.12	\$.11

Female Solder Contact

Part No.	Product No.	Desc.*	AWG	10	100	1000
223319CL	66569-3	6A	18 (max)	\$.225	\$.18	\$.162

Corporate Customers

Opening an account is easy!! Call 1-800-831-4242 for details today.

D-Subminiature Connector Hoods



- Use with D-sub solder cup and housing style connectors (hardware included)

D Series: plastic hood with strain relief (gray)

MD Series: metal coated plastic hood w/ strain relief

MH Series: die-cast metal hood with strain relief

Part No.	Mfr. Cross					
	Ref. No.	Connector	1	10	100	1000
15721CL	DB9H	9-pin	\$.49	\$.45	\$.39	\$.35
25620CL	MDB9H	9-pin	.59	.49	.39	.35
147740CL	MHDB9	9-pin	1.45	1.29	1.15	.99
15018CL	DA15H	15-pin	.49	.45	.40	.35
25566CL	MDA15H	15-pin	.56	.44	.36	.31
15085CL	DB25H	25-pin	.45	.39	.35	.32
25603CL	MDB25H	25-pin	.59	.49	.42	.35
15106CL	MHDB25	25-pin	1.39	1.19	1.09	.89
15456CL	DC37H	37-pin	.59	.55	.45	.39
25611CL	MDC37H	37-pin	.75	.69	.59	.53
15659CL	DD50H	50-pin	.99	.85	.75	.65

25-Pin Dual Plastic Hood

Designed for custom applications requiring two D-sub connectors. Applications include custom jumper boxes and interconnects.



Part No.	Description	1	10	100	500
34091CL	25-pin, plastic dual	\$.95	\$.85	\$.75	\$.59

4-40 Screw Hardware for D-Subminiature Connectors

4-40 x .187" Jack Screws and Standoffs



Prepackaged: order in increments of 10, 100 or 1000

Part No.	Description	1	10	100	1000
196293CL	.252 L jack screw	\$.21	\$.12	\$.08	
169931CL	.275 L jack screw	.15	.13	.11	
172603CL	.315 L jack screw	.14	.11	.09	
102816CL	.435 L jack screw	.49	.46	.41	.37
108986CL	.515 L jack screw	.55	.50	.45	.40
125014CL	4-40 x 1.65 L plastic beige thumbscrew	.39	.35	.28	.20
175636CL	.187 L standoff	.15	.13	.096	
102795CL	.236 L (6mm) standoff	.21	.15	.10	

4-40 Screw Sets

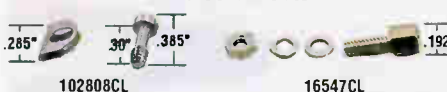

102808CL: 4-40 screw (.30 L) and retainer set
16547CL: 4-40 x .187" jack screw (.31 L thread), washer, lock washer, and nut set

- Prepackaged: order in increments of 10, 100 or 1000

Part No.	Description	10	100	1000
102808CL	Screw/retainer set	\$.35	\$.30	\$.20
16547CL	Screw/nut set	.31	.25	.17

D-Subminiature Connectors

- Metal shells are tin-plated for improved EMI/RFI shielding
- Insulation resistance: minimum 1000MΩ at 500VDC
- Dielectric withstanding voltage: 1000V (one minute)

- Current rating: 1A to 5A
- High temperature thermoplastic
- Insulation material: PBT

Right Angle PC Mount Connectors

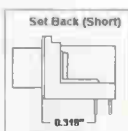

0.318" Set Back

- Short style
- Lead length: .138"
- Lead spacing: .115"
- Shell: metal
- Current rating: 1A

Quantity **SAVE**



15149CL

Part No.	Mfr. Cross Ref. No.	Cont.	Gender	1	10	100	500
104942CL	DB9P318	9	M	\$.55	\$.50	\$.40	\$.30
104951CL	DB9S318	9	F	.60	.55	.49	.45
71124CL	DA15P318	15	M	.69	.59	.55	.49
77956CL	DA15S318	15	F	.79	.69	.65	.45
168743CL	HDBB15S318*	15	M	.49	.42	.34	.31
71466CL	HDBB15S318*	15	F	.59	.53	.42	.31
15149CL	DB25P318	25	M	.79	.65	.55	.42
15181CL	DB25S318	25	F	.89	.79	.72	.65
71706CL	DC37P318	37	M	.99	.89	.71	.53
78182CL	DC37S318	37	F	1.15	.95	.69	.49

*High Density

0.590" Set Back

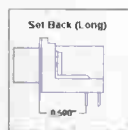

- Lead length: .178"
- Lead spacing: .104"
- Current rating: 1A
- Shell: Metal
- Long style



104977CL

Part No.	Mfr. Cross Ref. No.	Cont.	Gender	1	10	100
104969CL	DB9P590	9	M	\$.99	\$.83	\$.72
104977CL	DB9S590	9	F	.89	.79	.75
104993CL	DA15S590	15	F	.99	.85	.59
189624CL	DB25P590†	25	M	\$.85	.49	.45
105005CL	DB25S590	25	M	.99	.89	.79
105013CL	DB25S590	25	F	1.25	1.12	.99

† Without board tabs

IDC Ribbon Cable Connectors

- Current rating: 1 amp
- Insulation material: glass-filled polyester
- Temp range: -55°C to +120°C
- Contact material: phosphor bronze
- Terminates with standard D-type connectors
- Shell: MD: Metal; CD: Plastic (see mfr. cross ref. no.)



12431CL

Part No.	Mfr. Cross Ref. No.	Cont.	Gender	1	10	100
109225CL	MDB9P†	9	M	\$.135	\$.125	\$.109
12503CL	CDB9P	9	M	2.49	1.79	1.59
109217CL	MDB9S†	9	F	1.49	1.19	1.05
12520CL	CDB9S	9	F	2.59	2.35	2.09
117381CL	MDA15P	15	M	1.55	1.25	.69
12298CL	CDA15P	15	M	1.55	1.25	.75
116011CL	MDA15S	15	F	1.55	1.25	.85
12319CL	CDA15S	15	F	1.69	1.35	.79
115983CL	MDB25P	25	M	1.85	1.69	1.45
12335CL	CDB25P	25	M	1.89	1.69	1.29
115975CL	MDB25S	25	F	1.85	1.65	1.39
12431CL	CDB25S	25	F	1.95	1.79	1.39
115991CL	MDC37P	37	M	2.39	2.15	1.55
12466CL	DC37P	37	M	3.09	2.65	1.99
116003CL	MDC37S	37	F	2.95	2.69	2.42
12482CL	DC37S	37	F	3.49	2.99	2.25

† Require flat cable w/ .0625" centers

Crimp-Type Connectors and Pins

- Connectors: metal shell; removable male/female crimp pins
- Male/female pins: gold plated contact; tinned crimp tail
- Insertion/extraction tool: exchangeable tips
- Use 99442CL, pg 181 to crimp 43377CL, 43369CL

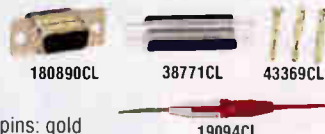

Prepackaged: order in increments of 10, 100 or 1000

Part No.	Description	1	10	100	1000
73189CL	DB9 M housing	\$.49	\$.39	\$.31	\$.19
73197CL	DB9 F housing	.49	.39	.31	.19
73200CL	DA15 M housing	.59	.53	.48	.43
73218CL	DA15 F housing	.62	.59	.47	.35
180881CL	HDBB15 M housing*	1.09	.98	.78	.58
180890CL	HDBB15 F housing*	.89	.79	.72	.65
38789CL	DB25 M housing	.56	.44	.36	.21
38771CL	DB25 F housing	.55	.44	.31	.21
43377CL	M crimp pin	.10	.09	.08	
43369CL	F crimp pin	.08	.07	.06	
185421CL	M crimp pin (180881CL)	.055	.045	.04	
185412CL	F crimp pin (180890CL)	.055	.05	.04	
19094CL	Insert/extract. tool for above pins (HT101)	2.79	2.49	2.15	2.15

* High Density

Solder-Cup Connectors



- Compatible with 24 AWG communications and 22 AWG solid cable, pg 60
- Shell: Metal

Part No.	Contacts	Gender	1	10	100	1000
15747CL	9	M	\$.56	\$.44	\$.36	\$.24
15771CL	9	F	.59	.49	.44	.31
15077CL	15HD*	M	.69	.59	.49	.31
164822CL	15HD*	F	.79	.69	.59	.39
15034CL	15	M	.55	.49	.42	.29
15051CL	15	F	.59	.49	.39	.24
15114CL	25	M	.99	.89	.79	.71
15157CL	25	F	.89	.80	.69	.61
203799CL	26HD*	M	.65	.58	.52	.52
203781CL	26HD*	F	.75	.68	.61	.61
15472CL	37	M	.99	.85	.79	.49
15499CL	37	F	1.19	1.05	.85	.49
15675CL	50	M	1.65	1.49	1.35	.99
15691CL	50	F	1.79	1.39	1.32	1.19

*High Density

Straight PC Mount Connectors

- Non-removable contacts
- 125 Vrms
- Current rating: 5 amps
- Operating temperature: -65°F to +250°F
- Shell: Metal



Part No.	Mfr. Cross Ref. No.	Cont.	Gender	1	10	100
111691CL	DB9PPCB	9	M	\$.55	\$.45	\$.32
15780CL	DB9SPCB	9	F	.55	.45	.32
176760CL	DA15PPCB	15	M	.49	.39	.27
176751CL	DA15SPCB	15	F	.49	.44	.39
15122CL	DB25PPCB	25	M	.65	.59	.42
15165CL	DB25SPCB	25	F	.74	.55	.31
180021CL	DC37SPCB	37	F	.85	.72	.54



.062" (1.57mm) Power Connectors

- Passive friction lock
- Polarized housing assures proper mating
- Voltage: 250V • Current: 5.0A
- Dielectric withstanding voltage: 1500VAC_{RMS}
- Contact retention to housing: 20 lbs. minimum
- Housing: nylon; UL94V-2
- Temperature range: -40°C to +105°C

Plugs



224485CL 230009CL 230084CL

Without Mounting Ears

Part No.	Product No.	Circuits	1	10	100
224477CL	03-06-2011*	1	\$.29	\$.16	\$.13
224485CL	03-06-2023*	2	.30	.18	.15
224493CL	03-06-2032*	3	.31	.19	.16
224506CL	03-06-2042*	4	.39	.27	.24
224514CL	03-06-2044**	4	.39	.27	.24
230244CL	03-06-2055*	5	.47	.26	.24
224522CL	03-06-2061**	6	.45	.28	.25
224531CL	03-06-2092**	9	.49	.27	.24
224549CL	03-06-2122**	12	.52	.30	.25

*In-line **Grid

With Mounting Ears

Part No.	Product No.	Circuits	1	10	100
229948CL	03-06-2024*	2	\$.30	\$.17	\$.14
229964CL	03-06-2033*	3	.35	.18	.15
229981CL	03-06-2041*	4	.47	.27	.24
230009CL	03-06-2043**	4	.47	.26	.24
230025CL	03-06-2054*	5	.47	.26	.24
230041CL	03-06-2062**	6	.47	.26	.24
230068CL	03-06-2091**	9	.47	.26	.24
230084CL	03-06-2121**	12	.55	.29	.26

*In-line **Grid

Receptacles



230252CL 229956CL 230092CL

Without Mounting Ears

Part No.	Product No.	Circuits	1	10	100
224397CL	03-06-1011*	1	\$.29	\$.16	\$.13
224400CL	03-06-1023*	2	.30	.18	.15
224418CL	03-06-1032*	3	.31	.19	.16
224426CL	03-06-1042*	4	.39	.27	.24
224434CL	03-06-1044**	4	.39	.27	.24
230252CL	03-06-1055*	5	.55	.35	.31
224442CL	03-06-1062**	6	.45	.28	.25
224451CL	03-06-1092**	9	.49	.27	.24
224469CL	03-06-1122**	12	.52	.30	.25

*In-line **Grid

With Mounting Ears

Part No.	Product No.	Circuits	1	10	100
229956CL	03-06-1022*	2	\$.31	\$.16	\$.14
229972CL	03-06-1038*	3	.32	.17	.15
229999CL	03-06-1041*	4	.49	.26	.23
230017CL	03-06-1043**	4	.49	.26	.23
230033CL	03-06-1055*	5	.59	.49	.36
230050CL	03-06-1061**	6	.47	.26	.23
230076CL	03-06-1091**	9	.47	.26	.23
230092CL	03-06-1121**	12	.49	.33	.30

*In-line **Grid

.093" (2.36mm) Power Connectors

- Passive friction lock
- Voltage: 250V
- Current: 12A per circuit
- Dielectric withstanding voltage: 1500VAC_{RMS}
- Contact retention to housing: 20 lbs. minimum
- Housing: nylon; UL94V-2
- Temperature range: -40°C to +105°C

Plugs



229825CL 230261CL 230181CL

Without Mounting Ears

Part No.	Product No.	Circuits	1	10	100
224063CL	03-09-2011*	1	\$.29	\$.18	\$.12
224071CL	03-09-2022*	2	.30	.25	.18
224080CL	03-09-2032*	3	.41	.32	.21
224098CL	03-09-2042*	4	.45	.22	.20
229825CL	03-09-2049**	4	.45	.34	.26
230261CL	03-09-2057*	5	.55	.29	.26
224101CL	03-09-2062**	6	.49	.39	.29
224119CL	03-09-2092**	9	.55	.35	.30
224127CL	03-09-2121**	12	.69	.59	.39

*In-line **Grid

With Mounting Ears

Part No.	Product No.	Circuits	1	10	100
230105CL	03-09-2021*	2	\$.35	\$.18	\$.16
230121CL	03-09-2031*	3	.42	.22	.20
230148CL	03-09-2041*	4	.42	.22	.20
230164CL	03-09-2040**	4	.64	.59	.35
230181CL	03-09-2061**	6	.35	.33	.25
230201CL	03-09-2091**	9	.65	.35	.31
230228CL	03-09-2122**	12	.71	.38	.35

*In-line **Grid

Receptacles



229817CL 230130CL 230199CL

Without Mounting Ears

Part No.	Product No.	Circuits	1	10	100
224135CL	03-09-1011*	1	\$.29	\$.09	\$.08
224143CL	03-09-1022*	2	.30	.25	.18
224151CL	03-09-1032*	3	.44	.25	.16
224160CL	03-09-1042*	4	.46	.25	.22
229817CL	03-09-1049**	4	.46	.33	.25
230279CL	03-09-1057*	5	.59	.49	.32
224178CL	03-09-1064**	6	.49	.23	.20
224186CL	03-09-1094**	9	.69	.59	.39
224194CL	03-09-1126**	12	.75	.49	.39

*In-line **Grid

With Mounting Ears

Part No.	Product No.	Circuits	1	10	100
230113CL	03-09-1027*	2	\$.35	\$.17	\$.15
230130CL	03-09-1081*	3	.48	.24	.22
230156CL	03-09-1041*	4	.40	.23	.17
230172CL	03-09-1040**	4	.48	.25	.23
230199CL	03-09-1061**	6	.49	.26	.25
230210CL	03-09-1091**	9	.62	.33	.30
230236CL	03-09-1125**	12	.62	.33	.30

*In-line **Grid

.062" (1.57mm) Contacts

- Durability: tin - 25 mating/un-mating cycles max.
- Contact: brass or phosphor bronze
- Tin plating
- Temperature range: -40°C to +105°C
- Prepackaged: order in increments of 10, 100 or 1000

Crimp-Type Contacts



224565CL 224557CL

Part No.	Product No.	Gender	AWG	10	100	1000
224565CL	02-06-2103	M	18-24	\$.18	\$.057	\$.038
224581CL	02-06-2132	M	24-30	.18	.057	.038
224557CL	02-06-1103	F	18-24	.18	.057	.038
224573CL	02-06-1132	F	24-30	.18	.057	.038

Solder-Tail Contacts



227379CL 227387CL

Part No.	Product No.	Gender	10	100	1000
227379CL	02-06-8103	Male	\$.18	\$.11	\$.066
227387CL	02-06-7103	Female	.18	.11	.066

.093" (2.36mm) Contacts

- Durability: tin - 25 mating/un-mating cycles max.
- Contact: brass or phosphor bronze
- Tin plating
- Temperature range: -40°C to +105°C
- Prepackaged: order in increments of 10, 100 or 1000

Crimp-Type Contacts



224207CL 224215CL

Part No.	Product No.	Gender	AWG	10	100	1000
224207CL	02-09-2118	M	18-22	\$.19	\$.06	\$.04
224223CL	02-09-2103	M	14-20	.18	.059	.04
224215CL	02-09-1119	F	18-22	.20	.07	.04
224231CL	02-09-1104	F	14-20	.18	.059	.04

Solder-Tail Contacts



224240CL 224258CL

Part No.	Product No.	Gender	10	100	1000
224240CL	02-09-2133	Male	\$.149	\$.129	\$.091
224258CL	02-09-1134	Female	.20	.14	.09

Hand Crimp Tool

This tool is designed to crimp terminals, strip and cut wires, and cut bolts. Cuts and strips wires from 18-30 AWG. For Molex crimp pin terminals with .062", .093" diameters and KK® series on opposite page.



- Length: 8.3"L • Weight: 0.5 lbs.

Part No.	Product No.	1	10
227491CL	W-HT-1921	\$.14.99	\$13.99

.062" Power Connector Kit

This assortment kit contains mating sets of housings and pins.

- Voltage: 250VAC • Current: 5A
- Temperature range: -40°C to +105°C

Includes: 3 ea. 2-pin plugs and 2-pin receptacles, 8 ea. male contacts and 8 ea. female contacts.

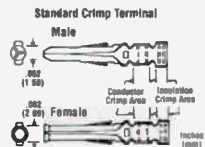

Part No.	Product No.	Description	1	10	50
142113CL	1625-2	Kit	\$5.69	\$5.15	\$4.59

.093" Power Connector Kits

These assortment kits contain mating sets of housings and pins.

- Voltage: 250VAC
- Temperature range: -40°C to +105°C

142181CL: • 3 ea. 2-pin plugs & receptacles, 8 ea. female & male contacts • Current: 12A

142201CL: • 2 ea. 4-pin plugs & receptacles, 10 ea. female & male contacts • Current: 9A

142228CL: • 2 ea. 6-pin plugs & receptacles, 14 ea. female & male contacts • Current: 9A

Includes: Male and female tin-plated standard brass .010" pins; 18-22 AWG crimp size wire

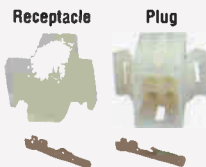

Part No.	Product No.	Description	1	10	50
142181CL	1545	Kit	\$4.95	\$4.49	\$3.95
142201CL	1490	Kit	5.69	5.15	4.65
142228CL	1261	Kit	5.25	4.75	3.95

Extraction Tools for Molex Connectors



142156CL/227467CL: For .062" power connectors
142236CL/227395CL: For .093" power connectors
236128CL/234940CL: For .100" KK® series housing

Part No.	Product No.	AWG	1	10
142156CL	W-HT-2285	18-30	\$14.49	\$13.49
227467CL	W-HT-2023	18-30	11.99	10.99
142236CL	W-HT-2038	14-30	14.49	13.49
227395CL	W-HT-2054	14-30	11.99	10.99
236128CL	W-HT-1884	22-30	9.99	8.99
234940CL	11-03-0022	22-30	14.99	12.99

Find more products on our website.
www.jameco.com

KK® Series .100" (2.54mm) Male Headers

- Voltage: 250V • Current: 4.0A
- Contact resistance: 20mΩ max.
- Dielectric withstanding voltage: 1500V
- Insulation resistance: 50,000MΩ min.
- Housing: nylon, UL94V-0
- Contact: brass, 0 – 6.4mm (0.25") square
- Durability: tin – 25 cycles max.; gold – 100 cycles max.

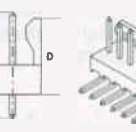
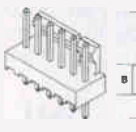
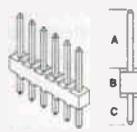

Straight Headers (Tin)

- Dimensions: (A) .295"; (B) .130"; (C) .135"

* Prepackaged: order in increments of 10 or 100

Part No.	Product No.	Positions	1	10	100
232178CL	22-03-2021	2	*	\$10	\$0.09
232186CL	22-03-2031	3	*	.16	.14
232194CL	22-03-2041	4	*	.21	.19
232207CL	22-03-2051	5	.29	.26	.24
232215CL	22-03-2061	6	.34	.31	.27
232223CL	22-03-2081	8	.40	.37	.33
232231CL	22-03-2101	10	.46	.42	.37
232240CL	22-03-2121	12	.56	.51	.45

Straight Friction Lock Headers (Tin)

- Dimensions: (A) .295"; (B) .125"; (C) .140"; (D) .322"

Part No.	Product No.	Positions	1	10	100
232266CL	22-23-2021	2	\$29	\$23	\$15
232274CL	22-23-2031	3	.35	.30	.19
232282CL	22-23-2041	4	.42	.36	.23
232291CL	22-23-2051	5	.49	.42	.27
232303CL	22-23-2061	6	.55	.48	.31
232311CL	22-23-2071	7	.63	.55	.36
232320CL	22-23-2081	8	.72	.63	.41
232338CL	22-23-2091	9	.76	.66	.36
232346CL	22-23-2101	10	.80	.70	.46
232354CL	22-23-2121	12	.95	.83	.55

Right Angle Friction Lock Headers (Tin)

- Dimensions: (A) .260"; (B) .125"; (C) .141"; (D) .322"

Part No.	Product No.	Positions	1	10	100
233437CL	22-05-3021	2	\$42	\$36	\$22
233445CL	22-05-3031	3	.56	.49	.30
233453CL	22-05-3041	4	.71	.61	.39
233461CL	22-05-3051	5	.77	.67	.43
233470CL	22-05-3061	6	.85	.74	.48
233488CL	22-05-3071	7	.99	.79	.56
233496CL	22-05-3081	8	1.03	.83	.58
233509CL	22-05-3101	10	1.08	.94	.61
233517CL	22-05-3121	12	1.19	.99	.69

Straight Friction Lock Headers (Gold)

- Dimensions: (A) .295"; (B) .125"; (C) .140"; (D) .322"

Part No.	Product No.	Positions	1	10	100
233584CL	22-11-2022	2	\$54	\$46	\$29
233592CL	22-11-2032	3	.85	.74	.47
233605CL	22-11-2042	4	.87	.76	.49
233613CL	22-11-2052	5	1.22	1.06	.69
233621CL	22-11-2062	6	1.34	1.17	.76
233630CL	22-11-2072	7	1.55	1.36	.89
233648CL	22-11-2082	8	1.62	1.42	.93
233656CL	22-11-2102	10	2.02	1.77	1.16
233664CL	22-11-2122	12	2.41	2.12	1.39

Right Angle Friction Lock Headers (Gold)

- Dimensions: (A) .260"; (B) .125"; (C) .141"; (D) .322"

Part No.	Product No.	Positions	1	10	100
233672CL	22-12-2024	2	\$89	\$77	\$48
233681CL	22-12-2034	3	1.15	.99	.63
233699CL	22-12-2044	4	1.36	1.19	.76
233701CL	22-12-2054	5	1.50	1.31	.84
233710CL	22-12-2064	6	1.64	1.43	.92
233728CL	22-12-2084	8	1.86	1.51	1.05

Don't worry about backorders.
Over 99% of our products are in stock!

We'll Send It Today!

Just place your order by 6PM EST
for same business day shipment

KK® Series .100" (2.54mm) Female Housing and Crimp Contacts

- Voltage: 250V
- Current: phosphor bronze – 4.0A max., brass – 2.5A max.
- Contact resistance: 20mΩ max.
- Dielectric withstanding volt.: 1500VAC
- Insulation resistance: 50,000MΩ

Housing Material:

- Contact insertion force: 1.5 lbs. max.
- Contact retention to housing: 8 lbs. min.
- Housing: nylon, UL94V-0
- Operating temperature: 0 to 75°C



Housing with Locking Ramp & Polarizing Ribs

Part No.	Product No.	Positions	1	10	100
234798CL	22-01-3027	2	\$29	\$17	\$10
234801CL	22-01-3037	3	.29	.21	.13
234819CL	22-01-3047	4	.31	.27	.17
234827CL	22-01-3057	5	.36	.31	.20
234835CL	22-01-3067	6	.42	.36	.23
234843CL	22-01-3077	7	.47	.41	.26
234851CL	22-01-3087	8	.54	.47	.30
234860CL	22-01-3097	9	.58	.50	.32
234878CL	22-01-3107	10	.65	.55	.35
234886CL	22-01-3127	12	.76	.66	.42

Housing with Locking Ramp

Part No.	Product No.	Positions	1	10	100
234704CL	22-01-2027	2	\$29	\$15	\$0.09
234712CL	22-01-2037	3	.29	.20	.12
234721CL	22-01-2047	4	.29	.24	.15
234739CL	22-01-2057	5	.33	.28	.17
234747CL	22-01-2067	6	.36	.32	.20
234755CL	22-01-2087	8	.47	.41	.26
234763CL	22-01-2097	9	.51	.44	.28
234771CL	22-01-2107	10	.57	.49	.31
234780CL	22-01-2127	12	.67	.58	.37

Crimp Contacts

- Accommodates 22 to 30 AWG
- Material: brass or phosphor bronze
- Insulation range: 0.062" (1.58mm) diameter max.
- Prepackaged: order in increments of 10, 100 or 1000

Part No.	Product No.	10	100	1000
234923CL	08-05-0114	\$0.065	\$0.048	\$0.029
234931CL	08-05-0102	.22	.17	.11



0.156" (3.96mm) Male Headers

- Voltage and current rating: 600VAC @ 7.0A
- Contact material/plating: copper alloy/tin
- UL94V-0 flammability rating
- 0.045" square posts
- Insulator material: polyester
- Solder tail material/plating: copper alloy/tin



231491CL

231571CL

232418CL

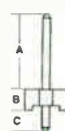

Straight Header

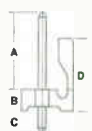

Straight Friction Lock

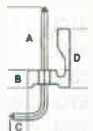

Right Angle Friction Lock

Straight Friction Lock Headers

- Dimensions: (A) .450"; (B) .125"; (C) .125"; (D) .425"

* Prepackaged: order in increments of 10 or 100

Part No.	Product No.	Positions	1	10	100
231546CL	640445-2	2*	\$.07	\$.06
231554CL	640445-3	3*	.075	.065
231562CL	640445-4	4*	.10	.08
231571CL	640445-5	5*	.14	.10
231589CL	640445-6	6*	.17	.13
231597CL	640445-7	7*	.18	.15
231600CL	640445-8	8*	.23	.17
231626CL	1-640445-0	1031	.23

Right Angle Friction Lock Headers

- Dimensions: (A) .450"; (B) .125"; (C) .125"; (D) .425"

Part No.	Product No.	Positions	1	10	100
232362CL	640389-2	2	\$.29	\$.26
232371CL	640389-3	344	.39
232389CL	640389-4	459	.52
232397CL	640389-5	574	.65
232400CL	640389-6	680	.71
232418CL	640389-7	793	.83
232426CL	640389-8	8	1.06	.94
232434CL	640389-9	9	1.19	1.06
232442CL	1-640389-0	10	1.33	1.18

Straight Headers

- Dimensions: (A) .450"; (B) .125"; (C) .125"

Part No.	Product No.	Positions	1	10	100
231458CL	640383-2	2	\$.23	\$.20
231466CL	640383-3	326	.23
231474CL	640383-4	429	.26
231482CL	640383-5	537	.33
231491CL	640383-6	640	.36
231503CL	640383-7	747	.42
231511CL	640383-8	855	.46
231520CL	640383-9	960	.53
231538CL	1-640383-0	1065	.52

0.156" (3.96mm) Female Housing

- Voltage and current rating: 250VAC @ 6.5A maximum
- Material: nylon, unreinforced 94V-0
- Dielectric withstanding voltage: 2kVAC
- Insulation resistance: 1,000MΩ minimum
- Hole diameter: .054" (1.37mm)



236259CL

236161CL

236347CL

Side View

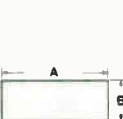

Without Locking Ramp

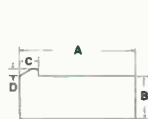

With Locking Ramp



With Locking Ramp & Polarizing Tabs

With Locking Ramp

- Dimensions: (A) .660"; (B) .250"; (C) .100"; (D) .0365"

* Prepackaged: order in increments of 10 or 100

Part No.	Product No.	Positions	1	10	100
236144CL	640250-2	2	\$.152	\$.134
236152CL	640250-3	3*	.086
236161CL	640250-4	4162	.15
236179CL	640250-5	5097	.096
236187CL	640250-6	6108	.106
236195CL	640250-7	7143	.108
236208CL	640250-8	8228	.144
236216CL	640250-9	8462	.419
236224CL	1-640250-0	10513	.466

With Locking Ramp and Polarizing Tabs

- Dimensions: (A) .660"; (B) .250"; (C) .100"; (D) .019" ±.003"

* Prepackaged: order in increments of 10 or 100

Without Locking Ramp

- Dimensions: (A) .660"; (B) .250"

* Prepackaged: order in increments of 10 or 100

Part No.	Product No.	Positions	1	10	100
236232CL	640251-2	2*	\$.096	\$.095
236241CL	640251-3	3228	.14
236259CL	640251-4	4304	.186
236267CL	640251-5	5*	.114	.106
236275CL	640251-6	6257	.251
236283CL	640251-7	7418	.326
236291CL	640251-8	8447	.373
236304CL	640251-9	9462	.419
236312CL	1-640251-0	10266	.25

Part No.	Product No.	Positions	1	10	100
236321CL	770849-2	2*	\$.114	\$.105
236339CL	770849-3	3228	.14
236347CL	770849-4	420	.173
236355CL	770849-5	5*	.171	.154
236363CL	770849-6	6304	.28
236371CL	770849-7	7361	.326
236380CL	770849-8	8409	.373
236398CL	770849-9	9464	.392
236401CL	1-770849-0	10314	.307

AMP Joins the Jameco Line

Introducing AMP D-subminiature connectors, crimp and solder contacts, headers and D-sub hoods—the standard for quality around the globe. Get AMP top-quality brand-name products, along with all your other electronic components and tools, with one call to Jameco. Take a look at our selection on this page and page 70.

.156" Crimp Contacts

- Voltage rating: 250VAC
- Current rating: 10A maximum
- Low level resistance: 30mΩ max.
- Dielectric withstanding voltage: 2000VAC/1 min.
- Insulation resistance: 1000MΩ minimum
- Compatible with .045" square or round posts
- Material and finish:
 - *A: brass, 0.012 bright tin plated
 - *B: brass, 0.012 pre-tin plated
 - *C: brass, 0.000030 gold over nickel plated
 - *D: phosphor bronze, 0.012 bright tin plated
 - *E: phosphor bronze, 0.000030 gold over nickel plated
- For use with .156" AMP housings (left below)
- Prepackaged: order in increments of 10, 100 or 500



*Fig. 1 (High-Force)

*Fig. 2 (Low-Force)

*Fig. 3 (Hooded - Dual Wipe)

Part No.	Product No.	Desc.*	AWG	10	100	500
248866CL	640706-1	1A	18-24	\$.171	\$.155	\$.145
248874CL	640706-2	1B	18-24	..152	.14	.13
248882CL	640707-1	2A	18-24	..20	.175	.119
248891CL	770258-1	2C	18-24	...39	.31	.29
248903CL	770522-1	3D	18-24	...19	.138	.123
248911CL	770258-2	3E	18-24	...304	.237	.184



See page 70 for AMP D-Sub Connectors with Crimp and Solder Contacts.



30-Day Money-Back Guarantee

If you're not completely satisfied with your purchase, we'll take it back!

Details on page 229.

.156" (3.9mm) Center Straight-Friction Lock Headers

- Ideal for AC and DC power distribution
- Voltage rating: 250VAC/VDC max.
- Current rating: 7 amps AC/DC
- Contact resistance: 20mΩ
- Temperature range: -25°C to +85°C
- Header material: pin - brass/tin-plated
- Base: nylon 66, UL94V-2



104811CL

* Prepackaged: order in increments of 10, 100, 1000

Part No.	Cross Ref. No.	Pins	1	10	100	1000
104791CL	LMH4	4*	\$.11	\$.09	\$.07
104803CL	LMH5	5*	\$.09	\$.07	\$.07
104811CL	LMH6	6*	\$.15	\$.12	\$.10
104838CL	LMH8	8*	\$.12	\$.09	\$.083
104846CL	LMH10	10*	\$.22	\$.17	\$.14
235491CL	8673-12-5	12*	\$.35	\$.32	\$.23

.156" (3.9mm) Center Housing Connectors

- Common to many power supplies carried by Jameco. Some power supplies (pgs 125-127) may require multiple connectors
- Housing material: nylon 66, UL94V-2
- Use with crimp pins, 78318CL, below

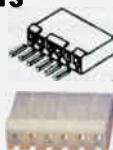

104731CL

* Prepackaged: order in increments of 10, 100, 1000

Part No.	Cross Ref. No.	Pins	1	10	100	1000
176743CL	LCH2	2*	\$.07	\$.045	\$.04
104432CL	LCH3	3*	\$.19	\$.12	\$.11
104715CL	LCH4	4*	\$.22	\$.15	\$.12
104723CL	LCH5	5*	\$.24	\$.22	\$.16
104731CL	LCH6	6*	\$.33	\$.30	\$.24
104766CL	LCH10	10*	\$.39	\$.32	\$.28

.156" (3.9mm) Center Crimp Pin

- Use with .156 housings (above)
- Material: brass/tin plated
- Pin wire gauge: 18-24 AWG



Prepackaged: order in increments of 10, 100, 1000

Part No.	Mfr.	Cross Ref. No.	10	100	1000
78318CL	JS-5001-T		\$.11	\$.08	\$.07

.156" Female Crimp Pins

- Pin wire gauge: 18-22 AWG
- Material: tin-plated brass
- Use 99442CL crimping tool, pg 181

Prepackaged: order in increments of 10, 100 or 1000

Part No.	Mfr.	Cross Ref. No.	10	100	1000
154093CL	LRPIN		\$.07	\$.05	\$.035

More Crimping Tools for above Crimp Pins – See page 181.

0.118"-Pitch ATX Power Connectors for Motherboards & Power Supplies

- Voltage rating: 250V AC/DC
- Current rating: 7A AC/DC
- Temperature range: -25°C to 85°C
- Insulation resistance: 1000MΩ min.
- Withstanding voltage: 1500V/min.

147379CL: ATX male 20-pin edge mount connector

- Material: nylon 66, UL-94V0
- Material of post: tin-plated brass
- Diameter of post: .045"

147387CL: Housing connector • Material: nylon 66, UL-94V0

147395CL: ATX power terminal pins • Material: tin-plated brass



* Prepackaged: order in increments of 10, 100 or 1000

Part No.	Description	L	W	H	Dia	Use With	1	10	100	1000
147379CL	20-pin male connector	1.7"	0.4"	0.6"	—	—	\$.59	\$.53	\$.48	\$.43
147387CL	20-pin housing connector	1.7"	0.4"	0.8"	—	147395CL	*	.19	.17	.15
147395CL	Power terminal pin, female	.59"	—	—	.068"	147387CL	*	.12	.11	.10

0.098"-Pitch AT Power Connectors for Motherboards & Power Supplies

- Voltage rating: 250V AC/DC
- Current rating: 7A AC/DC
- Temperature range: -25°C to 85°C
- Insulation resistance: 1000MΩ minimum
- Withstanding voltage: 1500V/min.

78300CL: AMP60G male 6-pin PCB mount connector

- Material of post: tin-plated brass
- Diameter of post: .09"

78326CL: AMP50G female 6-pin housing connector • Material: nylon

- Material: tin-plated brass



* Prepackaged: order in increments of 10, 100 or 1000

Part No.	Description	L	W	H	Dia	Use With	1	10	100	1000
78300CL	6-pin male connector	.93"	.37"	.57"	—	—	\$.45	\$.39	\$.35	\$.31
78326CL	6-pin housing connector	.94"	.25"	.74"	—	78300CL	.35	.31	.28	.25
78318CL	Power terminal pin, female	.69"	—	—	.09"	78326CL	*	.11	.08	.07

.156" (3.9mm) Center Housing Connectors and Crimp Contact

- Mating connectors for Mean Well LPS and LPP series power supplies (pgs 129-130)
- Current rating: 10A AC/DC
- Voltage rating: 250V AC/DC



215950CL



227416CL

227416CL:

- Material: brass
- Finish: tin-plated
- 18-22 AWG

* Prepackaged: order in increments of 10, 100, 1000

Part No.	Description	1	10	100	1000
215950CL	5 pos. housing	\$.35	\$.32	\$.28	\$.26
215976CL	8 pos. housing	.39	.35	.32	.28
215968CL	12 pos. housing	.49	.44	.39	.35
227416CL	Crimp contact	*	.29	.19	.10

Extraction Tools for Crimp Pins

- Quickly and easily extract 0.093" locking pins from interlocking connectors
- Length: 5"
- See right for crimp pins, 42729CL & 42649CL



131887CL

Part No.	Product No.	Description	1	10
131887CL	HT319C	Male tool for 42729CL	\$10.95	\$9.86
131879CL	HT319B	Fem. tool for 42649CL	10.95	9.86

Jameco's Low Price Guarantee

We'll match the print advertised price of any like product.

It's that simple!



0.2"-Pitch Power Connectors & Pins

Connector & Housing Specifications:

- Voltage rating: 250VAC (Mate-N-Lock 600VAC)
- Operating temperature: -55°C to +105°C

Crimp Pin Specifications:

- Material: tin plated brass
- Current rating: 1.5 amps
- Wire size range: 18-24 AWG
- Use crimp tool P/N 99442CL, pg 181

For 5.25" Disk Drives and Power Supplies

42075CL & 42067CL Connector Housings:

- Keyed mating connectors
- External key bar indicates pin 1

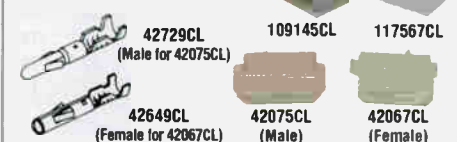

- See far left for extraction tools, 131887CL & 131879CL

* Prepackaged: order in increments of 10, 100 or 1000

Part No.	Description	10	100	1000
109145CL	4-pin M vert. PCB mtg	\$.59	\$.49	\$.31
117567CL	4-pin M PCB mounting, horizontal edge mount	.63	.55	.49
42075CL	4-pin M housing	.12	.11	.10
42067CL	4-pin F housing	.20	.15	.13
42729CL	M crimp pin for 42075CZ	.10	.07	.06
42649CL	F crimp pin for 42067CZ	.10	.07	.06

For 3.5" Disk Drives and Power Supplies



* Prepackaged: order in increments of 10, 100 or 1000

Part No.	Description	10	100	1000
114930CL	4-pin F housing	\$.19	\$.17	\$.15
114921CL	F crimp pin for 114930CL	.11	.095	.08

Part No.	Description	1	100	1000
114999CL	4-pin M rt. angle PCB mtg	..35	\$.31	\$.28

Solder Tail Low-Profile Sockets

- Material: beryllium copper or phosphor bronze
- Contact current: 1A
- Tin-plated contacts and tails
- Contact resistance: less than 5mΩ
- Dielectric withstanding voltage: 300Vrms
- Insulation resistance: greater than 1000MΩ
- Insulator: glass-filled polyester or glass-filled polyphenylene sulfide
- Sleeve material: brass
- Thru-hole lead length: .140" (A)
- Body height: .188" (B)



Single Wipe

- Prepackaged: order in increments of 10, 100 or 1000

Part No.	Mfr. Cross Ref. No.	Pins	Width (in.)	1	10	100	1000
51570CL	8LP	8	0.3	\$.07	\$.06	\$.05	
37161CL	14LP	14	0.3	\$.09	\$.07	\$.06	
37372CL	16LP	16	0.3	\$.10	\$.09	\$.06	
38113CL	18LP	18	0.3	\$.11	\$.094	\$.07	
38607CL	20LP	20	0.3	\$.12	\$.10	\$.07	
39132CL	22LP	22	0.4	\$.12	\$.10	\$.07	
39378CL	24SLP	24	0.3	\$.17	\$.12	\$.06	
39335CL	24LP	24	0.6	\$.16	\$.14	\$.09	
40301CL	28LP	28	0.6	\$.19	\$.13	\$.09	
41110CL	40LP	40	0.6	\$.19	\$.17	\$.12	

Dual Wipe

- Prepackaged: order in increments of 10, 100 or 1000

Part No.	Mfr. Cross Ref. No.	Pins	Width (in.)	1	10	100	1000
112192CL	6LPD	6	0.3	\$.09	\$.06	\$.05	
112205CL	8LPD	8	0.3	\$.09	\$.08	\$.07	
112213CL	14LPD	14	0.3	\$.10	\$.075	\$.05	
112221CL	16LPD	16	0.3	\$.13	\$.115	\$.095	
112230CL	18LPD	18	0.3	\$.16	\$.14	\$.12	
112248CL	20LPD	20	0.3	\$.17	\$.14	\$.11	
112281CL	24SLPD	24	0.3	\$.14	\$.13	\$.09	
112264CL	24LPD	24	0.6	\$.19	\$.16	\$.12	
112299CL	28SLPD	28	0.3	\$.21	\$.19	\$.17	
112272CL	28LPD	28	0.6	\$.21	\$.15	\$.09	
112301CL	32LPD	32	0.6	\$.18	\$.14	\$.10	
112310CL	40LPD	40	0.6	\$.26	\$.23	\$.19	
167396CL	48LPD	48	0.6	\$.35	\$.32	\$.29	
112326CL	64LPD	64	0.9	\$.39	\$.18	\$.15	

SIMM Sockets

- Locking tabs
- Tinned contacts
- Memory module sockets
- Keyed mounting posts



New Lower Prices

Part No.	Description	1	10	100	500
100301CL	Single x 30-pin, vert.	\$.52	\$.47	\$.43	\$.39
72531CL	Dual x 30-pin, vert.	\$.69	\$.27	\$.24	\$.22
72426CL	Single x 72-pin, vert.	\$.41	\$.22	\$.20	\$.18

PLCC Surface Mount Sockets

- Current: 1A
- Dielectric strength: 600VAC for 1 minute
- Insulator resistance: 5000MΩ minimum
- Temperature surface mount: -55°C / +170°C

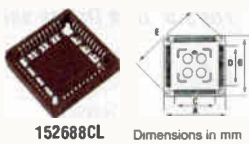

Part #	A	B	C & D	E
152688	23.18	12.70	28.50	
152696	30.80	20.32	40.00	

Part No.	Mfr. Cross Ref. No.	Pins	1	10	50	100
152688CL	PLCC44	44	\$.75	\$.69	\$.60	\$.55
152696CL	PLCC68	68	\$.525	\$.49	\$.45	\$.39

Machine Tooled Solder Tail Low-Profile Sockets

- Contact plating: gold
- Tin-plated leads
- Contact current: 3A
- Multiple contact elements
- Material: beryllium copper or phosphor bronze
- Contact resistance: less than 5mΩ
- Dielectric withstanding voltage: 300Vrms
- Insulation resistance: greater than 1000MΩ
- Insulator: glass-filled polyester or glass-filled polyphenylene sulfide
- Sleeve material: brass
- Thru-hole lead length: .177" (A)
- Body height: .117" (B)



Quantity SAVE

Part No.	Mfr. Cross Ref. No.	Pins	Width (in.)	1	10	100	1000
167003CL	6MLPT	6	0.3	\$.29	\$.26	\$.18	\$.16
51625CL	8MLP	8	0.3	\$.25	\$.22	\$.19	\$.17
37196CL	14MLP	14	0.3	\$.42	\$.38	\$.33	\$.30
37401CL	16MLP	16	0.3	\$.47	\$.43	\$.37	\$.34
65584CL	18MLP	18	0.3	\$.55	\$.49	\$.43	\$.39
38623CL	20MLP	20	0.3	\$.59	\$.55	\$.45	\$.39
192209CL	22ASMLP	22	0.4	\$.59	\$.53	\$.42	\$.32
39386CL	24SMLP	24	0.3	\$.65	\$.59	\$.47	\$.35
39351CL	24MLP	24	0.6	\$.72	\$.65	\$.52	\$.39
114411CL	28SMLP	28	0.3	\$.85	\$.75	\$.65	\$.55
184680CL	28ASMLP	28	0.4	\$.85	\$.75	\$.65	\$.55
40328CL	28MLP	28	0.6	\$.83	\$.75	\$.65	\$.59
105380CL	32MLP	32	0.6	\$.95	\$.85	\$.75	\$.65
41136CL	40MLP	40	0.6	\$.1.19	1.05	\$.79	\$.69
42059CL	48MLP	48	0.6	\$.1.29	1.18	\$.94	\$.71
200707CL	64MLP	64	0.9	\$.1.35	1.25	1.15	\$.99

Wire Wrap Socket I.D. Markers

- Quick identification of pin numbers
- Slips onto socket before wrapping
- Plastic
- Can easily write location, part number or function



Part No.	Prod. No.	Pins	Width (in.)	1	10	100	500
51561CL	8ID	8	0.3	\$.44	\$.35	\$.30	\$.28
37145CL	14ID	14	0.3	\$.35	\$.31	\$.28	\$.24
37356CL	16ID	16	0.3	\$.29	\$.26	\$.25	\$.23
38105CL	18ID	18	0.3	\$.49	\$.45	\$.39	\$.35
38586CL	20ID	20	0.3	\$.55	\$.49	\$.45	\$.41
39327CL	24ID	24	0.6	\$.59	\$.52	\$.43	\$.38
40299CL	28ID	28	0.6	\$.65	\$.55	\$.45	\$.41
41101CL	40ID	40	0.6	\$.89	\$.79	\$.69	\$.65

PLCC Solder Tail Sockets

- Solder tail allows through-hole board patterns in .100" grid
- Accepts JEDEC type "A" plastic leaded chip (0.05" centers)
- Thru-hole lead length: .125"
- Body height: .375"



Part No.	Mfr. Cross Ref. No.	Pins	1	10	50	100
71263CL	G1P428	28	\$.56	\$.44	\$.34	\$.29
71011CL	G1P432	32	\$.55	\$.41	\$.39	
71618CL	G1P444	44	1.15	\$.99	\$.81	\$.69
72442CL	G1P452	52	\$.99	\$.79	\$.65	\$.55
71968CL	G1P468	68	1.15	\$.99	\$.89	\$.79
71976CL	G1P484	84	1.29	1.19	\$.93	\$.70

Level 1, 2 & 3 Wire Wrap Sockets

- Contact plating/leads: gold (WW) or tin (TWW); Dual Wipe
- Material: beryllium copper or phosphor bronze
- Contact current: 1A
- Contact resistance: less than 5mΩ
- Dielectric withstanding voltage: 300Vrms
- Insulation resistance: greater than 1000MΩ
- Insulator: glass-filled polyester or glass-filled polyphenylene sulfide
- Sleeve material: brass
- Thru-hole lead length: .315" (L1); .438" (L2); .638" (L3)
- Body height: .300" (A)

Quantity SAVE



Gold (WW)

Part No.	Mfr. Cross Ref. No.	Pins	Width (in.)	1	10	100	500
51641CL	8WW2	8	0.3	\$.1.49	1.29	1.19	\$.99
196832CL	14WW1	14	0.3	\$.1.15	1.01	\$.83	\$.62
37233CL	14WW2	14	0.3	1.49	1.35	1.19	1.09
37479CL	16WW2	16	0.3	1.75	1.59	1.43	1.29
196859CL	18WW3	18	0.3	1.52	1.37	1.20	1.09
38674CL	20WW2	20	0.3	2.25	1.99	1.82	1.65
39394CL	24WW2	24	0.6	1.85	1.63	1.43	1.33
40352CL	28WW2	28	0.6	2.19	1.99	1.75	1.60
41187CL	40WW2	40	0.6	3.15	2.80	2.45	2.29

Tin (TWW)

Part No.	Mfr. Cross Ref. No.	Pins	Width (in.)	1	10	100	500
112660CL	8TWW2	8	0.3	\$.86	\$.61	\$.58	\$.55
37217CL	14TWW2	14	0.3	1.15	1.03	\$.93	\$.84
196841CL	14TWW3	14	0.3	\$.83	\$.71	\$.53	\$.49
37436CL	16TWW2	16	0.3	\$.99	\$.89	\$.73	\$.66
87636CL	18TWW2	18	0.3	1.09	\$.98	\$.81	\$.73
75379CL	20TWW2	20	0.3	1.69	1.52	1.35	1.23
75416CL	24TWW2	24	0.6	1.49	1.35	1.09	\$.79
75424CL	28TWW2	28	0.6	1.89	1.63	1.36	1.22
41179CL	40TWW2	40	0.6	2.49	2.15	1.79	1.59

Level 3 Machine Tooled Wire Wrap Sockets

- Contact plating: gold
- Tin-plated leads
- Contact current: 3A
- Contact resistance: less than 5mΩ
- Dielectric withstanding voltage: 300Vrms
- Material: beryllium copper or phosphor bronze
- Insulation resistance: greater than 1000MΩ
- Insulator: glass-filled polyester or glass-filled polyphenylene sulfide
- Sleeve material: brass
- Body height: .115" (A)
- Thru-hole lead length: .365" (L2); .515" (L3)

New Lower Prices

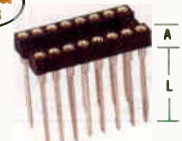

Part No.	Mfr. Cross Ref. No.	Pins	Width (in.)	1	10	100	500
94473CL	8MSWW3	8	0.3	\$.53	\$.46	\$.38	\$.34
62050CL	14MSWW3	14	0.3	\$.93	\$.80	\$.67	\$.60
37410CL	16MSWW3	16	0.3	1.09	\$.93	\$.78	\$.69
94481CL	18MSWW3	18	0.3	1.09	\$.93	\$.78	\$.74
38631CL	20MSWW3	20	0.3	1.33	1.14	\$.95	\$.86
185324CL	22MSWW3	22	0.3	1.35	1.21	1.09	\$.99
192831CL	22ASMSWW3	22	0.4	1.45	1.25	\$.99	\$.78
105371CL	24MSWW3	24	0.3	1.49	1.29	1.08	\$.97
94490CL	24MSWW3	24	0.6	1.60	1.38	1.15	1.05
200715CL	28MSWW3	28	0.3	1.69	1.43	1.19	1.07
40336CL	28MSWW3	28	0.6	1.69	1.43	1.19	1.07
117057CL	32MSWW3	32	0.6	2.19	1.99	1.59	1.19
94502CL	40MSWW3	40	0.6	2.66	2.28	1.90	1.71
200723CL	48MSWW3	48	0.6	2.99	2.69	2.39	2.15
200731CL	64MSWW3	64	0.9	2.96	2.69	2.45	2.22

Machine Contact Dual-In-Line Female Sockets

- 0.100" centers
- Solder tail contact: .114" L
- Pin sleeve: tin
- Contact clip: gold



Part No.	Mfr. Cross Ref. No.	Pins	1	10	300
212855CL	SA101000	10	\$.29	\$.23	\$.21
212863CL	SA121000	12	.30	.28	.25
212871CL	SA141000	14	.35	.33	.30
212880CL	SA161000	16	.40	.37	.34
212898CL	SA181000	18	.45	.42	.38
184612CL	SA201000	20	.50	.46	.42
212901CL	SA221000	22	.55	.51	.47
212919CL	SA241000	24	.60	.56	.51
212927CL	SA321000	32	.80	.74	.68
212935CL	SA481000	48	1.20	1.11	1.01

Machine Contact Single-In-Line Female Sockets

- Machine tooled
- Solder tail and wire wrap



Part No.	Description	1	10	100	500
102200CL	Single x 10-pin	\$.25	\$.22	\$.20	\$.18
192840CL	Single x 11-pin	.49	.44	.35	.26
78641CL	Single x 30-pin	.89	.80	.68	.61
175919CL	Single x 36-pin	1.19	1.09	.97	.87
101282CL	Single x 20-pin WW2†	1.49	1.35	1.09	.80
104053CL	Single x 30-pin WW3*	1.95	1.75	1.49	1.35

† Lead length: .435" (2) * Lead length: .575" (3)

ARIES Low Profile ZIF Sockets

Provides a low cost solution for ZIF test socket requirements. It has a height of only .319" (8.10mm), and even with the handle in open position it measures just .554" (14.07mm).

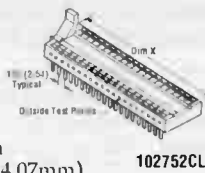

Part No.	Aries No.	Pins	Dim X	1	10	100
102744CL	28-526	28	1.64	\$5.49	\$4.99	\$4.49
102752CL	40-526	40	2.24	6.95	6.39	5.75

ARIES Universal ZIF Sockets

- Solder directly to PCB or plug directly into IC socket
- Screw mounting holes
- Accepts .300" to .600" IC centers x .10" spacing



Part No.	Aries No.	Pins	1	10	100
103991CL	24-6554-10	24	\$7.49	\$6.79	\$5.99
104002CL	28-6554-10	28	8.45	7.39	7.15
104011CL	32-6554-10	32	9.95	8.49	8.29
104029CL	40-6554-10	40	11.25	9.80	9.45



For Tools see pages 176 - 187.

.100" Male Headers (Gold)

- Solder to PC boards for instant plug-in access via shorting blocks, below
- Snap apart to fit your application
- Contact material: phosphor bronze
- Current rating: 1 amp
- Contact area: gold
- Temp. range: -55°C to +120°C
- .025" square posts on a .100" x .100" matrix
- Use with crimp connector housing, pg 78

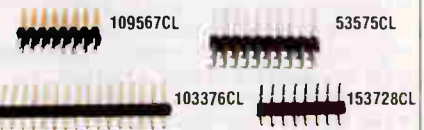

• Prepackaged: order in increments of 10, 100 or 1000

.100" Straight Male Headers Single Row

Part No.	Mfr. Cross Ref. No.	Contacts	1	10	100	1000
108337CL	SMH02	2	\$.16	\$.14	\$.13	
109575CL	SMH03	3	.17	.15	.135	
117559CL	SMH04	4	.17	.15	.135	
153699CL	SMH06	6	.17	.15	.135	
153701CL	SMH08	8	.20	.17	.15	
103392CL	SMH10	10	.18	.14	.10	
103376CL	SMH17	17	.16	.14	.13	
103368CL	SMH20	20	.25	.23	.21	
202825CL	SMH22	22	.25	.21	.16	
103350CL	SMH25	25	.25	.21	.16	
103341CL	SMH30	30	.35	.31	.28	.25
68339CL	SMH36	36	.42	.38	.34	.29
160881CL	SMH40	40	.49	.44	.40	.36

.100" Straight Male Headers Double Row

Part No.	Mfr. Cross Ref. No.	Contacts	1	10	100	1000
115027CL	923804DS	4	\$.10	\$.09	\$.07	
115035CL	923806DS	6	.18	.16	.14	
109516CL	923808DS	8	.18	.16	.14	
67820CL	923810DS	10	.18	.16	.14	
203810CL	923812DS	12	.60	.55	.49	.44
118455CL	923814DS	14	.45	.40	.36	.33
109567CL	923816DS	16	.55	.49	.45	.39
203828CL	923818DS	18	.65	.59	.55	.49
53479CL	923822DS	20	.59	.55	.48	.43
203836CL	923822DS	22	.70	.63	.50	.38
203844CL	923824DS	24	.70	.65	.59	.49
53495CL	923863DS	26	.70	.55	.40	.29
203852CL	923828DS	28	.75	.69	.55	.39
203879CL	923830DS	30	.75	.68	.54	.40
203861CL	923832DS	32	.75	.69	.55	.49
53516CL	923864DS	34	.65	.59	.53	.45
203887CL	923836DS	36	.80	.72	.58	.43
203895CL	923838DS	38	.80	.72	.58	.43
53532CL	923865DS	40	.65	.55	.39	.25
53559CL	923866DS	50	.60	.55	.49	.45
68574CL	923860DS	60	.70	.65	.59	.55
103405CL	923872DS	72	.85	.75	.69	.59
117196CL	923880DS	80	.90	.80	.75	.65

.100" Shorting Block w/ Handle

- Mates w/ .100" male headers, above
- Ratings:
 - Current: 3A
 - Accessible test point in handle
 - Contact resistance: 20mΩ max.
- Material:
 - Plastic: PBT, glass filled
 - Contact: phosphor bronze
- Prepackaged: order in increments of 10, 100 or 1000

Part No.	Description	10	100	1000
152670CL	.100" shorting block	\$.19	\$.15	\$.12

.100" Right Angle Male Headers Single Row

Part No.	Mfr. Cross Ref. No.	Contacts	1	10	100	1000
153728CL	RMH08	8	\$.45	\$.40	\$.30	\$.25
103270CL	RMH36	36	.75	.64	.58	.41

.100" Right Angle Male Headers Double Row

Part No.	Mfr. Cross Ref. No.	Contacts	1	10	100	1000
203908CL	923804DR	4	\$.49	\$.44	\$.31	\$.26
203916CL	923806DR	6	.55	.49	.29	.19
203924CL	923808DR	8	.49	.44	.35	.26
203932CL	923810DR	10	.59	.53	.40	.31
203941CL	923812DR	12	.59	.53	.42	.31
203959CL	923814DR	14	.65	.58	.47	.34
203967CL	923816DR	16	.65	.58	.47	.34
203975CL	923818DR	18	.65	.58	.47	.34
53575CL	923820DR	20	.59	.53	.48	.43
203983CL	923822DR	22	.65	.58	.47	.34
203991CL	923824DR	24	.65	.58	.47	.34
53583CL	923826DR	26	.69	.55	.41	.29
204003CL	923828DR	28	.69	.62	.50	.36
204011CL	923830DR	30	.75	.68	.54	.40
204020CL	923832DR	32	.75	.68	.54	.40
204038CL	923834DR	34	.75	.68	.54	.40
204046CL	923836DR	36	.75	.68	.54	.40
204054CL	923838DR	38	.75	.68	.54	.40
53604CL	923840DR	40	.85	.75	.57	.50
53612CL	923850DR	50	.85	.75	.57	.50
103413CL	923872DR	72	1.15	.99	.89	.75
139563CL	923880DR	80	1.35	1.19	1.09	.99

.100" and 2mm Shorting Blocks

- Mates to .025" square posts on .100" centers
- Shorting socket jumper to address or code strip line plugs
- Mate with male headers, above
- Pin material: phosphor bronze
- **Open:** open on top to allow for a test point
- **Closed:** closed - functionally they are the same
- **119263CL:** 2mm shorting block (for disk drives)
- Prepackaged: order in increments of 10, 100 or 1000

Part No.	Description	10	100	1000
22023CL	Top open, black (.100")	\$.12	\$.09	\$.06
119263CL	Top open, black (2mm)	.15	.13	.096
112424CL	Top open, blue (.100")	.12	.09	.06
112416CL	Top open, red (.100")	.12	.09	.06
19140CL	Top closed, black (.100")	.12	.09	.06
112441CL	Top closed, blue (.100")	.12	.09	.06
112432CL	Top closed, red (.100")	.16	.09	.075

.100" Non-Polarized Connector Housings and Crimp Pins

- Mates with .025" square post on pattern of .100" centers (male headers, see pg 77)
- Current rating: 1A • Pin material: brass/tin plated
- Pin wire gauge: 26-22 AWG • Plastic
- Temperature rating: -55°C to +105°C
- Use 159265CL pin crimper, pg 181 and 100765CL below

* Prepackaged: order in increments of 10, 100 or 1000

		Single Row					
		103190CL		100765CL			
Part No.	Mfr. Cross Ref. No.	Contacts	1	10	100	1000	
100811CL	SCH2	2	\$.23	\$.21	\$.17		
157382CL	SCH3	3	.24	.22	.18		
100802CL	SCH4	4	.25	.23	.19		
163686CL	SCH5	5	.27	.25	.22		
103211CL	SCH6	6	.31	.27	.21		
103202CL	SCH8	8	.35	.29	.25		
103190CL	SCH10	10	.42	.39	.36	.31	
103181CL	SCH20	20	.49	.45	.39	.35	
103157CL	SCH36	36	.49	.45	.39	.35	
100765CL	FCH1	Female pin	\$.11	.09	.06		
145357CL	MCH1	Male pin	\$.15	.135	.12		

		Double Row					
		145357CL		103253CL			
Part No.	Mfr. Cross Ref. No.	Contacts	1	10	100	1000	
103253CL	DCH8	8	\$.59	\$.53	\$.45	\$.39	
157420CL	DCH10	10	.69	.62	.55	.49	
157438CL	DCH14	14	.73	.71	.69	.59	
103237CL	DCH16	16	.79	.71	.57	.43	
103229CL	DCH20	20	.99	.89	.79	.69	
157462CL	DCH40	40	1.09	.99	.89	.75	
157471CL	DCH50	50	.65	.59	.47	.35	
100765CL	FCH1	Female pin	\$.11	.09	.06		
145357CL	MCH1	Male pin	\$.15	.135	.12		

USB-A & B Connectors and Pins 1.0 and 2.0



- 174060CL: USB-A & B (2.0) Male Connector**
- 3-part housing: tin plate over brass and glass fiber
 - 4-pins (P/N 159724CL) required per USB connector
- 161023CL/230949CL/230957CL: USB-A & B (1.0 & 2.0) Female Connectors**
- PC mount right angle with board locks
- 230965CL: Male Crimp Pin**
- Pin for P/N 174060CL (4 required) • Contact: gold
 - Use P/N 159265CL for crimping tool, pg 181

* Prepackaged: order in increments of 10, 100 or 1000

Part No.	Description	1	10	100	1000
161023CL	USB-A 1.0 conn. (F) ...	\$.79	\$.69	\$.62	\$.56
230949CL	USB-A 2.0 conn. (F)99	.85	.55	.42
174060CL	USB-B 2.0 conn. (M)79	.69	.62	.56
230957CL	USB-B 2.0 conn. (F)99	.85	.55	.42
230965CL	Crimp pin (M) for 2.0	\$.125	.09	.065	

.100" Low Profile Keyed Shrouded Headers and Connector CD-ROM 4-Pin Headers and Connector



- Voltage rating: 250V AC/DC
- Current rating: 3A AC/DC
- Insulation resistance: 1000MΩ min.
- Connector material: PBT, 30% glass
- Header material: PBT + 30% glass
- Withstanding voltage: 1000V AC/minute
- Pin material: tin-plated brass
- Recommended crimp tool P/N 99442CL, pg 181

* Prepackaged: order in increments of 10, 100 or 1000

Part No.	Description	1	10	100	1000
152741CL	Straight header	\$.45	\$.39	\$.35	\$.29
152725CL	Right angle header55	.50	.40	.30
152733CL	Single w/ latch†43	.37	.22	.16
181673CL	Female pins	\$.11	.08	.06	

† P/N 152733CL requires 4 pins (P/N 181673CL)

.100" DIP Header Plugs

- Gold-plated leads
- Header plugs: keyed corner to indicate pin 1
- U-shaped pin termination for easy component attachment
- Lead length: .188"
- 0.1" spacing between leads

Part No.	Mfr. Cross Ref. No.	Width	Pins	1	10	100
104336CL	8HP	0.3"	8	\$.79	\$.67	\$.57
37129CL	14HP	0.3"	14	1.19	.99	.89
37330CL	16HP	0.3"	16	1.35	1.25	1.09
38578CL	20HP	0.3"	20	1.49	1.35	1.19

.100" IDC DIP Flat Cable Plugs

- Mates with standard 14, 16, 20, 24, 26, 28 & 40-pin DIP sockets with 0.1" spacing
- Plastic with gold-plated contacts
- Uses 28 AWG flat ribbon cable, pg 60
- Current rating: 1 amp

Part No.	Mfr. Cross Ref. No.	Width	Contacts	1	10	100	500
42657CL	609-14	0.3"	14	\$.49	\$.40	\$.35	\$.29
42673CL	609-16	0.3"	16	.55	.45	.35	.30
104096CL	609-20	0.3"	20	.69	.62	.55	.49
42690CL	609-24	0.6"	24	.79	.71	.64	.59
99670CL	609-28	0.6"	28	.89	.80	.72	.59
42711CL	609-40	0.6"	40	1.15	1.05	.95	.85

Card-Edge Connectors

- Fits all PC boards • .054" to .070" thick
- Solder Eyelet .140" Spacing Between Rows**
- Contact centers: .156" • With mounting ears

Part No.	Position	Contacts	1	10	100
39116CL	22/44	Gold	\$.295	\$.265	\$.238

Solder Tail .200" Spacing Between Rows

- Contact centers: .100"
- Without mounting ears

Part No.	Position	Contacts	1	10	100
40694CL	31/62	Tin (PC/AT)	\$.93	\$.82	\$.65
42091CL	49/98	Tin (AT)89	.59	.39

Fiber Optic Infrared Detectors

- Mates with standard 1000µm core jacketed plastic fiber cable
 - Connector-less fiber termination and connection
 - Inexpensive plastic connector housing
 - Compatible with LED emitters, below
 - Interference-free transmission from light-tight housing
 - Internal micro-lens for efficient coupling
- 169990CL: TTL compatible output infrared detector D95T**
- 169981CL: TTL open-collector output infrared detector D96**



SALE

Part No.	Color Dot	Peak Wavelength Sensitivity	1	10
169990CL	Yellow	800nm	\$5.75	\$4.69
169981CL	White	850nm	7.99	7.35

Infrared and Visible Light Fiber Optic LED Emitters

- Mates with standard 1000µm core jacketed plastic fiber cable (recommend P/N 171272CL, below)
- Internal micro-lens for efficient coupling
- Connector-less fiber termination and connection
- Interference-free transmission from light-tight housing
- Excellent linearity
- Compatible with fiber optic photo detectors, above



- Peak Wavelength Sensitivity:**
- 169957CL: 950nm, Vf=1.7V max @ 50mA**
- 169965CL: 660nm, Vf=1.8V max @ 50mA**
- 169949CL: 660nm, Vf=1.8V max @ 50mA**

Part No.	Description	Color Out	1	10
169957CL	Fiber optic LED E91A	Blue	\$2.99	\$2.49
169965CL	Fiber optic LED E96	Pink	5.35	4.89
169949CL	Fiber optic LED E97	Red	5.75	4.75

10' Fiber Optic Cable

- 1000µm core jacketed plastic fiber optic cable (10')

Part No.	Description	1	10
171272CL	10' fiber optic cable	\$6.95	\$6.25

For Fiber Optic Kits, see page 228.

See the yellow and green highlighted items.

Jameco Special Values!

Details on page 2.

Modular Plugs



Quantity **SAVE**

P = No. of positions
C = No. of contacts
W/E = Western Electric type number

Prepackaged: order in increments of 10, 100 or 1000

Part No.	Description	W/E	1	10	100	1000
103491CL	4P4C (handset)	616	—	\$.11	\$.079	\$.067
79290CL	6P4C (RJ11)	623	—	.12	.11	.095
79273CL	6P6C (RJ11)	623	—	.22	.195	.18
79281CL	8P8C (RJ45) (for stranded wire)	641	—	.28	.24	.20
119343CL	8P8C (RJ45) unshielded (for solid wire)	—	.49	.44	.35	.28
116610CL	8P8C (RJ45) shielded	—	1.09	.99	.89	.79
204222CL	8P8C (RJ45) shielded (for STP solid wire)	—	\$1.49	.95	.89	.75
204231CL	8P8C (RJ45) shielded (for STP stranded wire)	—	\$1.89	1.55	1.49	1.15
116601CL	8P8C (RJ45) shielded (for solid wire)	—	.99	.79	.65	.49
180646CL	10P10C (for stranded wire)	—	1.39	1.15	.82	.69

Modular Jacks



Quantity **SAVE**

- PC mount
- Voltage rating: 150 volts AC max.
- Contact current rating: 1.5 amp max. @ 25°C
- Durability: 750 mating cycles

W/E = Western Electric type number

Part No.	Description	W/E	1	10	100
199620CL	4P4C (handset) .48 W	—	\$.36	\$.33	\$.30
115128CL	4P4C (handset) .395 W	—	.37	.34	.31
151765CL	6P4C (RJ11) side flange AMP	.45	.43	.39	
105945CL	6P4C (RJ11) top flange	623	.62	.49	.39
204206CL	6P4C (RJ11) lead wires	—	1.09	.99	.89
115836CL	6P6C (RJ11) side flange	—	.74	.67	.59
204177CL	6P6C (RJ11) dual	—	1.49	1.35	1.19
124038CL	6P6C (RJ11) 6 leads	—	1.25	1.15	.99
115844CL	8P8C (RJ45)	641	.48	.44	.40
204185CL	8P8C (RJ45) w/ key	—	1.35	1.15	.95
204193CL	8P8C (RJ45) w/o key	—	1.35	1.15	.95
204214CL	8P8C (RJ45) .81 L	—	1.19	1.09	.95
203449CL	8P8C (RJ45) shielded Pin spacing "A" = .055	—	1.19	.99	.85

SALE

"EZ" RJ45 Connector

Strip the wire and insert into the plug and pull out the wire on the other side. This ensures correct conductor order and uniformity in crimping. No wire bar and no wasted cable.

- For solid or stranded wire
- Use standard modular crimping tool
- 8P8C plug

Part No.	Product No.	1	10	100	250
158115CL	RJ45 (8P8C)	\$1.75	\$1.58	\$1.42	\$1.25

Modular Couplers and Adapters

Style 1 Reverse wiring for telephone systems

Style 2 Straight wiring for networking/printer sharing

Cat 5 Coupler!

Part No.	Description	Fig.	1	10	100
72207CL	6P4C male "T" adapter, Style 2. Provides 2 jacks from 1 line. Male modular plug (6P4C), 2 female modular receptacles (6P4C) RJ11	2	\$.99	\$.85	\$.65
71757CL	6P6C modular coupler, Style 1, RJ11	1	.95	.86	.79
135087CL	6P6C modular coupler, Style 2, RJ11	1	.99	.85	.65
181091CL	6P6C male "T" adapter, Style 2. Provides 2 jacks from 1 line. Male modular plug (6P6C), 2 female modular receptacles (6P6C) RJ11	2	.99	.89	.78
118501CL	8P8C modular coupler, Style 1, RJ45	1	\$1.95	1.85	1.75
135079CL	8P8C modular coupler, Style 2, RJ45	1	1.39	1.25	1.15
153023CL	8P8C modular coupler, Style 2 (for Cat. 5) RJ45	3	7.99	7.19	6.49
172814CL	8P8C modular coupler, Style 1 (for Cat. 5) RJ45	4	7.49	6.75	6.09

RJ45-Plug Color Caps (Boots)

- Round strain relief
- 10 piece minimum

New Lower Prices

Part No.	Color	10	100	500	1000
204409CL	Black	\$.14	\$.13	\$.10	\$.076
204388CL	Yellow	.14	.12	.10	.079
204353CL	Gray	.14	.12	.10	.079
204361CL	Blue	.14	.12	.10	.076
204425CL	Red	.14	.12	.10	.076
204396CL	Green	.14	.13	.10	.076
204370CL	Ivory	.14	.13	.10	.076

RS-232-to-RJ11/RJ45 Modular Jack Adapters

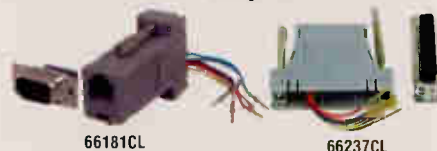

Change your RS-232 port to a RJ11 or RJ45 modular jack. This will allow you to use modular phone cable rather than RS-232 cable, thus simplifying networking applications. Comes complete with all necessary wiring and hardware.

Part Number	Description	Pricing		
		1	10	100
204265CL	DB9 M to RJ11 (6P4C)	\$1.95	\$1.65	\$1.25
66181CL	DB9 M to RJ11 (6P6C)	2.59	2.35	2.09
66190CL	DB9 M to RJ45 (8P8C)	2.89	2.65	2.35
114737CL	DB9 F to RJ11 (6P4C)	1.95	1.79	1.59
66202CL	DB9 F to RJ11 (6P6C)	2.79	2.55	2.29
66211CL	DB9 F to RJ45 (8P8C)	2.99	2.69	2.45
204281CL	DB25 M to RJ11 (6P4C)	2.39	2.15	1.29
66229CL	DB25 M to RJ11 (6P6C)	2.95	2.35	1.99
66237CL	DB25 M to RJ45 (8P8C)	2.99	2.69	2.45
204273CL	DB25 F to RJ11 (6P4C)	1.95	1.69	1.25
66245CL	DB25 F to RJ11 (6P6C)	2.59	1.95	1.39
66253CL	DB25 F to RJ45 (8P8C)	2.89	2.59	2.29

Modular Telephone/Printer Sharing Cables (Gray)

- RJ11 – 6P2C/6P4C for telephone or network
 - RJ11 – 6P6C for telephone or printer sharing
 - RJ45 – 8P8C for telephone or modem-dial-up use
- Style 1** – Reverse wiring for telephone systems
Style 2 – Straight wiring for networking/printer sharing

Low Cost Data/Phone Cables

Part No.	Conn. Style	Type	Length	Pricing		
				1	10	100
189940CL	1	RJ11-6P2C	7ft.	\$.99	\$.85	\$.65
196226CL	1	RJ11-6P4C	7ft.	1.49	1.15	.79
115533CL	2	RJ11-6P4C	7ft.	1.25	1.09	.89
205903CL	1	RJ11-6P4C†	14ft.	\$1.25	.70	.64
115545CL	1	RJ11-6P4C	25ft.	2.29	2.09	1.85
201232CL	2	RJ11-6P4C†	35ft.	1.95	1.66	1.24
115588CL	1	RJ11-6P6C	7ft.	1.55	1.35	1.15
115617CL	2	RJ11-6P6C	7ft.	2.19	1.99	1.79
115676CL	2	RJ45-8P8C	7ft.	1.89	1.75	1.49
115684CL	2	RJ45-8P8C	14ft.	\$2.09	1.89	1.39

† Beige

Next Generation
Cat 6 Cables
on page 62.



BNC Connectors and Adapters

- Frequency range: 0-4GHz
- Working voltage: 500V
- Contact plating: silver/gold
- Body plating: nickel/tin-lead
- Cable type:
 - 223351CL: RG58/58A/58C/141/303/LMR, Belden 7806A
 - 223360CL: RG55/141/142/223/400
 - 223394CL: RG59/62/71/140/210/302
 - 223474CL: RG59/62/140/210, Belden 8241/8263/8279/9209
 - 223693CL: RG5/9/87A/214/313/325



Fig. 1 Fig. 2 Fig. 3



Fig. 4 Fig. 5 Fig. 6 Fig. 7 Fig. 8 Fig. 9 Fig. 10 Fig. 11 Fig. 12 Fig. 13 Fig. 14 Fig. 15

Part No.	Product No.	Fig.	Industry No.	Description	1	10	100
223351CL	31-2	1	UG-88/U	50Ω plug, straight, clamp/solder	\$4.55 \$3.99	\$3.39	\$2.55
223431CL	31-202	1	UG-88C/U	50Ω plug, straight, solder cup	3.99	3.30	2.79
223360CL	31-5	2	UG-89/U	50Ω jack, straight, clamp/solder	\$5.99 4.89	4.49	3.49
223378CL	31-8	3	UG-274/U	50Ω/75Ω T-adapter, jack-plug-jack	10.39	9.59	8.15
223458CL	31-208	3	UG-274A/U	50Ω T-adapter, jack-plug-jack	\$10.49 8.59	6.59	6.49
223386CL	31-9	4	UG-306/U	50Ω right angle adapter, jack-plug	13.55	10.25	8.59
223466CL	31-209	4	UG-306A/U	50Ω right angle adapter, jack-plug	12.19	10.99	9.39
223394CL	31-12	5	UG-260/U	50Ω plug, straight, clamp	7.49	5.79	5.65
223474CL	31-212	5	UG-260B/U	50Ω plug, straight, clamp/solder	\$4.29 3.75	3.29	2.65
223415CL	31-17	6	CW-159/U	50Ω male shorting cap	\$7.59 5.39	4.99	4.49
223423CL	31-102	7	UG-657/U	50Ω bulkhead receptacle, straight, solder cup	\$6.15 5.19	4.75	4.69
223440CL	31-203	8	UG-290A/U	50Ω receptacle, straight/flange, solder cup	5.95	5.42	4.65
223482CL	31-218	9	UG-491A/U	50Ω in-series adapter, plug-plug	8.15	7.15	5.99
223491CL	31-219	10	UG-914/U	50Ω in-series adapter, jack-jack	\$5.89 4.39	3.59	2.49
223503CL	31-220H	11	UG-492A/U	50Ω in-series adapter, jack-jack	\$9.15 7.59	6.99	5.99
223554CL	31-3220	12	UG-492D/U	50Ω bulkhead adapter, straight, jack-jack	11.65	8.85	6.65
223511CL	31-221	13	UG-1094/U	50Ω bulkhead receptacle, straight, solder cup	2.19	1.99	1.20
223538CL	31-2221	14	UG-1094A/U	50Ω bulkhead receptacle, straight, solder cup	\$2.69 2.69	2.25	1.59
223520CL	31-236	13	UG-625B/U	50Ω bulkhead receptacle, straight, pin/pin	2.49	2.19	1.29
223685CL	5575	13	UG-625/U	50Ω bulkhead receptacle, solder	4.45	3.39	3.15
223693CL	6775	15	UG-959/U	50Ω right angle plug, clamp/solder	12.59	9.99	9.75

UHF Connectors and Adapters

- Frequency range: 0-300MHz
- Working voltage: 500V
- Contact plating: nickel & silver
- Cable type:
 - 223600CL/223618CL/223677CL: RG8/9/87A/214/313/225
 - 223651CL: RG58/141



Fig. 1 Fig. 2



Fig. 3 Fig. 4 Fig. 5 Fig. 6 Fig. 7 Fig. 8

Part No.	Product No.	Fig.	Industry No.	Description	1	10	100
223562CL	83-1AP	1	UG-646/U	In-series right angle adapter, jack-plug	\$7.19	\$5.79	\$5.75
223571CL	83-1F	2	UG-363/U	In-series bulkhead adapter, socket-socket	13.79	10.25	9.99
223589CL	83-1J	3	PL-258	In-series straight adapter, jack-jack	6.99	5.99	5.29
223837CL	83-1T	4	M-358	In-series T-adapter, jack-plug-jack	11.19	8.99	8.75
223597CL	83-1R	5	SO-239	Non-constant impedance panel receptacle, solder cup	2.99	2.55	1.65
223669CL	83-798	5	SO-239A	Non-constant impedance panel receptacle, solder cup	5.25	3.99	3.59
223600CL	83-1SP	6	PL-259	Non-constant impedance plug, straight, solder-solder	3.09	2.87	1.69
223618CL	83-1SP-1050	7	PL-259	Non-constant impedance plug, straight, solder-solder	\$2.29 1.69	1.52	1.15
223677CL	83-822	7	PL-259	Non-constant impedance plug, straight, solder-solder	3.89	2.99	2.59
223651CL	83-765	8	UG-177/U	Hood for 83-1R, above	2.55	1.99	1.69

BNC Adapters



- Frequency range: 0-4GHz with low reflection
- 188411CL: Straight jack-to-jack
- 188429CL: Jack-plug-jack
- 188402CL: Gasketed jack-to-jack

Part No.	Product No.	1	10	25	100
188411CL	31-219-RFX	\$2.99	\$2.66	\$1.64	\$1.49
188429CL	31-208-RFX	4.45	3.37	2.28	1.99
188402CL	31-220G-RFX	3.49	3.15	2.79	2.49

BNC 50Ω Cable Plugs

BNC 3-Piece

- Silver-plated
- Frequency range: 0-4GHz with low reflection
- Attachment (outer/inner): crimp/crimp



- 188306CL: RG58/184
- 188349CL: RG174/188/316

Part No.	Product No.	1	10	25	100
188306CL	31-320-RFX	\$1.55	\$1.28	\$0.99	\$0.90
188349CL	31-315-RFX	1.99	1.63	1.10	.96

Type N Crimp Connector

- Silver-plated
- RG58/141
- Attachment (outer/inner): crimp/crimp



Part No.	Product No.	1	10	50	100
188445CL	82-5375-RFX	\$4.35	\$3.29	\$2.50	\$2.25

SMA Brass Plug

- Frequency range: 0-18GHz
- Outer cable attachment: crimp
- Inner cable attachment: solder
- Construction: captive contact
- Type: crimp plug
- For RG174/U, RG188/U, and RG316/U cables



Part No.	Product No.	1	10	50
188488CL	901-9877-RFX	\$2.49	\$2.25	\$1.99

For BNC/F-Type
Keystone Style Jacks,
see page 62.



30-Day Money-Back Guarantee

If you're not satisfied
we'll take it back!
Details on page 229.

We carry major manufacturers – call for OEM PRICING.

BNC Coax Connectors

Quantity **SAVE**

- Miniature, lightweight units designed to operate up to 11GHz and typically yield low reflection up to 4GHz

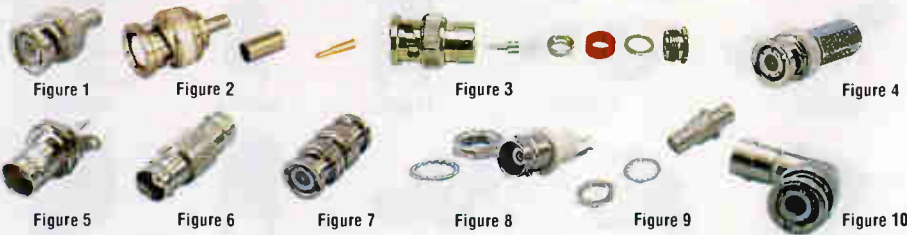

Part No.	Fig.	Description	1	10	100	500
71458CL	1	BNC male terminator (50Ω)	\$1.55	\$1.15	\$.99	\$.89
71790CL	1	BNC male terminator (75Ω)	1.35	1.09	.89	.73
135618CL	2	BNC male with pin and ferrule (RG6)	.89	.69	.45	.39
71482CL	2	BNC male with pin and ferrule (RG58)	1.65	1.49	1.35	1.25
71271CL	2	BNC male with pin and ferrule (RG59/62)	1.39	.81	.66	.54
112109CL	2	BNC male with pin and ferrule (RG174)	1.59	1.45	1.29	1.15
119394CL	3	BNC male clamp-on (RG59/62)	1.39	1.25	1.15	.89
108994CL	4	BNC male twist-on (RG58)	1.49	1.19	.95	.75
71781CL	4	BNC male twist-on (RG59/62)	1.09	.99	.89	.79
71589CL	5	BNC female panel mount (UG-1094A)	1.49	1.35	1.25	1.09
71909CL	6	BNC female/female coupler (UG-914)	1.29	.99	.85	.74
127343CL	7	BNC male/male coupler (UG-491B/U)	1.99	1.79	1.39	1.29
111561CL	8	BNC female isolated bulkhead	2.29	1.99	1.79	1.59
148224CL	9	BNC female bulkhead feed-thru	1.99	1.79	1.59	1.39
148232CL	9	BNC female isolated bulkhead feed-thru	2.49	2.25	1.79	1.35
127351CL	10	BNC M-F right angle (DG-306B/O)	2.49	2.19	1.85	1.59
160928CL	11	BNC female, crimp type (RG58)	1.25	1.09	.99	.89
161921CL	11	BNC female, crimp type (RG174)	1.49	1.35	1.19	1.05
174289CL	12	BNC female chassis mount	1.19	.98	.88	.79
174297CL	13	BNC female twist-on bulkhead	2.25	2.02	1.62	1.22
174254CL	14	BNC male to F connector female	1.99	1.59	1.45	1.19
207183CL	15	BNC male to RG58/59 crimp on	3.99	3.59	2.89	2.15



BNC PCB Connectors

- 146528CL: Ideal for applications where multiple insertions require a connector which can endure the stress of high torque
- 146510CL/161656CL: Maintains matching impedance at 50Ω & 75Ω. Ideal for LAN cards & precision video

New Lower Prices

Part No.	Description	Length (L)	1	10	100	500
146528CL	BNC straight metal	.719	\$2.79	\$2.49	\$1.99	\$1.55
210884CL	BNC straight/panel mount metal	.830"	2.29	1.99	1.65	1.25
146510CL	BNC right-angle plastic insulation	1.37	1.95	1.75	1.49	1.25
161656CL	BNC right-angle metal	.861	2.29	1.99	1.79	1.59



Quantity **SAVE**

New Lower Prices

BNC Adapters

- Silver-plated
- General purpose coax T-adapter
- ThinNet/Ethernet LAN adapter

Part No.	Description	1	10	100	500	
118594CL	Male to female/female T-adapter	\$2.39	\$2.15	\$1.75	\$1.25	
207108CL	Quad female adapter	3.99	3.49	2.99	2.49	
207095CL	Female to male/male T-adapter	6.99	6.25	5.59	4.99	
72629CL	Female to female/female T-adapter	2.49	2.25	1.99	1.69	
207087CL	Female to male/female T-adapter	9.95	8.95	6.45	5.39	
207132CL	Female to bulkhead female (rt. angle)	3.80	2.29	2.29	1.88	1.27
100589CL	Male to female/female T-adapter (90°)	4.95	4.45	3.99	3.65	
100597CL	Male to female/female T-adapter (180°)	5.99	5.39	4.85	3.99	
207116CL	Male to female/female/female T-adapter	7.19	6.45	5.79	4.95	
117461CL	Male to female/female F-adapter (90°)	4.29	3.89	3.49	2.99	
207124CL	Male/male to female/female T-adapter	4.49	4.05	3.25	2.45	
207167CL	RCA female to BNC female	1.99	1.79	1.59	1.39	
114788CL	RCA female to BNC male adapter	1.35	1.05	.99	.98	
207175CL	RCA male to BNC male	1.99	1.79	1.59	1.39	
114753CL	RCA male to BNC female adapter	1.59	1.45	1.15	.89	
114770CL	BNC female to "F" connector male adapter	1.79	1.59	1.39	1.19	
207141CL	3.5mm mono male to BNC female	1.89	1.45	1.25	.85	



BNC Coax Cables



- Male coax connectors

RG6 75Ω Cables

Part No.	Description	1	10	50	100
176794CL	3' BNC to BNC	\$3.95	\$3.55	\$3.19	\$2.89
176815CL	6' BNC to BNC	4.95	4.49	4.05	3.35

RG58/U 50Ω Cables

Part No.	Mr. Cross Ref. No.	Length (ft.)	Quantity				
			1	10	50	100	
181307CL	CRG58-1RR	1	\$3.65	\$3.29	\$2.95	\$2.75	
102314CL	CRG58-1	1.5	3.99	3.49	2.99	2.49	
256743CL	CBB-224-24	2	9.75	9.39	8.89	7.99	
11404CL	CRG58-3	3	4.29	3.89	3.49	3.15	
256760CL	CBB-224-72	6	12.19	11.75	11.12	9.99	
102331CL	CRG58-6	6	4.39	3.99	3.59	3.19	
152311CL	RG58MF-6*	6	2.95	2.66	2.12	1.59	
180822CL	CRG58-10	10	4.49	4.59	2.69	1.89	
102349CL	CRG58-12	12	4.95	4.49	3.99	3.39	
169818CL	CRG58-15	15	5.49	4.95	4.46	3.56	2.67
102357CL	CRG58-25	25	6.49	5.19	3.89	2.75	
102365CL	CRG58-50	50	9.49	8.55	7.69	6.89	
102381CL	CRG58-100	100	13.49	12.14	8.71	7.28	

*152311CL has male and female coax connectors

RG59/U 75Ω Cables

Part No.	Mr. Cross Ref. No.	Length (ft.)	Quantity			
			1	10	50	100
86471CL	CRG59-1	1.5	\$2.99	\$2.69	\$2.45	\$2.19
85542CL	CRG59-6	6	3.75	3.39	2.69	2.05
226253CL	BZA3636	8	4.49	3.95	3.65	3.29
102373CL	CRG59-12	12	5.49	4.95	4.45	3.99

RG174/U 50Ω Cables

Part No.	Mr. Cross Ref. No.	Length (ft.)	Quantity			
			1	10	50	100
111472CL	RG174U3	3	\$3.85	\$3.49	\$3.15	\$2.85
111481CL	RG174U6	6	4.59	4.15	3.75	3.35

SMB PCB Connector

- 0-4GHz electrical performance
- Gold plated brass
- Insulation: teflon
- Contact: beryllium copper



Part No.	Description	1	10	50
167311CL	Fem. right angle PCB ..	\$4.45	\$3.89	\$3.25

SMB PCB Jack Connectors



172363CL 172371CL

- For use with RG-174 cable
- 50Ω crimp type
- Gold plated
- Use with crimping tool P/N 114534CL, pg 180

Part No.	Description	1	10	50
172363CL	Bulkhead crimp jack	\$3.49	\$2.95	\$2.49
172371CL	Cable crimp plug	4.29	3.89	3.49

SMA/SMB 50Ω Coax Cables

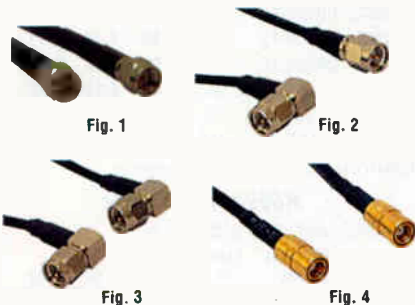

Fig. 1 Fig. 2

Fig. 3 Fig. 4

- Fig. 1: SMA male to SMA male
- Fig. 2: SMA male to SMA right angle male
- Fig. 3: SMA right angle male to SMA right angle male
- Fig. 4: SMB male to SMB male

Part No.	Cable	Fig.	Lgth (ft.)	1	10	50
159370CL	RG58	1	2	\$4.49	\$3.99	\$3.49
159396CL	RG58	1	6	5.49	4.89	4.19
169800CL	RG174	1	0.5	5.59	4.99	4.55
163854CL	RG174	1	1	4.49	3.95	3.39
153381CL	RG174	1	2	4.95	4.29	3.39
153390CL	RG174	1	4	5.49	4.75	4.29
159450CL	RG174	1	4	6.79	6.15	5.55
175126CL	RG174	2	0.5	4.49	3.95	3.49
175134CL	RG174	2	1	4.95	4.25	3.75
175142CL	RG174	3	0.5	5.75	5.25	4.49
175151CL	RG174	3	1	6.25	5.75	4.75
175169CL	RG174	4	0.5	4.25	3.19	2.25
175177CL	RG174	4	1	5.29	4.79	3.95

F-Type 75Ω Coax Cable

- Low signal loss
- Strain relief
- Male to male F-type

SALE



Part No.	Cable	Lgth (ft.)	1	10	50	100
85585CL	RG59	3	\$1.05	\$0.69	\$0.62	\$0.57

Jameco's Low-Price Guarantee

We'll match the print advertised price of any like product. It's that simple!

SMA Connectors, Adapters and Couplers



157972CL 153365CL 145381CL 145373CL 153285CL
159530CL 160021CL 160012CL 188509CL 188525CL

- Application: cellular phone, data communication, instrumentation, and video
- 50Ω impedance
- Frequency range: 0-18GHz
- Temperature range: -65°C to 165°C
- Plating: gold and nickel

Connectors

Part No.	Description	Cable Type	Plated	1	10	50	100
157972CL	SMA 50Ω crimp type male plug connector	RG58	Gold	\$3.99	\$3.59	\$3.29	\$2.99
153365CL	SMA 50Ω crimp type male plug connector	RG174	Gold	4.39	3.95	3.55	3.19
145381CL	SMA straight female PCB mount connector, 4 legs	—	Gold	5.25	4.75	4.25	3.49
145373CL	SMA 90° female PCB mount connector, 4 legs	—	Gold	7.39	6.65	5.95	5.39
153285CL	SMA bulkhead solder female w/ washer, rear mount	RG58/174	Gold	3.49	3.15	2.85	2.59
159530CL	SMA female panel mount conn., 4 mounting holes*	RG58/174	Gold	2.95	2.65	2.35	2.10
160021CL	SMA female panel mount conn., 2 mounting holes*	RG58/174	Gold	3.99	3.59	3.25	2.95
160012CL	Panel mount feed thru connector female - female	—	Nickel	4.99	4.49	3.99	3.49
188509CL	SMA PCB straight jack	—	Gold	3.69	3.35	2.99	2.69
188525CL	SMA PCB right angle jack	—	Gold	5.95	4.95	3.79	3.35

*159530CL/160021CL: Solder cup

SMA to BNC Adapters



153453CL 159468CL 153592CL 159476CL

Part No.	Description	Plated	1	10	50	100
153453CL	SMA female to BNC male adapter	Nickel	\$2.49	\$2.25	\$1.99	\$1.79
159468CL	SMA female to BNC female adapter	Nickel	2.69	2.45	2.19	1.99
153592CL	SMA male to BNC male adapter	Nickel	3.99	3.59	3.19	2.89
159476CL	SMA male to BNC female adapter	Nickel	2.99	2.69	2.45	2.19

Couplers



153293CL 161277CL 161293CL 161306CL

Part No.	Description	Plated	1	10	50	100
153293CL	SMA straight coupler female - jack-to-jack	Gold	\$3.85	\$3.39	\$2.19	\$1.79
161277CL	3-way coupler, 1 male - 2 female	Gold	3.49	3.15	2.85	2.45
161293CL	Straight coupler male - male	Gold	3.65	3.29	2.95	2.75
161306CL	Right angle coupler male - female	Gold	4.99	4.49	3.99	3.65

Cinch

Jones Plugs and Sockets

Multiple-Density Solder-Eyelet Connectors with Hood and 180° Clamp

- Insulation material: molded mono-block, black phenolic
- Contact material: plug-brass; socket-phosphor bronze
- Contact plating: cadmium
- Hood material: UL 94V-0 rated thermoplastic
- Operating voltage: 250 VAC_{RMS} maximum
- Current rating: 10 amps
- Contact resistance: 16MΩ maximum

New



248823CL 248786CL

Plugs

Part No.	Product No.	Contacts	1	25
248760CL	P-302-CCT	2	\$2.15	\$1.96
248778CL	P-303-CCT	3	2.37	2.15
248786CL	P-304-CCT	4	2.73	2.47
248794CL	P-306-CCT	6	2.89	2.62

Sockets

Part No.	Product No.	Contacts	1	25
248807CL	S-302-CCT	2	\$2.29	\$2.11
248815CL	S-303-CCT	3	2.67	2.43
248823CL	S-304-CCT	4	2.70	2.46
248831CL	S-306-CCT	6	3.08	2.80



Terminal Blocks and Header



For detailed specifications, please see our website at www.Jameco.com
 • 164814CL: Male header (.197") for use with 164793CL and 164806CL



Fig. 1 (99397CL)



Fig. 2 (160784CL)



Fig. 3 (161066CL)



Fig. 4 (189675CL)



Fig. 5 (164793CL)



Fig. 6 (164806CL)



Fig. 7 (249084CL)

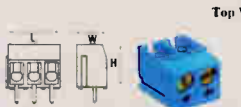

Fig. 8 (152346CL)



Fig. 9 (164814CL) (use with Fig. 5 & 6)

Part No.	Mfg.	Product No.	Fig.	Term.	Terminal Spacing	1	10	100	1000
99426CL	Dinkle	DT128 2	1	2	.197/5mm	\$.72	\$.55	\$.44	\$.40
99397CL	Dinkle	DT128V3P	1	3	.197/5mm	.99	.89	.79	.59
160784CL	Dinkle	EK500V-02P	2	2	.197/5mm	.65	.55	.45	.39
160792CL	Dinkle	EK500V-03P	2	3	.197/5mm	.95	.85	.75	.69
161066CL	Dinkle	EK500A-02P	3	2	.197/5mm	.75	.65	.49	.39
161058CL	Dinkle	EK500A-03P	3	3	.197/5mm	.95	.85	.75	.69
189675CL	OST	EDC500/2DS	4	2	.197/5mm	.79	.71	.64	.58
189667CL	OST	EDC500/3DS	4	3	.197/5mm	.89	.80	.72	.61
164793CL	OST	EDC130/2DS	5	2	.197/5mm	.59	.53	.47	.42
164806CL	OST	EDC130/3DS	6	3	.197/5mm	.84	.76	.62	.54
249084CL	OST	EDZ750/3	7	3	.200/5.08mm	1.49	1.39	1.19	.89
152346CL	OST	EDC120/2DS	8	2	.200/5.08mm	.65	.55	.45	.39
152354CL	OST	EDC120/3DS	8	3	.200/5.08mm	.47	.44	.39	.30
164814CL	OST	EDSTL130/24	9	24	.197/5mm	2.25	1.95	1.75	1.49

Cinch Double Row Terminal Blocks

- Voltage rating: 250VAC RMS max.
- Insulation: molded mono block, general purpose phenolic, black, UL rated 94V-1
- Eyelet material: brass with nickel plating
- Screw material: steel with nickel over copper flash plating
- Solder terminal material: brass with electro-tin plating



140 Series 15A

- 3750-watts per terminal max.
- 16 AWG wire max. • Size: 0.88 W x 0.41" H
- Screw: 5-40 x 3/16 • Density: .375"

Part No.	Prod. No.	Pos.	Length	1	10	100
230973CL	2-140	2	1.41"	\$.99	\$.89	\$.74
230981CL	3-140	3	1.78"	1.29	1.15	.95
230990CL	4-140	4	2.16"	1.45	1.29	1.05
231001CL	5-140	5	2.53"	1.59	1.44	1.18
231010CL	6-140	6	2.91"	1.99	1.79	1.48
231028CL	7-140	7	3.28"	2.19	1.95	1.59
231036CL	8-140	8	3.66"	2.49	2.24	1.83
231044CL	9-140	9	4.03"	2.79	2.49	2.03
231052CL	10-140	10	4.41"	3.25	2.89	2.35
231061CL	12-140	12	5.16"	3.55	3.15	2.59

141 Series 20A

- 5000-watts per terminal max.
- 14 AWG wire max. • Size: 1.13" W x 0.5" H
- Screw: 6-32 x 1/4" • Density: .438"

Part No.	Prod. No.	Pos.	Length	1	10	100
231351CL	2-141	2	1.63"	\$.99	\$.85	\$.72
231360CL	3-141	3	2.10"	1.69	1.45	1.09
231378CL	4-141	4	2.50"	1.79	1.59	1.25
231386CL	5-141	5	2.94"	1.85	1.64	1.33
231394CL	6-141	6	3.38"	1.99	1.75	1.45
231407CL	7-141	7	3.81"	2.49	2.25	1.85
231415CL	8-141	8	4.25"	2.79	2.35	1.94
231423CL	9-141	9	4.69"	2.99	2.59	2.19
231431CL	10-141	10	5.13"	3.19	2.79	2.29
231440CL	12-141	12	6.00"	3.59	3.29	2.69



DIN Rail-Mounted Terminal Block and DIN Rail

Foot snaps onto standard DIN and DIN 2 rails. Terminals are positively retained on rails, but can be removed without disturbing adjacent units.

- Molded thermoplastic • Spacing: 5.06mm (.199")
- UL rated voltage and current: 600V @ 20A • 14-22 AWG

Part No.	Product No.	Type	1	10	100
237083CL	41296.2	SR2.5	\$.89	\$.79	\$.69
248735CL	2094.0	TS35x7.5	6.79	5.45	4.10



European Terminal Blocks

- Number of poles: 12
- 1.2mm raised base
- Working temperature: 230°F (110°C)
- Material: Polyamide 66 (nylon 66), UL94V2, natural
- Terminal insert: brass metal alloy, nickel plated
- Wire protector: stainless steel spring
- Screws: zinc plated, yellow chromed



Part No.	Prod. No.	Amps	AWG	1	10	100
215010CL	PA8H	20A	12-22	\$1.79	\$1.59	\$1.29
215028CL	PA10H	30A	10-22	1.89	1.69	1.39
215036CL	PA12H	35A	10-22	2.59	2.29	1.99

KULKA® 601 GP Series Double Row Terminal Blocks



- Base: general purpose phenolic; 150°C
- Screws: #6-32, binder head, phillips-slot
- Terminals: brass plated • Width (W): 1.12"
- .437" (11 mm) centers • Height (H): .50"
- 1100Vrms; 20A ratings; for 14-16 AWG wires
- Open block design
- UL/CSA/CE approved



Part Number	Product Number	Poles	Dimensions			1	10	50
			A"	B"	B"			
188699CL	601GP4	4	2.19	2.50	1.69	\$1.49	\$1.35	\$1.35
188681CL	601GP6	6	3.06	3.38	2.39	2.19	1.89	1.89
188672CL	601GP8	8	3.94	4.25	2.95	2.75	2.49	2.49
188664CL	601GP10	10	4.81	5.13	3.49	3.25	2.95	2.95
188701CL	601GP12	12	5.69	6.00	5.49	4.95	3.95	3.95

Metric Double Row Terminal Blocks

- Wire gauge range: 12-18 AWG
- Body Material: black thermoplastic (UL94V-0)
- Terminals: brass tin plated
- Screws: steel nickel plated
- Insulation withstanding voltage: 2000VAC min.
- Insulation resistance: 1000MΩ or more at 500VDC



10A @ 600V

- Screw size: M3.0
- Width (W): 19.5mm
- Height (H): 11.9mm



Part Number	Product Number	Poles	Dimensions			1	10	50
			A	B	B			
208856CL	GGE-10-4P	4	47.5	55	\$.99	\$.89	\$.79	
208864CL	GGE-10-6P	6	64.5	74	1.39	1.25	1.15	
208872CL	GGE-10-8P	8	95	102.5	1.69	1.59	1.49	
208899CL	GGE-10-10P	10	104.5	112	2.39	2.15	1.89	
208881CL	GGE-10-12P	12	123.5	131	2.79	2.49	2.25	

20A @ 600V

- Screw size: M3.5
- Width (W): 22.0mm
- Height (H): 13.2mm



Part Number	Product Number	Poles	Dimensions			1	10	50
			A	B	B			
207538CL	GGE-20-4P	4	54.5	63.5	\$1.39	\$1.25	\$1.10	
207546CL	GGE-20-6P	6	76.3	85.3	1.99	1.79	1.59	
207554CL	GGE-20-8P	8	98.1	107.1	2.59	2.35	2.15	
207562CL	GGE-20-10P	10	119.9	128.9	3.29	2.99	2.69	
207571CL	GGE-20-12P	12	141.7	150.7	3.59	3.19	2.79	

DIN and Mini DIN Plugs and Receptacles



- Solder barrels including strain relief
- See page 60 for cable

Part No.	Pins	Type	1	10	100
142279CL	4	Mini plug	\$.79	\$.68	\$.53
142261CL	6	Mini plug	.89	.77	.59
177244CL	6	Mini receptacle	.99	.85	.69
111878CL	8	Mini plug	.99	.89	.74
177236CL	8	Mini receptacle	1.09	.93	.69
15878CL	5	DIN plug	.52	.44	.33
180873CL	5	DIN receptacle	.52	.45	.34
15886CL	6	DIN plug	.59	.50	.39
15894CL	8	DIN plug	.65	.56	.43

DIN Female Sockets

- Metal body
- Panel mount with solder lugs



Part No.	Mfr. Cross Ref. No.	# of pins	1	10	100	500
15843CL	DINJ5	5	\$1.29	\$1.15	\$1.05	\$.79
15851CL	DINJ6	6	1.39	1.25	1.15	.99
15860CL	DINJ8	8	1.49	1.35	1.15	1.05

Right Angle DIN Female Sockets

- Set back: 0.5"
- PC mount contacts
- 140791CL/119474CL: Plastic/metal body
- 29399CL: Plastic body



Part No.	Mfr. Cross Ref. No.	# of pins	1	10	100	500
140791CL	MDR4S	4 (mini)	\$.69	\$.59	\$.46	\$.34
119474CL	MDR6S	6 (mini)	.75	.68	.54	.40
207722CL	MDS8100	8 (mini)	.99	.89	.69	.55
29399CL	RD5	5	.59	.53	.40	.36

PCB Centronics Connectors



- Solder-type contacts
- Space between rows: .164"
- Space between pins: 0.1" • Metal body • PC mount

Part No.	Description	1	10	100
72151CL	36-contact fem., rt angle	\$3.55	\$3.19	\$2.87
159708CL	36-contact fem., straight	1.37	1.11	.95
72080CL	50-contact fem., rt angle	4.95	4.21	3.16

IDC Centronics Connector

- Contact material: gold plated phosphor bronze; plastic casing
- Current rating: 1 amp
- Temp. rating: -55°C to +105°C
- Use 73251CL IDC crimping tool, pg 181



Part No.	Mfr. Cross Ref. No.	Description	1	10	100
13848CL	CEN36M	36-contact male	\$1.75	\$1.55	\$1.39

Jameco Special Values!

See the yellow and green highlighted items. Details on page 2.

.100" IDC Plug Connectors

Double Row

- .100" x .100" grid
- Plastic
- Shrouded header w/o mounting ears
- Contact: gold-plated phosphor bronze
- Use with IDC socket for connectors, right



Part No.	Cross Ref. No.	Contacts	1	10	100
29188CL	P40	40	\$1.95	\$1.75	\$1.49
29217CL	P50	50	1.95	1.75	1.49

.100" Low-Profile Male Shrouded Headers

- Rating: 1A (max.) @ 250VDC
- Contact resistance: 15mΩ max.
- Features: UL recognized, CSA certified; .025" square post mates with sockets on .100" x .100" grid
- Contact: phosphor bronze, gold plated
- Use with IDC socket connectors, above



Straight Male Headers

Part No.	Description	1	10	100	1000
67811CL	10-pin	\$.39	\$.35	\$.32	\$.28
68179CL	16-pin	.44	.40	.35	.32
68291CL	20-pin	.49	.47	.39	.23
68371CL	26-pin	.54	.42	.35	.21
68582CL	34-pin	.79	.65	.46	.31
181104CL	40-pin	.75	.60	.45	.315

Right Angle Male Header

Part No.	Description	1	10	100	1000
211182CL	26-pin	\$.45	\$.39	\$.29	\$.19

.100" (2.5mm) Female Header Receptacles

- Gold plated contacts
- 0.1" contact center

Vertical Mount (Top Entry)

Part No.	Contacts	Type	1	10	100	500
70754CL	8	Single row	\$.59	\$.53	\$.43	\$.35
200782CL	12	Single row	.79	.59	.45	.42
70720CL	16	Double row	.89	.79	.72	.65
70826CL	20	Double row	.99	.89	.71	.53
105056CL	30	Double row	1.09	.99	.79	.59
163862CL	34	Double row	1.19	1.05	.92	.79
111704CL	40	Double (Tin)	1.29	1.15	.99	.89

Right Angle Mount (Side Entry)

Part No.	Contacts	Type	1	10	100	500
71159CL	20	Double row	\$1.25	\$1.10	\$.99	\$.85

Centronics Parallel Interface Connectors

Metal Body and Shell, Solder-Type Contacts



- Solder eyelets accept 24 AWG wire, pg 60
- Male cable plugs
- Complete with cable boot, shell and hardware

Part No.	Cross Ref. No.	Contacts	1	10	50
180072CL	57-30140	36	\$1.29	\$1.09	\$.99
42382CL	57-30360	36	1.79	1.59	1.49

.100" & 2mm IDC Socket Connectors

Double Row

- Mates with 2 rows of .025" Sq. or Dia. posts on patterns of .100" centers (male headers, see below)
- Industry standard IDC socket (plastic)
- Temperature rating: -55°C to +105°C
- Use crimper P/N 73251CL, pg 181



Polarized IDC Socket Connectors

Part No.	Mfr. Cross Ref. No.	Contacts	1	10	100	1000
32491CL	S10	10	\$.29	\$.25	\$.19	\$.15
153947CL	S14	14	.32	.27	.21	.16
119466CL	S16	16	.35	.29	.22	.17
32521CL	S20	20	.39	.32	.25	.18
32563CL	S26	26	.45	.35	.29	.19
32643CL	S34	34	.49	.39	.35	.25
32678CL	S40	40	.55	.45	.39	.29
100386CL	IDC440*	44 (2mm)	.99	.89	.75	.59
32707CL	S50	50	.65	.55	.45	.35
32758CL	S60	60	.75	.68	.54	.40

Non-Polarized IDC Socket Connectors

Part No.	Mfr. Cross Ref. No.	Contacts	1	10	100	1000
138376CL	SN10	10	\$.35	\$.32	\$.28	\$.24
138325CL	SN20	20	.45	.40	.36	.28
138333CL	SN26	26	.39	.35	.29	.19
138341CL	SN34	34	.45	.35	.29	.25
138350CL	SN40	40	.49	.45	.39	.29
138368CL	SN50	50	.65	.49	.35	.29

.100" (2.5mm) Straight Male Headers

With Standard Latch

- 0.1" contact center
- Mount vertical
- Keying slot
- Use with IDC socket connectors, above



Part No.	Description	1	10	100	500
117663CL	10-pin	\$1.29	\$1.09	\$.79	\$.49
71829CL	20-pin	1.39	1.25	1.13	.95
71933CL	26-pin	1.49	1.25	.99	.89
72215CL	50-pin	1.85	1.65	1.49	1.35

PANAVISE IDC Bench Press and Cable Cutter

Designed for low to medium volume mass termination of various IDC connectors on flat ribbon cable.



Part No.	Prod. No.	Description	Wt. (lbs.)	1	10
27174CL	M505	Bench press	7.0	\$179.95	\$159.95

M505 Accessories

27182CL	M507	Cable cutter	0.9	\$66.95	\$61.95
27203CL	M510	Base plate	0.5	26.49	23.49



See page 60 for Gray and Multicolor Ribbon Cables

Slim-Line D-Sub Gender Changers



For Confined Applications!

These revolutionary slim-line gender changers are only 0.69" wide, eliminating the space problems caused by standard gender changers. When plugged into your existing cable, they add only 0.44" to the cable. All-metal cases.

- Captive locking screw (male)
- Captive locking nut (female)
- Grounding tangs (male)

Quantity
SAVE

Part No.	Description	1	10	100
18497CL	9-pin male	\$4.95	\$4.49	\$3.99
18489CL	9-pin female	4.95	4.49	3.99
56071CL	15-pin male	3.95	3.49	2.95
56063CL	15-pin female	3.95	3.39	2.55
119319CL	15-pin female HD	4.29	3.89	3.49
119301CL	15-pin male HD	4.95	4.49	3.95
18446CL	25-pin male	4.95	4.49	3.99
18420CL	25-pin female	4.95	4.49	3.99
170085CL	25-pin M-F (pass through)	2.95	2.55	1.89

D-Sub 9-Pin to 25-Pin Serial Adapters

Quantity
SAVE

10305CL: For use in AT or other computer systems that have 9-pin D-sub serial ports.

163740CL/153576CL/10321CL:

For PC/XT systems with DB25 serial ports.

139985CL: gold-plated contacts, extra long thumbscrews

Part No.	Description	1	10	100
10305CL	DB9 F to DB25 M	\$3.49	\$2.99	\$2.25
163740CL	DB9 M to DB25 F, thumbscrews on DB9 side only	2.85	2.45	1.85
153576CL	DB9 M to DB25 F, thumbscrews on DB25 side only	3.95	3.59	2.99
10321CL	DB9 M to DB25 F	4.49	3.79	3.19
189632CL	DB9 M to DB25 M	3.49	3.15	2.85
139985CL	DB9 F to DB25 F	3.95	3.55	3.19

6-Pin Male Mini DIN to 9-Pin Male D-Sub Adapter

- Pin-to-pin connections: 1-1, 3-3 & 9, 4-2 & 5 & 7, 5-6
- Color: beige
- Size: 1.6" L x 1.3" W

New Lower Prices

Part No.	Description	1	10	100
100335CL	W/ thumbscrew	\$2.00 \$1.81	\$1.73	\$1.67

Standard D-Sub Gender Changers



Part No.	Description	1	10	100
16635CL	D-sub 9-pin male	\$1.95	\$1.75	\$1.49
16643CL	D-sub 9-pin female	1.95	1.75	1.49
22058CL	D-sub 25-pin male	1.95	1.49	1.05
22074CL	D-sub 25-pin female	1.99	1.79	1.65

AT and PS/2 Keyboard Adapters



159089CL/189771CL: AT keyboard adapter

- Connects PS/2 keyboard to AT
- 6-pin female mini DIN to 5-pin male DIN



159097CL/157930CL: PS/2 keyboard adapter

- Connects AT type keyboards to the PS/2
- 5-pin female DIN to 6-pin male mini DIN (PS/2)

Part No.	Length	Housing	1	10	100
159089CL	1.6"	Metal	\$2.95	\$2.65	\$2.39
159097CL	1.4"	Metal	2.95	2.65	2.39
157930CL	1.7"	Plastic/metal	\$2.49 2.95	2.51	1.89
189771CL	1.7"	Plastic	2.95	2.65	2.39

Laptop Computer Power Cord

- 2-conductor power cord for laptop computers
- Flat junior duty type cord
- 18/2 AWG • 6' cord

New Lower Prices

Part No.	Description	1	10
189587CL	6' laptop power cord	\$2.85	\$2.40

Apple Macintosh® Printer Cables



Part No.	Description	1	10	50
10604CL	6' mini DIN8M	\$4.95	\$4.45	\$3.99
130024CL	10' mini DIN8M	5.99	5.39	4.85

Full Handshaking Null Modem Adapters

Self-contained null-modem (cross-over) adapters. Change any standard straight cable into a null cable quickly and easily.



Internal pin configuration:
17224CL: 1-1, 2-3, 3-2, 4-5, 5-4, 6-20, 20-6, 7-7, 8-20
26243CL: 1-1, 2-3, 3-2, 4-8, 8-4, 5-8, 8-5, 6-20, 20-6, 7-7

Part No.	Description	1	10	100
26243CL	DB25 M to DB25 F	\$3.95	\$3.65	\$3.49
17224CL	DB25 F to DB25 F	3.49	2.95	2.49

IEEE 1284 Parallel & Serial Cables for High Speed

IEEE 1284 is the standard in high speed printing. Compatible w/ bidirectional communication data flow resulting in speeds up to 10 times faster than conventional applications.



- Double shielded with 28 AWG stranded twisted pair inner conductors
- Molded shells, PVC plastic
- Color: beige (P/N 130067CL); black (P/N 161630CL); gray (P/N 223845CL)

Part No.	Description	1	10
130067CL	6' DB25 M-Cent. parallel 36M	\$11.95	\$10.95
223845CL	6' DB25 M-Cent. parallel 36M	11.95	10.95
161630CL	10' DB25 M-M serial cable	14.95	13.49

IEEE 488 Cables

A variety of cable lengths are offered to ensure that IEEE system requirements are met (20 meters maximum length with a maximum of 15 devices). These cables are standard IEEE 488 with stackable 24-pin GPIB connectors on both ends.



Part No.	Description	Wt. (lbs.)	1	10	25
73154CL	1 meter	0.8	\$36.49	\$32.79	\$29.49
115781CL	2 meter	1.2	37.95	34.19	30.95
115801CL	4 meter	2.0	38.95	36.19	31.95

Switch Boxes, page 169

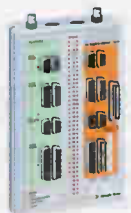

Cable Testers, page 204

30-Day Money-Back Guarantee

If you're not satisfied, we'll take it back!

Details on page 229.

Scott Edwards Electronics, Inc. Serial Servo Controller Module

- Controls 8 pulse-proportional servos
- Receives serially at 2400 or 9600 baud
- Module is addressable, allowing two units to share the same line to control a total of 16 servos
- Connections to serial input can be established using a modular jack (P/N 11553CL, pg 79) or modular adapter from DB9 to RJ11 (P/N 114737CL, pg 79)
- Size (PCB): 1.9"L x 1.4"W • One-year warranty



Part No.	Description	1	10
151001CL	Mini SSC II	\$43.95	\$41.79

PONTECH Servo Controller Board

- Controls 1 to 8 servos per board, 8-bit precision
- Interface to PC through RS-232 port @ 2400-19,200bps
- 5 channel, 8-bit A/D input port for reading 0 to 5V
- IR-receiver & transmitter feature
- Source/sink: 25mA per pin • 8k EEPROM
- Size: 1.7"L x 1.4"W (main board); 1.1"L x 0.9"W (infrared board)



Includes: Manual, supplement & sample code software

Part No.	Description	1	10
153648CL	Servo controller board	\$84.95	\$79.99

See our new expanded motor selection on pages 87-92.



rmv electronics 12-Bit Stepper Motor Control and Analog/Digital DAC Board

- High speed serial port interface up to 230.4kbps
- 4 channels with precision signal conditioning - 100mV, 2.5V and 5.0V inputs
- 24 digital I/O (TTL) and 11 analog channels with 12-bit resolution
- PWM, period measurement and stepper motor functions
- Free 32-bit DLL, OCX and Labview driver for rapid system development
- Size: 6.0"L x 2.6"W • Weight: 0.7 lbs.



Driver Schematic

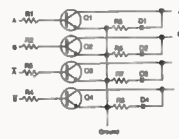

Requires: External driver circuit parts kit (P/N 208573CL, below) - consisting of 5 ea. 1kΩ 1/4W resistors, 5 ea. 330Ω 1/4W resistors, 5 ea. MJE 3055T transistors, and 5 ea. 1N4003 diodes

Part No.	Description	1	10
109911CL	Stepper motor control board	\$129.95	\$102.00
208573CL	Unipolar circuit parts kit	3.49	3.15

32-Bit Stepper Motor Controller

One Axis

- Controls one bipolar stepper motor with 32-bit absolute position
- Interface to PC through RS232 or RS485 @ 2400-19,200 bps
- Full, half or wave step modes
- Multiple boards may share same serial line (RS485 only)
- 2 channel general purpose 8-bit A/D input port for reading 0 to 5V
- 4-bit digital input for home limits
- Addressable up to 255 boards
- Size: 4.4"L x 2.3"H • Weight: 0.7 lbs.

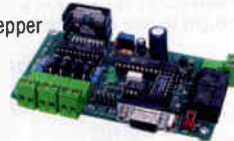

Includes: Manual and sample code software

Part No.	Description	1	10
153621CL	32-bit controller	\$158.95	\$150.99

rmv electronics Multi-Stepper Motor Control Board

- Simultaneous/independent control of up to 16 stepper motors through a single serial port
- High-speed serial communication interface 9.6kbps-230.4kbps
- 11 analog channels, A/D converter, 12-bit resolution
- 24-bit position register; can be read while motor is moving
- Linear acceleration/deceleration capability up to 8500 step/sec.
- Full step (monophasic and biphasic), half step and external driver modes
- Current-mode coil driver up to 2A/45V
- Automatic power down prevents motor overheating
- External driver control outputs: step, direction and power control
- 26 digital I/O and two SPI interfaces for control of external devices
- 32 bits DDL interface for Windows® 9X, NT & Linux
- Internal FIFO RAM (128 bytes) allows customized motion profiles
- Size: 7.7"L x 5.0"W x 1.0"H • Weight: 0.7 lbs.

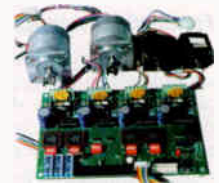

Shown w/ motors - not included

Part No.	Description	1	10
168727CL	Stepper motor control board	\$399.95	\$379.95

Electric Motors and Control Techniques

TAB Publishing Explains how different types of motors operate, and how electronic control devices can be used to improve efficiency in a wide range of applications. (294 pages, 1994)



Size: 7.3" x 9.2" • Weight: 1.1 lbs.

Part No.	Description	Price
137162CL	Electric Motors & Control	\$24.95

KAE

Industrial Motion Controllers for Brush, Brushless and Stepper Motors

All JR Kerr Automation Engineering controllers include integrated power amplifiers. Up to 32 controllers can be daisy-chained from a single full-duplex RS485 port. For RS-232 to RS-485 adapter see P/N 184971CL (below).

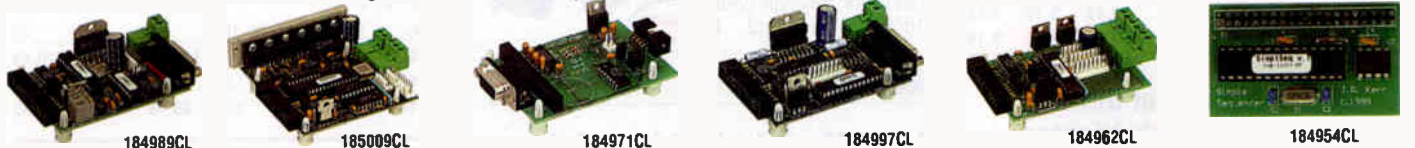

184989CL

185009CL

184971CL

184997CL

184962CL

184954CL

184989CL: PIC-SERVO motor control board

- For brush-type DC motors with 2 or 3 channel incremental encoders
- P.I.D. Servo control, trapezoidal position profiling, velocity mode, 32-bit resolution
- Integrated 12 to 48VDC supply power amplifier @ 3A continuous, 6A peak
- Limit switch inputs, general purpose analog input, PWM, DIR output for use with external amps

185009CL: PIC-SERVO 3PH motor control board for brush or brushless motors

- For 3-phase brushless motors with hall effect sensors or conventional DC brush-type motors
- High current amplifier: 7A continuous, 10A peak, 12 to 48VDC supply
- Same features as 184989CL above but with support for linear & circular interpolation using the PIC-SERVO CMC chipset

184971CL: Z232-485 serial port adapter

- Lets you operate the controllers above from any standard RS-232 port

Part No.	Description	Size (L" x W" x H")	1	10
184989CL	PIC-SERVO	3.1 x 2.1 x 0.9	\$179.95	\$161.95
185009CL	PIC-SERVO 3PH	3.1 x 3.1 x 1.0	239.95	215.95
184971CL	Z232-485	3.1 x 2.1 x 0.5	59.95	53.95

184997CL: PIC-STEP motor control board

- Integrated indexer and driver for 2 or 4 phase stepper motors
- Full/half step bipolar chopper drive, 2A per phase, 7.5 to 46VDC supply
- Trapezoidal position profiling, velocity mode, up to 50,000 steps per second
- Limit switch inputs, general purpose outputs, step/dir outputs for use with external drivers

184962CL: PIC-I/O multifunction I/O control board

- 12 I/O bits software configurable as inputs or outputs
- One counter input
- Three 8-bit analog inputs, two PWM outputs with high current drivers

184954CL: Simple sequencer stand-alone controller

- Programmable master controller for building stand-alone systems with the controllers above
- Plugs into a socket on the Z232-485 board (P/N 184971CL, left)

Part No.	Description	Size (L" x W" x H")	1	10
184997CL	PIC-STEP	3.1 x 2.1 x 0.9	\$159.95	\$143.95
184962CL	PIC-I/O	3.1 x 2.1 x 0.6	99.95	89.95
184954CL	Simple sequencer	2.1 x 1.0 x 0.4	59.95	53.95

GBM Bipolar and Unipolar Stepper Motors

Jameco just added many new two-phase bipolar and four-phase unipolar stepper motors for your precision applications. Be sure to check out the wide selection of 2 to 24 VDC models below.

- Bearing type: ball
- Dielectric strength: 500V, 50Hz/minute
- 18" lead wires
- Ambient temperature: -10°C to +55°C
- Insulation resistance: 100MΩ @ 500VDC
- Use P/N 161998CL, pg 217, for shaft coupler

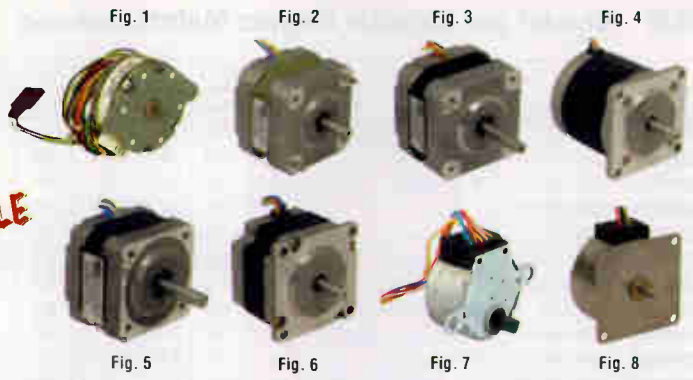
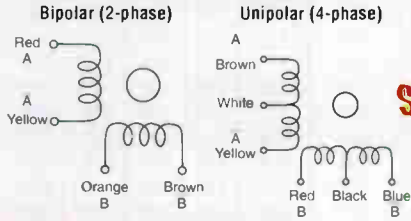

GBM is an ISO-9001 Certified Company

Part Number	Product No.	Fig.	Drive System	Voltage (VDC)	Step Angle	Phase Resis. (Ohms)	Curr. (mA)	Phase Inductance (mH)	Detent Torque (g-cm)	Holding Torque (g-cm)	Mounting Hole Space Diagonal (in.)	Mounting Holes (in.)	Shaft Dia. (in.)	Shaft Length (in.)	Motor Dia. (in.)	Motor Height (in.)	Weight (lbs.)	Pricing		
																		1	10	50
237526CL	42BYGH001	3	Bipolar	2	1.8	2.1	950	2.3	200	1700	1.22	0.10	0.20	0.95	1.67	1.34	0.50	\$16.49	\$14.85	\$13.35
237497CL	39BYG101-01	2	Bipolar	2.7	1.8	6.8	400	6.5	150	650	1.22	0.10	0.20	0.75	1.54	0.79	0.26	15.95	14.35	12.95
237420CL	35BYG002	3	Bipolar	3.2	1.8	4.8	800	3	15	50	1.02	0.10	0.20	0.83	1.38	1.02	0.30	15.95	14.35	12.95
237489CL	39BYG001	2	Bipolar	5	1.8	5	1000	—	150	1800	1.22	0.10	0.20	0.91	1.54	1.34	0.44	15.95	14.35	12.95
237737CL	42BY48H08	8	Bipolar	5	7.5	9.1	550	—	130	630	1.95	0.14	0.12	0.39	1.65	0.87	0.28	7.89	7.09	6.39
237577CL	57BYG061	4	Bipolar	6	1.8	12	500	24	—	3569	1.86	0.20	0.25	0.83	2.29	1.61	1.00	29.95	26.95	24.25
237518CL	42BYG017	2	Bipolar	6.3	1.8	15	420	16	150	1400	1.22	0.10	0.20	0.51	1.67	1.34	0.50	16.49	14.85	13.35
237454CL	39BYG201	2	Bipolar	9.6	1.8	20	480	—	200	1000	1.22	0.10	0.20	0.20	1.54	0.98	0.44	16.95	15.25	13.75
155459CL	42BYG023 ¹	2	Bipolar	12	1.8	30	400	36	220	2100	1.73	0.10	0.20	0.60	1.70	1.30	0.50	17.95	16.29	14.59
237411CL	35BYG005	2	Bipolar	12	1.8	20	500	—	1.5	10	1.02	0.10	0.20	0.83	1.38	1.10	0.37	15.95	14.35	12.95
237471CL	39BYG401A	2	Bipolar	12	1.8	30	400	32	200	2100	1.22	0.10	0.20	0.95	1.54	1.34	0.44	19.49	17.55	15.79
237817CL	25BY2414	7	Bipolar	12	15	27	440	15.5	48	140	1.26	0.11	0.08	0.37	0.98	0.59	0.08	7.19	6.45	5.79
237462CL	39BYG401	2	Bipolar	14	1.8	31	400	32	200	2300	1.22	0.10	0.20	0.95	1.54	1.34	0.44	19.49	17.55	15.79
237446CL	35BYG008	2	Bipolar	24	1.8	1.3	1600	1	1	9	1.02	0.10	0.20	0.83	1.38	1.14	0.33	16.95	15.25	13.75
237569CL	57BYG009	4	Unipolar	2.4	1.8	1	2400	1.5	—	5914	1.86	0.20	0.25	0.83	2.29	2.20	1.40	32.29	29.09	26.15
237614CL	57BYGH801	6	Unipolar	3.3	1.8	2.2	1500	22	—	5608	1.86	0.20	0.25	0.83	2.24	2.01	1.32	35.19	31.69	28.49
237534CL	42BYGH102	5	Unipolar	3.6	1.8	3	1200	3.2	220	3000	1.22	0.10	0.20	0.95	1.67	1.57	0.50	17.95	16.15	14.55
237551CL	57BYG008	4	Unipolar	4	1.8	3.1	1300	4.4	—	4996	1.86	0.20	0.25	0.83	2.29	2.01	1.30	29.95	26.95	24.25
237593CL	85BYGH450	6	Unipolar	4.4	1.8	2.2	2000	—	—	21414	2.76	0.26	0.51	1.38	3.35	2.95	4.90	161.95	145.75	131.19
237622CL	57BYGH802	6	Unipolar	4.8	1.8	3.2	1500	2.9	—	8157	1.86	0.20	0.25	0.83	2.24	2.20	1.54	37.69	33.95	30.55
237606CL	57BYGH001	6	Unipolar	5	1.8	5	1000	—	—	3976	1.86	0.20	0.25	0.83	2.24	1.61	1.10	32.49	29.25	26.35
237673CL	35BY48B06	1	Unipolar	5	7.5	10	500	65	65	250	1.65	0.13	0.08	0.45	1.38	0.59	0.15	6.49	5.85	5.25
237825CL	25BY4801	7	Unipolar	5	7.5	10	500	—	45	110	1.38	0.14	0.08	0.35	0.98	0.56	0.07	6.95	6.25	5.65
237770CL	20BY20H01	7	Unipolar	5	18	10	500	—	18	75	0.98	0.09	0.06	0.34	0.79	0.71	0.05	5.59	5.09	4.55
223870CL	57BYG070	4	Unipolar	5.4	1.8	3.6	1500	6	977	8974	2.65	0.20	0.25	0.80	2.20	2.20	2.00	49.95	44.95	40.49
237631CL	57BYGH803	6	Unipolar	6.3	1.8	4.2	1500	—	—	14276	1.86	0.20	0.25	0.83	2.24	2.99	2.43	64.59	58.15	52.35
172558CL	42BYG014	2	Unipolar	8.5	1.8	19	450	13	150	1300	1.22	0.50	0.20	0.87	1.67	1.34	0.50	16.49	14.85	13.35
237711CL	42BY48H06	8	Unipolar	9	7.5	20	450	18.5	130	800	1.95	0.14	0.12	0.39	1.65	0.87	0.30	7.89	7.09	6.39
237649CL	25BY2403	7	Unipolar	9	15	20	450	4.5	48	130	1.38	0.14	0.08	0.33	0.98	0.56	0.07	4.69	4.25	3.79
237788CL	25BY2402	7	Unipolar	9	15	50	180	14	48	100	1.26	0.13	0.08	0.35	0.98	0.59	0.08	6.95	6.25	5.65
172646CL	42BYG205	4	Unipolar	9.6	1.8	75	480	15	220	2300	1.73	0.10	0.20	0.90	1.70	1.40	0.50	17.95	16.19	14.55
173180CL	30BYJ02AH ²	7	Unipolar	12	0.9	200	60	49.5	400	736	1.42	0.14	0.19	0.36	1.18	0.68	0.10	12.99	11.69	10.49
224021CL	42BYG016	2	Unipolar	12	1.8	75	160	40	150	900	1.73	0.10	0.20	0.70	1.70	1.30	0.50	16.95	15.25	13.75
155432CL	42BYG228	2	Unipolar	12	1.8	30	400	23	220	2000	1.73	0.10	0.20	0.90	1.70	1.50	0.50	17.95	16.29	14.59
162026CL	57BYG084	4	Unipolar	12	1.8	20	600	22	725	6000	2.65	0.20	0.25	1.00	2.20	2.00	1.30	26.95	24.29	21.85
237542CL	57BYG007	4	Unipolar	12	1.8	32	380	30	—	2957	1.86	0.20	0.25	0.83	2.29	1.61	1.00	25.95	23.35	20.99
238537CL	42BYGH404	5	Unipolar	12	1.8	30	400	25	250	3200	1.22	0.10	0.20	0.95	1.67	1.89	0.60	19.95	17.95	16.15
213321CL	35BY48-27	1	Unipolar	12	7.5	15	800	68	90	460	1.96	0.13	0.08	0.25	1.38	0.83	0.20	12.95	11.69	10.49
237681CL	35BY48B069	1	Unipolar	12	7.5	50	270	28	65	300	1.65	0.13	0.08	0.26	1.42	0.85	0.15	6.49	5.85	5.25
238131CL	35BY48BH05	1	Unipolar	12	7.5	15	800	10	90	460	1.65	0.13	0.08	0.26	1.38	0.85	0.19	6.89	6.19	5.59
238158CL	35BY48BH10	1	Unipolar	12	7.5	42	286	25	90	400	1.65	0.13	0.08	0.26	1.38	0.85	0.19	6.89	6.19	5.59
237930CL	42BY48B14	8	Unipolar	12	7.5	50	240	—	145	450	1.95	0.14	0.12	0.39	1.65	0.59	0.22	8.95	8.09	7.25
237833CL	25BY4803	7	Unipolar	12	7.5	50	240	16	45	110	1.34	0.09	0.08	0.27	0.98	0.59	0.07	6.95	6.25	5.65
237884CL	42BY48B02	8	Unipolar	12	7.5	40	300	28	130	500	—	—	0.12	0.30	1.65	0.57	0.21	10.45	9.39	8.45
237892CL	42BY48B03	8	Unipolar	12	7.5	57	210	18	105	300	—	—	0.12	0.30	1.65	0.58	0.21	10.45	9.39	8.45
237657CL	25BY2406	7	Unipolar	12	15	30	400	7.5	48	120	1.26	0.13	0.08	0.35	0.98	0.59	0.07	4.69	4.25	3.79
237753CL	28BYJ012A	7	Unipolar	12	5.625/64	200	60	—	350	736	1.38	0.16	0.12	0.24	1.10	0.75	0.08	3.59	3.25	2.89
237972CL	28BYJ01A1	7	Unipolar	12	5.625/64	300	40	—	300	552	1.38	0.17	0.20	0.33	1.10	0.75	0.09	4.19	3.79	3.39
237745CL	28BYJ01A	7	Unipolar	12	5.625/64	200	60	—	350	736	1.38	0.16	0.12	0.24	1.10	0.75	0.10	3.59	3.25	2.89
237981CL	28BYJ01C	7	Unipolar	12	5.625/64	300	40	—	350	552	1.38	0.14	0.12	0.20	1.10	0.78	0.10	4.19	3.79	3.39

¹ 155459CL: Dual shaft ² 173180CL: Gear ratio 85.25:1

Stepper Motors continued on page 88



GBM Bipolar and Unipolar Stepper Motors (Continued)

Part Number	Product No.	Fig.	Drive System	Voltage (VDC)	Step Angle	Phase Resis. (Ohms)	Curr. (mA)	Phase Inductance (mH)	Detent Torque (g-cm)	Holding Torque (g-cm)	Mounting Hole Space Diagonal (in.)	Mounting Holes (in.)	Shaft Dia. (in.)	Shaft Length (in.)	Motor Dia. (in.)	Motor Height (in.)	Weight (lbs.)	Pricing		
																		1	10	50
237761CL	30BYJ011	7	Unipolar	12	7.5/85.25	300	40	—	350	644	1.38	0.18	0.12	0.20	1.18	0.69	0.10	\$3.59	\$3.25	\$2.89
238019CL	30BYJ01C1	7	Unipolar	12	7.5/85.25	300	40	—	350	644	1.54	0.17	0.12	0.20	—	—	0.10	4.79	4.29	3.89
238035CL	30BYJ03C	7	Unipolar	12	7.5/85.25	160	75	—	350	920	1.54	0.17	0.12	0.44	1.42	0.69	0.11	4.79	4.29	3.89
238043CL	30BYJ05-PH	7	Unipolar	12	7.5/85.25	300	40	—	350	552	1.42	0.17	0.20	0.30	1.18	0.69	0.10	4.79	4.29	3.89
238051CL	35BYJ01	7	Unipolar	12	7.5/85.25	130	92	—	350	1472	1.65	0.16	0.20	0.33	1.42	0.69	0.12	4.95	4.45	3.99
238060CL	35BYJ02	7	Unipolar	12	7.5/85.25	200	60	—	400	1104	1.65	0.16	0.20	0.33	1.42	0.67	0.13	4.95	4.45	3.99
238078CL	35BYJ02A	7	Unipolar	12	7.5/85.25	200	60	—	400	1104	1.85	0.16	0.20	0.33	1.38	0.69	0.13	4.95	4.45	3.99
238086CL	35BYJ03	7	Unipolar	12	7.5/85.25	400	40	—	450	828	1.65	0.16	0.20	0.33	1.42	0.67	0.12	4.95	4.45	3.99
237956CL	42BY48H05	8	Unipolar	14	7.5	70	200	—	130	450	—	0.14	0.12	0.39	1.65	0.87	0.27	8.95	8.09	7.25
237438CL	35BYG007	5	Unipolar	15	1.8	28	400	—	12	70	1.02	0.10	0.20	0.83	1.38	1.10	0.37	16.95	15.25	13.75
237702CL	35BY48BH02	1	Unipolar	16.2	7.5	60	270	50	90	450	1.65	0.13	0.08	0.33	1.38	0.59	0.20	6.49	5.85	5.25
237665CL	25BY2407	7	Unipolar	16.2	15	85	190	19	48	100	1.26	0.16	0.08	0.49	0.98	0.56	0.10	4.69	4.25	3.79
237796CL	25BY2408	7	Unipolar	16.2	15	60	270	16	48	120	1.26	0.17	0.08	0.55	0.98	0.56	0.10	6.95	6.25	5.65
237841CL	25BY4806	7	Unipolar	20	7.5	50	400	16	45	155	1.26	0.13	0.08	0.49	0.98	0.56	0.10	6.95	6.25	5.65
237850CL	25BY4807	7	Unipolar	20	7.5	50	400	16	45	155	1.38	0.14	0.08	0.22	0.98	0.87	0.10	6.95	6.25	5.65
237868CL	25BY4808	7	Unipolar	20	7.5	50	400	16	45	155	1.38	0.14	0.08	0.22	0.98	0.87	0.10	6.95	6.25	5.65
237876CL	25BY4809	7	Unipolar	20	7.5	50	400	16	45	155	1.42	0.35	0.08	0.22	0.98	0.87	0.10	6.95	6.25	5.65
238107CL	35BY48B07	1	Unipolar	24	7.5	11	240	70	65	330	1.65	—	0.08	0.26	1.38	0.59	0.15	6.89	6.19	5.59
238115CL	35BY48B08	1	Unipolar	24	7.5	75	320	38	65	270	1.65	—	0.08	0.35	1.38	0.59	0.15	6.89	6.19	5.59
237690CL	35BY48BH01	1	Unipolar	24	7.5	165	145	85	90	400	1.65	0.13	0.08	0.33	1.38	0.59	0.19	6.49	5.85	5.25
238140CL	35BY48BH07	1	Unipolar	24	7.5	110	240	70	90	350	1.65	0.13	0.08	0.26	1.38	0.85	0.20	6.89	6.19	5.59
237905CL	42BY48B04	8	Unipolar	24	7.5	110	220	53	145	630	1.95	0.14	0.12	0.45	1.65	0.59	0.20	8.95	8.09	7.25
237913CL	42BY48B04M	8	Unipolar	24	7.5	120	200	57	145	630	1.95	—	0.12	0.45	1.65	0.59	0.22	8.95	8.09	7.25
237921CL	42BY48B08	8	Unipolar	24	7.5	75	320	33	145	600	1.95	0.14	0.12	0.39	1.65	0.59	0.20	8.95	8.09	7.25
237948CL	42BY48H02	8	Unipolar	24	7.5	48	500	—	130	630	1.95	0.14	0.12	0.39	1.65	0.87	0.30	8.95	8.09	7.25
237729CL	42BY48H07	8	Unipolar	24	7.5	85	280	78	130	780	1.95	0.14	0.12	0.39	1.65	0.87	0.27	7.89	7.09	6.39
237809CL	25BY2409	7	Unipolar	24	15	118	200	22	48	100	1.37	0.13	0.08	0.37	0.98	0.59	0.10	7.19	6.45	5.79
238123CL	35BY48BH03	1	Unipolar	28.8	7.5	115	278	85	90	450	1.65	0.13	0.08	0.26	1.38	0.85	0.19	6.89	6.19	5.59
237585CL	110BYG450C	4	Unipolar	80-200	0.9/1.8	0.18	6000	2	3060	45,900	—	0.33	0.63	2.13	4.33	5.10	8.40	179.95	161.95	145.75

Bipolar and Unipolar Stepper Motors

- Excellent for precision control
- Can be operated in forward/reverse mode

Now Lower Prices

Quantity SAVE

Fig. 1



Fig. 2



Fig. 3



Fig. 4



Fig. 5



Part Number	Mfr. Cross Ref. No.	Fig.	Drive System	Volt. (VDC)	Step Angle	Phase Resis. (Ohms)	Curr. (mA)	Phase Inductance (mH)	Detent Torque (g-cm)	Holding Torque (g-cm)	Mounting Hole Space Diagonal (in.)	Mounting Holes (in.)	Shaft Dia. (in.)	Shaft Length (in.)	Motor Dia. (in.)	Motor Height (in.)	Weight (lbs.)	Pricing			
																		1	10	50	
117954CL	LB82773-M1	1*	Bipolar	5	7.5	6	800	7	100	1080	2.60	1.95	0.250	0.75	2.25	1.00	0.10	\$4.29	\$3.89	\$3.09	
163395CL	5017-935 ¹	2	Bipolar	8.4	0.9	30	280	25	36	791	1.73	0.15	0.155	0.29	1.64	1.20	0.10	\$5.59	4.95	4.21	3.16
163408CL	4017-806 ¹	2	Bipolar	9.2	1.8	38	240	52	36	664	1.73	0.15	0.155	0.23	1.66	1.25	0.10	2.49	2.15	1.65	
105881CL	SM4203 ²	3*	Bipolar	12	3.6	25	480	31	80	600	1.73	0.11	0.197	0.43	1.66	1.31	0.10	6.49	5.85	5.29	
164056CL	M82101-P1	1	Unipolar	5	7.5	20	255	5	9	94	1.4	0.13	0.078	0.35	1.00	0.46	0.10	1.85	1.69	1.55	
151861CL	C42M048A04	4*	Unipolar	5	7.5	9	550	10	90	750	1.94	0.13	0.117	0.40	1.65	0.83	0.10	6.19	5.59	5.05	
171601CL	PF35T48L4 ³	1	Unipolar	7	3.6	20	350	9	40	680	1.68	0.14	0.078	0.47	1.38	0.58	0.10	4.99	4.25	3.19	
210382CL	5620	1	Unipolar	24	7.5	100	436	60	40	380	1.67	0.13	0.078	0.40	1.38	0.58	0.10	\$4.95	2.99	2.69	2.45
210391CL	STP42N196S	5	Unipolar	24	3.75	110	436	60	60	600	1.95	0.13	0.118	0.42	1.65	0.54	0.10	4.95	4.19	3.15	

¹ 163395CL/163408CL: Dual shaft ² 105881CL: P/N 25216CL (IC, MC3479P, pg 19) bi-phase stepper motor driver can be used to operate; Use P/N 161998CL for shaft coupler, see pg 217
³ 171601CL: Dual shaft w/ 10 tooth gear * Shown below

5VDC Bipolar Stepper Motor

7.5° / Step

- No. of phases: 2
- Detent torque: 100 g-cm
- Holding torque: 1080 g-cm
- Phase resistance: 6Ω
- Phase inductance: 7mH
- Current: 800mA
- Mounting hole size: 1.95"
- Shaft size: 0.75"L x 0.250"Dia.
- Motor size: 2.25"Dia. x 1.00"H



Quantity SAVE

Part No.	Mfr. Cross Ref. No.	1	10	50
117954CL	LB82773-M1	\$4.29	\$3.89	\$3.09

12VDC Bipolar Stepper Motor

3.6° / Step

- No. of phases: 2
- Detent torque: 80 g-cm
- Holding torque: 600 g-cm
- Phase resistance: 25Ω
- Phase inductance: 31mH
- Current: 480mA
- Mounting hole size: 0.11"
- Shaft size: 0.43"L x 0.197"Dia.
- Motor size: 1.66"Dia. x 1.31"H



Part No.	Mfr. Cross Ref. No.	1	10	50
105881CL	SM4203	\$6.49	\$5.85	\$5.29

5VDC Unipolar Stepper Motor

7.5° / Step

- No. of phases: 4
- Detent torque: 90 g-cm
- Holding torque: 750 g-cm
- Phase resistance: 9Ω
- Phase inductance: 10mH
- Current: 550mA
- Mounting hole size: 0.13"
- Shaft size: 0.40"L x 0.117"Dia.
- Motor size: 1.65"Dia. x 0.83"H



Part No.	Mfr. Cross Ref. No.	1	10	50
151861CL	C42M048A04	\$6.19	\$5.59	\$5.05

1.5-112VDC Motors

Jameco has a broad selection of DC Motors not immediately available anywhere else! In fact, we're the only place in the country where you can buy them off-the-shelf. And because of our broad selection, major custom-design motor manufacturers send their customers to us! Be sure to check out all the new products below.

- Typical applications:**
- RC cars and airplanes
 - Motorized toys
 - Tire pumps
 - Arcade games
 - Vacuum cleaners
 - Paper shredders
 - Vending machines
 - Hair removers
 - Cordless power tools
 - Office automation products
 - Blow dryers

NICHIBO

Part Number	Product No.	Fig.	Nominal Voltage (VDC)	Voltage Range (VDC)	@ Maximum Efficiency			Efficiency	Terminal Type	Shaft Dia.	Shaft Length	Size (D" x L")	Pricing		
					Current (Amps)	Speed (RPM)	Torque (g-cm)						1	10	100
231917CL	FE-260-2670	5	1.5	1.5-3	0.66	3700	10.5	42.9	Solder	0.078	0.314	0.937 x 1.063	\$.99	\$.89	\$.85
231861CL	UE-260-2850	6	1.5	1.5-3	1.15	4260	13.4	34.9	Solder	0.078	0.314	0.944 x 1.063	1.25	1.09	.99
231853CL	UE-260-2838	6	1.5	1.5-2.4	1.57	5600	15.5	39.0	Solder	0.078	0.314	0.944 x 1.063	1.25	1.09	.99
232135CL	FF-050S-13130	3	2	2-4	0.11	3000	3	42.0	Solder	0.059	0.433	0.610 x 1.059	2.49	2.25	1.99
231909CL	FE-260-18130	5	3	1.5-4.5	0.36	4780	10.3	49.6	Solder	0.078	0.314	0.937 x 1.063	.99	.89	.85
231888CL	UE-260-20120	6	3	1.5-4.5	0.45	4780	12.9	49.8	Solder	0.078	0.314	0.944 x 1.063	1.25	1.09	.99
231790CL	PC-130F-18120	7	3	3-4.5	0.51	6260	8.1	35.6	Solder	0.078	0.377	0.803 x 0.984	2.09	1.89	1.69
231870CL	UE-260-2290	6	3	1.5-4.5	0.62	6400	12.9	47.1	Solder	0.078	0.314	0.944 x 1.063	1.25	1.09	.99
231925CL	FE-260-2295	5	3	1.5-4.5	0.63	6850	14	53.9	Solder	0.078	0.314	0.937 x 1.063	.99	.89	.85
232071CL	FC-280-2485	1	4.5	4.5-7.2	0.88	7820	26	52.7	Solder	0.078	0.472	0.944 x 1.200	1.75	1.59	1.45
232080CL	FC-280-2865	1	4.5	4.5-6	1.38	9970	30.4	50.1	Solder	0.078	0.472	0.944 x 1.200	1.75	1.59	1.45
231765CL	PC-130SF-15160	7	4.8	3-9	0.42	4960	16.6	42.6	Solder	0.078	0.377	0.803 x 0.984	2.09	1.89	1.69
231984CL	UC-260-14275	6	6	6-12	0.21	4150	13.1	45.8	Solder	0.078	0.314	0.944 x 1.063	1.49	1.35	1.19
231829CL	PC-280-16210	8	6	3-12	0.28	4260	18	47.6	Solder	0.078	0.433	0.944 x 1.200	2.45	2.19	1.99
231781CL	PC-130F-12240	7	6	3-9	0.25	6800	7	33.4	Solder	0.078	0.377	0.803 x 0.984	2.09	1.89	1.69
231992CL	UC-260-18160	6	6	3-9	0.57	7460	22.1	49.9	Solder	0.078	0.314	0.944 x 1.063	1.49	1.35	1.19
231811CL	PC-280-20125	8	6	3-9	0.57	7560	21.1	48.6	Solder	0.078	0.433	0.944 x 1.200	2.45	2.19	1.99
232063CL	FC-280-20120	1	6	4.5-9	0.60	7800	24.1	53.5	Solder	0.078	0.472	0.944 x 1.200	1.75	1.59	1.45
232143CL	FF-050S-11170	3	7	1.5-9	0.17	8500	7	51.3	Solder	0.059	0.433	0.610 x 1.059	2.49	2.25	1.99
232151CL	FF-050S-09250	3	8	5-11.5	0.11	6300	7	51.4	Solder	0.059	0.433	0.610 x 1.059	2.49	2.25	1.99
231802CL	PC-130F-10370	7	9	6-12	0.15	6410	8.5	43.9	Solder	0.078	0.377	0.803 x 0.984	2.09	1.89	1.69
231933CL	UC-280S-10450	9	12	12-24	0.11	2850	21.3	46.5	Solder	0.078	0.433	0.944 x 1.200	2.55	2.29	2.09
232012CL	MD5-12160	10	12	12-24	0.30	4000	34.3	39.1	Solder	0.091	0.622	1.082 x 1.279	2.25	1.99	1.79
231968CL	UC-260-09530	6	12	12-24	0.12	4030	12.5	36.7	Solder	0.078	0.314	0.944 x 1.063	1.49	1.35	1.19
231845CL	PC-280-10420	8	12	6-24	0.13	4270	14.5	43.6	Solder	0.078	0.433	0.944 x 1.200	2.45	2.19	1.99
231731CL	PC-130SF-09480	7	12	6-24	0.11	4800	12.3	49.6	Solder	0.078	0.377	0.803 x 0.984	2.09	1.89	1.69
231749CL	PC-130SF-09400	7	12	6-24	0.15	5130	14.3	42.5	Solder	0.078	0.377	0.803 x 0.984	2.09	1.89	1.69
231896CL	FE-260-08450	5	12	6-12	0.11	5560	10.3	46.6	Solder	0.078	0.314	0.937 x 1.063	.99	.89	.85
231773CL	PC-130F-09490	7	12	6-18	0.51	6260	8.1	39.1	Solder	0.078	0.377	0.803 x 0.984	2.09	1.89	1.69
232160CL	FF-050S-08220	3	12	9-18	0.09	6270	5	31.5	Solder	0.059	0.433	0.610 x 1.059	2.49	2.25	1.99
231757CL	PC-130SF-10315	7	12	6-18	0.25	6350	20	44.6	Solder	0.078	0.377	0.803 x 0.984	2.09	1.89	1.69
232055CL	FC-280-12280	1	12	6-12	0.26	6840	21.4	48.6	Solder	0.078	0.472	0.944 x 1.200	1.75	1.59	1.45
231976CL	UC-260-12335	6	12	6-12	0.24	7050	19.5	50.0	Solder	0.078	0.314	0.944 x 1.063	1.49	1.35	1.19
231837CL	PC-280-15265	8	12	6-12	0.30	7230	25	52.5	Solder	0.078	0.433	0.944 x 1.200	2.45	2.19	1.99
232004CL	UC-280S-19160	9	12	6-12	0.57	9000	46.6	63.4	Solder	0.078	0.433	0.944 x 1.200	2.55	2.29	2.09
232021CL	MD5-1885	10	12	6-18	0.74	9820	53.5	60.7	Solder	0.091	0.622	1.082 x 1.279	2.25	1.99	1.79
231950CL	UC-280S-20145	9	12	6-12	0.75	10000	55	64.0	Solder	0.078	0.433	0.944 x 1.200	2.55	2.29	2.09
232039CL	MD5-2070	10	12	6-12	1.20	12150	62.2	54.1	Solder	0.091	0.622	1.082 x 1.279	2.25	1.99	1.79
232127CL	MD5-2554AS-AA	2	12	6-12	1.70	17000	72.9	62.4	Quick Connect	0.091	0.512	1.083 x 1.279	3.59	3.19	2.89
232119CL	MD5-2450AS-AA	2	12	6-12	2.00	17200	77.5	55.9	Quick Connect	0.091	0.512	1.083 x 1.279	3.59	3.19	2.89
232047CL	MD5-2445	10	12	6-12	2.05	19850	79.7	66.0	Solder	0.091	0.622	1.082 x 1.279	2.25	1.99	1.79
231941CL	UC-280S-12285	9	24	12-24	0.39	10300	54.4	62.4	Solder	0.078	0.433	0.944 x 1.200	2.55	2.29	2.09
232098CL	MD5-15120AS-AA	2	24	12-24	0.70	15100	66.7	61.5	Quick Connect	0.091	0.512	1.083 x 1.279	3.59	3.19	2.89
232101CL	MD5-1980AS-AA	2	24	12-24	1.43	22600	88.5	60.9	Solder	0.091	0.512	1.083 x 1.279	3.59	3.19	2.89

Mabuchi-TF

238465CL	RF-310TA-11400 (CCW)	11	2.5	1-6	0.06	2190	3.3	—	Solder	0.078	0.744	0.960 x 0.791	\$5.35	\$4.85	\$4.35
238457CL	RF-300PA-11400 (CW)	12	3	1-3	0.07	2400	4.3	56.4	Wires	0.078	0.415	0.960 x 0.504	4.35	3.89	3.49
238511CL	RF-500TB-12560	13	6	1.5-12	0.08	2180	11.6	50.6	Solder	0.078	0.385	1.259 x 0.767	4.49	4.09	3.65
238431CL	EG-530AD-6B (CCW)	14	6	4.2-7.5	0.13	2400	8	—	Solder	0.078	0.307	1.377 x 0.984	4.49	4.09	3.65
238422CL	EG-530AD-6F (CW)	14	6	4.2-7.5	0.13	2400	8	—	Solder	0.078	0.307	1.377 x 0.984	4.49	4.09	3.65
238449CL	EG-530AD-9B (CCW)	14	9	6-11	0.09	2400	8	—	Solder	0.078	0.307	1.377 x 0.984	4.49	4.09	3.65
238490CL	EG-530YD-9B (CCW)	14	9	6.3-11.7	13/14	2000/4000	10	—	Solder	0.078	0.307	1.377 x 0.984	6.29	5.65	5.09
238481CL	EG-530YD-2B (CCW)	14	12	8.4-15	13/14	2000/4000	10	—	Solder	0.078	0.322	1.303 x 0.997	6.29	6.29	6.29
238502CL	EG-530KD-2B (CCW)	14	12	8.4-15.6	0.08	1600	10	—	Solder	0.078	0.307	1.377 x 0.984	4.95	4.45	3.99
238473CL	RF-370CA-15370	15	12	3-12	0.07	1970	16	61.4	Solder	0.078	0.346	0.960 x 1.213	5.55	4.95	4.49
238414CL	EG-530AD-2B (CW)	14	12	8.4-15	0.07	2400	60	—	Solder	0.078	0.307	1.377 x 0.953	4.49	4.09	3.65
238406CL	EG-530AD-2F (CCW)	14	12	8.4-15	0.07	2400	60	—	Solder	0.078	0.307	1.377 x 0.953	4.49	4.09	3.65

GBM

237391CL	29SYT003	4	13.5	13.5	13	18000	509	—	Quick Connect	0.125	1.003	1.141 x 2.283	\$5.95	\$5.35	\$4.85
237382CL	29SYT002	4	24	24	<0.93	2680	178	—	Wire	0.100	0.334	0.787 x 1.89	5.95	5.35	4.85
237403CL	40SYT002	—	26	26	1.5	300	815	—	Quick Connect	0.196	1.021	1.57 x 3.85	25.95	23.35	20.99
237374CL	29SYT001	4	112	112	<0.93	2680	178	—	Wire	0.100	0.334	1.15 x 1.89	5.95	5.35	4.85



Electromech

3-150VDC Motors

MITSUMI

NMB

MABUCHI MOTOR

star motor

JOHNSON ELECTRIC

Quantity **SAVE**

Now Lower Prices



Part Number	Manufacturer Cross Reference No.	Manufacturer	Nominal Voltage (VDC)	Voltage Range (VDC)	@ Maximum Efficiency			Efficiency	Terminal Type	Shaft Dia.	Shaft Length	Size (D" x L")	Pricing		
					Current (Amps)	Speed (RPM)	Torque (g-cm)						1	10	100
154915CL	ST-130-12240 ¹	Star Motor	3	1.5-3	0.170	3588	7.4	55	0.09/solder	0.08"	0.37"	0.79 x 1.13	\$1.09	\$0.93	\$0.69
154923CL	ST-130-22770 ¹	Star Motor	3	1.5-3	1.150	12500	10.3	40	0.09/solder	0.08"	0.37"	0.79 x 1.13	.99	.89	.79
211246CL	RC-260RA-2670	Mabuchi Motor	4.5	3-4.5	1.430	15290	21.8	53	0.11/solder	0.08"	0.28"	0.93 x 1.06	1.58	1.45	1.25
181411CL	HC685G-61810	Johnson Electric	5	3-14	0.470	10000	18.8	—	0.187/solder	0.13"	0.54"	1.40 x 1.98	2.95	2.55	1.89
177498CL	RC280RA-2485	Mabuchi Motor	7.2	3-14	1.180	14260	33.3	57	11/solder	0.08"	0.43"	0.95 x 1.20	1.75	1.55	1.39
174991CL	6424CL09W820	NMB	10	8-12	0.430	4100	—	—	8" wires	0.12"	0.64"	1.62 x 0.64	\$1.88	.73	.38
162579CL	TID20E	Operating Tech T&I	12	9-14	0.025	2150	—	—	0.20/solder	0.12"	0.48"	1.48 x 1.42	\$1.29	.71	.45
174692CL	21226-384221	Johnson Electric	12	9-14	0.015	3000	—	—	0.11/solder	0.08"	0.69"	0.97 x 1.19	2.49	2.15	1.59
181112CL	M25N-2	Mitsumi	12	5-15	0.018	3000	18.0	—	11/solder	0.08"	0.26"	0.97 x 1.30	1.99	1.69	1.29
206949CL	QJT360S14280	Nichibo	12	9-30	0.350	4930	44.5	52	0.11/solder	0.09"	0.45"	1.09 x 1.30	1.69	1.45	1.09
181964CL	NF203G12	Johnson Electric	12	9-14	0.030	5000	—	—	0.07/solder	0.08"	0.57"	0.95 x 1.20	1.55	1.29	.99
153656CL	RS550PF	Mabuchi Motor ²	12	6-15	1.400	6500	44.1	—	0.15/solder	0.13"	0.66"	1.45 x 2.25	3.29	2.99	2.69
161082CL	84055	Johnson Electric	150	145-152	0.168	6500	305.9	—	0.187/fast on	0.16"	0.55"	2.48 x 1.51	\$1.92	.41	.21

¹ 154915CL/154923CL: Use bushing P/N 162392CL, pg 217

² Manufacturer may vary

Electromech

HSIANG MENG

Now Lower Prices

12 and 24VDC Reversible Gear Head Motors

- Solder-type terminal
- High torque construction
- Oil bearing design for long service life
- Insulation resistance: 10MΩ
- Dielectric strength: 300VDC

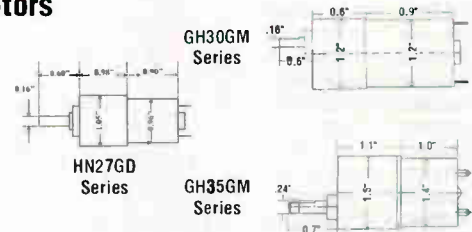

HN27GD Series

Part Number	Product Number	Rated Voltage (VDC)	Operating Range (VDC)	@ Maximum Efficiency			Gear Ratio	Gear Case Size Dia. x Length (In.)	Motor Size Dia. x Length (in.)	Shaft Size Dia. x Length (in.)	Pricing		
				Current (mA)	Speed (RPM)	Torque (g-cm)					1	10	50
167038CL	GH12-0953Y	12	4.5 - 24	90	9	1200	188:1	1.0 x 0.9	1.1 x 1.0	16 x .60	\$16.49	\$14.85	\$13.39
167046CL	GH12-1828Y	12	4.5 - 24	195	31	1300	90:1	1.1 x 1.3	1.1 x 0.8	16 x .60	21.95	19.79	17.79

GH30GM Series

170641CL	GH12-1828Y-10	12	6.0 - 24	105	8	3500	332:1	1.2 x 1.2	1.2 x 0.9	16 x .70	\$23.95	\$21.59	\$19.49
153437CL	GH12-1045Y	12	3.0 - 12	90	7	800	200:1	0.9 x 1.0	1.1 x 0.6	16 x .70	18.95	17.09	15.35
159417CL	GH12-1921Y	12	4.5 - 12	200	35	2000	132:1	1.2 x 1.2	1.2 x 0.9	16 x .70	21.95	19.79	17.79
162190CL	GH12-1324Y225	12	4.5 - 12	145	176	300	30:1	1.0 x 0.9	1.1 x 0.6	16 x .70	16.95	15.25	13.75

GH35GM Series

155011CL	GH12-1926	12	4.5 - 12	250	2	6000	3000:1	1.3 x 0.9	1.5 x 1.1	.23 x .90	\$21.95	\$19.79	\$17.79
155820CL	GH12-1830Y-P	12	4.5 - 12	220	3	4500	1000:1	1.3 x 0.9	1.5 x 1.0	.23 x .90	21.95	19.79	17.79
155838CL	GH12-1641T-L	12	3.0 - 12	250	15	3000	270:1	1.3 x 0.9	1.5 x 0.8	.23 x .90	23.95	21.59	19.45
152910CL	GH12-1926Y	12	4.5 - 12	172	35	2370	100:1	1.3 x 1.0	1.5 x 0.7	.24 x .90	21.95	19.75	17.75
151440CL	GH12-1632T	12	4.5 - 12	275	57	2200	100:1	1.3 x 0.9	1.5 x 0.7	.23 x .90	21.95	18.55	16.69
155854CL	GH12-1641T-F	12	3.0 - 12	250	71	1000	60:1	1.3 x 0.9	1.4 x 0.9	.23 x .90	21.95	19.79	17.79
155862CL	GH12-1926Y-F	12	4.5 - 12	300	70	1000	60:1	1.3 x 0.9	1.4 x 0.9	.23 x .90	21.95	19.79	17.79
161373CL	GH12-1345T	12	4.5 - 12	185	116	650	30:1	1.3 x 0.9	1.5 x 0.7	.23 x .90	23.95	21.59	19.45
161381CL	GH12-1634T	12	4.5 - 12	293	145	850	30:1	1.3 x 0.9	1.4 x 0.7	.23 x .90	21.95	19.79	17.79
164785CL	GH12-1640Y	12	4.5 - 24	120	220	180	10:1	1.3 x 0.9	1.4 x 0.7	.23 x .90	23.95	21.59	19.45
176049CL	GH12-1640Y00	24	12 - 24	340	1.8	6000	3000:1	1.3 x 0.9	1.5 x 1.1	.23 x .90	21.95	19.79	17.79
176031CL	GH24-1640Y06	24	12 - 24	340	50	2000	90:1	1.3 x 0.9	1.4 x 0.7	.23 x .90	21.95	19.79	17.79
176022CL	GH24-1640Y19	24	12 - 24	340	148	1000	30:1	1.3 x 0.9	1.4 x 0.7	.23 x .90	21.95	19.79	17.79

New

6 and 12VDC Gear Head Motors

32GM Series

Part Number	Product Number	Rated Voltage (VDC)	@ Maximum Efficiency			Gear Ratio	Gear Case Size Dia. x Height (in.)	Motor Size Dia. x Height (in.)	Shaft Size Dia. x Length (in.)	Pricing		
			Current (mA)	Speed (RPM)	Torque (g-cm)					1	10	50
253403CL	32-009	6	64	2.7	2500	450:1	1.9 x 0.41	1.3 x 0.90	0.3 x 0.7	\$17.95	\$16.15	\$14.55
253391CL	32-008	6	60	3	2000	400:1	1.9 x 0.41	1.3 x 0.90	0.3 x 0.7	17.95	16.15	14.55
253382CL	32-007	6	57	3.2	1800	377:1	1.9 x 0.41	1.3 x 0.90	0.3 x 0.7	17.95	16.15	14.55
253374CL	32-006	6	51	4	1680	300:1	1.9 x 0.41	1.3 x 0.90	0.3 x 0.7	17.95	16.15	14.55
253340CL	32-005	6	48	5	1600	240:1	1.9 x 0.41	1.3 x 0.90	0.3 x 0.7	17.95	16.15	14.55
253323CL	32-004	6	44	6	1500	200:1	1.9 x 0.41	1.3 x 0.90	0.3 x 0.7	17.95	16.15	14.55
253315CL	32-003	6	40	6.3	1350	190:1	1.9 x 0.41	1.3 x 0.90	0.3 x 0.7	17.95	16.15	14.55
253307CL	32-002	6	38	8	1200	150:1	1.9 x 0.41	1.3 x 0.90	0.3 x 0.7	17.95	16.15	14.55
253227CL	32-001	6	35	24	450	50:1	1.9 x 0.41	1.3 x 0.90	0.3 x 0.7	17.95	16.15	14.55

32GM Series

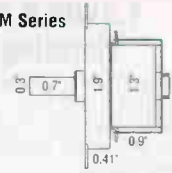

253227CL

38GM Series

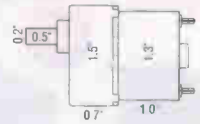

253446CL

38GM Series

Part Number	Product Number	Rated Voltage (VDC)	@ Maximum Efficiency			Gear Ratio	Gear Case Size Dia. x Height (in.)	Motor Size Dia. x Height (in.)	Shaft Size Dia. x Length (in.)	Pricing		
			Current (mA)	Speed (RPM)	Torque (g-cm)					1	10	50
253534CL	38-010	12	97	24	7500	250:1	1.5 x 0.7	1.3 x 1.0	0.2 x 0.5	\$18.95	\$17.09	\$15.35
253526CL	38-009	12	93.5	36	5400	167:1	1.5 x 0.7	1.3 x 1.0	0.2 x 0.5	18.95	17.09	15.35
253518CL	38-008	12	87.5	40	4800	150:1	1.5 x 0.7	1.3 x 1.0	0.2 x 0.5	18.95	17.09	15.35
253500CL	38-007	12	82	60	3200	100:1	1.5 x 0.7	1.3 x 1.0	0.2 x 0.5	18.95	17.09	15.35
253497CL	38-006	12	80	66	2100	90:1	1.5 x 0.7	1.3 x 1.0	0.2 x 0.5	18.95	17.09	15.35
253489CL	38-005	12	76	110	1300	56:1	1.5 x 0.7	1.3 x 1.0	0.2 x 0.5	18.95	17.09	15.35
253471CL	38-004	12	74	120	1100	50:1	1.5 x 0.7	1.3 x 1.0	0.2 x 0.5	18.95	17.09	15.35
253462CL	38-003	12	68	180	800	33:1	1.5 x 0.7	1.3 x 1.0	0.2 x 0.5	18.95	17.09	15.35
253454CL	38-002	12	65	200	700	30:1	1.5 x 0.7	1.3 x 1.0	0.2 x 0.5	18.95	17.09	15.35
253446CL	38-001	12	61.8	600	350	10:1	1.5 x 0.7	1.3 x 1.0	0.2 x 0.5	18.95	17.09	15.35

• Typical applications: cellular phones, pagers and toys

1.3-3VDC Vibrating Motors

Quantity **SAVE**

New Lower Prices

New



Fig. 1



Fig. 2

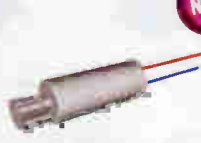

Fig. 3



Fig. 4



Fig. 5



Fig. 6



Fig. 7

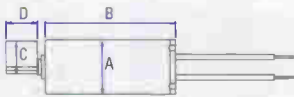

Fig. 3

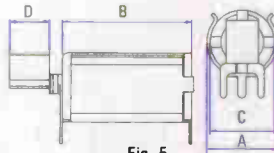

Fig. 5

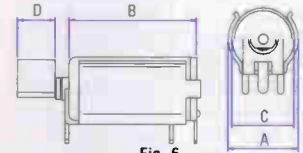

Fig. 6

Part No.	Mfr. Cross Ref. No.	Fig.	Operating Voltage (VDC @ mA)	Operating Range (VDC)	Rated RPM @ VDC	Lead Length (in.)	Motor Size (A x B) Dia. x L"	Shaft Size (C x D) Dia. x L"	Pricing		
									1	10	100
175062CL	OTL-7AL	1	1.3 @ 62	0.70 - 1.60	7000 @ 1.3	0.7	0.28 x 0.67	0.10 x 0.18	\$5.49	\$4.94	\$4.45
175396CL	OTL-4AL	2*	1.3 @ 65	0.70 - 1.60	8500 @ 1.3	0.8	0.16 x 0.55	0.15 x 0.23	5.49	5.52	4.14
256356CL	72K642	3	1.3 @ 70	1.00 - 1.60	7500 @ 1.3	4.7	0.28 x 0.66	0.18 x 0.22	4.65	4.19	3.75
256372CL	72K631	3	1.3 @ 70	0.80 - 1.60	7500 @ 1.3	1.1	0.28 x 0.66	0.12 x 0.16	4.65	4.19	3.75
190078CL	6CD-1201WL-00	4*	1.3 @ 80	N/A	7500 @ 1.3	1.1	0.24 x 0.47	0.10 x 0.22	6.55	5.57	4.18
256305CL	62K003	3	1.3 @ 80	0.85 - 1.60	8500 @ 1.3	1.0	0.23 x 0.39	0.10 x 0.10	3.29	2.99	2.69
256321CL	62K211	5	1.3 @ 80	0.80 - 1.60	8500 @ 1.3	PC Term	0.27 x 0.48	0.11 x 0.11	3.29	2.99	2.69
256145CL	42K036	6	1.3 @ 80	0.85 - 1.60	11000 @ 1.3	PC Term	0.17 x 0.43	0.07 x 0.16	5.95	5.35	4.85
256268CL	52K019	6	1.3 @ 85	0.80 - 1.60	10000 @ 1.3	PC Term	0.20 x 0.40	0.10 x 0.07	5.29	4.79	4.29
256049CL	42K041	3	1.3 @ 85	0.85 - 1.60	11000 @ 1.3	1.0	0.16 x 0.43	0.07 x 0.17	5.95	5.35	4.85
256241CL	52K011	3	1.3 @ 85	0.80 - 1.60	11000 @ 1.3	1.0	0.20 x 0.39	0.10 x 0.12	5.29	4.79	4.29
185228CL	FM31E	7	3.0 @ 45	2.50 - 3.80	4500 @ 3.0	Solder pads	0.55 x 0.13	N/A	3.85	3.27	2.45
256364CL	72K692	3	3.0 @ 60	2.40 - 3.00	6500 @ 3.0	4.7	0.28 x 0.66	0.18 x 0.22	4.65	4.19	3.75
256381CL	72K681	3	3.0 @ 60	2.40 - 3.60	7500 @ 3.0	1.1	0.28 x 0.66	0.12 x 0.16	4.65	4.19	3.75
256153CL	42K086	6	3.0 @ 70	1.30 - 3.60	12000 @ 3.0	PC Term	0.17 x 0.43	0.07 x 0.16	5.95	5.35	4.85
256313CL	62K053	3	3.0 @ 75	1.60 - 3.60	8500 @ 3.0	1.0	0.23 x 0.39	0.10 x 0.10	3.29	2.99	2.69
256330CL	62K261	5	3.0 @ 75	2.40 - 3.00	8500 @ 3.0	PC Term	0.27 x 0.48	0.11 x 0.11	3.29	2.99	2.69
256250CL	52K061	3	3.0 @ 75	2.40 - 3.00	10000 @ 3.0	1.0	0.20 x 0.39	0.10 x 0.12	5.29	4.79	4.29
256276CL	52K069	6	3.0 @ 75	2.40 - 3.00	10000 @ 3.0	PC Term	0.20 x 0.40	0.10 x 0.07	5.29	4.79	4.29
256090CL	42K091	3	3.0 @ 80	2.40 - 3.60	11000 @ 3.0	1.0	0.16 x 0.43	0.07 x 0.17	5.95	5.35	4.85

* More details on page 92

Color Code Legend
New

Vibrating Motors and AC Gear Motor

Color Code Legend
New Sale Qty. Save Closeout

1.3VDC 8,500 RPM Vibrating Motor

- Typical applications: cellular phones, pagers, and toys
- Rated RPM: 8,500 @ 1.3VDC
- Direction of rotation: clockwise
- Operating voltage: 1.3V @ 65mA (typical)
- Lead length: 0.75"
- Size: (motor) 0.16"Dia. x 0.55"L (shaft) 0.15"Dia. x 0.23"L

New Lower Price



Namiki

1.3VDC 7,500 RPM Vibrating Motor

- Typical applications: cellular phones, pagers and toys
- Rated RPM: 7,500 @ 1.3VDC
- Clock-wise rotation
- 1.1" lead wires
- Operating voltage: 1.3VDC @ 80mA
- Size: (motor) 0.47"L x 0.24"Dia. (shaft) 0.22"L x 0.10"Dia.

Quantity SAVE



120VAC Gear Motor **SALE**

6.0 RPM - 2.9 Watt

- Operating Voltage: 120VAC @ 60Hz
- Torque: >3.6 kg-cm
- Connector: 12" wires
- Screw down tabs for mounting (2.3" diagonal mounting hole space)
- Shaft diameter: 0.27" • Shaft length: 0.65"
- Overall size: 2.0" Dia. x 1.0" Thick
- Typical applications: air conditioner turnleaf motor, microwave turnplate motor



Part No.	Description	1	10	100
175396CL	Vibrating motor	\$6.49	\$5.52	\$4.14

Part No.	Description	1	10	100
190078CL	Vibrating motor	\$6.55	\$5.5	\$4.18

Part No.	Prod. No.	Description	1	10	100
213487CL	50TYZ	Gear motor	\$14.95	\$13.46	\$12.11

Solenoids

12 and 24VDC Continuous Push, Pull and Push/Pull Solenoids

New



Quantity SAVE

Part No.	Mfr. Cross Ref No.	Type	Voltage (VDC)	Coil Res. (±10%) (Ohms)	Power Consump. (W)	Holding Force (lbs. @ 20°C)	Stroke	Size L x Dia. (in.) †	Shaft Dia. (in.)	Wt. (lbs.)	Pricing		
											1	10	100
262246CL	SMO-0520L12STD	Open frame-pull	12	90	1.6	0.16	0.24	0.8 x 0.6 x 0.5	0.200	0.04	\$5.19	\$4.65	\$4.19
262289CL	SMO-1253L12AA	Open frame-pull	12	26	6.0	0.90	0.24	2.0 x 1.2 x 1.1	0.470	0.50	11.89	10.69	9.65
262262CL	SMO-0837L12STD	Open frame-pull	12	36	4.0	1.10	0.24	1.5 x 1.0 x 0.8	0.310	0.21	7.29	7.29	7.29
262238CL	SMO-0415S12AA	Open frame-push	12	180	0.8	0.01	0.12	0.6 x 0.4 x 0.3	0.040	0.01	5.95	5.35	4.79
262220CL	SMO-0415L12AA	Open frame-push	12	180	0.8	0.01	0.12	0.6 x 0.4 x 0.3	0.160	0.01	4.79	4.29	3.89
262254CL	SMO-0520S12STD	Open frame-push	12	90	1.6	0.16	0.24	0.8 x 0.6 x 0.5	0.06/0.20*	0.04	6.39	5.75	5.15
262297CL	SMO-1253S12AA	Open frame-push	12	26	6.0	0.90	0.24	2.0 x 1.2 x 1.1	0.10/0.47*	0.50	13.09	11.79	10.59
262271CL	SMO-0837S12STD	Open frame-push	12	36	4.0	1.10	0.24	1.5 x 1.0 x 0.8	0.08/0.31*	0.21	8.39	7.59	6.85
262166CL	SMT-1325L12STD	Tubular-pull	12	36	4.0	0.11	0.47	1.0 x 0.5	0.200	0.05	9.95	8.95	8.15
142463CL	SMT-1130L12A	Tubular-pull	12	36	4.0	0.63	0.40	1.6 x 0.4	0.150	0.04	6.95	6.26	5.63
262203CL	SMT-3864L24STD	Tubular-pull	24	34	17.0	1.32	1.18	2.5 x 1.5	0.620	1.10	29.95	26.95	24.29
262182CL	SMT-3257L24STD	Tubular-pull	24	44	13.0	3.30	0.70	2.3 x 1.3	0.500	0.65	19.59	17.69	15.89
215141CL	SMT-2251L24AA	Tubular-pull	24	60	10.0	4.00	1.00	3.0 x 1.0	0.440	0.40	10.95	9.86	8.87
163803CL	A420-067074-01	Tubular-push	12	43	3.4	0.75	0.17	2.0 x 0.6	0.156	0.10	9.95	7.65	5.75
149753CL	SMT-1325S12A	Tubular-push	12	36	4.0	0.75	0.47	1.9 x 0.5	0.063	0.05	9.95	8.95	7.95
149761CL	SMT-1632S12A	Tubular-push	12	21	7.0	1.50	0.24	2.5 x 0.6	0.098	0.10	10.95	9.86	8.87
262174CL	SMT-2551S24STD	Tubular-push	24	58	10.0	1.32	0.70	2.0 x 1.0	0.120	0.40	15.95	14.39	12.99
262211CL	SMT-3864S24STD	Tubular-push	24	34	17.0	1.32	1.18	2.5 x 1.5	0.160	1.10	31.39	28.19	25.39
262191CL	SMT-3257S24STD	Tubular-push	24	44	13.0	6.80	0.70	2.3 x 1.3	0.160	0.65	19.95	17.95	16.19
145314CL	SMT1913S12A	Tubular-push/pull	12	89	2.0	1.12	0.16	1.2 x 0.7	0.110	0.05	9.95	8.96	8.06

†Open frame type dimensions: L" x W" x H"; *Dual shaft

12VDC Solenoid Valve

- Operating voltage: 12VDC
- Operational temperature: -29°C to 85°C
- Current: 350mA
- Air leakage: 1c.c./min. max. 4psi
- 0.250" quick disconnect terminals
- Size: 1.2"L x 0.92"Dia • Weight: 0.1 lbs.

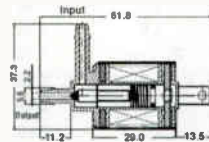

Part No.	Description	1	10	100
169834CL	Solenoid valve	\$6.95	\$6.25	\$5.59

See page 223 for our selection of Motor Kits.



Miniature Toggle Switches

- Mounting hole diameter: 1/4"
- Includes: Mounting hardware

Quantity **SAVE**



Part No.	Mfr. Cross Ref. No.	Fig.	Pins	Type () Momentary	Dimensions L" x W" x D"	Lead Spacing			Contact Rating (A @ VAC)	Lead Type	Lever Type	Pricing				
						A"	B"	C"				1	10	100	250	1000
76523CL	JMT113	1	2	SPST on-off	.52 x .32 x .38	—	.185	—	6 @ 125 & 3 @ 250	Solder lugs	Round	\$1.15	\$1.03	\$.93	\$.75	\$.65
21936CL	JMT123	3	3	SPDT on-on	.52 x .32 x .38	—	.185	—	5 @ 125 & 2 @ 250	Solder lugs	Round	1.15	1.03	.93	.75	.65
21910CL	JMT121	3	3	SPDT on-off-on	.52 x .32 x .38	—	.185	—	5 @ 125 & 2 @ 250	Solder lugs	Round	1.35	1.25	1.09	.95	.85
22832CL	LFH123	3	3	SPDT on-on	.52 x .28 x .36	—	.185	—	5 @ 125 & 2 @ 250	Solder lugs	Flat	1.15	1.05	.95	.85	.75
75854CL	SWM132	3	3	SPDT on-on	.52 x .32 x .38	—	.185	—	6 @ 125 & 3 @ 250	Solder lugs	Round	1.29	1.16	1.04	.94	.69
75889CL	SWM129	3	3	SPDT (on)-off-(on)	.52 x .32 x .38	—	.185	—	6 @ 125 & 3 @ 250	Solder lugs	Round	1.99	1.85	1.55	1.09	.95
26331CL	MPC123	3	3	SPDT on-on	.52 x .32 x .37	—	.185	—	6 @ 125 & 3 @ 250	PC	Round	1.39	1.25	1.12	.95	.78
26315CL	MPC121	3	3	SPDT on-off-on	.52 x .32 x .37	—	.185	—	5 @ 125 & 2 @ 250	PC	Round	1.29	1.19	.99	.79	.59
71597CL	SWM148	4	3	SPDT on-on	.52 x .32 x .38	—	.185	.20	5 @ 125 & 2 @ 250	PC right angle	Round	1.19	1.09	.91	.73	.55
75871CL	SWM145	5	3	SPDT on-on	.52 x .32 x .38	—	.185	.20	6 @ 125 & 3 @ 250	PC right angle	Round	1.49	1.35	1.09	.86	.79
22841CL	LFH221	2	6	DPDT on-off-on	.52 x .52 x .38	.20	.185	—	3 @ 125 & 1 @ 250	Solder lugs	Flat	1.45	1.35	1.19	1.09	.95
21979CL	JMT223	2	6	DPDT on-on	.52 x .52 x .38	.20	.185	—	5 @ 125 & 2 @ 250	Solder lugs	Round	1.49	1.29	1.15	.99	.59
22859CL	LFH223	2	6	DPDT on-on	.52 x .52 x .38	.20	.185	—	5 @ 125 & 2 @ 250	Solder lugs	Flat	1.29	1.19	1.05	.95	.85
105814CL	SWA208	2	6	DPDT on-(on)	.52 x .52 x .38	.20	.185	—	5 @ 125 & 2 @ 250	Solder lugs	Round	1.75	1.57	1.35	1.09	.80
75900CL	SWM133	2	6	DPDT on-on	.52 x .52 x .38	.20	.185	—	6 @ 125 & 3 @ 250	Solder lugs	Round	1.49	1.35	1.25	.99	.85
21952CL	JMT221	2	6	DPDT on-off-on	.52 x .52 x .38	.20	.185	—	6 @ 125 & 3 @ 250	Solder lugs	Round	1.29	1.16	1.04	.89	.75
75895CL	SWM130	2	6	DPDT (on)-off-(on)	.52 x .52 x .38	.20	.185	—	6 @ 125 & 3 @ 250	Solder lugs	Round	1.49	1.35	1.25	.99	.89
26366CL	MPC223	2	6	DPDT on-on	.52 x .52 x .38	.20	.185	—	5 @ 125 & 2 @ 250	PC	Round	1.49	1.35	1.25	.99	.89
26358CL	MPC221	2	6	DPDT on-off-on	.52 x .52 x .38	.20	.185	—	5 @ 125 & 2 @ 250	PC	Round	1.29	1.16	1.04	.89	.75
202964CL	WI24	6	6	DPDT on-off-(on)	.50 x .50 x .46	.15	.15	.20	6 @ 125 & 3 @ 250	PC right angle	Round	.99	.89	.75	.59	.45

Subminiature Toggle Switches

- Mounting hole diameter: 7/32"
- Pre-tinned leads
- Metal construction
- Includes: Mounting hardware



Part No.	Mfr. Cross Ref. No.	Fig.	Pins	Type	Dimensions L" x W" x D"	Lead Spacing		Contact Rating	Lead Type	Lever Type	Pricing				
						A"	B"				1	10	100	250	1000
106067CL	SWP124	1	3	SPDT on-on	.25 x .33 x .40	.20	.10	30mA @ 5VDC	PC right angle	Round	\$1.99	\$1.83	\$1.59	\$1.44	\$1.32
72160CL	SW1501	2	2	SPST on-off	.33 x .21 x .33	.10	—	1.5A @ 250VAC	Solder lugs	Round	1.29	1.24	1.14	.98	.79
75969CL	SWM136	2	3	SPDT on-on	.33 x .21 x .33	.10	—	3A @ 125VAC	Solder lugs	Round	1.55	1.44	1.21	.86	.63
72557CL	SW1502	2	3	SPDT on-off-on	.33 x .21 x .33	.10	—	1.5A @ 250VAC	Solder lugs	Round	1.35	1.25	1.05	.85	.60
138907CL	SW1503	3	6	DPDT on-off-on	.36 x .37 x .33	.17	.10	3A @ 120VAC	Solder lugs	Round	1.29	1.05	.85	.65	.55
75977CL	SWM137	3	6	DPDT on-on	.33 x .37 x .33	.17	.10	1.5A @ 250VAC	Solder lugs	Round	1.29	1.05	.85	.65	.55

Full-Size Toggle Switches

- Panel mount
- Mounting hole diameter: 1/2"
- Full-size round lever
- Medium duty
- Keyed plate indicates switch position
- Includes: Mounting hardware and on/off plate



Part No.	Mfr. Cross Ref. No.	Fig.	Pins	Type	Dimensions L" x W" x D"	Lead Spacing			Contact Rating (A @ VAC)	Lead Type	Lever Type	Pricing				
						A"	B"	C"				1	10	100	250	1000
76241CL	SWM128	1	2	SPST on-off	1.00 x .56 x .52	.23	—	—	4 @ 125 & 2 @ 250	Solder lugs	Round	\$1.49	\$1.29	\$1.19	\$.99	\$.89
158060CL	JKN32	1	4	DPST on-off	1.00 x .56 x .52	.23	—	.23	4 @ 125 & 2 @ 250	Solder lugs	Round	1.15	1.05	.95	.85	.75
76259CL	SWM126	1	6	DPDT on-on	1.12 x .77 x .60	.30	.60	.40	5 @ 125 & 3 @ 250	Solder lugs	Round	1.75	1.58	1.34	1.07	.80
158078CL	JKN3CC	1	6	DPDT on-on	1.19 x .76 x .73	.44	.59	.44	10 @ 125 & 6 @ 250	Screw lugs	Round	1.75	1.59	1.29	.99	.85
76232CL	SWM125	2	2	SPST on-off	1.00 x .53 x .51	—	—	—	6 @ 125 & 3 @ 250	6' lead wire	Round	1.75	1.59	1.45	1.29	1.15

Slide Switches

- Two mounting flanges
- Top actuation except P/N 204142CL
- Nylon actuator
- Phenolic insulated

New Lower Prices

Quantity **SAVE**



Part No.	Pins	Type	Description	Housing Material #	Dimensions			Lead Spacing		Contact Rating	Lead Length	Actuator Height	Pricing			
					L"	W"	D"	A"	B"				1	10	100	250
109170CL	3	SPDT on-on	PC mount	Plastic	.22	.45	.23	—	.12	0.5A @ 50VDC	.17"	.15"	\$.31	\$.26	\$.23	\$.19
202770CL	6	SPDT on-on	PC mount	Plastic	.71	.36	.38	.19	.20	0.1A @ 30VDC	.17"	.32"	\$29	16	13	12
202981CL	4	SP3T on-on-on	PC mount right angle	Metal	.61	.24	.18	—	.10	0.3A @ 125VAC	.26"	.15"	\$16	14	13	12
203001CL	3	SPDT on-off-on	PC mount right angle	Metal	.36	.20	.39	—	.11	0.1A @ 28VDC	.18"	.10"	\$29	18	17	11
204142CL	3	SPDT on-on*	PC mount	Plastic	.77	.40	.37	—	.19	2.0A @ 28VDC	.19"	.17"	.39	.37	.29	.22
161816CL	6	DPDT on-on†	PC mount	Plastic	.38	.14	.13	.13	.11	0.1A @ 20VDC	.11"	.08"	.59	.49	.39	.29
202972CL	6	DPDT on-on	PC mount	Plastic	.77	.43	.29	.24	.18	1.0A @ 24VDC	.21"	.51"	\$29	17	16	14
202930CL	6	DPDT on-on	PC mount	Plastic	.76	.44	.29	.22	.18	4A @ 28VDC	.23"	.40"	\$18	12	11	10
202948CL	3	SPDT on-on	PC mount right angle	Metal	.50	.27	.26	.38	.19	6A @ 28VDC	.13"	.19"	.29	.26	.23	.19

* Side actuated † Plastic - flanges # Plastic: 6/6 nylon, metal: steel zinc plated

Pushbutton Switches

• Contact rating: 3A @ 125VAC (except P/N 106112CL: 3A @ 110VAC) • 2-pin • Lead type: solder terminal

Now Lower Prices

Mountain Switch

Miniature Soft Touch Switches

Part No.	Product No.	Fig.	Type () Momentary	Dimensions	Lead Spacing	Thread Diameter	Button Color	Pricing			
								1	10	100	1000
164494CL	DS450R	1	SPST off-on	1.2"L x .59"Dia.	.175"	.387"	Red	\$1.84	\$1.77	\$1.70	\$1.63
164486CL	DS463R	1	SPST off-(on)	1.2"L x .59"Dia.	.175"	.387"	Red	1.66	1.60	1.54	1.48
164523CL	DS466R	2	SPST off-(on)	1.2"L x .60"Sq.	.160"	.383"	Red	1.69	1.62	1.56	1.50
196921CL	196921I	2	SPST off-on	1.6"L x 1.6"Sq.	.189"	.450"	Red	1.69	1.49	1.39	1.19
164558CL	DS471R	3	SPST off-(on)	1.2"L x .75"Sq.	.160"	.387"	Red	1.69	1.62	1.56	1.50



Figure 1



Figure 2



Figure 3



Figure 4



Figure 5



Figure 6



Figure 7



Figure 8

Standard Touch Switches

Part No.	Product No.	Fig.	Type () Momentary	Dimensions	Lead Spacing	Thread Diameter	Button Color	Pricing			
								1	10	100	1000
164566CL	MS402R	4	SPST off-(on)	.73"L x .22"Dia.	.078"	.190"	Red	\$1.25	\$1.18	\$1.12	\$1.06
164582CL	DS016B	5	SPST off-(on)	.88"L x .46"Dia.	.220"	.354"	Black	1.49	1.39	1.25	1.15
164638CL	MS3120R	6	SPST off-(on)	1.1"L x .31"Dia.	.175"	.268"	Red	1.32	1.19	1.07	.96
164671CL	NS801MOB	7	SPST off-(on)	1.1"L x .59"Dia.	.213"	.468"	Black	2.34	1.96	1.78	1.61
106112CL	DS412R*	8	SPST off-(on)	.63"L x .66"Dia.	.275"	.750"	Red	1.19	.99	.89	.86

* Solder lugs

Pushbutton Switches

IP and AV Series Pushbutton Switches

• Panel mount

171758CL / 171766CL: IP Series

• Initial contact resistance: 50mΩ max.

• Insulation resistance: 1GΩ min. @ 500VDC

• Mounting hole: 1/2"Dia.

• Dielectric strength: 1500Vrms min.

• Mechanical life: 1,000,000 cycles min.

171774CL: AV Series

• Initial contact resistance: 10mΩ max.

• Insulation resistance: 1000MΩ min.

• Mounting hole: 3/4"Dia.

• Dielectric strength: 1000Vrms min.

Part No.	Product No.	Pins	Type () Momentary	Dimensions			Lead Spacing	Contact Rating	Terminal Type	Pricing			
				L	W	D				1	10	100	250
171758CL	IPR3SAD2	2	SPST off-(on)	0.82"	—	0.46"	0.19"	0.2A @ 250VAC	Solder	\$10.39	\$9.35	\$8.45	\$7.49
171766CL	IPC3SAD6	2	SPST off-(on)	0.82"	0.69"	0.46"	0.19"	0.2A @ 250VAC	Solder	10.39	9.35	8.45	7.49
171774CL	AV191003C900	2	SPST off-(on)	1.20"	—	0.87"	0.37"	0.2A @ 48VDC	Screw	11.95	10.84	9.75	8.79

Pushbutton Switches

Quantity SAVE



Figure 1



Figure 2



Figure 3



Figure 4



Figure 5



Figure 6

Part Number	Mfr. Cross Ref. No.	Fig.	Pins	Mounting Hole Dia.	Type () Momentary	Dimensions (L" x W" x D")		Lead Spacing		Contact Rating	Terminal Type	Button Color	Pricing				
						L	W	A	B				1	10	100	250	1000
26622CL	MS102	1	2	1/4"	SPST off-(on)	.65 (D) x 1.10 (E)	—	.14	3A @ 125VAC	Solder lugs	Red	\$.55	\$.50	\$.45	\$.35	\$.29	
26649CL	MS103	1	2	1/4"	SPST on-(off)	.65 (D) x 1.10 (E)	—	.17	3A @ 125VAC	Solder lugs	Black	.55	.50	.45	.35	.29	
154878CL	PS11-123	2	3	1/4"	SPDT on-(on)	.50 x .27 x .37	—	.14	5A @ 125VAC	Solder, right angle	Red	.85	.75	.69	.59	.45	
71642CL	SWB210	3	2	7/32"	SPST off-(on)	.36 x .20 x .33	.20	.20	1A @ 120VAC	PC right angle	Black	2.19	1.99	1.78	1.60	1.39	
200774CL	TPI2SHBAQE	3	3	7/32"	SPDT off-(on)	.32 x .20 x .33	.20	.10	1A @ 120VAC	PC right angle	Black	4.70	3.35	2.95	2.19	1.59	
121304CL	CK8121	4	3	1/4"	SPDT on-(on)	.52 x .27 x .38	—	.185	5A @ 125VAC	Solder lugs	White	3.59	3.25	2.95	2.65	2.39	
28062CL	PB126	4	3	1/4"	SPDT on-(on)	.52 x .28 x .38	—	.185	5A @ 120VAC	Solder lugs	Red	3.69	3.35	2.85	2.29	1.99	
22200CL	J1881	5	2*	3/8"	SPST on-off, Alt†	.65 x .52 x .40	.25	—	2A @ 14VDC	5" Pigtail	White	1.19	1.09	.94	.83	.72	
22218CL	J1882	5	2*	3/8"	SPST off-(on)	.65 x .52 x .40	.25	—	2A @ 14VDC	5" Pigtail	Red	1.09	.98	.83	.67	.50	
174414CL	R13-510A	6	2	1/2"	SPST off-(on)	.67 (L) x .31 (D)	—	.167	3A @ 125VAC	Solder lugs	Red	.79	.78	.77	.74	.69	

† Alt = alternate action

* Lead wires

Jameco's Low-Price Guarantee

We'll match the print advertised price of any like product. It's that simple!

See pages 28 - 31 for our extensive selection of Prototyping Boards.

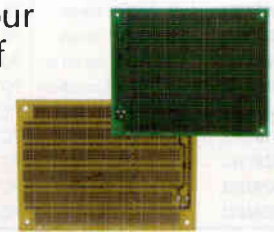



Miniature Basic Lever Switches

- 3 terminals: common; normally open; normally closed
- Size: 1.10"L x 0.40"W x 0.63"H



OMRON **Honeywell**

Quantity **SAVE** **New Lower Prices**

Part No.	Product No.	Manufacturer	Actuator Type	Contact Form	Contact Rating	Resistance (initial)	Service Life (Mech./Elec.)	Terminal Type	Pricing		
									1	25	50
159572CL	VS10N051C	Highly Electric	Hinged roller (0.60"L)	SPDT-NC	10A@125VAC, 10A@250VAC	15milliΩ (max.)	10M/100k	.183" quick connect	\$2.89	\$2.54	\$2.28
159581CL	VS10N021C2	Highly Electric	Hinge lever (1.05"L)	SPDT-NC	10A@125VAC, 10A@250VAC	15milliΩ (max.)	10M/100k	.183" quick connect	2.45	2.25	1.99
191388CL	V3-715	Honeywell	Pin plunger	SPDT-NC	0.5A@125VAC, 10A@250VAC	—	10M/1M	.220" solder	1.55	1.25	.93
203545CL	V7-3E11D8-022	Honeywell	Hinge lever (1.07"L)	SPDT-NC	0.5A@125VAC, 10A@250VAC	—	10M/100k	.183" quick connect	4.05	3.19	2.39
187792CL	V-10G2-1C24K	Omron	Hinge lever (1.08"L)	SPDT-NC	0.1A@125VAC, 10A@250VAC	30milliΩ (max.)	50M/300k	.183" quick connect	2.45	1.88	1.75
187805CL	V-10G3-1C24K	Omron	Long hinge lever (2.01"L)	SPDT-NC	0.1A@125VAC, 10A@250VAC	30milliΩ (max.)	50M/300k	.183" quick connect	2.75	2.48	2.29
213479CL	DMC Series	Defond	Long hinge lever (3.56"L)	SPDT-NC	15.1A@125VAC, 15.1A@250VAC	—	—	.250" quick connect	1.75	1.69	1.59



SS Subminiature Basic Switches

- Economical, subminiature basic switch offers long service life
- Free from overtravel restrictions, permits easy setting
- Lead spacing: A = 0.35"; B = 0.29"
- Dimensions: 0.78"L x 0.25"W x 0.40"H



OMRON

Part No.	Product No.	Manufacturer	Actuator Type	Contact Form	Contact Rating	Contact Force	Service Life (Mech./Elec.)	Terminal Type	Pricing		
									1	25	50
187709CL	SS-5GL	Omron	Hinge lever (0.6"L)	SPDT-NC	5A @ 125VAC, 3A @ 250VAC	50g	30M/200k	Solder	\$1.59	\$1.45	\$1.29
187733CL	SS-5GL2	Omron	Hinged roller (0.6"L)	SPDT-NC	5A @ 125VAC, 3A @ 250VAC	50g	30M/200k	Solder	1.25	1.09	.99
159599CL	SS0505A	Highly Electric	Hinge roller (0.7"L)	SPDT-NC	5A @ 125VAC, 3A @ 250VAC	45g	30M/200k	Solder	3.25	2.92	2.59

SPST Round Keylock Switches

- Used in computer & other security systems
 - Key removable from 2 positions
 - Two keys
 - Mounting hole = 0.75" except P/N 106649CL = 0.5"
- 196648CL: all keys are alike Includes: Mounting nut

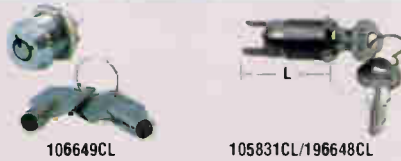

Part No.	Mfr. Cross Ref. No.	No. Flat. Dia.	Length	Terminal	Voltage/Current	Pricing			
						1	10	50	100
106649CL	KS4B	2.21"	.55"	Barrel	125VAC/3A	\$3.59	\$3.29	\$2.89	\$2.49
105831CL	KS3B	2.66"	1.48"	.25" quick connect	125VAC/6A	3.99	3.59	3.29	2.99
196648CL	3313E-M	2.66"	1.48"	.25" quick connect	125VAC/6A	4.49	3.99	3.65	3.29

OMRON D2F Series Subminiature Snap-Action Switch

Ideal for a wide variety of applications from household appliances and office equipment to audio and communications equipment.

- Actuator type: hinge lever(0.5"L)
- Contact form: SPDT-NC
- Contact rating: 2A @ 30VDC, 3A @ 125VAC
- Initial contact resistance: 30milliΩ max.
- Service life: 1M (mech.); 30k (elec.)
- Terminal type: PCB
- Dimensions: 0.50"L x 0.23"W x 0.26"H
- Lead spacing: 0.2"



Part No.	Product No.	1	25	50
188867CL	D2F-L	\$0.89	\$0.83	\$0.79

Magnetic Reed Switches

- NO (normally open)
- Contact form: SPST



Part No.	Mfr. Cross Ref. No.	Contact Rating	Size (L" x Dia.)"	Pricing			
				1	10	100	1000
171871CL	MKA141011015	500mA @ 100VDC	0.53 x 0.1	\$0.79	\$0.64	\$0.46	\$0.41
164081CL	MRS1	1A @ 250VAC; 1A @ 50VDC	1.43 x 0.2	.79	.63	.43	.39

Switch Assortment Kit

- Includes:
- 20-drawer component cabinet (81701CL), 20 clear plastic drawers (85454CL), 20 clear dividers (85446CL), pg 103 and 30 adhesive labels for drawers to identify parts in kit
 - 10 ea. miniature toggle switches (76523CL, 21936CL, 21910CL, 26331CL, 26315CL, 21979CL, 21952CL, 26366CL, 26358CL), pg 93
 - 10 ea. slide switches (109170CL), pg 93
 - 10 ea. pushbutton switches (26622CL, 26649CL), pg 94
 - 10 ea. DIP switches (38818CL, 38842CL), pg 96
 - 10 ea. tactile switches (153251CL), pg 97



SAVE \$52



Part No.	Description	Wt. (lbs.)	1	10
85059CL	150 pcs. switch kit	5.0	\$98.95	\$88.95

Switch Grab Bags



- 18235CL: 50 pcs. assorted – toggle, pushbutton, rocker and slide switches
 135378CL: 1 lb. (approx. 135 pcs.) assorted – toggle, pushbutton, rocker and slide switches

Part No.	Cross Ref. No.	Wt. (lbs.)	1	10
18235CL	GB165	0.4	\$8.75	\$7.69
135378CL	GB165LB	1.0	18.95	16.95

PCB Plunger Switch

Use in Place of Shorting Block

- SPST (on/off)
- Contact rating: 50mA @ 24VDC
- Non-removable plunger
- Size: 0.2"W x 0.1"D x 0.38"H
- Lead length: 0.1"L
- 10 piece minimum



Part No.	Description	10	100	1000
172700CL	Plunger switch	\$0.10	\$0.09	\$0.08

See pages 100-101 for our complete selection of Relays.

Jameco Special Values!

See the yellow and green highlighted items. Details on page 2.

Switches (Continued)

Color Code Legend
New Sale Qty. Save Closeout



Pushbutton Binary Coded Decimal (BCD) Switch

26788CL (2 switches shown)

Thumbwheel Binary Coded Decimal (BCD) Switch

(2 switches shown) 26817CL

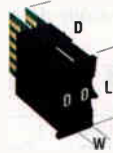

Pushbutton and Thumbwheel Switch Specifications:

- Contact resistance: 100mΩ max.
- 1/16" maximum panel thickness
- Gold plated BE-CU alloy contacts
- 0.15A @ 50VAC/28VDC
- Break before make
- Operating temperature: -40°C to +85°C
- Continuous load: 1 amp max.
- Front snap-tab mounting with end plates
- Switches snap together

Part No.	Mfr. Cross Ref. No.	Description	Size (L" x W" x D")	Character Height	Pricing			
					1	10	50	100
26788CL	MX72	10-position pushbutton	1.2 x 0.3 x 1.7	0.19"	\$5.69	\$5.15	\$4.65	\$4.15
26761CL	MXEP2	Mounting end plates for 26788	1.2 x 0.2 x 1.1	—	1.15	.99	.89	.79
26817CL	MX83	10-position thumbwheel	1.2 x 0.3 x 1.9	0.25"	4.49	3.95	3.55	3.19
26770CL	MXEP3	Mounting end plates for 26817	1.2 x 0.2 x 1.3	—	1.05	.88	.84	.77

Mini Pushbutton BCD Switch

- Operating temperature: -10°C to +65°C
- Switches snap together
- Positive logic ("0" all open output)
- 28VDC @ 10A
- Break before make

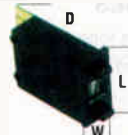

Part No.	Mfr. Cross Ref. No.	Description	Size (L" x W" x D")	Character Height	Pricing		
					1	10	100
136557CL	MX061	10-position straight	.59 x .30 x 1.0	0.12"	\$3.79	\$3.41	\$3.06

Excell Rotary DIP Switches

- Gold plated contacts to ensure reliable, low resistance connection
- Fully sealed construction
- Op force: 500g-cm max.
- Material: 94V-0 grade, UL approved fire retardant plastic
- Lead spacing: A = 0.1"; B = 0.3"
- Terminals: PC pin leads
- Life: 10,000 cycles min.
- Max. switching load rating: 25mA @ 24VDC



Part No.	Product No.	Position	Adjust	Code Type	W" x D" x H"	Pricing			
						1	10	50	100
139635CL	ERD110RS(DRD10)	10	top	BCD	.39 x .39 x .20	\$2.59	\$2.33	\$2.07	\$1.86
139651CL	ERD116RS	16	top	Hex	.39 x .20 x .39	2.75	2.49	2.22	1.99



Rotary DIP Switches

- Fully sealed construction
- Make and break current rating: 30mA @ 30VDC for 10,000 cycles
- 215992CL: 0.1" x 0.3" pin spacing (standard through hole)
- 216004CL: 0.1" pin spacing (right angle through hole)
- Rotor and switch body: plastic (UL94V-0)
- Contact and terminal material: copper alloy plated



Part No.	Product No.	Position	Adjust	Code type	W" x D" x H"	Pricing			
						1	10	100	1000
215992CL	HAB16	16	Top	HEX	.39 x .39 x .20	\$2.45	\$2.10	\$1.85	\$1.55
216004CL	HAB10R	10	Side	BCD	.44 x .30 x .40	2.45	2.10	1.85	1.55

Rocker and Lever Type Switches

- Contact rating: 5A @ 120VAC; 2A @ 250VAC, except P/N 196154CL: 15A @ 125VAC; 10A @ 250VAC
- Operating temp.: -30° to 85°C
- Electrical life: 50,000 make and break cycles at full load
- Contact resistance: 10mΩ typical
- Dielectric strength: 1000Vrms @ sea level
- Insulation resistance: 10MΩ min., except P/N 196154CL: 100MΩ min.

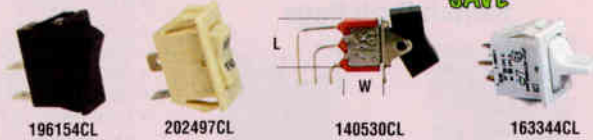

Part No.	Mfr. Cross Ref. No.	Pins	Type	Dimensions (ins.)			Lead Spacing	Lead Type	Pricing			
				L	W	D			1	10	100	1000
				196154CL	R30NSA	2			SPST on-off	1.07	.42	.77
202497CL	526VBU	2	SPST on-off	.89	.49	.64	N/A	Panel mt. quick discon.	\$2.29	.20	.18	.17
140530CL	CK7101	3	SPDT on-on	.50	.50	.27	.150"	Right angle PC (vert.)	1.49	1.34	1.21	1.09
163344CL	CKD103.5W	3	SPDT on-off-on	.67	.47	.59	N/A	Panel mt. solder eyelet	1.05	.85	.68	.50

Corporate Customers

Opening an account is easy!! Call 1-800-831-4242 for details today.

DIP Switches

Quantity **SAVE**



- Switch contacts: SPST
- Switches are numbered
- 50VDC @ 100mA
- Molded construction
- Standard switches have raised lever
- LP switches are flush to casing
- Pre-tinned leads

Compatible Socket Chart, see page 76 for Sockets

Switch	Socket	Switch	Socket	Switch	Socket
109057CL	112192CL	38826CL	37161CL	101856CL	38113CL
206359CL	51570CL	38834CL	37161CL	38797CL	38607CL
38818CL	51570CL	38842CL	37372CL	38800CL	39378CL
139002CL	51570CL	139011CL	37372CL	202921CL	37372CL

Part No.	Mfr. Cross Ref. No.	Pos.	Pricing			
			1	10	100	1000
109057CL	206-2	2	\$7.75	\$6.68	\$6.61	\$5.55
206359CL	206-3	3	.79	.65	.55	.43
38818CL	206-4	4	.65	.55	.49	.45
139002CL	206-4LP	4	.79	.70	.55	.44
38826CL	206-6	6	.99	.89	.79	.72
38834CL	206-7	7	.95	.86	.68	.50
38842CL	206-8	8	.89	.80	.72	.64
139011CL	206-8LP	8	.85	.76	.61	.47
202921CL	DIPSWRA8	8	\$5.69	.37	.34	.28
101856CL	206-9	9	.85	.79	.69	.49
38797CL	206-10	10	.95	.86	.68	.51
38800CL	206-12	12	1.05	.99	.93	.56

* Manufacturer may vary

Tri-State DIP Switch

- Switch contacts: bussed, tri-state
- Labeled tri-state positions (+, 0, -)
- Contact rating: 24VDC @ 25mA
- Two isolated busses
- Compatible socket, use P/N 37372CL, pg 76



Part No.	Mfr. Cross Ref. No.	1	10	50	100
138991CL	ETA108E	\$1.95	\$1.75	\$1.55	\$1.35

Replacement Switches for AT-Style Computer Cases

PC Pushbutton Switches

- Alternate action double pole switch
- Contacts rated at 250VAC
- UL/CSA/VDE approved
- Size: 0.9"L x 0.7"W x 0.9"D



Part No.	Description	Current	1	10	100
127044CL	PC push button	7.5A	\$2.95	\$2.25	\$1.55
174238CL	PC push button	8A	\$2.29	1.95	1.46

PC Rocker Switch

- For mini-tower cases
- DPST
- Contacts rated at 250VAC
- UL/CSA approved
- Size: 0.9"L x 1.2"W x 1.4"D



Part No.	Description	Current	1	10	100
127028CL	PC rocker	10A	\$2.95	\$2.69	\$2.39

Tactile Switches



- Bounce time: 10 msec.
- SPST momentary ON
- Contact resistance: 100mΩ
- Lead type: PC

Part No.	Mfr. Cross Ref. No.*	Fig.	Pins	Dimensions (in.)				Lead Spacing		Contact Rating (mA @ VDC)	Button Color	Pricing			
				L	W	D	C	A"	B"			1	10	100	250
122972CL	DTS1212	1	4	.47	.47	.18	—	20	.50	20 @ 15	Black	\$2.26	\$2.23	\$1.19	\$1.17
119010CL	KTIIBICM	2	8	.24	.24	.15	.30	.17	.25	20 @ 15	Black	.27	.24	.21	.18
149948CL	KT11P4CM	3	4	.24	.24	.15	.13	.17	.25	20 @ 15	Black	*	.23	.21	.19
115086CL	KIE22	4	2	.24	.24	.22	—	.25	—	20 @ 15	Blue	*	.19	.12	.10
199726CL	EVQ11A04M	8	2	.24	.24	.14	.30	.20	—	20 @ 15	White	*	.19	.17	.13
200361CL	EVQPB04K†	9	5	.24	.24	.14	.30	.17	.26	20 @ 15	Black	.29	.26	.21	.16
137189CL	PBS103	1	4	.47	.47	.17	—	.20	.50	50 @ 12	Black	.39	.35	.32	.19
153251CL	SDT620K	2	4	.24	.24	.15	.06	.17	.25	50 @ 12	Black	.29	.25	.20	.18
155248CL	KRS-3550-BK	5	2	.24	.14	.15	—	.27	—	50 @ 12	Black	.22	.20	.16	.15
155256CL	KRS-3550-WH	5	2	.24	.14	.15	—	.27	—	50 @ 12	White	.35	.27	.22	.16
206341CL	KPT1107A	5	2	.24	.14	.15	—	.25	—	50 @ 12	White	.52	.39	.25	.16
155379CL	KRS-1273B	6	4	.47	.47	.14	.14	.17	.53	50 @ 12	Brown	.39	.35	.31	.26
206332CL	MJTP1236E	10	2	.27	.27	.28	.14	.18	.18	50 @ 12	White	.47	.36	.29	.16
202956CL	KSM06330	7	2	.24	.24	.15	.38	.11	.18	50 @ 24	Red	.35	.19	.12	.12

Tactile Switch Caps

Part No.	Mfr. Cross Ref. No.*	Fig.	Description	Size (in.)	Material	For Use With	10	100	250
155389CL	KRS-CAP-A	11	Square	.47" L x .47" W x .16" H	Plastic	P/N 155379CL	\$1.15	\$1.11	\$1.10
155408CL	KRS-CAP-B	12	Round	.50" Dia. x .25" H	Plastic	P/N 155379CL	.15	.13	.11

* Manufacturer may vary † 200361CL: with ground pin



B3F Series Miniature Tactile Key Switch

Miniature, low profile and easy mounting. Applications: audio, office & communications equipment, measuring instruments, TVs, VCRs, etc.

- Extended mechanical/electrical service life
- Flux-tight base structure allows automatic soldering of the key switch onto a PC board
- Lead spacing: A = 0.18"; B = 0.26"



Part No.	Type	Operating Force	Dimensions (H x Pitch)	1	25	50	100
162886CL	B3F-1000	General purpose 100g	4.3 mm x 6.5 mm	\$4.45	\$4.40	\$3.36	\$3.33



SP5T Rotary Switch

- Panel mount • Fixed stop • 1/8" screwdriver slotted shaft • 0.06" solder terminals
- 36° angle of throw • Single pole, 5-positions • Contact resistance: 20mΩ max.
- Insulation resistance: 1,000MΩ minimum between mutually insulated parts
- Material: stainless steel shaft and detent contact springs; brass terminals (gold plated over nickel plate); zinc, cadmium plated bushing



Part No.	Product No.	Description	1	10	100
184727CL	50AB36-01-1-5-F	SP5T panel mount rotary switch	\$2.95 \$1.71	\$1.35	\$1.41

Rotary Switches

- Panel mount • Make before break • Solder lugs • Layers: 1
- Contact rating: 30VDC @ 0.3A • Insulation resistance: 10MΩ min.
- Contact resistance: 30mΩ • Lug size: 0.07" • Mounting hole diameter: 3/8"
- Material: solid brass bushings, slotted aluminum shafts, plated frame, phenolic contact wafer (except for P/N 101565CL – plastic casing)
- Compatible with Jameco rotary knobs P/N 102787CL and 104176CL, pg 106

Quantity **SAVE**



Part No.	Mfr. Cross Ref. No.*	Poles	Position	Shaft Size (L" x Dia. ")	1	10	100
101531CL	RS0261	1	12	0.46 x 0.25	\$1.29	\$1.10	\$0.85
101573CL	RS022	2	6	0.46 x 0.25	1.35	1.15	.90
101565CL	RS023	3	4	1.16 x 0.25	1.95	1.59	1.25
101557CL	RS024	4	3	0.46 x 0.25	1.09	.93	.69

* Manufacturer may vary

16-Button Indoor/Outdoor Keypads

- 9-pin .100" headers
- Fully sealed snap-dome contact
- For indoor or outdoor use
- Contact rating: 24VDC @ 10mA resistive
- Life test: 3,000,000 cycles per key
- Compatible with MOS, TTL and DTL (10Ω max.)
- Recommended connector: P/N 103190CL header and P/N 100765CL pin, pg 78
- Size (housing): 4.7"W x 1.7"H x 0.4"T



196171CL



152063CL

Part No.	Description	1	10	100
196171CL	2x8 matrix keypad	\$16.95	\$15.29	\$13.75
152063CL	4x4 matrix keypad	14.95	13.49	11.95
103190CL	Header housing (10-pin)	.42	.39	.36
100765CL	Header pin (10 per pack)	.11	.09	

12-Button Telephone Keypads

- White plastic
- 8-pin .100" header
- Contact rating: 12VDC @ 20mA
- Contact resistance: 200Ω max.
- Tactile type keypad
- Life test: 1,000,000 cycles per key
- Size: 2.8"L x 2.2"W x 0.6"H



153488CL

Part No.	Description	1	10	100
190561CL	Numeric keypad	\$8.75	\$7.45	\$5.59
153488CL	Alpha numeric keypad	9.49	8.55	7.69

12-Button Chrome Outdoor Keypad

- 3 x 4 matrix
- Weather resistant, attack resistant keypad
- Fully sealed metal housing
- 8-pin 0.1" male headers (mating connectors P/N 103202CL & 100765CL, pg 78)
- Contact resistance: 100Ω max.
- Insulation resistance: 50MΩ (min.)
- Operating voltage: 24VDC @ 50mA (max.)
- Size: 3.9"W x 0.5"D x 4.7"H



Part No.	Description	1	10
226122CL	Industrial keypad	\$49.99	\$44.99

16-Button Numeric Keypad

- 4 x 4 matrix keypad
- 8-position solder pad
- Contact rating: 24VDC @ 20mA
- Contact resistance: 200Ω max.
- Life test: 1,000,000 life cycles per key
- Size: 3.0"L x 2.8"W x 0.6"H



Part No.	Description	1	10	100
169244CL	Numeric keypad	\$7.95	\$6.95	\$6.25

30-Day Money-Back Guarantee

If you're not completely satisfied with your purchase, we'll take it back!
Details on page 229.

24VDC Liquid Level Sensors

Combine the control box and sensor to activate a water valve. When sensor is triggered by either a tank in full or empty condition, it will trigger an output status change.



Quantity **SAVE**

- 176241CL: Control Box**
- Input voltage: 24VDC @ 10A
 - Output voltage: 24VDC @ 10A
 - Size: 2.5"L x 1.8"W x 1.2"H

176250CL (Empty)

- Diameter: 1.0"
- Overall Length: 3.9"
- Travel Distance: 2.0"



176268CL (Full)

- Diameter: 1.1"
- Overall Length: 2.6"
- Travel Distance: .72"



Part No.	Description	1	10	25
176241CL	Control box	\$10.65	\$8.10	\$6.77
176250CL	Sensor empty type	9.95	8.95	7.95
176268CL	Sensor full type	11.45	9.75	7.95



-1.1 to 2.5 PSI Pressure Sensor

- Measurable pressure range: -1.1 to 2.5 PSI
- Maximum load pressure: twice of rated pressure
- Operating voltage: 5V @ <10mA
- Maximum excitation voltage: 8V
- Pressure type: gauge pressure
- Pressure media: non-corrosive gas
- On-chip amplification and temp. compensations
- Pre-calibration of offset voltage and span
- 1/8" diameter tubing is applicable
- Size: .55"L x .47"W x .20"H

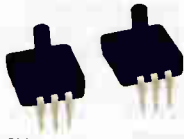

Quantity **SAVE**

Part No.	Product No.	1	10	100
196103CL	XFPN-025-KPGRNW1	\$24.95	\$21.25	\$15.95

0 to 5 PSI Pressure Sensor

- Maximum load pressure: 10 PSI
- Output voltage: 0 - 4.5V
- Operating voltage: 5V @ 10mA
- Pressure type: gauge pressure
- Pressure media: non-corrosive gas
- Accuracy: ±0.125 PSI at 25°C; ±0.250 PSI at -10 to 65°C
- High level output, on-chip signal conditioned, temperature compensated, and calibrated
- 1/8" diameter tubing is applicable
- Size: 0.6"L x 0.5"W x 0.2"H



Part No.	Product No.	1	10	100
173657CL	XFPN-050-KPGT1	\$15.95	\$14.35	\$12.95

servoflo 0 to 7 PSI Pressure Sensor

- Max. load pressure: 10.5 PSI
- Input excitation: 1.5mA
- Span output: 60-140mV
- Bridge resistance: 5kΩ ±1kΩ
- Accuracy: ±5% full scale
- High output, accuracy and stability
- Low noise
- 1/8" diameter tubing is applicable
- Size: 0.5"L x 0.5"W x 0.2"H



Part No.	Product No.	1	10	100
163731CL	FPM07PG	\$11.95	\$10.19	\$7.65

GORDOS-Type Digital I/O Modules

Quantity **SAVE**

- Industry standard package and pinout
- High immunity to false operation
- 4000Vrms optical isolation
- Continuous duty
- Color coded by function
- Capacitance: 8pF typical (input/output)

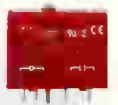

SALE

Part No.	Mfr. Cross Ref. No.	Description	Input Voltage	Output Voltage	Pricing		
					1	10	50
184541CL	ODC-5	DC output (red)	5VDC	3 to 60VDC @ 3A	\$7.29	\$6.85	\$6.39
184524CL	OAC-5	AC output (black)	5VDC	120VAC @ 3A	6.49	6.19	5.75
184583CL	IDC-5	DC input (white)	3.3 to 32VDC	5VDC	\$9.15	8.85	8.34

12VDC Inductive Proximity Switch Sensors

Cylindrical and Square Styles

- Operating voltage range: 10-30VDC
- Nominal operating voltage: 12VDC
- Current consumption: 10mA max.
- Switching frequency: 1.5kHz
- Sensing target: inductive type - magnetic metal
- Sensing distance: ±10% (tin)
- Short circuit protected
- LED status indicator
- Fast response
- 6' long cable
- Pre-tinned pigtail

155547CL (17mm)



Quantity **SAVE**

167020CL (12mm)



248858CL (12mm)



155571CL (18mm)



Part No.	Product No.	Output Circuit	Effic. Dist. (Iron)	Standard Target (Iron) (mm)	Size (L" x W" x H")	Mounting Hole (in.)	Pricing		
							1	10	25
155547CL	S18-05N-1	NPN	0-4.0mm	17 x 17 x 1	1.4 x 1.4 x 0.7	0.112	\$9.95	\$8.95	\$7.95
167020CL	TS12-02N-1	NPN	0-1.6mm	12 x 12 x 1	1.8"L x 0.46" Dia.	0.46	20.65	18.61	16.75
248858CL	TS12-02P-1	PNP	0-1.6mm	12 x 12 x 1	1.8"L x 0.46" Dia.	0.46	19.99	17.99	15.99
155571CL	TS18-05N-1	NPN	0-4.0mm	18 x 18 x 1	1.6"L x 0.70" Dia.	0.70	24.95	21.21	15.91

Ultrasonic Sensor Sets

- Use for motion or distance sensing
- Frequency: 40kHz ±1.0kHz
- Aluminum case



136653CL: Transmit/Receive Set

- Capacitance: 2000pF ±30%
- Case size: 0.47"H x 0.62" Dia.
- Transmitter: bandwidth 4.0kHz/112dB, sound pressure level 119dB/40±1.0kHz
- Lead length/spacing: 0.39"
- Receiver: bandwidth 3.5kHz @ -71dB, min. sensitivity 65dB/40±1.0kHz (0dB vs 1V pbar) R=3.9kΩ

136653CL

139491CL: Transmit/Receive Set

- Capacitance: 2000pF ±20%
- Lead length/spacing: 0.28"
- Transmitter: bandwidth 5.0kHz/100dB, sound pressure level 112dB/40 ±1.0kHz
- Receiver: bandwidth 5.0kHz @ -75dB, min. sensitivity 67dB/40 ±1.0kHz (0dB vs 1V pbar) R=3.9kΩ
- Case size: 0.30"H x 0.43" Dia.

139491CL

Part No.	Mfr. Cross Ref. No.	1	10	50
136653CL	40TR16F	\$6.95	\$6.29	\$5.65
139491CL	40TR12B	6.95	6.29	5.65

Latched Hall Effect Sensor

- SP (south pole): on; NP (north pole): off
- Supply voltage: 20Vcc
- Supply current: 4mA
- Output current: 20mA
- Max. operating point: ≤ 130
- Max. release point (gauss): ≤ 130

HI 300

Part No.	Mfr. Cross Ref. No.	1	10	100	1000
174043CL	HI-300	\$0.95	\$0.86	\$0.77	\$0.59

Vibration/Tilt Switch Sensor

Detects motion or vibration when the switch is mounted such that its main axis is near to the horizontal.

- Contact form: SPDT
- Maximum contact load: 24VDC/115VAC @ 0.5A
- Typical contact resistance: 1Ω (measured at 5VDC @ 0.01A with switch tilted 45° beyond operating point)
- Tilt: one plane only; ±10 degrees included angle
- Minimum operating temperature: -37°C



Part No.	Mfr. Cross Ref. No.	1	10	100
235926CL	Series 3004	\$1.49	\$1.25	\$1.15

0 to 1.45 PSI Pressure Sensor

- Typical full scale span @ 35mV: 0-10kPa (0-1.45 PSI)
- Maximum pressure (P_{MAX}): 75kPa (10.875 PSI)
- Operating volt. (typical): 3VDC @ 6mA
- Applications: air movement control, level indicators, leak detection, robotics and industrial controls
- 1/8" diameter tubing applicable
- Size: 0.7" Dia. x 0.78" Thick (with nozzle)



Quantity **SAVE**

Part No.	Product No.	1	10	100
218827CL	MPX10GS	\$8.99	\$7.65	\$5.75

Phone 1-800-831-8242
 Online www.Jameco.com

Order Anytime 24x7x365

Fax 1-800-237-6948

Small High-Current PC Mount Relays

Quantity **SAVE** **SALE**

An inexpensive means of switching loads up to 30 amps. While these small, low-cost relays are designed primarily for the appliance industry and the heating, air conditioning and ventilation markets, they are also well suited for automotive load management and other applications.

- Meets UL class F insulation standard
- Mechanical life expectancy is 10 million operations
- Electrical life expectancy is 100,000 operations at rated loads
- Dielectric strength: 1500Vrms (between contact and coil)

104926CL: Open frame relay

129349CL: Immersion cleanable, plastic sealed case

144186CL: For use with universal relay card (P/N 128910CL, pg 219)

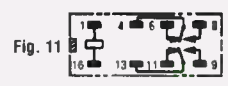
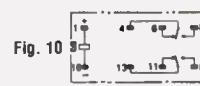
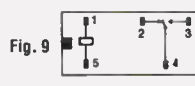
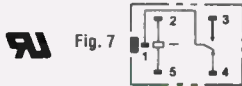
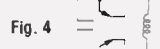
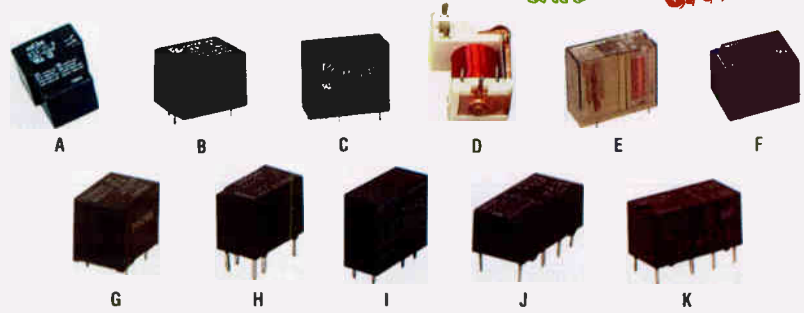

Part No.	Mfr. Cross Ref. No.	Manufacturer	Potter & Brumfield Cross Reference	Fig.	Contact Form	Coil Voltage	Coil (Ohms)	Contact Voltage	Contact Current	Pins	L x W x H (in.)	Pricing			
												1	10	50	100
145752CL	T90S1D12-12*	Magnecraft	T90S1D12-12	1A	SPST	12VDC	155	240VAC	30A	5	1.2 x 1.0 x .77	\$2.45	\$2.10	\$1.85	\$1.49
195864CL	RP838012	Schrack	—	5E	SPST	12VDC	270	250VAC	12A	4	1.1 x .48 x 1.0	1.35	1.09	.81	.57
134949CL	FKD130P5DC5V	Rayex	T90S5D12-5	1A	SPDT	5VDC	27	240VAC/28VDC	20A	6	1.3 x 1.1 x .80	2.49	2.15	1.93	1.65
174449CL	LU-5	Rayex	T81H5D215	3B	SPDT	5VDC	125	120VAC/24VDC	1A/2A	6	.60 x .40 x .45	1.79	1.66	1.55	1.49
187151CL	G5LE-1DC5	Omron	—	7G	SPDT	5VDC	63	120VAC/30VDC	10A/8A	5	.90 x .65 x .75	1.49	1.30	1.15	1.15
187240CL	G5V-1-DC5	Omron	—	8H	SPDT	5VDC	166.7	125VAC/24VDC	.5A/1A	6	.50 x .30 x .40	2.05	1.79	1.59	1.59
104926CL	733SPDT12VDC*	Song Chuan	T90N5D12-12	1D	SPDT	12VDC	155	240VAC/28VDC	20A/10A	6	1.2 x .90 x .63	1.85	1.69	1.49	1.27
129349CL	832-IC-S	Song Chuan	T90S5D12-12	1A	SPDT	12VDC	155	277VAC/28VDC	20A/10A	6	1.2 x 1.0 x .75	2.11	1.90	1.69	1.39
186669CL	G2R-14-DC12	Omron	—	9I	SPDT	12VDC	275	250VAC/30VDC	10A	5	1.2 x 1.0 x .51	2.99	2.62	2.31	2.09
172937CL	JS1-12V	Nais (Aromat)	T72M5D121-12	6F	SPDT	12VDC	400	125VAC/24VDC	10A/5A	5	.85 x .62 x .63	1.09	.99	.89	.75
144186CL	JZC-22F	Velleman	VR15M121C	2B	SPDT	12VDC	337	120VAC/28VDC	15A	5	.80 x .64 x .80	3.79	3.39	3.05	2.75
174431CL	LEG12F	Rayex	T7CS5D12	2B	SPDT	12VDC	400	120VAC/24VDC	15A	5	.76 x .62 x .60	1.49	1.29	1.19	1.09
184461CL	G5V-1-DC12	Omron	—	8H	SPDT	12VDC	960	125VAC/24VDC	.5A/1A	6	.50 x .30 x .40	2.25	1.79	1.58	1.42
187282CL	G6A-234PSTUSDC5	Omron	—	10J	DPDT	5VDC	125	125VAC/30VDC	.3A/1A	8	.80 x .40 x .33	4.35	3.88	3.47	3.06
174377CL	LM2-12D	Rayex	RKA5DZ12	4C	DPDT	12VDC	270	250VAC/30VDC	5A	8	1.2 x .48 x 1.0	2.49	2.25	1.95	1.75
187258CL	G5V-2-DC12	Omron	—	11K	DPDT	12VDC	288	125VAC/30VDC	.5A/2A	8	.81 x .40 x .45	2.49	2.28	2.02	1.82
200740CL	G5V-2-HIDC24	Omron	—	11K	DPDT	24VDC	1152	125VAC/30VDC	.5A/2A	8	.81 x .40 x .45	2.59	2.35	1.89	1.39

*Manufacturer may vary

Potter & Brumfield Type Plastic Enclosed Construction Relays

VF4 Type

- Dielectric strength: 500VDC (between contact & coil)
- Operating temperature: -35°C to +85°C
- Contact current: 40A
- Coil voltage: 12VDC except P/N 171521CL (5VDC)
- Normally open (NO), normally closed (NC)
- Terminal type: quick connect
- Dimensions: 1.1"L x 1.1"W x 1.0"H



Schematic 1



Schematic 2



Relay Socket with Coil Diode

VF4 Type

- For use with P/N 148582CL, left
- 12 AWG: 2 black & 1 blue wire
- 18 AWG: 1 black & 1 red wire
- Contact voltage/current: 12V/20A
- Diode coil suppression • 7.5" wire

Part No.	Ref. No.	1	10	50	100
170624CL	RSD03	\$2.35	\$2.15	\$1.69	\$1.25

Part No.	Mfr. Cross Ref. No.	P&B Cross Reference	Fig.	Contact Form	Coil Ohms	Contact Schematic	Contact Voltage	Pins	Pricing			
									1	10	50	100
171459CL	LD1A-12F	VF481F11S01	3	SPST-NO	78	2	14VDC	4	\$1.89	\$1.75	\$1.39	\$1.05
171441CL	961A-1A12D	VF411F11	2	SPST-NO	90	2	14VDC	4	2.35	2.20	2.14	2.09
171432CL	961A-1C-12DM	VF481F11	1	SPDT	90	1	12VDC	5	2.99	2.69	2.25	1.65
171521CL	LD5F	VF445D11	1	SPDT	14	1	12VDC	5	1.69	1.35	1.05	.71
148582CL	LD12F	VF485F11	1	SPDT	78	1	12VDC	5	2.49	2.25	1.95	1.75

See page 72 for our complete selection of Molex Power Connectors and page 80 for Amphenol Connectors.

Don't worry about backorders. Over 99% of our products are in stock!

We'll Send It Today!

Just place your order by 6PM EST for same business day shipment.

DC/AC and DC/DC Solid State Relays

- Screw terminal with hardware
- Photo isolation
- Metal mounting base
- Manufacturer may vary

New Lower Prices



Quantity SAVE



176698CL (Fig. 1)



153058CL (Fig. 2)



192815CL (Fig. 3)



162341CL (Fig. 4)



176735CL (Fig. 5)



187004CL (Fig. 6)



164996CL (Fig. 7)



127790CL (Fig. 8)

Part No.	Product No.	Mfr.	Control Voltage	Type	Contact Style	Contact Voltage	Contact Current	Pins	Fig.	Terminal Type	Agency Approval	Size L" x W" x H"	Pricing			
													1	10	50	100
Solid State Relays DC/AC Type																
153058CL	KSD203AC2	COSMD	4-32VDC	DC/AC	SPST	240VAC	3A	4	2	Solder Lead	—	1.4 x 0.3 x 0.9	\$9.95	\$8.95	\$7.95	\$7.25
162341CL	ESR51024-010 †	Excel	3-32VDC	DC/AC	SPST	240VAC	10A	4	4	Screw Terminal	UL	2.3 x 1.7 x 1.1	15.95	14.39	12.95	11.65
162368CL	ESR51024-025 †	Excel	3-32VDC	DC/AC	SPST	240VAC	25A	4	4	Screw Terminal	UL	2.3 x 1.7 x 1.1	21.95	19.79	17.79	16.05
162405CL	ESR51024-040 †	Excel	3-32VDC	DC/AC	SPST	240VAC	40A	4	4	Screw Terminal	UL	2.3 x 1.7 x 1.1	22.99	20.69	18.69	16.79
105081CL	615-8500	Teledyne	3-32VDC	DC/AC	SPST	250VAC	10A	4	3	Screw Terminal	UL	2.3 x 1.7 x 1.1	15.99	14.39	12.99	11.69
192815CL	KSD240AC8	COSMO	4-32VDC	DC/AC	SPST	250VAC	40A	4	3	Screw Terminal	—	2.3 x 1.8 x 0.6	17.99	15.99	14.11	12.88
175214CL	KB20C02A	Kyoto	3-32VDC	DC/AC	SPST	280VAC	2A	4	1	Solder Lead	—	1.4 x 0.3 x 1.5	5.95	5.69	5.32	5.05
127790CL	D2W202F	Crydom	3-32VDC	DC/AC	SPST	280VAC	2A	4	8	Solder Lead	UL/CSA	1.7 x 0.4 x 1.3	7.17	6.59	6.19	6.19
176698CL	KB20C06A	Kyoto	3-32VDC	DC/AC	SPST	280VAC	6A	4	1	Solder Lead	—	1.4 x 0.3 x 0.9	9.99	8.99	7.99	7.19
176719CL	KD20C40AX	Kyoto	3-32VDC	DC/AC	SPST	280VAC	40A	4	5	Screw Terminal	—	2.3 x 1.7 x 0.9	19.99	17.99	16.19	14.59
176735CL	KD20C75AX	Kyoto	3-32VDC	DC/AC	SPST	280VAC	75A	4	5	Screw Terminal	—	2.3 x 1.7 x 0.9	39.95	35.99	32.39	29.15
204441CL	TD24200	Crydom	4-15VDC	DC/AC	4PST	280VAC	20A	13	—	Solder Lead	UL/CSA	2.3 x 1.8 x 0.9	56.95	48.45	36.35	36.35
186992CL	G3NA-210B-DC5-24	Omron	5-24VDC	DC/AC	—	240VAC	10A	4	6	Screw Terminal	UL/CSA	2.3 x 1.7 x 1.1	14.29	13.55	12.89	12.25
187004CL	G3NA-220B-DC5-24	Omron	5-24VDC	DC/AC	—	240VAC	20A	4	6	Screw Terminal	UL/CSA	2.3 x 1.7 x 1.1	19.95	17.95	15.95	13.95
164988CL	S101S02	Sharp	1.2VDC@20mA	DC/AC	—	125VAC	1.5A	4	7	Solder Lead	UL/CSA	0.9 x .16 x .63	3.95	3.49	2.95	2.25
164996CL	S202TA1	Sharp	1.2VDC@20mA	DC/AC	—	200VAC	2.0A	4	7	Solder Lead	UL/CSA	0.9 x .16 x .63	4.95	4.49	4.05	3.65

Solid State Relay DC/DC Type

172591CL	KF0602D	Kyoto	3-32VDC	DC/DC	SPST	60VDC	2A	4	1	Solder Lead	—	1.4 x 0.3 x 0.9	\$9.95	\$8.95	\$7.95	\$6.95
175222CL	KF0604D	Kyoto	3-32VDC	DC/DC	SPST	60VDC	4A	4	1	Solder Lead	—	1.5 x 0.3 x 0.9	11.95	11.25	10.25	9.22
176647CL	KG1005D	Kyoto	3-32VDC	DC/DC	SPST	120VDC	5A	4	5	Screw Terminal	—	2.3 x 1.7 x 0.9	26.99	24.29	21.79	19.59
176655CL	KG1010D	Kyoto	3-32VDC	DC/DC	SPST	120VDC	10A	4	5	Screw Terminal	—	2.3 x 1.7 x 0.9	29.99	26.99	24.29	21.89

† Zero crossing

DIP Relays

- Logic control levels
- Long life with reliable operation
- Moisture resistant
- Compatible with IC sockets
- Compact design/construction
- Excellent for PCB applications



CLARE



106462CL



99901CL



206543CL



215909CL



EGE

FUJITSU

Aromat

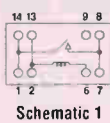

Schematic 1



Schematic 2

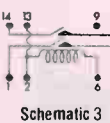

Schematic 3

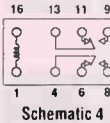

Schematic 4



Schematic 5

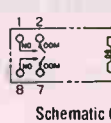

Schematic 6

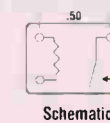

Schematic 7

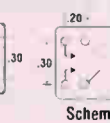

Schematic 8

Part No.	Mfr. Cross Reference No.	Manufacturer	Contact Schem.	Contact Form	Coil Voltage	Coil Ohms	Contact Voltage	Contact Current	Pins	Jameco Socket	Fig.	Size L x W x H (in.)	Leads A x B x C (in.)	Pricing			
														1	10	50	100
106462CL	201A05	Excel Cell Elect.	1	SPST-ND	5VDC	500	100VDC	0.5A	8	37161	3	.78 x .25 x .20	.10 x .40 x .30	\$2.15	\$1.81	\$1.52	\$1.25
138430CL	2D1A05	Excel Cell Elect.	2	SPST-NO	5VDC	500	100VDC	0.5A	8	37161	3	.77 x .30 x .22	.10 x .40 x .30	2.29	1.95	1.65	1.34
215896CL	OJE-SS-109LMF	DEG	7	SBT-ND	9VDC	400	250VAC/30VDC	3A/3A	4	—	1	.71 x .39 x .57	.50 x .60 x .30	2.29	1.95	1.69	1.39
106471CL	201A12	Excel Cell Elect.	1	SPST-NO	12VDC	1000	100VDC	0.5A	8	37161	3	.78 x .25 x .20	.10 x .40 x .30	2.29	1.95	1.65	1.39
138448CL	2D1A1200	Excel Cell Elect.	2	SPST-NO	12VDC	1000	100VDC	0.5A	8	37161	3	.77 x .30 x .22	.10 x .40 x .30	2.25	1.95	1.75	1.49
138456CL	202A05	Excel Cell Elect.	3	DPST-NO	5VDC	140	100VDC	0.5A	8	37161	3	.77 x .30 x .28	.10 x .40 x .30	3.49	3.15	2.69	2.19
173913CL	AZ831-2C-5DSE	American Zettler	4	DPDT	5VDC	125	125VAC/100VDC	.5A/1.25A	8	37401	1	.79 x .38 x .44	.18 x .28 x .29	2.35	2.15	1.69	1.25
139977CL	RSB5S	Shin Mei	4	DPDT	5VDC	125	120VAC/30VDC	1A/2A	8	37372	1	.79 x .39 x .37	.20 x .40 x .30	2.49	2.25	1.95	1.75
99338CL	LM12C00	Clare	4	DPDT	6VDC	71	125VAC/100VDC	2A	8	37372	1	.79 x .40 x .43	.20 x .40 x .30	2.49	2.19	1.59	1.29
99311CL	DS2Y-S-DC12V*	Aromat (NAIS)	4	DPDT	12VDC	720	110VAC/30VDC	.3A/1A	8	37372	1	.79 x .40 x .43	.20 x .40 x .30	2.49	2.31	2.05	1.75
99901CL	LX200D00	Clare	4	DPDT	12VDC	720	125VAC/100VDC	2A	8	37372	1	.79 x .40 x .30	.20 x .40 x .30	6.95	6.25	5.63	4.49
99320CL	LM12E00*	NEC	4	DPDT	24VDC	1110	125VAC/100VDC	2A	8	37372	1	.79 x .40 x .43	.20 x .40 x .30	2.95	2.69	2.39	2.15
136549CL	DS4E-M-DC5V*	Aromat	5	4PDT	5VDC	62.5	125VAC/30VDC	.6A/2A	14	112299	2	1.40 x .40 x .36	.20 x .30 x .30	5.49	4.95	4.45	4.05
176313CL	DS4E-M-DC12V	Aromat	5	4PDT	12VDC	360	125VAC/30VDC	.6A/2A	14	112299	2	1.40 x .40 x .36	.20 x .30 x .30	6.95	6.29	5.29	4.39
206543CL	DS4E-S-DC5V-1C-H137	Aromat	6	4PDT	5VDC	125	250VAC/220VDC	2A	14	112299	2	1.40 x .40 x .42	.20 x .30 x .30	8.45	7.50	6.50	4.50
215909CL	RKA-7D2-12	P & B	8	DPST-NO	12VDC	270	250VAC/24VDC	5A/5A	6	—	1	1.13 x .49 x .97	.20 x .80 x .30	2.29	1.95	1.69	1.39

* Manufacturer may vary

General Purpose Relays

Pin Type Terminals

- DPDT
- 8-pin
- Contact rating: 120/240VAC, 28VDC @ 10A
- Ambient operating temperature: -10°C to +50°C
- Size: 1.4"L x 1.4"W x 2.7"H



Series 250 Relays

Part No.	Mfr. Cross Ref. No.	P & B Cross Ref.	Coil Voltage	1	10	50
139766CL	BTA1-2C-12VDC	R02-11D10-12	12VDC	\$9.49	\$8.55	\$7.69
139740CL	BTA1-2C-120VAC	R02-11A10-120	120VAC	9.95	8.79	7.99

Series 250 Sockets

Part No.	Voltage	Current	Pins	Dimensions	1	10	50
141145CL	250VAC	20 amps	8	2.0"L x 1.6"W x 0.8"H	\$3.99	\$3.65	\$2.99
141153CL	250VAC	20 amps	11	2.0"L x 1.7"W x 1.2"H	5.19	4.85	4.19

Quick Connect Blade Terminal – Series 388

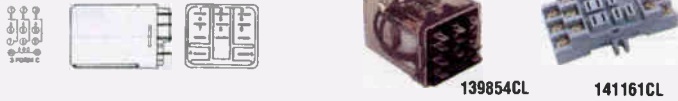

Flat terminals (0.187" x 0.020") for standard plug-in mounting; also accepts quick-connect receptacles or direct soldering.

- Contact rating: 120VAC/28VDC @ 13A; 240VAC @ 10A
- Ambient temperature operating: -30°C to +50°C
- Size: 1.5"L x 1.4"W x 2.2"H • 3PDT • 11-pin

Part No.	Mfr. Cross Ref. No.	P & B Cross Ref.	Coil Voltage	1	10	50
139854CL	BTA2-3C-24VDC	R10-14D10-24	24VDC	\$8.69	\$8.63	\$8.39

Series 388 Socket

Part No.	Voltage	Current	Pins	Dimensions	1	10	50
141161CL	250VAC	20 amps	11	3.0"L x 1.4"W x 1.0"H	\$3.95	\$3.56	\$3.20

Even lower OEM pricing for larger orders!

Corporate Customers

Call 1-800-831-4242 for details today.

Relay Controller Kit

velleman

Universal Relay Card Kit

An electronic controller that switches higher currents while providing insulation between the controller and the controlled devices.

- 64-piece kit
- Difficulty level: expert
- 8 channels expandable to 15 w/ 8 ea. P/N 144186CL, below
- Relay output: maximum 5A/220VAC
- TTL or 5V CMOS inputs
- Contact voltage: 12VDC/250mA

Requires: 220 or 125VAC power source

Part No.	Product No.	Dimensions	Wt. (lbs.)	1	10
128910CL	K6714	8.3"L x 5.9"W	1.8	\$59.95	\$53.95
144186CL	VR15M121C relay (JZC-22F)		0.028	3.79	3.39



SALE

Rayex General Purpose Relays



Potter and Brumfield Type LB2 Series

- DPDT • 8-pin
- Contact rating: 240VAC/30VDC @ 12A
- Mechanical life: 10,000,000 operations
- Electrical life: 100,000 operations min. at rated load



Part No.	Product No.	P & B Cross Ref.	Coil Voltage	1	10	50	100
172718CL	LB2-12DS	K10-11D15-12	12VDC	\$4.99	\$4.49	\$3.99	\$3.59
175564CL	LB2-24DS	K10-11D15-24	24VDC	5.99	5.49	4.93	4.49
175572CL	LB2-110AS	K10-11A15-120	110VAC	6.25	5.49	4.99	4.39

Rayex LB2 Socket

- DIN rail snap socket for LB2 relays



Part No.	Product No.	P & B Cross Ref.	Pins	1	10	50
175530CL	PTF08AA	27E895	8	\$5.95	\$5.39	\$4.85

Rayex LB4H Series

- 4PDT • 14-pin
- Insulation resistance: 1,500MΩ @ 500VDC
- Mechanical life: 10,000,000 operations
- Electrical life: 100,000 operations min. at rated load
- Contact rating: 240VAC/24VDC @ 5A; except P/N 183011CL 220VAC/24VDC @ 5A



Part No.	Product No.	P & B Cross Ref.	Coil Voltage	1	10	50	100
183011CL	GM4PDT12DF	KHAU-17D12-12	12VDC	\$6.95	\$6.38	\$6.04	\$4.99
175601CL	LB4H-24DS	KHAU-17D12-24	24VDC	4.95	4.45	3.99	3.59
175610CL	LB4H-110AS	KHAU-17A12-120	110VAC	4.25	3.85	3.45	3.25

Rayex LB4H Socket

- DIN rail snap socket for LB4H relays



Part No.	Product No.	P & B Cross Ref.	Pins	1	10	50
175556CL	PFY14AA	PFY14AA	14	\$3.95	\$3.49	\$2.95

T9A Series Relay

Low Cost PC Board or Panel Mount Only

- Contact form: SPDT • Coil voltage: 12VDC
- Coil: 155Ω • Contact voltage: 240VAC/28VDC
- Contact current: 20A/10A • 5-pin
- Terminal type: 0.1" disconnect (2); 0.25" disconnect (3)
- Mechanical life expectancy is 10 million operations
- Operating temperature: -55°C to +85°C
- Dielectric strength: 1500VAC (between open contacts)
- Dimensions: 2.0"L x 1.6"W x 1.8"H

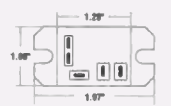

Part No.	Product No.	P & B Cross Ref.	1	10	50	100
137357CL	953-IC-12DM	T9ASD52-12	\$2.55	\$2.45	\$2.19	\$1.75

Reed Type Relay

New Lower Prices

- Manufacturer: Bestar
- Contact form: SPST-NO
- Coil voltage: 12VDC • Coil: 1050Ω
- Contact voltage: 120VAC/60VDC
- Contact current: 0.1A
- Dielectric strength: 1500VDC (between contact and coil)
- 4-pin • Operating temperature: -30°C to +60°C • Terminal type: PCB solder

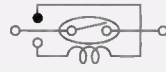

Part No.	Product No.	Dimensions	1	10	50	100
111448CL	RC1050T	0.8"L x 37"W x .38"H	\$5.55	\$3.35	\$3.32	\$2.29

See pages 76 – 78 for our selection of sockets and connectors.



Round Ferrite Speakers

- Pre-tinned speaker lugs • Large magnet • Anodized metal surfaces • Braided copper voice coil leads • Paper diaphragm

Part Number	Mfr. Cross Ref. No.	Dimensions (Dia. " x D")	Input		Impedance (Ω)	Output SPL (dB)	Frequency Range (Hz)	Magnet Size (Dia. " x H")	Pricing		
			Nom (W)	Max (W)					1	10	100
135589CL	FE200	2.0 x 0.7	0.2	0.4	8	83	420 - 5000	1.3 x 0.4	\$1.59	\$1.33	\$1.09
10840CL	FE201	2.2 x 0.7	0.2	0.4	8	88	400 - 4500	1.3 x 0.4	1.59	1.35	.99
177130CL	57RF07	2.2 x 0.8	0.5	0.9	45	88	500 - 8000	1.6 x 0.5	.54	.49	.43
135714CL	FE202	2.6 x 0.8	0.3	0.5	8	88	340 - 4000	1.3 x 0.4	.65	.56	.50

Quantity **SAVE**

For speaker wire, see page 60



135589CL Side



135589CL Back

Square Ferrite Speakers

- Pre-tinned speaker lugs • Large magnet • Anodized metal surfaces • Braided copper voice coil leads • Paper diaphragm

Part Number	Mfr. Cross Ref. No.	Dimensions (Dia. " x D")	Input		Impedance (Ω)	Output SPL (dB)	Frequency Range (Hz)	Magnet Size (Dia. " x H")	Pricing		
			Nom (W)	Max (W)					1	10	100
135693CL	FEB200	2.0 x 0.7	0.2	0.3	8	82	500 - 6000	1.3 x 0.5	\$1.59	\$1.45	\$1.29
31958CL	FEB216	2.6 x 0.8	0.2	0.4	16	85	330 - 8000	1.3 x 0.5	2.25	1.99	1.79
99995CL	FEB204	2.6 x 0.9	3.0	4.0	4	95	300 - 14000	1.8 x 0.5	2.49	2.25	1.99



99995CL Side



99995CL Back

Flat-Magnet, Square Piezo Speakers

- Excellent for alarms or other voice uses • Stainless steel diaphragm

Part Number	Mfr. Cross Ref. No.	Dimensions (Dia. " x D")	Input		Impedance (Ω)	Output SPL (dB)	Frequency Range (Hz)	Magnet Size (Dia. " x H")	Pricing		
			Nom (W)	Max (W)					1	10	100
34024CL	AZ30S	1.2 x 0.2	0.4	0.8	8	70	1300 - 8000	1.2 x 0.1	\$1.69	\$1.52	\$1.35
76030CL	AZ40S	1.6 x 0.2	0.4	0.8	8	70	600 - 6000	1.6 x 0.1	1.95	1.75	1.49



34024CL Side



34024CL Back

Alnico Speakers

- For computer case use • Paper diaphragm • Wide frequency response
- Pre-tinned solder lugs • Large magnet • Impedance: 8Ω

Quantity **SAVE**

Part Number	Mfr. Cross Ref. No.	Fig.	Dimensions (Dia. " x D")	Input		Output SPL (dB)	Frequency Range (Hz)	Magnet Size (Dia. " x H")	Pricing		
				Nom (W)	Max (W)				1	10	100
88410CL	A0200	1	2.0 x 0.8	0.2	0.4	87	430 - 4500	0.5 x 0.4	\$1.49	\$1.29	\$1.19
135765CL	A0201C	1	2.2 x 0.8	0.3	0.5	87	400 - 4000	0.5 x 0.4	1.59	1.35	.99
111587CL	B0102	2	1.7 x 0.6	0.1	0.3	83	500 - 5500	0.5 x 0.4	2.09	1.69	1.39
135811CL	A1527C02	3	1.6 x 2.8 x 1.2	2.0	5.0	82	450 - 20000	0.5 x 0.5	2.95	2.49	2.25

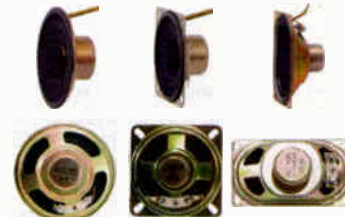

Fig. 1

Fig. 2

Fig. 3

Full-Range Replacement Speaker

Perfect replacements for TVs, stereos, and computer systems.

- Full-range coaxial speakers provide extended frequency response and can handle higher-powered amplifiers
- Dual-cone speakers provide richer bass tones and crisper high tones
- Two-way speakers provide extended frequency response with both a tweeter and woofer
- Shielded magnet prevents signal distortion of TVs, monitors, and CTRs
- RMS: 10 watts
- Dimensions: 4.0" square
- Impedance: 8Ω
- Frequency range: 120 - 10kHz
- Magnet wt.: 6.0 oz.



Part No.	Mfr. Cross Ref. No.	1	10
196402CL	480P039-1	\$6.49	\$5.85

1.2" (30mm) PCB Mountable Speaker

- Round frame design • Ideal for PC board mounting
- Mylar diaphragm • Solder leads
- Impedance: 8Ω • Output SPL: 82 dB
- Nominal input: 0.15W; max. input: 0.2W
- Frequency range: 700 - 5000Hz
- Pin spacing: 15mm • Dimensions: 1.2"Dia. x 0.5"D



Part No.	Mfr. Cross Ref. No.	1	10	100
135722CL	PCMA15	\$2.15	\$1.79	\$1.59

For speaker cables and hookup wire, see page 57.



Microphone Cartridges

Omni-directional Electret Condenser Microphone Cartridges

Applications:

- Tape recorders, intercoms, hearing aids, telephone and answering devices, sonic controlled toys and sensors
- Modems for computers
- Used for recording, testing, and monitoring



116505CL



160979CL



136573CL



196488CL



140986CL

Part No.	Type	Sensitivity	Impedance	Frequency (Hz)	Max. Op. Volt. (VDC)	Stand Op. Volt. (VDC)	Current (Max.)	Sensitivity Reduction	S/N Ratio	Terminals	Size (H x Dia.)	Pricing			
												1	10	100	1000
116505CL	WM-54PC	-44 ±2dB	>2.2kΩ	20-16,000	10V	2.5V	0.6mA	-3dB @ 2V	>60dB	PC pin leads	.20" x .38"	\$0.69	\$0.62	\$0.50	\$0.33
160979CL	WM-64PKT	-44 ±3dB	>2.2kΩ	20-16,000	10V	2.0V	0.5mA	-3dB @ 1.5V	>58dB	PC pin leads	.10" x .24"	.72	.65	.52	.35
136573CL	WM-60PC	-54 ±2dB	>2.2kΩ	20-12,000	12V	4.5V	0.5mA	-3dB @ 3V	>40dB	PC pin leads	.30" x .38"	.53	.48	.43	.39
196488CL	JL-061C	-58 dB	2kΩ	20-20,000	10V	2.0V	0.04mA	-3dB @ 1.5V	>55dB	Solder pad	.10" x .24"	1.29	.99	.89	.79
140986CL	CRM919	-64 ±3dB	1kΩ ±30%	20-10,000	12V	3.0V	0.8mA	-3dB @ 3V	>40dB	Lead wires	.90" x .39"	1.49	1.14	1.05	.89

SALE

Buzzers and Sonic Transducers

Quantity **SAVE**

New Lower Prices

Magnetic Transducers

• Applied voltage: 1/2 duty, square wave

Part Number	Fig.	Operating Volt. (Vp-p/mA)	Voltage Range (Vp-p)	Frequency (Hz)	Sound (dB)	Dimensions	Pricing			
							1	10	100	1000
138721CL	1	1.5/10	1-2	2048	80	.32"H x .46" Dia.	\$1.49	\$1.15	\$0.89	\$0.79
207917CL	2	1.5/30	1-2	2048	75	.22"H x .47" Dia.	1.45	1.16	.87	.61
207925CL	3	1.5/70	1-2	2048	80	.50"L x .50" W x .30"H	\$0.69	\$0.53	\$0.46	\$0.42
207941CL	4	1.5/80	1-2	2731	80	.28"H x .38" Dia.	.99	.89	.80	.72
207968CL	5	1.5/80	1-2	2731	80	.22"H x .35" Dia.	\$1.20	\$0.98	\$0.84	.78
207909CL	2	3.6/40	1-4	1980	70	.22"H x .47" Dia.	.98	\$0.81	\$0.71	\$0.63
138739CL	1	5/40	3-8	2400	85	.35"H x .46" Dia.	1.49	1.29	.99	.89
106500CL	1	5/40	3-8	2400	85	.40"H x .48" Dia.	1.49	1.29	.99	.79
207933CL	4	5/100	4-8	3100	85	.28"H x .38" Dia.	\$1.09	\$0.86	\$0.55	.50
207950CL	5	5/100	4-8	3100	85	.22"H x .35" Dia.	\$1.35	\$1.04	\$0.81	.71

Magnetic Buzzers

Part Number	Fig.	Operating Volt. (VDC/mA)	Voltage Range (VDC)	Frequency (Hz)	Sound (dB)	Dimensions	Pricing			
							1	10	100	1000
207984CL	6	1.5/30	1.25-2	2300	75	.47"H x .38" Dia.	\$2.99	\$2.69	\$2.45	\$2.15
76064CL	6	5/30	4-7	2300	85	.35"H x .46" Dia.	2.99	2.69	2.45	2.19
207976CL	6	12/30	8-15	2300	85	.47"H x .38" Dia.	2.49	2.19	1.99	1.69

Piezo Buzzers

Part Number	Fig.	Operating Volt. (VDC/mA)	Voltage Range (VDC)	Frequency (Hz)	Sound (dB)	Dimensions	Pricing			
							1	10	100	1000
206295CL	6	12/6	3-20	2900	95	.63"H x .92" Dia.	\$2.49	\$2.25	\$1.95	\$1.75
196357CL	6	12/5.8	3-16	4000	86	.30"H x .54" Dia.	2.69	2.45	1.95	1.45
138712CL	6	12/7	3-16	4000	80	.30"H x .54" Dia.	2.49	2.25	1.79	1.35
207896CL	7*	12/120	6-15	2600/3100	105	3.4"L x 2.2"W x 1.3"H	2.98	2.55	2.25	2.28
207888CL	7†	12/120	9-15	1500-3100	105	3.4"L x 2.2"W x 1.3"H	\$7.95	3.75	3.18	2.24
207992CL	8	12/250	6-16	3500	105	2.3"L x 1.8"W x 1.6"H	6.95	6.29	5.65	5.09
32601CL	9	24/15	1-28	2900	95	1.4"H x 1.7" Dia.	4.95	4.45	3.95	3.59
123537CL	9*	24/20	4-28	2900	80	1.4"H x 1.7" Dia.	4.19	3.79	3.39	2.95
76021CL	10	24/20	1.5-28	3200	95	1.0"H x 1.1" Dia.	4.99	4.49	3.99	3.49

* Dual tone † Siren

Mechanical/ElectroMechanical Buzzers

Part No.	Description	1	10	100	1000					
						24871CL	11	9/30	6-12	400
105822CL	12	9/220	—	500	80	1.3"H x 2.0" Dia.	1.39	1.25	1.15	.91
140695CL	11	12/25	9-15	400	75	1.3"L x 0.7"W x 0.6"H	1.79	1.59	1.49	1.29



110VAC Piezo Buzzer

- Sound pressure level: 90dB
- Output tone: pulse • 6' lead wires
- Operating range: 60-150VAC
- Current drain: 20mA
- Fits 1.125" diameter opening
- Size: 1.3"H x 1.7" Dia.



Includes: Mounting nut

Part No.	Product No.	1	10	100
134743CL	FM-110A-903AL	\$3.19	\$2.99	\$2.69

Component Cabinet, Boxes and Drawers

Component Cabinet



- Drawer can be divided into 4 sections (clear)
- Wall mountable cabinet (ABS black)
- Cabinet size: 6.0"D x 15"W x 7.9"H • Wt.: 4.7 lbs.
- Drawer size: 5.5"L x 2.7"W x 1.5"H
- Divider size: 2.4"L x 1.1"H

Includes: 20 clear plastic drawers, 20 dividers and 30 adhesive I.D. labels

• Prepackaged: order in increments of 10 or 50

Part No.	Description	1	10	50
81701CL	Component cabinet	\$15.95	\$13.95	\$12.49
85454CL	Drawer for cabinet	.39	.35	.29
85446CL	Divider for drawer	.19	.17	

Plastic Flip Top Boxes

- Clear plastic box with a clear plastic lid and removable dividers
- 100255CL: Size: 8.4"L x 4.5"W x 1.4"H
- 18 compartments (1.4" x 1.5" each)
- 148902CL: Size: 10.2"L x 4.7"W x 1.6"H
- 12 compartments (1.7" x 2.3" each)

Part No.	Description	1	10	100
100255CL	18 compartments	\$2.25	\$1.95	\$1.75
148902CL	12 compartments	3.95	3.49	2.95

Plastic Flip Top Box

Double-Sided Box

- Unique double-sided design allows box to be opened from both top and bottom
- Size: 6.5"L x 4.0"W x 1.5"H

Part No.	Description	1	10	100
148865CL	Double sided box	\$2.59	\$2.00	\$1.71

Plastic Flip Top Case for SMDs

128 Compartments for Surface Mount Components

- 8 rows x 16 columns grid
- Flip top openings on each bin
- Padded cover locks bins closed
- Perfect match to store P/N 156881CL SMD resistor assortment, pg 43
- Size: 11.0"L x 8.3"W x 1.7" Thick
- Weight: 1.4 lbs. • Color: gray

Includes: Labels for each bin

Part No.	Description	1	10
164267CL	SMD flip top case	\$49.95	\$44.99

Stackable Drawers

- Case size: 4.5"L x 4.4"W x 2.3"H
- Drawer size: 4.4"L x 4.0"W x 0.9"H
- Color: blue/white

Part No.	Description	1	10	100
11906CL	Case/drawers	\$2.95	\$2.00	\$1.31

Bug Boxes

- Anti-static plastic
- Fits in bug cage (P/N 11332CL, below)
- 11341CL: stores sixty 8-pin or thirty 16-pin DIPs
- 11375CL: Designed to store all types of components
- Box size: 4.9"L x 3.3"W x 0.6"H

Part No.	Description	1	10	100
11341CL	30 compartments	\$3.95	\$3.49	\$3.15
11375CL	3 compart./6 vertical & 6 horizontal dividers	\$4.49	\$3.99	\$3.28

Bug Trays

- Fits in bug cage (P/N 11332CL, below)
- 11826CL Open: 1 compartment 4.6"L x 3.2"W x 0.4"H
- 11800CL Divided: 10 compartments 3.2"L x 0.4"W x 0.4"H ea.
- Tray size: 4.8"L x 3.6"W x 0.5"H

Part No.	Description	1	10	100
11826CL	Open bug tray	\$2.45	\$2.00	\$1.50
11800CL	Divided bug tray	\$3.45	\$2.70	\$2.28

Bug Cage

- Holds bug boxes or trays
- Modular and interlocking
- Color: blue • Weight: 0.7 lbs.
- Case size: 5.0"L x 3.9"W x 5.1"H

Part No.	Description	1	10	100
11332CL	Bug cage	\$7.95	\$6.00	\$4.00

Prototype Builder Boards, Enclosures and Hardware

Call for additional OEM pricing.

The prototype builder boards on this page are specifically designed to fit into our ABS speedy boxes, die cast aluminum enclosures, aluminum boxes, metal cabinets and heavy-duty instrument cases shown in each grouping. These pre-cut boards have 2 or 4 mounting holes compatible with the PC board mounting hardware listed at the bottom, right (P/N 106551CL).

Board description: laminated glass epoxy 1/16" thick fire retardant per FR-4 specs. Copper-clad and solder mask one side. Drilled holes: .035" diameter on .080" square pad. Pads spaced on .10" x .10" grid.



See page 105 for hardware and knobs;
see page 30 for more printed circuit board details

*All boards sold individually; multiple boards shown

ABS Speedy Enclosures

Will not crack or split when drilled or punched. PCB mounting slots on all four sides. Lid has a lip for precision fit (adds 0.4" height). Complete with four screws and lid. All sizes below are for interior dimensions. • Color: black • ABS plastic



Part No.	Product No.	Size (L x W x D)	Wt. (lbs.)	1	10	50	100
18921CL	H2855	3.1" x 2.0" x 0.9"	0.1	\$3.15	\$2.84	\$2.55	\$2.30
18913CL	H2853	4.9" x 2.5" x 1.5"	0.2	3.69	3.32	2.99	2.69
18892CL	H2851	6.0" x 3.5" x 1.9"	0.4	4.79	4.31	3.88	3.49
18905CL	H2852	7.5" x 4.3" x 2.3"	0.5	6.89	6.20	5.58	5.02

Printed Circuit Boards for Above Enclosures

• Power/ground, perimeter bus with pad per hole (*except P/N 105099CL) • Plated one side holes

Part No.	Product No.	Size (L x W)	No. of Holes	1	10	50	100
105099CL*	2855PCB	2.7" x 1.6"	288	\$5.25	\$4.73	\$4.25	\$3.83
105128CL	2853PCB	4.4" x 2.0"	669	7.95	6.95	6.25	5.59
105152CL	2851PCB	5.5" x 3.1"	1450	9.95	8.95	7.95	6.95
105161CL	2852PCB	7.0" x 3.6"	2225	14.95	13.45	11.95	10.95

Die-Cast Aluminum Enclosures

High-quality die-cast aluminum cases come with channeled walls for easy PCB mounting. Ideal for RF circuits because the lid forms an effective screen against RFI interference. Made from aluminum, an excellent heat-sink, these cases are great for high temp circuits (up to 600°C). Complete with screws.



Part No.	Product No.	Size (L x W x D)	Wt. (lbs.)	1	10	50	100
11957CL	B5002	3.9" x 2.0" x 1.0"	0.2	\$5.95	\$5.39	\$4.85	\$4.35
11965CL	B5004	4.7" x 2.4" x 1.6"	0.4	8.49	7.64	6.88	6.19
11973CL	B5006	7.5" x 4.3" x 2.4"	1.2	13.95	12.56	11.30	10.17

Printed Circuit Boards for Above Enclosures

• Power/ground, perimeter bus with pad per hole • Plated one side holes

Part No.	Product No.	Size (L x W)	No. of Holes	1	10	50	100
105101CL	5002PCB	3.5" x 1.5"	365	\$6.95	\$6.25	\$5.59	\$4.95
105128CL	2853PCB	4.4" x 2.0"	669	7.95	6.95	6.25	5.59
105161CL	2852PCB	7.0" x 3.6"	2225	14.95	13.45	11.95	10.95

Aluminum Enclosures

Ideal boxes for those projects that get left lying around! Put them in an economical aluminum enclosure. The enclosure comes in two pieces which slide together.



Part No.	Product No.	Size (L x W x D)	Wt. (lbs.)	1	10	50	100
11869CL	B2300	4.0" x 2.0" x 2.8"	0.2	\$5.45	\$4.69	\$4.22	\$3.79
11885CL	B2320	5.0" x 4.0" x 3.0"	0.4	7.89	6.15	5.55	4.99
11893CL	B2335	7.0" x 6.2" x 4.6"	0.8	10.95	9.25	8.29	7.49

Printed Circuit Boards for Above Enclosures

• Power/ground, perimeter bus w/ pad per hole • Ground Bus • Plated one side holes

Part No.	Product No.	Size (L x W)	No. of Holes	1	10	50	100
105110CL	2300PCB	3.4" x 2.4"	637	\$7.95	\$6.95	\$6.25	\$5.59
105136CL	2320PCB	4.5" x 3.3"	1266	9.95	8.95	7.95	6.95
105179CL	2335PCB	6.5" x 5.0"	2829	14.95	13.49	11.95	10.95

Metal Enclosures

High-quality metal enclosures are made to suit a large variety of electronics projects and applications. The base is made of aluminum. Slots are located on the sides of the cases for maximum cooling. Cases screw together and come with an attractive two-tone finish.



• Mounting screws and rubber feet included
• Glossy black textured steel top cover and ivory aluminum base

Part No.	Product No.	Size (L x W x D)	Wt. (lbs.)	1	10	50	100
208901CL	B2741A	4.0" x 3.3" x 2.2"	0.4	\$6.49	\$5.89	\$5.29	\$4.69
208910CL	B2743A	5.9" x 5.3" x 3.0"	0.8	7.99	7.19	6.49	5.89
208928CL	B2744A	7.3" x 6.3" x 2.8"	1.1	8.99	7.99	7.19	6.49
209349CL	B2746A	6.3" x 7.8" x 2.5"	0.9	12.35	11.12	9.99	8.99
209357CL	B2747A	7.5" x 9.8" x 3.2"	1.4	14.99	13.49	12.19	10.99

Printed Circuit Boards for Above Enclosures

• Power/ground, perimeter bus with pad per hole • Plated one side holes

Part No.	Product No.	Size (L x W)	No. of Holes	1	10	50	100
105110CL	230APCB	3.4" x 2.4"	637	\$7.95	\$6.95	\$6.25	\$5.59
206578CL	2743APCB	4.6" x 4.3"	1684	7.49	6.74	6.07	5.46
206586CL	2746APCB	4.3" x 6.8"	2550	10.95	9.86	8.87	7.98
206594CL	2747APCB	5.5" x 8.0"	3906	14.99	13.49	12.14	10.93
105179CL	2505PCB	6.5" x 5.0"	2829	14.95	13.49	11.95	10.95

Heavy-Duty Instrument Cases

Both cases split apart for ease of working. Four plastic feet molded on unit. P/N 18876CL includes ventilation and speaker sound slots. • Color: gray



Part No.	Product No.	Size (L x W x D)	Wt. (lbs.)	1	10	50	100
18868CL	H2505	7.9" x 6.3" x 2.5"	0.8	\$7.89	\$7.10	\$6.39	\$5.75
18876CL	H2507	10.0" x 7.5" x 3.1"	1.4	8.99	7.99	7.28	6.55

Printed Circuit Boards for Above Instrument Cases

• Power/ground, perimeter bus with pad per hole • Plated one side holes

Part No.	Product No.	Size (L x W)	No. of Holes	1	10	50	100
105179CL	2505PCB	6.5" x 5.0"	2829	\$14.95	\$13.49	\$11.95	\$10.95
105187CL	2507PCB	8.8" x 6.1"	4771	29.95	26.95	23.95	21.95

ABS Enclosures w/ Clear Tops

Made of gray ABS plastic w/ clear polycarbonate top cover. Includes screws for mounting boards or electronic components, rubber gasket for a tight seal on your equipment & drilled holes for mounting.



Part No.	Product No.	Size (L x W x D)	Wt. (lbs.)	1	10	50	100
141831CL	203C1	4.6" x 3.2" x 1.8"	0.3	\$8.95	\$8.09	\$7.25	\$6.55
141840CL	203D1	6.3" x 3.2" x 1.8"	0.4	9.95	8.99	8.09	7.25
141858CL	203F1	7.0" x 5.5" x 2.5"	0.8	11.95	10.79	9.69	8.69

Mounting Hardware for PC Boards

• 4 spacers, 8 screws and 8 washers

Part No.	Description	1	10	50	100
106551CL	PC board mounting hardware	\$1.79	\$1.65	\$1.45	\$1.35

For 3M Adhesive Rubber Feet, see page 105.



Aluminum & Brass Threaded Standoffs

† Finish: Iridite (clear) per MIL-C-5541-D;
bright tin plate²; stainless steel³

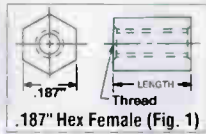

.187" Hex Female

4-40 Thread (Fig. 1) .187" Hex

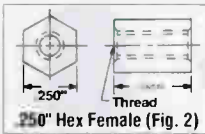

.250" Hex Female (Fig. 2)

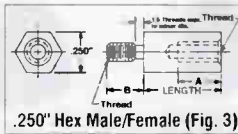

.250" Hex Male/Female (Fig. 3)

.250" Hex Male/Female

4-40 Thread (Fig. 3) (Thread A: .250"; B: .187")

Quantity
SAVE

Quantity
SAVE

* Prepackaged: order in
increments of 10, 100 or 1000

Part Number	Metal†	Hex Length	Pricing		
			10	100	1000
175636CL	Brass	.187"	\$.15	\$.13	\$.096
102795CL	Brass	.240"	.21	.15	.10
133612CL	Alum ¹	.250"	.20	.12	.09
133639CL	Alum ¹	.500"	.22	.20	.11
139791CL	Alum ¹	.562"	.18	.15	.13
133647CL	Alum ¹	.625"	.14	.13	.11
133655CL	Alum ¹	.750"	.39	.23	.14
139184CL	Alum ¹	1.000"	.39	.32	.27

.250" Hex Female

4-40 Thread (Fig. 2) .250" Hex

* Prepackaged: order in
increments of 10, 100 or 1000

Part Number	Metal†	Hex Length	Pricing		
			1	10	100
139192CL	Alum ¹	.250"	\$.16	\$.12	\$.08
77500CL	Alum ¹	.375"	.20	.15	.09
134762CL	Alum ¹	.437"	.21	.18	.15
108370CL	Alum ¹	.500"	.25	.17	.10
77518CL	Alum ¹	.625"	.42	.35	.19
133604CL	Alum ¹	.750"	.39	.35	.19
139205CL	Alum ¹	1.000"	.49	.35	.25

.250" Hex Female

6-32 Thread (Fig. 2) .250" Hex

* Prepackaged: order in
increments of 10, 100 or 1000

Part Number	Metal†	Hex Length	Pricing		
			1	10	100
77534CL	Alum ¹	.250"	\$.22	\$.14	\$.08
133591CL	Alum ¹	.375"	.29	.13	.09
77542CL	Alum ¹	.500"	.22	.17	.10
77551CL	Alum ¹	.625"	.25	.19	.14
77569CL	Alum ¹	.750"	.28	.21	.13
77577CL	Alum ¹	1.000"	.59	.35	.30
143407CL	Alum ¹	1.500"	.69	.61	.49
143440CL	Alum ¹	1.750"	.79	.59	.48

3M Adhesive Rubber Feet

These are perfect for project boxes,
providing a non-slip, non-scratch surface.



Part No.	Product No.	Type	Fig.	Pack	Dimensions (W" x H")	1	10	50
119618CL	SJ5012BLK4	Black cylindrical	1	4	.50 x .14	\$.39	\$.28	\$.26
142658CL	SJ5012BLKC	Black cylindrical	1	100	.50 x .14	5.95	5.35	4.79
142771CL	SJ5008BLKC	Black tapered square	2	100	.50 x .12	6.69	4.76	3.40
142682CL	SJ5018BLKC	Black tapered square	3	100	.50 x .23	9.95	8.25	5.39
126981CL	SJ5023BLK4	Black tapered square	4	4	.81 x .30	1.95	1.75	1.59
142666CL	SJ5023BLKC	Black tapered square	4	100	.81 x .30	14.25	9.10	8.69

See page 216 for
Spacers/Standoffs Assortments.



Hex .250" Male/Female

SAE Hardware

New Lower Prices

• Zinc-plated steel

Prepackaged: order in increments of 100 or 1000

Part Number	Screw Size	Thread	Length (inches)	100 piece minimum	
				100	1000
38172CL	2-56	Std	.250	\$.025	\$.022
40951CL	4-40	Std	.250	.019	.011
40969CL	4-40	Std	.375	.017	.012
106809CL	4-40	Std	.500	.018	.013
106542CL	6-32	Std	.250	.018	.013
42446CL	6-32	Std	.375	.019	.014
42438CL	6-32	Std	.500	.019	.015
106796CL	8-32	Std	.500	.04	.25

Part Number	Screw Size	Thread	Dia. (inches)	100 piece minimum	
				100	1000
38164CL	2-56	Std	.183	\$.022	\$.014
211123CL	4-40	Sm	.184	.023	.011
40942CL	4-40	Std	.243	.025	.013
42420CL	6-32	Std	.306	.014	.014
51553CL	8-32	Std	.334	.02	.014

Part Number	Screw Size	Dia. (inches)	100 piece minimum	
			100	1000
211131CL	4	.237	\$.09	\$.05
106825CL	4	.281	.022	.019
106833CL	6	.373	.022	.019
106841CL	8	.377	.04	.025

Part Number	Screw Size	Dia. (inches)	100 piece minimum	
			100	1000
106850CL	4	.258	\$.018	\$.015
106868CL	6	.277	.018	.015
106876CL	8	.323	.18	.15

Part Number	Screw Size	Dia. (inches)	100 piece minimum	
			100	1000
106788CL	2	.161	\$.024	\$.016
211140CL	4	.201	.02	.015
40977CL	4	.242	.02	.015
42462CL	6	.240	.011	.009
51609CL	8	.279	.012	.006

PCB Standoff Mounting Hardware



• Snap "on" • Nylon
 28337CL: 1.2"L x 0.6"W for 0.2" holes
 129251CL: 0.9"L x 0.4"Dia. for 0.2"/0.3" holes
 148056CL: 0.8"L x 0.5"W for 0.1"/0.2" holes
 156831CL: 0.68"L x 0.32"Dia for 0.140" holes
 • 10 piece minimum

Part No.	Mfr. Cross Ref. No.	10	100	1000
28337CA	PCST	\$.12	\$.07	\$.04
129251CA	PCST2	.18	.11	.075
148056CA	PCST3	.09	.08	.06
156831CA	KCS10	.125	.093	.063

We'll Send It Today!

Over 99% of our products are in stock!
 Just place your order by 6PM EST
 for same business day shipment.

New

Color Instrumentation Knobs (1/4" Shaft Diameters)

• CR-MS series: knurled shaft • JK-907 series: pressure fit type



Part No.	Product No.	Body Color	Pointer Color	Size (H" x Dia.)	1	10	100
264823CL	CPBTA191A1S6.4BK	Black/Black*	White	.79 x .77	\$.99	\$.93	\$.88
264786CL	CPBTA191A1S6.4RD	Black/Red	White	.79 x .77	.99	.93	.88
264794CL	CPBTA191A1S6.4YW	Black/Yellow	White	.79 x .77	.99	.93	.88
264807CL	CPBTA191A1S6.4BL	Black/Blue	White	.79 x .77	.99	.93	.88
264815CL	CPBTA191A1S6.4GN	Black/Green	White	.79 x .77	.99	.93	.88
264831CL	CPBTA191A1S6.4GY	Black/Grey	White	.79 x .77	.99	.93	.88
265156CL	JK-907A-BL	Grey/Blue	Blue	.76 x 1.27	1.99	1.87	1.78
265130CL	JK-907A-RD	Grey/Red	Red	.76 x 1.27	1.99	1.87	1.78
265148CL	JK-907A-YW	Grey/Yellow*	Yellow	.76 x 1.27	1.99	1.87	1.78
265181CL	JK-907B-BL	Grey/Blue	Blue	.86 x .94	1.99	1.87	1.78
265172CL	JK-907B-YW	Grey/Yellow	Yellow	.86 x .94	1.99	1.87	1.78
265164CL	JK-907B-RD	Grey/Red*	Red	.86 x .94	1.99	1.87	1.78
265199CL	JK-907C-RD	Grey/Red	Red	.72 x .68	1.99	1.87	1.69
265201CL	JK-907C-YW	Grey/Yellow	Yellow	.72 x .68	1.99	1.87	1.78
265210CL	JK-907C-BL	Grey/Blue*	Blue	.72 x .68	1.99	1.87	1.78
265050CL	JK-905A	Black/Red	White	.53 x .57	.92	.73	.66
265068CL	JK-905B	Black/Yellow	White	.53 x .57	.92	.73	.66
265076CL	JK-905C	Black/Blue	White	.53 x .57	.92	.73	.66
265084CL	JK-905D	Black/Green	White	.53 x .57	.92	.73	.66
265017CL	JK-904A	Black/Red	White	.47 x .78	.99	.93	.88
265025CL	JK-904B	Black/Yellow	White	.47 x .78	.99	.93	.88
265033CL	JK-904C	Black/Blue	White	.47 x .78	.99	.93	.88
265041CL	JK-904D	Black/Green	White	.47 x .78	.99	.93	.88
265261CL	CR-MS-5C5-T18	Grey	Grey	.68 x .51	.78	.67	.61
265252CL	CR-MS-4C5-T18	Grey	Green	.68 x .51	.78	.67	.61
265244CL	CR-MS-3C5-T18	Grey	Blue	.68 x .51	.78	.67	.61
265236CL	CR-MS-2C5-T18	Grey	Yellow	.68 x .51	.78	.67	.61
265228CL	CR-MS-1C5-T18	Gr	Red	.68 x .51	.78	.67	.61

* Photo shown

See pages 48-49 for our selection of Linear and Audio Taper Potentiometers.



New

Black Instrumentation Knobs (1/4" Shaft Diameters)

• Set screw for secure attachment • RN-112A/113A/114A: Numeric dial type



Part No.	Product No.	Body Color	Pointer Color	Size (H" x Dia.)	1	10	100
265092CL	JK-906A	Black	White	.72 x 1.39	\$1.09	\$.87	\$.80
265105CL	JK-906B	Black	White	.79 x .95	1.02	.71	.65
265113CL	JK-906C	Black	White	.64 x .82	.83	.62	.57
265121CL	JK-906D	Black	White	.58 x .61	.68	.53	.50
264997CL	JK-902A	Black	White	.69 x 1.31	.74	.57	.53
265009CL	JK-902B	Black	White	.60 x .95	.69	.47	.44
264920CL	JK-901A	Black/Alum	White	.79 x 1.77	1.34	1.16	1.05
264946CL	JK-901B	Black/Alum	White	.64 x 1.29	.90	.71	.65
264954CL	JK-901C	Black/Alum	White	.61 x 1.06	.75	.59	.54
264989CL	JK-901D	Black/Alum	White	.47 x .78	.68	.53	.48
264882CL	RN-112A	Black/Alum	Numeric	.90 x 1.46	.99	.93	.88
264891CL	RN-113A	Black/Alum	Numeric	.70 x 1.15	.99	.93	.88
264911CL	RN-114A	Black/Alum	Numeric	.58 x 1.46	.99	.93	.88
102787CL	KN141	Black	White	.54 x 1.25	.64	.41	.39
104176CL	KN143	Black	White	.49 x .75	.99	.85	.65
202286CL	K14SM	Black/Alum	White	.60 x .80	.79	.69	.64
136240CL	KN145	Black/Alum	White	.52 x .54	.65	.55	.49
138392CL	PKG90B	Black/Alum	White	.56 x .85	.79	.59	.54

Aluminum Instrumentation Knobs (1/8" and 1/4" Shaft Diameters)

Includes: Set screw for secure attachment
138384CL: Coarse surface for sensitive control; 1/8" shaft diameter



Part No.	Mr. Cross Ref. No.	Body Color	Pointer Color	Size (H" x Dia.)	1	10	100
162481CL	K5-1/4S	Chrome	Silver	.50 x .56	\$1.19	\$1.09	\$.96
138384CL	KD500G	Silver	Silver	.50 x .63	1.39	1.25	.99
162499CL	K5-1/4B	Black	White	.50 x .56	1.55	1.39	1.07
138481CL	KN031	Aluminum	Black	.61 x .65	1.49	1.29	.95
138501CL	KN032	Aluminum	Black	.87 x .75	1.95	1.71	1.55
138510CL	KN033	Aluminum	Black	1.18 x .87	2.49	2.24	1.95

Back Panel PC Cooling Fan

- Type: sleeve axial fan
- Back panel mountable
- Operating volt.: 12VDC @ 140mA
- Airflow: 43 CFM
- Noise ratio: 26dBA
- Power: 1.7W
- 10.5" wire with 4-pin Molex power connector
- Size: 4.3"L x 3.5"H x 1.1"Thick
- One-year warranty



Part No.	Description	1	10	50
152240CL	PC cooler fan	\$19.95	\$17.95	\$15.95

Thermoelectric Cooler Chips

- Cools down to -30°C (dependent on external temp.)
- T max. = 60°C
- 20 AWG wire leads, 4" long
- Heat or cool by changing direction of current

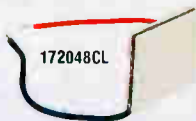

Part No.	Mfr. Cross Ref. No.	1	10
172030CL	TEC30	\$19.95	\$17.95
172048CL	TEC40	25.95	22.95
172056CL	TEC50	33.75	29.35

* Couples: # of P&N type semiconductor pairs connected electrically in series

Heat Sink Compound

Thermally loaded silicone-based grease that improves transfer of energy across the metal to metal interface between transistor or rectifier to heat sink.



- Color: opaque white

Part No.	Mfr. Cross Ref. No.	1	10	100
167249CL	THM250 (2 oz.)	\$9.95	\$8.96	\$8.06
236822CL	54114 (1 oz.)	4.95	4.49	3.95

Heat Sink Compound 4-Oz. Tube

This silicone-free compound provides more effective heat transfer. Will not harden, dry out, melt, or contaminate wave-solder baths.



Part No.	Product No.	1	10
169252CL	1978DP	\$16.95	\$14.95

Heat Sink Mounting Kits



- TO-3 and TO-220 heat sink insulator assemblies
- 10 kits per pack

Part No.	Type	Description	1	10	100
34121CL	TO-220	5 pieces	\$3.95	\$3.55	\$3.19
34139CL	TO-3	12 pieces	3.95	3.59	3.25

See below for Heat Sink Compound

CPU Heat Sinks and Fans

See page 5 for CPUs



New Lower Prices

Quantity SAVE

Quantity SAVE

- Excellent for avoiding CPU overheating during extended system on-time
- High efficiency cooling fans • Easy installation – just snap it in

Part No.	Description	Size (H x W x D")	Agency Approvals	1	10	50	100
211211CL	Heat sink w/ fan slot (SECC 1)	2.05 x 4.92 x 1.17	UL/CSA/TUV/CE	\$9.95	\$8.95	\$7.95	\$6.95
206244CL	Heat sink w/ dual fan slot (SECC 2)	5.25 x 1.95 x 1.30	CE	12.95	11.65	10.49	9.49
181278CL	Heat sink w/ fan for socket 7 (ATX)	2.12 x 2.05 x 1.67	UL/CE/CSA	8.49	7.65	6.89	6.19
216506CL	Heat sink w/ fan for socket 7 (A"/ATX)	1.95 x 2.05 x 1.37	CE	9.95	8.95	7.95	7.95
190545CL	Heat sink w/ fan for socket 370	2.45 x 2.42 x 2.10	—	14.99	13.99	12.99	11.99
185607CL	H-heat sink w/ fan for socket 7 & 370	0.98 x 2.37 x 2.40	CE	14.95	13.49	10.79	8.09
118092CL	Heat sink w/ fan for 586 CPU w. snap	2.18 x 2.30 x 0.86	UL/CE/TUV	3.95	3.19	2.39	1.69
129226CL	Heat sink for 486 CPU – adhesive back	1.70 x 1.63 x 0.36	—	2.95	2.65	2.39	2.15
129234CL	Heat sink for 486 CPU – adhesive back	1.70 x 1.64 x 0.66	—	2.09	1.74	1.58	1.44
191636CL	Heat sink w/ fan for 486 CPU w/ clip	1.85 x 1.92 x 0.72	UL/CE/TUV	5.95	4.95	2.99	1.99
174115CL	Heat sink w/ fan for 486 CPU w/ snap	1.93 x 1.96 x 0.93	UL/CUL	2.99	2.69	2.15	1.61

† 14 lead wires

Heat Sinks

Our TO-3/TO-218/TO-220 heat sinks are made from black anodized aluminum (except for P/N 107297CL which is light weight aluminum). They can be mounted horizontally or vertically depending on your applications. P/N 164734CL and 163846CL have mounting clips and some can be mounted vertically with solderable mounting tabs.



Part No.	Mfr. Cross Reference No.	Type	Watts	Size (L" x W" x H")	Pricing			
					1	10	100	1000
16512CL	DUDE4	TO 3	30.0	4.8 x 1.5 x 1.3	\$2.95	\$2.75	\$2.49	\$2.25
189835CL	635-5B2	TO 3	8.0	1.9 x 1.4 x 0.5	.95	.86	.68	.51
151546CL	635-125B2	TO-3	8.0	1.9 x 1.4 x 1.3	.99	.89	.67	.60
153846CL	THM7021B	TO-218/220	5.0	1.7 x 1.8 x 0.4	\$49.45	.39	.35	.29
42622CL	563002B00000	TO-220	3.9	1.2 x 1.0 x 0.5	.35	.30	.28	.26
228005CL	BK-T220	TO-220	3.9	1.2 x 1.0 x 0.5	.35	.30	.28	.26
40504CL	291-H-36AB	TO-220	2.0	0.9 x 1.0 x 0.4	.89	.79	.69	.59
158051CL	577102B00000	TO-220	2.0	.75 x .52 x .38	.39	.35	.29	.25
70914CL	THM6106	TO-220	1.9	1.2 x 1.0 x 0.5	35	30	26	26
70658CL	THM6073	TO-220	1.6	0.8 x 0.7 x 0.4	.22	.19	.16	.13
129242CL	THM6106	TO-220	1.6	1.2 x 1.0 x 0.5	.49	.45	.39	.35
107297CL	PSC-2-U (cup-style)	TO-220	1.5	0.8 x 1.0 x 0.4	.49	.45	.39	.35
164734CL	THM6072	TO-220	5.0	1.4 x 1.8 x 0.4	.49	.45	.39	.35

DC Brushless Fans

Color Code Legend
New Sale Low Save Closeout



163475CL



102921CL

Call for additional OEM PRICING – we carry major manufacturers.

- Low profile
- Ball and sleeve bearings
- Power input by lead wires or terminals
- PBT black thermo plastic frame and impeller
- Agency approved
- Low power consumption
- Low acoustical noise rating



213891CL

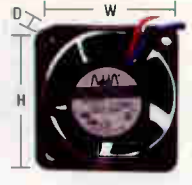

249375CL

SALE **UL** **SP** **CE** **DVE** **New Lower Prices** **Quantity SAVE**

Part Number	Manufacturer	Product Number	Voltage (VDC)	Size* (W" x H" x D")	Air Flow (CFM)	Bearing	Current (mA)	Power (Watts)	Agency Approvals	Noise (dBA)	Connection (Leads)	Pricing			
												1	10	50	100
163475CL	Nidec	C34427-55APP	5	1.00 x 1.00 x 0.40	0.5	Ball	90	0.45	—	22	2"	\$4.95	\$4.46	\$3.56	\$2.67
131246CL	Adda	AD0205LX-G50	5	1.00 x 1.00 x 0.40	1.8	Sleeve	100	0.5	UL/CSA/CE	15.6	5.5"	8.88	7.82	6.71	4.58
206156CL	Sunon	KDE0502PFB3-8	5	1.00 x 1.00 x 0.40	1.83	Ball	60	0.3	UL/CSA/TUV/CE	23	5"	11.95	10.95	9.95	8.95
196373CL	Sunon	KD0504PFB2-8	5	1.60 x 1.60 x 0.40	5.5	Ball	90	0.5	UL/CUL	23	12"	8.95	8.09	7.25	6.55
102921CL	Sunon	KD0504PFS2-8	5	1.60 x 1.60 x 0.40	6.3	Sleeve	120	0.6	UL/CUL	24.3	12"	7.95	6.95	6.25	5.59
171678CL	Delta	AFB0405HHD	5	1.60 x 1.60 x 0.80	8.6	Ball	700	2.0	—	36	2.5"	5.49	4.94	3.95	2.96
207061CL	Adda	AD0505MB-G90	5	2.00 x 2.00 x 0.40	10.5	Ball	120	0.7	UL/CSA/CE	24	11"	7.95	6.55	5.75	4.29
204433CL	Toyo	USTF802505HW	5	3.15 x 3.15 x 1.00	36	Ball	650	2.0	UL/VDE/CE	29	12"	10.95	8.95	7.89	5.89
212804CL	Sunon	KDE1202PFB3-8	12	1.00 x 1.00 x 0.40	1.3	Ball	40	0.5	UL/CUL/TUV/CE/VDE	26	5.9"	10.95	9.89	8.89	7.99
102912CL	Sunon	KD1202PFB2-8	12	1.00 x 1.00 x 0.40	2.0	Ball	60	0.7	UL/CSA/TUV	30	6"	11.95	8.59	7.95	7.49
212791CL	Sunon	KDE1202PFB1-8	12	1.00 x 1.00 x 0.40	2.4	Ball	80	1.0	UL/CUL/TUV/CE/VDE	33	5.9"	10.95	8.50	7.85	6.95
212767CL	Sunon	KDE1203PFB3-8	12	1.20 x 1.20 x 0.40	2.3	Ball	50	0.6	UL/CUL/TUV/CE/VDE	18.5	5.9"	10.95	8.75	7.85	6.95
212775CL	Sunon	KDE1203PFB2-8	12	1.20 x 1.20 x 0.40	3.0	Ball	60	0.8	UL/CUL/TUV/CE/VDE	25	5.9"	8.88	8.88	8.88	7.35
212783CL	Sunon	KDE1203PFB1-8	12	1.20 x 1.20 x 0.40	3.5	Ball	75	0.9	UL/CUL/TUV/CE/VDE	27	5.9"	10.95	8.50	7.85	6.95
212732CL	Sunon	KDE1235PFB3-8	12	1.40 x 1.40 x 0.40	3.2	Ball	50	0.6	UL/CUL/TUV/CE/VDE	18	5.9"	11.95	10.79	9.69	8.75
212741CL	Sunon	KDE1235PFB2-8	12	1.40 x 1.40 x 0.40	4.5	Ball	60	0.8	UL/CUL/TUV/CE/VDE	21	5.9"	11.95	9.49	8.49	7.65
212759CL	Sunon	KDE1235PFB1-8	12	1.40 x 1.40 x 0.40	5.2	Ball	80	1.0	UL/CUL/TUV/CE/VDE	25	5.9"	11.95	9.49	8.49	7.65
207052CL	Adda	AD0412MB-K90	12	1.60 x 1.60 x 0.25	5.5	Ball	60	0.72	UL/CSA/TUV/CE	25	5"	8.95	8.25	6.80	4.75
191476CL	Common Wealth	FP-108HX/DC	12	1.60 x 1.60 x 0.40	4.0	Sleeve	60	0.72	UL/CSA/TUV/CE	25	12"	5.95	4.79	3.59	2.55
210796CL	Sunon	KD1204PFB3H	12	1.60 x 1.60 x 0.40	4.7	Ball	50	0.6	UL/CUL/TUV/CE	24	14"	6.95	6.25	5.59	4.95
189691CL	Sunon	KD1204PFS2	12	1.60 x 1.60 x 0.40	6.3	Sleeve	70	0.9	UL/CSA/TUV	24	12"	7.95	7.19	5.75	4.35
161699CL	Sunon	KD1204PFB2-8	12	1.60 x 1.60 x 0.40	6.3	Ball	70	0.6	UL/CSA/TUV	30	12"	7.95	6.95	6.25	5.59
212716CL	Sunon	KDE1204PFB2-H	12	1.60 x 1.60 x 0.40	6.5	Ball	90	1.1	UL/CUL/TUV/CE/VDE	27	12"	6.65	4.95	4.36	3.95
213428CL	Adda ¹	AD0412HB-G76	12	1.60 x 1.60 x 0.40	6.7	Ball	100	1.2	CE	30.2	12/3 leads	7.59	7.19	6.99	5.95
212724CL	Sunon	KDE1204PFB1-H	12	1.60 x 1.60 x 0.40	8.3	Ball	110	1.4	UL/CUL/TUV/CE/VDE	34.4	12"	6.65	4.95	4.36	3.95
174131CL	Jamicon	JF0413S1M	12	1.60 x 1.60 x 0.50	3.8	Sleeve	90	1.1	UL/CSA/TUV	29	14"	2.95	2.66	2.12	1.59
213891CL	Adda	AD0412MB-D50	12	1.60 x 1.60 x 0.60	8.1	Ball	100	1.2	UL/CUL/CE	31.8	11.5"	7.59	7.19	6.45	5.85
136178CL	Adda	AD0412MS-C70	12	1.60 x 1.60 x 0.80	5	Sleeve	110	1.32	UL/CSA	23	9"	5.49	4.95	3.95	2.95
195899CL	Sunon	KDE1204PKS2	12	1.60 x 1.60 x 0.80	6.5	Sleeve	70	0.9	UL/CSA/TUV	25.5	12"	7.95	7.19	5.75	4.29
75344CL	Delta	DFB0412M	12	1.60 x 1.60 x 0.80	7.3	Ball	80	0.8	UL/CSA/VDE/CE	28	4.5"	7.69	6.92	5.54	4.15
195881CL	Common Wealth	FP-108G/DC(S1)	12	1.60 x 1.60 x 0.80	7.6	Ball	160	1.92	UL/CSA/CE	32	12"	7.88	6.82	5.88	4.88
206447CL	Delta	DFB0412H	12	1.60 x 1.60 x 0.80	8.5	Ball	100	1.0	UL/CSA/VDE	32	8"	7.95	6.95	6.25	4.29
249375CL	Adda ²	AD0412-12HB-C56	12	1.60 x 1.60 x 0.80	9.2	Ball	100	1.1	UL/CUL/TUV/CE	39.3	12"	8.95	8.09	7.25	6.55
206164CL	Sunon	KDE1204PKBX-8	12	1.60 x 1.60 x 0.80	10	Ball	90	1.1	UL/TUV/CE	29.4	12"	8.95	7.95	6.95	6.95
212679CL	Sunon	KDE1245PFB3-H	12	1.80 x 1.80 x 0.40	6.1	Ball	60	0.7	UL/CUL/TUV/CE/VDE	23	12"	6.65	4.95	4.36	3.95
212687CL	Sunon	KDE1245PFB2-H	12	1.80 x 1.80 x 0.40	8.0	Ball	90	1.1	UL/CUL/TUV/CE/VDE	29	12"	6.65	4.95	4.36	3.95
212695CL	Sunon	KDE1245PFB1-H	12	1.80 x 1.80 x 0.40	9.5	Ball	110	1.4	UL/CUL/TUV/CE/VDE	33.8	12"	6.65	4.95	4.36	3.95
212644CL	Sunon	KDE1205PFB3-HG	12	2.00 x 2.00 x 0.40	8.5	Ball	60	0.7	UL/CUL/TUV/CE/VDE	26	12"	8.88	8.88	8.88	7.35
212652CL	Sunon	KDE1205PFB2-HG	12	2.00 x 2.00 x 0.40	10.6	Ball	80	1.0	UL/CUL/TUV/CE/VDE	31.5	12"	6.65	4.95	4.36	3.95
212661CL	Sunon	KDE1205PFB1-HG	12	2.00 x 2.00 x 0.40	12.5	Ball	110	1.4	UL/CUL/TUV/CE/VDE	36	12"	6.65	4.95	4.36	3.95
212628CL	Sunon	KDE1205PHB3-H	12	2.00 x 2.00 x 0.60	10.2	Ball	60	0.7	UL/CUL/TUV/CE/VDE	22.5	12"	8.95	7.95	6.71	5.88
206965CL	Adda	AD0512HB-D71	12	2.00 x 2.00 x 0.60	11.7	Ball	100	1.2	UL/CUL/TUV/CE	28.5	5"	8.95	7.45	5.87	4.88
139601CL	Adda	AD0512HS-D71	12	2.00 x 2.00 x 0.60	12	Sleeve	100	1.2	UL/CSA/CE	29	12"	8.95	8.09	7.25	6.55
206172CL	Sunon ³	KDE1205PHB2-TM	12	2.00 x 2.00 x 0.60	12.7	Ball	140	1.7	UL/CSA/CE	27.8	11/3 leads	7.88	6.81	5.72	4.29
212636CL	Sunon	KDE1205PHB2-H	12	2.00 x 2.00 x 0.60	13	Ball	80	1.0	UL/CUL/TUV/CE/VDE	29.5	12"	6.65	4.95	4.36	3.95
147491CL	Shicoh	0610-12HH	12	2.36 x 2.36 x 0.40	16.2	Ball	150	1.8	—	38	5"	7.95	7.19	5.75	4.29
195944CL	Adda	AD612MS-D71GL	12	2.36 x 2.36 x 0.60	14.2	Sleeve	110	1.32	UL/CSA/TUV/CE	28.8	6"	6.95	6.29	5.05	3.79
249068CL	Jamicon	JF0615B1H	12	2.36 x 2.36 x 0.60	15.74	Ball	170	2.04	UL/CUL/TUV/CE	34	10.5"	8.75	7.89	7.09	6.39

¹ 213428CL: ATX PC type ² 249375CL: Speed sensor ³ 206172CL: Locked rotor alarm

DC Brushless Fans continued on pages 109 & 110

*Size Conversion: Inches to mm

Inches	mm	Inches	mm	Inches	mm	Inches	mm
0.25	6	1.00	25	2.00	50	3.72	95
0.40	10	1.20	30	2.36	60	3.83	97
0.60	15	1.40	35	2.48	75	4.68	120
0.80	20	1.60	40	3.15	80	5.90	150
0.90	23	1.80	45	3.63	92	6.75	170

See the yellow and green highlighted items.

Jameco Special Values!

Details on page 2.



234894CL



102955CL

SALE

Call for additional OEM PRICING – we carry major manufacturers.

- Low profile
- Ball and sleeve bearings
- Power input by lead wires or terminals
- PBT black thermo plastic frame and impeller
- Agency approved
- Low power consumption
- Low acoustical noise rating



Quantity **SAVE**



227900CL

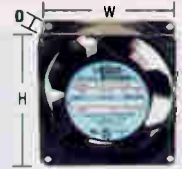

102875CL

Part Number	Manufacturer	Product Number	Voltage (VDC)	Size* (W" x H" x D")	Air Flow (CFM)	Bearing	Current (mA)	Power (Watts)	Agency Approvals	Noise (dBA)	Connection (Leads)	Pricing				
												1	10	50	100	
175046CL	Globe Motors	D24-B08A-04W3-000	12	2.36 x 2.36 x 0.80	10.6	Ball	90	0.8	UL/CSA/TUV/CE	22	13'	\$6.95	\$6.25	\$4.95	\$3.75	
144160CL	Adda	AD0612LB-C70GL	12	2.36 x 2.36 x 0.80	12.6	Ball	80	1.0	UL/CSA/TUV	22.7	6'	8.49	7.69	6.15	4.65	
189595CL	Sunon	KD1206PKS2	12	2.36 x 2.36 x 0.80	16.5	Sleeve	150	1.8	UL/CSA/TUV/CE	31	12'	4.95	3.99	2.99	2.09	
185818CL	Cheng	CHA6012DB	12	2.36 x 2.36 x 0.90	20.5	Ball	180	2.5	UL	33	12'	6.95	6.29	5.05	3.79	
237075CL	Nidec	TA225DC-B33399-55	12	2.36 x 2.36 x 1.00	12	Ball	110	1.3	UL/CSA	17.2	10'	5.85	5.25	4.15	3.25	
75352CL	Common Wealth	FP108FDC12VS2	12	2.36 x 2.36 x 1.00	15.5	Sleeve	110	1.3	UL/CSA/TUV/CE	25	12'	6.95	6.29	5.05	3.79	
136143CL	Delta	SB0612M	12	2.36 x 2.36 x 1.00	17.7	Sleeve	110	1.8	UL/CSA/VDE	26.5	5'	5.95	4.95	3.95	2.95	
102947CL	Jamicon	JF0625S1H	12	2.36 x 2.36 x 1.00	20.5	Sleeve	230	2.7	UL/CSA/TUV	30.5	11'	6.95	6.29	5.05	3.79	
150421CL	Jamicon	JF0625B1H	12	2.36 x 2.36 x 1.00	20.5	Ball	230	2.7	UL/CSA/TUV	30.5	10'	6.95	6.29	5.65	5.09	
191548CL	Common Wealth	FP108FOC12VS1B	12	2.36 x 2.36 x 1.00	21	Ball	130	1.6	UL/CSA/TUV/CE	30	12'	6.95	6.26	5.00	3.75	
195910CL	Sunon	KD1206PTS1	12	2.36 x 2.36 x 1.00	21.7	Sleeve	190	2.3	UL/CSA/TUV	34	12'	\$6.95	5.44	4.21	3.00	
109081CL	Adda	AD0812HS-D71	12	3.15 x 3.15 x 0.60	29	Sleeve	190	2.3	UL/CSA/TUV/CE	31.4	12'	9.95	8.99	8.09	7.25	
141920CL	Adda	AD0812HB-C70	12	3.15 x 3.15 x 0.80	27.3	Ball	240	2.9	UL/CSA/CE	34	12'	\$1.25	6.35	5.75	5.25	4.75
16993CL	Various ¹	FAN7315SL	12	3.15 x 3.15 x 1.00	25-40*	Sleeve	120-200*	1-2*	UL/CSA*	25*	4-12**	6.95	6.29	5.65	4.95	
75361CL	Various *	FAN6315BL	12	3.15 x 3.15 x 1.00	25-40*	Ball	120-200*	1-2*	UL/CSA*	25*	4-12**	5.95	5.39	4.35	3.25	
234894CL	Adda	AD0812LB-A70GL	12	3.15 x 3.15 x 1.00	27.6	Ball	120	1.44	UL/CSA/TUV/CE	22.5	11.5	8.19	6.39	5.89	5.49	
154288CL	Sunon	KDE1208PTS3-6	12	3.15 x 3.15 x 1.00	29.4	Sleeve	120	1.4	UL/CSA/TUV/CE	24.5	5.5'	4.55	4.09	3.29	2.45	
195952CL	Panasonic	FMB-08A12M	12	3.15 x 3.15 x 1.00	30	Sleeve	124	1.5	UL/CSA	28	11'	\$5.95	4.55	4.09	3.29	2.45
123529CL	Adda	AD0812MS-A70GL	12	3.15 x 3.15 x 1.00	32	Sleeve	150	1.8	UL/CSA/TUV	28.3	12'	6.95	6.29	5.05	3.79	
166959CL	NMB (Smart Fan)†	3110NL-012Q340-00	12	3.15 x 3.15 x 1.00	35	Ball	290	3.5	UL/CSA	35	2'	8.95	8.09	6.49	4.85	
191599CL	NMB	3110KL-04W-B50	12	3.15 x 3.15 x 1.00	39	Ball	230	2.7	CSA	34	10'	7.49	6.75	5.39	3.95	
185834CL	Panallo	FBM08A12H	12	3.15 x 3.15 x 1.00	39.6	Sleeve	220	2.1	—	32	11'	6.95	6.29	5.05	3.79	
206181CL	Sunon	KDE1208PTS1-6	12	3.15 x 3.15 x 1.00	42	Sleeve	220	2.6	UL/CSA/TUV/CE	34	9'	5.95	5.35	4.29	3.25	
185826CL	NMB ²	3110KL-04W-B69	12	3.15 x 3.15 x 1.00	42	Ball	340	3.1	UL/CSA/VDE/CE	35	13*/3 leads	6.95	6.29	5.05	3.79	
102955CL	Sunon	KD1208PTB1-6	12	3.15 x 3.15 x 1.00	42.5	Ball	220	2.6	UL/CSA/TUV/CE	33.5	12'	6.49	5.85	5.29	4.75	
249148CL	Sunon	KDE1208PTB1-6	12	3.15 x 3.15 x 1.00	42.5	Ball	—	2.6	—	33.5	12'	6.49	5.85	5.29	4.75	
172460CL	Nidec ³	TA300DCM33406-68	12	3.15 x 3.15 x 1.00	43	Ball	290	3.5	UL/CSA	41	11*/3 leads	9.95	8.99	7.19	5.39	
189755CL	Cheng	CHA8012DB	12	3.15 x 3.15 x 1.00	44.3	Ball	300	3.6	UL	37	2' w/ conn.	5.95	5.39	4.35	3.29	
196015CL	Cheng	CHA9212CB	12	3.63 x 3.63 x 1.00	44.1	Ball	190	2.3	UL/CSA	31	12'	\$5.95	5.25	4.69	3.79	2.89
75441CL	Common Wealth	FP108BDC12VS1	12	3.63 x 3.63 x 1.00	45	Sleeve	320	3.1	UL/CSA/TUV/CE	32	10'	3.19	2.79	2.49	2.29	
196007CL	Jamicon	JF0925S1M	12	3.63 x 3.63 x 1.00	45.4	Sleeve	200	2.4	UL/CSA/TUV/CE	34	12'	3.19	2.75	2.20	1.65	
154641CL	Nidec	TA350DC-M33422-16	12	3.63 x 3.63 x 1.00	48	Ball	290	3.5	UL/CSA	43	12'	7.55	6.79	5.45	4.09	
206199CL	Sunon	KDE1209PTS1-6	12	3.63 x 3.63 x 1.00	48.5	Sleeve	190	2.3	UL/CSA/TUV/CE	32.5	12'	\$2.67	4.39	3.89	3.65	
189780CL	Delta	DFB0912H	12	3.63 x 3.63 x 1.00	49.5	Ball	300	3.1	UL/CSA/TUV	35	5'	6.95	6.26	5.63	5.07	
190983CL	Sunon	KD1209PTB1-6A	12	3.63 x 3.63 x 1.00	51	Ball	220	2.6	UL/CSA/TUV	34	12'	7.25	6.55	5.89	5.29	
116476CL	Jamicon	JF0925S1H	12	3.63 x 3.63 x 1.00	52	Sleeve	350	4.2	UL/CSA/TUV	37	10'	\$2.95	4.19	4.09	3.69	3.35
162739CL	NMB (Smart Fan)†	3610KL-04W-B56	12	3.63 x 3.63 x 1.00	55	Ball	430	3.8	UL/CSA/VDE/CE	37	10*/3 leads	\$2.95	7.19	6.47	5.18	3.88
102963CL	Nidec	TA350DC-M33503-55	12	3.63 x 3.63 x 1.00	56	Ball	400	4.8	UL/CSA	45	8'	7.95	6.95	6.25	5.59	
213567CL	Nidec ⁴	A34124-33	12	3.83 x 3.72 x 1.30	25	Ball	650	7.8	UL/CUL	60	11.5*/3 leads	19.95	17.95	16.25	14.59	
174140CL	Common Wealth	FP108MS3	12	4.68 x 4.68 x 1.00	54	Sleeve	140	1.7	UL/CSA/TUV/CE	25	12'	6.95	6.29	5.05	3.79	
227900CL	Common Wealth	FP-108M-S1-B	12	4.68 x 4.68 x 1.00	80	Ball	330	4.0	UL/CSA/VDE/CE	42	12'	10.95	9.85	8.89	7.99	
102875CL	Delta	WFB1212H	12	4.68 x 4.68 x 1.00	86.5	Ball	360	4.3	UL/CSA/TUV	37.6	12	10.95	9.89	7.95	5.95	
174924CL	Globe Motors	D47-B10A-04T3-000	12	4.68 x 4.68 x 1.00	90	Ball	740	6.8	UL/CSA	39	Terminals	6.95	6.29	5.05	3.79	
163619CL	NMB (Smart Fan)†	4710NL012P535PO	12	4.68 x 4.68 x 1.00	90	Ball	740	8.9	—	38.5	12'	4.95	4.49	3.59	2.69	
159020CL	Sunon	KOE1212PMS1-6A	12	4.68 x 4.68 x 1.50	107	Sleeve	570	6.8	UL/CSA/TUV	41	12'	11.95	10.76	8.60	6.45	
163601CL	Delta (Smart Fan)†	WFC1212BE	12	4.68 x 4.68 x 1.50	108	Ball	650	6.6	UL/CSA/VDE	41.3	12'	10.95	9.89	7.95	5.95	
94625CL	Sunon	KD1212PMB1-6A	12	4.68 x 4.68 x 1.50	108	Ball	570	6.8	UL/CSA/TUV/CE	42	12'	11.95	10.79	8.65	6.49	
189851CL	Delta	WFB1212HE	12	4.68 x 4.68 x 1.50	108	Ball	490	5.9	UL/CSA/VDE/CE	41.3	12'	11.95	10.79	8.65	6.45	

¹ 16993CL: Replacement for the PC/XT computer power supply fan
² 185826CL: Speed sensor
³ 172460CL: Locked rotor alarm
⁴ 213567CL: Blower type
 † Temperature control: P/N 166959CL (40°C); P/N 162739CL (50°C, 3 leads); P/Ns 163619CL/163601CL (35°C)
 * Manufacturer & specifications may vary

DC Brushless Fans continued on page 110

• Size Conversion: Inches to mm

Inches	mm	Inches	mm	Inches	mm	Inches	mm
0.25	6	1.00	25	2.00	50	3.72	95
0.40	10	1.20	30	2.36	60	3.83	97
0.60	15	1.40	35	2.48	75	4.68	120
0.80	20	1.60	40	3.15	80	5.90	150
0.90	23	1.80	45	3.63	92	6.75	170

30-Day Money-Back Guarantee
 If you're not satisfied we'll take it back!
 Details on page 229.

DC Brushless Fans (Continued)

Color Code Legend
New Sale Qty. Save Closeout



227248CL



136160CL

Call for additional OEM PRICING – we carry major manufacturers.

- Low profile
- Ball and sleeve bearings
- Power input by lead wires or terminals
- PBT black thermo plastic frame and impeller
- Agency approved
- Low power consumption
- Low acoustical noise rating



Quantity **SAVE**



236099CL

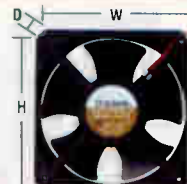

153411CL

Part Number	Manufacturer	Product Number	Voltage (VDC)	Size* (W" x H" x D")	Air Flow (CFM)	Bearing	Current (mA)	Power (Watts)	Agency Approvals	Noise (dBA)	Connection (Leads)	Pricing			
												1	10	50	100
206201CL	Sunon	KDE2404PKB3	24	1.60 x 1.60 x 0.80	6	Ball	30	0.7	UL/CSA/TUV/CE	24	12"	\$7.49	\$6.79	\$6.09	\$5.49
100909CL	Sunon	KD2404PKS2	24	1.60 x 1.60 x 0.80	6.5	Sleeve	50	1.2	UL/CSA/TUV/CE	25.5	12"	7.95	7.19	5.75	4.19
140661CL	NMB	2408NL-05W-B60	24	2.36 x 2.36 x 0.80	18.4	Ball	100	2.4	—	31	2"	5.95	5.39	4.34	3.24
174107CL	Jamicon	JF0625S2M	24	2.36 x 2.36 x 1.00	18	Sleeve	130	3.1	UL/TUV	28.5	10"	4.95	4.04	3.23	2.42
189860CL	Jamicon	JF0625B2M	24	2.36 x 2.36 x 1.00	18	Ball	130	3.1	UL/CSA/TUV/CE	28.5	10"	8.95	8.09	7.25	6.55
227248CL	Mechatronics	F6025E24B	24	2.36 x 2.36 x 1.00	24	Ball	125	3.0	UL/CUL/TUV	36	12"	7.95	7.59	6.49	5.99
136160CL	Jamicon	JF0825B2H	24	3.15 x 3.15 x 1.00	39.2	Ball	150	3.6	UL/CSA/TUV	31	12"	9.49	8.55	7.69	6.95
189878CL	Sunon	KD2408PTB1-6A	24	3.15 x 3.15 x 1.00	42.5	Ball	220	2.6	UL/CSA/TUV/CE	36.5	12"	9.95	8.99	7.19	5.39
236099CL	PAPST ¹	8314/19H	24	3.15 x 3.15 x 1.25	32	Ball	245	6.0	UL/CSA/VE/CE	36	12*3 leads	9.95	8.95	8.09	7.25
189886CL	NMB	3610KL-05W-B30	24	3.63 x 3.63 x 1.00	40.6	Ball	87	2.1	UL/CSA/VE	34	12"	7.95	6.39	4.79	3.35
174094CL	Jamicon	JF0925S2H	24	3.63 x 3.63 x 1.00	52	Sleeve	190	4.6	UL/CUL	37	10"	6.95	6.26	5.00	3.75
206210CL	Sunon	KDE2412PTS3-6A	24	4.68 x 4.68 x 1.00	67	Sleeve	130	3.1	UL/CSA	35	12"	9.95	8.99	8.09	7.25
175281CL	Globe Motors	D47B10A05W2000	24	4.68 x 4.68 x 1.00	70	Ball	160	2.9	UL/CSA/TUV/CE	34	12"	12.95	11.69	9.35	6.99
249287CL	Jamicon	JF1225B2H5	24	4.68 x 4.68 x 1.00	82.97	Ball	500	12	—	41.1	7.5"	12.39	11.15	9.99	8.99
206228CL	Sunon ¹	KDE2412PMS1-6A	24	4.68 x 4.68 x 1.00	107	Sleeve	310	7.4	UL/CSA/TUV/CE	41	11*3 leads	12.95	11.69	9.35	6.99
100968CL	Sunon	KDE2412PMB3-6A	24	4.68 x 4.68 x 1.50	83	Ball	140	3.4	UL/CSA/TUV/CE	35	12"	12.95	11.69	9.35	6.99
153411CL	Sunon	KD2412PMB2-6A	24	4.68 x 4.68 x 1.50	98	Ball	230	5.5	UL/CSA/TUV	36.5	12"	11.95	10.79	9.69	8.75
166730CL	Mechatronics	A9225H48B	48	3.63 x 3.63 x 1.00	51	Ball	100	4.8	UL/CSA/TUV	36	13"	3.75	3.41	3.10	2.82
196710CL	PAPST ²	7118N/12	48	6.75 x 5.90 x 1.50	212	Ball	250	12	UL/CSA/VE/CE	55	13*3 leads	3.75	3.41	3.10	2.82

¹ 236099CL/206228CL: Locked rotor alarm

² 196710CL: Speed sensor

AC Tube Axial Fans

Call for additional OEM PRICING – we carry major manufacturers.



111915CL



16977CL



- Rating 115 & 220VAC @ 50-60Hz
- Low acoustical noise rating
- Agency approved fans
- Ball and sleeve bearings
- Air flow from 10.2 to 226 CFM

Fan Power Cords on Next Page



102904CL



75432CL

Part Number	Manufacturer	Product Number	Voltage (VAC)	Size* (W" x H" x D")	Air Flow (CFM)	Bearing	Current (mA)	Power (Watts)	Agency Approvals	Noise (dBA)	Connection (Leads)	Pricing			
												1	10	50	100
162704CL	Toyo	USTF60301153W	115	2.36 x 2.36 x 1.18	11	Ball	38	4	UL/CSA/CE	29	12" leads	\$15.49	\$13.95	\$12.55	\$11.29
213866CL	Fulltech	UF60D11H	115	2.36 x 2.36 x 1.18	10.2	Ball	35	4	UL/CUL/VE/CE	28	12" leads	15.95	14.39	12.95	11.65
146077CL	Common Wealth	FP108AX-S1-B	115	3.15 x 3.15 x 1.00	23	Ball	140	14	UL/CE	29	12" leads	12.95	11.69	10.49	9.45
75408CL	Fulltech	UF80B12SWH	115	3.15 x 3.15 x 1.00	24	Sleeve	140	14	UL/CSA/TUV/CE	35	12" leads	14.95	13.49	12.15	10.95
212610CL	Fulltech	UF80B12BTH	115	3.15 x 3.15 x 1.00	24	Ball	140	14	UL/CSA/TUV/CE	35	Terminals	12.95	11.95	10.95	9.95
111915CL	Fulltech	UF80A12SWL	115	3.15 x 3.15 x 1.50	25	Sleeve	110	12	UL/CSA/TUV/CE	32	12" leads	11.95	10.95	9.95	8.95
16977CL	Fulltech	UF80A12BWL	115	3.15 x 3.15 x 1.50	25	Ball	110	11	UL/CSA/TUV/CE	32	12" leads	13.95	12.59	11.35	10.19
16969CL	Fulltech	UF80A12BTL	115	3.15 x 3.15 x 1.50	25	Ball	110	12	UL/CSA/TUV/CE	32	Terminals	14.95	11.99	8.99	8.59
102904CL	Fulltech	UF80A12BWH	115	3.15 x 3.15 x 1.50	29	Ball	120	12	UL/CSA/TUV/CE	36	12" leads	14.95	13.49	12.15	10.95
212601CL	Fulltech	UF80A12BTH	115	3.15 x 3.15 x 1.50	30	Ball	120	12	UL/CSA/TUV/CE	36	Terminals	13.95	12.95	11.95	10.95
75432CL	Sunon	SF11592A-1092HSL	115	3.63 x 3.63 x 1.00	36	Sleeve	130	12	UL/CSA/TUV/CE	39	12" leads	13.95	12.59	11.35	10.19
75459CL	Sunon	SF11592A-1092HBT	115	3.63 x 3.63 x 1.00	37	Ball	110	12	UL/CSA/TUV/CE	40	Terminals	15.95	14.39	12.95	11.65
124062CL	Sunon	SP101AT1122HBT	115	4.68 x 4.68 x 1.00	78	Ball	180	18	CSA/TUV/CE	46	Terminals	13.49	10.95	9.89	9.19

AC Tube Axial Fans continued on page 111

*Size Conversion: Inches to mm

Inches	mm	Inches	mm	Inches	mm	Inches	mm
0.25	6	1.00	25	2.00	50	3.72	95
0.40	10	1.20	30	2.36	60	3.83	97
0.60	15	1.40	35	2.48	75	4.68	120
0.80	20	1.60	40	3.15	80	5.90	150
0.90	23	1.80	45	3.63	92	6.75	170

Phone 1-800-831-8242
Online www.jameco.com

Order Anytime 24x7x365

Fax 1-800-237-6948



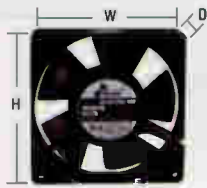

Call for additional OEM PRICING – we carry major manufacturers



- Rating 115 & 220VAC @ 50-60Hz
- Low acoustical noise rating
- Agency approved fans
- Ball and sleeve bearings
- Air flow from 11 to 226 CFM

Fan Power Cords Below

Quantity **SAVE**

New Lower Prices



118965CL

109874CL

106585CL

102891CL

Part Number	Manufacturer	Product Number	Voltage (VAC)	Size * (W" x H" x D")	Air Flow (CFM)	Bearing	Current (mA)	Power (Watts)	Agency Approvals	Noise (dBA)	Connection (Leads)	Pricing			
												1	10	50	100
118965CL	Fulltech	UF12A12BTL1	115	4.68 x 4.68 x 1.50	64	Ball	80	15	UL/CSA/TUV/CE	37	Terminals	\$14.95	\$13.49	\$12.15	\$10.95
109874CL	Fulltech	UF12A12STL	115	4.68 x 4.68 x 1.50	81	Sleeve	150	15	UL/CSA/TUV/CE	38	Terminals	12.95	11.69	10.55	9.49
111894CL	Common Wealth	FP108-1-S1-W	115	4.68 x 4.68 x 1.50	105	Sleeve	180	17	UL/CSA/CE	47	12" leads	13.95	12.59	11.35	10.19
106585CL	Common Wealth	FP108-1-S1/T	115	4.68 x 4.68 x 1.50	105	Sleeve	180	12	UL/CSA/CE	47	Terminals	15.95	14.39	12.95	11.65
16934CL	Common Wealth	FP108-1-S1-B	115	4.68 x 4.68 x 1.50	105	Ball	200	17	UL/CSA/TUV/CE	47	Terminals	16.95	15.29	13.75	12.39
212599CL	Fulltech	UF12A12BWH	115	4.68 x 4.68 x 1.50	106	Ball	190	15	UL/CSA/TUV/CE	46	12" leads	12.95	11.95	10.95	9.95
206308CL	Adda	AA1281UB-AT	115	4.68 x 4.68 x 1.50	107	Ball	230	24	CE	48	Terminals	14.95	13.45	10.79	8.09
102883CL	Sunon	SP100A-1123XBT	115	4.68 x 4.68 x 1.50	117	Ball	240	20	UL/CSA/TUV/CE	50	Terminals	14.95	13.95	12.95	11.95
108724CL	Fulltech	UF15AC12BTH	115	6.75 x 5.90 x 1.50	211	Ball	230	28	UL/CSA/TUV/CE	58	Terminals	27.95	27.10	26.29	25.49
212564CL	Fulltech	UF15PC12BTL	115	6.75 x 5.90 x 2.00	113	Ball	260	30	UL/CSA/TUV/CE	41	Terminals	\$34.95	34.49	33.25	32.39
212572CL	Fulltech	UF15PC12BWL	115	6.75 x 5.90 x 2.00	113	Ball	260	30	UL/CSA/TUV/CE	41	12" leads	\$28.95	28.49	27.58	27.44
212581CL	Fulltech	UF15PC12BWH	115	6.75 x 5.90 x 2.00	226	Ball	250	30	UL/CSA/TUV/CE	58	12" leads	29.95	26.95	23.95	21.49
189683CL	Fulltech	UF15PC12BTH	115	6.75 x 5.90 x 2.00	226	Ball	250	30	CSA	58	Terminals	29.95	26.95	21.59	16.19
174932CL	NMB	3115FS-23T-B10	220	3.15 x 3.15 x 1.50	25	Ball	30	4.6	UL/CSA/TUV/CE	25	Terminals	\$12.99	11.99	10.79	8.63
100917CL	Sunon	SF23080A/2083HSL	220	3.15 x 3.15 x 1.50	30	Sleeve	60	13.5	UL/CSA/TUV/CE	35	12" leads	10.49	8.39	7.55	5.66
209365CL	Innovative	4C-230LB	220	4.68 x 4.68 x 1.50	63	Ball	60	9	TUV/CE	34	10" leads	12.95	11.69	10.49	9.45
102891CL	Sunon	DP200A-2123XBT	220	4.68 x 4.68 x 1.50	117	Ball	120	21	UL/CSA/TUV/CE	50	Terminals	15.95	14.39	12.95	11.65

*Size Conversion: Inches to mm

Inches	mm	Inches	mm	Inches	mm	Inches	mm
0.25	6	1.00	25	2.00	50	3.72	95
0.40	10	1.20	30	2.36	60	3.83	97
0.60	15	1.40	35	2.48	75	4.68	120
0.80	20	1.60	40	3.15	80	5.90	150
0.90	23	1.80	45	3.63	92	6.75	170

Don't worry about backorders.
Over 99% of our products are in stock!

We'll Send It Today!

just place your order by 6PM EST
for same business day shipment.

Electromech

Fan Guards, Filters & Cords

Compatible with DC and AC Fans – pages 108 - 110

- All guards and filters fit all fans by matching the size dimension.
- Example: P/N 75408CL fan (3.15") matches P/N 31923CL metal guard (3.15").

New Lower Prices

Part No.	Description *	1	10	100	250
123502CL	1.60" metal (chrome) guard	\$.49	\$.43	\$.39	\$.35
163432CL	2.00" metal (chrome) guard	\$.44	\$.39	\$.35	\$.31
120037CL	2.36" metal (chrome) guard	.79	.71	.64	.58
31923CL	3.15" metal (chrome) guard	.79	.65	.52	.49
123511CL	3.63" metal (chrome) guard	.99	.78	.67	.61
25734CL	4.68" metal (chrome) guard	1.09	.89	.69	.65
138561CL	3.15" plastic guard with mesh	1.39	1.19	1.05	.95
229665CL	3.63" plastic guard with mesh	1.49	1.35	1.25	1.09
196816CL	4.68" plastic guard with mesh	1.95	1.55	1.39	1.25
138579CL	3.15" alum. washable filter	2.95	2.65	2.39	2.15
130104CL	4.68" alum. washable filter	3.49	3.19	2.75	2.49



123502CL



120037CL



31923CL/123511CL



25734CL



138561CL/196816CL



229665CL



138579CL/130104CL

Fan Power Cords: 24" Straight and Right-Angle

- Cord type: SPT-1 (2) conductor black
- Voltage rating: 300V
- Temperature range: 60°C
- Fits all terminal fans

Part No.	Description	Length	1	10	100	250
28564CL	Straight socket cord	24"	\$.89	\$.80	\$.66	\$.60
104192CL	90° angle socket cord	24"	.99	.89	.73	.68



28564CL



104192CL



191636CL



181278CL



174115CL



190545CL

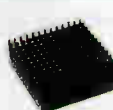

129226CL/129234CL

See page 107 for detailed specifications and prices on CPU Heat Sink Fans!

25-Watt Enclosed

S-25 Series: Single Output

- 100% full-load burn-in
- Universal AC input
- No minimum load required
- 1.2 watts/in³ maximum
- 105°C output capacitor
- Two-year warranty
- Mating connector: 103587CL, pg 63
- -10°C to +60°C working temp. (see output derating)
- Mounting hardware: use P/Ns 222121CL, 222156CL, 222172CL & 222164CL; see www.Jameco.com for specifications

Highlighted below in blue, the Mean Well S-25 series are low-cost, high-quality enclosed switchers that feature universal input of 85 to 264VAC, as well as 120 to 370VDC for battery-supported applications. Full rated power is available with free-air convection cooling. Protections include short-circuit, over-voltage and overload with auto-recovery. They are approved by UL and TUV, and carry the CE mark for use worldwide.



PERFORMANCE AT VALUE PRICES

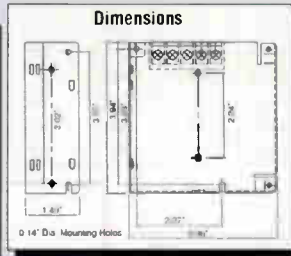
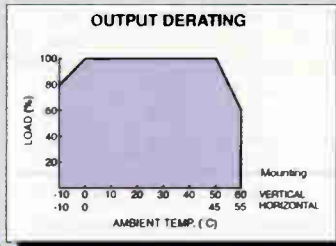

40-Watt Enclosed

S-40 & T-40 Series: Single & Triple Output

- 100% full-load burn-in
- Universal AC input
- 105°C output capacitor
- 1.6 watts/in³ max.
- Two-year warranty
- Mating connector: P/N 103587CL, pg 63
- -10°C to +60°C working temperature (see output derating)
- Mounting hardware: use P/Ns 222121CL, 222156CL & 222172CL; see www.Jameco.com for specifications

Highlighted in buff color below, the S-40 and T-40 series from Mean Well derive their impressive reliability from a conservative design, the exclusive use of high-quality components, and assured to operate correctly anywhere in the world. These switchers feature universal input voltage ranges of 85-264VAC and 120-370VDC. Protection includes short-circuit, overload and over-voltage; and a novel soft-start circuit limits the AC surge current. Manufacturer guaranteed safety standards comprise UL1012, UL1950 and TUV EN60950; and these products have earned the European CE mark.

Open-frame Power Supplies on pages 124-122.

Jameco Part No.	Manufacturer	Manufacturer Product Number	Output		Power	Input (VAC @ Hz)	Power Density (W/in ³)	Ripple & Noise (mV p-p)*	Load Reg. (±%)*
			Voltage@Current (min-max)	Power					
123246CL	Mean Well	S-25-5	+5V@0-5A		25.0W	85-264@47-63	1.17	50	1.0
123254CL	Mean Well	S-25-12	+12V@0-2.1A		25.2W	85-264@47-63	1.18	100	0.5
123262CL	Mean Well	S-25-15	+15V@0-1.7A		25.5W	85-264@47-63	1.20	100	0.5
123271CL	Mean Well	S-25-24	+24V@0-1.1A		26.4W	85-264@47-63	1.24	100	0.5
123289CL	Mean Well	S-40-5	+5V@0-8A		40.0W	85-264@47-63	1.34	75	1.0
123297CL	Mean Well	S-40-12	+12V@0-3.5A		42.0W	85-264@47-63	1.41	100	0.5
202139CL	Mean Well	S-40-15	+15V@0-2.8A		42.0W	85-264@47-63	1.41	100	0.5
123318CL	Mean Well	S-40-24	+24V@0-1.8A		43.0W	85-264@47-63	1.44	100	0.5
201988CL	Mean Well	T-40A	+5V@0.6-3A; +12V@0.2-2A; -5V@0.1-0.5A		41.5W	85-264@47-63	1.43	100	0.5
201996CL	Mean Well	T-40B	+5V@0.6-3A; +12V@0.2-2A; -12V@0.1-0.5A		45.0W	85-264@47-63	1.55	100	0.5
202008CL	Mean Well	T-40C	+5V@0.6-3A; +15V@0.2-1.5A; -15V@0.1-0.5A		45.0W	85-264@47-63	1.55	100	0.5
123326CL	Mean Well	S-60-5	+5V@0-12A		60.0W	85-264@47-63	1.67	120	1.0
123334CL	Mean Well	S-60-12	+12V@0-5A		60.0W	85-264@47-63	1.67	120	0.5
123342CL	Mean Well	S-60-15	+15V@0-4A		60.0W	85-264@47-63	1.67	150	0.5
123351CL	Mean Well	S-60-24	+24V@0-2.5A		60.0W	85-264@47-63	1.67	150	0.5
123457CL	Mean Well	D-60A	+5V@0.3-4A; +12V@0.2-3A		56.0W	85-264@47-63	1.56	75	0.5
123465CL	Mean Well	D-60B	+5V@0.3-3A; +24V@0.2-1.8A		58.0W	85-264@47-63	1.62	75	0.5
123473CL	Mean Well	T-60A	+5V@0.5-5A; +12V@0.2-2.5A; -5V@0-0.5A		57.5W	85-264@47-63	1.60	100	1.0
123481CL	Mean Well	T-60B	+5V@0.5-5A; +12V@0.2-2.5A; -12V@0-0.5A		61.0W	85-264@47-63	1.70	100	1.0
123490CL	Mean Well	T-60C	+5V@0.5-5A; +15V@0.2-2A; -15V@0-0.5A		62.5W	85-264@47-63	1.61	100	1.0
147045CL	Mean Well	Q-60B	+5V@0.5-5.5A; +12V@0.1-2A; -5V@0-0.5A; -12V@0-0.5A		60.0W	85-264@47-63	1.63	100	0.5

Other Versions Available: Call 800-831-4242

* Primary Output



SALE

Special Offers at Great Savings – 90-Day Warranty

Jameco Part No.	Manufacturer	Manufacturer Product Number	Output		Power	Input (VAC @ Hz)	Size Inches (LxWxH)	Mounting Holes Inches (LxWxDia.)	Power Density (W/in ³)	Ripple & Noise (mV p-p)*	Load Reg. (±%)*
			Voltage@Current (min-max)	Power							
211115CL	Fortron	SU65P10C	+5V@0-10A		50.0W	85-264@47-63	6.1x4.2x2.2	4.8x3.2x0.17	0.87	50	—
205815CL	Volgen	PRK30U-0524W	+5V@3A; +24V@0.6A		30.0W	100/120@50-60	6.3x3.6x1.5	4.0x2.5x0.08	0.88	100	1.0
205794CL	Volgen	PRK15U-1212W	+12V@1A; +12V@0.5A		15.0W	100/120@50-60	5.2x3.2x1.1	4.0x2.5x0.08	0.82	170	1.0
205831CL	Volgen	PRK50U-1515W	+15V@1.5A; +15V@1.5A		50.0W	100/120@50-60	7.6x3.7x1.5	6.0x3.0x0.08	1.19	200	1.0

* Primary Output

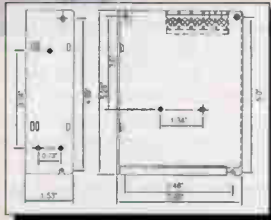

PERFORMANCE AT VALUE PRICES

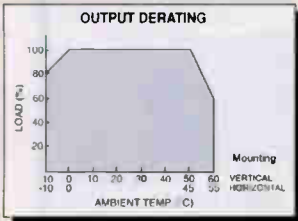

60-Watt Enclosed

S-60, D-60, T-60 & Q-60 Series: Single, Dual, Triple & Quad Outputs

- 100% full-load burn-in
- Universal AC input
- 105°C output capacitor
- 1.7 watts/in³ maximum
- Two-year warranty
- Mating connector: P/N 103587CL, pg 63
- -10°C to +60°C working temperature (see output derating)
- Mounting hardware: use P/Ns 222130CL, 222156CL & 222172CL; see www.Jameco.com for specifications

Highlighted in tan, these highly popular series have long been among Mean Well's most requested products. The solid, reliable, low-cost design features overload protection to 150% of rated load with auto-recovery, and over-voltage protection to 135% of rated output voltage. Input AC surge current is limited to a safe level by a novel soft-start circuit. Working temperature is -10°C to 60°C, with derating below 0°C and above 45°C. Safety standards include UL1012, UL1950, IEC950 and TUV EN60950, and these products all carry the European CE mark. The DC output voltage can be adjusted ±10% of nominal rating.



PERFORMANCE AT VALUE PRICES

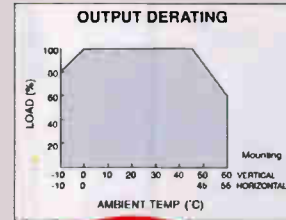
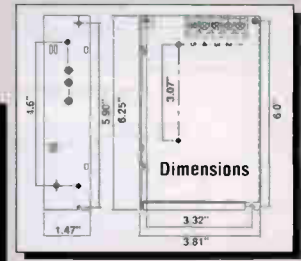

Call for LOWER PRICES on Larger Quantities

Open-Frame Power Supplies on pages 124-132.

Line Reg. (±%)*	Inrush Curr. (A@120VAC)	Isolation Voltage (VAC)	Leakage Current (mA@240V)	Rise Time (ms)	Hold-up Time (ms)	Vibration	Voltage Adjustment (%)*	Efficiency (%)	Weight (lbs.)	Certification	Jameco Part No.	Price		
												1	10	25
0.5	15	3,000	0.75	50	10	10-500Hz, 2G	10	72	0.8	UL/TUV/CE	123246CL	\$39.95	\$30.85	\$26.39
0.5	15	3,000	0.75	50	10	10-500Hz, 2G	10	76	0.8	UL/TUV/CE	123254CL	39.95	30.85	26.39
0.5	15	3,000	0.75	50	10	10-500Hz, 2G	10	77	0.8	UL/TUV/CE	123262CL	39.95	30.85	26.39
0.5	15	3,000	0.75	50	10	10-500Hz, 2G	10	80	0.8	UL/TUV/CE	123271CL	39.95	30.85	26.39
0.5	60	3,000	1.0	50	15	10-500Hz, 2G	10	72	1.0	UL/CUL/TUV/CE	123289CL	44.95	35.25	30.85
0.5	30	3,000	1.0	50	15	10-500Hz, 2G	10	76	1.0	UL/CUL/TUV/CE	123297CL	44.95	35.25	30.85
0.5	30	3,000	1.0	50	15	10-500Hz, 2G	10	76	1.0	UL/CUL/TUV/CE	202139CL	44.95	35.25	30.85
0.5	30	3,000	1.0	50	15	10-500Hz, 2G	10	78	1.0	UL/CUL/TUV/CE	123318CL	44.95	35.25	30.85
0.5	20	3,000	3.5	50	16	10-500Hz, 2G	10	72	1.0	UL/CUL/CE	201988CL	49.95	38.55	34.15
0.5	20	3,000	3.5	50	16	10-500Hz, 2G	10	72	1.0	UL/CUL/CE	201996CL	49.95	38.55	34.15
0.5	20	3,000	3.5	50	16	10-500Hz, 2G	10	72	1.0	UL/CUL/CE	202008CL	49.95	38.55	34.15
0.5	30	3,000	3.5	50	10	10-500Hz, 2G	10	73	1.2	UL/CUL/TUV/CE	123326CL	53.95	39.59	34.09
0.5	30	3,000	3.5	50	10	10-500Hz, 2G	10	76	1.2	UL/CUL/TUV/CE	123334CL	53.95	39.59	34.09
0.5	30	3,000	3.5	50	10	10-500Hz, 2G	10	77	1.2	UL/CUL/TUV/CE	123342CL	53.95	39.59	34.09
0.5	30	3,000	3.5	50	10	10-500Hz, 2G	10	79	1.2	UL/CUL/TUV/CE	123351CL	53.95	39.59	34.09
0.5	30	3,000	1.0	50	10	10-500Hz, 2G	10	73	1.2	UL/CUL/TUV/CE	123457CL	54.95	41.79	36.29
0.5	30	3,000	1.0	50	10	10-500Hz, 2G	10	76	1.2	UL/CUL/TUV/CE	123465CL	54.95	41.79	36.29
0.5	30	3,000	1.0	50	10	10-500Hz, 2G	10	72	1.2	UL/CUL/TUV/CE	123473CL	57.95	42.89	38.49
0.5	30	3,000	1.0	50	10	10-500Hz, 2G	10	72	1.2	UL/CUL/TUV/CE	123481CL	57.95	42.89	38.49
0.5	30	3,000	1.0	50	10	10-500Hz, 2G	10	72	1.2	UL/CUL/TUV/CE	123490CL	57.95	42.89	38.49
0.5	18	3,000	1.0	20	12	10-500Hz, 2G	10	70	1.2	UL/CUL	147045CL	59.95	45.09	39.59

Special Offers at Great Savings – 90-Day Warranty

SALE

New Lower Prices

Line Reg. (±%)*	Inrush Curr. (A@120VAC)	Isolation Voltage (VAC)	Leakage Current (mA@240V)	Rise Time (ms)	Hold-up Time (ms)	Vibration	Voltage Adjustment (%)*	Efficiency (%)	Weight (lbs.)	Certification	Jameco Part No.	Price		
												1	10	25
0.5	15	3,000	0.85	—	10	—	—	70	1.5	UL/CSA/TUV/CE	211115CL	\$8.95 \$4.43	\$1.94	\$1.41
0.4	35	1,500	0.5	100	20	10-55Hz, 2G	5	75	0.6	UL/CSA	205815CL	\$45.25 \$11.11	9.88	8.44
0.4	12	—	1.0	100	20	10-55Hz, 20G	5	64	0.4	UL/CSA	205794CL	\$22.95 \$10.88	9.89	8.99
0.4	—	1,500	0.5	100	20	10-55Hz, 20G	5	75	0.6	UL/CSA	205831CL	\$21.95 \$16.29	14.75	13.39

75 to 100-Watt Enclosed Switching DC Power Supplies

Color Code Legend
New Sale Qty. Save Closeout

75-Watt Enclosed with Power Factor Correction

SP-75 Series: Single Output

- 100% full-load burn-in
- No minimum load required
- 105°C output capacitor
- Power Factor Correction
- Mating connector: P/N 103587CL, pg 63
- -10°C to +60°C working temp. (see output derating)
- Mounting hardware: use P/Ns 222148CL, 222156CL, 222164CL & 222172CL; see www.Jameco.com for specifications
- Universal AC input
- 2.1 watts/in³ max.
- Three-year warranty



Highlighted in blue below, the Mean Well SP-75 series features input Power Factor Correction that meets EN61000-3-2, required in Europe for power supplies 75 watts and above. They are approved by UL and TUV, and carry the CE mark for use worldwide. The high-density enclosed packaging results in a profile of only 1.3" and a power density of 2.1 watts per inch³. As with all Mean Well power products, every SP-75 product is subjected to 100% full-load burn-in testing. This rigorous production procedure detects infant product failures, contributing to Mean Well's world-class reliability. Protection includes short-circuit, overload and over-voltage.

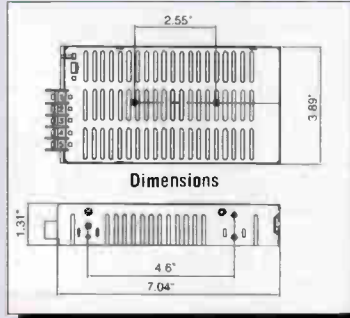
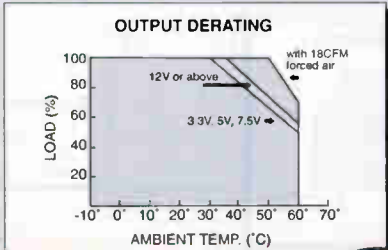

100-Watt Enclosed

S-100F Series: Single Output

- 100% full-load burn-in
- No minimum load required
- 105°C output capacitor
- Mating connector: P/N 103587CL, pg 63
- -10°C to +60°C working temp. (see output derating)
- Mounting hardware: use P/Ns 222130CL, 222156CL and 222172CL; see www.Jameco.com for specs
- 2.3 watts/in³ max.
- Two-year warranty

Highlighted below in buff color and surprisingly inexpensive for its capabilities, the S-100F series is one of Mean Well's most successful enclosed power supplies. With only free-air convection, the 100-watt rated power is available from 0°C to 50°C ambient temp. Protection includes short-circuit, overload and over-voltage. A novel soft-start circuit limits the AC surge current to a safe value. Guaranteed safety standards comprise UL1012, UL1950 and TUV EN60950; and these products have earned the European CE mark.

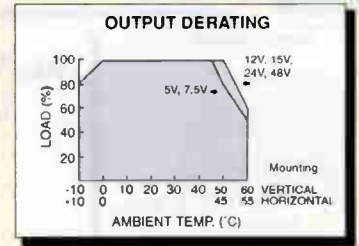

Open-Frame Power Supplies on pages 124-132. **SALE** More Lower Prices

Other Versions Available: Call 800-831-4242

Jameco Part No.	Manufacturer	Manufacturer Product Number	Output		Input (VAC @ Hz)	PFC	Size Inches (LxWxH)	Mounting Holes Inches (LxWxDia.)	Power Density (W/in ³)	Ripple & Noise (mV p-p)*	Load Reg. (±%)*
			Voltage@Current (min-max)	Power							
194829CL	Mean Well	SP75-5	+5V@0-15A	75.0W	85-264@47-63	✓	see diagram	see diagram	2.11	80	1.0
194837CL	Mean Well	SP75-12	+12V@0-6.3A	75.6W	85-264@47-63	✓	see diagram	see diagram	2.13	80	0.5
194845CL	Mean Well	SP75-15	+15V@0-5A	75.0W	85-264@47-63	✓	see diagram	see diagram	2.11	80	0.5
194853CL	Mean Well	SP75-24	+24V@0-3.2A	76.8W	85-264@47-63	✓	see diagram	see diagram	2.16	100	0.5
216805CL	Mean Well	SP75-48	+48V@0-1.6A	76.8W	85-264@47-63	✓	see diagram	see diagram	2.16	100	0.5
201961CL	Mean Well	S-100F-5	+5V@0-20A	100.0W	88-132/176-264@47-63	—	see diagram	see diagram	2.19	100	1.0
123385CL	Mean Well	S-100F-12	+12V@0-8.5A	102.0W	88-132/176-264@47-63	—	see diagram	see diagram	2.24	125	0.5
212450CL	Mean Well	S-100F-15	+15V@0-6.7A	100.5W	88-132/176-264@47-63	—	see diagram	see diagram	2.20	125	0.5
201970CL	Mean Well	S-100F-24	+24V@0-4.5A	108.0W	88-132/176-264@47-63	—	see diagram	see diagram	2.37	150	0.5
216792CL	Mean Well	S-100F-48	+48V@0-2.2A	105.6W	88-132/176-264@47-63	—	see diagram	see diagram	2.31	150	0.5
212441CL	Mean Well	SP100-3.3	+3.3V@0-20A	66.0W	86-264@47-63	✓	see www.Jameco.com		1.48	100	1.0
194790CL	Mean Well	SP100-5	+5V@0-20A	100.0W	86-264@47-63	✓	see www.Jameco.com		2.24	100	1.0
194802CL	Mean Well	SP100-12	+12V@0-8.5A	102.0W	86-264@47-63	✓	see www.Jameco.com		2.29	100	0.5
212433CL	Mean Well	SP100-15	+15V@0-6.7A	100.5W	86-264@47-63	✓	see www.Jameco.com		2.25	100	0.5
194811CL	Mean Well	SP100-24	+24V@0-4.2A	100.8W	86-264@47-63	✓	see www.Jameco.com		2.26	150	0.5
212425CL	Mean Well	SP100-48	+48V@0-2.1A	100.8W	88-264@47-63	✓	see www.Jameco.com		2.26	250	0.5
213794CL	Mean Well	TP-100A	+5V@3-10A; +12V@0.4-4A; -5V@0-0.6A	101.0W	90-264@47-63	✓	see www.Jameco.com		1.85	100	3.0
213786CL	Mean Well	TP-100B	+5V@3-10A; +12V@0.4-4A; -12V@0-0.6A	105.2W	90-264@47-63	✓	see www.Jameco.com		1.93	100	3.0
213778CL	Mean Well	TP-100C	+5V@3-10A; +15V@0.4-3A; -15V@0-0.6A	104.0W	90-264@47-63	✓	see www.Jameco.com		1.90	100	3.0
213760CL	Mean Well	TP-100D	+5V@3-10A; +24V@0.3-2A; +12V@0-0.6A	105.2W	90-264@47-63	✓	see www.Jameco.com		1.93	100	3.0
213639CL	Mean Well	QP-100-3B	+3.3V@0-8A; +5V@2-8A; +12V@0.3-2.2A; -12V@0-0.6A	100.0W	90-264@47-63	✓	see www.Jameco.com		1.64	100	2.0
213621CL	Mean Well	QP-100-D	+5V@2-8A; +12V@0-2.4A; +24V@0.3-1A; -12V@0-0.6A	100.0W	90-264@47-63	✓	see www.Jameco.com		1.64	120	2.0
213612CL	Mean Well	QP-100F	+5V@2-8A; +15V@0-2A; +24V@0.3-1A; -15V@0-0.6A	103.0W	90-264@47-63	✓	see www.Jameco.com		1.69	120	2.0

* Primary Output

Special Offers at Great Savings – 90-Day Warranty

Jameco Part No.	Mfr.	Manufacturer Product No.	Output		Input (VAC @ Hz)	PFC	Size Inches (LxWxH)	Mounting Holes Inches (LxWxDia.)	Power Density (W/in ³)	Ripple & Noise (mV p-p)*	Load Reg. (±%)*
			Voltage@Current (min-max)	Power							
205698CL	Volgen	ESK80U-1515	+5V@10A; +15V@0.8A; -15V@0.8A	74.0W	115/220@50-60	—	8.7x5.0x1.5	—	1.13	50	0.8
205858CL	Volgen	JRK-115B	+5V@4.5A; +15V@3.5A; +24V@0.4A; -5V@1.6A; -15V@1.5A	75.0W	100/240@50-60	—	10.5x5.0x2.5	—	0.36	100	0.8

* Primary Output

75 to 100-Watt Enclosed Switching DC Power Supplies



**PERFORMANCE
AT VALUE
PRICES**

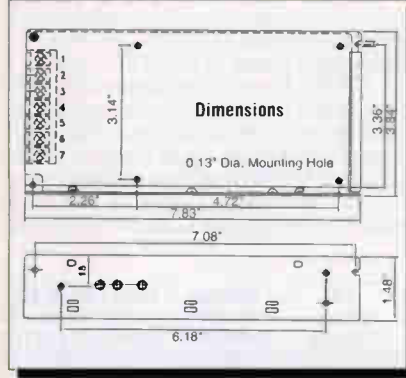

100-Watt Enclosed With Power Factor Correction



SP-100, TP-100 & QP-100 Series: Single, Triple & Quad Outputs

- 100% full-load burn-in
- 2.3 watts/in³ maximum
- 105°C output capacitor
- Mating connector: P/N 103587CL, pg 63
- -10°C to +60°C working temp. (see output derating)
- Mounting hardware use P/Ns 222130CL, 222164CL, 222156CL, 222172CL & 222181CL; see www.Jameco.com for specifications
- Universal AC input
- Power Factor Correction
- Three-year warranty

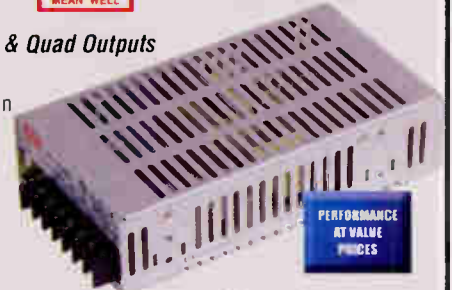

**PERFORMANCE
AT VALUE
PRICES**

Highlighted below in tan, this Mean Well family of 100-watt enclosed switchers feature input Power Factor Correction of 0.98 at 115VAC that complies with EN61000-3-2, required in Europe for power supplies 75 watts and above. They are approved by UL and TUV, and carry the CE mark, for use worldwide. The high-density enclosed packaging results in a profile of only 1.8" and a power density of 2.0 watts per inch³. As with all Mean Well products, all SP-100, TP-100 and QP-100 products are subject to 100% full-load burn-in testing. This rigorous production procedure detects infant product failures, contributing to Mean Well's world-class reliability. Protection includes short-circuit, overload & over-voltage.

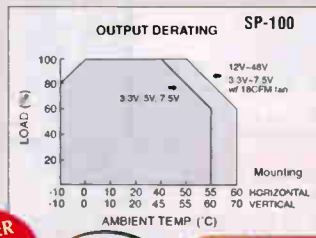
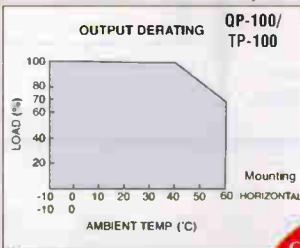

SALE

Call for LOWER PRICES on Larger Quantities

New Lower Prices

Open Frame Power Supplies on pages 124-127

Line Reg. (±%)*	Inrush Curr. (A@ 120VAC)	Isolation Voltage (VAC)	Leakage Current (mA@240V)	Rise Time (ms)	Hold-up Time (ms)	Vibration	Voltage Adjustment (%)*	Efficiency (%)	Weight (lbs.)	Certification	Jameco Part No.	Price		
												1	10	25
0.5	40	3,000	2.0	60	20	10-500Hz; 2G	10	72	1.2	UL/CUL/TUV/CE	194829CL	\$65.49	\$55.49	\$48.99
0.5	40	3,000	2.0	60	20	10-500Hz; 2G	10	77	1.2	UL/CUL/TUV/CE	194837CL	69.95	61.05	53.89
0.5	40	3,000	2.0	60	20	10-500Hz; 2G	10	79	1.2	UL/CUL/TUV/CE	194845CL	69.95	61.05	53.89
0.5	40	3,000	2.0	60	20	10-500Hz; 2G	10	80	1.2	UL/CUL/TUV/CE	194853CL	69.95	61.05	53.89
0.5	40	3,000	2.0	60	20	10-500Hz; 2G	10	80	1.2	UL/CUL/TUV/CE	216805CL	69.95	61.05	53.89
0.5	30	3,000	1.0	30	15	10-500Hz; 2G	10	76	1.4	UL/TUV/CE	201961CL	66.95	47.29	40.69
0.5	30	3,000	1.0	30	15	10-500Hz; 2G	10	80	1.4	UL/TUV/CE	123385CL	66.95	47.29	40.69
0.5	30	3,000	1.0	30	15	10-500Hz; 2G	10	81	1.4	UL/TUV/CE	212450CL	66.95	47.29	40.69
0.5	30	3,000	1.0	30	15	10-500Hz; 2G	10	83	1.4	UL/TUV/CE	201970CL	66.95	47.29	40.69
0.5	30	3,000	1.0	30	15	10-500Hz; 2G	10	84	1.4	UL/TUV/CE	216792CL	66.95	47.29	40.69
0.5	40	3,000	2.0	30	20	10-500Hz; 2G	10	70	1.3	UL/CUL/TUV/CE	212441CL \$69.95	55.95	45.95	35.95
0.5	40	3,000	2.0	30	20	10-500Hz; 2G	10	76	1.3	UL/CUL/TUV/CE	194790CL	81.95	67.09	58.29
0.5	40	3,000	2.0	30	20	10-500Hz; 2G	10	80	1.3	UL/CUL/TUV/CE	194802CL	81.95	67.09	58.29
0.5	40	3,000	2.0	30	20	10-500Hz; 2G	10	82	1.3	UL/CUL/TUV/CE	212433CL	69.95	62.99	56.69
0.5	40	3,000	2.0	30	20	10-500Hz; 2G	10	84	1.3	UL/CUL/TUV/CE	194811CL	81.95	67.09	58.29
0.1	40	3,000	2.0	30	20	10-500Hz; 2G	10	82	1.3	UL/CUL/TUV/CE	212425CL	81.95	67.09	58.29
1.0	40	3,000	3.5	60	20	10-500Hz; 2G	10	75	1.6	UL/CUL/TUV/CE	213794CL \$118.95	81.95	73.99	68.95
1.0	40	3,000	3.5	60	20	10-500Hz; 2G	10	78	1.6	UL/CUL/TUV/CE	213786CL \$118.95	87.29	78.29	71.14
1.0	40	3,000	3.5	60	20	10-500Hz; 2G	10	77	1.6	UL/CUL/TUV/CE	213778CL	118.95	103.39	93.49
1.0	40	3,000	3.5	60	20	10-500Hz; 2G	10	78	1.6	UL/CUL/TUV/CE	213760CL \$118.95	85.95	75.95	69.95
1.0	40	3,000	3.5	50	16	10-500Hz; 2G	10	74	1.6	UL/CUL/TUV/CE	213639CL \$123.95	88.95	82.95	75.95
1.0	40	3,000	3.5	50	16	10-500Hz; 2G	10	78	1.6	UL/CUL/TUV/CE	213621CL \$123.95	88.95	82.95	75.95
1.0	40	3,000	3.5	50	16	10-500Hz; 2G	10	78	1.6	UL/CUL/TUV/CE	213612CL \$123.95	88.95	82.95	75.95

Special Offers at Great Savings – 90-Day Warranty

Line Reg. (±%)*	Inrush Curr. (A@ 120VAC)	Isolation Voltage (VAC)	Leakage Current (mA@240V)	Rise Time (ms)	Hold-up Time (ms)	Vibration	Voltage Adjustment (%)*	Efficiency (%)	Weight (lbs.)	Certification	Jameco Part No.	Price		
												1	10	25
0.4	—	—	—	200	—	—	0.5	72	1.9	UL/CSA	205698CL \$24.95	22.95	\$18.95	\$16.95
0.4	20	—	—	200	—	—	—	75	2.4	—	205858CL \$24.95	22.95	17.95	15.95

120 to 150-Watt Enclosed Switching DC Power Supplies

Color Code Legend
New **Low Price** **Closeout**

120-Watt Enclosed

D-120 & Q-120 Series: Dual & Quad Outputs

- 100% full-load burn-in
- 1.9 watts/in³ max.
- 105°C output capacitor
- Two-year warranty
- Mating connector: P/N 103587CL, pg 63
- -10°C to +60°C working temp. (see output derating)
- Mounting hardware: use P/Ns 222130CL, 222156CL and 222172CL; see www.Jameco.com for specifications

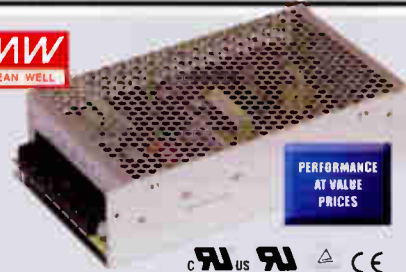

Highlighted below in blue, the workhorse D-120 and Q-120 have long been amongst the most popular Mean Well series of enclosed switching power supplies. Their efficiency and low working temperature contribute to their very high MTBF of 272,000 hours. Full 120 watts of power is available over the ambient temperature range of 0°C to 50°C. With derating (see below) the range extends to -10°C to 60°C. The solid, reliable, low-cost design features overload protection to 135% of rated load with auto-recovery, and over-voltage protection to 135% of rated output voltage. Additional protection includes short-circuit and a soft-start circuit that limits the AC surge current to a safe value.

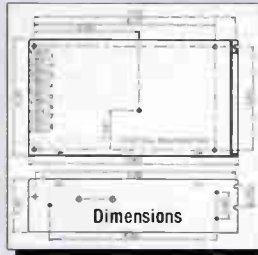
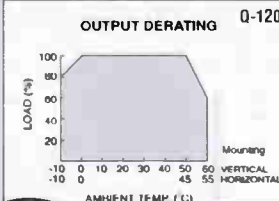
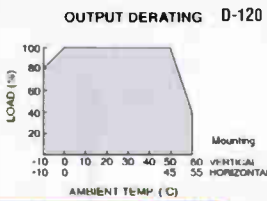

150-Watt Enclosed

S-150 Series: Single Output

- 100% full-load burn-in
- 2.3 watts/in³ maximum
- No minimum load required
- Two-year warranty
- 105°C output capacitor
- Mating connector: P/N 103587CL, pg 63
- -10°C to +60°C working temperature (see output derating)
- Mounting hardware: use P/Ns 222130CL, 222156CL & 222172CL; see www.Jameco.com for specifications



Highlighted in buff color below, the highly popular S-150 series from Mean Well delivers its impressive reliability from a conservative design, the exclusive use of high-quality components, and 100% full-load burn-in. Assured to operate correctly anywhere in the world, these switchers feature universal voltage input ranges of 85-264VAC and 120-370VDC. Protection includes short-circuit, overload and over-voltage; and a novel soft-start circuit limits the AC surge current. Manufacturer guaranteed safety standards comprise UL1950 and TUV EN60950, and these products have earned the European CE mark. The DC output voltage can be adjusted ±10% of nominal rating.

Open-Frame Power Supplies on pages 124-132.

Now Lower Prices

SALE

Other Versions Available: Call 800-831-4242

Jameco Part No.	Manufacturer	Manufacturer Product Number	Output Voltage@Current (min-max)	Power	Input (VAC @ Hz)	PFC	Size Inches (LxWxH)	Mounting Holes Inches (LxWxDia.)	Power Density (W/in ³)	Ripple & Noise (mV p-p)*	Load Reg. (±%)*
132409CL	Mean Well	D-120A	5V@2-12A; 12V@0.5-5A	120.0W	88-132/176-264@47-63	—	see diagram	see diagram	1.79	60	0.5
132396CL	Mean Well	D-120B	5V@2-6A; 24V@0.4-4A	126.0W	88-132/176-264@47-63	—	see diagram	see diagram	1.88	60	0.5
132388CL	Mean Well	Q-120B	5V@2-11A; -5V@0.2-1A; 12V@0.5-4A; -12V@0.2-1A	120.0W	88-132/176-264@47-63	—	see diagram	see diagram	1.79	80	0.5
132370CL	Mean Well	Q-120D	5V@2-8A; 24V@0.2-2A; 12V@0.2-2A; -12V@0.2-1A	124.0W	88-132/176-264@47-63	—	see diagram	see diagram	1.85	80	0.5
123393CL	Mean Well	S-150-5	5V@0-30A	150.0W	88-132/176-264@47-63	—	see diagram	see diagram	2.24	150	0.5
123414CL	Mean Well	S-150-7.5	7.5V@0-20A	150.0W	88-132/176-264@47-63	—	see diagram	see diagram	2.24	150	0.5
123422CL	Mean Well	S-150-12	12V@0-12.5A	150.0W	88-132/176-264@47-63	—	see diagram	see diagram	2.24	180	0.3
202024CL	Mean Well	S-150-13.5	13.5V@0-11.2A	151.2W	88-132/176-264@47-63	—	see diagram	see diagram	2.25	180	0.3
123431CL	Mean Well	S-150-15	15V@0-10A	150.0W	88-132/176-264@47-63	—	see diagram	see diagram	2.24	180	0.3
123449CL	Mean Well	S-150-24	24V@0-6.5A	156.0W	88-132/176-264@47-63	—	see diagram	see diagram	2.33	240	0.2
202032CL	Mean Well	S-150-27	27V@0-5.6A	151.2W	88-132/176-264@47-63	—	see diagram	see diagram	2.25	240	0.2
167345CL	Mean Well	S-150-48	48V@0-3.2A	153.6W	88-132/176-264@47-63	—	see diagram	see diagram	2.29	240	0.2
201902CL	Mean Well	SP-150-3.3	3.3V@0-30A	99.0W	85-264@47-63	✓	see www.Jameco.com		1.63	100	1.0
201911CL	Mean Well	SP-150-5	5V@0-30A	150.0W	85-264@47-63	✓	see www.Jameco.com		2.47	100	1.0
173420CL	Mean Well	SP-150-12	12V@0-12.5A	150.0W	85-264@47-63	✓	see www.Jameco.com		2.47	100	0.5
173411CL	Mean Well	SP-150-15	15V@0-10A	150.0W	85-264@47-63	✓	see www.Jameco.com		2.47	100	0.5
173403CL	Mean Well	SP-150-24	24V@0-6.3A	150.0W	85-264@47-63	✓	see www.Jameco.com		2.47	150	0.5
201929CL	Mean Well	SP-150-48	48V@0-3.2A	153.6W	85-264@47-63	✓	see www.Jameco.com		2.52	250	0.5
213858CL	Mean Well	TP-150A	5V@2-15A; 12V@0.4-6A; -5V@0-0.6A	150.0W	90-264@47-63	✓	see www.Jameco.com		2.75	100	3.0
213840CL	Mean Well	TP-150B	5V@2-15A; 12V@0.4-5.5A; -12V@0-0.6A	148.2W	90-264@47-63	✓	see www.Jameco.com		2.71	100	3.0
213831CL	Mean Well	TP-150C	5V@2-15A; 15V@0.4-4.5A; -15V@0-0.6A	151.5W	90-264@47-63	✓	see www.Jameco.com		2.77	100	3.0
213823CL	Mean Well	TP-150D	5V@2-15A; 24V@0.4-3A; 12V@0-0.6A	154.2W	90-264@47-63	✓	see www.Jameco.com		2.82	100	3.0
213633CL	Mean Well	QP-150-3B	3.3V@0-10A; 5V@3-10A; 12V@0.4-5A; -12V@0-0.6A	150.2W	90-264@47-63	✓	see www.Jameco.com		2.47	100	2.0
213655CL	Mean Well	QP-150D	5V@3-10A; 12V@0-4A; 24V@0.4-2A; -12V@0-0.6A	150.2W	90-264@47-63	✓	see www.Jameco.com		2.47	120	2.0
213647CL	Mean Well	QP-150F	5V@3-10A; 15V@0-3A; 24V@0.4-2A; -15V@0-0.6A	152.0W	90-264@47-63	✓	see www.Jameco.com		2.50	120	2.0

* Primary Output

Enclosed SALE

Now Lower Prices

Special Offers at Great Savings – 90-Day Warranty

Jameco Part No.	Manufacturer	Manufacturer Product Number	Output Voltage@Current (min-max)	Power	Input (VAC @ Hz)	PFC	Size Inches (LxWxH)	Mounting Holes Inches (LxWxDia.)	Power Density (W/in ³)	Ripple & Noise (mV p-p)*	Load Reg. (±%)*
205701CL	Volgen	EXU-05030	5V@30A	150.0W	100/120@50-60	—	7.7x3.7x2.3	5.0x2.2x0.16	2.29	—	0.8
199515CL	Globtek	RT-3S150-24	24V@6.5A	150.0W	115/230@50-60	—	7.9x4.3x1.9	6.8x3.8x0.14	2.32	100	5.0

* Primary Output

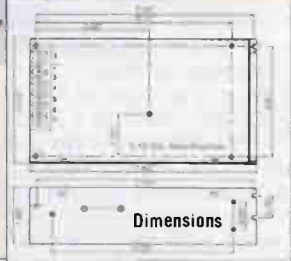
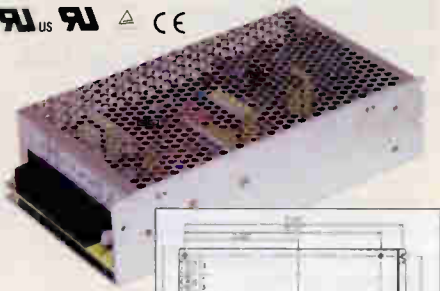

PERFORMANCE
AT VALUE
PRICES

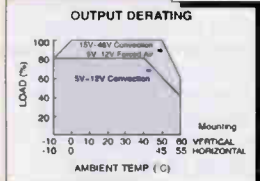

150-Watt Enclosed with Power Factor Correction

SP-150, TP-150 & QP-150 Series: Single, Triple & Quad Outputs

- 100% full-load burn-in
- Power Factor Correction
- 105°C output capacitor
- Mating connector: P/N 103587CL, pg 63
- -10°C to +60°C working temp. (see output derating)
- Mounting hardware: use P/Ns 222130CL, 222156CL, 222164CL, 222181CL & 222172CL; see www.Jameco.com for specifications
- Universal AC input
- 2.8 watts/in² maximum
- Three-year warranty

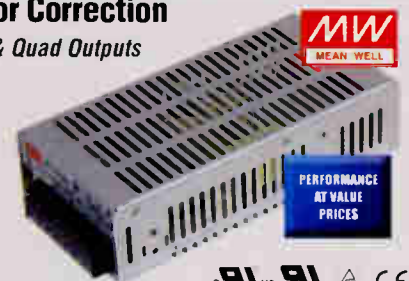

PERFORMANCE
AT VALUE
PRICES

Detailed below in tan, these advanced switchers are part of Mean Well's family of premium power supplies that carry an unusually long three-year manufacturer's warranty. Their performance, reliability and low cost result from a modern state-of-the-art design using integrated components. The SP-150, TP-150 and QP-150 offer input Power Factor Correction that meets EN61000-3-2. These enclosed switchers feature universal voltage input ranges of 85-264VAC and 120-370VDC. These products are approved by UL, CUL and TUV, and carry the CE mark, for use worldwide. EMC standards met are EN55022 Class B and EN61000-4-2/3/4/5/6/8/11.

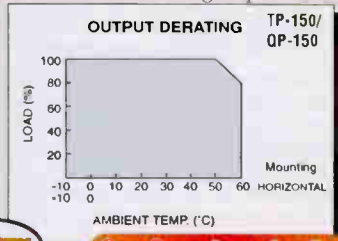
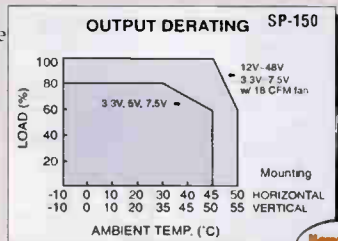

New Lower Prices

Open-Frame Power Supplies on pages 124-122.

Line Reg. (±%)	Inrush Curr. (A@120VAC)	Isolation Voltage (VAC)	Leakage Current (mA@240V)	Rise Time (ms)	Hold-up Time (ms)	Vibration	Voltage Adjustment (%)	Efficiency (%)	Weight (lbs.)	Certification	Jameco Part No.	Price		
												1	10	25
0.5	35	3,000	3.5	50	20	10-500Hz; 2G	10	78	1.9	UL/CUL/TUV/CE	132409CL	\$69.95	\$58.29	\$51.69
0.5	35	3,000	3.5	50	20	10-500Hz; 2G	10	80	1.9	UL/CUL/TUV/CE	132396CL	69.95	58.29	51.69
0.5	35	3,000	3.5	50	20	10-500Hz; 2G	10	77	1.9	UL/CUL/TUV/CE	132388CL	79.95	63.79	56.09
0.5	35	3,000	3.5	50	20	10-500Hz; 2G	10	80	1.9	UL/CUL/TUV/CE	132370CL	79.95	63.79	56.09
0.5	35	3,000	3.5	50	20	10-500Hz; 2G	10	78	1.8	UL/CUL/TUV/CE	123393CL	69.95	53.69	47.09
0.5	35	3,000	3.5	50	20	10-500Hz; 2G	10	80	1.8	UL/CUL/TUV/CE	123414CL	69.95	53.69	47.09
0.3	35	3,000	3.5	50	20	10-500Hz; 2G	10	82	1.8	UL/CUL/TUV/CE	123422CL	69.95	53.69	47.09
0.3	35	3,000	3.5	50	20	10-500Hz; 2G	10	83	1.8	UL/CUL/TUV/CE	202024CL	69.95	53.69	47.09
0.3	35	3,000	3.5	50	20	10-500Hz; 2G	10	84	1.8	UL/CUL/TUV/CE	123431CL	69.95	53.69	47.09
0.2	35	3,000	3.5	50	20	10-500Hz; 2G	10	85	1.8	UL/CUL/TUV/CE	123449CL	69.95	51.69	45.09
0.2	35	3,000	3.5	50	20	10-500Hz; 2G	10	86	1.8	UL/CUL/TUV/CE	202032CL	69.95	53.69	47.09
0.2	35	3,000	3.5	50	20	10-500Hz; 2G	10	87	1.8	UL/CUL/TUV/CE	167345CL	69.95	53.69	47.09
0.5	40	3,000	2.0	30	20	10-500Hz; 2G	10	67	1.7	UL/CUL/TUV/CE	201902CL	91.95	76.99	68.19
0.5	40	3,000	2.0	30	20	10-500Hz; 2G	10	75	1.7	UL/CUL/TUV/CE	201911CL	91.95	76.99	68.19
0.5	40	3,000	2.0	30	20	10-500Hz; 2G	10	80	1.7	UL/CUL/TUV/CE	173420CL	91.95	76.99	68.19
0.5	40	3,000	2.0	30	20	10-500Hz; 2G	10	81	1.7	UL/CUL/TUV/CE	173411CL	91.95	76.99	68.19
0.5	40	3,000	2.0	30	20	10-500Hz; 2G	10	83	1.7	UL/CUL/TUV/CE	173403CL	91.95	76.99	68.19
0.5	40	3,000	2.0	30	20	10-500Hz; 2G	10	84	1.7	UL/CUL/TUV/CE	201929CL	91.95	76.99	68.19
1.0	45	3,000	3.5	60	20	10-500Hz; 2G	10	75	1.8	UL/CUL/TUV/CE	213858CL	\$135.95 \$129.95	83.99	75.99
1.0	45	3,000	3.5	60	20	10-500Hz; 2G	10	77	1.8	UL/CUL/TUV/CE	213840CL	\$135.95 \$129.95	83.99	75.99
1.0	45	3,000	3.5	60	20	10-500Hz; 2G	10	77	1.8	UL/CUL/TUV/CE	213831CL	\$135.95 \$129.95	83.99	75.99
1.0	45	3,000	3.5	60	20	10-500Hz; 2G	10	78	1.8	UL/CUL/TUV/CE	213823CL	\$135.95 \$129.95	83.99	75.99
1.0	45	3,000	3.5	50	16	10-500Hz; 2G	10	75	1.8	UL/CUL/TUV/CE	213633CL	\$145.95 \$140.95	94.99	84.99
1.0	45	3,000	3.5	50	16	10-500Hz; 2G	10	78	1.8	UL/CUL/TUV/CE	213655CL	\$145.95 \$140.95	94.99	84.99
1.0	45	3,000	3.5	50	16	10-500Hz; 2G	10	78	1.8	UL/CUL/TUV/CE	213647CL	145.95	120.99	106.99

Special Offers at Great Savings – 90-Day Warranty

Line Reg. (±%)	Inrush Curr. (A@120VAC)	Isolation Voltage (VAC)	Leakage Current (mA@240V)	Rise Time (ms)	Hold-up Time (ms)	Vibration	Voltage Adjustment (%)	Efficiency (%)	Weight (lbs.)	Certification	Jameco Part No.	Price		
												1	10	25
0.4	30	2,000	0.5	200	—	10-55Hz; 20G	10	80	1.6	UL/CSA	205701CL	\$34.95 \$33.95	\$17.97	\$19.80
5.0	35	3,000	3.5	—	20	—	5	80	1.8	UL/CE	199515CL	59.95	47.95	35.95

Color Code Legend
New Sale On Store Closeout



PERFORMANCE
AT VALUE
PRICES



240-Watt Enclosed

S-240 Series: Single Output

- 100% full-load burn-in
- No minimum load required
- 105°C output capacitor
- Auto cooling fan
- Two-year warranty
- Mating connector: P/N 103587CL, pg 63
- -10°C to +60°C working temp. (see output derating)
- Mounting hardware use P/Ns 222148CL, 222156CL & 222172CL; see www.Jameco.com for specifications
- Auto-switch AC input
- 3.4 watts/in³ max.



PERFORMANCE
AT VALUE
PRICES



Highlighted below in tan, with a built-in cooling fan that operates from an automatic thermal switch, the workhorse Mean Well S-240 produces 240 watts of power from 0°C to 50°C, and is derated to -10°C and 60°C (see below). The input features an auto-sensing circuit that switches between 88-132VAC and 176-264VAC. The impressive reliability derives from a conservative design, the exclusive use of high-quality components, and 100% full-load burn-in. Protection includes short-circuit, overload and over-voltage. A novel soft-start circuit limits the AC surge current. Guaranteed safety standards comprise UL1950 and TUV EN60950, and these products carry the European CE mark. The DC output voltage can be adjusted $\pm 10\%$ of nominal rating.

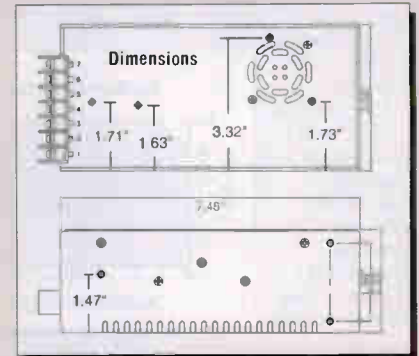
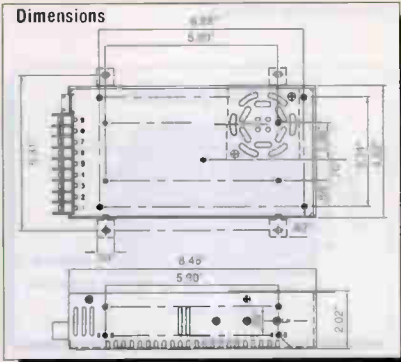

UNDERSTANDING POWER SUPPLIES #3

OUTPUT CURRENT LIMITING: An output protection feature which limits the output current to a predetermined value in order to prevent damage to the power supply or the load under overload conditions. The supply is automatically restored to normal operation following removal of the overload.

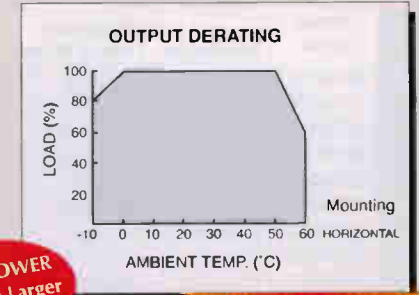
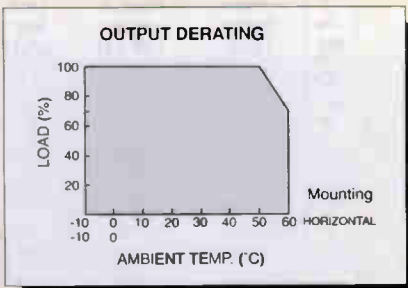

SALE

New Lower Prices

Call for LOWER PRICES on Larger Quantities

Open-Frame Power Supplies on pages 134-137.

Line Reg. ($\pm\%$)	Inrush Curr. (A@120VAC)	Isolation Voltage (VAC)	Leakage Current (mA@240V)	Rise Time (ms)	Hold-up Time (ms)	Vibration	Voltage Adjustment (%)	Efficiency (%)	Weight (lbs.)	Certification	Jameco Part No.	Price		
												1	10	25
0.5	40	3,000	2.0	30	20	10-500Hz: 2G	10	65	1.9	UL/CUL/TUV/CE	212417CL \$120.95	\$71.54	\$63.57	\$57.23
0.5	40	3,000	2.0	30	20	10-500Hz: 2G	10	71	1.9	UL/CUL/TUV/CE	202041CL	102.95	85.79	74.79
0.5	40	3,000	2.0	30	20	10-500Hz: 2G	10	79	1.9	UL/CUL/TUV/CE	194773CL	102.95	85.79	74.79
0.5	40	3,000	2.0	30	20	10-500Hz: 2G	10	80	1.9	UL/CUL/TUV/CE	212409CL	102.95	85.79	74.79
0.5	40	3,000	2.0	30	20	10-500Hz: 2G	10	81	1.9	UL/CUL/TUV/CE	202059CL	102.95	85.79	74.79
0.5	40	3,000	2.0	30	20	10-500Hz: 2G	10	83	1.9	UL/CUL/TUV/CE	194781CL	102.95	85.79	74.79
0.5	40	3,000	2.0	30	20	10-500Hz: 2G	10	84	1.9	UL/CUL/TUV/CE	202067CL	102.95	85.79	74.79
1.0	45	3,000	2.0	50	16	10-500Hz: 2G	10	72	2.4	UL/CUL/TUV/CE	213743CL \$156.95	\$122.50	\$107.50	\$111.48
1.0	45	3,000	2.0	50	16	10-500Hz: 2G	10	74	2.4	UL/CUL/TUV/CE	213735CL \$156.95	\$122.50	\$107.50	\$111.48
1.0	45	3,000	2.0	50	16	10-500Hz: 2G	10	75	2.4	UL/CUL/TUV/CE	213751CL	156.95	127.99	112.99
0.5	18	3,000	1.2	20	20	10-500Hz: 2G	10	78	2.5	UL/CUL/TUV/CE	202083CL \$100.95	\$71.11	\$63.99	\$57.79
0.5	18	3,000	1.2	20	20	10-500Hz: 2G	10	82	2.5	UL/CUL/TUV/CE	137648CL	109.95	98.95	89.09
0.5	18	3,000	1.2	20	20	10-500Hz: 2G	10	83	2.5	UL/CUL/TUV/CE	202075CL \$100.95	\$71.11	\$63.99	\$57.79
0.5	18	3,000	1.2	20	20	10-500Hz: 2G	10	84	2.5	UL/CUL/TUV/CE	137656CL	109.95	98.95	89.09
1.0	18	3,000	1.2	20	20	10-500Hz: 2G	10	87	2.5	UL/CUL/TUV/CE	167337CL	109.95	98.95	89.09

300 to 375-Watt Enclosed Switching DC Power Supplies

Color Code Legend
 New Save UL Save Closeout

300 & 320-Watt Enclosed With Power Factor Correction



SP-300 & SP-320 Series: Single Output

- 100% full-load burn-in
- Universal AC input
- No minimum load required
- Auto cooling fan
- Power Factor Correction
- Three-year warranty
- 105°C output capacitor
- Mating connector: P/N 103587CL, pg 63
- Working temperature: SP-300: -10° to +60°C (see output derating); SP-320 -20° to 65° (see www.Jameco.com)

• Mounting hardware: use P/Ns 222156CL, 222130CL, 222181CL & 222172CL; www.Jameco.com for specs
 Detailed below in blue, these series feature input Power Factor Correction that meets EN61000-3-2, required in Europe for power supplies 75 watts and above. These advanced switchers are part of Mean Well's family of premium power supplies that carry an unusually long three-year warranty. Couple this with the full range universal input ranges of 85-264VAC and 120-370VDC, and these switchers are ready for use worldwide. Meeting the requirements of TUV EN60950, they are approved by UL and TUV, and carry the CE mark.

The high-density enclosed packaging results in a profile of only 2" and a maximum power density of 4.3 watts per cubic inch. Protection includes short-circuit, overload and over-voltage.

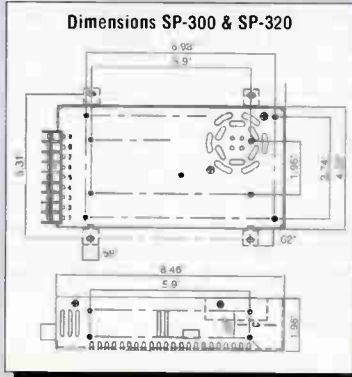
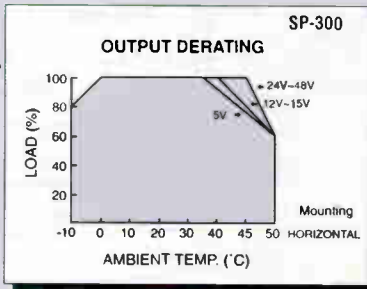

320-Watt Enclosed S-320 Series: Single Output



- 100% full-load burn-in
- Auto cooling fan
- No minimum load required
- 4.1 watts/in³ max.
- 105°C output capacitor
- Two-year warranty
- Mating connector: P/N 103587CL, pg 63
- -10° to +60°C working temp. (see output derating)
- Mounting hardware: use P/Ns 222156CL, 222148CL, 222181CL & 222172CL; see www.Jameco.com

Shown below in buff color, the workhorse S-320 series has long been one of the most popular series of Mean Well power supplies. Full 320 watts of power is available over the ambient temperature range of 0°C to 50°C. With derating the range extends to -10°C & 60°C. The solid, reliable, low-cost design features overload protection to 135% of rated load with auto-recovery, and over-voltage protection to 145% of rated output voltage.

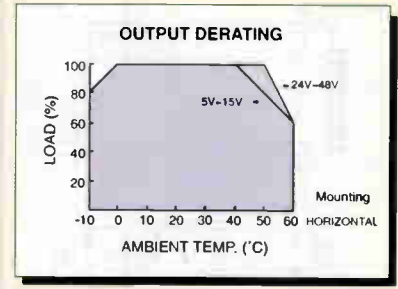

Open Frame Power Supplies on pages 124-132.

SALE

Now Lower Prices

Jameco Part No.	Manufacturer	Manufacturer Product Number	Output		Input (VAC @ Hz)	PFC	Power Density (W/in ³)	Ripple & Noise (mV p-p)*	Load Reg. (±%)*
			Voltage@Current (min-max)	Power					
202091CL	Mean Well	SP-300-5	+5V@0-50A	250.0W	88-264@47-63	✓	3.09	150	1.0
137390CL	Mean Well	SP-300-12	+12V@0-24A	288.0W	88-264@47-63	✓	3.56	150	0.5
212396CL	Mean Well	SP-300-13.5	+13.5V@0-21A	285.0W	88-264@47-63	✓	3.52	150	0.5
202104CL	Mean Well	SP-300-15	+15V@0-19A	285.0W	88-264@47-63	✓	3.52	150	0.5
137402CL	Mean Well	SP-300-24	+24V@0-12.5A	300.0W	88-264@47-63	✓	3.70	150	0.5
161980CL	Mean Well	SP-300-48	+48V@0-6.25A	300.0W	88-264@47-63	✓	3.70	240	0.5
244734CL	Mean Well	SP-320-5	+5V@0-55A	275.0W	88-264@47-63	✓	3.64	150	1.0
244742CL	Mean Well	SP-320-12	+12V@0-25A	300.0W	88-264@47-63	✓	3.97	150	0.5
244751CL	Mean Well	SP-320-24	+24V@0-13A	312.0W	88-264@47-63	✓	4.13	150	0.5
244769CL	Mean Well	SP-320-48	+48V@0-6.7A	321.6W	88-264@47-63	✓	4.26	240	0.5
216776CL	Mean Well	S-320-5	+5V@0-50A	250.0W	88-132/176-264@47-63	—	3.27	150	1.0
207212CL	Mean Well	S-320-7.5	+7.5V@0-36A	270.0W	88-132/176-264@47-63	—	3.53	150	0.5
207204CL	Mean Well	S-320-12	+12V@0-25A	300.0W	88-132/176-264@47-63	—	3.92	150	0.5
196656CL	Mean Well	S-320-24	+24V@0-12.5A	300.0W	88-132/176-264@47-63	—	3.92	150	0.5
207191CL	Mean Well	S-320-48	+48V@0-6.5A	312.0W	88-132/176-264@47-63	—	4.08	240	0.5
220302CL	Mean Well	QP-375-5A	+5V@3.5-30A; +12V@0-10A; +12V@0-6A; +12V@0-3A	378.0W	88-264@47-63	✓	2.77	100	0.8
220290CL	Mean Well	QP-375-5B	+5V@3.5-30A; +12V@0-10A; +12V@0-6A; +5V@0-3A	357.0W	88-264@47-63	✓	2.62	100	0.8
220281CL	Mean Well	QP-375-5D	+5V@3.5-30A; +12V@0-9A; +12V@0-4A; +24V@0-3A	378.0W	88-264@47-63	✓	2.77	100	0.8
220273CL	Mean Well	QP-375-24B	+24V@1-10A; +5V@0-10A; +12V@0-4A; +12V@0-4A	386.0W	88-264@47-63	✓	2.83	240	0.8

Other Versions Available: Call 800-831-4242

* Primary Output

SALE

Now Lower Prices

Special Offers at Great Savings – 90-Day Warranty

Jameco Part No.	Manufacturer	Manufacturer Product Number	Output		Input (VAC @ Hz)	PFC	Size Inches (LxWxH)	Mounting Holes Inches (LxWxDia.)	Power Density (W/in ³)	Ripple & Noise (mV p-p)*	Load Reg. (±%)*
			Voltage@Current (min-max)	Power							
205647CL	SSI	STM350-1022	+5V@50A; +12V@5A; +12V@8A	350.0W	120/240@50-60	—	13.5x5.0x2.5	—	2.07	—	2.0

* Primary Output

300 to 375-Watt Enclosed Switching DC Power Supplies



375-Watt Enclosed With Power Factor Correction



QP-375 Series: Quad Output

- 100% full-load burn-in
- Remote sense
- Auto cooling fan
- Three-year warranty
- 105°C output capacitor
- Mating connector: P/N 103587CL, pg 63
- -10°C to +60°C working temperature (see output derating)
- Mounting hardware: use P/Ns 222156CL & 222172CL; see www.Jameco.com for specifications
- Universal AC input
- 2.8 watts/in³ max.



PERFORMANCE
AT VALUE
PRICES



Highlighted below in tan, the Mean Well QP-375 series is a unique quad-output switcher design that offers no minimum current requirement for V2 & V3. Additionally, both V1 and V2 are fully isolated so they can be operated with ± polarity. Greater versatility results from availability of remote sensing for precise point-of-load voltage control and a "power good / fail signal". The built-in cooling fan assures safe operation at full power output over the ambient temp. range of -10 C to 45 C, with derating to 60 C (see below). The QP-375 series offers input Power Factor Correction that meets EN61000-3-2. This enclosed switcher line features universal voltage input ranges of 90-264VAC & 120-370VDC.

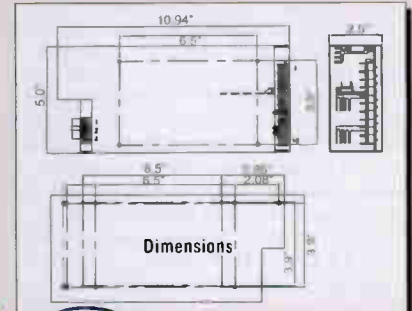
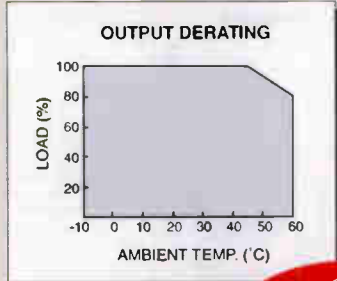
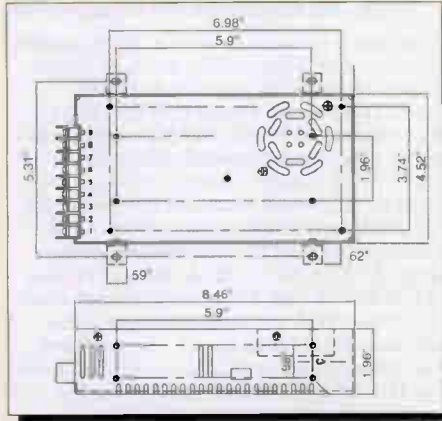

SALE Call for LOWER PRICES on Larger Quantities

New Lower Prices

Open-Frame Power Supplies on pages 120-132.

Line Reg. (±%)*	Inrush Curr. (A@ 120VAC)	Isolation Voltage (VAC)	Leakage Current (mA@240V)	Rise Time (ms)	Hold-up Time (ms)	Vibration	Voltage Adjustment (%)*	Efficiency (%)	Weight (lbs.)	Certification	Jameco Part No.	Price		
												1	10	25
0.5	18	3,000	1.0	50	20	10-500Hz: 2G	10	75	2.6	UL/CUL/TUV/CE	202091CL	\$181.95	\$136.39	\$120.99
0.3	18	3,000	1.0	50	20	10-500Hz: 2G	10	83	2.6	UL/CUL/TUV/CE	137390CL	181.95	136.39	120.99
0.3	18	3,000	1.0	50	20	10-500Hz: 2G	10	83	2.6	UL/CUL/TUV/CE	212396CL	181.95	136.39	120.99
0.3	18	3,000	1.0	50	20	10-500Hz: 2G	10	83	2.6	UL/CUL/TUV/CE	202104CL	181.95	136.39	120.99
0.2	18	3,000	1.0	50	20	10-500Hz: 2G	10	85	2.6	UL/CUL/TUV/CE	137402CL	181.95	136.39	120.99
0.2	18	3,000	1.0	50	20	10-500Hz: 2G	10	85	2.6	UL/CUL/TUV/CE	161980CL	181.95	136.39	120.99
0.5	22	3,000	1.0	50	16	10-500Hz: 2G	10	79	2.6	UL/CUL/TUV/CE	244734CL	146.95	132.25	118.99
0.3	22	3,000	1.0	50	16	10-500Hz: 2G	10	86	2.6	UL/CUL/TUV/CE	244742CL	146.95	132.25	118.99
0.2	22	3,000	1.0	50	16	10-500Hz: 2G	10	87	2.6	UL/CUL/TUV/CE	244751CL	146.95	132.25	118.99
0.2	22	3,000	1.0	50	16	10-500Hz: 2G	10	89	2.6	UL/CUL/TUV/CE	244769CL	146.95	132.25	118.99
0.5	20	3,000	3.5	20	20	10-500Hz: 2G	10	77	2.5	UL/CUL	216776CL	124.95	91.85	80.85
0.5	20	3,000	3.5	20	20	10-500Hz: 2G	10	80	2.5	UL/CUL	207212CL	124.95	91.85	80.85
0.5	20	3,000	3.5	20	20	10-500Hz: 2G	10	82	2.5	UL/CUL	207204CL	124.95	91.85	80.85
0.5	20	3,000	3.5	20	20	10-500Hz: 2G	10	86	2.5	UL/CUL	196556CL	124.95	91.85	80.85
0.5	20	3,000	3.5	20	20	10-500Hz: 2G	10	87	2.5	UL/CUL	207191CL	124.95	91.85	80.85
0.5	45	3,000	2.0	50	20	10-500Hz: 2G	10	77	5.1	UL/CUL/TUV/CE	220302CL ^{\$388.95}	277.11	248.40	224.48
0.5	45	3,000	2.0	50	20	10-500Hz: 2G	10	77	5.1	UL/CUL/TUV/CE	220290CL ^{\$388.95}	277.11	248.40	224.48
0.5	45	3,000	2.0	50	20	10-500Hz: 2G	10	78	5.1	UL/CUL/TUV/CE	220281CL ^{\$388.95}	277.11	248.40	224.48
0.5	45	3,000	2.0	50	20	10-500Hz: 2G	10	78	5.1	UL/CUL/TUV/CE	226273CL ^{\$388.95}	277.11	248.40	224.48

Special Offers at Great Savings – 90-Day Warranty

Line Reg. (±%)*	Inrush Curr. (A@ 120VAC)	Isolation Voltage (VAC)	Leakage Current (mA@240V)	Rise Time (ms)	Hold-up Time (ms)	Vibration	Voltage Adjustment (%)*	Efficiency (%)	Weight (lbs.)	Certification	Jameco Part No.	Price		
												1	10	50
0.3	20	—	—	—	16	—	10	75	5.5	UL/TUV	205647CL ^{\$20.14}	\$8.88	\$9.89	\$8.99

500-Watt Enclosed With Power Factor Correction

SP-500 Series: Single Output

- 100% full-load burn-in
- Universal AC input
- No minimum load required
- 3.6 watts/in³ max.
- Power Factor Correction
- Auto cooling fan
- 105°C output capacitor
- Three-year warranty
- Remote control
- Mating connector:
P/N 103587CL pg 63
- -10° to +60°C working temp.
(see www.Jameco.com for output derating)
- Mounting hardware: use P/Ns 222199CL, 222156CL & 222172CL; see www.Jameco.com for specifications



PERFORMANCE
AT VALUE
PRICES

Detailed below in blue, this advanced switcher line is part of Mean Well's family of premium power supplies that carry an unusually long three-year manufacturers warranty. Their performance, reliability and low cost result from a modern state-of-the-art design using highly integrated components. The SP-500 offers input Power Factor Correction of 0.98 at 115VAC that meets EN61000-3-2, required in Europe for power supplies 75 watts and above. Assured to operate correctly anywhere in the world, these enclosed switchers feature universal voltage input ranges of 88-264VAC and 124-370VDC. These products are approved by UL, CUL, and TUV; and carry the CE mark, for use worldwide. EMC standards met are EN55022 Class B and EN61000-4-2/3/4/5/6/8/11.

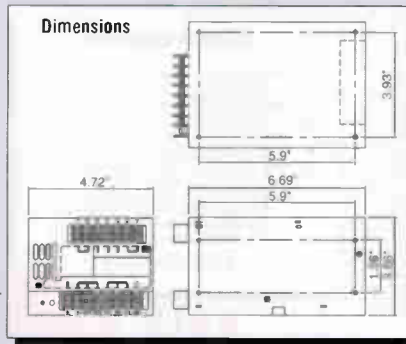

CE

500, 1000 & 1500-Watt Enclosed With Power Factor Correction & Current Sharing

PSP-500, PSP-1000 & PSP-1500 Series: Single Output

- 100% full-load burn-in
- Universal AC input
- No minimum load required
- 3.6 watts/in³ max.
- 105°C output capacitor
- Three-year warranty
- Parallel operation (current sharing)
- Remote sense and control
- Auto cooling fan
- Mating connector: P/N 103587CL, pg 63
- -10° to +60°C working temp.
(see www.Jameco.com for output derating)
- Mounting hardware: use P/Ns 222156CL & 222172CL; see www.Jameco.com for specifications

Highlighted below in buff color, these families of feature rich, high-quality, low-cost switchers provide parallel operation to 2000W, Power Factor Correction of 0.98 at 115VAC that complies with EN61000-3-2, remote sensing for precise point-of-load voltage control, and ON-OFF remote control. Cooling is provided by an integral forced air fan (two in the PSP-1000) that assures safe operation at full power output over the ambient temperature range of 0°C to 50°C, with derating -10°C and 60°C at 80% of load. Protection includes short-circuit, overload, and over-voltage; a novel soft-start circuit limits the AC surge current. Guaranteed safety standards comprise UL1950 and TUV EN60950, and they carry the CE mark. The PSP-500 and the PSP-1000 series meet EMC standards EN55022 Class B and EN61000-4-2/3/4/5/6/8/11.

Open-Frame Power Supplies
on pages 124-122.

Power	Jameco Part No.	Manufacturer	Manufacturer Product Number	Output		Input (VAC @ Hz)	PFC	Size Inches (LxWxH)	Mounting Holes Inches (LxWxDia.)	Power Density (W/in ³)	Ripple & Noise (mV p-p)	Load Reg. (±%)
				Voltage@Current (min-max)	Power							
Enclosed	190692CL	Mean Well	SP500-12	+12V@0-40A	480.0W	100-240@50-60	✓	see diagram	see diagram	3.60	240	0.5
	212388CL	Mean Well	SP500-13.5	+13.5V@0-36A	486.0W	100-240@50-60	✓	see diagram	see diagram	3.65	240	0.5
	213604CL	Mean Well	SP500-15	+15V@0-32A	480.0W	100-240@50-60	✓	see diagram	see diagram	3.60	240	0.5
	147053CL	Mean Well	SP500-24	+24V@0-20A	480.0W	100-240@50-60	✓	see diagram	see diagram	3.60	240	0.5
	190705CL	Mean Well	SP500-27	+27V@0-18A	486.0W	100-240@50-60	✓	see diagram	see diagram	3.65	200	0.5
	161795CL	Mean Well	SP500-48	+48V@0-10A	480.0W	100-240@50-60	✓	see diagram	see diagram	3.60	300	0.5
	202112CL	Mean Well	PSP-500-5	+5V@0-80A	400.0W	90-264@47-63	✓	see diagram	see diagram	2.91	100	2.0
	190713CL	Mean Well	PSP-500-12	+12V@0-41.5A	498.0W	90-264@47-63	✓	see diagram	see diagram	3.62	150	0.5
	202121CL	Mean Well	PSP-500-15	+15V@0-33A	498.0W	90-264@47-63	✓	see diagram	see diagram	3.60	150	0.5
	190721CL	Mean Well	PSP-500-24	+24V@0-20.8A	499.2W	90-264@47-63	✓	see diagram	see diagram	3.63	150	0.5
	190730CL	Mean Well	PSP-500-27	+27V@0-18.5A	499.5W	90-264@47-63	✓	see diagram	see diagram	3.63	150	0.5
	190748CL	Mean Well	PSP-500-48	+48V@0-10.5A	504.0W	90-264@47-63	✓	see diagram	see diagram	3.67	200	0.5
	217373CL	Mean Well	PSP-1000-5	+5V@0-145A	725.0W	90-264@47-63	✓	see www.Jameco.com		2.61	100	2.0
	217365CL	Mean Well	PSP-1000-12	+12V@0-75A	900.0W	90-264@47-63	✓	see www.Jameco.com		3.24	150	0.5
	231642CL	Mean Well	PSP-1000-13.5	+13.5V@0-67A	1000.0W	90-264@47-63	✓	see www.Jameco.com		3.65	150	0.5
	231634CL	Mean Well	PSP-1000-15	+15V@0-60A	900.0W	90-264@47-63	✓	see www.Jameco.com		3.24	150	0.5
	217357CL	Mean Well	PSP-1000-24	+24V@0-37.6A	902.4W	90-264@47-63	✓	see www.Jameco.com		3.25	150	0.5
	231651CL	Mean Well	PSP-1000-27	+27V@0-33.6A	907.2W	90-264@47-63	✓	see www.Jameco.com		3.26	150	0.5
	217349CL	Mean Well	PSP-1000-48	+48V@0-19A	912.0W	90-264@47-63	✓	see www.Jameco.com		3.28	200	0.5
	231669CL	Mean Well	PSP-1500-5	+5V@0-217.5A	1087.5W	176-264@47-63	✓	see www.Jameco.com		2.76	100	2.0
	231677CL	Mean Well	PSP-1500-12	+12V@0-112.5A	1350.0W	176-264@47-63	✓	see www.Jameco.com		3.42	150	0.5
	231685CL	Mean Well	PSP-1500-13.5	+13.5V@0-100.5A	1356.75W	176-264@47-63	✓	see www.Jameco.com		3.44	150	0.5
	231693CL	Mean Well	PSP-1500-15	+15V@0-90.0A	1350.0W	176-264@47-63	✓	see www.Jameco.com		3.42	150	0.5
	231706CL	Mean Well	PSP-1500-24	+24V@0-56.4A	1353.6W	176-264@47-63	✓	see www.Jameco.com		3.43	150	0.5
	231714CL	Mean Well	PSP-1500-27	+27V@0-50.4A	1360.8W	176-264@47-63	✓	see www.Jameco.com		3.45	150	0.5
	231722CL	Mean Well	PSP-1500-48	+40V@0-28.5A	1368.0W	176-264@47-63	✓	see www.Jameco.com		3.47	200	0.5
	220249CL	Mean Well	SCN-600-05	+5V@0-100A	500.0W	90-130/180-260@47-63	—	see diagram	see diagram	3.10	100	2.0
	220257CL	Mean Well	SCN-600-12	+12V@0-50A	600.0W	90-130/180-260@47-63	—	see diagram	see diagram	3.72	120	1.0
220265CL	Mean Well	SCN-600-24	+24V@0-25A	600.0W	90-130/180-260@47-63	—	see diagram	see diagram	3.72	240	1.0	

Other Versions
Available: Call
800-831-4242

* Primary Output



PSP-500



PERFORMANCE
AT VALUE
PRICES

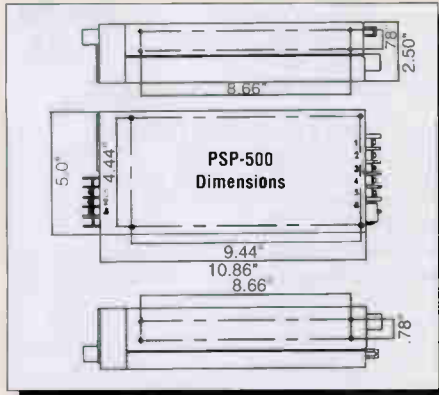

600-Watt Enclosed With Current Sharing

SCN-600 Series: Single Output



PERFORMANCE
AT VALUE
PRICES



- 100% full-load burn-in
- Auto cooling fan
- No minimum load required
- 3.7 watts/in² maximum
- 105°C output capacitor
- Two-year warranty
- Parallel operation (current sharing)
- Remote sense and control
- Mating connector:
P/N 103587CL, pg 63
- -10° to +65°C working temperature;
(+50° to -65°C @ 50% load)
- Mounting hardware: use P/Ns 222156CL &
222172CL; see www.Jameco.com for specifications

Shown below in tan, the SCN-600 family of 600-watt enclosed switchers offer advanced N+1 parallel operation, remote sensing for precise point-of-load voltage control and built-in remote ON-OFF control. Also, a unique capability allows output voltage adjustment from 10-100% of rated value with an external 1-5VDC signal. The DC output voltage can be adjusted ±5% of nominal rating. The solid, reliable, low-cost design features overload protection to 135% of rated load with auto-recovery, and over-voltage protection to 145% of rated output voltage. Additional protection includes short-circuit and a soft-start circuit that limits the AC surge current to a safe value. Meeting the requirements of UL1950 and TUV EN60950, these products are approved by UL, CUL and TUV; and carry the CE mark.

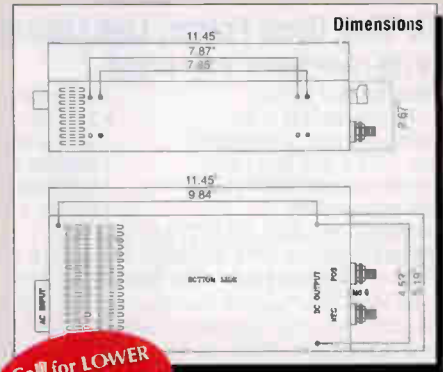

Call for LOWER
PRICES on Larger
Quantities

Dyna-Flex Power Supplies
on pages 134-137

Line Reg. (±%)*	Inrush Curr. (A@ 120VAC)	Isolation Voltage (VAC)	Leakage Current (mA@240V)	Rise Time (ms)	Hold-up Time (ms)	Vibration	Voltage Adjustment (%)	Efficiency (%)	Weight (lbs.)	Certification	Jameco Part No.	Price		
												1	10	25
0.5	18	3,000	3.5	50	20	10-500Hz; 2G	10	84	4.2	UL/CUL/TUV/CE	190692CL	\$249.95	\$193.39	\$170.29
0.5	18	3,000	3.5	50	20	10-500Hz; 2G	10	84	4.2	UL/CUL/TUV/CE	212388CL	249.95	193.39	170.29
0.5	18	3,000	3.5	50	20	10-500Hz; 2G	10	83	4.2	UL/CUL/TUV/CE	213604CL	249.95	193.39	170.29
0.5	18	3,000	3.5	50	20	10-500Hz; 2G	10	85.5	4.2	UL/CUL/TUV/CE	147053CL	249.95	193.39	170.29
0.5	18	3,000	3.5	50	20	10-500Hz; 2G	10	86.5	4.2	UL/CUL/TUV/CE	190705CL	249.95	193.39	170.29
0.5	18	3,000	3.5	50	20	10-500Hz; 2G	10	87	4.2	UL/CUL/TUV/CE	161795CL	249.95	193.39	170.29
0.5	20	3,000	1.0	50	15	10-500Hz; 2G	10	76	5.5	UL/CUL/TUV/CE	202112CL ^{\$269.95}	269.95	193.39	170.29
0.3	20	3,000	1.0	50	15	10-500Hz; 2G	10	82	5.5	UL/CUL/TUV/CE	190713CL	269.95	232.09	216.69
0.3	20	3,000	1.0	50	15	10-500Hz; 2G	10	82	5.5	UL/CUL/TUV/CE	202121CL	269.95	232.09	216.69
0.2	20	3,000	1.0	50	15	10-500Hz; 2G	10	84	5.5	UL/CUL/TUV/CE	190721CL	269.95	232.09	216.69
0.2	20	3,000	1.0	50	15	10-500Hz; 2G	10	84	5.5	UL/CUL/TUV/CE	190730CL	269.95	232.09	216.69
0.2	20	3,000	1.0	50	15	10-500Hz; 2G	10	86	5.5	UL/CUL/TUV/CE	190748CL	269.95	232.09	216.69
0.5	35	3,000	2.0	50	15	10-500Hz; 2G	10	76	10.4	UL/CUL/TUV/CE	217373CL	523.95	442.19	402.59
0.3	35	3,000	2.0	50	15	10-500Hz; 2G	10	82	10.4	UL/CUL/TUV/CE	217365CL	523.95	442.19	402.59
0.3	40	3,000	2.0	50	15	10-500Hz; 2G	10	84	10.4	UL/CUL/TUV/CE	231642CL	523.95	442.19	402.59
0.3	40	3,000	2.0	50	15	10-500Hz; 2G	10	84	10.4	UL/CUL/TUV/CE	231634CL	523.95	442.19	402.59
0.2	35	3,000	2.0	50	15	10-500Hz; 2G	10	84	10.4	UL/CUL/TUV/CE	217357CL	523.95	442.19	402.59
0.2	40	3,000	2.0	50	15	10-500Hz; 2G	10	86	10.4	UL/CUL/TUV/CE	231651CL	523.95	442.19	402.59
0.2	35	3,000	2.0	50	15	10-500Hz; 2G	10	86	10.4	UL/CUL/TUV/CE	217349CL	523.95	442.19	402.59
0.5	100	3,000	3.5	50	15	10-500Hz; 2G	10	77	15.2	CUL/TUV/CE	231669CL	786.95	663.25	619.25
0.3	100	3,000	3.5	50	15	10-500Hz; 2G	10	84	15.2	CUL/TUV/CE	231677CL	786.95	663.25	619.25
0.3	100	3,000	3.5	50	15	10-500Hz; 2G	10	84	15.2	CUL/TUV/CE	231685CL	786.95	663.25	619.25
0.3	100	3,000	3.5	50	15	10-500Hz; 2G	10	84	15.2	CUL/TUV/CE	231693CL	786.95	663.25	619.25
0.2	100	3,000	3.5	50	15	10-500Hz; 2G	10	85	15.2	CUL/TUV/CE	231706CL	786.95	663.25	619.25
0.2	100	3,000	3.5	50	15	10-500Hz; 2G	10	85	15.2	CUL/TUV/CE	231714CL	786.95	663.25	619.25
0.2	100	3,000	3.5	50	15	10-500Hz; 2G	10	86	15.2	CUL/TUV/CE	231722CL	786.95	663.25	619.25
0.5	60	1,500	3.5	50	16	10-200Hz; 2G	5	77	5.7	UL/CUL	220249CL	273.95	213.99	197.99
0.5	60	1,500	3.5	50	16	10-200Hz; 2G	5	80	5.7	UL/CUL	220257CL	273.95	213.99	197.99
0.5	60	1,500	3.5	50	16	10-200Hz; 2G	5	85	5.7	UL/CUL	220265CL	273.95	213.99	197.99

Power

Enclosed

30-Watt Open Frame, Low Leakage

MPS-30 Series: Single Output

- 100% full load burn-in test
- 105°C output capacitor
- Universal AC input
- High-efficiency, low heat generation
- -10°C to +50°C working temperature (see www.Jameco.com)
- Load regulation: ±1.0%, except 220978CL: ±2.0%
- Line regulation: ±0.5%, except 220978CL & 220986CL: ±1.0%
- Inrush current: 35A@120VAC • Leakage current: 0.3mA@240V
- Three-year warranty • Size: 4.0"L x 2.59"W x 0.98"H
- Mounting holes: 3.74"L x 2.02"W x 0.12"Dia.
- Mating connectors: P/Ns 104723CL & 104432CL, pg 75



- Isolation voltage: 4000VAC
- 2.9 watts/in² maximum
- Weight: 0.3 lbs.

The Mean Well MPS-30 medical power supplies are low cost, high reliability open frame power supplies that feature a low leakage current of 0.3mA@240VAC. Other features of this open frame power supply are: universal input of 88-264VAC as well as 120-370VDC for battery-supported applications. Protections include short-circuit, overload, and over-voltage. They are UL and TUV approved, and carry a CE mark for use worldwide.

110-Watt Open Frame, Low Leakage

NFS110-79xxP Series: Quad Outputs

- 100% full-load burn-in
- 110W with 20 CFM of air
- Leakage current: 0.1mA@240V
- Size: 7.0"L x 4.25"W x 1.8"H
- In-rush current: 17A@120VAC
- Two-year warranty
- Mounting holes: 6.6"L x 3.75"W x 0.156"Dia.
- Mating connectors: P/Ns 104723CL, 104766CL & 104432CL, pg 75
- 0°C to +70°C working temp. (see www.Jameco.com)

- Universal AC input
- 2.1 watts/in² maximum
- Voltage adjustment: 3%
- Isolation voltage: 4000VAC
- Line regulation: ±0.1%
- Weight: 1.3 lbs.



SALE



TOP QUALITY U.S. BRAND

The NFS110-79xxP models have proven to be highly reliable and versatile for a wide range of communication and industrial applications, with a very high peak current capability on each output for drive and motor applications. These models have full medical safety approval to EN60601 and UL 2601, and meet conducted emissions requirements of EN55022 level A. They are designed for use in low power medical, dental and laboratory applications.

45 & 65-Watt Open Frame, Low Leakage

MPS-45 & MPS-65 Series: Single Output

- 100% full load burn-in test
- 105°C output capacitor
- Universal AC input
- High-efficiency, low heat generation
- Isolation voltage: 4000VAC
- 2.9 watts/in² max.
- Voltage adjustment: 10%
- -10°C to +60°C working temperature (see www.Jameco.com)
- Leakage current: 0.3mA@240V
- Inrush current: 20A@120VAC
- Line regulation: ±1.0%
- Load regulation: ±2.0%, except 221031CL, 221049CL, 221057CL, 221129CL, 221137CL, 221145CL: ±3.0%
- Soft-start circuit, limiting AC surge current
- Three-year warranty • Weight: 0.6 lbs.
- Size: MPS-45: 5.0"L x 3.0"W x 1.06"H; MPS-65: 5.0"L x 3.0"W x 1.65"H
- Mounting holes: 4.55"L x 2.55"W x 0.14"Dia.
- Mating connectors: P/Ns 104432CL and 104731CL, pg 75

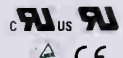

The Mean Well MPS-45 & MPS-65 medical power supplies are low cost, high reliability open frame power supplies. Other features of these power supplies are: universal input of 88-264VAC, as well as 120-370VDC for battery-applications. Full rated power is available with 18CFM forced air convection applied. Protections include short-circuit, overload, and over-voltage.

For Complete Specifications visit www.Jameco.com.

Expanded Power Supplies on pages 112-122.

Jameco Part No.	Manufacturer	Manufacturer Product Number	Output		Input (VAC @ Hz)	Ripple & Noise (mV p-p)*	Certification	Price		
			Voltage@Current (min-max)	Power				1	10	25
220978CL	Mean Well	MPS-30-5	+5V@0-5A	25.0W	88-264@47-63	80	UL/CUL/TUV/CE	\$36.95	\$33.26	\$29.93
220986CL	Mean Well	MPS-30-12	+12V@0-2.5A	30.0W	88-264@47-63	120	UL/CUL/TUV/CE	36.95	33.26	29.93
220994CL	Mean Well	MPS-30-15	+15V@0-2A	30.0W	88-264@47-63	150	UL/CUL/TUV/CE	36.95	33.26	29.93
221006CL	Mean Well	MPS-30-24	+24V@0-1.2A	28.8W	88-264@47-63	240	UL/CUL/TUV/CE	36.95	33.26	29.93
221014CL	Mean Well	MPS-30-27	+27V@0-1.1A	29.7W	88-264@47-63	240	UL/CUL/TUV/CE	36.95	33.26	29.93
221022CL	Mean Well	MPS-30-48	+48V@0-0.6A	28.8W	88-264@47-63	240	UL/CUL/TUV/CE	36.95	33.26	29.93
221031CL	Mean Well	MPS-45-3.3	+3.3V@0-8A	26.4W	90-264@47-440	80	UL/CUL/TUV/CE	37.95	34.16	30.74
221049CL	Mean Well	MPS-45-5	+5V@0-8A	40.0W	90-264@47-440	100	UL/CUL/TUV/CE	37.95	34.16	30.74
221057CL	Mean Well	MPS-45-7.5	+7.5V@0-5.4A	40.5W	90-264@47-440	100	UL/CUL/TUV/CE	37.95	34.16	30.74
221065CL	Mean Well	MPS-45-12	+12V@0-3.7A	44.4W	90-264@47-440	100	UL/CUL/TUV/CE	37.95	34.16	30.74
221073CL	Mean Well	MPS-45-13.5	+13.5V@0-3.3A	44.6W	90-264@47-440	100	UL/CUL/TUV/CE	37.95	34.16	30.74
221081CL	Mean Well	MPS-45-15	+15V@0-3A	45.0W	90-264@47-440	100	UL/CUL/TUV/CE	37.95	34.16	30.74
221090CL	Mean Well	MPS-45-24	+24V@0-1.9A	45.6W	90-264@47-440	100	UL/CUL/TUV/CE	37.95	34.16	30.74
221102CL	Mean Well	MPS-45-27	+27V@0-1.7A	45.9W	90-264@47-440	100	UL/CUL/TUV/CE	37.95	34.16	30.74
221111CL	Mean Well	MPS-45-48	+48V@0-1A	48.0W	90-264@47-440	100	UL/CUL/TUV/CE	37.95	34.16	30.74
221129CL	Mean Well	MPS-65-3.3	+3.3V@0-12A	39.6W	90-264@47-440	80	UL/CUL/TUV/CE	38.95	35.06	31.55
221137CL	Mean Well	MPS-65-5	+5V@0-12A	60.0W	90-264@47-440	100	UL/CUL/TUV/CE	38.95	35.06	31.55
221145CL	Mean Well	MPS-65-7.5	+7.5V@0-8A	60.0W	90-264@47-440	100	UL/CUL/TUV/CE	38.95	35.06	31.55
221153CL	Mean Well	MPS-65-12	+12V@0-5.2A	62.4W	90-264@47-440	100	UL/CUL/TUV/CE	38.95	35.06	31.55
221161CL	Mean Well	MPS-65-13.5	+13.5V@0-4.7A	63.5W	90-264@47-440	100	UL/CUL/TUV/CE	38.95	35.06	31.55
221170CL	Mean Well	MPS-65-15	+15V@0-4.2A	63.0W	90-264@47-440	100	UL/CUL/TUV/CE	38.95	35.06	31.55
221188CL	Mean Well	MPS-65-24	+24V@0-2.7A	64.8W	90-264@47-440	100	UL/CUL/TUV/CE	38.95	35.06	31.55
221196CL	Mean Well	MPS-65-27	+27V@0-2.4A	64.8W	90-264@47-440	100	UL/CUL/TUV/CE	38.95	35.06	31.55
221209CL	Mean Well	MPS-65-48	+48V@0-1.35A	64.8W	90-264@47-440	100	UL/CUL/TUV/CE	36.95	31.99	27.99
220222CL	Artesyn	NFS110-7901P	+5.1V@0-8; +12V@0-4.5A; -5V@0-0.5A; -12V@0-0.5A	110W	90-253@47-440	50	UL/CSA/VDE/CE	\$134.15 164.00	94.00	88.15
220214CL	Artesyn	NFS110-7902P	+5.1V@0-8A; +12V@0-4.5A; +24V@0-3.5A; -12V@0-0.5A	110W	90-253@47-440	50	UL/CSA/VDE/CE	\$134.15 164.00	94.00	88.15

* Primary Output

Call for **LOWER PRICES** on Larger Quantities

10 to 25-Watt Open-Frame Switching DC Power Supplies

15 & 25-Watt Open Frame

PSA15 & PSA25 Series: Single & Triple Outputs

- Load regulation: $\pm 2.0\%$
- Line regulation: $\pm 1.0\%$
- Universal input
- Inrush current: 30A @ 120VAC
- Isolation voltage: 3,000VAC
- Leakage current: 0.75mA@240V, except 230535CL: 0.25mA@240V
- Voltage adjustment: 5% (PSA15 only)
- Temperature: 0° to +40°C
- One-year warranty
- Size: 4.33"L x 1.57"W x 0.91"H, except 230527CL 5.0"L x 2.0"W x 1.1"H and 230535CL 3.6"L x 2.5"W x 1.1"H
- Weight: 0.3 lbs.
- Mounting holes: 4.02"L x 1.26"W x 0.16" Dia. (except P/Ns 230527CL 4.1"L x 1.7"W x 1.4"H and 230535CL 3.3"L x 2.2"W x 1.0"H)



PERFORMANCE AT VALUE PRICES

SALE



25-Watt Open Frame

NLP-25 Series: Single & Triple Outputs

- 100% full-load burn-in
- Universal AC input
- 3.3 watts/in² maximum
- Line regulation: $\pm 2.0\%$
- Load regulation: $\pm 2.0\%$
- Isolation voltage: 3,000VAC
- Leakage current: 0.4mA@240V
- Mounting holes: 3.73"L x 1.80"W x 0.13" Dia.
- 0°C to +50°C working temp. (see www.Jameco.com)
- Two-year warranty
- Size: 4.0"L x 2.07"W x 0.91"H
- Mating connectors: P/Ns 104432CL & 104723CL, pg 75



TOP QUALITY U.S. BRAND



SALE

The NLP25 series provides 25W of power with free-air convection cooling that can peak at 30W for 60 seconds. Standard features include over-voltage and short-circuit protection. The NLP25 series, with full international safety approvals and the CE mark, meets conducted and radiated emissions EN55022 level B and complies to EN61000-4-2/3/4/5/6 immunity standards.

For Complete Specifications visit www.Jameco.com.

25-Watt Open Frame

PS-25 & PD-25 Series: Single & Dual Outputs

- 100% full-load burn-in
- 105°C output capacitor
- Size: 4.20"L x 2.40"W x 1.10"H
- Inrush current: 40A @ 120VAC
- -10°C to +60°C working temp (see www.Jameco.com)
- Mating connectors: P/Ns 104432CL & 104715CL, pg 75
- 2.1 watts/in² maximum
- Universal AC input
- Leakage current: 0.5mA@240V
- Mounting holes: 3.70"L x 2.10"W x 0.14" Dia.
- Isolation voltage: 3,000VAC
- Two-year warranty
- Weight: 0.3 lbs.



SALE

PERFORMANCE AT VALUE PRICES



The PS-25 and PD-25 series are low-cost, high-quality switchers that can be used for many lower-power commercial applications, both single and dual-output. Full rated power is available with free-air convection cooling in an industry-standard package size and mounting dimensions. They feature universal input and numerous features such as short-circuit, over-voltage, overload and over-temperature protection.

Increased Power Supplies on pages 112-123.

Part Number	Load Reg. ($\pm\%$) [*]	Line Reg. ($\pm\%$) [*]	Part Number	Load Reg. ($\pm\%$) [*]	Line Reg. ($\pm\%$) [*]
212361CL	2.5	0.5	212311CL	4.0	1.0
212353CL	2.0	0.5	212337CL	1.0	0.5
148603CL	1.0	0.3	212329CL	1.0	0.5
216768CL	1.0	0.3	148689CL	3.0	0.5
212345CL	0.5	0.2			

New Lower Prices

Jameco Part No.	Manufacturer	Manufacturer Product Number	Output		Power	Input (VAC @ Hz)	Ripple & Noise (mV p-p) [*]	Certification	Price		
			Voltage@Current (min-max)						1	10	25
229041CL	Phihong	PSA15LN3-050	+5V@0-3A		15.0W	90-264@47-63	50	UL/CUL/TUV/CE	\$ 17.95	\$ 17.95	\$ 17.95
229059CL	Phihong	PSA15LN3-120	+12V@0-1.25A		15.0W	90-264@47-63	120	UL/CUL/TUV/CE	17.95	17.95	17.95
229067CL	Phihong	PSA15LN3-240	+24V@0-0.63A		15.0W	90-264@47-63	240	UL/CUL/TUV/CE	17.95	17.95	17.95
230527CL	Phihong	PSA25LS-050	+5V@0-5A		25.0W	90-264@47-63	50	UL/CUL/CSA/TUV	\$23.49	23.49	23.49
230535CL	Phihong	PSA25L-301	+5V@0.2-2A; +12V@0.1-1A; -12V@0-0.3A		25.0W	90-264@47-63	50	UL/CUL/TUV/CE	23.49	21.15	18.99
218472CL	Artesyn	NLP25-7605	+5V@0-5A		25.0W	90-264@47-440	50	UL/CSA/DE/CE	26.19	22.55	22.29
218481CL	Artesyn	NLP25-7612	+12V@0-2.08A		25.0W	90-264@47-440	120	UL/CSA/DE/CE	26.19	22.55	22.29
218499CL	Artesyn	NLP25-7624	+24V@0-1.04A		25.0W	90-264@47-440	150	UL/CSA/DE/CE	26.19	22.55	22.29
218501CL	Artesyn	NLP25-7608	+5V@0.2-2A; +12V@0.1-0.8A; -12V@0-0.1A		20.8W	90-264@47-440	50	UL/CSA/DE/CE	26.19	22.55	22.29
212361CL	Mean Well	PS-25-3.3	+3.3V@0-5A		16.5W	85-264@47-63	80	UL/CUL/TUV/CE	\$18.95	17.95	16.19
212353CL	Mean Well	PS-25-5	+5V@0-5A		25.0W	85-264@47-63	80	UL/CUL/TUV/CE	\$18.95	17.95	16.19
148603CL	Mean Well	PS-25-12	+12V@0-2.1A		25.2W	85-264@47-63	100	UL/CUL/TUV/CE	18.95	17.95	17.19
216768CL	Mean Well	PS-25-15	+15V@0-1.7A		25.5W	85-264@47-63	100	UL/CUL/TUV/CE	\$18.95	17.95	16.19
212345CL	Mean Well	PS-25-24	+24V@0-1A		24.0W	85-264@47-63	240	UL/CUL/TUV/CE	18.95	17.95	17.19
212311CL	Mean Well	PD-2505	+5V@0.1-3A; -5V@0.1-2.5A		25.0W	85-264@47-63	50	UL/CUL/TUV/CE	19.95	18.95	17.95
212337CL	Mean Well	PD-25A	+5V@0.2-2.5A; +12V@0.1-1.5A		25.0W	85-264@47-63	50	UL/CUL/TUV/CE	\$19.95	18.95	17.95
212329CL	Mean Well	PD-25B	+5V@0.2-2A; +24V@0.1-1A		25.2W	85-264@47-63	50	UL/CUL/TUV/CE	19.95	18.95	17.95
148689CL	Mean Well	PD-2512	+12V@0.1-1.2A; -12V@0.1-1A		24.0W	85-264@47-63	50	UL/CUL/TUV/CE	19.95	18.95	17.95

Other versions Available: Call 800-831-4242

* Primary Output

Special Offers at Great Savings – 90-Day Warranty

Jameco Part No.	Mfr.	Manufacturer Product No.	Output		Input (VAC @ Hz)	Size Inches (LxWxH)	Mounting Holes Inches (LxWxDia.)	Ripple & Noise (mV p-p)	Load Reg. ($\pm\%$)	Line Reg. ($\pm\%$)	Certification	Price		
			Voltage@Current (min-max)	Power								1	10	25
189747CL	Tamura	79642191	+5V@1A; +12V@1A	17.0W	120/230@50-60	4.7x2.4x1.1	—	50	—	1.0	—	\$8.95	\$7.65	\$5.75
173374CL	AUTEC	UPS20-2002†	+5V@1A; +12V@1.5A	23.0W	115/230@50-50	5.0x3.0x1.1	5.1x1.6x0.16	50	2.0	1.0	UL/CSA/TUV	7.95	6.76	5.07
166967CL	Super Mac	U002512010	+5V@2.5A; +12V@1A	24.5W	100-240@50-60	3.7x2.5x1.2	—	50	—	1.0	UL/CSA/TUV	12.95	10.95	8.25
210770CL	ST	G25AC-51333	+5.1V@3A; +12.5V@0.75A; +33.3V@0.02A	25.0W	120@60	4.0x2.2x1.3	—	50	—	1.0	UL	6.95	6.29	5.65

* Primary Output

† Hold-up Time: 20ms

Color Code Legend
New Sale Qty. Save Closeout

Order 24/7 Toll Free 1-800-831-4242

World Radio History

30 to 50-Watt Open-Frame Switching DC Power Supplies

Color Code Legend
New Sale Qty. Save Closeout

40-Watt Open Frame

NFS-40 Series: Single & Triple Outputs

- 100% full-load burn-in
- No minimum load required
- 50 watts with 20 CFM of air
- Load regulation: $\pm 2.0\%$
- Inrush current: 12A@120VAC
- Isolation voltage: 3000VAC
- Size: 5.0"L x 3.0"W x 1.2"H
- 0° to +70°C working temperature (see www.Jameco.com)
- Mating connectors: P/Ns 104432CL & 104731CL, pg 75
- Universal AC input
- 2.8 watts/in² maximum
- Leakage current: 0.32mA@240V
- Line regulation: $\pm 0.2\%$
- Voltage adjustment: 5%
- Two-year warranty
- Weight: 0.6 lbs.
- Mounting holes: 4.56"L x 2.55"W x 0.16"Dia.

ARTESYN TECHNOLOGIES

SALE

TOP QUALITY U.S. BRAND



45-Watt Open Frame

PSA45 Series: Single, Triple & Quad Outputs

- Load regulation: $\pm 2.0\%$
- Line regulation: $\pm 2.0\%$
- Universal input
- Inrush current: 20A @ 120VAC
- Leakage current: 3.5mA@240V
- Temperature: 0° to +50°C
- One-year warranty
- Size: 5.0"L x 3.0"W x 1.2"H
- Weight: 0.9 lbs.
- Mounting holes: 4.56"L x 2.55"W x 0.16"Dia.

Call for LOWER PRICES on Larger Quantities

PHIHONG

PERFORMANCE AT VALUE PRICES



The Artesyn NFS40 series are industry-standard 40W power supplies with the capability to supply 50 watts with forced air cooling. Over-voltage and short-circuit protection are standard features. The NFS40 is ideal for use in equipment installed around the world because of its UL, CSA, VDE, EN60950 and IEC 950 approvals. These low-profile switchers with high power density are perfect for use in small digital systems of all types.

For Complete Specifications visit www.Jameco.com.

45-Watt Open Frame

PS-45, PD-45 & PT-45 Series: Single, Dual & Triple Outputs

- 100% full-load burn-in
- 105 C output capacitor
- Mounting holes: 4.56"L x 2.55"W x 0.15"Dia.
- Load regulation: $\pm 3.0\%$ (except 213727CL/213719CL/213701CL: $\pm 2.0\%$)
- Inrush current: 20A@120VAC
- Mating connectors: P/Ns 104432CL & 104731CL, pg 75
- -10 C to +60 C working temperature (see www.Jameco.com)
- Universal AC input
- Size: 5.0"L x 3.0"W x 1.06"H
- Line regulation: $\pm 1.0\%$
- Leakage current: 0.5mA@240V
- Two-year warranty
- Weight: 0.5 lbs.
- 2.7 watts/in² maximum
- Voltage adjustment: 10%
- Isolation voltage: 3000VAC

MW MEAN WELL

PERFORMANCE AT VALUE PRICES

SALE



PERFORMANCE AT VALUE PRICES

The Mean Well PS-45, PD-45 and PT-45 series offer excellent performance with high reliability. These 45-watt switchers support full output power with free-air convection cooling. The high-density open-frame package features industry-standard mounting dimensions. Intended for virtually any medium power-application, these units provide short-circuit and over-voltage protection, as well as overload protection with auto-recovery.

Jameco Part No.	Manufacturer	Manufacturer Product Number	Output		Power	Input (VAC @ Hz)	Ripple & Noise (mV p-p)*	Certification	Price		
			Voltage@Current (min-max)						1	10	25
218510CL	Artesyn	NFS40-7605	+5.1V@0-6A		30.6W	85-264@47-440	100	UL/CSA/VDE/CE	\$49.95	\$11.25	\$11.25
218528CL	Artesyn	NFS40-7612	+12V@0-3.3A		39.6W	85-264@47-440	120	UL/CSA/VDE/CE	\$49.95	\$11.25	\$11.25
218536CL	Artesyn	NFS40-7624	+24V@0-1.6A		38.4W	85-264@47-440	240	UL/CSA/VDE/CE	\$49.95	\$11.25	\$11.25
190086CL	Artesyn	NFS40-7608	+5V@0-3A; +12V@0-2A; -12V@0-0.35A		43.2W	85-264@47-440	50	UL/CSA/VDE/CE	\$49.95	\$11.25	\$11.25
218552CL	Artesyn	NFS40-7610	+5V@0-3A; +15V@0-2A; -15V@0-0.35A		50.2W	85-264@47-440	50	UL/CSA/VDE/CE	\$49.95	\$11.25	\$11.25
229075CL	Phihong	PSA45-050	+5V@0-8A		40.0W	90-264@47-63	50	UL/CSA/TUV/CE	29.95	26.95	24.25
229091CL	Phihong	PSA45-120	+12V@0-4A		48.0W	90-264@47-63	120	UL/CSA/TUV/CE	29.95	26.95	24.25
229112CL	Phihong	PSA45-240	+24V@0-2A		48.0W	90-264@47-63	240	UL/CSA/TUV/CE	29.95	26.95	24.25
229121CL	Phihong	PSA4531	+5V@0-4A; +12V@0-1.5A; -12V@0-0.5A		44.0W	90-264@47-63	50	UL/CSA/TUV/CE	31.95	28.79	25.89
229139CL	Phihong	PSA4534	+5V@0-4A; +15V@0-1.2A; -15V@0-0.5A		45.5W	90-264@47-63	50	UL/CSA/TUV/CE	31.95	28.79	25.89
229147CL	Phihong	PSA4541	+5V@0-3A; +12V@0-2A; -5V@0-0.5A; -12V@0-0.5A		47.5W	90-264@47-63	50	UL/CSA/TUV/CE	32.95	29.65	26.69
217331CL	Mean Well	PS45-5	+5V@0-8A		40.0W	90-264@47-440	100	UL/CUL/TUV/CE	27.95	21.99	19.85
213727CL	Mean Well	PS45-12	+12V@0-3.7A		44.4W	90-264@47-440	100	UL/CUL/TUV/CE	27.95	21.99	19.85
213719CL	Mean Well	PS45-24	+24V@0-1.9A		45.6W	90-264@47-440	100	UL/CUL/TUV/CE	27.95	21.99	19.85
213701CL	Mean Well	PS45-48	+48V@0-1A		48.0W	90-264@47-440	100	UL/CUL/TUV/CE	27.95	21.99	19.85
194861CL	Mean Well	PD45A	+5V@0.4-3.2A; +12V@0.2-2		40.0W	90-264@47-440	50	UL/CUL/TUV/CE	29.95	23.09	20.89
194870CL	Mean Well	PD45B	+5V@0.4-3.2A; +24V@0.2-1.2A		44.8W	90-264@47-440	50	UL/CUL/TUV/CE	29.95	23.09	20.89
88401CL	Mean Well	PT45B	+5V@0.4-3A; +12V@0.2-2A; -12V@0-0.3A		45.0W	90-264@47-440	50	UL/CUL/TUV/CE	29.95	23.09	20.89

Special Offers at Great Savings - 90-Day Warranty

Jameco Part No.	Mfr.	Manufacturer Product No.	Output		Power	Input (VAC @ Hz)	Size Inches (LxWxH)	Mounting Holes Inches (LxWxDia.)	Ripple & Noise (mV p-p)	Load Reg. (%)	Line Reg. (%)	Certification	Price		
			Voltage@Current (min-max)										1	10	25
210841CL	Power-One	MAP42-1005	+5V@0-8A		40.0W	120-240@50-60	5.0x3.0x1.3	4.6x2.6x0.16	50	1.0	0.2	UL/CSA/TUV/CE	\$19.95	\$14.99	\$10.49
163985CL	Samsung	PSP430201A	+5V@5A; +12V@1.5A		43.0W	100-120@50-60	6.1x2.1x1.0	—	—	—	—	UL/CUL	\$14.95	\$11.95	\$10.16
204548CL	IPD Power	SRW-45-3102	+5V@2.5A; +14.5V@2A; -5.2V@3A		45.0W	85-264@47-63	5.0x3.0x1.2	4.6x2.6x0.16	—	0.5	—	—	\$11.75	—	—
204492CL	IPD Power	SRW-45-4002	+5V@5A; +15V@0.7A; -5V@2A		45.0W	85-264@47-63	5.0x3.0x1.2	4.6x2.6x0.16	—	0.5	—	UL/CSA/TUV/CE	\$12.49	—	—
204476CL	IPD Power	SRW-45-4004-27	+5V@5A; +15V@0.7A; +27V@1A		45.0W	85-264@47-63	5.0x3.0x1.1	4.6x2.6x0.16	—	0.5	—	UL/CUL/TUV/CE	\$14.59	—	—
204530CL	IPD Power	SRW-45-4008	+3.3V@5A; +3.3V@3A; +5V@3A; +12V@0.7A		45.0W	85-264@47-63	5.0x3.0x1.2	4.6x2.6x0.16	—	0.5	—	UL/CUL/TUV/CE	\$14.95	—	—
168225CL	Converter Concepts	STRC0006	+5V@2.7A; +12V@1.2A; +35V@0.35A; -5V@0.18A		30.0W	85-135@57-63	9.0x2.0x1.6	—	—	—	—	UL	\$3.35	—	—

* Primary Output

Call for **LOWER PRICES** on Larger Quantities

50 to 75-Watt Open-Frame Switching DC Power Supplies

50-Watt Open Frame

LPS-50 Series: Single Output

- 100% full burn-in
- Built-in remote ON-OFF
- Input voltage: 90-264VAC@47-63Hz, 127-370VDC
- Power density: 3.32 watts / in² maximum
- Voltage adjustment: 10%
- Line regulation: ±1.0%
- Leakage current: <1mA @ 240VAC
- Size: 7.7"L x 2.2"W x 0.9"H
- Weight: 0.5 lbs.
- Universal AC input
- Short circuit, overload, over-voltage protection
- Inrush current: 25A@115VAC
- Load regulation: ±2.0% (LPS-50-12); ±1.0% (LPS-50-24)
- Inrush current: 25A@115VAC
- Isolation voltage: 3000VAC
- Working temperature: -20 to +70C
- Other voltages available
- LED power indicator
- Mounting holes: 7.28"L x 1.77"W x 0.15"Dia.
- Two-year warranty



PERFORMANCE AT VALUE PRICES

New



The new Mean Well LPS-50 series open-frame power supply is suitable for the growing demand of low-cost, small-wattage applications. With its compact size and universal AC input, it is ideal for 1U (single unit) installations with a height of only 0.9" (23mm). It provides full output power with free-air convection cooling, built-in remote ON-OFF control, short-circuit, overload, and over-voltage protection. Meeting the requirements of UL60950 and TUV EN60950, these products are approved by UL/CUL/TUV and carry the CE mark.

65-Watt Open Frame

NLP65-76 Series: Single & Triple Outputs

- 100% full-load burn-in
- Universal AC input
- 75 watts with 20 CFM of air
- 3.9 watts/in² maximum
- Load regulation: ±2.0%
- Line regulation: ±2.0%
- Inrush current: 17A@120VAC
- Isolation voltage: 3000VAC
- Leakage current: 0.7mA@240V
- Size: 5.0"L x 3.0"W x 1.26"H
- Mounting holes: 4.55"L x 2.55"W x 0.16"Dia.
- Weight: 0.6 lbs.
- Mating connectors: P/Ns 104432CL & 104731CL, pg 75
- 0° to +70°C working temperature (see www.Jameco.com)
- Two-year warranty



SALE



HIGH QUALITY U.S. BRAND

The Artesyn NLP65 series is one of the smallest in the industry and perfect for 1U applications. With just 20 CFM of air, the power can be boosted 15% to 75 watts from the free-air power of 65 watts. The NLP65 series, with full international safety approvals, and the CE mark, meets conducted and radiated emissions EN55022; and complies to EN61000-4-2/3/4/5/6 immunity standards. If Power Factor Correction is required, the Artesyn NLP65-96 series is also available in the same package (see page 128). The NLP65 is designed for use in low power data networking, computer and telecom applications such as hubs, routers POS terminals, internet servers, cable modems and PBXs; as well as many industrial applications.

For Complete Specifications visit www.Jameco.com.

Included Power Supplies on pages 112-123.

65-Watt Open Frame

PS-65, PO-65 & PT-65 Series: Single, Dual & Triple Outputs

- 100% full-load burn-in
- Universal AC input
- 105°C output capacitor
- 2.9 watts/in² maximum
- Load regulation: ±2.0%, except 201937CL/194888CL/216725CL: 3.0% and 194896CL/216733CL: ±4.0%
- Line regulation: ±1.0%, except 194896CL/216733CL: ±2.0%
- Inrush current: 20A@120VAC
- Isolation voltage: 3000VAC
- Voltage adjustment: 10%
- Leakage current: 0.5mA@240V
- Size: 5.0"L x 3.0"W x 1.65"H
- Mounting holes: 4.56"L x 2.55"W x 0.15"Dia.
- Mating connectors: P/Ns 104432CL & 104731CL, pg 75
- -10°C to +60°C working temperature (see www.Jameco.com)
- Two-year warranty
- Weight: 0.6 lbs.



SALE



PERFORMANCE AT VALUE PRICES

The PS-65 and PT-65 series open-frame switchers from Mean Well are packaged in a high-density board with industry-standard mounting dimensions. Their impressive reliability derives from a conservative design, the exclusive use of high-quality components, and 100% full-load burn-in. Full rated power is available with free-air convection cooling. They are approved by UL and TUV, and carry the CE mark, for use worldwide. Assured to operate correctly anywhere in the world, these switchers feature universal voltage input ranges of 85-264VAC and 120-370VDC.

Jameco Part No.	Manufacturer	Manufacturer Product Number	Output		Input (VAC @ Hz)	Ripple & Noise (mV p-p)*	Certification	Price		
			Voltage@Current (min-max)	Power				1	10	25
252401CL	Mean Well	LPS-50-12	+12V@0-4.2A	50.4W	90-264@47-63	80	UL/CUL/TUV/CE	\$28.95	\$23.65	\$20.95
252620CL	Mean Well	LPS-50-24	+24V@0-2.1A	50.4W	90-264@47-63	80	UL/CUL/TUV/CE	28.95	23.65	20.95
218561CL	Artesyn	NLP65-7605	+5V@0-13A	65.0W	85-264@47-63	50	UL/CUL/CSA/DE/CE	\$64.59	\$5.99	\$5.99
218579CL	Artesyn	NLP65-7612	+12V@0-5.4A	64.8W	85-264@47-63	120	UL/CUL/CSA/DE/CE	\$64.59	\$1.99	\$5.99
235088CL	Artesyn	NLP65-7629	+5V@0-7A; +12V@0-2.5A	65.0W	85-264@47-63	50	UL/CUL/CSA/DE/CE	\$64.59	\$1.99	\$5.99
218587CL	Artesyn	NLP65-7608	+5V@0-7.5A; +12V@0-2.5A; -12V@0-0.65A	75.3W	85-264@47-63	50	UL/CUL/CSA/DE/CE	\$64.59	\$5.99	\$5.99
201937CL	Mean Well	PS-65-5	+5V@0-12A	60.0W	90-264@47-440	100	UL/CUL/TUV/CE	29.95	25.29	21.99
148638CL	Mean Well	PS-65-12	+12V@0-5.2A	62.4W	90-264@47-440	100	UL/CUL/TUV/CE	29.95	25.29	21.99
216750CL	Mean Well	PS-65-15	+15V@0-4.2A	63.0W	90-264@47-440	100	UL/CUL/TUV/CE	29.95	25.29	21.99
148646CL	Mean Well	PS-65-24	+24V@0-2.7A	64.8W	90-264@47-440	100	UL/CUL/TUV/CE	29.95	25.29	21.99
201945CL	Mean Well	PS-65-27	+27V@0-2.4A	64.8W	90-264@47-440	100	UL/CUL/TUV/CE	29.95	25.29	21.99
201953CL	Mean Well	PS-65-48	+48V@0-1.35A	64.8W	90-264@47-440	100	UL/CUL/TUV/CE	29.95	25.29	21.99
194888CL	Mean Well	PD65A	+5V@0.4-7A; +12V@0.2-3.2A	61.1W	90-264@47-440	50	UL/CUL/TUV/CE	34.95	26.39	23.09
194896CL	Mean Well	PD65B	+5V@0.4-3.5A; +24V@0.2-2A	65.5W	90-264@47-440	50	UL/CUL/TUV/CE	34.95	26.39	23.09
216733CL	Mean Well	PT-65B	+5V@0.4-5.5A; +12V@0.2-2.5A; -12V@0-0.5A	63.5W	90-264@47-440	50	UL/CUL/TUV/CE	36.95	28.59	25.29
216725CL	Mean Well	PT-65C	+5V@0.4-5.5A; +15V@0.2-2A; -15V@0-0.5A	65.0W	90-264@47-440	50	UL/CUL/TUV/CE	36.95	28.59	25.29

Other Versions Available: Call 800-831-4242

* Primary Output

Corporate Customers Opening an account is easy!! Call 1-800-831-4242 for details today.

50 to 75-Watt Open-Frame Switching DC Power Supplies

Color Code Legend
New High Qty. Save Closeout

Call for LOWER PRICES on Larger Quantities



65-Watt Open Frame with Power Factor Correction

NLP65-96 Series: Single & Triple Outputs

- 100% full-load burn-in
- Universal AC input
- Power Factor Correction
- No minimum load required
- 3.9 watts/in³ maximum
- 75 watts with 20 CFM of air
- Load regulation: ±2.0%
- Line regulation: ±2.0%
- Inrush current: 17A@120VAC
- Leakage current: 0.7mA@240V
- Isolation voltage: 3000VAC
- Two-year warranty
- Weight: 0.6 lbs.
- Size: 5.0"L x 3.0"W x 1.26"H
- Mounting holes: 4.55"L x 2.55"W x 0.16"Dia.
- Mating connectors: P/Ns 104432CL & 104731CL, pg 75
- 0° to +70°C working temperature (see www.Jameco.com)



TOP QUALITY U.S. BRAND

SALE

75-Watt Open Frame

LPS-75 Series: Single Outputs

- 100% full-load burn-in
- Universal AC input
- 3.43 watts/in³ maximum
- Built-in remote ON/OFF
- PWM control and regulated
- Cooling by free-air convection
- Line regulation: ±1.0%
- Load regulation: (244718CL) ±1.0%; (244726CL) ±2.0%
- Inrush current: 24A@120VAC
- Isolation voltage: 3000VAC
- Leakage current: 1.0mA@240V
- Voltage adjustment: 10%
- Two-year warranty
- Weight: 0.5 lbs.
- Size: 8.74"L x 2.16"W x 1.18"H
- Mounting holes: 8.34"L x 1.77"W x 0.149"Dia.
- Mating connectors: P/N 215950, p.129
- -20°C to +60°C working temperature (see www.Jameco.com)



PERFORMANCE AT VALUE PRICES



The Artesyn NLP65 series is one of the smallest in the industry and perfect for 1U applications. With just 20 CFM of air, the power can be boosted 15% to 75 watts from the free-air power of 65 watts. The NLP65 series, with full international safety approvals, and the CE mark, meets conducted and radiated emissions EN55022; and complies to EN61000-4-2/3/4/5/6 immunity standards. The Artesyn NLP65-96 models provide input harmonic current correction (Power Factor Correction) to satisfy EN61000-3-2. If Power Factor Correction is not required, the Artesyn NLP65-76 series is also available in the same package (see page 127).

The NLP65 is designed for use in low power data networking, computer and telecom applications such as hubs, routers POS terminals, internet servers, cable modems and PBXs; as well as many industrial applications.

One of the newest modern designs is the open frame LPS 75 series power supplies. With their full range universal input of 90-264VAC@47-63Hz and 127-370VDC, these switchers are ready for use worldwide. Meeting the requirement of UL60950 and TUV EN60950, these products are approved by UL, CUL, TUV and carry the CE mark for use worldwide. EMC standards met are EN61000-4-2/3/4/5/6/8/11. The small and compact layout results in an impressive power density of 3.4watt/in³ and maximum height of 1.2".

Other Versions Available: Call 800-831-4242

For Complete Specifications visit www.Jameco.com.

Now Lower Prices

Jameco Part No.	Manufacturer	Manufacturer Product Number	Output		Power	Input (VAC @ Hz)	Ripple & Noise (mV p-p)*	Certification	Price		
			Voltage@Current (min-max)	Power					1	10	25
218595CL	Artesyn	NLP65-9612	+12V@0-5.4A		64.8W	85-264@47-63	120	UL/CUL/CSA/DE/CE	\$71.39	\$4.25	\$7.85
218608CL	Artesyn	NLP65-9624	+24V@0-2.7A		64.8W	85-264@47-63	240	UL/CUL/CSA/DE/CE	71.39	4.25	7.85
218616CL	Artesyn	NLP65-9608	+5V@0-7.5A; +12V@0-2.5A; -12V@0-0.65A		75.3W	85-264@47-63	50	UL/CUL/CSA/DE/CE	71.39	4.25	7.85
244718CL	Mean Well	LPS-75-12	+12V@0-6.8A		74.4W	90-264@47-63	100	UL/CUL/TUV/CE	38.95	35.59	31.99
244726CL	Mean Well	LPS-75-24	+24V@0-3.5A		76.8W	90-264@47-63	120	UL/CUL/TUV/CE	38.95	35.59	31.99

* Primary Output

Quantity SAVE

Special Offers at Great Savings - 90-Day Warranty

Now Lower Prices

Jameco Part No.	Mfr.	Manufacturer Product No.	Output		Power	Input (VAC @ Hz)	Size Inches (LxWxH)	Mounting Holes Inches (LxWxDia.)	Ripple & Noise (mV p-p)*	Load Reg. (±%)*	Line Reg. (±%)*	Certification	Price			
			Voltage@Current (min-max)	Power									1	10	25	
171731CL	Delta	DPS-60MPB	+3.3V@0.8-8A; +5V@1-9A;		65.0W	90-270@47-63	5.8x3.3x1.4	—	50	2.0	2.0	UL/CUL/TUV	\$7.95	\$6.95	\$5.89	\$4.45
169068CL	Autec	UPS65-1051	+5V@0.2-13A		65.0W	115/230@50-60	6.0x3.5x1.5	4.8x3.2x0.16	50	1.0	0.5	UL/CSA/VE	11.95	10.59	8.95	
169050CL	Autec	UPS50-2002	+5V@0.2-3A; +12V@0.1-3A		51.0W	90-264@47-440	5.0x3.0x1.9	4.6x2.6x0.16	50	3.0	0.5	UL/CSA/TUV	13.95	12.55	11.29	
206463CL	Skynet	SNP-9F43-2	+5V@0-3A; +12V@0-3.5A		57.0W	115/230@50-60	5.0x3.0x1.3	4.6x2.6x0.16	50	1.0	1.0	UL/CSA/TUV	12.95	11.05	8.29	
204468CL	IPD Power	SRW-65-2006	+5V@9A; +12V@2A		65.0W	85-264@47-63	6.0x4.0x1.1	5.7x3.5x0.15	50	1.0	—	UL/CUL/TUV/CE	\$4.09	1.33	10.29	8.36
196824CL	Encad	U006612010	+5.2V@3A; +24V@2A		65.0W	90-250@50-60	6.3x3.9x1.5	—	—	—	—	UL/CUL/TUV	15.95	13.59	10.19	
182916CL	Artesyn	NLP70-9693†	+3.3@10.5A; +5V@10.5A; +12V@0.65A		70.0W	100-240@50-60	5.5x3.0x1.3	4.6x2.6x0.16	—	2.0	2.0	UL/CSA/VE/CE	3.95	3.55	3.25	
226211CL	Phihong	PSA-60-302	+5V@6A; +12V@1.2A; -12V@1.2A		60.0W	100-240@50-60	5.0x3.0x1.6	4.5x2.5x0.15	50	2.0	2.0	UL/CSA/VE	29.95	26.95	24.29	
215706CL	Mean Well	PT-65D	+5V@0.5-4A; +12V@0.2-2A; +24V@0.2-1A		65.0W	90-264@47-440	5.0x3.0x1.5	4.6x2.6x0.15	50	2.0	1.0	UL/CUL/TUV/CE	29.95	26.95	24.29	
229850CL	IPD Power	SRW-65-3003	+5V@5A; +15V@3.5A; -15V@1A		65.0W	85-264@47-63	6.0x4.0x1.1	5.7x3.5x0.15	50	1.0	—	UL/CUL/TUV/CE	22.95	20.69	18.59	
189966CL	Autec	UPS61-1004-T	+3.3V@4A; +5V@2A; +12V@3A; +32V@0.5A		65.0W	115/230@50-60	5.0x3.5x1.8	—	—	—	—	CSA/CE	\$0.69	1.24	1.22	1.18

* Primary Output

† Power Factor Correction

For mating connectors see page 75.



Call for LOWER PRICES on Larger Quantities

80 to 100-Watt Open-Frame Switching DC Power Supplies

100-Watt Open Frame

LPS-100 Series: Single Output

- 100% full-load burn-in
- Auto-switch AC input
- No minimum load required
- 4.4 watts/in² maximum
- 105°C output capacitor
- Load regulation: ±1.5%, except 173462CL/216709CL: ±0.5%
- Line regulation: ±0.5%
- Inrush current: 30A@120VAC
- Isolation voltage: 3000VAC
- Leakage current: 1.0mA@240V
- Voltage adjustment: 10%
- Three-year warranty
- Weight: 0.8 lbs.
- Size: 8.74"L x 2.44" x 1.25"W
- Mounting holes: 8.34"L x 2.04"W x 0.13"Dia.
- Mating connectors: P/Ns 215950CL & 215976CL, pg 75
- -10°C to +60°C working temperature (see www.Jameco.com)



UL US CE

SALE

One of Mean Well's premium series that carries an unusually long 3-year warranty. The LPS-100 benefits from a modern state-of-the-art design using highly integrated components. Assured to operate correctly anywhere in the world, these open-frame switchers feature universal voltage input ranges of 85-264VAC and 120-370VDC. The highly compact layout results in an impressive power density of 3.4 watts per inch² and a maximum height of 1.3". These products are approved by UL, CUL and TUV; and carry the CE mark for use worldwide. EMC standards met are EN55022 (CISPR22) Class B and IEC1000-2/3/4.

Enclosed Power Supplies on pages 112-123.

Other Versions Available: Call 800-831-4242

100-Watt Open Frame

PQ-100 Series: Quad Outputs

- 100% full-load burn-in
- Universal AC input
- 105°C output capacitor
- 1.9 watts/in² maximum
- Load regulation: 217306CL: ±2.0%; 217293CL: ±1.0%
- Line regulation: ±1.0%
- Inrush current: 50A@120VAC
- Isolation voltage: 3000VAC
- Leakage current: 1.0mA@240V
- Voltage adjustment: 10%
- Two-year warranty
- Weight: 1.1 lbs.
- Size: 7.0"L x 4.25"W x 1.88"H
- Mounting holes: 6.5"L x 3.75"W x 0.156"Dia.
- Mating connectors: P/Ns 104723CL, 104766CL & 104432CL pg 75
- -10°C to +60°C working temperature (see www.Jameco.com)



UL US CE

SALE



This impressive series of quad-output 100-watt switchers features universal input voltage ranges of 90-264VAC and 127-370VDC. The solid, reliable, low cost design features overload protection to 140% of rated load with auto-recovery, and over-voltage protection to 135% of rated output voltage. Additional protection includes short-circuit and a soft-start circuit that limits the AC surge current to a safe value. With free-air convection the 100-watt rated power is available from -10°C to 50°C ambient temperature, and 60°C with fan cooling. Withstand voltage is 3kVAC for input-to-output & 1.5kVAC input-to-ground.

For Complete Specifications visit www.Jameco.com.

Jameco Part No.	Manufacturer	Manufacturer Product Number	Output		Power	Input (VAC @ Hz)	Ripple & Noise (mV p-p)*	Certification	Price		
			Voltage@Current (min-max)						1	10	25
213591CL	Mean Well	LPS100-5	+5V@0-20A		100.0W	88-264@47-63	100	UL/CUL/TUV/CE	\$52.95	\$48.39	\$42.89
173471CL	Mean Well	LPS100-12	+12V@0-8.4A		100.8W	88-264@47-63	100	UL/CUL/TUV/CE	52.95	48.39	42.89
216717CL	Mean Well	LPS100-15	+15V@0-6.7A		100.5W	88-264@47-63	100	UL/CUL/TUV/CE	\$62.95 41.11	36.95	33.30
173462CL	Mean Well	LPS100-24	+24V@0-4.2A		100.8W	88-264@47-63	150	UL/CUL/TUV/CE	52.95	48.39	42.89
216709CL	Mean Well	LPS100-48	+48V@0-2.1A		100.8W	88-264@47-63	200	UL/CUL/TUV/CE	52.95	48.39	42.89
217306CL	Mean Well	PQ-100B	+5V@2-10A; +12V@0.5-3.5A; -5V@0-0.5A; -12V@0-0.5A		100.5W	100-264@47-63	80	UL/CUL/TUV/CE	66.95	53.89	51.69
217293CL	Mean Well	PQ-100D	+5V@2-5A; +12V@0.5-2A; +24V@0.4-2A; -12V@0-0.5A		103.0W	100-264@47-63	80	UL/CUL/TUV/CE	\$66.95 47.35	42.56	39.34

* Primary Output

Quantity

SAVE

Special Offers at Great Savings – 90-Day Warranty

Jameco Part No.	Mfr.	Manufacturer Product No.	Output		Input (VAC @ Hz)	Size Inches (LxWxH)	Mounting Holes Inches (LxWxDia.)	Ripple & Noise (mV p-p)*	Load Reg. (±%)*	Line Reg. (±%)*	Certification	Price			
			Voltage@Current (min-max)	Power								1	10	25	
190676CL	Astec	LPS112	+5V@0-16A	80.0W	100-250@50-60	7.0x4.0x1.7	6.5x3.5x0.16	50	—	—	UL/CSA/VDE/CE	\$15.99	\$13.99	\$11.79	
208750CL	Digital Pwr	USS100-245	+5V@20A	100.0W	90-250@50-60	5.0x3.2x1.5	2.7x2.7x0.08	100	3.0	0.2	UL/CUL/CSA/TUV/CE	2.88	1.83	1.59	
237024CL	Lite-On	PA-1101-1	+12V@2-8.5A	102.0W	85-264@47-63	6.0x4.0x1.3	—	1200	10.0	1.0	UL/CUL/TUV/CE	33.95	25.45	22.89	
203326CL	EOS	VLT100-1004†	+48V@0.2-2.1A	100.0W	100-240@50-60	5.0x3.0x1.0	4.6x2.6x0.16	480	3.0	0.3	UL/CUL/VDE/CE	27.95	23.75	17.88	
196251CL	Lambda Power	PW-G-00790	+3.3V@15A; +5V@7A +12V@0.8A	85.0W	100-240@50-60	8.0x3.5x1.3	—	—	—	—	UL/CSA/TUV/CE	\$2.49 1.33	3.21	1.18	
202876CL	Power-One	MAP80-4003	+5V@14A; +15V@3.5A; -5V@1A; -15V@1A	80.0W	100/230@47-63	7.2x4.3x1.8	6.7x3.2x0.17	50	1.0	0.2	UL/CSA/TUV/CE	\$24.95	22.95	20.69	18.59

* Primary Output

† Power Factor Correction

New Lower Prices

SALE



Don't worry about backorders.
Over 99% of our products are in stock!
Just place your order by 6PM EST for same business day shipment.

We'll Send It Today!

100-Watt Open Frame With Power Factor Correction

LPP-100 Series: Single Output

- 100% full-load burn-in
- Auto-switch AC input
- No minimum load required
- 4.4 watts/in² maximum
- 105°C output capacitor
- Power Factor Correction
- Load regulation: ±0.5%, except 173462CL: ±1.0%
- Line regulation: ±0.5%
- Inrush current: 40A@120VAC
- Isolation voltage: 3000VAC
- Leakage current: 2.0mA@240V
- Voltage adjustment: 10%
- Three-year warranty
- Weight: 0.8 lbs.
- Size: 8.75"L x 2.44"W x 1.25"H
- Mounting holes: 8.34"L x 2.04"W x 0.13"Dia.
- Mating connectors: P/Ns 215950CL & 215976CL, pg 75
- -10°C to +60°C working temperature (see www.Jameco.com)



PERFORMANCE
AT VALUE
PRICES



100-Watt Open Frame with Power Factor Correction

PPQ-1003 & PPQ-100 Series: Quad Outputs

- 100% full-load burn-in
- Auto-switch AC input
- 2.3 watts/in² maximum
- Power Factor Corrected
- 105°C output capacitor
- Load regulation: ±2.0%
- Line regulation: ±1.0%
- Inrush current: 40A@120VAC
- Isolation voltage: 3000VAC
- Leakage current: PPQ-1003: 1.0mA@240V; PPQ-100: 3.5mA@240V
- Voltage adjustment: 10%
- Weight: 1.1 lbs.
- Three-year warranty
- Size: 7.0"L x 4.25"W x 1.6"H
- Mounting holes: 6.5"L x 3.75"W x 0.16"Dia.
- Mating connectors: PPQ1003-P/Ns 104766CL & two 104432CL, pg 75; PPQ100-P/Ns 104715CL & two 104723CL, pg 75;
- -10°C to +60°C working temperature (see www.Jameco.com)



PERFORMANCE
AT VALUE
PRICES



SALE

One of Mean Well's newest and most modern designs, the open-frame LPP100 series features input Power Factor Correction that meets EN61000-3-2, required in Europe for power supplies 75 watts and above. Couple this with their full range universal input ranges of 85-264VAC and 120-370VDC, and these switchers are ready for use worldwide. Meeting the requirements of UL1950 and TUV EN60950, these products are approved by UL, CUL, and TUV; and carry the CE mark, for use worldwide. EMC standards met are EN55022 Class B and EN61000-4-2/3/4/5/6/8/11. The highly compact layout results in an impressive power density of 3.4 watts/in² and maximum height of 1.3".

For applications requiring 3.3VDC and a total of four outputs, these series offer excellent performance, high reliability and surprisingly low cost. These open-frame switchers include both input Power Factor Correction and universal input voltage ranges of 85-264VAC & 120-370VDC. Full 100-watt output power is available from -10°C to 50°C with 17CFM of forced air cooling, and 80 watts is available to 60°C. Protection includes short-circuit, overload and over-voltage; and a novel soft-start circuit limits the AC surge current to a safe value. Guaranteed safety standards comprise UL1950 and TUV EN60950, and these products have earned the European CE mark.

Enclosed Power Supplies
on pages 92-123.

For Complete Specifications visit www.Jameco.com.

New Lower
Prices

Jameco Part No.	Manufacturer	Manufacturer Product Number	Output		Input (VAC @ Hz)	Ripple & Noise (mV p-p)*	Certification	Price		
			Voltage@Current (min-max)	Power				1	10	25
216696CL	Mean Well	LPP-100-5	+5V@0-20A	100.0W	85-264@47-63	100	UL/CUL/TUV/CE	\$64.95	\$56.09	\$49.49
216688CL	Mean Well	LPP-100-12	+12V@0-8.5A	102.0W	85-264@47-63	100	UL/CUL/TUV/CE	64.95	56.09	49.49
216670CL	Mean Well	LPP-100-15	+15V@0-6.7A	100.5W	85-264@47-63	100	UL/CUL/TUV/CE	64.95	56.09	49.99
204610CL	Mean Well	LPP-100-24	+24V@0-4.2A	100.8W	85-264@47-63	150	UL/CUL/TUV/CE	64.95	56.09	49.49
216653CL	Mean Well	LPP-100-48	+48V@0-2.1A	100.8W	85-264@47-63	250	UL/CUL/TUV/CE	64.95	56.09	49.49
213815CL	Mean Well	PPQ-1003B	+3.3V@0-10A; +5V@2-10A; +12V@0.2-2A; -12V@0-0.3A	110.6W	90-264@47-63	100	UL/CUL/TUV/CE	\$81.95	\$71.95	\$69.19
213807CL	Mean Well	PPQ-1003D	+3.3V@0-10A; +5V@2-10A; +12V@0.2-2A; +24V@0-0.3A	114.2W	90-264@47-63	100	UL/CUL/TUV/CE	\$81.95	\$71.95	\$69.19
217277CL	Mean Well	PPQ-100B	+5V@2-10A; +12V@0.3-3.4A; -12V@0-0.6A; -5V@0-0.6A	101.0W	90-264@47-63	100	UL/CUL/TUV/CE	81.95	71.95	69.19
217285CL	Mean Well	PPQ-100D	+5V@2-8; +24V@0.3-2A; +12V@0-0.6A; -12V@0-0.6A	102.4W	90-264@47-63	100	UL/CUL/TUV/CE	87.95	65.39	62.89

* Primary Output

Other Versions Available: Call 800-831-4242

Medical Power Supplies

- Open-Frame Pg 124
- Table-Top Pg 143
- Adapters Pg 143

Jameco is the only place in the country where you can buy a wide selection of DC or stepper motors off-the-shelf. We've nearly tripled our selection so you can find just the motor you're looking for and get it quickly with one phone call. See our expanded selection on pages 87-91.

Call for LOWER PRICES on Larger Quantities

110-Watt Open-Frame Switching DC Power Supplies

110-Watt Open Frame

NFS110-76 Series: Single & Quad Outputs

- 100% full-load burn-in
- Universal AC input
- 110W with 20 CFM of air
- 2.8 watts/in² maximum
- Load regulation: ±2.0%
- Line regulation: ±0.1%
- Inrush current: 35A@120VAC
- Isolation voltage: 3000VAC
- Leakage current: 0.2mA@240V
- Voltage adjustment: 3%
- Two-year warranty
- Weight: 1.3 lbs.
- Size: 7.0"L x 4.25" W x 1.8"H
- Mounting holes: 6.6"L x 3.75" W x 0.16"Dia.
- Mating connectors: P/Ns 104723CL, 104766CL & 104432CL, pg 75
- 0°C to +70°C working temp. (see www.Jameco.com)

SALE



TOP QUALITY U.S. BRAND

The Artesyn NFS110 series are 110 watt universal-input power supplies on a 7" x 4.25" x 1.8" card. The NFS110-76 models have proven to be highly reliable and versatile for a wide range of communication and industrial applications, with a very high peak current capability on each output for drive and motor applications. The NFS110-76 series is popular in low power data networking, computer, telecom and industrial applications such as servers, thermal printers, storage devices, vending machines and POS equipment.

For Complete Specifications visit www.Jameco.com.

Featured Power Supplies on pages 112-123.

Jameco Part No.	Manufacturer	Manufacturer Product Number	Output Voltage@Current (min-max)	Power	Input (VAC @ Hz)	Ripple & Noise (mV p-p)*	Certification	New Lower Prices		
								1	10	25
218982CL	Artesyn	NFS110-7612	+12V@0-7A	84.0W	85-264@47-440	120	UL/CUL/CSA/VDE/CE	\$106.95	\$91.79	\$82.59
218974CL	Artesyn	NFS110-7624	+24V@0-3.5A	84.0W	85-264@47-440	240	UL/CUL/CSA/VDE/CE	\$106.95	\$91.79	\$82.59
218966CL	Artesyn	NFS110-7602P	+5.1V@0-8A; +12V@0-4.5A; -5V@0-0.5A; -12V@0-0.5A	103.3W	85-264@47-440	50	UL/CUL/CSA/VDE/CE	\$106.95	\$91.79	\$82.59
220231CL	Artesyn	NFS110-7604	+5.1V@0-8A; -15V@0-4A; -5V@0-0.5A; -15V@0-0.5A	110.6W	85-264@47-440	50	UL/CUL/CSA/VDE/CE	\$109.95	\$91.79	\$82.59
218915CL	Artesyn	NLP110-9605	+5V@0.5-15A	75.0W	90-264@47-63	50	UL/CUL/CSA/VDE/CE	\$107.65	\$91.79	\$82.59
218923CL	Artesyn	NLP110-9612	+12V@0.3-6.4A	76.8W	90-264@47-63	120	UL/CUL/CSA/VDE/CE	\$107.65	\$91.79	\$82.59
218931CL	Artesyn	NLP110-9624	+24V@0.2-3.2A	76.8W	90-264@47-63	240	UL/CUL/CSA/VDE/CE	\$107.65	\$91.79	\$82.59
218940CL	Artesyn	NLP110-9693	+3.3V@0.2-13A; +5V@0.5-13A +12V@0-0.65A	110.0W	90-264@47-63	50	UL/CUL/CSA/VDE/CE	\$107.65	\$91.79	\$82.59
218958CL	Artesyn	NLP110-9608	+5V@0.2-13A +12V@0.2-6.5A; -12V@0-0.65A	110.0W	90-264@47-63	120	UL/CUL/CSA/VDE/CE	\$107.65	\$91.79	\$82.59

* Primary Output

Other Versions Available: Call 800-831-4242

Special Offers at Great Savings – 90-Day Warranty

Jameco Part No.	Mfr.	Manufacturer Product No.	Output Voltage@Current (min-max)	Power	Input (VAC @ Hz)	Size Inches (LxWxH)	Mounting Holes Inches (LxWxDia.)	Ripple & Noise (mV p-p)*	Load Reg. (±%)*	Line Reg. (±%)*	Certification	New Lower Prices			
												1	10	25	
211297CL	Power-One	MAP110-4300 †	+3.3V@15A; +5V@8A; +12V@1A; -12V@1A	110.0W	85-264@47-63	7.0x4.3x2.0	6.5x2.8x0.17	30	0.7	0.3	UL/CSA/TUV/CE	\$29.95	\$22.49	\$15.75	
204505CL	IPD Power	SRW-115-4001	+5V@12A; +12V@4A; -5V@4A; -12V@2A	115.0W	85-264@47-63	7.0x4.3x1.2	6.0x3.8x0.16	—	1.0	—	UL/CUL/TUV/CE	\$24.95	18.69	16.99	15.49
204450CL	IPD Power	SRW-115-4001-48	+5V@15A; +12V@1A; -5V@3A; -48V@1A	115.0W	85-264@47-63	7.0x4.3x1.2	6.0x3.8x0.16	—	1.0	—	UL/CUL/TUV/CE	\$19.95	14.83	12.38	12.81

* Primary Output

† Power Factor Correction

Opening an account is easy!!

Corporate Customers

Call 1-800-831-4242 for details today.



120 to 350-Watt Open-Frame Switching DC Power Supplies

Color Code Legend
New Sale Qty Save Pull Closeout

Call for LOWER PRICES on Larger Quantities

150-Watt Open Frame With Power Factor Correction

NLP150 Series: Single & Quad Output

- 100% full-load burn-in
- Universal AC input
- Power Factor Correction
- 4.3 watts/in³ maximum
- 150W with 300LFM of air
- Load regulation: ±2.0%
- Line regulation: ±2.0%
- Inrush current: 40A@120VAC
- Isolation voltage: 3000VAC
- Leakage current: 0.99mA@240V
- Parallel operation (current sharing)
- Two-year warranty
- Weight: 1.2 lbs.
- Size: 6.8"L x 3.8"W x 1.26"H
- Mounting holes: 6.45"L x 3.45"W x 0.156" Dia.
- Mating connectors: P/N 104432CL, pg 75 & 103587CL, pg 63
- 0° to +70°C working temperature (see www.Jameco.com)



TOP QUALITY U.S. BRAND



The Artesyn NLP150 series are Power Factor Corrected to meet the EN61000-3-2 standard, and they support current sharing on V_o and V_o. Standard features include universal input, over-voltage and short-circuit protection, as well as power fail detection. This series carries UL, CSA and VDE approvals; and are CE marked. With a height of only 1.26", these supplies are commonly used in 1U shelves and boxes, and are primarily intended for networking applications that have a heavy logic content, such as access concentrators, midrange routers, LAN switches and shared media hubs.

For Complete Specifications visit www.Jameco.com.

Enclosed Power Supplies on pages 112-123.

150-Watt Open Frame With Power Factor Correction

LPP-150 Series: Single Output

- 100% full-load burn-in
- Auto-switch AC input
- No minimum load required
- 3.6 watts/in³ maximum
- 105°C output capacitor
- Power Factor Correction
- Load regulation: 213698CL & 213680CL: ±1.0%; 213671CL & 216645CL: ±0.5%
- Line regulation: ±0.5%
- Inrush current: 40A@120VAC
- Isolation voltage: 3000VAC
- Leakage current: 3.5mA@240V
- Three-year warranty
- Size: 8.74"L x 2.95"W x 1.61"H
- Mounting holes: 8.34"L x 2.55"W x 0.13" Dia.
- Mating connectors: P/N 215950CL & 215968CL, pg 75
- -10°C to +60°C working temperature (see www.Jameco.com)



PERFORMANCE AT VALUE PRICES



- Voltage adjustment: 10%
- Weight: 1.2 lbs.

The LPP-150 series is Mean Well's most powerful open-frame switching power supply. It features input Power Factor Correction that complies with EN61000-3-2 and achieves 0.98 at 115VAC. Couple this with the full-range universal input ranges of 85-264VAC and 120-370VDC, and these switchers are ready for use worldwide. Full 150-watt output power is available from 0°C to 50°C with 18 CFM of forced air cooling and 120 watts is available to -10°C and 60°C. Meeting the requirements of UL1950 and TUV EN60950, these products are approved by UL, CUL, and TUV; and carry the CE mark. The highly compact layout results in an impressive power density of 3.6 watts per cubic inch and maximum height of 1.6".

Jameco Part No.	Manufacturer	Manufacturer Product Number	Output		Power	Input (VAC @ Hz)	Ripple & Noise (mV p-p)*	Certification	Price		
			Voltage@Current (min-max)						1	10	25
218991CL	Artesyn	NLP150L-96S3	+3.3V@1-22A		72.6W	90-264@47-63	50	UL/CSA/VDE/CE	\$116.85	\$110.00	\$108.00
219011CL	Artesyn	NLP150L-96S5	+5.1V@1-22A		112.2W	90-264@47-63	50	UL/CSA/VDE/CE	\$116.85	\$110.00	\$108.00
219002CL	Artesyn	NLP150L-96S8	+24V@0.15-4.6A		110.4W	90-264@47-63	240	UL/CSA/VDE/CE	\$116.85	\$110.00	\$108.00
219029CL	Artesyn	NLP150L-9605366	+3.3V@0.5-10A; +5.1V@1.5-20A; +12V@0-2A; +12V@0-0.65A		120.0W	90-264@47-63	50	UL/CSA/VDE/CE	\$116.85	\$110.00	\$108.00
213698CL	Mean Well	LPP-150-5	+5V@0-30A		150.0W	85-264@47-63	100	UL/CUL/TUV/CE	\$74.95	\$71.95	\$71.95
213680CL	Mean Well	LPP-150-12	+12V@0-12.5A		150.0W	85-264@47-63	100	UL/CUL/TUV/CE		71.95	53.89 47.29
213671CL	Mean Well	LPP-150-24	+24V@0-6.3A		150.0W	85-264@47-63	150	UL/CUL/TUV/CE		71.95	53.89 47.29
216645CL	Mean Well	LPP-150-48	+48V@0-3.2A		153.6W	85-264@47-63	250	UL/CUL/TUV/CE		71.95	53.89 47.29

Other Versions Available: Call 800-831-4242

* Primary Output

Quantity

Special Offers at Great Savings – 90-Day Warranty

SAVE

SALE

Jameco Part No.	Mfr.	Manufacturer Product No.	Output		Input (VAC @ Hz)	Size Inches (LxWxH)	Mounting Holes Inches (LxWxDia.)	Ripple & Noise (mV p-p)*	Load Reg. (±%)	Line Reg. (±%)	Certification	Price		
			Voltage@Current (min-max)	Power								1	10	25
204564CL	Digital Pwr	USS250-115	+15V@0-16.5A	250.0W	90-250@47-63	8.0x4.5x2.0	7.6x3.2x0.08	50	1.0	0.2	UL/CUL/CSA/TUV/CE	\$39.95	\$35.99	\$32.39
208670CL	Power-One	MPU1503300S240	+3.3V@30A; +12V@3A	135.0W	85-250@50-60	8.1x4.2x1.5	6.5x3.8x0.16	50	1.5	0.6	UL/CSA/TUV	\$29.95	\$29.95	\$29.95
196795CL	Cherokee	QP2A2-1A-A	+5V@40A; +12V@2.5A	230.0W	115/230@50-60	10.0x4.3x2.5	7.5x3.0x0.15	50	0.25	0.25	TUV	11.95	10.16	8.49
204581CL	Digital Pwr	UP300-201	+5V@1-40A; +12V@0.2-12A	300.0W	90-250@47-63	8.0x4.5x2.0	7.6x3.2x0.10	50	1.0	0.2	UL/CUL/CSA/TUV/CE	\$49.95	\$49.95	\$49.95
220193CL	Cherokee	MQT154A1†	+3.3V@8A; +5V@26A; +12V@6A; -12V@1A	150.0W	100-240@47-63	8.0x4.3x1.5	6.4x2.5x0.13	—	—	—	UL/CSA	28.95	23.19	17.39
210876CL	EOS	VLT130-4100 †	+3.3V@0.5-16A; +5V@0.5-14A; +12V@0.1-1.5A; -12V@0.1-1.5A	130.0W	100-240@50-60	5.0x3.0x0.9	4.6x2.6x0.16	50	1.0	0.3	UL/CUL/VDE/CE	19.95	17.95	15.95
203431CL	Cherokee	QT24A1V	+5V@15A; +12V@5A; -5V@1A; -12V@1A	150.0W	115-240@50-60	6.8x3.9x1.5	6.4x2.5x0.08	50	5.0	5.0	UL/CSA/TUV	29.95	26.95	23.95
206906CL	SSI	SQM200-1221	+5V@30A; +12V@7A; +12V@5A; ±5V@5A	200.0W	100/240@50-60	10.5x5.0x2.5	10.0x4.4x0.14	50	1.0	0.2	UL/CSA/TUV	\$29.95	18.79	17.09 15.55
208733CL	Digital Pwr	USS256-351	+5.5V@1.8A; +12.9V@10A; +12.9V@0.9A	250.0W	90-250@47-63	10.0x4.5x1.9	—	—	—	—	UL/CUL/CSA/TUV/CE	\$29.95	21.35	19.39 17.39
210905CL	Lambda	WA305-00-03	+5V@50A; +12V@10A; +24V@4A; -5.2V@4A; -12V@4A	300.0W	85-264@45-440	11.9x5.0x1.8	8.1x2.5x0.16	50	1.0	0.2	CE	49.95	37.49	26.25
196461CL	TODD	MAX3541205AC	+5V@50A; +12V@12A; -5V@2A; -12V@4A	350.0W	115/230@50-60	9.0x5.0x2.5	6.5x3.9x0.08	50	1.0	1.0	TUV	47.95	40.79	30.59

* Primary Output

† 8" power cable included

1 Power Factor Correction

6-Amp SIL06C Series



- Ultra-wide trim range
- Horizontal and vertical models
- "Power good" signal
- Protection: over-current & short-circuit
- Working temperature: 0° to +80°C (derated above 50°C)

Highlighted below in blue, the SIL06C series are new high-density, open-frame, non-isolated DC-to-DC converters for space-sensitive applications.

An external resistor adjusts the output voltage from its pre-set value of 0.9V to any value up to the 3.3V maximum. The SIL06C series offers remote ON/OFF and over-current protection as standard. With full international safety approval including EN60950 and UL60950, the SIL06C reduces compliance costs and time to market.

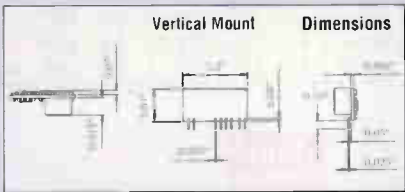
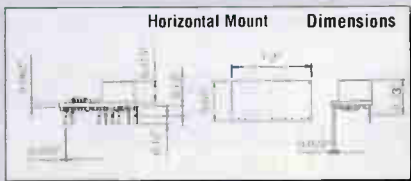

10-Amp SIL10E Series



- Highest power density: 107W/in³
- Remote sense
- 96% efficiency at 3.3V
- Protection: thermal & short-circuit
- Working temperature: -40° to +100°C (derated above 70°C)

Detailed below in tan, the SIL10E series are non-isolated DC/DC converters packaged in a single-in-line footprint giving designers a cost-effective and easy-to-fit solution for conversion from either a 3.3V or 5V input voltage to an output voltage in the range of 0.8V-3.6V. The SIL10E offers both fixed outputs and wide output trim range, which allows maximum design flexibility and a pathway for future upgrades. The SIL10E is designed for applications that include distributed power, workstations, optical network and wireless applications.

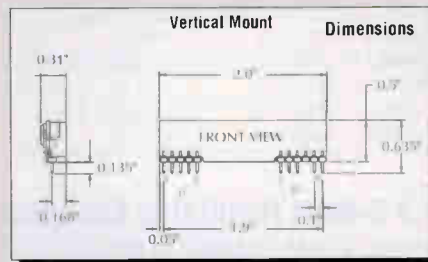

15-Amp SIL15C Series



- 91% efficiency
- Ultra-wide trim range
- "Power good" signal
- Protection: over-current & short-circuit
- Working temperature: 0° to +80°C (derated above 50°C)

Highlighted below in buff color, the SIL15C series are new high-density, open frame, non-isolated DC/DC converters for space-sensitive applications. Each model has a wide input range (4.5-5.5V or 10.2-13.8V) and offers a wide output voltage range of either 0.9-3.3V or 0.9-5V with a 15A load.

An external resistor adjusts the output voltage from its pre-set value of 0.9V to any value up to the maximum allowed value for the model. With full international safety approval including EN60950 and UL/CUL60950, the SIL15C Series reduces compliance costs and time to market.

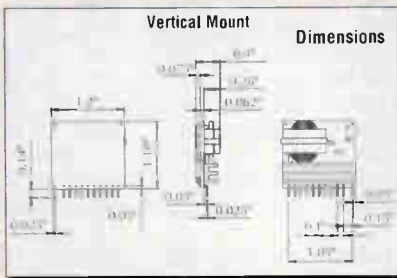

30-Amp SIL30C Series

- 91% efficiency
- Ultra-wide trim range
- Horizontal & vertical models
- "Power good" signal
- Protection: over-current, over-temperature & short-circuit
- Working temperature: 0° to +80°C (derated above 50°C)

Highlighted below in rose color, the SIL30C series are new high-density, open-frame, non-isolated DC/DC converters for space sensitive applications. The converters have a wide input range (10.2-13.8VDC) and offer a wide 0.9-5V output voltage range with a 30A load.

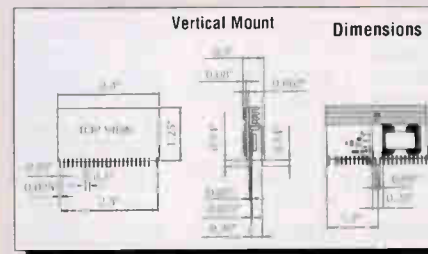

The SIL Series Converters above also have the following features:

- di/dt: 10A/μs
- 100% burn-in test
- No minimum load
- Planar magnetics technology
- Very high MTBF
- Remote ON/OFF
- Two-year warranty

Mfr.	Manufacturer Product Number*	Input Range	Output		Size Inches (LxWxH)	Pins	Line Reg. (±%)	Load Reg. (±%)	Temp. °C	Efficiency (%)	MTBF (hours)	Jameco Part No.	Price			
			Voltage@Current	Power									1	10	25	100
Artesyn	SIL06C-05SADJ-V	4.5V-5.5V	0.9-3.3V@6A	20W	1.20x0.61x0.07	8	0.2	0.5	0 to +80	89	1,300,000	219150CL	\$40.25	\$3.45	\$2.52	\$1.99
Artesyn	SIL06C-05SADJ-H	4.5V-5.5V	0.9-3.3V@6A	20W	1.20x0.61x0.53	8	0.2	0.5	0 to +80	89	1,300,000	219168CL	\$40.25	\$3.45	\$2.52	\$1.99
Artesyn	SIL10E-05S1V8-V	3.0V-5.5V	1.8V@10A	18W	2.00x0.50x0.31	11	1.0	1.0	-40 to +100	92	7,042,000	219141CL	\$24.95	\$2.18	\$1.67	\$1.33
Artesyn	SIL10E-05S2V5-V	3.0V-5.5V	2.5V@10A	25W	2.00x0.50x0.31	11	1.0	1.0	-40 to +100	94	7,042,000	219133CL	\$24.95	\$2.18	\$1.67	\$1.33
Artesyn	SIL10E-05W3V3-V	4.5V-5.5V	0.8-3.6V@10A	33W	2.00x0.50x0.31	11	1.0	1.0	-40 to +100	95	7,042,000	219117CL	\$24.95	\$2.18	\$1.67	\$1.33
Artesyn	SIL10E-05S3V3-V	4.5V-5.5V	3.3V@10A	33W	2.00x0.50x0.31	11	1.0	1.0	-40 to +100	95	7,042,000	219125CL	\$24.95	\$2.18	\$1.67	\$1.33
Artesyn	SIL15C-05SADJ-V	4.5V-5.5V	0.9V-3.3V@15A	50W	1.20x1.10x0.40	13	0.2	0.5	0 to +80	89	7,817,000	218886CL	\$38.95	\$3.29	\$2.39	\$1.89
Artesyn	SIL15C-12SADJ-V	10.2V-13.8V	0.9V-5V@15A	75W	1.20x1.10x0.40	13	0.2	0.5	0 to +80	91	7,817,000	218878CL	\$38.95	\$3.29	\$2.39	\$1.89
Artesyn	SIL30C-12SADJ-V	10.2V-13.8V	0.9V-5V@30A	150W	2.40x1.25x0.47	24	0.2	1.0	0 to +80	91	129,000	218860CL	\$73.95	\$5.49	\$4.09	\$3.31

* Suffix: V=Vertical; H=Horizontal

0.5 to 10-Watt Isolated DC-to-DC Converters

Color Code Legend
New Sale Qty. Save Closeout

Other Versions Available: Call 800-831-4242

0.5 & 1-Watt Regulated & Unregulated Encapsulated

SRS05, SPR01 & SUS01 Series: Single Output

- 1000VDC isolation
- Input filter: capacitor type
- 100% burn-in test
- One-year warranty
- No external components needed
- Switching frequency: 100kHz, except P/N 213225CL: 500kHz
- Working temperature: -15 to +60°C @ full load; -25 to +71°C @ 80% load
- Protection: short-circuit
- Very high MTBF
- Ripple & noise: 100 mV p-p



PERFORMANCE AT VALUE PRICES



The Mean Well SRS05, SPR01 and SUS01 series are low-cost, highly reliable, low-power, 0.5-watt and 1.0-watt DC-to-DC converters that are easy to use because no external components are required. Internally they employ high-density SMD technology and are packaged in a non-conductive plastic case for safety. The input-to-output isolation is an impressive 1000VDC, with I/O isolation resistance of 100MΩ and capacitance of 80pF maximum. Short-circuit protection is a standard feature and electrical noise is minimized with a capacitor-type input filter.

Jameco Part No.	Manufacturer Product Number	Input Range	Output		Size Inches (LxWxH)	Pins	Line Reg. (±%)	Load Reg. (±%)	Weight (lbs.)	Price			
			Voltage@Current	Power						1	10	25	100
213225CL	SRS-0505	4.5-5.5V	+5V@100mA	0.5W	0.88x0.39x0.33	8	1.0	1.0	0.01	\$7.95	\$7.48	\$7.01	\$6.54
216830CL	SPR01L-12	4.5-5.5V	+12V@84mA	1.0W	0.77x0.28x0.4	4	1.0	1.0	0.01	9.95	8.95	8.09	7.28
216848CL	SPR01L-15	4.5-5.5V	+15V@67mA	1.0W	0.77x0.28x0.4	4	1.0	1.0	0.01	\$7.95	7.89	6.43	5.88
213250CL	SPR01N-05	21.6-26.4V	+5V@200mA	1.0W	0.77x0.28x0.4	4	1.0	1.0	0.01	\$7.95	6.78	5.74	5.09
213241CL	SUS01L-05	4.5-5.5V	+5V@200mA	1.0W	0.88x0.39x0.33	8	8.0	1.2	0.01	\$7.95	6.15	5.59	5.05

SALE

Worst Lowest Prices

3 & 5-Watt Regulated Encapsulated

DCW03, SCW03, DLW05 & SLW05 Series: Single & Dual Outputs

- 1000VDC isolation
- 2:1 wide input range
- Free-air convection cooling
- Ripple & noise: 100 mV p-p
- Industry standard package
- Working temperature: -15 to +60°C @ full load; -25 to +71°C @ 80% load
- Input filter: Pi network
- Shielded metal case
- Very high MTBF
- Switching frequency: 50kHz, except SCW03 and DCW03 series: 25kHz
- One-year warranty
- No external components needed
- 100% burn-in test
- Protection: short-circuit & overload



PERFORMANCE AT VALUE PRICES

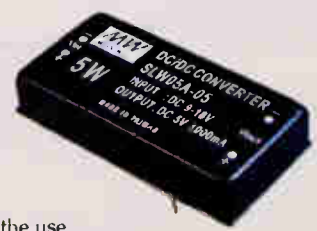

These popular regulated DC-to-DC converters performance features include a wide input voltage range of 2:1 and the use of a pi-network input filter for low noise operation. The input-to-output isolation is an impressive 1000VDC, with I/O isolation resistance of 100MΩ. The Mean Well SCW03 and DCW03 families include single and dual-output 3-watt configurations packaged in six-sided shielded metal cases. The industry-standard package size supports full power with free-air convection. Offering both single and dual outputs, the Mean Well SLW05 and DLW05 5-watt series are very popular because of their low-cost, reliability, and industry-standard package comprised of a six-sided shielded metal case. Continuous short-circuit protection and overload protection, both with auto-recovery, are standard features.

Jameco Part No.	Manufacturer Product Number	Input Range	Output		Size Inches (LxWxH)	Pins	Line Reg. (±%)	Load Reg. (±%)	Weight (lbs.)	Price			
			Voltage@Current	Power						1	10	25	100
213268CL	SCW03A-05	9-18V	+5V@600mA	3.0W	1.25x0.8x0.48	10	1.0	0.5	0.03	\$15.49	\$13.95	\$12.59	\$11.29
155918CL	DCW03A-05	9-18V	+5V@300mA; -5V@300mA	3.0W	1.25x0.8x0.48	10	1.0	0.5	0.03	20.95	18.89	16.99	15.29
161701CL	DCW03A-12	9-18V	+12V@125mA; -12V@125mA	3.0W	1.25x0.8x0.48	10	1.0	0.5	0.03	20.95	18.89	16.99	15.29
220388CL	SLW05L-12	4.5-9V	+12V@417mA	5.0W	1.98x0.99x0.44	5	0.2	0.5	0.07	24.95	22.49	20.25	18.25
220370CL	SLW05L-15	4.5-9V	+15V@333mA	5.0W	1.98x0.99x0.44	5	0.2	0.5	0.07	\$24.95	18.89	17.25	15.88
220353CL	SLW05A-033	9-18V	+3.3V@1500mA	5.0W	1.98x0.99x0.44	5	0.2	0.5	0.07	24.95	22.49	20.25	18.25
216928CL	SLW05A-05	9-18V	+5V@1000mA	5.0W	1.98x0.99x0.44	5	1.0	0.2	0.07	24.95	22.49	20.25	18.25
216899CL	SLW05A-12	9-18V	+12V@417mA	5.0W	1.98x0.99x0.44	5	1.0	0.2	0.07	\$24.95	18.89	17.25	15.88
216881CL	SLW05A-15	9-18V	+15V@333mA	5.0W	1.98x0.99x0.44	5	1.0	0.2	0.07	24.95	22.49	20.25	18.25
220361CL	SLW05B-033	18-36V	+3.3V@1500mA	5.0W	1.98x0.99x0.44	5	0.2	0.5	0.07	\$24.95	18.89	17.25	15.88
216936CL	SLW05B-05	18-36V	+5V@1000mA	5.0W	1.98x0.99x0.44	5	1.0	0.2	0.07	24.95	22.49	20.25	18.25
216910CL	SLW05B-12	18-36V	+12V@417mA	5.0W	1.98x0.99x0.44	5	1.0	0.2	0.07	\$24.95	18.89	17.25	15.88
216872CL	SLW05B-15	18-36V	+15V@333mA	5.0W	1.98x0.99x0.44	5	1.0	0.2	0.07	\$24.95	18.89	17.25	15.88
213233CL	SLW05C-05	36-72V	+5V@1000mA	5.0W	1.98x0.99x0.44	5	1.0	0.2	0.07	\$49.95	17.25	15.50	13.95
216901CL	SLW05C-12	36-72V	+12V@417mA	5.0W	1.98x0.99x0.44	5	1.0	0.2	0.07	\$24.95	18.89	17.25	15.88
216856CL	DLW05A-12	9-18V	+12V@208mA; -12V@208mA	5.0W	1.98x0.99x0.44	5	0.2	0.2	0.07	\$29.95	22.55	18.55	15.44
216864CL	DLW05B-12	18-36V	+12V@208mA; -12V@208mA	5.0W	1.98x0.99x0.44	5	0.2	0.2	0.07	\$29.95	22.55	18.55	15.44

SALE

Worst Lowest Prices

Special Offers at Great Savings – 90-Day Warranty

- Temperature: -25° to +70°C
- Weight: 0.03 lbs.

SALE

Jameco Part No.	Manufacturer	Manufacturer Product Number	Input Range	Output		Size Inches (LxWxH)	Pins	Ripple & Noise (mV p-p)	Line Reg. (±%)	Load Reg. (±%)	Switching Freq. (Hz)	Isolation Voltage	Price				
				Voltage@Current	Power								1	10	25	100	
206076CL	Trimag	TDB4W-4805S	36-72V	+5V@500mA	3.0W	1.2x0.8x0.5	12	50	1.0	1.0	25k	500	\$9.95	\$7.85	\$7.15	\$6.49	\$5.89

Other Versions Available: Call 800-831-4242

10-Watt Open Frame

CXA10 Series: Single Output

- Isolation voltage: 1500VDC
- Protection: short-circuit & overload
- Two-year warranty
- Switching frequency: 400kHz

- Industry standard footprint
- 100% burn-in test
- Very high MTBF
- Ripple & noise: 30mV p-p

- Remote ON/OFF
- 4:1 input voltage range
- UL/CUL/CSA/VDE/CE approved
- Working temp.: -40 to +100°C (see www.Jameco.com)



The CXA10 series has a wide 4:1 input voltage range of 18 to 75 VDC. The CXA10 has been designed as a competitive open-frame alternative for the communications market, featuring an industry-standard footprint of 2" x 1" x 0.4". Planar magnetics are used in the design to improve reliability and reduce the profile. The series has full international safety approval to EN60950 and UL1950, reducing system compliance costs. The basic insulation system from input to output makes it suitable for a wide variety of applications.

Jameco Part No.	Manufacturer Product Number	Input Range	Output		Size Inches (LxWxH)	Pins	Line Reg. (±%)	Load Reg. (±%)	Weight (lbs.)	Price			
			Voltage@Current	Power						1	10	25	100
219037CL	CXA10-48S3V3	18-75V	+3.3V@2400mA	7.9W	2.0x1.0x0.536	6	0.1	0.2	0.03	\$44.45	\$38.88	\$33.31	\$28.44
219045CL	CXA10-48S05	18-75V	+5.0V@2000mA	10.0W	2.0x1.0x0.536	6	0.1	0.2	0.03	\$44.45	\$38.88	\$33.31	\$28.44

15-Watt Open Frame

CXE15 Series: Single Output

- Isolation voltage: 1500VDC
- Protection: over-voltage & over-current
- Two-year warranty
- 87% efficiency at 5V
- Ripple & noise: 219070CL/219088CL: 40mV p-p; 219053CL/219061CL 70mV p-p

- Industry standard footprint
- 100% burn-in test
- Remote ON/OFF
- No minimum load

- Switching frequency: 265kHz
- UL/CUL/TUV/CE approved
- Output trim
- Planar magnetics technology
- Working temperature: -40° to +65°C



The CXE15 is a high-efficiency, open-frame, isolated 15-watt DC-to-DC converter series in an industry standard footprint. The output voltage on each model is adjustable from 90% to 110% of the nominal value. With full international safety approval including EN60950 and UL1950, the CXE15 reduces compliance cost and time to market.

Jameco Part No.	Manufacturer Product Number	Input Range	Output		Size Inches (LxWxH)	Pins	Line Reg. (±%)	Load Reg. (±%)	Weight (lbs.)	Price			
			Voltage@Current	Power						1	10	25	100
219070CL	CXE15-48S1V8	33-75V	+1.8V@6000mA	10.8W	2.0x1.0x0.35	6	0.3	2.0	0.03	\$44.85	\$42.40	\$39.31	\$36.99
219088CL	CXE15-48S2V5	33-75V	+2.5V@6000mA	15.0W	2.0x1.0x0.35	6	0.3	1.5	0.03	\$44.85	\$42.40	\$39.31	\$36.99
219053CL	CXE15-48S3V3	33-75V	+3.3V@4500mA	15.0W	2.0x1.0x0.35	6	0.1	0.5	0.03	\$44.85	\$42.40	\$39.31	\$36.99
219061CL	CXE15-48S05V	33-75V	+5V@3000mA	15.0W	2.0x1.0x0.35	6	0.1	0.5	0.03	\$44.85	\$42.40	\$39.31	\$36.99

10-Watt Encapsulated

SKE10 & DKE10 Series: Single & Dual Outputs

- Isolation voltage: 1000VDC
- Protection: short-circuit & overload
- Ripple & noise: 60mV p-p, except for 216961CL/220337CL/216952CL/220345CL/216944CL/217031CL/217058CL/217040CL: 50 mV p-p
- Working temperature: -15 to +60°C @ full load; -25 to +71°C @ 80% load
- Switching frequency: 250kHz, except for 216961CL/217007CL/216979CL: 300kHz & 220337CL/220345CL: 200kHz
- Input filter: Pi-network
- One-year warranty
- 100% burn-in test
- Very high MTBF
- 2:1 wide input range
- Shielded metal case
- Industry standard package
- Free-air convection cooling



The Mean Well SKE10 & DKE10 families of regulated DC-to-DC converters include popular single and dual-output 10-watt configurations. The industry-standard package size supports full power with free-air convection. Performance features include a wide input voltage range of 2:1 and the use of a pi-network input filter for low noise operation.

Jameco Part No.	Manufacturer Product Number	Input Range	Output		Size Inches (LxWxH)	Pins	Line Reg. (±%)	Load Reg. (±%)	Weight (lbs.)	Price			
			Voltage@Current	Power						1	10	25	100
216961CL	SKE10A-05	9-18V	+5V@2000mA	10.0W	1.98x0.99x0.44	5	0.3	1.0	0.07	\$33.95	\$30.55	\$26.95	\$24.55
217007CL	SKE10A-12	9-18V	+12V@840mA	10.0W	1.98x0.99x0.44	5	0.3	1.0	0.07	\$33.95	\$30.55	\$26.95	\$24.55
216979CL	SKE10A-15	9-18V	+15V@666mA	10.0W	1.98x0.99x0.44	5	0.3	1.0	0.07	\$33.95	\$30.55	\$26.95	\$24.55
220337CL	SKE10B-033	18-36V	+3.3V@2400mA	8.0W	1.98x0.99x0.44	5	0.3	0.5	0.07	\$33.95	\$30.55	\$26.95	\$24.55
216952CL	SKE10B-05	18-36V	+5V@2000mA	10.0W	1.98x0.99x0.44	5	0.3	0.5	0.07	\$33.95	\$30.55	\$26.95	\$24.55
217023CL	SKE10B-12	18-36V	+12V@840mA	10.0W	1.98x0.99x0.44	5	0.3	0.5	0.07	\$33.95	\$30.55	\$26.95	\$24.55
216995CL	SKE10B-15	18-36V	+15V@666mA	10.0W	1.98x0.99x0.44	5	0.3	0.5	0.07	\$33.95	\$30.55	\$26.95	\$24.55
220345CL	SKE10C-033	36-72V	+3.3V@2400mA	8.0W	1.98x0.99x0.44	5	0.3	0.5	0.07	\$33.95	\$30.55	\$26.95	\$24.55
216944CL	SKE10C-05	36-72V	+5V@2000mA	10.0W	1.98x0.99x0.44	5	0.3	1.0	0.07	\$33.95	\$30.55	\$26.95	\$24.55
217015CL	SKE10C-12	36-72V	+12V@840mA	10.0W	1.98x0.99x0.44	5	0.3	1.0	0.07	\$33.95	\$30.55	\$26.95	\$24.55
216987CL	SKE10C-15	36-72V	+15V@666mA	10.0W	1.98x0.99x0.44	5	0.3	1.0	0.07	\$33.95	\$30.55	\$26.95	\$24.55
217031CL	DKE10A-05	9-18V	+5V@1000mA; -5V@1000mA	10.0W	1.98x0.99x0.44	5	0.3	0.5	0.07	\$34.95	\$31.45	\$27.95	\$25.45
217091CL	DKE10A-12	9-18V	+12V@420mA; -12V@420mA	10.0W	1.98x0.99x0.44	5	0.3	0.5	0.07	\$34.95	\$31.45	\$27.95	\$25.45
217111CL	DKE10A-15	9-18V	+15V@333mA; -15V@333mA	10.0W	1.98x0.99x0.44	5	0.3	0.5	0.07	\$34.95	\$31.45	\$27.95	\$25.45
217058CL	DKE10B-05	18-36V	+5V@1000mA; -5V@1000mA	10.0W	1.98x0.99x0.44	5	0.3	0.5	0.07	\$34.95	\$31.45	\$27.95	\$25.45
217082CL	DKE10B-12	18-36V	+12V@420mA; -12V@420mA	10.0W	1.98x0.99x0.44	5	0.3	0.5	0.07	\$34.95	\$31.45	\$27.95	\$25.45
217074CL	DKE10B-15	18-36V	+15V@333mA; -15V@333mA	10.0W	1.98x0.99x0.44	5	0.3	0.5	0.07	\$34.95	\$31.45	\$27.95	\$25.45
217040CL	DKE10C-05	36-72V	+5V@1000mA; -5V@1000mA	10.0W	1.98x0.99x0.44	5	0.3	0.5	0.07	\$34.95	\$31.45	\$27.95	\$25.45
217103CL	DKE10C-12	36-72V	+12V@420mA; -12V@420mA	10.0W	1.98x0.99x0.44	5	0.3	0.5	0.07	\$34.95	\$31.45	\$27.95	\$25.45
217066CL	DKE10C-15	36-72V	+15V@333mA; -15V@333mA	10.0W	1.98x0.99x0.44	5	0.3	0.5	0.07	\$34.95	\$31.45	\$27.95	\$25.45

15 to 25-Watt Isolated DC-to-DC Converters

Other Versions Available: Call 800-821-4242

Color Code Legend
New **SALE** Closeout

20-Watt Open Frame

CXA20 Series: Single Output

- Isolation voltage: 1500VDC
- Remote ON/OFF
- No minimum load
- Working temperature: -40° to +60° C (see www.Jameco.com)
- Industry standard footprint
- 4:1 input voltage range
- Output trim

SALE

ARTESYN TECHNOLOGIES

UL US CE

- 100% burn-in test
- Ripple & noise: 75 mV p-p
- Switching frequency: 400kHz
- Protection: over-voltage, over-temperature & short-circuit
- Planar magnetics technology
- UL/CUL/CSA/VE/CE approved
- Two-year warranty

TOP QUALITY U.S. BRAND



The CXA20 features a 4:1 input voltage range of 18 to 75VDC, making it suitable for a wide variety of communications and distributed power applications. Provides an easy upgrade option for those seeking a high-performance, cost-effective DC-to-DC converter.

Jameco Part No.	Manufacturer Product Number	Input Range	Output		Size Inches (LxWxH)	Pins	Line Reg. (±%)	Load Reg. (±%)	Weight (lbs.)	Price				
			Voltage@Current	Power						1	10	25	100	
219109CL	CXA20-48S3V3	18-75V	+3.3V@6000mA	19.8W	2.0x1.6x0.41	8	0.1	0.2	0.06	\$39.95	\$39.95	\$45.29	\$11.74	\$10.09
219096CL	CXA20-48S05	18-75V	+5V@4000mA	20.0W	2.0x1.6x0.41	8	0.1	0.1	0.06	\$39.95	\$39.95	\$45.38	\$11.74	\$10.09

New Lower Prices

15-Watt Encapsulated

SKE15 & DKE15 Series: Single & Dual Outputs

- Isolation voltage: 1000VDC
- Protection: short-circuit & overload
- Free-air convection cooling
- Ripple & noise: 155715CL/213276CL/217138CL: 50 mV p-p; 155707CL/213284CL/217120CL/161728CL/217154CL: 60 mV p-p; 155694CL/213292CL: 80 mV p-p
- Input filter: Pi network
- 100% burn-in test
- Working temperature: -15° to +60° C @ full load; -25° to +71° C @ 80% load
- Switching frequency: 150kHz
- Shielded metal case
- 2:1 wide input range
- One-year warranty

SALE

MW MEAN WELL

PERFORMANCE AT VALUE PRICES



The Mean Well SKE15 & DKE15 series are very popular regulated 15-watt DC-to-DC converters because of their low-cost, reliability, and industry-standard package. Continuous short-circuit protection and overload protection, both with auto-recovery, are standard features.

Jameco Part No.	Manufacturer Product Number	Input Range	Output		Size Inches (LxWxH)	Pins	Line Reg. (±%)	Load Reg. (±%)	Weight (lbs.)	Price				
			Voltage@Current	Power						1	10	25	100	
155715CL	SKE15A-05	9-18V	+5V@3000mA	15.0W	2.0x2.0x0.43	5	0.3	0.5	0.15	\$34.95	\$34.95	\$31.49	\$28.15	\$25.35
155707CL	SKE15A-12	9-18V	+12V@1250mA	15.0W	2.0x2.0x0.43	5	0.3	0.5	0.15	34.95	34.95	31.19	28.15	25.35
155694CL	SKE15A-24	9-18V	+24V@625mA	15.0W	2.0x2.0x0.43	5	0.3	0.5	0.15	34.95	34.95	31.49	28.15	25.35
213276CL	SKE15B-05	18-36V	+5V@3000mA	15.0W	2.0x2.0x0.43	5	0.3	0.5	0.15	34.95	34.95	31.49	28.15	25.35
213284CL	SKE15B-12	18-36V	+12V@1250mA	15.0W	2.0x2.0x0.43	5	0.3	0.5	0.15	34.95	34.95	31.49	28.15	25.35
217138CL	SKE15C-05	36-72V	+5V@3000mA	15.0W	2.0x2.0x0.43	5	0.3	0.5	0.15	\$34.95	\$34.95	\$33.75	\$27.59	\$19.83
217120CL	SKE15C-12	36-72V	+12V@1250mA	15.0W	2.0x2.0x0.43	5	0.3	0.5	0.15	\$34.95	\$34.95	\$33.75	\$27.59	\$19.83
161728CL	DKE15A-12	9-18V	+12V@625mA; -12V@625mA	15.0W	2.0x2.0x0.43	5	0.3	0.5	0.15	35.95	35.95	32.36	25.88	19.41
213292CL	DKE15A-24	9-18V	+24V@313mA; -24V@313mA	15.0W	2.0x2.0x0.43	5	0.3	0.5	0.15	\$36.95	\$36.95	\$29.85	\$26.00	\$24.05
217162CL	DKE15B-15	18-36V	+15V@500mA; -15V@500mA	15.0W	2.0x2.0x0.43	5	0.3	0.5	0.15	\$38.95	\$38.95	\$31.36	\$28.01	\$20.36
217154CL	DKE15C-15	36-72V	+15V@500mA; -15V@500mA	15.0W	2.0x2.0x0.43	5	0.3	0.5	0.15	\$38.95	\$38.95	\$33.82	\$27.59	\$19.83

New Lower Prices

20-Watt Encapsulated

DKB20 & TKB20 Series: Dual & Triple Outputs

- Isolation voltage: 1000VDC
- Protection: short-circuit & overload
- Shielded metal case
- Output trim
- Ripple & noise: 100 mV p-p
- Working temp.: -40° to +71° C
- Switching frequency: 100kHz
- Industry standard package
- Free-air convection cooling
- Input filter: Pi network
- 100% burn-in test
- One-year warranty

SALE

MW MEAN WELL

PERFORMANCE AT VALUE PRICES



The Mean Well DKB20 & TKB20 families of regulated DC-to-DC converters are superior for applications where the output voltage must stay within tight limits during extreme operating conditions. For ease of use, the DKB20 & TKB20 units require no external components and provide both voltage trim and remote ON/OFF capability.

Jameco Part No.	Manufacturer Product Number	Input Range	Output		Size Inches (LxWxH)	Pins	Line Reg. (±%)	Load Reg. (±%)	Weight (lbs.)	Price				
			Voltage@Current	Power						1	10	25	100	
217630CL	DKB20A-05	9-18V	+5V@2000mA; -5V@2000mA	20.0W	1.2x2.0x0.82	8	0.2	0.2	0.25	\$44.95	\$44.95	\$40.49	\$36.45	\$32.79
217584CL	DKB20A-12	9-18V	+12V@833mA; -12V@833mA	20.0W	1.2x2.0x0.82	8	0.2	0.2	0.25	\$44.95	\$44.95	\$33.27	\$30.25	\$27.59
217621CL	DKB20A-15	9-18V	+15V@667mA; -15V@667mA	20.0W	1.2x2.0x0.82	8	0.2	0.2	0.25	\$44.95	\$44.95	\$33.27	\$30.25	\$27.59
217592CL	DKB20B-12	18-36V	+12V@833mA; -12V@833mA	20.0W	1.2x2.0x0.82	8	0.2	0.2	0.25	\$44.95	\$44.95	\$33.27	\$30.25	\$27.59
217605CL	DKB20B-15	18-36V	+15V@667mA; -15V@667mA	20.0W	1.2x2.0x0.82	8	0.2	0.2	0.25	\$44.95	\$44.95	\$33.27	\$30.25	\$27.59
217576CL	DKB20C-12	36-72V	+12V@833mA; -12V@833mA	20.0W	1.2x2.0x0.82	8	0.2	0.2	0.25	\$44.95	\$44.95	\$33.27	\$30.25	\$27.59
217613CL	DKB20C-15	36-72V	+15V@667mA; -15V@667mA	20.0W	1.2x2.0x0.82	8	0.2	0.2	0.25	\$44.95	\$44.95	\$33.27	\$30.25	\$27.59
217656CL	TKB20A-B	9-18V	+5V@2500mA; ±12V@310mA	20.0W	1.2x2.0x0.82	8	0.2	0.2	0.25	\$44.95	\$44.95	\$37.78	\$34.34	\$31.22
217664CL	TKB20B-B	18-36V	+5V@2500mA; ±12V@310mA	20.0W	1.2x2.0x0.82	8	0.2	0.2	0.25	\$44.95	\$44.95	\$37.78	\$34.34	\$31.22
217672CL	TKB20B-C	18-36V	+5V@2500mA; ±15V@250mA	20.0W	1.2x2.0x0.82	8	0.2	0.2	0.25	\$44.95	\$44.95	\$37.78	\$34.34	\$31.22
217648CL	TKB20C-B	36-72V	+5V@2500mA; ±12V@310mA	20.0W	1.2x2.0x0.82	8	0.2	0.2	0.25	\$44.95	\$44.95	\$37.78	\$34.34	\$31.22

New Lower Prices

Special Offers at Great Savings – 90-Day Warranty

Jameco Part No.	Mfr.	Manufacturer Product No.	Input Range	Output		Size Inches (LxWxH)	Pins	Ripple & Noise (mV p-p)	Line Reg. (±%)	Load Reg. (±%)	Switching Freq. (Hz)	Temp. (°C)	Price			
				Voltage@Current	Power								1	10	25	100
109276CL	Astec	AA9090A	0-20V	+5.1V@3750mA; +12.6V@100mA; -26V@40mA	21.0W	3.6x1.6x0.8	27	50/100/200	2.0	5.0	40k	0 to +50	\$1.80	\$1.63	\$1.48	\$1.35

SALE

New Lower Prices

Other Versions Available: Call 800-831-4242

25 to 30-Watt Isolated DC-to-DC Converters

25-Watt Enclosed

SD25 Series: Single Output



SALE



PERFORMANCE AT VALUE PRICES

- Isolation voltage: 500VDC
- Shielded metal case
- Protection: short-circuit, overload and over-voltage
- Ripple & noise: 100 mV p-p, except 175804: 120 mV p-p and 175812: 150 mV p-p
- Mounting hardware use P/Ns 222121CL, 222164CL, 222156CL & 222172CL see www.Jameco.com for specifications
- Input filter: Pi-network
- Industry standard package
- Free-air convection cooling
- 105°C output capacitor
- Working temperature: -10° to +60°C (see www.Jameco.com)
- 2:1 wide input range
- 100% burn-in test
- One-year warranty
- Very high MTBF

Well known for its reliability and low cost, the Mean Well SD-25 family of enclosed DC-to-DC converters offers wide 2:1 input voltage ranges. The physical ruggedness is complemented by the many electrical protections; short-circuit, overload with auto-recovery, and over-voltage to 165% of rated output. The input-to-output isolation is 500VDC and the isolation resistance is 100MΩ at 500VDC. The highly-efficient, low-temperature design provides full power from 0°C to 40°C, with derating to -10°C and +60°C (see www.Jameco.com). The line and load regulation are both ±0.5% maximum. The Mean Well SD-25 series complies with EMC standards EN55022 class B and EN61000-4-2/3/4/6/8.

Jameco Part No.	Manufacturer Product Number	Input Range	Output		Size Inches (LxWxH)	Pins	Line Reg. (±%)	Load Reg. (±%)	Weight (lbs.)	Price			
			Voltage@Current	Power						1	10	25	100
175661CL	SD-25A-5	9-18V	+5V@500mA	25.0W	see www.Jameco.com	5	0.5	0.5	0.80	\$40.95	\$30.99	\$28.99	\$24.99
175804CL	SD-25A-12	9-18V	+12V@2100mA	25.2W	see www.Jameco.com	5	0.3	0.3	0.80	40.95	30.99	28.99	24.99
175812CL	SD-25A-24	9-18V	+24V@1100mA	26.4W	see www.Jameco.com	5	0.2	0.2	0.80	40.95	30.99	28.99	24.99
212556CL	SD-25B-5	19-36V	+5V@500mA	25.0W	see www.Jameco.com	5	0.5	0.5	0.80	\$35.95	\$27.99	\$25.44	\$21.82
216629CL	SD-25C-5	36-72V	+5V@500mA	25.0W	see www.Jameco.com	5	0.5	0.5	0.80	\$48.95	\$34.54	\$31.40	\$26.54

New Lower Prices

30-Watt Encapsulated

DKA30 & TKA30 Series: Dual & Triple Output



SALE



PERFORMANCE AT VALUE PRICES

- Isolation voltage: 1000VDC
- Protection: short-circuit & overload
- 2:1 wide input range
- Shielded metal case
- Working temperature: -40° to +71°C
- Input filter: Pi-network
- Free-air convection cooling
- Industry standard package
- Remote ON/OFF
- Very high MTBF
- Switching frequency: 100kHz
- Ripple & noise: 100 mV p-p
- 100% burn-in test
- One-year warranty
- Output trim

The Mean Well DKA30 & TKA30 families of regulated 30-watt DC-to-DC converters include popular dual and triple-output configurations packaged in six-sided, shielded metal cases. Load regulation applies for a load change of 10% to full load for both dual and triple-outputs. The industry-standard package supports full power with free-air convection over the ambient temperature range of -40°C to 71°C. Performance features include a wide input voltage range of 2:1 and the use of a pi-network input filter for low noise operation. The input-to-output isolation is an impressive 1000VDC, with I/O isolation resistance of 1000MΩ.

Jameco Part No.	Manufacturer Product Number	Input Range	Output		Size Inches (LxWxH)	Pins	Line Reg. (±%)	Load Reg. (±%)	Weight (lbs.)	Price			
			Voltage@Current	Power						1	10	25	100
217701CL	DKA30A-12	9-18V	±12V@1250mA	30.0W	2.0x2.0x0.82	8	0.2	0.2	0.25	\$64.95	\$48.00	\$43.35	\$37.00
218544CL	DKA30B-12	18-36V	±12V@1250mA	30.0W	2.0x2.0x0.82	8	0.2	0.2	0.25	64.95	58.45	52.59	47.35
217699CL	DKA30C-12	36-72V	±12V@1250mA	30.0W	2.0x2.0x0.82	8	0.2	0.2	0.25	\$64.95	\$48.00	\$43.35	\$37.00
217736CL	TKA30A-B	9-18V	+5V@3500mA; ±12V@310mA	25.0W	2.0x2.0x0.82	8	0.2	0.2	0.25	\$69.95	\$51.46	\$46.78	\$42.53
217728CL	TKA30B-C	18-36V	+5V@3500mA; ±15V@250mA	25.0W	2.0x2.0x0.82	8	0.2	0.2	0.25	\$69.95	\$51.46	\$46.78	\$42.53
217681CL	TKA30C-B	36-72V	+5V@3500mA; ±12V@310mA	25.0W	2.0x2.0x0.82	8	0.2	0.2	0.25	\$69.95	\$51.46	\$46.78	\$42.53

New Lower Prices

Power

30-Watt Regulated Encapsulated

SDM30 Series: Single Output



PERFORMANCE AT VALUE PRICES



SALE

- Isolation voltage: 1000VDC
- Ripple & noise: 100 mV p-p, except 217200CL/217218CL/217226CL: 75 mV p-p
- Industry standard package
- Remote ON/OFF
- Very high MTBF
- Input filter: Pi-network
- Free-air convection cooling
- Shielded metal case
- One-year warranty
- Working temperature: -25° to +85°C
- Protection: short-circuit, overload & over-voltage
- 2:1 wide input range
- 100% burn-in test
- Output trim

With efficiency as high as 85%, this impressive family of 30-watt encapsulated DC-to-DC converters provides full power output with free-air convection cooling. The compact size of 2.0"x2.0"x0.63" and the 6-sided shielded metal case lend to its easy adaptability to numerous types of applications. Input voltage ranges are a full 2:1. Protection includes short-circuit, overload to 105% with auto-recovery, and over-voltage to 150% of rated output. The isolation voltage is 1000VDC and the resistance is 100MΩ at 500VDC. The SDM30 series features ±10% trimming output and remote ON/OFF control. They completely comply with EN55022 class B, FCC part 15) and EN60950 safety and EMI requirements.

Jameco Part No.	Manufacturer Product Number	Input Range	Output		Size Inches (LxWxH)	Pins	Line Reg. (±%)	Load Reg. (±%)	Weight (lbs.)	Price			
			Voltage@Current	Power						1	10	25	100
217200CL	SDM30-12S05	9-18V	+5V@500mA	25.0W	2.0x1.8x0.62	8	1.0	1.0	0.22	\$45.95	\$32.99	\$31.87	\$28.88
217234CL	SDM30-12S12	9-18V	+12V@2100mA	25.2W	2.0x1.8x0.62	8	1.0	1.0	0.22	\$45.95	\$32.99	\$31.87	\$28.88
217189CL	SDM30-12S15	9-18V	+15V@1700mA	25.5W	2.0x1.8x0.62	8	1.0	1.0	0.22	\$45.95	\$32.99	\$31.87	\$28.88
217218CL	SDM30-24S05	18-36V	+5V@500mA	25.0W	2.0x1.8x0.62	8	1.0	1.0	0.22	\$45.95	\$32.99	\$31.87	\$28.88
217242CL	SDM30-24S12	18-36V	+12V@2500mA	30.0W	2.0x1.8x0.62	8	1.0	1.0	0.22	45.95	41.35	37.25	33.55
217171CL	SDM30-24S15	18-36V	+15V@2000mA	30.0W	2.0x1.8x0.62	8	1.0	1.0	0.22	\$45.95	\$32.99	\$31.87	\$28.88
217226CL	SDM30-48S05	36-72V	+5V@500mA	25.0W	2.0x1.8x0.62	8	1.0	1.0	0.22	\$45.95	\$32.99	\$31.87	\$28.88
217251CL	SDM30-48S12	36-72V	+12V@2500mA	30.0W	2.0x1.8x0.62	8	1.0	1.0	0.22	\$45.95	\$32.99	\$31.87	\$28.88
217197CL	SDM30-48S15	36-72V	+15V@2000mA	30.0W	2.0x1.8x0.62	8	1.0	1.0	0.22	\$45.95	\$32.99	\$31.87	\$28.88

New Lower Prices

50-Watt & Up Isolated DC-to-DC Converters

Color Code Legend
New Sale Qty. Save Closeout

Other Versions Available: Call 800-831-4242

60-Watt Open Frame

EXQ60 Series Dual Outputs

- Isolation voltage: 1500VDC
- Protection: short-circuit, over-current & over-voltage
- 100% burn-in test
- 91% efficiency at 5V & 3.3V
- Planar magnetics technology
- Switching frequency: 218894CL: 325kHz; 218907CL: 400kHz
- Industry standard footprint
- Remote ON/OFF
- Output trim
- Working temperature: -40 to +100°C

ARTESYN TECHNOLOGIES

UL US

SALE

- Two-year warranty
- Very high MTBF
- No minimum load
- UL/CUL/TUV approved
- Ripple & noise: 60 mV p-p

TOP QUALITY U.S. BRAND



The EXQ60 delivers very high output current at low voltages, and excellent useable power density for today's high-end applications. The models offered feature an input voltage range of 33 to 75VDC and are available in output voltages of 2.5V/3.3V and 3.3V/5V. The output voltage on each model is adjustable from 90% to 110% of the nominal value. Typical efficiencies for the models are 90% for the 2.5V/3.3V and 91% for the 3.3V/5V versions. Over-current and over-voltage protection features are included as standard. With full international safety approval including EN60950 and UL1950, the EXQ60 reduces compliance cost and time to market.

Jameco Part No.	Manufacturer Product Number	Input Range	Output		Size Inches (LxWxH)	Pins	Line Reg. (±%)	Load Reg. (±%)	Weight (lbs.)	Price			
			Voltage@Current	Power						1	10	25	100
218894CL	EXQ60-48D3V3-2V5-R	33-75V	+2.5V@16A; +3.3V@12A	40.0W	2.3x1.5x0.5	7	—	—	0.10	\$122.79	\$118.25	\$108.09	\$90.15
218907CL	EXQ60-48D05-3V3-R	33-75V	+3.3V@15A; +5V@12A	60.0W	2.3x1.5x0.5	7	—	—	0.10	127.79	118.25	106.09	88.15

New Lower Prices

50, 100 & 150-Watt Enclosed

SD50, SD100 & SD150 Series: Single Output

- Isolation voltage: 1500VDC
- Protection: short-circuit, overload & over-voltage
- Very high MTBF
- 2:1 wide input range
- Working temperature: -10° to +60°C (see www.Jameco.com)
- Ripple & noise: 212548CL/212521CL/216602CL/212476CL/212484CL: 100 mV p-p; 212530CL/212505CL/216565CL/212468CL/212726CL: 120 mV p-p; 212513CL/212492CL: 150 mV p-p
- Input filter: Pi-network
- Shielded metal case
- 105°C output capacitor
- Mounting hardware: use P/Ns 222156CL & 222172CL; see www.Jameco.com for specifications

MW MEAN WELL

SALE

PERFORMANCE AT VALUE PRICES



The Mean Well SD families of enclosed DC-to-DC converters are known for their reliability and low cost. The physical ruggedness is complemented by the many electrical protections; short-circuit, overload with auto-recovery, and over-voltage to 165% of rated output. These converters offer wide 2:1 input voltage ranges of 9-18VDC and 36-72VDC. The input-to-output isolation is 500VDC and the isolation resistance is 100MΩ at 500VDC. The line and load regulation are both ±0.5% maximum. The Mean Well SD series complies with EMC standards EN55022 class B and EN61000-4-2/3/4/6/8.

Jameco Part No.	Manufacturer Product Number	Input Range	Output		Size Inches (LxWxH)	Pins	Line Reg. (±%)	Load Reg. (±%)	Weight (lbs.)	Price			
			Voltage@Current	Power						1	10	25	100
212548CL	SD-50A-5	9-18V	+5V@10A	50.0W	see www.Jameco.com	5	0.5	0.5	1.10	\$61.95	\$58.79	\$52.58	\$38.88
212521CL	SD-50B-5	19-36V	+5V@10A	50.0W	see www.Jameco.com	5	0.5	0.5	1.10	\$61.95	58.79	52.58	37.01
212530CL	SD-50B-12	19-36V	+12V@4.2A	50.4W	see www.Jameco.com	5	0.3	0.3	1.10	\$61.95	51.95	39.99	36.99
212513CL	SD-50B-24	19-36V	+24V@2.1A	50.4W	see www.Jameco.com	5	0.2	0.2	1.10	\$61.95	55.79	32.58	29.58
216602CL	SD-50C-5	36-72V	+5V@10A	50.0W	see www.Jameco.com	5	0.5	0.5	1.10	\$61.95	37.34	33.95	30.98
212505CL	SD-50C-12	36-72V	+12V@4.2A	50.4W	see www.Jameco.com	5	0.3	0.3	1.10	\$61.95	51.95	39.99	36.99
212492CL	SD-50C-24	36-72V	+24V@2.1A	50.4W	see www.Jameco.com	5	0.2	0.2	1.10	\$61.95	47.95	43.19	38.85
212476CL	SD-100B-5	19-36V	+5V@20A	100.0W	see www.Jameco.com	7	0.5	0.5	1.30	\$64.95	50.55	45.95	41.79
216565CL	SD-100B-12	19-36V	+12V@8.5A	102.0W	see www.Jameco.com	7	0.3	0.3	1.30	\$72.95	48.99	45.82	41.29
212484CL	SD-100C-5	36-72V	+5V@20A	100.0W	see www.Jameco.com	7	0.5	0.5	1.30	\$64.95	52.45	47.68	43.35
212468CL	SD-100C-12	36-72V	+12V@8.5A	102.0W	see www.Jameco.com	7	0.3	0.3	1.30	\$72.95	63.95	53.99	50.99
212726CL	SD-150B-12	19-36V	+12V@12.5A	150.0W	see www.Jameco.com	7	0.5	0.5	1.90	\$72.95	82.95	70.99	65.99

New Lower Prices

Special Offers at Great Savings – 90-Day Warranty

Jameco Part No.	Manufacturer	Manufacturer Product Number	Input Range	Output		Size Inches (LxWxH)	Pins	Ripple & Noise (mV p-p)	Line Reg. (±%)	Load Reg. (±%)	Temp. °C	Price			
				Voltage@Current	Power							1	10	25	100
206105CL	Shindengen	HGE05024	20-32V	+5V@24A	120.0W	4.5x2.3x0.5	13	400	0.01	0.05	-10 to +80	\$24.95	\$23.25	\$18.41	\$13.18
203561CL	Power One	HBD0602GE-A1V1	34-75V	+3.3V@15A; +5V@12A	60.0W	2.3x2.4x0.5	10	75/100	0.2	0.5	-40 to +100	\$40.45	30.49	25.4	20.7
206113CL	Datei	BCP-5/15-3.3/15-D48	36-75V	+3.3V@15A; +5V@15A	75.0W	2.3x2.4x0.5	10	50	0.2	0.5	-40 to +45	\$49.95	32.42	22.20	11.05
206041CL	Power Cube	PD150-048-05-PC	36-76V	+5V@30A	150.0W	2.3x2.4x0.5	9	50	0.05	0.05	—	\$24.95	22.80	18.41	13.18
206033CL	Power Cube	PD300-300-15-PC	200-300V	+15V@20A	300.0W	4.6x2.4x0.5	11	150	0.05	0.05	—	\$39.95	33.14	21.04	16.13
206121CL	Lambda	PH300F-280-3	200-400V	+3V@60A	180.0W	5.8x3.4x0.5	12	100	0.4	0.8	-20 to +85	\$27.95	27.31	19.74	14.31

For complete specifications see www.Jameco.com

See the yellow and green highlighted items.

Jameco Special Values!

Sale details are on page 2.

For Power Supplies see pages 113 - 142.



Additional
Mounting Rails see
www.jameco.com

- Low cost, high reliability
- PFC (some models)
- International AC input range
- Soft-start circuit, limiting AC surge current
- Short-circuit, overload, over-voltage protected
- 100% full-load burn-in test
- For DIN-Rail terminal blocks see page 83



192698CL

212273CL

212290CL

221891CL

New 252662CL

UL-508



SALE

Part No.	Product No.	Power (W)	Output Volts@Current	Input Voltage (VAC @ Hz/VDC)	Input Current @ Maximum Load	Size (L" x W" x H")	Wt. (lbs.)	1	10	25
212302CL	DR4505	25	5VDC @ 5A	85-264 @ 47-63/120-370	1.5A(115V)/750mA(230V)	3.0 x 2.6 x 3.6	0.9	\$45.95	\$35.19	\$32.99
192698CL	DR4512	42	12VDC @ 3.5A	85-264 @ 47-63/120-370	1.5A(115V)/750mA(230V)	3.0 x 2.6 x 3.6	0.7	45.95	35.19	32.99
221874CL	DR4515	42	15VDC @ 2.8A	85-264 @ 47-63/120-370	1.5A(115V)/750mA(230V)	3.0 x 2.6 x 3.6	0.9	45.95	35.19	32.99
192680CL	DR4524	48	24VDC @ 2A	85-264 @ 47-63/120-370	1.5A(115V)/750mA(230V)	3.0 x 2.6 x 3.6	0.7	45.95	35.19	32.99
212290CL	DR7512	75	12VDC @ 6.3A	85-264 @ 47-63/120-370	2.0A(115V)/1.2A(230V)	3.9 x 2.1 x 4.9	1.2	73.95	56.09	51.69
212281CL	DR7524	75	24VDC @ 3.2A	85-264 @ 47-63/120-370	2.0A(115V)/1.2A(230V)	3.9 x 2.1 x 4.9	1.2	73.95	56.09	51.69
221866CL	DR7548	75	48VDC @ 1.6A	85-264 @ 47-63/120-370	2.0A(115V)/1.2A(230V)	3.9 x 2.1 x 4.9	1.2	73.95	56.09	51.69
212273CL	DR12012	120	12VDC @ 10A	88-132/176-264* @ 47-63	2.8A(115V)/1.7A(230V)	2.6 x 3.9 x 4.9	1.4	85.95	64.89	60.49
212265CL	DR12024	120	24VDC @ 5A	88-132/176-264* @ 47-63	2.8A(115V)/1.7A(230V)	2.6 x 3.9 x 4.9	1.4	85.95	64.89	60.49
221903CL	DR12048	120	48VDC @ 2.5A	88-132/176-264* @ 47-63	2.8A(115V)/1.7A(230V)	2.6 x 3.9 x 4.9	1.4	85.95	58.99	54.99
221891CL	DRP24024†	240	24VDC @ 10A	85-264 @ 47-63/120-370	3.5A (115V)/1.8A(230V)	3.9 x 4.9 x 4.9	2.4	156.95	112.19	104.49
221882CL	DRP24048†	240	48VDC @ 5.0A	85-264 @ 47-63/120-370	3.5A(115V)/1.8A(230V)	3.9 x 4.9 x 4.9	2.4	156.95	112.19	104.49
252638CL	DR48024	480	24VDC @ 20.0A	180-264 @ 47-63/25-370	6.0A(230V)	8.9 x 3.9 x 4.9	4.6	222.89	200.59	180.55
252646CL	DR48048	480	48VDC @ 10.0A	180-264 @ 47-63/25-370	6.0A(230V)	8.9 x 3.9 x 4.9	4.6	222.89	200.59	180.55
252662CL	DRP48024†	480	24VDC @ 20.0A	180-264 @ 47-63/25-370	4.0A(230V)	8.9 x 3.9 x 4.9	4.6	243.29	218.95	197.09
252654CL	DRP48048†	480	48VDC @ 10.0A	180-264 @ 47-63/25-370	4.0A(230V)	8.9 x 3.9 x 4.9	4.6	243.29	218.95	197.09

*Switch selectable † With Power Factor Correction

DIN Mounting Rail

DIN rail enables easy installation of components such as fuseable terminal blocks and power supplies configured for DIN mounting.



Part No.	Product No.	Description	Material	Type	Length	1	10	100
248735CL	2094.0	Prepunched	Zinc bichromate plate steel	TS35x7.5	1 meter (39")	\$6.79	\$5.45	\$4.10

13.8VDC Precision Regulated Linear Power Supplies

- Output voltage: 13.8VDC
- Input voltage: 115VAC @ 60Hz
- Illuminated rocker switch
- Heavy duty 5' 8" 3-prong power cord
- Short-circuit protection • Fuse protected
- Output terminals: see page 152 for mating cigarette plugs and page 202 for mating banana terminal plugs

135845CL
Banana & Cigarette



136581CL
Banana terminal



138667CL
Banana terminal (rear)



Part No.	Model No.	Power (W)	Output Current (A)	Output Terminals	Size (L" x W" x H")	Wt. (lbs.)	1	10	25
135845CL	RPS1204	55.2	4	Banana terminals / cigarette plug	6.7 x 5.2 x 3.2	5.5	\$29.95	\$26.95	\$23.95
136581CL	RPS1207†	96.6	7	Banana terminals	8.7 x 5.7 x 3.6	8.5	59.95	53.95	48.95
138667CL	38-381	138.0	10	Banana terminals (rear)	7.0 x 6.6 x 4.3	10.0	69.95	62.95	56.95
138675CL	52-192012	276.0	20	Banana terminals	10.0 x 7.8 x 4.4	15.9	109.95	99.95	89.95

† P/N 136581CL includes overheating protection

power-one

Linear Power Supplies

- Input voltage: 100/120/220/240VAC @ 47-63Hz
- Input connector: 0.119" solder terminals
- Output connector: solder post
- MTBF rating: greater than 300,000 hours
- Ripple and noise: 5.0mVp-p • Efficiency: 45%
- Over-voltage, over-current, short-circuit protection, remote sensing and 100% burn-in

202884CL: Output voltage: +5VDC @ 1.5A; -5VDC @ 1.5A

202892CL: Output voltage: +5VDC @ 3.0A; -5VDC @ 3.0A

Part No.	Product No.	Power	Size (L x W x H)	Weight (lbs.)	1	10	50
202884CL	HAA5-1.5/OVP-A	15W	6.5 x 4.0" x 1.6"	2.6	\$9.22	\$8.36	\$6.65
202892CL	HBB5-3/OVP-A	30W	7.0 x 4.9" x 2.5"	4.7	17.95	15.29	11.45

SALE



ACDC Electronics

45-Watt Linear Power Supply

- Output voltage: 15V @ 3A
- Input voltage: 115VAC @ 50-60Hz
- Input connector: 0.173" solder terminals
- Output connector: solder studs
- Size: 5.6"L x 5.0"W x 3.0"H • Weight: 4.0 lbs.

Part No.	Product No.	1	10	25
214615CL	ECV15N3	\$24.95	\$18.97	\$16.47

SALE



**We'll Send
It Today!**

Don't worry about backorders. Over 99% of our products are in stock!
Just place your order by 6PM EST for same business day shipment.

AC-to-DC Regulated Switching Table-Top Power Supplies

Color Code Legend
New Sale **Save Closeout**

See page 150 for International Power Cords



SALE
 Quantity **SAVE**
 GS CE



New Lower Prices

Power	Part Number	Mfr. ▲	Mfr. Cross Ref. No. ▲	Output		Input VAC@Hz	Output Connector ID x OD/Polarity F female M male		Pwr. Ind.	Color	Size (L" x W" x H")	Cords* (DC/AC)	Wt. (lbs.)	Agency Approvals	Pricing			
				Pwr (W)	Volts (VDC)/Current (A)		Ind.	Color							1	10	50	100
2 Wire AC Input - Regulated Switching																		
5-24 Watt	221823CL	Mean Well	P15A-0P2JU	7	+3.3/2.2	90-264@47-63	2.1mm x 5.5mm F 2	Yes	Black	3.6 x 1.6 x 1.5	6/6*	0.5	UL/CUL/TUV/CE	\$19.49	\$17.59	\$15.79	\$14.19	
	221591CL	Mean Well	P30B-0P2JU	12	+3.3/3.6	90-264@47-63	2.1mm x 5.5mm F 2	Yes	Black	4.3 x 2.6 x 1.4	6/6*	0.8	UL/CUL/TUV/CE	21.95	19.79	17.79	15.99	
	237059CL	Cisco	ADP-12GB	12.5	+5/2.5	100-240@50-60	2.5mm x 5.5mm F 2	No	Black	3.5 x 2.3 x 1.2	6/3*	0.6	UL/CUL/TUV/CE	14.95	13.40	12.70	8.80	
	249050CL	Phihong	PSA15W-050	12.5	+5/2.5	100-240@50-60	2.5mm x 5.5mm F 2	No	Black	4.3 x 2.6 x 1.0	6/3*	0.4	UL/CSA/TUV/CE	19.49	17.75	16.39	14.55	
	211300CL	Horizon	SSL20-7605	20	+5/4.0	100-240@50-60	2.5mm x 5.5mm F 2	No	Black	4.2 x 2.3 x 1.0	6/3*	1.5	UL/CSA/VE/CE	24.95	19.99	14.99	10.49	
	221604CL	Mean Well	P30B-1P2JU	20	+5/4.0	90-264@47-63	2.1mm x 5.5mm F 2	Yes	Black	4.3 x 2.6 x 1.4	6/6*	0.8	UL/CUL/TUV/CE	25.95	23.35	20.99	18.99	
	195805CL	Horizon	DCR920F12	18	+9/2.0	100-240@50-60	2.1mm x 5.5mm F 2	Yes	Black	4.2 x 2.6 x 1.4	6/6*	0.9	UL/CUL/TUV/CE	26.95	24.29	21.85	19.65	
	195768CL	Horizon	DCR920F52	18	+9/2.0	100-240@50-60	2.5mm x 5.5mm F 2	Yes	Black	4.3 x 2.6 x 1.4	6/6*	0.9	UL/CUL/TUV/CE	22.95	20.69	18.59	16.75	
	249041CL	Phihong	PSA15W-120	15	+12/1.25	100-240@50-60	2.1mm x 5.5mm F 2	No	Black	4.3 x 2.6 x 1.0	6/3*	0.3	UL/CSA/TUV/CE	19.49	17.75	16.39	14.55	
	242958CL	Mean Well	G158-3P2JR15	15	+12/1.3	100-240@50-60	2.1mm x 5.5mm F 2	No	Black	3.9 x 2.3 x 1.6	6/3*	0.5	UL/CSA/TUV/CE	19.49	17.69	16.39	14.51	
211174CL	Horizon	SC102TA1503	18	+15/1.2	100-240@47-63	2.1mm x 5.5mm F 2	No	Black	4.0 x 1.9 x 1.4	6/3*	0.5	UL/CUL/TUV/CE	19.95	17.85	14.25	10.70		
221858CL	Mean Well	P15B-6PJU	15	+24/0.6	90-264@47-63	2.1mm x 5.5mm F 2	Yes	Black	3.6 x 1.6 x 1.5	6/6*	0.5	UL/CUL/TUV/CE	19.49	17.59	15.79	14.19		
196138CL	DVE	DSA-02B3A	23	+5/1, +12/1.49 -5.43	100-240@47-63	5-pin DIN M	No	Black	4.9 x 2.7 x 1.5	6/3*	0.8	UL/CSA/TUV	17.95	16.19	12.95	9.69		
25-60 Watt	220311CL	Horizon	SL120300	36	+12/3.0	100-240@50-60	2.1mm x 5.5mm F 2	Yes	Black	4.3 x 2.0 x 1.2	6/3*	0.6	UL/CUL/TUV/CE	29.95	26.99	24.29	21.85	
	220441CL	Horizon	SL120300RT	36	+12/3.0	100-240@50-60	2.5mm x 5.5mm F 2†	Yes	Black	4.3 x 2.0 x 1.2	6/3*	0.6	UL/CUL/TUV/CE	29.95	26.99	24.29	21.85	
	224055CL	Horizon	SL120300-4.5	36	+12/3.0	100-240@50-60	2.1mm x 5.5mm F 2	Yes	Black	4.3 x 2.0 x 1.2	4.5/3*	0.6	UL/CUL/TUV/CE	29.95	26.99	24.29	21.85	
	224047CL	Horizon	SL120300RT-4.5	36	+12/3.0	100-240@50-60	2.5mm x 5.5mm F 2†	Yes	Black	4.3 x 2.0 x 1.2	4.5/3*	0.6	UL/CUL/TUV/CE	29.95	26.99	24.29	21.85	
	230498CL	Phihong	PSA60W-120	50	+12/4.2	90-264@47-63	2.1mm x 5.5mm F 2	No	Black	4.0 x 2.5 x 1.3	6/3*	0.5	UL/CUL/TUV/CE	36.49	32.85	29.55	29.55	
	230501CL	Phihong	PSA60W-180	60	+18/3.3	90-264@47-63	2.1mm x 5.5mm F 2	No	Black	4.0 x 2.5 x 1.3	6/3*	0.5	UL/CUL/TUV/CE	36.49	32.85	29.55	29.55	
	221612CL	Mean Well	P30B-6P2JU	27	+24/1.1	90-264@47-63	2.1mm x 5.5mm F 2	Yes	Black	4.3 x 2.6 x 1.4	6/6*	0.8	UL/CUL/TUV/CE	25.95	23.35	20.99	18.99	
	229841CL	Phihong	PSA60W-240	60	+24/2.5	90-264@47-63	2.1mm x 5.5mm F 2	No	Black	4.0 x 2.5 x 1.3	6/3*	0.5	UL/CUL/TUV/CE	36.49	32.85	29.55	29.55	
205911CL	Delta	ADP-25HB	25	+30/0.83	100-125@50-60	2.1mm x 5.5mm F 2	No	Black	3.5 x 2.4 x 1.2	6/7*	1.1	UL/CUL	17.49	15.75	12.59	9.45		
3-Wire AC Input - Regulated Switching																		
5-14W	221671CL	Mean Well	P30A-0P2JU	12	+3.3/3.6	90-264@47-63	2.1mm x 5.5mm F 2	Yes	Black	4.3 x 2.6 x 1.4	6/6*	0.8	UL/CSA/TUV/CE	\$26.95	\$24.29	\$21.85	\$19.65	
	196218CL	GlobeTek	GT210891005T3	10	+5/2.0	120-240@60-60	2.1mm x 5.5mm F 2	No	Black	3.4 x 1.9 x 1.3	6/2*	0.4	UL/CUL/TUV/CE	19.95	17.95	16.15	14.55	
	153752CL	Skynet	LVT-T022	8	+5/1.5, -5/0.1	115-230@50-60	5-pin mini DIN M	No	Black	5.5 x 2.9 x 1.5	6/2*	1.1	UL/CSA/TUV	12.95	11.69	9.35	6.99	
15-20 Watt	221567CL	Mean Well	P40A-0P2JU	15	+3.3/4.5	90-264@47-63	2.1mm x 5.5mm F 2	Yes	Black	4.3 x 2.6 x 1.4	6/6*	0.8	UL/CUL/TUV/CE	29.95	26.99	24.29	21.85	
	202796CL	Mean Well	UA15-2.5U	15	+5/2.5	100-240@47-63	2.5mm x 5.5mm F 2	No	Black	3.3 x 2.0 x 1.3	4/6*	0.4	UL/CSA/TUV	19.65	17.85	15.95	13.95	
	221786CL	Mean Well	U24S102-P2JU	15	+5/3.0	90-264@47-63	2.1mm x 5.5mm F 2	Yes	Black	4.2 x 2.6 x 1.2	6/6*	0.8	UL/CUL/TUV/CE	23.95	21.55	19.39	17.45	
	206236CL	Netgear	A15D3-05MP	15	+5/3.0	100-240@50-60	2.5mm x 5.5mm F 2	No	Black	3.8 x 2.1 x 1.4	5/2*	0.4	UL/CSA/TUV	24.95	22.49	17.99	13.49	
	228996CL	Phihong	PSA31U-050	20	+5/4.0	90-264@47-63	2.1mm x 5.5mm F 2	No	Black	4.5 x 2.4 x 1.4	6/2*	0.5	UL/CUL/TUV/CE	26.95	24.25	21.85	19.65	
	213583CL	Mean Well	P30A-1P2JU	20	+5/4.0	100-240@50-60	2.1mm x 5.5mm F 2	Yes	Black	4.3 x 2.6 x 1.4	6/6*	0.7	UL/CUL/TUV/CE	26.95	24.25	21.85	19.65	
	228988CL	Phihong	PSA18U-120	18	+12/1.5	90-264@47-63	2.1mm x 5.5mm F 2	No	Black	3.9 x 2.2 x 1.2	6/2*	0.5	UL/CUL/TUV/CE	22.95	20.65	18.59	16.75	
	216549CL	Mean Well	KWM12F-P2JU	18	+12/1.5	100-240@47-63	2.1mm x 5.5mm F 2	No	Black	4.0 x 1.9 x 1.5	6/6*	0.4	UL/CUL/TUV/CE	22.95	20.65	18.59	16.75	
	216531CL	Mean Well	KWM12F-P2MU	18	+12/1.5	100-240@47-63	2.5mm x 5.5mm F 2	No	Black	4.0 x 1.9 x 1.5	6/6*	0.4	UL/CUL/TUV/CE	26.95	24.25	21.85	19.65	
	243002CL	Mean Well	G15A-6P2JU	15	+24/0.6	90-264@47-63	2.1mm x 5.5mm F 2	No	Black	3.9 x 2.3 x 1.3	6/2*	0.4	UL/CUL/TUV/CE	19.95	17.95	16.15	14.55	
21-29 Watt	159353CL	Mean Well	KA60AU	17	+5/1, ±12/0.5	100-240@50-60	5-pin DIN M	Yes	Black	4.1 x 2.6 x 1.5	6/5*	1.0	UL/CSA/TUV	36.95	33.29	29.95	26.95	
	213575CL	Mean Well	P40A-1P2JU	25	+5/5.0	100-240@50-60	2.1mm x 5.5mm F 2	Yes	Black	4.3 x 2.6 x 1.4	6/6*	0.7	UL/CUL/TUV/CE	29.95	26.99	24.29	21.85	
	211019CL	Mean Well	KA52B	25	+9/2.78	100-240@47-63	2.5mm x 5.5mm F 2	No	Black	4.2 x 2.6 x 1.5	6/2*	0.9	UL/CSA/TUV/CE	29.95	26.99	24.29	21.85	
	211027CL	Mean Well	KA52BMOD	25	+9/2.78	100-240@47-63	2.1mm x 5.5mm F 2	No	Black	4.2 x 2.6 x 1.5	6/2*	0.9	UL/CSA/TUV/CE	\$29.95	\$27.85	\$24.29	\$21.85	
	173825CL	Ault	SW109	25	+9/2.78	100-250@50-60	3-pin Molex F	No	Black	5.0 x 3.0 x 1.5	5/8/2*	1.3	UL/CSA/CE	\$5.49	4.79	4.29	3.89	
	203086CL	Ault	SW110	25	+12/2.08	100-250@50-60	2.5mm x 5.5mm F 2	No	Black	5.1 x 3.1 x 1.6	6/2*	2.0	UL/CSA/CE	24.95	22.49	19.95	17.95	
	243011CL	Mean Well	P30A-41P2JU	27	+15/1.8	90-264@47-63	2.1mm x 5.5mm F 2	Yes	Black	4.2 x 2.6 x 1.4	6/2*	0.8	UL/CUL/TUV/CE	25.95	23.39	21.05	18.95	
	206455CL	Ault	SC100	25	+16/1.56	100-240@50-60	2.5mm x 5.5mm F 2	No	Black	4.2 x 2.6 x 1.5	6/2*	1.2	UL/CUL/TUV/CE	\$19.95	17.95	14.95	10.95	
	221680CL	Mean Well	P30A-6P2JU	27	+24/1.1	90-264@47-63	2.1mm x 5.5mm F 2	Yes	Black	4.3 x 2.6 x 1.4	6/6*	0.8	UL/CSA/TUV/CE	26.95	24.29	21.85	19.65	
	203772CL	Ault	SC100	25	+48/0.52	100-250@50-60	2.5mm x 5.5mm F 2	No	Black	4.2 x 2.6 x 1.5	6/2*	0.8	UL/CUL/TUV/CE	19.95	17.95	14.39	10.79	
215087CL	Mean Well	P30A-8P2J	27	+48/0.56	100-240@50-60	2.1mm x 5.5mm F 2	Yes	Black	4.3 x 2.6 x 1.4	6/2*	0.7	UL/CSA/TUV/CE	\$26.95	\$25.95	\$23.39	\$21.39		
215079CL	Mean Well	P30A-8P2MU	27	+48/0.56	100-240@50-60	2.5mm x 5.5mm F 2	Yes	Black	4.3 x 2.6 x 1.4	6/6*	0.7	UL/CSA/TUV/CE	\$26.95	\$25.95	\$23.39	\$21.39		
196269CL	Everglow	PSU25A13	25	+5/2.5, +12/1.0	100-240@47-63	4-pin mini DIN M	No	Black	4.2 x 2.6 x 1.4	6/4*	1.2	UL/CUL/TUV/CE	27.95	25.19	22.65	20.39		

* See accessory table-top power cord chart on page 142 when AC cord needed; refer to 1, 2 or 3 in Cord (DC/AC) column above for correct power cord † Right angle
 ▲ Manufacturer and Manufacturer Cross Reference Number may vary except for Mean Well, Phihong, Jameco and GlobTek

3-Wire Table-Top Power Supplies Continued on Page 141

AC-to-DC Regulated Switching Table-Top Power Supplies

See page 150 for
International
Power Cords



Quantity
SAVE

SALE

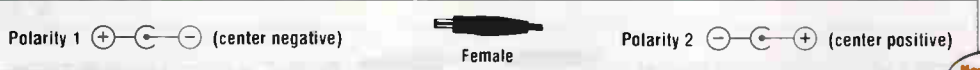

New Lower Prices

Power	Part Number	Mfr. ▲	Mfr. Cross Ref. No. ▲	Output		Input VAC@Hz	Output Connector ID x OD/Polarity F = female M = male	Pwr. Ind.	Color	Size (L" x W" x H")	Cords (DC/AC)	Wt. (lbs.)	Agency Approvals	Pricing			
				Pwr (W)	Volts (VDC)/Current (A)									1	10	50	100
3-Wire AC Input - Regulated Switching (Continued)																	
21-29 Watt (cont'd)	221751CL	Mean Well	P25A13-R1BU	25	+5/2.5, +12/1.0	90-264@47-63	5-pin DIN M	Yes	Black	4.3 x 2.6 x 1.4	6/6'	0.8	UL/CSA/TUV/CE	\$27.95	\$25.19	\$22.69	\$20.39
	221760CL	Mean Well	P25A14-R1BU	25	+5/2.5, +15/0.8	90-264@47-63	5-pin DIN M	Yes	Black	4.3 x 2.6 x 1.4	6/6'	0.8	UL/CSA/TUV/CE	27.95	25.19	22.69	20.39
	189561CL	Phihong	PSM-3012G	26	+5/4, +12/0.5	100-240@50-60	5-pin mini DIN M	Yes	Beige	5.8 x 2.9 x 1.6	6/7'	1.3	UL/CSA	6.25	5.62	4.50	3.38
	190650CL	Ault	SW300	25	+5/4.0, +12/1.0	100-250@50-60	5-pin DIN M	No	Black	5.9 x 3.4 x 2.1	6/7'	1.5	UL/CSA/TUV	9.95	8.70	7.58	6.44
	221778CL	Mean Well	P25A16-R1BU	25	+5/2.5, +24/0.5	90-264@47-63	5-pin DIN M	Yes	Black	4.3 x 2.6 x 1.4	6/6'	0.8	UL/CUL/TUV/CE	27.95	25.19	22.69	20.39
	190959CL	Mean Well	P25A13D-R1U	26	+5/2.5, +12/0.8 -12/0.3	100-240@47-63	5-pin DIN M	Yes	Black	4.1 x 2.6 x 1.4	6/6'	1.1	CUL/TUV/CE	32.95	29.69	26.69	24.05
	221719CL	Mean Well	P25A14E-R1BU	25	+5/2.5, +15/0.3 -15/0.3	90-264@47-63	5-pin DIN M	Yes	Black	4.3 x 2.6 x 1.4	6/6'	0.8	UL/CUL/TUV/CE	32.95	29.69	26.69	24.05
	221516CL	Mean Well	U45S102-P2JU	40	+5/8.0	90-264@47-63	2.1mm x 5.5mm F 2	Yes	Black	5.7 x 3.0 x 1.7	4/6'	1.4	UL/CUL/TUV/CE	37.95	34.19	30.79	27.69
	206527CL	Mean Well	P40A-1-1P25U	30	+7.5/4.0	100-240@50-60	2.1mm x 5.5mm F 2	No	Black	4.3 x 2.7 x 1.5	6/6'	1.5	UL/CUL/TUV/CE	29.95	26.95	23.95	21.95
	229008CL	Phihong	PSA31U-120	30	+12/3.5	90-264@47-63	2.1mm x 5.5mm F 2	No	Black	4.5 x 2.4 x 1.4	6/7'	0.5	UL/CUL/TUV/CE	26.95	24.25	21.85	19.65
30-40 Watt	155213CL	Mean Well	P40A-3P2JU	40	+12/3.3	100-240@50-60	2.1mm x 5.5mm F 2	Yes	Black	4.5 x 2.3 x 1.5	6/6'	0.7	UL/CUL/TUV	35.95	32.36	29.12	26.21
	229016CL	Phihong	PSA31U-150	30	+15/2.0	90-264@47-63	2.1mm x 5.5mm F 2	No	Black	4.5 x 2.4 x 1.4	6/7'	0.5	UL/CUL/TUV/CE	26.95	24.25	21.85	19.65
	206471CL	Mean Well	P40A-4AR01U	30	+15/2.0	100-240@50-60	2.5mm x 5.5mm F 2	No	Black	5.6 x 2.9 x 1.6	6/6'	1.2	UL/CUL/TUV/CE	26.95	24.29	21.85	19.65
	221575CL	Mean Well	P40A-4P2JU	40	+15/2.7	90-264@47-63	2.1mm x 5.5mm F 2	Yes	Black	4.3 x 2.6 x 1.4	6/6'	0.8	UL/CUL/TUV/CE	33.95	30.56	27.50	24.75
	230480CL	Phihong	PSA31U-180	30	+18/1.6	90-264@47-63	2.1mm x 5.5mm F 2	No	Black	3.9 x 2.2 x 1.2	6/7'	0.5	UL/CUL/TUV/CE	26.95	24.25	21.85	21.85
	229024CL	Phihong	PSA31U-240	40	+24/1.25	90-264@47-63	2.1mm x 5.5mm F 2	No	Black	4.5 x 2.4 x 1.4	6/7'	0.5	UL/CUL/TUV/CE	26.95	24.25	21.85	19.65
	181884CL	Mean Well	P40A6P2JU	40	+24/1.66	100-240@50-60	2.1mm x 5.5mm F 2	Yes	Black	4.1 x 2.6 x 1.4	6/6'	0.7	UL/TUV/CE	35.95	32.36	29.12	26.21
	229032CL	Phihong	PSA31U-480	30	+48/0.63	90-264@47-63	2.1mm x 5.5mm F 2	No	Black	4.5 x 2.4 x 1.6	6/7'	0.5	UL/CUL/TUV/CE	26.95	24.25	21.85	19.65
	221583CL	Mean Well	P40A-8P2JU	40	+48/0.8	90-264@47-63	2.1mm x 5.5mm F 2	Yes	Black	4.2 x 2.6 x 1.4	6/6'	0.8	UL/CUL/TUV/CE	33.95	30.56	27.50	24.75
	211191CL	Westinghouse	FSA30P31	30	+5/3, +12/0.8	35-264@47-63	5-pin DIN M	No	Black	5.8 x 3.0 x 1.7	4/7'	1.1	UL/CSA/TUV	22.95	21.39	19.79	18.19
41-49 Watt	203043CL	Ault	SC200	32	+5/4, +12/1	100-240@50-60	5-pin DIN M	No	Black	5.0 x 3.0 x 1.6	6/7'	1.3	UL/CSA/CE	17.95	17.48	14.98	13.78
	221524CL	Mean Well	U45S105-P2JU	45	+12/3.8	90-264@47-63	2.1mm x 5.5mm F 2	Yes	Black	5.7 x 3.0 x 1.7	6/6'	1.3	UL/CSA/TUV/CE	37.95	34.15	30.75	27.65
	221532CL	Mean Well	U45S106-P2JU	45	+15/3.0	90-264@47-63	2.1mm x 5.5mm F 2	Yes	Black	5.7 x 3.0 x 1.7	6/6'	1.3	UL/CSA/TUV/CE	37.95	34.15	30.75	27.65
	221508CL	Mean Well	L60A24-P1JU	48	+24/2.0	90-264@47-63	2.1mm x 5.5mm F 2	Yes	Black	4.3 x 2.4 x 1.2	6/6'	0.8	UL/CUL/TUV/CE	32.95	29.66	26.69	24.02
	221559CL	Mean Well	U45S111-P2JU	48	+48/1.0	90-264@47-63	2.1mm x 5.5mm F 2	Yes	Black	5.7 x 3.0 x 1.7	6/6'	1.3	UL/CUL/TUV/CE	37.95	34.19	30.79	27.69
	221727CL	Mean Well	U45D201-R1BU	42	+5/3.5, +12/2.0	90-264@47-63	5-pin DIN M	Yes	Black	5.7 x 3.0 x 1.7	4/6'	1.3	UL/CSA/TUV/CE	38.95	34.95	31.55	28.35
	221735CL	Mean Well	U45D202-R1BU	42	+5/3.5, +15/1.5	90-264@47-63	5-pin DIN M	Yes	Black	5.7 x 3.0 x 1.7	4/6'	1.3	UL/CUL/TUV/CE	38.95	34.95	31.55	28.35
	221743CL	Mean Well	U45D203-R1BU	42	+5/3.5, +24/1.0	90-264@47-63	5-pin DIN M	Yes	Black	5.7 x 3.0 x 1.7	4/6'	1.3	UL/CUL/TUV/CE	38.95	34.95	31.55	28.35
	215132CL	Mean Well	U45T302-R1BU	42	+5/5, +12/1 -12/0.3	90-264@47-63	5-pin DIN M	Yes	Black	5.8 x 3.1 x 1.8	4/6'	1.4	UL/CUL/TUV/CE	49.95	44.99	40.49	36.45
	211107CL	Fortron	FSA55P31	45	+5/5, +12/3 -12/0.5	85-264@50-60	5-pin DIN M	Yes	Black	7.0 x 3.8 x 2.2	4/7'	1.6	UL/CSA/TUV	49.95	39.99	29.99	20.99
50-59 Watt	221689CL	Mean Well	U45T303-R1BU	42	+5/3.5, +15/1.2 -15/0.3	90-264@47-63	5-pin DIN M	Yes	Black	5.7 x 3.0 x 1.7	4/6'	1.3	UL/CSA/TUV/CE	36.95	33.25	29.95	26.95
	237366CL	Mean Well	P50A14E-R1BU	42	+5/3.5, +15/1.2 -15/0.3	100-240@47-63	5-pin DIN M	Yes	Black	5.8 x 3.0 x 1.7	4/6'	1.2	UL/CUL/TUV/CE	36.95	33.25	29.95	26.95
	221487CL	Mean Well	SPU50-1U	50	+5/10	90-264@47-63	2.1mm x 5.5mm F 2	Yes	Black	5.7 x 3.0 x 1.7	6/6'	2.0	UL/CUL/TUV/CE	36.95	33.95	31.95	29.49
	243045CL	Mean Well	P66A-5P2JU	50	+18/2.77	90-264@47-63	2.1mm x 5.5mm F 2	Yes	Black	5.8 x 3.0 x 1.7	6/7'	1.2	UL/CUL/TUV/CE	38.49	34.91	32.21	29.55
	169076CL	Eitron	808050-00	50	+20/2.5	100-240@50-60	2.5mm x 5.5mm F 2	Yes	Black	6.7 x 3.3 x 2.3	6/7'	1.4	UL/CSA/TUV	22.95	18.39	13.79	9.65
60-80 Watt	221541CL	Mean Well	U45S108-P2JU	50	+24/2.1	90-264@47-63	2.1mm x 5.5mm F 2	Yes	Black	5.7 x 3.0 x 1.7	6/6'	1.3	UL/CSA/TUV/CE	37.95	34.15	30.75	27.65
	221701CL	Mean Well	P50A13D-R1BU	50	+5/4.0, +12/2.0 -12/0.5	90-264@47-63	5-pin DIN M	Yes	Black	5.7 x 3.0 x 1.7	4/6'	1.5	UL/CUL/TUV/CE	48.95	44.09	39.69	35.69
	155230CL	Mean Well	SPU50-3U	60	+12/5.0	100-240@47-63	2.1mm x 5.5mm F 2	Yes	Black	5.6 x 2.9 x 1.5	6/6'	1.3	UL/CSA/TUV	49.95	44.95	39.95	35.95
	182959CL	Elpac	W7212	72	+12/6.0	95-250@47-63	5-pin DIN F	Yes	Black	6.2 x 3.8 x 2.6	6/6'	2.5	UL/CSA/CE	54.95	49.49	39.59	29.69
	221428CL	Mean Well	U65S105-P2JU	80	+12/6.7	95-264@47-63	2.1mm x 5.5mm F 2	Yes	Black	6.6 x 3.1 x 1.8	6/6'	2.0	UL/CUL/TUV/CE	64.95	55.29	49.95	47.49
	221479CL	Mean Well	SPU50-4U	80	+15/4.0	90-264@47-63	2.1mm x 5.5mm F 2	Yes	Black	5.7 x 3.0 x 1.7	6/6'	2.0	UL/CUL/TUV/CE	38.49	34.65	31.19	28.09
	221436CL	Mean Well	U65S106-P2JU	80	+15/5.33	95-264@47-63	2.1mm x 5.5mm F 2	Yes	Black	6.6 x 3.1 x 1.8	6/6'	2.0	UL/CUL/TUV/CE	64.95	55.29	49.95	47.49
	221444CL	Mean Well	U65S107-P2JU	80	+18/4.4	95-264@47-63	2.1mm x 5.5mm F 2	Yes	Black	6.6 x 3.1 x 1.8	6/6'	2.0	UL/CUL/TUV/CE	64.95	55.29	49.95	47.49
	161605CL	Mean Well	SPU50-6U	60	+24/2.5	100-240@47-63	2.1mm x 5.5mm F 2	Yes	Black	5.6 x 2.9 x 1.6	19/6'	1.3	UL/CSA/TUV	44.95	39.95	35.95	32.95
	221452CL	Mean Well	U65S108-P2JU	80	+24/3.3	95-264@47-63	2.1mm x 5.5mm F 2	Yes	Black	6.6 x 3.1 x 1.8	6/6'	2.0	UL/CUL/TUV/CE	64.95	55.29	49.95	47.49
172064CL	Mean Well	SPU50-9U	80	+48/1.25	100-240@47-63	2.1mm x 5.5mm F 2	Yes	Black	5.6 x 2.9 x 1.7	6/6'	1.3	UL/CSA/TUV	44.95	40.49	36.45	32.79	
221461CL	Mean Well	U65S111-P2JU	80	+48/1.7	95-264@47-63	2.1mm x 5.5mm F 2	Yes	Black	6.6 x 3.1 x 1.8	6/6'	2.0	UL/CUL/TUV/CE	64.95	55.29	49.95	47.49	

* See accessory table-top power cord chart on page 142 when AC cord needed; refer to 1, 2 or 3 in Cord (DC/AC) column above for correct power cord
▲ Manufacturer and Manufacturer Cross Reference Number may vary except for Mean Well, Phihong, Jameco and GlobTek

Color Code Legend
New Sale Qty. Save Closeout

Order 24/7 Toll Free 1-800-831-4242

World Radio History

AC-to-DC Regulated Linear Table-Top Power Supplies

Color Code Legend
New Sale Qty Save Closeout

See page 150 for International Power Cords

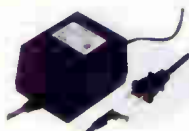

DIN M



Molex

Polarity 1 \oplus \ominus (center negative)



Female



Male

Polarity 2 \ominus \oplus (center positive)

Now Lower Prices

Quantity **SAVE**

Stripped

Power	Part Number	Mfr. ▲	Mfr. Cross Ref. No. ▲	Output		Input VAC@Hz	Output Connector ID x OD/Polarity F = female; M = male	Pwr. Ind.	Color	Size (L" x W" x H")	Cords* (DC/AC)	Wt. (lbs.)	Agency Approvals	Pricing			
				Pwr (W)	Volts (VDC)/ Current (A)									1	10	50	100
2 Wire AC Input - Regulated Linear																	
5-25 Watts	211060CL	Pacific Data	DV-51AAT	5	+5/1	120@60	2.1mm x 5.5mm rt angle F 2	No	Black	3.4 x 2.7 x 2.2	6/6/6	1.7	UL/CSA	\$12.95	\$8.99	\$5.99	\$4.99
	116089CL	Atari	C070042	5	+5/1	115@60	7-pin DIN M	No	Black	3.4 x 2.7 x 2.3	6/6/6	1.6	UL	\$9.99	\$6.99	\$4.99	\$3.99
	174844CL	Jameco	DCR2410F12	24	+24/1	120@60	2.1mm x 5.5mm F 2	No	Black	4.4 x 3.0 x 2.5	6/6/6	2.6	—	16.95	15.25	12.19	9.15
	174852CL	Jameco	DCR2410F52	24	+24/1	120@60	2.5mm x 5.5mm F 2	No	Black	4.4 x 3.0 x 2.5	6/6/6	2.7	—	14.95	12.95	10.95	9.95
	240127CL	—	FW3698	24	+24/1	120@60	2.5mm x 5.5mm F 2	No	Black	4.0 x 3.0 x 2.7	6/6/7/2	2.5	—	14.79	13.29	11.99	9.95
103173CL	Jameco	JE9100	9	+5/0.6, ±12/0.25	120@50-60	5-pin DIN M	No	Black	4.8 x 3.1 x 2.5	6/6/6	2.3	UL/CSA	20.95	18.89	16.99	14.95	
3 Wire AC Input - Regulated Linear																	
5-20 Watts	203596CL	Elpac	WM150	15	+5/3	120@60	5-pin DIN M	No	Black	5.4 x 3.9 x 2.6	6/6/6	3.5	UL/CSA	\$9.15	\$6.99	\$4.99	\$3.99
	265295CL	—	T5121000/37	12.2	+5/1, ±12/0.3	120@60	6-pin mini DIN M	No	Black	4.5 x 3.0 x 2.5	6/6/6	2.6	UL/CSA	9.69	8.72	6.98	5.23
	155651CL	Globtek	TR2V100MD8	12.2	+5/1, ±12/0.3	120@60	8-pin mini DIN M	No	Black	4.5 x 3.0 x 2.5	6/6/6	2.6	UL	9.69	8.72	6.98	5.23
	154624CL	Motorola	5712-305-4C3E	5.6	+5/0.5, ±12/0.13	120@60	8-pin mini DIN M	No	Black	2.9 x 2.6 x 1.9	6/6/2	1.2	UL/CSA	12.95	10.39	7.79	5.45
	243088CL	Regal	RJM-551228	17.4	+5/0.9, ±12/0.62, -5/0.2, -28/0.16	120@60	6-pin DIN M	No	Black	5.9 x 3.6 x 2.6	6/6/6	3.4	UL/CUL	16.95	15.25	13.75	12.35

† Wall-Mount * See accessory table-top power cord chart below when AC cord needed; refer to 1, 2 or 3 in Cord (DC/AC) column above for correct power cord
 ▲ Manufacturer and Manufacturer Cross Reference Number may vary except for Mean Well, Phihong, Jameco, and GlobTek

AC-to-DC Unregulated Linear Table-Top Power Supplies

SALE

Now Lower Prices

Quantity **SAVE**

Power	Part Number	Mfr. ▲	Mfr. Cross Ref. No. ▲	Output		Input VAC@Hz	Output Connector ID x OD/Polarity F = female; M = male	Pwr. Ind.	Color	Size (L" x W" x H")	Length Cords (DC/AC)	Wt. (lbs.)	Agency Approvals	Pricing			
				Pwr (W)	Volts (VDC)/ Current (A)									1	10	50	100
2-Wire AC Input - Unregulated																	
10-30 Watts	190051CL	APS	APS48EA114	10	+7/1.5	120@60	2.5mm x 5.5mm female 2	No	Black	3.4 x 2.3 x 1.9	6/6/6	1.9	UL/CUL	\$9.95	\$8.99	\$7.19	\$5.39
	243109CL	Regal	JK-91001-N	9	+9/1.0	120@60	Stripped & Tinned	No	Black	3.3 x 2.2 x 1.9	6/6/6	1.2	UL/CSA	17.95	16.99	12.95	9.95
	203182CL	Brother	A71222D	25	+11.5/2.2	120@60	2.1mm x 5.5mm female 1	No	Black	4.1 x 2.8 x 2.2	6/6/6	2.0	UL/CSA	\$12.95	11.95	10.75	9.95
	136565CL	Jameco	DDC1210P	12	+12/1.0	120@60	Stripped & Tinned	No	Black	3.2 x 2.2 x 1.9	6/6/6	1.2	—	13.95	12.59	11.39	10.19
	140880CL	Jameco	DC1215ST	18	+12/1.5	120@60	Stripped & Tinned	No	Black	3.1 x 2.1 x 1.9	6/6/6	1.5	UL	12.95	11.66	10.49	9.44
	143714CL	—	DC1220F1	24	+12/2.0	120@60	2.1mm x 5.5mm female 2	No	Black	3.8 x 2.8 x 2.3	6/6/6	2.2	—	14.95	13.49	12.19	10.99
	143722CL	Jameco	DC1220F5	24	+12/2.0	120@60	2.5mm x 5.5mm female 2	No	Black	3.8 x 2.8 x 2.3	6/6/6	2.2	—	12.95	11.69	10.55	9.49
	143731CL	—	DC1220M3	24	+12/2.0	120@60	3.5mm M 2	No	Black	3.8 x 2.8 x 2.3	6/6/6	1.9	—	12.95	11.49	9.39	6.99
	220919CL	Jameco	EFU135170	23	+13.5/1.7	120@60	2.1mm x 5.5mm F 1	No	Black	3.4 x 2.7 x 2.1	6/6/6	1.8	UL/CUL	\$12.49	11.99	10.99	9.99
	139096CL	Jameco	DC2412F1	29	+24/1.2	120@60	2.1mm x 5.5mm female 2	No	Black	4.4 x 3.1 x 2.6	6/6/6	2.5	—	14.95	13.49	12.15	10.95
173665CL	Skyнет	DND-3005	15	+30/0.5	120-127@60	2.5mm x 5.5mm F 2	No	Black	3.0 x 2.5 x 2.2	5/9/3/2	1.4	UL/CUL	13.29	11.99	9.59	7.24	
205920CL	Skyнет	DND-3012	30	+30/1.0	120-127@50-60	2.5mm x 5.5mm female 2	No	Black	4.0 x 2.9 x 2.5	6/6/6	1.7	UL/CUL	\$9.95	8.95	7.95	6.95	
3 Wire AC Input Unregulated																	
15 Watts	157956CL	Everglow	EFU120150	18	+12/1.5	120@60	2.5mm x 5.5mm female 2	No	Black	3.4 x 2.7 x 2.2	6/6/6	2.0	UL	\$10.95	\$9.86	\$7.88	\$5.91
	196306CL	—	A51813D	23	+18/1.3	120@60	2.5mm x 5.5mm female 2	No	Black	3.6 x 2.4 x 2.0	6/6/6	1.8	UL/CSA	12.95	11.69	9.34	7.04

▲ Manufacturer and Manufacturer Cross Reference Number may vary except for Mean Well, Phihong, Jameco, and GlobTek



Quantity **SAVE**

Accessory Power Input Cords for Regulated Table-Top Power Supplies

Now Lower Prices



Part No.	Ref. No.**	Description	Color	AWG	Certification	Cord Length	Wt. (lbs.)	Cord Type	1	10	100	250
38041CL	1	3-conductor power cord	Beige	18/3	UL/CSA	6'	0.4	SVT	\$3.49	\$3.15	\$2.79	\$2.49
38050CL	2	3-conductor power cord	Black	18/3	UL/CSA	6'	0.4	SVT	3.75	3.25	2.99	2.05
189587CL	3	2-conductor power cord	Black	18/2	UL/CSA	6'	0.3	SPT	3.95	3.49	3.19	2.99

For Additional Power Cords See Page 69.

GlobTek®

AC-to-DC Medical Table-Top Switching Power Supplies

- Input voltage: 90-264VAC @ 47-63Hz
- 3-wire AC input
- Leakage current: 0.1mA maximum
- Isolation voltage: 4,000VAC
- Regulation (line & load): ±5%
- Ripple and noise: 1% or 100mV, whichever is smaller
- 2.5mm x 5.5mm female center positive
- Cord length (DC/AC): 6' / use P/N 38050CL
- Size: 2.9"L x 2.0"W x 1.6"H
- UL/CUL/TUV/CE approved for medical applications



Part Number	Product Number	Power (W)	Output Volts (VDC)/Current (A)	Pricing			
				1	10	50	100
230658CL	TR9CA2600CP	13.0	+5/2.6	\$32.95	\$29.65	\$26.69	\$23.99
230682CL	TR9CE1250CP	15.6	+12/1.3	32.95	29.65	26.69	23.99
230691CL	TR9CG1200CP	18.0	+15/1.2	32.95	29.65	26.69	23.99
230711CL	TR9CI750CP	16.8	+24/0.7	32.95	29.65	26.69	23.99
230738CL	TR9CA6000LCP	30.0	+5/6.0	52.95	47.65	42.89	38.59
230762CL	TR9CE4000LCP	49.2	+12/4.0	52.95	47.65	42.89	38.59
230771CL	TR9CG3333LCP	49.5	+15/3.3	52.95	47.65	42.89	38.59
230797CL	TR9CI2100LCP	50.4	+24/2.1	52.95	47.65	42.89	38.59

GlobTek®

AC-to-DC Medical Regulated Switching Wall Adapters

- Input voltage: 100/240VAC @ 47-63Hz
- 3-prong input plug
- Leakage current: 0.1mA maximum
- Isolation voltage: 4,000VAC
- Regulation (line & load): ±5%
- Ripple and noise: 1% or 100mV, whichever is smaller
- 2.5mm x 5.5mm female center positive
- Output cord length: 6'
- Size: 2.9"H x 1.9"W x 1.6"D
- Agency approval: UL/CUL/TUV/CE approved for medical applications



Part Number	Product Number	Power (W)	Output Volts (VDC)/Current (A)	Pricing			
				1	10	50	100
230818CL	WR92A2600LCP	13.0	+5@2.6	\$32.95	\$29.65	\$26.69	\$23.99
230842CL	WR92E1250LCP	15.6	+12@1.3	32.95	29.65	26.69	23.99
230851CL	WR92G1200LCP	18.0	+15@1.2	32.95	29.65	26.69	23.99
230877CL	WR92I750LCP	16.8	+24@0.75	32.95	29.65	26.69	23.99

For Open-Frame Medical Power Supplies see page 124.

AC-to-DC Regulated Wall Adapters

Interchangeable Plug Wall Adapters

- Field changeable AC Plugs (sold separately, see below)
- Power-On LED
- Input voltage: 90-264VAC@47-63Hz
- Output connector: 2.1mm x 5.5mm female center positive

- Regulated output
- Double Insulated
- Class B EMI



4 to 5-Watt Wall Adapters (Plug clip required, see below)

- Applications: PDAs, digital cameras, MPEG players, personal electronics
- Dimensions: 2.8"L x 1.8"W x 1.2"H

- Efficiency: 60% min.
- Weight: 0.3 lbs.



Part No.	Manufacturer	Product No.	Power (W)	Output Voltage (VDC)	Current (A)	Ripple (mVp-p)	Line Regulation	Load Regulation	Pricing			
									1	5	25	100
228734CL	Phihong	PSA05R-033	4.0	3.3	1.2	50	±1%	±5%	\$16.95	\$15.25	\$13.75	\$12.35
228742CL	Phihong	PSA05R-050	5.0	5.0	1.0	50	±1%	±5%	16.95	15.25	13.75	12.35
228751CL	Phihong	PSA05R-090	5.0	9.0	0.56	90	±1%	±5%	16.95	15.25	13.75	12.35
228769CL	Phihong	PSA05R-120	5.0	12.0	0.42	120	±1%	±5%	16.95	15.25	13.75	12.35

6 to 10-Watt Wall Adapters (Plug clip required, see below)

- Applications: wireless communications, portable equipment, digital camera, peripherals, networking
- Dimensions: 3.4"L x 2.1"W x 1.4"H

- Efficiency: 65% typical



Part No.	Manufacturer	Product No.	Power (W)	Output Voltage (VDC)	Current (A)	Ripple (mVp-p)	Line Regulation	Load Regulation	Pricing			
									1	5	25	100
228785CL	Phihong	PSA11R-033	6.6	3.3	2.0	50	±1%	±5%	\$17.95	\$16.15	\$14.55	\$13.09
228793CL	Phihong	PSA11R-050	10.0	5.0	2.0	50	±1%	±5%	17.95	16.15	14.55	13.09
228806CL	Phihong	PSA11R-090	10.0	9.0	1.1	90	±1%	±5%	17.95	16.15	14.55	13.09
228814CL	Phihong	PSA11R-120	10.0	12.0	0.83	120	±1%	±5%	17.95	16.15	14.55	13.09
228822CL	Phihong	PSA11R-150	10.0	15.0	0.67	150	±1%	±5%	17.95	16.15	14.55	13.09
228777CL	Phihong	PSA11R-240	10.0	24.0	0.42	240	±1%	±5%	17.95	16.15	14.55	13.09

15 to 20-Watt Wall Adapters with LoadSense™ (Plug clip required, see below)

- Senses and controls the voltage out the connector, eliminating the effect of a voltage drop in the cable
- Applications: peripherals, portable equipment, gaming machines, point-of-sale equipment, network equipment
- Dimensions: 3.9"L x 2.5"W x 1.4"H

- Efficiency: 70% Typical



Part No.	Manufacturer	Product No.	Power (W)	Output Voltage (VDC)	Current (A)	Ripple (mVp-p)	Line Regulation	Load Regulation	Pricing			
									1	5	25	100
228831CL	Phihong	PSA21R-050	15.0	5.0	3.0	50	±1%	±2%	\$27.95	\$25.15	\$22.65	\$20.39
228849CL	Phihong	PSA21R-120	20.0	12.0	1.67	120	±1%	±2%	27.95	25.15	22.65	20.39
228857CL	Phihong	PSA21R-150	20.0	15.0	1.33	150	±1%	±2%	27.95	25.15	22.65	20.39
229745CL	Phihong	PSA21R-180	20.0	18.0	1.11	180	±1%	±2%	27.95	25.15	22.65	20.39
228873CL	Phihong	PSA21R-240	20.0	24.0	0.83	240	±1%	±2%	27.95	25.15	22.65	20.39

AC Plug Clips and Plug Clip Kits (sold separately, required for above adapters)

Part No.	Manufacturer	Product No.	Description	Pricing			
				1	10	50	100
229155CL	Phihong	RPA	USA Plug	\$.53	\$.51	\$.50	\$.49
229163CL	Phihong	RPE	European Plug	.61	.59	.58	.57
229171CL	Phihong	RPK	UK Plug	.99	.97	.94	.91
229180CL	Phihong	RPKIT	Kit w/ RPA/RPE/RPK/RPS (AUST)	2.65	2.39	2.32	2.25



AC-to-DC Regulated Wall Adapters

Color Code Legend
New Sale On-Line Closeout

We specialize in Wall Adapters - Call for additional OEM PRICING.



We will change any power plug (pg 152) on any DC wall adapter listed (100 pc. minimum).

Polarity 1 \oplus \ominus \ominus (center negative)

Polarity 2 \ominus \oplus \oplus (center positive)

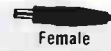

SALE

Quantity SAVE

Now Lower Prices

2 Wire AC Input - Linear Regulated

Part Number	Brand	Product Number	Output Rating		Output Connector ID x OD/Polarity F = female; M = male	Input VAC @ Hz	Size H" x W" x D"	Case Color	Output Cord Length	Weight (lbs.)	Agency Approvals	Pricing			
			Voltage (VDC)	Current (mA)								1	10	50	100
236435CL	APX	AP2814	5	300	1.3mm x 3.5mm right angle F 2	120@60	2.9 x 1.9 x 1.6	Black	6'	0.6	UL/CSA	\$ 8.95	\$ 7.16	\$ 5.72	\$ 4.25
164101CL	Jameco	DCR505F12	5	500	2.1mm x 5.5mm F 2	120@60	2.8 x 2.0 x 1.6	Black	6'	0.6	UL/CSA	9.95	8.96	8.06	7.25
220935CL	Jameco	DDU050060	5	600	2.1mm x 5.5mm F 1	120@60	2.7 x 2.2 x 1.9	Black	6'	0.8	UL/CUL	\$13.25	\$ 9.25	\$ 7.00	\$ 5.50
171301CL	Imitation	JOD48U08	5	1000	2.1mm x 5.5mm F 2	120@60	3.1 x 2.9 x 2.0	Black	6'	1.0	UL/CUL	10.95	9.89	8.89	7.99
196411CL	Jameco	DCR510F12V	5	1000	2.1mm x 5.5mm F 2	120@60	3.3 x 2.2 x 1.9	Ivory	6'	1.0	UL/CUL	10.95	9.86	7.88	5.81
168604CL	ITE Power Supply	RWP480505	5	1000	2.5mm x 5.5mm F 2	120@60	3.3 x 2.2 x 1.9	Black	6'	1.2	UL/CSA	11.39	10.49	9.65	8.29
228726CL	ORB	777-052000S-UF	5	2000	2.1mm x 5.5mm F 2	100@50-60	3.1 x 2.1 x 1.5	Black	5'	0.5	UL/CUL	12.95	10.35	7.79	5.49
248743CL	MEI	EPA-101M-05A	5	2500	2.1mm x 2.5mm F 2	120@60	3.2 x 2.4 x 1.4	Black	6'	0.5	UL/CUL	15.49	12.15	8.75	7.20
190511CL	Salom Electric	SADB-085A	6	200	2.1mm x 5.5mm F 2	115@60	2.6 x 1.8 x 1.5	Black	6'	0.4	UL/CUL	6.95	6.26	5.44	4.06
190529CL	NOMA	AD9123	9	250	2.5mm x 5.5mm right angle F 2	120@60	2.5 x 2.0 x 1.6	Black	12'	0.5	UL/CSA	6.49	5.84	4.67	3.50
220898CL	Jameco	DCU120020	12	200	2.1mm x 5.5mm F 1	120@60	2.5 x 2.0 x 1.7	Black	6'	0.5	UL/CUL	7.85	7.29	6.85	6.45
162996CL	Jameco	DCR1205F12	12	500	2.1mm x 5.5mm F 2	120@60	3.2 x 2.2 x 1.9	Black	6'	0.9	UL/CUL	9.95	8.96	8.06	7.25
170245CL	Jameco	DCR1210F12	12	1000	2.1mm x 5.5mm F 2	120@60	3.2 x 2.3 x 2.0	Black	6'	1.2	UL/CUL	13.95	12.59	11.35	10.19
174861CL	Jameco	DCR2405F12	24	500	2.1mm x 5.5mm F 2	120@60	3.4 x 2.7 x 2.2	Black	6'	1.3	UL/CUL	11.95	10.79	9.69	8.75
174879CL	Jameco	DCR2405F52	24	500	2.5mm x 5.5mm F 2	120@60	3.4 x 2.7 x 2.2	Black	6'	1.3	—	11.95	10.79	9.69	8.75

2 Wire AC Input - Switching Regulated

Part Number	Brand	Product Number	Output Rating		Output Connector ID x OD/Polarity F = female; M = male	Input VAC @ Hz	Size H" x W" x D"	Case Color	Output Cord Length	Weight (lbs.)	Agency Approvals	Pricing			
			Voltage (VDC)	Current (mA)								1	10	50	100
230543CL	Phihong	PSA05A-050	5	1000	2.1mm x 5.5mm F 2	90-264@47-63	2.4 x 1.8 x 1.0	Black	6'	0.4	UL/CUL	\$16.39	\$14.75	\$13.29	\$13.29
225995CL	Delta Electronics	ADP-5DB	5	1000	2.5mm x 5.5mm F 2	100-120@50-60	2.5 x 1.8 x 1.1	Black	6'	0.2	UL	10.95	9.95	7.89	5.84
216442CL	AK II Power Supply	A05C1-05MP	5	1600	2.5mm x 5.5mm F 2	100-240@50-60	2.2 x 1.8 x 1.1	Black	6'	0.4	UL/CUL/CE	12.95	11.65	10.49	9.49
228881CL	Phihong	PSC10A-050	5	2000	2.1mm x 5.5mm F 2	90-132@57-63	2.9 x 1.9 x 1.4	Black	6'	0.4	UL/CUL	12.79	11.99	10.89	10.49
189190CL	Interex	EPA101MU-05B	5	2000	2.5mm x 5.5mm F 1	100-240@50-60	3.2 x 2.8 x 1.3	Black	6'	0.4	UL/CUL	12.95	10.25	7.75	5.45
210892CL	Interex	EPA101MU	5	2000	2.5mm x 5.5mm F 2	100-240@50-60	3.2 x 2.4 x 1.3	Black	6'	0.4	UL/CUL	12.95	11.69	9.35	6.99
236751CL	GlobTek	WR92A2600CCP†	5	2600	2.1mm x 5.5mm F 2	100-240@50-60	2.9 x 1.9 x 1.6	Black	6'	0.5	UL/CUL/TUV/CE	13.49	12.15	10.95	9.85
228937CL	Phihong	PSC15A-050	5	3000	2.1mm x 5.5mm F 2	90-132@57-63	2.9 x 1.9 x 1.4	Black	6'	0.4	UL/CUL	13.35	12.29	11.26	10.95
228890CL	Phihong	PSC10A-090	9	1100	2.1mm x 5.5mm F 2	90-132@57-63	2.9 x 1.9 x 1.4	Black	6'	0.4	UL/CUL	12.79	11.89	10.89	10.49
228945CL	Phihong	PSC15A-090	9	1600	2.1mm x 5.5mm F 2	90-132@57-63	2.9 x 1.9 x 1.4	Black	6'	0.4	UL/CUL	13.35	12.29	11.26	10.95
227782CL	Mean Well	KWM020-09B	9	1670	2.1mm x 5.5mm F 2	90-264@47-63	1.6 x 2.0 x 2.9	Black	6'	0.4	UL/CSA	13.35	12.29	11.26	9.89
230551CL	Phihong	PSA05A-120	12	420	2.1mm x 5.5mm F 2	90-264@47-63	2.4 x 1.8 x 1.0	Black	6'	0.4	UL/CUL	16.39	14.75	13.29	13.29
229753CL	Phihong	PSC10A-120	12	830	2.1mm x 5.5mm F 2	90-132@57-63	2.9 x 1.9 x 1.4	Black	6'	0.4	UL/CUL	12.95	11.89	10.99	10.59
228953CL	Phihong	PSC15A-120	12	1250	2.1mm x 5.5mm F 2	90-132@57-63	2.9 x 1.9 x 1.4	Black	6'	0.4	UL/CUL	13.35	12.29	11.26	10.95
220687CL	Mean Well	L15D12B-P1J	12	1250	2.1mm x 5.5mm F 2	90-264@50-60	3.1 x 2.2 x 1.2	Black	6'	0.4	UL/CSA/TUV	13.55	12.29	11.35	9.89
249076CL	Mean Well	G15U-3P2L	12	1250	2.5mm x 5.5mm F 2	100-240@50-60	3.1 x 2.1 x 1.4	Black	6'	0.4	UL/CUL/CE	14.95	13.49	12.15	10.95
249244CL	Horizon	DFU1250/G9760	12	1500	2.1mm x 5.5mm F 2	108-132@50-60	3.3 x 2.7 x 2.2	Black	6'	0.4	UL/CUL	14.95	13.49	12.15	10.95
228911CL	Phihong	PSC10A-150	15	670	2.1mm x 5.5mm F 2	90-132@57-63	2.9 x 1.9 x 1.4	Black	6'	0.4	UL/CUL	12.95	11.89	10.99	10.59
224590CL	Mean Well	L15D15B-P1J	15	1000	2.1mm x 5.5mm F 2	90-240@50-60	3.2 x 2.2 x 1.3	Black	6'	0.5	UL/CSA	13.55	12.29	11.35	9.89
228961CL	Phihong	PSC15A-150	15	1000	2.1mm x 5.5mm F 2	90-132@57-63	2.9 x 1.9 x 1.4	Black	6'	0.4	UL/CUL	13.35	12.29	11.26	10.95
168487CL	Mean Well	KWM020188	18	1000	2.1mm x 5.5mm F 2	100-240@50-60	2.9 x 1.9 x 1.6	Black	6'	0.4	UL/CUL	17.95	16.19	14.55	13.09
228929CL	Phihong	PSA10A-240	24	420	2.1mm x 5.5mm F 2	90-132@57-63	2.9 x 1.9 x 1.4	Black	6'	0.4	UL/CUL	12.95	11.89	10.99	10.59
228970CL	Phihong	PSC15A-240	24	620	2.1mm x 5.5mm F 2	90-132@57-63	2.9 x 1.9 x 1.4	Black	6'	0.4	UL/CUL	13.55	12.29	11.26	10.95

† 3-wire AC input

▲ Brand and Product Number may vary except for Mean Well, Phihong, GlobTek and Jameco

AC-to-DC Unregulated Wall Adapters

We will change any power plug (pg 152) on any DC wall adapter listed (100 pc. minimum).

Now Lower Prices

Quantity SAVE

• Input: 120VAC @ 60Hz

Polarity 1 \oplus \ominus \ominus (center negative)



Polarity 2 \ominus \oplus \oplus (center positive)



2-Wire AC Input - Unregulated

Part Number	Brand	Product Number	Output Rating		Output Connector ID x OD/Polarity F = female; M = male	Size H" x W" x D"	Case Color	Output Cord Length	Weight (lbs.)	Agency Approvals	Pricing			
			Voltage (VDC)	Current (mA)							1	10	50	100
237227CL	Freeplay	DX351307	4.5	100	1.3mm x 3.5mm F 2	2.4 x 1.7 x 1.4	Black	6'	0.4	UL/CSA	\$4.49	\$4.04	\$3.23	\$2.42
243070CL	Regal	WH045300-10N	4.5	300	2.1mm x 5.5mm F 1	2.2 x 1.7 x 1.5	Black	6'	0.4	UL/CSA	6.95	6.26	5.00	3.75
112070CL	Jameco	DC502F5	5	225	2.5mm x 5.5mm F 2	1.9 x 2.2 x 2.0	Black	7'	0.3	UL/CSA	7.29	6.59	5.95	5.35
155601CL	Jameco	DC510F1	5	1000	2.1mm x 5.5mm F 2	2.6 x 2.0 x 1.7	Black	6'	0.7	UL/CSA	5.19	4.67	4.20	3.78
219651CL	—	FE4823-050E120	5	1200	2.5mm x 5.5mm F 2	3.5 x 2.4 x 1.9	Black	6'	1.2	UL/CUL	5.16	4.76	3.81	2.86

▲ Brand and Product Number may vary except for Mean Well, Phihong, GlobTek and Jameco

AC-to-DC Wall Adapters continued on pages 145 - 147

AC-to-DC Unregulated Wall Adapters (Continued)

We specialize in Wall Adapters - Call for additional OEM PRICING.
We will change any power plug (pg 152) on any DC wall adapter listed (100 pc. minimum).

• Input: 120VAC @ 60Hz

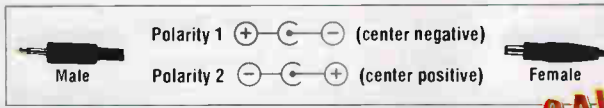

227951CL

Quantity
SAVE

227774CL

237067CL

New Lower Prices

169519CL

2-Wire AC Input - Unregulated

Part Number	Brand▲	Product Number▲	Output Rating		Output Connector ID x DD/Polarity F = female; M = male	Size H" x W" x D"	Case Color	Output Cord Length	Weight (lbs.)	Agency Approvals	Pricing			
			Voltage (VDC)	Current (mA)							1	10	50	100
237251CL	Freeplay	DPX350817	6	100	2.1mm x 5.5mm F 2	2.4 x 1.7 x 1.4	Black	6'	0.4	UL/CSA	\$1.85	\$3.38	\$1.85	\$3.38
243117CL	Regal	WH060200-10N	6	200	2.5mm x 5.5mm F 1	2.2 x 1.7 x 1.5	Black	6'	0.4	UL/CSA	1.85	3.38	1.85	3.38
119255CL	Jameco	DC605F11	6	500	2.1mm x 5.5mm F 1	2.3 x 1.8 x 1.8	Black	6'	0.6	UL/CUL	4.29	3.86	3.47	3.13
101266CL	Jameco	DC605F12	6	500	2.1mm x 5.5mm F 2	2.4 x 1.9 x 1.6	Black	6'	0.4	UL/CSA	4.29	3.86	3.47	3.13
15544CL	Jameco	DC605M3	6	500	3.5mm M 2	2.4 x 1.9 x 1.6	Black	6'	0.4	UL/CSA	4.29	3.86	3.47	3.13
201451CL	APX Technologies	AP4733	6	700	2.1mm x 5.5mm F 2	2.6 x 1.9 x 1.4	Black	6'	0.5	UL/CUL	4.95	4.49	4.05	3.65
147707CL	Jameco	DC608F1	6	800	2.1mm x 5.5mm F 2	2.3 x 2.0 x 1.6	Black	6'	0.6	UL/CSA	4.95	4.49	4.05	3.65
220943CL	Jameco	DCU060120	6	1200	2.1mm x 5.5mm F 1	2.5 x 2.0 x 1.7	Black	6'	0.7	UL/CUL	7.85	7.25	6.59	6.25
227951CL	—	JOD-48U-33	6	2100	2.1mm x 5.5mm F 2	3.3 x 2.2 x 1.9	Black	6'	1.3	UL/CUL	7.95	7.15	6.45	5.79
220951CL	Jameco	DCU075100	7.5	1000	2.1mm x 5.5mm F 1	2.5 x 2.0 x 1.7	Black	6'	0.6	UL/CUL	9.19	8.59	7.55	7.19
248751CL	Uniq	AD-071A	7.5	1000	2.5mm x 5.5mm F 2	2.3 x 2.3 x 1.9	Black	6'	0.9	UL/CSA	3.89	3.50	2.80	2.10
249279CL	AESP	FO-AC-4305	7.5	1000	2.1mm x 5.5mm right angle F 2	3.2 x 2.0 x 1.7	Black	6'	0.8	UL/CUL	6.95	6.25	5.65	5.09
196761CL	Voltek	8233	7.5	1100	2.1mm x 5.5mm F 2	2.1 x 1.9 x 1.0	Black	6'	0.2	UL/CSA	6.95	6.25	5.65	5.09
230623CL	—	MKD-48752100	7.5	2100	2.1mm x 5.5mm F 2	3.3 x 2.2 x 1.9	Black	6'	1.3	UL/CUL	7.95	7.15	6.45	5.79
127511CL	Jameco	DC810F1	8	1000	2.1mm x 5.5mm F 2	3.1 x 2.5 x 2.1	Black	6'	1.3	UL	7.95	7.19	6.45	5.85
134025CL	Jameco	DC902F11	9	200	2.1mm x 5.5mm F 1	2.1 x 1.7 x 1.6	Black	6'	0.4	UL/CSA	4.95	4.49	3.95	3.59
100845CL	Jameco	DC902F12	9	200	2.1mm x 5.5mm F 2	2.1 x 1.7 x 1.5	Black	6'	0.4	UL/CSA	3.95	3.59	2.89	2.15
237243CL	Freeplay	DPX351322	9	200	2.1mm x 5.5mm F 2	2.4 x 1.7 x 1.4	Black	6'	0.4	UL/CSA	3.95	3.59	3.25	2.95
100837CL	Jameco	DIA3590	9	200	3.5mm M 2	2.6 x 1.8 x 1.6	Black	6'	0.4	UL/CSA	3.95	3.59	3.25	2.95
191767CL	—	CTPS350903002C0	9	300	1.3mm x 3.5mm right angle F 2	2.3 x 1.8 x 1.5	Black	6'	0.4	UL/CSA	4.19	3.77	3.02	2.26
133891CL	—	DC903F1	9	300	2.1mm x 5.5mm F 2	2.0 x 1.5 x 1.5	Black	6'	0.4	UL/CSA	3.95	3.59	2.85	2.15
189237CL	ACI World	35-9-300C	9	300	2.5mm x 5.5mm F 2	2.2 x 1.7 x 1.4	Black	6'	0.4	UL/CSA	4.25	3.59	2.95	2.35
216469CL	Everglow	D350900300U	9	300	2.5mm x 5.5mm F 1	2.4 x 1.7 x 1.7	Black	6'	0.4	UL/CUL	\$3.95	3.59	2.95	2.35
169519CL	Panasonic	KX-TCA1	9	350	2.1mm x 5.5mm right angle F 1	2.7 x 1.7 x 1.6	Dk. Gray	6'	0.4	UL/CSA	3.89	3.50	2.80	2.10
202155CL	Jameco	DC9035F12	9	350	2.1mm x 5.5mm F 2	3.2 x 2.4 x 2.0	Black	6'	0.3	UL/CUL	3.29	2.96	2.66	2.40
140636CL	Jameco	DC904F5	9	400	2.5mm x 5.5mm F 2	2.6 x 2.0 x 2.0	Black	6'	0.6	UL/CSA	4.19	3.79	3.39	3.05
202171CL	Jameco	DC9045F12	9	450	2.1mm x 5.5mm F 2	3.3 x 2.9 x 2.3	Black	6'	0.5	UL/CUL	3.95	3.59	3.25	2.89
163627CL	Jameco	DC905F11	9	500	2.1mm x 5.5mm F 1	2.5 x 1.9 x 1.7	Black	6'	0.6	UL/CSA	5.49	4.95	4.45	3.95
170270CL	Panasonic	POLV1	9	500	2.1mm x 5.5mm right angle F 1	2.7 x 1.9 x 1.8	Gray	6'	0.6	UL/CSA	4.49	4.04	3.64	3.27
100853CL	Jameco	DC905F12	9	500	2.1mm x 5.5mm F 2	2.5 x 1.9 x 1.7	Black	6'	0.6	UL/CSA	4.95	4.46	4.01	3.61
147731CL	Global Village	43-1125	9	500	2.1mm x 5.5mm F 2	2.6 x 2.0 x 1.7	Beige	6'	0.6	UL/CSA	\$5.99	5.79	5.21	4.69
236937CL	Horizon	DCU090050A	9	500	2.5mm x 5.5mm right angle F 2	2.5 x 2.0 x 1.7	Black	6'	0.4	UL/CSA	5.79	5.21	4.69	4.22
15561CL	—	DC905M3	9	500	3.5mm M 2	2.5 x 2.0 x 1.6	Black	6'	0.5	UL/CSA	4.85	4.36	3.93	3.54
202180CL	Jameco	DC906F12	9	600	2.1mm x 5.5mm F 2	3.3 x 2.9 x 2.3	Black	6'	0.6	UL/CUL	4.89	4.05	3.49	2.65
100175CL	Jameco	DC906F5	9	600	2.5mm x 5.5mm F 2	2.5 x 1.9 x 1.8	Black	6'	0.6	UL/CSA	5.49	4.75	4.25	3.95
202198CL	Jameco	DC908F12	9	800	2.1mm x 5.5mm F 2	3.3 x 2.9 x 2.3	Black	6'	0.6	UL/CUL	6.95	6.29	5.25	3.69
164929CL	CUI Stack	48-9-900D	9	900	2.1mm x 5.5mm F 1	2.7 x 2.3 x 1.8	Black	6'	0.9	UL/CUL	7.95	7.15	5.75	4.29
100888CL	Everglow	DDU090100	9	1000	2.1mm x 5.5mm F 2	2.6 x 2.4 x 2.0	Black	6'	1.0	UL/CSA	7.95	7.19	6.45	5.79
227774CL	GTE	ADP2108GT	9	1000	2.1mm x 5.5mm right angle F 2	2.5 x 2.2 x 1.9	Black	6'	0.9	UL/CUL	7.95	7.15	6.45	5.79
127503CL	Atari	DC910F5	9	1000	2.5mm x 5.5mm F 2	2.6 x 2.4 x 2.0	Black	6'	0.9	UL/CSA	7.49	6.75	5.39	4.05
15587CL	Atari	PAG1200	9	1000	3.5mm M 2	2.6 x 2.4 x 2.0	Black	6'	0.9	UL/CSA	7.95	7.19	5.75	4.29
130526CL	Jaguar	DC912F11	9	1200	2.1mm x 5.5mm F 1	2.4 x 2.0 x 1.8	Black	6'	1.0	UL/CSA	8.95	8.09	7.29	6.59
143693CL	Jameco	DC915F1	9	1500	2.1mm x 5.5mm F 2	3.3 x 2.5 x 2.3	Black	6'	1.3	UL/CSA	9.95	8.95	6.95	5.19
237067CL	APS	D9-15-950	9	1500	2.5mm x 5.5mm F 2	3.1 x 2.3 x 1.9	Black	6'	1.3	UL/CUL	9.95	8.99	7.19	5.39
163993CL	Jameco	DC1202F11R	12	200	2.1mm x 5.5mm right angle F 1	2.4 x 1.7 x 1.6	Black	6'	0.4	UL/CSA	4.79	4.31	3.88	3.49
100095CL	Jameco	DC1202F1	12	200	2.1mm x 5.5mm F 2	2.1 x 1.8 x 1.5	Black	6'	0.4	UL/CSA	3.95	3.49	3.06	2.75
237235CL	Freeplay	DPX351326	12	200	2.1mm x 5.5mm F 2	2.4 x 1.7 x 1.4	Black	6'	0.4	UL/CSA	3.79	3.49	3.15	2.85
158043CL	Jameco	DC1202F12R	12	200	2.1mm x 5.5mm right angle F 2	2.2 x 1.7 x 1.5	Black	6'	0.4	UL/CSA	4.49	4.04	3.64	3.27
220433CL	Jameco	DBU120020	12	200	2.5mm x 5.5mm right angle F 2	2.2 x 1.7 x 1.5	Lt. Gray	6'	0.4	UL/CSA	4.39	3.95	3.59	3.21
185658CL	—	DV1220DCB	12	200	2.5mm x 5.5mm right angle F 2	2.2 x 1.7 x 1.5	Black	6'	0.4	UL/CSA	4.79	4.31	3.86	2.94
211238CL	Quotrek	35D-12-250	12	250	2.5mm right angle M 2	2.2 x 1.7 x 1.5	Black	6'	0.4	UL/CSA	3.95	3.55	3.25	2.85
219601CL	Jameco	DCU120025	12	250	Stripped & tinned	2.5 x 2.0 x 1.7	Dk. Gray	6'	0.4	UL/CUL	3.95	3.55	3.25	2.85
163491CL	—	AD1230	12	300	Connector end may vary	2.2 x 2.2 x 1.6	Black	6'	0.5	UL/CSA	4.29	3.89	3.49	3.09
201099CL	—	SPN4230A	12	300	1.3mm x 3.5mm right angle F 2	2.3 x 2.0 x 1.7	Black	6'	0.5	UL/CSA	4.99	4.49	3.59	2.69
127976CL	Xircom	DC1203F12	12	300	2.1mm x 5.5mm F 2	2.6 x 1.8 x 1.6	Black	6'	0.7	UL/CSA	4.75	4.25	3.45	2.59
249236CL	Horizon	DBU120030G8970	12	300	2.5mm x 5.5mm right angle F 2	2.2 x 1.7 x 1.5	Black	6'	0.5	UL/CUL	4.85	3.85	3.39	3.09

▲ Brand and Product Number may vary except for Mean Well, Pihong, Globek and Jameco

More AC-to-DC Wall Adapters listed on pages 144 - 147



Order 24/7 Toll Free 1-800-831-4242

World Radio History

AC-to-DC Unregulated Wall Adapters (Continued)

Color Code Legend
New Sale Qty Save Closeout

We specialize in Wall Adapters - Call for additional OEM PRICING.
 We will change any power plug (pg 152) on any DC wall adapter listed (100 pc. minimum).

• Input: 120VAC @ 60Hz



Now Lower Prices

SALE

Quantity SAVE

2-Wire AC Input - Unregulated

Part Number	Brand	Product Number	Output Rating		Output Connector ID x OD/Polarity F = female; M = male	Size H" x W" x D"	Case Color	Output Cord Length	Weight (lbs.)	Agency Approvals	Pricing			
			Voltage (VDC)	Current (mA)							1	10	50	100
190502CL	Lucent Tech.	DV114ODC	12	400	2.1mm x 5.5mm right angle F 2	2.6 x 2.1 x 1.9	Black	6'	0.5	UL/CUL	\$ 8.95	\$ 10.2	\$ 11.5	\$ 12.8
114825CL	Jameco	DC1205ST	12	500	Connector end may vary	2.5 x 2.0 x 1.7	Black	6'	0.6	CUL	4.75	4.35	3.45	2.59
15368CL	Jameco	DC1205F11	12	500	2.1mm x 5.5mm F 1	2.5 x 1.9 x 1.6	Black	6'	0.6	UL/CSA	6.49	5.85	5.29	4.75
102496CL	ITE Power Supply	DC1205F12	12	500	2.1mm x 5.5mm F 2	2.5 x 1.9 x 1.6	Black	6'	0.6	UL/CSA	4.99	4.49	3.99	3.49
131300CL	Jameco	SCP41	12	500	2.1mm x 5.5mm right angle F 2	2.6 x 1.9 x 1.7	Beige	6'	0.6	UL/CSA	5.49	4.94	4.45	4.00
200125CL	Noostuff Inc.	DV1250	12	500	2.5mm x 5.5mm F 1	2.4 x 2.0 x 1.6	Black	6'	1.0	UL/CSA	\$4.95 4.25	3.91	3.12	2.39
102277CL	Jameco	DC1205F5	12	500	2.5mm x 5.5mm F 2	2.5 x 2.1 x 1.7	Black	6'	0.6	UL/CSA	5.19	4.67	4.20	3.78
17267CL	Jameco	DC1205M3	12	500	3.5mm M 2	2.5 x 1.9 x 1.6	Black	6'	0.6	UL/CSA	5.19	4.67	4.20	3.78
202201CL	Jameco	DC1206F12	12	600	2.1mm x 5.5mm F 2	3.3 x 2.9 x 2.3	Black	6'	0.6	UL/CUL	4.95	4.45	3.55	2.69
202219CL	Jameco	DC120F12	12	700	2.1mm x 5.5mm F 2	3.3 x 2.9 x 2.3	Black	6'	0.6	UL/CUL	5.19	4.67	4.20	3.78
117479CL	Jameco	DC1208F1	12	800	2.1mm x 5.5mm F 2	3.0 x 2.3 x 2.0	Black	6'	0.9	UL/CSA	6.95	6.29	5.65	5.09
129331CL	Jameco	48-12-800	12	800	2.5mm x 5.5mm F 2	3.0 x 2.3 x 2.0	Black	6'	0.9	UL/CSA	5.49	4.95	4.45	4.05
237358CL	QSE	P155-D150567	12	800	2.5mm x 5.5mm F 2	3.0 x 2.3 x 1.9	Black	6'	0.9	UL	5.19	4.67	4.20	3.78
211051CL	Calrad	DV-1280 Dual	12	800	2.5mm x 5.5mm rt angle F 2 w/ input switch	2.6 x 2.4 x 1.9	Black	6'	0.9	—	5.19	4.67	4.20	3.78
121232CL	Jameco	DC1208M3	12	800	3.5mm M 2	2.6 x 2.4 x 2.0	Black	6'	0.9	UL/CSA	6.19	5.57	5.01	4.51
100870CL	Jameco	DC1210F1	12	1000	2.1mm x 5.5mm F 2	3.1 x 2.4 x 2.0	Black	6'	0.9	UL/CSA	8.19	7.37	6.63	5.97
240101CL	—	FW3288	12	1000	2.1mm x 5.5mm F 2	3.8 x 2.4 x 2.2	Black	6'	1.0	UL/CSA	7.49	6.75	6.09	5.49
105478CL	Superworld	DC1210F5	12	1000	2.5mm x 5.5mm F 2	3.1 x 2.4 x 2.0	Black	6'	1.0	UL/CSA	7.49	6.74	6.07	5.46
199566CL	Superworld	WK1201A01DN	12	1000	2.5mm x 5.5mm F 2 (w/ RF filter)	3.2 x 2.2 x 2.0	Black	6'	1.2	UL/CSA	6.95	6.26	5.63	5.07
189579CL	Fellowes	BCU12100	12	1000	2.5mm x 5.5mm right angle F 2	3.2 x 2.2 x 1.9	Black	6'	1.0	UL/CSA	7.95	7.19	5.75	4.35
15392CL	Jameco	DC1210M3	12	1000	3.5mm M 2	3.3 x 2.4 x 2.0	Black	6'	1.0	UL/CSA	7.95	7.16	6.44	5.80
213559CL	—	GPC-081	12	1000	Auto lighter power outlet	4.3 x 2.2 x 1.9	Black	—	1.1	UL/CUL	\$4.95 4.95	4.38	3.80	3.22
196779CL	Jameco	D1212950	12	1200	2.5mm x 5.5mm F 2	3.0 x 2.3 x 1.9	Black	6'	1.0	UL/CUL	8.79	7.91	7.12	6.41
235096CL	—	DSA-0151A-12S	12	1250	2.1mm x 5.5mm F 2	3.2 x 2.1 x 1.4	Black	6'	0.3	UL/CUL	13.49	12.15	10.95	9.85
189325CL	KCS Industries	57D12-1500	12	1500	Stripped and tinned (w/ on-off switch)	3.4 x 2.6 x 2.2	Black	8'	1.5	UL	11.19	10.07	8.99	6.74
203035CL	Brother	A41215	12	1500	2.1mm x 5.5mm F 1	3.6 x 2.5 x 1.9	Black	6'	1.5	UL/CSA	12.95	11.69	9.35	6.99
136881CL	Leader Electronics	DC1215F1	12	1500	2.1mm x 5.5mm F 2	3.4 x 2.7 x 2.2	Black	6'	1.5	UL	12.95	11.69	10.55	9.45
101291CL	KCS Industries	DC1215F5	12	1500	2.5mm x 5.5mm F 2	3.4 x 2.7 x 2.2	Black	6'	1.5	UL	10.39	9.35	8.42	7.57
189211CL	ACI World	57-12-15000	12	1500	8-pin mini DIN M	3.4 x 2.6 x 2.2	Black	3.4'	1.7	UL/CUL	4.95	4.49	3.59	2.69
192786CL	—	MK135100	13.5	1000	2.1mm x 5.5mm F 1	2.9 x 2.3 x 2.0	Black	6'	1.0	UL	\$8.95 8.79	7.91	7.12	6.41
210817CL	DRA Electronics	MK135100-1	13.5	1000	2.1mm x 5.5mm F 2	2.9 x 2.3 x 1.9	Black	6'	1.0	UL	9.95	8.99	7.19	5.39
212812CL	Jameco	DC1402F12	14	200	2.1mm x 5.5mm F 2	2.2 x 1.7 x 1.5	Black	6'	0.8	UL/CUL	\$3.95 3.95	2.79	2.30	2.04
212821CL	Jameco	DC1403F12	14	300	2.1mm x 5.5mm F 2	2.2 x 1.7 x 1.5	Black	6'	0.8	UL/CUL	4.95	4.46	3.56	2.67
129314CL	—	DV-1250	14	360	2.5mm x 5.5mm right angle F 2	2.3 x 2.0 x 1.6	Black	6'	0.6	UL/CSA	5.19	4.67	3.74	2.80
212839CL	Jameco	DC1405F12	14	500	2.1mm x 5.5mm F 2	2.2 x 1.7 x 1.5	Black	6'	0.8	UL/CUL	\$4.95 4.79	4.35	3.46	2.69
123932CL	Jameco	DC1407F1	14	700	2.1mm x 5.5mm F 2	2.6 x 2.4 x 2.0	Black	6'	1.0	UL/CSA	8.49	7.65	6.89	6.19
202243CL	Everglow	DC1407F52	14	700	2.5mm x 5.5mm F 2	3.9 x 2.9 x 2.4	Black	6'	0.8	UL/CUL	7.25	6.55	5.89	5.29
202260CL	Jameco	DC1410F12	14	1000	2.1mm x 5.5mm F 2	3.9 x 2.9 x 2.4	Black	6'	0.9	UL/CUL	7.95	6.95	6.25	5.59
190001CL	Jameco	DC1505F1	15	500	2.1mm x 5.5mm F 2	2.3 x 2.4 x 1.9	Black	6'	0.8	UL/CSA	\$6.95 6.49	5.84	5.26	4.73
189982CL	Jameco	DC1505F5	15	500	2.5mm x 5.5mm F 2	2.3 x 2.4 x 1.9	Black	6'	0.8	UL/CSA	6.95	6.29	5.05	3.79
155803CL	Jameco	DC1506F11	15	600	2.1mm x 5.5mm F 1	2.9 x 2.3 x 1.9	Black	6'	1.0	UL/CSA	8.95	8.06	6.44	4.83
232258CL	Horizon	DDU150080	15	800	2.1mm x 5.5mm F 1	2.9 x 2.3 x 1.9	Black	6'	1.0	UL	9.49	8.55	7.69	6.95
203502CL	Jameco	48150900	15	900	2.5mm x 5.5mm F 2	2.6 x 2.2 x 1.9	Black	6'	1.0	UL/CSA	6.95	6.25	5.49	4.75
151992CL	Jameco	AD-SS-2	15	1000	2.1mm x 5.5mm F 1	3.1 x 2.0 x 1.9	Beige	6'	1.5	UL/CSA	\$9.69 8.99	8.09	6.47	4.85
191652CL	Jameco	DC1510F12	15	1000	2.1mm x 5.5mm F 2	3.3 x 2.2 x 1.9	Black	6'	1.0	UL/CSA	9.59	8.65	7.79	6.99
220901CL	Drake	3690454	16	250	Stripped & tinned	2.2 x 2.1 x 1.6	Black	6'	0.8	UL/CSA	8.95	7.95	7.29	6.59
162317CL	Jameco	DC1605F1	16	500	2.1mm x 5.5mm F 2	2.2 x 2.4 x 1.9	Black	6'	0.8	UL/CSA	7.95	6.95	6.25	5.59
217541CL	NiteRider	FE4116168C030	16.8	300	2.5mm x 5.5mm F 2 w/ LED indicator	3.1 x 2.1 x 1.6	Black	6'	0.6	UL/CUL	3.95	3.30	2.65	2.19
181729CL	Jameco	CXV18250	18	250	2.1mm x 5.5mm F 2	2.6 x 2.0 x 1.6	Black	6'	0.6	UL	6.95	6.29	5.65	5.09
217568CL	NiteRider	FE4126180P040	18	400	2.5mm x 2.5mm F 2 w/ LED indicator	3.5 x 2.1 x 1.6	Black	6'	0.8	UL/CUL	4.95	4.30	3.65	3.09
163272CL	Jameco	48-18-500D	18	500	2.1mm x 5.5mm F 2	2.6 x 2.3 x 1.9	Black	6'	0.8	UL/CUL	9.95	8.99	8.09	7.25
206957CL	Globtek	WD1H1000LCX	18	1000	2.5mm x 5.5mm F 2	3.4 x 2.6 x 2.1	Black	6'	1.4	—	9.95	8.99	7.19	5.39
236443CL	—	FE4823240D030	24	300	2.5mm x 5.5mm F 2	3.5 x 2.4 x 1.9	Black	12'	1.2	UL/CUL	7.49	6.75	6.09	5.45
102285CL	Jameco	DC2404F1	24	400	2.1mm x 5.5mm F 2	3.0 x 2.3 x 2.0	Black	6'	0.9	UL/CUL	7.95	7.19	6.45	5.85

† 110/220VAC switchable

▲ Brand and Product Number may vary except for Mean Well, Phihong, GlobTek and Jameco

More AC-to-DC Wall Adapters listed on pages 144 - 147

AC-to-DC Unregulated Wall Adapters (Continued)

We specialize in Wall Adapters - Call for additional OEM PRICING.
We will change any power plug (pg 152) on any DC wall adapter listed (100 pc. minimum).

• Input: 120VAC @ 60Hz



Polarity 1 (+) (-) (-) (center negative)

Polarity 2 (-) (-) (+) (center positive)

Male

Female



2-Wire AC Input - Unregulated

Part Number	Brand▲	Product Number▲	Output Rating		Output Connector ID x OD/Polarity F = female; M = male	Size (+0%-20%) H" x W" x D"	Case Color	Output Cord Length	Weight (lbs.)	Agency Approvals	Pricing			
			Voltage (VDC)	Current (mA)							1	10	50	100
163635CL	Jameco	DC2405F11	24	500	2.1mm x 5.5mm F 1	3.1 x 2.3 x 1.9	Black	6'	1.0	UL/CUL	\$8.95	\$8.09	\$7.25	\$6.55
191556CL	Jameco	DC2405F5	24	500	2.5mm x 5.5mm F 2	3.1 x 2.3 x 1.9	Black	6'	1.0	UL/CUL	8.95	8.06	6.44	4.83
139088CL	Jameco	DC2405M3	24	500	3.5mm M 2	3.1 x 2.3 x 1.9	Black	6'	1.0	UL/CUL	7.95	7.19	5.75	4.29
196322CL	3Com	P48240600A020G	24	600	2.1mm x 5.5mm F 2	3.3 x 2.3 x 1.9	Black	6'	1.1	UL/CSA	8.95	8.06	6.44	4.83
168495CL	Jameco	DC2408F1	24	800	2.1mm x 5.5mm F 2	2.9 x 1.9 x 1.6	Black	6'	0.4	UL/CUL/TUV	10.95	9.89	8.89	7.99
220960CL	Jameco	DFU240100	24	1000	2.1mm x 5.5mm F 1	3.4 x 2.7 x 2.2	Black	6'	1.6	UL/CUL	13.89	12.95	11.39	10.89
163651CL	Jameco	DC2412F11	24	1200	2.1mm x 5.5mm F 1	3.8 x 3.0 x 2.6	Black	6'	2.0	—	14.95	13.49	10.79	8.09
249130CL	Horizon	DFU240120/G8530	24	1200	2.1mm x 5.5mm F 1	3.4 x 2.7 x 2.2	Black	6'	1.7	UL/CUL	15.95	14.85	13.09	12.49
249121CL	Horizon	DFU240120/G8520	24	1200	2.1mm x 5.5mm F 2	3.4 x 2.7 x 2.2	Black	6'	1.7	UL/CUL	15.95	14.85	13.09	12.49
163643CL	Jameco	DC2412F12	24	1200	2.1mm x 5.5mm F 2	3.8 x 3.0 x 2.6	Black	6'	2.0	—	14.95	13.49	12.15	10.95
249113CL	Horizon	DFU240120/G8510	24	1200	2.5mm x 5.5mm F 2	3.4 x 2.7 x 2.2	Black	6'	1.7	UL/CUL	15.95	14.85	13.09	12.49
121241CL	Jameco	DC2412M3	24	1200	3.5mm M 2	3.4 x 2.7 x 2.2	Black	6'	2.0	—	12.95	11.49	9.95	8.95
199523CL	Jameco	DDU300050	30	500	2.5mm x 5.5mm F 2	2.9 x 2.3 x 1.9	Black	6'	1.1	UL/CUL	9.95	8.95	7.19	5.39
215095CL	—	MW48-4800250	48	250	2.5mm x 5.5mm F 2	2.9 x 2.3 x 1.9	Black	6'	1.1	UL/CUL	7.95	7.15	6.49	5.79
230631CL	—	MW48-4800250-2.1	48	250	2.1mm x 5.5mm F 2	3.3 x 2.7 x 2.2	Black	6'	1.1	UL/CUL	8.95	8.09	7.25	6.55
215108CL	—	MW48-4800500	48	500	2.5mm x 5.5mm F 2	2.9 x 2.3 x 1.9	Black	6'	1.1	UL/CUL	10.95	9.85	8.85	7.95
230640CL	—	MW48-4800500-2.1	48	500	2.1mm x 5.5mm F 2	3.3 x 2.7 x 2.2	Black	6'	1.1	UL/CUL	11.95	10.75	9.69	8.95
15309CL	Mean Well	DCM05	3, 4.5, 6, 7.5, 9, 12	500	1.35 x 3.5, 2.1 x 5.0, 2.5 x 5.5 female 2.5, 3.5 male, 9V battery snap (LED ind.)	3.0 x 2.2 x 2.1	Black	6'	0.7	UL/CSA	9.49	8.54	7.69	6.92
190641CL	—	DCM08	3, 4.5, 6, 7.5, 9, 12	800	1.5 x 5.5, 2.1 x 5.0, 2.1 x 5.5, 2.5 x 5.5 fem 2.5, 3.5 male, polarity sw. (LED ind.)	3.9 x 2.7 x 2.3	Black	6'	0.9	UL/CSA	7.95	7.19	5.75	4.29
123158CL	ProAm	DCM10 †	1.5, 3, 4.5, 6, 7.5, 9, 12	1000	1.35 x 3.5, 2.1 x 5.0, 2.5 x 5.5 female 2.5, 3.5 male, 9V battery snap (LED ind.)	3.7 x 2.2 x 2.5	Black	6'	0.9	—	10.95	9.86	8.87	7.98

† 120 to 220VAC

▲ Brand and Product Number may vary except for Mean Well, Pihong, GlobTek and Jameco

Compact Switching DC Regulated Power Adapter with Detachable Plugs

This state-of-the-art switching power adapter offers some major advantages such as stabilized outputs, short circuit and overload protection, compact design, and low idle consumption versus typical wall adapters.

- Universal input voltage: 100-240VAC
- Power output: 10W
- Efficiency: 80%
- Selectable output voltages: 3 / 4.5 / 6 / 7.5 / 9 / 12 VDC @ 800mA (regulated) with 1.5A max. output
- 8 plugs: 2.5mm M mono, 3.5mm M mono, 1.0mm x 3.0mm F, 1.3mm x 3.5mm F, 1.7mm x 4.0mm F, 2.1mm x 5.0mm F, 1.5mm x 5.5mm F, and 2.5mm x 5.5mm F

Part No.	Description	Size	Weight	Price
239564CL	Compact power adapter	2.9"H x 1.2"W x 1.9"D	0.2 lbs.	\$22.95

Slim Line Regulated Switching Wall Adapters

Introducing our new slim line switching wall adapters. Compact in size and lightweight, they are the perfect power solution in all those applications where space is critical. And their high efficiency satisfies requirements for minimizing power losses. You no longer have to deal with traditional wall adapters that block unused outlets in wall plates and power strips/surge protectors.

- Input voltage: 100 - 240VAC@47-63Hz
- 2-wire AC input
- Output connector: 2.1mm x 5.5mm F (center positive)
- Agency approvals: UL/CUL/TUV/CE
- Output cord length: 6'
- Color: black

New



Part Number	Prod. Number	Output Rating		Size (H" x W" x D")	Wt. (lbs.)	Pricing			
		Volts (VDC)	Current (mA)			1	10	50	100
251539CL	S08AA033100	3.3	1000	2.5x1.1x1.7	0.2	\$10.49	\$9.52	\$8.79	\$8.48
251563CL	S08AA033150	3.3	1500	2.5x1.1x1.7	0.2	10.95	9.94	9.17	8.85
251598CL	S15AA033250	3.3	2500	2.9x1.3x2.2	0.3	11.49	10.43	9.63	9.29
252700CL	S08AB050050	5.0	500	2.5x1.1x1.7	0.2	10.49	9.52	8.79	8.48
252718CL	S08AB050100	5.0	1000	2.5x1.1x1.7	0.2	10.95	9.94	9.17	8.85
252726CL	S08AB050150	5.0	1500	2.5x1.1x1.7	0.2	11.49	10.43	9.63	9.29
252734CL	S15AB050250	5.0	2500	2.9x1.3x2.2	0.3	11.95	10.85	9.99	9.64
252742CL	S08AO090025	9.0	250	2.5x1.1x1.7	0.2	10.49	9.52	8.79	8.48
252751CL	S08AD090050	9.0	500	2.5x1.1x1.7	0.2	10.95	9.94	9.17	8.85
252769CL	S08AD090090	9.0	900	2.5x1.1x1.7	0.2	11.49	10.43	9.63	9.29
252777CL	S15AD090120	9.0	1200	2.9x1.3x2.2	0.3	11.95	10.85	9.99	9.64
252785CL	S15AS090170	9.0	1700	2.9x1.3x2.2	0.3	12.49	11.34	10.47	10.10
252793CL	S08AE120025	12.0	250	2.5x1.1x1.7	0.2	10.49	9.52	8.79	8.48

Color Code Legend
New **Save** Closeout

Order 24/7 Toll Free 1-800-831-4242

International Step-Up/Step-Down Transformers

Color Code Legend
New **Hot** **Buy** **Save** **Closeout**

International Step-Up/Step-Down Auto and Isolation Transformers

- Wide selection to meet your power requirements

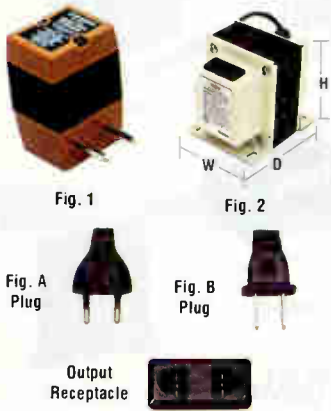

Part Number	Mfr. Cross Ref. No. *	Fig.	Type	Primary Voltage	Secondary Voltage	Power (VA)	Dimensions			Weight (lbs.)	Pricing		
							H"	W"	D"		1	10	100
99573CL	AC110V50	1/A	Auto	220VAC	110VAC	50	2.50	1.63	1.33	0.7	\$9.95	\$8.99	\$8.09
85016CL	AC110V300	2/A	Auto	220VAC	110VAC	300	3.50	3.05	3.95	4.8	27.95	24.95	22.49
111851CL	AC110V500	2/A	Auto	220VAC	110VAC	500	3.99	3.60	4.84	8.5	34.95	31.49	28.95
221250CL	GSD-1000	2/A	Auto	220VAC	110VAC	1000	4.63	3.81	6.06	17.0	83.95	74.95	60.89
142906CL	AC110V1500	2/A	Auto	220VAC	110VAC	1500	5.25	4.50	5.75	15.2	79.95	71.95	64.95
99477CL	AC220V50	1/B	Auto	110VAC	220VAC	50	2.50	1.63	1.33	0.7	8.95	8.09	7.25
221233CL	P8638	2/B	Auto	110VAC	220VAC	125	3.13	2.50	3.00	3.0	28.95	26.55	22.35
85008CL	AC220V300	2/B	Auto	110VAC	220VAC	300	3.50	3.05	3.95	4.8	27.95	24.95	22.49
221217CL	P8689	2/B	Auto	110VAC	220VAC	1000	4.63	3.75	6.13	17.0	61.95	57.55	43.85
221313CL	G1SD-500	2/A	Isolation	220VAC	110VAC	500	4.69	3.75	6.00	16.0	78.95	69.95	57.49
222092CL	G1SD-1000	2/A	Isolation	220VAC	110VAC	1000	5.38	4.38	8.13	31.0	149.95	132.55	129.25
221348CL	G1S-250	2/B	Isolation	110VAC	110VAC	250	4.69	3.75	4.38	9.0	68.95	63.49	49.65
221330CL	G1S-500	2/B	Isolation	110VAC	110VAC	500	4.69	3.75	6.00	16.0	78.95	69.95	57.49
221321CL	G1S-1000	2/B	Isolation	110VAC	110VAC	1000	5.38	4.38	8.13	31.0	149.95	121.95	112.79

* Manufacturer may vary

International Power Cords

- 3-conductor detachable power cords
- Excellent resistance to jacket abrasion
- Voltage rating: 300 volts
- BSI: British Standard Institution



SALE

Cord Configuration Chart - End 1



Now Lower Prices

Cord Configuration Chart - End 2



117911CL (Fig. 1)



174633CL (Fig. 2)

European Agency Approvals

Germany	VDE	
Austria	DVE	
Belgium	CEBEC	
Denmark	DEMKO	
Finland	FIMKO	
France	LCIE	
Netherlands	KEMA	
Norway	NEMKO	
Sweden	SEMKO	
Switzerland	SEV	

Fig. 3

Part Number	Mfr. Cross Reference No. *	Country	Agency Approvals	Cord Plug Fig.		Length	Cord Color	Conductors	Cord Type	Pricing			
				End 1	End 2					1	10	100	250
117911CL	PCVDE-6B	Europe	All in Fig. 3	A	1	6 ft.	Black	3/75mm ²	H05VVVF	\$5.49	\$4.95	\$3.95	\$2.99
174633CL	21071H5182	UK/Ireland	BSI	A	2	8 ft.	Black	3/1.0mm ²	H05VVVF	6.49	5.84	5.26	4.73

* Manufacturer may vary

DataCom Transformers

Modem Coupling Transformers

- Insulation resistance: 100MΩ
- Hipot tested: 1000VAC

- Core type: EI-14
- ±20% impedance matching

- Vacuum wax impregnated
- ±20% DC resistance matching

Quantity **SAVE**

Part Number	Mfr. Cross Reference No.	Impedance (Ω)		Resistance (Ω)		Pricing		
		Primary	Secondary	Primary	Secondary	1	10	100
125356CL	XFR6006A14	600CT	600CT	65	55	\$1.29	\$1.18	\$1.08
205962CL	60-282-0	1.2KCT	8	45	1.5	1.69	1.45	1.09



125356CL

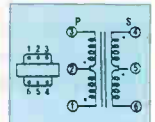

125356CL

Modem Coupling Transformers

- Dielectric strength: 1250VAC

SALE

Now Lower Prices



141621CL

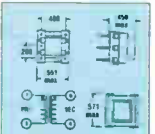

141621CL

Part Number	Mfr. Cross Ref. No.	Impedance (Ω)		Resistance (Ω)		Insertion Loss	Pricing		
		Primary	Secondary	Primary	Secondary		1	10	100
141621CL	671-8255	600	600	46.5	67.6	1.25dB @ 1kHz	\$1.95	\$1.79	\$1.35
199540CL	671-8079	600	301	150	150	3.00dB @ 1kHz	\$1.65	.33	.28
117760CL	671-8014	600	600	108	120	2.50dB @ 1kHz	\$2.15	1.99	1.69
206391CL	TTC-105	600	600	71	117	2.50dB max. @ 800Hz to 3.5kHz	\$2.95	1.42	1.29

117760CL

See pages 149 & 151 for Power Transformers and Variable Transformers

Current Sensing Transformers

Class 1 Current Transformer

This series can be applied to test, control, display, and record the running of electrical equipment, and to protect the equipment against damage in the AC circuit.

- Maximum voltage: 660VAC
- Size: 3.0"L x 3.2"W x 1.6"T

- Frequency: 50-60Hz
- Weight: 1.1 lbs.

Includes: Mounting bracket and hardware

SALE



Current Sensing Transformer

- Inductance: 5mH
- Turns: 60
- Sensitivity current (I_s): 1A
- Max. current: 300mA
- Freq. range: 10-50 kHz
- Sensitivity voltage (V_{out}): 1V
- Terminating resistor: 50Ω
- Size: 0.8"H x 0.7"W x 0.4"T



Quantity **SAVE**

Part No.	Mfr. Cross Ref. No.	Power	Ratio	1	10	100
174887CL	MSQ30	5VA	200A/5A; 5VA	\$ 1.99	\$ 1.79	\$ 1.39

Part No.	Mfr. Cross Ref. No.	1	10	100
164718CL	MTC30101	\$2.15	\$1.85	\$1.39

Convenient On-Line Ordering www.Jameco.com

World Radio History

JAMECO

6VAC/9VAC Dual Output Power Transformer

12VA

- Input voltage: 120VAC
- Output voltage: 6VAC @ 500mA center tap (blue wires); 9VAC @ 1A center tap (yellow wires)
- Size: 2.1"L x 3.2"W x 2.0"H • Weight: 1.3 lbs.

Part No. Mfr. Cross Ref. No. 1 10 100

183089CL YS57H-099FAA \$4.95 \$3.99 \$2.99

Quantity SAVE



120VAC to 120VAC Isolation Transformer

300VA

- Input voltage: 120VAC @ 60Hz
- Input connector: 5.5' cord with 2-prong plug
- Output voltage: 120VAC @ 2.5A (isolated)
- Size: 4.2"H x 3.2"W x 4.6"D • Weight: 7.0 lbs.

Part No. Mfr. Cross Ref. No. 1 10 100

181315CL ITR300 \$44.95 \$33.75 \$23.65



EMI Suppression Cores with Case

Reduce Electro Magnetic Interference (EMI) with a snap of these suppression cores around a power cord or data cord. Easy to install and an affordable way to reduce EMI without redesigning your product.

Part No. Size (OutDia. x InDia. x L) 1 10 100

218173CL .64" x .20" x 1.15" \$.99 \$.89 \$.79

217841CL .78" x .34" x 1.40" 1.45 1.29 1.15

Open Closed



320VA Variable AC Transformer

- Input voltage: 110VAC @ 60Hz (using pin 1-2) 110VAC @ 50Hz (using pin 1-4)
- Matching input/output terminals: P/N 103667CL and 109111CL (disconnect .25" solderless terminals), pg 63
- Maximum current: 2.5A
- Size: 2.8"Dia. x 2.1"H
- Weight: 2.5 lbs.
- Panel mount
- Shaft length: 0.5"
- One-year warranty

Includes: 3 disconnect .25" solderless terminals

Part No. Description 1 10 50

149323CL 320VA variable \$53.95 \$48.59 \$43.75



550VA Variable AC Transformer

SALE

- Input voltage: 110VAC @ 60Hz
- Output voltage: 0-140VAC
- Rated current: 5A
- Panel mount
- Input/output terminals: binding post with 0.188" diameter post
- Size: 4.3"Dia. x 4.0"H
- Weight: 6.8 lbs. • One-year warranty

Part No. Description 1 10 50

152936CL 550VA variable \$ 99 \$ 89 \$ 79



500VA & 2000VA Variable Transformers

- Input voltage: 110VAC @ 60 Hz
- Power: 500 or 2000VA
- Output voltage: 0 to 130VAC
- Output analog voltmeter
- Input conn.: 3-prong plug w/ 5' cord
- Output conn.: 3-prong outlet type
- Lighted on/off power switch

169640CL: • 5A @ 250V fuse

169658CL: • 20A @ 250V fuse

• Size: 8.3"L x 6.5"W x 7.0"H • Weight: 15.6 lbs.

• Size: 9.8"L x 8.0"W x 7.0"H • Weight: 26.5 lbs.

Part No. Description 1 10 50

169640CL 500VA trans. \$84.95 \$76.49 \$68.85

169658CL 2000VA trans. 124.95 112.49 101.25



500-2000VA Variable Transformers

- Input: 110VAC or 220VAC
- Power: 500-2000VA
- Output: 0-240VAC
- Banana/screw input terminals
- Universal US/European output plugs
- Lighted on/off power switch

Part No. Description 1 10 50

121275CL 500VA trans. \$79.95 \$69.95 \$62.95

129007CL 1000VA trans. 164.95 148.49 133.65

152581CL 2000VA trans. 174.95 158.45 139.95

Part No.	Fuse	Size (L" x W" x H")	Wt. (lbs.)
121275CL	3A/250V (P/N 69438CL)	5.3 x 7.3 x 7.0	10.4
129007CL	5A/250V (P/N 10401CL)	9.4 x 6.5 x 7.7	14.8
152581CL	10A/250V (P/N 69462CL)	9.0 x 7.0 x 7.7	19.8



30-Day Money-Back Guarantee

If you're not satisfied we'll take it back!

Details on page 229.

Power Entry Filters and AC Receptacles



Now Lower Prices

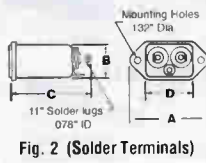

Quantity SAVE

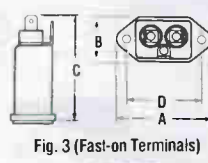

Frequency: 50/60Hz

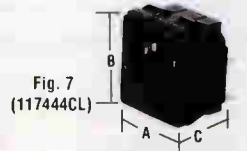
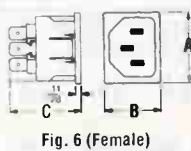
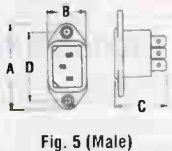

SALE

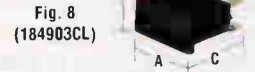

Part Number	Mfr. Cross Ref. No.	Corcom Cross	Description	Fig.	Current (A)	Voltage (VAC)	Terminals	Agency Approvals	Terminal Size	Dimension (inches)				Pricing			
										A	B	C	D	1	10	100	500
146907CL	03DENG3B*		Power entry filter (snap-in)	1	3	250	fast-on	UL/CSA/VDE	.25"	1.25	0.95	2.23	N/A	\$4.95	\$4.45	\$3.39	\$2.49
150615CL	03AC1	3EF1	Power entry filter, straight (flanged)	2	3	250	solder	UL/CSA/VDE	.16"	1.89	0.88	2.58	1.58	5.95	4.79	3.59	2.55
42454CL	06AC1	6EF1	Power entry filter, straight (flanged)	2	6	250	solder	UL/CSA/VDE	.16"	1.96	0.88	2.06	1.58	8.95	8.09	7.25	6.55
165016CL	SUP-J15G-E-2		Power entry filter, straight (flanged)	2	15	250	solder	JL/CSA/VDE	.16"	1.89	0.88	2.18	1.58	5.95	5.35	4.29	3.25
40601CL	03AE1*	3EF1F	Power entry filter, straight (flanged)	3	3	250	fast-on	UL/CSA/VDE	.25"	1.97	0.90	2.16	1.58	5.95	4.79	3.59	2.55
63132CL	06AE1	6EF1F	Power entry filter, straight (flanged)	3	6	250	fast-on	UL/CSA/VDE	.16"	1.96	0.88	2.06	1.58	9.95	6.29	5.65	5.09
217744CL	10AE1	10EF1F	Power entry filter, straight (flanged)	3	10	250	fast-on	UL/CSA/VDE	.25"	1.96	0.89	2.23	1.58	9.95	5.89	5.11	4.84
220206CL	10GEEG3E		Power entry filter, straight (flanged)	3	10	250	solder	UL/CSA/VDE	.16"	1.96	0.87	2.16	1.58	8.49	7.65	6.89	6.19
210913CL	01GEEW3E		Power entry filter, straight (flanged)	4	1	250	wire	UL/CSA/VDE	4.1"	2.05	0.99	1.78	1.58	5.95	4.79	3.59	2.55
147109CL	42R02		AC power inlet (male) snap-in	5	15	250	fast-on	UL/CSA/VDE	.25"	1.22	0.94	1.13	N/A	.26	.23	.21	.19
16651CL	JR101		AC power inlet (male) flanged	5	15	250	fast-on	UL/CSA/VDE	.187"	1.96	0.89	1.07	1.58	.79	.71	.57	.41
147900CL	P0707*		AC power inlet (male) flanged	5	15	250	solder	UL/CSA/VDE	.16"	1.96	0.89	1.04	1.58	.75	.68	.59	.55
218288CL	0708-1-CQ		AC power outlet (female) flanged	6	10	250	fast-on	UL/CSA/VDE	.189"	1.97	1.14	1.27	1.58	9.89	7.11	6.44	5.84
117444CL	0717 ¹		AC power inlet (male) fused (snap-in)	7	10	250	fast-on	UL/CSA/VDE	.187"	1.18	1.30	1.21	N/A	1.95	1.79	1.59	1.45
184903CL	42R36315210U		AC power inlet (male) w/ switch (snap-in)	8	15	250	fast-on	UL/CSA/VDE	.25"	1.30	1.58	1.42	N/A	1.95	1.69	1.39	1.05

* Manufacturer may vary

¹ Includes spare fuse holder - Fuse type 5mm x 20mm (250V)

Male & Female Power Jacks

- Use with mating power plugs, below
- Dimensions do not include barrel

Mounting	Code
Panel	C
PCB	D
Panel & PCB	E
Cable	F

Terminals	Code
Solder eyelet	A
PC board	B

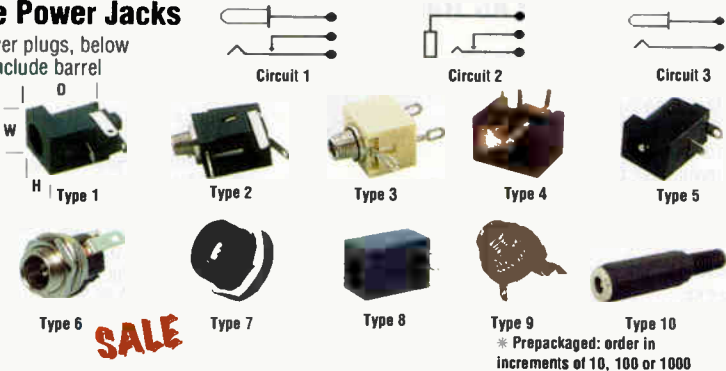

New Lower Prices

SALE

Part Number	Mfr. Cross Ref. No.	Dimensions H x W x D (mm)	Type/ Mount	Circuit/ Terminal	Mating Plug (below)	Pricing			
						1	10	100	1000
1.3 mm Male Jacks									
101194CL	PP024	6.0 x 6.0 x 9.0	8/D	1/B	1.3 mm female	\$1.65 \$0.63	\$0.49	\$0.44	\$0.39
2.1 mm Male Jacks									
101178CL	PP014	10.9 x 9.0 x 14.5	1/D	1/A	2.1 mm female	\$0.49	\$0.44	\$0.39	\$0.35
137672CL	PP013	10.9 x 9.0 x 14.5	5/D	3/A	2.1 mm female	.49	.44	.35	.29
151589CL	DPJ-021A	13.0 x 12.6 Dia.	7/C	1/A	2.1 mm female	1.09	.93	.70	.65
151554CL	DPJ-026	15.1 x 8.0 Dia.	6/E	1/A	2.1 mm female	1.49	1.25	1.05	.89
159610CL	PJ1014A	35.8 x 12.6 Dia.	10/F	3/A	2.1 mm female	1.49	1.25	1.09	.89
2.5 mm Male Jacks									
207714CL	HEC0470	11.0 x 9.0 x 14.5	1/D	1/B	2.5 mm female	\$0.45	\$0.35	\$0.29	\$0.25
101186CL	PP014A	11.0 x 9.0 x 14.5	1/D	1/A	2.5 mm female	.59	.53	.48	.43
151562CL	DPJ-026A	15.1 x 8.0 Dia.	6/E	1/A	2.5 mm female	1.49	1.24	1.13	.99
159505CL	PJ1015A	35.8 x 12.6 Dia.	10/F	3/A	2.5 mm female	1.39	1.25	1.13	1.01
202358CL	HD2388	17.0 x 12.0 Dia.	7/C	3/A	2.5 mm female	1.09	.98	.88	.79
3.5 mm Female Jacks									
101143CL	PJ0352	10.0 x 10.0 x 18.5	2/E	2/A	3.5 mm male	*	\$0.25	\$0.22	\$0.19
109495CL	PJ035PM	10.5 x 9.0 x 8.8	3/C	2/A	3.5 mm male	.45	.40	.36	.32
165729CL	PJ0354	8.9 x 5.7 Dia.	9/C	3/A	3.5 mm male	.69	.59	.49	.39

Male & Female Power Plugs

- Use with mating power jacks found in table, above
- Solder eyelets 1 mm diameter
- Threaded screw-on housing (strain relief)
- Use with AC/DC wall adapters, pgs 144-0
- Shield crimp tabs
- Use 24 AWG 2 conductor wire, P/N 100280CL, to make custom length power cables, pg 60



SALE

Part Number	Mfr. Cross Ref. No.	Description Plug ID x OD (mm)	Dimensions (mm) S (shaft) x L x ID (strain relief)	Type	Pricing			
					1	10	100	1000
Female Plug								
71191CL	PP137	1.3 x 3.5	9.6 x 43.9 x 4.8 (black)	1/A	\$0.79	\$0.71	\$0.65	\$0.59
191484CL	PP049W	2.1 x 5.5	9.6 x 43.9 x 4.5 (white)	1/A	.69	.62	.56	.50
28759CL	PP049	2.1 x 5.5 (P205)	8.5 x 41.4 x 4.6 (black)	1/A	.59	.49	.39	.29
147328CL	PP049L	2.1 x 5.5 (P205L)	14.0 x 46.4 x 4.6 (black)	1/A	.69	.62	.56	.50
138587CL	PJ021R	2.1 x 5.5 rt. angle	12.0 x 22.5 x 3.9 (black)	1/B	.79	.63	.55	.49
190537CL	PP109S	2.5 x 5.5 (P206S)	9.0 x 43.5 x 4.8 (black)	1/A	.39	.32	.29	.19
28767CL	PP109	2.5 x 5.5 (P206)	10.1 x 45.4 x 4.3 (black)	1/A	.59	.49	.39	.33
191492CL	PP109W	2.5 x 5.5	10.1 x 45.4 x 4.5 (white)	1/A	\$0.69 .39	.35	.32	.29
147336CL	PP109L	2.5 x 5.5 (P206L)	13.6 x 47.5 x 4.8 (black)	1/A	.75	.68	.61	.55
168241CL	PP109N	2.5 x 5.5	13.7 x 36.5 x 3.9 (black)	1/C	.59	.49	.43	.35
Male Plug								
101135CL	PJ1025	2.5 (P201)	11.1 x 49.0 x 4.3 (black)	2/A	\$1.69 \$0.59	\$0.53	\$0.39	\$0.29
147459CL	PJ1025L	2.5 (P201L)	10.5 x 48.0 x 5.0 (black)	2/A	\$1.45 .35	.32	.25	.19
101151CL	PJ1035	3.5 (P202)	13.8 x 51.8 x 4.2 (black)	2/A	.69	.62	.49	.39
147344CL	PJ1035L	3.5 (P202L)	14.1 x 51.0 x 5.2 (black)	2/A	.64	.58	.48	.35

Automobile Power Plug & Cord Assembly

- Screw assembly with strain relief
- Accepts .25" x 1.25" fuse
- Plugs directly into cigarette lighter

Part No.	Description	1	10	100
115001CL	W/ 5A/250VAC fuse	\$1.95	\$1.65	\$1.19
124759CL	W/ 3A/250VAC fuse & 3' cord	1.89	1.72	1.69



80-Watt DC-AC Inverter

- Input voltage: 12VDC
- Output voltage: 115VAC ±5%
- Overload and thermal protection
- Output connector: 2-prong receptacle
- Input connector: automobile power plug
- Size: 4.1"L x 1.5"W x 1.5"H
- Weight: 2.0 lbs.

SALE

Part No.	Description	1	10	25
202809CL	80W inverter	\$26.11 \$20.40	\$18.55	\$16.86

140 & 270-Watt DC-AC Inverters

- Input voltage: 10-15VDC
- Output voltage: 110VAC @ 60Hz
- Peak power surge capable
- Overload & thermal protection
- Battery low shutdown
- Wt.: 1.3 lbs.

182893CL: Size: 5.5"L x 2.6"W x 1.6"H
 202016CL: Size: 9.3"L x 4.1"W x 2.2"H

Part No.	Description	1	10	25
182893CL	140W auto plug	\$49.95	\$42.49	\$31.89
202016CL	270W auto/battery clip	\$64.95 \$33.95	\$12.25	\$8.69

400-Watt DC-AC Inverter

Exclusive twin circuit design of dual high-output transformers provides 30% more power. MOSFET technology transistors with split design for cooler internal operating temperature. Outboard mounted replaceable with dual 25AMP spade-type fuses. Dual grounded standard 110VAC receptacles. Includes: 12VDC cigarette lighter accessory plug, heavy-duty cable clamps, and spare 25A spade fuse.

- Input: 10-15VDC
- Max. continuous power: 400W
- Surge capacity (peak power): 800W
- 90% max. efficiency
- No load draw: 0.3A
- Size: 6.4"L x 6.1"W x 2.1"H
- Weight: 2.4 lbs.

Part No.	Product No.	1	10	25
249164CL	VEC031POB	\$57.49	\$54.65	\$51.89

DC-to-DC Power Converter

A high quality 1000mA regulated DC adapter with the ability to convert power from your cigarette lighter plug in 1.5V increments from 1.5V to 9.0V. You may choose from a full range of universal plugs (2.1mm/2.5mm jack/1/8" jack/9V battery snaps) and output polarity (center + or -). Perfect for cassette players, CD players, radios, mini TV's and many other battery run appliances.

- Two DC output cigarette lighter outlets
- Built-in 10A mini blade fuse on plug

Part No.	Description	1	10
218819CL	DC-to-DC Converter	\$14.49	\$12.99
218801CL	10' Extension cord	6.49	5.99

Automobile Power Plug Splitter

- Input: cigarette adapter; non-fused
- Splits out into two 5" female automobile-type receptacles

Part No.	Description	1	10	50
123182CL	Power plug splitter	\$4.55	\$4.09	\$3.85

Compact Battery Tester

Simply lift the swivel arm of this battery tester and place your battery between the contacts and it will provide you a voltage measurement of your batteries. Tests AAA, AA, C, D, 9V, and button cell batteries.



Part No.	Description	Price
239556CL	Compact battery tester	\$4.99

9-Volt Battery Snaps and Clip

- Use with standard "9 volt" batteries
- Fully insulated; contacts are nickel-plated brass
- Leads are color-coded, stripped and pre-tinned
- Snap: male outer dia. = 0.225" • Female inner dia.: 0.215"

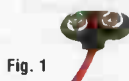

Fig. 1

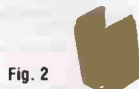

Fig. 2

* 10 piece minimum

Part Number	Fig.	Description	Dimensions (in.)			Pricing			
			L	W	H	1	10	100	1000
11279CL	1	3". 26 AWG, 6 prong battery snap	1.0	.50	—	\$.25	\$.22	\$.19	\$.16
105793CL	2	Battery holder clip	.63	.71	1.2	.28	.23	.16	.14
109153CL	3	6". 26 AWG, 6 prong battery snap	1.0	.50	—	*	.17	.15	.135
101469CL	3	10". 26 AWG, 6 prong battery snap	1.0	.50	—	.29	.25	.21	.14
216451CL	4	6". 26 AWG, 6 prong battery snap	1.0	.50	—	.34	.30	.20	.18



Fig. 3



Fig. 4

Eveready® Energizer® Alkaline Batteries



Energizer® and the Energizer Bunny® are registered trademarks of the Eveready Battery Company, Inc.

- Single use Energizer® alkaline batteries for heavy drain and frequent use applications
- Prepackaged: order in increments of 4

Part No.	Description	4	8	12
198707CL	AA	\$.64	\$.63	\$.62
198715CL	AAA	.55	.52	.48
Part No.	Description	1	4	
198731CL	9-volt	\$2.59	\$2.22	
215845CL	D	1.95	1.69	

Battery Holders

Eliminate battery retention problems in portable DC power applications and products. High-retention snaps are made from special materials that maintain retention properties longer than conventional snaps. They can be with leads, or attached to battery holders.

Part No.	Product No.	Fig.	No. of Cells	Connector	Sides	Features	1	10	100	500
216071CL	BH-311-2A	1	1-AA	Wires	Single		\$.69	\$.59	\$.54	\$.49
237315CL	1029	19	1-2/3AA	PC Mount	Single		.75	.69	.59	.55
216080CL	BH-321-2A	3	2-AA	Wires	Single		.69	.59	.54	.49
216098CL	BH-321-4A	3	2-AA	Wires	Single	With mounting tabs	.69	.59	.54	.49
216101CL	SBH-321-2A	5	2-AA	Wires	Single	With cover, no switch	.79	.69	.64	.59
216119CL	SBH-321-1AS	5	2-AA	Wires	Single	With cover and switch	.79	.69	.64	.59
216127CL	BH-322-1B	4	2-AA	Snaps	Dual		.69	.59	.54	.49
216135CL	BH-331-A	6	3-AA	Snaps	Single		.89	.79	.74	.69
216143CL	SBH-331-AS	7	3-AA	Wires	Single	With cover and switch	.99	.79	.75	.68
216151CL	BH-341-2A	8	4-AA	Wires	Single		.99	.89	.84	.79
105857CL	*	12	4-AA	Wires	Single	Wires with connector	.89	.75	.68	.59
216160CL	BH-342-A	9	4-AA	Wires	Dual		.69	.53	.47	.43
216178CL	BH-343-1A	10	4-AA	Wires	Dual		.75	.55	.49	.45
216186CL	SBH-341-1AS	13	4-AA	Wires	Single	With cover and switch	1.09	.89	.85	.75
216194CL	BH-341-2B	8	4-AA	Snaps	Single		.76	.59	.53	.47
216207CL	BH-343-1B	10	4-AA	Snaps	Dual		.99	.89	.84	.79
216215CL	BH-363-A	15	6-AA	Wires	Dual		.95	.79	.69	.65
216223CL	BH-364-A	14	6-AA	Wires	Single		.95	.79	.72	.65
216231CL	BH-363-B	15	6-AA	Snaps	Dual		.99	.75	.69	.65
216240CL	BH-383-A	17	8-AA	Wires	Dual		1.19	.99	.89	.85
216258CL	BH-382-B	16	8-AA	Snaps	Dual		1.19	.99	.89	.85
216266CL	BH-383-B	17	8-AA	Snaps	Dual		1.19	.99	.89	.85
216274CL	BH-411-1A	1	1-AAA	Wires	Single		.69	.59	.54	.49
216282CL	BH-421-1A	3	2-AAA	Wires	Single		.69	.59	.54	.49
216291CL	SBH-421-AS	5	2-AAA	Wires	Single	With cover and switch	.79	.69	.59	.49
216303CL	BH-431-1A	6	3-AAA	Wires	Single		.89	.79	.74	.69
216311CL	SBH-431-1AS	7	3-AAA	Wires	Single	With cover and switch	.79	.69	.59	.49
216320CL	BH-441-1A	8	4-AAA	Wires	Single		.99	.89	.84	.79
216338CL	SBH-441-AS	13	4-AAA	Wires	Single	With cover and switch	1.39	1.15	1.05	.95
216346CL	BH-211-A	1	1-C	Wires	Single		.62	.56	.51	.44
216354CL	BH-221-A	3	2-C	Wires	Single		1.09	.99	.94	.84
216362CL	BH-242-1A	11	4-C	Wires	Single		1.39	1.29	1.09	.99
216371CL	BH-111-1A	1	1-D	Wires	Single		.69	.59	.54	.49
216389CL	BH-121-1A	3	2-D	Wires	Single		.89	.75	.69	.59
216397CL	BH-121-1B	3	2-D	Snaps	Single		.99	.85	.75	.69
216400CL	BH-142-A	11	4-D	Wires	Single		1.19	.95	.85	.75
216418CL	BH-143-1A	8	4-D	Wires	Single		1.15	.89	.81	.74
216426CL	BH-9V-A	2	1-9V	Wires	Single		.79	.69	.64	.59
216434CL	BH-511-1A	1	1-N	Wires	Single		.69	.59	.54	.49
236996CL	103	18	1-CR2032	PC Mount	Coin Cell		.95	.85	.79	.69
38535CL	2S2032	18	1-CR2032	PC Mount	Coin Cell		.59	.49	.35	.25
38543CL	2S2325	18	1-CR2354 or 2-CR2325	PC Mount	Coin Cell		.99	.89	.69	.49

* Battery holder used in many personal computers



Fig. 1

Fig. 2

Fig. 3



Fig. 4

Fig. 5

Fig. 6



Fig. 7

Fig. 8

Fig. 9



Fig. 10

Fig. 11

Fig. 12



Fig. 13

Fig. 14

Fig. 15



Fig. 16

Fig. 17



Fig. 18

Fig. 19

Zinc Chloride, Silver Oxide, Alkaline, NiCAD, Lithium and NiMH Batteries (continued)

Lithium & Lithium Ion (continued)

Part Number	Mfr Cross Ref	Figure	Size	Volts	mAh	Terminals/Connection	Dimensions	1	10	25
263927CL	CR14250	2	1/2AA	3	850	Consumer Tip	0.989"L x 0.564"Dia.	\$4.39	\$4.25	\$3.99
240266CL	ER14250	2	1/2AA	3.6	1000	Consumer Tip	0.989 L x 0.564 Dia.	3.99	3.89	3.81
263898CL	ER14250	3	1/2AA	3.6	1000	With axial leads	0.989 L x 0.564 Dia.	4.29	4.11	3.90
263978CL	ER14335	3	2/3AA	3.6	1450	With axial leads	1.316" L x 0.562" Dia.	4.79	4.62	4.36
263951CL	ER14335	4	2/3AA	3.6	1450	With solder tabs	1.316" L x 0.562" Dia.	4.59	4.43	4.19
240282CL	ER14335	5	2/3AA	3.6	1450	Consumer Tip	1.316 L x 0.562 Dia.	4.59	4.45	4.19
240303CL	ER14505	6	AA	3.6	2100	Consumer Tip	0.963" L x 0.565" Dia.	3.19	3.25	3.25
263935CL	ER14505	1	AA	3.6	2100	With solder tabs	0.963" L x 0.565" Dia.	4.99	4.38	4.14
263901CL	CR17335	7	2/3A	3	1200	Consumer Tip	1.316" L x 0.670" Dia.	4.75	4.56	4.31
263919CL	CR17335	3	2/3A	3	1200	With axial leads	1.316" L x 0.670" Dia.	5.25	5.05	4.78
240320CL	ER17335	7	2/3A	3.6	1900	Consumer Tip	1.281" L x 0.662" Dia.	5.25	4.75	4.39
264217CL	ER17335	3	2/3A	3.6	1900	With axial leads	1.316 L x 0.562" Dia.	5.55	4.99	4.59
263986CL	ER26500	—	C	3.6	8500	With axial leads	1.954 L x 1.014" Dia.	13.19	12.42	11.67
240160CL	ER26500	8	C	3.6	8500	Consumer Tip	1.954 L x 1.014" Dia.	11.95	11.50	11.05
263994CL	ER34615	—	D	3.6	16500	With axial leads	2.420 L x 1.340" Dia.	16.65	15.68	14.73
240151CL	ER34615	8	D	3.6	16500	Consumer Tip	2.420" L x 1.340" Dia.	15.05	14.49	13.95
244646CL	UR18650H1	9	—	3.6	2200	Flat Top Lithium Ion (rechargeable)	2.558" L x 0.706" Dia.	17.55	15.79	14.21



NiMH

Part Number	Mfr Cross Ref	Figure	Size	Volts	mAh	Terminals/Connection	Dimensions	1	10	25
244937CL	PRIZ-F6(48)-700	10	—	1.2	700	Flat Top-Prismatic	0.86" L x 0.65" W x 0.23" T	\$3.12	\$2.81	\$2.53
244945CL	PRIZ-75F6-1100	10	—	1.2	1100	Flat Top-Prismatic	2.63" L x 0.65" W x 0.23" T	4.11	3.69	3.33
244582CL	2/3AAA-300	11	2/3AAA	1.2	300	Flat Top	1.168" L x 0.403" Dia.	1.49	1.25	.99
244785CL	5/4AAA-750	11	5/4AAA	1.2	750	Flat Top	1.953" L x 0.400" Dia.	2.29	2.11	2.05
261665CL	TY-AAA-700FT	12	AAA	1.2	700	Flat Top	1.742" L x 0.403" Dia.	2.21	1.99	1.91
244806CL	4/5AA-1200	13	4/5AA	1.2	1200	Flat Top	1.678" L x 0.553" Dia.	3.25	2.93	2.63
244814CL	AA-1800	6	AA	1.2	1800	Flat Top	0.963" L x 0.565" Dia.	2.35	2.12	1.99
244822CL	AA-1800-CT	14	AA	1.2	1800	Consumer Tip	0.963" L x 0.565" Dia.	2.35	2.12	1.99
244831CL	4/3AA-1900	7	4/3AA	1.2	1900	Flat Top	1.678" L x 0.553" Dia.	6.89	6.20	5.58
244849CL	1/5A-400	15	1/5A	1.2	400	Flat Top	0.658" L x 0.661" Dia.	2.39	2.15	1.93
244857CL	2/3A-1100	7	2/3A	1.2	1100	Flat Top	1.084" L x 0.662" Dia.	3.59	3.07	2.99
244603CL	2/3A-1100	7	2/3A	1.2	1100	Flat Top	1.083" L x 0.661" Dia.	1.99	1.81	1.71
244864CL	4/5A-1800	7	4/5A	1.2	1800	Flat Top	1.671" L x 0.660" Dia.	3.15	2.97	2.78
244620CL	A-1400	16	A	9	200	Flat Top	1.939" L x 0.664" Dia.	7.79	6.92	6.22
244970CL	A-2200	16	A	1.2	2200	Flat Top	1.965" L x 0.663" Dia.	3.69	3.49	3.25
244873CL	4/3A-2500	7	4/3A	1.2	2500	Flat Top	2.617 L x 0.649" Dia.	5.29	5.01	4.68
244890CL	SC-2900-HD	17	Sub-C	1.2	2900	High Discharge	1.665" L x 0.876" Dia.	6.49	6.04	5.89
244902CL	D-9000	8	D	1.2	9000	Flat Top	2.270" L x 1.279" Dia.	21.44	17.54	16.08
244911CL	D-9000-CT	8	D	1.2	9000	Consumer Tip	2.270 L x 1.279" Dia.	21.44	17.54	16.08



Long-Lasting Rechargeable NiMH Batteries & Chargers

Why buy & throw away hundreds of batteries? Now you can reuse longer-lasting, money saving NiMH rechargeable batteries instead! They feature twice the power of NiCad batteries, so they're ideal for power-hungry devices like digital cameras and camcorders. The chargers below are specifically designed for NiMH batteries.

NiMH Batteries

Part No.	Description	1	10	25	100
231095CL	2x AAA, 600mAh	\$6.95	\$6.25	\$5.65	\$5.05
231087CL	4x AA, 1600mAh	13.95	12.55	11.29	10.19
231116CL	2x C, 3000mAh	10.49	9.45	8.49	7.65
231124CL	2x D, 7000mAh	19.59	17.65	15.89	14.29
231108CL	1x "9V", 150mAh	8.39	7.95	7.59	7.19

NiMH Chargers

231141CL: Compact battery charger with 4 AA batteries

231132CL: Universal battery charger for AAA, AA, C, D and "9V" cells (batteries not included)

- Selector switch for NiCd or NiMH type batteries
- Recharge batteries in single or group
- Automatic charging current selection for different size of batteries
- Fast charging in the specified period with automatic switch for trickle charge
- LED lamp to indicate proper charging
- Built-in IC timer control

Part No.	Description	1	5	10
231141CL	Compact AA charger	\$19.95	\$17.95	\$16.15
231132CL	Universal charger	19.95	17.95	16.15



NiMH & NiCAD Battery Charger

Charge your AA or AAA NiMH and AA NiCAD batteries with this 8-hour battery charger. Simply plug into a wall outlet. Red LED indicates charging and green LED indicates ready to use.

- Charging bay allows 4AA or 4AAA batteries to be charged at the same time (only AA NiCAD)
- Output: 4AA 1.35V @ 250mA or 4AAA 1.35V @ 95mA
- Size: 2.8" x 2.4" x 4.6" • Weight: 1.0 lb.

Part No.	Description	1	10
217533CL	Plug-in charger	\$7.95	\$5.95

TYSONIC NiCAD & NiMH Rapid Charger

Why buy & throw away hundreds of batteries? Now you can reuse and recharge your NiCAD and NiMH batteries and save money. Charger is portable so you can recharge your batteries in your car, office or home, in a fraction of the time it takes standard chargers. Includes 4 AA NiMH batteries, wall adapter, and cigarette adapter. Also includes discharge function.

Part No.	Description	1	10
244638CL	AA or AAA charger	\$21.15	\$20.85





Lead Acid Batteries

- Color-coded terminals
- Sealed
- Rechargeable

- UL approved
- Two-year warranty



155328CL



155336CL



159679CL



218430CL



218376CL

Tempest is an ISO-9001 Certified Company

Part Number	Product Number	Nominal Voltage	Amp. Hrs.	Charging Voltage		Cross Reference			Terminal Size	Size (L" x W" x H")	Wt. (lbs.)	Pricing	
				Standby	Cyclic	Panasonic	YUASA	Eagle Picher				1	10
218309CL	TR1.3-6	6	1.3	6.8-6.9	7.25-7.45	LC-R01R3P	NP01.2-6	CF6V1.6	Quick connect 0.185"	3.8 x 1.0 x 2.0	0.7	\$7.89	\$7.39
155328CL	TR4-6	6	4	6.75-6.9	7.2-7.5	LCR6VP	NP4-6	CF16V4	Quick connect 0.185"	2.8 x 1.9 x 4.0	1.8	10.49	9.25
218317CL	TR5-6A	6	5	6.8-6.9	7.25-7.45	LCR6V4PL	NP4-6	CF6V4.5	Quick connect 0.185"	2.8 x 1.9 x 4.0	2.1	11.45	10.49
218325CL	TR5-6B	6	5	6.8-6.9	7.25-7.45	—	—	—	Spring	2.6 x 2.6 x 3.8	2.2	11.45	10.49
218333CL	TR7-6	6	7	6.8-6.9	7.25-7.45	LC-R067R2P	NP7-6	CF6V7	Quick connect 0.185"	6.0 x 1.3 x 3.8	3.0	12.95	10.29
218341CL	TR8-6A	6	8	6.8-6.9	7.25-7.45	—	—	CF6V8	Quick connect 0.185"	3.9 x 2.2 x 4.5	3.8	14.95	13.59
175054CL	TR10-6	6	10	6.75-6.9	7.2-7.5	LCR6V10P	NP10-6	CFM6V10	Quick connect 0.185"	5.9 x 2.0 x 3.8	4.3	14.49	12.95
218350CL	TR12-6A	6	12	6.8-6.9	7.25-7.45	LC-R0612P	NP10-6	CF6V12	Quick connect 0.185"	5.9 x 2.0 x 3.8	4.6	15.95	12.49
218368CL	TR14-6	6	14	6.8-6.9	7.25-7.45	—	—	—	Wire w/ power connector	4.3 x 2.8 x 5.5	6.0	25.95	23.49
218376CL	TR0.8-12	12	0.8	13.6-13.8	14.5-14.9	—	NP0.8-12	—	Wire w/ power connector	3.8 x 1.0 x 2.4	0.8	15.95	14.49
218384CL	TR1.3-12	12	1.3	13.6-13.8	14.5-14.9	LC-R121R3PU	NP1.2-12	CF12V1.3	Quick connect 0.185"	3.8 x 1.7 x 2.0	1.3	16.49	14.85
159661CL	TR2.3-12	12	2.3	13.5-13.8	14.4-15	LCR12V2.2P	NP2.3-12	CF12V1.5	Quick connect 0.185"	7.0 x 1.3 x 2.3	1.9	16.95	15.25
218392CL	TR2.9-12	12	2.9	13.6-13.8	14.5-14.9	—	—	—	Quick connect 0.185"	3.1 x 2.2 x 3.9	2.5	17.95	16.49
218405CL	TR3.2-12	12	3.2	13.6-13.8	14.5-14.9	LC-R123R4P	NP3.2-12	CF12V3	Quick connect 0.185"	5.3 x 2.7 x 2.4	3.1	19.95	17.95
155336CL	TR4-12	12	4	13.5-13.8	14.4-15	LCR12V4PF	NP412	CF12V4	Quick connect 0.185"	3.6 x 2.8 x 4.0	3.4	17.95	16.19
218413CL	TR5-12	12	5	13.6-13.8	14.5-14.9	LC-R125P	NP5-12	—	Quick connect 0.185"	6.6 x 6.9 x 4.9	21.1	18.49	16.65
155344CL	TR7.5-12	12	7.5	13.5-13.8	14.4-15	LCR12V7.2BP	NP712	CFM12V65	Quick connect 0.185"	6.0 x 2.6 x 4.0	5.9	18.95	17.15
168188CL	TR12-12	12	12	13.5-13.8	14.4-15	PS12120	—	CFM12V12	Quick connect 0.185"	5.9 x 3.8 x 3.8	9.0	30.95	26.95
159679CL	TR18-12*	12	18	13.5-13.8	14.4-15	LCR12V17BP	NPG18-12	CF12V18	Quick connect 0.472"	7.1 x 3.0 x 6.6	13.8	33.95	28.95
218421CL	TR22-12	12	22	13.6-13.8	14.5-14.9	—	—	—	Terminal pad 0.472" Dia.	7.2 x 3.0 x 6.6	15.0	39.95	35.95
218430CL	TR26-12	12	26	13.6-13.8	14.5-14.9	—	NP24-12	CFM12V2	Quick connect 0.649"	6.6 x 6.9 x 4.9	21.1	54.95	48.49
218448CL	TRU1-34	12	34	13.6-13.8	14.5-14.9	—	—	—	Quick connect 0.649"	7.8 x 5.2 x 6.2	25.6	57.95	52.95
218456CL	TR55-14	12	55	13.6-13.8	14.5-14.9	—	—	—	Quick connect 0.629"	9.0 x 5.4 x 8.2	39.7	94.95	88.49
218464CL	TR70-12B	12	70	13.6-13.8	14.5-14.9	—	—	—	Quick connect 0.590"	10.3 x 6.7 x 8.2	55.1	148.95	134.95

*159679CL: Bolt terminals w/ bolt & nut set

Motherboards, Memory & Books

SALE

DIMM and SIMM Memory

Part No.	Mfr. Cross Ref. No.	Pins	Description	1	10
148398CL	4MBX64SDRAM	168	4M x 64 10ns Syn. DRAM DIMM (32MB)	\$16.95	\$15.95
148401CL	8MBX64SDRAM	168	8M x 64 10ns Syn. DRAM DIMM (64MB)	\$28.95 28.50	26.95
148419CL	16MBX64SDRAM	168	16M x 64 10ns Syn. DRAM DIMM (128MB)	\$69.95 65.95	59.95
130729CL	JEEDO7208	72	2M x 32 60ns SIMM EDO module (8MB)	9.95	7.95
130711CL	JEEDO7216	72	4M x 32 60ns SIMM EDO module (16MB)	\$12.79 11.35	10.35
148443CL	JEEDO7232	72	8M x 32 60ns SIMM EDO module (32MB)	43.95	39.59
148451CL	JEEDO7264	72	16M x 32 60ns SIMM EDO module (64MB)	29.95	28.45
75133CL	P361000-XX-6	72	1M x 36 60ns SIMM module (4MB)	12.95	11.65
75096CL	P362000-XX-6	72	2M x 36 60ns SIMM module (8MB)	21.99	19.99
75184CL	P364000-XX-6	72	4M x 36 60ns SIMM module (16MB)	\$28.99 21.95	20.15
75168CL	P364000-XX-7	72	4M x 36 70ns SIMM module (16MB)	\$28.99 24.95	22.55
148460CL	8MBX36-60	72	8M x 36 60ns SIMM module (32MB)	\$48.99 39.95	36.99
41751CL	421000A9B-70	30	1M x 9 70ns SIMM module (3 chips)	3.95	3.45

Now Lower Prices

Celeron 400-700MHz and Pentium III 533-1000MHz

Intel 815E (Solano 2) Chipset

- Phoenix BIOS
 - Windows® Plug and Play compatible
 - Slot 370 type for Celeron 400MHz-700MHz or Pentium® III 533MHz to 1000MHz
 - Supports three 168-pin SDRAM PC100/ PC133 memory upgradeable to 512MB
 - 6 PCI slots and 1 AGP slot
 - On-board I/O controller: 2 EIDE ports that support 4 EIDE devices, floppy drive port that supports LS-120 drive; IRDA port
 - PS/2 female keyboard and mouse; 2 USB ports; DB9 male and female serial ports; DB25 female parallel port; DB15 female game port; 3 audio I/O jacks (modular connectors)
 - 20-pin ATX form factor
 - Size: 12.0"L x 8.8"W • Weight: 3 lbs.
- Includes: Manual and drivers on CD-ROM



SOYO Innovation by design

SALE

Part No.	Product No.	1	10
218835CL	SY-71SA	\$64.95 \$59.95	\$55.95

See the yellow and green highlighted items.

Sale details are on page 2.

Jameco Special Values!

Serial Port Complete

Lakeview Research RS-232 & RS-485 are the most versatile, inexpensive interfaces for linking, but the hardware and programming are often misunderstood. This book provides you with everything you need to design, program, install & troubleshoot the links you set up. (306 pages, 1998)

• Size: 7" x 10" • Weight: 1.3 lbs.

Includes: 3.5" diskette



Part No.	Description	Price
154771CL	Serial Port Complete	\$39.95

Parallel Port Complete

Lakeview Research Hands-on approach to PCs and their connections to parallel ports. This state-of-the-art book offers many tips on how to get the most out of your parallel port. Enhanced (EPP) and extended capabilities (ECP) types are covered. (343 pages, 1999)

• Windows® 3.1 & Windows® 95 • Selecting cables • PC to PC links • Size: 7.0" x 10.0" • Wt.: 1.4 lbs.

Includes: 3.5" diskette



Part No.	Description	Price
138261CL	Parallel Port Complete	\$39.95

ATX 150-Watt

- Output:
+3.3V @ 6A
+5V @ 10A
+12V @ 6A
+5VSB @ 0.72A
-5V @ 0.2A
-12V @ 1A
- 20-pin ATX form factor
- Mating input connector:
suggest using P/N 38050CL
power cord, pg 69 – not included
- Input voltage:
115/230VAC @ 50-60Hz (auto switching)
- Power on/off switch • Built-in fan

Quantity
SAVE

Special
Purchase
LOW LOW PRICE



AT 200-Watt

- Output:
+5V @ 20A
+12V @ 8A
-5V @ 0.5A
-12V @ 0.5A
- Input voltage:
115/230VAC @
50-60Hz (switchable)
- AT compatible connectors
- Mating input connector:
3-prong AC receptacle
with 6' power cord
- Built-in fan



Includes: 6' power cord

ATX 250-Watt + 250-Watt Redundant

- Output:
+3.3V @ 15A
+5VSB @ 1.5A
+5V @ 30A
+12V @ 14A
-5V @ 0.5A
-12V @ 1A
- Hot swappable;
power fail alarm
- Input volt.:
90-264VAC @ 47-63Hz (auto ranging)
- Internal OR-ing diode for redundant operation
- Built-in fan • 20-pin ATX form factor

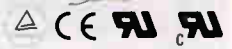

Part No.	Product No.	Description	1	10	25
196189CL	MPW-6150F	150W	\$49.95	\$44.95	\$37.75

Part No.	Product No.	Description	1	10	25
172822CL	AA-230	200W	\$49.95	\$44.96	\$40.46

Part No.	Product No.	1	10	25
201443CL	EPR2251	\$109.49	\$89.95	\$71.44

SALE

150 to 400-Watt PC Power Supplies

Quantity
SAVE

New Lower
Prices

Part Number	Mfr.	Product Number	Power (W)	Output (VDC/A)	Input (VAC @ Hz)	Input Connector (Mating Connector/Cord)	Output Conn. (Mating Conn.)	Certification	Size (L" x W" x H")	Wt. (lbs.)	Pricing		
											1	10	25
201435CL	Xtreme Power	EPA400	400	+3.3/33, +5/45, +12/15, +5VSB/1.5 -5/1.5, -12/1	115/230 @ 47-63 switchable	3-prong AC receptacle with 6' power cord	ATX	UL/CSA/TUV/CE	5.6 x 5.9 x 3.4	5.0	\$109.99	\$89.95	\$59.95
155539CL	American Media	JE2033†	300	+3.3/14, +5/30, +12/8, +5VSB/1.5, -5/0.5, -12/0.5	115/230 @ 50-60 switchable	3-prong AC receptacle with 6' power cord	ATX-13	UL/CSA/TUV	5.9 x 5.5 x 3.4	3.7	69.95	62.95	56.95
155811CL		JE5300	300	+3.3/14, +5/25, +12/12, +5VSB/0.8, -5/0.5, -12/0.5	115/230 @ 50-60 switchable	3-prong AC receptacle with 6' power cord	ATX	UL/CSA/TUV	5.9 x 5.5 x 3.2	4.1	69.95	62.99	56.69
236929CL	Sunpower	SAP6300	300	+3.3/25, +5/30, +12/12, -5/0.5, -12/1, +5VSB/1	115/230 @ 50-60 auto sense	3-prong AC receptacle with 6' power cord	ATX	UL/CUL/TUV/CE	5.5 x 5.9 x 3.4	4.1	54.95	49.45	44.49
201443CL	Etasis	EPR2251*	250/250 Dual	+3.3/15, +5/30, +12/14, +5VSB/1.5, -5/0.5, -12/1	90-264 @ 47-63 auto ranging	3-prong AC receptacle with 6' power cord	ATX	UL/CUL/TUV/CE	7.0 x 3.4 x 9.0	2.6	109.49	89.95	71.44
205938CL	TGR	FA250N16	250	+3.3/14, +5/25, +12/10, +5VSB/3, -5/0.5, -12/1	115/230 @ 50-60 switchable	3-prong AC receptacle (P/N 38050CL, pg 69)	ATX	UL/CUL/TUV/CE	5.5 x 6.0 x 3.5	3.5	21.95	19.39	17.35
152194CL	American Media	JE2031	250	+3.3/14, +5/25, +12/10, +5VSB/1.5, -5/0.5, -12/0.5	115/230 @ 50-60 switchable	3-prong AC receptacle with 6' power cord	ATX	UL/CSA/TUV	6.0 x 5.5 x 3.4	3.5	49.95	44.99	40.49
152514CL	High Power	JE8250	250	+3.3/16, +5/25, +12/10, +5VSB/1.5, -5/0.5, -12/0.5	115/230 @ 50-60 switchable	3-prong AC receptacle with 6' power cord	ATX	UL/CSA/TUV	5.5 x 5.9 x 3.4	3.3	49.95	44.99	40.49
196437CL	Hipro	HP235NLXAK	235	+3.3/14, +5/25, +12/8, +5VSB/0.1, -5/0.5, -12/0.5	115/230 @ 50-60 switchable	3-prong AC receptacle (P/N 38050CL, pg 69)	ATX	UL/CSA/TUV/CE	5.5 x 5.9 x 3.2	3.2	24.99	21.25	15.35
196111CL	SPI	FSP23560GT	235	+3.3/14, +5/22, +12/8, +5VSB/0.8, -5/0.3, -12/0.8	100/240 @ 50-60 switchable	3-prong AC receptacle (P/N 38050CL, pg 69)	ATX	UL/CUL/TUV/CE	5.6 x 5.9 x 3.4	3.2	31.95	28.76	25.89
202788CL	Enhance	SFX2015	150	+3.3/7, +5/12, +12/5, +5VSB/0.8, -5/0.2, -12/0.3	115/240 @ 47-63 switchable	3-prong AC receptacle (P/N 38050CL, pg 69)	ATX	UL/CUL/TUV/CE	5.9 x 3.6 x 3.4	2.1	29.95	26.96	24.26
196189CL	Emacs	MPW-6150F*	150	+3.3/6, +5/10, +12/6, +5VSB/0.72, -5/0.2, -12/1	115/230 @ 50-60 switchable	3-prong AC receptacle (P/N 38050CL, pg 69)	ATX	UL/CUL/TUV/CE	7.5 x 4.0 x 1.6	2.5	44.95	39.76	22.29
132185CL	APS	JE1035	300	+3.3/28, +5/30, +12/10, -5/1, -12/1	110/220 @ 50-60 switchable	3-prong AC receptacle with 6' power cord	IBM AT	UL/CSA/TUV	5.5 x 5.9 x 3.4	4.7	89.95	85.49	81.25
190094CL	Delta	DPS200PB	200	+3.3/20, +5/20, +12/8, -5/0.5, -12/0.5	100-240 @ 50-60	3-prong AC receptacle (P/N 38050CL, pg 69)	IBM AT	UL/CSA/TUV	5.5 x 5.9 x 3.4	3.2	59.95	54.95	49.45
190115CL	API	API-3186S	200	+3.3/20, +5/20, +12/8, -5/0.5, -12/0.5	115/230 @ 50-60 switchable	3-prong AC receptacle (P/N 38050CL, pg 69)	IBM AT	UL/CSA/TUV	5.5 x 5.9 x 3.7	3.5	7.95	7.16	6.44
205639CL	Sunpower	SO-3005	300	+5/30, +12/12, -5/0.5, -12/0.5	115/230 @ 50-60 auto switching	3-prong AC receptacle with 6' power cord	AT	UL/CSA/VOE	5.6 x 5.9 x 3.4	4.1	49.95	44.96	40.46
174465CL	Logic Concept	LC250C	250	+5/20, +12/10, -5/0.5, -12/0.5	110/220 @ 50-67 switchable	3-prong AC receptacle with 6' power cord	AT	UL/CSA/TUV/CE	5.5 x 5.9 x 3.4	2.0	54.95	49.46	44.51
233525CL	Sparkle Power	SPI-230G	230	+5/23, +12/9, -5/0.5, -12/0.5	115/230 @ 50-60 switchable	3-prong AC receptacle (P/N 38050CL, pg 69)	AT	UL/CSA/TUV	5.9 x 5.5 x 3.4	2.0	34.95	31.45	28.29
200694CL	Compaq	OPS-200PB-38	200	+5/22, +12/7, -5/0.15, -12/0.15	110/230 @ 50-60 switchable	3-prong AC receptacle (P/N 38050CL, pg 69)	AT	UL/CSA/TUV	5.5 x 5.9 x 3.5	2.8	10.88	9.89	8.96
172822CL	Mean Well	AA-230*	200	+5/20, +12/8, -5/0.5, -12/0.5	115/230 @ 50-60 switchable	3-prong AC receptacle with 6' power cord	AT	CSA/TUV/CE	6.0 x 4.6 x 3.4	2.6	49.95	44.96	40.46

* See photo above † Pentium 4 rated

Check out our complete line of Power Products including our New Slim-Line Wall Adapters on Pages 112-152.



1.44MB 3.5" Internal Floppy Disk Drives

- IBM PC/XT and higher compatibles
- Compatible with DOS versions 3.3 or higher
- Automatically determines if disk is high or low density
- Size: 4.0"W x 5.9"D x 1.0"H (actual drive size)
- Weight: 1.4 lbs.



Part No.	Cross Ref. No.	Mfr.	Color	1	10
224346CL	JU256A216P*	Panasonic	Gray	\$16.95	\$15.25
115490CL	FD235	TEAC	Beige	21.95	19.95
189165CL	—	Varies	Beige	9.95	8.95
249367CL	MPF920-Z	Sony	Beige	16.95	15.99
224012CL	FD235HF	TEAC	Black	12.95	11.65
200686CL	—	Varies	No Bezel	4.43	4.03

Internal IDE CD-ROM Drives

- 5.25" half-height design
- One-year warranty
- Manufacturer varies



Includes: Audio cable

Part No.	Speed	Buffer	kB/sec.	1	10
149307CL	24x	256kB	3600	\$29.95	\$25.95
189051CL	32x	128kB	4800	29.95	25.95
189069CL	40x	128kB	6000	34.95	29.95
189077CL	48x	128kB	7200	35.95	30.95
189448CL	56x	128kB	8400	39.95	26.48

CD-ROM Audio Cables



Part No.	Connection from Sound Blaster to	Length	1	10	50
127546CL	Sony/MPC2	25"	\$2.95	\$2.65	\$2.29
168612CL	Universal	18"	4.95	3.99	3.29

CD Laser Lens Cleaner

- 6-language voice guide instructions
- Single brush wet-dry cleaner
- Removes accumulated oils, dust and debris from CD optical lens



Part No.	Description	1	10	25
228531CL	CD laser lens cleaner	\$9.99	\$8.99	\$7.39

CD Accessories



Part No.	Description	1	5	10
249447CL	48x/700MB/80 min./100 pk.	\$29.95	\$28.45	—
172179CL	Single jewel case	.40	.36	.31
208514CL	Paper envelope 25 pk.	2.49	2.15	1.59
208493CL	Slim asst. color 10 pk.	3.95	3.75	3.49

Business Card CD-R Kit

Differentiate yourself or your business from others. This kit includes 12 50MB capacity CD-R and sleeves, 16 labels and label design software. A great way to promote your business in trade shows and exhibits. Easy to carry and cost-effective.



Part No.	Description	Price
249308CL	Business Card CD-R kit	\$5.95

IDE, EIDE & SCSI Hard Drives and Mounting Kits

PC/XT/AT and Compatibles

- Manufacturers may vary and capacity may exceed specification; we carry Seagate, Western Digital, IBM and others.



Part No.	Capacity	Description	Conn. Pins	Wt. (lbs.)	Average Access Time (ms)	Warranty	1	10
115764CL	425MB	3.5" LP IDE	40	1.7	12.5	3 mos.	\$59.95	\$53.95
118949CL	850MB	3.5" LP IDE	40	1.7	14	1 year	59.95	53.95
124978CL	1.27GB	3.5" LP IDE	40	1.1	14	1 year	59.95	53.95
146325CL	1.7GB	3.5" LP IDE (Fast ATA-2)	40	1.1	12	1 year	39.95	35.95
146333CL	2.5GB	3.5" LP EIDE (Fast ATA-2)	40	1.0	11	1 year	69.95	62.95
151036CL	3.2GB	3.5" LP EIDE (Ultra DMA33)	40	1.1	11	1 year	35.00	29.00
151044CL	4.3GB	3.5" LP EIDE (Ultra DMA33)	40	1.1	11.5	1 year	49.95	45.95
162261CL	8.45GB	3.5" LP EIDE (Ultra DMA33)	40	1.2	9.5	1 year	89.95	69.95
200651CL	10.2GB	3.5" LP IDE	40	1.1	9.5	3 mos.	78.65	71.50
200660CL	13.0GB	3.5" LP IDE (ATA-4)	40	1.1	9.5	3 mos.	87.15	79.20
200678CL	15.0GB	3.5" LP IDE	40	1.1	9.5	3 mos.	79.00	72.99
200803CL	17.2GB	3.5" LP IDE	40	1.1	9.5	3 mos.	79.95	71.95
197579CL	4.0GB	3.5" HH Fast SCSI-II (1.5")	50	1.3	8.0	3 mos.	35.30	32.09
189914CL	9.1GB	3.5" LP Ultra-wide SCSI SCA	80	1.4	5.0	3 mos.	60.00	54.00

Removable IDE HDD Enclosure for 5.25" Drive Bay

Easily remove a hard drive from your PC or workstation, safeguard your data and an ideal way to back-up data. Because rack kit is hot removable, you can remove your hard drive without shutting down your computer operations. Aluminum case transfers heat away from the drive for longer & more reliable drive life.



- 5.25" rack kit for 3.5" hard drives
- Drive activity LED
- Built-in fan
- Aluminum rack
- Keylock for security

Removable IDE HDD Enclosure For 5.25" Drive Bay

- Supports DMA 66 hard drive
- Retaining lock mechanism
- 12VDC @ 50mA fan
- CFM rating: 5.6
- Size: 5.9"W x 8.7"D x 1.6"H
- Weight: 1.3 lbs.



Part No.	Description	1	10	25
211035CL	Enclosure kit (IDE)	\$29.95	\$26.95	\$23.95

Removable IDE HDD Enclosure For 3.5" Drive Bay

- For quick drive swapping
- Power LEDs
- Keylock for security



Part No.	Description	1	10	25
196040CL	IDE encl. w/ insert...	\$27.95	\$20.95	\$14.69
196031CL	Insert for 196040CL...	19.95	16.99	12.99

Front Panel Access Ports

Enjoy easy up front access to all your most used ports, including USB, IEEE 1394, audio, and serial ports, without moving the PC.



Tower not included

Part No.	Description	1	10
208004CL	2 USB; 1 IEEE 1394; Line-In; Line-Out; RS232 (9-pin male)	\$34.95	\$32.45
213532CL	4 USB; Line-In; Line-Out	18.95	16.95

PCMCIA Card Drive For Desktop PC

Now you can have a PCMCIA drive on your desktop PC. Supports SRAM cards, FLASH cards, LAN cards and FAX/MODEM cards.



- Jumper selectable for 4 drives
- Supports DOS 5.0 or later, Windows 3.1 or later
- Supports Type I/II/III PCMCIA cards

Part No.	Description	1	10
210999CL	PCMCIA drive	\$69.95	\$49.95

External IDE HDD Enclosure with Parallel Interface

An external HDD enclosure for IDE hard drives with a parallel port interface to be connected to a PC or laptop. No drivers needed. Windows® 98 and above will automatically detect hard disk drive.



- Parallel port interface
 - Built-in fan and 110V power supply
- Includes: Parallel cable and power cord
- | Part No. | Description | 1 | 5 |
|----------|------------------------|---------|---------|
| 249316CL | HDD external enclosure | \$19.95 | \$15.95 |

Harman/Kardon Multimedia Amplified System

- 4.5W RMS per amplified speaker
- Transducer: 3" full range driver, magnetically shielded
- Freq. range: 90Hz to 20kHz
- Volume control, bass and treble control, LED indicator and headphone jack
- Size: 8.5"H x 4.5"W x 5.0"D • Weight: 4.7 lbs.



Includes: 16VAC @ 1A power supply

Part No.	Description	1	10
211001CL	H/K speaker system	\$42.95 \$0.49	\$7.85

480-Watt Multimedia Speakers

- Input voltage: 120VAC
- 2 magnetically shielded speakers
- 2-channel stereo amplifier
- Push button type power switch with LED indicator
- Knob controls for volume, bass & treble
- Size: 5.5"W x 7.0"D x 9.1"H • Weight: 5.3 lbs.



Part No.	Description	1	10
196066CL	480W speakers	\$39.95	\$35.95

Hands-Free Condenser Microphone

- Cord length: 8'
- Connector: 3.5mm male stereo plug
- Size: 1.9"L x 1.2"W x 0.3"H
- One-year warranty



Part No.	Description	1	10	50
135247CL	Microphone	\$4.49	\$3.99	\$3.49

U.S. Robotics® Wireless Audio Broadcast System

Why limit your music's reach when you can listen to your favorite tunes anywhere. Release your MP3s and Internet radio from the confines of your computer and listen to them in HI-FI on stereo from the living room. Simply plug the transmitter into a music source (PC/MP3 player, CD/DVD, etc.) and either plug the receiver unit into your stereo's audio input or simply set your FM tuner to 88.1 or 88.3 station.



- Listen and enjoy internet radio/audio on your home stereo or any FM receiver
- Freedom to rebroadcast music where you are
- Transmits on 900MHz frequency up to 1000'
- Compatible with any audio device's 3.5mm or RCA output jack
- Size: (transmitter) 3.8"H x 4.9"W x 4.0"D; (receiver) 3.7"H x 4.9"W x 3.7"D
- Weight: 2.2 lbs.

Includes: Two 6VDC @ 100mA power supply, 3.5mm stereo cable, 3.5mm to RCA cable and RCA cable

Part No.	Description	1	5
210981CL	Wireless audio system	\$43.18 \$39.25	

World Famous Boston Acoustics Self-Amplified Speaker and Subwoofer System

The key to this 3-piece outstanding speaker system is the 2 1/2" satellite speakers that deliver rich mid and high frequency response. Boston Acoustics employs advanced computer modeling to design drivers that reproduce seven audible octaves with remarkable accuracy and smoothness. The satellite speakers come with their own stand and MagnaGuard magnetic shielding to prevent video interference. The subwoofer delivers a robust room-filling sound that compliments the satellite speaker output.



Boston Acoustics computer modeling to design drivers that reproduce seven audible octaves with remarkable accuracy and smoothness. The satellite speakers come with their own stand and MagnaGuard magnetic shielding to prevent video interference. The subwoofer delivers a robust room-filling sound that compliments the satellite speaker output.

- Frequency response (±3dB): 56Hz - 20kHz
- Maximum sound pressure level: 104dB
- Cross over frequency: 240Hz
- Master volume/power & sub-woofer volume switch
- Satellite speaker size: 3.3"L x 3.3"W x 3.5"H
- Subwoofer speaker size: 7.8"L x 6.0"W x 7.0"H
- Weight: 6.0 lbs.

Includes: 12VAC @ 2A power supply

Part No.	Description	1	5
213911CL	Speaker/subwoofer system	\$47.25 \$43.50	\$39.50

Mice & Trackballs

PS/2 2-Button No Tail Mouse

Perfect mouse for laptop and mobile power users. Extract cable to desired length in small spaces thus eliminating tangle and loose cables. Cable retracts into the body of the mouse for compact storage and mouse is switchable from PS/2 to serial.



- Retractable cable for laptop and power notebook users
- Switch selectable from PS/2 to serial mouse
- Adjustable to perfectly fit your limited computer work area • Size: 4.5"L x 2.4"W x 1.1"H

Includes: PS/2 to serial adapter, retractable RJ11 modem cable, and carrying case

Part No.	Description	1	10
213330CL	PS/2 mouse	\$6.25 \$4.95	\$4.50

Single Button Apple Mouse

- 275 CPI resolution
- Soft, quick, responsive mechanical click button
- ADB connector
- 29' cord
- Size: 4.8"L x 2.4"W x 1.2"H
- One-year warranty



Part No.	Description	1	10	25
150480CL	Single button	\$15.29 \$14.47	\$13.15	\$11.96

3-Button Serial Mouse

- Microsoft® mouse compatible
- IBM PC/XT and higher compatibles
- Size: 4.3"L x 2.3"W x 1.2"H



Part No.	Description	1	10	50	100
104441CL	Serial mouse	\$4.75	\$4.35	\$3.95	\$3.50

PS/2 3-Button Mouse

- Basic 3-button mouse
- PS/2 connector (6-pin mini DIN)
- 48" cord
- High resolution and excellent tracking
- Fully compatible with all operating systems
- Size: 4.8"L x 3.5"W x 1.8"H



Part No.	Description	1	10	50	100
233322CL	PS/2 mouse	\$4.95	\$4.49	\$4.05	\$3.65

Trackball with Menu Software

- Detachable wrist support
- Variable resolution (20-6400dpi)
- One million cycle life tactile switches • 3.5" disk
- Ergonomic design
- Size: 5.5"L x 4.6"W x 2.0"H
- Weight: 1.2 lbs.



System requirements: IBM PC/XT & higher compatible systems; MS DOS 3.3 or later, Windows® 95 & higher

Part No.	Description	1	10	25
128995CL	LIBRA 90 MP NET	\$29.95	\$26.95	\$24.25

Mini Mouse Pad

- Tough non-skid neoprene backing • Size: 7.0"L x 5.5"W
- Smooth-gliding cloth surface on top



Part No.	Description	1	10	100
121363CL	Mini mouse pad	\$2.95	\$2.55	\$1.89

Mouse Pad/USB Label Printer

Labeling envelopes, binders and files is one-click easy! This combination mouse pad and mini-printer makes labeling chores simple. Just highlight the text in your document, or type labels directly and your 18mm label pops out, ready-to-use.



Part No.	Description	Price
235483CL	Mouse pad label printer	\$19.95 \$14.95

QTRONIX. USB or PS/2 3-Button Optical Wheel Mouse

- Ergonomic style 3-button optical wheel mouse
- High tech optical sensor for all surface types
- Size: 3.9"L x 2.3"W x 1.5"H
- Weight: 0.2 lbs.



System requirements: IBM PC or compatible, Windows® 98/2000/XP, available PS/2 or USB port

Part No.	Description	1	10	25
199591CL	LYNX-LVII	\$29.95	\$26.95	\$24.25

QTRONIX. 104-Key Keyboard with Jumbo Trackball



- PC/AT and PS/2 compatible w/ DOS 3.0 or higher
- "N-Key" roll-over for quick typists
- Tactile click sound and feel
- One-year warranty
- Windows® 95 compatible
- Size: 19.0"L x 6.8"W x 1.4"H
- Weight: 3.7 lbs.

Includes: Software and AT cable adapter

Part No.	Description	1	10	25
128717CL	Scorpius 35PM/NET	\$99.95	\$90.95	\$84.95

QTRONIX. 108-Key Compact Keyboard



- IBM PC PS/2 or higher compatible
- Use adapter P/N 85500CL, pg 68 for AT systems
- LED indicator for Num, Caps, and Scroll Lock
- 12 function keys
- High quality rubber mechanical key switches
- Size: 15.5"L x 6.5"W x 1.1"H • Weight: 1.9 lbs.

Part No.	Description	1	10	25
180347CL	Scorpius 2KP	\$39.95	\$35.95	\$32.49

COMPAQ. 101-Key Keyboard



- For PS/2 systems • Tactile touch
- 12 function keys with separate cursor & numeric keys
- LED indicators for Num, Caps, and Scroll lock
- Recommend using adapter P/N 85500CL, pg 68 or P/N 159089CL, pg 85
- Size: 18.3"L x 6.5"W x 1.3"H • Weight: 3.6 lbs.

Part No.	Description	1	10	25
191530CL	101-key keyboard	\$18.95	\$16.95	\$14.95

Gateway. 104-Key USB Keyboard



- For PC's with USB ports • Soft-touch key
- 12-function keys with separate cursor and numeric keypad • Windows® compatible
- Extra USB ports on side and rear
- LED indicator for Num, Caps, Scroll Locks
- Multifunction keys for email, multimedia functions, sound
- Windows® start menu key
- Size: 18.6"L x 7.8"W x 1.4"H • Weight: 3.8 lbs.

Part No.	Description	1	10
263521CL	USB keyboard	\$16.25	\$15.45

Space Saver Keyboards

Full featured AT & PS/2 mini keyboards save valuable desktop space.



Standard Keyboard

Mini Keyboards save up to 30% desk space!

- Adjustable tilt mechanism
- Tactile key stroke
- LED indicators for Num, Caps, and Scroll lock

114868CL



199718CL: 83-key keyboard

- For PS/2 systems
- Auto repeat
- N-key rollover
- Size: 12.8"L x 6.2"W x 1.0"H
- Weight: 1.9 lbs.

SALE

199718CL



114868CL: 84-key keyboard

- For AT systems, designed for Windows® 95
- Size: 12.8"L x 6.6"W x 1.0"H
- Weight: 2.4 lbs.

211756CL

211756CL: 88/89-key keyboard w/ touch pad

- For AT systems, designed for Windows®
- Built-in touch pad and embedded keyboard
- Soft touch membrane contact
- Size: 11.4"L x 8.5"W x 1.2"H • Weight: 2.3 lbs.

Part No.	Description	1	10	25
199718CL	83-key PS/2	\$49.95	\$45.95	\$37.95
114868CL	84-key AT	49.95	44.95	38.95
211756CL	88/89-key AT	59.95	53.95	48.95

Illuminated Computer Keyboard

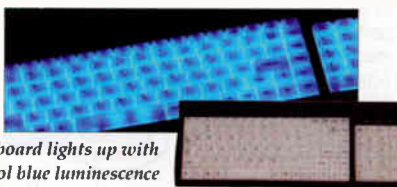

Keyboard lights up with a cool blue luminescence

Work or play under any lighting conditions with this unique, trendy keyboard. Lit with a cool blue luminescence, all keys on this PS/2 peripheral are instantly identifiable, even in total darkness. Why break the mood of your favorite game with harsh overhead lighting, when you can keystroke with perfect, futuristic, illuminated accuracy?

- Size: 15.3"L x 5.9"W x 1.3"H • Weight: 1.7 lbs.

Part No.	Description	Price
235563CL	Illuminated computer keyboard	\$79.95



EyeD OptiMouse with Biometric Recognition Software – Page 237

EyeD Hamster USB Fingerprint Scanner – Page 237



Sun 104-Key Keyboard



- For PS/2 systems • Windows® 95 compatible
- Unmarked window keys • Size: 18.2"L x 7.0"W x 1.5"H
- LED indicators for Num, Caps and Scroll Locks
- 12 Function keys w/ separate arrow & numeric keys
- Tactile feedback • Tilt mechanism • Wt.: 2.7 lbs.

Part No.	Description	1	10	25
173649CL	104-key keyboard	\$12.95	\$9.75	\$6.85

QTRONIX. Keypads

- Tactile click-sound and touch
- 2-key rollover
- Auto repeat function
- One-year warranty
- 265375CL: 22-key serial
- Serial DB9 connector
- Size: 6.2"L x 4.2"W x 1.3"H
- Weight: 0.8 lbs.

265375CL

NEW

151811CL

System requirements: IBM PC/XT or higher compatibles; and MS DOS 3.X

Includes: 3.5" driver diskette and manual

151811CL: 17-key PS/2

- Switch life of 20 million cycles
- Installs into 6-pin mini DIN keyboard connector (no software required) • Size: 5.6"L x 3.4"W x 0.9"D

Part No.	Description	1	10	25
265375CL	Scorpius 22RB	\$39.95	\$35.95	\$32.49
151811CL	Scorpius 20PB	34.95	31.49	27.95

Wireless RF Keyboard and 3-Button Scroll Mouse



Stop struggling with cords that catch and tangle. It provides the performance of corded peripherals without needing a clear path or pointing the mouse and keyboard at the computer. This convenient and compatible keyboard provides one-touch Internet access. Simply plug-in the receiver to your PS/2 interfaces.

Keyboard: 104/105 keys enhanced Windows® layout • 16 internet/media hot key • 27MHz wireless radio frequency

3-Button Scroll Mouse:

- Opto-mechanical technology and 27MHz wireless radio frequency • Resolution: 400 dpi

System Requirements: 2 PS/2 ports, CD-ROM, sound blaster compatible card, Windows® 95/98/2000/ME/NT

Includes: 4-AA for receiver and mouse; user's guide, and CD-ROM software

Part No.	Description	Price
233381CL	RF Wireless keyboard and mouse	\$29.95

We'll match the print advertised price of any like product. It's that simple!

Jameco's Low-Price Guarantee



Glare Free Document Light and Holder

This ergonomically-designed document light and holder reduces glare, while creating a well-lit work area. Optometrists recommend the Eclipse Document Light, especially if you work for more than two hours a day. Attaches to either side of your computer monitor. Secure the cord to the back of the computer for clutter-free desk, turn on the energy efficient 10,000-hour bulb, and you will immediately notice the difference. Swings out of the way when not in use; adjustable height. Contemporary design blends in with any office decor.



SALE

Part No.	Description	Price
224311CL	Glare free document light and holder	\$39.95 \$23.95



Glare Free Eclipse Executive Computer Light

Give your eyes a break!

The Eclipse Executive Computer Light helps prevent glare, which is a cause of eyestrain. Ergonomically designed and attaches to the top of your monitor providing glare free indirect lighting. Reduces headaches, eyestrain, and over all fatigue while you work.



SALE

- Mounts easily to monitors
- Low energy usage
- 13-Watt fluorescent bulb (included) last up to 10,000 hours
- Detachable power cord
- Size: 10"L x 4"W x 8"H
- Five-year limited manufacturer's warranty

• 110V@60Hz
• Silver graphite color

Part No.	Description	Price
224303CL	Eclipse executive light	\$38.49 \$31.95

USB Color Video Camera

- Plug & Play compatible
- Sensor: 1/3" CMOS
- 640 (H) x 480 (V) pixels
- Minimum illumination: less than 15 lux
- Integrated lens: F2.0
- Resolution and output performance: VGA (640 x 480) up to 10 frames per second
- Size: 3.6"L x 2.1"W x 2.0"H • Weight: 0.4 lbs.



System requirements: Pentium® 166MHz, 16MB of RAM, Windows® 98, USB port
Includes: CD-ROM drivers

Now Lower Prices

Part No.	Description	1	10
204134CL	USB color video camera	\$18.99 \$14.85	\$13.50

ISA 16-Bit VGA Card

- Supports 16 colors; requires 1MB video RAM
- Supports VESA standard graphics and text modes
- Emulates VGA, EGA, CGA, MDA & Hercules modes
- 1024 x 768 resolution in non-interlaced/interlaced modes • Output HDDB15 female (analog)
- On board memory



Requirements: IBM AT and higher compatibles

Includes: Software and manual

Part No.	Description	1	10	25
104660CL	VGA card	\$49.95	\$44.95	\$39.95

PCI Graphics Accelerator Card

- High performance Savage IX 8MB PCI graphics accelerator
- 800K polygon/sec
- Supports texture, transparency, blending, wrapping and mirror, fogging and blending, point sampled, linear & bi-linear texture filtering
- Built-in direct draw accelerator & NTSC/PAL video encoder • 14-bits resolution in IDCT transformation
- Supports per pixel texture perspective correction and Z & alpha buffer
- Size: 5.2"L x 2.2"W • Weight: 0.4 lbs.



Now Lower Prices

Part No.	Description	1	10
248840CL	PCI accelerator card	\$39.95 \$31.95	

Pro-Video Editing Controller at Breakthrough Price

CommandPost is a pro-quality video-editing controller for your favorite video/multimedia applications at a new breakthrough special purchase price. Working with your favorite video/multimedia applications has never been easier or faster. Now the most popular controls such as jog wheel, fader, etc., from professional non-linear editors, DVEs and DDRs are brought to your desktop. Includes a free copy of VideoWave Version 4.0 video editing software plus templates for most popular video and graphics applications, including Videonics Effetto Pronto, Apple iMovie, Apple Final Cut Pro, Adobe Premiere, Adobe After Effects, and Digital Origin EditDV.

- Concentric jog/shuttle control
- Centering joystick with pushbutton
- Internally illuminated for readability in darkened edit rooms
- Fader arm, 15 tactile push-button switches
- Supports standard or user-defined keysets
- Easy assignment of control sequences and keyset names

System requirements: USB 1.1 compliant PC: Windows® 98 or 2000, Pentium® 133 or higher, 5MB RAM minimum. 8MB minimum hard disk space. MAC: O.S. 8.6 or higher, Power PC, 10MB of RAM minimum, 5MB min. hard disk space

Part No.	Description	Size	Weight	Price
220329CL	CommandPost	1.5"W x 10.0"W x 7.0"D	2.0 lbs.	\$29.95



AverKey Pro PC to TV Converter Box

- Converts VGA video or Macintosh® 640 x 480 to standard NTSC
- Built-in flicker filter
- Resolution: 800 x 600
- TV brightness control
- Compatible w/ Microsoft® Windows® 3.0 and higher
- Size: 6.0"L x 4.0"W x 1.0"H • Weight: 2.2 lbs.



• Two-year warranty

System requirements: VGA-based PC, DOS 3.0 or higher, 640kB RAM or larger

Includes: Compact PC to video converter box, transformer, cables and manual

Part No.	Description	1	10
167193CL	Video signal pro	\$109.95	\$99.95

15" SVGA Color Monitor

- 0.28mm dot pitch
- Resolution: 1280 x 1024 @ 60Hz
- Digital panel control
- Input voltage: 100-240VAC, 50/60Hz (auto switching)
- Power, contrast, brightness, horizontal/vertical size position, recall & trapezoid front control • Weight: 45 lbs.
- HDDB15 male connector • UL/CSA/TUV approved
- Size: 14.5"W x 16"D x 14.6"H • Refurbished



Requirements: IBM PC/XT or higher compatibles
Includes: Power cable, tilt and swivel base

Part No.	Description	1	10
153306CL	13.5" monitor viewable †	\$99.95	\$89.95

14" SVGA Color Monitor

- 13" diagonal view
- 0.28mm dot pitch
- HDDB15 male connector
- Power, contrast, brightness, horizontal/vertical position, recall & trapezoid knobs
- Resolution: 1152 x 864 @ 60Hz
- Input voltage: 100-240VAC @ 50-60Hz
- Size: 14.2"W x 14.6"D x 13.5"H
- Weight: 25 lbs. † Refurbished



Requirements: IBM PC/XT or higher compatible
Includes: Power cable, tilt and swivel base

Part No.	Description	1	10
174537CL	13" monitor viewable †	\$69.99	\$64.99

PCI 32-Bit Sound Card

Listen to music come alive using the analog four-speaker output - even if your sound source doesn't support 3D sound! Utilizes the same EMU10K1 audio processor as the Sound Blaster Live, the most powerful audio chip available today. This translates into higher frame rates in your games, more bandwidth for 3D audio and an all-around fantastic sounding audio experience.

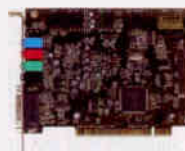

- Operating system: Windows® NT 4.0 or 95/98
- Connectors: 2 audio line-out/mini-phone stereo 3.5 mm F, 1 microphone input/mini-phone mono 3.5 mm F, 1 audio line-in/mini-phone stereo 3.5 mm F, 1 game port/MIDI generic DB-15 F
- Max sampling rate: 48 kHz

Includes: CD-ROM drivers

Part No.	Description	1	5
249404CL	PCI sound card	\$36.95	\$35.19

New



ISA High-Speed 4-Port Serial I/O

SALE

Quad 16C650 Serial Ports

- 32-byte FIFO
- 16-bit ISA interface
- MS-DOS, Windows 3.x, 95 and NT compatible
- Four 16C650 ultra high-speed serial ports
- Supports COM 1-8 & IRQs 3-15 (jumper selectable)
- Size: 6.2"L x 4.3"W
- One-year warranty
- Weight: 1.2 lbs.

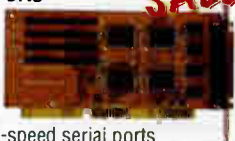

System requirements: IBM PC/AT & AT compatibles
Includes: 37-pin male to 4 DB25M cable and manual

Part No.	Product No.	1	10
152291CL	4042A	\$41.84 \$35.23	\$32.07

ISA 2-Port High-Speed Serial I/O

Dual 16C550 UART Ports

- 16-byte FIFO
- Transfer rates up to 921kb/sec.
- Dual high-speed serial ports
- 2 DB9 male connectors
- IRQ (3, 5, 7, 9, 10, 11, 12, 15) and address jumper configurable
- Size: 5.0"L x 2.7"W
- Weight: 0.5 lbs.



System requirements: 486/586 and higher compatibles; Windows® 95/98/NT/2000

Includes: Manual and drivers on CD-ROM

Part No.	Description	1	10
171555CL	Dual serial	\$24.95	\$21.85

ISA 4-Port Serial I/O

Quad 16C550 Serial Ports

- High-speed 16C550 UARTs with 16 or 32-byte FIFO
- 4 serial ports; 2 each DB9M and DB25M
- IRQs: 3, 4, 5, 9, 10, 11, 12, or 15
- Supports IRQ sharing
- Weight: 0.7 lbs.
- One-year warranty



COM Address	COM Address
1 3F8	5 3F0
2 2F8	6 3E0
3 3E8	7 2E0
4 2E8	8 260

System requirements: IBM AT & higher compatibles

Includes: DB25 male and DB9 male panel bracket assembly and instruction sheet

Part No.	Description	1	10
132572CL	4-port hi-speed serial	\$59.95	\$53.95

PCI Ultra High-Speed Parallel

Single Ultra High-Speed Port

- Supports ECP and EPP
- 32-byte FIFO
- Transfers data up to 2MB/sec.
- Supports IRQ sharing
- Plug & Play ready
- 1 DB25 female connector
- 32-bit PCI interface
- Size: 4.7"L x 2.2"W
- Weight: 0.5 lbs



System requirements: 486/586 and higher compatibles; Windows® 95/98/NT/2000

Includes: Manual and drivers on CD-ROM

Part No.	Description	1	10
171926CL	PCI single parallel	\$39.95	\$35.95

ISA 2-Port Parallel

21.4MB/Sec. Bidirectional

- Supports EPP/ECP/SPP+BPP/ECP+BPP
- Supports 770kB/sec. transfer rate in EPP/SPP/BPP modes
- IRQ: 3/4/5/7/9/10/11/12/15 and address selectable per port
- Compatible with color printers, scanners, plotters, ZIP drives and MP3 players
- 1 external DB25 female connector and 1 internal 26-pin male header
- Weight: 0.6 lbs.



New Lower Prices

System requirements: 75MHz or higher compatible, 32MB RAM, 16-bit ISA slot, Windows® 95/98/ME/NT/2000

Part No.	Description	1	10	25
132214CL	2-port parallel	\$29.95 \$23.85	\$21.58	\$18.71

ISA Single-Port Parallel

Single Bidirectional Parallel Port

- Single standard and bidirectional port
- Jumper selectable for printer address and port (LPT1 - LPT3)
- Jumper selectable for IRQ addressing (3, 4, 5, 7, 9)
- Size: 4.0"L x 2.0"W
- One-year warranty



System requirements: PC/XT/AT and higher

Part No.	Description	1	10	25
155660CL	Printer card	\$19.95	\$17.95	\$14.95

PCI Ultra High-Speed I/O

Serial 16C550 and Parallel Port

- 32-bit PCI bus with PCI bus 2.1 specification compliant
- Serial ports are software configurable with throughputs up to 921.6kbps
- BPP/SPP mode compliant
- Windows® 95/98/NT 4.0 drivers supported
- 169594CL: 2 serial DB9M on card and 1 parallel DB25F panel bracket assembly



SALE

Part No.	Description	1	10
146691CL	Single parallel	\$39.95 \$23.95	\$21.95
163707CL	Dual parallel	\$49.95 28.95	25.95
146667CL	Dual serial (16C550)	38.95	36.95
169594CL	2 serial (16C550) and 1 parallel	59.95	53.95

PCI 4-Port I/O

2 Serial 16C650 and 2 Parallel ECP/EPP/SPP/BPP Ports

- Plug & Play compliant
- Serial port: SUN1889 chipset; 32-byte FIFO; compatible with 16C450/550/650 chip; RS-232 IEEE standard interface; 921kb/sec. transfer rate
- Parallel port: SUN1689 chipset, 32-byte FIFO; ACC3203/ST78C36/HT6535 compatible chips; ECP/EPP/SPP IEEE standard interface; 2Mb/sec. transfer rate
- 2 DB9 male connectors and 2 DB25 female connectors
- Size: 4.7"L x 3.6"W
- Weight: 0.8 lbs.

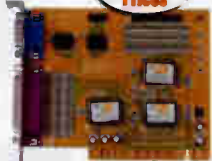

New Lower Prices

System requirements: 486/Pentium® & higher comp. Windows® 95/98/NT/2000; available PCI slot

Part No.	Description	1	10
173260CL	PCI 4-port	\$69.95 \$48.17	\$41.98

PCI High-Speed Multi-Port Serial I/O

2, 4 or 8 16C650 Serial Ports

- 32-byte FIFO
- Plug & Play compatible
- Standard RS-232 interface
- Transfer rate: up to 921kb/sec.
- Supports RQ sharing



172005CL: Dual 16C650 Serial Ports

- Two DB9 male connectors
- Size: 4.7"L x 2.8"W
- Weight: 0.5 lbs.

Includes: Manual and drivers on CD-ROM and floppy

171547CL: Quad 16C650 Serial Ports

- Size: 4.7"L x 2.8"W
- Weight: 0.9 lbs.

Includes: Manual, cable (37-pin male to 4 DB25 male) and drivers on CD-ROM

171660CL: Eight 16C650 Serial Ports

- Size: 6.5"L x 3.6"W
- Weight: 1.8 lbs.
- Includes: Manual, internal cable with bracket, 2 cables (37-pin male to 4 DB25 male) and drivers on CD-ROM

System requirements: 486 and higher compatibles, Windows® 95/98/NT/2000

Part No.	Description	1	10
172005CL	2-port PCI serial	\$69.95 \$48.45	\$43.65
171547CL	4-port PCI serial	129.95	116.95
171660CL	8-port PCI serial	179.95	161.95

PCI Single-Port Serial I/O

Single 16C550 Port

- Plug & Play ready
- Transfer rates up to 921kb/sec.
- 32-bit PCI bus interface
- 32-byte FIFO
- Supports IRQ sharing
- Size: 4.8"L x 1.8"W
- One-year warranty

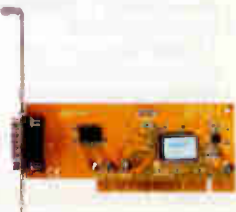

System requirements: 486/Pentium® and higher compatibles; Windows® 95/98/NT/2000

Part No.	Description	1	10
171361CL	Single serial	\$38.95	\$35.95

ISA 2-Port High-Speed Serial I/O

Dual 16C650 Serial Ports

- 32-byte FIFO
- IRQ (3, 5, 7, 9, 10, 11, 12, 15) and address jumper configurable
- DB9 male connector
- Size: 5.0"L x 2.0"W

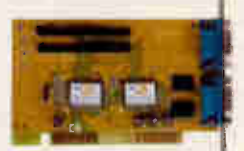

System requirements: 486/586 or higher compatibles, Windows® 95/98/NT

Includes: Manual and drivers on CD-ROM

Part No.	Description	1	10
172380CL	Dual serial	\$49.95 \$18.95	\$17.59

SALE

PCMCIA RS-232 Interface

PC card/PCMCIA-based serial port card.

- Low cost single port RS-232 interface
- Uses 16550 UART
- 5, 6, 7 or 8 data bits
- Odd, even or no parity
- 115k baud data rates
- PCMCIA type II compliant
- Configured as COM1, COM2, COM3 or COM4
- Drivers not available for Windows® XP



Now Lower Prices

Includes: 1' cable

Part No.	Description	1	10
164451CL	PCM-COM232 card	\$118.95 \$97.95	\$82.95

ISA IDE Super 16-Bit I/O Plus

Supports 2 IDE and 2 Floppy Drives

- Parallel printer port interface (P/N 131318CL is bidirectional)
- Game port
- Two RS-232 serial ports
- UART emulation: 67061CL: 16450; 131318CL: 16550
- Weight: 0.9 lbs. • One-year warranty



131318CL

Includes: Manual and cables

Part No.	Description	1	10
67061CL	16450 UART I/O	\$14.95	\$13.49
131318CL	16550 UART I/O	29.95	26.95

ISA Fast SCSI-II Controller

- Compatible with DOS, Windows®, Windows® NT, Windows® 95, OS2 Netware, and SCO Unix
- Internal and external SCSI-II connectors
- Size: 6.3"L x 2.9"W • Weight: 0.6 lbs.
- One-year warranty



SALE

Includes: Setting sheet, ribbon cable, and 3.5" disk

Part No.	Description	1	10
149294CL	ISA SCSI-II controller	\$44.95	\$39.95

ISA Controller Card

- 16-bit data transfer which is fully compatible with IBM PC/AT interface
- Supports two floppy disk drives (360k, 720k, 1.2Mb, 1.44Mb)
- Controls two "AT BUS" hard disk drives
- High bandwidth host interface works up to 16MHz host I/O clock • Size: 5.5"L x 2.1"W



SALE

Part No.	Description	1	10
206316CL	ISA controller card	\$19.95	\$15.95

PCI Ultra-II SCSI Controller

- AIC-7890AB chipset
- Windows® 95/NT, NetWare, OS/2 compatible
- Plug & Play design
- Internal/external Ultra-II SCSI 68-pin connectors
- Supports Ultra-II SCSI peripherals at speeds up to 80Mbytes/sec. or Ultra/UltraWide peripherals up to 40Mbyte/sec.
- Supports up to 15 SCSI peripherals
- Size: 6.0"L x 3.5"W • Weight: 0.3 lbs.



SALE

Part No.	Description	1	10
191513CL	Ultra-II SCSI	\$105.49 \$69.95	\$53.65

PCI GPIB IEEE-488.2 Board

PCI Bus

- 1 MB/s transfer rate
- 1024 word FIFO buffer
- 7 interrupt lines, shared interrupt capability
- IEEE 488.2 standard interface
- Transparent interrupt enabling/disabling
- Complete talker/listener/controller



Part No.	Mfr. Cross Ref. No.	1	10
177121CL	PCI-GPIB-1M	\$398.95	\$358.95
73154CL	IEEE-488 1 meter cable	36.49	32.79
115781CL	IEEE-488 2 meter cable	37.95	34.19
115801CL	IEEE-488 4 meter cable	38.95	36.19



16-Bit Active-Slot PC Extension Interface

Gives you three additional expansion slots.

- Compatible with 8 or 16-bit ISA cards
- Supports: MONO/EGA/VGA/FDC/HDC, game and most I/O
- Control card installs inside your PC with four external slots
- Two mounting brackets to interface the unit via 37 and 62-pin cables
- Isolates system providing short circuit protection
- Can insert and remove cards while power is on
- Can be powered off the PC or externally using 6-pin connection (P/N 78318CL & P/N 78326CL, pg 75)
- One-year warranty
- Size: 9.5"L x 6.8"W x 1.0"H • Weight: 5.5 lbs.



SALE

System requirements: IBM PC/XT and higher comp.

Part No.	Description	1	10
131238CL	PC slot extender unit	\$265.95 \$205.95	\$185.95



Digital Data Acquisition and Control Board

PCI Bus

- 12-bit resolution
- ±5V input range
- Software available, see above
- Digital I/O: 3 input/4 output
- Three 16-bit counters
- 50kHz sample rate
- Data transfer: S/W polled, may be IRQ driven
- For terminal board, enclosure and cable, see below



Now Lower Prices

Includes: InstaCal: installation & test utilities software

Part No.	Product No.	1	5
193922CL	PCI-DAS08	\$247.95 \$215.95	\$195.95



Terminal Boards, Enclosures and Cables for the Above Boards



Part No.	Product No.	Description	1	5
193973CL	shown with P/N 193965CL (not included)			
193973CL	CIO-MINI37	Terminal brd.	\$6.25	\$1.10
193973CL	ENCMINI-37	Enclosure	24.95	22.79
193949CL	C37FF-2	Cable ribbon	21.59	19.63
193957CL	CF37FFS-5	Cable shielded	29.95	27.50

PC-Based Data Acquisition Software

Graphical Programming Software for Measurement Computing Boards **SALE**

SoftWIRE is a graphical programming package for Visual Basic; one window holds the graphical program while the other holds the user interface on a Visual Basic form. By simply using the 130+ functions included with the software, you can click on the function, make connections to the controls with wires, provide your options, then run the program. While you are creating all these functions and connections, the software also provides the code in Visual Basic.



System requirements:

- Pentium® 90 or higher, Windows® 95/98/2000/ME/NT4.0, VGA or higher resolution monitor and Microsoft® Visual Basic 6.0 or later
- Any Measurement Computing DAQ or GPIB board

Part No.	Description	1	5
194028CL	SoftWIRE/VB-PPD	\$409.95 \$429.95	\$399.95



Serial Communications Board - RS-422/RS-485

- Configured as COM1, COM2, COM3 or COM4
- RS-422/RS-485 cable length: 1.2km maximum
- PCI Bus
- 16C550 UART
- 460kbps • 2 ports
- PCI bus 2.1 compliant



Now Lower Prices

Part No.	Product No.	1	10
197915CL	PCI-COM422/485	\$198.95 \$169.95	\$155.95



Digital Input/Output Boards - TTL Level

PCI Bus

- Output: 2.5mA @ 0.45V sink, 2.5mA @ 2.4V source
- Software available, see above
- 24-bit digital I/O
- Three 8-bit ports:
- For terminal board, enclosure and cable, see left

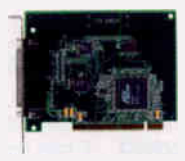

Includes: InstaCal: installation & test utilities software

Part No.	Product No.	1	10
197827CL	PCI-DIO24	\$88.95	\$85.95



Opto-Isolated Digital Input and Relay Output Board

- PCI Bus
- Input range: 5-24VDC or VAC, 50-1000Hz; Rin: 450Ω
- 8 relay outputs: 5 form-C, 3 form-A (28VDC @ 6A, 120VAC @ 5A; contact R = 100ms)
- Opto-isolated inputs: 500V isolation channel-to-channel and channel-to-ground
- For terminal board, enclosure and cable, see left



SALE

Part No.	Product No.	1	10
197843CL	PCI-PDIS08 (PCI)	\$248.95 \$215.95	\$195.95

ATEN 5-Port USB 2.0 PCI Card

40 Times Faster Than the Original USB!

USB 2.0 will offer enhanced functionality, allowing more devices to share the increased bandwidth.

- Supports high speed data transfer rate of up to 480 Mbps
- Full backwards compatible with USB 1.1
- Supports Windows® 98SE/2000/ME/XP
- Hot swappable Plug & Play
- 1 internal USB-A port
- 4 external USB-A ports
- PC Power Management v2.2 compliant



Now Lower Prices

Part No.	Description	1	10	10
197940CL	5-port USB 2.0 PCI card	\$54.95	\$39.95	\$35.95

2-Port USB-A PCI Card

- Plug & Play compatible
- Uses VIA VT83C572 controller chip
- USB specification V.1.1 compatible
- USB legacy BIOS supports
- Operates in USB-aware operating system (Win® 95, 98)
- Size: 4.7"L x 2.0"W
- One-year warranty



Includes: Manual

Part No.	Description	1	10	25
155299CL	PCI USB	\$24.99	\$22.49	\$20.25

USB 2.0 Cables **SALE**

USB-A Male to USB-A Male

Part No.	Description	1	10	25
229581CL	6' cable beige	\$6.99	\$1.85	\$1.40
222033CL	6' cable black	6.49	5.99	5.69
229551CL	6' cable clear	6.49	5.99	5.69

USB-A Male to USB-B Male

Part No.	Description	1	10	25
229711CL	3' cable beige	\$5.99	\$1.55	\$1.39
222607CL	3' cable black	5.99	5.39	4.99
229585CL	3' cable clear	5.99	5.39	4.99

USB-A Male to USB-A Female

Part No.	Description	1	10	25
229770CL	6' cable beige	\$7.99	\$1.65	\$1.49
222068CL	6' cable black	7.99	7.19	6.49
229622CL	6' cable clear	7.99	7.19	6.49

* Special purchase: limited offer

IEEE 1394 Firewire Cables

4-pin Male to 4-pin Male

Part No.	Description	1	10	25
175821CL	6' cable black	\$7.99	\$6.99	\$5.99
222244CL	10' cable black	9.99	7.19	6.49

4-pin Male to 6-pin Male Firewire

Part No.	Description	1	10	25
175839CL	6' cable black	\$7.99	\$6.99	\$5.99
222228CL	10' cable black	9.99	8.99	7.99

6-pin Male to 6-pin Male

Part No.	Description	1	10	25
175847CL	6' cable black	\$7.99	\$6.99	\$5.99
222201CL	10' cable black	9.99	8.99	7.99

USB Thumb Drives

What better way to keep your data safe than to keep it close to you? Thumb drives



SALE

are compact and fit easily in your pocket or hang it around your neck. Portable and lightweight, no external power needed. No drivers necessary for Windows® ME and above.

- 10 year data retention
- Size: 2.9"L x 0.7"W x 0.4"H
- Windows® 98/98SE drivers are available at www.Jameco.com

Part No.	Description	1	10
217761CL	32MB	\$36.45	\$29.95
217779CL	64MB	\$51.95	46.75
217787CL	128MB	\$87.95	79.15
217795CL	512MB	\$289.95	189.95

2-Port USB-A CardBus PC Card

- New 32-bit CardBus
- PCMCIA type-II card
- Size: 4.6"L x 2.1"W
- USB 2.0 EHCI USB standard; 480Mbps max.



System requirements: Windows® 98, ME, 2000, and Mac OS 8.6 or later

Part No.	Description	1	10
208047CL	USB 2.0 CardBus	\$89.95	\$59.95

Firewire CardBus PC Card

Designed to connect Firewire devices to any notebook computer. With its two external ports, you can have 63 devices on the same ports with a max speed for 400Mbps. A mini DC jack is provided on the card for IEEE 1394 devices that require power through the cable.



- Fully IEEE 1394 OHCI compliance
- 133MB/s CardBus master DMA transfer rate
- Real time transmission data
- Open architecture API
- Peer to peer communication structure
- Backward compatible speeds
- Increases efficiency of data transactions while simplifying software driver designs
- Supports Windows® 98SE/ME/XP/2000 & Apple® MAC OS 8.6 or above
- Size: 4.7"L x 2.1"W
- 32-bit bus

Includes: 6' Firewire cable, manual, and ULEAD VideoStudio software

Part No.	Description	1	10
215984CL	Firewire CardBus PC card	\$89.95	\$79.95

Everything You Need To Develop Custom USB Peripherals Book

Lakeview (2nd Edition) This USB Complete book provides an easy-to-use interface for computer peripherals. The book covers topics such as what USB can do, transfer types, chip choices, what's inside a USB controller, writing firmware, how the host communicates and more. (523 pages, 1999)



Part No.	Description	Price
171900CL	Complete USB Book	\$49.95

External 3-Port USB Thumbhub

Expand your single USB port to a stacked 3-port thumbhub.



- USB Revision 1.1 compliant
- Downstream port with OCP (over current detection) and OCP (overcurrent protection)
- LED indicators uplink/down port communication, and OCP status
- Supports full speed (12Mbps) and low speed (1.5Mbps) transfer rate
- Self-powered mode
- Compatible with Windows® 98/98SE/2000/ME/MAC OS 8.5
- Size: 3.1"L x 0.8"W x 1.2"H



Now Lower Prices

Part No.	Description	1	10
208451CL	3-port thumbhub	\$18.95	\$16.95

External 7-Port USB Hub

- 7 USB-A female output ports
- USB-B female root port
- Plug & Play compatible
- Allows you to attach 127 USB devices to your PC
- LED indicators for port, status, and power
- Size: 7.9"L x 2.8"W x 1.1"H
- Weight: 2.6 lbs.



Now Lower Prices

Includes: 6VDC power adapter and USB-A male to USB-B female cable

Part No.	Description	1	10
191450CL	7-Port USB hub	\$34.19	\$25.45

USB-A to Joystick (DB15) Adapter

- Fully compatible with any 15-pin game port PC game controller
- Mode switch selector for maximum compatibility and flexibility
- Input connector: USB-A male
- USB Plug & Play
- Output connector: DB15-pin female connector
- Size: 3.2"L x 2.3"W x 1.3"H



Quantity SAVE

System requirements: 586 or higher compatible; available USB-A port or Hub; Windows® 98 or higher

Part No.	Description	1	10
189510CL	USB to game port adapter	\$39.95	\$35.95

External USB-A IrDA Transceiver

Convert your USB port into an infrared communications port to transfer data from you PDA, notebooks, camera, cellular phone, and other mobile devices.



- Adjustable base for height and angle
- Supports standard USB port
- Meets IrDA v1.0 and v1.1
- Plug & Play
- Supports data transfer rate from 115.2k up to 4Mbit per second
- Transmission distance of 3.3' or 39.4"
- Size: (including base) 2.4"L x 1.6"W x 0.9"H

Now Lower Prices

System requirements: Windows® 98/ME/2000/XP

Part No.	Description	1	10
213903CL	USB-A to IrDA transceiver	\$47.95	\$35.95

ATEN SVGA Monitor Splitters

Duplicate a video signal from one source to monitors up to 210 feet away.



176866CL

- Suitable for SVGA, VGA and multisync monitors

176866CL: 2-channel

- 1 HDDB15 male connector from PC to box; 2 HDDB15 female connectors from box to monitors

• Size: 6.6"L x 3.3"W x 1.1"H • Weight: 1.4 lbs.

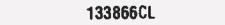

133866CL

133866CL: 4-channel

- Slide switch for video signal gain control
- Daisy chainable
- One-year warranty
- Size: 8.8"L x 6.0"W x 1.9"H • Weight: 3.6 lbs.

Includes: Power adapter and manual

Part No.	Description	1	10
176866CL	2-channel monitor splitter	\$49.95	\$44.95
133866CL	4-channel monitor splitter	68.95	61.95

2-Port K/V/M Switch Box

This two port K/V/M switch box can access two computers from one keyboard, mouse, and monitor. No interface card or software to configure.



Operation is as simple as pushing a button on the front panel and entering hot-key commands.

- Supports Microsoft® IntelliMouse, Logitech Net Mouse, etc.
- Supports operating systems DOS, Win 3.x, Win95/98/98SE/2000/ME, WinNT, Netware, Unix, Linux
- Keyboard and mouse pluggable at anytime
- Hot-key function allows easy computer access
- Audible sound for switching port confirmation
- Port and console connectors: female PS/2 keyboard and mouse, female HDDB15 for video
- High VGA resolution • Size: 4.3"L x 3.0"W x 1.2"H

Part No.	Description	1	10
216063CL	2 port switch box	\$69.95	\$62.95
204062CL	6' PS/2 cable	16.95	15.29

4-Port Auto Printer Switches

- Connects up to 4 PCs to 1 printer or 4 printers to 1 PC
- Non-powered
- Compact size
- Auto form-feed selectable
- Transparent to user

SALE



177421CL

ATEN

- 177421CL: bidirectional; 3.5" software included; 5 DB25 female connectors
- 177412CL: 5 DB25 female connectors

Part No.	Description	1	10	25
177421CL	1 to 4 or 4 to 1	\$7.75	\$6.96	\$6.26
177412CL	4 to 1 printer	\$3.49	2.85	1.87
			1.70	

Need Printer Cables?

See page 66 for complete selection.



HP K80xi All-In-One Color Office Jet

Print / Fax / Copy / Scan

A compact, sturdy all-in-one product that provides presentation quality printing, convenient faxing, and easy to use scanning and copying, and internet ready for your home office. Crisp, clear plain paper color and black and white faxing from the front panel (does not require a PC). Save time by sending unattended faxes with the 20-page automatic document feeder. The PC fax, send, auto redial, and memory send/receive is compatible with answering machines and modems. Extensive memory stores incoming faxes even when the machine is out of paper or ink. Exceptionally high-quality scanning captures subtle contrast and vivid, true-to-life colors for photo-quality reproductions of originals with a 600 x 1200 dpi optical (up to 3600 dpi enhanced). Excellent color and black only copying with professional results, at up to 12 copies per minute black and 8 copies per minute color. 20-page automatic document feeder for unattended copying and reduction and enlargements from 25% to 400%. An Internet ready unit allows you to send and receive email and print web pages directly to the printer without the use of a PC.

SALE



- 150 sheet capacity, adjustable tray for letterheads, envelopes, labels, transparencies & custom size print media
- HP color smart technology for print quality, specific paper types or film & special features such as two-sided printing • Front output bin • 20-page document feeding for unattended faxing and copying
- Color or black copying with 25% to 400% reduction or enlargement
- 12 pages per minute black and white and 10 pages per minute color printing with maximum resolution of 2400 x 1200 dpi • Maximum scan size: 8 1/2 x 11 • Maximum paper size: 8 1/2 x 14
- Compatible with Windows® 95/95/2000/ME/NT4.0/XP • Size: 9.25"H x 14.6"W x 14.6"D • Weight: 22 lbs.

Part No.	Product No.	Description	1	5
237201CL	K80xi	All-in-one color office jet	\$149.95	\$134.95

HP Laserjet 2200D Printer

Delivers a feature-packed, internet-enabled, easy-to-use printer and maintains HP's high standard for reliability. The 220 series is the solution that puts quality, performance, and value in the same package. Fast print speed with true 1200 dpi printing provides superior print quality, instant on-fuser eliminates warm-up time, large memory, fast processor, and a high monthly duty cycle deliver the best performance for small workgroups. Allows point-and-print wireless printing from portable PCs, PDAs, and cell phones without special drivers.



- 250 sheet tray capacity, adjustable tray for letterhead, envelopes, labels, transparencies and custom sized print media • True 1200 x 1200 dpi printing • Built-in duplexer for dual side printing
- 19ppm using standard letter size • Two output bins: top or rear output selectable for convenience
- Parallel, USB, (FIR) fast infrared port, or network connection • Size: 13.2"H x 16.0"W x 17.1"D
- 8MB RAM standard expandable to 72MB (2 slots for fonts or memory upgrade); 1 (EIO) enhanced input/output port for network connection • (RET) resolution enhancement technology
- Fast printing performance, built-in intellifont and true type scaling technology • Weight: 35.9 lbs.
- Compatible with Windows® 3.1x/95/98/2000/ME/NT4.0/XP or MAC system 7.5.5 or above

Includes: Power cable, CD-ROM drivers and manual

Part No.	Description	1	5
228718CL	HP Laserjet 2200D	\$529.95	\$505.45
236136CL	C4096A ink cartridge	127.49	—
235061CL	Print server I/O port	335.95	—

Printer Port Extender

- 4-wire phone line transfer of parallel printer data • Non-powered
- Max. distance: 1300' (396 meters) • Max. data transfer speed: 21kb/sec.
- Transmitter & receiver - DB25M and RJ11 (6P4C) jack • Size: 3.0"L x 1.9"W x 0.9"H



Includes: 25 ft. RJ11 cable

SALE

Now Lower Prices

Part No.	Description	1	10
183337CL	Printer port (DB25M)	\$2.45	\$2.21

Wireless Printer Kit

Print up to 100 feet away, wirelessly!

Convenience and ease-of-use is what the wireless revolution is all about, and this kit will easily make your current printer conveniently cable-free! Now you can place your printer where you want it, not just where the cable will reach. Easy, plug-and-play USB installation means set-up is trouble-free, too. Works with USB connected Canon, Epson, HP and Lexmark printers, and Windows® XP/2000/ME/98 or Mac OS X v10.2.



- USB-B type adapter for printer and USB-A type adapter for PC
- Data throughput: 340kbps
- Frequency range: 2.4GHz to 2.4835GHz
- Windows® 98SE/ME/2000/XP compatible
- Receiver sensitivity: -84dBm
- 128-bit encryption

Part No.	Description	Price
235133CL	Wireless printer kit	\$89.95

For Networking Products see page 172

Color Code Legend
New Sale Qty. Save Closeout

226-Piece Network Connector Kit

Every connector needed by a network field technician to repair a network.

SALE



Now Lower Prices

• Size: 10.5"L x 7.0"W x 1.5"H • Weight: 2.5 lbs.

This kit includes:

Quantity	Connector Type
50 pieces (each)	RJ11 solid flat cable (6P4C) RJ11 solid flat cable (4P4C)
25 pieces (each)	RJ11 solid round cable (6P4C) RJ45 solid round cable (8P8C) RJ45 solid flat cable (8P8C)
20 pieces	RJ45 protection caps (assorted colors)
5 (each)	BNC for RG58/U cable BNC for RG59/62/U cable BNC for RG174 cable BNC 50Ω terminator BNC Female-to-female adapter BNC T-adapter male-female-female
1 piece	Storage kit

Part No.	Description	1	10
207079CL	Network connector kit	\$42.99 \$34.99	\$31.81

AUI/10BaseT Transceiver

Provides connectivity with work stations equipped with AUI ports to 10BaseT ethernet local area network. Switch selectable SQE (signal quality error) / "Heartbeat Test" to detect collision circuitry in operation.



- IEEE 802.3 10BaseT compliancy
- 4 LED indicators for receive, transmission, collision and link
- SQE enable/disable switch
- AUI 15-pin male connector, RJ45 connector
- Size: 2.3"L x 1.7"W x 0.8"H • Weight: 0.2 lbs.

Part No.	Description	1	10
215917CL	Ethernet transceiver	\$29.95	\$27.95

NETGEAR® PCMCIA Network Card

Share printers and access to the internet, send and receive email and messages, drag and drop files between computers.



- Auto detection of 10/100Mbps speed (10Base-T / 100Base-Tx)
- Full duplex capability • PCMCIA type II
- Plug and play, easy installation
- LED indicator for 100Mbps activity and link activity

Requirements: 486/Pentium® compatible laptop, PCMCIA slot (type II), Windows® operating system

Includes: 3.5" disk, PCMCIA to RJ45 adapter & cable

Part No.	Description	1	10
210972CL	10/100 PCMCIA card	\$29.95	\$27.95

Cat 6 Cables available on page 62.



NETGEAR® 4-Port Firewall Router

11Mbps Cable/DSL

This true firewall is broadband capable, and provides you with the utmost in business class security – Denial of Service (DoS) protection and Intrusion Detection using Stateful Packet Inspection (SPI), URL access and content filtering, logging, reporting, and real-time alerts. With 4 auto-sensing, switched LAN ports and Network Address Translation (NAT) routing, up to 253 users can access your broadband connection at the same time. Smart Wizard and Install Assistant to get your network up and running in minutes.



- 4 (LAN) 10/100 auto-sensing ports
- 1 (WAN) 10/100BaseT Ethernet RJ45 port to connect to any broadband modem such as DSL/Cable
- Wireless slot for NETGEAR MA401 PC card
- Security protection: Firewall – SPI (Stateful Packet Inspection), DoS (Denial of Service), IDS (Intrusion Detection System)
- VNP functionality: NAT traversal, PPTP and L2TP
- Model of operation: NAT (Network Address Translation), static routing, unrestricted users per port
- IP address assignment: static IP address assignment, internal DHCP server on LAN, DHCP client on LAN, PPPoE client support
- 40/64 and 128-bit WEP encryption
- Smart wizard to automatically detect ISP address type, port range forwarding, exposed host, enable/disable WAN ping, MAC address cloning, NTP support, URL content filtering
- Size: 1.3"H x 7.4"W x 4.9"D
- Weight: 1.8 lbs.

Includes: 10' CAT5 cable, power adapter, user guide & CD-ROM software

Part No.	Description	Price
233331CL	11Mbps cable/DSL firewall router	\$99.95 \$89.95

PCI Ethernet Card

10/100Mbps, Auto Detect

- 32-bit PCI bus mastering for high throughput and low CPU command
- Complies with IEEE 802.3 ethernet standards
- Auto set IRQs & I/O address
- Auto negotiation functions
- Plug & Play installation
- Full duplex and half duplex operation
- RJ45

Includes: 3.5" disk drivers and manual

Part No.	Description	1	10	25
173606CL	RJ45 (10/100Mbps)	\$14.95	\$13.49	\$12.15

ISA Ethernet Card

10Mbps

- Supports Novell NetWare, Windows® NT, LAN Manager, UNIX TCP/IP, Windows® 95/3.1
- LED indicators for diagnostics
- FCC class approved

Includes: 3.5" disk driver

Part No.	Description	1	10
144936CL	10Mb ISA card	\$14.95	\$13.49

IBM® 8-Port Ethernet Hub

Although designed to the exacting standards of IBM for use in large corporate networks, its price and easy setup make it perfect for small office or home office use. Compatible with all standard STP, UTP, and FTP cables. Can be cascaded to support larger networks via the MDI (uplink) port. Provides port-by-port link/activity and partition LEDs. Partitions ports automatically when excessive collisions or jabbering are detected.



- Conforms to IEEE 802.3 10Base-T standards
- AUI port allows for connection to 10BASE-2, 10BASE-5, and 10BASE-F Ethernet
- MDI port allows cascading of 8242's with straight through cables
- Crossover ports, automatic partitioning
- Size: 8.7"W x 5.3"D x 1.1"H
- Weight: 1.7 lbs.

Special Purchase
Only \$24.95
Was \$133

Part No.	Description	1	10
226149CL	8-port hub	\$44.95	\$39.95

Intel® AnyPoint Home Network

Powerful, Simple, Fast Network!

Save money sharing files, printers, modems and DSL connections on a network. In the past, networking has been reserved for companies and businesses since the cost of setting up one for home use was too expensive to be justified.



However, the use of computers is increasing and households having more than one is becoming much more common. Installing networks require Ethernet cards, hubs, cables, reading extensive manuals, opening up your computer to install hardware, and so on. Wouldn't it be nice if setting up your network was as easy as plugging in a keyboard or a mouse? Intel thought so, and introduced the AnyPoint Home Networking System. Install this network in three easy steps: connect the cables to the parallel port of your PC & existing phone lines of your home, install the software with it's tutorial interface, and you have a network up and running.

• Freq. range: 5.5 to 9.5MHz

• Max. distance between nodes: 500'

• Controller: Intel® 21145 phone/Ethernet LAN controller

• No wires or cables to run; use existing phone lines

• 3 easy steps to install a complete network

• Save money by sharing a printer and having both computers access the same internet connection

• Size: 8.0"H x 3.8"W x 3.8"D

- Freq. range: 5.5 to 9.5MHz
- Max. distance between nodes: 500'
- Controller: Intel® 21145 phone/Ethernet LAN controller
- No wires or cables to run; use existing phone lines
- 3 easy steps to install a complete network
- Save money by sharing a printer and having both computers access the same internet connection
- Size: 8.0"H x 3.8"W x 3.8"D

Includes: 2 phone cables, 2 data cables (parallel cables), 2 power supplies, manual & CDROM drivers

System requirements: 486 or higher processor, Windows® 95/98, 8MB of RAM, 18MB of hard disk space, parallel port for printer use

Part No.	Description	Price
220417CL	Home network	\$99.95 \$19.95

Personal Fast Ethernet Switch Hub

- Eliminate bottlenecks and improve your home or small business network with true 100Mbps connection from JAMECO's choice as the best performance/value combination in networking - PHOEBE.
- IEEE 802.3 (10Base-T)/802.3U (100Base-TX) compliant
- Auto MDI/MDIX, auto negotiation RJ45 ports
- Store and forward method
- Packet forwarding rate: 10Base-T - 14880pps to 10Mbps; 100Base-TX - 148800pps to 100Mbps
- 8k media access control (MAC) addresses
- Buffer memory size: 256k bytes RAM
- LED indicator for power and link activity



SALE

Includes: 7.5VDC @ 1A power supply, installation guide and mounting hardware

Part No.	Description	Size (LxWxH)	1	10
220863CL	5-port	4.9" x 2.9" x 1.2"	\$19.95	\$26.95

Single-Line Telephone Filter

In-line Z-BLOCKER® filter blocks interference between DSL/HPN, voice and RF from cordless phones. Plugs directly into any standard phone jack and works with any single line phone, fax or dial-up modem.



SALE

Part No.	Description	1	10	25	
196429CL	Telephone filter	\$2.99	\$1.35	\$1.21	\$1.10

Black Magic Telephone Ringing Generator

Switching inverter that produces low-frequency alternating current to signal telecom ringers or equivalents.



- Frequency: 20Hz
- Series resistor: 300Ω
- Nominal output voltage: 86 Vrms
- No reverse polarity protection

Part No.	Product No.	1	10	25
145816CL	LBMR12	\$26.95	\$24.49	\$21.95

ATEN RS-232 to RS-485/422 Bidirectional Converters

- Cable length: 4000' max.
- Data rate: 1MB/second
- 4-wire full duplex or 2-wire half duplex
- Controlled by RTS signal
- DCE and DTE selectable
- Point-to-point and multidrop operations
- RS-485: terminal block and RJ11 connections
- RS-232: DB25 female connector
- Input: 110VAC; except P/N 129218CL 220VAC input
- Weight: 0.9 lbs. • One-year warranty



Now a European Version!

197931CL: port powered (power adaptor not included)
Data rate: 100kbps

122956CL: features RS-485SI optical isolation: 2000V

129218CL: features 220VAC input

Includes: 9VDC @ 300mA power adaptor

Part No.	Description	1	10
117701CL	RS-232-485/422	\$57.95	\$51.95
197931CL	RS-232-485/422	69.95	62.99
122956CL	RS-232-485/422 OPT ISO	119.99	107.99
129218CL	RS-232-485/422 (220 VAC)	42.95	36.95

AT&T Fax Switcher

- Features automatic ring reduction, answering system transfer and transfer timer, extension in use detection and calling tone detection, dial pulse/rotary transfer, unanswered call transfer, reverse modem detection, remote call alert, line interrupt protection, calling tone detection
- System capacity: line-in, answering machine, phone, modem/fax connection
- Size: 4.9"L x 5.1"W x 1.4"H • Weight: 1.8 lbs.



Includes: 12VAC @ 830mA power supply, 6' 11" telephone cable, and manual

Part No.	Product No.	Description	1	10
152004CL	ATT200A	Fax switcher	\$24.95	\$22.49

Wall Mount Phone Plate with DSL In-Line Filter

Replace your existing regular wall mount phone plates with this phone plate with built-in DSL in-line filter. Provides a single jack for filtered voice devices; i.e. phone, fax, answering machine, caller ID, analog modem, and DSL modem.



- Stop band isolation is 21dB from 25kHz to 50kHz and 25dB or greater
- Filter topology: 2-pole low pass
- DC resistance through T&R to telephone port is 13Ω maximum
- Size: 4.7"H x 3.2"W x .025"Thick

Part No.	Description	1	10
237041CL	Phone mounting plate	\$19.95	\$18.95

Bidirectional Non-Buffered Serial-to-Parallel Converter

- Bidirectional conversion of parallel and serial signals
- Serial interface: hardware handshake RTS/CTS, software handshake XON/XOFF; DCE/DTE selectable; parity: odd, even, or no parity; data bits: 7, 8
- Connectors: one DB25 female and one Centronics 36-pin male
- Baud rate: 300 to 38,400bps
- Size: 4.0"L x 2.5"W x 1.0"H
- One-year warranty
- Stop bits: 1 or 2
- Weight: 0.8 lbs.



Includes: AC adapter (9VAC @ 200mA) and manual

Part No.	Description	1	10	25
116935CL	Bi-converter	\$49.95	\$44.95	\$39.95

Bidirectional Serial/Parallel Converter

- 115.2kbps, 512kb Buffer
- One DB25 female connector, one Centronics 36-pin male connector
- Fully compatible w/ Win® 95
- Baud rate: 300bps - 115,200bps
- FCC class A certified, CE certified
- LED indicator for parallel busy status
- Stop bits: 1 or 2
- Size: 3.8"L x 2.4"W x 1.0"H
- DCE/DTE selectable
- One-year warranty
- Weight: 0.8 lbs.



Includes: 9VAC @ 200mA adaptor

Part No.	Description	1	10	50	
182983CL	Converter	\$64.95	\$48.49	\$44.11	\$40.10

External 56kbps Fax/Modem with Digital Answering Machine

- Digital telephone answering machine with voice mail system
- RS-232 (DB9 female) interface
- Modem line speed: 300-56000bps
- Standard compatibility: ITU-T V.92, V.90, V.34, V.32, V.32bis, V.23, V.22bis, V.21 and Bell 103, 212A
- Error correction: ITU-T V.42, MNP2-4
- Data compression: ITU-T 1.42bis, MNP5
- Flow control: RTS/CTS, XON/XOFF
- Comment set: TIA/EIA 602 'AT' command set
- Fax/Modem line speed: 2400-14400bps
- Standard compatibility: ITU-T V.17, V.27 ter, V.29
- Command set: Class 1, 1.0, 2 and associated AT command sets
- Size: 6.3"L x 4.0"W x 1.3"H



System requirements: Pentium® or PC compatible with 16MB of memory, available RS-232 slot; Windows® 9x/ME/NT4.0/2000/XP

Includes: RS-232 cable (DB25/DB9 female to DB9 male); phone cord, 9VAC@1A power supply, CD-ROM drivers and manual

Part No.	Description	1	10
216493CL	Serial modem (Rockwell)	\$49.95	\$44.95

Short Haul Modem

- Up to 38,400 baud
- Will communicate over 6.3 miles of cable
- No external power required
- DCE/DTE selectable
- Xon-Xoff or hardware handshaking
- RS-232 interface (DB25 female)



Part No.	Description	1	10	25
116581CL	Short haul modem	\$29.95	\$26.95	\$23.95

Cellphone Headset

The MAB-18 is the first in-ear system headset for mobile telephones. It offers a flexible microphone arm, cable clip and the possibility of left or right wearing style. It comes with a 2.5mm jack plug that is compatible with most mobile phones.



- 20Hz to 22,000Hz freq. response (headphones); 40-15,000Hz (microphone)
- Omnidirectional microphone
- 106dB sound pressure level
- 32Ω impedance (headphone), 1.4kΩ impedance (microphone)

Now Lower Prices

Part No.	Description	Price
227096CL	Cellphone headset	\$21.95 \$19.25

Opening an account is easy!!

Corporate Customers

Call 1-800-831-4242 for details today.



19" Rack Mount Enclosures

Perfect for equipment setup in home, studio or laboratory.

- Ventilation holes on all sides
- Front and back panels are steel w/ aluminum, pre-punched face plates
- Top, bottom, sides durable 0.035" steel
- Front panel: 0.12" Thick • Black front panel
- All enclosures have handles except P/N 132812CL



Includes: Mounting screws

Part Number	Dimensions (In.)			Weight (lbs.)	Pricing	
	H1	H2	D		1	10
132812CL	1.73	1.25	9.75	6.2	\$39.95	\$35.99
132821CL	3.46	3.0	9.75	7.9	47.95	43.49
132839CL	3.46	2.88	11.75	9.1	53.95	48.59
132847CL	5.22	4.75	11.75	10.6	63.95	55.99
132855CL	5.22	4.75	13.50	11.8	73.95	66.95
132863CL	8.56	8.0	13.50	15.4	94.95	84.95

19" Equipment Wall Mount Brackets

Save space in your office or computer room by installing your 19" equipment to the walls with this wall mount brackets.



- Black powder coat finish
- Size: P/N 229454CL - 7.0"H x 12.0"D
P/N 229462CL - 12.25"H x 12.0"D

Part No.	Description	1	10
229454CL	Bracket for 2U	\$49.95	\$44.95
229462CL	Bracket for 3U	84.95	76.45

19" Industrial Chassis with PC-AT 300-Watt Power Supply

EIA RS-310C Compliant

- Back panel with 12 open slots
- Supports one 3.5" and two 5.25" external accessible bays and two 3.5" internal bays
- Use with 14-slot PC-BUS compatible backplane P/N 135061CL, above right
- Removable disk drive bay w/ shock resistant design
- Front 12VDC cooling fan with removable air filter screen and mesh
- Waterproof front panel
- Color: gray • Weight: 37 lbs.
- Size: 16.8"L x 16.9"W x 7.0"H



Now Lower Prices

Includes: Mounting hardware

Part No.	Description	1	10
146851CL	19" chassis w/ 300W PS	\$219.99	\$201.99

19" Rack Mount Enclosure for 14" Monitor

- Clear glass front panel
- Hinged door for accessing monitor controls
- Color: gray
- Size: 19.0"W x 15.1"D x 14.0"H
- Weight: 30 lbs.

SALE



Part No.	Description	1	10
136021CL	Enclosure for 14" monitor	\$179.50 \$157.55	\$143.23

16-Slot ISA-PCI-PICMG Passive AT Backplane

- Ten 16-bit ISA slots, four 32-bit PCI slots and two 48-bit PICMG slots
- LED indicators for $\pm 5V/\pm 12V$
- Compatible with P/N 146851CL (below left)
- Size: 12.5"L x 10.0"W
- Weight: 1.9 lbs.

SALE



Part No.	Description	1	10
135061CL	Passive AT backplane	\$71.99 \$54.95	\$50.16

Cabinet Mounting Plate for 19" Cabinet

- Use as industrial chassis mounting plate for servers, PCs or patch panels
- Made of industrial grade steel and aluminum
- Size: 19.0"W x 15.8"D x 3.5"H • Color: beige



Part No.	Description	1	10
149500CL	Cabinet mount plate	\$39.95	\$35.95

19" Rack Mount Keyboard Tray

This sliding keyboard tray only occupies a 1U or 1.75" space on a rack mount. A hinged articulating arm provides cable management and accommodates most standard size keyboards.



- Black powder coat finish • Size: 3.5"H x 20.0"W x 9.0"D

Part No.	Description	1	10
229471CL	19" rack mount KB tray	\$99.95	\$89.95

19" Rack Mount Drawer with Keyboard and Trackball

- Occupies a single unit (1U) rack space
- PS/2 connector for keyboard and trackball
- Color: gray
- Size: 19"W x 13"D x 2.8"H
- Weight: 18 lbs.



Includes: Wrist pads, module, PS/2 to 5-pin DIN and PS/2 to 9-pin adapters, and software

Part No.	Description	1	10
220644CL	Rack mount KB drawer	\$249.99	\$234.99



See the yellow and green highlighted items for savings up to 54%. Sale details are on page 2.

Jameco Special Values!

Relay Rack & Rack Panels

Rack:

- Black powder coat finish
- 10-32 threaded holes
- Used with 19" wide panels
- 16 gauge CRS base
- 1/8" aluminum side rails
- Size: 84"H (133751CL); 47.25 (231079CL)
- Size (at base): 19.8"W x 15.3"D

133751CL



19" Wide Panel:

- 10-gauge black aluminum



Rack screw:

- 10/32 screw; 5/8" phillips head (50 ea.)

133276CL

Part No.	Description	Height	1	10
133751CL	Relay rack	84"	\$159.95	\$144.95
231079CL	Relay rack	47.25"	119.95	105.95
133276CL	Rack panel (1U)	1.75"	9.45	8.49
229489CL	Rack panel (2U)	3.50"	10.35	9.39
229497CL	Rack panel (3U)	5.25"	12.89	11.69
229500CL	Rack panel (4U)	7.00"	14.15	12.79
229446CL	Rack screw (50 ea.)	—	8.25	7.45

Rack Mount Card Cage

- For 19" rack mounts
- 24 slots • Weight: 6.3 lbs.
- Fits card size: 6.5"L x 5.5"W
- Size: 6.5"L x 17.3"W x 6.1"D



Quantity SAVE

Part No.	Description	1	10	25
172099CL	Rackmount card cage	\$7.95 \$6.95	\$5.91	\$4.43

19" Rack Mount CAT 6 Patch Panels

For the Maximum Network Performance

Our CAT 6 patch panels feature 110D punch blocks that are compatible with KRONE or 110-impact tool. The RJ45 jacks are top entry type; PBT UL94 V0 rated. UL/CUL listed and CAT 6 certified. Can be used with T568 A/B installations. Color-coded to T568 specifications.



229518CL

Part No.	Description	1	10
229518CL	24-port patch panel	\$129.95	\$116.95
229526CL	48-port patch panel	\$239.95	\$215.95

For Cat 5e and Cat 6 Cables see page 62.



19" Cable Management Rack

Make your cable looms neat and organized with our 2 unit cable management rack. Simply slip in the cable between spaces and route them to their destinations.



Now Lower Prices

SALE

Part No.	Description	1	10
208776CL	2U Ducting type holder	\$19.95 \$17.10	\$14.00

2-Way & 4-Way Monitor/Keyboard/Mouse-to-PC Switch Boxes

HDDB15/5-Pin DIN/DB9M

- Allows 2 or 4 users to share one PC system
- Internal diodes maintain keyboard in powered state when switching between systems
- Each user may need 2 or 4 sets of the following cables: P/N 114913CL, 5-pin DIN M-M for keyboard (right); P/N 66173CL, DB15HD M-M for monitor; P/N 132345CL, DB9 F-F for serial mouse (cables, pg 66)
- Size: 7.5"L x 5.3"W x 2.8"H



132249CL



134017CL

Part No.	Description	Wt. (lbs.)	1	10
132249CL	2-user switch box	1.6	\$17.95	\$15.95
134017CL	4-user switch box	2.3	21.95	19.95

Keyboard/Monitor-to-PC Switch Box

HDDB15/5-Pin DIN Female

- 2-way switch box
- For 2 PCs connected to 1 keyboard and 1 monitor - diodes maintain keyboard in powered state
- Size: 6.0"L x 4.0"W x 2.3"H • Weight: 1.3 lbs.



Part No.	Description	1	10
114155CL	2 computers	\$14.95	\$13.49

Keyboard/Monitor-to-PC Switch Box

HDDB15/6-Pin Mini DIN Female

- Connects 2 monitors and 2 keyboards to a PC
- Size: 6.0"L x 4.5"W x 2.6"H
- Weight: 1.3 lbs.



Part No.	Description	1	10
79177CL	2-way switch box	\$16.95	\$15.25

Serial Port-to-PC Switch Boxes

DB9 Female

- Connects 2 or 4 serial ports to a PC
- Size: 6.0"L x 4.8"W x 2.5"H
- Weight: 1.2 lbs.
- 183417CL: 4-serial port switch box
- Size: 6.1"L x 4.0"W x 2.2"H
- Weight: 1.3 lbs.



79126CL



183417CL

Part No.	Description	1	10
79126CL	2-serial port switch box	\$9.95	\$8.95
183417CL	4-serial port switch box	19.95	17.95

Network Devices-to-Server Switch Box

RJ45 8P8C Female

- Connects network devices to 4 servers
- 5 RJ45 8P8C females
- Size: 8.0"L x 6.1"W x 2.2"H
- Weight: 2.0 lbs.

SALE



Part No.	Description	1	10
180099CL	4-server RJ45 switch box	\$14.95	\$13.49

Fax/Modem/Telephone-to-PC Switch Box

RJ11 6P6C Female

- Connects fax, modem, or telephone to 2 PCs
- Size: 6.0"L x 4.8"W x 2.5"H
- Weight: 1.2 lbs.



1 10

Part No.	Description	1	10
79142CL	2-PC RJ11 switch box	\$9.95	\$8.95

Parallel Printer-to-PC Switch Boxes

DB25 Female

- Connects 2 or 4 PCs to one printer
- 20095CL: 2-PC switch box
- Size: 6.0"L x 5.8"W x 2.3"H
- Weight: 1.3 lbs.
- 155512CL: 2-PC switch box
- Size: 7.2"L x 4.9"W x 2.5"H
- Weight: 2.3 lbs.
- Includes: DB25 M-M cable
- 20124CL: 4-PC switch box
- Size: 6.0"L x 4.0"W x 2.4"H
- Weight: 1.5 lbs.

Quantity SAVE



20095CL



155512CL



20124CL

Part No.	Description	1	10
20095CL	2 PC switch box	\$8.95	\$7.95
155512CL	2 PC switch box	6.49	5.54
20124CL	4 PC switch box	14.95	13.49

Coaxial Switch Box

- 3-way switch box, switches from a single input source to 3 outputs
- 60dB isolation - shielded housing
- 75Ω input-output
- 5-900MHz UHF/VHF/FM



Part No.	Description	1	10	25
228241CL	Coaxial switch box	\$4.85	\$4.59	\$4.35

ATEN SVGA Monitor Splitters

Duplicate a video signal from one source to monitors up to 210 feet away.

- Suitable for SVGA, VGA and multisync monitors
- 176866CL: 2-channel
- 1 HDDB15 male connector from PC to box; 2 HDDB15 female connectors from box to monitors
- Size: 6.6"L x 3.3"W x 1.1"H • Weight: 1.4 lbs.
- 133866CL: 4-channel
- Slide switch for video signal gain control
- Daisy chainable • One-year warranty
- Size: 8.8"L x 6.0"W x 1.9"H • Weight: 3.6 lbs.



176866CL



133866CL

Part No.	Description	1	10
176866CL	2-channel monitor splitter	\$49.95	\$44.95
133866CL	4-channel monitor splitter	68.95	61.95

Cables...Cables...Cables!			
Serial.....Pg 66 & 85	Network.....Pg 62		
Printer....Pg 66	Extension.....Pg 66		
Monitor..Pg 66	Coax.....Pg 81-82		

K/V/M Switch Boxes for up to 4 Computers



- Selects any computer by hot keys or switch
- Serial and PS/2 mouse and keyboard emulation for automatic PC boot up
- Three stage cascadable for accessing more computers
- Supports SVGA, VGA and Multisync monitors
- Keyboard LED status recorded and restored while switching among computers
- Auto scan for monitoring PC periodically
- One-year warranty
- Size (149382CL): 9.0"L x 6.0"W x 2.0"H (149391CL): 10.0"L x 7.0"W x 3.0"H



149382CL (front)



149382CL (rear)



149391CL (front)



149391CL (rear)

Includes: Manual & power supply (9VDC @ 600mA)

Part No.	Description	Wt. (lbs.)	1	10
149382CL	2 computers	4.0	\$122.59	\$111.45
149391CL	4 computers	7.1	229.95	209.95
204062CL	6' PS/2 cable		16.95	15.29

2-Port K/V/M Switch Box

This two port K/V/M switch box can access two computers from one keyboard, mouse, and monitor. No interface card or software to configure.



Operation is as simple as pushing a button on the front panel and entering hot-key commands.

- Supports Microsoft IntelliMouse, Logitech Net Mouse, etc.
- Supports operating systems DOS, Win 3.x, Win95/98/98SE/2000/ME, WinNT, Netware, Unix, Linux
- Keyboard and mouse pluggable at anytime
- Hot-key function allows easy computer access
- Audible sound for switching port confirmation
- Port and console connectors: female PS/2 keyboard and mouse, female HDDB15 for video
- High VGA resolution • Size: 4.3"L x 3.0"W x 1.2"H

Part No.	Description	1	10
216063CL	2 port switch box	\$69.95	\$62.95
204062CL	6' PS/2 cable	16.95	15.29

4-Port Auto Printer Switches

- Connects up to 4 PCs to 1 printer or 4 printers to 1 PC
- Non-powered
- Compact size
- Auto form-feed selectable
- Transparent to user
- 177421CL: bidirectional; 3.5" software included; 5 DB25 female connectors
- 177412CL: 5 DB25 female connectors

SALE



177421CL

Part No.	Description	1	10	25
177421CL	1 to 4 or 4 to 1	\$7.75	\$6.96	\$6.26
177412CL	4 to 1 printer	\$2.49	1.99	1.19

TRIPP-LITE isobar®

Surge Protectors



The world's best known, most advanced surge protectors provide total protection against surges, spikes and line noise.

- Up to \$50,000 Ultimate Lifetime Insurance covers Isobar and connected equipment against surge damage for life!
- Diagnostic indicators on Ultra versions alert you to improper outlet wiring, loss of AC power, and damage to protection circuitry
- "Cascade Circuitry" allows you to chose increased noise protection level for your most sensitive equipment
- UL 1449 and 1283 listed • Lifetime warranty
- IsoTel model has dual RJ11 jacks for complete modem/fax surge protection
- 4 & 6-outlet protectors: 6' cord; 8 and 12-outlet protectors: 12' cord



ULTIMATE LIFETIME INSURANCE



Isobar Premium 19" Rack Mount Surge Protector

Part No.	Product No.	Joules	Description	Wt. (lbs.)	1	10
139686CL	IBAR12RM	750	12 outlet, 2 isolated filters	4.7	...	\$119.95 \$107.99

Isobar Premium Surge Protectors

18981CL	ISOBAR 4	2200	4 outlet, 2 isolated filters	2.4	...	\$49.95 \$44.95
74544CL	ISOBAR 6	2350	6 outlet, 3 isolated filters	2.7	...	\$54.95 \$1.05 49.95

Isobar Ultra Premium Surge Protector

19001CL	ISOBAR 8U	2350	8 outlet, 4 isolated filters	3.5	...	\$69.95 \$62.95
---------	-----------	------	------------------------------	-----	-----	-----------------

Isotel AC/Phone Line Surge Protector

185113CL	ISOTEL 4U	2700	4 outlet, 2 isolated filters	2.7	...	\$45.09 \$39.95
----------	-----------	------	------------------------------	-----	-----	-----------------



Standard Surge Protectors



Economical and effective spike and noise suppression with diagnostic LEDs.

- 168954CL: \$5,000 Ultimate Lifetime Insurance
- 124337CL/32045CL: \$35,000 Ultimate Lifetime Insurance

Part No.	Product No.	Joules	Description	Wt. (lbs.)	1	10
168954CL	Striker 7	480	Up to 27,000 amp spikes	1.2	...	\$8.95 \$8.49
124337CL	Super 7	1402	Up to 42,000 amp spikes	1.6	...	17.95 15.95
32045CL	Super 8	1200	Up to 54,500 amp spikes	1.7	...	22.76 20.69



Battery-Backed UPS Systems

- Protects your PC, fax/modem and all peripherals against all types of power problems
- Automatic system shutdown with free PowerAlert software for 500VA and 700VA
- Up to \$25,000 Ultimate Lifetime Insurance for connected equipment • Up to 45 minutes runtime
- 6-outlets, RJ11 for fax/modem protection

SALE



Part No.	Product No.	Description	Agency	Wt. (lbs.)	Price
185130CL	I0500	500VA, 6 outlets	UL/CSA	16.0 \$112.89
185148CL	I0700	700VA, 6 outlets	UL/CSA	20.0 135.99

Surge Suppressor Stops Crawling and Toe Cramp

Use our remote control surge suppressor and stop crawling under your desk or flipping on your equipment power with your toe. Just place the small control strip anywhere easily at hand, up to 6 feet away from the base unit. If you like to keep you desktop clear, just attach the remote to the side of your monitor with the enclosed adhesive strips. Then power up 4 plugs, or turn off specific outlets with a touch of a button. One play stays alive continuously. The extra long power cord lets you place the base unit up to 9 feet from you wall outlet.

Free \$25,000 Equipment Protection Policy

Kensington is so sure their product will protect both your equipment and phones that they back it up with The Kensington Limited Lifetime Warranty that protects your equipment for up to \$25,000 against damage (see package for details).

- Energy rating: 420 joules (140 each line)
- Clamping voltage: 330V; telephone protection @ 465V
- EMI/RFI filtering: attenuation up to 40dB with frequency range of 600kHz-26MHz
- Size: (outlet strip) 12.5"L x 3.0"W x 3.5"H; (remote) 6.5"L x 2.0"W x 1.0"H
- Current peak: 39,000A • 15A circuit breaker
- 5 outlets/3 switches • Failure indicator light • UL listed

Part No.	Description	Weight (lbs.)	1	5
211203CL	MasterPiece plus remote	2.0	\$39.95 \$35.95



Special Purchase Limited Quantity Only \$39.95 Sug. Retail \$169.95

POWERWARE 300-VA UPS System

With Dual Outlet

- Protects against blackouts and brownouts
- Battery charging: less than 6 hours to 90% usable capacity
- Battery backup time: 5-10 mins. @ full load; 10-20 mins. with partial load
- Input voltage: 120VAC @ 60Hz
- Output current: 2.5A (full load)
- Output voltage: 120VAC
- Size: 3.4"W x 5.8"D x 13.2"H
- Weight: 12.4 lbs.

Part No.	Product No.	Description	1	10
179961CL	PRB300A	300-VA UPS system	\$59.95 \$53.95



RCA Integrated Wall Plate Surge Protectors

RCA delivers a revolutionary breakthrough technology in the RCA Smart Plate™ Surge Protector. These surge protectors replace your traditional wall plate in seconds. An RCA Smart Plate™ (235002CL) is ideal for protecting your satellite/cable TV receivers or antennas from coaxial line surges, and a second unit (234991CL) protects modems, phones and faxes from phone line surges.

- \$5,000 surge equipment guarantee
- Safe-operation indicator lights
- Size: 10.8"H x 6.9"W x 1.0"D • Weight: 0.7 lbs.
- 2 outlets • Noise-filter • UL/CUL approved

235002CL: Satellite/Cable TV protection

- Cable ready • 670 joules
- Includes: 6-foot coaxial cable

234991CL: Modem/Phone/Fax protection

- Internet ready • 410 joules
- Includes: 6-foot phone line cord

Now Lower Prices

Part No.	Product No.	Description	1	6	12
235002CL	SPC300	Satellite/cable TV protection	\$12.95 \$9.95	\$8.95 \$8.29
234991CL	SPT300	Modem/phone/fax protection	\$12.95 9.95	8.95 8.29



235002CL



234991CL

For our complete selection of power cords see page 69.



Power Strip Saver Single Outlet

Get full use of your power strips and UPS outlets with our high quality power strip outlet saver, you can use all the outlets on your surge suppressors, UPS, and outlet strips. Just plug a bulky power adapter into this cable and free up your other outlets.



Add more wall adapters to your power strip!

Before
Four Outlets
Blocked



After
Every Outlet
is Usable

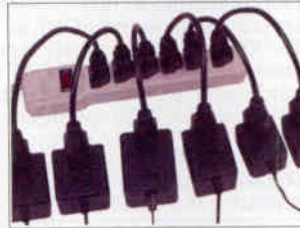

Now Lower Prices

Part No.	Description	Length	Cord Type	1	10	100
199777CL	AC Power cord (black)	1 ft.	SVT	\$1.69	\$1.55	\$1.39
208338CL	AC Power cord (beige)	1 ft.	SVT	\$1.69 1.05	.96	.87

"Y" Power Strip Saver Double Outlet

Get full use of your power strips and UPS outlets with the "Y" power strip saver. Plug those bulky adapters into these cables and plug the cables into the power strip. Need the extra adapter to be plugged into the power strip? Use the "Y" power strip saver to add an extra adapter.



Part No.	Description	1	10	100
208346CL	Power strip saver	\$2.89	\$2.75	\$2.59

APC Personal Surge Arrestors

PER Series

- Nominal input voltage: 120VAC@50/60Hz (auto sensing)
- 3 outlet with cable TV protection;
- Receptacle style: NEMA5-15R
- Surge energy rating: 240 Joules
- Peak current normal mode: 6.5KAmps
- Peak current common mode: 13.0KAmps
- EMI/RFI noise rejection: 60dB
- UL 1449 TVSS rating: 330V
- UL/CSA approved
- Lifetime warranty with \$2,500 lifetime equipment protection policy



191273CL



Now Lower Prices

Part No.	Description	1	10	100
191273CL	3-outlet w/ cable TV.....	\$14.25 \$13.55	\$12.95	
191265CL	7-outlet	\$14.15 11.15	10.84	
191855CL	7-outlet w/ fax/modem	\$18.99 15.99	14.50	

APC Power Manager-POW6T

- 6 outlets
- 480 joules
- Peak current normal mode: 13KAmps
- Peak current common mode: 26KAmps
- UL1449 TVSS rating: 330V
- \$25,000 lifetime equipment protection policy
- Size: 12.5"W x 14.6"D x 1.7"H



Now Lower Prices

Part No.	APC No.	Wt. (lbs.)	1	10
191804CL	POW6TWH	6.0	\$58.75 \$44.99	\$42.79

PC Monitor Power Cable

- Allows connection of monitors directly to standard IBM type power supplies
- Monitor turns on/off automatically via system power switch
- IBM PC/XT and higher compatibles
- See page 69 for more power adapter cables



Part No.	Description	1	10	100
177447CL	1' monitor cable	\$2.95	\$2.49	\$2.15

APC Professional Surge Arrestor-PRO8

- 8 outlets with RJ11 modem/fax/DSL protection
- 320 joules
- Peak current normal and common mode: 13KAmps
- EMI/RFI noise rejection: 60dB
- \$10,000 lifetime equipment protection policy
- 8 outlet with RJ11 modem/fax/DSL protection
- Size: 8.0"W x 5.8"D x 1.8"H



191839CL



Now Lower Prices

Part No.	APC No.	Wt. (lbs.)	1	10
191839CL	PRO8T2	2.5	\$21.85 \$19.59	\$17.80

Computer Power Cord

- 3-conductor piggy-backed power cord for computers
- 18/3 AWG
- SJT round junior service type cord
- UL/CSA approved
- Weight: 0.5 lbs.



Part No.	Description	1	10
84937CL	6' computer power cord	\$6.95	\$6.29

Computer Power Cord

- 3-conductor power cord extension for computer power supplies
- 18/3 AWG
- SVT round light service type cord
- UL/CSA approved
- Weight: 0.4 lbs.



Part No.	Description	1	10
28468CL	6' computer power cord	\$4.39	\$3.95

Laptop Computer Power Cords

- 2-conductor power cord for laptop computers and power supplies
- 18/2 AWG
- SPT-2 flat junior duty type cord
- UL/CSA approved
- Weight: 0.3 lbs.

Quantity SAVE

189587CL

200791CL

Part No.	Description	1	10
189587CL	6' "8" style laptop power cord	\$2.95	\$2.49
200791CL	6' "D" style laptop power cord ..	2.95	2.69

Compact Surge Protector for Notebook Computers

- Single 3-prong receptacle outlet; and telephone modem protection
- 3-prong wall mount type
- 210 joule rating
- Surge LED indicator
- RFI noise blocker
- Size: 2.3"W x 1.3"D x 3.3"H



SL WABER

Part No.	Description	1	10	25
206279CL	Outlet protector	\$6.95	\$6.25	\$5.59

For our complete line of Power Cords see page 69.



UTP Ethernet Cable Tester

- Connector type: RJ45 8P8C
- System used: 258A, 356A, AT&T/Ethernet 10BaseT
- Miswire, open, short tests
- Size 4.5"L x 2.5"W x 1.3"H

Requires: 9V battery (recommend P/N 151095CL, pg 154)

Includes: Zipper case



Part No.	Description	1	10
115895CL	Network Cat. 5 tester	\$29.95	\$26.95

Modular Cable Tester with Remote Terminator

Easily read correct pin configuration of 10baseT, 10base2, RJ45/RJ11 modular cables, 258A, TIA568A/568B, token ring, etc. Test installed cables either on wall plate or patch panel from a distance.



- Check for cable continuity, miswiring, open, short, grounding, and pin configurations
- Cable adapters: RJ45 M-M, 2 RJ45M-BNCM and BNC F-F • Weight: 0.7 lbs.
- On-board conn.: 2 RJ45F (tester) and 1 RJ45F (remote) • One-year warranty
- Size: 4.0"L x 2.5"W x 1.0"H (Main console)
- Size: 4.0"L x 1.3"W x 1.0"H (Remote)

Includes: Manual and test cables

Part No.	Description	1	10
145710CL	Modular cable tester	\$84.95	\$76.49

Tone Generator & Amplifier Probe For Tracing Wires & Cables

- Tests wire trace, continuity, clear/busy/ringing line, tip/ring identification
- Insulated inductive probe tip prevents shorting conductors
- Selectable continuous or variable tone generation
- Built-in speaker on probe with sensitivity control
- Output jacks for both headphones and handsets



Includes: Alligator test leads, modular phone connector cables, 9V battery, and carrying pouch

Part No.	Description	1	10
198002CL	Tone gen. & amp. probe	\$79.95	\$71.95

19" Rack Mount CAT 6 Patch Panels

For the Maximum Network Performance

Our CAT 6 patch panels feature 110D punch blocks that are compatible with KRONE or 110-impact tool. The RJ45 jacks are top entry type; PBT UL94 V0 rated. UL/CUL listed and CAT 6 certified. Can be used with T568 A/B installations. Color-coded to T568 specifications.



Part No.	Description	1	10
229518CL	24-port patch panel	\$129.95	\$129.95
229526CL	48-port patch panel	239.95	215.95

19" Rack Mount Patch Panels

Our CAT 5 patch panels feature 110D punch blocks that are compatible with KRONE or 110D tool. UL and CUL listed and certified, CAT 5 certified and can be used with T568 A/B installations. Blocks are color coded for T568 color-coding, and easy wire management.



Part No.	Description	1	10
208768CL	12-port patch panel	\$35.95 \$28.99	\$27.55
208784CL	24-port patch panel	65.95	59.95

Category 6 Network Cables



Part No.	Description	1	10	100
219707CL	3' gray cable	\$6.29	\$5.79	\$5.29
219862CL	7' blue cable	7.99	7.39	6.79
219766CL	7' black cable	7.99	7.39	6.79
220020CL	14' white cable	8.99	8.29	7.59
219977CL	14' yellow cable	8.99	8.29	7.59
219934CL	25' red cable	13.49	12.39	11.39
219846CL	50' green cable	22.49	20.69	18.99

For more Cat 6 Network Cables see page 62.

LAN Tester Tool Kit For RJ11, RJ45, USB, and BNC

A great tool kit for network cable and telephone-cabling system installers, network debugging engineers and technicians, datacom consultants. This tester offers simple and easy operation, compatible with RJ11, RJ45, USB, and BNC wiring system; you can verify the condition and status before or after installation within two seconds. The kit includes punchdown tools, crimper tool, and cable tester.



- Shield/ground test
- Connected wire display
- Crossover/wrong connection display
- Ethernet 10Base2/5, cable modem, CATV termination value detection
- Open/short wire test

Part No.	Description	1	10
249252CL	LAN tester kit	\$99.95	\$89.95
198791CL	9V battery	2.85	2.55

Net Toner and Probe Kit

With testing functions such as sending tones, verifying lines, indicating line conditions, identifying tip and ring, providing "talk" battery and testing continuity, you can use this kit on single conductor, twisted pairs, coaxial cables, and non-energized electrical wiring. Great for installing or troubleshooting telephone, data, security/alarm, heating and air, audio/visual, and electrical systems. Connections include alligator clips, RJ45 jacks and RJ12 plugs.

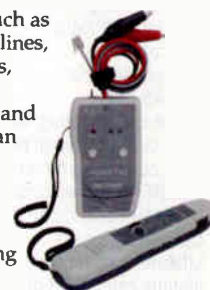

Includes: Padded zipper case w/ belt loop & spare tips

Part No.	Description	1	5
227897CL	Net toner & probe kit	\$79.95	\$76.95

Jameco's Low-Price Guarantee

We'll match the print advertised price of any like product.

PC Testing & Diagnostics

Computer Monitor & NTSC Tester Mac, PC and TV

- Tests VGA, Super VGA, Mac monitors and TVs
- Checks full-field color bars, color raster, dots (static and dynamic convergence), cross-hatch and windows (power supply regulation, checks for a clear distinction between white and black portions)
- Connectors: HDB15F, DA15F
- Two video conn. for TV, composite and S-video
- Power with either a 9V battery or an external DC adapter (recommend P/N 151095CL, pg 154 or P/N 100845CL, pg 145)
- Size: 5.5"L x 3.0"W x 1.4"H
- Weight: 0.7 lbs. • One-year warranty



Part No.	Description	1	10
149729CL	Computer monitor tester	\$189.95	\$179.95

Diagnostic Card for PCI-Bus Systems

This is the first diagnostic card for monitoring Power-On-Self-Test results in systems using PCI-Bus architecture.

- Plugs into any PCI I/O slot
- Digital indicators for every POST code error
- LEDs for monitoring power (DC): +12, -12, +5, +3
- LEDs for clock and reset failure
- Comprehensive manual w/ error codes from all major BIOS manufacturers including AMI, AWARD, PHOENIX and more • One-year warranty



Part No.	Description	1	10
135108CL	PCI-POST diagnostic card	\$265.95	\$239.95

PC Diagnostic Software "Quicktech '98"

Self-booting software for 386, 486 and Pentium® II/MMX/III/AMD Athlon

- Verify proper operation and troubleshoot failures of all major PC components: hard drives (MFM, RLL, IDE, SCSI); floppy drives; base, extended and external cache RAM; VGA/EGA/VESA compliant video cards; keyboard; monitor; printer; and I/O ports
- 48 hour burn-in mode for lengthy testing
- Floppy drive head cleaning function

Includes: Loopback testers for DB9 and DB25 serial and DB25 parallel ports, manual and 3.5" disk



Part No.	Description	1	10
134826CL	QuickTech '98 software	\$117.95 \$98.95	\$98.95

5.6" Color TFT Monitor

NTSC Format

- TFT color LCD display
- 224 x 640 pixel display resolution
- Built-in 1 watt speaker
- Brightness, color and volume adjustments
- Video input: 1.0Vp-p; 75Ω
- Audio input: 2Vp-p; 2kΩ
- Size: 6.1"W x 4.8"H x 1.2"D
- Weight: 2.6 lbs.



Includes: RCA cable, mounting stand with hardware and 12VDC @ 500mA power supply

Part No.	Description	1	10
201702CL	5.6" TFT color monitor	\$279.95	\$259.95

4" TFT LCD Monitor

NTSC Format

- TFT color LCD
- Resolution 234 x 383dpi
- Backlight: cold cathode fluorescent lamp
- Power source: 12VDC @ 400mA
- 5" long lead wire with 4 position molex type power connector
- Tint color and brightness adjustable
- Size: 4.1"L x 3.3"W x 0.7"H (display)
- Size: 4.7"L x 3.3"W x 1.3"H (unit) • Weight: 0.7 lbs.



Part No.	Description	1	10
172742CL	4" color LCD monitor	\$159.95	\$149.95

Video Text Display Module

NTSC composite (1Vp-p, 75Ω)

- Asynchronous serial input: 2400, 4800, 9600 or 19.2kbps
- 30-pin SIMM form factor (socket supplied)
- Compatible with Parallax Basic Stamp®, see pg 221
- Auto-switching genlock overlay or internal video generation
- Power supply: +8-16VDC @ 65mA input; 5VDC aux. output (regulated) provided
- Displays up to 308 characters (11 lines of 28)
- 12 x 18 pixel character pattern
- Size: 3.5"L x 1.1"H



Part No.	Mfr. Cross Ref. No.	1	10	25
162051CL	BOBII	\$69.95	\$62.95	\$56.65

SMK RF Modulator

- Output frequency: NTSC Ch. 3/4, switch selectable
- 12VDC RF modulator
- Operating voltage: 12V @ 50mA max.
- RF output impedance: 75Ω (F-type connector)
- Video modulation: 1.0V p-p
- Audio FM deviation: 1.4V p-p
- PC connections: solder tab connectors
- Size: 1.7"L x 1.7"W x 0.7"H
- Manufacturer No.: WMM2144-01



Quantity
SAVE

Part No.	Description	1	10	50	100
141639CL	RF modulator	\$4.95	\$4.29	\$3.29	\$2.49

SONY® Color CCD Camera

Sony Chipset

- 1/4" Sony super HAD CCD sensor
- NTSC system with 510(H) x 492(V)
- Furnished mini lens: 3.6mm
- Minimum illumination: 0.5 lux @ F2.0
- Signal to noise ratio: >48dB • 330 TV lines
- Supports these functions: auto electronic shutter (AES), auto iris control (AIC), auto gain control (AGC), auto white balance (AWB), back light compensation (BLC) and flicker less (FL)
- Video drive iris control; high/low switchable auto gain control; on/off backlight compensation
- Internal, negative synchronous system
- Video output: 1Vp-p; 75Ω



Requires: 12VDC @ 120mA power supply (recommend P/N 100095CL, pg 145)

Includes: Power/signal cable & mounting hardware

Part No.	Description	1	10
213436CL	Enclosed color camera	\$179.95	\$161.95

Mini Enclosed Color NTSC Camera

- 1/4" CCD Sensor
- 350 horizontal TV lines
- 1 lux/F2.0
- Electronic shutter: up to 1/120,000 sec.
- NTSC system with 512(H) x 492(V)
- Scanning system: 2:1 interlace
- Signal to noise ratio: 48dB
- Lens: 3.7mm/F2.0
- Video output: 1Vp-p, 75Ω • FOV: 92°
- Size: (enclosure) 1.3"L x 1.1"W x 0.9"D
- Weight: 0.3 lbs. • Two-year warranty



Requires: 9VDC - 12VDC @ 500mA power supply (recommend P/N 100853CL, pg 145)

Includes: BNC/Power cable and mounting hardware

Part No.	Description	1	10
215423CL	Mini enclosed camera	\$129.95	\$119.95

Color Interline Camera

Water Resistant with Adjustable Mounting Bracket

- EIA format
- 1/3" CMOS image sensor
- EIA format: 512(H) x 492(V)
- 330 horizontal line resolution
- 2:1 scanning interlace system
- 5 lux sensitivity
- Video output: 1V p-p; 75Ω
- 6mm lens/F2.0
- S/N ratio: 40dB • FOV: 530
- Electronic shutter: 1/60 - 1/1,200 sec.
- Connectors: 1 standard RCA female jack for video, and in-line 2.1mm power-plug connector for power supply • Size: 2.6"L x 0.9"Dia.



Includes: Adjustable mounting bracket, instruction sheet and 9V @ 100mA power supply

Part No.	Description	1	10
185017CL	Color camera	\$99.95	\$89.95

Color Camera Board

NTSC Format

- 1/3" CCD image sensor
- 5.0 lux • FOV: 92°
- 3.6mm lens/F2.0 • 330 TV lines
- Low power consumption
- Automatic exposure, gain and white balance
- Size: 1.0"L x 0.9"W x 1.1"H



Part No.	Description	1	10
171011CL	Camera board	\$73.95	\$66.59

SONY® Black & White Low-Light Camera

Sony Chipset

- Signal to noise ratio: >48dB
- Requires 12V power source (not included)
- 6" wires with 4-pin Molex-type keyed connector
- EIA system 537(H) x 505(V)
- Composite output with 420 line resolution • Lens: 3.6mm
- Shutter speed: 1/60 - 1/1000 • FOV: 92.6°
- Video output: 1.0Vpp composite video/75Ω
- Size: 1.3"L x 1.3"W x 1.0"H • One-year warranty



Part No.	Description	1	10	25
150931CL	Camera board	\$89.95	\$80.95	\$71.95
159071CL	8mm lens 38.6"	17.95	17.10	16.25

Black & White Camera

EIA Format

- 1/3" CCD image sensor
- 510(H) x 492(V)
- S/N ratio: 46dB
- Horizontal resolution: >350 lines
- Scanning system: 2:1 interlace
- Sensitivity: 0.7 lux/F2.0
- Video output: 1Vp-p, composite video 75Ω
- Power supply: 12VDC (recommend P/N 162996CL, pg 144)
- Size: 1.3"L x 1.3"W x 1.2"H
- Power consumption: 110mA • FOV: 92°
- Electronic shutter: 1/125,000 sec. (linear)



Part No.	Description	1	10
171029CL	Camera board	\$44.95	\$40.45

10" Black & White Security Monitor with Audio

- EIA format
- 9" viewable screen
- Resolution: 700 line
- Push down front panel for volume and power switch
- BNC jacks for audio/video input
- Input voltage: 120VAC @ 60Hz (2-prong 5' cable)
- Size: 9.3"W x 12"D x 9.1"H
- Weight: 15 lbs.



Part No.	Description	1	10
253067CL	10" black & white monitor ..	\$109.95	\$89.95

Opening an account is easy!!

Call 1-800-831-4242 for details today.

Corporate Customers



4-Channel 2.4GHz Wireless Audio/Video Transmitter System

CCIR, NTSC, PAL, EIA Format

- ISM Band: 2.413 - 2.470GHz
- Four selectable transmitter and receiver channels
- Antenna mode: dipole (omnidirectional)
- Impedance: 50Ω typical
- Video input: 1 Vp-p composite
- Audio input: 2Vp-p max.
- Weight: 3.2 lbs.



Includes: Two 9VDC @ 300mA with 1.3mm x 3.5mm center positive plug, and two 2.5mm male to RCA patch cables

Part No.	Description	1	10
265308CL	4-ch. wireless system	\$149.95	\$134.95

Affordable Wireless Security 2.4GHz Wireless Security Camera w/ Receiver

Your own full-color indoor video monitoring/security system is only seconds away! The compact, wall-mountable camera transmits up to 150 feet for convenient viewing on a standard TV or recording on a standard VCR.



Includes: camera, receiver, remote control, power adapters and RCA cables

Part No.	Description	Price
233375CL	Wireless camera w/ receiver & remote	\$69.95

DigiVue™ Digital Surveillance System

This new high-speed PCI video capture card comes with 4-channel video and 1-channel audio input that provides superb digital images from multiple cameras and remote surveillance. Add up to 4 cards per system controlling up to 16 cameras.

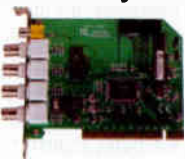

- Input signal: 4 video, 1 audio synchronized mono (with sound card)
- Display: 1/4/9/16/full screen
- Display and record: 60 frames per second (per card)
- Record mode: event/continuous/scheduled
- Enhanced MPEG4 format
- Time/date stamp
- Color adjust: adjustable light, contrast, hue, saturation
- Resolution: 160 x 120 up to 640 x 240
- Multitask: monitoring, recording, PTZ control, remote, back-up
- Motion detection: 16 zone x multi area for each camera
- Size: 4.9"L x 3.6"H
- Storage: HDD, VDRAM, CD-RW, DAT, ZIP
- Support internet monitoring: client software, explorer, or windows media player

Includes: CD-ROM software and drivers
Minimum system requirements: Pentium® III/800MHz, 128 MDRAM, 32M AGP video card or above (recommend Pentium® 4/1.8GHz, 64M AGP video card)

Part No.	Product No.	1	4
262019CL	EDV-XVIEW4	\$237.55	\$225.95

Cable Assembly (BNC - BNC 75Ω RG59/U)

Part No.	Length	1	10	50	100
262730CL	25'	\$10.45	\$10.25	\$9.95	\$9.50
262748CL	50'	17.05	16.25	15.45	14.69
262764CL	100'	30.39	28.89	27.45	25.99

4-Channel 2.4GHz Wireless Audio/Video Receiver and 10mW Transmitter

Make your camera wireless up to 492 feet!

- Transmission range: 492' (150M outdoors); 164' (50M indoors)
- 4-channel switch selectable on transmitter
- Output power (transmitter): 10mW
- Output impedance: 50Ω typical
- Video input: 1Vp-p composite
- Audio input: 2Vp-p max.
- RCA jacks for audio and video connectors

192858CL



Receiver:

- Non-volatile memory protects system set-up from power loss
- Video loss detection and freeze channel
- Mute and alarm trigger port
- Size: (transmitter) 4.5"L x 3.2"W x 1.0"H
- Size: (receiver) 6.5"L x 5.5"W x 1.4"H
- Wt.: 1.8 lbs.

192866CL



Includes: RCA cable, 12VDC@500mA adapter, RCA to F connector adapter (receiver unit only)

Part No.	Description	1	10
192858CL	4-channel transmitter	\$89.95	\$79.95
192866CL	4-channel receiver	124.95	112.95

2.4GHz Wireless Antenna Booster Extend Video Transmitting Distance

- Output power: 700mW (±10%)
- Input power: 10mW ~ 60mW
- Consumption 350mA
- Impedance output: 50Ω typical (to antenna)
- Frequency: 2400MHz - 2.5GHz
- Size: 2.2"L x 2.0"W x 0.8"H

215175CL



179872CL

Includes: 9VDC @ 800mA power supply
179864CL: For use with 2.4GHz cameras, transmitters, and receivers • Gain: 3dB; unidirectional

Part No.	Description	1	10
215175CL	Antenna booster	\$199.95	\$179.95
179864CL	2.4GHz SMA RF antenna	15.95	14.35
179872CL	Wireless extension cable	10.99	9.89

Mini Wireless Color Camera

Now you can place a color video camera with sound almost anywhere! This super-small (1" x 3/4" by 7/8") 1/4 ounce, 3 Lux wireless camera and receiver combo delivers sharp, full-motion video images at 380 lines of resolution. With its 150-foot (unobstructed) range, light weight, and 9-volt battery power, you can now add video capability to a world of hobby applications.



NEW

Part No.	Description	Price
249025CL	Wireless color camera	\$89.95

Mount your video camera almost anywhere

As steady as a tripod, the Window Camera Mount lets you anchor that video camera to any glass surface at any height.

Mount your video or CCTV camera on any window or other non-porous surface, and capture what you've never been able to before.

This heavy-duty metal mounting bracket attaches securely to any glass surface with a strong lever-activated 3.25" neoprene suction cup. Mount your camera onto the tripod-style screw. Adjust to any position, and you're ready to shoot hands-free. It's perfect for temporary surveillance of your business or home. For cameras up to 3 lbs.



Mounts easily to your car window

Part No.	Description	1	5
222746CL	CCTV camera window mount	\$39.95	\$34.95

12 Version Camera Mounting Kit

A unique component system allows you to build one of twelve versions for today's smaller cameras. Quality ball housing provides 120° tilt and 360° camera rotation. Shafts are 1/2" dia. Vinyl cover adds a finished and professional look.

PANAVISE



- Wall ceiling and T-Bar clip mounting
- Shafts: 2" (50.8mm), 4" (101.6mm) or 6" (152.4mm) long
- Knob & set screw adjustment CCTV mounts

224354CL

Part No.	Product No.	Description	Price
224354CL	845-246	CCTV mounting kit	\$16.95
224389CL	860	Tri-foot base	7.49
224371CL	861	Square base	6.29
224362CL	862W	J-Box plate	8.95

Mini Indoor Pan & Tilt Mechanism Continuous Pan

- Automatic scanning: 0° - 355° angular travel; pan clockwise and counter-clockwise
- Manual tilt: 0° - 90°
- Pan speed: 5"/sec.
- Maximum load: 4.4 lbs.
- Power consumption: 1 watt
- Size: 2.5"Dia. x 2.4"H
- Warranty: 2 years continuous use
- Weight: 0.4 lbs.



Camera not included

Includes: 24V @ 150mA power supply, wall mount bracket and mounting hardware

Part No.	Description	1	10
215407CL	Mini pan/tilt	\$49.95	\$44.95

See the yellow and green highlighted items. Sale details are on page 2.

Jameco Special Values!

Black & White CCD Camera with 6" Monitor

Camera: EIA Format

- 512(H) x 492(V)
- 1/3" CCD image sensor
- 380 TV line res.
- 6 IR LED light for view in the dark application
- 15.734kHz horizontal synch. frequency
- 2:1 interlace scanning system
- 1/100,000 second electronic shutter
- 3.6mm lens with F2.0 • S/N ratio: 48dB
- Video output: 1Vp-p, 75Ω
- Audio output: 2Vp-p, 50Ω maximum • 0 lux at 2M
- BNC connector for video & RCA connector for audio
- Power supply: 12-15V @ 130mA • FOV: 92°
- Size: 2.2"W x 2.8"D x 2.1"H



Includes: Camera bracket

Monitor: EIA Format

- 6" 2-channel flat screen monochrome monitor
- Vertical hold, brightness and contrast adjustment knobs at rear of monitor
- Size: 6.7"W x 7.2"D x 5.2"H • Weight: 7.7 lbs.

Includes: 20M audio/video cable, manual and 15V @ 1A center positive power supply

Part No.	Description	1	10
170616CL	Camera w/ monitor	\$159.95	\$143.95

Mini Dome Color Camera

NTSC Format

- Perfect for ceilings
- 1/4" CCD image sensor
- 512(H) x 492(V)
- 330 horizontal line res.
- S/N ratio: 46dB
- 15.73kHz horizontal synch. frequency
- Scanning system: 2:1 interlace
- Up to 1/96,000 second electronic shutter
- 3.6mm lens with F2.0 • Video output: 1Vp-p, 75Ω
- Power supply: 12VDC @ 160mA (recommend P/N 162996CL, pg 144)
- 2 lux/F2.0 • FOV: 92°
- Size: 3.5"Dia. x 2.3"H



Includes: Mounting hardware

Part No.	Description	1	10
171037CL	Mini-dome camera	\$139.95	\$125.95

Monitor/TV Wall Mount Brackets

- 95° swivel
- Assembly required
- Requires unit base to be mounted securely to wall stud
- Wall mount screws not included
- Supports up to 66 lbs. • Weight: 9.0 lbs.



Part No.	Description	1	10
181817CL	12"-18" TV wall mount	\$29.95	\$27.95

Mounting Brackets for Enclosed Camera

- Material: plastic
- Base mounted w/ 3 screws
- Swivel angle: 360° • Tilt angle: 90°
- For use w/ enclosed cameras (P/Ns 150404CL and 169404CL, right)



Part No.	Mfr. Cross Ref. No.	Ht. (in.)	1	10
171002CL	• Color: ivory		Max load: 11 lbs.	
170982CL	• Color: white		Max load: 6.6 lbs.	
171002CL	15-B002L	6.4	29.95	5.49
170982CL	15-B004	2.0	8.49	7.65

Color Camera

- 1/3" Panasonic CCD image sensor
- Image size: 4.82mm (H) x 3.64mm (V)
- More than 380TV lines horizontal resolution
- 15.734kHz synch. freq.
- Scanning system: 2:1 interlace
- S/N ratio: more than 46dB
- BNC connector for video • FOV: 42.6°
- Video output: 1Vp-p; 75Ω • 1.0 lux / F1.4
- Size: 4.0"L x 2.2"W x 2.0"H • Weight: 0.9 lbs.
- 512(H) x 492(V) NTSC signal format
- Auto iris: DC driver / video driver switchable



Requires: 12VDC @ 140mA power supply (recommend P/N 162996CL, pg 144)

Part No.	Description	1	10
171248CL	Color CCD camera	\$224.95	\$201.95

Night Vision Infrared Lighted Camera

EIA Format

- Adjustable camera lens
- Auto iris controlled
- Built-in voltage regulator
- Horizontal synch. frequency: 15.734kHz
- 6 infrared LEDs for night vision
- Scanning system: 2:1 interlace
- Video output: 1Vp-p; 75Ω • Lens: 3.6mm
- Audio output: 2Vp-p max. • 380 TV line resolution
- FOV: 92° • 0.1 lux with F2.0
- Matching conn.: RG59 BNC (P/N 71271CL, pg 81)
- Size: 2.9"L x 2.0"W x 2.0"H • Weight: 1.2 lbs.



Includes: 12VDC @ 500mA power supply and wall mounting bracket

Part No.	Description	1	10
150404CL	Infrared lighted camera	\$119.95	\$109.95

Mini Alarm Siren

- Sound pressure: 108dB
- Output frequency: 3000Hz
- Rated: 2-12VDC @ 300mA
- Adjustable mounting plate
- 16" color coded connector wires, tinned
- Size: 2.8"Dia. x 2.5"L



Part No.	Description	1	10	50
148152CL	Alarm siren	\$7.95	\$6.79	\$5.09

Audio/Video Adapters (CAT 5 UTP)

- Converts impedance of video/audio signals to 100Ω for transmission over CAT 5 UTP cable
- Supports both NTSC or PAL video signals
- Built-in impedance matching device and filter for video and audio signal transmission
- Use with existing premises wiring and wall jacks for easy and cost effective installation
- Video transmission distance: 1000' color/2000' B/W
- 210471CL: Signal pair: video (BNC), CAT pair 1 (RJ45)
- 220880CL: Signal pairs: video (BNC), CAT pair 4 (RJ45); audio 1 (RCA); CAT pair 3 (RJ45); audio 2 (RCA), CAT pair 2 (RJ45)



Includes: 1 RCA to BNC adapter & 2 mounting screws

Part No.	Connector Type	1	10
210471CL	BNC/RJ45	\$29.95	\$26.95
220880CL	BNC/RCA/RJ45	42.95	38.95

Black and White Camera with 8mm Lens

- 1/3" CCD image sensor
- Horizontal res: 420TV lines
- Min. illumination: 0.1lux
- Horizontal freq.: 15.734kHz
- 510(H) x 492(V) EIA signal format
- Vertical freq.: 60Hz • Clock freq.: 19.0699MHz
- Scanning system: 2:1 interlace • S/N ratio: 48dB
- Electronic shutter: 1/100,000 sec.
- Auto iris lens: DC drive / AES / video drive
- Video out.: 1Vp-p, 750Ω • Audio out.: 2Vp-p max., 50Ω
- Backlight compensation and auto gain control selectable
- Power requirements: 12VDC @ 100mA; 24VAC
- Size: 4.5"L x 2.0"W x 2.0"H • Weight: 0.8lbs.



Part No.	Description	1	10
245041CL	Black & white CCD camera ..	\$109.95	\$99.95

Solar Outdoor Security Light

Dark spots around your business, house or neighborhood are vulnerable to vandalism or burglary. To protect your property, equip it with our new outdoor security lights and motion sensors. All you need are simple tools to mount the unit to the wall. No complicated wiring or electrician needed. The built-in batteries are rechargeable by sunlight, so if the main power goes out you still have security lighting. The solar panel, which has a 12' cord, can be positioned for optimum light exposure.



- Lights up to 60 times on a single charge
- Charges by day, lights by night • Easy to install
- Complete with built-in motion detector, rechargeable battery and bright halogen light • Weight: 7.1 lbs.

Part No.	Description	1	10
219580CL	Security light	\$79.95	\$74.95

Wall Mount Permanent Key Lockbox

An ideal business solution for access to secure areas like tool cages, construction sites, and computer rooms. This stylish keybox can be attached securely to a wall, in plain view, and can hold up to 5 keys. Easy pushbutton combination lock with protective cover.



Part No.	Description	1	5
223941CL	Wall mount, clay	39.95	33.85
			\$30.76

Outdoor Metal Camera Enclosures

- Plate glass: 3mm thick
- Outdoor use
- 170931CL: without heater
- Clear window area: 2.5"W x 2.3"H
- Max. camera size: 4.0"L x 2.4"W x 2.4"H
- Size: 16.0"L x 4.9"W x 4.9"H • Weight: 2.8 lbs.
- 170940CL: w/ heater (keeps optics from fogging)
- Clear window area: 3.5"W x 3.1"H
- Max. camera size: 6.5"L x 3.2"W x 3.2"H
- Size: 11.0"L x 3.6"W x 3.6"H • Weight: 6.8 lbs.



Part No.	Description	1	10
170931CL	Camera housing	\$29.95	\$26.95
170940CL	Camera housing w/ heater	69.95	62.95

USB Camera on page 161.

Professional Electronic Technician Tool Kits for Every Situation!

25-Piece Field Repair Tool Kit

Two-in-one design allows user to carry a tool case and a briefcase in one. Features a separate case for tools that attaches to the briefcase with zippers.

- In addition to the tools listed in the matrix below, the kit includes:
 - 5" snipe nose pliers
 - Alignment driver
- Size: 14.2"W x 11.0"D x 4.7"H • Weight: 6.6 lbs.



Part No.	Description	1	5
218211CL	Master electronic tool kit	\$69.95 \$59.95	\$53.96

28-Piece Cellular Phone Services Tool Kit

This kit is perfect for mobile phone repair.

- In addition to the tools listed in the matrix below, the kit includes:
 - 4" micro cutting pliers
 - 5" snipe nose pliers
 - Hot air tip
 - Self igniting micro torch
 - S-needle tip
- Size: 11.9"L x 9.8"W x 1.9"H • Weight: 3.2 lbs.



Part No.	Description	1	5
218202CL	Cellular phone tool kit	\$69.95 \$59.95	\$53.96

51-Piece Tech Tool Kit

Essential Kit for Electronic Machine Maintenance and Repair Jobs!

- In addition to the tools listed in the matrix below, the kit includes:
 - 2 nut drivers
 - Solder pen
- Case features removable pallets, a combination lock and a cushioned black plastic handle
- Size: 12.5"L x 17.5"W x 3.5"H • Weight: 10.4 lbs.



Part No.	Description	1	5
26681CL	51-piece tool kit	\$99.95 \$94.95	\$75.95

27-Piece Technician's Tool Kit

All the essential technician's tools in a durable canvas carrying case.

- In addition to the tools listed in the matrix below, the kit includes:
 - 5" precision range side cutting pliers
 - 5.3" precision range long nose pliers
 - Solder wick
 - Alignment driver
 - Nut screwdriver (1/4")
- Size: 16.2"W x 13.0"D x 3.0"H • Weight: 7.1 lbs.



Part No.	Description	1	5
218229CL	Technician's tool kit	\$116.95 \$99.95	\$89.96

55-Piece Tech Tool Kit

An assortment of tools for general & precision work for technicians, engineers, students, etc.

- In addition to the tools listed in the matrix below, the kit includes:
 - Screwdriver handle
 - 6-piece mini-hammer set
 - 5 piece of double edge blade
 - PLCC extraction tool
- Carrying case has outer velcro pockets to store paperwork, etc.
- Complete your assortment with a multimeter (See pages 188-192)
- Size: 17.6"L x 12.8"W x 4.0"H • Weight: 9.2 lbs.



Part No.	Description	1	5
136311CL	55-piece tool kit	\$124.95	\$112.46

57-Pc. Master Electronics Tool Kit

Simply every tool needed for field repair or installation. All in a handsome lockable case, with room for spare parts or special equipment.

- In addition to the tools listed in the matrix below, the kit includes:
 - 5" & 6" side cutter
 - 5" & 6" long nose pliers
 - 8" combination pliers
 - 9.5" water pump pliers
 - Testing driver
 - Alignment driver
 - Solder wick
 - Parts tube
 - PVC insulated tape
 - 5-piece file set
 - Oil can
 - 6" stainless scissors
 - Carpenter hammer
- Carrying case has two removable pallets, adjustable compartments, and combination locks
- Size: 18.0"W x 13.0"D x 4.0"H • Weight: 16.0 lbs.



Part No.	Description	1	5
218245CL	Master electronic tool kit	\$131.95 \$124.95	\$117.95

Quick-Reference of Professional Tool Kit Contents

Parts included in kits	218211CL	218229CL	218202CL	26681CL	136311CL	218245CL	242851CL	149024CL
3-prong holder					1	1	1	1
Anti-static strap					1	1	1	1
Brush		1		1	1	1	1	1
Crimping tool		1 (7-way)			1 (7-way)	1	1	1
Desoldering pump	1	1		1	1	1	1	1
Digital Multimeter		1		1	1	1	1	1
Drill set								1
Files, needle		2-pc		2-pc			6-pc	5-pc
Flashlight		1			1	1	1	1
Forceps					1	1	1	1
Heat sink					1	1	1	1
IC extractor	1	1			1	1	1	1
Inspection mirror					1	1	1	1
Measuring tape, 10-foot	1				1	1	1	1
Pliers, 8" lineman	1 (6")				1	1	1	1
Pliers, bent needle nose				1	1	1	1	1
Pliers, diagonal cutter	1			1	1	1	1	1
Pliers, flat nose				1	1	1	1	1
Pliers, needle nose				1	1	1	1	1
Pliers, snipe nose			1					1
Scissors				1		1	1	1
Screwdriver set	6-pc	7-pc	12-pc	8-pc	3-pc	8-pc	12-pc	9-pc
Screwdrivers, precision			2-pc	6-pc	6-pc	6-pc	6-pc	6-pc
Solder core	1	1	1		1	11	1	1
Soldering aid kit, 3-pc			1 (6-pc)	1	1	1	1	1
Soldering iron	1 (30W)	1 (30W)		1	1 (30W)	1 (30W)	1 (30W)	1 (25W)
Soldering stand		1		1		1	1	1
Tape, electrician		1					1	1
Tweezers	1	1	1	1	2	1	1	1
Utility components box		1				1	1	1
Utility knife	2-in-1	1		1	1	1	1	1
Wire stripper								1
Wrench, adjustable	1	1			1	1	1	1
Wrench, hex key	7-pc	7-pc		7-pc	7-pc	7-pc	7-pc	7-pc
Wrench set						6-pc	5-pc	10-pc
Total Pieces	25	27	28	51	55	57	100	114
Price	\$59.95	\$99.95	\$59.95	\$94.95	\$124.95	\$124.95	\$199.95	\$279.95

100-Piece Professional Electronics Tool Kit

Kit for Field Technicians and Engineers!

- In addition to the tools listed in the matrix left, the kit includes:
 - Computer/polarity circuit tester
 - Mini vacuum cleaner
 - Cassette head cleaning fluid
 - 3.6V cordless screwdriver kit (bits included)
- Aluminum case features removable pallets, surface-type locks, and black plastic handle
- Size: 18.0"L x 14.0"W x 6.0"H • Weight: 15.5 lbs.



Part No.	Description	1	5
242851CL	100-piece tool kit	\$199.95	\$189.95

114-Piece Tech Service Tool Kit

- In addition to the tools listed in the matrix left, the kit includes:
 - 40-pc socket pack
 - 6" side cutter
 - 6" long nose plier
 - 6" slip joint plier
 - carpenter hammer
 - 3 piece trimmer set
 - stainless steel spring hook
 - solder wick
 - 8" combination plier
 - 2 removable pallets
- Size: 18.5"L x 13.8"W x 6.7"H • Weight: 22.8 lbs.



Part No.	Description	1	5
149024CL	114-piece tool kit	\$279.95	\$251.99

Economy Tool Kits for Every Budget!

8-Piece Compact Tool Kit

The perfect size and tools for quick repairs.

- 5" side cutter
- 5" long nose pliers
- PRO-SOFT 3 x 75mm slotted screwdriver
- PRO-SOFT #0 x 75mm Phillips screwdriver
- Stainless tweezers
- Solder core • Desoldering pump
- Portable gas soldering iron with torch tip
- Size: 8.1"L x 5.7"W x 1.4"H • Weight: 1.2 lbs.



Part No.	Description	1	5
218181CL	8-piece compact tool kit	\$19.95	\$17.95

10-Piece Electronic Tool Kit

Ideal for repairing electronic devices and perfect for the electronic enthusiast.

- #0 Phillips and 3mm slotted screwdrivers
- Precision Phillips and slotted screwdrivers
- Stainless steel tweezers
- Flat and round needle files
- 5" side cutter and long-nose pliers
- Size: 7.7"L x 3.7"W x 1.3"H • Weight: 0.8 lbs.



Part No.	Description	1	5
226077CL	10-piece electronic tool kit	\$14.95	\$14.19

11 & 12-Piece Lightweight Computer-Service Tool Kits

- Both kits include:
 - 2 nut drivers: 3/16", 1/4"
 - 3-claw parts holder
 - 1-pc hex key wrench
 - IC extractor
 - 4-pc screwdriver set
 - Tweezers



167206CL

167206CL: 11-Piece Tool Kit

- In addition this kit includes:
 - Clear components, tube holder
- Size: 8.5"L x 5.9"W x 1.3"H
- Weight: 1.1 lbs.



14189CL

14189CL: 12-Piece Tool Kit

- In addition this kit includes:
 - 14-16 pin IC inserter/straightener
- Size: 9.0"L x 5.8"W x 1.3"H • Weight: 1.2 lbs.

Part No.	Description	1	10	25
167206CL	11-piece tool kit	\$12.95	\$11.49	\$9.95
14189CL	12-piece tool kit	16.95	15.26	13.73

20-Piece SAE Computer Tool Kit

- The kit includes:
 - 1-pc hex key wrench
 - 30W soldering iron
 - Adjustable wrench
 - Needle nose plier
 - 6-pc screwdriver set
 - 6" solder - Tweezers
 - 8" wire cutter/stripper
 - Clamping tweezers
 - 3-pronged parts retriever
 - Spare parts tube
 - Flashlight with battery
 - 2 nut drivers (1/4" & 3/16")
- Size: 11.9"L x 9.2"W x 2.0"H • Weight: 3.5 lbs.



Part No.	Description	1	10	100
170966CL	Computer tool kit	\$24.95	\$22.46	\$20.21

24-Piece PC Premium Tool Kit

- 3.2mm x 75mm slotted screwdriver
- #0 x 75mm Phillips screwdriver
- 3 prong holder
- Spring tweezers
- Spare parts tube
- IC extractor • Torch
- Extension bar for ratchet bits
- Adjustable ratchet screwdriver
- Side cutter pliers
- 5mm and 7mm slotted bit
- #1 and #2 Phillips bit
- T10, T15, T20, T25, and T30 Torx bit
- 1/4" and 3/16" nut
- Size: 8.4"L x 5.9"W x 1.4"H • Weight: 1.3 lbs.



Part No.	Description	1	5
226085CL	24-piece premium tool kit	\$19.95	\$18.95

26-Piece SAE Hobby Tool Set

- 4-1/2" long nose pliers
- 4-1/2" diagonal cutting pliers
- #1 & #2 Phillips bits
- #1 & #2 pozi bits
- 3/16" & 1/4" slotted bits
- Hex to 1/4" driver adapter
- T-10, T-15, and T-20 Torx bits
- Driver handle
- 3" extension bar for 1/4" drive
- 3 slotted and 3 screw driver precision set
- 3/16", 1/4", 11/32" and 3/8" sockets for 1/4" drive
- Size: 12.0"L x 9.0"W x 2.0"H • Weight: 1.5 lbs.



Part No.	Description	1	10	25
170069CL	26-pc. SAE tool set	\$17.95	\$16.16	\$13.69

26-Piece Metric Hobby Tool Set

- 6 screwdrivers: Phillips #0, #1, slotted 0.05", 0.08", 0.09", 0.12"
- 10 bits: 5mm, 6mm, #No.1, #No.2, No.1, No.2, T-10, T-15, T-20, socket adapter
- Stainless steel tweezers
- Extension bar
- 4" long nose pliers
- Size: 6.4"L x 4.1"W x 2.0"H • Weight: 1.2 lbs.



Part No.	Description	1	10	25
99629C	26-piece tool set	\$8.95	\$8.06	\$7.25

40-Piece Electronic Tech Tool Kit

- The kit includes:
 - Wire cutters/stripper
 - Adapter bit for sockets
 - Pocket clip screwdriver
 - Potentiometer alignment tools
 - T10-T25 reversible Torx screwdriver bits
 - 3/16"-1/2" S.A.E. nut driver sockets
 - 6mm-12mm metric nut driver sockets
 - Slotted and Phillips screwdriver bits
 - 10-pc screwdriver set
 - Extra long 3-claw parts holder
 - IC inserter w/ pin straightener
- Size: 9.5"L x 6.8"W x 1.4"H • Weight: 1.7 lbs.



Part No.	Description	1	10	25
119183CL	40-piece tool kit	\$21.95	\$19.76	\$17.78

Professional Tool Case

- Aluminum framed
- Padded interior and adjustable dividers (6 sections)
- Detachable tool organizer for easy access
- Color: black with aluminum trimmings
- Size: 18"L x 13"W x 6"H
- Weight: 8.1 lbs.



Part No.	Description	1	10
149016CL	Professional tool case	\$41.95	\$37.76

Aluminum Tool Case

- This heavy-duty case is made of lightweight durable aluminum. Two inside panels and adjustable compartments easily carry hand tools, small soldering equipment, hand-held test equipment, and more.
- Size: 19"L x 14"W x 6"D



Part No.	Description	1	5
261884CL	Tool case	\$51.39	\$44.15

Heavy-Duty Tool/Equipment Case

- Made of lightweight aluminum, this tool case is designed to take rough field use. Case includes tool pallet, egg carton foam lid, and 2.5" thick pre-cut foam bottom. Ideal for carrying fragile instruments, test equipment, and small hand tools.
- Size: 19"L x 14"W x 6"D



Part No.	Description	1	5
261876CL	Tool/equipment case	\$51.39	\$44.15

Kwik Change Tool/Parts Tote

- Versatile storage tote for organized storage space. Front drop panel reveals four slide-out storage boxes and includes two interchangeable racks and one double deep rack. Bulk storage beneath lid for larger tools and exterior rack for small tool storage. Ruler on front for added convenience.
- Size: 20.5"H x 12"W x 14.5"D



Part No.	Description	1	5
261892CL	Tool/parts tote	\$49.85	\$47.35

2-In-1 Zippered Tool Bag

- A high-quality tool tote case that can be used as two separate bags or zipped together as one case. The first bag has two large pouches for documents & paperwork or large items. The second bag contains 20 pockets for tools.
- Size: 16"L x 12"W x 2.5"D



Part No.	Description	1	5
261868CL	Tool/tote case	\$24.25	\$22.09

17-Piece Offset Ratchet and Socket Driver Set

This offset ratchet and socket driver set includes 6 hexagon sockets made from quality hardened carbon steel. The handle features a 1/4" male head drive to accommodate the accompanying bits & sockets.



- Phillips bits: #1 and #2
- Pozi bits: #1 and #2
- Torx bits: T10, T15 & T20
- Slotted bits: 4, 5 & 6mm
- Hex sockets: 3/16", 7/32", 1/4", 5/16", 11/32" & 3/8"
- Reversible driver handle with 1/4" male head

Part No.	Description	1	5
226069CL	Offset ratchet & socket	\$7.49	\$7.19

Flexible Ratchet Driver Set

With the mini-ratcheting handle and 7.5" flexible shaft, you can loosen or tighten those hard-to-reach screws.



Includes: Flexible shaft (190mm), mini ratchet handle that has forward, reverse and conventional settings, slotted bits (4mm, 5mm & 6mm), Phillips (#1 & #2 bits), Pozi (#1 & #2 bits), and Torx (10, 15 & 20mm bits)

Part No.	Description	1	5
223802CL	Ratchet drivers set	\$9.35	\$8.25

33-Piece Ratchet Driver Set

High torque reversible ratchet handle with forward, reverse, and conventional settings. Magnetic shaft holds steel screws to bit for easy positioning. Bits can easily be stored in handle for easy transport.



- Torx bits: T6, T7, T8, T9, T10, T15 and T20
- Nut bits: 3/16", 1/4", 9/32", 5/16", 11/32" and 7/16"
- Hex bits: 1.5, 2.0, 2.5, 3, 4, 5, 6 and 8mm
- Pozi bits: #0, #1, #2
- Phillips bits: #0, #1, #2
- Slotted bits: 3, 4.7 and 6.3mm
- 50mm adapter
- Size: 9.1"W x 2.0"D x 7.6"H
- Weight: 1.7 lbs.

Part No.	Description	1	5
226051CL	33-piece ratchet driver set	\$27.95	\$19.95

29-Piece 1/4" Driver Socket Wrench Set

- Flank driver socket (6 pt): 4, 4.5, 5, 5.5, 6, 7, 8, 9, 10, 11, 12 and 13mm
- Slotted bit: 4, 5.5 & 7mm
- Hex bit: 3, 4, 5, 6 & 8mm
- Phillips bits: #1 and #2
- Pozi bits: #1 and #2
- 2" extension bar
- Sliding T bar
- Universal joint
- Extension bar with spinner handle
- Pear-type ratchet handle with quick release
- Size: 8.7"L x 4.3"W x 1.6"H
- Weight: 1.8 lbs.



Part No.	Description	1	5
226229CL	1/4" driver socket	\$29.95	\$28.49

25-Piece Screwdriver Grab Bag

25 assorted sizes and types of screwdrivers in a box. Types may include slotted, Phillips, Torx or star.



Part No.	Description	1	10
235070CL	Assorted screwdrivers	\$15.99	\$14.99

Ballpoint Allen Hex Socket-Type Screwdriver Set

- Unique ballpoint tip ideal for tightening and removing Allen socket screws in hard-to-reach spots
- Will engage screw-heads from any angle
- Ends are precision-machined to close tolerances to help slip easily into sockets and hold securely without reaming
- Clear plastic case



Ballpoint tip

Xcelite®

Kit includes: 99X5 extension, 991 handle, 9 pcs of 4" long blades (.05, 1/16, 5/64, 3/32, 7/64, 1/8, 9/64, 5/32, 3/16)

Part No.	Description	1	5
217859CL	11-piece screwdriver set	\$59.95	\$53.99

SALE

Xcelite® Flat-Tip Allen Hex Socket-Type Screwdriver Set

- Inch sizes
 - Clear plastic case
- Kit includes:** Regular handle, extension bar, .05, 1/16, 5/64, 3/32, 7/64, 1/8, 9/64, 5/32, 3/16 blades



Flat-tip

Part No.	Description	1	5
217912CL	11-piece screwdriver set	\$39.95	\$35.96

Xcelite® 9-Piece Screwdriver Set

- Handles more jobs with fewer tools, saves bench space and lightens service kits
 - Equipped with remarkable black, "piggyback" torque amplifier handle
 - Color coded handles
 - Clear plastic case
- Kit includes:** Green 3/32", red 1/8", black 5/32", orange 3/16", amber 1/4", blue #0 Phillips, brown #1 Phillips, amber #2 Phillips, and black torque amplifier handle



SALE

Part No.	Product No.	Description	1	10
218069CL	PS88	9-piece set	\$24.95	\$22.46

6-Pc Long-Neck Screwdriver Set

- Three slotted: 0.09"Dia. x 6.6"L, 0.12"Dia. x 6.6"L, 0.16"Dia. x 9.6"L
- Three Phillips: No.0, 0.12"Dia. x 6.64"L; No.1, 0.16"Dia. x 9.61"L; No.2, 0.09"Dia. x 6.65"L



Part No.	Description	1	10	50
99451CL	6-pc. screwdriver set	\$8.95	\$8.06	\$7.25

6-Pc Precision Screwdriver Sets

- 34041CL includes:** 3/64", 1/16", 5/64", 5/32", 1/8" & 9/64" slotted screwdrivers
- 34059CL includes:** 3/64"#0, 1/16"#0, 5/64"#0, 3/32"#0, 1/8"#1 and 9/64"#1 Phillips screwdrivers



Part No.	Description	1	10	50
34041CL	Slotted set	\$3.59	\$3.23	\$2.91
34059CL	Phillips set	\$3.59	\$3.23	\$2.91

11-Pc Precision Screwdriver Set

- 0.9, 1.2, 1.4, 1.8, 2.4 and 3mm slotted screwdrivers
- Phillips #00, #0 and #1 screwdrivers
- Awl
- Magnetic pick-up



Part No.	Description	1	5
226093CL	Precision screwdriver	\$4.49	\$4.29

7-Piece Insulated Screwdriver Set

- Tapered handle for sure grip
 - Precision ground shank
 - Hardened, magnetic tips
- Includes:** 0.4/0.8/1.0/1.2mm slotted; #0/1/2 Phillips



Part No.	Description	1	5
261999CL	Screwdriver set	\$19.25	\$17.59

6-Pc Precision Torx Screwdriver Set

- T5 and T6 x 50mm Torx screwdrivers
- T7, T8, T9, T19 x 50mm Torx hex screwdrivers



Part No.	Description	1	5
226106CL	Precision TORX screwdriver	\$12.95	\$12.29

6-Piece Screwdriver & Pliers Set

- One micro cutting nipper
- One micro flat nose pliers
- 2 long-neck slotted: 0.12"Dia. x 9.61"L; 0.09"Dia. x 7.64"L
- 2 long-neck Phillips: No.0, 0.12"Dia. x 9.61"L; No.2, 0.09"Dia. x 7.64"L



Part No.	Description	1	10	50
99565CL	Screwdriver/pliers	\$13.49	\$11.49	\$8.59

JAMECO® Pocket Screwdriver

Phillips/Flat head

- Pocket screwdriver with Phillips and slotted
- Pen clip for pocket storage
- Size: 6"L



Part No.	Description	1	10	100
127271CL	Pocket screwdriver	\$1.55	\$1.45	\$1.19

Xcelite® Heavy-Duty Nut Driver Kit

This set of heavy-duty nut drivers is ideal for service/repair, manufacturing or anywhere you encounter small metric components.

- 31.35mm shaft hole depth
- Includes:** 4 thru 8, 10, 11 & 13mm



Part No.	Description	1	5
218042CL	Metric nut driver kit	\$52.95	\$49.99

7-Piece Nut Driver Sets

- Premium hardened steel sockets
 - Large colored handles
- 261850CL:** Metric 5mm, 6mm, 7mm, 8mm, 9mm, 10mm & 11mm
- 261841CL:** SAE 3/16", 1/4", 5/16", 11/32", 3/8", 7/16", 1/2"



Part No.	Description	1	5
261850CL	Metric nut driver set	\$8.99	\$8.65
261841CL	SAE nut driver set	9.89	9.49

Twin Wrench Driver Set

The handle of this twin wrench driver set has two tips, horizontal and vertical for those hard-to-reach areas.



- Non-slip double ended driver
- Three slotted bits: 4mm, 5mm, and 6mm
- Phillips bits: #1 and #2
- Torx bits: 10mm, 15mm, and 20mm

Part No.	Description	1	10
223811CL	Twin wrench driver set	\$4.65	\$3.99

Xcelite Needle Nose Pliers



217891CL (submini needle nose): Serrated jaws

- Positive gripping of fine wire or subminiature components
 - Fine point allows use in confined areas
- 217963CL:** Fine serrated jaws • General purpose
- 217998CL:** Smooth jaws
- General purpose for pick-up and wire forming

Part No.	Prod. No.	Description	1	10
217891CL	L4	4" mini needle nose	\$14.95	\$13.69
217963CL	LN55	5.5" thin long nose	14.95	13.46
217998CL	LN54G	5" thin long nose	16.95 14.95	13.46

Xcelite 6-Piece Pliers Kit

- A compact kit designed for an electronics technician or dedicated hobbyist
- Durable pocket-pouch with heavy-duty snaps
- Each professional quality tool features the unique Copaloy rivet for smoother action

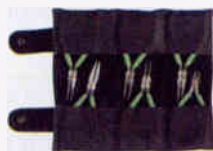

Kit includes: 4.5" transverse end-cutting pliers, 4" diagonal-cutting pliers, 5" long-nose pliers with side cutters, 5" fine-tip needle nose pliers, 5" flat-nose pliers, and 5" long-nose pliers

Part No.	Prod. No.	Description	1	5
218051CL	C1K	6-piece pliers kit	109.95 99.95	93.75

Retaining Ring Pliers

Internal/External

- Black oxide finish
- Hi-carbon tempered steel
- Vinyl grip • Length: 6"
- For 0.47" to 0.98" diameter retaining rings



Part No.	Description	1	10
177551CL	Retaining ring pliers	2.93 1.89	1.71

Half-Round Long Nose Pliers

- Drop forged steel
- Heat treated
- Spring return action
- Vinyl grips
- Length: 4.5"
- Knurled jaws



Part No.	Description	1	10	50	100
177607CL	Half-round pliers	\$4.95	\$4.49	\$3.95	\$3.59

5.3" Flat and Half-Round Long Nose Pliers

- Stainless steel • Spring return
 - Durable rubber handles
 - 5.3" length w/ 1.4" plier nose
- 35473CL/35490CL:** Knurl jaws
- 195531CL:** Smooth jaws



Part No.	Description	1	10	50	100
35473CL	Flat long nose	\$5.49	\$4.99	\$4.49	\$3.49
195531CL	Flat long nose	4.95	4.49	3.95	3.49
35490CL	Half round	5.49	4.99	4.49	3.49

Precision 5-Piece Stainless Steel Pliers Set



- Spring return
 - Insulated handles
- Includes: One 3.5"L micro cutting nippers and one each 4"L micro round nose pliers, long nose pliers, flat nose pliers and bent nose pliers

Part No.	Description	Wt. (lbs.)	1	10	25
73120CL	5-piece set	0.6 ...	\$17.95	\$16.16	\$14.54

5-Piece Pliers Set

- Precision machined heat-treated jaws
 - Vinyl insulated handles
- Includes: 6.5" needle nose; 7.5" lineman's; 8" slip joint; 8" groove joint & cutting pliers



Part No.	Description	1	5
261905CL	Pliers set	\$9.75	\$9.25

5" Cutting Pliers

Recommended for cutting copper and soft lead wires. Ideal for precise circuit board work. Spring loaded.



Part No.	Description	1	5
261809CL	Cutting pliers	\$4.99	\$4.55

Xcelite Diagonal Cutters

Manufactured from the finest forged alloy steel with polished head and cushion comfort handles, these cutters are designed for the demands of engineers and manufacturing environments.

- Flush or semi-flush cutting edge handles most cutting requirements
- Cutting edges machine ground and electronically hardened for extended life
- Forged alloy steel w/ polished head for high durability
- Patented COPALLOY rivet construction provides smooth operation and long life
- Handle coil springs for fast cutting action
- ESD safe cushion grips for maximum comfort

217904CL: Flush cutting of leads in restricted spaces; narrow tip gives increased clearance

217955CL: Used for cutting component leads

Part No.	Product No.	Description	1	10
217921CL	MS54J	4" oval head-flush cut	16.95 15.95	14.36
217955CL	S475JS	4" relieved head-flush cut	16.95 14.95	13.46
217904CL	MS549J	4" tapered head-flush cut	16.95 14.95	13.46
217867CL	MS545J	4" slim line tapered head-flush cut	16.95 14.95	13.46
218034CL	MS545	4" slim line tapered semi-flush cut	15.95	14.85

Xcelite Cutters and Pliers

SALE



- Spring returns
- 146712CL:** Micro series wire cutter – flush; 6"
- 146739CL:** Diag. wire cutter – semi-flush; 4"
- 146721CL:** Long needle nose pliers – flat; 5"

Part No.	Product No.	1	10	50	100
146712CL	170M	\$5.75	\$5.19	\$4.69	\$4.19
146739CL	MS54V	13.95	12.95	11.95	10.95
146721CL	MN7776V	16.95	15.95	14.95	13.95

Xcelite Shear/Pliers Set

- Improved handle grip for control and comfort
- Non-glare black finish carbon steel
- Size (plier): 5.6"
- Size (shear/cutter): 5.2"



Part No.	Prod. No.	Description	1	10	25
152055CL	S2K	Cutter/pliers set	\$15.95	\$14.95	\$13.95

Cutting Pliers

Flush Cut

- Stainless steel
- Side cutting flush cut
- Leaf spring for smooth controlled action



Part No.	Description	1	5
261788CL	Cutting pliers	\$6.95	\$6.55

Opening an account is easy!!

Corporate Customers

Call 1-800-831-4242 for details today.

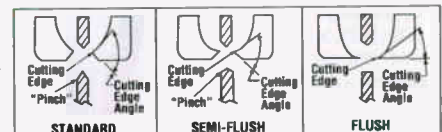

Choose the finished cut best for your projects

Expanded Xcelite Professional Tools



217921CL 217955CL 217904CL

SALE



217867CL 218034CL

4" Diagonal Wire Cutter

- Drop forged steel
- Heat treated
- Vinyl grips
- Spring return action
- Polished head
- Length: 4"



Part No.	Description	1	10	50	100
179901CL	Wire cutter	\$5.49	\$4.94	\$4.45	\$4.00

4.3" Diagonal Wire Cutter

- Cuts component wire up to 1.2mm thick
- Stainless steel
- Durable rubber handles
- Jaws are designed for flush cutting
- 4.3"L x 2.1"W with 0.5" cutting blade



Part No.	Description	1	10	50	100
35481CL	Wire cutter	\$5.59	\$4.99	\$4.55	\$3.99

5" Diagonal Wire Cutter

- Cuts component wire up to 1.2mm thick and 0.08mm fine wire
- Insulated handles
- Jaws are designed for flush cutting
- 5.0"L x 1.8"W w/ 0.5" cutting blade



Part No.	Mfr. Cross Ref. No.	1	10	25
167411CL	Wire cutter	\$7.49	\$6.74	\$6.07

5" Wire Cutter/Stripper

- Strips and cuts 20-24 AWG wires
- Insulated grips
- Spring loaded for easy use
- Cutter angled @ 45 degrees for use in tight places
- Size: 5.0"L x 3.0"W



Part No.	Product No.	1	10	50	100
159273CL	HT109	\$5.49	\$4.94	\$4.45	\$4.00

5" Wire Cutter/Strippers

- Insulated handles
- Spring return
- Tempered steel cutting edge
- Size: 5.0"L x 3.0"W
- One-year warranty



Part No.	Mfr. Cross Ref. No.	1	10	50	100
78991CL	10-30 AWG (screw adjustable)				
215888CL	10-24 AWG (dial to adjust for wire gauge)				

Part No.	Mfr. Cross Ref. No.	1	10	50	100
78991CL	HT108	\$3.95	\$3.49	\$2.95	\$2.59
215888CL	JE-2022C	3.95	3.49	2.95	2.59

Heavy Duty Tubing Cutter

- Clever design eliminates spiraling, resulting in straight clean cuts with no burrs
- Cuts copper, brass, aluminum tubing and thin-wall conduit up to 1-1/8" diameter
- Extra cutter wheel stored in body
- Lightweight aluminum body and knob
- Fold-away reamer
- Telescopic wheel-feeding mechanism keeps turning radius constant
- Length: 4.8"



Part No.	Description	1	5
227475CL	Tubing cutter	\$19.95	\$17.95

IDEAL 6" Wire Cutter/Strippers

- Contoured cushion-grip handles
- Wire size markings, in AWG and mm
- Size: 6.0"L x 2.0"W

161226CL: Premium T-5
• 10-18 AWG solid
• Color: yellow

161234CL: Premium T-6
• 16-26 AWG stranded
• Color: red

161218CL: Standard T-6
• 16-26 AWG stranded
• Color: red



Part No.	Prod. No.	Description	1	10
161226CL	ID45-215	T-5 10-18 AWG	\$15.95	\$14.49
161234CL	ID45-216	T-6 16-26 AWG	16.95	15.26
161218CL	ID45-121	T-6 16-26 AWG	12.95	11.66

Xcelite® 6.5" Snip Tool

- Shearing action of 1.5" cut pointed blades prevent peaks on fine wires & filaments
- Useful for removing insulation and cutting light sheet metal
- Coil spring opens blades
- Safety latch
- Plastic coated cushion grips provide maximum leverage



Part No.	Prod. No.	Description	1	10
218026CL	86CG	Snip tool	\$29.95	\$27.95

6.6" Wire Stripper

- Wire stripper, cutter, steel wire cutter, and wire loop
- Scale: AWG and mm
- Strips and cuts wires from 20-30 AWG
- Size: 6.6"L x 2.0"W



Part No.	Product No.	1	10	50
159290CL	HT5023	\$9.95	\$8.96	\$8.06

7-in-1 Wire-Handling Tool

- Wire stripper, wire cutter, steel wire cutter, pliers and wire loop
- Solderless crimping tool
- Scale: mm and inch
- Size: 6.6"L x 3.0"W



Part No.	Prod. No.	Description	1	10	50
18796CL	HT104	10-18AWG	\$4.95	\$4.49	\$3.95
127861CL	HT1042	16-26AWG	5.49	4.94	4.45
127870CL	HT1043	22-30AWG	5.49	4.94	4.45

Rotary Coax Cable Strippers

2 and 3 Blade

159118CL (3 Blade):
2 settings RG58/59/62

- For cable sizes 4-10mm
- Size: 4.2"L x 1.3"W
- Color: black

159185CL (2 Blade):
4 settings RG58/59/62/174

- For cable sizes 4-12mm
- Size: 3.9"L x 0.7"W
- Color: gray

Includes: Hex key wrench for adjusting blade

Part No.	Product No.	1	10	25
159118CL	HT312B (3 blade)	\$13.95	\$12.56	\$11.30
159185CL	HT332D (2 blade)	13.95	12.56	11.30



Automatic Wire Strippers

- 175097CL: Spring load grip
- Size: 7.0"L x 2.5"W
- Weight: 0.8 lbs.

Includes: Wire stopper for desired strip length

202841CL:
• Size: 6.5"L x 3.0"W
- Weight: 0.3 lbs.

237219CL:
• Size: 5.2"L x 2.7"W



Part No.	Description	1	10	25
175097CL	Strips 8-22 AWG	\$16.95	\$15.26	\$13.73
202841CL	Strips 3-24 AWG	10.95	9.86	8.87
237219CL	Strips 14-24 AWG	9.95	8.95	8.09

Hex Crimp Tools

- Use with RG-58 and RG-59 connectors with up to a 3/8" ferrule

261745CL: 1.7mm
standard crimp for crimping center conductor on BNC & TNC connectors; up to 3/8" ferrule

261737CL: Ferrules up to 1/2"



Part No.	Description	1	5
261745CL	Hex crimp tool (3/8")	\$19.75	\$18.55
261737CL	Hex crimp tool (1/2")	19.49	18.29

Compression Multi-Tool

Designed to compress ferrules of "F"/BNC/RCA connectors. Black oxide steel frame w/ interchangeable die sockets, ratchet mechanism w/ manual release releases after a complete cycle securing a fully compressed ferrule. Integrated coax cutter for cutting cables to appropriate lengths.



Part No.	Description	1	5
261761CL	Compression multi-tool	\$35.65	\$33.85

"F" Connector Compression Tool

Compresses RG-6 and RG-59 Snap-N-Seal type connectors.

- Length: 5"



Part No.	Description	1	5
261753CL	Compression tool	\$29.95	\$28.45

Solderless Terminal Crimping Tool

- Crimps solderless terminals: 18-22 AWG red, 14-16 AWG blue and 10-12 AWG yellow
- Size: 9.0"L x 2.0"W



Part No.	Product No.	1	10	25
72995CL	HT303	\$18.95	\$17.06	\$15.35

Ratcheted BNC Crimping Tool

- Crimps RG58, RG59, RG62, RG174 and fiber optic
- Hex sizes: 0.043", 0.068", 0.100", 0.137", 0.213", 0.255"
- Size: 8.5"L x 2.5"W



Part No.	Product No.	1	10	25
114534CL	HT-336G	\$23.95	\$21.59	\$19.45

Crimp/Cut/Strip Tool

For RJ11 (6P) and RJ45 (8P) Modular Plugs

- Repeatable crimp action for consistent high-quality connections
- Push-down locking mechanism
- Size: 8.0"L x 2.0"W • Weight: 0.8 lbs.



Includes: Cut and strip blade

Part No.	Mfr. Cross Ref. No.	1	10
174684CL	TTK071	\$29.95	\$26.99

Telemaster Modular Connector Crimp/Cut/Strip Tool

For RJ11 (6P) and RJ45 (8P) Modular Plugs

- Repeatable crimp action for consistent high quality connections
- Size: 6.0"L x 2.0"W
- Weight 0.8 lbs.



Includes: Cut and strip blade

Part No.	Product No.	1	10
161091CL	ID30-496	\$39.95	\$35.99

Ratchet Crimp Tool

For RJ11 (6P) and RJ45 (8P) Modular Plugs

- Repeatable crimp action for consistent high-quality connections
- Size: 8.5"L x 2.2"W
- Weight: 1.2 lbs.



Includes: Cut and strip blade

Part No.	Mfr. Cross Ref. No.	1	10
174676CL	TTK070	\$39.95	\$35.99

Professional Modular Connector Crimping Tool

- Spring return action
- 6mm and 12mm stripping guide
- Crimp modular plugs without changing dies
- Crimps 10P10C, RJ45: 8P8C, RJ11 and RJ12: 6P6C, and 4P4C
- Insulated handles • Size: 8.2"L • Weight: 1.2 lbs.



Part No.	Product No.	1	10	25
181147CL	HT200	\$54.95	\$49.49	\$44.55

Modular Connector Crimping Tool Set

- 8" metal modular crimping tool
- Cuts, strips and crimps
- Crimps RJ11 and RJ45 plugs
- Carrying case: blue hard plastic, 8.0"L x 10.5"W x 2.0"H
- Weight: 2.1 lbs.



Includes: 90 modular plugs, 40 pcs. 4P4C, 30 pcs. 6P6C, 20 pcs. 8P8C

Part No.	Product No.	1	10	25
73496CL	HT2000B	\$74.95	\$67.49	\$60.75

See page 72 for Molex Hand Crimp Tool.

Metal Modular Connector Crimping Tool

- Cable stripper and wire cutter
- Size: 8.0"L
- Weight: 1.8 lbs.
- Crimps 6P and 8P plugs (6P2C, 6P4C, 6P6C, 8P2C, 8P4C, 8P6C, 8P8C)



Part No.	Description	1	10	25
114526CL	RJ11/RJ45	\$24.95	\$22.49	\$20.25

Ratcheted Modular Connector Crimping Tool

- Insulated grip
- Ratcheted type
- Metal • 7.5"L
- Crimps RJ45 (8P8C) and RJ11/12 (6P6C) • Weight: 0.7 lbs.



Part No.	Description	1	10	25
159311CL	RJ45/11/12	\$21.95	\$19.95	\$17.95

IDC Connector Crimping Tool

- Crimping distance: 27.5mm to 6mm (with attachment)
- Cushioned red handles
- Crimp insulation displacement connectors
- Use for IDC socket connectors, pg 84
- Size: 9.2"L x 3.0"W • Weight: 1.1 lbs.



Part No.	Product No.	1	10	25
73251CL	HT214	\$15.95	\$14.39	\$12.95

Non-Insulated Terminal D-Sub Crimping Tool

14-26 AWG

- Heavy-duty metal tool with cutter and insulated handles
- For computer pins and sockets, D-sub 26-28 AWG wire
- For butt-insulated connectors, 22-26 AWG wire
- For telephone spade lugs, 22-26 AWG wire
- For non-insulated connectors, 20-22 AWG wire
- For non-insulated connectors, 14-18 AWG wire
- Coiled spring return • Size: 7.3"L x 1.5"W



Part No.	Product No.	1	10	25	100
99442CL	HT202A	\$9.49	\$8.55	\$7.69	\$6.95

D-Sub Crimping Tool

20-28 AWG

- Crimps D-sub pins and sockets
- For use w/ P/Ns 43377CL, 43369CL, pg 71 & 100765CL, pg 78
- Size: 7.0"L x 4.0"W



Part No.	Product No.	1	10	25
159265CL	HT213	\$10.95	\$9.89	\$8.89

Multi-tool Storage Rack

Organize and store 106 of the most common tools in 24" of wall space. Made of durable plastic material, it easily mounts on a wall with the included screws.



Part No.	Description	1	4	8
239353CL	Storage rack	\$5.99	\$5.49	\$4.99

Pocket Multi-Tools

These heavy-duty, all-in-one multi-tools are really handy for do-it-yourself users, students, handy-men, and sportsmen. Folded, they fit in the palm of your hand or slip into a sheath on your belt. Just the tools you need for everyday use!



	227264CL	227221CL	227192CL	227184CL	227213CL
Accessory bits					7
Awl		1	1	1	
Can/bottle opener	1 (bottle)	2	2	2	2
File (wood/metal)	1 (metal)	1 (metal)	1 (metal)	2	
General screwdriver handle					1
Flashlight	1				
Hammer, nail remover					2
Hex nuts				1	3
Knife blade	1	1	1 (small)	1	1
Nail pick	1	1			
Pliers, regular				1	
Pliers, handyman/long-nose	2	1	2	2	
Ruler			1		
Saw					2
Scissors		1			
Screwdriver, flat head		1 (small)	3 (S, M, L)	2 (S, M)	
Screwdriver, Phillips	1	1	1	1	1
Wire cutter	1	1	1	1	
Description	9-in-1	11-in-1	13-in-1	14-in-1	19-in-1
Pricing	1 5	\$9.95 8.95	\$11.95 10.95	\$19.95 18.95	\$19.95 18.95

3-Piece Open-End Ratcheting Wrench Sets

The most useful development in open-end wrenches in 40 years. Most open-ended wrenches need a pivot angle of 60° to reinsert the wrench to make the next movement. The Alden Wrench needs only 30°, and with the built-in ratchet, you need not even remove the wrench from the head of the bolt or nut.

Coupled with its small head sizes and ratcheting action, you can loosen or tighten a bolt faster and in tighter spaces than any standard combo wrench. It is made of stainless steel alloy widely used in aerospace and is individually hand polished.

- Weight: 0.6 lbs.
- 223896CL: SAE 3/8-7/8, 1/2-9/16, 5/8-11/16
- 223909CL: Metric 10-12, 13-14, 15-17

Part No.	Description	1	5
223896CL	SAE	\$34.95	
223909CL	Metric	34.95	



4-Piece Adjustable Wrench Set

Heavy-duty carbon steel wrenches with black industrial finish.

Constructed w/ rugged I-beam handle and four-sided jaw design for better fit and strength.

- Length x Jaw opening:
12" x 1 1/8"; 10" x 1 1/16";
8" x 1"; 6" x 1 1/16"

Part No.	Description	1	5
261711CL	Adjustable wrench set	\$9.65	\$9.15



10-Piece Metric Combo Wrench Set

- Chrome vanadium steel for strength and durability
- Drop forged for accuracy
- Ideal for confined working areas
- Sizes: 4mm, 4.5mm, 5mm, 5.5mm, 6mm, 7mm, 8mm, 9mm, 10mm, and 11mm

Part No.	Description	1	5
261489CL	Combo wrench set	\$7.99	\$7.59



Adjustable Wrench

Made of chrome-plated carbon steel with knurled adjustment screw and angled head.

- Size: 6"L x 13/16"

Part No.	Description	1	5
261649CL	Adjustable wrench	\$4.15	\$3.69



30-Day Money-Back Guarantee

If you're not satisfied we'll take it back!

Details on page 229.

Combination Wrenches

Made from hardened, tempered, drop forged chrome vanadium steel. These wrenches have a straight open end and a 120° offset bi-hexagonal ring.

Part No.	Size	1	5
261702CL	9/16"	\$6.39	\$6.09
261690CL	1/2"	6.19	5.89
261681CL	7/16"	5.69	5.39



8-Piece Fold-Up Torx Key Set

- 3.7" long handle
- Torx bits: T9, T10, T15, T20, T25, T27, T30, T40
- Size: 3.7"L x 1.2"W

Part No.	Description	1	10	100
176006CL	Torx key set	\$11.49	\$10.35	\$9.35



25-Piece Hex Key Set

- 12-piece SAE long arm with sizes from 1/16" to 3/8"
- 13-piece Metric short arm with sizes from 1.5mm to 1cm

Includes: vinyl pouch

Part No.	Description	1	5
261825CL	Hex key set	\$6.95	\$6.59



1/4 - 1/2 Watt Resistor Lead Forming Tool

- Watt size indicates appropriate package size
- Bends lead length in .05" increments
- Excellent for capacitors also
- 1/4W: 0.4"-1.5"; 1/2W: 0.5"-1.5"; 5.4"L x 1.5"W

Part No.	Description	1	10	50
106884CL	1/4-1/2W	\$2.75	\$2.39	\$2.39



5" Steel Hemostats

- Grade 410 A.I.S.I. stainless steel
- Three locking positions

Part No.	Mfr. Cross Reference	Description	1	10	50
115107CL	HEM01	Straight	\$3.49	\$3.14	\$2.83
115115CL	HEM02	Curved	3.95	3.56	3.20



3-In-1 Tool Measuring Tape, Knife, and Saw

Cut through drywalls, wood, PVC plastic, and paper. This 3-in-1 tool has a serrated saw on one side, a straight edge blade on the other and a detachable 6' measuring tape.

- Length: 8.4"

Part No.	Description	1	10
218641CL	3-in-1 tool	\$4.49	\$3.99



Deluxe Precision Knife Set

- Three different knife handles - fine work, medium and heavy duty power grip
- Size: 6.3"L x 2.8"W x 1.4"H

Part No.	Description	1	10	25
72768CL	13 blade knife set	\$10.95	\$9.86	\$8.87



Heavy Duty Staple Guns

Built with all-steel construction with hardened steel working parts. These standard and cable staplers are designed for the most demanding of environments. The standard stapler is perfect for contractors, home do-it-yourselfers, and specialty trade applications. We also offer the cable tackers that are ideal for a wide variety of applications such as telephone wire, cable TV, hi-fi systems, alarm systems, intercommunications and general electrical contract work. Both are made of durable nickel-plated steel for heavy-duty use. Rubber grip assures comfortable operation.

- Handle locking
- Easy rear loading
- Adjustable high impact tension knob
- Easy squeezing action
- Comfortable rubber grip
- Hand stop for safe stapling control
- Visual reload window & rear loading

242878CL: Cable Tacker

- 4.8mm maximum cable diameter, uses T-25 type staples, 1/4" width
- Weight: 1.9 lbs.

242886CL: Cable Tacker

- 6.4mm maximum cable diameter, uses T-37 type staples, 5/16" width
- Weight: 1.9 lbs.

227969CL: Staple Gun

- Handles 5/16"; 3/8", 1/2", & 9/16" staples; uses T-50 type staples
- Weight: 2.1 lbs.

Part No.	Description	1	5
242878CL	T-25 cable tacker staple gun	\$24.95	\$22.45
242886CL	T-37 cable tacker staple gun	28.95	25.95
227969CL	T-50 staple gun	19.95	17.95



Staples

Part No.	Description	1	5
244988CL	T-25, 3/8"L, 1000 ea.	\$1.69	\$1.59
245008CL	T-25, 9/16"L, 1000 ea.	1.89	1.79
245016CL	T-37, 1/2"L, 1000 ea.	1.89	1.79
245032CL	T-37, 9/16"L, 1000 ea.	2.25	2.15
230295CL	T-50, 5/16", 1250 ea.	2.45	2.35
230308CL	T-50, 3/8", 1250 ea.	2.75	2.65
230316CL	T-50, 1/2", 1250 ea.	2.89	2.79
230324CL	T-50, 9/16", 1250 ea.	3.15	3.05

Rivet Tool

Sets 3/32", 1/8", 5/32" & 3/16" rivets without adjustments. Simply change the appropriate nozzle, slip the rivet into the pre-drilled hole, and you have a perfect fastener. Spring-loaded handle for automatic ejection of the mandrel.

Part No.	Description	1	5
226114CL	Rivet tool	\$6.95	\$6.69
226288CL	1/8" x 1/4" long rivet (100 pk)	2.19	1.99
226296CL	3/16" x 1/4" long rivet (100 pk)	3.49	3.29



For Tool Kits and Tool Cases see pages 176 - 177.



12-Piece File Tool Kit

- Fine and coarse file assortment for metal and wood
- 3-piece metal flat; 2-piece metal triangle; 1 each wood round; metal round; wood half-round; metal half-round; metal/wood half-round; and 2 detachable handles



Part No.	Description	1	5
233314CL	12-piece file kit	\$14.95	\$13.45

Steel File Sets

- Strong tool steel
- **100360CL: 8-piece (5.65"L)**
 - 1 ea. 0.15"Dia., 0.13"Dia., 0.12"Dia., 0.11"Dia. and four 0.22"Dia.
- **202833CL: 6-piece (5.5"L)**
 - 1 ea. 0.12"Dia. (round), 0.11"W (triangle), 0.10"W (square), 0.20"W (half-round) and two 0.2"W (flat)

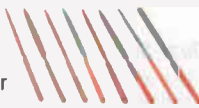

Part No.	Mfr Cross Ref. No.	Description	1	10
100360CL	FS108F	8-piece file set	\$9.49	\$8.54
202833CL	08110	6-piece file set	2.09	1.90

Impact Punch-Down Tool

- Reversible clip-in blade
- Adjustable (HI-LO) spring-loaded impact mechanism
- Storage bin on handle for spare blade
- **175071CL: Punch-down tool with blade**
 - For 66-type terminals
 - Size: 5.2"L x 1.5"W x 1.0"H
- **175089CL: Punch-down blade**
 - Blade for 110-type terminals



Part No.	Description	1	10
175071CL	Tool with 66 blade	\$34.95	\$31.46
175089CL	Punch-down blade 110	14.95	13.49

Impact Punch-Down Tool

- Conforms to AT&T performance specification. Reversible clip-in blade, adjustable spring-loaded impact mechanism and spare storage blade in the handle.
- One-year warranty
 - **Paladin Tools®**
 - **124142CL:** For 66-type bifurcated terminals
 - Size: 7.0"L x 1.4"W x 1.1"H
 - **124151CL:** Blade for 110-type terminals



Part No.	Description	1	10
124142CL	# 3527 Tool with 66 blade	\$49.95	\$45.00
124151CL	110 blade	19.95	17.95

See other Paladin Tools on page 185.

Don't worry about backorders.
Over 99% of our products
are in stock!

We'll Send It Today!

Just place your order by 6PM EST
for same business day shipment.

4-Piece Steel Tweezer Set



- 4 styles of stainless steel tweezers, one self-locking
- Ideal for picking up small components in hard-to-reach places

Part No.	Description	1	10	50
10735CL	4-piece tweezer set	\$7.95	\$6.95	\$5.95

Automatic Center-Punch Tool

- Adjustable**
- Precision instrument
 - Alloy steel point
 - Knurled steel body
 - Size: 5.0"L x 0.5"Dia.



Part No.	Description	1	10	50
160282CL	Center punch tool	\$5.95	\$5.39	\$4.85

T-Handle Reamer Tool

- Excellent for aluminum chassis work**
- For enlarging starter holes on panel mount components from 1/8" to 1/2" diameter
 - T-handle for easy rotation of tool
 - Handle: 3.3" long, tool: 5.3" long

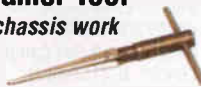

Part No.	Description	1	10	25
151749CL	T-handle reamer tool	\$7.95	\$7.49	\$6.95

Nibbling Tool

- Perfect for cutting, trimming, or notching sheet metal up to 18 AWG
- Time-saver when working on prototyping, chassis, and circuit boards
- Minimum .375" hole required
- Size: 7.8"L



Part No.	Prod. No.	Description	1	10	25
18809CL	HT204	Nibbling tool	\$7.95	\$7.16	\$6.44
29330CL	HT204B	Replcmnt bit	4.49	4.04	3.64

Strip-Wrap-Unwrap Tool

- Tool tip made of tempered steel
- Spring steel cutter
- Use with 30 AWG wire on .025" square posts
- No solder necessary, see pg 60 for wire
- Wrap 1 to 2 turns of insulated portion of wire for secure connections
- 4.5" long



Part No.	Mfr. Cross Ref. No.	1	10	25
34585CL	HSM30 (Modified)	\$49.99	\$44.99	\$39.99
236785CL	HSR30 (Regular)	29.95	26.95	23.95

30 AWG Wire Wrap/Strip Tools

- Recommended for use on 0.025" (0.63mm) square posts on 0.100" (2.54mm) center grids. The first 1-1/2 loop on the modified tool has wire insulation while all loops on a regular tool have bare wires.
- Knurled handle for easy grip
 - 5" Long



Part No.	Description	1	10	25
242801CL	Tool (Regular)	\$17.95	\$16.15	\$14.55
242798CL	Tool (Modified)	19.95	17.95	16.15
242827CL	Replace tip for 242801CL	8.49	7.65	6.89
242819CL	Replace tip for 242798CL	9.49	8.55	7.69
242835CL	Replace stripper assembly	5.49	4.95	4.45

Tweezers



- **253163CL:** Straight, round tapered, wide-point tip stainless steel
- **252929CL:** Straight round tapered, fine-point tip, stainless steel
- **253121CL:** Wide-tip, insulated
- **252945CL:** Self-closing reverse-action tweezers; wide point tip; stainless steel
- **252937CL:** Self-closing reverse-action tweezers; medium point tip; stainless steel
- **253091CL:** Curved fine-point tip
- **252911CL:** Straight fine-point tip
- **253112CL:** Fine-point tip, insulated, anti-static

Part No.	Length	Photo	1	10	25
253163CL	4.5"	1	\$9.99	\$8.89	\$7.79
252929CL	4.75"	2	2.25	1.99	1.79
253121CL	4.6"	3	1.49	1.35	1.25
252945CL	6.6"	4	2.59	2.35	2.09
252937CL	4.6"	5	2.25	1.99	1.79
253091CL	4.3"	6	2.25	1.99	1.79
252911CL	4.75"	7	2.25	1.99	1.79
253112CL	4.75"	8	2.25	1.99	1.79

IC Pin Straightener

- Straighten bent pins safely and easily with Jameco's IC pin straightener.
- Straightens 8/14/16/18/20/24/28/40/42-pin ICs
 - Materials: black plastic
 - Size: 3.3"L x 1.5"W x 0.4"H
- Includes:** Ground terminal



Part No.	Description	1	10	100
99362CL	IC straightener	\$6.95	\$6.26	\$5.63

Trimmer Potentiometer Adjustment Pocket Tool

- Glass-filled body
- Stainless steel blade
- Size: 5.2"L



Part No.	Description	1	10	100
153314CL	Trimmer tool	\$1.35	\$1.22	\$1.09

Crimp Pin Extraction Tools

- Easily extract 0.093" locking pins from connectors
- Heavy duty metal
- Precision design
- Length: 5"
- See crimp pins on pg 75 (42729CL and 42649CL)



Part No.	Prod. No.	Description	1	10	10
131887CL	HT319C	Male tool for 42729CL	\$10.95	\$9.86	
131879CL	HT319B	Female tool for 42649CL	10.95	9.86	

BNC Connector Removal Tools

- For deep chassis removal
- Allows access to hard-to-reach places



Part No.	Product No.	Length	1	10	25
159151CL	HT2206	6"	\$8.49	\$7.64	\$6.88
152047CL	HT2212	12"	15.95	14.36	12.92

D-Sub Pin Insertion/Extraction Tool

- Insertion/extraction tool: red/white plastic body; exchangeable tips



Part No.	Description	1	10	100
19094CL	insert/extract tool	\$2.79	\$2.49	\$2.15

Steel Fish Tapes

Fishing wires inside finished walls or through conduit is not fun. But with our steel fish tapes, you won't have to spend all day finishing the job. Designed specifically to make the retrieval of wires quick and easy.



- Impact resistant yellow ABS case won't rust or dent
- Finger grips around reel to ensure easy control
- Trigger provides constant-pressure tension while retracting

Part No.	Length	1	10	25
217470CL	50'	\$27.95 \$21.95	\$19.76	\$17.78
217488CL	100'	\$46.95 \$39.95	\$35.96	\$32.36
217496CL	200'	\$62.95 \$52.95	\$47.66	\$42.89

Magnetic Tip Measuring Tape

Measuring height or width with a regular tape measure is not easy, especially if you are working single-handed with metal materials. Typical end hooks will always slide out or will not hook properly. With this measuring tape, you can easily clamp on to metal surfaces with its magnetic hook and make precise height or width measurements.



- Magnetic end hook for convenient measuring and TRU ZERO function
- Blade with nylon coating for easy scale reading
- Anti slip and shockproof rubber case
- Heavy duty spring and blade system
- Tape measure length: 25'

SALE

Part No.	Description	1	10
215415CL	Magnetic tip tape measure	\$12.85 \$9.95	\$8.95

33' Measuring Tape

This retractable measuring tape's case has a rubber finish for easy grip and yellow contrast for easy visibility. Tape has easy-to-read markings with fractional scale every 1/16". Triple riveted end hook. Belt clip and strap for convenience.



NEW

Part No.	Description	1	5
261833CL	Measuring tape	\$9.35	\$8.49

6" Drywall Saw

Ideal for cutting holes in drywall.

- Hardened tempered steel blade
- Sharp tip for plunge cuts
- Hard plastic handle



SALE

Part No.	Description	Price
224004CL	6" drywall saw	\$2.99 \$2.49

Spring-Hook Tools

Grab or place in position springs and wires in those hard-to-reach areas with these 8" long spring hook tools.



Part No.	Description	1	5
226042CL	Spring hooks	\$5.95	\$5.69

Digital Display Calipers

Metric or Inches

- Hardened stainless steel
- Display: inches to 1/1000THS mm to 1/100THS
- Resolution: 0.01mm (0.0005")
- Instructions for making internal, external, depth and step measurements
- Calipers measure to 6 inches/150mm
- Weight: 0.8 lbs. • One-year warranty



Includes: Fitted case and 1.5V silver oxide battery (replacement battery, P/N 140783CL, pg 154)

Part No.	Description	1	10	25
127482CL	Digital disp. calipers	\$64.95	\$58.46	\$52.61

Metal Dial Calipers

Metric or Inches

- For accurate measurements every time
- Measures outside, inside and depth
- Easy-to-read dial gauge
- Length: 6" (150mm)
- Color: silver
- Materials: metal
- Weight: 0.7 lbs.



Includes: Fitted plastic storage case

Part No.	Description (min. reading)	1	10	25
116134CL	Metric (.02 mm)	\$29.95	\$26.96	\$24.26
116126CL	Inches (.001 inch)	29.95	26.96	24.26

Precision Micrometer

0"-1" Range ± .0001"

Forged steel frame precision micrometer is complete with chrome barrel and thimble for easy-to-read contrasting graduation. Hardened, precision-ground measuring surface with positive spindle lock holds measurements. Accurate to .0001". Quick and easy zero adjustment.



Part No.	Description	1	10	25
169543CL	Precision meter	\$10.79 \$8.45	\$8.55	\$7.77

Magnetizer / Demagnetizer

Magnetize tips of screwdrivers for easy pick-up of small metal objects; demagnetize tips to prevent electrostatic discharge that will damage electronic components.

- Size: 2.0"L x 2.0"W x 1.2"D



Part No.	Description	Price
239530CL	Magnetizer/Demagnetizer	\$6.99

Glue Gun and Sticks

- Adheres to PCBs, cardboard, wires, metal and cloth
- Silicon nozzle
- Electronic heating
- Trigger action
- Utilizes 100mm long glue-sticks (2 sticks included)
- Size: 7.3"L x 6.3"W • Weight: 0.8 lbs.



Part No.	Description	1	10	25
72696CL	Glue gun	\$10.95 \$9.95	\$8.96	\$8.06
78633CL	Glue sticks (6/pk)	3.15	2.84	2.55
176292CL	Glue sticks (10/pk)	4.95	4.29	3.79

1000W Heat Gun

- Dual heat setting: 600°F/1100°F
- Use with heat-shrink material
- Works with spot dry paints, plaster, spackle, and cure adhesives
- Thaw pipes, frozen locks, and loosen rusted bolts
- Input voltage: 110-120 VAC



NEW

Part No.	Description	1	6	12
254924CL	Heat gun	\$42.55	\$41.10	\$36.85

Heat Gun/Stripper

Dual-Setting

- Use with heat shrink material
- Works with spot-dry paint, plaster, spackle cure adhesives
- Will remove adhesive-applied tiles and linoleum without chipping
- Dual heat setting: 600°F/1100°F
- Thaw pipes, frozen locks and loosen rusted bolts
- UL listed • Weight: 1.8 lbs. • Size: 9.3"L x 7.0"W



Part No.	Description	1	10	25
76865CL	Heat gun	\$39.95	\$35.95	\$31.95
217816CL	Heat shrink attachment	1.95	1.85	1.75
217832CL	Air spreader	1.95	1.85	1.75

Weller® 250-Watt, 3-Setting Industrial Heat Gun

- 750°F to 800°F hot air at nozzle; 3-position switch; hot-off-cool
- Designed for assembly and repair applications such as shrink tubing and vinyl, epoxy curing/drying/cooling
- 120VAC @ 60Hz • ESD safe
- Long-life heater and fan components
- 3-wire grounded plug; 6' cord



Part No.	Product No.	WT. (lbs.)	1	10
191943CL	6966C	1.2	\$119.95	\$107.95

WAHL® 1,200°F Portable Heat Gun

- Portable and flameless heat
- Temperatures up to 1,200°F (650°C)
- Typical applications: shrink tubing, activate adhesives and potting compounds, form plastics and laminates and preheat flux
- Each cartridge (disposable butane lighter) provides approximately 20 minutes of heat
- Includes disposable gas lighter
- Electronic ignition
- Size: 4.8"L x 0.9"W • One-year warranty

ETL listed



Part No.	Description	1	10
150691CL	Portable flameless heat gun	\$26.49	\$25.25

See the yellow and green highlighted items.

Jameco Special Values!

Sale details are on page 2.

SurePunch™ Series Punchdown Tools

Terminates and cuts telephone wire and data cable into 66 and 110 termination panels for insulation displacement (IDC) type bifurcated terminals.



- Cushion grip, molded to the shape of your hand, for comfort and a sure, non-slip hold
- Increased HI/LO impact force to meet demands of new cable types and gauges
- For 22-28 AWG solid or stranded wire
- Blades twist and lock into place
- New latch cover blade storage area in end of handle
- Length (with blade): 8.0" • One-year warranty

230391CL: 110/66 combo w/ reversible cut-only blade
230383CL: 110 reversible cut & punch/punch-only blade
230375CL: Both 110 & 66 reversible cut & punch/punch-only blades

Part No.	Product No.	1	10
230391CL	3571	\$53.95	\$48.55
230383CL	3572	\$3.95	\$8.55
230375CL	3579	\$1.95	\$5.75

SurePunch™ PRO Punchdown Tool

With 110/66 Combo Blade

New and improved design of Paladin's SurePunch™ series.



The FIRST and ONLY punchdown tool to have a detachable light, making it easy to work in dark environments. Multi-purpose spudger in handle can be used as a screwdriver or IDC contact insertion tool. Also built into the handle is a hook to feed wires through holes and a pick to separate bonded twisted pair cables, strip insulation, and cut wires.

- Adjustable HI/LO spring compression for all types of cables
- Detachable light with long-life 2200mcd LED specially designed to focus the light on the panel work area
- Finger grips and non-slip rubber-embedded cushion handle for comfort • Length (tool only): 7.0"
- Blades twist and lock into place; accepts other manufacturers' twist and lock type blades
- 10-year warranty on blade; one-year on tools

Part No.	Product No.	1	10
230359CL	3588	\$68.95	\$61.95

Non-Impact 110 Punchdown Tool

Cut and Punch

Terminates and cuts telephone and data wire into 110 terminating panels.



For insulation displacement (IDC) type bifurcated terminals.

- Non-impact, low-cost • 22-28 AWG
- Solid or stranded, single insulation wire
- Comfortable rubber grip handle • Length: 4.0"
- Perfect for small jobs and do-it-yourself installers

Part No.	Product No.	1	10
230367CL	3580	\$10.89	\$9.79

"GripP-STRIPPER" Wire Cutter/Stripper

The newest wire stripper and cutter from Paladin Tools. Combines ergonomic design with versatility. Two tools strip & cut the most common wire and cable types: electrical wire, hook-up wire, multi-conductor cable, and flat cables.



- The tool head and handles are designed at optimum 22° angle to prevent awkward wrist bends
- Spring loaded closure
- Contoured wire stripping areas precision ground for accuracy
- Non-scoring strip and smooth wire cutting
- Features screw cutter and wire loops embedded in frames • Gripping jaws on front of tool
- Size: 7.1"L x 2.3"W x .65"D • One-year warranty

Part No.	Product No.	Description	1	10
230463CL	1117	For 10-22 AWG	\$14.69	\$13.25
230471CL	1118	For 20-30 AWG	14.69	13.25

Data SureStrip™ Universal Cable Cutter/Stripper

This multi-purpose tool is an easy-to-use universal cable cutter and stripper for data, telephone, and network installations. Works with standard wires and can be used with coaxial cable by adjusting the blade for various strip depths.



- Cuts and strips multiple cable types: 4/6/8-conductor flat satin cables; 4/6/8-conductor UTP/STP data cables, 25-pair UTP/STP data and telephone cables; multi-conductor round bundled cables of up to 0.5" diameter; 8-14 AWG wire
- Small and compact, slips right into your pocket
- Works left or right handed
- Fully adjustable with simple thumb screw
- Self-regulating to prevent nicking
- Contoured finger grips for power cutting
- Length: 4.5" • One-year warranty

Part No.	Product No.	1	10
230447CL	1116	\$19.89	\$17.89

Cable Slitter/Stripper

AM25 Slitter with 2109 blade

This is the original tool designed for slitting cable insulation. Strips and slits round cables with PVC, Teflon, and THNN insulation from 0.18"-1.0" diameter.



- Adjustable cutting depth to 0.18" • Length: 5.3"
- Swivel blade for circular, longitudinal & spiral cuts
- Cable holding clip with integrated edge for removing slit insulation • Spare blade in handle
- Slits PVC, Teflon, and THNN cables
- Lifetime tool warranty; one-year on blade

Part No.	Prod. No.	Description	1	10
230404CL	1820	Cable slitter/stripper	\$39.95	\$35.95
236769CL	2109	Blade for 1820	13.40	12.75

RG59/6/RG6 Quad CATV "F" Coaxial Cable Stripper

The newest coax cable stripper from Paladin Tools. It combines high-performance and ergonomic design. Easily removes the outer jacket, shield braid, and inner dielectric in one single step.



- Self-regulating tension
- Adjust cutting depth on each blade for varying cable thickness with the included hex key
- Pre-set for common strip lengths (also pre-set for RG6 CATV "F") • For RG59/6/RG6 Quad CATV "F"
- Length: 4.3" • One-year warranty

Part No.	Product No.	1	10
230439CL	1257	\$16.95	\$15.29

CrimpALL® Crimpers for RG58/59/62AU, RJ45 & CATV "F"

Designed with user satisfaction in mind, superior comfort, and ease of use.



- Ultra-smooth, fully-ratcheting crimp cycle with built-in safety release
- Long lasting tools that deliver over 50,000 crimp cycles
- Soft rubber embedded handles
- Rugged, double-plated jaw, designed to increase life span
- Angled head to prevent awkward wrist bending
- Reduced handle grip distance makes it easy for large and small hands
- Higher crimp force produced with less hand force
- No break-over hand force – less effort by the user to make the last click before making a complete crimp, the CrimpALL does all the work
- EZI-Change™ die screws makes changing dies quick and easy • Length: 9.9" • Weight: 1.3 lbs.

230341CL: For RG58/59/62AU with 2034 die
230332CL: For RJ45 (8P8C) with 2061 die
230455CL: For CATV "F" and RJ45 with 2687 die

Part No.	Product No.	1	10
230341CL	8001	\$64.49	\$57.99
230332CL	8030	64.49	57.99
230455CL	8045	69.49	62.59

Crimpers for Twisted Pair Cable and BNC/TNC

Paladin's Original 1300 Series interchangeable-die crimping system.



- Fully-ratcheting cycle with built-in safety release
- Easy to use and maintain
- EZI-Change™ die screws make changing dies quick and easy – no screwdriver required
- Precise and tightest tolerances on die sets
- For RJ45 (8P8C) crimps 22-28 AWG flat/round, solid/stranded wires
- For 2 or 3 piece BNC/TNC connectors crimps RG58/RG59/RG62AU cables • Length: 8.9"
- Crimps 22-28 AWG flat/round, solid/stranded wires
- Crimps RG58/59/62AU cables

Part No.	Prod. No.	Description	1	10
230421CL	1307	For RJ45 (8P8C)	\$51.89	\$46.69
230412CL	1317	For 2 or 3-pcs. BNC/TNC	51.89	46.69

Opening an account is easy!! Call 1-800-831-4242 for details today.

Corporate Customers

Powerful Cordless Screwdriver Set

Save time and your wrist with those stubborn screws. This 4.8 Volt rechargeable cordless screwdriver features a spindle lock for greater control and a 180 RPM motor that produces 40 in.-lb. of torque for starting and finishing screws. Comes with 2 magnetic bit holders, 11-piece bit set (5 slotted, 3 Phillips, 3 torque), and power supply at no extra cost.

- Narrow nose for extended reach in tight places
- Construction grade quality
- Size: 10.5" long
- Recharges in 7 to 9 hours
- Weight: 1.4 lbs.

Part No.	Description	1	5
211254CL	Cordless screwdriver	\$18.95	\$17.95

30-Pc 1/4" Bit Set with Organizer

A 30-piece bit set supplied in a neat, compact storage drum organizer allows quick access, identification, and selection of the desired bit. All the bits are compatible with power tools, rechargeable drills, and multi-bit screwdriver handles.

Set includes:

- Nut bits: 7/16", 3/8", 11/32", 5/16", 9/32", 1/4", 3/16"
- Hex bits: 3/16", 1/8", 7/64", 5/64"
- Torx bits: T10, T15, T20, T25, T30
- Phillips bits: #0, #1, #2, #3
- Slotted bits: #3, #4, #5, #6, #7
- Pozi bits: #1, #2, #3
- 1 bit holder
- 2 screw aligners

Part No.	Description	1	5
227230CL	30-piece 1/4" bit w/ organizer	\$9.95	\$8.95

32-Piece Security Bit Set

This security bit set contains most of the bits commonly used in today's electronic products to make them tamper resistant. Now you can open the cases of these products to repair them without damaging the case or screw.

Includes:

- Torx bits: 4, 6, 8 and 10mm; Tri-wing bits: #1, #2, #3 and #4; Security hex bits: 2, 2.5, 3, 4, 5 and 6mm; 5/32", 9/64", 1/8", 7/64", 3/32" and 5/64"; Security Torx bits: T8, T10, T15, T20, T25, T27, T30, T35 and T40; and 60mm magnetic bit extension

Part No.	Description	1	10
223829CL	32-piece security bit set	\$11.95	\$10.75

Mini-Drill and Stand

This Mini Drill is excellent for drilling through circuit boards and proto-boards. The drill comes with an array of drilling, grinding and sanding attachments. Drill stand is designed to function like a drill press.

Part No.	Description	Wt. (lbs.)	1	10	25
26702CL	MS398 drill	0.8	\$29.95	\$26.95	\$23.95
26711CL	MS399 stand	1.8	19.95	17.95	15.95

Adjustable Cordless Screwdriver

- Adjustable handle can be used folded or unfolded
 - Thumb switch for reverse and forward action
 - No load speed: 180 RPM
 - Clutch operating torque from 4 to 21kg-cm
 - 3.6V rechargeable battery
 - Size: 10.5"L x 1.5" Dia.
 - Weight: 1.6 lbs.
- Includes:** 6VDC @ 300mA power supply and screwdriver bits, slotted and Phillips

Part No.	Description	1	10
176680CL	Cordless screwdriver	\$36.95	\$33.26

60-Piece Bit, 1/4" Socket and Driver Tool Kit

This compact kit contains the most popular bits and 1/4" sockets with a comfortable cushioned, reversible ratchet driver handle.

- Drill bits: 1/16", 3/32", 1/8", 5/32", 3/16"
- Socket bits: 3/16", 7/32", 1/4", 9/32", 5/16", 11/32", 3/8", 7/16", 1/2", 5mm, 6mm, 7mm, 8mm, 9mm, 10mm, 11mm, 12mm, 13mm
- Phillips bits: #1, #2, #3
- Phillips Z bits: 1, 2, 3
- Slotted bits: 1/8", 5/32", 3/16", 1/4", 9/32"
- Hex bits: 5/64", 3/22", 1/8", 5/32", 3/16", 7/32", 1/4"
- Torque bits: T-10, T-15, T-20, T-25, T-30, T-40
- Square bits: 1, 2, 3
- 2.4" Magnetic bit adapter
- Reversible ratchet screwdriver
- 7.5" Flexible extension
- Socket adapter
- 6" long nose pliers
- 6" adjustable wrench
- Vinyl zipper case with organizer to find sizes fast
- Size: 8.5"L x 6.5"W x 2.2"H
- Weight: 3.1 lbs.

Part No.	Description	1	5
218261CL	60-piece tool kit	\$36.95	\$32.95

High-Speed Steel Step Drills

Drill multiple holes in thin material with the same bit, faster and easier. Each bit does the work of many drill bit sizes. You can drill holes in most materials such as plastic, metal, and wood up to 1/8" thick.

No center punching on most sizes.

229657CL: • Shank size: 3/8" • 2.4" long
172401CL: • Shank size: 1/4" • 2.5" long

Part No.	Description	1	10	25
229657CL	3/16" - 7/8" 13-step	\$14.95	\$13.45	\$12.10
172401CL	3/16" - 1/2" 6-step	9.95	8.95	7.95

9-Piece Assorted Drill Bit Kit

- Variety of sizes: .014" to .126"
 - Each kit will vary in contents of bit sizes
 - Shank diameter: .125"
- Includes:** Plastic case

Part No.	Description	1	10	50
131676CL	9-piece drill bit kit	\$9.95	\$8.95	\$7.95

For Tool Kits and Cases see page 176 - 177.

Data VAC PRO Vacuum/Blower



The Data-Vac "PRO" has plenty of power for the toughest jobs plus a toner filter system that picks up dangerous toner spills from laser printers and copiers. "PRO" is perfect for cleaning all types of office equipment—from micros to mainframes, laser printers, copiers, fax machines, disc drives, calculators, and automatic teller machines.

Includes: 6' flexible hose, pick-all air pin pointer, crevice tool, snap in brush, soft bristle dusting brush, snorkel probe, air maximizer, adapter nozzle, flexible neck extension wand, micro dusting brush and micro crevice tool

Part No.	Description	1	5
219213CL	Data VAC PRO vacuum	\$139.95	\$132.95
219248CL	Carrying case	\$57.95	\$52.95
219230CL	Toner replacement bags (5pk)	34.95	29.95
219221CL	Disposable paper bags (5pk)	5.95	5.49

PC Board Drill Bits

- Reconditioned carbon steel bits
- High quality long lasting cutting edge
- Use for drilling holes in glass PC boards
- Shank diameter: .125"

Part No.	Drill	1	10	100
16619CL	.021" 75 Miscellaneous	\$1.49	\$1.34	\$1.21
16580CL	.040" 59 Plated thru holes	1.59	1.43	1.29

12-Piece Deluxe Hole Saw Kit

- Cut smooth, accurate holes from 3/4" to 5" diameter in drywall, wood, plaster, aluminum, laminates, and plastic. With the 1/4" and 3/8" mandrels you can use it with any battery or electric drill.
- Hole saw diameters: 3/4", 7/8", 1 1/8", 1 1/4", 1 1/2", 1 3/4", 2", 2 1/2", 3", 3 1/2", 4", 5"
 - 1/4" & 3/8" drive mandrels
 - Allen wrench
 - Size: 8.0"L x 6.0"W x 1.9"H
 - Weight: 2.8 lbs.

Part No.	Description	1	10
211262CL	Hole saw kit	\$18.95	\$17.45

We'll match the print advertised price of any like product.

Jameco's Low-Price Guarantee

It's that simple!

For detailed size dimensions, please visit our website at www.Jameco.com

6-Piece Rotary Brush Set



• Bristle brushes • Copper brushes • Steel brushes

Part No.	Description	1	5
226641CL	6-pc. rotary brush set	\$15.95	\$14.35

7-Piece Rotary Finishing Set

- Copper wire brushes
- Aluminum oxide grinding wheels
- Wool polishing wheels
- Mandrel bit



Part No.	Description	1	5
226659CL	7-pc. rotary finishing set	\$9.99	\$8.99

7-Piece Engraving Cutter Set

- Ball tips
- Arrow head, v-cut
- Flat cut
- Bullet tip, round cut
- Fine point, v-cut
- Flat head



Part No.	Description	1	5
226624CL	7-pc. engraving cutter set	\$17.95	\$16.15

7-Piece Grinding/Polishing Set

- Aluminum oxide cylindrical stone
- Aluminum oxide blunt nose stone
- Cylindrical cotton
- Bullet head cotton
- Cylindrical cork



Part No.	Description	1	5
226667CL	7-pc. grinding stone set	\$12.95	\$11.25

10-Piece Grinding Stone Set



- Aluminum oxide stone bits:
- Cylindrical
 - Blunt nose
 - Bullet head
 - Tear drop
 - Flat edge wheel
 - Round edge wheel
 - Ball tip

Part No.	Description	1	5
226632CL	10-pc. grinding stone set	\$11.95	\$10.79

22-Piece Drum Sander Set



- 3/8" & 1/2" sander bands and bits

Part No.	Description	1	5
226616CL	22-pc. drum sander set	\$13.95	\$12.89

30-Piece All-Purpose Bit Set



- 5 sander bands
- Steel brush bit
- Copper wire brush wheel bit
- Cylindrical cotton bit
- Drum sander
- 8 aluminum carbide, cut-off metal wheels
- 4 aluminum carbide, cut-off wood wheels
- Bullet tip, round cut engraver point
- Flat head engraver point
- Aluminum oxide, cylindrical grinding stone bit
- Aluminum oxide, bullet head grinding stone bit
- Aluminum oxide, ball tip grinding stone bit
- Aluminum oxide, wheel-type grinding stone bit
- Aluminum oxide, grinding stone wheel
- Mandrel bit
- Wool polishing wheel

Part No.	Description	1	5
226675CL	30-pc. all purpose bit set	\$28.95	\$26.49

Variable High-Speed Rotary Tool Kit



A multiple high-speed rotary tool kit with 6-speed selections ranging from 8,000 to 30,000 RPM, along with 40 bits and accessories, provides you all the power and precision you need to tackle almost any cutting, drilling, polishing, sanding or engraving job. With its high-speed output, plus a nylon body, you can grasp the tool lightly to perform fast rough work or delicate craftsmanship. A convenient shaft-lock button provides fast-and-easy accessory bit changing.

- 9" long variable-speed rotary tool
- Drum sander wheel
- 2 felt buffing pads
- Disk sanding arbor
- 7 disk grinders
- 4 rotary files
- 3 drum sander pads
- Grinder dressing stone
- 6 disk sanding pads
- 10 rotary grinders
- 2 drill bits
- Wrench
- One-year manufacturer's warranty

Part No.	Description	1	5
211289CL	Rotary tool kit	\$44.95	\$42.95

50-Piece Cut-Off Wheel Set



- 4 aluminum carbide cut-off wheels, 7/8" Dia.
- 18 aluminum carbide cut-off metal wheels, 15/16" Dia.
- 6 aluminum carbide cut-off wood wheels, 15/16" Dia.
- 18 aluminum carbide cut-off wheels, 1.0" Dia.
- 4 aluminum carbide cut-off wheels, 1 1/4" Dia.

Part No.	Description	1	5
226608CL	50-pc. cut-off wheel set	\$24.49	\$22.29

Order Anytime 24x7x365

Online www.Jameco.com Phone 1-800-831-4242

Rotary Tool Accessory Bulk Packs



Part No.	Description	Price	Part No.	Description	Price
226561CL/226587CL	Aluminum carbide cut-off wheel 1 1/2" Dia. x 1/16" T (10 pk)	\$7.95	226456CL	Sander band aluminum oxide bit 1/2" Dia. (15 pk)	\$6.79
226552CL/226579CL	Aluminum carbide cut-off wheel 1.0" Dia. x 0.02" T (20 pk)	8.49	226501CL	Copper wire wheel 1.0" Dia. (3 pk)	8.49
226595CL	Aluminum carbide cut-off wheel 15/16" Dia. x 0.02" T (20 pk)	8.49	226499CL	Copper wire wheel 3/4" Dia. (3 pk)	7.59
226579CL	Aluminum carbide cut-off wheel 15/16" Dia. x 0.02" T (4 pk), wood	4.99	226536CL	Wool polishing wheel 1/2" Dia. (10 pk)	8.95
226510CL	Aluminum oxide grinding wheel 7/8" Dia. x 0.01" T (10 pk)	8.49	226544CL	Wool polishing wheel 1.0" Dia. (10 pk)	8.95
226528CL	Aluminum oxide grinding wheel 0.9" x 0.1" (10 pk)	7.49	226448CL	Drum sander bit 1/2" Dia. (2 pk)	2.95
226472CL	Sander band 3/8" Dia. (8 pk)	6.79	226464CL	Drum sander bit 3/8" Dia. (2 pk)	2.95
			226481CL	Mandrel bit, 1-7/8" x 0.1" (4 pk)	5.95

Color Code Legend
New Sale Qty. Save

Digital Multimeter Quick Selection Guide

* See indicated page for more details on each product

All measure DC Voltage, AC Voltage, Resistance and Current, except as noted

Handheld Digital Multimeters

Manufacturer No. Part No. <i>Best Sellers</i>	Model No.	Display Count	Features		Standard Functions			Special Functions			Unit Price		
			RS-232 PC Interface	Analog Bar Graph	Autorange	True RMS	Capacitance	Inductance	Frequency	Temperature		Diode Test	Logic Test
119212CL	JE110	191	2000										\$19.95
222519CL	Wavetek/MM 30XR	189	2000										\$59.49
220812CL	Mastech M300	193	2000			✓							\$12.95
220855CL	M83013	189	2000										9.95
220759CL	Mastech MAS830L	193	2000										15.49
220821CL	Mastech M3900	193	2000										24.95
27115CL	Metex M3800	190	2000										39.95
197958CL	Extech MV110	192	2000										39.95
265359CL	Wavetek/MM 15XP	189	2000										58.95
220741CL	Mastech MAS838	193	2000										\$24.95
220775CL	Mastech MY64	193	2000					✓					\$45.95
220783CL	Mastech M9704	193	2000					✓					\$56.95
177480CL	AEEC2890	191	2000					✓					49.95
220791CL	Mastech M9508	193	2000					✓					\$56.95
147096CL	BelMerit DX460L	192	2000					✓					99.95
160813CL	Metex M3640D	190	2000	✓	✓			✓					\$89.79
155491CL	Metex ME-22T	190	2000	✓	✓		✓	✓					55.95
192639CL	Wavetek/MM DM78A	189	3200	✓		✓							29.95
101936CL	EZ Digital DM333	192	3200	✓		✓							112.95
182035CL	Fluke 73-III	Right	3200	✓		✓							148.95
220767CL	Mastech MY68	193	3260	✓	✓		✓						\$54.95
220804CL	Mastech M320	193	4000										\$26.95
192583CL	Wavetek/MM AC40A	204	4000			✓	(No DC current)						74.95
222501CL	Wavetek/MM DM9	189	4000			✓							\$39.49
221989CL	Metex P-09EF	190	4000			✓							\$39.95
221971CL	Metex P-10	190	4000			✓							39.95
216514CL	Metex ME-31	190	4000	✓	✓								21.95
220724CL	Wavetek/MM 34XR	189	4000			✓		✓					\$109.95
211650CL	Extech MN26	192	4000			✓		✓					39.95
222535CL	Wavetek/MM 33XR	189	4000	✓		✓							\$89.49
265367CL	Wavetek/MM 35XP	189	4000	✓		✓							78.95
222308CL	Metex ME-32	191	4000	✓	✓								\$79.95
221997CL	Metex M3270D	190	4000	✓		✓							89.95
216522CL	Metex ME-32F	191	4000	✓	✓								75.95
215589CL	Metex M3890D	191	4000	✓	✓								99.95
117372CL	Metex M3850D	191	4000	✓	✓								189.95
137461CL	Metex M3860D	191	4000	✓	✓								149.95
190967CL	Fluke 110 (No I)	Right	6000	✓		✓							\$198.95
190975CL	Fluke 111	Right	6000	✓		✓							138.50
185527CL	Fluke 112	Right	6000	✓		✓							148.95
192655CL	Fluke 175	Right	6000	✓		✓							179.55
192663CL	Fluke 177	Right	6000	✓		✓							208.95
185535CL	Fluke 179	Right	6000	✓		✓							213.95
222560CL	Wavetek/MM HD160B	189	10,000	✓		✓							219.95
222527CL	Wavetek/MM 37XR	189	10,000	✓		✓		✓					129.49
222543CL	Wavetek/MM 38XR	190	10,000	✓		✓							149.49
136590CL	Mastech MY65	193	20,000			✓							73.49
144872CL	Metex M4640A	191	20,000	✓	✓								132.95
222375CL	Fluke 187	Right	50,000	✓		✓							388.95
185201CL	B&K BK5380	192	50,000	✓		✓							149.99
182043CL	Fluke 189	Right	50,000	✓		✓							398.95

Fluke 73 Series III 3200-Count Analog/Digital Multimeter

- 3200-count digital display with 31 segment analog bar graph
- Cat II 600V rating with overvoltage protection
- Automatic touch hold
- Default auto range mode
- Resolution: 100µV maximum
- DC/AC voltage ranges: 320mV – 600V
- DC/AC current ranges: 320mA – 10A
- Resistance ranges: 320Ω – 32MΩ
- Diode and continuity test
- Weight: 2.0 lbs.



Part No.	Model No.	1	5
182035CL	Fluke 73 III	\$148.95	\$138.95

Fluke 110 Series 6000-Count DMMs

- Basic DC accuracy of 0.7%
- True RMS reading
- Autoranging
- Min./max./average functions
- CAT III 600V rated
- Resolution: 1mV maximum
- DC/AC voltage ranges: 6V – 600V
- Resistance ranges: 600Ω – 40MΩ
- Also capacitance, frequency and continuity
- Size: 11.8"L x 7.0"W x 3.0"H
- Weight: 1.3 lbs.
- 185527CL (Fluke 112): • Backlight display



Part No.	Model No.	AC/DC current	1	10
190967CL	Fluke 110	Not included	\$108.95	\$97.19
190975CL	Fluke 111	10A / 6A/10A	138.50	131.59
185527CL	Fluke 112	10A / 6A/10A (backlit)	148.95	141.95

Fluke 175/177/179 6000-Count DMMs

- Min./max./average functions
- Auto hold and manual hold
- IEC 1010 rating Cat IV 600V/ Cat III 1000V
- Resolution: 100µV maximum
- DC/AC voltage ranges: 600mV – 1000V
- DC/AC current ranges: 60mA – 10A
- Resistance ranges: 600Ω – 50MΩ
- Also capacitance and frequency
- Size: 6.3"L x 3.3"W x 9.2"H
- Weight: 1.5 lbs.
- 185535CL (Fluke 179): • Temperature: -40 to +400°C



Part No.	Model No.	DC Accuracy	1	5
192655CL	Fluke 175	0.15%	\$179.55	\$170.59
192663CL	Fluke 177	0.09%	208.95	198.55
185535CL	Fluke 179	0.09% + temp.	213.95	203.29
214308CL	Fluke 808K	temperature probe	19.95	18.95

Fluke 187/189 50,000-Count Analog/DMMs w/ Temperature

- Digital and analog bar graph display
- Backlight with 2 brightness levels
- Fast auto range
- AC/DC true RMS
- Resolution: 1µV maximum
- Resistance range: 500Ω – 500MΩ
- DC/AC voltage ranges: 50mV – 1000V
- DC/AC current ranges: 500µA – 10A
- Also capacitance, frequency & temp.
- Conductance, diode testing and continuity functions
- Wt.: 2.0 lbs.
- Size: 8.0"L x 3.9"W x 2.0" Thick
- 182043CL (Fluke 189): • Data logging stores 288 intervals; saves 100 readings

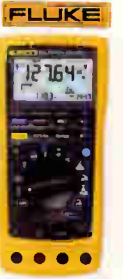

Part No.	Model No.	Description	1	5
222375CL	Fluke 187	W/O data logging	\$388.95	\$369.55
182043CL	Fluke 189	W/ data logging	398.95	378.95
214308CL	Fluke 808K	Temperature probe	19.95	18.95

8-Function 2000-Count Multimeter with Non-Contact Voltage Detection

- Unique voltage Safety Tester™
- 8 function/26 ranges & 6 range volt tester
- Large 17mm (.67") display
- Resolution: 0.1mV maximum
- **DC voltage ranges:** 200mV – 1000V
- **AC voltage ranges:** 200V – 750V
- **DC/AC current ranges:** 200µA – 2A
- **Resistance ranges:** 200Ω – 20MΩ
- Diode test, continuity beeper, and logic test
- Safety tester: 6, 12, 24, 50, 110 and 220 volts
- Size: 2.8"W x 1.3"D x 6.1"H
- One-year warranty



Part No.	Product No.	1	5
265359CL	15XP	\$58.95	\$55.99

10-Function 4000-Count Multimeter with Non-Contact Voltage Detection

- 10 functions/39 ranges
- Digital bar graph display
- Long 300 hour battery life with auto off for power saving
- Resolution: 0.1mV maximum
- **DC voltage ranges:** 400mV – 1000V
- **AC voltage ranges:** 400mV – 750V
- **DC/AC current ranges:** 400µA – 2A
- **Resistance ranges:** 400Ω – 40MΩ
- **Capacitance ranges:** 4nF – 4mF
- Diode test, continuity beeper, and frequency
- Data hold
- One-year warranty
- Size: 2.8"W x 1.3"D x 6.1"H



Part No.	Product No.	1	5
265367CL	35XP	\$78.95	\$74.99

4000-Count Multimeter with Temperature, Capacitance and Frequency Measurements

- 3½-digit LCD display with 41-segment analog bargraph
- 10 functions, 33 ranges
- Resolution: 100µV maximum
- **DC voltage ranges:** 400mV – 1000V
- **AC voltage ranges:** 400mV – 750V
- **DC/AC current ranges:** 400µA – 10A
- **Resistance ranges:** 400Ω – 4MΩ
- **Capacitance ranges:** 4µF – 4000µF
- **Temperature ranges:** -20°C to 1000°C (-4°F to 1832°F)
- **Frequency ranges (auto-ranging):** 4kHz – 40MHz
- CAT III 600V, CAT II 1000V rated
- Input warning tone when test leads are in wrong jack
- Diode and continuity test
- Auto power off to save battery life
- Min/Max, relative, peak and data hold
- Size: 3.5"W x 2.3"D x 7.7"H
- Weight: 0.9 lbs.



Includes: Spare fuse, test leads and 9V battery

Part No.	Product No.	1	5
222535CL	33XR	\$89.49	\$84.99

2000-Count Multimeter With Non-Contact Voltage and Battery Tester

- 9 functions, 26 ranges
- 3½-digit LCD display
- Resolution: 100µV maximum
- **DC/AC voltage ranges:** 200mV – 600V
- **DC/AC current ranges:** 200µA – 10A
- **Resistance ranges:** 200Ω – 20MΩ
- **Battery tester ranges:** 1.5V – 9V
- **Non-contact voltage detector ranges:** 70VAC – 600VAC
- CAT III 300V, CAT II 600V rated
- Diode and continuity test
- Size: 3.5"W x 2.4"D x 7.7"H
- Min/Max, data hold
- Weight: 1.0 lb.



Includes: Spare fuse, test leads, and 9V battery

Part No.	Product No.	1	5
222519CL	30XR	\$89.49	\$84.99

8-Function 4000-Count Multimeter with Battery Tester

- 8 functions, 19 ranges
- 3½-digit LCD display
- Resolution: 1mV maximum
- **DC/AC voltage ranges:** 4V – 600V
- **DC/AC current ranges:** 400mA
- **Resistance ranges:** 4000Ω – 40MΩ
- **Battery tester ranges:** 1.5V – 9.0V
- Diode and continuity test
- Special ranges to test household batteries with Go/NoGo LED
- CAT II 600V rated
- Size: 3.1"W x 1.6"D x 5.5"H
- Auto ranging
- Weight: 0.6 lbs.



Includes: Spare fuse, test leads, and 9V battery

Part No.	Product No.	1	5
222501CL	DM9	\$29.49	\$28.99

7-Function 10,000-Count Heavy-Duty Multimeter

- 7 functions, 19 ranges
- 4-digit LCD display with bargraph
- Resolution: 100µV maximum
- **DC voltage ranges:** 1V – 1500V
- **AC voltage ranges:** 10V – 1000V
- **DC/AC current ranges:** 10mA – 10A
- **Resistance ranges:** 1kΩ – 40MΩ
- Diode and continuity test
- True RMS measuring
- Unique live voltage Safety Tester
- Special sealing for environment and water proofing
- CAT III 1000V rated
- Size: 3.9"W x 2.3"D x 8.8"H
- Auto ranging
- Weight: 1.4 lbs.



Includes: Spare fuse, test leads, and 9V battery

Part No.	Product No.	1	5
222560CL	HD160B	\$119.99	\$114.99

5-Function 3200-Count Pocket Multi-Tester

- 5 functions, 15 ranges
- 3½-digit LCD display w/ bargraph
- Resolution: 100µV maximum
- **DC voltage ranges:** 320mV – 450V
- **AC voltage ranges:** 3.2V – 450V
- **Resistance ranges:** 320Ω – 32MΩ
- Diode and continuity test
- Auto power off for longer battery life
- CAT I 600V, CAT II 300V rated
- Size: 2.2"W x 0.4"D x 4.3"H
- Data hold
- Weight: 0.2 lbs.



Includes: Manual, case and battery

Part No.	Product No.	1	10
192639CL	DM78A	\$29.95	\$26.99

11-Function 4000-Count Multimeter

- 11 functions/32 ranges
- Resolution: 100µV maximum
- **DC voltage ranges:** 400mV – 1000V
- **AC voltage ranges:** 400mV – 750V
- **DC/AC current ranges:** 400µA – 10A
- **Resistance ranges:** 400Ω – 40MΩ
- **Capacitance ranges:** 4µF – 4000µF
- **Temperature ranges:** -20°C to 1000°C (-4°F to 1832°F)
- **Frequency:** 4kHz – 40MHz
- Duty cycle and continuity test
- MIN./MAX., data hold and range lock
- Auto power off
- CAT III 600V, CAT II 1000V
- Size: 7.8"W x 3.6"D x 2.4"H
- Holster with strap
- Weight: 1.0 lb.
- Three-year warranty



Part No.	Product No.	1	10
220724CL	34XR	\$108.95	\$104.99

10,000-Count True RMS Multimeter w/ Decibel Measurement, Component & Logic Test

- 13 functions, 42 ranges
- 4-digit LCD display with 41-segment analog bargraph
- Resolution: 100µV maximum
- **DC voltage ranges:** 1000mV – 1000V
- **AC voltage ranges:** 1000mV – 750V
- **DC/AC current ranges:** 100µA – 10A
- **Resistance ranges:** 1000Ω – 40MΩ
- **Capacitance ranges:** 40nF – 400µF
- **Inductance ranges:** 4mH – 40H
- **Frequency ranges:** 100Hz – 10MHz
- **Decibel ranges:** -13dBm – +50dBm
- Logic, continuity, diode test
- Duty Cycle: 0 to 90%
- Input warning tone when test leads are in wrong jack
- Min/Max, average, relative, peak, and data hold
- Auto power off to save battery life
- True RMS
- CAT III 600V and CAT II 1000V rated
- Size: 7.8"H x 3.6"W x 2.4"D
- Weight: 1.0 lb.



Includes: Spare fuse, test leads, and 9V battery

Part No.	Product No.	1	5
222527CL	37XR	\$129.49	\$122.99



Don't worry about backorders. Over 99% of our products are guaranteed to be in stock!

We'll Send It Today!

Just place your order by 6PM EST for same business day shipment.

13-Function 10,000-Count True RMS Multimeter

- 13 functions, 43 ranges
 - 4-digit LCD display with 41-segment analog bargraph
 - Resolution: 100µV maximum
 - **DC voltage ranges:** 1000mV - 1000V
 - **AC voltage ranges (True RMS):** 1000mV - 750V
 - **AC/DC voltage ranges:** 1000mV - 750V
 - **DC/AC current ranges:** 100µA - 10A
 - **Resistance ranges:** 1000Ω - 40MΩ
 - **Capacitance ranges:** 40nF - 400µF
 - **Temperature ranges:** -20°C - +1300°C (-4°F - +2372°F)
 - **Frequency ranges:** 100Hz - 10MHz
 - **Decibel ranges:** -13dBm - +50dBm
 - Diode and continuity test
 - Duty Cycle: 0% to 90%
 - Min/Max, average, relative, peak and data hold
 - Auto power off and auto-ranging
 - Input lead warning
 - Optical PC interface (P/N 222551CL): with the optional software and RS-232 cable, the multimeter can be used for real-time data acquisition using any industry standard Windows® PC
 - CAT IV 600V, CAT III 1000V rated
 - Size: 7.8"H x 3.6"W x 2.4"D
 - Weight: 1.0 lb.
- Includes:** Test leads with threaded alligator clips, temperature adaptor, K-type thermocouple, 9V battery, spare fuse, and manual



WAVETEK Metromax

Part No.	Product No.	1	5
222543CL	38XR	\$149.49	\$141.99
222551CL	38SW (software/cable)	19.49	18.49

METEX® 2000-Count Multimeter 0.6" Digit Height • LCD Readout

- Resolution: 100µV maximum
 - **DC voltage ranges:** 200mV - 1000V
 - **AC voltage ranges:** 200mV - 700V
 - **DC/AC current ranges:** 20µA - 20A
 - **Resistance ranges:** 200Ω - 20MΩ
 - Diode test and continuity beeper
 - Auto zeroing
 - Input impedance: 10MΩ
 - Surge protection up to 3kV
 - See page 203 for compatible leads (P/Ns: 77745CL, 21856CL, 21864CL)
 - Size: 3.5"W x 1.3"D x 6.8"H
 - Weight: 1.2 lbs.
 - One-year warranty
- Includes:** Probes, carrying case, manual & 9V battery



CE

Part No.	Product No.	1	10	50
27115CL	M-3800	\$39.95	\$35.95	\$32.49

For test leads to accompany your multimeters, see pages 202 - 203.



METEX® 2000-Count Multimeter w/ RS-232, Analog Bar and Temperature

- 3½-digit LCD (.65" digit height) with analog bar
 - RS-232C computer interface
 - Resolution: 100µV maximum
 - **DC voltage ranges:** 200mV - 1000V
 - **AC voltage ranges:** 200mV - 750V
 - **DC/AC current ranges:** 2mA - 20A
 - **Resistance ranges:** 200Ω - 2000MΩ
 - **Frequency ranges:** 2kHz - 20MHz
 - **Temperature:** -40°C to +1200°C @ 1°C resolution
 - Data hold
 - Diode, transistor h_{FE} and logic test and continuity test
 - Size: 3.0"W x 1.5"D x 7.2"H
- Includes:** Operating manual, probes, K-type thermocouple, 9V battery and software



CE

True RMS

PC INTERFACE

Part No.	Product No.	1	10	25
155491CL	ME-22T 000A-2T	\$85.49	\$61.25	\$77.19

2000-Count Multimeter w/ RS-232 & Dual Display

- Dual displays for comparative measurements
 - 3½-digit LCD w/ 2000 counts (.65" digit height)
 - Auto/min/max/data hold function
 - Resolution: 100µV maximum
 - **DC voltage ranges:** 200mV - 1000V
 - **AC voltage ranges:** 200mV - 750V
 - **DC/AC current ranges:** 2mA - 20A
 - **Resistance ranges:** 200Ω - 2000MΩ
 - Tests continuity, diode, transistor h_{FE}, frequency, capacitance and temperature
 - Size: 3.2"W x 1.2"D x 7.1"H
 - Weight: 1.8 lbs.
 - One-year warranty
- Includes:** PC interface cable, probes, temperature probe, manual, software and 9V battery



METEX

CE

PC INTERFACE

Part No.	Product No.	1	10	25
160813CL	M-3640D	\$88.79	\$77.35	\$63.89

4000-Count Multimeter with Dual Display and Bargraph

- 10 functions, 16 ranges
 - 3½-digit LCD display with 43-segment bargraph and dual display
 - Resolution: 100µV maximum
 - **DC voltage ranges:** 400mV - 1000V
 - **AC voltage ranges:** 4V - 750V
 - **DC/AC current ranges:** 400µA - 20A
 - **Resistance ranges:** 400Ω - 40MΩ
 - **Capacitance ranges:** 4nF - 400µF
 - **Frequency ranges:** 4kHz - 4MHz
 - Diode, continuity, h_{FE} test
 - Dual display for related readings
 - Data-hold, range-hold, auto/min/max-hold and relative offset
 - Memory and recall for 10 values
 - Auto-ranging and auto polarity indication
 - Size: 7.1"H x 3.3"W x 1.3"D
- Includes:** Test leads and battery



METEX

Part No.	Product No.	1	10
221997CL	M-3270D	\$89.95	\$85.49

METEX® 4000-Count Pocket Multimeters

- 3½-digit LCD display with 0.46" digit height
 - Resolution: 100µV maximum
 - Diode test
 - Continuity buzzer
 - Battery check
 - Built-in test leads and battery
 - Auto ranging and auto polarity indication
 - Size: 4.6"H x 2.9"W x 0.7"D
- 221971CL:**
- 10 functions, 13 ranges
 - **DC voltage ranges:** 400mV - 400V
 - **AC voltage ranges:** 4V - 400V
 - **DC/AC current ranges:** 400µA - 400mA
 - **Resistance ranges:** 400Ω - 40MΩ
 - **Frequency ranges:** 10Hz - 10MHz
 - **Capacitance ranges:** 40nF - 40µF
 - Duty measurement of 100%
- 221989CL:**
- 6 functions, 7 ranges
 - **DC/AC voltage ranges:** 400mV - 400V
 - **DC current ranges:** 400mA
 - **Resistance ranges:** 400Ω - 40MΩ
 - **Electric Field Test ranges:** 50VAC - 400VAC, 50-60Hz
- Includes:** Operating manual, probes, K-type thermocouple, 9V battery and software



221971CL



221989CL

New Lower Prices

Part No.	Product No.	1	10	25
221971CL	P-10	\$39.95	\$37.95	\$35.95
221989CL	P-09EF	\$39.95	37.95	36.89 34.29

4000-Count Multimeter with RS-232 and Analog Bar

- 3½-digit LCD display with analog bar (0.6" digit height)
 - RS-232 computer interface
 - Automatic polarity indication
 - Data hold/range hold function
 - Resolution: 100µV maximum
 - **DC voltage ranges:** 400mV-1000V
 - **AC voltage ranges:** 400mV-750V
 - **DC/AC current ranges:** 4mA-20A
 - **Resistance ranges:** 400Ω-4MΩ
 - Diode and continuity test
 - Size: 3.3"W x 1.5"D x 7.3"H
 - Weight: 1.9 lbs.
- Includes:** Probes, 9V battery, software, RS-232 cable and manual



METEX

PC INTERFACE

Part No.	Product No.	1	10
216514CL	ME-31	\$56.95	\$54.15

We'll match the print advertised price of any like product.

Jameco's Low-Price Guarantee

It's that simple!

4000-Count Multimeters w/ RS-232, Analog Bar and Temperature

- 3½-digit LCD display (0.6" digit height) with bargraph
- Automatic polarity indication
- Range hold function
- RS-232 computer interface
- Resolution: 100µV max.
- **DC voltage ranges:** 400mV – 1000V
- **AC voltage ranges:** 400mV – 750V
- **DC/AC current ranges:** 4mA – 20A
- **Resistance ranges:** 400Ω – 4MΩ
- **Capacitance ranges:** 4nF – 400nF
- **Temperature ranges:** -4°F – 2000°F
- Continuity, diode and transistor h_{FE} test
- Size: 3.2"W x 1.5"D x 7.3"H • Weight: 1.7 lbs.



216522CL
(reading in °F only)

222308CL: same as above except with temperature measurement in °C only

Includes: Probes, K-type temperature probe, software, 9V battery and manual

Part No.	Product No.	Description	1	10
216522CL	ME-32F	F	\$79.95	\$72.19
222308CL	ME-32	C	\$75.95	\$72.19

4000-Count Multimeter w/ RS-232, Dual Display, Inductance & True RMS

- Dual displays for comparative measurements
- 3½-digit LCD (0.63" digit height)
- True RMS
- Resolution: 100µV maximum
- **DC voltage ranges:** 400mV – 1000V
- **AC voltage ranges:** 400mV – 750V
- **DC/AC current ranges:** 400µA – 20A
- **Resistance ranges:** 400Ω – 40MΩ
- **Temperature:** -40°C to +1200°C; 1°C resolution • Weight: 1.9 lbs.
- Measures inductance, capacitance, transistor h_{FE} and frequency
- Computer interface (RS-232C) w/ software & cable
- Autoranging all measurement settings
- Size: 3.3"W x 1.8"D x 7.2"H • One-year warranty



137461CL
M-3860D

Includes: 9V battery and software

Part No.	Product No.	1	10
137461CL	M-3860D	\$149.95	\$134.99

4000-Count Multimeter with Triple Display, USB Interface and Temperature

- 3½-digit LCD display with triple display (main/sub1/sub2) and analog bar (0.76" digit height)
- Dual-display readout for temperature in °C and °F
- Data hold, memory, relative offset, recall, range, minimum/maximum hold functions
- Auto power off • Auto ranging
- Computer interface: USB-A male to USB-B male cable with Windows® 98/ME/2000 software
- **DC voltage ranges:** 400mV – 1000V
- **AC voltage ranges:** 4V – 750V
- **DC current ranges:** 400µA – 20A
- **AC current ranges:** 400µA – 20A
- **Resistance ranges:** 400Ω – 40MΩ
- **Capacitance ranges:** 4nF – 200µF
- **Frequency ranges:** 4kHz – 4MHz
- **Temperature:** -40°F to 2192°F (-40°C to 1200°C)
- Diode, continuity, transistor h_{FE} , and logic test
- Size: 3.5"W x 1.7"D x 7.8"H • Weight: 1.6 lbs.



Includes: Manual, probes, K-type thermocouple, USB-A male to USB-B male cable, software and 9V battery

Part No.	Product No.	1	10
215589CL	M-3890D	\$99.95	\$94.99

20,000-Count Multimeter w/ RS-232 & Multi-Display

- 0.63" digit height
- LCD readout
- Multi-display: 4 simultaneous displays for relative and comparative measurements
- Resolution: 10µV maximum
- **DC voltage ranges:** 200mV – 1000V
- **AC voltage ranges:** 200mV – 750V
- **DC/AC current ranges:** 2mA – 20A
- **Resistance ranges:** 200Ω – 20MΩ
- **Capacitance ranges:** 20nF – 200µF
- **Frequency ranges:** 20kHz – 2MHz
- Diode/continuity: measures forward resistance of a semiconductor junction in kΩ a test current of approximately 1mA
- Measures transistor h_{FE}
- Size: 3.3"W x 1.5"D x 7.5"H • Weight: 2.0 lbs.
- LCD size: 2.4"W x 1.3"H • One-year warranty



144872CL
M-4640A

Includes: Software, test leads, PC interface cable, manual and 9V battery

Part No.	Product No.	1	10
144872CL	M-4640A	\$132.95	\$128.99

2000-Count Pocket Multimeter

- **DC voltage ranges:** 200mV, 2V, 20V, 200V, 1000V
- **AC voltage ranges:** 200V, 750V
- **DC current ranges:** 200µA, 2mA, 20mA, 200mA, 10A
- **Resistance ranges:** 200Ω, 2kΩ, 20kΩ, 200kΩ, 2MΩ
- Diode and transistor tests
- 0.5" digit height
- Removable test leads
- Size: 2.6"W x 1.0"D x 4.8"H
- Weight: 0.5 lbs. • One-year warranty



Includes: 9V battery

Part No.	Description	1	10	50
119212CL	Pocket multimeter	\$19.95	\$17.95	\$16.19

2000-Count Multimeter with Temperature & Frequency Measurement

- 3½-digit LCD (1.0" digit height)
- Resolution: 100µV maximum
- **DC voltage ranges:** 200mV – 1000V
- **AC voltage ranges:** 2V – 700V
- **DC current ranges:** 2mA – 10A
- **AC current ranges:** 200mA – 10A
- **Resistance ranges:** 200Ω – 20MΩ
- **Capacitance ranges:** 2nF – 20µF
- **Frequency:** 20kHz
- **Temperature range:** -20°C – 1000°C
- Data hold switch
- Diode, transistor and continuity testing
- Size: 4.0"W x 2.0"D x 8.0"H • Weight: 1.6 lbs.



Includes: Manual, probes, and 9V battery

Part No.	Mr. Cross Ref. No.	1	10
177480CL	AEEC2890	\$49.95	\$44.95

4000-Count Multimeter w/ RS-232, Temperature & Autorange

- 3½-digit LCD (0.63" digit height)
- RS-232C computer interface
- Resolution: 100µV max.
- **DC voltage ranges:** 400mV – 1000V
- **AC voltage ranges:** 400mV – 750V
- **DC/AC current ranges:** 400µA – 20A
- **Resistance ranges:** 400Ω – 40MΩ
- **Temperature:** -40°C to +1200°C
- Diodes and continuity
- Measures transistor h_{FE} , frequency, and capacitance
- Autoranging all scale settings
- One-year warranty
- Size: 3.3"W x 1.8"D x 7.2"H • Weight: 1.8 lbs.



Includes: Manual, software, RS-232 interface cable, temperature probe and probes

Part No.	Product No.	1	10	25
117372CL	M-3850D	\$114.95	\$98.99	\$94.99

Need
Replacement
Batteries For
Your DMMs?
See pages
153 – 155.



Opening an account is easy!! Simply call us and we'll take your information right over the phone or you can also visit www.jameco.com. Call 1-800-831-4242 for details today.

Corporate Customers

Comparison table for all DMMs - see page 188

Color Code Legend
New Sale Qty Save

2000-Count Multimeter with Inductance

- Function and range annunciators
- Data hold
- Resolution: 100µV max.
- **DC voltage ranges:** 200mV - 1000V
- **AC voltage ranges:** 200mV - 750V
- **DC/AC current ranges:** 200µA - 10A
- **Resistance ranges:** 200Ω - 20MΩ
- **Capacitance ranges:** 2nF - 2000µF
- **Frequency ranges:** 2kHz - 20MHz
- **Inductance ranges:** 20mH - 20H
- Diode and continuity test
- Auto power off
- $Z_{IN} = 10M\Omega$
- Size: 4.0"W x 1.5"D x 8.0"H • Weight: 2.7 lbs.



BelMERIT

Part No.	Product No.	1	10
147096CL	DX460L	\$99.95	\$89.95

2000-Count Multimeter w/ Adjustable Viewing Angle

- Adjustable 1" LCD display for better viewing
- Auto power-off
- Improper test lead position alarm alerts user if position does not match function
- Accuracy: ±0.5% for DCV
- Resolution: 100µV maximum
- **DC voltage ranges:** 200mV - 1000V
- **AC voltage ranges:** 200mV - 750V
- **DC/AC current ranges:** 20µA - 10A
- **Resistance ranges:** 200Ω - 200MΩ
- Tests diode, continuity and transistor h_{FE}
- Size: 3.5"W x 1.3"D x 7.3"H • Weight: 0.6 lbs.



EXTECH

Part No.	Product No.	1	10	25
197958CL	MV110	\$36.95	\$35.19	\$33.45

Autoranging 3200-Count Analog/Digital Multimeter

- 3½-digit (0.53" digit height) LCD with analog bar graph
- Resolution: 100µV maximum
- **DC voltage ranges:** 320mV - 1000V
- **AC voltage ranges:** 320mV - 750V
- **DC/AC current ranges:** 320µA to 10A
- **Resistance ranges:** 320Ω - 32.5MΩ
- Data hold
- Diode/continuity test
- Auto range • Auto power off
- Size: 3.9"W x 1.5"D x 7.7"H • Weight: 1.5 lbs.



EZ DIGITAL

Part No.	Mr. Cross Ref. No.	1	10
101936CL	DM333	\$84.59	\$81.39

See the yellow and green highlighted items.

Jameco Special Values!

Sale details are on page 2.

11-Function 4000-Count Multimeter with Autorange

- 4000-count large LCD display
- Auto ranging with manual override
- Resolution: 0.1mV max.
- **AC/DC voltage ranges:** 400mV - 600V
- **AC/DC current ranges:** 400µA - 10A
- **Resistance ranges:** 400Ω - 40MΩ
- **Capacitance ranges:** 4nF - 200µF
- **Frequency ranges:** 10Hz - 10MHz
- **Temperature ranges:** 0°F - 1400°F (0°C - 760°C)
- Diode test, duty cycle and continuity
- Relative zero, data hold, range hold, auto off
- Size: 2.4"W x 1.6"D x 4.8"H • Weight: 0.6 lbs.



EXTECH

Part No.	Product No.	1	10
211650CL	MN26	\$39.95	\$37.95

4000-Count True RMS Multimeter with IR Thermometer

- Built-in IR thermometer with laser pointer distance of 8:1 to target ratio, 0.95 fixed emissivity
- Audible and visual input alerts
- Relative function for establishing a base line reference
- 1" digit height LCD display with backlight
- Accuracy: ±0.3% for VDC
- Resolution: 100µV maximum
- **DC/AC voltage ranges:** 400mV - 600V
- **DC/AC current ranges:** 400µA - 20A
- **Resistance ranges:** 400Ω - 40MΩ
- **Capacitance ranges:** 4nF - 100µF
- **Frequency ranges:** 10Hz - 10MHz
- **Temperature ranges (Type K):** -4°F to 518°F (-20°C to 270°C)
- Diode and continuity test
- Size: 3.2"W x 2.0"D x 7.4"H • Weight: 0.8 lbs.



EXTECH

Part No.	Product No.	1	5
245948CL	EX470	\$128.95	\$122.49

50,000-Count Digital Multimeter with Analog Bargraph

- True RMS reading
- Auto and manual ranging
- Large LCD display provides easy readability; all test parameters in clear view (0.55" digit height)
- AC/DC voltage protection
- Continuity and diode testing
- Basic DC accuracy: 0.025%
- **DC voltage ranges:** 500mV - 1000V (10µV - 100mV resolution)
- **AC voltage ranges:** 500mV - 750V (10µV - 100mV resolution)
- **AC/DC current ranges:** 500µA - 10A (10µA - 1mA resolution)
- **Resistance:** 500Ω - 50MΩ (10mΩ - 1kΩ res.)
- **Capacitance:** 50nF - 50mF (10pF - 10µF res.)
- **Frequency:** 0.6Hz - 500kHz
- Size: 3.2"W x 1.6"D x 7.5"H • Weight: 1.5 lbs.



BK PRECISION

Part No.	Product No.	1	10	25
185201CL	BK5380	\$149.99	\$127.49	\$95.65

Pocket Analog Multimeter

- DC/AC voltage ranges: 0 - 500V
- DC current ranges: 0 - 250mA
- Resistance ranges: 0 - 1kΩ
- Size: 2.3"W x 1.2"D x 3.6"H



Part No.	Description	1	10	50
206287CL	Pocket multimeter	\$1.95	\$7.61	\$5.71

Digital LCR Meter

- 3½-digit display (0.5" digit height)
- **Inductance ranges:** 200µH to 200H
- **Capacitance ranges:** 200pF to 2000µF
- **Resistance ranges:** 2mΩ to 20MΩ
- Dissipation factor measurement
- Size: 3.3"W x 1.4"D x 6.7"H
- Weight: 1.1 lbs.
- One-year warranty



Part No.	Description	1	10	25
127538CL	LCR meter	\$149.95	\$134.95	\$121.46

Passive Component LCR Meter

- Measures L, C, and R with secondary parameter Q, D or R; both are displayed
- Accuracy of 0.7% for L & C, 0.5% for R
- **Inductance ranges:** 2000.0uH to 2000.0H
- **Capacitance ranges:** 2000.0pF to 2000.0uF
- **Resistance ranges:** 20.0000Ω to 20.0000MΩ
- Test frequencies of 120Hz and 1kHz
- Dissipation Factor (D) reading: 0 to 0.9999
- Quality (Q) reading: 0 to 9999
- Selectable parallel or series equivalent circuit
- Set HI/LO limits, absolute or percentage
- 4½-digit backlit LCD display
- Bidirectional RS-232 port with optional software
- Max./Min./Avg. recording with auto power off
- Size: 3.6"W x 2.1"D x 7.6"H
- Weight: 0.8 lbs.



198678CL

Part No.	Description	1	10
198678CL	LCR Meter	\$178.95	\$160.95
189237CL	9VDC @ 300mA adapter	4.25	3.59

High Voltage AC/DC Test Probe

- Maximum voltages: DC: 40kV, AC: 40kV peak, 28kVrms
- Accuracy: DC: ±1.5%, AC: ±5%
- 10MΩ meter input impedance required
- Input/output impedance: 1.000MΩ/1.1MΩ
- Cable length: 39"
- Probe length: 14" • Weight: 0.8 lbs.



Part No.	Description	1	10
132290CL	High volt. test probe	\$79.95	\$72.95

Extremely Low Cost 7-Function 2000-Count Multimeter

- 3 1/2-digit LCD display (0.5" digit height)
- Resolution: 100µV maximum
- **DC voltage ranges:** 200mV - 500V
- **AC voltage ranges:** up to 500V
- **DC current ranges:** 200µA - 10A
- **Resistance ranges:** 200Ω - 2000kΩ
- Diode, continuity and transistor h_{FE} test
- Size: 2.7"W x 1.0"D x 5.0"H



Part No.	Product No.	1	10	25
220855CL	M830B	\$9.95	\$9.45	\$8.99

2000-Count Auto-Range Pocket Multimeter

- 3 1/2-digit LCD display (0.43" digit height)
- Resolution: 100µV maximum
- **DC voltage ranges:** 2V - 500V
- **AC voltage ranges:** 200V - 500V
- **DC current ranges:** 200mA
- **Resistance ranges:** 2kΩ - 2000kΩ
- Diode and continuity test
- Size: 2.7"W x 0.8"D x 4.7"H



SALE

Part No.	Product No.	1	10	25
220812CL	M300	\$12.95 \$9.79	\$8.81	\$7.93

8-Function 2000-Count Multimeter

- 8-functions/30 ranges
- 3 1/2-digit LCD display (0.8" digit height)
- Resolution: 100µV maximum
- **DC voltage ranges:** 200mV - 1000V
- **AC voltage ranges:** 200mV - 700V
- **DC/AC current ranges:** 20µA - 10A
- **Resistance ranges:** 200Ω - 20MΩ
- Diode, continuity and transistor h_{FE} test
- CAT II 1000V and CAT III 600V rated
- Size: 3.4"W x 1.3"D x 6.8"H



Part No.	Product No.	1	10	25
220821CL	M3900	\$24.95	\$23.69	\$22.55

2000-Count Multimeter w/ Frequency & Temperature Measurements

- 3 1/2-digit LCD display (1.0" digit height)
- Resolution: 100µV maximum
- **DC voltage ranges:** 200mV - 1000V
- **AC voltage ranges:** 200mV - 700V
- **DC/AC current ranges:** 200µA - 10A
- **Resistance ranges:** 200Ω - 200MΩ
- **Capacitance ranges:** 2nF - 20µF
- **Frequency ranges:** up to 20kHz
- **Temperature ranges:** -20°C - +1000°C
- Diode, continuity, and transistor h_{FE} test
- Tilting LCD display • Hold data button
- Size: 4.0"W x 1.8"D x 8.0"H



Now Lower Prices

Includes: Test leads and K-type thermocouple

Part No.	Product No.	1	10	25
220791CL	M9508	\$68.95 \$61.25	\$48.89	\$46.25

2000-Count Multimeter w/ Temperature Measurement

- 8 function/17 ranges
- 2000-count 3 1/2-digit LCD display (0.6" digit height)
- Resolution: 100µV maximum
- **DC voltage ranges:** 200mV - 600V
- **AC voltage ranges:** 200V - 600V
- **DC current ranges:** 2mA - 10A
- **Resistance ranges:** 200Ω - 2MΩ
- **Temperature ranges:** -20°C - +1000°C
- Diode, transistor h_{FE}, and continuity test
- Data hold switch
- Size: 3.0"W x 1.4"D x 5.7"H



Now Lower Prices

Includes: Test leads, and temperature probe

Part No.	Product No.	1	10	25
220741CL	MAS838	\$24.95 \$22.95	\$21.79	\$20.69

2000-Count Multimeter with Diode and h_{FE} Test

- 2000-count 3 1/2-digit LCD display (0.6" digit height)
- 7 function/17 ranges
- Resolution: 100µV maximum
- **DC voltage ranges:** 200mV - 600V
- **AC voltage ranges:** 200V - 600V
- **DC current ranges:** 200µA - 10A
- **Resistance ranges:** 200Ω - 2MΩ
- Diode, continuity, and transistor h_{FE} test
- Data hold switch & backlight button
- Size: 3.0"W x 1.4"D x 5.7"H



SALE

Part No.	Product No.	1	10	25
220759CL	MAS830L	\$15.49	\$13.94	\$12.55

2000-Count Multimeter w/ Digital & Analog Pointer Display, Frequency & Temperature Measurements

- 3 1/2-digit LCD display (0.7" digit height) with analog pointer
- Resolution: 100µV maximum
- **DC/AC voltage ranges:** 200mV - 600V
- **DC/AC current ranges:** 2mA - 200mA
- **Resistance ranges:** 200Ω - 20MΩ
- **Capacitance ranges:** 2nF - 20µF
- **Frequency ranges:** up to 20kHz
- **Temperature ranges:** -20°C to +1000°C
- Diode, continuity, and transistor h_{FE} test
- Zero adjustment knob for analog pointer display
- Built-in test leads • Size: 4.0"W x 1.5"D x 7.6"H



Includes: K-type thermocouple

Part No.	Product No.	1	10	25
220783CL	M9704	\$56.95 \$38.79	\$34.91	\$31.42

30-Day Money-Back Guarantee

If you're not satisfied we'll take it back!

Details on page 229.

2000-Count Multimeter w/ Temperature & Frequency Measurements

- 11 functions/33 ranges
- 2000-count LCD display with 1" digit height
- Resolution: 100µV max.
- **DC voltage ranges:** 200mV - 1000V
- **AC voltage ranges:** 200mV - 700V
- **DC/AC current ranges:** 2mA - 10A
- **Resistance ranges:** 200Ω - 200MΩ
- **Capacitance ranges:** 2nF - 20µF
- **Frequency ranges:** 2kHz - 20kHz
- **Temperature ranges:** -20°C - +1000°C
- Diode, continuity, and transistor h_{FE} test



Includes: Test leads and K-type thermocouple

Part No.	Product No.	1	10	25
220775CL	MY64	\$45.95 \$38.79	\$34.91	\$31.42

3260-Count Multimeter with Analog Bargraph & Frequency Measurements

- 10-functions/29 ranges
- 3260-count 0.67" digit height LCD display with analog bar graph
- Resolution: 100µV maximum
- **DC voltage ranges:** 326mV - 1000V
- **AC voltage ranges:** 3.26V - 750V
- **DC/AC current ranges:** 326µA - 10A
- **Resistance ranges:** 326Ω - 32.6MΩ
- **Capacitance ranges:** 326nF - 32.6µF
- **Frequency ranges:** 32.6kHz - 150kHz
- Diode, continuity, and transistor h_{FE} test
- Auto range and data hold push button



Part No.	Product No.	1	10	25
220767CL	MY68	\$54.95 \$38.79	\$34.91	\$31.42

4000-Count Auto-Range Pocket Multimeter

- 3 1/4-digit LCD display (0.43" digit height)
- Resolution: 100µV maximum
- **DC/AC voltage ranges:** 4V - 500V
- **DC/AC current ranges:** 40mA - 400mA
- **Resistance ranges:** 400Ω - 40MΩ
- Diode and continuity test
- Data hold button
- Size: 2.7"W x 0.8"D x 4.8"H • Built-in test leads



Part No.	Product No.	1	10	25
220804CL	M320	\$26.95 \$21.95	\$19.76	\$17.78

Our Lowest Priced 20,000-Count Multimeter

- Extra-large digits (0.8" digit height)
- Resolution: 10µV maximum
- **DC voltage ranges:** 200mV - 1000V
- **AC voltage ranges:** 2V - 700V
- **DC/AC current ranges:** 2mA - 10A
- **Resistance ranges:** 200Ω - 200MΩ
- **Capacitance ranges:** 200pF - 20µF
- Measures transistor h_{FE} & continuity
- Hold button • Auto power off
- Size: 3.9"W x 1.9"D x 8.0"H
- Weight: 1.5 lbs. • One-year warranty



Includes: Protective boot, 9V battery, probes and manual

Part No.	Product No.	1	10	25
136590CL	MY65	\$73.49	\$66.15	\$59.55

2000-Count Benchtop Multimeter

- 8 functions, 33 ranges
- LCD display with 0.5" digit height
- Resolution: 100µV maximum
- **DC voltage ranges:** 200mV – 1000V (0.5% accuracy)
- **AC voltage ranges:** 200mV – 750V (1% accuracy)
- **DC/AC current ranges:** 200µA – 20A
- **Resistance ranges:** 200Ω – 20MΩ
- **Capacitance ranges:** 2nF – 20µF (2% accuracy)
- Diode and continuity test
- Input voltage: 110/220VAC @ 50-60Hz
- Size: 9.6"W x 11.0"D x 3.7"H
- Weight: 4.4 lbs.



Now Lower Prices

INSTEK

Includes: Power cord, operations manual & test leads

Part No.	Product No.	1	5
229277CL	GDM-8034	\$249.95	\$224.95
			\$213.75

2000-Count Multimeter

The Fluke 8012A is a portable, bench-type, digital multimeter with 3½ digit liquid crystal display (LCD).

- Resolution: 100µV maximum
- **DC voltage ranges:** 200mV – 1000V
- **AC voltage ranges:** 200mV – 700V
- **DC/AC current ranges:** 20µA – 2A
- **Resistance ranges:** 2Ω – 20Ω (low range) 200Ω – 20MΩ
- **Conductance ranges:** 2µS – 200nS
- Size: 7.5"W x 9.6"D x 2.5"H
- Weight: 2.6 lbs. † Refurbished



Part No.	Product No.	Price
203801CL	8012A†	\$139.95

4000-Count True RMS Benchtop Multimeter with RS-232

- 9 functions, 32 ranges
- 3½-digit backlit LCD display with bargraph
- Auto/manual ranging
- True RMS AC volts and amps
- Resolution: 100µV maximum
- **DC voltage ranges:** 400mV – 1000V (0.3% accuracy)
- **AC voltage ranges:** 4V – 750V
- **DC/AC current ranges:** 4mA – 10A
- **Resistance ranges:** 400Ω – 40MΩ
- **Capacitance ranges:** 4nF – 40µF
- **Frequency ranges:** 100Hz – 600kHz
- Diode and continuity test • Delay hold mode
- Min., max., and relative hold function
- Input voltage: 9V battery or 90-132VAC/198-264VAC @ 50-60Hz
- Size: 9.0"W x 9.4"D x 3.3"H
- Weight: 3.3 lbs.
- Two-year warranty



Protex

Includes: Manual, test leads, power adapter, 9V battery, RS-232 cable and software (98/ME/2000/XP compatible)

Part No.	Product No.	1	5
230586CL	B940	\$148.95	\$141.55

20,000-Count True RMS Benchtop Multimeter

- 4½-digit green LCD
- DC accuracy: 0.05%
- Full overload protection
- Resolution: 10µV max.
- **DC voltage ranges:** 200mV – 1000V
- **AC voltage ranges:** 200mV – 750V
- **DC/AC current ranges:** 2mA – 10A
- **Resistance ranges:** 200Ω – 20MΩ
- **Frequency measurement up to 200kHz**
- Continuity check with beeper
- Data hold, diode check, transistor h_{FE} measurement available
- Size: 9.9"L x 9.8"W x 3.6"H • Weight: 6.1 lbs.
- One-year manufacturer's warranty



EZ DIGITAL

Part No.	Product No.	1	10	25
132564CL	DM441	\$219.95	\$209.95	\$199.95

20,000-Count Benchtop Multimeter w/ RS-232, Analog Bar & 4 Displays

- Automatic polarity indicator
- 1-2 readings per second
- DC accuracy: 0.1% +5 digits
- 10 reading storage and compare
- Resolution: 10µV max.
- **DC voltage ranges:** 200mV – 1000V
- **AC voltage ranges:** 200mV – 750V
- **DC/AC current ranges:** 2mA – 20A
- **Resistance ranges:** 200Ω – 20MΩ
- **Frequency ranges:** 20kHz – 20MHz
- Min., max., average, relative functions
- Logic, diode, transistor h_{FE} and continuity test
- Size: 11.2"L x 8.2"W x 3.2"H • Weight: 7.5 lbs.



METEX

Includes: Manual, power cable, probes and software

Part No.	Product No.	1	10
166852CL	MXD4660A	\$249.95	\$224.95

20,000-Count True RMS Benchtop Multimeter

- 6 functions, 22 ranges
- 4½-digit red LED display with 0.5" digit height
- Resolution: 10µV maximum
- **DC voltage ranges:** 200mV – 1200V (0.03% accuracy)
- **AC voltage ranges:** 200mV – 1000V (0.03% accuracy)
- **DC/AC current ranges:** 200µA – 20A
- **Resistance ranges:** 200Ω – 20MΩ
- Diode test • AC or AC+DC coupling
- Interlocking push buttons for easy selection
- 3600 adjustable tilting bail for maximum readability of display
- Input power: 117VAC or 234VAC @ 50-60Hz
- Size: 13.0"W x 9.0"D x 3.1"H • Weight: 4.7 lbs.



WAVETEK Meterman

Now Lower Prices

Part No.	Product No.	1	5
222578CL	BDM40	\$468.95	\$419.95
			\$379.95

50,000-Count Dual-Display True RMS Benchtop Multimeter

- 9 functions, 38 ranges
- Dual display indicates ACV and Hz, DCV (ACV) and dBm, or DCV and ACV ripple
- Auto range/manual operating modes
- AC or AC+DC true RMS • RS-232 interface
- Resolution: 10µV maximum
- **DC voltage ranges:** 500mV – 1200V (0.03% accuracy) • Diode and continuity test
- **AC voltage (True RMS) ranges:** 500mV – 1000V
- **DC/AC current ranges:** 500µA – 20A
- **Resistance ranges:** 500Ω – 20MΩ
- **Capacitance ranges:** 5nF – 50µF
- **Frequency ranges:** 10Hz – 200kHz
- Min., max., dBm, relative and hold functions
- Input voltage: 120/230V @ 50-60Hz
- Size: 9.9"W x 11.5"D x 3.6"H • Weight: 5.7 lbs.
- Two-year warranty



Now Lower Prices

Includes: Power cord, operations manual & test leads

Part No.	Product No.	1	5
229235CL	GDM-8245	\$499.95	\$449.95
			\$427.49

100,000-Count Dual-Display True RMS Benchtop Multimeter

A feature-rich 5-digit, 100,000 count meter that truly fits all applications and virtually any measurement needed on the workbench or in the field. Two multifunction displays and 16 different measurement capabilities allow wide ranging versatility at an affordable price. The Fluke 45 delivers high performance and flexibility for manufacturing test, depot & field service, as well as R&D applications.



FLUKE

- Multifunction vacuum fluorescent dual display allows the user to measure two different parameters of the same signal from one test connection, and view both measurements at the same time.
- True RMS voltage and current, including AC + DC
- Frequency measurement to 1 MHz
- dB measurements: 21 selectable reference impedances from 2 to 8000, and audio power from 2W to 16W • 2.5 reading per second
- Compare (Hi/Lo/Pass) function for quick in-tolerance tests • Resolution: 1µV maximum
- 0.05% DC current accuracy for 4-20mA current loop service • 8 functions, 31 ranges
- Diode and continuity test
- **DC voltage ranges:** 100mV – 1000V
- **AC voltage ranges (True RMS; AC-coupled):** 100mV – 750V
- **DC/AC current ranges:** 10mA – 10A
- **Resistance ranges:** 100Ω – 100MΩ
- **Frequency ranges:** 1kHz – 1MHz
- Size: 8.5"W x 11.3"D x 3.7"H
- 222367CL: RS-232 interface; Weight: 5.2 lbs
- 229833CL: GPIB interface with battery; Weight: 7.0 lbs.
- 222359CL: Battery pack; Weight: 1.8 lbs.

5% Below New Fluke Price

Part No.	Product No.	Description	1	5
222367CL	FLK-45	RS-232 interface	\$799.95	\$759.95
229833CL	FLK-45-15	GPIB interface	999.95	949.95
222359CL	FLK-45-01K	Battery pack only	184.95	175.69

110-Watt Programmable Linear Power Supply with RS-232/485 Interface

- Output voltage and current: 0-36V @ 0-3A
- Resolution: 1mV/1mA
- Volts, amps, and power are displayed on a backlit LCD display
- Values may be entered from keyboard, rotary dial, or RS-232 interface
- 10 memory settings
- Voltage/current regulation: $\pm 0.03\%$ load; $\pm 0.02\%$ line
- Ripple: $\leq 2\text{mV RMS}$
- Program settling time: 10ms increasing output voltage; 30ms decreasing output voltage
- Over voltage and current protection
- Input voltage: 110/220VAC @ 50-60Hz
- Size: 8.3"W x 9.8"D x 3.5"H
- Weight: 13.2 lbs.
- Two-year warranty



Protek

Includes: Manual, power cord, rack-mounting kit, RS-232 cable and software (98/2000/ME/XP compatible)

Part No.	Product No.	Description	1	5
230578CL	P6000	Programmable linear power supply	\$298.95	\$283.95

200-Watt Programmable Switching Power Supplies with RS-232 Interface

- Voltage regulation: $\leq 10\text{mV}$ load; $\leq 0.05\%$ line
- Current regulation: $\leq 5\text{mA}$ load; $\leq 0.05\%$ line
- Output ON/OFF control • Ripple: $\leq 20\text{mV}_{\text{rms}}$; $\leq 10\text{mA}_{\text{rms}}$
- Program voltage accuracy: 0.05%
- 5.7" (320 x 240 pixel) LCD display
- 3-step fan speed control
- Over-voltage/over-current/over-power/over-temperature protection
- Key lock to avoid unauthorized operation
- Normal, +%, & -% output operation key
- Standard RS-232C 9-pin female interface
- Input voltage: 115/230VAC @ 50-60Hz
- Size: 8.9"W x 12.0"D x 3.9"H • Weight: 8.8 lbs. • Two-year warranty



INSTEK

Includes: Power cord, operations manual and test leads

Part No.	Product No.	Description	1	5
229323CL	PSP-2010	0-20V @ 0-10A	\$349.95	\$332.45
229294CL	PSP-603	0-60V @ 0-3.5A	349.95	332.45

500-VA AC Power Source with True RMS Meter

- Wide range variable output voltage/frequency
- 4 save/recall voltage and frequency memories
- Stable and low distortion output waveforms
- Over-temperature, over-current, short circuit protection
- Output capacity: 500VA
- Output: 0.0-300.0VAC in 0.1V steps; 100 and 220VAC selectable
- Maximum current: 4.2A_{rms} for 0-150V; 2.1A_{rms} for 0-300V
- Frequency: 45.0 – 500.0Hz in 0.1Hz steps to 100.0Hz and 1Hz steps to 500Hz
- Load and Line regulation: 0.1V or 0.5%
- Frequency response: 0.1V recovering time of ≤ 2 seconds
- Frequency stability: $\leq 0.01\%$
- True RMS voltage display ranges: 0.0 – 380.0V
- True RMS current display ranges: 0.00 – 2.00A or 1.80 – 35.00A
- Watt display ranges: 0.0 – 360.0W or 320.0 – 3500.0W
- Power factor display ranges: 0.000 – 1.000
- Waveform: sinewave with $\leq 0.5\%$ THD
- Input voltage: 115/230VAC @ 50-60Hz
- Size: 16.9"W x 19.7"D x 5.4"H

SALE



INSTEK

New Lower Prices

- Frequency display ranges: 0.0 – 999.9Hz
- Two-year warranty
- Weight: 55.1 lbs.

Includes: Power cord and operations manual

Part No.	Product No.	Description	1	5
224882CL	PS-9501	Power source with true RMS meter	\$1,499.95	\$1,367.95

Don't worry about backorders. Over 99% of our products are in stock!
Just place your order by 6PM EST for same business day shipment.

150MHz 2-Channel Digital Oscilloscope

Color or Monochrome with RS-232/USB/Parallel Interfaces

- Bandwidth (-3dB): 150MHz
- Real-time sample rate: 100MS/s maximum on each channel; equivalent: 25GS/s
- 2 channels with 8-bit vertical resolution
- FFT function
- Auto set vertical, horizontal, and trigger level
- 15 sets of measurements conditions can be saved and recalled
- Vertical sensitivity: 2mV/div – 5V/div
- Input impedance: 1M Ω $\pm 2\%$, 22pF
- Time base range: 1nS/div – 10S/div
- Delay range: pre-trigger – 20 div. maximum; post-trigger – 1000 div. • Record length 125k/CH
- Trigger sensitivity: DC – 25MHz: 0.35div or 3.5mV; 25MHz – 150MHz: 1.5div or 10mV
- 5.7" (320 x 240 resolution) LCD display with adjustable display contrast
- Waveform display graticule: 8 x 10 divisions
- Display mode: dot, vector, accumulate
- Frequency counter: 6 digits $\pm 50\text{ppm}$; AC coupled, 10Hz – 150MHz
- Input voltage: 100-240VAC @ 50-60Hz
- Size: 12.2"W x 10.0"D x 5.6"H
- Weight: 9.3 lbs. • Two-year warranty



SALE INSTEK

New Lower Prices

Includes: BNC cable, power cord & operations manual

Part No.	Product No.	1	5
229307CL	GDS-820	\$1,299.95	\$1,169.95
229358CL	GDS-820S	\$1,399.95	1,259.95
229366CL	GDS-820C	\$1,599.95	1,439.95

150MHz 2-Channel Digital Oscilloscope

- Repetitive B/W: 150MHz
- Sample rate: 100MS/s max. (real time)
- Record length: 32k
- Resolution: 8-bits
- 5.7" mono LCD display (320 x 240)
- Math functions and set-up save/recall
- Automatic measurement amplitude, auto set-up of vertical, horizontal D.F., & trigger level
- Vertical sensitivity: 2mV/div to 5V/div
- Input impedance: 1M Ω or 50 Ω , 20pF nominal
- Max. input: 300V@1M Ω ; 5V @ 50 Ω
- Horizontal time base range: 2ns/Div to 5s/Div
- Trigger sensitivity: DC – 10MHz; 0.5 Div.
- Input voltage: 90 to 250VAC @ 48-440Hz
- Size: 12.9"L x 12.3"W x 5.9"H • Weight: 13.2 lbs.



EZ DIGITAL

Includes: Two (X1/X10) 250MHz probes, power cord, and operations manual

Part No.	Product No.	1	5
201865CL	DS-1150	\$1,445.95	\$1,373.95

Detailed specifications for Test Equipment
www.Jameco.com

EZ DIGITAL

90-Watt Digital DC Power Supply

30VDC @ 3A

- Constant current and constant voltage operation
- Can be used for positive or negative source
- Overload protection circuit
- Input voltage: 100/240VAC @ 50-60Hz
- Size: 5.2"W x 5.6"H x 10.0"D
- Weight: 10.9 lbs.
- One-year warranty



Part No.	Product No.	1	10
121152CL	GP4303D	\$189.95	\$179.95

150-Watt Digital Power Supply

30VDC @ 5A

- Adjustable voltage/current outputs
- Constant voltage and current operation
- LCD displays for both current and voltage
- Coarse and fine adjustment knobs for current and voltage
- Color-coded terminals for positive, negative and ground connections
- 2A @ 250V fuse
- Dual digital display
- Input voltage: 110/220VAC @ 50-60Hz (switchable)
- One-year warranty
- Size: 5.4"W x 10.7"D x 6.0"H • Weight: 13.8 lbs.



Part No.	Description	1	10	25
153242CL	30VDC @ 5A	\$234.95	\$211.49	\$190.35

150-Watt Power Supply

50VDC @ 3A

- Adjustable voltage/current outputs
- Constant voltage & current operation
- Color-coded terminals for ground, positive and negative terminals
- 3A @ 115V fuse
- Color-coded adjustment knobs for voltage, current and fine adjustment
- Input voltage: 110VAC @ 60Hz
- Color: dark gray
- Size: 9.0"L x 4.75"W x 7.5"H
- Weight: 12.3 lbs. • One-year warranty



Part No.	Description	1	10	25
163723CL	50VDC @ 3A	\$159.95	\$144.95	\$137.95

100-Watt Triple Output Digital and Analog DC Power Supplies

30VDC @ 3A

- Triple output with fixed 5VDC @ 0.5A, 12VDC @ 0.5A
- Adjustable 0 - 30V voltage and 0 - 3A current outputs
- Displays of both voltage and current
- Constant voltage or current
- Current limiting indicator
- Overload and short circuit protection
- Binding post terminals for variable supply
- Input voltage: 110/220VAC @ 50-60Hz (switchable)
- Size: 9.5"L x 6.0"W x 5.6"H • Weight: 10.0 lbs.



197991CL



197982CL

Part No.	Description	1	10
197991CL	Digital DC	\$198.95	\$178.95
197982CL	Analog DC	168.95	151.95

150-Watt Linear Power Supply

15VDC @ 10A

- Output voltage: 2VDC to 15VDC
- Output current: 15A max.
- Constant voltage operation
- Color-coded terminals for positive and negative terminals, voltage adjustment knob
- Overvoltage, overcurrent, short-circuit protection
- Cigarette lighter output current plug
- LED indicator for power and warning
- Current and voltage panel meter
- Built-in fan
- Input voltage: 110VAC @ 60Hz
- Size: 5.7"L x 6.2"W x 4.0"H • Weight: 12.0 lbs.



Part No.	Mfr. Cross Ref. No.	1	10	25
175265CL	DPS150A	\$149.95	\$134.95	\$129.95

190-Watt Triple Output Power Supply

Digital Display

- Output voltage: 0 to +30VDC @ 3A, 0 to -30VDC @ 3A, +5VDC @ 2A
- Ripple voltage: less than 3mVp-p
- Volt and current meter: LED display (±1% + 1 digit)
- Overload protection circuit
- Input voltage: 100VAC/230VAC @ 50-60Hz (switchable)
- Weight: 23 lbs. • One-year warranty



EZ DIGITAL

Includes: Manual and spare fuse

Part No.	Product No.	1	5
157518CL	GP4303TP	\$549.95	\$529.95

SALE

225-Watt Analog Power Supply

15VDC @ 15A

- Output voltage: 9VDC to 15VDC
- Output current: 25A max. (22A continuous @ 13.8VDC)
- Constant voltage operation
- Over-voltage protection @ 16.5V
- Short-circuit protection @ 27.5A
- Color-coded adjustment knob and output terminals for voltage
- Cigarette lighter plug for current output
- Power and fan LED indicator • Built-in fan
- Voltage and current panel meter
- Input voltage: 110VAC/220VAC @ 47-63Hz (switchable)
- Size: 5.6"L x 6.2"W x 4.0"H • Weight: 3.8 lbs.



Now Lower Prices

Part No.	Mfr. Cross Ref. No.	1	10	25
175257CL	SPS250A	\$159.95	\$143.95	\$129.56

250-Watt Analog Power Supply

50VDC @ 5A

- Adjustable voltage/current outputs
- Constant voltage and current operation
- Color-coded adjustment knobs for voltage, current, and fine tuning
- Color-coded terminals for ground, positive, negative
- 5A @ 250V fuse • Isolated ground
- Input voltage: 110VAC @ 50-60Hz
- Color: dark gray
- Size: 4.9"L x 7.7"W x 6.7"H • Weight: 13.8 lbs.



Part No.	Mfr. Cross Ref. No.	1	10	25
175249CL	DPS5050	\$189.95	\$179.95	\$171.49



100W to 600W Benchtop Power Supplies

- Voltage and current adjustable
- Current restricted and short-circuit protection
- Input voltage: 110/220 ±10% VAC

Analog display power supplies

- Accuracy: 2.5%

Digital display power supplies

- Voltage accuracy: 1% + 2 digits
- Current accuracy: 1.5% + 2 digits



207618CL



207706CL



211705CL

Single Output

Part No.	Product No.	Displays	Power (W)	Voltage (VDC)/Current (A)	Size (W"xH"xD")	Wt. (lbs.)	1	10
207618CL	HY3005C	2-Analog	150	30/5	5.4 x 6.2 x 11.5	14	\$159.95	\$144.95
207626CL	HY3010C	2-Analog	300	30/10	10.4 x 6.5 x 14.4	28	299.95	269.95
207693CL	HY5002	2-Digital	100	50/2	5.4 x 6.2 x 11.5	13	189.95	170.95
207706CL	HY5003	2-Digital	150	50/3	5.4 x 6.2 x 11.5	14	249.95	224.95
207600CL	HY5005	2-Digital	250	50/5	10.4 x 6.5 x 14.4	28	299.95	269.95
207634CL	HY3010	2-Digital	300	30/10	10.4 x 6.5 x 14.4	32	399.95	359.95
207685CL	HY3020	2-Digital	600	30/20	10.4 x 6.5 x 14.4	46	499.95	449.95

Multiple Output

Part No.	Product No.	Displays	Power (W)	Voltage (VDC)/Current (A)	Size (W"xH"xD")	Wt. (lbs.)	1	10
211721CL	HY3002-2	2-Digital	120	0-30/2; 0-30/2	10.4 x 6.5 x 14.4	23	\$249.95	\$224.95
211705CL	HY3002D-2	4-Digital	120	0-30/2; 0-30/2	10.4 x 6.5 x 14.4	23	269.95	242.95
211692CL	HY3003D-2	4-Digital	180	0-30/3; 0-30/3	10.4 x 6.5 x 14.4	28	289.95	259.95
211730CL	HY3003-2	2-Digital	180	0-30/3; 0-30/3	10.4 x 6.5 x 14.4	28	299.95	269.95
211713CL	HY3003-3	2-Digital	195	0-30/3; 0-30/3; 5/3	10.4 x 6.5 x 14.4	29	319.95	287.95
211684CL	HY3003D-3	4-Digital	195	0-30/3; 0-30/3; 5/3	10.4 x 6.5 x 14.4	29	329.95	296.95

Handheld 1MHz Digital Oscilloscope and Multimeter

Six Units in One!

- 4,000 count True-RMS DMM
- 1MHz bandwidth oscilloscope
- 20MHz sampling rate
- Logic test
- Frequency counter
- Trend mode allows recording of sine waves for a period of time
- Component test • Three-year warranty

Includes: AC charger, test leads & manual



FREE Protective Boot - \$19.95 value!

Part No.	Description	1	5
160805CL	440 digital scope	\$309.95	\$285.18
168330CL	RS-232 software and cable	69.95	62.95

Handheld 2MHz Digital Oscilloscope

- 10MHz for repetitive signals; 2MHz for single shot events
- Input impedance: 1MΩ/20pF
- Max. input voltage: 100V peak (AC + DC)
- Input coupling: DC, AC, and GND (GND for auto zero reference)
- LCD graphics display: 112 x 192 pixels
- Vertical resolution: 8-bit
- Timebase range: 50ns to 1 hr./div
- Input sensitivity: 5mV to 20V/div
- Trigger mode: run, normal, once, and ± slope • Linearity: ±1 bit
- True RMS and dB measurements
- High contrast LCD display w/ 3.3" viewing angle
- Recommend 9VDC @ 300mA power supply (133891CL, pg 145) • Screen hold
- Batteries not included, recommend 5 ea. 32627CL or 151087CL, pg 154 • Weight: 1.0 lb.



Includes: Insulated BNC-to-alligator clip measurement probes

Part No.	Description	1	5
236507CL	2MHz DSO (HPS5)	\$194.95	\$185.25

Handheld 5MHz Digital Oscilloscope w/ True RMS Multimeter

- 5MHz bandwidth; 25MS/s sampling rate
- Auto power off
- RS-232 PC interface
- 160 x 160 pixel graphical display with backlight
- Vertical sensitivity: 10mV - 200V per div. (14 div.)
- Single channel with 1MΩ impedance
- 4000-count dual display with analog bargraph
- Resolution: 100uV maximum
- DC voltage ranges: 400mV to 1000V
- AC voltage ranges: 400mV to 700V
- DC/AC current ranges: 400mA to 20A
- Resistance ranges: 400Ω to 40MΩ
- Capacitance ranges: 40nF to 100μF
- Frequency ranges: 1Hz to 5MHz
- DBm, diode and continuity test
- Max/Min/Average w/ sampling rate & graphical plot
- Size: 4.2"W x 2.2" D x 8.3"H • Weight: 1.8 lbs.

Includes: Protective holster, built-in stand, Windows® 95-XP compatible software, RS-232 cable, 6 AA batteries, fuse, test leads, and alligator clips

Part No.	Product No.	1	5
245930CL	381285	\$398.95	\$378.95



PC INTERFACE

Handheld 5MHz Oscilloscope with 4000-Count Digital Multimeter

- 128 x 128 pixel graphic STN LCD
- E/L backlight
- PC interface via RS-232
- Memory and recall for 4 values
- Temperature measurement

Oscilloscope:

- DC-5MHz bandwidth; 20MS/sec. sampling rate; single channel
- Vertical axis: 3 steps (±0.5/5/50 volts) with 4 divisions
- Horizontal axis: 16 steps (800ns/div to 26.2ms/div) in 8 divisions
- Trigger: auto and internal mode, slope and 5 trigger level selectable
- Text display for peak to peak, min./max. voltage and frequency

Digital Multimeter:

- 3½-digit with 43 segment bargraph
- Auto ranging; triple display for related reading; data and range hold; auto/min/max hold and relative offset
- DC voltage ranges: 400mV - 1000V
- AC voltage ranges: 4V - 750V
- DC/AC current ranges: 400uA - 400mA
- Resistance ranges: 400Ω - 40MΩ
- Frequency ranges: 4kHz - 4MHz
- Temperature ranges: -40°C - +1200°C
- Capacitance ranges: 4nF - 400μF
- Diode and continuity
- Size (unit): 3.4"W x 1.5"D x 8.0"H • Weight: 3.9 lbs.

Includes: Manual, power adapter and test leads

Part No.	Description	1	5
221962CL	MS-1280 (w/ temperature)	\$349.95	\$332.95
221938CL	RS-232 cable & software	19.95	18.95
221946CL	Scope probe	24.95	23.69
221954CL	Holster	5.95	5.65



221962CL

METEX®

Handheld 20MHz Digital Oscilloscope & Multimeter

- 4-in-1: digital oscilloscope, DMM, frequency counter & logic analyzer
- Oscilloscope: 2-channel input, 5mV-2V/div; DC-20MHz(-3dB); 50ns - 0.5us/div; 20 MS/s sampling rate
- Logic analyzer: 8 inputs; 1.4V threshold level; 35VDC max. input; 50ns min. pulse width
- Digital multimeter: 3½-digit (max. 3999 counts); 40 segment analog bargraph; AC/DC voltage 400mV-600V; AC current 40uA-400mA; DC current 400uA-400mA; resistance 400Ω-40MΩ; continuity & diode testing
- Frequency counter: 5Hz-20MHz; 5 digit max.; autoranging; AC/DC/DC input coupling; ±10ppm accuracy; 35Vrms/42V-P/60VDC max. input
- Oscilloscope probes: Use P/N 22891CL or 216047CL, pg 198
- Battery required for portable use (see below)
- Size: 10.0"L x 5.0"W x 2.0"H
- Weight: 9.2 lbs. • One-year warranty

Includes: Manual, 5VDC @ 3A power supply, power cord, DMM test leads, holster and case

Part No.	Description	1	5
162430CL	20MHz digital scope	\$749.95	\$712.95
162974CL	Logic probe	59.95	53.95
163141CL	Rechargeable battery	45.95	41.49
162966CL	RS-232 cable and software	26.95	24.25
221946CL	Scope probe	24.95	23.69



(Shown w/ logic probe P/N 162974CL - not included)

METEX®

Fluke 123 20MHz Industrial Scopemeter® with FlukeView Software

Digital Scope, 15-Function Digital Multimeter & Recorder

The Fluke 123 is the ideal choice for troubleshooting industrial machinery, instrumentation, and power systems. Automatically recognizes signal patterns and sets up correct triggering, timing, and amplitude for stable displays.

- Recorder: dual-channel TrendPlot™
- Digital Multimeter: dual-input 20MHz oscilloscope with 1.25GS/sec. repetitive sampling rate
- Digital Multimeter: dual-input 5000-count True RMS meter with ohms, capacitance & temperature
- Size: 4.5"W x 2.0"D x 9.1"H • Weight: 5.8 lbs.
- FlukeView Software (Version 3.04)
- Documenting: transfer screens, waveforms & data to your PC for printing or importing to other programs
- Archiving: store and retrieve waveforms with text annotations and create your own library
- Analysis: gather valuable data and enable cursor measurement, extend recording of up to four user-selected measurements, upload waveforms and use cursors for detailed measurements
- Compatible with Windows® operation system

Part No.	Product No.	Price
203131CL	Fluke 123S †	\$1195.95 \$1,099.95



SALE

† Refurbished

Fluke 124 40MHz Oscilloscope w/ 5000-Count Digital Multimeters and Paperless Recorder

The compact ScopeMeter 124 is the rugged solution for industrial troubleshooting and installation applications. It's a truly integrated test tool, with oscilloscope, multimeter and "paperless" recorder in one affordable, easy-to-use instrument.

FlukeView software helps you get more out of your Scopemeter by: (A) Documenting by transferring waveforms, screens and measurement data from the ScopeMeter to a PC; (B) Adding user text to individual ScopeMeter settings provides guidance to the operator when recalling a set-up; (C) Archiving creates a library of waveforms with your comments for easy reference and comparison; (D) Storing complete Replay cycles for analysis of waveform changes and memory content for back-up purposes; and (E) Analyzing use cursors, perform spectrum analysis or export data to other analysis programs.

- Dual-input 40MHz or 20MHz digital oscilloscope
- Two 5,000-count true-RMS digital multimeters
- A dual-input TrendPlot™ recorder
- Connect-and-View™ trigger simplicity for hands-off operation • Optically isolated RS-232 interface
- Shielded test leads for oscilloscope, resistance and continuity measurements
- 10:1 Voltage Probe included for reduced circuit loading • 600 V CAT III safety certified

Part No.	Product No.	1	5
222421CL	FLK-124	\$1,399.95	\$1,329.95
222412CL	FLK124S (w/ software)	\$1,699.95	\$1,614.95



222421CL

SALE

Fluke 190 Series 200MHz ScopeMeters with 5000-Count Digital Multimeters

Color and B/W

For the more demanding applications, the ScopeMeter 190 series high-performance oscilloscopes offer specifications usually found on more expensive bench instruments. With up to 200MHz bandwidth, 2.5 GS/s real-time sampling and a deep memory of 27,500 points per input, they're ideal for engineers who need the full capabilities of a high-performance oscilloscope in a handheld, battery-powered instrument.



222404CL

- Dual-input – 200 or 100MHz bandwidth
- Up to 2.5 GS/s real-time sampling per input
- Connect-and-View™ automatic triggering and a full range of manual trigger modes
- Digital Persistence for analyzing complex dynamic waveforms like on an analog scope
- Fast display update rate for seeing dynamic behavior instantaneously
- Automatic capture and replay of 100 screens
- 27,500 points per input record length using ScopeRecord mode
- TrendPlot paperless chart recorder for trend analysis up to 22 days
- Up to 1000V independently floating isolated inputs
- Waveform reference for visual comparisons and automatic pass/fail testing of waveforms
- Vpwm function for motor drive and frequency inverter applications
- 1000 V CAT II and 600 V CAT III safety certified
- Four-hour rechargeable NiMH battery pack

Now Lower Prices

211220CL: Includes FlukeView software

Includes: Test leads, probes and manual

Part No.	Product No.	1	5
222404CL	FLK-196C (100MHz) color	\$2,599.95	\$2,469.95
222383CL	FLK-199C (200MHz) color	2,899.95	2,754.95
222391CL	FLK-199B (200MHz) B&W	2,599.95	2,469.95
211220CL	FLK-199B/S (200MHz)	2,249.95	2,137.49

† Refurbished

PC-MultiScope 20MHz 2-Channel Digital Oscilloscope

mission technology



Turn your PC into a digital storage oscilloscope for 1/2 the cost of a DSO!

- 100MHz sampling; dual channel
- Chart recorder and FFT mode
- 5mV to 5V per div.; 20MHz bandwidth; ext. trigger
- 0-4MHz sine and square wave signal generator
- Triple power supply; 5VDC @ 500mA and ±0-8VDC @ 250mA
- One-year warranty
- Size: 4.3"L x 5.0"W x 1.5"H
- Weight: 3.8 lbs.

Includes: Parallel port cable, AC adapter, alligator clip probe, Windows® 3.1/95/98 software

Part No.	Description	1	10
163230CL	PC-MultiScope 3	\$579.95	\$529.95

50MHz Digital PC-Based Oscilloscope, Spectrum Analyzer and Transient Recorder

- Sampling frequency: 1.25kHz–50MHz real-time; 1GHz repetitive
- Input impedance: 1MΩ/30pF
- Parallel Port Interface
- Inputs: 2 channels, 1 external trigger input
- Max. input voltage: 100V (AC and DC)
- Power required: 9V to 10V @ 1000mA (recommend P/N 100888CL, pg 145)



Oscilloscope:

- Timebase: 20ns–100ms per division
- Input sensitivity: 5mV–15V per division with auto step-function
- Recording length: 4096 samples per channel

Spectrum Analyzer:

- Frequency range: 0 to 25MHz

Transient Recorder:

- Time scale: 20ms/div–2000s/div
- Max. recording time: 9.4 hours/screen
- Max. number of samples: 100/s

System requirements: IBM compatible PC, Windows® 95/98/ME, SVGA card, mouse, printer port, CD-ROM

Includes: 2 test leads, PC parallel cable, manual and CD-ROM software

Part No.	Product No.	1	5
200184CL	PCS500AU	\$478.95	\$429.95

1GHz Spectrum Analyzers with Digital Display and RS-232 Interface

- Frequency ranges: 150kHz – 1GHz
- Fully digital phase-locked-loop design
- High frequency stability: ±10ppm
- Two markers for absolute and relative measurement with resolution of 0.1dB, 1kHz
- 9 save-and-recall memories
- Max. hold, average (2 – 32 traces), freeze, peak search, marker-to-center functions
- High span resolution to measure detailed signal: zero, and 2kHz – 100MHz/div in a 1-2-5 sequence
- Bandwidth resolution: 3kHz, 30kHz, 220kHz, 4MHz
- High input protection level: +30dBm continuous, ±25VDC
- Input impedance: 50Ω nominal
- FM/AM demodulator: WBFM 120kHz; MBFM 75kHz; NBFM 30kHz deviation
- Input voltage: 100/120/220/230VAC @ 50-60Hz
- RS-232 interface to PC
- Two-year warranty
- Size: 12.2"W x 17.9"D x 5.9"H
- Weight: 19.2 lbs.



INSTEK

229340CL:

- With tracking generator: frequency range of 150kHz – 1GHz; 0 – 50dBm amplitude range with 1dB resolution; <-30dBc harmonics; 50Ω nominal impedance

Includes: Operations manual

Part No.	Product No.	1	5
229315CL	GSP-810	\$2,374.95	\$2,137.49
229340CL	GSP-810TG	3,274.95	3,111.25

Now Lower Prices

100MHz Logic Analyzer USB Interface

DigiView™ is a new 18-channel, 100MHz logic analyzer with professional quality and high portability. DigiView™ uses a deep-capture buffer and real time hardware compression to achieve long period captures without reducing resolution.



- 18-channels, 100MHz
- USB interface and power source for portability
- Real time hardware compression
- Compression ratio up to 256,000:1
- Trigger on rising, falling, or transition of any channel
- Pre-trigger and post-trigger data capture
- Captures up to 5 minutes of data @ 10ns resolution

Part No.	Description	1	5
256866CL	USB logic analyzer	\$498.95	\$474.09
256874CL	Cable replacement	29.95	28.49
256882CL	Grabber clip set (10)	29.95	28.50

20MHz 2-Channel Analog Oscilloscope



EZ DIGITAL

Blue CRT for higher resolution!

- 6" rectangular high-resolution blue CRT with internal graticule & scale
- Vertical deflection: 5mV/div to 5V/div in 10 calibrated steps
- Horizontal deflection: 0.2μs/div to 0.2s/div in 19 calibrated steps, 1-2-5 sequence
- Max. signal input voltage: 250V (DC and peak AC)
- ADD function measures sum of two signals
- Input voltage: 98-125VAC @ 1A, 198-225VAC @ 0.5A, 50-60Hz, 45W
- Two-year manufacturer's warranty
- Size: 16.4"L x 12.6"W x 5.3"H
- Weight: 20.8 lbs.

Part No.	Product No.	1	5
136098CL	OS5020	\$399.95	\$385.95

20MHz 2-Channel Analog Oscilloscope with 1MHz Function Generator

Basic specs same as OS5020 (above)

Function generator

- Frequency range: 0.1Hz to 1MHz (7 ranges)
- Output waveforms: sine, triangle, square, TTL pulse
- Output impedance: 50Ω
- Output voltage: 14Vp-p
- Two-year manufacturer's warranty
- Size: 12.6"L x 12.6"W x 6.8"H
- Weight: 23.8 lbs.

Includes: Two X1/X10 40MHz probes, power cord, manual, BNC to alligator, and cable

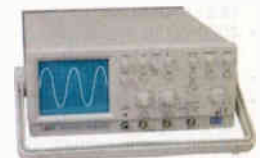

2 Instruments in 1

EZ DIGITAL

Part No.	Product No.	1	10
94650CL	OS5020G	\$529.95	\$499.95

Detailed specifications for Test Equipment – www.Jameco.com

20MHz 2-Channel Analog Oscilloscope with Built-in Component Checker

- 6" rectangular CRT with internal graticule
- Built-in component checker/tester for resistors, capacitors, coils, diodes
- Vertical sensitivity: 5mV/div to 20V/div in 12 calibrated steps (1-2-5 sequence)
- Input impedance: 1MΩ, 20pF
- Max. input (vertical amplifier): 300VDC or AC peak
- Horizontal sweep time: 0.2μs/div to 0.5s/div in 20 calibrated steps (1-2-5 sequence)
- Internal trigger sensitivity: 20Hz to 20MHz
- Size: 17"L x 14"W x 5.75"H • Weight: 15.5 lbs.



Protek

Includes: Two X1/X10 60MHz probes, power cord, and operations manual

Part No.	Product No.	1	5
201857CL	P-3502C	\$394.95	\$375.19

20MHz 2-Channel Analog Oscilloscope with Alt-Mag and 1mV/div Sensitivity

- Large 6" CRT with internal graticule
- Alt-Mag sweep for simultaneous displays of the main and X5 magnified trace
- Auto-focus
- Input voltage: 100V, 120V, 220V, 240V @ 50-60Hz (selectable)
- Size: 14.8"L x 13.4"W x 5.5"H • Weight: 24 lbs.
- Vertical Amplifier
- Sensitivity – 1mV/div to 1V/div (X5 Mag); 5mV/div to 5V/div in 10 steps (1-2-5 seq.)
- Bandwidth: (-3dB): DC to 20MHz
- Input impedance: 1M ohms, 25pF
- Maximum input voltage: 400V (DC or AC peak)



Protek

- Horizontal Sweep
 - Sweep time: 0.1μs/div to 0.2S/div in 20 steps (1-2-5 seq); X5 mag: 20ns/div to 40ms/div
 - Triggering
 - Sensitivity: Internal – DC to 2MHz: 2 divisions; 2MHz to 20MHz: 3 divisions
- Includes: X1 and X10 probes, power cord & manual
- | Part No. | Product No. | 1 | 5 |
|----------|-------------|----------|----------|
| 220679CL | PROTEK 6502 | \$448.95 | \$425.95 |

20MHz 2-Channel Analog Oscilloscope w/ 1mV/div Sensitivity

- 6" rectangular CRT with internal graticule
- Input sensitivity: 1mV/div
- Vertical deflection: 1mV/div – 1V/div (X5Mag); 5mV – 5V/div in 10 steps (1-2-5 sequence)
- Bandwidth (-3dB): DC – 20MHz
- Input impedance: 1MΩ, 25pF
- Horizontal deflection: 0.2us/div – 0.2s/div in 19 steps (1-2-5 sequence); X10Mag extends maximum sweep rate to 20ns/div
- Trigger system: internal and external trigger system
- External maximum input voltage: 300V (DC+AC)
- Input voltage: 110V/220V @ 48-62Hz
- Size: 14.5"L x 12.2"W x 5.1"H • Weight: 14.3 lbs.



Part No.	Product No.	1	5
226261CL	AEEC-2550S	\$389.95	\$369.95

100MHz 2-Channel Analog Oscilloscope

- 2-channel dual trace
 - Delay line
 - Auto focusing according to intensity
 - Two-year warranty
 - Size: 16.9"L x 12.6"W x 5.5"H
 - Weight: 22.8 lbs.
- Includes: Two (X1/X10) 100MHz probes, power cord, and operations manual



EZ DIGITAL

Part No.	Product No.	1	5
121179CL	OS5100	\$999.95	\$949.95

100MHz Delayed Sweep Analog Oscilloscope w/ Cursor Readout 2 Channel

- Bandwidth (-3dB): DC-100MHz
- Cursor readout with 7 measurements
- Time base auto range
- 10 save-and-recall memories
- Z-axis modulation input
- TV synchronization
- Vertical sensitivity: 2mV – 5V/div, 11 steps in 1-2-5 sequence; 2mV/div max. to 20MHz
- Max. input voltage: 400V DC+AC peak @ 1kHz or less
- Input impedance: 1MΩ ±2%, 25pF
- Main sweep time (A): 50ns – 0.5s/div
- Delay sweep time (B): 50ns – 50ms/div
- 6" continuously adjustable rectangular CRT with internal graticule, 8x10 div. • Delay time: 1us – 5s
- Input voltage: 100/120/230VAC @ 50-60Hz (switchable) • Size: 12.2"W x 17.9"D x 5.9"H
- Weight: 19.8 lbs. • Two-year warranty



INSTEK

Includes: BNC cable, power cord & operations manual

Part No.	Product No.	1	5
229278CL	GOS-6103	\$1,599.95	\$1,519.95

100MHz Delayed Sweep Analog Oscilloscope w/ Frequency Counter 2 Channel, 4 Trace

- DC to 100MHz bandwidth
 - 6" rectangular CRT with internal graticule
 - Auto set, readout cursor, delay sweep, hold-off functions
 - Z-axis intensity modulation: DC to 2MHz bandwidth; 30VDC + peak AC max. input voltage
 - Vertical deflection factor: 2mV/div to 5V/div
 - Horizontal time base A/B deflection: 5ns/div to 0.5s/div in 22 calibrated steps
 - Input coupling: AC, GND, DC
 - Rise time: 3.5ns or less • Weight: 17.6 lbs.
- Includes: Two X1/X10 100MHz probes, power cord, and operations manual



EZ DIGITAL

Part No.	Product No.	1	5
190932CL	OS5100RB	\$1,199.95	\$1,139.95

See the yellow and green highlighted items. Sale details are on page 2.

Jameco Special Values!

Pomona® 100MHz Probe Set

- Complete accessory kit included
- Attenuation: x1/x10
- Bandwidth: 15/100MHz (-3dB)
- Risetime: 23.33/3.5ns
- Input resistance: 1/10MΩ
- Capacitance: 64/10.5pF
- Compensation range: 10–60pF
- 48" cable



Part No.	Product No.	Description	1	10
156451CL	4550B	Probe kit	\$51.95	\$46.95

PROBE MASTER® Oscilloscope Probes

Designed for use with Tektronix and Hewlett Packard oscilloscopes.

- 3 position switch: x1, ref, x10
- Bandwidth @ 3dB: 10MHz (x1); 150MHz (x10)
- Loading: 57pF, 1MΩ (x1); 15pF, 10MΩ (x10)
- Low-resistance gold contacts
- Cord length: 5'



174473CL

Now Lower Prices



Part No.	Product No.	1	10
174473CL	4901-02 (150MHz)	\$49.95	\$43.95
212214CL	4915 (150MHz)	\$149.95	\$134.95
212257CL	4915A (250MHz)	\$159.95	\$149.95

Modular Oscilloscope Probes



- Hook and pointed probes
- 216047CL/236777CL: with IC test ground cover and spring ground contact • Length: 5'
- Alligator clip ground wire • BNC male connector
- Maximum input voltage: 600V

Part No.	Bandwidth (±3dB)		Impedance (R/C)*	
	Attenuation		Attenuation	
	x1	x10	x1	x10
22891CL	6MHz	60MHz	1MΩ/180pF	10MΩ/22pF
216047CL	6MHz	100MHz	1MΩ/47pF	10MΩ/16pF
236777CL	6MHz	250MHz	1MΩ/47pF	10MΩ/14pF

* with 20pF oscilloscope input

Part No.	Mir. Cross Ref. No.	1	10	50
22891CL	LF101E	\$24.95	\$22.46	\$20.21
216047CL	HF-9100	34.95	29.95	26.95
236777CL	HP-9250	45.95	43.39	37.25

Oscilloscope Guide Book

Prompt Publishing This book's full illustrations and diagrams bring oscilloscopes to life. Learn how to use them to conduct many tests and measurement techniques. This book answers questions about various types of oscilloscopes and how to obtain useful test results. (214 pages, 2001)



- Size: 7.5" x 9.2" • Weight: 0.9 lbs.

Part No.	Description	Price
185404CL	Oscilloscope Guide Book	\$29.95 \$27.49

120MHz Frequency Counter

- Frequency and period measurement
- Frequency range: 1Hz to 120MHz
- Gate time: 0.1s, 1s, 10s
- 8-digit LED display (0.3" digit height) with Hz, kHz, MHz, s, ms, us, ns, and overflow
- Input sensitivity: 15mVrms 10Hz - 10MHz; 50mVrms at 120MHz
- Selectable low pass filter
- Impedance: 1M Ω , 35pF
- Time base oscillation frequency/aging rate: 10MHz \pm 1 PPM per month
- Input voltage: 100/120/220/230VAC @ 50-60Hz
- Size: 9.1"W x 11.0"D x 3.7"H • Weight: 3.8 lbs.
- Two-year warranty



INSTEK

Now Lower Prices

Part No.	Product No.	1	5	
229243CL	GFC-8010H	\$249.95	\$224.95	\$213.75

1.5GHz Frequency Counters

2 Channels

- Input voltage: 115/230VAC @ 50-60Hz (switchable)
- Gate time: 0.01s, 0.1s, 1s, 10s
- 9-digit green LED display
- Size: 10.3"L x 10.0"W x 3.2"H
- One-year warranty

Now Lower Prices



201873CL

EZ DIGITAL

Includes: Fuse, manual and BNC cable

55790CL:

- Frequency range: 0.1Hz to 150MHz (A input); 50MHz to 1.5GHz (B input)
- Resolution: 0.1Hz to 10Hz (A input); 0.1Hz to 100kHz (B input)
- Frequency, period, totalize, RPM • Weight: 5.3 lbs.
- 201873CL: With Time Interval and Ratio
- Frequency range: 0.1Hz to 150MHz (A/B input); 50MHz to 1.5GHz (C input)
- Resolution: 1Hz to 10Hz
- Sensitivity: 20Vrms (A, B input); 30Vrms (C input)
- Impedance: 1M Ω , < 40pF (A, B inputs), 50 Ω (C input)
- Totalize, period & RPM function • Weight: 6.0 lbs.

Part No.	Product No.	1	5	
55790CL	FC-7150	\$299.95	\$284.95	\$259.95
201873CL	FC-7150U	329.95	329.95	313.49

2MHz Sweep Function Generator with Frequency Counter

- Frequency range: 0.02Hz-2MHz in 7 ranges
- Sweep width: 1:1 to 100:1; rate: 20ms to 25s (.5Hz-50Hz)
- Output impedance: 50 Ω \pm 5%
- Frequency counter range: 0.2Hz to 50MHz
- Maximum input voltage: 150Vrms @ 1kHz
- Input voltage: 115/230VAC @ 50-60Hz (switchable)
- Size: 10.3"L x 10.0"W x 3.2"H
- Weight: 5.8 lbs. • One-year warranty



EZ DIGITAL

Includes: Probe and detachable power cord

Part No.	Product No.	1	5	
94676CL	FG7002C	\$329.95	\$296.95	

2.4GHz Programmable Universal Counter with RS-232 Interface

- Measures frequency, period, duty cycle, RPM, frequency ratio, difference frequency, time interval, and totalize
- Frequency ranges: 2.4GHz (Ch C); 120MHz (Ch A & B)
- Resolution: .00001Hz (Ch A/B); 100Hz (Ch C)
- Plots trend graph on LCD display
- Compare, relative error, and min./max. functions
- 8 set-up screens can be saved and retrieved from memory
- Gate times: 50ms to 10s (20 settings)
- Display: 128 x 64 pixel super twist LCD
- RPM measurement range: 0 to 600,000 RPM
- Duty cycle range: 0.01% to 99.99% with frequency range of 0 to 100kHz
- Channel A/B inputs: sensitivity of 25mV; input impedance of 1M Ω , 35pF capacitance; maximum input volts of 250V DC or AC peak
- Channel C input: sensitivity 25mVrms; input impedance of 50 Ω , and maximum input voltage of 5VDC or AC peak
- RS-232 interface with PC software for controlling, displaying data, and data logging
- Input voltage: 85-270VAC @ 48-66Hz
- Size: 11.6"W x 11.0"D x 3.3"H
- Weight: 4.4 lbs.



Protek

Includes: Manual, power cord, BNC cable, RS-232 and software (98/2000/ME/XP compatible)

Part No.	Product No.	1	5	
230560CL	C3100	\$428.95	\$399.95	\$379.95

Now Lower Prices

2MHz & 10MHz Sweep Function Generators w/ Frequency Counter

Function Generator

- Wave forms: sine, square, triangle, skewed, ramp, pulse & TTL level square
- Frequency: 2Hz to 2MHz in 7 ranges (192671CL); 1Hz to 10MHz (221911CL)
- Output amplitude: 2 to 20Vpp at open load; 1 to 10Vpp at 50 Ω load
- Output impedance: 50 Ω \pm 10%
- Offset variable range (max.): \pm 10VDC at open load
- Frequency sweep time: 20ms to 2s



METEX

Now Lower Prices

Frequency Counter

- Measuring range: channel A: 1Hz to 20MHz; channel B: 20MHz to 2.7GHz
- Input sensitivity: channel A: 20mVRMS sinewave or 100mVp-p; channel B: 40mVRMS for 20MHz to 1.3GHz; 70mVrms for 1.3GHz to 2.7GHz
- Maximum input voltage: channel A: 35Vp-p; channel B: 3Vp-p
- Input impedance: channel A, 1M Ω ; channel B, 50 Ω
- Data logging and graphic software
- Size: 11.0"L x 8.2"W x 3.7"H • Weight: 13.4 lbs.

Includes: Coax & power cable, manual, serial cable and software

Part No.	Description	1	5	
192671CL	2MHz/2.7GHz	\$319.95	\$303.95	
221911CL	10MHz/2.7GHz	\$439.95	417.95	396.99

Detailed specifications for Test Equipment - www.Jameco.com

2MHz Sweep Function Generator

- Waveforms: sine, square, triangle, pulse, ramp
- Frequency ranges: 0.02Hz - 2MHz in 7 ranges
- Tuning range: 100:1 on each range
- DC offset and voltage controlled frequency (VCF) inputs
- Amplitude: 2Vp-p - 20Vp-p open circuit
- Output impedance: 50 Ω \pm 5%
- Less than 2% sine wave distortion
- Variable symmetry: 1:1 to 4:1 • TTL sync output
- Linear sweep mode • 20ms to 2s variable sweep time
- Input voltage: 100/120/220/240VAC @ 48-66Hz
- Size: 8.8"W x 10.1"D x 3.3"H • Weight: 8.0 lbs.
- Two-year warranty



Protek

Part No.	Product No.	1	5
230594CL	B801	\$244.95	\$232.69

METEX 4-in-1 Universal System With Function Generator, Universal Counter, DC Power Supply & Digital Multimeter

- Function generator capable of generating seven forms of waves (sine, square, triangle, skewed sine, ramp, pulse, and TTL square wave) in seven frequency ranges from 0.2Hz to 2MHz
- Universal counter capable of measuring frequency ranges from 5Hz to 1.3GHz
- DC power supply capable of generating 5V @ 2A, 15V @ 1A fixed and 0 to 30V @ 0 to 2A variable
- Digital multimeter with ranges of: DC voltage (400mV to 100V), AC voltage (400mV to 750V), DC/AC current (40mA to 20A), resistance (400 Ω to 40M Ω), capacitance (4nF to 400 μ F) and forward resistance of a semiconductor junction in k Ω
- Size: 14.5"W x 14.0"D x 7.0"H • Weight: 37 lbs.
- One-year warranty



Save bench space & \$800!

Includes: Manual, cables and software

Part No.	Product No.	1	5
160864CL	MS9150	\$549.95	\$499.95

AC/DC Electrical Safety Tester

- 500VA AC output
- True RMS current readings
- ACW/DCW test: 0.1 - 5kV output voltage with \pm 3% accuracy
- Arc detection of 0.3 - 100mA on AC/DC
- Test time: 1 - 180 seconds or continual
- Voltage output adjustable during test period
- 3 ranges of adjustable current protection: over/under/none • Zero turn-on operating switch
- Automatic FAIL indicator of alarm lamp and buzzer
- 9-pin remote control for START, RESET
- Triple digital display output: 3 $\frac{1}{2}$ -digit LED display for voltage and current; 3-digit LED display for timer; 0.39" digit height • Two-year warranty
- Input voltage: 115/230VAC @ 50-60Hz
- Size: 13.0"W x 17.6"D x 5.9"H • Weight: 44.1 lbs.



INSTEK

Now Lower Prices

Part No.	Product No.	Description	1	5	
229374CL	GPT-815	Hi-pot tester	\$995.00	\$899.95	\$854.95

3MHz Sweep Function Generator with 150MHz Frequency Counter

- 6-digit green LED with 0.3" digit height
- Square, triangle, and sine waves; TTL and CMOS pulse outputs
- Frequency range: 0.3Hz to 3MHz in 7 ranges
- Impedance: 50Ω ±10%
- DC offset: <-5V to +5V (into 50Ω load)
- CMOS output level: 4Vpp ±1Vpp to 14.5Vpp ±0.5Vpp adjustable
- Manual sweep selector operation
- Internal/external frequency counter switch selector
- Frequency counter range: 0.3Hz to 3MHz internal; 5Hz to 150MHz external
- Frequency counter impedance: 1MΩ /150pF
- Signal polarity invert button
- Variable duty cycle
- Linear and logarithmic sweep
- Size: 9.6"W x 11.5"D x 3.6"H



Now Lower Prices

Part No.	Product No.	1	5	
222586CL	FG3C	\$498.95	\$473.95	\$452.89

2MHz Function Generator

- Frequency range: 0.02Hz to 2MHz
- Waveforms: sine, triangle, square, ramp, TTL pulse, skewed sine
- Variable waveform/duty cycle symmetry
- DC offset voltage from 0 to ±10V; can be superimposed to output waveform
- Output voltage: 20Vp-p (open circuit), 10Vp-p (into 50Ω)
- Input voltage: 110V/220V 50-60Hz
- Size: 10.0"L x 8.0"W x 3.0"H
- Weight: 5.4 lbs.
- One-year manufacturer's warranty



Includes: Cord, BNC to clip cable, fuse and manual

Part No.	Product No.	1	5	10
66069CL	FG8002	\$189.95	\$179.95	\$169.95

3MHz Function Generator

- Square, triangle, and sine waves; TTL and CMOS pulse outputs
- Frequency: 0.3Hz to 3MHz in 7 ranges
- Output impedance: 50Ω ±10%
- CMOS output level: 4Vpp, ±1Vpp to 14.5Vpp; ±0.5Vpp adjustable
- DC offset: <-5V to +5V into 50Ω load
- Variable controlled frequency input
- Variable DC offset control
- Signal polarity invert button
- Size: 9.6"W x 11.5"D x 3.7"H
- Duty cycle control
- Weight: 4.4 lbs.



Now Lower Prices

Part No.	Product No.	1	5
222594CL	FG2C	\$239.95	\$234.95

5MHz Function Generator

- Engineered for high reliability and user convenience.
- Waveforms: sine, square, triangle, and ramp
 - 0.5 to 5MHz
 - 100% DC offset
 - Variable duty cycle
 - Output impedance: 50Ω
 - Coarse and fine tuning
 - Size: 10.4"W x 11.7"D x 3.4"H
 - Weight: 6.2 lbs.
 - Two-year warranty



Now Lower Prices

Part No.	Prod. No.	Description	1	5
160469CL	BK4011A	0.5 to 5MHz	\$299.95	\$295.95

150kHz Sine/Square-Wave Audio Generator

Small and convenient, this audio generator can be used to test telco and audio equipment.

- 20Hz to 150kHz in 46 steps
- Low distortion R-C oscillator
- Variable output control
- Size: 5.9"L x 3.2"W x 0.8"H
- Output impedance: 600Ω
- One-year manufacturer's warranty



Part No.	Product No.	Wt. (lbs.)	1	10
166334CL	BK3001	0.7	\$78.95	\$75.99

Test Lead Kits **FLUKE**

214332CL: Wavetek Meterman Basic DMM Test Lead Kit

- One pair (red & black) of:
- Standard probe tips
 - Alligator clips
 - Spade lugs
 - Silicone lead wires, 48" long

214332CL



222471CL: Wavetek Meterman Deluxe DMM Test Lead Kit

- One pair (red & black) of:
- Silicone lead wires, 48" long
 - Standard probe tips
 - Alligator clips
 - Spade lugs
 - Spring loaded crimp tips
 - Red tip length extender

222471CL



222463CL: Fluke Deluxe Electronic Test Lead Kit

- One pair (red & black) of:
- One meter long test lead with a right-angle banana connector on one end
 - Insulated probe tip extender
 - Modular test probe with banana connector in handle
 - Modular hook-style clip test lead w/ banana connector
 - Modular pinch-style clip test lead with banana connector
 - Insulated alligator clip
 - Modular alligator clip with banana connector
 - Slide-on IC probe tip adapter and test lead couplers
 - Bare spade lug with banana connector

Now Lower Prices



222463CL



222455CL: Fluke Basic Electronic Test Lead Kit

- One pair (red & black) of:
- One meter long test lead with a right-angle banana connector on one end
 - Insulated probe tip extender
 - Insulated alligator clip

222455CL



222447CL: Fluke SureGrip Industrial Test Lead Kit

- Includes: One pair (red & black) of:
- AC220 insulated alligator clips: nickel plated jaws grip objects up to 3/8" (9.5mm); blunt tip grabs round screw heads
 - TP220 industrial test probes: sharp, 1/2" (12mm) stainless steel tip provides reliable contact; flexible finger barrier improves grip
 - TL222 industrial right angle test leads: 1.5 meter silicone insulated wire resists heat and cold; superior strain relief

222447CL

Part No.	Product No.	1	5	
214332CL	DL243C	\$34.49	\$31.95	\$30.39
222471CL	DL248C	54.65	51.89	
222463CL	TL81A	98.95	93.95	
222455CL	TL80A	\$38.95	\$36.95	\$35.19
222447CL	TL220	\$44.95	\$42.49	\$40.59

Don't worry about backorders.
Over 99% of our products are in stock!

2MHz & 3MHz Function Generators w/ Frequency Counter

Function Generator

- Wave forms: sine, triangle, square, TTL, and CMOS output; 229260CL has ramp
- Frequency ranges: 229251CL: 0.2Hz - 2MHz in 7 ranges; 229260CL: 0.3Hz - 3MHz in 7 ranges
- Output amplitude: >10Vp-p into 50Ω load
- Output impedance: 50Ω ±10%
- DC offset range: <-5V to +5V into 50Ω load
- Voltage controlled frequency function
- Variable DC offset control



229251CL



229260CL

Frequency Counter

- Input voltage: 115/230VAC @ 50-60Hz
- Weight: 4.4 lbs.
- Two-year warranty
- 229251CL:
 - 4-digit LCD display
 - Ranges: 0.2Hz to 2MHz internal only; with resolution of 0.1Hz to 1kHz
 - Size: 9.1"W x 11.0"D x 3.7"H
- 229260CL:
 - 6-digit LCD display
 - Ranges: INT/EXT switch, 0.3Hz to 3MHz internal and 5Hz to 150MHz external; resolution of 10nHz to 0.1Hz
 - Size: 9.9"W x 11.5"D x 3.6"H

Includes: Power cord, operations manual and leads

Part No.	Product No.	Description	1	5
229251CL	GFG-8020H	2MHz	\$259.95	\$246.95
229260CL	GFG-8216A	3MHz	299.95	284.95

Detailed specifications for Test Equipment - www.Jameco.com

Mini-Clip to Banana Test Cables

- Plunger-type action
- Available in black or red
- Positive connection that won't disconnect from components
- Banana plug connection on opposite end
- Length: 3.5' • 20 AWG insulated wire



21864CL

Part No.	Description	1	10	100
21856CL	Black test cable	\$3.95	\$3.55	\$2.99
21864CL	Red test cable	3.95	3.49	2.99

Pomona® Stackable Banana Test Lead Cables



159898CL 159901CL 159919CL

- 5000V @ 15A • 55°C max.
- 159898CL: Two 36" leads, mini clip w/ banana
- 45VAC @ 5A max.; beryllium copper contact and glass filled insulation
- 159901CL: Two 24" leads 159919CL: Two 36" leads

Part No.	Prod. No.	Description	1	10	25
159898CL	3782-36	Mini w/ banana	\$7.95	\$7.19	\$6.59
159901CL	B-24-02	Patch cord	9.95	8.95	7.95
159919CL	B-36-02	Patch cord	9.95	8.95	7.95

Banana-to-Banana Test Leads

- Stackable
- Color coded; 2 each red, yellow, blue, black, white • 9.8" long
- 10 per package
- 18 AWG wire



Part No.	Description	1	10	25
77841CL	Test leads	\$22.95	\$20.69	\$18.59

Double-Banana Plug to Alligator Clips Test Cable

- Red & black rubber boot
- 4' lead wire • Length: 3'



Part No.	Description	1	10	50	100
107422CL	Test cable	\$3.95	\$3.49	\$2.95	\$2.49

Alligator Clip Leads

- 24 AWG wire
- Color-coded, 15" long
- Insulated alligator clip on each end
- 10 per pkg. in assorted colors



Part No.	Description	1	10	100	1000
10444CL	Alligator leads	\$3.99	\$3.59	\$3.25	\$2.95

BNC to Alligator Clip Test Cable

Permits BNC assembly to be used as a test cable.

- Upper connection: two alligator clips – red 5.5" 22AWG wire; black 9" 22AWG wire
- Lower connection: 23" RG/58U cable with BNC connector



Part No.	Description	1	10	100	1000
11383CL	BNC cable	\$3.49	\$2.49	\$2.25	\$2.05

Pomona® Test Lead Holders

- 155985CL:
 - Max cable dia.: 0.450"
 - 11"L • Color: blue
- 155977CL:
 - Max cable dia.: 0.320"
 - 11"L • Color: black
- 155969CL:
 - Max cable dia.: 0.210"
 - 11"L • Color: orange



155985CL



155977CL

Part No.	Prod. No.	No. of Slots	1	10	25
155985CL	2708B	9	\$9.95	\$9.45	\$8.95
155977CL	4408	10	9.95	9.45	8.95
155969CL	1508	14	9.95	9.45	8.95

Insulated Alligator Clips

- Color-coded
- Insulated barrel
- Jaw opening .375"-0.5"
- Accepts standard banana connector
- Solder strap and pre-drilled hole for 6-32 self threading screw • Size: 2.3"L x 0.5"W



Includes: One red and one black clip

Part No.	Description	1	10	100	1000
70990CL	Alligator clips	\$0.39	\$0.36	\$0.33	\$0.30

1 1/16" Banana Plugs

- Set-screw connection
- Standard banana spring plug
- Additional 6-32 threaded hole for connection reliability
- .1875" lead opening
- Insulating sleeve is threaded to banana plug body
- Size: 1.6"L x 0.4"Dia.



Includes: One red and one black plug

Part No.	Description	1	10	100	1000
72194CL	Banana plugs	\$1.59	\$1.49	\$1.25	\$1.09

2 1/4" Banana Plugs

- Nine rib spring plug
- Will accept up to 0.1" dia. wire
- Set-screw connection
- Each plug equipped with hole for interconnection
- Size: 2.3"L x 0.3"W
- Insulating sleeve fits snugly over copper post



Includes: One red and one black connector

Part No.	Description	1	10	100
137525CL	Banana plugs	\$2.95	\$2.12	\$1.84

Pomona® Solderless Banana Plug Sets



159863CL

159855CL

159927CL

- Nickel-plated
- ABS insulation
- Color: 1 red and 1 black per set
- Set screws secure leads
- 5000VDC @ 15A • 50°C max.
- 159863CL: Solderless with safety collar & set screw
- 159855CL: Solderless with set screw
- 159927CL: Solderless double banana plug w/ wire guide

Part No.	Product No.	1	10	25
159863CL	1825-02 set	\$2.45	\$2.19	\$1.95
159855CL	1325-02 set	3.29	2.99	2.69
159927CL	MDP-02 set	4.49	4.05	3.65

Double Banana Plugs

- Dual gold-plated female banana plugs
- Stackable

125217CL



Part No.	Description	1	10	100
125209CL	Blk banana conn.	\$2.65	\$2.39	\$2.15
125217CL	Red banana conn.	\$2.39 1.99	1.79	1.61

1" Screw-Type Binding Posts

- For both wire and standard banana
- 0.16" hole for banana test leads
- Chassis mount with lock washer and nut
- Solder tab hole: 0.06" diameter
- Size: 1.0"L x 0.5"Dia.



Requires: 0.32" mounting hole

Includes: One red and one black insulated post

Part No.	Description	1	10	100	1000
71239CL	Binding posts (2)	\$0.99	\$0.85	\$0.69	\$0.59

1/4" Screw/Solder Binding Posts

- For both wire and standard banana
- 0.16" hole for banana test leads
- Solder post: 0.0625" diameter • Chassis mounting
- Size: 1.8"L x 0.5"Dia.



Includes: One red and one black insulated post

Part No.	Description	1	10	100	1000
77690CL	Binding posts (2)	\$1.09	\$0.95	\$0.79	\$0.69

Double Binding Posts – Dual Banana

- Red/Black design
- Screw-mount
- 0.72" between posts
- Size: 1.6"L x 1.4"W



Part No.	Description	1	10	100
125196CL	Screw mount bind post	\$3.95	\$3.45	\$3.19

Single Binding Post to BNC Male

- Binding post with captive thumb nut
- Accepts standard banana plugs
- Operating voltage: 500 VRMS
- Brass nickel plated



Part No.	Description	1	10	100
100600CL	Red binding post	\$1.35	\$1.07	\$0.85
100618CL	Black binding post	\$1.49 1.35	1.07	0.85

BNC to Double Binding Posts – Dual Banana

- Red/Black design

125233CL



Part No.	Description	1	10	100
125233CL	BNC-female	\$4.95	\$4.49	\$4.05
99354CL	BNC-male	4.95	4.49	4.05

BNC to Standard Double Banana Plugs

- Permits BNC cables to be used with equipment having banana jacks. Lower connection: BNC; upper connection: double banana plug on .750" centers. Cross holes .166" diameter in body provide side stack-up connections.



11439CL

125225CL

Part No.	Description	1	10	100
11439CL	BNC banana plug (F)	\$4.49	\$4.05	\$3.65
125225CL	BNC banana plug (M)	5.49	4.95	4.45

Protected Banana Style Multimeter Test Probes



- Threaded/pointed test tip
- 18 AWG wire
- 42" long
- Black and red
- 2 per package

Part No.	Description	1	10	25
77737CL	Protected probes	\$6.49	\$5.85	\$5.25

Standard Banana Style Multimeter Test Probes



- Black and red
- 18 AWG wire
- 42" long
- 2 per package

Part No.	Description	1	10	25
77745CL	Std. banana probes	\$7.69	\$6.95	\$6.25

PROBE MASTER® Probe Test Leads

- 23K gold tips
- Silicon wire
- 1000V rated
- Length: 3'3"
- Spring loaded micro tip



174625CL Includes:
10 plunger type tips

212222CL Includes: 10 pieces; screw-on alligator clips, spade lugs and spring hooks

Part No.	Description	1	10	25
174625CL	Micro tip test leads	\$24.95	\$22.50	\$19.95
212222CL	Softie test leads	\$24.95	\$22.50	\$19.95

PROBE MASTER® Probe Kits

- Rating: 1000V 10A
- Gold tips and contacts
- 212231CL:** Universal probe kit includes leads with shrouded right angle banana plug, probes, sprung hook probes, alligator clips and spade lugs



212249CL: Electronic deluxe probe kit includes same as P/N 212231, plus extender probes, minigator leads, .025" wire wrap leads, pico hooks and pincer hooks

Part No.	Description	1	10	25
212231CL	Universal probe kit	\$29.99	\$22.95	\$19.95
212249CL	Elect. deluxe probe kit	\$49.95	\$41.95	\$34.95

Pomona® Replacement Probe Test Lead Set

- Set of two PVC 48" insulated leads, probe to banana plug
- Fits all DMMs
- Right-angle multimeter connectors



Part No.	Product No.	1	10	25
155951CL	5519A	\$12.95	\$11.49	\$10.49

Breadboard-Pin to Breadboard-Pin Test Leads

- 4 each red, yellow, blue, black, white
- 5.9" long
- 20 AWG wire
- 20 per package



Part No.	Description	1	10	25
77825CL	Breadboard pin leads	\$12.95	\$11.69	\$10.49

Pomona® Basic Electronic DMM Test Lead Kit

Kit contains 2 each (black/red):

- Test probes with silicone insulated lead
- Slide-on extended tips & alligator clips
- Supplied in a reusable plastic case
- 48" leads
- Fits most equipment with banana jacks



Part No.	Product No.	1	10	25
155942CL	5672A	\$29.95	\$27.75	\$24.95

Universal Test Lead Kit

- Includes:** 3 ft. black/red cables, 4.5" black/red insulated test probes, 0.8" needle probes, spade terminals, 2 sets of 4 pieces each red/black insulated alligator clips and banana plug



Part No.	Description	1	10	100
168516CL	Universal kit	\$8.95	\$7.95	\$6.95

Micro Test Clip

- One piece per package



Part No.	Description	1	10	100	1000
153162CL	1.6" micro test clip	\$1.49	\$1.34	\$1.20	\$1.05

Mini Test Clips

- Two lengths

Includes: One black and one red hooked probe clip



Part No.	Description	1	10	100
114809CL	1.75" mini test clips	\$1.89	\$1.49	\$1.35
114817CL	3.5" mini test clips	1.75	1.55	1.39

Mini-Clip Test Leads

These spring loaded mini-clips hook easily to IC pins for testing.

- Set of five: red, blue, green, black and yellow
- 14"L; clips on both ends
- 26 AWG to 300V CSA/UL approved wire



Part No.	Description	1	10	100	1000
135298CL	Mini test leads	\$11.49	\$10.39	\$9.29	\$8.39

BNC Female Connector with 20AWG Lead Wires

Solder the 20AWG wires onto your protoboard, plug the BNC female connector on to your test equipment and you have an instant testing board for varied applications.

- BNC female connector
- 7" 20AWG lead wires



Part No.	Mfr. Cross Ref. No.	1	10	100
256831CL	CBB-069	\$4.59	\$4.39	\$4.19

Pomona® Minigrabber® Test Clip Patch Cord Kits

- One each of 10 colors: black, brown, red, orange, yellow, green, blue, violet, gray and white
- 24" leads; clips on both ends



Part No.	Prod. No.	Description	1	10
156494CL	5523	Patch cord (hook)	\$34.95	\$31.49
156507CL	5521	SMD cord (jaws)	\$4.75	\$3.99

BNC to Clip Test Cables



BNC connectors are designed for signal frequencies into the gigahertz range, making them ideal for communications, video & test equipment.

- Micro-clip or mini-clip
- Length: 39"

Part No.	Description	1	10	50	100
11421CL	Micro-clip RG174	\$3.99	\$3.19	\$2.89	\$2.59
11463CL	Mini-clip RG174	4.39	3.99	3.59	3.19

Pomona® BNC to Minigrabber® Test Clips

- RG 174/U, .100" O.D.
- Rating: 300 V^{max} max., +50°C (+122°F) max.
- Strain relief: PVC molded directly to connector
- Length: 36"



Part No.	Prod. No.	Description	1	10
176954CL	5187-K-36	Minigrabber	\$21.95	\$19.95

Pomona® BNC Male w/ Molded Strain Relief to Minigator® Test Clips

- RG 58C/U, .195" O.D.
- Rating: 45 V^{max} max., +50°C (+122°F) max.
- Jaws open to .187" max.
- Length: 36"



Part No.	Prod. No.	Description	1	10
176971CL	4532-C-36	BNC/Minigator	\$14.95	\$13.95

Pomona® BNC Cables

- RG58 C/U 50Ω cable
- BNC male connectors
- Molded strain relief
- Length: P/N 159871CL: 36" P/N 159880CL: 60"



Part No.	Product No.	1	10	25
159871CL	2249-C-36	\$15.95	\$14.39	\$12.95
159880CL	2249-C-60	\$15.95	\$14.39	\$12.95

Insulation-Piercing Test Clips with Banana Jack

Makes contact with insulated wires without cutting stripping. Pierces insulation on wires from 22 to 14 AWG.

Part No.	Description	1	10	25
217453CL	Piercing clips	\$29.95	\$27.95	\$26.95



Claw Clips and Alligator Clips



Jameco offers different types of clips for different applications. Claw clips with teeth on three sides of the jaw for a better grip, and screw terminal connections. Steel alligator clips with either solder/crimp connection or barrel/screw connection. • Prepackaged: order in increments of 2

Part No.	Description	Size	2	4	10
248920CL	Mini-alligator clip solder/crimp	1.2"L x 0.3"W	NEW \$0.28	\$0.25	\$0.23
248954CL	Red insulator for 248920CL	—	.18	.16	.14
248946CL	Black insulator for 248920CL	—	.18	.16	.14
256524CL	Alligator clip, barrel/screw	1.9"L x 0.2"W	.45	.38	.35
248938CL	Alligator clip, solder/crimp	1.6"L x 0.3"W	.52	.48	.42
248971CL	Red insulator for 248938CL/256524CL	—	.21	.19	.17
248962CL	Black insulator for 248938CL/256524CL	—	.21	.19	.17
248989CL	Claw clip 10A, screw terminal	2.1"L x 0.4"W	.45	.44	.40
249009CL	Claw clip 20A, screw terminal	2.5"L x 0.5"W	.55	.50	.45
248997CL	Claw clip 30A, screw terminal	2.8"L x 0.6"W	.69	.62	.55

Mini DC/AC 2000-Count Clamp Meter/Multimeter

- Bright 1/2" LCD display with DATA HOLD
- 0.5" digit height
- Compatible w/ P/N 162325CL, below
- Size: 7.1"L x 1.9"W x 1.4"H
- Weight: 0.9 lbs.
- One-year warranty



ACA*	20A 200A	+1.2% + 5d
DCA	200A	+1.2% + 5d
ACV*	500V	+1.0% + 2d
DCV	200V	+0.8% + 1d
Resistance	200kΩ	+1.2% + 1d
*Frequency Response	40-400Hz	
Zero Adjust	External knob for DCA	

Requires: 9V battery not included (P/N 151095CL, pg 154)

Includes: Test leads, manual and case

Part No.	Description	1	10
115756CL	Mini DC/AC clamp meter	\$119.95	\$107.95

17MHz Logic Probe

- Max input freq.: 17MHz
- Minimum pulse width: 30ns
- Input impedance: 1MΩ
- Pulse flash time: 500ms
- Audible tones for high and low
- Power supply protection: ±20V
- TTL threshold: Lo = 0.8V ±0.2V, Hi = 2.3V ±0.2V
- CMOS threshold: Lo = 30% VCC, Hi = 70% VCC
- Size: 7.7"L x 1.0"W x 0.6"H



Part No.	Description	1	10	25
149930CL	Logic probe	\$29.95	\$26.99	\$24.29

Logic Pulser

- Compatible with TTL, DTL and CMOS ICs
- 1MΩ sync input impedance
- "One shot" or continuous 5Hz train pulse
- Pulse repetition rate: 0.5pps/400pps
- Pulse width output at 100mA load: 10µs
- Pulse mode output current: 10mA
- Square wave current output: 5mA
- Size: 7.8"L x 1.0"W x 0.6"H



Now Lower Prices

Part No.	Description	1	10	25
24601CL	Logic pulser	\$18.95	\$17.06	\$15.35

5-Function 4000-Count Clamp Meter/Multimeter

- 4000-count display with bar graph
- Resolution: 0.1mV maximum
- DC/AC voltage range: 600V
- AC current range: 400A • Auto off
- Resistance range: 400Ω • Data hold
- Continuity test • One-year warranty
- 1.0" max conductor size • Autoranging
- Compatible with P/N 162325CL AC line separator, below
- Size: 11.4"L x 6.6"W x 2.1"D



Part No.	Model No.	1	10
192583CL	AC40A	\$74.95	\$72.39

15A AC Line Separator for AC Current Clamp Meters

- Max. overload: 250VAC@15A
- X1 and X10 clamp areas
- Convenient 0.1"Dia. meter tip test points for neutral/earth/line
- Socket compatible with US & European connectors
- Size: 6.0"L x 1.9"W x 1.4"T • One-year warranty



Part No.	Description	1	10	25
162325CL	3-prong US-type plug ..	\$10.95	\$9.95	\$8.95

50mV/50A Current Shunt

- Current ranges: 0 to 50A
- Accuracy: 0.8% ±0.2mV
- Output ratio: 1mV/1A
- Max. current: 100A • Size: 5.3"L x 1.2"W x 1.4"H



Part No.	Description	1	10	25
162309CL	Current shunt	\$24.95	\$22.49	\$19.95

PC Cable-Check™ Tester

Tests standard computer cables for open, shorted and cross-connected wires. PC Cable-Check™ also tests any combination of D-sub 9-pin, D-sub 15-pin, D-sub 25-pin, Centronics 36-pin printer, plus RJ11, and RJ45 telephone plugs. A separate section to check USB-A to USB-B cables, as well as a separate section to check female BNC to female BNC cables.



Part No.	Description	1	10
123916CL	PC cable-check™	\$169.95	\$152.95

RS-232 Mini-Tester with Status LEDs

Tests any RS-232 (DB25) interface and helps to identify equipment that has failed. Seven bicolor LEDs indicate the status of TD, RD, RTS, CTS, DSR, CD and DTR. LEDs indicate positive (red) and negative (green). No extra power is required. Connectors: male to female DB25.



Part No.	Description	1	10	100
26729CL	Mini-tester	\$11.95	\$10.76	\$9.68

Miniature RS-232 Breakout Box for Quick Design Changes

Design new interfaces or modify old ones quickly and easily. Completely self-contained. Connectors: male to female DB25.



Includes: 25 each 22 AWG wire jumpers and machine tool sockets

Part No.	Description	1	10	100
11181CL	Breakout box	\$8.95	\$7.95	\$6.95

RS-232 Loopback Tester

The tester acts as a data verifier by sending data back to the transmission device. Used for diagnostic testing of RS-232 circuits. 4 LEDs monitor lines 2 to 3, 4 to 5, 6 to 20, and 15 to 17. Connectors: male to female DB25.



Part No.	Description	1	10	100
22728CL	Loopback tester	\$6.95	\$5.95	\$4.45

RS-232 Line Status Tester

Identifies simple interface problems which you can repair yourself. Targets the status of lines 2, 3, 4, 5, 6, 8, 11, 19, and 20. Connectors: male to female DB25.



Part No.	Description	1	10	100
14285CL	Check line tester	\$8.95	\$8.09	\$7.25

RS-232 Signal Adapter/Splitter

- Metal connectors: DB25 female and male, and DB9 male
- Gold-plated contacts



Part No.	Description	1	10	100
105195CL	Tri-port serial adapter	\$7.95	\$6.95	\$5.95

Flexible Multilink RS-232 Tester & Breakout Box

Visually indicates the status of lines 2, 3, 4, 5, 6, 8, 20, and 22 on the DTE and DCE sides. Provides signal status at a glance.

Complete cable "breakout" & reconfiguration. Connectors: DB25 male & DB25 female.

- Cable length: 4' • Size: 3.5"L x 3.3"W x 1.0"H
- Includes: handy carrying case, 10 jumper wires and a device wiring chart

Part No.	Description	1	10	25
25945CL	Tester/breakout box	\$22.95	\$19.95	\$17.95

ExStik pH Waterproof Meters

This compact, portable pH meter provides a low-cost method for monitoring pH. Ideal for measuring chlorine in drinking water, cooling towers and waste water discharges. Waterproof design floats in water and protects the meter in wet environments. Flat surface electrodes also provide surface pH spot measurements.



- Simultaneous display of pH and temperature
- Measure pH from 0.00 to 14.00 with accuracy of ±0.01pH
- Automatic temperature compensation
- Measures temperature from 23°F to 194°F (-5°C to 90°C)
- Smart chip predicts pH electrode performance
- "CAL" indicator alerts user when to recalibrate
- Large 3½-digit display with bar graph
- Bar graph originates at neutral point (7.0pH)
- Tripak buffers: 6 each of 4, 7, 10 pH and 2 rinsing solutions
- Size: 6.8"L x 1.6"W x 1.4"T • Weight: 0.3 lbs.

Includes: Meter and electrode, protective sensor cap, sample cup, 4 LR44 button batteries, and neckstrap

Part No.	Description	1	5
218122CL	pH waterproof meter	\$79.95 \$74.03	\$67.30
218131CL	Tripak buffers for calibration ..	24.95	23.69
218165CL	Carrying pouch	18.95	17.95

Heavy Duty pH/mV Temperature Meter

This is an ideal meter for field measurement of pH, millivolts and temperature with laboratory-quality accuracy at a very attractive price.

- Dual display for pH or mV and temperature
- Degrees C/F switchable
- Easy 2-point slope and cal adjustments at pH4 and pH7
- Min./max., and average recall
- Super-large LCD with contrast adjust
- Manual and auto temperature compensation using temperature probe
- Auto shutoff and data hold
- Low battery indicator
- Size: 7.0"L x 2.9"W x 1.3"T
- Weight: 0.8 lbs.



Includes: Temp. probe, pH probe and carrying case

Part No.	Description	1	5
223861CL	Heavy duty temp. meter	\$268.95	\$255.49
218131CL	Tripak buffers for calibration ..	24.95	23.69
218149CL	Vinyl carrying case	9.95	9.49



Opening an account is easy!!

Call
1-800-831-4242
for details today.

Corporate Customers

Pro-Vane Thermo-Anemometer

Remote vane rotates freely to measure airflow and temperature. Ideal for checking performance of fans, blowers, exhaust hoods and HVAC applications.

- 2.83" remote vane wheel
- Data hold function
- Super large 0.7" LCD display
- Measures air velocity as ft/min, m/s, km/h, knots
- Utilizes Type K sensor for thermometer measurements in the range of 32°F to 140°F (0°C to 60°C) with accuracy of 1.5°F (0.8°C) with 0.1° resolution
- Durable housing case and sensor made of ABS plastic with 39" cable
- Size: 6.6"L x 3.2"W x 1.2"T • Weight: 0.8 lbs.



Includes: Sensor, hard vinyl carrying case, and 9V battery

Part No.	Description	1	5
218093CL	Thermo-anemometer	\$199.95 \$172.33	\$156.66

Mini Thermo-Anemometer



Foldable housing extends 9" for better reach



Waterproof, pocket size with air velocity, temperature and windchill, all in one. Ideal for checking blowers, fans, exhaust hoods and balancing AC/HT ducts.

- Measures temperature and windchill from 0°F to 122°F (-18°C to 50°C)
- Measures wind speed in ft/min, MPH, m/s, km/h, knots and Beaufort force
- Large dual display for air velocity and temperature
- Auto shut-off 20 minutes after last key is pressed
- Water resistant housing floats and drop tested to 6'

Includes: CR2032 lithium battery and lanyard

Part No.	Description	1	5
218085CL	Mini thermo-anemometer	\$89.95 \$79.28	\$72.07

2dB Sound Level Meter

Ideal instrument to measure OSHA compliance, equipment design, community sound ordinances and sound system installations.

- High & low measuring ranges: High: 75 to 130dB; Low: 35 to 90dB w/ 0.1dB res.
- A and C weighting
- Large: 0.5", 3½-digit display
- Meets ANSI and IEC 651 Type II standards
- Fast/slow response; max. hold with reset button
- Built in calibration check
- Utilizes a 0.49" condenser microphone
- Size: 9.5"L x 2.7"W x 1.0"T • Weight: 0.5 lbs.

Includes: Hard vinyl case and 9V battery

Part No.	Description	1	5
218114CL	Digital decibel sound meter	\$248.95 \$221.85	\$201.68



Electromagnetic Radiation Meter

Electromagnetic radiation is all around us, some of it good, some bad; but there's never been an easier, more portable device to detect and measure it until the ZAP Checker.

Now you can measure your microwave oven's emissions or take engineering measurements of HF, VHF, or UHF transmissions. ZAP Checker does it all. Its portability, multiple settings, ultra-high sensitivity and expanded bandwidth allows you to search out EMR whenever and wherever needed.

- 10MHz to 4.5GHz



Totally Unique

Part No.	Description	1	10
217808CL	ZAP checker	\$129.95	\$114.95

Laser and Contact Tachometer

This combination non-contact and contact laser tachometer is ideal for measuring the revolving speed of fans, motors, gears, pumps, conveyors, and elevators.

- Photo tachometer range: 10 to 99,999 RPM with accuracy of ±0.05% + 1 digit
- Contact tachometer range: 10 to 19,999 RPM with accuracy of ±0.05% + 1 digit
- Measures from up to 6.5 feet from the target for improved safety and accessibility
- Memory stores last, maximum and minimum readings
- Display characters reverse direction for measurement type selected
- Large 0.4" (5-digit) LCD display
- Weight: 0.7 lbs.

Includes: 4-AA batteries, tips and wheel for RPM or linear surface speed, reflective tape, & carrying case

Part No.	Description	1	5
218106CL	Laser contact tachometer ..	\$278.95 \$248.56	\$225.97



Digital Light Meter

- Measures in Lux and footcandle ranges
- Range: Lux - 0 - 50,000 Lux (3 ranges); footcandle - 0 - 5,000 Fc (3 ranges)
- Analog output connectors for external recording
- Separate light sensor for optimum location sampling
- 0.5" digit height
- Dimensions (sensor probe): 3.2"L x 2.2"W x 0.5"H
- Weight: 0.9 lbs. • One-year warranty

Part No.	Description	1	10
131764CL	Digital light meter	\$99.95	\$89.95



Find more products on the Jameco website.
www.Jameco.com

Temperature/Humidity Meter with Min/Max Memory

- Displays (%) relative humidity and temperature (°C/°F) simultaneously
- Min./Max. memory on both relative humidity and temperature with reset function
- Temperature range: 14°F to 140°F (-10°C to 60°C);
- Humidity range: 10% to 99%
- 1" high readout
- Size: 4.3"L x 3.9"W x 0.8"Thick



Includes: Built-in tilt stand, AAA battery, and wall mounting bracket

Part No.	Description	1	10	25
198045CL	Temp./humidity meter	\$38.95	\$34.95	\$32.95

Pocket IR Thermometer

The pocket IR thermometer measures the surface temperature of objects which are difficult to reach or unsafe to contact. It also measures hot spots in electrical panels and equipment. In-process temperature measurements. With a 6:1 ratio field of view and built-in laser for improved aim, it covers 90% of surface applications for temperature measurement.

- Temperature range: -58°F to 518°F
- Built-in laser pointer to improve aim
- °F/°C switchable
- Fixed emissivity (0.95) covers 90% of surface applications
- Visual overrange indicator
- 6:1 field of view
- Pocket size meter
- Data hold and max hold
- Size: 3.8"L x 2.0"W x 0.9"D

Includes: 2 AA batteries



Part No.	Description	Price
219361CL	Pocket IR thermometer	\$59.99

Rapitest Moisture Test Meter

This efficient and cost-effective meter lets you ferret out potential water damage, and check water moisture on surfaces. Dual scales (relative and percentage moisture) provide quick readings on a clear analog display. A 3-foot coiled cable makes it easy to get the contact probes into hard-to-reach places. Locate leaks, detect potential mildew problems and eliminate wetness with this versatile handheld tool.



- Size: 4.6"L x 2.8"W x 1.7"Thick

Part No.	Description	Price
239361CL	Temperature/humidity meter	\$34.99

Wireless Weather Station

This indoor/outdoor wireless thermometer features a graphical weather forecaster, lighted alarm clock, day/date calendar, and audible temperature alarm. It's even a pool and pond thermometer. The outdoor sensor transmits up to 100' through walls. Slide the sensor out of its bracket, plug in the 10' waterproof probe, and check the temperature of your pool or pond. A flashing storm alert warns of severe weather ahead. Programmable audible high/low temperature alerts to help prevent potential catastrophes. Readings displayed in °C or °F. Base uses 2 AA batteries (included). Remote uses 2 AAA batteries (included).



Part No.	Description	Price
227117CL	Wireless weather station	\$49.95

Water Resistant Multi-Function Sports Timer/Stop Watch

- Time calendar display: hours, minutes, seconds, month, date, and day of the week
- Stopwatch accuracy: 1/100 of a second during the first 30 minutes, 1 second after 24 hours
- Time display mode: 12/24 hour mode (selectable)
- Alarm and snooze function
- Size: 2.2"W x 2.7"H x 0.8"Thick

• Weight: 0.1 lbs.



Part No.	Description	Price
239652CL	Sports timer/stop watch	\$9.99

LCD Stopwatch with Alarm and Calendar

- Water resistant housing, complete with 39" neck strap and battery
- Large LCD display
- Accurately times a two-person competition
- Displays accumulated elapsed time and split-time measurements
- Timing capacity of 23 hours, 59 minutes, and 59 seconds
- 12/24 hour clock operation with settable hour chime, wake and snooze alarm
- Accurate to ±3 seconds/day
- Size: 2.3"W x 2.8"H x 0.5"Thick



Part No.	Description	1	10
154739CL	Stopwatch w/ alarm	\$17.95	\$16.95

Non-Contact Infrared Thermometer

Non-contact thermometer with laser pointer measures up to 500°F (260°C)

- Temperature range: -4°F to 500°F (-20°C to 260°C)
- Basic accuracy: ±3% of reading
- Built-in laser pointer identifies target area
- Field of view: 6:1 (6" distance measures 1" target)
- Backlighting illuminates display for taking measurements at night or in areas with low background light levels
- Automatic data hold when trigger released and auto power off
- Fixed 0.95 emissivity covers 90% of surface application
- Size: 6.7"L x 1.7"W x 1.6"D
- Weight: 0.3 lbs.

Includes: 9V battery



Part No.	Description	1	10
236451CL	Non-contact thermometer	\$79.95	\$74.95



See pages
153 - 155
for
Batteries.



Waterproof Thermometer



- 2.75" stainless steel stem
- Digital display of 0.1" resolution
- °C/°F switchable ranges -40°F to 392°F (-40°C to 200°C)
- Max./min. recall of high and low temperature
- HOLD and AUTO-OFF features
- Size: 5.9"L x 0.8"W x 0.7"T
- Weight: 0.1 lbs.



Waterproof housing allows thermometer to be completely submerged in water

Includes: LR44 button battery and protective cover

Part No.	Description	1	5
218077CL	Waterproof thermometer	\$18.95	\$17.95

See the yellow and green highlighted items throughout the catalog offering up to 54% savings.

Jameco Special Values!

Details on page 2.

300-Watt Solder Pot

Temperature Regulated between 420 - 450°C

- HI/LO switch selectable for temperature
- 2 conductor power cord: 5' 9" long
- Holds up to 1 bar of P/N 170464CL or 176057CL, below
- Input voltage: 110VAC @ 2.7A; 50-60Hz
- Size: (unit) 4.8"H x 5.5" Dia. (base)
- Size: (tub) 2.4"Dia. x 1.6"D
- Weight: 5.9 lbs. • One-year warranty



Part No.	Description	1	10	25
160303CL	300W solder pot ...	\$64.95	\$58.49	\$52.65

600-Watt Solder Pot

Temperature Adjustable

- 2-wire power cord (5'5")
- Temperature: 0°C to 500°C
- Self regulating temperature
- On-off power switch and LED indicator for heat
- Input voltage: 110VAC @ 5.5A
- Holds up to 3 bars of P/N 170464CL or 176057CL, below
- Size (unit): 6.8"L x 5.5"W x 2.8"H
- Size (tub): 3.9"L x 1.6"D • Weight: 7.4 lbs.



Now Lower Prices

Includes: Skimmer and removable dross tray

Part No.	Description	1	10
172275CL	600W solder pot	\$179.95	\$170.95

2000-Watt Solder Pot

- Thermostat control for setting temperature from 50°C to 300°C
- Holds up to 48 bars of P/N 170464CL or 176057CL, below
- Input voltage: 110VAC @ 18A 50-60Hz single phase
- 3 conductor pigtail power cord: 5' long
- Size (unit): 18.1"L X 11.5"W X 6.0"H
- Size (tub): 12.0"L X 8.0"W X 2.9"H
- Weight: 23.1 lbs. • One-year warranty



Part No.	Description	1	5
149876CL	2000 watt solder pot	\$399.95	\$359.95

Solder Bars

- Used for soldering pots
- Tin/lead: 60/40 & 63/37
- Size: 13"L x 0.9"Dia.



Part No.	Description	Wt. (lbs.)	1	10	25
176057CL	60/40	1.1	\$8.49	\$7.65	\$6.89
170464CL	63/37	1.8	6.95	6.60	6.25

Solder Spool Stand

- 12 pc. solder spool stand (some assembly required)
- Size: 3.6"W x 3.9"D x 4.3"H
- Shaft dia.: 0.6" • Weight: 1.6 lbs.



Part No.	Description	1	10	100
141760CL	Solder spool stand ...	\$8.95	\$7.95	\$6.95

Solder Spool and Iron Stand

- 4 pc. spool stand (some assembly required)
- Shaft diameter: 0.6"
- Size: 6"L x 3.5"W x 3.1"H
- Sponge size: 1.6"W x 2.4"L
- Weight: 2.0 lbs.



Part No.	Description	1	10	100
169551CL	Spool & iron stand	\$16.95	\$15.29	\$13.75

Fume Extractor and Filters

Absorbs noxious lead fumes using activated-carbon filter and a high-efficiency fan

- Operate continuously providing filtered air
- Air flow: 115 CFM
- Compact size allows use on work bench w/ minimum space
- 120VAC, 60Hz, 22 watt
- On/off power switch
- Aerodynamic hood design for effective removal of solder fumes
- Noise: 49dB fan • Fuse protected
- Static ground jack • One-year warranty
- Removable carbon-impregnated filter
- Black anodized aluminum case
- Size: 6.4"W x 4.6"D x 7.9"H • Weight: 4.6 lbs.



Includes: Detachable power cord

Part No.	Description	1	10	25
120150CL	Fume extractor	\$58.95	\$52.95	\$47.79
127183CL	Replace. filters (2/pk)	12.95	11.66	10.49

Combination 42-Watt Soldering Station and Fume Extractor

- Power consumption: 42W @ 650°F (soldering iron)
- Adjustable knob for temperature control: 500° to 800°F
- Stability @ idle: ±9°F
- Maximum air volume: 95/115CFM
- Electronic zero-voltage switching
- LED indicator for pilot light & lighted on-off switch
- Input voltage: 100-120VAC @ 60Hz
- Size: 6.4"W x 7.8"H x 4.7"D • Weight: 5.2 lbs.



Includes: Soldering iron, iron holder, sponge, carbon activated filter, power cord and manual

Part No.	Product No.	1	10
183169CL	456DLX	\$89.95	\$86.29

Electric & Manual Desolder Pumps

- Easily disassembled for cleaning
- Replacement tips available



- 19254CL: • UL listed
- One-hand operation
- Size: 10.5"L x 1.0"Dia.
- 19166CL: Size: 7.8"L x 0.8"Dia.

Part No.	Description	1	10
19254CL	Electric desolder pump	\$26.95	\$23.95
19166CL	Manual desolder pump	4.95	4.49
19262CL	1 tip for 19254CL	4.95	4.49
22091CL	2 tips for 19166CL	4.49	3.95

Vacuum Pen Tools



- ESD safe body
- Picks up components with weight of 1.1 lbs. or less
- 207239CL: 4 tips and cups
- 207247CL: Aluminum body; 6 tips and cups

Part No.	Description	1	10	25
207239CL	Handivac tool	\$19.99	\$17.99	\$16.19
207247CL	Pen vac tool	37.95	34.25	30.49

Protective Coiled Grounding Wrist Strap

- Comfortable, adjustable Velcro wrist strap
- The coiled cord has banana plug and alligator clips
- Extended cord: 9' long
- Color: black



Includes: 1 MΩ resistor for added safety

Part No.	Description	1	10	100
34551CL	Anti-static strap	\$6.49	\$5.85	\$5.29

Anti-Static Heel Strap

- Discharges static without restricting your mobility
- Ideal for anyone handling static sensitive devices
- Ground strap: 15.5"L



Part No.	Description	1	10	100
100327CL	Heel strap	\$5.49	\$4.99	\$4.55

Anti-Static Work Mats

Make your work environment safe from static discharge! These mats are made of attractive semi-conductive vinyl that provide adequate discharging, yet will not short leads or pins.



Part No.	Dimensions	Wt. (lbs.)	1	10	100
10575CL	11.3' x 22'	0.7	\$9.95	\$8.96	\$8.06
10583CL	19.5' x 23.5'	1.1	13.95	12.59	11.35
236540CL	23.5' x 27.5'	1.4	24.95	22.49	20.19

Conductive Anti-Static Foam and Bags

Don't get zapped!

Protect your investment with these inexpensive bags and ensure a safe work area with our conductive anti-static foam.

- For safe storage of static sensitive devices
- 13864CL: 24.0"L x 12.0"W x 0.25"H
- 78668CL: 4" x 6" anti-static bags
- 78650CL: 8" x 10" anti-static bags



Part No.	Description	1	5
13864CL	Anti-static foam	\$7.95	\$6.95
78668CL	4" x 6" anti-static bags16	.15
78650CL	8" x 10" anti-static bags79	.71

Anti-Static Plastic DIP IC Storage Tubes and Rubber Rail Stops

- 29516CL: Thin tube (rail) fits 8, 14, 16, 18, 20 and 22-pin integrated circuits. • Length: 23.75"
- 29524CL: Wide tube (rail) fits 24, 28, 32, 40 and 48-pin integrated circuits. • Length: 20"
- 29583CL: Rubber stops used to plug plastic rail ends



Part No.	Mfr. Cross Ref.	Description	1	10	100
29516CL	RIC20	Thin rail	\$.49	\$.44	\$.39
29524CL	RIC220	Wide rail39	.25	.15
29583CL	RRS	Rubber stop *	.07	.07	.06

60-Watt Analog Display Soldering Station

Maintains a steady temperature using a cartridge heating element, providing a longer life for the solid soldering tip.

- Electronic temperature control: 300°F to 850°F
- CMOS devices protected against voltage spikes
- Size: 4.3"W x 6.0"D x 3.4"H • Weight: 4.1 lbs.

Includes: One 1/16" tip (P/N 35115CL - opposite pg.)

- 236460CL: Replacement sponge
- 168401CL: SMD tweezer iron w/ .078" tip
- 168583CL: Tip .078" for 168401CL
- 168591CL: Tip .590" for 168401CL

Part No.	Product No.	1	10	25
236110CL	168-3C	\$89.95	\$79.95	\$72.95
236460CL	78-744615	2.99	2.69	2.49
168401CL	TWZ50ESD	79.95	71.95	64.95
168583CL	46-060102	11.95	10.79	9.69
168591CL	46-060115	12.95	11.69	10.49



Weller 40-Watt Soldering Station

- Lighted on/off switch
- Adjustable power from 5 watts to 40 watts
- 120V @ 60Hz
- Temperature is electronically controlled from 350°F to 850°F
- Size: 5.5"L x 4.5"W x 3.5"H • Weight: 1.9 lbs.

Includes: ST3 1/8" screwdriver tip, soldering station and manual

Part No.	Prod. No.	Description	1	10
146595CL	WLC100	Soldering station	\$48.95	\$44.09



Weller Soldering Tips Replacement Tips for WLC100, WP25 & WP23

Part No.	Prod. No.	Description	1	10
146608CL	ST1	Screwdriver tip 1/16"	\$5.95	\$5.35
146616CL	ST3	Screwdriver tip 1/8"	5.95	5.35
192145CL	ST6	Screwdriver tip .031"	5.25	4.75
146624CL	ST7	Conical tip 1/32"	5.95	4.95

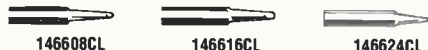

65-Watt Soldering Station with Micro Soldering Pencil



The micro soldering pencil has the shortest tip-to-grip distance on the market today, giving you excellent control by putting you closer to the work. The heating element is contained in the pencil rather than the tip so you do not throw away a good heater every time you wear out a tip.

- Fast heat-up and thermal recovery
- Tips are secured to the pencil by use of a threaded end, eliminating the use of a barrel nut
- Temperature is reduced to 300°F (150°C) when pencil is not used for 20 minutes. Unit is switched off after 60 minutes of inactivity
- ESD safe to protect sensitive components
- Voltage: 120V input; 24V output
- Temperature range: 150°F-850°F (66°C-454°C)
- Temperature accuracy: ±9°F (±5°C)
- Temperature stability: ±10°F (±6°C)

Includes: WSLPU power unit, WMP soldering pencil with NT1 tip, and WMPH iron stand

Part No.	Product No.	1	5
227408CL	WSL	\$255.95	\$237.95

Weller Soldering Tips Replacement Tips for WSL

Part No.	Prod. No.	Description	1	5
233576CL	NT1X	0.8mm bent round ..	\$8.89	\$8.45
233550CL	NTA	0.6mm chisel	7.59	7.25
233568CL	NTB	2.4mm chisel.....	7.59	7.25
233541CL	NT1	.25mm micro	7.59	7.25

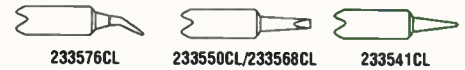

SMD Rework Station

Engineered to meet the demanding needs of today's electronic industry, technician service/repair centers, and assembly work. With this system, replacement of surface mount devices or dual-in-line components is a snap. It not only increases productivity in SMD assembly repair, but achieves a new standard of quality, superior performance, and ease of operation.

- High-performance, inexpensive, versatile
- Adjustable temperature: 250°C - 450°C (482°F - 842°F)
- Thermocouple sensor for stable temperature
- Long-life ceramic heating element
- Rapid heat-up and recovery
- 40W station, 25W ceramic element
- Size: 7.4"L x 5.0"W x 3.3"H • Weight: 2.6 lbs.

Includes: Base power unit, sponge, stand, surface mount tweezer iron, and stand for tweezers

Part No.	Description	1	10	25
224629CL	Rework station	\$89.95	\$80.99	\$72.85



42-Watt Controlled-Output Soldering Station



- Transformer powered soldering station complete with macro style, low voltage, temperature controlled soldering iron
- Closed loop method of controlling max. tip temperature for protection of temperature sensitive components
- Power unit housing features impact resistant plastic for durability
- Quick disconnect plug for soldering iron and lighted on/off switch
- Separate conductor grounds iron tip and terminates third pin of power cord
- 120VAC @ 60Hz input
- Uses PT series tips
- Size: 5.9"L x 4.5"W x 3.6"H • Weight: 4.0 lbs.

Includes: Soldering iron and PTA7 tip (below)

Part No.	Prod. No.	Description	1	10
170552CL	WTCPT	Solder station ...	\$129.95	\$124.95
192161CL	TC201T	Replac. iron	68.95	62.05
192170CL	PTA6	.062" screwdriver tip (600°F)	6.95	6.25
192188CL	PTA7	.062" screwdriver tip (700°F)	5.69	5.15
192196CL	PTA8	.062" screwdriver tip (800°F)	5.69	5.15

50-Watt Analog & Digital Display Soldering Stations

Innovative heater and sensor combination for quick heat-up and rapid temperature recovery

- Tip temperature offset capability allows user to reset temperature readings to match tip size and style
- Wireless temperature lockout
- Auto power-down after 90 minutes of inactivity
- Temperature range: 350°F to 850°F
- Temp. accuracy: ±9.0°F
- ESD safe
- Size: 5.9"L x 4.5"W x 3.6"H • Weight: 4.0 lbs.

Includes: PES51 50W soldering iron with ETA tip, PH50 stand and sponge, and adjustment tool

Part No.	Product No.	Description	1	10
217461CL	WES51	Analog	\$115.95	\$105.95
233533CL	WESD51	Digital	158.95	150.99



Weller Soldering Tips

Replacement Tips for WES51

- Tip leakage: less than 2mV
- Tip to ground resistance: less than 2Ω
- Tips also used with WCC100 station
- Additional tips can be special ordered

Part No.	Prod. No.	Description	1	10
16774CL	ETA	Screwdriver 1/16"	\$6.95	\$6.25
16782CL	ETJ	Long screwdriver 1/32"	6.95	6.25
16803CL	ETR	Narrow screwdriver 1/16"	6.95	6.25
16811CL	ETS	Long conical 1/64"	6.95	6.25

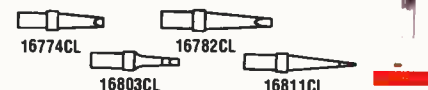

We'll match the print advertised price of any like product.

Jameco's Low-Price Guarantee

It's that simple!

45-Watt Analog Display Soldering Station

Grounded Soldering Tip

- 500°F to 850°F • Fully grounded
- Insulated ceramic heating element for rapid heat-up and heat recovery • Wt.: 2.5 lbs.
- Heater insulation exceeds 100MSΩ
- Zero voltage circuitry eliminating high voltage spike and magnetic field generation • Size: 7.0"L x 4.5"W x 3.5"H

Includes: Manual, soldering iron, stand and two sponges

Part No.	Product No.	Description	1	10	25
229673CL	XYT379-C	45-Watt soldering station	\$59.95	\$53.95	\$48.95
156814CL	XYB01	Sharp conical chisel 1/32" tip	4.95	4.49	3.95
156822CL	XYB04	Conical chisel 1/16" tip	4.95	4.49	3.95
134631CL	SP715	Replacement sponge	2.99	2.69	2.49



60-Watt Desoldering & Solder/Desoldering Stations



- Simple fine tune feature to select within 300–850°F range
- Vacuum pump activated "on demand" using finger tip switch on desolder handle
- CMOS devices protected against voltage spikes

125508CL:

- Size: 9.2"L x 7.2"W x 3.6"H
- Weight: 13.1 lbs.

Includes: XYD12 tip and solder holder

125516CL/223853CL: Size: 11"L x 10"W x 4.0"H; Wt.: 18.1 lbs.

Includes: XYD12 tip, solder holder, tip cleaner and tweezers

223853CL: Dual display of tip temperature with selector switch for °C or °F and read/set temperature

60-Watt Digital Display Soldering Stations

Designed for soldering situations where precise temperature is required for sensitive components.

- Temperature is maintained at ±6°F
- Electronic temperature control from 392° to 878°F
- External calibration port
- CMOS devices protected against voltage spikes
- Power-on and heater-on LED indicators
- Size: 5.1"W x 8.0"D x 4.0"H • Weight: 4.8 lbs.

Includes: One 1/16" tip (P/N 35115CL – below)

Part No.	Product No.	Description	1	10	25
236101CL	XY9-60D/ESD	Digital soldering station – ESD safe	\$109.95	\$99.95	\$89.95
168401CL	TWZ50ESD	SMD tweezer iron w/ 0.078" tip	79.95	71.95	64.95
168583CL	46-060102	Tip .078" for P/N 168401CL	11.95	10.79	9.69
168591CL	46-060115	Tip .590" for P/N 168401CL	12.95	11.69	10.49
236460CL	78-744615	Replacement sponge for both stations	2.99	2.69	2.49



Special 5% Bundle Savings
Complete ISO 9000 digital station – P/N 236101CL & 125508CL
Sold separately \$409.90
Combined: P/N 207263CL \$388.95

Part No.	Product No.	Description	1	10	25
125508CL	968	Desoldering station	\$299.95	\$269.99	\$242.99
125516CL	988	Solder/desoldering station	399.95	359.99	323.99
223853CL	988D	Solder/desoldering (dual display)	459.95	413.95	372.55
207271CL	TWZ60ESD	SMD tweezer iron with .078" tip	69.95	62.95	56.95
207221CL	D1A60A	Replacement desoldering iron	74.95	67.49	59.95
168583CL	46-060102	Tip .078" for P/N 207271CL	11.95	10.79	9.69
168591CL	46-060115	Tip .590" for P/N 207271CL	12.95	11.69	10.49
236460CL	78-744615	Replacement sponge for all stations	2.99	2.69	2.49

Replacement Sponges for Legacy Models					
Part No.	Product No.	For Station	1	10	100
134640CL	SP815	168-3C	\$2.99	\$2.55	\$1.95
134631CL	SP715	XY-60D, XY-379 & P/N 229673CL	2.99	2.69	2.49

For New Chemicals to Assist You in Your Soldering Projects see page 213.

Tips & Replacement Parts For XYTronic Soldering and Desoldering Products

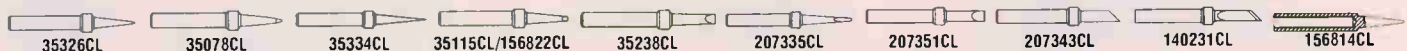

Part Number	Product Number	Description	For XYTronic Model Numbers (*Legacy Models)										Pricing					
			138ESD	200HX 169	200HX 200PHG	ALSD 373	XY960A DESD	960D	968	968	999300A	13425P	168-3C	2660	1	10	25	
35326CL	XY401	Soldering tip - conical bevel 1/32	✓	✓	✓	✓	✓	✓	✓	✓	✓	✓	✓	✓	✓	\$4.49	\$3.95	\$3.65
35078CL	XY402	Soldering tip - semi-chisel 1/32	✓	✓	✓	✓	✓	✓	✓	✓	✓	✓	✓	✓	✓	4.49	3.95	3.65
35334CL	XY403	Soldering tip - conical sharp 1/64	✓	✓	✓	✓	✓	✓	✓	✓	✓	✓	✓	✓	✓	4.49	3.95	3.65
35115CL	XY404	Soldering tip - conical chisel 1/16"	✓	✓	✓	✓	✓	✓	✓	✓	✓	✓	✓	✓	✓	4.49	3.95	3.65
35238CL	XY405	Soldering tip - semi-chisel wide 1/8"	✓	✓	✓	✓	✓	✓	✓	✓	✓	✓	✓	✓	✓	4.49	3.95	3.65
207335CL	XY406	Soldering tip - long conical chisel 3/64	✓	✓	✓	✓	✓	✓	✓	✓	✓	✓	✓	✓	✓	2.95	2.69	2.39
207351CL	XY410	Soldering tip - chisel 3/16"	✓	✓	✓	✓	✓	✓	✓	✓	✓	✓	✓	✓	✓	2.95	2.69	2.39
207343CL	XY411	Soldering tip - wedge 3/16"	✓	✓	✓	✓	✓	✓	✓	✓	✓	✓	✓	✓	✓	2.95	2.69	2.39
140231CL	XY430	Soldering tip - SMD flat pack 7/32"	✓	✓	✓	✓	✓	✓	✓	✓	✓	✓	✓	✓	✓	8.95	7.95	7.25
156814CL	XYB01	Soldering tip - sharp conical chisel 1/32	✓	✓	✓	✓	✓	✓	✓	✓	✓	✓	✓	✓	✓	4.95	4.49	3.95
207301CL	XYB02	Soldering tip - conical semi-sharp 1/32	✓	✓	✓	✓	✓	✓	✓	✓	✓	✓	✓	✓	✓	4.95	4.49	3.95
207327CL	XYB03	Soldering tip - conical sharp 1/64	✓	✓	✓	✓	✓	✓	✓	✓	✓	✓	✓	✓	✓	4.95	4.49	3.95
156822CL	XYB04	Soldering tip - conical chisel 1/16"	✓	✓	✓	✓	✓	✓	✓	✓	✓	✓	✓	✓	✓	4.95	4.49	3.95
207298CL	XYB05	Soldering tip - semi-wide chisel 1/8"	✓	✓	✓	✓	✓	✓	✓	✓	✓	✓	✓	✓	✓	4.95	4.49	3.95
207280CL	XYB06	Soldering tip - long conical chisel 3/64	✓	✓	✓	✓	✓	✓	✓	✓	✓	✓	✓	✓	✓	4.95	4.49	3.95
207319CL	XYB30	Soldering tip - wedge blade 3/16"	✓	✓	✓	✓	✓	✓	✓	✓	✓	✓	✓	✓	✓	2.95	2.69	2.39
35191CL	XY25	Soldering tip - conical sharp 1/64	✓	✓	✓	✓	✓	✓	✓	✓	✓	✓	✓	✓	✓	6.49	5.85	5.25
35297CL	XY37	Heating element - (nichrome)	✓	✓	✓	✓	✓	✓	✓	✓	✓	✓	✓	✓	✓	20.95	18.95	16.95
35318CL	XY48	Assembly - 60W w/ nichrome heater	✓	✓	✓	✓	✓	✓	✓	✓	✓	✓	✓	✓	✓	30.95	27.95	24.95
127634CL	XYD10	Desoldering tip - 1.0mm (.0394")	✓	✓	✓	✓	✓	✓	✓	✓	✓	✓	✓	✓	✓	8.95	7.95	7.25
127642CL	XYD12	Desoldering tip - 1.2mm (.0472")	✓	✓	✓	✓	✓	✓	✓	✓	✓	✓	✓	✓	✓	8.95	7.95	7.25
127651CL	XYD15	Desoldering tip - 1.5mm (.0586")	✓	✓	✓	✓	✓	✓	✓	✓	✓	✓	✓	✓	✓	8.95	7.95	7.25



16 to 30-Watt Variable Soldering Iron, Stand & Sponge

116572CL:
• Length: 7.5"

36329CL:
• Black anodized steel base - 5.3"L x 3.3"W
• See below for replacement sponge (P/N 134631CL)
• Fits most soldering irons .85" diameter

Includes: Sponge

Part No.	Description	1	10	100
116572CL	Soldering iron	\$16.95	\$15.29	\$13.75
36329CL	Soldering stand	4.95	4.46	4.01
134631CL	Sponge (for P/N 36329CL)	2.99	2.69	2.49

Weller® Light-Duty 23-Watt Soldering Iron & Kit

• Ideal for hobby or electronics kit work
• 1/8" removable tip
• Indicator light
• Length: 8"
• 120VAC @ 60Hz

191960CL: Includes iron, MT1 (cone shaped), MT2 (screwdriver), MT3 (chisel) 1/8" tips, lead free solder, soldering aid tool and stand • Weight: 2.0 lbs.

189384CL/191978CL/191986CL: 2 pack

Part No.	Description	1	10	25
152872CL	Iron only (SP23L) \$11.95	\$10.73	\$8.76	\$8.87
191960CL	Iron kit (SP23LK) \$17.19	15.95	15.49	14.75
189384CL	1/8" cone tip (MT1)	4.95	4.49	3.95
191978CL	1/8" scrdrv tip (MT2)	3.79	3.59	3.45
191986CL	1/8" chisel tip (MT3)	4.95	4.49	3.95

Thermally Balanced 25-Watt Soldering Iron

The XY200GX is a thermally balanced soldering iron for the professional or hobbyist.

• 120VAC; 6' cord • 25-watt power consumption
• Interchangeable tips (pg 209)
• One-year warranty • UL listed • Length: 8.0"

Includes: 1.6mm conical tip

Part No.	Description	1	10	25
129040CL	25W solder. iron	\$11.49	\$10.35	\$9.35

Weller® High-Quality 25-Watt & 35-Watt Soldering Irons

• Interchangeable heater elements
• Lightweight handle with cushioned grip
• Quick change knurled collar
• Length: 9"
• 120VAC @ 60Hz

Includes: Power cord & ST3 tip (pg 208)

Part No.	Product No.	Description	1	10
170587CL	WP25	25W solder iron	\$32.95	\$31.35
192102CL	WP35	35W solder iron	39.95	35.95
192153CL	PH25	Solder iron stand	16.19	15.35

Special! Low-Cost Irons

30-Watt Soldering Iron and Stand

• UL approved
• Ideal for precision work
• 1/4" removable tip
• Length: 8.3"
• 110-120VAC

Part No.	Description	1	10	100
102461CL	30W soldering iron	\$4.99	\$4.49	\$4.04
116020CL	Replacement tips (2)	2.25	1.79	1.25
36329CL	Soldering stand	4.95	4.46	4.01

35-Watt Soldering Iron

• UL approved
• Ideal for maintenance and hobby use
• 0.157" removable tip
• Length: 8.1"
• 110-120VAC

Part No.	Description	1	10	100
208987CL	35W soldering iron	\$2.99	\$2.69	\$2.45
208995CL	Replacement tips (2)	.99	.89	.79
209074CL	Solder roll, 8mm (.031")	5.49	4.89	3.95

Weller® 40-Watt Soldering Iron

• Develops 900°F (482°C) of heat
• MT10 1/4" (10mm) diameter replaceable nickel plated copper tip
• Stainless steel barrel
• Length: 8.25"
• 120VAC @ 50-60Hz
• Weight: 0.27 lbs.
• Heat & impact resistant handle • 7-year warranty

Part No.	Prod. No.	Description	1	10
170561CL	SP40L	40W solder iron	\$13.83	\$12.57
188980CL	MT10	1/4" chisel tip 2 pk	6.99	6.29

Economical, High-Performance Soldering Irons

High-quality soldering irons that are suitable for both professional and do-it-yourself applications.

• 25W, 40W, & 60W • Length: 9"
• 120VAC; 6' cord with 3-prong plug
Tips for 224611CL/224602CL:
226000CL chisel; **226018CL** conical
Tips for 195223CL:
226026CL chisel; **226034CL** conical

Part No.	Product No.	1	10	25
224611CL	200PHG-25W	\$7.95	\$7.15	\$6.45
224602CL	200PHG-40W	9.95	8.95	8.09
195223CL	200PHG-60W	13.95	12.49	12.11
226000CL	44-240517 tip	.95	.85	.79
226018CL	44-240513 tip	.95	.85	.79
226026CL	44-240617 tip	1.95	1.79	1.59
226034CL	44-240603 tip	1.95	1.79	1.59

Weller® 100-Watt Soldering Iron

• "Closed loop" method of controlling maximum tip temperature
• Nominal heat-up time with 700°F tip is 110 seconds
• 120VAC @ 60Hz input
• Length: 6" • Weight: 0.7 lbs.

Includes: CT6F7 (0.375" screwdriver tip; 700°F)

Part No.	Prod. No.	Description	1	5
192081CL	W100PG	Solder iron	\$62.95	\$59.79
192090CL	CT6F7	.375" scrdrv tip	8.59	7.75

SMD Tweezer Iron

• Maximum efficiency ceramic heating elements insures rapid heat-up and instant heat recovery
• Max. temp.: 760°F
• 120VAC
• Heater insulation exceeds 100MΩ
• Heater power consumption: 35W each

Includes: 0.095" tip

Part No.	Description	1	10	25
168410CL	Tweezer iron	\$59.95	\$53.95	\$48.95
168583CL	Tip .078"	11.95	10.79	9.69
168591CL	Tip .590"	12.95	11.69	10.49

WAHL® Cordless Soldering Iron

The #1 choice for field service soldering!

IsoTip® Power Pro Model #7904

• 900°F tip temperature
• Iron performance equivalent to 25-watt iron
• Solders 200+ joints or up to 30 minutes of continuous soldering
• LED indicator light
• Weight: 1.1 lbs.

Includes: Soldering iron, recharging stand, Ni-Cad battery pack, and tips

Part No.	Description	1	10
132783CL	Power Pro cordless iron	\$61.95	\$58.85

Weller® Cordless Soldering Iron Kit

• Self igniting and instant heat
• Adjustable temperature (25W to 125W)
• Auto switch off
• Visible gas level
• Additional tips can be special ordered
• 2 hours of heat on average tank setting

Includes: soldering tool, hot blower tip, hot knife tip, 2.4mm and 4.8mm double flat tip, cleaning sponge, storage case and instruction manual

Part No.	Prod. No.	Description	1	5
152207CL	PSI-100K	Tool kit	\$79.95	\$75.95

See the yellow and green highlighted items.

Jameco Special Values!

Sale details are on page 2.



Hot-Air Rework Station and Cordless Soldering Iron

Hot Air SMD Rework Station with Digital Display

The Hot-Air SMD 850D is engineered to meet the demanding needs of today's electronic industry, technicians, service/repair and assembly rework. The system not only increases productivity for SMD assembly and repair but also achieves a new standard of quality.

- Incorporates a US made pump – the largest in the industry
- Long life ceramic heater insures accurate and sufficient heat where you need it
- Adjustable air-flow
- Electronically controlled temperature system with digital readout in preset and actual temperature
- Automatic cooling mode protects the heating element
- Power supply: 100-120 or 220-240VAC
- Airflow capacity: 1.5L/min. – 28L/min.
- 310W nichrome heating element
- Hot air temperature range: 100°-385°C (212° – 725°F)
- Size: 7.4"W x 9.6"D x 5.0"H



- 25W diaphragm pump
- Weight: 10.8 lbs.



Includes: 5 pc. Precision non-magnetic tweezer set, 4 focus hood tips (single 2.5mm and 4.4mm pipes, P/N 262895CL and 262908CL)

Part No.	Product No.	Description	1	5
262705CL	850D	Hot air SMD rework station	\$395.00	\$375.25
262983CL	HG850D	Heat gun replacement	78.95	74.95
262924CL	A1141B	Focus hood tip, PLCC 11.5 x 14	34.95	33.25
262810CL	A1135B	Focus hood tip, PLCC 17.5 x 17.5	34.95	33.25
262959CL	A1136B	Focus hood tip, PLCC 20 x 20	49.95	48.29
262836CL	A1137B	Focus hood tip, PLCC 30 x 30	49.95	48.29
262967CL	A1138B	Focus hood tip, PLCC 30 x 30	49.95	48.29
262895CL	A1125B	Focus hood tip, QFP 10 x 10	34.95	33.25
262908CL	A1126B	Focus hood tip, QFP 14 x 14	34.95	33.25
262772CL	A1128B	Focus hood tip, QFP 14 x 20	34.95	33.25
262916CL	A1127B	Focus hood tip, QFP 17.5 x 17.5	34.95	33.25
262852CL	A1261B	Focus hood tip, QFP 20 x 20	49.95	48.29
262844CL	A1182B	Focus hood tip, BQFP 24 x 24	49.95	48.29
262801CL	A1129B	Focus hood tip, QFP 28 x 28	49.95	48.29
262861CL	A1263B	Focus hood tip, QFP 28 x 40	79.95	75.95
262887CL	A1265B	Focus hood tip, QFP 32 x 32	79.95	75.95
262879CL	A1264B	Focus hood tip, QFP 40 x 40	79.95	75.95
262932CL	A1258B	Focus hood tip, SOP 7.6 x 12.7	34.95	33.25
262941CL	A1260B	Focus hood tip, SOP 8.6 x 18	34.95	33.25
262975CL	A1259B	Focus hood tip, SOP 13 x 28	49.95	48.29

Focus Hood Tips Dimensions: mm (in.)

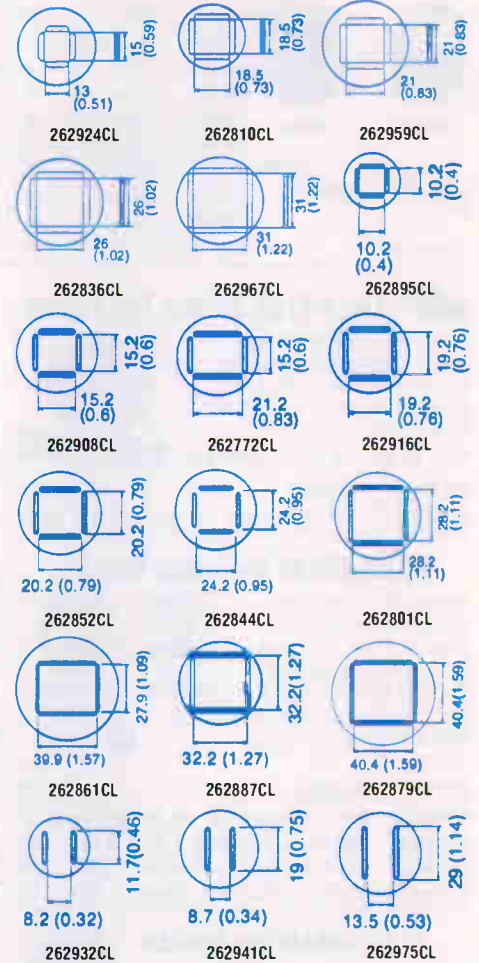

Soldering Tip

What is the correct way to solder?

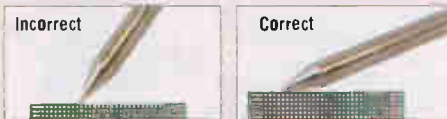

Follow these three steps:

Step 1: The connection to be soldered must be clean. A small file, sanding pen or steel brush can be used if needed. A good soldered connection also requires a good mechanical connection. Make sure that wires are firmly attached to terminals or each other before soldering.

Step 2: When using a new soldering tip, coat the tip with solder to prevent oxides from forming, then immediately brush off the excess with a soft cloth to form a smooth, silvery soldering surface. This process is referred to as "tinning".

Step 3: Apply tapered surface of the soldering iron tip to the connection (see picture above). Allow connection to become hot, then apply solder. Don't use the point to melt solder—let the connection melt it to avoid "cold" solder joints. When soldering delicate components, work quickly and use a heat sink to draw off damaging heat.

Butane-Powered Cordless Soldering Iron and Tips

This butane-powered soldering iron is designed for many popular cordless applications. Most common are automotive repair, aviation, electrical components, field repair, shrink tubing, television repair and more.

- Cordless, simple operation in the shop or field
- No electrical interference
- Automatic ignition
- Up to 200 minutes of operation in a full load
- Soldering temperature range: 240°F to 1000°F
- Torch temperature: 2400°F



Part No.	Product No.	Description	1	5
255265CL	PRO-120	Butane soldering iron	\$44.95	\$42.69
262107CL	S-30	Tip, deflector	1.19	1.09
255273CL	PS-1	Tip, 1/32" flat	8.99	8.75
255290CL	PS-2	Tip, 3/32" flat	8.99	8.75
255302CL	PS-3	Tip, 1/8" flat	8.99	8.75
255311CL	PS-4	Tip, 3/16" flat	8.99	8.75
255329CL	PS-5	Tip, 1/32" chisel	8.99	8.75
255337CL	PS-6	Tip, 3/32" chisel	8.99	8.75
255361CL	PS-9	Tip, hot blower	8.99	8.75
255370CL	PS-10	Tip, hot knife	8.99	8.75

30-Day Money-Back Guarantee

If you're not completely satisfied with your purchase, we'll take it back! Details on page 229.

Rosin Core Solder Rolls and Pocket Packs



Part No.	Mfr.	% Composition			Dia. (In.)	Wt. (lbs.)	Pricing			
		Tin	Lead	Silver			1	10	50	100
141778CL		60	40	0	.031	0.04	\$2.59	\$2.35	\$1.99	\$1.85
32117CL	Kester	60	40	0	.031	1.00	13.19	11.89	10.69	9.59
73576CL	Kester (pak)	62	36	2	.020	0.10	1.75	1.49	1.31	1.15
112344CL	Kester	63	37	0	.020	1.10	17.95	16.19	14.55	13.09
151474CL	Kester*	63	37	0	.031	1.00	14.95	13.49	12.15	10.95
170456CL	Golden	60	40	0	.031	0.06	1.39	1.25	1.05	.74
141794CL	Super	60	40	0	.031	0.55	5.95	5.39	4.85	4.35
141786CL	Super	60	40	0	.031	1.10	7.95	6.95	6.25	5.59
141778CL	Super	60	40	0	.031	2.20	13.95	12.95	11.95	10.95

* Organic core

Lead-Free Solder Tip Tinner

Prevents oxide buildup and tin depletion on the tip. Increases tip life and heat transfer resulting in a better solder joint!

- 0.7 oz. tin with self adhesive pad



Part No.	Description	1	10	50
132986CL	Lead-free tip tinner	\$4.95	\$4.59	\$4.19

5' No-Clean Desolder Braids

Meets all of the most stringent soldering standards for worldwide application including: MIL-F-142560D Type R, NASA specification NHB5300.4, NPC200-4 and SP-5002. • Length: 5'



Part No.	Description	1	10	100
139951CL	.030"W desolder braid ..	\$2.25	\$1.95	\$1.75
124126CL	.060"W desolder braid	2.35	2.15	1.95
124118CL	.075"W desolder braid	2.39	2.15	1.95
263708CL	.098"W desolder braid	2.59	2.35	2.23

5' Desoldering Braids

- Easy-to-use, handy dispenser
- Braided copper with flux



Part No.	Description	1	10	100
41081CL	.079"W braid (5')	\$1.49	\$1.35	\$1.19
41099CL	.098"W braid (5')	1.55	1.29	1.15
153461CL	.120"W braid (5')	1.59	1.39	1.25

ProWick® Desoldering Braid

Pure Rosin

Finest oxygen-free and oil-free fine gauge wire, the 100% copper wick is then coated with flux, which cleans connections thoroughly during desoldering to insure maximum solderability.

- The thin coating of flux also provides dependable, long lasting protection from oxidation.
- 263581CL with bobbin



Part No.	Product No.	1	10	100
263695CL	1803-5F (0.075"W)	\$1.95	\$1.77	\$1.68
263599CL	1804-5F (0.098"W)	2.09	1.89	1.79
263581CL	1811-5F (0.098"W)	2.39	2.19	2.09

Desoldering Wick

No more burnt fingers

- Handy dispenser
- Length: 5'
- Pure copper braid
- No clean flux formula



Part No.	Description	1	10	25
175986CL	0.067"W braid	\$2.99	\$2.69	\$2.42

One-Shot Desoldering Gun

This low maintenance desoldering gun with self-contained vacuum pump is perfect for desoldering through-hole components.



- Power consumption: 60W
- Interchangeable standard tips
- Zero static tip, 3 wire grounded
- Sensitive where CMOS protection is needed
- Quick release stainless solder collector
- Electronic temperature control
- Ergonomic, lightweight design
- 120VAC • One-year warranty
- Gun casing size: 7.0"L x 4.0"W
- Weight: 2.2 lbs.

Includes: 1.0mm tip

Part No.	Description	1	10	25
129066CL	Desolder gun	\$99.95	\$89.95	\$79.95
140214CL	"Y" replacement tip	10.95	9.95	8.95
134594CL	1.0mm replace. tip	8.95	7.95	7.19
134607CL	1.2mm replace. tip	8.95	7.95	7.19

Clip-On Heat Sink

- Absorbs and dissipates heat during soldering and desoldering sensitive parts
- Size: 2.7"L x 0.7"W



Part No.	Mfr. Cross Ref. No.	1	10	25
159126CL	HT156	\$2.65	\$2.38	\$2.15

Heat Sink and 7-Piece Soldering Aid Kit



100378CL: Heat sink absorbs and dissipates heat during soldering & desoldering of sensitive parts
100503CL contains: Soldering wick, 3 pc. scraper set, acid brush, clip-on heat sink and empty squirt bottle

Part No.	Description	1	10	50
100378CL	Heat sink	\$4.95	\$4.05	\$3.59
100503CL	Soldering kit	4.95	4.05	3.79

Plastic Pump Bottle

- 6 oz. bottle
- ESD compliant
- Plastic bottle with dispenser cover



Part No.	Description	1	10	50
158131CL	Pump bottle	\$9.95	\$8.95	\$7.95

Soldering Tip Cleaner with Stand and Rosin Paste Flux

156777CL:

- For cleaning soldering iron tips without the use of water and sponge



- Metal wool for cleaning
- Rubberized base for stability

73584CL: Highly active non-corrosive and non-conductive flux with excellent wetting action

Part No.	Description	1	10	50
156777CL	Tip cleaner & stand	\$4.95	\$4.49	\$4.05
160004CL	Metal wool replacement	2.79	2.49	2.29
73584CL	Rosin paste flux (2 oz.)	1.99	1.89	1.79

PANA VISE Vacuum Base Vise

An exceptionally lightweight, portable vise that firmly attaches to any flat, smooth, non-porous surface. A single knob locks the head into position, while a second knob locks the arm at any angle you select. This vise will hold any item weighing up to 3 pounds.



- Head moves through three planes: 210° tilt, 360° turn and rotation
- Grooved jaws are excellent for holding small objects and are made of reinforced thermal alloy and opens up to 2.9"
- Fine/coarse adjustment knobs control jaw pressure
- Arm movement is 140°; positive indents control movement to prevent "flopping"
- Lever locks vacuum pad into place on any flat, smooth, non-porous surface
- Jaw size: 2"H x 1"W
- Overall height: 7.5"H
- Base diameter: 3.4"
- Weight: 0.8 lbs.

Part No.	Product No.	1	10
251791CL	209	\$32.49	\$30.99

PANA VISE Vacuum Vise

- Features the patented "split ball" that tilts, turns and rotates through three planes
- Nylon jaws open a full 2.25"
- Powerful suction pad for quick and easy set-up
- Size: 5.0"L x 4.0"W x 6.3"H
- Weight: 3.3 lbs. • One-year warranty



Part No.	Product No.	Description	1	10
27131CL	M381	Vacuum vise	\$55.95	\$53.25

PANA VISE PV Jr. Vise

- Jaw opening: 2.8"
- Jaw size: 1" wide x 2" long
- Jaw heat tolerance: 350°F
- Vertical/horizontal jaw grooves
- Fine/course adjusting knob
- The vise neck tilts, turns and rotates
- Vise height: 6.8"
- Base bolt is 4.3" and fits all PanaVise base mounts
- Weight: 1.4 lbs. • One-year warranty



Part No.	Description	1	10
134439CL	Jr. vise w/ mountable base ..	\$21.95	\$19.95

For additional tools
see pages 176 - 187.

Vacuum Vise

- Features the patented "split ball" that tilts, turns and rotates through three planes
- Nylon jaws open a full 2.25"
- Powerful suction pad for quick and easy set-up
- Size: 5.0"L x 4.0"W x 6.3"H
- Weight: 3.3 lbs. • One-year warranty



Part No.	Product No.	Description	1	5
262115CL	GV-300	Vacuum vise ..	\$47.19	\$44.85

Hobby Table Vise

Made of aluminum die cast construction, this is an ideal tool for the hobbyist.

- Jaw width: 2.4"
- Maximum opening: 2.0"
- Clamps to any surface up to 1" thick



Part No.	Description	1	5
262001CL	Hobby vise	\$6.75	\$6.35

Clamp Vise

- Lightweight, sturdy construction
- No tools needed - finger turn to tighten
- Ball cup allows vise to adjust to any angle
- Nylon jaws open 2" • Size: 10.0"L x 2.5"W



Part No.	Description	Wt. (lbs.)	1	10
127167CL	Clamp vise	2.1	\$10.95	\$7.95

PANAMISE Electronic Work Center

- Circuit board holder, standard base, tray base mount, solder station, sponges and wire holder included
- Size: 8.5"W x 7.8"H
- Weight: 5.3 lbs.
- One-year warranty



Part No.	Description	1	5	10
27060CL	Electronic center	\$74.95	\$71.25	\$66.95

Third Hand

- Frees hands for soldering
- Two adjustable arms with alligator clip jaws
- 2" diameter magnifying lens
- Quick and easy rotation
- Sturdy, heavy base
- Weight: P/N 26690CL: 0.7 lbs.; P/N 72864CL: 1.4 lbs.



Part No.	Description	1	10	50
26690CL	Third hand	\$5.95	\$5.35	\$4.79
72864CL	W/ soldering holder	7.95	7.19	6.49

DATAK Direct Etch PCB "Starter" Set

Includes: 4 blank circuit boards, dry concentrated ferric chloride etchant, instructions, 8 sheets of direct etch donuts, DIP, patterns, lines and 1/32" & 1/16" etch resist tape.



Part No.	Prod. No.	Description	Wt. (lbs.)	1	10
70412CL	ER1	PCB kit	0.7	\$11.95	\$10.95



Workshop Chemicals

- Safe on plastics
- EPA SNAP approved, no CFCs or HCFCs



Envi•Ro•Tech™ Duster

Removes microscopic contaminants, line, dust, metallic oxide, deposits, and other soils without the use of harmful solvents.

Part No.	Description	Wt. (lbs.)	1	12
139900CL	10 oz. aerosol w/ trigger*	0.8	\$1.05	\$7.25
263530CL	15 oz. aerosol w/ trigger*	8.23	7.49	

Envi•Ro•Tech™ Freezer

Rapidly evaporating liquid that can chill to -62°F.

Part No.	Description	Wt. (lbs.)	1	12
139934CL	10 oz. aerosol can*	0.8	\$8.99	\$7.99

ECOLINE Flux Remover

- Dissolves R, RMA, RA, SA & most no-clean fluxes

Part No.	Description	Wt. (lbs.)	1	12
118041CL	10 oz. Flux remover*	0.8	\$4.49	\$3.39

ECOLINE Contact Cleaner

- Ideal for switches, relays & other places on electrical connections
- Will not damage switch housings

Part No.	Description	Wt. (lbs.)	1	12
118033CL	10 oz. Contact cleaner*	0.9	\$8.95	\$7.95

TechClean® Wiper

This hydro-entangled cellulose/polyester wipe has high absorbency with extra-low particulate and chemical extractables.

Part No.	Description	1	12
263564CL	100 sheet/pk	\$15.59	\$14.25

Isopropyl Alcohol

99.8%+ pure, anhydrous isopropanol for all-purpose cleaning. Excellent for tape head cleaning, removal of fluxes, light oils, polar soils, and white mineral residue.

Part No.	Description	1	12
263572CL	1 pint bottle	\$7.35	\$6.69

* Shipped via UPS ground to continental U.S. only

DATAK Photo Etch™ Printed Circuit Kit

Generate your own 1:1 artwork. Then use the patented Fast Neg film process to make a photo negative and sensitize and expose a blank copper board. Finish by developing & etching. No camera or darkroom is required.



Part No.	Product No.	Wt. (lbs.)	1	10
16731CL	12-750*	4.6	\$39.95	\$36.95

DATAK Dry Concentrated Etchant

- Makes one pint of etch solution

Part No.	Prod. No.	Description	1	10	25
70201CL	ER3	Dry etchant	\$3.95	\$3.49	\$2.95

* Shipped via UPS ground to continental U.S. only

Fine-L-Kote™ Silicone Conformal Coating

A type SR silicone resin conformal coating that has excellent moisture and fungus resistance properties offers chemical resistance and is recommended for harsh environments. Contains Opti/Scan™ to allow for black light inspection.

Part No.	Description	1	12
263548CL	12 oz. aerosol can*	\$16.79	\$15.95

Fine-L-Kote™ Urethane Conformal Coating

As a urethane coating, this is highly resistant to most solvents, moisture, fungus, and molds. A clear, repairable coating, it is formulated with a black light indicator Opti/Scan, to provide checks for conformity in quality control.

Part No.	Description	1	12
263556CL	12 oz. aerosol can*	\$15.45	\$14.69

Flux Remover Pen

A unique combination of hydrocarbon solvents and alcohols makes it an excellent defluxer. This can also be used as an all-purpose cleaner for removal of light oils, silicones, waxes, greases, and similar contaminants.

Part No.	Product No.	1	12
263724CL	11.5 ml pen	\$6.19	\$5.61

Conductive Pen

Contains a fast-drying, silver-filled ink designed to quickly make highly conductive silver traces.

- Repairs traces
- Links components
- Makes smooth jumpers
- Shields components

Part No.	Description	1	12
263716CL	4.89 ml pen	\$12.69	\$12.05

Overcoat Green Pen

Designed to insulate printed circuit board traces and components against high voltage arcing, and provides protection from moisture. Configured for rework and repair where precision application is necessary.

- Protects conductive pen traces
- Repairs permanent solder mask

Part No.	Description	1	12
263732CL	5 ml pen	\$9.85	\$9.36

Acid Brush

- Used for application of reactive solvents

Part No.	Description	1	10	100	1000
153322CL	Metal handle, 6"	\$6.65	\$5.99	\$4.45	\$3.31

DATAK Pre-Sensitized Circuit Boards & Developer

- Pre-coated circuit board 156751CL
- Size: 3.0"L x 4.0"W x 1/16" T

Part No.	Description	1	10	25
156751CL	Single sided	\$4.95	\$4.49	\$3.95
156742CL	Double sided	6.49	5.85	5.25
156734CL	4 oz. Pos. developer*	6.95	5.95	4.95

* Shipped via UPS ground to continental U.S. only

3X, 3-Bulb Adjustable Magnifying Lamp

Adjustable rectangular 3-diopter lens allows independent movement of the lens for best lighting and viewing angles. Three 9-watt compact fluorescent bulbs located to the side and top of the lens provide superior lighting to your workspace or job at hand. The integral spring-balance arm reduces the chance of pinched hands from springs, and provides a sleek clean look.

- 47" long arm
- 2 on/off buttons
- Color: beige
- UL listed

Part No.	Description	1	10	25
217517CL	Adj. magnifying lamp	\$79.95	\$74.95	\$69.95

3X Rectangle Magnifying Lamp

3x diopter rectangular magnifying lens provides a large viewing angle and compact design. With its two 7-watt fluorescent lamps located to the side of the lens, it provides superior lighting for any job. Enclosed springs in the arms reduce the chance of pinched hands and make it easier to clean.

- 47" long arm
- Color: beige
- UL listed

Part No.	Description	1	10	25
217509CL	Magnifying lamp	\$49.95 \$30.75	\$49.00	\$45.00

Tweezers with 8X Magnifier

The perfect combination hand tool for professionals working with small objects. Magnifying glass stays in perfect focus with tweezer heads.

- Stainless steel construction
- Precision tip tweezers
- 1.2" diameter 8 diopter lens
- Length: 3.8"

Part No.	Description	1	5
217824CL	Tweezer magnifier	\$5.95	\$5.39

Wide View 2X Foldable Magnifier

This folding 2X magnifier is very popular among professionals needing a large-view magnifier plus the convenience of portability. Made of high-quality plastic, the frame is light with a precision glass lens. Easy-to-read scales in inches (scale of 1/16") and millimeters are etched on the base.

- Size (unfolded): 6.1"W x 5.3"D x 6.5"H

Part No.	Description	1	10
218296CL	Foldable magnifier	\$9.95	\$8.95

General Purpose Illuminated 3X Magnifier

- 75mm diameter lens
- Great for magnifying fine print
- Light requires 2 AA batteries, see below
- Size: 7.5"L x 3.75"Dia.

Part No.	Description	1	10	25
149542CL	Illuminated magnifier	\$3.95	\$3.56	\$3.20
151087CL	1.5V AA battery (req. 2)	.22	.21	.20

3X Magnifying Lamps

- 45" extension arm
- Supplied with 22-watt circuline tube
- New wire clip design permits easy installation
- Extra strong, all-metal mounting base with electrical outlet
- Metal bulb holder for extra protection
- Power requirement: 110VAC/60Hz
- 3X magnification
- Weight: 7.3 lbs.

Part No.	Description	1	10	25
100829CL	Black lamp	\$59.95	\$53.95	\$49.95
149981CL	White lamp	59.95	53.95	49.95

Standard Adjustable 3X Magnifying Lamp

- 4" Diameter lens
- Maneuverable 30" arm extension
- Lamp tilts or turns in any direction
- Uses 60W incandescent bulb (not included)
- 3X magnification
- Power requirement: 110VAC/60Hz
- Weight: 2.9 lbs.

Part No.	Description	1	10	25
22710CL	Magnifying lamp	\$26.49	\$25.19	\$23.89

Precision 5X Magnifying Lamp

The arm extends to 40", is adjustable to any direction or angle, and has a 5X magnifying glass with built-in light. This is the perfect tool to help identify small electronic components and magnify a printed circuit board to help solder electronic components.

- 5" diameter lens
- Weight: 7.1 lbs.
- Power requirement: 110VAC/60Hz

Includes: 22W circuline fluorescent bulb

Part No.	Description	1	10	25
197456CL	Magnifying lamp	\$109.95	\$98.95	\$88.95

3X Magnifier with Adjustable Stand

- Heavy duty steel base
- Size: 15"L (full stand) x 4"Dia. (base)

Part No.	Description	Wt. (lbs.)	1	10
148881CL	Magnifier	2.5	\$12.99 \$11.95	\$10.76

Flexible Neck Magnifier

Never squint again on small fine prints or have a hard time holding a magnifying glass at the same time holding two other tools with only two hands. Just simply clamp the magnifying lens on to a table or workbench and adjust the flexible gooseneck into position.

- 3.5" diameter & 3x diopter lens
- Arm length: 20"

Part No.	Description	Price
239548CL	Flexible neck magnifier	\$12.99

For Our Complete Selection of Tools
see pages 176 - 187.

Super Bright, Super Reliable LED Flashlights

The perfect tool for individuals who really depend upon a flashlight that always works. Containing space-age solid-state circuitry, batteries last 14 times longer than conventional flashlights and function continuously up to one month. Its super bright white LEDs will last at least 11 years.

- Waterproof, designed for all weather conditions
- Shockproof, withstands a drop from 4'
- Low cost per hour of operation
- Industrial grade switch, rated for 10,000 operations
- Rubber over-molding

215677CL: One month continuous operation using three "D" cell batteries (not included, P/N 215845CL, pg 153)

215685CL: 25-days continuous operation using three "C" cell batteries (not included)

215693CL: 14-days continuous operation using three "AA" cell batteries (not included, P/N 198707CL, pg 153)

262422CL: 210 hours of continuous operation using 3 "AAAA" batteries (included)

261972CL: Headtorch delivers 330 hours of continuous operation using 3 "AA" batteries (not included, use P/N 198707CL, pg 153)

Part No.	Prod. No.	LEDs	Length	1	10
215677CL	LW-4000	10	10.6"	\$59.95	\$53.95
215685CL	LW-3000	7	8.9"	\$49.95 44.95	42.29
215693CL	LW-2100	4	7.9"	\$34.95 32.95	30.39
262422CL	LW-TEC10001	—	—	21.80	20.55
261972CL	LW-HT	4	—	37.95	34.16

Digital Display Calipers

Metric or Inches

- Hardened stainless steel
 - Display: inches to 1/1000THS mm to 1/100THS
 - Resolution: 0.01mm (0.0005")
 - Instructions for making internal, external, depth and step measurements
 - Calipers measure to 6 inches/150mm
 - Weight: 0.8 lbs.
 - One-year warranty
- Includes: Fitted case and 1.5V silver oxide battery (replacement battery, P/N 140783CL, pg 154)

Part No.	Description	1	10	25
127482CL	Digital disp. calipers	\$64.95	\$58.46	\$52.61

We'll match the print advertised price of any like product.



Jameco's Low-Price Guarantee

It's that simple!

650nm Line and Dot Laser Diodes

143845CL/173243CL:

- Focus adjustable w/ locking set screw
- Wattage: 5mW
- Operating voltage: 3-5V
- Size: 3.3"L x 0.9"Dia.
- One-year warranty

Class IIIa Laser Product



143845CL: Line laser module

- Laser line width: 1mm
- Laser fan angle: 60°

173243CL: Cross hair laser diode module

- Laser fan angle: 60°
- Female 2.1mm power connector
- Size: 3.0"L x 0.9"D

143837CL: Module regulated power supply

- Output: 5VDC @ 100mA
- Short circuit protection
- Input voltage: 95-125VAC or 190-250VAC switchable
- Size: 2.0"W x 1.7"D x 9.2"H
- Weight: 0.6 lbs.

143853CL: Laser module mount

- Built to hold laser diode on target.
- X-Y tilt, θ movement
- Tightening screw for tilt adjustment



Part No.	Description	1	10
143845CL	Line laser diode module	\$114.95	\$103.95
143853CL	Laser diode module mount	49.95	39.95
173243CL	Cross hair laser diode mod.	89.95	80.95
143837CL	Regulated power supply	19.95	17.95

Line Laser Diode Level



- Skew is determined by built-in bubble
- Two magnets at the bottom of the unit for metal to magnet mounting
- Laser wavelength: 650nm
- Line laser model • Threaded mounting hole at the bottom of unit for tripod mounting
- Size: 5.4"L x 0.8"W x 1.4"H

Includes: Manual, 2 AAA batteries and plastic casing

Part No.	Mfr. Cross Ref.	1	5
169762CL	TI3284E	\$47.05	\$39.83

Green Laser Pointer



Even the sleepest audience will sit up and salute when you whip out a laser pointer that's green, not red...and so bright, you could be standing nearly half a mile away. Using a wavelength closely matched to the highest sensitivity of the human eye and built with cutting-edge crystal technology, this laser projects a green beam so powerful you can see it against a clear sky at night. You won't believe how bright it is.

Ultra-intense green beam is much brighter, goes much farther and is easier on the eyes than standard red lasers.

- Output wavelength: 532nm
- Output power: <5mW
- 90-day mfg. warranty

Includes: Metal gift box, clip and 2 AAA batteries

Part No.	Description	Price
223731CL	Green laser pointer	\$199.95

ALPEC Laser Pointer w/ Key Ring

- Range up to 150 yards
- 650nm red laser
- One-year warranty

Class IIIa Laser Product



Includes: 2 coin cell batteries

Part No.	Description	Size (L" x Dia.)"	1	10
153613CL	Laser pointer	2.1 x 0.5	\$16.95	\$14.95

Glass-Lens Red Laser Diode and Line Generator

133292CL: Laser Diode

This lens design uses 3-element glass to collect almost all the power from the laser diode resulting in a brighter spot than many typical laser applications.

- Operating voltage: 4.0-6.0VDC (recommend P/N 112070CL, pg 144)
- Maximum output: 4mW
- Beam size at 7m: oval - 5mm x 8mm
- Wavelength: 660nm
- Beam divergence: 0.2mrad
- Green LED indicator
- Module size: 2.0"L x 0.5"W

Class IIIa Laser Product



134148CL: 60° Line Generating Lens

- Adjustable focus range: 50 cm to ∞
- Back focal length: 1.5mm
- Focal length: 8.0mm
- Beam divergence: 2.0mrad
- Lens construction: 3E.3G (glass)
- Fan angle: 60°
- Length at 1 meter distance: 1.7 m



Part No.	Description	1	10	25
133292CL	Glass laser diode	\$44.95	\$39.95	\$35.95
134148CL	60° lens	12.95	11.49	9.95

Laser Light Show



Now Lower Prices

A Laser Light show in the palm of your hands. Push a switch for fascinating, ever-changing laser patterns. This state-of-the-art laser device provides hours of fun for kids from 10 to 70 years young. A great and fun way to teach students about lasers and mechanical

- Range: 30 yards free form/500 yards dot point
- Output wavelength: 650nm
- Output power: <5mW

Includes: 3 LR44 batteries and neck strap

Laser Diode Module

- Operates on 3VDC @ <5mW
- 670nm wavelength
- Beam diameter: 3.2mm
- Working distance: over 50 meters/yards (daylight), 200 meters/yards (dark)
- Size: 0.9"L x 0.3"Dia.
- One-year warranty

Class IIIa Laser Product



Part No.	Description	1	10	25
131203CL	Laser module, brass...	\$44.95	\$40.49	\$36.45

Laser Diode and Driver

182932CL: Laser Diode

- Optical output power: \leq 5mW maximum
- Operating current: 30mA
- Operating voltage: 2.6V maximum
- Lasting wavelength: 650nm typical
- 5.6mm packaging size
- Beam divergence of 11 degrees from center line maximum

Class IIIa Laser Product

182932CL



161736CL: Laser driver w/ regulator

- Input voltage: 2.6-6VDC
- Input current: 40mA

161736CL



Part No.	Description	1	10	25
182932CL	650nm laser diode ...	\$11.95	\$10.79	\$9.69
161736CL	Laser driver	7.95	6.95	6.25

ALPEC Laser Pointer Pens



- Range up to 500 yards
- 670nm red laser

Includes: 2 AAA batteries

Class IIIa Laser Products

Part No.	Description	Size (L" x Dia.)"	1	10
153605CL	Black pen	5.2 x 0.4	\$19.95	\$17.95
127749CL	Silver brass	5.4 x 0.4	21.95	19.95

Green Laser Pointer



Even the sleepest audience will sit up and salute when you whip out a laser pointer that's green, not red...and so bright, you could be standing nearly half a mile away. Using a wavelength closely matched to the highest sensitivity of the human eye and built with cutting-edge crystal technology, this laser projects a green beam so powerful you can see it against a clear sky at night. You won't believe how bright it is.

Ultra-intense green beam is much brighter, goes much farther and is easier on the eyes than standard red lasers.

- Output wavelength: 532nm
- Output power: <5mW
- 90-day mfg. warranty

Includes: Metal gift box, clip and 2 AAA batteries

Part No.	Description	Price
223731CL	Green laser pointer	\$199.95

Smart Pointer Presenter

The best presenters know to "keep it simple," and this pen-sized presentation pal is the essence of simplicity. It provides easy, wireless "forward/backward" control of your Power Point slides, and incorporates a laser pointer into its go-anywhere, pen-format design. Bluetooth technology means plug-and-play set-up and solid control from up to 45 feet away!

Part No.	Description	Price
256428CL	Smart pointer presenter	\$89.95

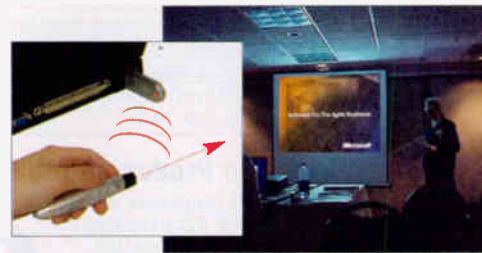

Control your electronic slides from up to 45 feet away!

Check our website at www.jameco.com for additional laser products.

Component Grab Bags

Color Code Legend
New Sale 9/7/2008 **Closeout**



135394CL - Electrolytic 135271CL - LEDs 169578CL - Photocells 18294CL - Toy Motors 149649CL - Fans 55968CL - Spacers 81701CL - Cabinet

* LB grab bag quantities are approximate • Opened grab bags are not returnable • Use our 20-drawer cabinet w/ labels to store your components, P/N 81701CL, pg 103

Shaded in green on this page you will find Jameco's nine most popular component Grab Bags. They are all individually bagged, and are combined to make up the Schwab's School Selection (P/N 163213CL) referenced towards the bottom of the page.

Capacitors

Part No.	Cross Ref. No.	Description	Wt. (lbs.)	1	10
17857CL	GB100	200 asst. ceramic disc capacitors	0.2	\$4.95	\$4.49
135355CL	GB100LB*	1 lb. (813 pcs) asst. ceramic disc caps.	1.0	12.95	11.49
17881CL	GB101	100 assorted mylar capacitors	0.3	5.95	5.35
135458CL	GB101LB*	1 lb. (440 pcs) asst. mylar capacitors	1.0	14.95	13.49
17911CL	GB102	100 assorted electrolytic capacitors radial, axial, snap	0.5	4.95	4.49
135394CL	GB102LB*	1.5 lb. assorted (300 pcs) electrolytic caps. radial, axial, snap (photo above)	1.5	12.95	11.49
17945CL	GB103	100 assorted tantalum capacitors (dipped epoxy and solid tubular)	0.1	9.95	8.95

Diodes, Transistors and Crystals/Oscillators

Part No.	Cross Ref. No.	Description	Wt. (lbs.)	1	10	25
17961CL	GB107	200 assorted diodes (zener, switching, silicon)	0.1	\$5.95	\$5.35	\$4.79
18171CL	GB127	100 assorted transistors (NPN, PNP, power)	0.1	5.95	5.35	4.79
114446CL	GB150	50 assorted crystals/oscillators	0.2	7.95	6.95	6.25

Trimmer and Single-Turn Potentiometers

Part No.	Cross Ref. No.	Description	Wt. (lbs.)	1	10
18075CL	GB113	100 asst. 1/10W to 1/8W trimmer pots (100Ω to 2MΩ values)	0.1	\$6.95	\$6.25
18278CL	GB174	100 assorted 1/4W & 1/2W single turn pots (100Ω to 5MΩ assorted values)	0.2	6.95	6.25
135407CL	GB174LB*	1 lb. (295 pcs) 1/4W & 1/2W single turn pots (100Ω to 5MΩ assorted values)	1.0	15.95	14.39

Integrated Circuits and Sockets

Part No.	Cross Ref. No.	Description	Wt. (lbs.)	1	10
17996CL	GB108	100 assorted 7400, 74LS00 series (74, 74C, 74F, 74S, 74ALS, 74HC, 74HCT)	0.2	\$6.95	\$6.25
135280CL	GB108LB*	1 lb. (400 pcs) asst. 7400, 74LS00 series (74, 74C, 74F, 74S, 74ALS, 74HC, 74HCT)	1.0	16.95	14.95
18024CL	GB109	100 asst. linear series (LM300, 500, 700, 7800, 7900 reg.) DIP, TO-3, TO-220	0.6	7.95	6.95
145242CL	GB109LB*	2 lb. (300 pcs) asst. linear series (LM300, 500, 700, 7800, 7900 reg.)	2.0	16.95	14.95
114964CL	GB171	100 asst. microprocessor series (micros, PALS, RAMs, PROMs, EPROMs)	0.7	7.95	6.95
105620CL	GB120	100 asst. IC sockets (DIP IC, PGA, TO-3)	0.3	5.95	5.35
135386CL	GB120LB*	1 lb. (260 pcs) assorted IC sockets (DIP IC, PGA, TO-3)	1.0	12.95	11.49

Surprise Computer Products Grab Bag

Various electronic components (capacitors, connectors, sockets, LEDs, resistors, diodes, ICs, transistors, pots, oscillators/resonators, inductors, crystals, switches), cables, power supply, transformer, fan, PC board, keyboard, misc. computer products.

• Weight is approximate

Part No.	Cross Ref. No.	Description	Wt. (lbs.)	1	10
18331CL	GB190	Component/computer grab bag	20-25	\$17.95	\$15.95



LEDs and Displays

Part No.	Cross Ref. No.	Description	Wt. (lbs.)	1	10	25
18041CL	GB110	100 assorted sizes & colored LEDs (T1/T1 ^{3/4} round and rectangular)	0.1	\$6.95	\$6.29	\$5.65
18323CL	GB186	500 asst. sizes #18041CL LEDs	0.3	19.95	17.95	15.95
135271CL	GB110LB*	1 lb. (1900 pcs) asst. #18041CL LEDs	1.0	44.95	40.95	38.95
18201CL	GB162	50 asst. sizes of colored displays (7-segment LED, modules, stick)	0.5	\$9.95 6.95	5.95	5.95

1/4W, 1/2W Resistors and Photocells

Part No.	Cross Ref. No.	Description	Wt. (lbs.)	1	10
18104CL	GB116	200 asst. 1/4W resistors (5/10%)	0.1	\$5.49	\$4.95
135351CL	GB116LB*	1 lb. (2000 pcs) asst. 1/4W resistors	1.0	14.95	13.49
18139CL	GB117	200 asst. 1/2W resistors (5/10%)	0.2	5.95	5.35
169578CL	GB125	100 asst. values photocells	0.2	12.95	11.49

Switches, Toy Motors and Fans

Part No.	Cross Ref. No.	Description	Wt. (lbs.)	1	10
18235CL	GB165	50 assorted switches (toggle, pushbutton, rocker, slide)	0.4	\$8.75	\$7.69
135378CL	GB165LB*	1 lb. (135 pcs) asst. #18235CL switches	1.0	18.95	16.95
18294CL	GB182	5 asst. toy DC motors (1.5-24V)	1.1	5.49	4.95
149649CL	GB193	5 asst. AC/DC fans (photo above)	4.5	8.75	7.69

Hardware Assortments

• 2-56 • 4-40 • 6-32 • 8-32 • Screws • Plastic • Nuts • Washers • Steel • Brass • Lock Washers • Aluminum

Part No.	Cross Ref. No.	Description	Wt. (lbs.)	1	10	25
171571CL	GB149*	1 lb. (500 pcs) asst. types of screws, nuts, washers & lock washers	1.0	\$5.95	\$5.35	\$4.79
171635CL	GB149LB*	3 lbs. (1400 pcs) asst. types; same as P/N 171571CL (above)	3.0	12.95	11.49	9.95

Spacers and Standoffs Assortments

• Round • Hex • Aluminum • Brass • Steel • Plastic • Nylon

Part No.	Cross Ref. No.	Description	Wt. (lbs.)	1	10	25
166481CL	GB440	100 asst. 4-40 spacers/standoffs	0.5	\$6.95	\$6.25	\$5.59
166490CL	GB632	100 asst. 6-32 spacers/standoffs	0.5	6.95	6.25	5.59
55968CL	GB140	100 asst. 4-40, 6-32, 8-32 round/hex, alum/brass/nylon spacers	0.3	7.95	6.95	6.25
135423CL	GB140LB*	1 lb. (310 pcs) same as P/N 55968CL	1.0	17.95	15.95	13.95

Schwab's School Selection

Jameco's nine most popular Grab Bags (highlighted on this page) are all individually bagged. North Dakota Engineer, Loren Schwab, recommended this selection of products as a standard item. He also recommended a 20-drawer component cabinet with labels (81701CL photo above) for storage. What's your suggestion?

Includes: Ceramic and electrolytic capacitors, diodes, transistors, potentiometers, switches, LEDs, 1/4W resistors, spacers and standoffs.

Part No.	Cross Ref. No.	Description	Wt. (lbs.)	1	10
163213CL	GB197	Schwab's School Selection	3.3	\$39.95	\$34.95
81701CL	CAB20	20-drawer component cabinet	4.7	15.95	13.95

Surprise Component Grab Bag

Axial and radial electrolytics, monolithic, dipped silver mica and mylar capacitors, connectors, sockets, thermistors, LEDs, resistor networks, diodes, ICs, standoffs, transistors, oscillator/resonators, inductors, crystals, resistors, pots and switches (1075 pcs).

Part No.	Cross Ref. No.	Description	Wt. (lbs.)	1	10	25
135263CL	GB191LB*	3 lbs. electronic components		\$17.95	\$15.95	\$13.95



High-Efficiency Robotic Servo

Excellent power-to-weight ratio for robotic projects.

- Supply voltage: 4.8-6 volts
- Torque: 49 oz.-in. @ 4.8V
- Speed: 16 seconds to 60°
- Can be operated by P/Ns 153648CL, 151001CL, pg 86 and 157059CL, see right
- Size: 0.8"W x 1.4"D x 1.6"H



Part No.	Description	1	10
157067CL	Robotic servo	\$19.95	\$17.95

Giant Robotic Ball-Bearing Servo

Extremely powerful!
Perfect for large robotic projects where power is a must.

- Power supply volt.: 4.8-6 volts
- Torque: 161 oz.-in.
- Speed: 19 seconds to 60°
- Can be operated by P/Ns 153648CL & 151001CL, pg 86 and 157059CL, see above right



Part No.	Description	1	10
166351CL	Giant robotic servo	\$49.95	\$44.95

Spider Couplers

- Used with motors
- 1 set screw/hub
- Hub OD: 0.625" Dia.
- Hub length: 0.56"
- Parts sold individually

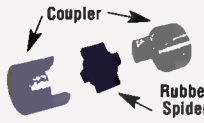

Part No.	Description	1	10	50
162288CL	125" (3.18 mm) hub	\$1.35	\$1.15	\$.86
161998CL	.197" (5.00 mm) hub	1.09	.89	.59
162270CL	.250" (6.35 mm) hub	1.35	1.19	1.09
162000CL	Rubber spider	1.29	1.15	1.05

Climax Spider Shaft Couplers

209285CL/106606CL:

- 1 set screw per hub
- Hub OD: 0.625" Dia.
- Hub length: 0.56"



138288CL:

- 2 set screws (10-32 x 1/8)
- Size: 0.75" L x 0.5" D



Part No.	Description	1	10	100
209285CL	.156" shaft hub	\$.85	\$.65	\$.39
106606CL	.250" shaft hub	.75	.59	.45
138288CL	.250" sleeve coupler	4.49	4.05	3.65

Spider Coupler Set

- Used with motors
- 1 set screw per hub
- Hub OD: 0.785"D
- Hub length: 0.743"L
- For 0.25" shaft diameter



Part No.	Description	1	10	100
211166CL	Spider coupler set	\$3.25	\$2.95	\$2.65

Gears and Shafts Kit

Bag of gears, shafts and accessories.
Great for science projects. All parts fit 2mm shaft motors.



Part No.	Description	1	10
215298CL	Gears and shafts kit	\$5.89	\$5.29

Radio Control System

- 75MHz band • 1/4 mile range
- 2-channel proportional operation
- HP-2RNB mini AM receiver
- 2 HS-303 standard servos
- Size: 7.5"L x 2.25"W x 2.25"H
- Weight: 1.5 lbs.



Requires: 8 AA batteries, pg 154

Part No.	Description	1	10
157059CL	Radio control system	\$89.95	\$79.95

Robot Drive Wheels

- Extremely high traction foam rubber compound
- 2 hubs with mounting hardware
- Size: 2.5"Dia. x 2.0"W



Part No.	Description	1	10
157227CL	Drive wheels (2 pc set)	\$27.95	\$24.95

Easy Roller Robot Wheel Kit

Designed to simplify mechanical mounting requirements for small robotic projects. This product replaces mechanical mounting systems with a dependable solid structure and provides an easy-to-implement method of engineering a skid-steering drive system.



- No load current: 111mA • No load speed: 200 RPM • Wheel size: 2.0"W x 2.5"Dia.

Part No.	Description	Operating Voltage Range	Torque	Gear Ratio	1	10
215571CL	Roller robot wheel kit	4.5-12VDC	3.6kg cm	30:1	\$52.95	\$48.98

26-Pitch Press Fit Gears and Gear Set

- Works with DC motors with 0.078" shaft diameter (use P/N 162392CL)
- Heavy-duty plastic construction
- Diametral pitch: 26
- Material: polyethylene resin

New Lower Prices

131801CL: 20-piece gear set includes 2 each of the following: T10, T20, T30, T40, T50 and 10 bushings

* Prepackaged: please order in increments of 10

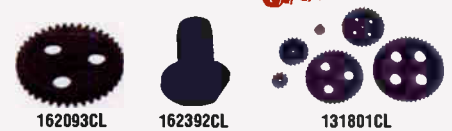

Part No.	Description	Bore Size	Pitch Dia.	Works w/ Shaft Dia.	Duter Gear Dia.	1	10	100
162069CL	10 teeth gear	0.149"	0.378"	0.156 (5/32)"	0.455"	\$.89	\$.69	\$.55
162077CL	20 teeth gear	0.149"	0.756"	0.156 (5/32)"	0.842"	.89	.69	.49
162085CL	30 teeth gear	0.149"	1.142"	0.156 (5/32)"	1.225"	.89	.69	.49
162093CL	40 teeth gear	0.149"	1.540"	0.156 (5/32)"	1.623"	.79	.55	.49
162106CL	50 teeth gear	0.149"	1.900"	0.156 (5/32)"	1.985"	.89	.69	.49
162392CL	Bushing	0.075"	—	0.078 (5/64)"	—	*	.24	.24

Part No.	Description	1	10	50
131801CL	Gear set - 20 pieces (see description above)	\$7.99	\$7.29	\$6.49

16-Pitch Sprocket Set and Chain

- Operates in high humidity and corrosive environments
- Chain links can easily be added or removed to adjust total length
- Chain tension load: 2.0 lbs.

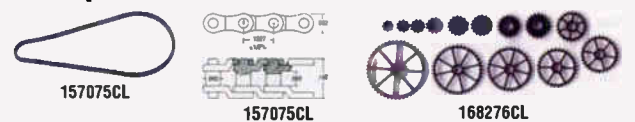

168276CL: 14-piece sprocket set includes 1 each of the following: 8, 9, 10 teeth at 1/8" bore size; 12, 15, 16, 18, 20, 24, 30, 32, 36, 40 and 48 teeth at 1/4" bore size

Part No.	Description	1	10	25
157075CL	Drive chain (12" long)	\$9.95	\$8.95	\$7.95
168276CL	Sprocket set - 14 pieces (see description above)	29.49	26.49	23.89

Hub and 48-Pitch Gear Set

- Low coefficient of friction requires little or no lubrication
- Residual stress removed by annealing process

168284CL: 12-piece gear set includes 1 each of the following: 10 teeth at 3/8" bore size; 14 and 16 teeth at 1/2" bore size; 20, 24, 30, 36, 44, 54, 66, 84 and 100 teeth at 3/4" bore size



Part No.	Description	1	10	25
157104CL	1/4" bore aluminum mounting hub w/ set screws	\$4.95	\$4.49	\$3.95
168284CL	Gear set - 12 pieces (see description above)	39.95	34.95	31.95

Selectable Gear Box Kit

Great 35-piece kit for learning about gear ratios or to add a gear box to your robot project. See-through case has gear ratios from 6.8:1 to 807.93:1.

- Difficulty level: intermediate



Part No.	Description	Dimensions	Price
145509CL	Selectable gear box kit with 3V motor	2.5"L x 1.1"W x 1.5"H	\$15.95

Distance, Light Kits and Muscle Wires

Color Code Legend
New Sale Qty. Save Closeout

velleman Parking Radar Kit ■ 55-piece kit

Parking in tight places can be difficult, but this unit can tell you when you have come within an adjustable preset distance of the object behind you.

- Detection range: 5cm - 1.5m; angle: 5°
- Transmitter frequency: 40kHz
- PCB size: base (4.9"L x 1.9"W) sensor (3.8"L x 1.1"W)

Requires: 10-15VDC @ 16mA max (recommend P/N 100095CL, pg 145) or auto power plug (recommend P/N 115001CL, pg 152)

Part No.	Product No.	1	10
129120CL	K3502	\$39.95	\$34.95



SALE

Ultrasonic Motion Detector Kit ■ 49-piece kit

Detect motion/movement 13 - 23 ft. away and trigger an alarm w/ this kit.

- 2 boards: one with matched pair of ultrasonic transducers to detect motion from 13 to 23 ft. away; 2nd board contains crystal controlled oscillator & all circuits
- Switchable latch, red LED indicator
- Solder pad output to drive external relay or circuits
- Size: main board: 2.8"L x 2.0"W x 0.8"H; transducer board: 2.8"L x 0.6"W x 0.9"H

Requires: 9V battery (recommend P/N 151095CL, pg 154)

Part No.	Description	1	10
125090CL	Ultrasonic alarm kit	\$29.95	\$26.95



Flex Sensor

- Maximum resistance: 30kΩ to 40kΩ, proportional to the degree of flexing or bending
- Nominal resistance: 10kΩ
- Applications: virtual reality data gloves, robotic, bio-metric, physics and engineering



Part No.	Description	1	10
150551CL	Flex sensor	\$12.95	\$11.65

MONDO-TRONICS Flexinol Muscle Wires®

These unique nickel-titanium alloy Muscle Wires® actually shorten in length when electrically powered, and can lift thousands of times their own weight. • Length: 1 meter

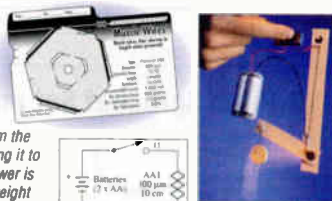

How it works... Pressing the switch lets power flow from the batteries through the Muscle Wire®, heating it and causing it to contract and raise the lever and lift the weight. When power is removed, the Muscle Wire® cools and relaxes, and the weight helps it return to its starting position.

141348CL: Muscle Wires® Book & Deluxe Kit

- Kit includes one each Flexinol 100, 150 and 250 Muscle Wires® (below) and Project Book
- 3 meters of wire

Includes: Crimps and instructions

Part No.	Description	Wire Dia. (microns)	Linear Resistance (ohm/m)	Typical Current (mA)	Deform Weight* (grams)	Recovery Weight* (grams)	Typical Rate**	Pricing	
								1	10
141321CL	100LT	100	150	180	28	150	33	\$15.95	\$14.49
141874CL	150LT	150	50	400	62	330	20	16.95	15.29
160055CL	375LT	375	8	2750	393	2000	4	19.95	17.95

* Multiply by 0.0098 to get force in Newtons ** Cycles per minute, in still air, at 20° Centigrade

Part No.	Description	1	10
141348CL	Muscle Wires® kit	\$50.95	\$52.95

Now Lower Prices

velleman Scrolling Message Kit ■ 76-piece kit

Create your own scrolling message with this 35-LED graphic display kit. Press "SET" to change a particular character, "UP" or "DOWN" arrow to select the character, and end your scrolling message with the "<" character.

- 35-LED display
- Maximum 16 characters
- Adjustable scrolling speed

Requires: 9 to 12VDC @ 20mA (recommend P/N 100845CL, pg 145)

Part No.	Product No.	Dimensions	Wt. (lbs.)	1	10
200310CL	MK124	3.5"L x 2.6"W x 1.8"H	0.2	\$24.95	\$22.45



velleman 3-Channel Light Organ Kit ■ 80-piece kit

Add a 3-channel dancing light display to your music. Each channel displays a different range of sound.

- Frequency ranges are adjustable
- Microphone input
- Maximum load 2A per channel
- Each output has individual sensitivity control

Part No.	Product No.	Dimensions	Wt. (lbs.)	1	10
131684CL	K8017	6.7"W x 5.6"D x 1.7"H	1.2	\$54.95	\$49.95



SALE

velleman Stroboscope Kit ▲ 19-piece kit

Make your own snapshots and "lightning" light effects. Flash frequency adjustable from 2 - 20Hz.

- Input: 110VAC

Part No.	Product No.	Dimensions	Wt. (lbs.)	1	10
117639CL	K5300	3.5"L x 2.6"W	0.5	\$18.95	\$16.95



velleman Flashing LED Sweetheart Kit ■ 46-piece kit

This kit shows a beating heart. Great for decorations!

- Power consumption: 8mA
- Requires: 8 to 15VDC wall transformer (P/N 100095CL, pg 145) or 9VDC battery (P/N 151095CL, pg 154)

Part No.	Product No.	Dimensions	Wt. (lbs.)	1	10
147555CL	MK101	2.5"L x 2.4"W x 1.2"H	0.1	\$11.95	\$10.95

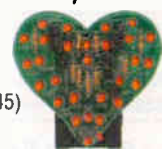

velleman Flashing LED Kit ■ 23-piece kit

Activates 2 flashing LEDs for applications such as model constructions. Adjustable flashing speed by potentiometers.

- 5.5" wire w/ 9V battery connector
- Minimum consumption: 4mA
- Requires: 9VDC battery (P/N 151095CL, pg 154)

Part No.	Product No.	Dimensions	Wt. (lbs.)	1	10
147580CL	MK102	1.3"L x 1.4"W x 0.6"H	0.1	\$7.95	\$7.19



Light Sensitive Relay Kit ■ 20-piece kit

Build a stable and advanced circuit that uses light to control a SPDT 10A relay.

- Dimensions: 2.4"L x 1.3"W x 1.0"H
- Requires: 12VDC power supply (recommend P/N 100095CL, pg 145)

Part No.	Description	Wt. (lbs.)	1	10
136223CL	Light relay kit	0.1	\$12.95	\$11.65



IR LED Illuminator Kit ● 41-piece kit

- Improve low-light camcorder and CCD camera images without visible light
- 36 high powered infrared LEDs
- At 24' the beam is approximately 3.5' across

Requires: 12-15VDC power supply (recommend P/N 114825CL, pg 146)

Part No.	Description	Dimensions	1	10
157964CL	IR illuminator kit	2" Dia.	\$16.95	\$15.29



Ideal for CCD Cameras

30-Day Money-Back Guarantee

If you're not satisfied we'll take it back!

Details on page 229.

OWI Robotic Arm Trainer Kit ▲ 109-piece kit

Five Axes of Motion

Teaches basic robotic sensing and locomotion principles while testing your motor skills as you build and control the arm. This unit can be commanded or instructed through its five-switch wired controller with lights to grab, release, lift, lower, rotate wrist, and pivot sideways. Five motors and joints allow flexibility.

- Max. length outwards: 14.2" • Max. height upwards: 20.1"
- Grip opens to 2" wide • Max. lifting capacity: 4.6 oz.
- Shoulder movement @ 120° • Elbow moving range @ 135°
- Wrist rotation clockwise or counter clockwise @ 340°
- Rotates left to right at the base @ 350° • Weight: 4.5 lbs.

Requires: 4 D batteries (not included)

Part No.	Description	1	10
157366CL	Robotic arm kit (unassembled)	\$74.95	\$67.49
159345CL	Robotic controller software (assembled)	84.95	76.49

Build It Yourself!



OWI Soccer Jr. Kit ● 242-piece kit

New and improved Soccer Jr. kit with the addition of a third motor used to catch and shoot the ball (included). This kit has 6 operational legs, a retrieving and kicking mechanism, and a wired controller to activate movement and ball control. Runs forward, backward, turns left and right, and executes a 360° turn.

- Assembled electronic PC board • 6 legs driven by 2 DC motors
- Power usage: approximately 900mA max. • Wire controlled

Requires: 4 AA batteries (recommend P/N 198715CL, pg 153)

Part No.	Product No.	Dimensions	Wt. (lbs.)	1	10
215861CL	OWI-9820	6.7 L x 3.4 W x 5.5 H	2.0	\$44.95	\$37.95



SALE

OWI Obstacle Avoidance Robot Kit ▲ 107-piece kit

Six crank motion legged robot utilizes an infrared light sensing system to find obstacles and maneuvers itself around them. This IR detection kit includes an infrared diode, photo diode, IC, 2 DC motors and all hardware.

Part No.	Description	Dimensions	Wt. (lbs.)	1	10
140821CL	Spider kit	12.0 L x 7.0 W x 3.5 H	1.2	\$59.95	\$53.95



OWI Rokit Robot Kit ▲ 96-piece kit

Explore the fundamentals of robotics with this informative and entertaining robot kit. An intelligent robot with a touch/sound sensor, if it comes in contact with an object or hears a loud noise, it automatically reverses, then turns left.

- Soldering required of PCB • Size: 4.5 L x 5.0 W x 3.5 H

Requires: 2 AA batteries (recommend P/N 151087CL, pg 154)

Part No.	Description	Wt. (lbs.)	1	10
199603CL	Rokit robot Expert	1.0	\$21.95	\$19.55



OWI Line Tracking Robot Kit ▲ 134-piece kit

Watch as this robot follows a black line you specify. Utilizes infrared light to detect the line and control direction. This educational kit utilizes the same line follow principle of many industrial robots.

Part No.	Description	Dimensions	Wt. (lbs.)	1	10
140839CL	Line tracker kit	12.0 L x 7.0 W x 3.5 H	1.1	\$49.95	\$44.49



Micro Bug Kits ■

A bright colored miniature bug shaped robot that is attracted to light.

- Two open chassis sub-miniature motors
- Adjustable light sensitivity that suits almost any light conditions
- LED "eyes" indicate driving direction
- Stops in total darkness • Size: 4.0" x 2.4"

Requires: 2 AAA batteries (recommend P/N 231095CL, pg 155)

Part No.	Product No.	Description	Pieces	1	10
200328CL	MK127	Running	26	\$18.95	\$16.95
200336CL	MK129	Crawling	29	\$21.45	\$19.35



Computer Control Interface Kit ▲ 301-piece kit

Connects to printer port without interruption of the printer. Works well in control applications such as the DC dimmer (P/N 128901CL, below).

- 16 I/Os with opto coupler
- Analog outputs: eight 6-bit (64 steps), one 8-bit (256 steps)
- Analog inputs: four 8-bit (256 steps)
- Full opto-isolation with computer
- 3.5" driver disk w/ routines in C++, QBASIC, Turbo Pascal

Requires: DB25 cable (P/N 65787CL, pg 66)

Part No.	Product No.	Dimensions	Wt. (lbs.)	1	10
128928CL	K8000	9.3 L x 5.3 W	1.7	\$139.95	\$125.95



DC Controlled Dimmer Kit ▲ 37-piece kit

This circuit is ideal for replacing an existing dimmer switch; can be used in a control application via P/N 128928CL interface board, above.

- Supply voltage: 110VAC or 220-240VAC, 50 or 60Hz
- Can be used for 24VAC • DC control voltage: 0-10VDC
- Maximum control current: 2.25mA @ 12V

Part No.	Product No.	Dimensions	Wt. (lbs.)	1	10
128901CL	K8003	3.0 L x 2.0 W x 1.8 H	0.7	\$21.95	\$19.95



SALE

Remote Control by Telephone ▲ 116-piece kit

- Possible to turn on or off up to three devices (switching lights on-off; check alarm systems; water heater on-off; garage doors)
- Check conditions of a switch (open or closed)
- Protected by a user-defined code
- Pick up after 3 or 8 rings (selectable)

Requires: 12VAC @ 300mA (recommend P/N 101258CL, pg 148)

Includes: Relay for one output (10A/250VAC)

Part No.	Product No.	Dimensions	Wt. (lbs.)	1	10
120678CL	K6501	4.1 L x 5.1 W	0.7	\$69.49	\$62.59



Universal Relay Controller Card Kit ▲ 64-piece kit

An electronic controller that switches higher currents while providing insulation between the controller and the controlled devices.

- 8 channels expandable to 15 with 8 each P/N 144186CL, below
- Relay output: maximum 5A/220VAC
- TTL or 5V CMOS inputs
- Contact voltage: 12VDC/250mA

Requires: 220 or 125VAC power source

Part No.	Product No.	Dimensions	Wt. (lbs.)	1	10
128910CL	K6714	8.3 L x 5.9 W	1.8	\$59.95	\$53.95
144186CL	VR15M121C relay (JZC-22F)		0.028	3.79	3.39



SALE

Robot Builder's Bonanza

TAB Publishing This fascinating guide offers a complete, unique collection of tested and proven project modules that you can mix and match to create an almost endless variety of highly intelligent and workable robot creatures. (753 pages, 2001)

- Size: 7.3" x 9.2" • Weight: 2.5 lbs.

New Lower Prices

Part No.	Description	Price
137171CL	Robot Builder's Bonanza	\$28.95 \$17.95



Robot Builder's Source Book

McGraw-Hill Everything you need to find and acquire common and uncommon robotic parts and supplies. Jameco and over 2500 mail order suppliers and other sources, including local and international businesses all cross-referenced and categorized to make your search quick and easy. (711 pages, 2003)

- Size: 8.5" x 10.0" • Weight: 3.9 lbs.

New Lower Prices

Part No.	Description	Price
213461CL	Robot Builder's Source Book	\$18.95 \$10.95



Solutions!

Motor Mind B Module

Motor control supports one or two line serial communication stream. DC motors with operating voltages as great as 30VDC and continuous currents of 2A can be controlled. An on board frequency counter has a range of 0-65,528Hz. Motor speed (254 steps) and direction can be controlled. Motors with tachometers or encoders may make use of the automated speed control function.



SALE

Part No.	Description	1	10
143802CL	9-pin motor mind B module	\$28.95	\$26.95

Solutions!

Motor Mind C Single or Dual DC Motor Controller

The Motor Mind C has been designed to function as a versatile DC motor control system. The module is ideal for use in small robotics projects for controlling two-wheel axles.



New Lower Prices

The motor connections may also be tied in parallel to control a single larger motor.

- Control 10-24V brushed DC motors
- Maximum continuous current 4.0A
- 40-pin DIP socket package
- Single or dual independent motor control options
- Over-current and over-temperature protection
- Serial control of 10-bit PWM signal
- Alternative analog control (0-5VDC) of PWM signal
- Alternative R/C (1-2ms) pulse control of PWM signal

Part No.	Description	1	10
215546CL	Motor mind C	\$58.95	\$49.95

Solutions!

Micro PID Position Controller (UPID)

The Micro PID position controller is a stand-alone motor position controller for use with small DC motors. This device provides 32-bit position control of DC motors with quadrature encoders. Four modes of operation allow for use in a wide variety of applications.



SALE

New Lower Prices

- Up to 2A continuous current, 10A peak
- 6-30VDC brushed motors
- Direct position control via 38.4Kbps, 19.2Kbps, or 9.6Kbps serial interface
- Stores up to 16 trapezoidal profile segments, and 3 PID settings
- Analog position control mode (1024 positions) with offset and multiplier functions
- Velocity control mode
- Built in data-logging modes for trapezoidal or direct control operating modes
- Brake, reset, negative limit switch, and positive limit switch inputs
- Custom software simplifies programming & testing
- X4 or X1 quadrature signal decoding

Part No.	Description	1	10
215562CL	UPID position controller	\$74.95	\$69.95

Parallax's "Stamps In Class" Series Kits

Enabling Students to "Micro-Control" the World

PARALLAX 7

Learn BASIC Stamp programming essentials from the experts. Each kit combines an educational book with the components needed to cover robotics, process control and microcontroller interfacing. The program emphasizes creative PBASIC programming in the classroom. For use with the "Board of Education" below.

More Training Boards on pages 31-32

Robotics

Build a BOE-BOT by adding a chassis, servo motors, power supply and proximity sensor to

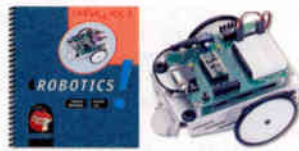

your Board of Education (right). Experiments cover basic programming and servo control, sensor interfacing using an infrared LED and receiver, light following, and communication between BOE-BOTs.

New Lower Prices

- Experience: moderate
- 84 piece kit with book

Requires: BS2 starter kit (P/N 140071CL, pg 221)

Part No.	Parallax No.	1	10
170131CL	28154	\$124.95	\$123.95
			\$115.95

"Board of Education"

The BOE was designed in coordination with Parallax's educational customers to teach microcontroller programming and interfacing.

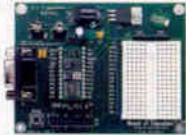

- Mechanically interlocked power supply to prevent dual connection of wall-pack and 9-volt battery
- DB9 connector for BS2-IC programming and serial communication during run-time
- P0 - P15 I/O pins, Vdd and Vss connections brought adjacent to 2" x 1-3/8" breadboard area
- Traces on top of the board show connections between BS2-IC and breadboard connections

Includes: Set of ten 10 color-coded 22 gauge wires

Part No.	Parallax No.	1	10
162536CL	28150	\$58.95	\$52.95
202331CL	45185 BS2P40 adapter	34.95	34.95

Microcontrol'n Apps

PIC Microcontroller Applications (Version 2)

Square 1 Publishing This book is a revision and/or the successor to PIC'n Up The Pace. Materials covered in the book include talking to a PIC microcontroller with a PC running a terminal, simple data logger and digital voltmeter experiment, PIC16F87x and 10-bit A/D conversion. (437 pgs, 2002)



- Size: 8.5" x 11.0" • Weight: 1.7 lbs.

Part No.	Description	Price
215052CL	Microcontrol'n Apps	\$44.95

Time'n and Count'n

Intermediate Level PIC Applications

Square 1 Publishing The material and information presented in this book previously appeared in PIC'n Techniques book. The more current PIC16F870 is substituted for the PIC 16C63. Topics such as test equipment for timing and counting experiments to using timer 1 / timer 2, and capture/compare/PWM as well as programs are included in this book. (218 pages, 2002)



- Size: 8.5" x 11.0" • Weight: 1.4 lbs.

Part No.	Description	Price
210489CL	Time'n and Count'n	\$34.95

PIC BASIC Programming and Projects

Newnes Publications The BASIC language, as used by the most popular PIC compilers, is introduced from square one, with simple code used to illustrate each of the most commonly used instructions. PIC BASIC is the simplest and quickest way to get up and running - designing and building circuits using a microcontroller. (210 pages, 2001) • Size: 6.1" x 9.2" • Wt.: 0.8 lbs.



Part No.	Description	1	10
200168CL	PIC BASIC Programming	\$34.95	\$32.95



MICROCHIP



Just Added

Over 150 **NEW**

PIC Microcontrollers!

See page 7 for our complete selection.

For more books on programming and projects using PIC Microcontrollers, see page 228.

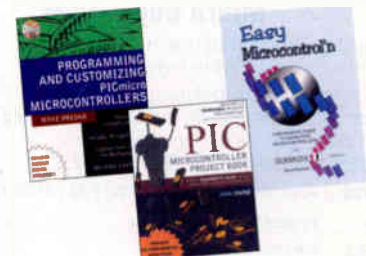

Edu & Hobby

BASIC Stamps

SALE

BASIC Stamps are small computers using a variation of BASIC called PBASIC to control execution of many applications, such as robotics, radio-controlled interface of a digital camera, industrial pallet stacker, health monitoring systems, and much more. The BS1-IC has 8 I/O lines, while the BS2-IC has 16 I/O lines which can be connected directly to buttons, LEDs, registers, and many other TTL level devices. Each allows you to store data in the EEPROM before downloading a BASIC program.

Includes: Embedded BASIC plus instruction sets; basic interpreter, EEPROM (non-volatile), a resonator and 5V regulator



127693CL

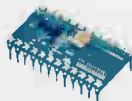

130892CL

See page 39 for
Serial LCD Modules

Specifications:	127693CL	130892CL
EEPROM	256 bytes	2048 bytes
RAM	16 bytes	32 bytes
Cur. Draw @ 5V	2mA run/20µA	8mA run/100µA
Microcontroller	PIC16C56	PIC16C57
Program speed	2000/sec.	4000/sec.
# of I/O Pins	8	16 + 2 serial
Package	14-pin SIP	24-pin DIP
Volts Required	5-15VDC	5-15VDC
Size	1.4"L x 0.4"W	1.2"L x 0.6"W

Part No.	Parallax No.	1	10
127693CL	BS1-IC	\$32.95 \$18.95	\$14.95
130892CL	BS2-IC	48.95	43.95

BASIC Stamp® 2 Starter Kit with BS2-IC (27203)

Design your own project today using this BASIC Stamp kit. Includes the super carrier board, software, manual and programming cable. BASIC Stamp 2 can be connected directly to buttons, LEDs, registers and many other TTL devices.

• Weight: 1.9 lbs.



Inset of Carrier Board

Part No.	Parallax No.	1	10
140071CL	27203 Kit	\$148.95	\$142.95

50MHz BASIC Stamp 2SX Module

High-speed version of BS2-IC with additional RAM and EEPROM.

- Microcontroller: Ubcicom SX28AC
- Program execution speed: 10,000 instructions/sec. • Volts required: 5-12 VDC
- EEPROM program size: 8 x 2k bytes, 4,000 instructions • Scratch pad RAM: 64 bytes
- Current draw @ 5V: 60mA run/200µA sleep
- Number of I/O pins: 16 + 2 serial
- RAM size: 32 bytes • Size: 1.2"L x 0.6"W



Part No.	Parallax No.	1	10
159775CL	BS2SX-IC 24-pin	\$48.95 \$32.95	\$27.95

BASIC Stamp 2P Modules

In addition to the BS2-SX (above) features, includes new commands for HD44780 compatible LCDs, Dallas Semiconductor 1-wire and Philips I2C parts.

- Voltage requirements: 5-12VDC
- Program execution speed: 12,000 instructions/sec.
- RAM size: 38 bytes (12 I/O, 26 variable)
- Scratch pad RAM: 128 bytes
- EEPROM program size: 8 x 2k bytes, 4,000 instructions
- Current draw @ 5V: 40mA run; 400µA sleep
- 184911CL: Size: 1.2"L x 0.6"W x 0.4"H
- Number of I/O pins: 16 + 2 serial
- 184920CL: Size: 2.0"L x 0.6"W x 0.4"H
- Number of I/O pins: 32 + 2 serial



184911CL



184920CL

New Lower Prices

Part No.	Parallax No.	1	10
184911CL	BS2P24-IC 24-pin	\$18.95 \$10.95	\$7.95
184920CL	BS2P40-IC 40-pin	\$7.95 \$4.95	\$3.95

BS2P Professional Starter Kit

Provides the engineer with all the parts required to get started with the BSP2 microcontroller. The kit includes a selection of components and ready-to-run source code that will help master some of the exciting new features of the BSP2.

Includes: Programming manual, BS2P demo board, BS2P-24 microcontroller, DB9 (serial) programming cable, PCF8583 chip, 32.678kHz crystal, 24LC32 serial EEPROM, DS18B22 thermometer, (3) 4.7K resistors, jumper wires.



Part No.	Parallax No.	1	10
202323CL	27235 kit	\$207.95	\$187.95
202331CL	45185 BS2P40 adapter	34.95	34.95

BASIC Stamp 2 OEM Kit

A through-hole version of the popular BASIC Stamp modules.

- 20-pin SIP, standard 0.1" spacing
- PC board includes labeled component locations with visible traces between parts
- PBASIC interpreter and EEPROM are socketed to allow for replacement
- Programmed using PBASIC DOS or Windows® editor just like the BASIC Stamp modules

Includes: PBASIC interpreter, EEPROM, resonator, DB-9, resistors and transistors



Part No.	Parallax No.	1	10
183071CL	27291 BASIC Stamp 2 kit	\$48.95 \$18.95	\$12.95

Stamp Works Kit

This all-in-one kit takes you beyond theory, into a well-written collection of 32 experiments that will teach you first class BASIC Stamp programming. You'll learn to get the most out of the BASIC Stamp and to increase its versatility by connecting to popular active and passive components.

Includes: Manual, BASIC Stamp Experiment Board, BS2-IC, 2x16 parallel LCD with custom cable, digital multimeter with 2 probes, wire cutter/stripper/pliers, three 100' rolls 22 AWG wire, screwdriver kit, photoresistor, 555 timer, 8-bit serial-to-parallel and 8-bit parallel chips, Dallas Semiconductor 1620 digital thermometer and real-time clock with 32.768MHz crystal, National Semiconductor ADC0831 8-bit A/D converter, Maxim 7219 8-digit LED display driver, National Semiconductor LM358 op-amp, stepper motor, servo, power supply, resistor assortment, capacitors, serial cable, CD-ROM and plastic box for parts

• Weight: 4.0 lbs.



Part No.	Parallax No.	Price
184946CL	27297	\$348.95

BASIC Stamp Prototyping Boards

Optional boards for BS1-IC, BS2-IC and BS2SX-IC Stamps.

- Easy use of Stamp with prototyping area, 9-volt battery clips, I/O header, reset button, and programming connector.

130921CL:

- Use w/ P/N 130892CL, far left
- Size: 3.0"L x 2.6"W

164726CL:

- Use w/ P/Ns 127693CL & 130892CL, far left and P/N 159775CL, above
- Size: 4.0"L x 3.0"W



164726CL

Part No.	Parallax No.	1	10
130921CL	27120	\$27.95 \$21.95	\$12.95
164726CL	27130	58.95	52.95

BASIC Stamp Data Book

Newnes Publishing Covers both the hardware and software of the Parallax BASIC stamp I and II microprocessor operation and design. The basic stamp is built on PC microcontroller hardware and uses PBASIC as its programming language which makes it simple to use and modify for beginners and professionals. (305 pages, 2000)

- Size: 6.0" x 9.2" • Weight: 0.9 lbs.

Part No.	Description	Price
143651CL	Basic Stamp Data Book	\$34.95

More books at www.Jameco.com

Don't worry about backorders.
Over 99% of our products
are in stock!

We'll Send It Today!

Just place your order by
6PM EST for same
business day shipment.

velleman RF Code Lock Transmitter & Receivers ▲

- Use for car alarms, garage doors, door locks, lighting control, etc. • Range: 100 ft.
- Over 8000 selectable codes
- Use several transmitters with one receiver
- Receivers feature relay output (10A change-over or pulse contact)
- P/N 117647CL use with P/Ns 173235CL & 117655CL



117655CL

Requires: Transmitter: 12V battery type V23G; receivers: 12-16VDC @ 100mA (recommend P/N 100095CL, pg 145)

Part No.	Description	Kit Pieces	Wt. (lbs.)	1	10
117647CL	K6706 2-ch transmitter (RF)	29	0.3	\$16.95	\$15.25
173235CL	K6727 2-ch receiver (RF)	75	0.5	39.95	35.95
117655CL	K6707A 1-ch receiver (RF)	75	0.5	29.95	26.99

Infrared Remote-Control Receiver Modules



220628CL



165008CL



176541CL

- Commonly used in TVs, VCRs, audio equipment, car stereos and home computers that receive signals or data via infrared
- Single unit module which incorporates a PIN diode & a receiving preamplifier IC
- Excellent mechanical strength and electrical stability
- 940nm wavelength • Size: 0.6"L x 0.6"W x 0.5"H

Quantity
SAVE

Part No.	Description	Voltage Input	1	10
220628CL	38.0kHz, side view	4.5VDC @ 1.4mA	\$2.99	\$2.69
165008CL	40.0kHz, top view	5VDC @ 5mA	2.99	2.69
176541CL	56.8kHz, side view	5VDC @ 2mA	1.99	1.53

Infrared Transmitter/Receiver Kit ● 26-piece kit

Transmit a 40kHz modulated I-R signal to a distance of 6' to 8'. Can be used as a remote switch to turn objects OFF and ON by infrared. The IR receiver will only receive 40kHz modulated infrared light. You can configure the output for normally ON or normally OFF operation. This allows you to use it as a security sensor or as a remote control switch. You can use the receiver to test TV or VCR remote controls.



- Transmitter size: 1.0"L x 0.8"W • Receiver size: 1.4"L x 1.2"W

Requires: 6 to 15VDC battery (recommend P/N 151095CL, pg 154)

Part No.	Mfr. Cross Ref. No.	Description	1	10
177092CL	IR-2	Transmitter/receiver	\$24.95	\$22.49

Function Generator Kit ■ 21-piece kit

Sine, Triangle and Square Wave

Great for prototyping electronic circuits, whether analog or digital! Produces sinusoidal, triangular, and square waveforms at frequencies continuously variable from 1Hz to 100kHz.

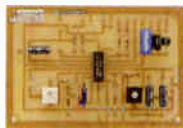

- 21-piece kit (chip, components, PC board, hardware)

Requires: 12VDC supply or ±6VDC split supply (recommend P/N 20626CL, pg 223)

Part No.	Mfr. Cross Ref. No.	Dimensions	1	10
20685CL	JE2206	4.1"L x 1.5"W	\$24.95	\$22.95

velleman Water Leak Alarm Kit ● 7-piece kit

Alarms you of water overflows and leaks!

- Water sensor can be placed at a distance by cutting the board and using wires for connection
- Incorporated loud alarm buzzer

Requires: 9VDC battery (P/N 151095CL, pg 154)



Part No.	Product No.	Dimensions	Wt. (lbs.)	1	10
157315CL	MK108	2.8"L x 1.8"W	0.1	\$10.95	\$9.95

Crossbow Accelerometers and Interface

141591CL 1-Axis and 141575CL 3-Axis Accelerometers

- Dynamic range and excellent frequency response
- Acceleration range: ±4g
- Shielded cable: 2'L pigtail
- Size: 1.9"L x 1.0"W x 0.8"H

141591CL



SALE

Requires: 5VDC power supply (not included – recommend P/N 164101CL, pg 144)

141583CL: Digital Accelerometer Interface

- Measures acceleration, impact, tilt, vibration, etc.
- Simple digital interface for 1-axis and 3-axis
- Plugs into any RS-232 port @ 38.4k baud
- 200Hz max. sampling rate
- Size: 3.0"L x 2.5"W x 1.3"H

141583CL



Requires: DB9 male to female cable (recommend P/N 25700CL, pg 66)

Includes: User friendly graphical software and 9VDC @ 500mA power supply

Part No.	Description	Axis	Current	1	10
141591CL	CXL04LP1	One	8mA	\$149.95	\$134.89
141575CL	CXL04LP3	Three	24mA	339.95	319.95
141583CL	Digital interface card			312.95	299.95

Accelerometer Evaluation Boards

Dual Axis

Evaluation board for the ADXL202, dual axis, 2g accelerometer.

Crossbow



177308CL: features RS-232 interface to connect to PC serial ports. Also includes software to display real time acceleration data.

177308CL

Part No.	Product No.	Description	1	10
177287CL	ADXL202EB	Dual axis	\$59.95	\$53.95
177308CL	ADXL202EB-232	w/ RS-232	159.95	144.95



PRECISION NAVIGATION, INC.

Vector 2X Compass Module

- 2° accuracy, 1° resolution
- 5Hz sampling rate • Hard iron calibration
- Pin selectable BCD or binary output format
- Raw uncalibrated magnetometer output optional
- 3-wire serial output format (compatible with Motorola SPI and National Microwire)
- Master or slave capability for data clock generation



Requires: Power supply 5V @ 10mA (recommend P/N 112070CL, pg 144)

Part No.	Description	1	10
126703CL	Vector 2X module	\$49.95	\$44.95

Senix Distance Sensor Modules

Sends out a sound wave 20 times per second and calculates the distance based on the time differential between send and receive signals. The distance is represented by an output voltage from 0 to 10VDC (P/N 134105CL) or RS-232 signal (P/N 151482CL).

- Sensing range: 4" to 60" • Sensor diameter: 1.8"
- Board size: 2.8"L x 1.8"W x 0.9"H • One-year warranty

Requires: 15 to 24VDC @ 40mA (not included), recommend P/N 114825CL, pg 146

- 134105CL: • Output voltage: 0-10VDC
- Each 1VDC increment = 5.6" (e.g.: 1VDC output = 9.6")
- 151482CL: • RS-232 output

Includes: Disk and computer cable

Part No.	Description	Wt. (lbs.)	1	10
134105CL	Sensor – voltage output	0.2	\$159.95	\$143.95
151482CL	Sensor – RS-232 output	1.0	179.95	161.95



134105CL



151482CL

CEBEK 1 Second to 3 Minute Timer Module

By operating a button, the relay will be activated for the selected time.

- Output contact rating: 5A @ 200VAC
- Size: 3.0"L x 1.7"W x 1.2"H

Requires: Power supply 12V @ 50mA (recommend P/N 100095CL, pg 145)



Part No.	Description	1	10
147871CL	I-1 timer	\$19.95	\$17.95

3 Second On to 1 Minute Off Cyclic Timer Module

By triggering the timer, the contacts will be engaged. Once this time has expired, the relay will remain in the off state for 3-60 seconds.

It then restarts, repeating the on and off process until power is disconnected.

- Output by relay
- Contact rating: 5A @ 200VAC
- Size: 3.0"L x 1.7"W x 1.2"H

Requires: Power supply 12V @ 50mA (recommend P/N 100095CL, pg 145)



Part No.	Description	1	10
147846CL	I-10 timer	\$22.49	\$20.29

Power Supply and Motor Kits

Velleman 1 Amp Power Supply Kit 12-piece kit

Provides a regulated voltage adjustable between 1.2 and 35 volts at 1 amp. LM317 regulator gives you remarkably better ripple and regulation characteristics than conventional regulators. Chip includes current limiter and thermal overload protection.

- Output current max.: 1.5A
- Max. dissipation: 15W (cooled)
- Max. input voltage: 40V

Requires: 25.2VCT @ 2A quick connect power transformer (recommend P/N 102103CL or equivalent, pg 149)



Part No.	Product No.	Dimensions	1	10
117621CL	K1823	2.1"L x 2.1"W	\$12.95	\$11.65

Dual Adj. Regulated Power Supply Kit 48-piece kit

Build a dual adjustable power supply for your circuits. Outputs positive-negative voltages from ± 5 to ± 15 VDC.

- Adjustable positive and negative supplies ± 5 to ± 15 VDC, 175mA - 750mA per supply
- 120VAC input
- LED on indicator
- PC board construction

Includes: Components and hardware

Part No.	Mfr. Cross Ref. No.	Dimensions	Wt. (lbs.)	1	10
20626CL	JE215	5.1"L x 3.5"W x 2.0"H	2.1	\$22.95	\$20.49



Velleman DC to Pulse Width Modulator Kit 40-piece kit

The circuit converts a DC voltage into a series of pulses, such that the pulse duration is directly proportional to the value of the DC voltage.

- PWM range: 0 to 100%
- Operating voltage: 8 to 35VDC
- PWM frequency: 100Hz to 5kHz (adjustable)
- Min. consumption: 35mA
- Max. output current: 6.5A
- Efficiency: better than 90% at full load
- Adjustable sensitivity: 2.5 to 35VDC

Part No.	Product No.	Dimensions	Wt. (lbs.)	1	10
120539CL	K8004	3.3"L x 1.9"W x 1.8"H	0.5	\$22.95	\$20.49



30-Day Money-Back Guarantee

If you're not satisfied, we'll take it back!

Details on page 229.

Velleman Quartz Clock Mechanism

Build your own clock or replace the clock mechanism of a damaged clock with this quartz clock mechanism from Velleman.

Includes: 1 x 1.5AA battery

- Dimensions: 2.2"Sq x 0.6"Thick

Part No.	Description	1	Price
239661CL	Quartz clock mechanism		\$3.49



Velleman Dual Electronic Dice Kit 85-piece kit

Board games provide an excellent source of entertainment. Update your game. Play with these electronic dice. Great for education of probability theory. Displays are switched off automatically after 30 seconds to save battery power.

- Two fully independent dice, at your choice you can play with one or two dice.

Part No.	Product No.	Dimensions	Wt. (lbs.)	1	10
200352CL	K3400	3.0"L x 2.8"W	0.5	\$18.95	\$16.95

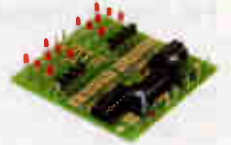

DC Motor Speed Control Kit 35-piece kit

- This kit uses Pulse Width Modulation to vary the speed of a DC motor and maintain torque
- For motors up to 100VDC/5A max.

Requires: 5-16VDC supply (recommend P/N 114825CL, pg 146)

Part No.	Description	Dimensions	1	10
127829CL	Motor control kit	3.6"L x 2.3"W x 1.2"H	\$19.95	\$17.95



Unipolar Stepper Motor Driver Kit 29-piece kit

- Drives 5, 6 or 8 lead unipolar stepper motors
- Will drive unipolar stepper motors rated up to 6-30VDC @ 1.25A
- Onboard 5VDC regulator

Part No.	Description	Dimensions	1	10
139109CL	Stepper motor	2.6"L x 1.9"W x 1.0"H	\$29.95	\$26.95



DC Voltage Monitor Kit 46-piece kit

If battery status is important, you need this kit. It uses 7 LEDs to monitor 12VDC in 1V, 0.5V, or 0.25V steps. Monitor 8V or 5V in 0.25V steps. Great for boats, motor homes, model planes or race car Ni-Cads.

Part No.	Mfr. Cross Ref. No.	Dimensions	1	10
181833CL	VM-1	2.7"L x 1.3"W	\$8.95	\$7.95

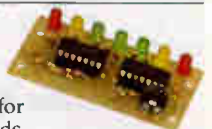

Stepper Motor Controller Card and Motor Kit 102-piece kit

This kit is very useful in any home automation project where positioning is needed, such as controlling valves, HVAC duct dampers, natural light through window blinds, remotely turning down water heaters, or any robotic projects. This controller card can be used with P/N 128928CL (K8000 - computer interface board) and 16 of these kits can be connected to a single computer interface board. Both bipolar and unipolar motor can be used with this controller card (1A maximum). Includes a high precision stepping motor (0.9 degree stepping angle).

- IC controlled via P/N 128928CL (K8000)
- Check status of switches via computer interface board or drive another motor
- Power supply: 7 - 25VAC or VDC @ 1.5A
- Adjustable drive speed
- Emergency stop can be sent to one or all cards
- Programmable in Visual Basic, Turbo Pascal for DOS, and Quick Basic (Windows® 95/98/ME)

Part No.	Product No.	Dimensions	1	Price
263628CL	K8005	3.9"L x 3.5"W		\$59.95



Super Snooper Big Ear Audio Amplifier Kit

17-piece kit

Listen through walls, hear conversations across the room or listen to sounds a block away. Add a parabolic reflector or mount the microphone in a tube to isolate unwanted noise and make a directional microphone.

- Operating voltage: 9VDC (recommend P/N 151095CL, pg 154)

Includes: Instructions, outputs for speakers or headsets and schematic

Part No.	Description	Dimensions	1	10
151204CL	Audio amplifier kit	1.8"L x 1.0"W x 0.6"H	\$10.95	\$9.95



FM Stereo Transmitter Mini Kit

37-piece kit

Run your own FM radio station! Plug any stereo signal into this unit and it will be transmitted to any FM radio. Tuneable from 76-108MHz. Plug in a CD player or tape deck and you have a wireless link to an FM radio within 200 feet. Clarity is approximately 40dB stereo separation.

Requires: 9VDC power supply (recommend P/N 151095CL, pg 154)

Part No.	Description	Dimensions	1	10
151239CL	FMT-100 stereo kit	2.7"L x 2.0"W	\$29.95	\$26.95



velleman FM Transmitter

26-piece kit

Mini FM transmitter (100-108MHz) ideal for family broadcasts, baby monitors and security. May be received by any portable FM radio or tuner.

- Integrated pre-amplifier (sensitivity 5mV)

Requires: 9-12VDC power supply (recommend P/N 20626CL, pg 223)

Part No.	Product No.	Dimensions	1	10
117604CL	K1771	1.8"L x 2.8"W	\$12.49	\$11.29



velleman FM Radio Kit

65-piece kit

Easy to assemble - no coils to wind. Receives the complete FM band of 88 - 108MHz.

- With on/off switch, volume control, and LED indicator
- Single adjustment

Requires: 12VDC @ 100mA power supply (recommend P/N 100095CL, pg 145)

Part No.	Product No.	Dimensions	1	10
211772CL	MK118	4.8"L x 3.3"W	\$21.95	\$19.95



One-Chip AM Radio Kit

39-piece kit

- Uses an IC that performs as an RF amp, detector and AGC in an AM radio

Requires: 9V battery (recommend P/N 151095CL, pg 154)

Part No.	Description	Dimensions	1	10
125161CL	AM radio kit	4.0"L x 1.3"W x 0.5"H	\$13.95	\$12.95



TV Notch Filters Mini Kit

33-piece kit

Eliminates unwanted TV channels or interference that alters sound and video. Works on cable channels 2 to 22 and 97 to 99.

Part No.	Description	Dimensions	1	10
151167CL	DF-222 TV filter kit	3.2"L x 0.9"W	\$15.95	\$14.49



velleman 10 LED Mono VU Meter Kit

36-piece kit

- Instant visualization of audio signal levels
- Easy hook up to a LINE level (LOW input) signal source
- Special input (HIGH input) is provided, which allows direct connection to a speaker output
- Frequency range: 20Hz to 30kHz
- Dot or bar display mode selectable

Requires: 15VDC @ 300mA max. power supply (P/N 189982CL, pg 146)

Part No.	Product No.	Dimensions	Wt. (lbs.)	1	10
147643CL	K4304	2.7"L x 1.4"H	0.3	\$21.95	\$19.75

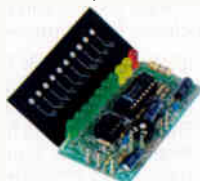

velleman Universal Mono Pre-Amplifier

17-piece kit

For audio applications with insufficient input signal.

- Output impedance: 1kΩ
- Max. input signal: 40mV
- Frequency range: 20Hz - 20kHz +/-3dB
- Adjustable output level: 40dB max.

Requires: 10/30VDC @ 10mA power supply (recommend P/N 20626CL, pg 223)

Part No.	Product No.	Dimensions	1	10
117612CL	K1803	1.2"L x 1.8"W	\$8.95	\$7.95



1-Watt Amplifier Kit

9-piece kit

Amplifies audio signals for an 8Ω speaker. Use on P/N 125111CL and P/N 147838CL.

- Ideal part for larger projects & battery powered circuits
- Circuit designed around a single TDA7052 IC
- Battery and battery snap not included (recommend P/N 151095CL, pg 154 and 109153CL, pg 153)
- Drives 8Ω speaker (not included)

Part No.	Description	Dimensions	1	10
125111CL	1 watt amp kit	1.2"L x 1.2"W x 0.9"H	\$6.29	\$5.59



Super Mini 2.5W Audio Power Amplifier

27-piece kit

This circuit has incredibly tiny dimensions. The IC has a pre-amplifier and power amplifier, which can be used separately by cutting a jumper.

- Operating frequency: 60Hz to 15kHz
- Max. output power: 2.5W (4Ω, 12V)
- Short circuit/thermal overload protection

Requires: 4.5-15VDC @ 400mA power supply (recommend P/N 114825CL, pg 146)

Part No.	Product No.	Dimensions	1	10
127175CL	K2637	1.7"L x 1.3"W x 1.1"H	\$10.95	\$9.95



velleman 7-Watt Amplifier Kit

22-piece kit

- Music output power: 7W/4Ω
- RMS output: 3.5W/4Ω & 2W/8Ω
- Harmonic distortion: 0.05% (1W/1kHz)
- Frequency response: 20 to 20kHz (-3dB)
- Short circuit/overload protection

Requires: 15VDC (8-18VDC) @ 500mA power supply (recommend P/N 155803CL, pg 146); speakers

Part No.	Product No.	Dimensions	1	10
127255CL	K4001	2.2"L x 1.4"W	\$13.95	\$12.49



18-Watt Bridged Mono Amplifier Kit

17-piece kit

- Drives 3-8 ohm speakers
- Based on the Hitachi HA13118 amplifier IC

Requires: 12VDC supply (recommend P/N 100095CL, pg 145)

Part No.	Description	1	10
136207CL	18 watt amplifier kit	\$15.59	\$13.95



CEBEK 20-Watt RMS Amplifier Module

- Input signal: 250mV
- Maximum current: 2A
- Output impedance: 4-8Ω (mono)
- Terminals: .100" matching disconnect solderless terminals
- Size: 2.8"L x 2.8"W x 1.6"H

Requires: Power supply: 12V @ 2A (recommend P/N 143714CL, pg 142)

Part No.	Description	1	10
147838CL	E-11 mono amplifier	\$24.95	\$22.49



velleman 30-Watt Stereo Power Amplifier

38-piece kit

General purpose stereo amp for audio applications.

- RMS output: dual 15W @ 4Ω or dual 10W @ 8Ω
- Frequency bandwidth: 7Hz to 60kHz (-3dB)
- Separation: 70dB
- Supply voltage: 24VCT @ 2A (recommend P/N 101864CL, pg 149)

Part No.	Product No.	Dimensions	1	10
129138CL	K4003	2.8"L x 2.0"W	\$29.95	\$26.95



velleman Sound Generator Kit ■ 61-piece kit

- Produces 10 different sounds w/ adjustable speed: guns, sirens, car engines, explosions, tunes, screeching tires, phaser guns
- Push-button keyboard



Requires: 8Ω/1 watt speaker (recommend P/N 102031CL, pg 98); 9V battery (recommend P/N 151095CL, pg 154)

Part No.	Product No.	Dimensions	1	10
127562CL	K4401	2.8"L x 2.8"W	\$29.95	\$26.95

Siren Kit ● 20-piece kit

SALE

- Oscillator is off until you press the switch, then a rising tone is produced until a steady value is reached
- If switch is released, tone starts dropping until it cuts off
- Circuit designed around a dual op amp connected as an oscillator and driver



Requires: 9V battery (recommend P/N 151095CL, pg 154)

Part No.	Description	Dimensions	1	10
125137CL	9V siren	2.0"L x 0.8"W x 0.5"H	\$5.95	\$5.39

Train Sound Generator Kit ● 11-piece kit

- Produces 4 train sounds by switch selection
- Components supplied for operation on 3VDC (includes battery holder for 2 AA batteries), but circuit will operate from 2.4-6VDC (recommend P/N 151087CL 2 each, pg 154)



Part No.	Description	Dimensions	1	10
125170CL	4 train noises	1.1"L x 0.6"W x 0.2"H	\$9.49	\$8.59

velleman Karaoke Kit ■ 59-piece kit

You can do your "Elvis" impersonation by hooking up this kit between your CD player, MD player, or any other line-level source and your amplifier; and sing along to your favorite Elvis' music. Adjustable microphone level and "vocal reduction" switch reduces original vocals on most stereo surroundings.



- RCA input and output sockets
- ON/OFF switch and led power indicator
- 6.3mm microphone jack that fits most microphones
- Low power consumption: 16mA typical

Requires: 9V battery (recommend P/N 198731CL, pg 154)

Part No.	Product No.	Description	Wt. (lbs.)	1	10
215394CL	MK140	3.9"L x 3.3"W x 1.0"H	0.2	\$15.95	\$14.35

Speech Recording & Recognition Kits

Digital Voice Module

- Selectable 16k/32k/44k bps sampling rate
- 0.5W audio amp on board with volume control
- All components soldered on board
- Plays 16 messages • 1M DRAM on board
- Power requirements: 6-12VDC, 200mA (P/N 100095CL, pg 145)



SALE

Part No.	Mfr. Cross Ref. No.	1	10
124871CL	DVM58D	\$69.95 \$65.95	\$59.95

velleman Voice Activated LEDs Kit ■ 33-piece kit

Uses sound to activate the flashing of 4 bright red LEDs.

- Power consumption: 0.5mA min./12mA max.
- Adjustable sensitivity

Requires: 8-15VDC power supply (P/N 100095CL, pg 145) or 9VDC battery (P/N 151095CL, pg 154)



Part No.	Product No.	Dimensions	Wt. (lbs.)	1	10
147571CL	MK103	2.5"L x 1.6"W x 1.4"H	0.1	\$9.95	\$8.95

Voice Direct II Stand-Alone Speech Recognition Kit

Bring life to consumer electronics, toys, motors, appliances, lights, and games through the power of VoiceActivation™ from Sensory. Voice Direct™ II is a speaker-dependent speech recognition module, allowing training of up to 15 words; capable of being organized into 1 to 3 command sets. Using sophisticated speech recognition technology, Voice Direct™ II maps spoken commands to system control functions via digital I/O ports. Each time one of the words is recognized, output pins on the module are toggled high for 1 second. With Continuous Listening Technology, it means no button press is required for activation. Up to 3 "gateway" words can be programmed, each allowing access to 5 commands. In addition, Sensory's latest Voice Direct™ II technology builds on the original Voice Direct™ by offering even higher accuracy, faster response times, and improved noise immunity.



Part No.	Product No.	Description	Wt. (lbs.)	1	10
225971CL	66-0101	Speech kit	0.4	\$59.95	\$53.95

Electronic Locks

Electronic Combination Lock ■ 19-piece kit

- Programmable 4-digit combination lock with separate 9 touch-pad board
- Output: 240VAC 12A relay controls external loads

SALE

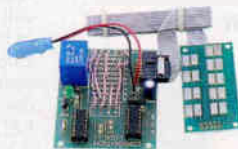

Requires: 9V battery (P/N 151095CL, pg 154)

Part No.	Description	Dimensions	1	10
125129CL	Lock kit	3.0"L x 2.5"W x 1.0"H	\$10.50 \$9.85	\$0.92

velleman Code Lock Kit ■ 67-piece kit

- Switch an alarm on and off or open door locks
- 3000+ codes possible
- LED indicates state
- Pulse or switch outputs
- Relay contact rating: 5A/220V

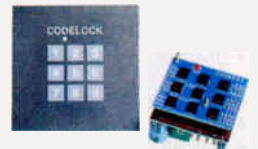

Requires: 9-15VDC (P/N 163491CL, pg 145) or 8-12VAC (P/N 100061CL, pg 148) power supply

Part No.	Product No.	Dimensions	Wt. (lbs.)	1	10
127554CL	K6400	1.7"L x 1.8"W	0.5	\$29.95	\$26.95

See the yellow and green highlighted items.

Jameco Special Values

Details on page 2.

Keypads on page 97.

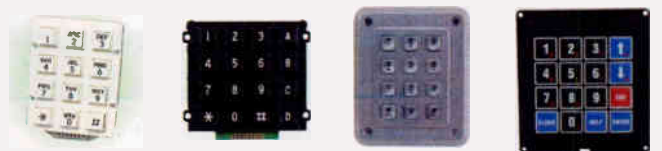

Solar Photon Racer Kit

Build your own solar racer and tap into the power of the sun! This easy-to-assemble kit comes with everything you need, including a high-powered 1V, 500ma, ultra lightweight encapsulated solar cell and high-amp/low-voltage motor for maximum torque and speedy acceleration. Sleek transparent plastic body, made from recycled pop bottles, looks great as is, or add your own custom paint job. The Photon can travel 10 feet in three seconds on a smooth, flat surface, when exposed to full sun.



214738CL

- Difficulty level: beginner
- Size: 8.5"L x 3.8"W x 2.0"H

New Lower Prices

Part No.	Description	1	10
214738CL	Photon-P (painted)	\$28.95	\$26.99
215183CL	Photon-1 (non-painted)	24.89	21.79

Forever Keychain Light

Miniature rechargeable light lasts for years and you'll never need to change a battery or bulb.

Energized by solar cells, it is entirely self-contained. A squeeze turns on the LED emitting yellow light. Perfect for keychain or gift.

- Size: 2"Dia. x 0.5"Thick



Part No.	Description	1	10
215212CL	Forever keychain light	\$19.89	\$17.99

Clear Case with Gears

Motor case & gears
Build a 2-speed motor with the parts in this kit. Works with our solar motor (P/N 215263CL, see below).

Includes: Clear SM-15 plastic case



Part No.	Description	1	10
215280CL	Motor case with gears	\$6.89	\$6.29

Solar Motor

- Operates on 0.5-3.0V @ 200mA start-up
- Runs at 80mA no load
- Low stall torque: 25-48 g-cm
- High RPM: 2500-5000 @ maximum efficiency
- Shaft diameter: 2mm
- Motor size: 1.0"Dia. x 1.5"L



Part No.	Description	1	10
215263CL	Solar motor	\$2.89	\$2.69

Mini-Panel Solar Cells

Ready to Use! No Soldering.

Encapsulated mini-panels utilize solar cells similar to those that power our satellites in space, yet they are safe and simple to use. Mini-panels allow for handling without the normal breakage and cell damage associated with fragile solar cells. 6" red/black lead wires attached. Modules may be connected to create different outputs.



200221CL

- Size: 3.8"L x 2.5"W • Connection: lead

Part No.	Prod. No.	VDC @ mA	Size (LxW)	1	10
200205CL	SOL2	0.5 @ 800	2.6" x 3.7"	\$7.95	\$7.15
200221CL	SOL4	2.0 @ 200	3.0" x 3.7"	8.99	7.99
215301CL	4-1.5-200	1.5 @ 200	3.8" x 2.5"	12.79	11.59
215319CL	4-3.0-100	3.0 @ 100	3.8" x 2.5"	14.29	12.89
215327CL	4-6.0-50	6.0 @ 50	3.8" x 2.5"	15.79	14.39

Solar Energy Project Kit

Learn about the renewable energy available with solar power. Experimenter kit demonstrates the power of the solar cell to run an electric motor. Contains motor connected to solar cell, propeller, optical illusion spirals, and informative booklet.

- Difficulty level: beginner



Part No.	Description	1	10
215204CL	Solar energy project kit	\$11.89	\$10.79

Photovoltaic Sun Tracker Solar Kit

This kit gives students and hobbyists a realistic taste of practical applications for solar power. Contains motor, gear train, solar cell, tracker device, and instruction booklet. Booklet explains how to make sundials and three other unusual solar projects.



Part No.	Description	1	10
215191CL	Sun tracker solar kit	\$29.89	\$26.99

Motor and Gear Case

Combination motor and gear train in plastic case.

- Operates on 0.5-3.0V @ 0.5V
- Runs at 20mA
- Strong torque @ 3V: 41 g-cm
- 6 RPM
- Shaft diameter: 2mm
- Size 3.0"L x 2.0"W x 1.5"D



Part No.	Description	1	10
215271CL	Motor and gear case	\$17.39	\$15.75

Eye-Catching Solar Powered Retail Display Device



See Jameco.com for Data Sheet.

Add eye-catching motion to your in-store advertising with this solar clip-on motion display. Just clip on to a fluorescent light bulb, add your own signage, turn the lights on and your in-store advertising sign comes to life. Long-life solar motor turns your sign counter clockwise. No batteries or AC power to worry about. No need to worry about tripping your motion sensing alarm systems. Just simply switch off your fluorescent light and the movement stops.

Part No.	Description	1	10
215221CL	Clip-on motion retail display ...	\$24.89	\$22.49

Solar Pocket Charger

Charge your batteries with free solar power. Inexpensive, easy and safe to use—completely self-contained unit, no moving parts or cords. Uses satellite type solar cells that produce the highest power to weight ratio. Compact and lightweight, you can carry this charger with you anywhere. Re-energizes carbon-zinc, alkaline, nickel-cadmium (NiCad), and nickel-metal-hydride (NiMH) batteries.

- Size: 3.6"L x 3.1"W x 1.5"D

Includes: Battery adapter to charge, AA, C, and D type batteries.



Part No.	Description	1	10
215239CL	Solar pocket charger	\$32.89	\$29.69

Solar Button Cell Battery Charger

A convenient and safe way to revitalize worn down button cell batteries used in hearing aids, cameras, calculators, remote controls, clocks, alarms and more. LED indicator lets you know when the battery is being charged. Charges nickel-cadmium (NiCad), nickel-metal-hydride (NiMH), alkaline, mercury, and most zinc air (1.2V-1.5V) batteries.

Part No.	Description	1	10
215247CL	Solar button cell charger	\$16.89	\$15.29



Gears and Shafts Kit

Bag of gears, shafts and accessories. Great for science projects. All parts fit 2mm shaft motors.



Part No.	Description	1	10
215298CL	Gears and shafts kit	\$5.89	\$5.29

We'll match the print advertised price of any like product.

Jameco's Low-Price Guarantee

It's that simple!



PowerFilm. Flexible Thin Film Solar Modules

Wireless Electronics Series

The wireless electronics series offers a new opportunity to solve the old problem of limited power for wireless electronics in portable and remote applications. These modules are lightweight, paper thin, and durable. With their ultra-film profile, they are easily integrated with devices for solar recharging or direct powering. Specifically developed to recharge AA, AAA, plus 6 and 12 volt batteries.

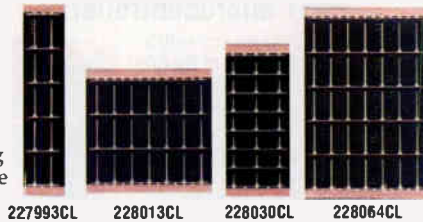

Part No.	Product No.	Operating Voltage (V)	Operating Current (mA)	Size (L x W x T)		Pricing		
				Inches	mm	1	10	100
227985CL	SP3-37	3.0	22	2.5 x 1.5 x .01	64 x 37 x 0.2	\$3.89	\$3.49	\$3.19
227993CL	TX 3-25	3.0	25	4.5 x 1.0 x .01	114 x 25 x 0.2	2.89	2.45	1.85
171061CL	MP3-37	3.0	50	4.5 x 1.5 x .01	114 x 37 x 0.2	5.89	5.29	5.29
228013CL	MPT3.6-75	3.6	50	2.9 x 3.0 x .01	74 x 75 x 0.2	8.89	7.99	7.19
228021CL	MPT3.6-150	3.6	100	2.9 x 5.9 x .01	74 x 150 x 0.2	17.89	15.99	14.39
228030CL	SP4.2-37	4.2	22	3.3 x 1.5 x .01	84 x 37 x 0.2	5.89	5.29	4.79
228048CL	MPT4.8-75	4.8	50	3.7 x 3.0 x .01	97 x 75 x 0.2	11.89	10.69	9.59
228056CL	MPT4.8-150	4.8	100	3.7 x 5.9 x .01	94 x 150 x 0.2	22.89	20.59	18.49
228064CL	MPT6-75	6.0	50	4.5 x 3.0 x .01	114 x 75 x 0.2	13.89	12.49	11.29
228072CL	MPT6-150	6.0	100	4.5 x 5.9 x .01	114 x 150 x 0.2	27.89	24.99	22.49
228081CL	MP7.2-75	7.2	100	10.0 x 3.0 x .02	253 x 75 x 0.6	24.89	22.39	20.19
228099CL	MP7.2-150	7.2	200	10.0 x 5.9 x .02	253 x 150 x 0.6	39.89	37.99	34.99
228101CL	MPT15-75	15.4	50	10.0 x 3.0 x .02	253 x 75 x 0.6	26.89	24.29	21.99
228110CL	MPT15-150	15.4	100	10.0 x 5.9 x .02	253 x 150 x 0.6	44.89	42.99	39.99

Remote Control Aircraft Series

Designed to be easily integrated with Remote Control Aircraft or anywhere weight is critical. These modules are very lightweight and can be soldered to from the back of the module via the extended copper tape, and have an extra edge seal for protection. We offer output currents with and without a strong pressure-sensitive adhesive for simple bonding.

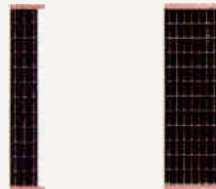

228128CL/228136CL 228144CL/228152CL

Part No.	Product No.	Operating Voltage (V)	Operating Current (mA)	Size (L x W x T)		Pricing		
				Inches	mm	1	10	100
228128CL	RC7.2-37	7.2	50	10.6 x 2.2 x .01	270 x 55 x 0.2	\$16.89	\$15.29	\$13.79
228136CL	RC7.2-37PSA*	7.2	50	10.6 x 2.2 x .01	270 x 55 x 0.2	19.39	17.49	15.79
228144CL	RC7.2-75	7.2	100	10.6 x 3.5 x .01	270 x 90 x 0.2	29.89	26.99	24.29
228152CL	RC7.2-75PSA*	7.2	100	10.6 x 3.5 x .01	270 x 90 x 0.2	32.89	29.79	26.79

*PSA = Pressure Sensitive Adhesive

WeatherPro Series

The right choice for permanent outdoor applications that are directly exposed to the elements. These modules feature rugged construction, a UV-stabilized surface, extra edge seal for weather protection, and tin-coated copper leads that extend from the module.

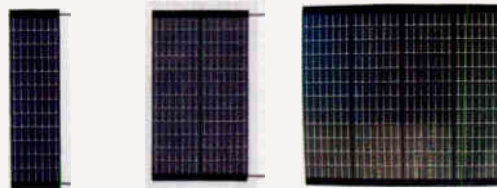

228161CL/228187CL 228179CL/228195CL 228208CL

Part No.	Product No.	Operating Voltage (V)	Operating Current (mA)	Size (L x W x T)		Pricing		
				Inches	mm	1	10	100
228161CL	P7.2-75	7.2	100	10.3 x 3.9 x .04	270 x 100 x 1.1	\$39.89	\$36.99	\$33.99
228179CL	P7.2-150	7.2	200	10.3 x 6.9 x .04	270 x 175 x 1.1	59.89	54.99	49.99
228187CL	PT15-75	15.4	50	10.3 x 3.9 x .04	270 x 100 x 1.1	39.89	36.99	33.99
228195CL	PT15-150	15.4	100	10.3 x 6.9 x .04	270 x 175 x 1.1	59.89	56.99	52.99
228208CL	PT15-300	15.4	200	10.3 x 12.8 x .04	270 x 325 x 1.1	99.89	94.99	89.99

Solar Cell Grab Bag Assortment

About 40 pieces of irregular sizes, shapes, and current ratings at 0.5VDC. Connect in series to increase voltage or connect in parallel to increase current.



Part No.	Description	1	10
215255CL	Solar cell assortment	\$9.89	\$8.99

Photovoltaic Solar Panel

- Output connection: conductive film requiring pressure contact or use of 3M conductive epoxy
- Rated 9.5VDC open circuit; 9VDC @ 0.06A in direct sunlight
- Size: 6.0"L x 6.0"W x 0.1"Thick



Part No.	Description	1	10
141751CL	0.5W solar panel	\$7.95	\$7.19

Miniature Glass Solar Panel



- Open circuit voltage: 16.5VDC in full sunlight
- Operating temperature range: -5° to +40°C
- Operating voltage: 12VDC @ 3mA
- Size: 3.6"L x 1.0"W

Part No.	Description	1	10
171985CL	Glass solar panel	\$7.89	\$7.19

DC Voltage Monitor Kit

If battery status is important, you need this kit. It uses 7 LEDs to monitor 12VDC in 1V, 0.5V, or 0.25V steps. Monitor 8V or 5V in 0.25V steps. Great for boats, motor homes, model planes or race car Ni-Cads.

- 46-piece kit
- Difficulty level: beginner
- Dimensions: 2.7"L x 1.3"W

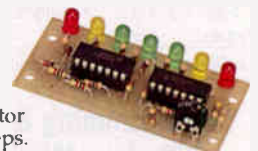

Part No.	Mfr. Cross Ref. No.	1	10
181833CL	VM-1	\$8.95	\$7.95

Even lower OEM pricing for larger orders!

Corporate Customers

Call 1-800-831-4242 for details today.

See pages 154-155 for Jameco's assortment of NiCAD and NiMH batteries.



Easy Microcontrol'n

Beginners Guide (Version 4)

Square 1 Publishing A revision of and the successor to Easy PIC'n that covers Peripheral Interface Controller (PIC) PIC16F84, writing programs, interrupts, timing and counting, and much more. (178 pages, 2002)

• Size: 8.5" x 11.0" • Weight: 1.2 lbs.

Part No.	Description	Price
215061CL	Easy Microcontrol'n	\$29.95



Serial Communications

Serial Communications PIC Applications

Square 1 Publishing Topics such as asynchronous serial communications, RS242 standard, ASCII character code, bit-bang asynchronous communications, synchronous serial communications to name a few are covered in this book as well as tool box modules and applications. (566 pages, 2002)

• Size: 8.6" x 11.0" • Weight: 3.5 lbs.

Part No.	Description	Price
210497CL	Serial Communications	\$49.95



PIC Microcontroller Project Book

Comprehensive Beginner's Guide

McGraw-Hill Provides you with hands-on directions for putting Microchip's RISC-based chips with up to 8k of memory to work. Starting with simple projects and experiments, this book leads you gradually into sophisticated programming techniques. Provides you guidance on getting the equipment you need and programming your chip. (203 pages, 2000)

• Size: 7.3" x 9.2" • Weight: 1.0 lb.

Part No.	Description	Price
174650CL	PIC Beginner's Guide	\$29.95



Programming & Customizing PICmicro Microcontrollers

Second Edition

McGraw-Hill Details the features of the PICmicro® and how to use these embedded chips to access and control many different devices. Shows what happens within the PICmicro® when an instruction is executed and how it interfaces with external devices. (1190 pages, 2001)

• Size: 9.2" x 7.3" • Weight: 4.0 lbs.

Includes: CD-ROM and PIC PCB

Part No.	Description	Price
183046CL	PICmicro Programming	\$49.95



Making Your Own Printed Circuit Board Book

JV Enterprises No darkroom or special equipment needed. Shows steps for drilling and shaping your printed circuit board and the materials you will need. (91 pages)

• Size: 8.5" x 11" • Weight: 0.5 lbs.

Part No.	Description	Price
141524CL	Making PCBs Book	\$19.95



Programming and Customizing 8051 Microcontrollers

McGraw-Hill Provides you with a complete understanding of the 8051 chip compatibles along with all the information needed to design and debug applications. Covers how to use these embedded chips to access and control many different devices. Includes over 30 experiments, 12 projects and CD-ROM featuring source code and PDF data sheets. (541 pages, 1999)

• Size: 7.5" x 9.2" • Weight: 2.5 lbs.

Part No.	Description	Price
161402CL	Program/Customizing	\$29.99 \$25.89



TTL LogicData Book

Texas Instruments Contains specifications and technical information on a broad line of TTL integrated circuits including Schottky TTL circuits. (1240 pages, 1988)

• Size: 6.0" x 8.5" • Weight: 2.6 lbs.

Part No.	Description	1	10
88225CL	TTL Logic Data Book	\$34.95	\$31.49



Practical Electronics Book for Inventors

McGraw-Hill Provides information needed for practical use in a format you can understand. With hand-drawn illustrations, this learn-as-you-go guide shows you what a particular device does, looks like and compares with other similar devices. Provides an easy-to-understand overview of basic components, resistors, diodes, capacitors, inductors, rectifiers, amplifiers, voltage regulators, discrete passive and active devices and so on. (604 pages, 2000) • Size: 8.4" x 11" • Wt.: 2.8 lbs.

Part No.	Description	Price
174529CL	Practical Electronics	\$39.95



Troubleshooting & Repairing Consumer Electronics without a Schematic

TAB Publishing Learn how to locate, test, and repair defective components in audio amplifiers, car radios, cassette decks, TV chassis, compact disc players, power supplies, AM/FM receivers and VCRs. (475 pages, 1997)

• Size: 7.4" x 9.3" • Weight: 1.1 lbs.

Part No.	Description	1	10
136080CL	Consumer Electronics	\$24.95	\$22.49



Controlling the World with Your PC

Hightext Publishing Make your PC control stepping motors, monitor fluid levels, or switch appliances on and off! Each of the circuits in this book connects directly to the parallel printer port of your PC and comes complete with a circuit diagram and listings for control software written in Pascal, C and BASIC. (257 pages, 1994)

Includes: 3.5" disk

Part No.	Description	Price
116943CL	Controlling the World	\$34.95

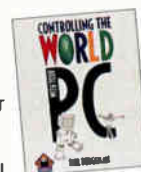

Electronic Pocket Reference

Third Edition

McGraw-Hill Publishing A pocket reference manual that provides definitions, passive component equations and color coding, parameters of standard semiconductor, linear circuits, filters, power supply and regulation, electronic measurement and mathematical tables and formulas. (529 pages, 2000) • Size: 4.0" x 6.0" • Weight: 0.9 lbs.

Part No.	Description	Price
174481CL	Electronics Pocket Ref.	\$29.95

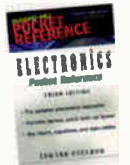

Analog and RF Circuits

Newnes Publishing The author, one of the leading analog and RF engineers, uses illustrations and examples rather than mathematical theory to present a wealth of ideas and tips based on his experience. Essential reading for anyone designing analog circuits. Topics include RF amplifiers, oscillator design and behavior, waveform analysis, optoelectronics, filters, and op-amps. (299 pages, 1998) • Size: 7.4" x 9.2" • Wt.: 1.1 lbs.

Part No.	Description	Price
200150CL	Analog and RF Circuits	\$49.95



Complete Embedded Ethernet and Internet Book

Lakeview Research A guide to designing and programming embedded systems to communicate in local Ethernet networks and on the Internet. This book is organized for anyone who wants to design, program, or learn about networking with embedded systems. Topics include networking basics, hardware options in building a network, using internet protocol in local and internet communications, serving web pages, etc. (482 pages, 2003) • Size: 7.0" x 9.0" • Weight: 1.7 lbs.

Part No.	Description	Price
236945CL	IC Design Projects Book	\$44.95

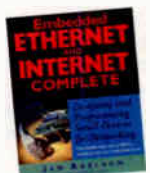

How to Test Almost Everything Electronic

TAB Publishing Filled with easy-to-follow instructions on how to troubleshoot all types of electronic systems. Learn the many uses of electronic tools, test equipment and troubleshooting techniques using flowcharts. (326 pages, 1993) • Size: 7.4" x 9.3" • Weight: 1.3 lbs.

Part No.	Description	1	10
126199CL	How to Test Everything	\$17.95	\$16.15



Lab Course and Lab Kit

Experiment guide contains nine fiber optic experiments. Kit contains all the fiber optic and electronic components needed to complete the experiments.

- Making a light guide • Fiber optic transmitter
- Fiber optic cable transmission
- Characteristics of connectors and splices
- Index-matching procedures • Receiver design
- Speed of opto-electronic devices
- Fiber termination techniques • Weight: 0.7 lbs.

Part No.	Description	1	10
169914CL	Lab course and lab kit	\$46.89	\$42.29



SHIPPING INFORMATION



Guaranteed Delivery Time for UPS Ground (Business Days)

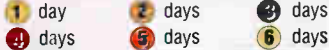

Orders received Mon.-Fri. by 6:00 p.m. Eastern Standard Time will be shipped the same day. Orders received Saturday and Sunday will ship the following Monday (except on holidays). If we are unable to fill your order on the day received, we will send you a gift certificate worth \$5.00 towards your next Jameco purchase. This offer does not apply to orders waiting for credit approval or backordered items.

Options and Rates*



Shipping delivery times are based on working days.

Ground Service

Up to 6 working days for commercial address (up to 9 working days for residential). Guaranteed delivery times may vary depending on zip code. \$6.95 for 1st 2 lbs.; \$0.79 for each additional lb.

2-Day Air Service

\$12.49 for 1st 2 lbs.; \$1.59 for each additional lb.

Next Day Air Service

- \$22.95 for AM delivery for 1st 2 lbs.; \$1.99 for each additional lb.
- \$16.95 for afternoon delivery for 1st 2 lbs.; \$1.99 for each additional lb.

Priority Mail (USPS)

\$4.95 for 1st lb.; \$1.99 for each additional lb. Order must be placed before 5:00 p.m. Eastern Standard Time to ship same day. Jameco reserves the right to rebill shipping surcharges for customer misaddressed packages.

* The above rates apply to single box shipments that are less than 50 lbs. Please call for shipping quote on packages greater than 50 lbs.

International Shipping & Handling

Shipping is via courier or postal service, depending on your preference, insurance availability, and the size and weight of your package. Jameco will apply actual shipping charges with a nominal handling charge on all foreign orders. For mail-in customers, please include 25% for shipping charges or call for a shipping quotation. All returns that meet postal requirements must be sent prepaid via air parcel post. All courier shipments to Canada and Mexico require a certificate of origin. Jameco will provide a certificate of origin for a \$25 processing fee.

POLICIES

Confirming Orders

Please do not send confirming orders. If company policy necessitates a confirming order, please mark "CONFIRMING" boldly on the first page of the order.

No Minimum Order

A \$5.00 processing fee will be added to orders under \$20.00.

5 EASY WAYS TO ORDER

Telephone: Toll-Free 24 hours a day!

1-800-831-4242

International orders, call 1-650-592-8097



Toll-Free

FAX:

US/Canada: 1-800-237-6948

Brazil: 000-817-455-6119

Columbia: 980-9-136748

Indonesia: 1-803-015-237-6948

Mexico: 001-800-593-1449

New Zealand: 080-044-0470

Other Countries: 1-650-592-2503

Online:

<http://www.Jameco.com>



On-line catalog! Our complete offering of over 9,000 products searchable on the Jameco website!

Mail:



E-mail your order to:

sales@jameco.com or fill out the order form (next page) and mail it to us.

In-Person:



Visit Jameco at 1355 Shoreway Rd., Belmont, CA. Will-call office hours are 8:00 a.m. – 5:00 p.m. Monday – Friday

CONTACT INFORMATION

The following services are available at 1-650-592-8097 Monday – Friday from 6:30 a.m. – 5:00 p.m. PST or via e-mail:

- International Sales (international@jameco.com)
- Customer Service (custservice@jameco.com)
- Credit Department (credit@jameco.com)
- Technical Support (tech@jameco.com)

Toll-Free Hotline!

Please call us at 1-800-831-4242.

A Nuestros Clientes en

La Republica Mexicana: Si usted requiere tratar en Espanol y adquirir nuestros productos facturados L.A.B. Cd. De Mexico (libres de Aduana) y enviados al interior del pais via Estafeta, contacte con nuestro Representante y Distribuidor exclusivo;

Proyeccion Electronica de Mexico, S.A. de

C.V. a: General E-mail: info@proyel.com

Quote E-mail: jmc@proyel.com

Phone/Fax: 01-(55) 5273-5029

Direccion:

Benjamin Franklin No. 166 Desp. 1
Col. Escandon Deleg. Miguel Hidalgo
C.P. 11800 Mexico, D.F.

Los demas paises de Latinoamerica: Ya pronto tendremos servicio en su Region. Si usted tiene alguna duda o comentario respecto a los servicios de Jameco, contacte con la empresa arriba mencionada en la Ciudad de Mexico, ellos le pueden ayudar.

PRICES

Prices are effective 4-19-04. In the unlikely event you find a lower price in a printed catalog or magazine, simply call us with the details at the time of purchase. We'll match any price above our cost. Prices and discounts are subject to change without notice. We are not responsible for any typographical errors in this catalog. Photos are representative; product appearance may vary.

ONLINE INFORMATION

Get answers to frequently asked questions on the Jameco website at:

<http://www.Jameco.com>

PAYMENT OPTIONS

Credit Card/Check Cards

We accept VISA, MasterCard, American Express and Discover. No surcharge. Your account will not be charged until your order is shipped. When ordering, please advise name on card and credit card billing address.

Check or Money Order

You may pay by check or money order in U.S. funds, drawn on a U.S. bank.

Open Account

It is easy to open an account with Jameco. Contact us for obtaining open account status.

C.O.D.

Personal checks are accepted. Please add \$7.00 per C.O.D. order. Include the name and address of your bank and your account number.

International Orders

All foreign orders must be prepaid with a credit card (see approved credit cards above), wire transfer, traveler's check, cashier's check or money order drawn on a U.S. bank in U.S. funds only. Please do not send cash. Jameco cannot accept letters of credit as a form of payment.

E-mail: international@jameco.com.

SERVICES

30-Day Money Back Guarantee

If for any reason you are not completely satisfied with your purchase, simply return the product, in its original packaging, within 30 days for a refund, credit or exchange. Parts returned due to customer ordering error may be subject to a restock fee. Call our customer service department at 1-800-536-4316 or visit www.Jameco.com to request an RMA#. It should appear clearly on the outside of the box. Returns without an RMA# will not be accepted, and no freight collect packages will be accepted. A completed Jameco customer service form, located on the back of the packing slip, must be included with your return. We're sorry, but books, kits, software, grab bags and special orders cannot be returned. Special orders consist of products sold at an OEM quantity discount or products not listed in the Jameco catalog.

Jameco Warranty

Jameco warrants all merchandise against defects in material or workmanship for a period of 90 days from the original purchase date unless otherwise stated in writing by Jameco. If Jameco receives the product considered to be defective within this warranty period and the product is determined to be defective, Jameco will, at its sole option and discretion, either repair or replace the product. The foregoing is your sole and exclusive remedy and states Jameco's entire liability arising out of this warranty. [However, Jameco will transfer to customer whatever transferable warranties and indemnities Jameco receives from the manufacturer of the products. Any claims arising from such manufacturer's warranties shall be the sole responsibility of the manufacturer and not of Jameco.] Moreover, Jameco's limited warranty is void if the damage or defect has resulted from improper customer assembly, failure by customer to follow instruction, product modification, negligent or improper operation, accident, abuse or misapplication. Products returned to Jameco pursuant to this warranty must be returned to Jameco prepaid.

No Other Warranties

The limited warranty above is exclusive and in lieu of all other conditions and warranties for the products and documentation. Jameco makes no other conditions or warranties, express, implied, statutory or otherwise, and expressly disclaims all other conditions and warranties, including but not limited to, implied conditions or warranties of merchantability, fitness for a particular purpose, and non-infringement of the products.

Limitation of Liability

Jameco shall not be liable for any incidental, special or consequential damages for breach of any warranty, expressed or implied, directly or indirectly arising out of Jameco's sale of merchandise, including any failure to deliver any merchandise, or arising out of customer's installation or use, whether proper or improper, of the product, separately or in combination with other equipment, or from any other cause. Products sold by Jameco are not authorized for use as critical components in life support devices or systems.

Order Form

See previous page for Ordering Information

Fax 1-800-237-6948 Order 24 hours/7 days a week!

Jameco, 1355 Shoreway Road, Belmont, CA 94002 Call: 1-800-831-4242 International TEL: 1-650-592-8097 FAX: 1-650-592-2503

1 Ordered By (We will ship to this address unless you enter #2).

Customer No. _____ VIP No. _____
(see back cover)

Company _____

Name of Requisitioner _____ Title _____

Name of Purchasing Agent _____ Title _____

Street Address/PO Box Number _____

City _____ State _____ Zip Code _____

Contact information (please provide all information and check method preferred)

() _____
Daytime phone number - Required for Credit Card Orders

() _____
Fax Number

E-mail Address _____

Please check this box if you prefer not to receive special offers via e-mail from Jameco.

2 Ship To (Only required if different from #1)

Company _____

Name _____ Title _____

Street Address/PO Box Number _____

City _____ State _____ Zip Code _____

3 Method of Payment

Prepaid (check enclosed) C.O.D. (\$7.00 service charge)

Net 30 Days (Account must be previously established. Authorized P.O. # required.)

PURCHASE ORDER NO.: _____

Credit Card

Credit Card users only:



Credit Card Number

Exp. Date: Month Year Name on card _____

Billing Address Street/PO Box _____ City/State/Zip _____

4

ITEM NO.	QTY.	PART NUMBER	DATA SHEETS	DESCRIPTION	PAGE NO.	WEIGHT (LBS.)	UNIT PRICE	TOTAL
1								
2								
3								
4								
5								
6								
7								
8								
9								
10								
11								

5 Please Check Shipping Method Below



- Priority Mail (USPS)\$4.95 for 1st lb., \$1.99 for each additional lb.
- Ground\$6.95 for 1st 2 lbs., \$0.79 for each additional lb.
- 2 Day Air Service\$12.49 for 1st 2 lbs., \$1.59 for each additional lb.
- Next Day Air Service (AM delivery).....\$22.95 for 1st 2 lbs., \$1.99 for each additional lb.
- Next Day Air Service (PM delivery).....\$16.95 for 1st 2 lbs., \$1.99 for each additional lb.
- Foreign Shipment via Air Parcel PostShipping approximately 25% of order total. Excess fees will be refunded. Additional shipping methods available

Some restrictions may apply. See order information (previous page) for other shipping methods and conditions of sale. Shipping rate is based on a single package shipment.

TOTAL WEIGHT	SUB-TOTAL
	Add \$5.00 processing fee on orders under \$20
	Please Add Applicable Sales Tax (California Only)
	Shipping (See Item 5)
	C.O.D. (add \$7.00)
	Canada and Mexico Certificate of Origin (\$25)
	Credit Memo (please attach)
	TOTAL

6 **JAMECO** thanks you for Your Order!

FOR OFFICE USE ONLY
_____ / _____

Red indicates new products found throughout the catalog.

A

A/D CONVERTERS	16,20
ACCELEROMETERS	222
ACCESS PANELS	158
ADAPTERS	
Audio/Video	64,65,85,175
Binding Post to BNC	202
BNC	80,81
Digital Audio Optical	64
D-Sub	85
Hard Drive	68
Keyboard	68,85
Modular Telephone	79
Network	79
Null Modem	85
PLCC	31
SCSI	68
Serial	85
SMA/SMB	80,82
SMD Adapters	26
Telephone	79
Token Ring	62
UHF	80
USB	67,164
Wall Transformers	143,148
ZIF	28
ALLIGATOR CLIPS/CONNECTORS	202,204
ANTI-STATIC EQUIPMENT	207
APPLE/MACINTOSH PRODUCTS	
	85,154,159,161,172
AUDIO EQUIPMENT	
Amplifiers	224
FM Transmitters	224
Headphones	167
Microphones	159
RCA Cables	64,65
Sound Cards	161
Speakers	102,159
AUTOMOBILE PLUGS	152
AUTOMOBILE POWER INVERTERS	152

B

BANANA PLUGS/JACKS	202,237
BASIC STAMP CONTROLLERS	220,221
BATTERIES & ACCESSORIES	
Alkaline	153,154,172
Chargers	155
Holders & Snaps	153
Lead Acid	156,237
Lithium	154,155
Lithium Ion	155
Ni-CAD	154,155
NiMH	154,155
Rechargeable	155
Silver Oxide	154
Tester	153
Zinc Chloride	154
BINDING POSTS	202
BNC CABLES/CONNECTORS/ADAPTERS	
	80,81,203
BNC CONNECTOR REMOVAL TOOLS	183
BOOKS	86,156,164,199,219-221,228
BOTTLE, PUMP	212
BOXES	103,104,148
BRACKETS/MOUNTING RAILS	
	67,68,158,168,175
BREADBOARDS	29-32
BREAKOUT BOXES	204
BUFFER, PRINTER	169
BUG BOXES AND TRAYS	103
BUZZERS	103

C

CABINETS/ENCLOSURES	103,104,148,168
CABLE CRIMPERS	72,180,181,185
CABLE MARKERS	61
CABLE SLEEVES	61
CABLE STRIPPERS	72,180,181,185
CABLE TESTERS	172,204
CABLE TIES & CLAMPS	61,63
CABLE, ASSEMBLIES AND BULK	
Adapter	66
Audio	64,65,158
BNC	81,203
Break-Out Box	204

Category 5 (UTP) Network	62
Category 5e	59
Category 6 RJ45 Network	62
Centronics	66
Coaxial	56,57,60,81
DB25-Pin Extension	66
Digital Audio Optical	64
Extension	66,68
Fiber Optic	78
Floppy Drive	68
F-Type Coaxial	82
Hard Disk Drive	68
IEEE 488/1284/1394 Cable	66,67,85
Keyboard	66,68,169
Management	61,63,168,172
Modem	66
Modular Telephone	79
Monitor	66,169
Mouse	66
Multi-Conductor	59
Network	62,79
Null Modem	66
Paired	58,59
Panel Bracket	68
Patch	65
Power Cords	69,111,150,171
Printer	66,67,85
RCA	64,65
Retractable (USB/Firewire)	67
Ribbon	60,68,163
SCSI	68
Serial	66,85
Shielded	60,66,163
SMA/SMB	82
S-VHS	65
Switch Box	66
Telephone	79
Testers	66,204
Ultra DMA 66	68
USB	67
Video, Patch	65
Video, RGB	64,66
Wireless	184
CAMERAS AND ACCESSORIES	
Antennas/Boosters	174
Board	173
CCD	173,175
Dome	175
Enclosed	173-175
Infrared	175
Lenses	173
Mounts, Mounting Kits, Brackets	174,175
Siren	175
Surveillance	174
Transmitters/Receivers	174
USB	161
Wireless	174
CAPACITORS	
Assortment/Kits/Grab Bags	34,216
Ceramic Disc	45
Dipped Tantalum	48
Electrolytic, Axial	45
Electrolytic, Large Can Aluminum	44
Electrolytic, Radial	44
Kits	34
Memory Back-Up	48
Monolithic, Ceramic	45
Mylar	46
Silver Mica	46
Surface Mount Capacitors	43
Tantalum	43
Trimmer, Ceramic	48
CARDS, COMPUTER	
Camera Board	173
Controller	163
Data Acquisition	163
Diagnostic	172
Graphic	161
Hard/Floppy Disk Drive Controller	163
Input/Output	162,163
Interface	163
Network	166
Parallel	162
Printer	162
Prototyping	28,30,31
SCSI	163
Serial	162
Sound	161
USB	164

CD-ROM DRIVES & ACCES.	158
CD-Rs	158
CELL PHONE ACCESSORIES	
Headset	167
CHEMICAL CLEANERS & ACCES.	213
CHOKES	53
CIRCUIT BOARD MNTG HARDWARE	
	104,105
CIRCUIT BOARDS	29,30,213
CLEANERS/DEGREASERS	213
CLIPS	
Alligator	202
Battery	153
Test	8,203
CLOCK CHIPS	16
CLOCK MODULES	16
CLOCKS/TIMERS	206
COMPASS MODULE	222
COMPONENT ASSORTMENTS	
Carbon Film Resistors	33,47
SMD Resistors	43
COMPONENT CABINETS	103
COMPUTER	
Accessories	158
Board/Cards	161-164,166,168,172,220,221
Brackets	67,68,158
Cables, Int./Ext./Network	66,68,158,169
Cameras	161,173,175
Cases/Enclosures	158,168
CPU Fans	107
CPUs/MPUs	105
Data Acquisition, Cards/Software	163
Drives	158,164
Fans	107
Hardware/Brackets/Rails	67,158
Industrial Products	163,168
Keyboards	160,168
Keypads	160
Kits/Grab Bags	216
Lights	161
Math Coprocessors	5
Memory	156
Mice	159,237
Monitor	161,173
Motherboards	156
Power Cords	69,150,171
Power Supplies	157
Prototype Boards	28-30,31
Signal Converter	167
Switch Boxes	169
Trackballs	159,160
Video Cards	161
Video RAM	5
CONNECTORS	
Amphenol	80
ATX	75
BNC	62,80,81
Card Edge	78
Centronics, IDC/PCB Right Angle	84
Centronics, Parallel Interface	84
Coax	80,81
Contacts	70,72,73
DIN	84
D-Sub, Hardware/Hoods/Crimp Housing	
	70,71
D-Sub, IDC/Solder Cup	70,71
D-Sub, PC Mount, Right Angle/Straight	71
Gender Changers	67,85
Header Housings	73-75
Header Receptacles	73,84
Headers	73-75,77,78,83,84
Housings, Square Pin	75,78
IDC Plug & Socket/Wire	63,78,84
Jones Plugs and Sockets	82
Modular/Telephone	62,63,79
Molex	73
Network	62,79,166
Pins, Crimp/Power	70,72-75
Power	72,73,75
RCA Jacks/Plugs	64,65
Shorting Blocks	77
SMA/SMB	82
Telecom Splice	63
Telephone	63,79
Terminal Blocks	83
Token Ring	62
USB	78

CONSUMER PRODUCTS	
Vacuums & Accessories	186
Weather Station	206
CONTROLLER CARDS	163
CONTROLLERS	
Micro	6,7,8,220,221
Motor	86,220,223
PIC	6-8
Robotics	220,221
CONVERTERS, DC-DC	
Encapsulated	134-138
Enclosed	137,138
Non-Isolated	133
Open Frame	135,136,138
CONVERTERS, SIGNAL	167
COOLERS, THERMOELECTRIC/CHIPS	107
CORDS, POWER	69,150,171
COUPLERS, SHAFT	217
CPUs	5
CRIMP PINS	70-75,78
CRIMPING TOOLS	72,180,181,185
CRYSTALS/OSCILLATORS	55

D

D/A CONVERTERS	16,20
DATA ACQUISITION	163
DATA BOOKS	86,156,164,199,219-221,228
DC/GEARHEAD MOTORS	90,91
DC-AC INVERTERS	152
DC-DC CONVERTERS	133-138
DESOLDER STATION & EQUIP	
	207,209,212
DIGITAL I/O MODULES/CARDS	98,163
DIGITAL LABS	32
DIGITAL MULTIMETERS	188,189-194,204,205
DIGITAL PANEL METERS	39
DIN-RAIL PRODUCTS	139
DIODES	
Diac	23,25
Germanium	22
Infrared (LEDs)	37
Kits/Grab Bags	34,216
LED Displays	40
LEDs	36-38
Miscellaneous	25
Quadrac	23
Rectifiers, Bridge, SCR	23,25
Sidac	25
Surface Mount	22
Switching	22
Transient Voltage Suppressor	22,25
Triac	23,25
Zener	22,25
DIP SWITCHES	96
DISPLAYS, LED & LCD	38-40
DISPLAYS, VIDEO TEXT	173
DRILL BITS	186
DRIVES, COMPUTER	
Accessories	68,158
CD-ROM	158
Floppy	158
Hard	158
PCMCIA	158
Thumb Drives	164

E-F

EDUCATIONAL ELECTRONIC LABS	32
EEPROMS	4
ELAB	16
ELECTRONIC KITS	99,206,217-219,221-226,228
EMI SUPPRESSION CORE	151
ENCLOSURES	103,104,148,158,163,168
EPROM ACCESSORIES	27,28,207
EPROM PROGRAMMERS/ERASERS	26-28
ESP SMT TOOLS & ACCESSORIES	29
ETHERNET PRODUCTS	166,167
FANS & ACCESSORIES	
AC Tube-Axial	110,111
Brushless DC	108-110
Cooling System	107
Cords	111
CPU Heat Sink w/ Fan	107
Filters	111
Guards	111
PC	107

Product Index

Red indicates new products found throughout the catalog.

FAX/MODEMS	167
FIBER OPTICS	78,228
FILES	183
FILTERS, PWR. ENTRY/LINE/AC PLUG	143,151
FIREWIRE CABLES	67
FISH TAPE	184
FLASHLIGHTS/ACCESSORIES	214
FLOPPY DRIVES/ACCESSORIES	68,158
FLUORESCENT LAMPS	42
FREQUENCY COUNTERS	199-201
FUME EXTRACTOR & ACCES.	207
FUNCTION GENERATORS	198,200,201
FUSES & ACCESSORIES	
Clips	54
Fuses	54
Holders	54
Resettable Fuses	54
Thermal	25

G-H

GALs	8
GEARS	217
GENDER CHANGERS/ADAPTERS	67,85
GENERATOR, TELEPHONE RINGER	167
GIPB (IEEE-488)	
Cables	85
Cards, PC	163
GLUE GUN & STICKS	184
GRAB BAGS	103,216
GROUNDING/STATIC CONTROL	207
HALL EFFECT SENSORS	98
HANDY BOXES	103,104,148
HARD DISK DRIVES/ACCES.	68,158
HARDWARE	
Cable Mounting	61,63
Computer Brackets	68
Drive Mounting	158
Fan Guards	111
Handles	105
Heat Sink Mounting	107
Kit	34,216
Knobs	106
LED Mounting	42
PCB Mounting	104,105
Prototype Enclosures	104
Rubber Feet	105
Screws, Nuts, Washers	71,104,105,168
Spacers	71,104,105,216
Standoffs	105
HEADER PLUGS	78
HEADERS	73,74,77,83,84
HEADSETS/HEADPHONES	167
HEAT GUNS	184
HEAT SHRINK TUBING	63
HEAT SINKS & ACCESSORIES	
486/Pentium Heat Sink & Fan	107
Clip on	212
Compound	107
CPU	107
Mounting Kits	107
Thermo Pad	25
TO-3, TO-218, TO-220	107
HOME OFFICE	
Ink Cartridge	165
Lights	161
Printers & Accessories	159,165
Stapler/Staples	182
HOODS, D-SUB	70,71
HUBS	164,166,167

I

I/O CARDS	162,163
I/O MODULES/MOUNTING BOARDS	98
IEEE 1284 CABLES	66,85
IEEE 1394 CABLES (Firewire)	67
IEEE 488 (GIPB)	
Cables	85
Cards, PC	163
INDUCTORS, TOROID	53
INDUSTRIAL COMPUTING	168,172
INFRARED	
Cameras	175
Diodes	37,78
Kits	218,222
Remote Control Modules	222
Thermometers	206
USB Transceiver	164

INPUT DEVICES	
Accessories	66,68
Keyboards/Keypads	160,168
Mice/Pointing Devices	159,237
INTEGRATED CIRCUITS	
4000-CMOS (DIP/SMT)	12,13,15,33
5000 Series	16
6500 Series/Commodore	5
6800/68000 Series	5,6
7400-TTL (DIP)	13,33,216
74AC-TTL (DIP)	13,14
74ACT-TTL (DIP)	14
74AHC-TTL (DIP)	14
74AHCT-TTL (DIP)	14
74ALS-TTL (DIP)	14
74C-TTL, CMOS (DIP)	13,15
74HC-TTL, CMOS (DIP/SMT)	9,10
74HCT-TTL, CMOS (DIP/SOIC)	10,11
74LS-TTL (DIP/SMT)	11,12,33,216
74S-TTL (DIP)	15
8000 Series	6,8,15
9000 Series	15
A/D & D/A Converters	16,20
Assortment	33,216
Atmel (AT89C Series)	8
Basic Stamps/Accessories	221
Clock Chips	15,16
Clock Modules	16
CMOS Devices (DIP/SMT)	8,15
CMOS PIC Microcontrollers	6-8
Converters	16,20
CPUs/MPUs	5
Dallas Semiconductors	15
Decoder/Encoder Chips	16
Development Tools	29,183
Digital Interface	16
E-Lab Digital Interface	16
Embedded Microcontrollers	221
EPROMs & EEPROMs	4
Flash Memory	5
GALs and PALs	8
Interface Series	15,16
Kits	33
Linear Series (DIP/SOIC/TO)	15-20,24,33
Math Coprocessors	5
Maxim-Type Interface	15
Memory Chips	5
Memory Modules	156
Microchip	6-8
Microcontrollers	6-8
Microprocessors	6-8
Optoisolators	35
PALs and GALs	8
PEEL(TM) ICT CMOS	8
Pentium/Processor Chips	5
PIC	6-8
PROMs	4,8,15
RAM	5
Servo & Stepper Motor Controller	16
SMT	15,17,19
Sockets	25,33,76,77,216
Storage Tubes	207
Surface Mount	15,17,19
Test Clips	8
UARTs	16
V20 Chip	6
Voice Chips	8
Voltage Regulators	16,17,24
Z80 Series	5
INVERTERS	152
ISOCOM OPTOISOLATORS	35

J-K

JACK SCREWS/HEX NUTS	71,105
JOYSTICK ADAPTER, USB	164
JUMPER LEADS	32
KEYBOARDS	160,168
KEYCHAINS	215
KEYPADS	78,97,160
KITS, COMPONENTS	
Assortment	33
Capacitors	34,216
CMOS, CD4000 Series	33
Diodes	34,216
Grab Bags	103,216
Hardware, Mounting	34,216
IC Kit, 7400 Series	33,216

IC Kit, 74LS00 Series	33,216
IC Sockets	33,216
LED Hardware	33
LEDs	33,216
Linear ICs	33,216
Potentiometers	34,216
Refills	33,34
Resistors	33,47,216
SMD Resistors	43
Switches	34,216
Transistors	34,216
KITS, ELECTRONICS	
Audio Transmitters and Amplifiers	224
BASIC Stamp Programming	221
Clock	223
Compass Module	222
DIY	42
Electronic Locks	225
Fiber Optics	228
Infrared Transmitters and Receivers	222
Liquid Level, Distance and Light	218,222
Motor Controller	223
PC Photo Etch	213
PCB Design Kit	213
Power Supply	223
Radar	218
Relay Controller	219
Robot Kits	219,220
Solar	226
Sound Generation and Detection	225
Speech and Recognition	225
Test & Measurement	222
Timers	206,223
Velleman	218,219,222-225
KNIFE SET	182
KNOB	106

L-M

LAMPS AND ACCESSORIES	
Fluorescent	42
Incandescent	41,42
Magnifier/Desktop	214
Neon	41,42
Panel Mount	42
Power Supplies	42
LAPTOP PRODUCTS	69,164,166
LASER	
Accessories	215
Diodes	215
Levels	215
Pointer	215
Tachometer	205
LCD DISPLAYS/MODULES	38,39,173
LEADS, TEST	172,201-203
LED HARDWARE	42
LEDs	
Accessories/Hardware	33,42,216
Cable Assemblies	42
Clusters	40
Displays	40
High Output	37
HLMF Series	38
Infrared	37,218
Kits/Grab Bags	33,216,222
Panel Indicators	42
Standard Output	38,38
LENSES (Camera)	173
LIGHT METER, DIGITAL	205
LINE SEPARATOR, AC	204
LOCK BOXES	175
LOGIC PROBE AND PULSER	199,204
MACINTOSH PRODUCTS	85,154,159,161,172
MAGNETIZER/DEMAGNETIZER	184
MAGNIFYING GLASSES/LAMPS	214
MARKERS	61
MATH COPROCESSORS	5
MEMORY	
Batteries	154
Capacitors	46
DIMM	156
EDO	156
SIMM	156
METERS	
Accessories	205
Benchtop	168,194
Clamp	204
DIMM	189-193,205,206

Environmental	205,206
LCR	192,193
Pocket	189-193
Temperature/Time	205,206
MICE AND ACCES.	159,237
MICROCONTROLLERS	6-8
MICROMETER	184
MICROPHONE	
Cartridge/Condenser	102
PC Desktop	159
MICROPROCESSOR CRYSTALS	55
MICROPROCESSORS	5,6,221
MODEMS/FAX	167
MODULAR JACKS & ADAPTERS	
DC	62,63,79,80
MODULATORS	173
MONITOR STAND/BRAKETS	168,175
MONITOR TESTER	172
MONITORS	161,173,175
MOTHERBOARDS	156
MOTION DETECTOR	218
MOTOR CONTROLLERS	86,220,223
MOTORS	
DC	89,90
Geared	90,91,92
Servo/Radio Controlled	217
Shaft Couplers	217
Stepper	87,68
Stepper Controllers	86,223
Vibrating	91,92
MOUSE PAD	159
MULTIMEDIA	159,161
MULTIMETER TEST PROBES	201-203
MULTIMETERS	168,169-194,204
MUSCLE WIRE	218

N-O

NETWORK PRODUCTS	62,79,166,167,172
NUTS	71,105
OPTICAL SWITCHES	35
OPTOELECTRONICS	35
OPTOISOLATORS	35
ORDER FORM & INFORMATION	229,230
OSCILLATORS/CRYSTALS	55
OSCILLOSCOPE PROBES/ACCESSORIES	197,199
OSCILLOSCOPES	195-199

P-R

PALs	8
PANAVISE	84,212,213
PANEL METERS	39
PATCH CORDS	62,202
PATCH PANELS	172
PC BOARDS/EXTENDERS	28,29,30,31
PC PHOTO ETCH	213
PCB DEVELOPMENT TOOLS/ACCES.	213
PCI CARDS	31,161-164,166,168,172
PEELS	8
PHONE JACKS	62,63,79
PHONE LINE FILTERS (DSL)	167
PHOTO TRANSISTORS	35
PHOTOCELLS	35
PIC MICROCONTROLLERS	6,7,8,28
PIN INSERT/EXTRACT TOOLS	73
PLUGS	
Banana	202
DIN, IDC, DIP	78,84
Power Entry	143,151
Power, Low Power	65,152
RCA	65
POTENTIOMETERS	
Adjustment Tool	183
Bourns	49,50
Cermat	49,51,52
ClaroStat	48
Kits/Grab Bags	34,216
Linear Taper	48,49,52
Trimmer	50-52
POWER BASES/STRIPS	171
POWER CONNECTORS/PINS	
AC Plug	143,151
AT/ATX Motherboard	75
Disk Drive, Power Supply	75
Entry Filter	151
Kits	73
Pins	74,75
Plugs/Receptacles	72

Red indicates new products found throughout the catalog

POWER CONVERTERS 133-138,152
 POWER CORDS/ADAPTERS 69,111,150,171
 POWER ENTRY & LINE FILTERS 151
 POWER INVERTERS 152
 POWER JACKS/PLUGS 65,152
 POWER PINS 74,75
 POWER PROTECTION 170,171
 POWER SUPPLIES
 AC Variable Transformers 151
 AC/DC 113-132,139-143
 Benchtop 195,196
 Breadboard 32
 Computer 157
 DIN-Rail 139
 Enclosed 113-123,128,131,132,139
 Kits 223
 Linear 139,140,142
 Low Leakage 124,143
 Medical 124,143
 Open Frame 124-132
 Switching 113-132,139-141,143,147
 Table-Top 140-142
 Unregulated 142
 Wall Adapters 143-148
 POWER TOOLS 186,187
 POWER TRANSFORMERS 149,151
 PRESSURE SENSOR 98
 PRINTED CIRCUIT BOARD SUPPLIES 30,31,213
 PRINTERS & ACCESSORIES
 Auto Switchers/Switch Boxes 169
 Buffers/Sharers/Networks 165,169
 Extenders 165
 Ink Cartridges 165
 Printer 159,165
 PROBES 172,197,199,203,204
 PROGRAMMERS 26-28
 PROMS 4,8,15
 PROTOTYPE ADAPTER 31
 PROTOTYPE BOARDS 28-31
 PROXIMITY SWITCH SENSORS 98
 PUNCH DOWN TOOLS 183,165
 RACKS/RACK MOUNT EQUIP. 158,168,172,202
 RAM 5,156
 RCA JACKS/PLUGS/CABLES 64,65
 RECTIFIERS 23,25
 RELAYS
 DIP 100
 General Purpose 99,101
 PCB 99
 Power 99
 Reed 101
 Sockets 99,101
 Solid State 100
 RESETTABLE FUSES 54
 RESISTORS
 Assortments 33,47
 Carbon Film 33,47
 Kits/Grab Bags 33,216
 Network 47
 Surface Mount 43
 RFI POWER/LINE FILTERS 151
 ROBOTICS 217,219,220
 ROTARY SWITCHES 96
 RUBBER FEET 105

S

SCREWS 71,105,168
 SCRs 23
 SECURITY 173-175
 SENSORS
 Hall Effect 98
 Light 37
 Liquid 98
 Pressure 98
 Proximity 98
 Ultrasonic 98
 Vibration 98
 SERVOS/CONTROLLERS 86,217,220,223
 SHAFT COUPLERS 217
 SHORTING BLOCKS 77
 SHRINK TUBING 83
 SIMMS 156

SOCKETS & ACCESSORIES
 Assortment, Kits/Grab Bags 33,216
 DIP 84
 DIP 76,77
 Header Plugs 78
 Machine Tooled 76,77
 Oscillators 55
 PLCC 29,78
 PLCC Prototype Adapter 31
 Relay 99
 SIMMS/SIPP 76,77
 Slim Line 76
 Sockets 99,101
 Solder Tail 76,77
 Wire Wrap 76
 Wire Wrap ID Labels 76
 ZIF 77

SOFTWARE
 Data Acquisition 183
 Diagnostic 172
 PIC Programmer 28
 Reference 156,228

SOLAR PRODUCTS
 Cells 226
 Chargers 226
 Kits 219,226
 Lights 175,226
 Miscellaneous 226,227
 Modules 227
 Panels 226,227

SOLDER/DESOLDERING EQUIP.
 Accessories 207-210,212
 Pots 207
 Pump 207
 Solder 207,210,212
 Sponges 209
 Stations/Irons/Kits 207-211
 Tips 207-211
 Tools 213

SOLDERLESS BREADBOARDS 29,31
 SOLENOIDS 92
 SOUND CARDS 161
 SOUND DEVICES/BUZZERS 102,103
 SPACERS 34,71,104,105,216
 SPEAKERS 102,159
 SPECTRUM ANALYZER 198
 STANDOFFS 34,104,105,216
 STATIC CONTROL 207
 STATIC RAM 5
 STEPPER MOTOR CONTROLLERS 16,86,223
 STEPPER MOTORS 87,88
 STOPWATCHES 206
 STORAGE, CABINETS 103,181
 STRAIN RELIEF BUSHINGS 83
 SUBSTITUTION BOXES 32
 SURFACE MOUNT
 Capacitors 43
 Cases, Storage 103
 Diode 22
 ICs 9-13,15-19
 PLCC Sockets 76
 Resistors 43
 Tools 29,208
 Transistors 20,21
 SURGE PROTECTORS 170,171
 SWITCH BOXES/CABLES 66,167,169
 SWITCHES
 AT Computer 96
 Binary 96
 DIP 96
 General Purpose 95
 Keylock 95
 Kit/Grab Bag 34,216
 Magnetic Reed 95
 Optical 35
 Pushbutton 94-96
 Rocker 96
 Rotary 96,97
 Sensor 98
 Slide 93
 Snap Action 95
 Tactile 97
 Thumbwheel 96
 Toggle 93

T

TABLE-TOP POWER SUPPLIES 124,140-143
 TAPE MEASURE 184
 TECH SPRAY CHEMICALS & ACCES. 213
 TELEPHONE ACCESSORIES 167
 TELEPHONE CONNECTORS 62,83,79,167
 TEMPERATURE/TIME METERS 191,205,206
 TERMINALS
 Blocks 75,83
 DIN Rail Blocks 83
 European 83
 Solderless 83
 Wire Wrap 30
 TEST EQUIPMENT
 Anemometer 205
 Benchtop 194
 Benchtop Power Supplies 195,196
 Cable/Interface 172,190,197,204
 Current Clamp Meter 204
 Electrical Safety 200
 Environmental 205,206
 Fluke 188,197,198
 Frequency, Counter/Generator 199-201,205
 Hi-Pot 200
 IC Test Clips 8
 Leads/Probes 172,188,192,197,199,201-203
 Light Meter, Digital 205
 Line Separator 204
 Logic Probe 199,204
 Monitor 172
 Multimeter, Analog/Digital 188-194,204,205
 Multimeter, Benchtop 194
 Oscilloscopes 195-199
 pH Meter 205
 Probes 192,197,199,203,204
 Programmable Testers 26,27
 Shunt 204
 Signal Generator/Analyzer 198
 Software 190,197
 Sound Level Meter 205
 Spectrum Analyzer 198
 Substitution Boxes 32
 Tachometer 205
 Temperature/Time 205
 Thermometers 205,206
 Tone/Telephone 172
 Video 172
 Voltage/Metal Detectors 192,222
 TEST LEADS/PROBES/CLIPS 8,172,188,192,201-204
 THERMISTORS, NTC 53
 THERMOELECTRIC COOLERS/CHIPS 107
 THERMOMETERS 205,206
 TIE MOUNTS 61,83
 TIME/TEMPERATURE METERS 191,206
 TOKEN RING ADAPTER 62
 TOOL KITS 29,172,176-179,181-183,186,187
 TOOLS
 Anti-Static 207
 Bits (Rotary) 186,187
 Calipers 184
 Cases 177
 Center Punch 183
 Compression 180
 Crimping/Stripping/Cutting 72,179-181,165
 Drills 186
 File Sets 183
 Fish Tape 184
 Glue Gun 184
 Grinder (Electric) 187
 Heat Guns 184
 Hemostat 182
 IC 29
 Insertion/Extraction 29,70,73,183
 Kits/Sets 29,176-179,181-183,186
 Knife Set 182
 Lead Forming 182
 Micrometer 184
 Miscellaneous 29,83,207
 Nibbling 183
 Pliers 178,179
 Pocket Multi-Tool 181
 Power 186,187
 Punch-down 183,165

Ratchet/Socket Drivers 178,182
 Reamer 183
 Rivet 182
 Saws 184,186
 Screw/Nut Drivers 178,186
 Snips/scissors 180
 Soldering 207-213
 Spring-Hook 184
 Stapler/Staples 182
 Tape Measure 184
 Tweezers 183,214,237
 Vises 84,212,213
 Wire Wrap 183
 Wire/Coax Cutters/Strippers 180,185
 Wrenches 178,179,182

TRACKBALLS 159,160
 TRANSFORMERS
 Current 150
 International Step Up/Down 150
 Isolated 151
 Modem Coupling 150
 Power/Split Bobbin 149,151
 Table-Top 148
 Variable 151
 Wall (AC and DC) 143-148
 TRANSISTORS 20-25,34,216
 TRANSMITTER, CAMERA 174
 TRIAC COUPLER 35
 TRIACS 23
 TWEEZERS 29,183,237

U-Z

UARTS 16
 ULTRASONIC SENSORS 98,218
 UPS SYSTEMS 170
 USB PRODUCTS
 Adapters/Connectors 67,78,164
 Cable 67
 Cameras 161
 Cards 164
 Hubs 164
 Miscellaneous 67,164,237
 Pocket/Thumb Drives 164
 UVP EPROM ERASERS 28
 VACUUM PENS 207
 VACUUMS AND ACCESSORIES 186
 VARISTORS 53
 VGA/VIDEO CARDS 161
 VIDEO ADAPTERS 175
 VIDEO CONVERTERS 161
 VIDEO MODULATORS 173
 VIDEO MONITORS 161,173
 VIDEO RAM 5
 VISES 212,213
 VOICE CHIPS/MODULES 8,225
 WALL ADAPTERS
 AC to AC 148
 AC to DC 142-147
 AC/DC Switching 147
 Enclosures 148
 Interchangeable Plug 143
 Medical 143
 WALL JACKS/PLATES 62,83
 WALL MOUNTS, TV/MONITOR 168,175
 WASHERS 71,105
 WIRE JUMPERS 32
 WIRE/CABLE, BULK (Also Cable Assemblies)
 Coaxial Cable 56,57,60
 Computer Cable 60
 Flat Ribbon Cable 60
 Flexinol 218
 Hookup Wire, Solid/Stranded 57,60
 Markers 61
 Modular Telephone Cable 60
 Muscle Wire 218
 Power/Speaker Wire 60
 Retractable 67
 Speaker 57
 Telephone 60
 Ties 61,83
 Tools 61
 Twisted Pair/Category 5 (UTP) 58-60,62
 Twisted Pair/Category 5e (UTP) 58,59
 USB 67
 Wire Management 61,83
 Wire Wrap 60
 WIRELESS PRODUCTS 159,160,174
 ZENER DIODES 22

Manufacturer Index

A

3Com	147
3M	105
Aavid Thermalloy	107
ACDC	139
ACI World	145
Adda	108,109,111
AESP	145
AK II Power Supply	144
Alpec	215
Alpha	48
American Media	157
American Zettler	100
AMP	70,74
Amphenol	80
Ampire	38
AMS	158
APC	171
APEM	94
API	157
Apple / Macintosh Products	
.....	85,154,159,161,172
APS	142,145,157
APX Technologies	144,145
Aries	77
Aromat	99,100
ART	27
Artesyn	124-128,131-133,135,136,138
Astec	126,129,136
AT&T	167
Atari	142,145
ATEN	67,164,167,169
Atmel	8
Ault	140,141,148
Autec	125,128
AVerMedia	161

B-C

Belden	56-59
Bellin Dynamic Systems, Inc.	29
BelMerit	192
BestProto	31
BK Precision	192,201
Boca Semiconductor	20
Bomar	79
Boston Acoustics	159
Bourns	49,50
Brother	142,146
Calrad	146
Capital Advanced Technologies, Inc.	29
Cebek	223,224
Cheng	109
Cherokee	132
China Semiconductor	40
ChipQuik	29
Cinch	82,83
Cisco	140
Clare	100
ClaroStat	48
Cobra	152
Common Wealth	108-111
Compaq	157,160
Converter Concepts	126
Creative	161
Crossbow	222
CUI Stack	145

D-E

Dallas Semiconductors	5,15
Datak	213
Datel	138
Datona	155
Delta	108,109,128,140,144,157
Digital Power	129,132
Dinkle	83
Dolphin Peripherals	162
Drake	146

Duracell	154,172
DVE	140
Eclipse	161
EE Tools	27
E-Lab	16
Elpac	142
Eltron	141
Emacs	157
Encad	128
Enhance	157
EOS	129,132
Epson	16
ESP	29
Etasis	157
Eveready Energizer	153
Everglow	140,142,145,146,148
Excel	100
Excel Cell Electronics (ECE)	100
Extch	32,172,192,196,197,205,206
EZ Digital	192,194-198

F-H

Fairchild	20
Fellowes	146
Fluke	188,194,197,198
Focus Enhancements	161
Fortron	113,141
Freeplay	144,145
Frino	148
Fujikura	98
Fulltech	110,111
Gateway	160
GBM	87-89
Global Village	145
Globe Motors	109,110
GlobTek	117,140,142,143,144,146
Grayhill	96,97
Hanlong	29,180,181,183
Hewlett Packard	36,40,165
High Power	157
Highly Electric	95,98
Hightext Publishing	228
Hi-Lo Systems	27,28
Hipro	157
Honeywell	95
Horizon	140,144-148
Hsiang Neng	90

I-L

IBM	166
Ideal	180,181
IERC	107
Imitation	144
Innovative	111
Instek	194,195,198-201
Integrated Power Design	126,128,131
Intel	166
Interex	144
ISD	8
Isobar	170
Isocom	35
ITE Power Supply	144,146,148
Jaguar	145
Jamicon	108-110
JKL	42
Johnson Electric	90
JV Enterprises	228
KAE	16,86
KCS Industries	146
Kensington	170
Kester	212
Kulka	83
Kynar	60
Lakeview Research	156,164
Lambda	129,132,138
Leader Electronics	146,148
Leap	26,27,163
Ledtech	37,40

Ligitek	40
LiteOn	40
Lite-On	129
Logic Concept	157
Lucent Technnology	146

M

Mabuchi Motor	90
Macally	159
Mastech	193,196,204
Matrix Orbital	39
McGraw-Hill	219,228
Mean Well	113-141,144,147,152,157
Measurement Computing	163
Mechatronics	110
MEI	144
Metex	144,190,191,194,197,200,201
MG Electronics	148
Micro Engineering Labs	28
Microchip	6
MicroMint	8
Mission Technology	198
Mitsumi	90
Molex	70,72,73
Mondo-Tronics	218
Motorola	21,98,142,148
Mountain Switch (Xicor)	94

N-P

Namiki	92
National Semiconductor	21,36,40
NEC	100
Netgear	140,166
Newnes Publishing	220,221,228
NIC	43
Nichibo	89,90
Nidec	108,109
NiteRider	146
NMB	90,109-111
NOMA	144
Noostuff, Inc.	146
NTE	24,25,53
Omron	95,97,99
Optek	35
Optrix	38
ORB	144
Orig. Elec. Mfg.	148
OST	83,139
OWI	217,219
Pacific Data	142
Pacrim	148
Paladin Tools	183,185
Panaflo	109
Panasonic	40,145,158
Panavise	84,212,213
PAPST	110
Parallax	5,8,220,221
Pentium	5,107
Phihong	125,126,140,141,143,144
Phoebe	167
PhoneMate	148
Point Six	38
Pomona	199,202,203
Pontech	86
Power Cube	138
PowerFilm	175,226,227
Power-One	126,129,132,138,139
Powerware	170
Precision Navigation, Inc.	222
Pro	200
ProAm	147
Probe Master	199,203
Prompt Publishing	199
Protek	194,195,199,200

Q-S

Qtronix	159,160
Quotrek	145

Racal	148
RAF Elec. Hardware	105
Rayex	99,101
RCA	170
Regal	128,142,144,145
RMV Electronics	86
ROHM	40
Salom Electric	144
Samsung	20
Scott Edwards	39,86
Senix	222
Sennheiser	167
Sensory, Inc.	225
ServoFlo	98
Shichon	108
Shin Mei	100
Shindingen	138
Siliconix	21
Sincore	148
Skynet	128,140,142
SL Waber	171
Smart Communications	27
Solutions Cubed	217,220
Sony	158,173
Soyo	156
Sparkle Power	157
SPI	157
Sprague	21
Square 1 Publishing	220,228
SSI	121,132
ST	125
Star Motor	90
SUN Microsystems	160
Sunon	108-111
Sunpower	157
Super Mac	125
Superworld	146

T-U

Tab Publishing	86,219,228
Tamura	125
TEAC	158
Tech Spray	107,212,213
Techflex, Inc.	61
Tempest	156
Texas Instruments	8-10,20,38,40,228
TGR	157
Thermalloy	107
Three-Five Systems, Inc.	36
TODD	132
Toyo	108,110
TPI	197
Trimag	134
Tripp-Lite	170
Trisys	39
Tysonic	155
Ultra-X	172
Uniq	145
US Robotics	148
UVP	28

V-Z

VCC	42
Velleman	99,197,198,218,219,222-225
VL	39
Volgen	113,115,117
Voltek	145
Wahl	184,210
Wakefield	107
Wavetek/Meterman	189,190,194,201,204
Weller	184,208,210,211
Westinghouse	141
Xcelite	178-180
Xeltek	26
Xircor	145
Xtreme Power	157
Xytronic	207-212



We offer GREAT DEALS across our product line, not just those on the cover or page 3. Take a look below and see why we're proud to stand behind our Guaranteed Lowest Prices!



Aluminum Axial-Lead Electrolytic Capacitors

Electrolytic capacitors may all look the same, but they're certainly not priced the same! See pages 43-45, then reduce your costs by purchasing from Jameco.



Save Up to 27%

Jameco Part No.	Value (µF)	Voltage	PRICES - See Bottom Right For Details				Minimum Savings Discount	
			Jameco	Digi-Key	Mouser	Newark		
199304CL	330	25V	\$.29	\$0.53	\$0.37	—	\$0.08	21.6%
199312CL	470	25V	.35	\$0.65	\$0.47	\$0.50	\$0.12	25.5%
11033CL	2200	16V	.79	\$1.37	\$0.98	—	\$0.19	19.4%
93673CL	4700	25V	1.69	\$2.33	\$2.61	—	\$0.64	27.5%

1/2-Watt, 3/8" Square Single Turn Trimmer Pots

3386P Series

Be sure to take a look at our expanding line of single-turn trimmer pots and learn how you can save! Our complete selection is on pages 48-52.

Save Up to 22%

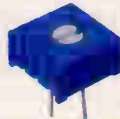

Jameco Part No.	Ohms	PRICES - See Bottom Right For Details				Minimum Savings Discount	
		Jameco	Digi-Key	Mouser	Newark		
254318CL	500	\$.85	\$1.29	\$1.10	\$1.28	\$0.25	22.7%
254334CL	2k	.85	\$1.29	\$1.10	\$1.28	\$0.25	22.7%
254377CL	25k	.85	\$1.29	\$1.10	\$1.28	\$0.25	22.7%
254414CL	250k	.85	\$1.29	\$1.10	\$1.28	\$0.25	22.7%
254431CL	1M	.85	\$1.29	\$1.10	\$1.28	\$0.25	22.7%

3/4-Watt, 3/4" Rectangular 15-Turn Cermet Pots

3386P Series

Jameco recently introduced a broad line of money-saving potentiometers, and our 15-turn Cermet pots are no exception. See pages 49-52 for details.

New
Save Up to 19%

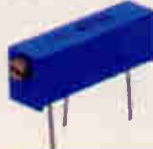

Jameco Part No.	Ohms	PRICES - See Bottom Right For Details				Minimum Savings Discount	
		Jameco	Digi-Key	Mouser	Newark		
241277CL	2k	\$1.25	\$1.73	\$1.55	\$1.73	\$0.30	19.4%
241306CL	20k	1.25	\$1.73	\$1.55	\$1.73	\$0.30	19.4%
241322CL	50k	1.25	\$1.73	\$1.55	\$1.73	\$0.30	19.4%
241357CL	250k	1.25	\$1.73	\$1.55	\$1.73	\$0.30	19.4%
241373CL	1M	1.25	\$1.73	\$1.55	\$1.73	\$0.30	19.4%

BNC Connectors and Adapters

Why spend more when you can buy more for less? Jameco offers a broad line of BNC connectors and adapters, all priced to save you money! See pages 80-81.



Save Up to 21%

Jameco Part No.	Description	PRICES - See Bottom Right For Details				Minimum Savings Discount	
		Jameco	Digi-Key	Mouser	Newark		
223423CL	Bulkhead receptacle	\$5.19	\$8.11	\$6.44	\$8.11	\$1.25	19.4%
223440CL	Receptacle	5.95	\$9.06	\$7.38	\$8.57	\$1.43	19.4%
223503CL	In-series adapter	7.59	\$11.68	\$9.61	\$10.84	\$2.02	21.0%
223511CL	Bulkhead receptacle	2.19	\$3.23	\$2.69	\$2.86	\$0.50	18.6%

.100" Right Angle Double Row Male Headers

Instead of paying over \$100, why not keep over \$50 in your pocket? These right angle connectors are highly discounted and available on page 77.

Save Up to 64%



Jameco Part No.	Contacts	PRICES - See Bottom Right For Details				Minimum Savings Discount	
		Jameco	Digi-Key	Mouser	Newark		
203908CL	4	\$.49	\$1.32	\$0.82	—	\$0.33	40.2%
203932CL	10	.59	\$1.15	\$1.11	—	\$0.52	46.8%
203983CL	22	.65	\$1.86	\$1.83	—	\$1.18	64.5%
204011CL	30	.75	\$2.10	\$2.30	—	\$1.35	64.3%
204046CL	36	.75	\$2.28	\$1.50	—	\$0.75	50.0%

150-Watt Enclosed Switching DC Power Supplies

We offer a broad selection of enclosed Switching DC power supplies, and they're available off-the-shelf at unbelievable prices. Be sure to check out pages 112-123 now!



Save Up to 54%

Jameco Part No.	Description	PRICES - See Bottom Right For Details				Minimum Savings Discount	
		Jameco	Digi-Key	Mouser	Newark		
123393CL	+5V @ 0-30A	\$69.95	\$169.14	\$154.13	—	\$84.18	54.6%
123422CL	+12V @ 0-12.5A	69.95	\$169.14	\$154.13	—	\$84.18	54.6%
123449CL	+24V @ 0-6.5A	69.95	\$169.14	\$154.13	—	\$84.18	54.6%

24-Watt AC-to-DC Regulated Switching Table-Top Power Supply

Why pay so much more for tabletop power supplies when you can get the same products from Jameco for less? Instead of passing up savings, pass over pages 140-142.



Save 32% or More

Jameco Part No.	Description	PRICES - See Bottom Right For Details				Minimum Savings Discount	
		Jameco	Digi-Key	Mouser	Newark		
221751CL	+5VDC @ 2.5A; +12VDC @ 1.0A	\$27.95	\$118.00	\$41.14	—	\$13.19	32.1%

ISOBAR® 8U Surge Protector

Do you really want to pay over \$40 more for the same product from a distributor? Jameco also offers finished products at great low prices.



Save 40%

Jameco Part No.	Description	PRICES - See Bottom Right For Details				Savings Discount	
		Jameco	Digi-Key	Mouser	Newark		
19001CL	8-outlet	\$69.95	\$116.95	\$116.95	—	\$47.00	40.1%

PC Mount Slide Switches

Switch on to great savings with a broad selection of common switches. Our products are priced to save you money, so be sure to see our selection on pages 93-97.



Save Up to 52%

Jameco Part No.	Description	PRICES - See Bottom Right For Details				Minimum Savings Discount	
		Jameco	Digi-Key	Mouser	Newark		
202770CL	SPDT on-on	\$.29	\$0.37	\$0.34	—	\$0.05	14.7%
202981CL	SP3T on-on-on rt. ang.	.16	\$0.37	\$0.34	—	\$0.18	52.9%
202930CL	DPDT on-on	.18	\$0.37	\$0.34	—	\$0.16	47.0%

BNC Coax Cables

Jameco is a leader in money saving cables. Compare the prices of our test cables below, then be sure to find the product you're looking for on pages 81-82.



Save 22% More

Jameco Part No.	Description	PRICES - See Bottom Right For Details				Minimum Savings Discount	
		Jameco	Digi-Key	Mouser	Newark		
256743CL	RG58/U, 2'	\$9.75	\$13.21	\$12.63	\$16.52	\$2.88	22.8%
256760CL	RG58/U, 6'	12.19	\$16.53	\$15.79	\$20.66	\$3.60	22.7%

More on Price Comparisons

These are single unit prices taken from each party's website on March 19, 2004 and do not include shipping & handling charges, volume discounts or any other discounts. Pricing does fluctuate, so please be sure to check when making purchases.

Great Deals Across Our Product Line!



We offer GREAT DEALS across our product line, not just those on the cover or page 3. Take a look below and see why we're proud to stand behind our Guaranteed Lowest Prices!



Texas Instruments 74HC Series Integrated Circuits

Our NEW selection of Texas Instruments products will save you about 5-10% off market prices. Look to pages 9-11 for a complete line of 74HC and 74HCT products.



Save Up to 43%

Jameco		PRICES - See Bottom Right For Details				Minimum	
Part No.	Product No.	Jameco*	Digi-Key*	Mouser*	Newark*	Savings	Discount
246051CL	74HCT138M	.30	\$0.45	\$0.52	—	\$0.15	33.3%
251459CL	SN74HC273N	.26	\$0.40	\$0.44	—	\$0.14	35.0%
251635CL	SN74HC590AN	.33	\$0.48	\$0.86	—	\$0.15	31.2%
251686CL	SN74HC4040N	.26	\$0.48	\$0.46	—	\$0.20	43.3%

74HCT Series Integrated Circuits

Save up to 20% with functionally equivalent products from a few major manufacturers. Be sure to review pages 10-11 for more details on this money-saving option.



Save Up to 29%

Jameco		PRICES - See Bottom Right For Details				Minimum	
Part No.	Product No.	Jameco*	Digi-Key*	Mouser*	Newark*	Savings	Discount
246051CL	74HCT138M	\$2.27	\$0.45	\$0.35	—	\$0.08	22.9%
253024CL	74HCT164M	.30	\$0.50	\$0.37	—	\$0.07	18.9%
246086CL	74HCT240WM	.31	\$0.50	\$0.38	—	\$0.07	18.4%
246107CL	74HCT245WM	.31	\$0.50	\$0.38	—	\$0.07	18.4%
246131CL	74HCT373WM	.31	\$0.50	\$0.38	—	\$0.07	18.4%
246158CL	74HCT374WM	.31	\$0.50	\$0.38	—	\$0.07	18.4%
246238CL	74HCT574WM	.34	\$0.50	\$0.48	—	\$0.14	29.2%

74ACT Series Integrated Circuits

You can save even more with Jameco's selection of 74ACT products. This popular CMOS logic family can save you 20, 30, even over 40%. See page 14 for more details.



Save Up to 48%

Jameco		PRICES - See Bottom Right For Details				Minimum	
Part No.	Product No.	Jameco*	Digi-Key*	Mouser*	Newark*	Savings	Discount
212011CL	74ACT74N	\$2.20	\$0.39	\$0.41	\$0.60	\$0.19	48.7%
212038CL	74ACT138N	.24	\$0.45	\$0.54	\$0.51	\$0.21	46.6%
212097CL	74ACT374N	.31	\$0.56	\$0.63	\$0.72	\$0.25	44.6%

Voltage Regulators

Jameco offers savings throughout our product lines, including voltage regulators. Take a look at some of these exceptional deals, and then find the product you're looking for on pages 16-17.



Save Up to 58%

Jameco		PRICES - See Bottom Right For Details				Minimum	
Part No.	Product No.	Jameco*	Digi-Key*	Mouser*	Newark*	Savings	Discount
193551CL	LM317LM	\$2.22	\$0.72	\$0.53	\$0.64	\$0.31	58.5%
193586CL	LM337LM	.79	\$0.98	—	\$0.98	\$0.19	19.4%
193800CL	78L12ACM	.35	\$0.45	—	\$0.45	\$0.10	22.2%
193789CL	78L15ACM	.20	\$0.45	—	\$0.45	\$0.25	55.6%
193797CL	79L05ACM	.28	\$0.50	—	\$0.50	\$0.22	44.0%

Linear Series Integrated Circuits

Check out our complete line of money-saving products on pages 17-20 of this catalog and you too will understand why this is one of our most popular product lines.



Save Up to 34%

Jameco		PRICES - See Bottom Right For Details				Minimum	
Part No.	Product No.	Jameco*	Digi-Key*	Mouser*	Newark*	Savings	Discount
33161CL	TL062CP	\$2.29	\$0.50	\$0.33	\$0.50	\$0.04	12.1%
242026CL	TLC274CN	.74	\$0.81	\$0.84	\$0.84	\$0.07	8.6%
23608CL	LM318N	.59	\$1.50	\$0.90	\$1.50	\$0.31	34.4%
245420CL	LF347M	.54	\$1.73	\$0.81	\$1.73	\$0.27	33.3%
22904CL	LF347N	.53	\$0.76	\$0.56	\$0.59	\$0.03	5.3%
22939CL	LF353N	.39	\$0.68	\$0.46	\$0.68	\$0.07	15.2%
212185CL	MC3303N	.43	\$0.52	\$0.64	\$0.57	\$0.09	17.3%

Maxim-Type Interface Series ICs

Save more than 20% on devices that convert real-world signals into the digital signals necessary for computer processing. See page 15 for our complete selection.

Save Up to 41%



Jameco		PRICES - See Bottom Right For Details				Minimum	
Part No.	Product No.	Jameco*	Digi-Key*	Mouser*	Newark*	Savings	Discount
142535CL	MAX202CPE	\$2.49	\$3.31	—	\$3.32	\$0.82	24.8%
106147CL	MAX232CWE	1.95	\$3.31	—	\$3.32	\$1.38	41.1%
106155CL	MAX232EPE	2.49	\$3.98	—	\$3.98	\$1.49	37.4%
106163CL	MAX233CPP	5.75	\$7.45	—	\$7.45	\$3.70	22.8%
106260CL	MAX1232CPA	2.49	\$3.52	—	\$3.53	\$1.03	29.2%

Optoisolators

Jameco offers a wide selection of optoisolators, and they're priced to save you money. See page 35 for everything from switches to triac drivers.

Save Up to 41%



Jameco		PRICES - See Bottom Right For Details				Minimum	
Part No.	Product No.	Jameco*	Digi-Key*	Mouser*	Newark*	Savings	Discount
41030CL	4N33	\$2.29	\$0.51	\$0.32	\$0.56	\$0.05	9.3%
18825CL	H11AA1	.39	\$0.65	\$0.57	\$0.65	\$0.18	27.8%
24918CL	MCT6	.49	\$0.87	\$0.83	\$0.84	\$0.34	41.0%
26278CL	MOC3010	.49	\$0.87	\$0.87	\$0.84	\$0.35	43.8%

Transistors

Need a low-noise, small-signal amplifier or a high-power MOSFET switcher? Be sure to review our full selection of money saving transistors on pages 20-22.

Save Up to 36%



Jameco		PRICES - See Bottom Right For Details				Minimum	
Part No.	Product No.	Jameco*	Digi-Key*	Mouser*	Newark*	Savings	Discount
32977CL	TIP102	\$4.45	\$0.82	\$0.70	\$0.65	\$0.20	30.7%
120416CL	TIP122	.38	\$0.62	\$0.59	\$0.51	\$0.13	25.0%
211529CL	MJE340	.30	—	\$0.52	\$0.44	\$0.14	31.8%
38324CL	2N3772	1.49	—	\$2.34	\$2.90	\$0.85	30.3%
209269CL	2N5194	.33	—	\$0.52	\$0.67	\$0.19	36.5%

Bridge Rectifiers

Don't miss out on the savings available in bridge rectifiers too! Our selection of full-wave rectifiers consistently offers positive savings, so be sure to see page 22.

Save Up to 23%



Jameco		PRICES - See Bottom Right For Details				Minimum	
Part No.	Product No.	Jameco*	Digi-Key*	Mouser*	Newark*	Savings	Discount
256559CL	DF10S	\$3.31	\$0.38	\$0.38	\$0.40	\$0.07	18.4%
256575CL	DF08M	.34	\$0.80	\$0.42	\$0.40	\$0.06	15.0%
255960CL	DF005S	.30	\$0.40	\$0.37	\$0.40	\$0.07	18.9%
256567CL	DF08S	.29	\$0.38	\$0.42	\$0.40	\$0.09	23.7%
253286CL	2KBP10M	.40	\$0.81	\$0.50	\$0.49	\$0.09	18.4%

Dipped Tantalum Capacitors

Don't let capacitors bypass your potential savings. Our network of sources finds the best deals in Tantalum capacitors, and we're passing the savings on to you!

Save Up to 47%



Jameco		PRICES - See Bottom Right For Details				Minimum	
Part No.	Value (µF) Voltage	Jameco*	Digi-Key*	Mouser*	Newark*	Savings	Discount
33718CL	15 25V	\$5.89	\$1.86	\$1.70	—	\$0.81	47.6%
33751CL	22 6.3V	.45	\$0.81	\$0.66	—	\$0.21	30.8%

More on Price Comparisons

These are single unit prices taken from each party's website on March 19, 2004 and do not include shipping & handling charges, volume discounts or any other discounts. Pricing does fluctuate, so please be sure to check when making purchases.

Panel Mount Banana Jacks 1/4" - 32 Thread

Mounts in panels ranging in thickness from 0.063" to 0.375".

- Plating: bright tin
- Material: brass
- Insulation: polycarbonate
- 10 pieces per pack



Part No.	Cross Ref. No.	Color	1	10	100
256778CL	R1-17-BLK	Black	\$7.79	\$7.49	\$7.31
263863CL	R1-17-RED	Red	7.79	7.49	7.31

2-Piece Tweezer Set

- PVC insulated handles
- Serrated tips for parts handling
- Bent tip and straight rounded tip (wide tip)
- Length: 5.8"



Part No.	Description	1	10	25
253180CL	Tweezer set	\$2.99	\$2.69	\$2.45

30-Day Money-Back Guarantee

If you're not satisfied we'll take it back!

Details on page 229.

EyeD Hamster USB Fingerprint Scanner

The EyeD Hamster fingerprint recognition tool for computers focuses on both security and convenience. This unit, which can be connected to the USB port of a computer and separate from the mouse, provides a simple convenient and reliable security system instead of using passwords which are hard to remember or can be stolen. Applications such as computer networks, computer security, business IT solutions, E-commerce, banking and financial security and medical information systems are some of the environments where security plays an essential part.



- Assures computer security through fingerprint recognition
- Provide fast matching
- Compact in size, takes up less than 3" of desk space
- USB interface

Includes: installation manual and CD-ROM drivers

System requirements: Windows® 95/98/NT4.0/2000/ME/XP, available USB port

Part No.	Description	1	5
262713CL	EyeD Hamster	\$119.95	\$109.25

EyeD USB OptiMouse with Biometric Recognition Software

With security and convenience of its finger print recognition module, this is the world's smartest mouse. The compact size of its finger print reader, located to the left-hand side of the mouse, eliminates additional and bulky biometric devices. No longer do you need to memorize passwords, the simple yet unique touch of your finger securely protects your PC, network, and the Internet all at once.



- Compact design
- Surface Enhanced Irregular Reflection optical design
- State of the art fingerprint extraction and verification technology
- Applications: PC and network security, Enterprise IT solution, secure files and folders within your PC, E-commerce

Includes: Installation guide, CD-ROM secure desktop software and drivers

System requirements: Windows® 95/95/NT/2000/ME/XP, available USB port

Part No.	Description	1	5
262625CL	EyeD USB OptiMouse	\$129.95	\$123.45

Lead Acid Batteries

- Sealed
- UL approved
- Rechargeable
- Two-year warranty



Part Number	Product Number	Nominal Voltage	Amp-Hrs.	Cross Reference				Terminal Size	Size (L" x W" x H")	Wt. (lbs.)	Pricing	
				Panasonic	YUASA	Eagle Picher	Tempest				1	10
264014CL	TY-6-4.5	6	4.5	LCR6VP	NP4-6	CF16V4	TR-4-6	Quick Connect 0.187"	2.8 x 1.9 x 4.0	1.9	\$8.99	\$7.89
264022CL	TY-6-10	6	10.0	LCR6V10P	NP10-6	CFM6V10	TR10-6	Quick Connect 0.187"	5.9 x 2.0 x 3.9	4.6	14.45	12.97
264031CL	TY-12-2.3	12	2.3	LCR12V2.2P	NP2.3-12	CF12V1.5	TR2.3-12	Quick Connect 0.187"	7.0 x 1.3 x 2.4	2.1	15.39	14.59
264049CL	TY-12-4.5	12	4.5	LCR12V4PF	NP412	CF12V4	TR4-12	Quick Connect 0.187"	3.5 x 2.8 x 4.0	3.8	15.79	14.55
264057CL	TY-12-7	12	7.0	LCR12V7.2BP	NP712	CFM12V65	TR7.5-12	Quick Connect 0.187"	5.9 x 2.6 x 3.7	5.6	16.95	15.15
264065CL	TY-12-12	12	12.0	PS12120	—	CFM12V12	TR12-12	Quick Connect 0.187"	5.9 x 3.9 x 3.9	9.0	30.65	28.25
264073CL	TY-12-18	12	18.0	LCR12V17BP	NPG18-12	CF12V18	TR18-12	Quick Connect 0.472"	7.1 x 3.0 x 6.6	13.3	32.85	28.15

Jameco now has 16-bit Microcontrollers! (and they're in FLASH!)

Benefits of these 16-bit microcontrollers over our current 8-bit offerings are:

- 2X performance (10MIPS, 2MB addressing, twice the instruction set)
- up to 32KB of flash
- upwardly compatible with existing PICs
- up to three 16-bit timers
- up to four channels of 10-bit PWM output
- up to 21 interrupts

In addition to these microcontrollers, Jameco now stocks full ISO CAN2B Microcontrollers!

The CAN interface is programmable and handles up to 1Mbps of data. It is ideal for industrial networking, medical equipment, numerical machine control, railway signaling, controlling building services, and vending machines.

Jameco is adding the ICs you need to make your designs a reality!

We've Added 100s of NEW PIC Microcontrollers. See pages 6-8.



PIC 18F Microcontrollers

Part No.	Product No.	Pkg.	Memory	Speed (MHz)	ROM Words	RAM Bytes	I/O Pins	1	25
248090CL	PIC18F1220-I/P	DIP-18	Flash	40	2k	256	16	\$4.35	\$3.89
248102CL	PIC18F1220-I/SO	SOIC-18	Flash	40	2k	256	16	4.35	3.89
248111CL	PIC18F1320-I/P	DIP-18	Flash	40	4k	256	16	4.89	4.40
248129CL	PIC18F1320-I/SO	SOIC-18	Flash	40	4k	256	16	4.89	4.40
247986CL	PIC18F242-I/SO	SOIC-28	Flash	40	8k	768	23	7.39	6.61
247978CL	PIC18F242-I/SP	DIP-28	Flash	40	8k	768	23	7.39	6.61
248006CL	PIC18F252-I/SO	SOIC-28	Flash	40	16k	1536	23	8.05	7.20
247994CL	PIC18F252-I/SP	DIP-28	Flash	40	16k	1536	23	8.05	7.20
200504CL	PIC18C252-I/SP	DIP-28	OTP	40	32k	1536	23	7.75	6.95
248022CL	PIC18F258-I/SO	SOIC-28	Flash	40	16k	1536	23	9.65	8.62
248014CL	PIC18F258-I/SP	DIP-28	Flash	40	16k	1536	23	9.65	8.62
248081CL	PIC18F442-I/L	PLCC-44	Flash	40	8k	768	34	9.59	8.63
248073CL	PIC18F442-I/P	DIP-40	Flash	40	8k	768	34	8.15	7.35
200512CL	PIC18C452-I/P	DIP-40	OTP	40	32k	1536	23	9.19	7.49
200521CL	PIC18C452-I/JW	DIP-40	EPROM	40	32k	1536	23	22.85	20.55
248049CL	PIC18F452-I/L	PLCC-44	Flash	40	16k	1536	34	10.29	9.26
248031CL	PIC18F452-I/P	DIP-40	Flash	40	16k	1536	34	8.85	7.99
248065CL	PIC18F458-I/L	PLCC-44	Flash	40	16k	1536	34	11.15	10.05
248057CL	PIC18F458-I/P	DIP-40	Flash	40	16k	1536	34	9.79	8.75

Our Discount Prices and Great Service Make Us Your #1 Source of "Quality Components For Less"

New: 150 PIC Microcontrollers!

No typo there! Jameco just added 150 Microchip PIC microcontrollers, including the 10 MIPS PIC 18F 16-bit flash series. Now you can purchase your microcontrollers at Jameco's guaranteed lowest prices, knowing that over 99% of our products are in stock and ready for same-day shipment.



Complete Selection of PIC Microcontrollers on pages 6-8.

Your New Source for NTE

Looking for replacement semiconductors? Jameco recently became an authorized NTE distributor, giving you a direct line to this outstanding provider of high-quality, broad-tolerance components. So if you don't see what you need in the catalog, call us at (800) 831-4242 and we'll find it for you!

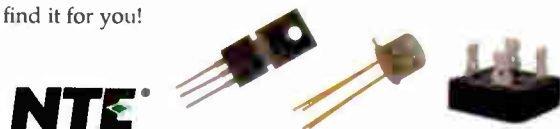

For NEW NTE products see pages 24-25.

Discrete Components

Jameco offers a complete line of widely-used discrete components. And at these money-saving prices, you'll want to be sure your supply cabinets are fully stocked. Be sure to check out our selection and learn how you can save money on your discrete component purchases.



See pages 35-55 for complete listing.

Full Connector Selection

We recently expanded our line of D-Sub, UHF, BNC and power connectors. Now you can purchase AMP, AMPHENOL and MOLEX connectors at Jameco's great prices! So whether you need data, RF or power connectors, you'll find the products you need.



Complete selection on pages 70-85.

Test & Measurement

Whether you need a sophisticated programmable bench-top device or a low-cost spare DMM, be sure to check out Jameco's complete line of test and measurement equipment. We offer many well-known brands, such as Fluke, and all are priced to save you money.



See pages 188-213 for Test Equipment.

Find More Products @ www.Jameco.com



1355 Shoreway Road, Belmont, CA 94002-4100

Toll Free Ordering, Customer Service & Technical Support
 Domestic: 1-800-831-4242 / International: 1-650-592-8097
 Domestic FAX: 1-800-237-6948 / International FAX: 1-650-592-2503
 e-mail: info@Jameco.com

<http://www.Jameco.com>

PRESORTED STANDARD
 AUTOCR
 US POSTAGE PAID
 JAMECO ELECTRONICS

Customer Number

VIP Number

000000000

K21

FREE SHIPPING on orders over \$119. Now thru 5/14/04 Be sure to mention your VIP!

*****AUTO**5-DIGIT 85710
 BARRY MISHKIND
 2033 S AUGUSTA PL
 TUCSON AZ 85710-7905

0038



Receiving duplicates? Incorrect address? No longer wish to receive the Jameco Catalog? Please see page 2.