

ALLIED

Broadcast Equipment

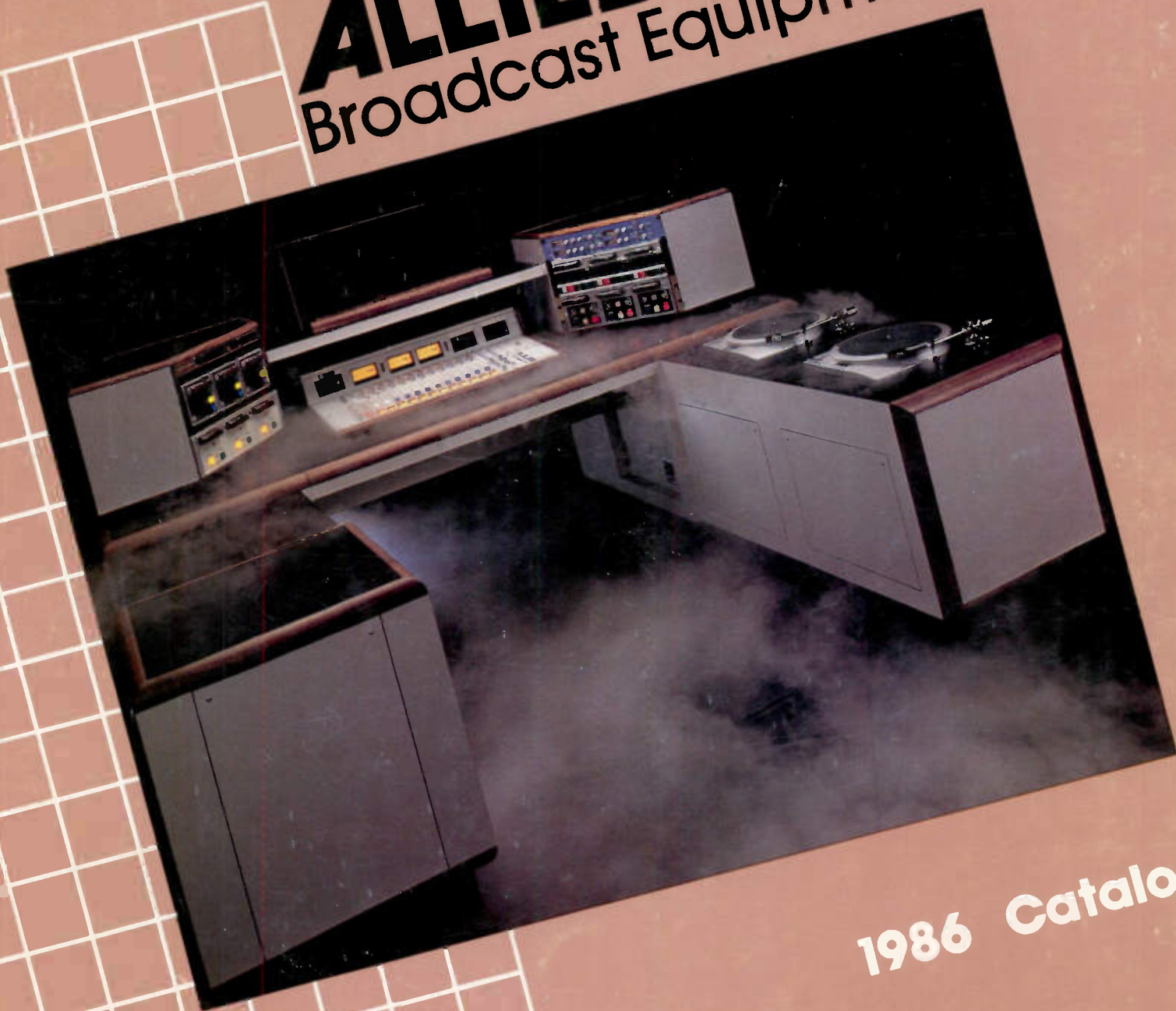

1986 Catalog

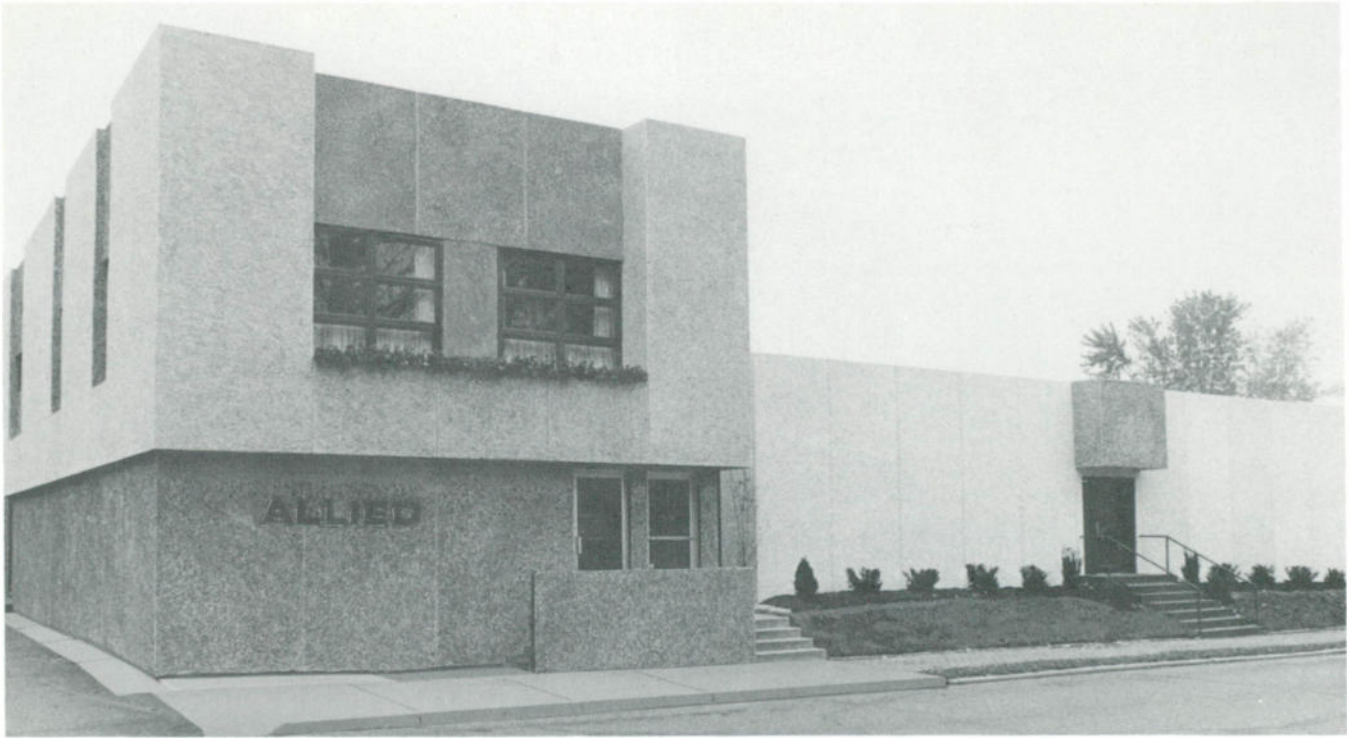

CORPORATE OFFICE: 635 South E Street • P. O. Box 1487 • Richmond, IN 47375

Dear Broadcasters:

As technology moves forward, so does the ability of Allied to accommodate you with the latest advances the industry offers.

With this 1985-86 catalog issue you will find many new and innovative items -- as well as the familiar standbys. Allied Broadcast is excited with our growth and continued maintenance of our leader position in the field of domestic audio broadcast equipment, as well as a leader in the world marketplace through Allied International with some 60 world-wide representatives. We also lead the way in space with our Satellite Broadcast Equipment, and most recently established Allied Broadcast Equipment Canada, Ltd.

It has been a great year for us, and although we are growing, you will find the same friendly, honest atmosphere in our sales, service and quote endeavors.

We're proud of the Allied "family" and the personal touch method of doing business in today's sophisticated environment.

Our business depends upon the people we deal with -- broadcasters. If you feel we are "doing our thing" right, we'd appreciate your comments. By the same token, if you feel we've "done you wrong," your message is just as important. Allied is here to serve you. What better way than listening to our clientele? Thanks!

Sincerely,

ROY M. RIDGE
President
Allied Corporation

DAVID C. BURNS
National Sales Manager
Allied Broadcast Equipment

AMPLIFIERS

ALLIED
Broadcast Equipment

CROWN D-75 AMPLIFIER



The CROWN D-75 offers significant benefits to the professional user, benefits like IOC input/output comparator that reports all forms of signal overload, lockable level control shafts, active-balanced XLR connectors as well as unbalanced 1/4" phone plugs and signal presence indicators that notify the user whenever the D-75 output signal is greater than 1/8 watt. 35 watts per channel.

MANUFACTURER'S SUGGESTED LIST PRICE.....\$524.00

ALLIED PRICE \$ _____

D-150A SERIES II



Retaining the D-150A tradition for sonic accuracy and reliability, the CROWN D-150A Series II is rated at 80 watts per channel into 8 ohms, 250 watts into 8 ohms mono. The frequency response is ± 0.1 dB DC to 20 kHz at one watt into 8 ohms; ± 1 dB DC to 100 kHz., less than .001% harmonic distortion, less than .01 I.M. distortion and 6 volts per microsecond slew rate.

MANUFACTURER'S SUGGESTED LIST PRICE.....\$729.00

ALLIED PRICE \$ _____

DC-300A SERIES II



Since its introduction, the DC-300 and its modifications have been a standard of sonic accuracy, power and reliability. It is FTC rated at 250 watts per channel into 8 ohms; 500 watts into 8 ohms mono. The DC-300A Series II looks different from the front, with a scratch resistant, baked enamel front panel, new power switch, and relocated level controls.

MANUFACTURER'S SUGGESTED LIST PRICE.....\$1149.00

ALLIED PRICE \$ _____

PS-400



The CROWN PS-400 power amp is designed and built for the professional sound system. Into 8 ohms it will provide 180 watts per channel, into 8 ohms mono it will provide 520 watts. Check the all-pro features, terminal strips and phono jacks, ground separation strip, mono-stereo switch with binding posts conveniently positioned for quick conversion, detented controls, 4 second turn-on delay, IOC and signal presence indicators.

MANUFACTURER'S SUGGESTED LIST PRICE.....\$1259.00

ALLIED PRICE \$ _____

PS-200



The CROWN PS-200 power amplifier is designed as a low power companion for the PS-400. Like the 400, the 200 is designed, and built for professional sound systems. It delivers 90 watts per channel into 8 ohms, 270 watts into 8 ohms mono. It is another powerful, all-day reliable CROWN amplifier that is unaffected by mismatches, shorted outputs, low impedance or physical abuse.

MANUFACTURER'S SUGGESTED LIST PRICE.....\$819.00

ALLIED PRICE \$ _____

SL-2



The CROWN Straight Line Two is a rack-mounted preamplifier for total control. Automatic muting eliminates thumps and pops and it features 5 switched and 1 unswitched 115AC outlets. It has tuner, phono, auxiliary and processor inputs and (2) main, (2) tape, processor and front outputs. The SL-2 features detented level controls for reset, a loudness control for accurate bass, ± 10 dB of bass boost and ± 10 dB of treble boost. Case optional.

MANUFACTURER'S SUGGESTED LIST PRICE.....\$595.00

ALLIED PRICE \$ _____

CROWN PL-2



The CROWN Power Line Two is a rack-mounted power amplifier rated at 50 watts per channel with detented level controls for precision selection of level. The PL-2 features a dynamic analyzing display which includes IOC distortion indication.

MANUFACTURER'S SUGGESTED LIST PRICE.....\$625.00

ALLIED PRICE \$ _____

PL-3



The CROWN Power Line Three is a rack-mounted power amplifier rated at 90 watts per channel into 8 ohms, with a T.H.D. of less than .05%, and I.M.D. of less than .05% and a slew rate of 12 volts per microsecond. The frequency analyzing display shows peak levels in all three frequency bands, provides information on spectral balance to check system, music, amplifier, speakers or room.

MANUFACTURER'S SUGGESTED LIST PRICE.....\$995.00

ALLIED PRICE \$ _____

PL-4



The CROWN Power Line Four is a rack-mounted power amplifier rated at 165 watts per channel into 8 ohms. It features a frequency analyzing display that includes IOC distortion indication.

MANUFACTURER'S SUGGESTED LIST PRICE.....\$1495.00

ALLIED PRICE \$ _____

UREI 6150



UREI amplifiers offer exceptionally large power supplies, exceedingly high speed and high current circuitry combine to produce low-end punch and high end sparkle which is unexcelled in professional power amplifiers. Moderate use of negative feedback results in fast recovery from transient overloads and avoids high-order harmonic distortion during clipping. The UREI 6150 is rated at 80 watts per channel.

MANUFACTURER'S SUGGESTED LIST PRICE.....\$746.00

ALLIED PRICE \$ _____

6500



As opposed to the "fix-it-up-with-feedback" approach in common use today, UREI carefully departed from conventional design techniques. Each amplifier stage in the 6500 was engineered for optimum performance with no overall feedback. The 6500 features two channels on an independent, modular plug-in chassis with front panel access. The 6500 is rated at 275 watts into 8 ohms per channel output with .1 THD.

MANUFACTURER'S SUGGESTED LIST PRICE.....\$2396.00

ALLIED PRICE \$ _____

SYMETRIX A-220



The SYMETRIX A-220 is a rack-mounted stereo amplifier rated at 20 watts per channel into 8 ohms, 40 watts mono into 8 ohms with .08% maximum distortion, an input impedance of 20K ohms balanced and 30K ohms unbalanced. The A-220 uses 3-pin XLR type connectors for balanced input, 1/4" phone jacks for unbalanced inputs. The outputs are dual banana jacks (rear panel) and head-phone jack on the front panel.

MANUFACTURER'S SUGGESTED LIST PRICE.....\$289.00

ALLIED PRICE \$ _____

"WE DELIVER WHAT WE PROMISE"

AMPLIFIERS

ALLIED
Broadcast Equipment

NAD 3020B



The NAD 3020B is a 20 watt state-of-the-art unit, offering totally uncompromised performance at a cost that buyers can afford. Among other things, the 3020B contains a unique "soft-clipping" circuit which allows it to play much louder than its rated power suggests. The 3020B has less than .02% of all types of distortion and a LED peak power indicator. Rack mount optional.

MANUFACTURER'S SUGGESTED LIST PRICE.....\$178.00

ALLIED PRICE \$ _____

BGW 85



The BGW 85 is a rack-mounted power amplifier rated at 35 watts per channel at 8 ohms, with 0.1% T.H.D. 20 Hz to 20 kHz, 90 watts into 8 ohms mono, with 0.15% T.H.D. (The Model 85 features modular circuit assembly, toroidal mains transformer, packaged & cased transistors.

MANUFACTURER'S SUGGESTED LIST PRICE.....\$449.00

ALLIED PRICE \$ _____

150



The BGW 150 is a rack mounted power amplifier rated at 50 watts per channel into 8 ohms, 150 watts into 8 ohms mono, with inter-modulation distortion of less than .02%, a frequency response of -.25 dB 20 Hz to 20 kHz and is designed for any load impedance equal to or greater than 4 ohms.

MANUFACTURER'S SUGGESTED LIST PRICE.....\$699.00

ALLIED PRICE \$ _____

ATI MICRO AMP SERIES



The ATI M-1000 dual microphone and L-1000 dual line series of Micro Amps are rackable, handsome, microsized, stackable, versatile and RF protected. The series provide +22 dBm at clipping for transformer and single ended outputs, +26 dBm for balanced differential outputs. They're quiet, total amplifier noise is typically within 1 dB of the thermal noise of source impedance. A 13 microsecond slew rate minimizes the irritating harshness of TIM distortion. 100 dB open loop gain per stage and 50 mHz gain bandwidth product hold typical circuit harmonic distortion below .005% even at 20 kHz.

L1000-1 dual transformer outputs.....\$315.00
ALLIED PRICE \$ _____

L1000-2 balanced differential outputs.....\$315.00
ALLIED PRICE \$ _____

L1000-3 unbalanced outputs.....\$295.00
ALLIED PRICE \$ _____

M1000-1 dual transformer outputs.....\$345.00
ALLIED PRICE \$ _____

M1000-2 balanced differential outputs.....\$345.00
ALLIED PRICE \$ _____

M1000-3 unbalanced outputs.....\$325.00
ALLIED PRICE \$ _____

ATI PRICES ABOVE ARE MFGR'S SUGGESTED LIST PRICES
CALL FOR THE ALLIED PRICE

RTS 1400



The RTS 1400 is more than a microphone preamp. It is a unique and versatile tool. Its well planned features, rugged construction and excellent specifications make it a professional problem solver, an audio "adapter" with countless applications. The 1400's gain is continuously variable via a front panel control. At any level of operation the 1400 can sufficiently boost the mic level input to any load. It's perfect for location recording, remote broadcasting and production.

MANUFACTURER'S SUGGESTED LIST PRICE.....\$251.00

ALLIED PRICE \$ _____

**“PROFESSIONAL PEOPLE, SALES,
SERVICE & PRODUCT”**

RTS 465



The Model 465 is a single channel, wideband microphone preamp designed for pro use in areas such as broadcast operations, television production, sound reinforcement and more. It features outstanding electrical specifications along with fully floating transformer balanced input and output circuits, switchable phantom power and an integral power supply. The 465 employs a switchable limiter to preclude the possibility of preamp overload from any mic source.

MANUFACTURER'S SUGGESTED LIST PRICE.....\$454.00

ALLIED PRICE \$ _____

HAFLER

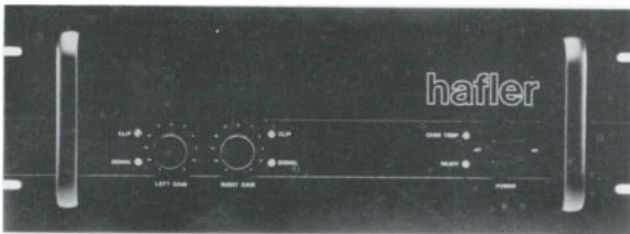

The Hafler P-500 rack mounted amplifier has been well accepted in critical audio circles. It has the quality and reliability which is required for commercial and professional sound installations.

The P500 is very conservatively rated to deliver 255 watts per channel on a continuous basis into an 8 ohm load. In practice, over 300 watts is available across the audio band before the onset of clipping. To achieve this with a wide safety margin, six high power MOSFETs are employed on each channel. Their high current capability enables them to drive difficult reactive loads with ease. Paralleled loudspeakers, and other low impedance loads, are easily accommodated by the P500's enormous reserve, and safe operation (restricted only by thermal limits) into loads even below 2 ohms (typically 500 w/ch into 2 ohms). So rugged is the design, that it can deliver over 20 amperes into a short circuit (before the supply fuses open)! When switched to mono operation, the amplifier's rated output is 800 watts into 8 ohms, which is capable of driving a 70 volt line distribution system directly. In practice, well over 900 watts of mono power is available.

MANUFACTURER'S SUGGESTED LIST PRICE.....\$950.00

ALLIED PRICE \$ _____

**“ENTIRE CONTENTS COPYRIGHT
ALLIED BROADCAST
EQUIPMENT, INC.”**

ORBAN 8100A/1



The ORBAN 8100A FM OPTIMOD® offers wideband or multiband operation, more versatile setup controls that permit precise “tuning” for different formats, improved voice/music balances, an improved stereo generator with cleaner baseband, new overshoot compensation that permits full modulation at all frequencies, yet doesn't increase low frequency IM distortion, plus a dual-chassis option, built-in crosstalk test generator, rigorous RFI shielding and true VC gain control. FM's favorite processor!

MANUFACTURER'S SUGGESTED LIST PRICE.....\$4395.00

ALLIED PRICE \$ _____

9100A/1 & 2



The 9100A/1 and A/2 ORBAN OPTIMOD® was designed for the state-of-the-art AM broadcaster. If your station has an AM transmitter and audio chain which will come close to passing an FM proof, an STL good out to 15 kHz (for co-located facilities) and an antenna system capable of 11 kHz minimum bandwidth there is not a better AM processor made.

9100A/1 mono.....\$4395.00 ALLIED PRICE \$ _____

9100A/2 stereo.....\$5295.00 ALLIED PRICE \$ _____

ORBAN PRICES ABOVE ARE MFGR'S SUGGESTED LIST PRICES.
CALL FOR THE ALLIED PRICE

MOSELEY SCD-9



The MOSELEY SCD-9 stereo demodulator transforms a composite stereo waveform into discrete left and right channels for AM stereo and FM broadcast. It includes de-emphasis circuitry, 15 kHz low pass filters and front panel and stereo indication, with a SPDT relay for external control. An easy way to take advantage of composite STLs for AM Stereo.

MANUFACTURER'S SUGGESTED LIST PRICE.....\$1595.00

ALLIED PRICE \$ _____

PROCESSORS

ORBAN 8182A



The new, second-generation ORBAN OPTIMOD® TV 8182A. Licensed from CBS TECHNOLOGY CENTER, and incorporating the latest research technology, the in-built loudness controller automatically recognizes program material whose perceived loudness exceeds a certain threshold, then quickly and indiscernably lowers the gain until the loudness is consistent with the rest of the program. The result is smoother more easily-listenable audio, operator errors are corrected and obnoxious commercials are tamed.

MANUFACTURER'S SUGGESTED LIST PRICE.....\$4995.00

ALLIED PRICE \$ _____

8182A/SG

This fresh "out of the box" ORBAN 8182A/SG OPTIMOD TELEVISION STEREO GENERATOR when mated to your existing 8182A stereo audio processor for precise harmonization, gives you: left and right computer-optimized filters, a dbx encoder card, sum-and-difference 11-pole 15 kHz low pass filters, sync bus to simplify installation, video loop through, built in monitor, stereo base band generator, user-adjustable base band clipper. For audio processing and base band generation in TV stereo, this is it!!

MANUFACTURER'S SUGGESTED LIST PRICE.....\$4995.00

ALLIED PRICE \$ _____

418A

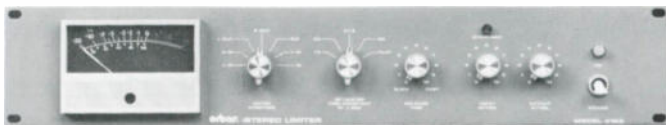

The ORBAN 418A is a complete limiting system consisting of a pair of ganged broadband compressor/limiters with exceptionally smooth and subtle characteristics, followed by a high frequency limiter with four different time constants, user selectable by means of a front-panel switch. This variable time constant feature is unique in the industry and permits the characteristics of the high-frequency limiter to be tailored to recording medium following the limiter. Not suitable for use by itself as an FM processor.

MANUFACTURER'S SUGGESTED LIST PRICE.....\$899.00

ALLIED PRICE \$ _____

"PRICES ARE U.S. DOMESTIC ONLY"

422A/424A

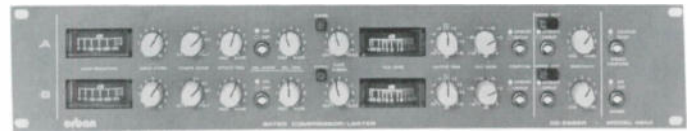

The ORBAN 424A has a real compression ratio control for those few times when you want to maintain some real dynamic range. However you will be astonished at the openness and apparent dynamic range available even at the infinite ratio. You may be even more astonished when you discover the apparent loudness increase achieved without the usual side effects.

422A single channel.....\$629.00 ALLIED PRICE \$ _____

424A dual channel.....\$989.00 ALLIED PRICE \$ _____

ORBAN PRICES ABOVE ARE MFGR'S SUGGESTED LIST PRICES. CALL FOR THE ALLIED PRICE

US AUDIO GATEX® NOISE GATE



The GateX® audio processing tool is an innovative way to offer state-of-the-art technology that is highly effective. At your fingertips, control: reverberation decay time, background noise in multiple mic conferences, program feed line noise reduction as well as unused open mic's during live performances or filming. All user controlled parameters are optimized for ease in set up and operation.

MANUFACTURER'S SUGGESTED LIST PRICE\$435.00

ALLIED PRICE \$ _____

TEXAR AUDIO PRISM



The TEXAR AUDIO PRISM is a very high-performance multi-band audio processor designed for major market broadcast use and other applications where sophisticated program handling is required. It utilizes four intelligent digitally-controlled processor cards to achieve high apparent loudness while producing few processing artifacts. This absence of undesirable subliminal listener aggravation reduces listener tune-out, producing higher quarter-hour ratings.

For AM broadcast, the AUDIO PRISM is designed to be used with the TEXAR EAGLE AM Modulation Controller. For FM, the AUDIO PRISM is designed to be used in conjunction with a high-quality limiter/stereo generator combination. If transmitter and studio are at separate locations, the preferred placement for the AUDIO PRISM is at the studio. This prevents accidental overdriving of the telephone lines or STL and provides the maximum signal-to-noise ratio over the program circuit.

AM or FM Audio Prism.....\$1995 per channel

AM Eagle Clipper.....\$495 per channel

"WE ARE A 'SOUND' BUSINESS!!"

COMPELLOR™ COMPRESSOR/LEVELER/PEAK LIMITER



Presenting the COMPELLOR™, a revolutionary audio processor. It delivers intelligent compression, leveling, peak limiting simultaneously! The COMPELLOR™ control circuits are actually analog computers that constantly monitor the input, adapt and control a single VCA per channel for minimal signal path. Operating controls are kept to a minimum, for the COMPELLOR™ intelligently varies all the parameters for you. All you need do is set input level to control the amount of processing, adjust output level, and set the balance between compression and leveling. That's it.

This smart, versatile, cost effective processor is equally at home in broadcast pre-processing, microphone control, audio production, tape duplicating, live sound and film dubbing; producing the "sound" audio engineers have always sought but seldom found.

MANUFACTURER'S SUGGESTED LIST PRICE.....\$1195.00

ALLIED PRICE \$ _____

APHEX AURAL EXCITER™ II B



The remarkable Aphex Aural Exciter is a unique proprietary audio processing device that makes use of highly advanced psychoacoustic principals to effectively restore and enhance audio presence, brightness and intelligibility. The patented psychoacoustic process creates the perception of an increase in mid and high frequency energy, with *no* actual increase in power or level.

The Broadcast Aural Exciter has complete R.F. shielding and safety bypass relays in the event of power failure. Designed specifically for on-air use, this unit provides AM stations with the clarity and brightness of FM, while restoring to FM the naturalness and openness normally lost due to processing.

The most impressive aspect of the Aphex Broadcast Aural Exciter is the fact that the lower the quality of the playback system, the better the comparative benefit derived. The sound of your broadcast will satisfy the most demanding audiophile, and at the same time grab the attention of the rush-hour commuter.

MANUFACTURER'S SUGGESTED LIST PRICE.....\$2950.00

ALLIED PRICE \$ _____

AURAL EXCITER TYPE B



The Aural Exciter Type B is engineered for less demanding situations. It utilizes the same psychoacoustic principles to make Aural Excitement available to small clubs, studios, halls, restaurants, musicians, tape duplicators and sound contractors operating on a more modest budget. Retaining the most important features of its bigger brothers, the Aural Exciter Type B is a small, lightweight package with extensive capabilities limited only by the user's imagination.

MANUFACTURER'S SUGGESTED LIST PRICE.....\$495.00

ALLIED PRICE \$ _____

EMT 266 X & 277 DX TRANSIENT LIMITERS

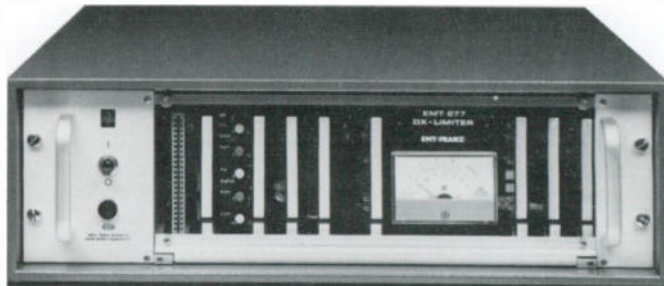

EMT 277 AM Transient Limiter

The EMT 266 & 277 transient limiters were designed for absolute prevention of overdriving through use of the transient-limiter principle. Basic achievement is realized by means of predelay of the signal to be controlled.

Most limiters are designed with feed-back control to maintain long-term stability. With this technique, overdriving occurs at the output by the very nature of the design. This contributes to the inevitability of brief overshoots.

The EMT approach solves these problems with 2 interesting circuit configurations:

- predelay of the program signal
- an additional feedback regulated control limiter

The 266X for FM and the 277 DX for AM. Mono and Stereo configurations available.

PRICES UPON APPLICATION

CRL AM-4 STEREO



This four band system will outperform any other multi-band compressor. It provides maximum density to increase coverage and pre-emphasis for improved fidelity. The AM-4 stereo package contains the SPP800 PREPARATION PROCESSOR, a two band AGC unit that is gated to prevent noise pull-up, one SEP800 STEREO SPECTRAL ENERGY PROCESSOR, four band compressor/expanders with gating in each band, and an SMP900 AM STEREO MATRIX PROCESSOR, a state-of-the-art limiter which processes L + R and L-R separately.

MANUFACTURER'S SUGGESTED LIST PRICE.....\$5950.00

ALLIED PRICE \$ _____

**“PUT OUR PAST
EXPERIENCE TO WORK
IN YOUR FUTURE
SUCCESS”**

PROCESSORS

CRL FM-4

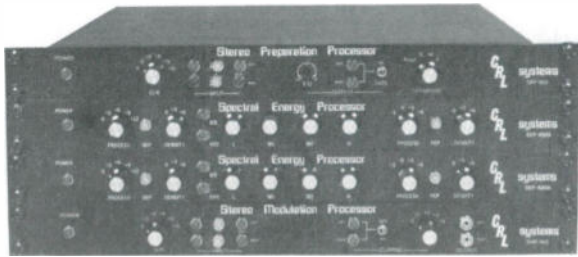

This is the ultimate FM system. Maximum fidelity, maximum loudness and maximum control. The FM-4 connects to your stereo generator and includes SPP800, a PREPARATION PROCESSOR, a two band AGC that is gated to prevent noise pull up, SMP800, an FM STEREO MODULATOR PROCESSOR, that provides absolute peak control and maximum fidelity and one SEP800 SPECTRAL ENERGY PROCESSOR, four band compressor/expanders with gating in each band.

MANUFACTURER'S SUGGESTED LIST PRICE.....\$5750.00

ALLIED PRICE \$ _____

UREI LA-4



The UREI LA-4 compressor/limiter is another great performer in the expanding product line from UREI, the company which has built and sold more limiters and compressors throughout the world than any other manufacturer. Making use of patented electro-optical attenuator technology, the LA-4 offers smooth, predictable performance coupled with ease of operation. Features a long-life LED optical attenuator, selectable compression ratios and simple stereo coupling. 50 μ sec preemphasis selectable.

MANUFACTURER'S SUGGESTED LIST PRICE.....\$496.00

ALLIED PRICE \$ _____

UREI 1176LN

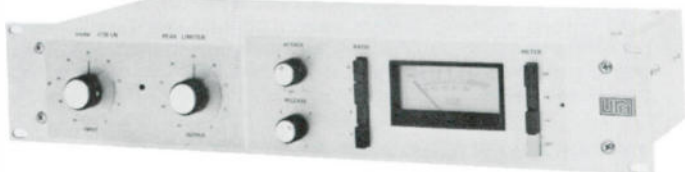

The UREI 1176LN single channel limiter features FET gain reduction ahead of the first stage. No tricky balancing required ever, there's no distortion adding active element in the gain reduction circuit, pushbutton selection of four different compression ratios and ultra fast attack time independent of peak duration or frequency and it's fully adjustable from the front panel.

MANUFACTURER'S SUGGESTED LIST PRICE.....\$596.00

ALLIED PRICE \$ _____

UREI 1178

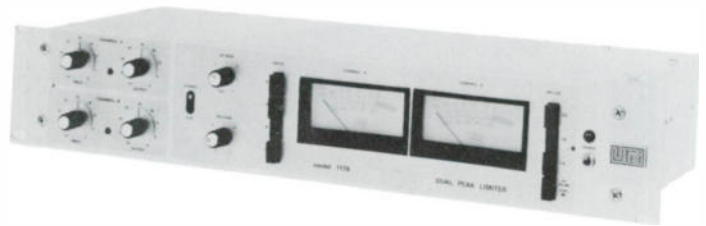

The UREI 1178 dual peak limiter is a two channel version of the 1176LN. The 1178 was designed for those applications where two channels of program material are processed and the balance of these audio channels must be maintained. The two limiters in the 1178 are perfectly matched to assure the high degree of tracking necessary for critical stereo applications. Limiting is accomplished by utilizing FET's as voltage variable resistors.

MANUFACTURER'S SUGGESTED LIST PRICE.....\$896.00

ALLIED PRICE \$ _____

VALLEY PEOPLE 610



The Model 610 dual compressor/expander offers the convenience of two high-quality compressors with flexibility of multi-function dynamics processing in an attractive rack package. Each of the two channels consists of a compressor section and an expander section both controlling the common channel VCA. A special release coupling circuit provides symmetrical release characteristics for both the compressor and expander making interactive processing possible, thus eliminating the problems associated with using separate dedicated-function units.

MANUFACTURER'S SUGGESTED LIST PRICE.....\$995.00

ALLIED PRICE \$ _____

DBX160X



The DBX 160X compressor/limiter provides the studio operator, broadcaster or sound reinforcement specialist with outstanding performance and operational flexibility in a slim-line rack mount package. The 160X has all the features of the famous 160 and more. It is the only compressor/limiter that offers you the choice of OVER EASY or hard-knee operation, regardless of the compression ratio selected.

MANUFACTURER'S SUGGESTED LIST PRICE.....\$420.00

ALLIED PRICE \$ _____

**“PRODUCT AND SERVICE
FOR THE INDUSTRY”**

“ONE STOP SHOPPING @ ALLIED”

DBX165A



The DBX 165A is a result of combining the 165 and PEAKSTOP. The PEAKSTOP circuit which follows the compressor/limiter circuitry is a specially "soft clipper" that rounds the leading and trailing edges off the peak being clipped. By avoiding the normally sharp edges of a clipped peak, far fewer high order harmonics are generated making PEAKSTOP less audible than other types of clippers.

MANUFACTURER'S SUGGESTED LIST PRICE.....\$670.00

ALLIED PRICE \$ _____

ORBAN 111B/1



The versatility of the quasi-parametric midrange equalizer complements the simple, inflexible equalization found on many low-cost mixers, and permits the owners of such systems to get the exact reverb sound they want. In addition, the 111B has very high basic input sensitivity (-30 dBm), and a front-panel input gain control makes it usable with all mixers—even those with unusually low level sends.

This versatility is complemented by a fully-professional 9 dBm balanced, floating output. This arrangement vastly improves immunity to RF interference, and assures easy integration into any system without introducing ground loops and hum.

- NUMBER OF CHANNELS: two, entirely independent except for power supply.
- REVERBERATION ELEMENT: six-spring array (per channel).
- DELAY TIME: Approximately 30 milliseconds between direct sound and first reflection.
- INPUT LEVEL: will accept input levels between -30 and +4 dBm. Audio-taper input level attenuator available on the front panel. Limiter will control overloads up to 25 dB above limiting threshold before clipping and distortion occur.
- INPUT IMPEDANCE: 10,000 ohms, unbalanced. Source impedance non-critical.
- OUTPUT LEVEL: nominally 0 dBm, adjustable by front panel control, ±20 dBm clipping level allows adequate headroom for equalization and spring resonances.
- OUTPUT IMPEDANCE: 600 ohms; transformer-coupled; balanced and floating.
- DIMENSIONS: 19"W x 3½"H x 12"D.
- SHIPPING WEIGHT: 10 pounds

PRICE UPON APPLICATION

MODULATION SCIENCES

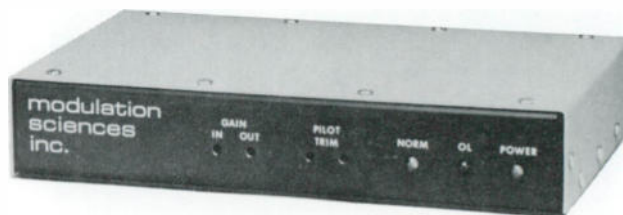

The CP-803 Composite Processor corrects the distortion that conventional processors sometime create. Conventional audio processors work with the left and right audio. But the CP-803 deals with the stereo composite signal that comes out of the stereo generator.

This baseband signal is made up of the L + R main channel, the 19 kHz pilot and the L-R subcarrier. By working on this signal instead of left and right audio, many audio problems are avoided.

The CP-803 gives you extra loudness with no audible increase in distortion. The amount of free dB's you obtain depends on the pre-processing of the audio before it reaches the unit. The less pre-processing beforehand, the more you get from the CP-803. RACK MOUNT IS EXTRA.

MANUFACTURER'S SUGGESTED LIST PRICE.....\$889.00

ALLIED PRICE \$ _____

VALLEY PEOPLE 440



The VALLEY PEOPLE 440 limiter/compressor/dynamic sibilance processor offers the convenience of a peak limiter, a high quality compressor/expander package and a dynamic sibilance processor section, each controlling a common voltage controlled amplifier. The employment of linear integration detection allows the unit's detector to emulate the response of the human ear in order to maintain correct musical relationships in processed material. In the compressor section you get proprietary circuitry such as linear integration detection, peak reversion correction, and anticipatory release computation. The control section features adjustable threshold, attack time, ratio and release time. Other features are easy to read metering, bypass switch, an auto mode, switchable sensitivity to configure DSP and an intercoupling device. This is a new and revolutionary piece of equipment! FM 75 μ sec preemphasis selectable.

MANUFACTURER'S SUGGESTED LIST PRICE.....\$599.00

ALLIED PRICE \$ _____

RELIABLE

RESPECTED

RENOWN

**"SHIPPING AND HANDLING
WILL BE ADDED"**

VALLEY PEOPLE — 800 SERIES

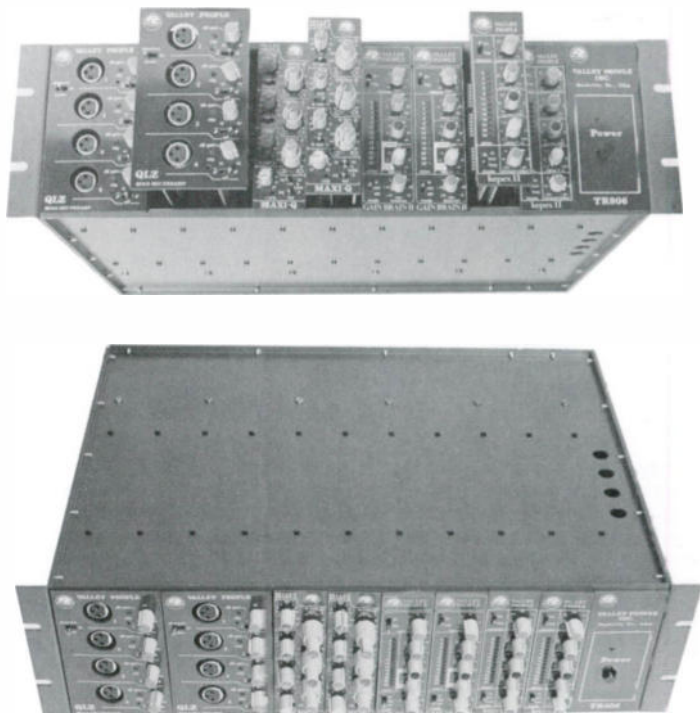

QLZ (813)

Transparent, low-noise, distortion-free operation is what the QLZ transformerless quad mic preamp delivers. Each of the four independent, low impedance inputs is adjustable from 20 dB to 60 dB of gain. An LED clip indicator and phase reverse switch are provided for each input. The QLZ is also equipped with 48 volt 'phantom' powering.

MANUFACTURER'S SUGGESTED LIST PRICE.....\$550.00

MAXI Q (812)

The wide 7-octave range on each of the 812's 3 frequency bands results in a 6-octave overlap insuring effective spectrum coverage. Series filters are used to eliminate filter interaction and reduce noise and distortion usually developed in the summing stage. The exclusive 'tune' mode allows the operator to 'solo' filter settings prior to affecting equalization.

MANUFACTURER'S SUGGESTED LIST PRICE.....\$400.00

KEPEX II (810)

Beyond its unsurpassed noise gating capability, the KEPEX II handily eliminates tape hiss, equipment hum and buzz and undesirable ambient noise. Increased dynamic range is recognized via the 810's active expansion mode.

MANUFACTURER'S SUGGESTED LIST PRICE.....\$400.00

GAIN BRAIN II (811)

This limiter/compressor preserves program dynamic integrity because it understands music and speech. The 811 does not respond to arbitrary voltage or power levels; its response is variable depending upon the degree of waveform complexity.

MANUFACTURER'S SUGGESTED LIST PRICE.....\$400.00

TR806 RACK

The TR806 processing package is designed to house and power up to 10 single-card "800" series modules. This rack mounting scheme is the most cost effective means of implementing the full complement of Valley People "800" series equipment. A TR806 unit fits into a 5 1/4" x 19" rack space.

MANUFACTURER'S SUGGESTED LIST PRICE.....\$800.00

CALL FOR THE ALLIED DEAL

VALLEY PEOPLE — 400 SERIES



Design criteria dictated that the "400" series do all things exceedingly well to outperform the very best "dedicated-purpose equipment." Proprietary circuitry evolved through exhaustive studies of the physics and psycho-acoustics of dynamic manipulation is employed in the "400" series to increase dynamic integrity or "listenability." Yet, the "400" series remains the most versatile and cost-efficient approach to multi-function signal processing on the market today!

The Dyna-Mite (430), available in mono or stereo, performs several variations of 18 specific operating modes, including: limiting; expanding; noise gating; keying; FM limiting; de-essing; and "voice-over".

MANUFACTURER'S SUGGESTED LIST PRICE.....\$560.00

The Dyna-Mic/Mite (431), combination adds transformerless brilliance to a variety of input impedances and optimizes them for routing through the 3-band EQ section and/or the Dyna-Mite. The signal then appears at the output enhanced by processing which only a device of this caliber can deliver.

MANUFACTURER'S SUGGESTED LIST.....\$560.00

The Dyna-Mic (432), available in mono or stereo, offers 2 independent, transformerless preamps, with on-board 3-band tone control. Each of the 2 inputs on a Dyna-Mic card may be optimized for microphone, line or musical instrument impedances and levels. The single output of each card is switchable to +4 dBm, -10 dBv or -20 dBv nominal line levels.

MANUFACTURER'S SUGGESTED LIST PRICE.....\$560.00

CALL FOR THE ALLIED DEAL

BARCUS-BERRY 202R

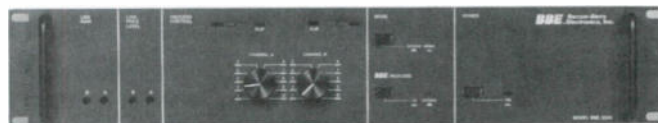

The Barcus-Berry 202R uses a sound technology which is based on load reactance compensation and specifically designed to enhance overall quality of sound produced by any dynamic speaker. The company has designed this quality as BBE Sound™.

This new unit utilizes high speed dynamic gain-control circuitry to audibly improve the reproduction of program transients. The processing and effect occurs in real time and may be used in any signal chain without encoding/decoding.

The 19-inch rack-mountable chassis occupies two standard EIA spaces; adding the piece requires nothing more than insertion between the program source and an amplifier, recorder or signal transmission line. A simple adjustment is all that is required for normal set-up.

Phase adjustments are primarily directed toward preventing high-frequency time lag and the automatic gain changes are based on interband program amplitude ratios. The swept frequency response of the system is essentially flat from 20 Hz to 20 kHz.

MANUFACTURER'S SUGGESTED LIST PRICE.....\$1495.00

ALLIED PRICE \$ _____

dbx 700 DIGITAL AUDIO PROCESSOR

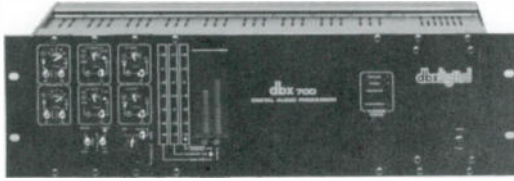

From the time that digital was first applied to recording, it was both a blessing and a curse. The sound was a blessing. The price was cursed. But once that sound was heard, there was no turning back. So dbx, the very same people who brought you breakthroughs in noise reduction, turned its collective technical prowess to the matter of the curse. And in true dbx fashion, they came up with a way to make that crisp, clean digital sound available at an astoundingly affordable price.

The "hows, whys and wherefores" are important. Because all along, digital audio encoding/decoding could be achieved two different ways. One way is PCM (pulse-code modulation). It's the accepted and great-sounding (but very expensive) circuit you find in digital recording systems right now. The other way is DM (delta modulation). It's less expensive but produces less-than-acceptable sound. So when dbx entered the digital ring, they knew their task was to create the best of both worlds. dbx engineers did just that, by tackling what were thought to be the insurmountable problems inherent in basic delta modulation.

Precision Companding solves a major problem with delta modulation—limited dynamic range. The dbx 700 offers a dynamic range of more than 110 dB, resulting in an unbelievably low noise floor that's completely neutral-sounding. (Other forms of delta modulation have less dynamic range and may have a noise floor with a distinct tonal character.) The compander's novel design and the direct digital link between encoder and decoder guarantee not just that it cannot mistrack but that its overall performance is absolutely transparent.

Linear Prediction estimates a signal's future by monitoring its recent past. It does this 700,000 times a second. This further increases the dynamic range of our fixed delta modulator and prevents the audible noise modulation common in other forms of DM.

The bottom line is the extraordinary sound quality of digital at a fraction of the cost of the competition. A cost so low that you can create a digital remote transmission system with the dbx 700 Digital Audio Processor and the MA/COM system that will rival live performance.

SPECIFICATIONS:

Channels:	two
Frequency response:	10 Hz-20 kHz \pm 1/2 dB
Dynamic range:	(unweighted, maximum rms signal to noise floor, input shorted, noise bandwidth 20 kHz): greater than 110 dB
Wow/flutter:	less than 0.01% unweighted; less than 0.006% wrms
THD:	less than 0.03% total harmonic distortion, 1 kHz, 1 V rms input
Sampling rate:	700 k bits/sec
A/D conversion:	precision-companded, linear-predictive delta modulation
Headphone jack:	yes
Console connections:	Line in, balanced, 10 k-ohms. Line out, electronically balanced; will drive 600 ohms to +24 dBm
Dimensions:	5 1/4" H x 19" W x 11 1/2" D
Weight:	approx. 20 lbs

PRICE UPON APPLICATION

2 Required for STL

"THE FIRST FAMILY OF BROADCAST EQUIPMENT"

NOISE REDUCTION

DBX 900 SERIES

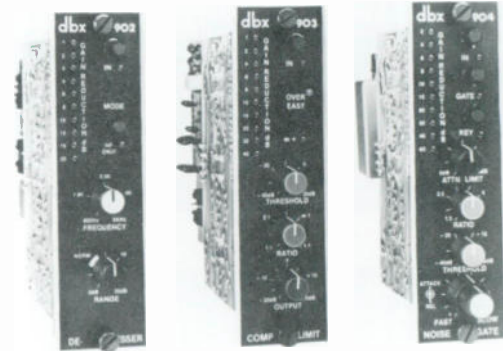

Today's signal processing plays a greater role in sound production than ever before. With this in mind, DBX has created the Series 900 modular signal processing system. The Model 902 De-esser can be used as a conventional broadband de-esser or for attenuating only a user-determined portion of the high frequency range. The Model 903 Compressor with its OVER EASY compressor gives smoother, more listenable compression. The Model 904 Noise Gate is the ultimate noise gate, with a combination of features not found on any other noise gate. Features like adjustable attack and release rates, threshold adjustment from -30 to +30 dB, attenuation limit adjustment from 0 to 60 dB, with DBX OVER EASY downward expansion for a smooth sound.

DBX 902.....\$350.00 **ALLIED PRICE \$ _____**

DBX 903.....\$350.00 **ALLIED PRICE \$ _____**

DBX 904.....\$350.00 **ALLIED PRICE \$ _____**

DBX PRICES ABOVE ARE MFGR'S SUGGESTED LIST PRICES CALL FOR THE ALLIED PRICE

DBX 941/942 and 906

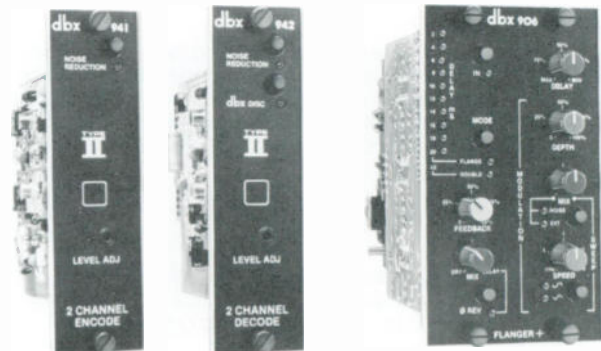

The DBX Models 941 and 942 provide broadcasters with Type II noise reduction in the convenient Series 900 modular format. The 941 is a two-channel encode only Type II noise reduction unit, the 942 is a two channel decode only Type II noise reduction module which features an additional switchable provision for decoding DBX encoded discs. The Model 906 Flanger answers the need for an electronic system that achieves precise, predictable control of the flanging effect while providing the signal quality, 100:1 frequency sweep and low noise previously obtained by using matched tape machines.

DBX 941.....\$260.00 **ALLIED PRICE \$ _____**

DBX 942.....\$270.00 **ALLIED PRICE \$ _____**

DBX 906.....\$750.00 **ALLIED PRICE \$ _____**

Housing including power supply.....\$525.00 **ALLIED PRICE \$ _____**

Blank panels (each).....\$17.50 **ALLIED PRICE \$ _____**

DBX PRICES ABOVE ARE MFGR'S SUGGESTED LIST PRICES CALL FOR THE ALLIED PRICE

NOISE REDUCTION / EQUALIZATION

ALLIED
Broadcast Equipment

DBX 140 TYPE II



The DBX 140 simultaneous encode/decode broadcast noise reduction system is a two channel compressor/expander providing a minimum of 30 dB broadband audio noise reduction with a 10 dB increase in system headroom. The two channels feature independent encode and decode circuitry. Not compatible with type I. The DBX system eliminates tape hiss in recording, and prevents the noise build-up normally encountered in transferring information from one recorded medium to another.

MANUFACTURER'S SUGGESTED LIST PRICE.....\$590.00

ALLIED PRICE \$ _____

EQUALIZATION

ORBAN 622

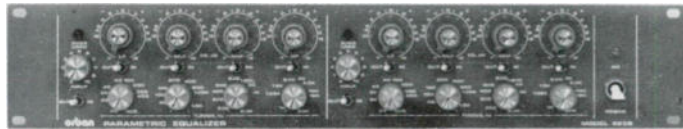

The 622 parametric equalizer consists of a balanced input buffer amplifier, and input attenuator, and four peak/dip equalization sections connected in series, assuring no interaction between sections. The final section contains a current booster capable of driving 600 ohm loads. The output of the input buffer and each of the equalization sections is monitored at all times by the overload indicator. The EQ IN/OUT switch bypasses all circuitry but the input buffer and output amplifier. It is arranged so that the gain and signal polarity are maintained constant in the IN and OUT modes.

622A single channel.....\$569.00 ALLIED PRICE \$ _____

622B dual channel.....\$879.00 ALLIED PRICE \$ _____

RET-5 optional output balancing transformer
(1 per channel).....\$16.00

ORBAN PRICES ABOVE ARE MFGR'S SUGGESTED LIST PRICES.
CALL FOR THE ALLIED PRICE.

ORBAN 672A/674A

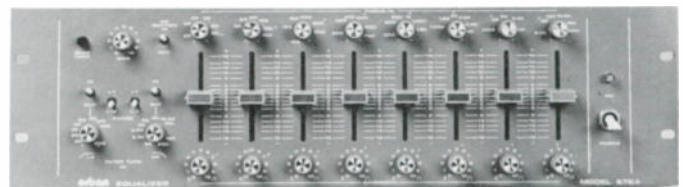

The ORBAN mono Model 672A and stereo Model 674A are cost effective, professional, quasi-parametric equalizers with the convenience of graphic type EQ controls. Wide range high and low pass filters with 12 dB/octave Butterworth slopes follow the graphic section for added versatility. Each feature has been thoughtfully

chosen and cleverly implemented to make the equalizer a particularly powerful tool in nearly all areas of audio.

672A mono.....\$689.00 ALLIED PRICE \$ _____

674A stereo.....\$1299.00 ALLIED PRICE \$ _____

RET-6 optional output balancing transformer
(1 per channel).....\$16.00

ORBAN PRICES ABOVE ARE MFGR'S SUGGESTED LIST PRICES.
CALL FOR THE ALLIED PRICE.

WHITE 4400



The Model 4400 is White Instruments new 1/3 octave, L-C active graphic equalizer. It culminates over ten years experience in building L-C graphic equalizers. The 4400 features active inductor-capacitor tuned filters. The resonant frequency of each filter is derived passively by a tuned L-C pair. This approach, though expensive, drastically reduces the number of active devices necessary to build a 28-band graphic equalizer.

MANUFACTURER'S SUGGESTED LIST PRICE.....\$950.00

ALLIED PRICE \$ _____

WHITE 4100A

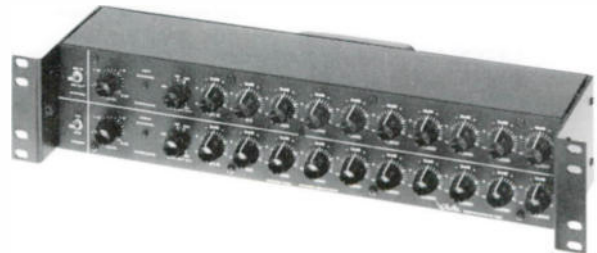

The Model 4100A is White Instruments two channel, octave band L-C active graphic equalizer that has been updated to be as versatile as possible for the audio professional. The 4100A is reputed to be the only two channel, octave band graphic equalizer to feature active, inductor-capacitor tuned filters. The resonant frequency of each filter is derived passively by a tuned L-C pair. This approach, although expensive, drastically reduces the number of active devices necessary to build a ten band graphic equalizer.

MANUFACTURER'S SUGGESTED LIST PRICE.....\$890.00

ALLIED PRICE \$ _____

**“PRICES ARE SUBJECT
TO CHANGE
WITHOUT NOTICE”**

KLARK/TEKNIK

Klark/Teknik's continuing commitment to provide products suitable for professional sound engineering industry has led to development of the Series 300 Graphic Equalizers. Utilizing the microelectronic proprietary filter design the Klark/Teknik Series 300 will provide dependable system performance to the installer.

DN332

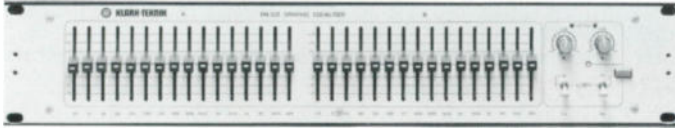

Primarily the DN332 dual 2/3 octave 16 band equalizer is used for stereo tonal control but the unit can be used in virtually any situation where equalization is required and particularly in outside broadcasting to equalize lines but where rack space availability is of obvious importance. The use of the DN332 can provide the engineer with two full frequency range 2/3 octave channels of equalization within only 2" vertical rack space.

Model	Description	Price
DN332	Dual 2/3 octave, 16 band.....	\$1095.00
		ALLIED PRICE \$ _____
DN332B	DN332 with balanced outputs.....	\$1245.00
		ALLIED PRICE \$ _____

KLARK/TEKNIK PRICES ABOVE ARE MFGR'S SUGGESTED LIST PRICES. CALL FOR TODAY'S ALLIED PRICE.

DN300

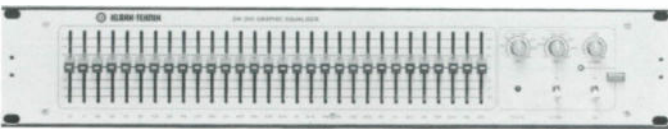

Primarily the DN300 1/3 octave 30 band mono equalizer is used for tonal control but the unit can be used in virtually any situation where equalization is required and particularly studio listening rooms to improve the overall frequency response of the monitoring sound system and to obtain optimal matching between stereo channels for accurate imaging.

Model	Description	Price
DN300	1/3 octave mono, 30 band equalizer.....	\$975.00
		ALLIED PRICE \$ _____
DN300B	DN300 with balanced output.....	\$1050.00
		ALLIED PRICE \$ _____

KLARK/TEKNIK PRICES ABOVE ARE MFGR'S SUGGESTED LIST PRICES. CALL FOR TODAY'S ALLIED PRICE.

DN360

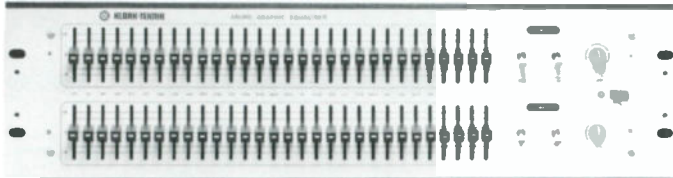

Primarily the DN360 dual 1/3 octave 30 band equalizer is used for stereo tonal control but the unit can be used in virtually any situation where equalization is required but particularly in Audio and Video cassette duplication, to correct for frequency response or tonal irregularities during mastering and to adjust for tape loading characteristics.

Model	Description	Price
DN360	dual 1/3 octave, 30 band equalizer.....	\$1575.00
		ALLIED PRICE \$ _____
DN360B	DN360 with balanced output.....	\$1725.00
		ALLIED PRICE \$ _____

KLARK/TEKNIK PRICES ABOVE ARE MFGR'S SUGGESTED LIST PRICES. CALL FOR TODAY'S ALLIED PRICE.

WHITE INSTRUMENTS 151



The White Instruments Model 151 is a compact, battery-powered, digitally generated pink noise generator with 268,000,000 bit word length, a flat output from 20 Hz through 20 kHz, with microphone or line level output.

MANUFACTURER'S SUGGESTED LIST PRICE.....\$140.00

ALLIED PRICE \$ _____

CROWN EQ-2



The CROWN EQ-2 is a stereo equalizer featuring eleven bands per channel providing full equalization from 10 Hz to 20 kHz with each band featuring a ± 15 dB boost or cut capability. 19-position step switches permit precision control of the individual band levels. The filters are of 1/2 octave constant band width design, set nominally on octave centers. Each filter has an associated control allowing $\pm .5$ octave adjustment of the center frequency. The two channels can be cascaded to produce a full range 1/2 octave equalizer. The EQ-2 may be rack-mounted or as shown, an optional cabinet is available. Case is optional.

MANUFACTURER'S SUGGESTED LIST PRICE.....\$1299.00

ALLIED PRICE \$ _____

ALLIED ALSO HAS A CATALOG FOR SATELLITE EQUIPMENT AS WELL AS A CATALOG FROM ALLIED INTERNATIONAL FOR USE IN OVERSEAS SALES. IF YOU HAVE NEED OF EITHER, PLEASE CALL FOR YOUR COPY.

EQUALIZATION

UREI 535

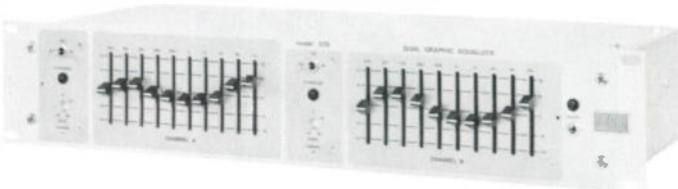

The UREI 535 dual graphic equalizer offers 10 filter sections per channel with increased control range, and more output capability. The 535 provides 12 dB of boost or cut at each of its 10 frequencies, which are centered at ISO one-octave increments from 31.5 Hz to 16 kHz, with balanced bridging differential amplifier inputs, variable gain, floating transformer isolated outputs of 150 ohms or greater load and is rack-mountable.

MANUFACTURER'S SUGGESTED LIST PRICE.....\$896.00

ALLIED PRICE \$ _____

UREI 537

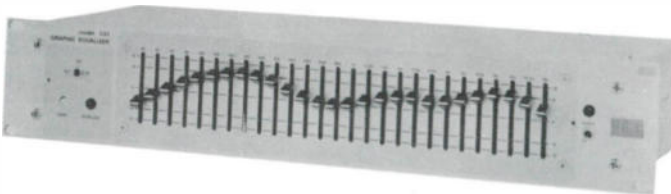

The Model 537 is a 1/3 octave equalizer set for general purpose frequency response adjustment of audio signals. It offers 27 adjustable equalizers on ISO 1/3 octave center frequencies, 12 dB boost or attenuation at each center frequency, stepless-noiseless controls, precision calibrated, state-of-the-art L-C filter circuitry, low distortion-low noise with minimum phase shift, zero insertion loss and is rack-mountable.

MANUFACTURER'S SUGGESTED LIST PRICE.....\$896.00

ALLIED PRICE \$ _____

UREI 539

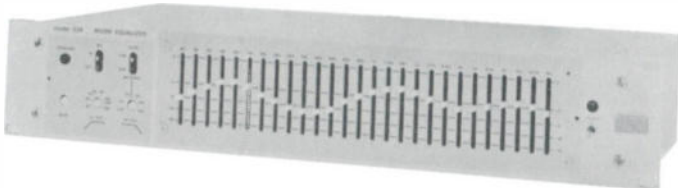

The Model 539 is an active filter set specifically designed for room "equalization" or tuning. The 539 utilizes advanced circuit technology and latest state-of-the-art components to achieve quantum improvements in performance and at lower cost. Signal to noise ratio is better than 110 dB at maximum output. Filter parameters have been optimized to produce excellent combining and minimum phase shift.

MANUFACTURER'S SUGGESTED LIST PRICE.....\$1046.00

ALLIED PRICE \$ _____

EVENTIDE H949



The EVENTIDE H949 Harmonizer is used by top bands and top recording organizations around the world. They are incredibly versatile units combining digital delay, pitch change, and a variety of other features. Harmonizers can be used for doubling vocals, for delay equalization in sound reinforcement, and for many types of reverb/echo. When used with a variable speed tape recorder, a Harmonizer can be used to tailor program material to fit a particular time slot, while retaining the original pitch.

MANUFACTURER'S SUGGESTED LIST PRICE.....\$3500.00

ALLIED PRICE \$ _____

EVENTIDE BD931/BD932



EVENTIDE, the world leader in digital broadcast audio delays, presents the "no compromise" economy obscenity delays, the mono BD931 and stereo BD932 each in 3.2 and 6.4 second configurations. Priced to be cost effective even for stations that air only limited talk programming. Digital RAM based circuitry eliminates all the problems of tape loop delays. 16 kHz band width.

BD931 mono 3.2 seconds.....\$1795.00

ALLIED PRICE \$ _____

BD931 mono 6.4 seconds.....\$2295.00

ALLIED PRICE \$ _____

BD932 stereo 3.2 seconds.....\$2595.00

ALLIED PRICE \$ _____

BD932 stereo 6.4 seconds.....\$4495.00

ALLIED PRICE \$ _____

EVENTIDE PRICES ABOVE ARE MFGR'S SUGGESTED LIST PRICES. CALL FOR THE ALLIED PRICE.

EVENTIDE BD955



The Model BD955 was designed specifically for policing of live talk shows. It is a RAM based digital delay line, available in two frequency ranges, 7.5 kHz for reproduction of telephone audio and 15 kHz for quality reproduction of the full spectrum. There are two maximum delay times available, 3.2 or 6.4 seconds. The unit has a unique "catch up" feature which enables it, after the objectionable material has been dumped, to regain its delay safety margin automatically. Two of the same model are required for stereo.

BD955 7.5 kHz 3.2 seconds.....\$2700.00

ALLIED PRICE \$ _____

BD955 7.5 kHz 6.4 seconds.....\$3350.00

ALLIED PRICE \$ _____

BD955 15 kHz 3.2 seconds.....\$3350.00

ALLIED PRICE \$ _____

BD955 15kHz 6.4 seconds.....\$4300.00

ALLIED PRICE \$ _____

Stereo interconnect add \$150

EVENTIDE PRICES ABOVE ARE MFGR'S SUGGESTED LIST PRICES. CALL FOR THE ALLIED PRICE.

EVENTIDE H969



Eventide presents "the next step in pitch change technology" with its PRO PITCH HARMONIZER® H969 giving you the cleanest, highest quality pitch change ever. The digital electronic-splicing algorithm attains glitch-free pitch changes. Its 16 bit liner PCM circuitry delivers superb audio quality in all modes. At your fingertips are instant pitch change presets with independent pitch and delay readouts — all fast and sure! Wide range delay — up to 3 seconds, variable time presets and delays, plus flanging and doppler features. This is Eventides best harmonizer ever!

MANUFACTURER'S SUGGESTED LIST PRICE.....\$4500.00

ALLIED PRICE \$ _____

INTERFACES

VALLEY PEOPLE HH 2 x 2

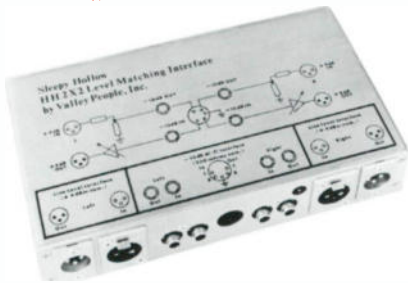

The HH 2 x 2 level matching interface is a line amplifier/attenuator which interfaces +4 or +8 dBm professional recording or broadcasting equipment with -10 dBm high fidelity and semi-pro equipment. Because the unit is transformerless, it achieves improved transient response. Each HH 2 x 2 level matching interface is a complete stereo system. Indeed, it is a stereo amplifier which boosts -10 dBm signals to a nominal +4 or +8 line level output.

MANUFACTURER'S SUGGESTED LIST PRICE.....\$215.00

ALLIED PRICE \$ _____

VALLEY PEOPLE HH 2 x 2B

You've told us that the HH 2 x 2 level matching interface is the most cost effective and reliable product to solve the age old dilemma of interfacing -10 dB equipment to the studio and broadcast standards of +4 and +8 dB. But, what about those high RF fields, and the need to drive line levels for longer distances? In response to these situations, VALLEY PEOPLE has designed the HH 2 x 2B. In addition to the original features the 2 x 2B offers electronic balancing for the +4/+8 outputs and improved RFI rejection.

MANUFACTURER'S SUGGESTED LIST PRICE.....\$250.00

ALLIED PRICE \$ _____

**"THERE'S MORE TO ALLIED
THAN BROADCAST EQUIPMENT"**

HENRY MATCHBOX



The MATCHBOX is the ideal, inexpensive way to correctly interconnect high fidelity or semi pro equipment with pro studio gear. The MATCHBOX is bi-directional, with four independent amplifiers providing full stereo input and output interface. Two amplifiers convert a stereo IHF HI-Z unbalanced source to LO-Z balanced outputs at studio level. A second pair of amplifiers converts the stereo balanced studio line source to unbalanced IHF outputs to feed the inputs of an IHF device. All circuitry is active and direct coupled for absolute sonic transparency.

MANUFACTURER'S SUGGESTED LIST PRICE.....\$195.00

ALLIED PRICE \$ _____

RTS 444



The Model 444 is a dual, two channel buffer amplifier designed to interface professional systems with semi-pro and high fidelity equipment. Although components designed for home use offer desirable features for studio applications, interconnections between the two kinds of equipment are complicated by differences in levels, impedances and balanced and unbalanced modes of operation. The 444 corrects these problems while maintaining signal integrity.

MANUFACTURER'S SUGGESTED LIST PRICE.....\$350.00

ALLIED PRICE \$ _____

— NOTES —

CONEX CG-25



The CONEX 25 Hz tone generator has built-in high pass filters for both the left and right channels, front panel LED indication of tone duration, silence and maximum length of untimed tone. All timing intervals, tone lengths and audio levels are easily adjustable from the rear panel. Standard six-pin "Cinch Jones" type connectors are provided for simple connection between the console and the recorder. The tone is switch-selectable to allow recording tone on either channel. For ease of servicing all integrated circuits are socket mounted. The CG-25 offers low distortion circuitry, the oscillator and audio have less than .5% total harmonic distortion.

MANUFACTURER'S SUGGESTED LIST PRICE.....\$350.00

ALLIED PRICE \$ _____

CONEX CS-25A



The CS-25 dual 25 Hz tone sensor is a compact and reliable bridging-type 25 Hz tone sensor for use in broadcast automation and tape control systems. The unit features two independent sensors, allowing very economical expansion of existing systems. The CS-25 offers front panel stop-delay adjustment to accommodate any tape format, indicator lights on the front panel to indicate presence of tone, front panel disable switches which inhibit the relays allowing the tape to run without stopping at tones or signalling of the automation system.

MANUFACTURER'S SUGGESTED LIST PRICE.....\$395.00

ALLIED PRICE \$ _____

SONOMAG (SMC) ESP-2

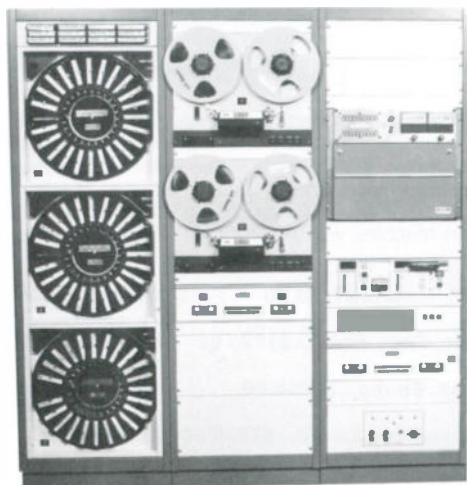

The industry's most cost effective programming tool, the ESP-2, will operate fully automated, satellite fed, live assist, or in any combination.

The ESP-2's 4,000 event memory (expandable to 8,000) allows programming days in advance. With its 682 step, seven day, user pro-

grammable clock, the ESP-2 executes time instructions for updates, network joins or external time functions with ease.

The ESP-2 gives the operator full manual control of up to 20 audio sources for live assist operation or semi-auto operation.

The ESP-2 will replace outdated programmers; and with appropriate interfaces, your existing source equipment can be used in many cases.

TYPICAL MUSIC SERVICE SYSTEM

- ESP-2 Programmer (Rack Mounted, with Remote Control Head)
- 3-Random Access Carousels
- 3-SMC/OTARI ARS-1000 Reel to Reel Reproducers with SMC exclusive Auto-Rewind/Recue and 25 Hz tone sensors
- 2-721 Dual Cartridge Playbacks (4 single play sources)
- 3-System Racks, fully cabled

PRICES VARY WITH APPLICATION CONTENT

CALL FOR THE ALLIEDEAL

MPA PROGRAMMER 3A "LIVE ASSIST"



The PROGRAMMER 3A is the latest in a series of highly successful radio music programming aids. The 3A allows the stations to take advantage of music formats which have been recorded on reel-to-reel tape for automation systems. Up to four reel-to-reel tape decks can be controlled by PROGRAMMER 3A. The outputs can be wired mono or stereo directly to program and cue buses of a studio console eliminating the need for additional console inputs. A memory circuit allows the operator to select the music deck he will play next.

MANUFACTURER'S SUGGESTED LIST PRICE.....\$990.00

ALLIED PRICE \$ _____

MPA 25 Hz PROCESSOR



Designed and built to fill a need in the broadcast field, the PERSONS 25 Hz tone processor performs all the tone handling functions required to interface a reel-to-reel recorder with an automation or "live assist" system. One 25 Hz tone processor will handle one stereo or two mono tape decks. Each 25 Hz tone processor consists of two 25 Hz tone decoders tied to two program amplifiers with 25 Hz notch filters. The 25 Hz tone detectors offer accurate, false-free recognition of tones. The stop/delay timers are precise and repeatable. All logic circuits are relay contacts for interfacing with any tape deck and system. Incoming and outgoing terminations are brought to a convenient, clearly marked terminal strip on the rear.

MANUFACTURER'S SUGGESTED LIST PRICE.....\$399.00

ALLIED PRICE \$ _____

COMPUSONICS DSP 1000 SERIES



For the first time, in-house digital recording by an instrument that's totally broadcast ready and realistically priced. The model 1000 provides a system of recording, reproducing, and processing digital audio signals. The format is remarkably small when one considers delivered specifications which rival the compact disc.

Proprietary data reproduction permits use of a standard 5 1/4" floppy "diskette" for recording and playback of broadcast program material. The 1000 interfaces directly with broadcast levels and impedances and is broadcast ready.

PRICES UPON APPLICATION — CALL FOR THE ALLIEDEAL

COMPUSONICS DSP2002 PRODUCTION SERIES



CompuSonics created the DSP-2002 for professional radio and television broadcasting service. Functionally, the DSP-2002 equals or exceeds conventional tape recorders with the additional benefits of digital sound quality, random access and interactive editing. Recording time capacity ranges from 30 to 960 minutes in stereo, depending on the number of Storage Modules installed.

COMPUSONICS DSP 2000 MIXER SERIES



The CompuSonics DSP-2000 is a series of computer audio consoles for digital mixing, recording and editing. The numeric designations represent the number of microphone or line input channels. The DSP-2004 is the smallest console, supporting 4 inputs. The DSP-2016 is a 16 input console, and so on. The recording time capacity of any DSP-2000 Series console may range from 30 to 960 minutes in stereo, depending on the number of Music Workspace (storage) Modules installed. The key features of the DSP-2000's are:

- Trackball Array control panel integrated to 19" color console display for mixer and recorder control functions
- Ergonomic adjustable console and display
- Fast set-up mobile
- Instant access, no tape re-wind
- No signal loss on dubbing or re-mixes
- High signal to noise ratio

- Ease of editing
- Stereo mix-down to Compact Disk PCM master format
- Data reduction for efficient storage

*Specifications for all 2000 Series

SPECIFICATIONS

Resolution.....	16 bits
Wow & Flutter.....	none
Signal to noise.....	92 dB
Channel separation.....	92 dB
Frequency response.....	.20 to 15,000 Hz
Dynamic range.....	better than 92 dB
Sample rate.....	50,000 Hz (other rates optional)
Distortion at 1 kHz, 10V peak to peak.....	less than .01%, 3d Harmonic

- Plain English menu; no computer training is required to operate the DSP-2002
- Stereo or mono audio input and output are under software control
- Twelve inch video monitor with detached typewriter style keyboard
- Random access and playback in programmable sequence
- Compatible with digital VCR audio archival storage
- High capacity hard-disk and SuperFloppy drives
- Auto-data reduction for efficient storage
- No signal loss on re-dubbing
- No tape rewind or cueing

PRICES UPON APPLICATION — CALL FOR THE ALLIEDEAL

CARTRIDGE MACHINES

BROADCAST ELECTRONICS 2100 SERIES



The 2100 family of tape cartridge machines combines versatile operation, quality components and top specifications, all at an economical price. There's more value in the 2100 series than ever found before in any professional cart machine. The combination of advanced engineering and cost saving production methods produces a cart machine with double value for the most quality minded users.

2100P Play, Mono...\$1150.00	ALLIED PRICE \$ _____
2100RP Rec./Play, Mono...\$1725.00	ALLIED PRICE \$ _____
2100PS Play, Stereo...\$1250.00	ALLIED PRICE \$ _____
2100RPS Rec./Play, Stereo...\$2025.00	ALLIED PRICE \$ _____

Accessory prices upon request
BROADCAST ELECTRONICS PRICES ABOVE ARE MFGR'S SUGGESTED LIST PRICES. CALL FOR TODAY'S ALLIED PRICE.

"PRICES ARE SUBJECT TO CHANGE WITHOUT NOTICE"

CARTRIDGE MACHINES

BROADCAST ELECTRONICS 3000 SERIES



Series 3000 machines have all the standard features: a direct drive hysteresis synchronous motor, an air damped solenoid with excellent reserve capability, and a 1/2" thick machined aluminum deck. In addition, these machines are loaded with extras like the Phase Lok III head bracket, low voltage solenoid switching, advanced integrated circuit/solid-state design with exceptionally wide dynamic operating ranges, long life NORTRONICS DURACORE heads, and an outstanding set of performance specifications.

3100P Play, Mono...\$1250.00	ALLIED PRICE \$ _____
3100PS Play, Stereo...\$1400.00	ALLIED PRICE \$ _____
3200P Play, Mono...\$1275.00	ALLIED PRICE \$ _____
3200RP Rec/Play, Mono...\$2175.00	ALLIED PRICE \$ _____
3200PS Play, Stereo...\$1425.00	ALLIED PRICE \$ _____
3200RPS Rec/Play, Stereo...\$2525.00	ALLIED PRICE \$ _____
3300P Play, Mono...\$1350.00	ALLIED PRICE \$ _____
3300RP Rec/Play, Mono...\$2225.00	ALLIED PRICE \$ _____
3300PS Play, Stereo...\$1525.00	ALLIED PRICE \$ _____
3300RPS Rec/Play, Stereo...\$2575.00	ALLIED PRICE \$ _____
3400P Play, Mono...\$1400.00	ALLIED PRICE \$ _____

3400PS Play, Stereo...\$1550.00	ALLIED PRICE \$ _____
3400RP Rec/Play, Mono...\$2225.00	ALLIED PRICE \$ _____
3400RPS Rec/Play, Stereo...\$2575.00	ALLIED PRICE \$ _____

Accessory prices upon request
BROADCAST ELECTRONICS PRICES ABOVE ARE MFR'S SUGGESTED LIST PRICES. CALL FOR TODAY'S ALLIED PRICE.

BROADCAST ELECTRONICS 5300 SERIES



The Model 5300B is the most advanced multi-deck cartridge machine on the market. It is a top-of-the-line pro machine that features solid-state integrated circuit design, a direct drive hysteresis synchronous motor, air damped solenoid, 1/2" thick machined aluminum deck and long life NORTRONICS DURACORE heads. Features unique to this multi-deck design are plug in decks, computer ribbon cabling, rear panel LED service aids, and run lights adjacent to each deck.



Record Module

5301B Play, Mono...\$2950.00	ALLIED PRICE \$ _____
5302B Cue Tones/Play, Mono...\$3150.00	ALLIED PRICE \$ _____
5303B Play, Stereo...\$3450.00	ALLIED PRICE \$ _____
5304B Cue Tones/Play, Stereo...\$3650.00	ALLIED PRICE \$ _____

Accessory prices upon request
BROADCAST ELECTRONICS PRICES ABOVE ARE MFR'S SUGGESTED LIST PRICES. CALL FOR TODAY'S ALLIED PRICE.

**“ENTIRE CONTENTS
COPYRIGHT ALLIED BROADCAST
EQUIPMENT, INC.”**

BROADCAST ELECTRONICS DELAY MACHINES

The versatile delay cartridge machines handle a variety of functions, continuous delay, network delay, normal recording and normal playback yet with all the same top performance specifications of 3000 series. These delay machines take the worry out of live telephone talk shows and interviews. When in the delay mode, the tape crosses the erase/record head where it is erased and the live material recorded. The tape then moves through a full cycle of the cartridge before reaching the playback head. The time span of the delay is determined by the length of the cartridge.

3200RP/DL.....\$2550.00 ALLIED PRICE \$ _____

3300RP/DL.....\$2600.00 ALLIED PRICE \$ _____

3400RP/DL.....\$2600.00 ALLIED PRICE \$ _____

Accessory prices upon request

BROADCAST ELECTRONICS PRICES ABOVE ARE MFGR'S SUGGESTED LIST PRICES. CALL FOR TODAY'S ALLIED PRICE.

RAMKO PHASESTABLE



The problems of stereo phase stability in cart machines is overcome with RAMKO PHASESTABLE cart machines. From the inception of the PHASESTABLE line RAMKO has always maintained there was an electronic solution. By employing leading-edge technology, RAMKO determined that the PHASESTABLE could out perform everything in the audio chain, right on through the transmitter. The signal-to-noise, distortion, and wow/flutter performance rivals reel-to-reel specs giving the ultimate in stability.

PS1 Play, Stereo...\$2738.00 ALLIED PRICE \$ _____

RPS1 Rec/Play, Stereo...\$4400.00 ALLIED PRICE \$ _____

Accessory prices upon request

RAMKO PRICES ABOVE ARE MFGR'S SUGGESTED LIST PRICES. CALL FOR TODAY'S ALLIED PRICE.

RAMKO PRIMUS

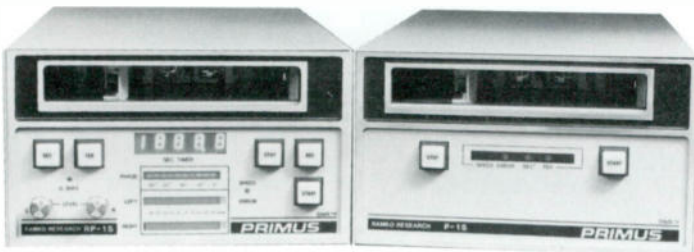

The PRIMUS line of cart machines continues a standard of excellence that has made the RAMKO name one of the most respected in the industry. With all the standard features of the RAMKO line, the PRIMUS machines will deliver several years of dependable service.

P-1S Play, Stereo...\$1930.00 ALLIED PRICE \$ _____

RP-1S Rec/Play, Stereo...\$2729.00 ALLIED PRICE \$ _____

P-1M Play, Mono...\$1794.00 ALLIED PRICE \$ _____

RP-1M Rec/Play, Mono...\$2485.00 ALLIED PRICE \$ _____

Accessory prices upon request

RAMKO PRICES ABOVE ARE MFGR'S SUGGESTED LIST PRICE. CALL FOR TODAY'S ALLIED PRICE.

TAPECASTER

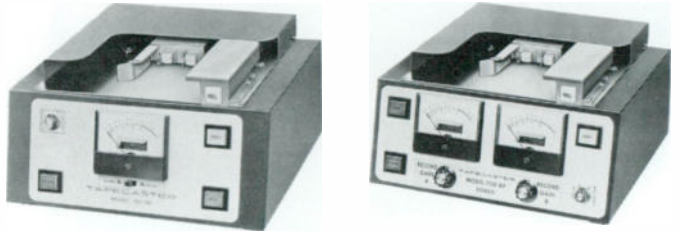

For the broadcaster who doesn't need an expensive multi-deck cart machine configuration, the TAPECASTER line has become a standard. With either stereo or mono playback or playback/record machines available, the dependable, sturdy TAPECASTER line is more machine for the dollar.

X700RP mono record/play.....\$850.00 ALLIED PRICE \$ _____

X700P mono play.....\$650.00 ALLIED PRICE \$ _____

X700RPD mono record/play/delay.....\$1000.00
ALLIED PRICE \$ _____

X700RPS stereo record/play.....\$1000.00
ALLIED PRICE \$ _____

X700PS stereo play.....\$750.00 ALLIED PRICE \$ _____

Auxiliary tone option.....\$75.00 ALLIED PRICE \$ _____

Accessory prices upon request

TAPECASTER PRICES ABOVE ARE MFGR'S SUGGESTED LIST PRICE. CALL FOR TODAY'S ALLIED PRICE.

AUDICORD E-SERIES PLAYBACK



The Models E-10 through E-16 offer modular construction, interchangeable transports and other assemblies, 1 or 3 tones in mono or stereo, a replay reminder system, full remote control that's automation compatible with latching connectors and a slip/lift cover.

E-10 mono, 1 cue, desk.....\$819.00 ALLIED PRICE \$ _____

E-10R mono, 1 cue, rack mount.....\$819.00
ALLIED PRICE \$ _____

E-11 mono, 3 cue, desk.....\$849.00 ALLIED PRICE \$ _____

E-11R mono, 3 cue, rack mount.....\$849.00
ALLIED PRICE \$ _____

E-15 stereo, 1 cue, desk.....\$889.00 ALLIED PRICE \$ _____

E-15R stereo, 1 cue, rack mount.....\$889.00
ALLIED PRICE \$ _____

E-16 stereo, 3 cue, desk.....\$919.00 ALLIED PRICE \$ _____

E-16R stereo, 3 cue, rack mount.....\$919.00
ALLIED PRICE \$ _____

Accessory prices upon request

AUDICORD PRICES ABOVE ARE MFGR'S SUGGESTED LIST PRICES. CALL FOR TODAY'S ALLIED PRICE.

CARTRIDGE MACHINES

E-SERIES RECORD/PLAYBACK

The Models E-20 through E-26 offer a unique slide out panel for control access, mono or stereo record/playback, 1 or 3 cue tones, and auto switching meters. If top quality recording and playback are what you're looking for try AUDICORD first.

- E-20 mono, 1 cue, desk.....\$1379.00 ALLIED PRICE \$ _____
- E-20R mono, 1 cue, rack mount.....\$1379.00 ALLIED PRICE \$ _____
- E-21 mono, 3 cue, desk.....\$1419.00 ALLIED PRICE \$ _____
- E-21R mono, 3 cue, rack mount.....\$1419.00 ALLIED PRICE \$ _____
- E-25 stereo, 1 cue, desk.....\$1619.00 ALLIED PRICE \$ _____
- E-25R stereo, 1 cue, rack mount.....\$1619.00 ALLIED PRICE \$ _____
- E-26 stereo, 3 cue desk.....\$1659.00 ALLIED PRICE \$ _____
- E-26R stereo, 3 cue, rack mount.....\$1659.00 ALLIED PRICE \$ _____

Accessory prices upon request

AUDICORD PRICES ABOVE ARE MFGR'S SUGGESTED LIST PRICES. CALL FOR TODAY'S ALLIED PRICE.

E-SERIES THREE TRANSPORT PLAYBACK

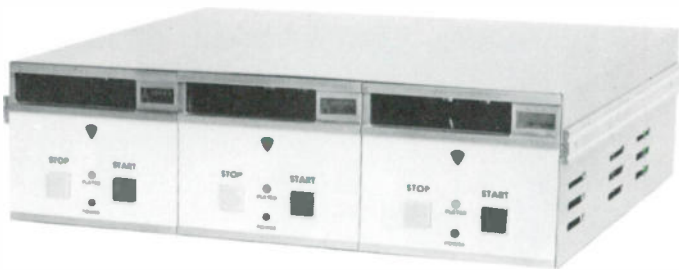

The Models E-30 through E-36 are three playback configurations that feature modular construction, interchangeable transports, 1 or 3 cue tones mono or stereo, replay reminder system, full remote control that's automation compatible, latching connectors and slip/lift cover. These models offer three independent outputs and three independent control systems.

- E-30 mono, 1 cue, desk.....\$2429.00 ALLIED PRICE \$ _____
- E-30R mono, 1 cue, rack mounted.....\$2429.00 ALLIED PRICE \$ _____
- E-31 mono, 3 cue, desk.....\$2519.00 ALLIED PRICE \$ _____
- E-31R mono, 3 cue, rack mounted.....\$2519.00 ALLIED PRICE \$ _____
- E-35 stereo, 1 cue, desk.....\$2629.00 ALLIED PRICE \$ _____
- E-35R stereo, 1 cue, rack mounted.....\$2629.00 ALLIED PRICE \$ _____
- E-36 stereo, 3 cue, desk.....\$2719.00 ALLIED PRICE \$ _____
- E-36R stereo, 3 cue, rack mounted.....\$2719.00 ALLIED PRICE \$ _____

Accessory prices upon request

AUDICORD PRICES ABOVE ARE MFGR'S SUGGESTED LIST PRICES. CALL FOR TODAY'S ALLIED PRICE.

“PRICES ARE U.S., DOMESTIC ONLY”

E-SERIES DUAL TRANSPORT RECORD/PLAYBACK

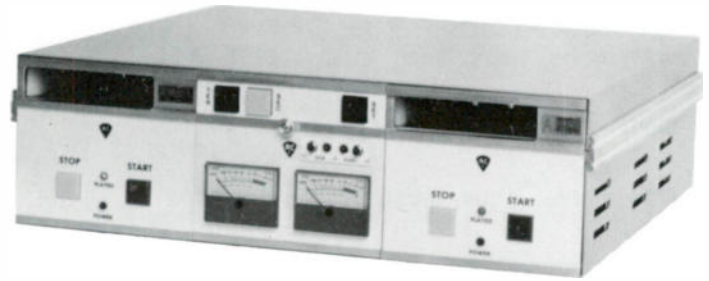

The Models E-50 through E-56 are dual transport record/playback machines which allow single deck or dual deck recording, sound on sound, composites and stereo to mono mix dubs. Features include a slide out front panel, interchangeable transports and other assemblies, 1 or 3 cue tones mono or stereo, a replay reminder system, full remote control that's automation compatible and latching connectors and slip/lift cover.

- E-50 mono, 1 cue, desk.....\$2219.00 ALLIED PRICE \$ _____
- E-50R mono, 1 cue, rack mounted.....\$2219.00 ALLIED PRICE \$ _____
- E-51 mono, 3 cue, desk.....\$2279.00 ALLIED PRICE \$ _____
- E-51R mono, 3 cue, rack mounted.....\$2279.00 ALLIED PRICE \$ _____
- E-55 stereo, 1 cue, desk.....\$2539.00 ALLIED PRICE \$ _____
- E-55R stereo, 1 cue, rack mounted.....\$2539.00 ALLIED PRICE \$ _____
- E-56 stereo, 3 cue, desk.....\$2599.00 ALLIED PRICE \$ _____
- E-56R stereo, 3 cue, rack mounted.....\$2599.00 ALLIED PRICE \$ _____

Accessory prices upon request

AUDICORD PRICES ABOVE ARE MFGR'S SUGGESTED LIST PRICES. CALL FOR TODAY'S ALLIED PRICE.

S-SERIES



These new cartridge machines are more than just attractive. They were designed new from the cabinet feet up, selecting the materials which offered the best manufactured cost consistent with functional integrity to insure the most machine for the dollar. Still the "S-Series" contains new operating features, maintenance access and rugged construction to keep pace with modern broadcast operations.

PLAYBACK

- S-11 mono, 3 cue, desk.....\$1029.00 ALLIED PRICE \$ _____
- S-11R mono, 3 cue, rack mounted.....\$1029.00 ALLIED PRICE \$ _____
- S-16 stereo, 3 cue, desk.....\$1119.00 ALLIED PRICE \$ _____
- S-16R stereo, 3 cue, rack mounted.....\$1119.00 ALLIED PRICE \$ _____

AUDICORD S-SERIES

RECORD/PLAYBACK

S-21 mono, 3 cue, timer, desk.....\$1799.00
ALLIED PRICE \$ _____

S-21R mono, 3 cue, timer, rack.....\$1799.00
ALLIED PRICE \$ _____

S-26 stereo, 3 cue, timer, desk.....\$1989.00
ALLIED PRICE \$ _____

S-26R stereo, 3 cue, timer, rack.....\$1989.00
ALLIED PRICE \$ _____

DELAY MACHINES

S-32 mono, network delay, 3 cues + timer, desk.....\$1889.00
ALLIED PRICE \$ _____

S-32R mono, network delay, 3 cues + timer, rack mounted.....\$1889.00
ALLIED PRICE \$ _____

TDS MACHINES



TDS-1 twin transport, mono, 3 cues, desk.....\$1499.00
ALLIED PRICE \$ _____

TDS-1R twin transport, mono, 3 cues, rack mount.....\$1538.00
ALLIED PRICE \$ _____

TDS-6 twin transport, stereo, 3 cues, desk.....\$1679.00
ALLIED PRICE \$ _____

TDS-6R twin transport, stereo, 3 cues, rack mount.....\$1718.00
ALLIED PRICE \$ _____

Accessory prices upon request

AUDICORD PRICES ABOVE ARE MFGR'S SUGGESTED LIST PRICES. CALL FOR TODAY'S ALLIED PRICE.

ITC

DELTA SERIES PLAYBACK



The DELTA series presents superior audio quality for greater signal to noise performance, less harmonic distortion, lower wow and flutter and better high frequency definition means clear, crisp and accurate sound. Features include hi speed recue, enhanced reliability and compact size.

PLAYBACK

DELTA I mono, 3 cue, desk.....\$1995.00
ALLIED PRICE \$ _____

DELTA I stereo, 3 cue, desk.....\$2155.00
ALLIED PRICE \$ _____

DELTA II mono, 3 cue, desk.....\$2260.00
ALLIED PRICE \$ _____

DELTA II stereo, 3 cue, desk.....\$2470.00
ALLIED PRICE \$ _____

DELTA III mono, 3 cue, desk.....\$4345.00
ALLIED PRICE \$ _____

DELTA III stereo, 3 cue, desk.....\$4695.00
ALLIED PRICE \$ _____

NOTE: ALL MODELS CONVERT TO RECORDER WITH ADDITION OF DELTA IV RECORDING AMPLIFIER

DELTA RECORDING AMPLIFIER

For use with DELTA SERIES I, II, III to provide recording and reproducing capability.

DELTA IV mono.....\$1225.00 ALLIED PRICE \$ _____

DELTA IV stereo.....\$1325.00 ALLIED PRICE \$ _____

DELTA PRICES ABOVE ARE MANUFACTURER'S SUGGESTED LIST PRICES. CALL FOR TODAY'S ALLIED PRICE

OMEGA SERIES

RECORD/PLAYBACK

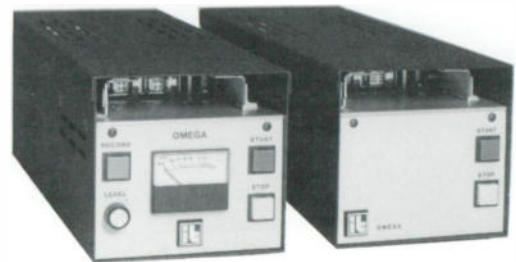

The OMEGA series brings to you quality at an affordable price with features to delight everyone. This includes rugged design with reliable components, but quick, easy maintenance when necessary. Microtechnology offers convenience of solid-state circuitry, adjust-free cue tones, and lockouts, indicator lights, flashers plus brushless servo motor, long life heads and heavy duty trim pots. The OMEGA series was design engineered with you in mind.

OMEGA I mono play, desk.....\$1050.00
ALLIED PRICE \$ _____

OMEGA I stereo play, desk.....\$1195.00
ALLIED PRICE \$ _____

OMEGA record/mono play, desk.....\$1575.00
ALLIED PRICE \$ _____

DELTA PRICES ABOVE ARE MANUFACTURER'S SUGGESTED LIST PRICES. CALL FOR TODAY'S ALLIED PRICE.

**“PUT OUR PAST
EXPERIENCE TO WORK
IN YOUR FUTURE
SUCCESS”**

TAPE CARTRIDGES

ITC

99B SERIES RECORD/PLAYBACK

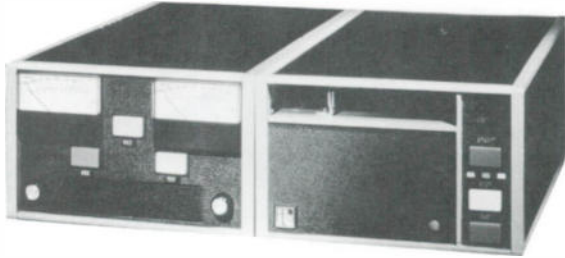

Broadcast professionals who demand the best select the 99B series to delight the most discriminating engineer, operator and listener. This machine is the only one of its kind in the world with the optional patented ELSA system wherein the cartridge is erased, the splice located and the record head automatically azimuth aligned for maximum phase response performance. Consider having a distortion free cartridge adjusting system, true positioning solenoid for guide release and fast stop, micro adjust head module, microprocessor system controls, crystal referenced servo motor, plug in PC cards, meters with peals indicators, hi speed recue, secondary and tertiary cue tone switches, a color coded meter and special function panel. This is "the best"!

RECORD/PLAYBACK

99B-RPM mono, 3 cue, desk.....\$4425.00
ALLIED PRICE \$ _____

99B-RPS stereo, 3 cue, desk.....\$5025.00
ALLIED PRICE \$ _____

99B-RPME mono, 3 cue, desk.....\$5000.00
ALLIED PRICE \$ _____

99B-RPSE stereo, 3 cue, desk.....\$5595.00
ALLIED PRICE \$ _____

PLAYBACK

99B-PM mono, 3 cue, desk.....\$2340.00
ALLIED PRICE \$ _____

99B-PS stereo, 3 cue, desk.....\$2585.00
ALLIED PRICE \$ _____

DELTA PRICES ABOVE ARE MANUFACTURER'S SUGGESTED LIST PRICES. CALL FOR TODAY'S ALLIED PRICE.

CAPITOL



A2

The audio cartridge tape that has become a standard for broadcasters the world over is the CAPITOL A2. For stations who really care about how they sound, the A2 is the logical answer to better sound.

CALL FOR TODAY'S ALLIED PRICE

AA4

The key feature of the AA4 is the new SGS-4 broadcast mastering tape. When recorded on a high quality cartridge recorder, the SGS-4 tape can produce virtually identical copies of the best analog or digital mastering tapes.

CALL FOR TODAY'S ALLIED PRICE

FIDELIPAC



Master Cart I

Master Cart II

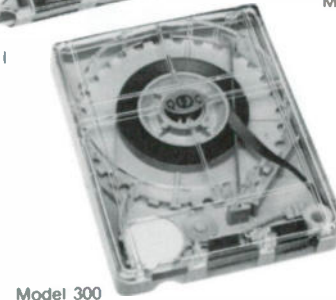

Model 300

MODEL 300

The Model 300 broadcast audio cartridge provides performance at a price that is within the budget of all radio and TV broadcasters. Its endurance under severe operating conditions in everyday studio operations is surprising, frequently lasting over five years with only replacement of worn tape and pressure pads.

CALL FOR TODAY'S ALLIED PRICE

MODEL 350

The Model 350 broadcast audio cartridge is designed primarily for use in stereo cartridge tape machines that have inadequate tape guidance at the tape input side of the record head. The Model 350 contains an adjustable corner post which is factory adjusted to the NAB Standard height of .562 inch. The corner post can be adjusted by the stations engineers to precisely match the cartridge machine to improve stereo performance.

CALL FOR TODAY'S ALLIED PRICE

MASTER CART I

The Master Cart, unlike conventional cartridges, does not rely upon the cartridge for precision tape guidance. Master Cart's tape path is controlled primarily by the tape guides in the cartridge machine. This neutrality of tape flow is assured by a unique tape path plus precision molding of the cartridge base, reel and top cover. Performance is repeatable each time the cartridge is used and also from cartridge to cartridge.

CALL FOR TODAY'S ALLIED PRICE

MASTER CART II

Master Cart II is a cartridge that will work in most tape machines including multiple slot automation devices while providing the highest possible level of stereo performance. Master Cart II features a new and unique front corner post design. This precision molded upper and lower tape limiting device does not interfere with the neutral tape handling concept. It does provide an upper and lower limit to tape travel when the cart is used in less-than-perfectly aligned machines.

CALL FOR TODAY'S ALLIED PRICE

MODEL 600

The Model 600 audio cartridge is available for broadcast, industrial and medical applications where extended playing times are required. This cartridge offers all of the features of the Model 300 plus the capability of up to 750 feet of tape.

CALL FOR TODAY'S ALLIED PRICE

MODEL 1200

The Model 1200 provides the maximum amount of playback time available in an NAB continuous-loop audio cartridge. Available with up to 1500 feet of tape, the Model 1200 provides 40 minutes of playing time at a tape speed of 7.5 ips. Many of the features of the Model 300 are also provided in the Model 1200. Several differences can be seen in the corner post, pressure pad and cover areas.

CALL FOR TODAY'S ALLIED PRICE

SCOTHCART

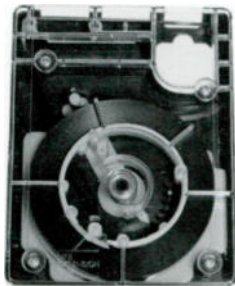

The innovative design of this cart and the superior mastering tape formulation offer you performance capabilities far beyond what you have come to expect from broadcast cartridges. Not only will you hear unbelievable reel-to-reel sound quality, but SCOTCH has used the most advanced technologies to eliminate many of the most unwanted cart problems like excessive tension, phase jitter, wow and flutter, distortion, pressure pad problems, short life and generally poor sound.

CALL FOR TODAY'S ALLIED PRICES.

SONOMAG

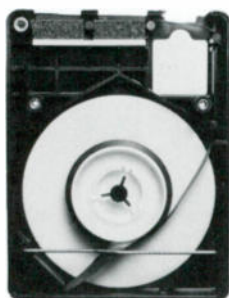

MARK IV

The MARK IV is mechanically equal or superior to any cartridge in the industry; it is a machine manufacturers cartridge designed to operate with maximum life and performance. It has superior pressure pads that won't gum and are easy to replace; also it provides proper head wrap in the widest variety of cart machines and is the only cartridge that provides consistent performance in delay cartridge recorders. Available in lengths from 20 sec. to 7.5 minutes.

CALL FOR TODAY'S ALLIED PRICE.

**“WE ARE A
'SOUND' BUSINESS”!!**

CART ACCESSORIES

AUDIOLAB

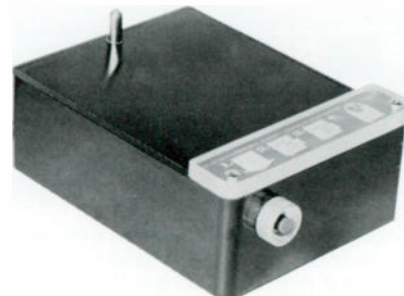

The AUDIOLAB TD-1B tape degausser with automatic overhead thermal protection erases audio tape, carts and cassettes. It erases up to 3/4" tape widths, accommodates up to 10 1/2" reels, provides a wide focused magnetic field to assure complete erasure and provides results every time with a simple two pass operation for broadcast NAB audio cartridges.

MANUFACTURER'S SUGGESTED LIST PRICE.....\$115.00

ALLIED PRICE \$ _____

GARNER



AUDIO TAPE DEGAUSSER

It takes just four seconds to erase all sizes and types of audio tape up to 16" with GARNER degaussers. GARNER has designed their units to automate your tape erasing operations and eliminate residual noise problems, and their customers say they have a winner!

MODEL	DESCRIPTION	PRICE
70	up to 7" reel	\$990.00...ALLIED PRICE \$ _____
105	up to 10 1/2" reel	\$1390.00..ALLIED PRICE \$ _____
114	up to 19" reel	\$2190.00..ALLIED PRICE \$ _____
116	up to 21" reel	\$2390.00..ALLIED PRICE \$ _____

GARNER PRICES ABOVE ARE MFGR'S SUGGESTED LIST PRICES. CALL FOR TODAY'S ALLIED PRICE.

**“THE FIRST FAMILY OF
BROADCAST EQUIPMENT”**

CART ACCESSORIES

GARNER VIDEO TAPE DEGAUSSERS

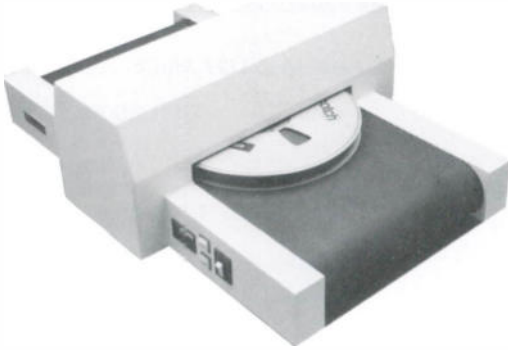

Imagine erasure depth of video tape that exceeds professional standards in 5 to 16 seconds in just one pass (two for larger units) — doesn't matter if it's video cassette cartridge or reel. You're assured of superb, clean, quiet erasure to the most stringent recording standards — we guarantee it!

MODEL	DESCRIPTION	PRICE
270	1"x 8½" dia red	\$2985.00..ALLIED PRICE \$ _____
1100*	1"x 10½" dia red	\$4450.00..ALLIED PRICE \$ _____
1400*	1"x 14" dia red	\$5750.00..ALLIED PRICE \$ _____

* Erases 1" high coercivity video tape and video cassettes

GARNER PRICES ABOVE ARE MFRG'S SUGGESTED LIST PRICES. CALL FOR TODAY'S ALLIED PRICE.

FIDELIPAC 400

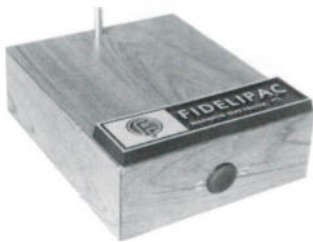

The Model 400 features a removable guide pin, a scuff resistant top, a power-on indicator and hand rubbed hardwood case. It can erase all audio, video and computer tapes up to 1" wide and it has a thermal protected core that will not burn out.

MANUFACTURER'S SUGGESTED LIST PRICE.....\$99.50

ALLIED PRICE \$ _____

FIDELIPAC "BLANK-IT"



If you need blank tape fast and are worried about recorder erase head wear, then worry no more. With the easy to handle "BLANK-IT" eraser from FIDELIPAC, you'll save time, no need to run the

tape through your recorder, you'll save money, it allows instant reuse of the erased tape without worry about program residue or those mind destroying 'whomps.' "BLANK-IT" is hand-held for rapid, accurate tape erasing in any setting.

MANUFACTURER'S SUGGESTED LIST PRICE.....\$64.75

ALLIED PRICE \$ _____

BROADCAST ELECTRONICS

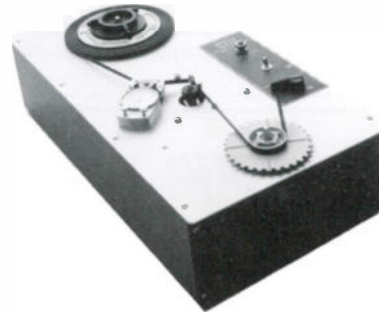

The BROADCAST ELECTRONICS TW-120T cartridge winder with timer is a rugged, dependable and field tested tape cart winder which fills a need in every station using cartridge equipment. It's no longer necessary to limit your cartridge operation by using only stock sizes or to tie up your conventional tape equipment to load tape cartridges. Worn tape in old tape cartridges is easily replaced to any length you desire.

MANUFACTURER'S SUGGESTED LIST PRICE.....\$475.00

ALLIED PRICE \$ _____

TAPECASTER



The TAPECASTER X-100 features "state of the art" technology for the serious broadcaster who has an eye to saving. It has two direct-drive motors, a floating aluminum tape supply disc holds a 7" reel or 10½" pancake of lubricated tape. The solenoid brake stops the supply disc at the end of the wind. The X-100 has adjustable tension control for the supply disc brake, ramp design tape guides and four gold-contact rotary switches to program the wind to 7.5 ips. The wind time is accurately metered by the light chopper and nylon counter wheel.

MANUFACTURER'S SUGGESTED LIST PRICE.....\$495.00

ALLIED PRICE \$ _____

**"PROFESSIONAL PEOPLE,
SALES, SERVICE
& PRODUCT"**

ALLIED CART LABELS



For labelling those all important commercial, music and program audio cartridge tapes, the Allied Cart Label will stick. If label peeling is a problem, then you need a label from ALLIED! They stay when they should. They come off completely when they should.

CART LABELS.....\$0.20 per sheet

CLOCKS AND TIMERS

AUDIOMETRICS

TI-85



The AUDIOMETRICS studio timer is designed as a versatile, easy to operate broadcast accessory with the capability of timing events out to 9:59:59. The timer will readily and simultaneously interface with all types of tape machines, turntables, and other studio equipment for automation operation. Has a large, easy to read 9/16" readout. Easy pull-to-ground or contact starts via barrier strip. Rack mount available.

MANUFACTURER'S SUGGESTED LIST PRICE.....\$215.00

ALLIED PRICE \$ _____

SETH THOMAS



The standard in studios and control rooms around the world are the SETH THOMAS quartzmatic line of clocks. Where accuracy and visibility are a must the SETH THOMAS line is just what the announcer or engineer ordered. Available in 8" or 12" face sizes.

12" \$49.95.....ALLIED PRICE \$ _____

8" \$45.95.....ALLIED PRICE \$ _____

SETH THOMAS PRICES ABOVE ARE MFGR'S SUGGESTED LIST PRICES. CALL FOR TODAY'S ALLIED PRICE.

ESE

302



The ES-302 is a four digit, 100 minute timer with six controls: count

up, count down, stop, minutes advance, seconds advance and reset. Minutes and seconds can be advanced simultaneously or independently in order to pre-set for a specified countdown. With the ES-302, the user can preset times much faster because lever wheel type switches are used for the preset feature. The ES-302 can drive 80 series and 90 series slaves. Options prices available upon request.

MANUFACTURER'S SUGGESTED LIST PRICE.....\$333.00

ALLIED PRICE \$ _____

112E

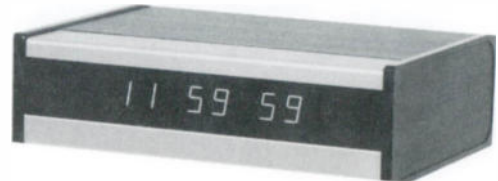

The ES-112E is a solid state 12 hour CMOS, six digit clock. It features three simple controls: fast advance, slow advance and hold which make setting to the precise second easy. The display is a bright orange, gas-discharge, seven segment, .55" high digital. An optional CMOS compatible BCD output can drive two .55" slaves or two 80 series slaves or one 90 series slave. Options prices are available upon request.

MANUFACTURER'S SUGGESTED LIST PRICE.....\$182.00

ALLIED PRICE \$ _____

510E

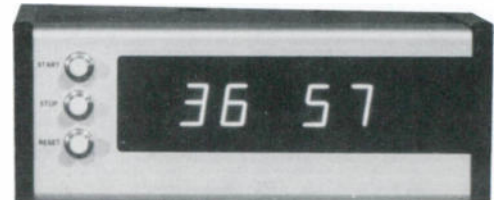

The ES-510E is a four digit, 60 minute timer with start, stop and reset controls. Runs continuously unless stopped or reset. If stopped, display will hold time reading and when restarted will continue with next count from last displayed figure. Reset returns display to all zeros. Can reset while running or stopped. If reset while running, timer will continue to run. ES-510E can drive two 80 series or one 90 series slave. Displays are .55" bright orange gas discharge digital. Remote ready. Options prices are available upon request.

MANUFACTURER'S SUGGESTED LIST PRICE.....\$174.00

ALLIED PRICE \$ _____

562E



The ES-562E is a combination six-digit clock and 12 hour timer with memory, allowing the user to set the clock to the correct time of day, switch to timer mode, then by pushing one button switch back to time of day. The time of day will be correctly displayed in hours, minutes and seconds. The controls on the ES-562E may be removed. Options prices are available upon request.

MANUFACTURER'S SUGGESTED LIST PRICE.....\$345.00

ALLIED PRICE \$ _____

ESE
172



The ES-172 is a console mount clock/timer in compact enclosure, with bright easy to read six digit .4" red LED's. The controls consist of three settings: Fast Advance, Slow Advance, and Hold. The unit has access to control inputs on rear mounted connector and is entirely enclosed in a high impact black plastic case. Option prices are available upon request.

MANUFACTURER'S SUGGESTED LIST PRICE.....\$174.00

ALLIED PRICE \$ _____

CONSOLES

BROADCAST AUDIO

Introducing the Broadcast Audio family of fine audio consoles and related products. These consoles not only look great...they sound great!

SYSTEM 8

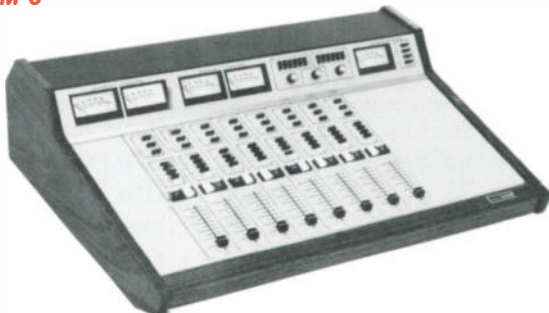

System 8 is an expandable, completely modular broadcast mixer, with unprecedented features and performance. It was designed exclusively for broadcast and is not a scaled-down version of recording or sound reinforcement equipment, so it performs flawlessly even in high RF environments. An elegant low profile appearance is accented by solid walnut end panels and armrest. This mixer sets on top of the desk and doesn't require recessed mounting, so it's easy to install, with all connections made from the top. Two stereo and one mono outputs. Accessory and module prices on request.

MANUFACTURER'S SUGGESTED LIST PRICE.....\$6950.00

ALLIED PRICE \$ _____

SYSTEM 12



System 12 is a model of engineering simplicity, using motherboard construction with only two types of amplifier modules and a plug-in interconnecting harness. Two independent industrial grade power supplies are rack mounted in a common housing with front AC and DC status indicators. The power supply is short-circuit proof and an optional redundant supply is also available. Operator conveniences include 4 inch log taper slide faders for extremely accurate tracking between channels. In addition to a cue detent position on the fader, there is a separate button for cueing when the fader is up. Three stereo and one mono outputs. Accessory and module prices upon request.

MANUFACTURER'S SUGGESTED LIST PRICE.....\$9150.00

ALLIED PRICE \$ _____

SYSTEM 14



System 14 is the latest and most technically sophisticated console in the line. A digital slide fader and digitally controlled CMOS high resolution logarithmic audio attenuator significantly reduce signal paths. Three plug-in mixers are available. Noiseless DC audio switching is used for all program and monitor functions, which also enables each mixing channel to be turned off and on from a remote location, such as an announce studio, news booth, or video switcher. Three stereo and one mono outputs. Accessory and module prices upon request.

MANUFACTURER'S SUGGESTED LIST PRICE.....\$16,530.00 with 12 modules

ALLIED PRICE \$ _____

SYSTEM 16



System 16 features DC audio switching, using LCR's for completely quiet audio control. This also enables each mixing channel to be turned off and on from a remote location. Ten plug-in relays, with switch selection of maintained or momentary contacts, can be used for muting or remote start from any combination of mixers. Operator conveniences include 4" long taper slider faders for extremely accurate tracking between channels. Three stereo and one mono outputs. Accessory and module prices upon request.

MANUFACTURER'S SUGGESTED LIST PRICE.....\$9950.00

ALLIED PRICE \$ _____

BROADCAST AUDIO SYSTEM 20



System 20 has options that enable you to virtually design your own audio console, for on-air use or production. Three plug in mixers are available. Each mixer has a transformer balanced mic input and a differential balanced line level input. Motherboards and mixers are all double-sided with extensive ground planes for optimum noise and crosstalk, plus RFI rejection. All integrated circuits have sockets and are brand name off-the-shelf devices. Three stereo and one mono outputs. Accessory and module prices upon request.

**MANUFACTURER'S SUGGESTED LIST PRICE.....\$24,530.00
with 18 modules**

ALLIED PRICE \$ _____

BROADCAST ELECTRONICS 4S50, 4S50R, 4M50, 4M50R



The 4S50 and 4S50R consoles accommodate 12 stereo input sources. Features high/low input sensitivity selection, has cue switches on all mixers and individual monitor, cue and headphone amplifiers. R series for rack mounting.

4S50 stereo, 4 mixer.....\$1995.00.....ALLIED PRICE \$ _____

4S50R stereo, 4 mixer.....\$2050.00.....ALLIED PRICE \$ _____

4M50 mono, 4 mixer.....\$1050.00.....ALLIED PRICE \$ _____

4M50R mono, 4 mixer.....\$1095.00.....ALLIED PRICE \$ _____

BROADCAST ELECTRONICS PRICES ABOVE ARE MFGR'S SUGGESTED LIST PRICES. CALL FOR TODAY'S ALLIED PRICE.

5S150, 5M150, 8S150, 8M150

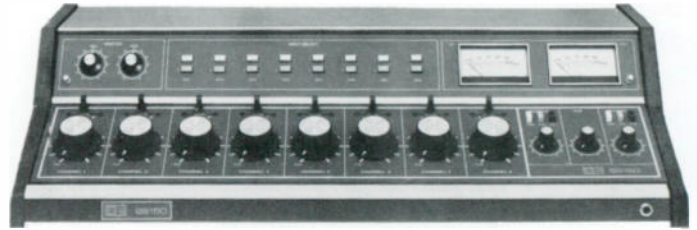

The 5S150, 5M150, 8S150 and 8M150 consoles feature sealed pots, 3600 series electronics and contact free FET bus selection. Each mixing channel accommodates two pushbutton selected inputs and may be preset for mic or line level input.

5S150 stereo, 5 mixer.....\$2850.00.....ALLIED PRICE \$ _____

5M150 mono, 5 mixer.....\$2295.00.....ALLIED PRICE \$ _____

8S150 stereo, 8 mixer.....\$3550.00.....ALLIED PRICE \$ _____

8M150 mono, 8 mixer.....\$2795.00.....ALLIED PRICE \$ _____

BROADCAST ELECTRONICS PRICES ABOVE ARE MFGR'S SUGGESTED LIST PRICES. CALL FOR TODAY'S ALLIED PRICE.

5S250, 5M250, 8S250, 8M250, 10S250, 10M250

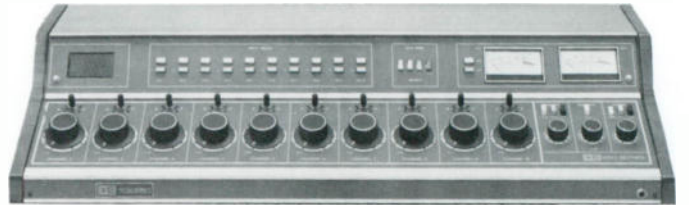

The 5S250, 5M250, 8S250, 8M250, 10S250 and 10M250 consoles feature ladder type step attenuators with cue bus switching, telephone type channel keys and contact-free FET bus selection. Field proven 3600 plug-in electronics make this a truly outstanding line of consoles for any broadcast application.

5S250 stereo, 5 mixer.....\$3550.00.....ALLIED PRICE \$ _____

5M250 mono, 5 mixer.....\$2695.00.....ALLIED PRICE \$ _____

8S250 stereo, 8 mixer.....\$4650.00.....ALLIED PRICE \$ _____

8M250 mono, 8 mixer.....\$3595.00.....ALLIED PRICE \$ _____

10S250 stereo, 10 mixer.....\$5795.00.....ALLIED PRICE \$ _____

10M250 mono, 10 mixer.....\$4650.00.....ALLIED PRICE \$ _____

BROADCAST ELECTRONICS PRICES ABOVE ARE MFGR'S SUGGESTED LIST PRICES. CALL FOR TODAY'S ALLIED PRICE.

MICROTEL MT-1



The Microtel MT-1 is an ultra light, battery-operated mixing console for use in a variety of applications.

It consists of a small box with an input for a microphone, a mini-jack input for another source such as a cassette deck, a jack for a headset, a mini-jack for direct output to a tape recorder or similar device and a modular jack for direction connection to the telephone line.

Totally modular in design, uses two 9 volt batteries (not included), measures 2½" wide by 5" long by 2½" high and weighs less than 1 lb.

MANUFACTURER'S SUGGESTED LIST PRICE.....\$199.00

ALLIED PRICE \$ _____



ARRAKIS
150SC

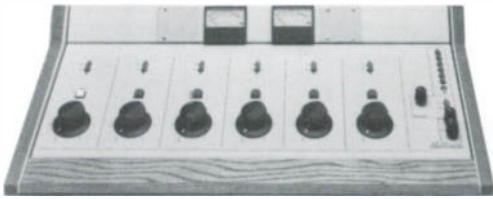

The 150SC is designed for use in small studio or portable applications. Utilizes Allen-Bradley mod pots, VCA audio control, ITT "Schadow" switches, 5 pin Molex gold plated input and output connectors, active balanced circuitry inputs and outputs. Rack mountable.

150SC mono, active in/out.....\$1895.00
ALLIED PRICE \$ _____

150SC stereo, active in/out.....\$1995.00
ALLIED PRICE \$ _____

ARRAKIS PRICES ABOVE ARE MFGR'S SUGGESTED LIST PRICES. CALL FOR TODAY'S ALLIED PRICE.

500SC



The 500SC is a rugged and versatile console designed for broadcast applications. Utilizes Allen-Bradley mod pots, VCA audio control, ITT "Schadow" switches, Electrovert screw terminal strip input and output connectors and active balanced circuitry inputs and outputs.

500SC mono, active in/out.....\$3550.00
ALLIED PRICE \$ _____

500SC stereo, active in/out.....\$3750.00
ALLIED PRICE \$ _____

ARRAKIS PRICES ABOVE ARE MFGR'S SUGGESTED LIST PRICES. CALL FOR TODAY'S ALLIED PRICE.

2000SC



Designed for ease of operation, uncompromising performance and durability, is the 2000SC console. Each of the 12 channels features a single input per channel. Two remote select switches bring in an additional 14 inputs. Cue is accomplished by a detent on the industries finest fader while lighted momentary reed relay switches actuate the program and audition buses which are simultaneously monitored with VU meters. What console could be more rugged in

aluminum and wood construction, with reliable mother board electronics and ease of audible performance?

2000SC stereo, active in/out.....\$4695.00
ALLIED PRICE \$ _____

2000SC mono, active in/out.....\$4495.00
ALLIED PRICE \$ _____

ARRAKIS PRICES ABOVE ARE MFGR'S SUGGESTED LIST PRICES. CALL FOR TODAY'S ALLIED PRICE.

RAMKO



The RAMKO DC 38 series consoles are the latest version of what has become a standard of the broadcast industry in the area of DC (VCA) control of audio. RAMKO in 1975 became the first manufacturer to utilize full DC control which allows for simpler, more efficient audio control.

DC 38-5S 5 mixer, dual stereo.....\$5083.00
ALLIED PRICE \$ _____

DC 38-5M 5 mixer, dual mono.....\$4323.00
ALLIED PRICE \$ _____

DC 38-8S 8 mixer, dual stereo.....\$6733.00
ALLIED PRICE \$ _____

DC 38-8M 8 mixer, dual mono.....\$5386.00
ALLIED PRICE \$ _____

DC 38-10S 10 mixer, dual stereo.....\$7780.00
ALLIED PRICE \$ _____

DC 38-10M 10 mixer, dual mono.....\$5980.00
ALLIED PRICE \$ _____

RAMKO PRICES ABOVE ARE MFGR'S SUGGESTED LIST PRICES. CALL FOR TODAY'S ALLIED PRICE.

HOWE

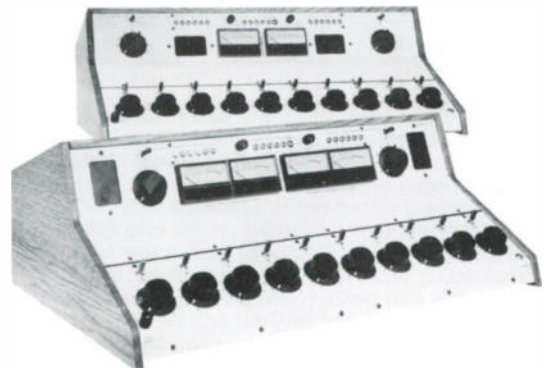

The HOWE 7000 and 7500 series consoles are packed with the most advanced features, yet are designed to be simple to operate and maintain. The VCA is a unique HOWE AUDIO design employing optically coupled transistors to separate the DC control signal from the audio section.

7012 12 mixer.....\$6900.00.....ALLIED PRICE \$ _____

7012A 12 mix, 4 meter.....\$7300.00...ALLIED PRICE \$ _____

7512A 12 mixer.....\$10,500.00.....ALLIED PRICE \$ _____

HOWE PRICES ABOVE ARE MFGR'S SUGGESTED LIST PRICES. CALL FOR TODAY'S ALLIED PRICE.

AUTOGRAM



AUTOGRAM AC and IC consoles are built in only one series. A premium-grade series which features ladder-type attenuators, engraved numbers and letters, 1/4" front panel, and fully balanced and floating inputs and outputs. They're flexible, functional and "bullet proof"!

- AC-6 typical stereo.....\$5014.00.....ALLIED PRICE \$ _____
 - AC-6 typical mono.....\$4399.00.....ALLIED PRICE \$ _____
 - AC-8 typical stereo.....\$6279.00.....ALLIED PRICE \$ _____
 - AC-8 typical mono.....\$5564.00.....ALLIED PRICE \$ _____
 - IC-10 typical stereo.....\$8445.00.....ALLIED PRICE \$ _____
 - IC-10 typical mono.....\$7650.00.....ALLIED PRICE \$ _____
- AUTOGRAM PRICES ABOVE ARE MFGR'S SUGGESTED LIST PRICES. CALL FOR TODAY'S ALLIED PRICE.**

MICROGRAM

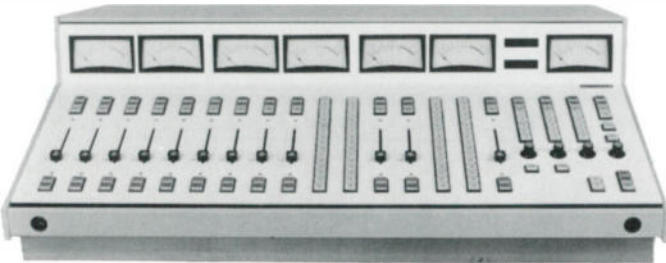

AUTOGRAM'S "Microgram" microprocessor controlled audio console is a powerful addition for any broadcast control room. It's built to handle board functions with ease while signalling and mixing numerous prescheduled events simultaneously. The Microgram console can handle 3 stereo buses simultaneously, or run two completely separated automation systems on AM and FM, and still leave a bus open for production, or allow one bus to call another bus for simulcasting and other special situations. In fact, the Microgram console can perform just about any control function you want it to, from handling your daily schedules, to joining and leaving local or network programming, to turning on or off a coffee pot and station lights.

- MICROGRAM 24 inputs, 3 stereo output buses, 1 mono bus, with LIVE ASSIST, logging capability, remote starts and remote controls, 2 mic channels and balance hi level, clock, timer and temperature readout.**
TYPICAL PRICE.....\$16,535.00
ALLIED PRICE \$ _____
(24-input console w/1-channel automation ... \$21,356.00)
- 40 inputs, 3 stereo output buses, 1 mono bus, with LIVE ASSIST, logging capability, remote starts and remote controls, 2 mic channels and balance hi level, clock, timer and temperature readout.**
TYPICAL PRICE.....\$23,155.00
ALLIED PRICE \$ _____

AUTOGRAM PRICES ABOVE ARE MFGR'S SUGGESTED LIST PRICES. CALL FOR TODAY'S ALLIED PRICE.

RUSSCO

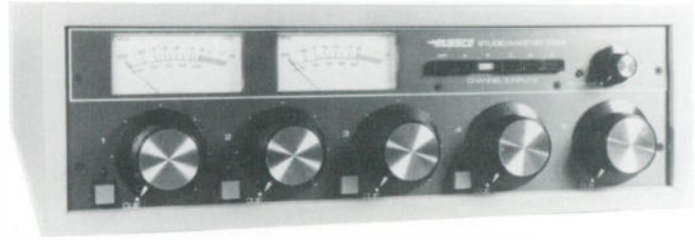

The RUSSCO line of consoles packs a terrific value into a compact size at an unheard bargain price. Designed for broadcast studio use, this terrific five channel mixing console is as modern as tomorrow, with sophisticated features and fully integrated circuitry for dependability. They're engineered for easy operation and simple servicing and they're as good looking as they are good working.

- 505 Mono, built in monitor amp.....\$1469.00
ALLIED PRICE \$ _____
 - 505S Stereo, without monitor amp.....\$2150.00
ALLIED PRICE \$ _____
- RUSSCO PRICES ABOVE ARE MFGR'S SUGGESTED LIST PRICES. CALL FOR TODAY'S ALLIED PRICE.**

QUANTUM



For over ten years QUANTUM has dedicated itself to the building of small to medium sized studio consoles for highest professional demands. No component used in QUANTUM consoles are of any lesser quality than in the products of other manufacturers. The Series 22 consoles feature transformer balanced and floating mic inputs, differentially balanced line level inputs and differentially balanced echo return inputs. The outputs are transformer balanced and floating and strappable for other nominal levels.

CALL FOR TODAY'S ALLIED PRICE.

"SPECIFICATIONS SUBJECT TO CHANGE WITHOUT NOTICE"

CONSOLES

ALLIED
Broadcast Equipment

AUDITRONICS 200



The 200 series on-air broadcast control console represents the culmination of latest technology applied for broadcast use. The design is based on information gathered during extensive research conducted throughout the broadcast industry and the expertise of Auditronics 15-year history in this business. The 200 series offers a high degree of reliability together with simplicity of use in a compact, operator oriented package.

Typical pricing with typical input modules.

206MF typical 6 input mainframe.....\$9000.00
ALLIED PRICE \$ _____

212MF typical 12 input mainframe.....\$14,000.00
ALLIED PRICE \$ _____

218MF typical 18 input mainframe.....\$19,000.00
ALLIED PRICE \$ _____

224MF typical 24 input mainframe.....\$23,500.00
ALLIED PRICE \$ _____

Module pricing upon request.

AUDITRONICS PRICES ABOVE ARE MFRG'S SUGGESTED LIST PRICES. CALL FOR TODAY'S ALLIED PRICE.

300



The 300 series audio production console is a revolutionary new concept developed by Auditronics to complement the particular requirements of today's modern facilities. The 300 series has been developed as a building block system to satisfy the requirements of small or large and complex facilities. Adequate space is reserved for accessory mounting, both in the operational area where signal processing equipment, remote controls, and even modules from other manufacturers may be added on.

Standard configuration for 4 output operation includes mainframe with metering, designated number of input positions.

Typical pricing with standard configuration.

341-8 8 inputs in 16 input mainframe.....\$21,106.00
ALLIED PRICE \$ _____

341-16 16 inputs in 16 input mainframe.....\$27,546.00
ALLIED PRICE \$ _____

341-24 24 inputs in 24 input mainframe.....\$36,006.00
ALLIED PRICE \$ _____

341-32 32 inputs in 32 input mainframe.....\$44,466.00
ALLIED PRICE \$ _____

AUDITRONICS PRICES ABOVE ARE MFRG'S SUGGESTED LIST PRICES. CALL FOR TODAY'S ALLIED PRICE.

Standard configuration for 8 output operation includes mainframe with metering, designated number of input positions.

Typical pricing with standard configuration.

381-12 12 inputs in 16 input mainframe.....\$27,026.00
ALLIED PRICE \$ _____

381-16 16 inputs in 16 input mainframe.....\$30,246.00
ALLIED PRICE \$ _____

381-24 24 inputs in 24 input mainframe.....\$38,706.00
ALLIED PRICE \$ _____

381-32 32 inputs in 32 input mainframe.....\$47,166.00
ALLIED PRICE \$ _____

Module pricing upon request.

AUDITRONICS PRICES ABOVE ARE MFRG'S SUGGESTED LIST PRICES. CALL FOR TODAY'S ALLIED PRICE.

LPB ALPHA-SERIES

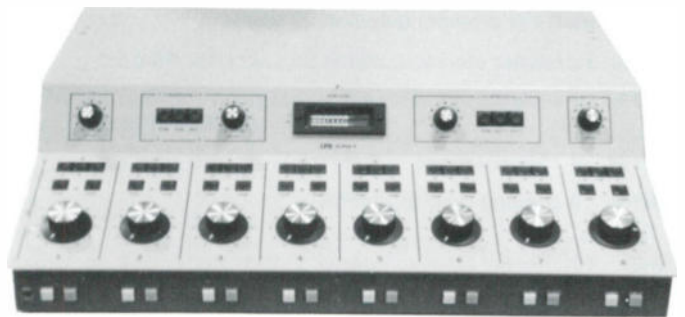

The new LPB Alpha-series broadcast audio consoles are designed to be cost effective, yet completely "state-of-the-art." VCA level control and DC solid-state switching keep the audio signal path short to virtually eliminate signal degradation through the console. Three inputs per mixer, user-programmable monitor and cue muting, transformerless design (output transformers optional), mono mix-down output, built-in 8-watt per channel monitor amplifier, headphone and monitor switching, +8dBm/600 ohm auxiliary outputs, all input plug-ins capable of mic or line level, screw barrier terminal input and output connections, long-life pushbuttons, LED status indicators, fluorescent level meters, 15dB output headroom above +8dBm, momentary remote start pushbuttons, tally contacts and ease of studio interconnection all add up to make these stereo consoles a superior value.

ALPHA 6 channel stereo.....\$2795.00 ALLIED PRICE \$ _____

ALPHA 8 channel stereo.....\$3795.00 ALLIED PRICE \$ _____

ALPHA 10 channel stereo.....\$4795.00
ALLIED PRICE \$ _____

LPB PRICES ABOVE ARE MFRG'S SUGGESTED LIST PRICES. CALL FOR TODAY'S ALLIED PRICE.

**"PRICES ARE U.S.
DOMESTIC ONLY"**

**LPB
SIGNATURE II**



The LPB SIGNATURE II consoles feature transformer audio inputs. Monitor speaker muting and on-air light relays are provided. A cue position is provided in each mixer and all models include an internal cue system consisting of a cue amplifier, level control and 5" speaker. The internal monitor amplifier is switch selectable to monitor program or two external monitor inputs. The illuminated VU meter reads the program output at all times.

- S-12 5 channel stereo.....\$3395.00....ALLIED PRICE \$ _____
- S-13C 8 channel mono/stereo.....\$4495.00
ALLIED PRICE \$ _____
- S-14A 5 channel mono.....\$2695.00...ALLIED PRICE \$ _____
- S-15A 8 channel dual out/mono.....\$3495.00
ALLIED PRICE \$ _____
- S-20 10 channel dual out/stereo.....\$5395.00
ALLIED PRICE \$ _____

(Note: add \$95 for mono mixdown)
S-21B 10 channel dual out/mono.....\$4395.00
ALLIED PRICE \$ _____

Accessory and spares prices upon request.
LPB PRICES ABOVE ARE MFGR'S SUGGESTED LIST PRICES.
CALL FOR TODAY'S ALLIED PRICE.

CITATION



The LPB CITATION consoles come in only stereo and in only two configurations, 8 channel and 10 channel. The series features transformer balanced inputs and outputs, with three inputs per mixer, program, audition, mono mixdown, monitor, cue, headphone and tape outputs. The CITATION console features a signal to noise ratio of better than 74 dB below +18 dBm output with -50 dBm input 20 Hz to 20 kHz.

- C-8S 8 channel dual stereo.....\$6995.00
ALLIED PRICE \$ _____
- C-8SL 8 channel dual stereo.....\$7995.00
ALLIED PRICE \$ _____

- C-10S 10 channel dual stereo.....\$7995.00
ALLIED PRICE \$ _____
- C-10SL 10 channel dual stereo.....\$8995.00
ALLIED PRICE \$ _____

Accessory and spares prices upon request.
LPB PRICES ABOVE ARE MFGR'S SUGGESTED LIST PRICES.
CALL FOR TODAY'S ALLIED PRICE.

UREI



The UREI 1650 and 1680 series broadcast consoles have the features most requested by engineers and consultants, priced within the budget of small market stations and built with UREI quality. The new consoles offer a choice of five or eight mixers and a choice of attenuator types, rotary conductive plastic, Shallco precision rotary or Penny and Giles straight line. Provisions are for customization to fit the individual station needs, but no accessories are required to put them on the air as they are shipped.

- 1651 5 mixer, conductive.....\$2696.00
ALLIED PRICE \$ _____
- 1652 5 mixer, Shallco.....\$3396.00
ALLIED PRICE \$ _____
- 1653 5 mixer, Penny & Giles.....\$3696.00
ALLIED PRICE \$ _____
- 1681 8 mixer, conductive.....\$3296.00
ALLIED PRICE \$ _____
- 1682 8 mixer, Shallco.....\$4496.00
ALLIED PRICE \$ _____
- 1683 8 mixer, Penny & Giles.....\$4896.00
ALLIED PRICE \$ _____

Accessory and spares prices upon request.
UREI PRICES ABOVE ARE MFGR'S SUGGESTED LIST PRICES.
CALL FOR TODAY'S ALLIED PRICE.

**MICRO-TRAK
6510 SERIES**



The Model 6510 features ten mixing channels, fourteen inputs, stereo or mono, selectable muting switch, relays for "on-the-air" lights, high quality VU meters, VCA attenuators, plug-in printed circuit cards and switches for easy maintenance, pushbutton input selector switches, barrier terminal strip input and output terminations, monitor output at line level, sealed main pots and compact design.

- 6510 DBM (MONO)
MANUFACTURER'S SUGGESTED LIST PRICE.....\$3150.00
- 6510 DBS (STEREO)
MANUFACTURER'S SUGGESTED LIST PRICE.....\$3495.00
- ALLIED PRICE \$ _____

CONSOLES

MICRO-TRAK 6509



The Model 6509 audio console features five mixing channels, nine mixing inputs, outputs for stereo, mono, monitor, headsets and cue speaker, selectable muting, slotted screw terminal connections, illuminated VU meters. Crosstalk spec'd at -50 dB to -74 dB and distortion is 0.4% Re: +8 dBm output, 800 Hz, hi level input. Package size is 17 3/4" W x 12 3/4" D x 6 1/2" H and weighs 16 lbs.

MANUFACTURER'S SUGGESTED LIST PRICE.....\$1995.00

ALLIED PRICE \$ _____

IIXL SERIES



The new IIXL series of audio control consoles from MICRO-TRAK are at the forefront being extra rugged, versatile, top performer units for radio and/or television. The exciting features include electronically balanced transformerless inputs, 2 inputs per channel, switch select input levels, FET input switching, FET bus selection switches, long life linear faders, analog VU metering, pushbutton switches for cue selection with LED indicators, push button remote start switches for carts, electronically balanced outputs. The IIXL series deserves your close attention.

IIXL-5, 5 channel, stereo.....\$2995.00

ALLIED PRICE \$ _____

IIXL-10, 10 channel, stereo.....\$4750.00

ALLIED PRICE \$ _____

MICRO-TRAK PRICES ABOVE ARE MFGR'S SUGGESTED LIST PRICES. CALL FOR TODAY'S ALLIED PRICE.

TASCAM

M-16



The M-16 comes in 16 or 24 input configurations. It features 8 main program mixing buses with submaster faders, 8 main board outputs, stereo solo in-place, input, monitor and effects returns, remix solo enable, input PFL/Solo select, 2 independent stereo mixing buses, 16 meters switchable to read bus or external source, 100 millimeter conductive plastic faders for smooth, positive control, 4 band, 8 knob parametric equalizers that may be switch bypassed, four auxiliary mixing buses and 16 x 2 channel or dual 8 x 2 channel monitor selection. A sophisticated production board for every need. Accessory prices upon request.

M-16 16 inputs.....\$10,500.00.....ALLIED PRICE \$ _____

M-16 24 Inputs.....\$13,000.00.....ALLIED PRICE \$ _____

M-500 SERIES

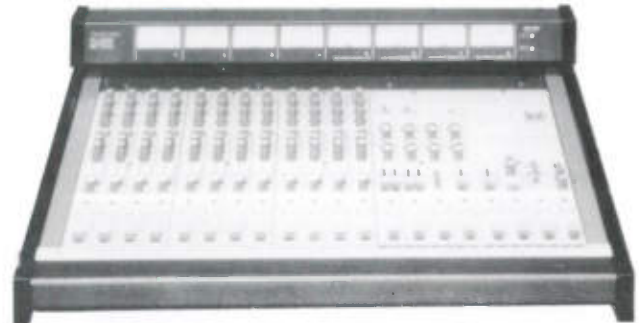

The TASCAM M-500 SERIES are sophisticated audio mixing consoles designed for professional production applications. The M-520 (20-in/8-bus) is intended primarily for 16-track studios, while the M-512 (12-in/8-bus) is ideal for 8 track installations. Basic features include selectable inputs, balanced XLR microphone inputs with individually switchable phantom power, 2 pair instrument inputs, 2 RIAA phono inputs, 16 or 8 line inputs, 16 or 8 multitrack tape returns, 8 main buses, 4 auxiliary buses, 8 balanced amplifiers, 12 or 8 VU meters with LED peak indicators. Each input channel has access send/receive, 3-band parametric EQ, mute switch, and direct out. Also includes stereo SOLO, prefader listen and talk back mic plus slatetone/test oscillator. Console has optional pedestal available.

M-520 \$5495.00

ALLIED PRICE \$ _____

M-512 \$3995.00

ALLIED PRICE \$ _____

TASCAM PRICES ABOVE ARE MFGR'S SUGGESTED LIST PRICES. CALL FOR TODAY'S ALLIED PRICE.

ELECTRO VOICE C-12 SERIES TWO



The ELECTRO VOICE C-12 SERIES TWO console is a compact, high performance 12 in/4 subgroup/stereo and mono output mixer designed for musical, speed, theatrical sound reinforcement, and recording applications. A new balanced output option uses highest quality transformers and circuitry with XLR connectors on all 10 outputs (Mono, L/R Stereo, 4 Subgroups, Monitor, Aux, and Hi Effects Sends) for lowest noise and distortion. These may be used either singly, or in any combination with the normally provided unbalanced (1/4" phone) outs. This variety of outputs and the versatility provided by having access jacks at almost every point in the signal path makes the mixer equally at home in broadcast, recording or production environments.

C-12/2 \$3855.00

ALLIED PRICE \$ _____

ELECTRO VOICE PRICES ABOVE ARE MFGR'S SUGGESTED LIST PRICES. CALL FOR TODAY'S ALLIED PRICE.

SHURE

M-67

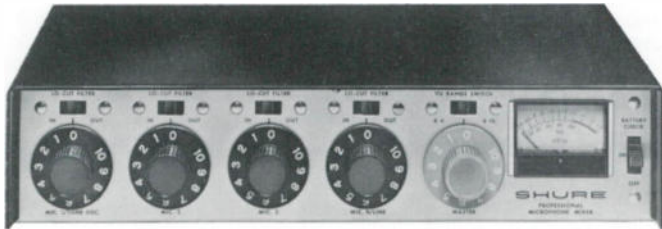

The M-67 is a transistorized microphone mixer/remote amplifier specifically designed for professional applications. The excellent performance and versatility of this complete, compact console make it an ideal choice for studio, remote, or original sound reinforcement use, and as an "add-on" mixer for expanding existing facilities. It is also ideally suited for use with tape recorders and VTR's to provide multiple microphone inputs.

MANUFACTURER'S SUGGESTED LIST PRICE.....\$400.00

ALLIED PRICE \$ _____

M-267

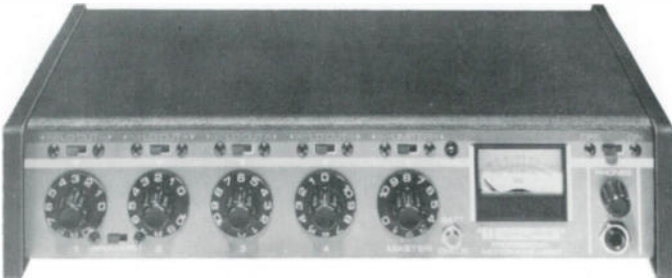

The SHURE Model M-267 is a microphone mixer/remote amplifier specifically designed for professional applications. The excellent performance, versatility and features of this complete, compact console make it an ideal choice for studio, remote, or sound reinforcement use, and as an add-on mixer for expanding existing facilities. It is also ideally suited for use with audio and video tape recorders to provide multiple microphone inputs.

MANUFACTURER'S SUGGESTED LIST PRICE.....\$440.00

ALLIED PRICE \$ _____

FP-31



The Model FP-31 is a compact, portable microphone mixer specially designed for electronic news gathering (ENG) and electronic field production (EFP) use including film, video and remote broadcast applications. The FP-31 provides a wide, flat frequency response, low distortion, and up to +18 dBm output. The unit features extremely low internal noise and switchable low-cut filters for each input that effectively reject low-frequency handling and wind noise. 400 Hz slate tone, 1 kHz cue tone.

MANUFACTURER'S SUGGESTED LIST PRICE.....\$830.00

ALLIED PRICE \$ _____

TELFAX

131A



From TELFAX, manufacturers of the most widely used miniature phone remote units comes a new unit for the professional broadcaster, the TFX-131A. More features like pushbutton dialing with memory redial, LCD clock/stopwatch timer, test oscillator, closed circuit spotter channel, instant compatibility with low frequency extenders and other external audio processors, custom engraved call letter plate, modular phone connectors and much more.

MANUFACTURER'S SUGGESTED LIST PRICE.....\$795.00

ALLIED PRICE \$ _____

31C



This is the new standard in remote broadcasting, the Telfax TFX-31C phone remote unit. It is the smallest, lightest and most feature-packed unit on the market. Just connect it to the phone line, plug in your headset and you're ready to broadcast with superior audio quality. Compare size, features and price carefully, the Telfax TFX-31C is the only wise choice.

MANUFACTURER'S SUGGESTED LIST PRICE.....\$595.00

ALLIED PRICE \$ _____

MAXI-TEL

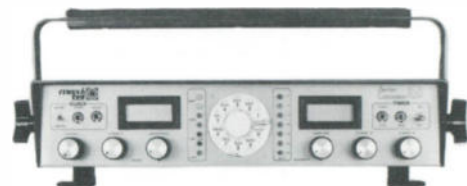

Utilizing the latest "developed technology" electronic design, the MAXI-TEL is your answer to all of your remote broadcast problems when using telephone lines. When you are broadcasting sports games, grand openings, conventions or whatever, the MAXI-TEL will serve you flawlessly with exceptional broadcast quality. 120 volt operation plus up to 40 hours of battery backup makes the MAXI-TEL one of the most reliable pieces of broadcast equipment that you own.

MANUFACTURER'S SUGGESTED LIST PRICE.....\$825.00

ALLIED PRICE \$ _____

CONSOLES

RUSSCO



Here's the Remote Mixer you've been waiting for! The STELLAR SERIES TELEMOTE 321 gives you two low impedance microphone inputs and one medium impedance tape recorder input in a handy-dandy 3 pound package. The RUSSCO TELEMOTE 321 3 CHANNEL MIXER makes life easy for you. No batteries or AC plugs to worry about. Just hook up to your phone line and you're on the air!

MANUFACTURER'S SUGGESTED LIST PRICE.....\$550.00

ALLIED PRICE \$ _____

MAXI-TWO

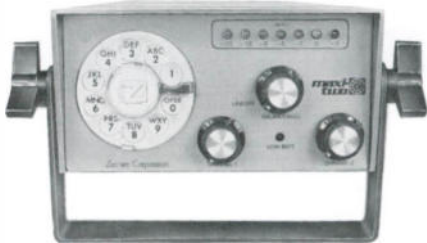

If a two channel mic/tape mixer will perform all the functions you need for remote broadcasting then the MAXI-TWO will fill the need. With two mic inputs or one plus a tape input for cassette, LED VU indication, battery or AC operation, and a telephone dial the MAXI-TWO is the maximum two channel mixer for your remote broadcasting program.

MANUFACTURER'S SUGGESTED LIST PRICE.....\$425.00

ALLIED PRICE \$ _____

MICRO-TRAK

SPORT III & SPORT IV



This two channel console incorporates many features found desirable by sports broadcast personnel including talkback for setup, a built-in AC power supply, low cost battery requirements, a "Touchtone" telephone dial and three headphone outputs. The SPORT III is attractively packaged in a self-contained carrying case. Open the cover, connect the telephone line, plug in the AC if available, turn to battery operation if not, plug in a microphone or sportscaster headset and it's play-by-play time. The SPORT IV has all the features of the SPORT III with five mic inputs, 4 mix to program + spotter to headset only.

SPORT III.....\$699.00

ALLIED PRICE \$ _____

SPORT IV.....\$849.00

ALLIED PRICE \$ _____

MICRO-TRAK PRICES ABOVE ARE MFGR'S SUGGESTED LIST PRICES. CALL FOR TODAY'S ALLIED PRICES.

BONNEVILLE

DA-6



The Bonneville DA-6 is a premium quality, general purpose audio distribution amplifier for the professional. It is suitable for multiple line-level feeds from a single source. Heat buildup is no problem. As many as 30 have been stacked and operated for years. The DA-6 is supplied with six outputs. Up to 10 outputs can be ordered or field-installed in the prepunched chassis. The unit meets design specifications with all ten outputs as well as six. Additional output and black anodized panel option prices upon request.

MANUFACTURER'S SUGGESTED LIST PRICE.....\$595.00

ALLIED PRICE \$ _____

DA-106



The DA-106 is a premium-quality general-purpose audio distribution amplifier. It is suitable for multiple line-level feeds of audio or real-time SMPTE time-code signals from a single source.

The unit features a balanced, bridging transformer input complete with static shield and R-F bypassing. Up to 30 dB of gain is adjustable by a front-panel control. The amplifier and power supply modules are easily removable from the front of the unit.

All outputs are transformer-isolated and are fully protected against short-circuits. Outputs are isolated from each other by a minimum of 60 dB across the entire audio bandwidth. Outputs can be strapped for 150 or 600-ohm source impedances. The individually-calibrated VU meter can be set for either +4 or +8 dBm systems. A front-panel headphone jack is provided for aural monitoring. A bipolar regulated power supply is self-contained. The rectifier/regulator module is removable from the front of the unit. The amplifiers and power supply are designed for continuous sine-wave duty. The distribution system is engineered to interface with a system without introducing ground loops.

The DA-106 offers some of the most enviable features available in audio distribution at the most reasonable pricing in its class.

DA106Stereo..... \$1095.00

ALLIED PRICE \$ _____

DA106Mono..... \$695.00

ALLIED PRICE \$ _____

BONNEVILLE

DA-108

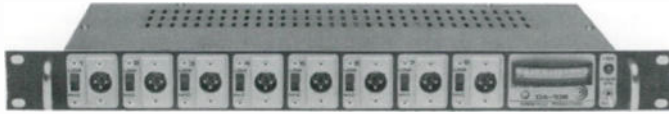

The DA-108 is particularly suited to provide multiple microphone or line-level outputs to reporters and sound cameramen at press conferences. It is also suited for multiple feeds in portable sound reinforcement systems. The DA-108 features XLR connectors in and out, transformer inputs and outputs, a 20K bridging input, up to +24 dBm outputs, selectable line or mic outputs, adjustable gain to +30 dB and a self contained power supply.

MANUFACTURER'S SUGGESTED LIST PRICE.....\$695.00
ALLIED PRICE \$ _____

PC-2

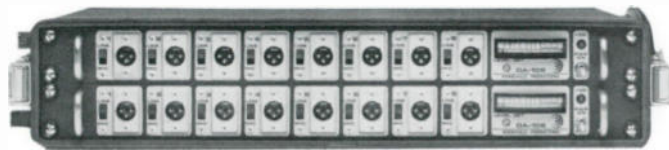

The "Press Corps 2" audio distribution package combines two DA-108 distribution amplifiers in a rugged carrying case. The two DA's may be bridged from a single input line using the cable supplied, or may be operated independently as separate 1 x 8 units. The carrying case has a detachable front and back cover to completely protect the distribution system during transportation. Transformer isolation on all inputs and outputs protects against AC ground loop current and RFI.

MANUFACTURER'S SUGGESTED LIST PRICE.....\$1495.00
ALLIED PRICE \$ _____

A-10

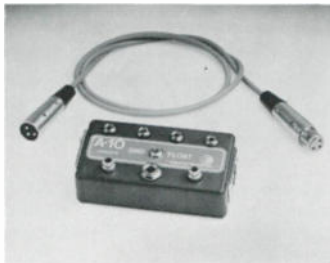

The A-10 audio accessory is a passive interface box designed to provide multiple isolated outputs from a single line-level input. Several cassette tape recorders may be driven from a single distribution amplifier line-level input. All output jacks are insulated from the case. A ground switch is provided to maximize the flexibility of the unit.

MANUFACTURER'S SUGGESTED LIST PRICE.....\$59.00
ALLIED PRICE \$ _____

LA-404 Line/Isolation Amplifier



The Bonneville Model LA-404 is a self-contained general purpose line amplifier suitable for program feeds, headphone drivers, signal-level boosting and audio distribution or isolation.

This premium-quality unit features four separate line amplifiers with transformer-isolated inputs and outputs. All inputs are bridging and outputs are short-circuit protected. The output (source) impedance is available in 150,600 ohms or a selected alternate. A bi-polar

regulated power supply is self-contained, and an electronically-isolated VU-meter may be selected to any of the four channels. VU-meter may be selected to any of the four channels. VU-meter range is selectable to +4, +8 or +20 dBm equal to the 0-VU indication. A headphone jack is provided on the front panel for monitoring the system audio. The headphone output follows the meter selector switch and the headphone level is adjustable by a front-panel control.

Available gain from each amplifier channel is 30 dB, and is continuously adjustable from zero output to 30 dB of gain by means of four individual front-panel controls.

Input and output connections are by means of an unbreakable screw-type barrier strip. The general design of the amplifier incorporates performance, reliability, ruggedness and quality parts.

The amplifier is designed for standard 19" rack mounting and requires 3 1/2 inches of vertical rack space.

The LA-404 is designed by professional broadcasters for professional audio use.

MANUFACTURER'S SUGGESTED LIST PRICE.....\$895.00
ALLIED PRICE \$ _____

AUDIOMETRICS

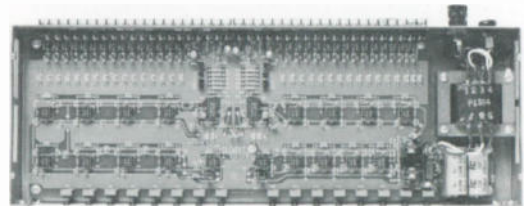

The AUDIOMETRICS distribution amplifiers combine solid state electronics and functional flexibility into one small package. A single high quality audio op amp provides balanced output, and individual gain adjustments for each channel. Excellent isolation is provided between outputs. Each balanced channel, regardless of level set and load, is unaffected by the other channels. Audio sources can be routed to multiple locations with various level requirements and impedances while maintaining the integrity of the signal quality throughout.

DA-84 2 x 16.....\$409.00 **ALLIED PRICE \$ _____**

AUDIOMETRICS PRICES ABOVE ARE MFGR'S SUGGESTED LIST PRICES. CALL FOR TODAY'S ALLIED PRICE.

TELLABS MODULAR

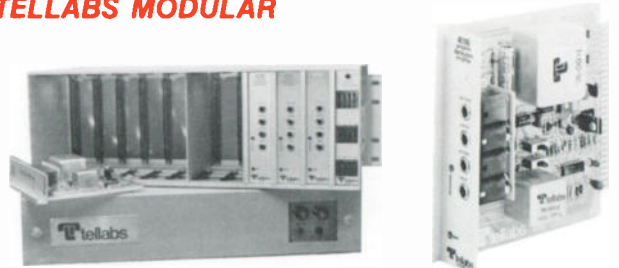

Each Tellabs 4018 module provides a 1 x 8 distribution amplifier with high impedance bridging or 600 ohms input and 600 ohms each port output. The 1012 housing permits mounting of up to eleven 4018 modules plus a 9021 fuse protection module. Combine this package with a rack-mounted 8013 power supply, and you have up to 11 x 88 distribution amplifier. All Tellabs equipment is connected by .075 wirewrap terminals. Cabinets must be wired by user.

4018 DA module.....\$141.32 **ALLIED PRICE \$ _____**

1012 Housing.....\$106.25 **ALLIED PRICE \$ _____**

8003A Power supply.....\$183.82 **ALLIED PRICE \$ _____**

TELLABS PRICES ABOVE ARE MFGR'S SUGGESTED LIST PRICES. CALL FOR TODAY'S ALLIED PRICE.

HEACO

5002A



The 5002A audio distribution amplifier from HEACO offers a 15K ohm transformer balanced input. The frequency response of the amplifier is down less than .25 dB over a frequency range of 20 Hz to 20 kHz. Distortion is less than .25% over the same range. Eighteen 600 ohm balanced outputs are provided that are isolated by greater than 80 dB. The output level, as well as input level, can be monitored by a high-quality VU meter allowing the operator to check the operation of the DA as well as accurately set the audio level to the outputs.

MANUFACTURER'S SUGGESTED LIST PRICE.....\$387.50

ALLIED PRICE \$ _____

5004A



The dual 5004A distribution amplifier from HEACO is what can accurately be described as "developed technology" carried to its highest. With only 1 3/4" of rack space, it makes bulky distribution amplifiers a thing of the past. The 5004A consists of dual, extremely low distortion amplifiers. Each amplifier has a differential, balanced bridging input. The frequency response is less than .25 dB over a frequency range of 20 Hz to 20 kHz. Distortion is less than .25% over the same range. The 5004A offers a choice of 1 x 8 or 2 x 16 operation, with integrated circuitry and popless input to the output meter switch.

MANUFACTURER'S SUGGESTED LIST PRICE.....\$593.50

ALLIED PRICE \$ _____

RAMKO



The new PRIMUS RS-1616 is an audio thru data routing/amplifying system with performance and versatility unmatched by any similar units on the market. In addition to performance that will surpass the requirements of even the most critical studio professional, the user friendly controls (local front panel, remote 4 bit binary, common 3 wire serial, or standard RS-232 personal computer control) provide you with the power to program or control these units, limited only by your imagination.

The system can be configured from as little as 8 mono/4 stereo in by 2 out, to as large as 128 mono/64 stereo in by 64 out, with each main frame capable of handling up to 16 mono/8 stereo (or combinations thereof) and 16 out. Up to 32 main frames may be looped together and controlled with a single control system.

Nothing could be easier to operate. If it is local control (front panel), simply select the input you want and then the output. Remote controls, due to the wide variety of methods available, can be configured practically any way desired.

PRICE ON APPLICATION

UTAH SCIENTIFIC

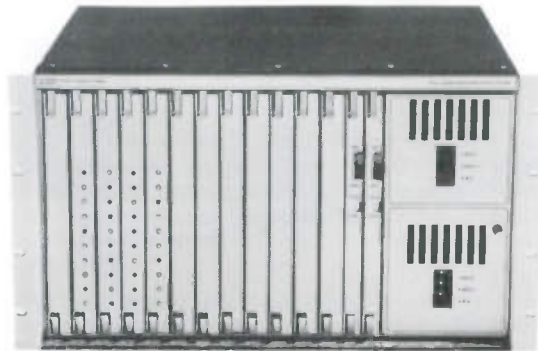

The AVS-1 Switching System has been developed to meet the needs of broadcasters and others whose requirements call for reliable, distortion-free routing of audio, video, tally, time code or machine control signals. Standard configurations are offered in matrix sizes from 10 x 10 to 150 x 160 providing video only, audio only, or audio follow video switching. Multi-level audio, regenerative time code, tally and metallic contact matrices are also available. Performance parameters are controlled by 1% components having extremely good temperature and aging characteristics. Redundant cooling fans are employed. Four redundant party lines are provided. A standby control and memory card are available to permit instant replacement of 100% of the shared components and redundant diode-isolated power supplies are also available.

PRICE UPON APPLICATION.

CONEX

UM-33 OMNI-Q



The CONEX Omni-Q is a stereo, eight channel in, one channel out general purpose cue, monitor, and line amplifier.

The Omni-Q provides the easiest, least expensive, and most compact way of handling a variety of common monitoring, cueing, amplifying, and switching situations in any audio installation.

Typical Omni-Q applications include:

- * Network or remote line monitor and buffer amplifier
- * Transmitter input selector and monitor
- * Automation cue amplifier
- * Tape recorder input selector
- * Telephone line source selector
- * Headphone amplifier
- * Intercom, communication system, or multi-media testing
- * Console input expander

Special Features:

- * 8 balanced bridging stereo inputs
- * 600 Ohm and direct switched outputs
- * Stereo LED VU meters with front panel calibration (-20 to +8)
- * Stereo monitor amplifier drives external speakers at 2 watts per channel
- * Also contains two built-in speakers
- * Front panel headphone jack and speaker switch
- * Built-in low-distortion 3 frequency test oscillator with level control
- * Front panel jacks for easy connection of test equipment to the switched audio bus
- * Self-contained in a compact 1 3/4" rack mounting package

MANUFACTURER'S SUGGESTED LIST PRICE.....\$495.00

ALLIED PRICE \$ _____

AUDITRONICS 1100 SERIES



Designed to meet the requirements of the modern broadcast facility, the 1100 SERIES audio distribution amplifier systems from AUDITRONICS include the mainframe, power supply and a 1 x 6 distribution amplifier module. The DA-6/LC module includes one balanced input with internally accessed master gain control and six balanced outputs each module with individual front panel accessible attenuation controls.

- 1100-MFP** 8 input mainframe with integral PS-1100 power supply.....\$850.00
ALLIED PRICE \$ _____
- 1100-MF** 10 input mainframe exclusive of power supply.....\$500.00
ALLIED PRICE \$ _____
- DA-6/LC** 1 input with gain control + 6 outputs with individual attenuation controls.....\$166.00
ALLIED PRICE \$ _____
- PS-60** Rack mount external power supply system.....\$475.00
ALLIED PRICE \$ _____
- PSI-60** Rack mount power supply isolator.....\$250.00
ALLIED PRICE \$ _____
- PS-1100** Spare integral power supply for 1100 MFP mainframe.....\$350.00
ALLIED PRICE \$ _____

AUDITRONICS PRICES ABOVE ARE MFRG'S SUGGESTED LIST PRICES. CALL FOR TODAY'S ALLIED PRICE.

STANDARD FREE STANDING

Model	Cap.	Mfrg's List	ALLIED PRICE \$
A/L 20	20	\$22.00	_____
A/L 36	36	\$38.00	_____
A/L 40	40	\$40.00	_____
A/L 50	50	\$48.00	_____
A/L 60	60	\$58.00	_____
A/L 100A	100	\$84.00	_____
(Rows 5 wide, 20 high - as picture shows)			
A/L 100B	100	\$84.00	_____
(Rows 10 wide, 10 high)			
A/L 150	150	\$128.00	_____
A/L 200	200	\$169.00	_____

N-SERIES FREE STANDING

Model	Cap	Mfrg's List	ALLIED PRICE \$
A/L 100N	100	\$87.00	_____
A/L 150N	150	\$128.00	_____
A/L 200N	200	\$169.00	_____
A/L 250N	250	\$220.00	_____
A/L 300N	300	\$255.00	_____
A/L 350N	350	\$301.00	_____
A/L 400N	400	\$336.00	_____
A/L 450N	450	\$383.00	_____
A/L 500N	500	\$429.00	_____
A/L 600N	600	\$486.00	_____
A/L 800N	800	\$642.00	_____
A/L 1000N	1000	\$840.00	_____

LAZY SUSAN MODELS



Lazy susan cart racks are normally supplied with standard 4" base. However, any size base up to 30" is available. Special size racks are available. Walnut, pecan, gold or black laminate are standard. Call or write for prices on special bases, sizes or laminates.

Model	Cap	Mfrg's List	ALLIED PRICE \$
A/L 100LS	100	\$166.00	_____
A/L 160LS	160	\$249.00	_____
A/L 240LS	240	\$290.00	_____
A/L 400LS	400	\$496.00	_____
A/L 800LS	800	\$836.00	_____
A/L 1000LS	1000	\$1302.00	_____
A/L 1200LS	1200	\$1508.00	_____

FURNISHINGS

A-LINE CART RACKS



For audio cartridge storage Allied offers the high-quality, highly flexible A-LINE of cart racks. From the standard wall mount to the most exotic lazy susan models, everything is available from Allied. All cart racks are normally supplied with walnut, pecan, gold or black laminate. Special laminates and sizes are available, call or write for prices.

ALLIED WIRE LAZY SUSAN CART RACKS



Where strength and capacity are required at a minimal cost, the Allied line of welded, durable wire lazy susan cart racks can fill the need. Available in a choice of 50, 300 or 500 capacity, these industrial quality cart racks will give many years of dependable service.

Model	Cap	Mfgr's List	ALLIED PRICE \$
50	50	\$42.95	\$ _____
300	300	\$349.00	\$ _____
500	500	\$495.00	\$ _____

ALLIED IS A MAJOR SUPPLIER OF COPPER

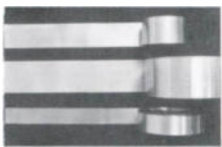

for RF Management,
COPPER STRAP
.020 or .032 thickness,
all widths

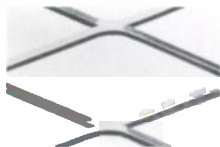

for tower counterpoise,
COPPER GROUNDSCREEN



for equipment or
room shielding,
COPPER FLYSCREEN



for construction wiring,
SOFT #10 COPPER WIRE

CALL FOR TODAY'S PRICE.

FIDELIPAC CART RACKS



The Fidelipac line gives you a choice of styles and sizes.

Model	Description	ALLIED PRICE \$
WR25	Wall mount-25 carts.....\$28.70	\$ _____
MRB-1	rack base (8-WR25).....\$66.90	\$ _____
MR-200	mobile rack holds 200.....\$296.50	\$ _____
TR-48	table top rack holds 48.....\$83.70	\$ _____
TR-96	tabletop rack holds 96.....\$150.40	\$ _____

FIDELIPAC PRICES ABOVE ARE MFGR'S LIST PRICES. CALL FOR TODAY'S ALLIED PRICE.

MICRO TRAK CART RACKS

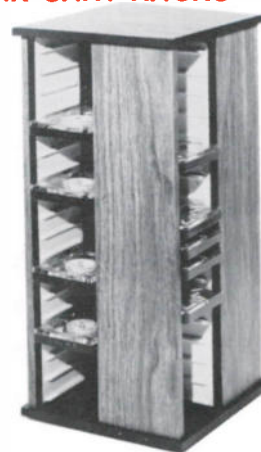

The Model 72 lazy susan cart rack is designed to complement the L series studio furniture line as is the L-90 wall mount unit. The Micro Trak line of cart racks offers clean efficient lines and a maximum of storage with a minimum of utilized space.

Model	Description	ALLIED PRICE \$
72	Lazy Susan cart rack.....\$94.50	\$ _____
90	Wall mount cart rack.....\$94.50	\$ _____

MICROTRAK PRICES ABOVE ARE MFGR'S SUGGESTED LIST PRICES. CALL FOR TODAY'S ALLIED PRICE.

SIMPAC

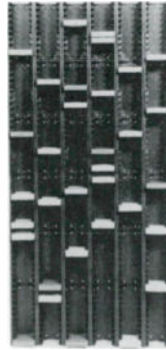

For a cart rack that will mount anywhere and will hold up to 10 carts, the SIMPAC line from Allied is just what the engineer ordered. Black only.

MANUFACTURER'S SUGGESTED LIST PRICE.....\$7.00 per module

ALLIED PRICE \$ _____

A-LINE 19" EIA EQUIPMENT RACKS



All rack cabinets are made of 3/4" high-density particle board and covered with walnut, honey gold, pecan or black laminate. However, any color or wood grain laminate is available. Backs of all equipment racks feature an exclusive snap-out panel for easy access to equipment. Custom heights are available. Optional casters are \$37.00 per set. For overall dimensions add 4" to the panel height, all units are 23 1/4" wide overall, 17" depth racks are 18" deep overall, 23" depth racks are 24" deep overall.

Model	Panel Ht	Depth	Mfgr's List	ALLIED PRICE \$
A/L R100	7"	17"	\$78.00	_____
A/L R100	7"	23"	\$82.00	_____
A/L R101	8 3/4"	17"	\$85.00	_____
A/L R101	8 3/4"	23"	\$89.00	_____
A/L R102	10 1/2"	17"	\$91.00	_____
A/L R102	10 1/2"	23"	\$97.00	_____
A/L R103	12 1/4"	17"	\$105.00	_____
A/L R103	12 1/4"	23"	\$111.00	_____
A/L R104	14"	17"	\$118.00	_____
A/L R104	14"	23"	\$125.00	_____
A/L R105	15 3/4"	17"	\$130.00	_____
A/L R105	15 3/4"	23"	\$136.00	_____

A/L R106	17 1/2"	17"	\$144.00	ALLIED PRICE \$ _____
A/L R106	17 1/2"	23"	\$160.00	ALLIED PRICE \$ _____
A/L R107	19 1/4"	17"	\$161.00	ALLIED PRICE \$ _____
A/L R107	19 1/4"	23"	\$167.00	ALLIED PRICE \$ _____
A/L R108	21"	17"	\$171.00	ALLIED PRICE \$ _____
A/L R108	21"	23"	\$175.00	ALLIED PRICE \$ _____
A/L R109	24 1/2"	17"	\$174.00	ALLIED PRICE \$ _____
A/L R109	24 1/2"	23"	\$182.00	ALLIED PRICE \$ _____
A/L R110	31 1/2"	17"	\$184.00	ALLIED PRICE \$ _____
A/L R110	31 1/2"	23"	\$191.00	ALLIED PRICE \$ _____
A/L R111	35"	17"	\$190.00	ALLIED PRICE \$ _____
A/L R111	35"	23"	\$197.00	ALLIED PRICE \$ _____
A/L R112	42"	17"	\$202.00	ALLIED PRICE \$ _____
A/L R112	42"	23"	\$213.00	ALLIED PRICE \$ _____

SOUNDOLIER CABINET RACKS

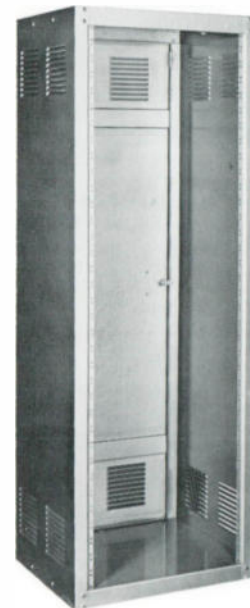

Soundolier cabinet relay racks are designed for standard 19" rack panels. Sturdy 16 gauge CRS is used throughout. A rear door is provided as standard equipment and is hung on slip jointed hinges. Knockouts and internal louvers are among the exclusive features offered by Soundolier. Six 3/4" to 1" conduit Knockouts (three on top and three on back flange) are provided at top of the rack with six knockouts at the bottom. To facilitate cable entry, three 2 13/16" diameter holes are located toward the rear of the base of the rack. Ventilation is improved while providing a neat and clean appearance.

PRICE ON APPLICATION

“SPECIFICATIONS SUBJECT TO CHANGE WITHOUT NOTICE”

H.O.M.E.



The DR series of H.O.M.E. 19" modular racks includes several features including sturdy welded construction of 16 gauge CRS, optional side panels that are removable for multiple bolt-together assemblies, adjustable 11 gauge angles tapped for 10-32 screws on standard EIA spacing that makes panel mounting easy. A cable opening is provided in the bottom panel. A rear door with lock and handle is provided. You can choose from 20 standard baked enamel colors. Depths to 24" available.

CALL FOR TODAY'S ALLIED PRICE

201 SERIES TURNTABLE BASES

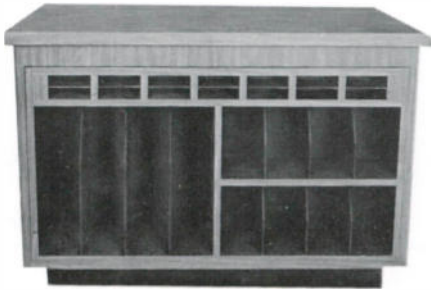

A-LINE turntable bases are constructed of 3/4" high-density particle board covered with standard laminates. Tops are 1 1/4" thick. Turntable bases are normally supplied with rack rails constructed of 11 gauge steel, tapped to accept 10-32 standard EIA rack panel screws. Cover panels are available at \$6 per bay. Custom cabinets with record and/or tape storage inserts are available.

Model	Description	Price
A/L 201A	Single turntable base.....	\$222.00
		ALLIED PRICE \$ _____
A/L 201B	Double turntable base.....	\$347.00
		ALLIED PRICE \$ _____
A/L 201C	Triple turntable base.....	\$447.00
		ALLIED PRICE \$ _____

SHOCK ABSORBER JR.



The SHOCK ABSORBER JR. is a turntable isolation platform designed for retrofit and OEM installations. It consists of a turntable mount plate and a base plate separated by four live rubber mounts. The mount plate is high density particle board with a lead strip in-laid around the perimeter. This massive plate is isolated from the base plate by four live rubber shock mounts to further reduce resonance and vibrations. The unit can accommodate all popular direct-drive turntable/tonearm combinations, providing up to 8-10 dB of feedback headroom and 20 dB of isolation. Standard finishes include walnut, pecan, black or gold laminate. The mount plate will be pre-cut if the turntable/tonearm combination is specified with this order.

SHOCK ABSORBER JR.....	\$305.00
SHOCK ABSORBER JR. for SP10 MARK III.....	\$359.00

ALLIED PRICE \$ _____

SHOCK ABSORBER



Allied's turntable isolator has been integrated into a package known as the Shock Absorber. This approach attacks head-on the many problems associated with protecting otherwise noise free turntable-tone arm combinations from all types of interference. Gives 8 to 10 dB of feedback headroom improvement and up to 20 dB of isolation. Turntable and tone arm not included.

SHOCK ABSORBER.....	\$516.00	ALLIED PRICE \$ _____
SHOCK ABSORBER for SP10 MARK III.....	\$580.00	ALLIED PRICE \$ _____

ALLIED RADIO BASE



A table top turntable base that will accommodate all the popular turntable/tone arm combinations. Comes in standard walnut or black laminate. Special laminates are available at extra cost. (Turntable and tone arm not included.)

MANUFACTURER'S SUGGESTED LIST PRICE.....	\$125.00
ALLIED PRICE \$ _____	

GRAPHIC EXPRESS



Our audio cabinet, developed through years of experience, offers both ergonomically and functionally correct designs, extreme flexibility, competitive price and is available for immediate delivery.

The ability to choose precisely the modular components needed means added flexibility for studio layouts. You can have exactly the design you want—and you can expand or modify the system later should your needs change. The modular design insures compatibility with new or existing studios. Premium quality materials are used throughout. Our work stations for on the air studios and production rooms are designed to maximize the efficiency of the operator and station's engineer. The stylish image that the consoles project, not only enhance your station's look to potential advertisers and the visiting public, but also improve the working environment.

The large number of access panels, held in place with quarter turn fasteners, allow easy cable handling and quick access to cable runs. All units provide access through cabinet bottoms for sub-floor cable ducting. Rack rails are included where specified.

Revitalize your studio and increase your efficiency through proven design and modular flexibility.

We also offer design and fabrication of custom studio cabinetry built to your specifications. Contact us for details.

PRICES UPON APPLICATION

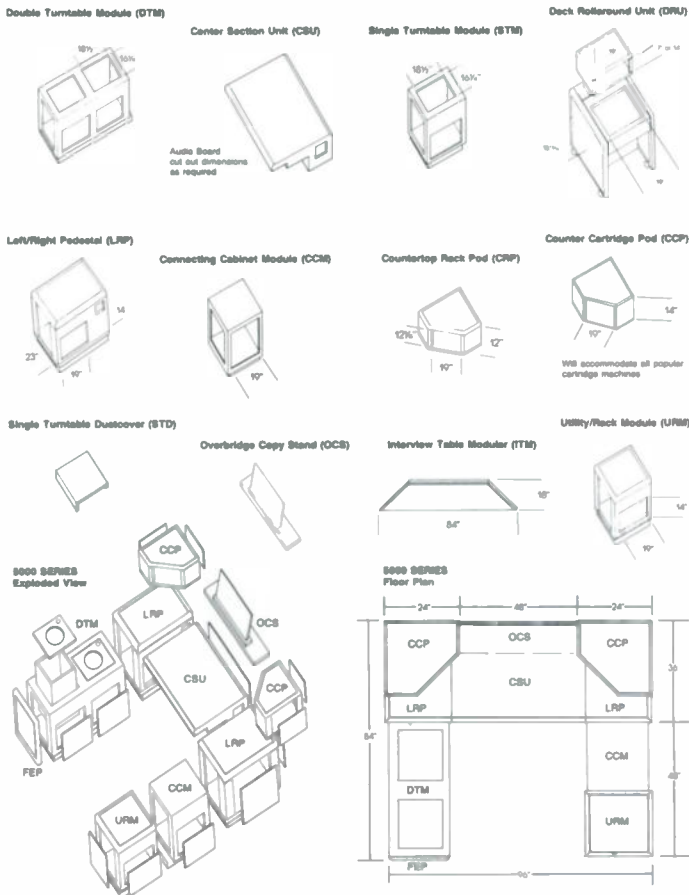

ALLIED STUDIO PACKAGE

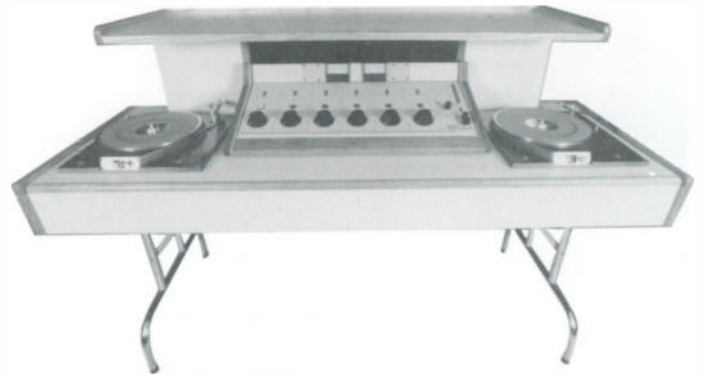

The ALLIED STUDIO PACKAGE is the answer for remote broadcasts, news and production studio establishment, or disco operations. This convenient portable package is available wired and equipment ready in either mono or stereo with turntables, phono preamps, tonearms, phono cartridges and rugged cabinetry with solid oak trim. Design a system around equipment you already own or select your favorite brand equipment for installation. Overbridge is an optional feature. You'll find this package to be a space saving solution to many of your production problems.

PRICES VARY DEPENDING ON EQUIPMENT SELECTED. CALL FOR YOUR ALLIED PACKAGE PRICE.

(NOTE: If not picked up at Richmond Warehouse—add \$150 packing charge.)

CONSOLE TABLE

The A-LINE console table comes in a standard size 30" x 96" table top with legs and modesty panel available.

Model	Description	Price
A/L 202	Console tabletop 30" x 96".....	\$149.00 ALLIED PRICE \$ _____
A/L 1111	Legs for console tabletop.....	\$186.00 ALLIED PRICE \$ _____
A/L 2222	Modesty panel for tabletop.....	\$19.00 ALLIED PRICE \$ _____

STANDARD BROADCAST DESK



A heavily-built "real" piece of control room furniture. Standard in 29" height with tabletop of 30" x 96", this unit can be varied in size to meet your precise needs. Shipped modular for rapid assembly. A pullout kneewell back affords easy access to hidden wiring compartments. Amplifier optional.

Model	Description	Price
A/L 230	Console desk, no drawers.....	\$593.00 ALLIED PRICE \$ _____
A/L 2300	Console desk, two drawers.....	\$644.00 ALLIED PRICE \$ _____

ELECTRO-DUCT® by Electrovert

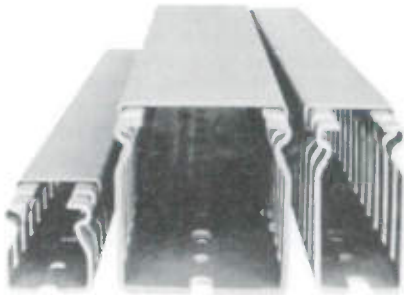

This plastic duct has more positive features than any other. If you've had to fight cover-on & cover-off with inferior brands, you'll appreciate the zip-on, zip-off ability of Electro-Duct's cover.

When you buy Electro-Duct, the cover is included in the price. Allied stocks 1" x 1", 2" x 2", 3" x 3", and 5" x 3". Length: 6½ ft. Color: gray.

We went for the best so you can have the best. There are many PVC Duct manufacturers. There's only one Electrovert.

PRICE UPON APPLICATION

RECORD STORAGE CABINETS



Now your music or transcription library can be put in alphabetical or numerical order with standard or custom size record storage cabinets from Allied.

Model	Record Size	Cap Size	Mfg'r's List	ALLIED PRICE \$
A/L 1000A	7"	1000	\$226.00	ALLIED PRICE \$ _____
A/L 1500A	7"	1500	\$268.00	ALLIED PRICE \$ _____
A/L 3000A	7"	3000	\$321.00	ALLIED PRICE \$ _____
A/L 750B	12"	750	\$231.00	ALLIED PRICE \$ _____
A/L 1000B	12"	1000	\$269.00	ALLIED PRICE \$ _____
A/L 1500B	12"	1500	\$330.00	ALLIED PRICE \$ _____

REEL TAPE STORAGE CABINETS

Every station has a room running over with reel-to-reel tapes, commercials, programs, and a widely assorted variety of other types of taped material. The A-LINE reel tape storage cabinets are available in standard or custom sizes for every application.

Model	Tape Size	Cap	Mfg'r's List	ALLIED PRICE \$
A/L 350TB	7"	350	\$194.00	ALLIED PRICE \$ _____
A/L 500TB	7"	500	\$309.00	ALLIED PRICE \$ _____
A/L 200TC	10½"	200	\$267.00	ALLIED PRICE \$ _____
A/L 400TC	10½"	400	\$320.00	ALLIED PRICE \$ _____

RUSLANG RL-500



For mounting any standard 19" x 15¾" tape transport, the Ruslang RL-500 is constructed with the same care as other top name consoles constructed over the past few years. Accepts Ampex, MCI, Otari and Tascam transports and includes the tilt feature.

CALL FOR TODAY'S ALLIED PRICE

RUSLANG RL-600



Accepts tape transports which are 19" by up to 21". This console was designed specifically for the newer generation of decks which have their electronics integrated with the transport including the Otari 5050B and others. The RL-600 is built with the same quality concern that has identified the Ruslang name for years.

CALL FOR TODAY'S ALLIED PRICE

OMNIMOUNT



The Omnimount mounting system puts added flexibility into a wide variety of equipment mounting functions including speakers, clocks, and some types of equipment including monitors. Omnimount is of industrial quality, built to last a long time. A key to its remarkable performance is the ball joint design. The ball is molded of an ebonite polymer compound, with excellent memory-return and is just about indestructible. The ball is bonded to the thick-walled carbon steel tube the same way that heavy duty motor mounts are bonded. You can mount Omnimount on the wall or ceiling and it does its job with extraordinary flexibility, not limited to the usual "pan and tilt" functions. A wide variety of models is available to choose from.

CALL FOR TODAY'S ALLIED PRICE

COPPER PRODUCTS

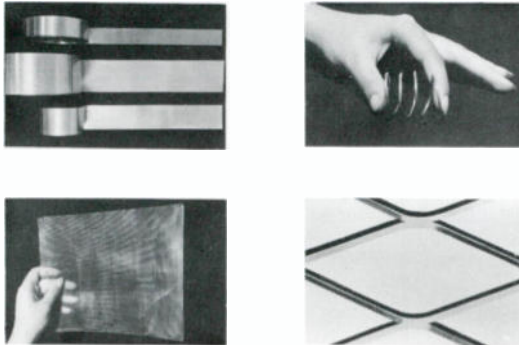

When you start wiring, shielding or screening your studio, Allied has all the copper products you'll need including copper strap up to 8" widths in .020 or .032 thickness, #10 soft drawn copper wire, copper flyscreen and copper groundscreen. Whatever your copper need, Allied can meet the situation with a complete selection.

CALL FOR TODAY'S ALLIED PRICE

BELDEN WIRE



Belden is recognized as the leader in the wire/cable/cord industry and manufactures thousands of different electronic cable and cord constructions utilized in a vast assortment of applications. Many cables are custom designed/manufactured for specific applications prior to becoming standardized for systems in data processing, computers, medical applications, broadcasting, etc. Belden Black 8451 is especially popular with broadcasters as well as 8728. With Belden in our "background," we offer you the worlds largest inventory of wire/cable/cord available to anyone, anywhere.

ALLIED OFFERS THE COMPLETE BELDEN LINE ON A VERY COMPETITIVE PRICE STRUCTURE.

CALL FOR TODAY'S ALLIED PRICE.

WEST PENN WIRE

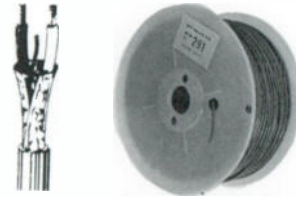

Put some color into your life by using WEST PENN easy to strip color shielded cable. A particular favorite of broadcasters is #291 two conductor twisted pair shielded cable. #291 comes in 22 AWG stranded with a 24 AWG drain wire with insulation colors of white, red, brown, black, yellow, green, gray, blue, violet and orange. This product is comparable to the leading manufacturers, but with reduced price structure.

ALLIED OFFERS THE ENTIRE WEST PENN LINE ON A VERY COMPETITIVE PRICE STRUCTURE.

CALL FOR TODAY'S ALLIED PRICE.

ALLIED TERMINATION SYSTEM

Allied can offer everything you need to establish a type "66" punch block wiring system in your studio or station.

"O" PADS

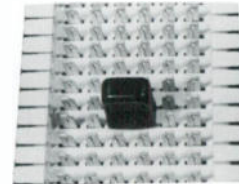

Where specific attenuation is needed the Allied "O" pad can provide a choice of 3, 6, 10, 17, or 23 dB attenuation.

TERMINATION



Your choice of vertical or horizontal termination 300, 600 or 10K ohms. Terminating, bridging, or build-out.

"SA-1" BRIDGE CLIPS



For jumper applications in use of "66" punch block wiring.

ALLIED TERMINATION SYSTEM PUNCH TOOLS



For punch board wiring applications, this is the most efficient method utilized.

Model	Description
S66MT	spring loaded
S66BT	manual
S714	automatic

"66" PUNCH BLOCKS

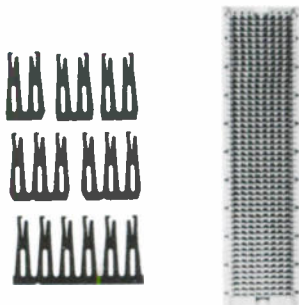

Absolutely the easiest way to accomplish complex wiring projects. A must for efficient console, rack mounted equipment or other types of wiring installations.

Model	Description
S66B3-75	Group of 2 clips
S66B3-50	Group of 3 clips
S66B4-25	Group of 6 clips

SNAP-IN WALL MOUNT



Perfect for mounting a type "66" punch block on the wall or any available space. The model S66B6 will fit most standard punch blocks.

WIRE AND CABLE HANGERS



Allied has wire and cable hangers for every application.

Model	Description
S66147	Cable hanger
S66145	Cable hanger

CALL FOR TODAY'S ALLIED PRICE ON TERMINATION COMPONENTS.

CONTROL ROOM CHAIR



Just as important to your air sound as a turntable, the Allied chair built for any environment includes black naugahyde back and seat covers, and easy roll wheels. High or low versions are available for standup or sitdown operation.

Model	Description	Mfgr's List	ALLIED PRICE \$
HI	standup model	\$108.50	_____
LO	sitdown model	\$100.00	_____

GENTNER FLEXIBLOCK



The Gentner Flexiblock is an insulation-displacement punch block system made specifically for stranded wire. Connections to Flexiblock are fast, easy and reliable. A high number of connections may be made in a small space (up to eight connections per circuit) and connections are virtually short-circuit proof. Standard size is 10"L x .56"H x 3.37"W with 50 terminals. (Variables available)

S81-25 MANUFACTURER'S SUGGESTED LIST PRICE.....\$19.90

ALLIED PRICE \$ _____

ALLIED WARNING LIGHTS "MICRO SERIES"



The Allied "MICRO SERIES" warning light is supplied with one 1820/28 volt lamp. The unit is designed for use with 24 volts for extended life. All models mount on standard single gang wall boxes or plaster rings. The wedge shaped translucent cover is available in red or white.

Model	Voltage	Message	Price
L-101	24 VDC	ON AIR	\$28.80
L-101	24 VDC	BLANK	\$22.50

ALLIED WARNING LIGHTS "STROBE SERIES"



An adaptation of technology to a unique application is the 70,000 candlepower "STROBE SERIES" of telephone and "ON AIR" warning lights from Allied. These bright attention drawing lights come in a variety of lens colors including white, blue, red, amber and green, lettered with "PHONE" or "ON AIR". 12 and 24 volt DC and 115 VAC "ON AIR" models are available. Only 115 volt AC models available for "PHONE."

Model	Voltage	Message	Price
WHI-12	12VDC	ON AIR	\$68.00
WHI-24	24VDC	ON AIR	\$68.00
WHI-115	115VAC	ON AIR	\$68.00
PS11AWA	115VAC only	PHONE	\$84.00

ARCHITECTURAL SERIES



FLAT WALL



EXTENDED
OR
CEILING MOUNT

Enhance the environment of any broadcast application with the Allied "ARCHITECTURAL SERIES" OF WARNING LIGHTS. The series includes flat wall and wall or ceiling mounted models. These are well constructed warning lights made in a one piece die cast aluminum housing of 1/8" minimum wall thickness. There's no external hardware. The spring clip mechanisms firmly secure the directional panel to the housing eliminating light leaks. The extending bracket and ceiling units have a cast aluminum canopy.

Type	Message	Price
Flat Wall-7½"x7½"	On Air	\$74.50
Ceiling 7½"x8½"	On Air	\$110.00

STANDARD



The model of warning light that has served the broadcast industry for many years is the Allied "STANDARD" model. This durable, highly visible and efficient on air warning light is available now.

\$45.00

FIDELIPAC



Your broadcast or recording studio will really be "off limits" when Fidelipac Studio Warning Lights are lit. Their brilliant red lettering on jet black background can be seen even in the brightest ambient light conditions. With a faceplate of unbreakable plexiglas, the light includes lamps and mounting hardware. Custom legend minimum 6 pieces.

Model	Message	Mfgr's List	ALLIED PRICE \$
340	ON AIR-English	\$47.60	ALLIED PRICE \$ _____
340-S	ON AIR-French, German, Greek, Japanese, Polish, Russian, Spanish or Swedish.	\$47.60	ALLIED PRICE \$ _____
340-REC	RECORDING-English	\$47.60	ALLIED PRICE \$ _____
340-REC-S	RECORDING-Spanish	\$47.60	ALLIED PRICE \$ _____
340-CUS	Customized legend	\$67.10	ALLIED PRICE \$ _____

LUXO MICROPHONE ARMS



The model LM-1 from Allied is a high quality piece of studio furniture. The LM-1 will hold any microphone up to 3 pounds maximum. You have a choice of three mounting bases. Please specify base A, B or C.

MANUFACTURER'S SUGGESTED LIST PRICE.....\$42.00
ALLIED PRICE \$ _____

TITUS



This flush mounted ON AIR light from TITUS was designed to provide the broadcaster with a low voltage device which can be mounted horizontally or vertically and have simple bulb replacement. Unit uses #1819 bulbs for 24V operation and #1815 for 12V operation, and measures 8¼" by 4¼".

MANUFACTURER'S SUGGESTED LIST PRICE.....\$99.00
ALLIED PRICE \$ _____

AUDIOMETRICS



M2MD-U

M3MD-U

The heavy-duty AUDIOMETRICS model M2MD-U mic arm will hold any mic in place. With optional heavy duty springs, it will hold the heaviest mic. The M3MD-U has an extra "arm" giving it an additional 12 inches of reach. Accessories are available for these mic arms to enhance their use.

Model	Nomenclature	Mfr's List	ALLIED PRICE \$
M2MD-U	Single Ext.	\$84.00	_____
M3MD-U	Double Ext.	\$100.00	_____
Heavy Springs	Hvy Springs.....	\$8.00pr.	ALLIED PRICE \$
11427	Bench Mt. Base.....	\$9.00	_____
11426	Wall Mt. Base.....	\$9.00	_____
14005	Clamp Mt. Base.....	\$9.00	_____
14100	Riser-1 ft.	\$19.00	_____
EB-1	Arm-Angle Ext.	\$30.00	_____



Hvy Springs

14100

EB-1



11425

11427

14005

TRIPLE MIC ARM



This unit was designed for those "around the table" conference and/or group interviews where multiple mics are required. The base — which rises approximately 9 inches, must be bolted to a supporting surface and contains 3 M2MD-U mic arms with standard springs. Each arm rotates 360° allowing various extension configurations.

TMA \$249.00
ALLIED PRICE \$ _____

AUDIOMETRICS MIC ARM



Hold Everything
M2MD-U Mic Arm w/1 ft. riser\$84.00*
14005 clamp mount.....\$9.00
11426 wall mount.....\$9.00
11427 bench mount.....\$9.00
*For microphones over 5 lbs., add.....\$8.00

SONEX



Sonex acoustic tile from Alpha Audio offers the isolation qualities you require for any application. Comes in natural colors of charcoal, brown, tan and blue or painted colors of silver, blue, brown or orange.

4' x 4' sheets-Natural colors

Depth	per carton	sq. ft./carton	Price
2"	8	128	\$266.00
3"	6	96	\$260.00
4"	4	64	\$255.00

4' x 4' sheets-Painted colors

Depth	per carton	sq. ft./carton	Price
2"	8	128	\$342.00
3"	6	96	\$334.00
4"	4	64	\$327.00

15" x 15" audio tiles

Depth	per carton	sq. ft./carton	Price
2"	28	50	Natural \$198.00 Painted \$249.00

2", 3" and 4" sample kits are available at special prices.
Quantity discounts apply.

ATLAS

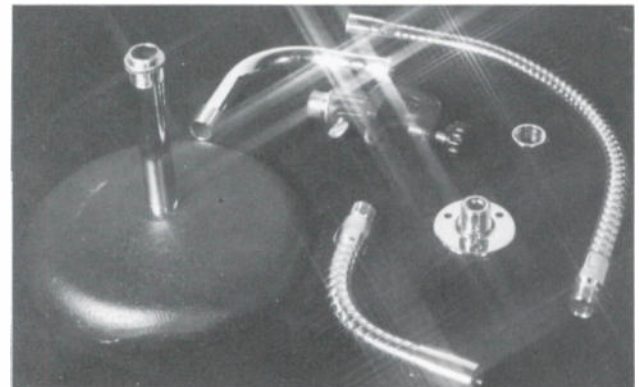

A wide variety of mic stands, goosenecks and booms are available from Atlas Sound and Allied for every application. Whether it's for the studio, portable or mobile application, there's an Atlas for the job.

AKG



K-45



K-18

K-45

The K-45 is an excellent choice whenever an economical, rugged headphone is preferred which is high in performance, supra-aural and is a true "open air" design. It's equipped with large transducers such as those found in higher-end models. Provides supreme clarity and definition throughout the entire frequency spectrum. It's vented acoustical foam earpads are cardan-coupled on a flexi-plastic headband.

MANUFACTURER'S SUGGESTED LIST PRICE\$45.00

ALLIED PRICE \$ _____

K-18

The K-18 is an ultra-lightweight boom set. It consists of two monophonically connected dynamic earphones and boom arm with noise-cancelling dynamic microphone. The headphone matches with 4 to 300 ohm outputs and comes with a 3¼ ft. cable with stripped and tinned leads. ALLIED CARRIES THE ENTIRE AKG HEADPHONE LINE.

MANUFACTURER'S SUGGESTED LIST PRICE.....\$59.00

ALLIED PRICE \$ _____

ASTROLITE 2637-G1



The 2637-G1 has a noise cancelling electret mic with performance equalling fine studio microphones. Its noise cancellation properties make it suitable for use in noisy environments. The 2637-G1 features phantom or battery power.

MANUFACTURER'S SUGGESTED LIST PRICE.....\$259.00

ALLIED PRICE \$ _____

2636-G1

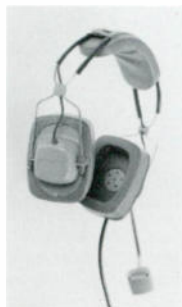

The 2636-G1 features ear-enveloping cushions which provide attenuation for use in noisy environments. The close-talking dynamic mic equals the performance of studio microphones-even in high ambient noise levels. Comes with ventilated or standard earphone cushions. Ventilated cushions optional.

MANUFACTURER'S SUGGESTED LIST PRICE.....\$208.00

ALLIED PRICE \$ _____

KOSS

PRO 4AAA



It's hard to believe that Koss could improve on the previous models, but just slip on the triple A and you'll hear a clarity, brilliance and liveliness you've never heard before. Deep rich lows and crisp, clean highs. The triple A features an extra large 1" voice coil and oversize diaphragm, special earcushions and a dual suspension headband for extra comfort.

MANUFACTURER'S SUGGESTED LIST PRICE.....\$80.00

ALLIED PRICE \$ _____

SENNHEISER



HD414SL

The HD-414SL is an improved version of original Sennheiser "Open-Aire" headphones offering natural sound with smooth frequency response and realistic dynamic range over the entire sound spectrum. The swivel-action headband adjusts for comfortable fit. The soft, lightweight cushions caress the ears for fatigue-free listening. ALLIED CARRIES THE ENTIRE SENNHEISER HEADPHONE LINE.

MANUFACTURER'S SUGGESTED LIST PRICE.....\$84.00

ALLIED PRICE \$ _____

**DEVELOP A SOUND FUTURE
WITH ALLIED**

TELEX CS-91



The CS-91 "Sportcaster II" is a professional sports announcer headset designed specifically for live, remote broadcasting. Omnidirectional dynamic boom microphone allows full freedom of head movement while the circumaural ear cushions screen out ambient noise.

MANUFACTURER'S SUGGESTED LIST PRICE.....\$165.00

ALLIED PRICE \$ _____

HD-4



The HD-4 "Hearing Protector Sportscaster" is a new concept. The noise attenuating earcups provide up to 45 dB attenuation in a motor racing pit or the midst of a screaming basketball crowd. A close-talking electret microphone is noise cancelling to assure intelligible sports broadcasting.

MANUFACTURER'S SUGGESTED LIST PRICE.....\$165.00

ALLIED PRICE \$ _____

RANE



The rack-mount HC-6 offers more performance and flexibility than you ever hoped for. Designed into the HC-6 are separate inputs for each of the six stages, which individually bypass the master stereo inputs. The HC-6 can handle up to six totally separate programs for many additional applications including custom headphone monitor mix. ALL OUTPUTS MAY ALSO BE FED FROM ONE INPUT.

MANUFACTURER'S SUGGESTED LIST PRICE.....\$349.00

ALLIED PRICE \$ _____

INTERCOMS

RTS TW

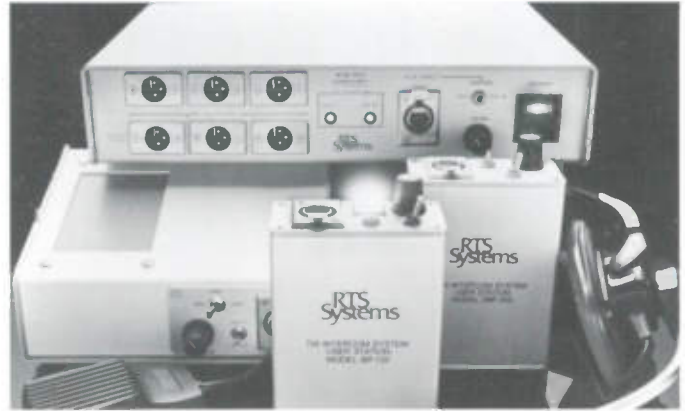

The TW Intercom System is a high performance conference line intercommunications system that features over 30 different components to allow a broad variety of system configurations. The system designed for teleproduction and broadcast operations as well as industrial and commercial applications. Proven performance by demanding professionals has established the TW Intercom System as a standard in the field of intercommunications.

PRICES UPON APPLICATION

CALL FOR TODAY'S ALLIED PRICE

TELEX AUDICOM



The Audicom is a closed circuit headset intercom system of exceptional versatility. Components may be selected for a single or multiple line intercom, suitable for small or large, indoor or outdoor, portable or permanent installations. The system provides clear two-way communications "behind the scenes" at concerts and stage productions, film or TV studios, sports stadium or race tracks, industrial, military, public safety and security applications.

PRICE UPON APPLICATION

CALL FOR TODAY'S ALLIED PRICE

**"THERE'S MORE TO
ALLIED THAN
BROADCAST EQUIPMENT"**

AKG
D-80



The D-80 is a cardioid dynamic microphone which was designed for both vocal and music applications. It is particularly suited for use with high quality sound reinforcement systems and cassette decks. A foam wind and pop filter eliminates pop and breath noise, as well as wind noise when the microphone is used in the open. ALLIED CARRIES THE ENTIRE AKG MICROPHONE LINE.

MANUFACTURER'S SUGGESTED LIST PRICE.....\$90.00

ALLIED PRICE \$ _____

C-451E/CK-1



The C-451E/CK-1 is a cardioid polar pattern microphone. The C-451E preamp with interchangeable capsules creates a modular system which can be changed to suit any studio or recording application. Special feature is low noise and high reliability. Includes foam windscreen, SA-30 stand adaptor and foam lined vinyl case.

MANUFACTURER'S SUGGESTED LIST PRICE.....\$380.00

ALLIED PRICE \$ _____

C-414EB/P48



This pressure gradient condenser microphone has an exceptionally wide dynamic range. A unique feature is four selectable polar patterns on the mic. Thus four different types of microphones are combined into one all-metal housing with black chrome finish. This unit has low current consumption as well as low self noise. Includes foam windscreen, SA-18/3 clamp-type stand adapter and foam lined vinyl case. Unsurpassed for digital recordings.

MANUFACTURER'S SUGGESTED LIST PRICE.....\$795.00

ALLIED PRICE \$ _____

D-1200E

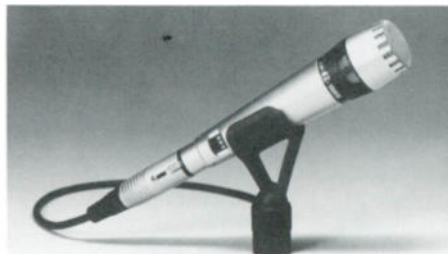

The D-1200E is a boom or hand held dynamic cardioid polar pattern microphone. Electric impedance @1,000Hz is a low 200 ohms. The three-position BMS switch permits changing response to suit individual performer and environment. Elastically suspended capsule reduces handling noise in this ruggedly constructed microphone. The SA-31 "quick-release" stand adapter is also included.

MANUFACTURER'S SUGGESTED LIST PRICE.....\$135.00

ALLIED PRICE \$ _____

CROWN

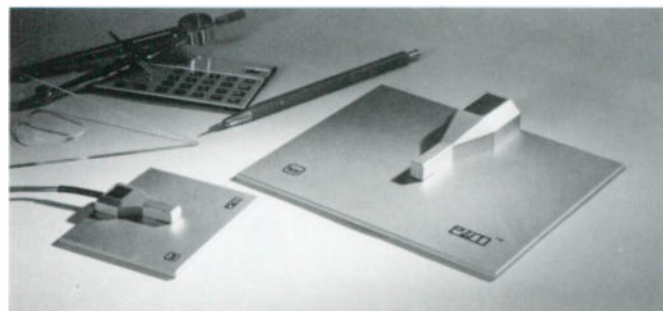

The pressure recording process, invented by Long and Wickersham, introduced a bright new concept to audio engineering. They discovered that sound approaching a boundary such as a floor, wall, table, podium, etc. creates a thin zone in which the direct and reflected signals are coherently in phase and reinforce each other. The Crown PZM microphone creatively realizes the potentials of that invention offering significant improvements in signal clarity and range. Comb filtering is eliminated.

**PRICES UPON APPLICATION
CALL FOR TODAY'S ALLIED PRICE**

ELECTROVOICE

635A



The 635A dynamic omnidirectional is a rugged, durable microphone manufactured by Electrovoice. The sound of the 635A is the standard against which other up-close omnidirectional vocal microphones are compared.

MANUFACTURER'S SUGGESTED LIST PRICE.....\$102.58

ALLIED PRICE \$ _____

MICROPHONES

ELECTROVOICE

DO-56



The DO-56 is a shock mounted omnidirectional dynamic microphone for hand-held broadcast applications. All handling noises and cord vibration are isolated from the microphone element. Shock isolation is enhanced by having the main acoustic cavity and the diaphragm/voice-coil assembly isolated as a unit from the case making capsule/case collision impossible.

MANUFACTURER'S SUGGESTED LIST PRICE.....\$129.50
ALLIED PRICE \$ _____

RE-10



A fine, moderate cost microphone for sound reinforcement, broadcast and stage work. The RE-10 is similar in design to the RE-15, but meets requirements where somewhat more unit-to-unit variability is acceptable. It has effective directional control, little off-axis coloration, greatest rejection of unwanted sounds at 150 degrees off axis and a bass roll-off switch.

MANUFACTURER'S SUGGESTED LIST PRICE.....\$177.00
ALLIED PRICE \$ _____

RE-11



An excellent microphone for broadcast and quality sound reinforcement, the RE-11 is a modestly priced unit with many features of the R-16 but where the most precise unit-to-unit matching is not necessary. It has a built-in blast filter, Memraflex grille screen, a high degree of directional control, little off axis coloration and a bass roll-off switch.

MANUFACTURER'S SUGGESTED LIST PRICE.....\$189.25
ALLIED PRICE \$ _____

"WE ARE A 'SOUND' BUSINESS!!"

RE-15



Literally born in a TV studio, the performance and reliability of the RE-15 have made it a workhorse directional microphone for broadcast. Two nulls at 150 degrees off axis provide greater average rejection over the microphone's rear hemisphere than a traditional single-null cardioid pattern, particularly useful on the boom and on-stage.

MANUFACTURER'S SUGGESTED LIST PRICE.....\$265.94
ALLIED PRICE \$ _____

RE-20



The RE-20 was created especially for critical recording, broadcast, and sound reinforcement applications which require response that extends to the frequency extremes. The RE-20 provides performance heretofore available only from the most expensive condenser microphones. The RE-20's dynamic element provides undistorted output at the high sound pressure levels found in up-close vocal and instrument miking (in excess of 160 dB). Its Variable-D design frees it of any bass-boosting proximity effect. A high-performance integral blast filter surrounds all acoustic openings for unusually complete freedom from vocal "P-pops." A bass roll-off switch adapts the RE-20 when flat low-frequency response would be detrimental. Transducer parts are nested and shock mounted to reduce vibration transfer.

The sound of the RE-20 has made it one of the most coveted, unique microphones in the world and the choice for many eminent vocalists.

MANUFACTURER'S SUGGESTED LIST PRICE.....\$512.95
ALLIED PRICE \$ _____

RE-50



The RE-50 was designed expressly for hand-held ENG. It has the same tailored frequency response and high output level as the famous 635A. The RE-50 rubber shock mount "mike-within-a-mike" design achieves a degree of shock isolation never before known in the industry. The construction is also highly resistant to damage from mechanical shock.

MANUFACTURER'S SUGGESTED LIST PRICE.....\$155.40

ALLIED PRICE \$ _____
"ALLIED CARRIES THE ENTIRE LINE OF E-V MICROPHONES"

SENNHEISER
MD-421-U-5



This is the microphone which has become a broadcast standard. Ruggedly constructed to precision standards, the MD-421-U-5 withstands hard use with Sennheiser's legendary reliability. Its pressure gradient dynamic transducer provides faultless performance both in the protected confines of the studio and the often hostile environment outdoors. Less cable.

MANUFACTURER'S SUGGESTED LIST PRICE.....\$332.00

ALLIED PRICE \$ _____

MKE-2R

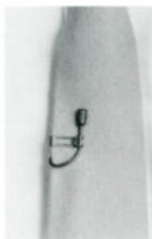

Measuring a mere 5.9 millimeters in diameter and 11 millimeters in length, the MKE-2R represents Sennheiser's thoughtfully conceived answer to the increasing demand for small and less conspicuous lavalier microphones. Its exceedingly small size, finish and the multitude of mounting options provide the video, movie and television professions with a broad choice of inconspicuous or concealed microphone placement possibilities.

MANUFACTURER'S SUGGESTED LIST PRICE.....\$242.00

ALLIED PRICE \$ _____

"ALLIED CARRIES THE ENTIRE LINE OF SENNHEISER MICROPHONES"

SHURE
SM-5B

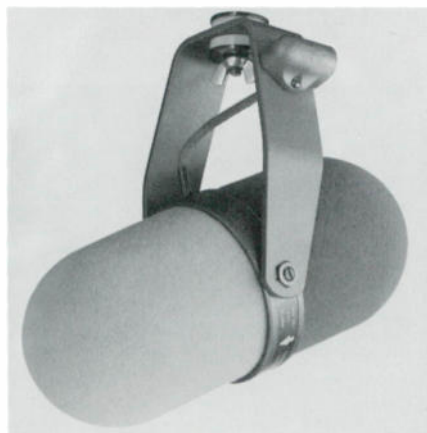

Specifically designed to minimize boom microphone problems in television studio and location applications, the SM-5B is also excellent for radio deejay use. A smooth, wide-range frequency response with moderate presence rise makes it especially suitable for vocal pickup as well as scoring assignments. The SM-5B has a cardioid pickup pattern with exemplary off-axis uniformity, even at

the extreme low end, giving minimal coloration and maximum rejection of unwanted sounds. Popular for its "warmth". Less cable.

MANUFACTURER'S SUGGESTED LIST PRICE.....\$551.75

ALLIED PRICE \$ _____

SM-7

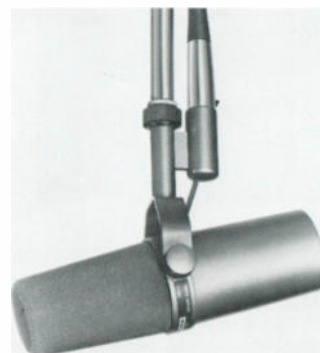

The SM-7 designed in conjunction with professional users, is among the finest studio professional dynamic microphones in use today. Its "smooth and silky" sound has made it extremely popular for voice-over recording in radio and television. Announcers love its "mellow" sound. Less cable.

MANUFACTURER'S SUGGESTED LIST PRICE.....\$510.00

ALLIED PRICE \$ _____

SM-11-CN



Tiny, rugged, with wide-range frequency response, the SM-11 is one of the world's smallest dynamic element lavalier microphones. Less than half the size of a standard microphone connector, it is ideal for on-camera TV and movie applications.

MANUFACTURER'S SUGGESTED LIST PRICE.....\$98.00

ALLIED PRICE \$ _____

SM-58-CN



The world-standard professional stage microphone, with the distinctive Shure upper mid-range presence peak for an intelligible, lively sound. A tough, handsome microphone that weighs less than 11 ounces, the SM-58 is often imitated in appearance, but never duplicated in performance, ruggedness or reliability. Cable included.

MANUFACTURER'S SUGGESTED LIST PRICE.....\$186.50

ALLIED PRICE \$ _____

MICROPHONES

**SHURE
SM-59-CN**



The revolutionary design of the SM-59 makes this microphone virtually immune to extraneous noise. An extraordinarily efficient mechano-pneumatic shock mount shields the cartridge from rumble and other mechanically transmitted noise, whether on a stand or hand held. Cable included.

MANUFACTURER'S SUGGESTED LIST PRICE.....\$211.25

ALLIED PRICE \$ _____

SM-63L-CL



The SM-63 is a small, elegant, rugged microphone with very high output, up to 6 dB higher than comparable omnidirectional microphones. Its low profile makes it the perfect choice for on-camera applications. Cable included.

MANUFACTURER'S SUGGESTED LIST PRICE.....\$128.00

ALLIED PRICE \$ _____

SM-81-LC



A matchless standard in high-quality professional condenser microphones, the SM-81 is a superb studio instrument that also meets the most demanding needs of location recording and sound reinforcement.

MANUFACTURER'S SUGGESTED LIST PRICE.....\$337.00

ALLIED PRICE \$ _____

SM-82-LC



A hand-held, self-contained, unidirectional condenser microphone with a built-in line level amplifier, peak limiter and battery. The exceptional performance and unique features of the SM-82 make it an outstanding choice for on-the-spot broadcasting applications. It's also excellent for long line (up to 1 mile) runs for sporting events, parades and political conventions.

MANUFACTURER'S SUGGESTED LIST PRICE.....\$365.00

ALLIED PRICE \$ _____

"ALLIED CARRIES THE ENTIRE SHURE MICROPHONE LINE"

NEUMANN U 87



The model U 87 is the best known and most widely used of the fet 80° series. Its dual membrane capsule uses evaporated gold on polyester film which has proven to be the most heat and aging resistant material. Three switches are provided beneath the capsule itself: for selecting the three directional patterns, frequency response and sensitivity. Its high frequency response is practically linear even in its cardioid and figure-8 positions even close-up. The response below 40 Hz is purposely rolled off to prevent low frequency blocking. This roll-off may be switched to 200 Hz to allow compensation for the bass rise common to all good directional microphones when used at close range. The U 87 is specifically designed for close miking studio applications. This is *THE* world class microphone! 48 volt power supply required. Wind screen and shock mounting optionally available.

PRICES UPON APPLICATION

KM 83 i



KM 83, 84, 85 Series

The KM 83 i omnidirectional miniature condenser microphone is a pressure transducer with gold sputtered polyester membrane and omnidirectional pattern. The self resonance of its membrane lies in the high frequency domain. The free field frequency response of the KM 83 i is linear except for a desirable slight rise at the high frequency end, which results in a flat response in the diffuse sound field. This microphone is therefore well suited for picking up the overall sound impression of big orchestras. Maximum sensitivity is axial. Includes swivel and wind screen.

MANUFACTURER'S SUGGESTED LIST PRICE.....\$349.00

ALLIED PRICE \$ _____

NEUMANN
KM 84 i

The KM 84 i miniature microphone has a cardioid directional pattern and is outstanding because of its nearly frequency-independent directivity. Its capsule works according to the pressure-gradient transducer principle and features an acoustical delay network.

The resulting frequency response at an angle of ± 135 degrees is almost parallel to the 0° on-axis curve. Attenuation at 135° is about 14 dB between 100 Hz and 18 kHz. As a result, a sound source impinging on the microphone anywhere within a 3/4 arc around it will have identical sound quality, even though at different levels. Maximum sensitivity is axial. Includes swivel and wind screen.

MANUFACTURER'S SUGGESTED LIST PRICE.....\$349.00

ALLIED PRICE \$ _____

KM 85 i

The KM 85 i miniature microphone has a cardioid directional pattern and is a special version of the KM 84 i with its virtually frequency-independent directivity. In addition, the KM 85 i intentionally attenuates more distant low-frequency sounds such as undesirable sound from sources nearby as well as wind noise (12 dB at 50 Hz), while close-up sound sources will be recorded with linear frequency response. This microphone is therefore widely used for close talking and, in connection with the WS 21 wind-screen, for outdoor recording and on rapidly moving microphone booms in studios. Maximum sensitivity is axial. Includes swivel and windscreen.

MANUFACTURER'S SUGGESTED LIST PRICE.....\$349.00

ALLIED PRICE \$ _____

SONY
ECM-50PSW/ECM-50PBW

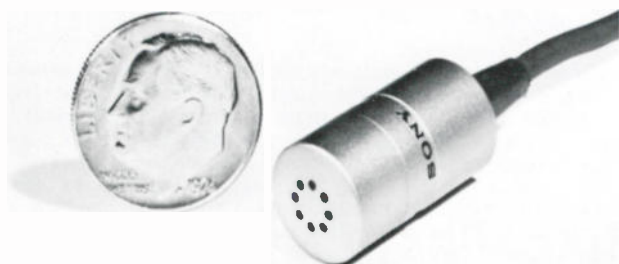

A new edition of Sony's highly acclaimed and widely used professional miniature lavalier microphone offers a choice of either the familiar silver finish or a new, non-reflective matte black finish. Other improvements include both a double and single tie clip in the provided accessories. The ECM-50 provides omnidirectional high performance vocal pickup and operates from battery or phantom power.

MANUFACTURER'S SUGGESTED LIST PRICE.....\$215.00

ALLIED PRICE \$ _____

"ALLIED CARRIES THE ENTIRE SONY PROFESSIONAL MICROPHONE LINE"

SONY-WIRELESS SYSTEM

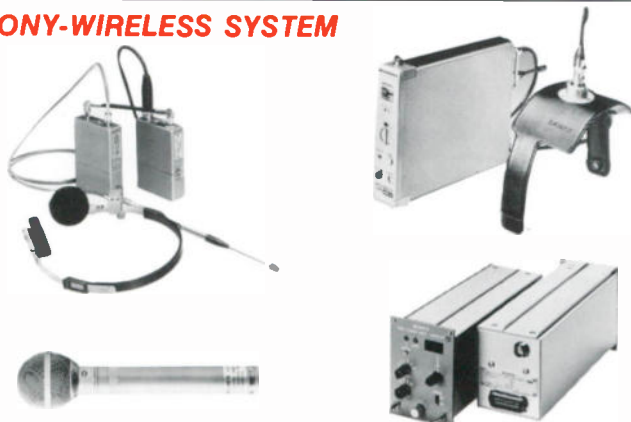

The Sony wireless microphone system was designed to be able to withstand the most strenuous of professional applications. The system in no way compromises sound quality. Every possible obstacle arising from wireless design was thoroughly examined and solved, using Sony's advanced transducer and FM tuner technologies. With this reliable, high quality Sony system, wireless operation will never again be a risky proposition.

PRICES UPON APPLICATION

CALL FOR TODAY'S ALLIED PRICE

"ALLIED CARRIES THE ENTIRE SONY WIRELESS LINE"

TELEX-WIRELESS SYSTEM



The TELEX wireless microphone system adds significant innovations to the state of the art. Innovations which not only make TELEX an outstanding value among wireless systems, but which provide performance capability that equals or exceeds that of wire microphone systems for professional applications. Applicable equipment is FCC type accepted.

The professional TELEX wireless system transmits the microphone signal via FM radio transmission to a receiving station. The user of the microphone is thus able to move without the encumbrance or limitations of a microphone cable.

In addition to mobility, the TELEX wireless system offers other advantages such as the elimination of hum and noise pickup through the microphone cable and connectors, avoidance of microphone boom shadows, elimination of shock hazard from poor grounding, and most important, elimination of sound mixing problems as the performer moves about the stage.

PRICE UPON APPLICATION

CALL FOR TODAY'S ALLIED PRICE

VEGA-WIRELESS SYSTEM



The Cetec-Vega wireless system has led the way in this field for years. Recent developments in the Vega wireless line have made this reputation grow even more. The Vega system uses Electrovoice and Shure mic elements to insure the high quality sound reproduction. New designs have gotten rid of the now infamous "rubber ducky" antenna, added new dimensions to "wireless" applications and made the use of this type equipment more widespread than ever before in the broadcast field.

PRICE UPON APPLICATION

CALL FOR TODAY'S ALLIED PRICE

"ALLIED CARRIES THE ENTIRE VEGA WIRELESS LINE"

MONITORS

ALLIED
Broadcast Equipment

QEI



The 691 FM Monitor/Test Set is a high technology, precision instrument employing a combination of new techniques in a single, highly versatile, but very compact package. It was designed to be a complete FM test package with facilities for all proof-of-performance measurements and a wide range of trouble-shooting tests. Operator convenience and simplicity of use were primary considerations in the design of the system. Component selection and device ratings are such as to enhance the instrument's reliability even with adverse handling. It occupies only 10½" of vertical rack space in a standard 19" rack.

Model	Description	ALLIED PRICE \$
691	Modulation monitor/test set.....	\$5295.00
691/01	Modulation monitor/test set with 1 SCA.....	\$6295.00
691/02	Modulation monitor/test set with 2 SCA.....	\$6695.00

QEI PRICES ABOVE ARE MFGR'S SUGGESTED LIST PRICES. CALL FOR TODAY'S ALLIED PRICE.

BELAR FMM-1



Belar FM monitors are designed as a totally integrated, solid-state system to enable the broadcaster to fulfill his monitoring equipment requirements as the need arises. The FMM-1 Frequency and Modulation Monitor is a wideband, all solid-state FM monitor expressly designed to fulfill all the requirements for monaural monitoring as well as to provide a virtually pure, distortionless signal to drive the companion FMS-1 and SCM-1 for multiplex monitoring.

PRICES UPON APPLICATION

FMS-1



The FMS-1 when added to the FMM-1 provides complete monitoring and test functions to meet the daily requirements for stereo monitoring, and provides additional facilities for making the proper tests for weekly and monthly maintenance checks to insure maximum performance from stereo transmitters.

PRICES UPON APPLICATION

FMM-2

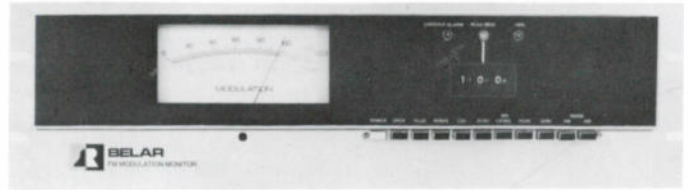

The FMM-2 sets new standards in accurate FM monitoring. It's the first to incorporate a sample hold peak modulation meter circuit independent of modulation polarity to allow the meter to respond to program peaks of the shortest duration. The heart of the FMM-2 is an ultra-linear digital discriminator which provides a distortionless baseband signal for accurate monitoring as well as precise stereophonic and SCA decoding.

MANUFACTURER'S SUGGESTED LIST PRICE.....\$1350.00
ALLIED PRICE \$ _____

FMS-2

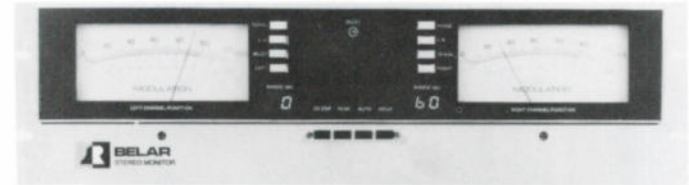

Working in conjunction with the FMM-2, the FMS-2 offers two independent peak modulation meters for simultaneous monitoring of left and right channels or L + R and L - R. It also has two independent auto-ranging voltmeters with LED displays for simplified automatic measurements of channel separation, crosstalk, sub-carrier suppression and noise.

MANUFACTURER'S SUGGESTED LIST PRICE.....\$1550.00
ALLIED PRICE \$ _____

AMM-2A

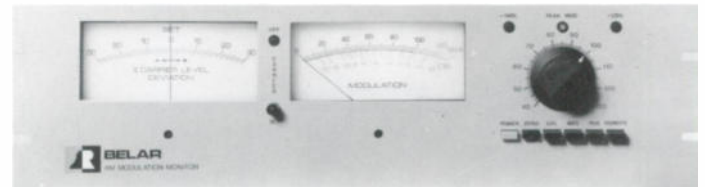

The AMM-2A Modulation Monitor sets standards in accurate AM monitoring. It's the first AM monitor to incorporate true ratio-type peak indicators. The AMM-2A contains a unique modulation cancellation scheme to recover unmodulated carrier to reference the modulation peaks to. Thus the instantaneous carrier without the need of time constants, as with AGC devices. True carrier is indicated with asymmetrical modulation encountered in today's high positive peak modulation, and peaks are automatically referenced to this true carrier to give the most accurate indication of program peaks.

MANUFACTURER'S SUGGESTED LIST PRICE.....\$990.00
ALLIED PRICE \$ _____

BELAR
AMM-3

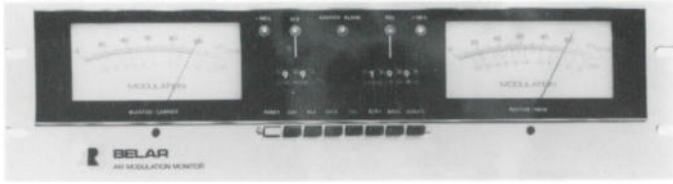

The AMM-3 Modulation Monitor is basically the same as the AMM-2A except for an ability to read both positive and negative modulation peaks.

MANUFACTURER'S SUGGESTED LIST PRICE.....\$1400.00

ALLIED PRICE \$ _____

AMM-4



The AMM-4 Frequency Monitor is designed especially for ATS. Any frequency from 10 kHz to 50 MHz may be monitored for deviation.

MANUFACTURER'S SUGGESTED LIST PRICE.....\$990.00

ALLIED PRICE \$ _____

SCM-1



The SCM-1 SCA Frequency and Modulation Monitor, when added to the FMM-1 provides complete monitoring and test functions for SCA storecasting and remote telemetering applications. Up to four crystal switch positions allow four channels to be operated and tested.

MANUFACTURER'S SUGGESTED LIST PRICE.....\$1650.00

ALLIED PRICE \$ _____

RFA-1



The RFA-1 FM RF Amplifier allows for remote monitoring of the transmitter in conjunction with Main and SCA FM modulation monitoring equipment. It offers a RF input sensitivity of 100 microvolt for full output, 50 to 75 ohms of input impedance and operates from 88 to 108 MHz.

MANUFACTURER'S SUGGESTED LIST PRICE.....\$575.00

ALLIED PRICE \$ _____

RFA-2



The RFA-2 AM RF Amplifier offers a selective, high gain, all silicon solid-state unit with AGC and makes it possible to monitor off-the-air AM signals accurately and conveniently without the problems associated with changes in transmitter power level, antenna patterns and signal fading. The RFA-2 when used in conjunction with AMM-2A, AMM-3 or AMM-4 allows monitoring of modulation characteristics at a remote point.

MANUFACTURER'S SUGGESTED LIST PRICE.....\$595.00

ALLIED PRICE \$ _____

TVM-1



The TVM-1 Television Aural Modulation Monitor is a wideband, all solid-state TV aural monitor designed to provide accurate modulation monitoring for the TV Broadcaster, UHF or VHF. The state-of-the-art TVM-1 measures both positive and negative peaks simultaneously and automatically selects and registers the higher of the two on both the true peak meter and peak flasher. Exclusive polarity lamps indicate the instantaneous polarity of the peaks registered on the peak meter and peak flasher. Calibration accuracy may be checked at any time with the front panel push-button modulation calibrator.

MANUFACTURER'S SUGGESTED LIST PRICE.....\$1850.00

ALLIED PRICE \$ _____

TVM-100

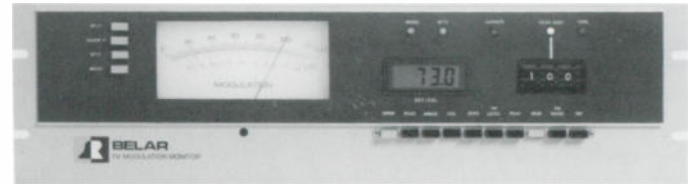

The Belar Model TVM-100 Television Aural Modulation Monitor is a precision wide band monitor designed to measure the total modulation characteristics of mono as well as multi-channel television audio. Utilizing split sound and quasi-parallel detection modes, automatic deviation calibrators for 25 KHz (mono) and 73 KHz (BTSC Stereo) and a digital display for indication of actual deviation, the TVM-100 satisfies all requirements for mono and stereo baseband monitoring and test.

MANUFACTURER'S SUGGESTED LIST PRICE.....\$

ALLIED PRICE \$ _____

MONITORS

BELAR TVM-200

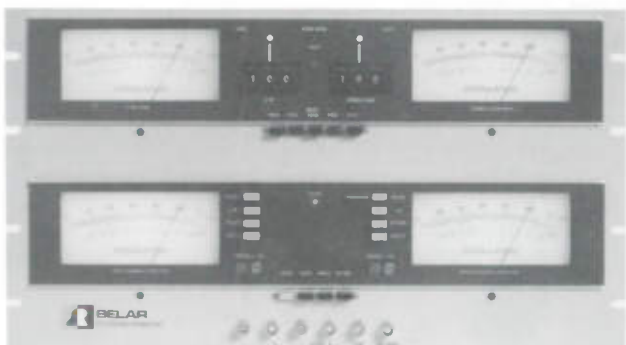

The Belar Model TVM-200 TV Stereo Modulation Monitor is designed to operate in conjunction with the Belar Model TVM-100 TV Baseband Modulation Monitor to provide complete monitoring of BTSC stereo transmission systems. The test and measurement capabilities are enhanced by the integration of two auto-ranging voltmeters, allowing automatic measurement of channel separation, crosstalk, pilot phase and pilot level. An equivalent mode test function is also provided, which bypasses the DBX decoder for non-encoded transmitter testing. Multiple metering allows full-time monitoring of L + R and stereo composite modulation and selectable metering of total and L - R modulation along with left and right channel audio.

MANUFACTURER'S SUGGESTED LIST PRICE TVM 100....\$2495.00
MANUFACTURER'S SUGGESTED LIST PRICE TVM 200....\$3995.00

CALL FOR TODAY'S ALLIED PRICES

MCMARTIN TG-1/EBS



The McMartin TG-2/EBS Precision Two Tone EBS Generator is FCC type-accepted to produce the two-tone attenuation signal for the Emergency Broadcast System. Effective for all AM-FM and TV stations.

MANUFACTURER'S SUGGESTED LIST PRICE.....\$375.00

ALLIED PRICE \$ _____

GORMAN REDLICH CEB



The CEB offers in a single rack mounting chassis, everything necessary for the two-frequency EBS system required by the commission except a receiver that can be tuned to the station monitored.

Model	Description	Manufacturer's Suggested List Price	Allied Price
CEB	Encoder-decoder.....	\$475.00	ALLIED PRICE \$ _____
CE	Encoder only.....	\$330.00	ALLIED PRICE \$ _____
CE	Encoder with stereo option.....	\$360.00	ALLIED PRICE \$ _____
CD	Decoder only.....	\$280.00	ALLIED PRICE \$ _____

GORMAN REDLICH PRICES ABOVE ARE MFR'S SUGGESTED LIST PRICES. CALL FOR TODAY'S ALLIED PRICES.

CRW

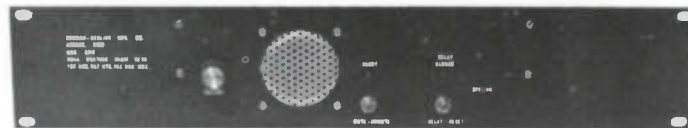

The CRW weather receiver is rack mounted, remotable with a black anodized rack panel. Demuting and remote alarm are initiated by a 1050 Hz "alert" tone. A relay closure is initiated by either the 1050 Hz tone or a 1650 Hz forecast update signal tone. The CRW features crystal and ceramic IF filters, plus a double tuned dual gate MOSFET RF stage.

MANUFACTURER'S SUGGESTED LIST PRICE.....\$475.00

ALLIED PRICE \$ _____

CM



The Model CM is a stable, accurate monitor for DA installations not requiring telemetering of antenna readings. It offers true ratio readout. Non-reference and reference amplitudes are separately measured and divided electronically to give a digital readout that will not change with transmitter power and is exceptionally stable under conditions of asymmetric modulation. Stability of the readout makes readings accurate and easy to read.

PRICES ON APPLICATION

CMR

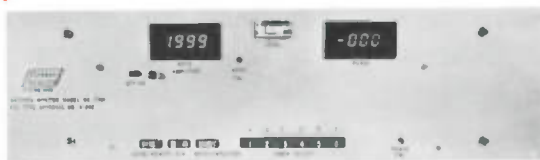

The Model CMR is the latest in "developed technology" from G-R at a price comparable to analog monitors. With typical modulation, the CMR's true ratio readout is a factor of 10 more stable than instruments that measure normalized amplitude, and its phase readout is rock solid. Phase sign is automatic with no extra operations. Practically speaking, these features mean quick, accurate log or remote calibration readings. The CMR is fully remotable via land line or telemetry, using standard remote control equipment.

PRICES ON APPLICATION

DAV TRONICS RFA-5



The RFA-5 AM RF Amplifier is designed to operate frequency and modulation monitors at a location remote from the transmitter, typically at the studio. When driven by a local antenna with an RF signal as low as 0.6 mv, the RFA-5 will drive most contemporary AM monitoring equipment, as well as providing a low-level output for an oscilloscope, and a clipped/limited output for a standard frequency counter.

PRICES UPON APPLICATION

POTOMAC FIELD STRENGTH METERS



The Potomac line of field strength meters represent a new generation of precision instruments for direct measurement of electromagnetic fields in the 100 kHz to 960 mHz frequency spectrum. These units are intended for portable field use and include a laboratory quality receiver, integral shielded loop antenna, precision attenuator, internal calibration source, and voltage regulated battery power supply. An interlock switch prevents inadvertent battery discharge when the cover is closed. Batteries are not included.

Model	Description	ALLIED PRICE \$
FIM-21	535-1605 kHz.....	\$1950.00
FIM-22	200-550 kHz.....	\$2600.00
FIM-41	540-5000 kHz.....	\$2600.00
FIM-71	45-225 mHz.....	\$3825.00
FIM-72	470-960 mHz.....	\$5250.00

POTOMAC PRICES ABOVE ARE MFGR'S SUGGESTED LIST PRICES. CALL FOR TODAY'S ALLIED PRICE.

ANTENNA MONITORS

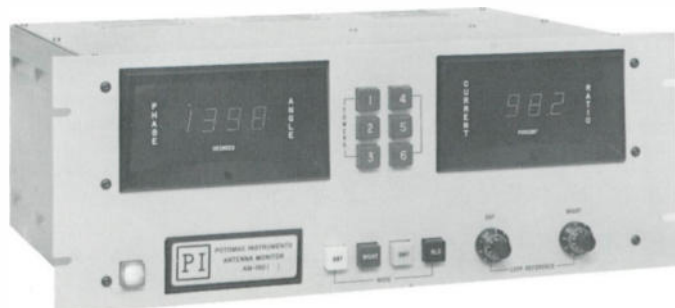

Model	#Towers	ALLIED PRICE \$
AM-19	2.....	\$2550.00
AM-19D	2.....	\$3250.00
PM-19	2.....	\$6700.00

Additional prices upon application.

POTOMAC PRICES ABOVE ARE MFGR'S SUGGESTED LIST PRICES. CALL FOR TODAY'S ALLIED PRICE.

AM MONITOR RECEIVERS



The SMR-11 is an AM broadcast band receiver of superior performance with many capabilities useful to the broadcaster. Receiver tuning is continuous from 530 to 1700 kHz, and can be locked with crystal accuracy at any desired frequency. The antenna can be a remotely located tunable ferrite rod unit (ANT-11), broadband wire or a whip. Bandwidth is determined by two switch-selected 455 kHz ceramic filters with bandwidths of 28 kHz and 12 kHz. Other special filters are available and can be installed.

Model	Description	ALLIED PRICE \$
SMR-11R	Rack mount version.....	\$1575.00
SMR-11D	Desk mount version.....	\$1675.00
ANT-11	Remote, tunable ferrite rod antenna with internal, low noise preamplifier.....	\$500.00

POTOMAC PRICES ABOVE ARE MFGR'S SUGGESTED LIST PRICES. CALL FOR TODAY'S ALLIED PRICE.

PROTON



To achieve uncompromising fidelity with plenty of power, one 20-watt amplifier powers the 4½ inch woofer, and a second 5-watt amp drives the efficient 1¾ inch dome tweeter. Since each amplifier functions best within its own portion of the frequency spectrum, the radio's 25-watts are equivalent to over 40 watts from a conventional amplifier. The Schotz variable bandwidth PLL detects or gives a revolutionary and dramatic effect on reception. Optional "ears" available for rack mounting.

MANUFACTURER'S SUGGESTED LIST PRICE.....\$280.00

ALLIED PRICE \$ _____

DELTA DAM-1



The DAM-1 is a true digital antenna monitor designed specifically for measuring the parameters of broadcast frequency directional antenna systems. Digital data is not obtained by adding an A/D converter to the output of conventional analog circuitry, instead, the latest digital techniques and TTL components are applied to achieve a truly digital approach to phase and current ratio measurements. Data is displayed on front panel seven-segment digital readouts to minimize reading error. A simplified selection system reduces operation of the DAM-1 to a straight-forward procedure.

PRICES ON APPLICATION

AAM-1



The AAM-1 Analog Antenna Monitor is designed specifically for measuring the parameters of AM broadcast frequency directional antenna systems. The monitor measures the relative current in each tower, the ratio of the current in each tower to that of a reference tower and the phase of the current in each tower relative to that of the reference tower. The AAM-1 can be equipped for up to eight input samples without external switching. Two reference towers can also be selected for DA-2 applications.

PRICES ON APPLICATION

AMC-1



By continuously sampling the modulation levels at the AM transmitter output and comparing these levels with internal preset minimum and maximum modulation thresholds, the AMC-1 Amplitude Modulation Controller detects conditions of under or over modulation. The AMC-1 then uses a digital logic process to adjust the audio level of the transmitter. The audio control circuit is strictly linear so that no compression or asymmetry is added to the program.

PRICES ON APPLICATION

FMC-1



The FMC-1 Frequency Modulation Controller provides automatic control of the modulation levels of an FM broadcast transmitter or audio channel of a TV transmitter. The FMC-1 provides a closed loop system around the transmitter which allows the broadcast engineer to maintain modulation at the desired level despite variations in the audio level from different program sources and other system variances. Through gain is controlled by a digital attenuator maintaining true transparency at all gain settings. No clipping or compression is used.

PRICES ON APPLICATION

APC-1



The APC-1 Automatic Power Controller measures the operating power of an AM or FM station, and by interconnection to the transmitter's RAISE/LOWER controls causes the power to remain well within limits. The unit monitors a DC voltage from an external linear rectifier driven by an RF sample of the common point or base antenna current in AM applications, or a similar linear DC sample from the FM power meter or directional coupler. A special long time constant circuit removes modulation components and averages carrier shift variations in AM applications.

PRICES ON APPLICATION

RG-4



The RG-4 Receiver/Generator couples precision with reliable performance, providing an indispensable piece of test gear for broadcast engineers. An RF signal generator to excite the impedance bridge and a sensitive receiver for external null detection are housed in a single rugged case. With an OIB-1 or OIB-3, the RG-4 forms a portable impedance measuring system. Operates from 100 kHz to 29.999 MHz in 1 kHz increments. Runs off batteries, 115/230 VAC 50/60 Hz with 35 watts input power.

PRICES ON APPLICATION

DELTA
OIB IMPEDANCE BRIDGES



Delta OIB operating impedance bridges measure the operating impedance of the individual radiators, networks, transmission line sections, and common point of directional antenna systems while they are functioning under normal power. This "operating impedance" cannot be measured by usual impedance bridge methods because the system characteristics are disrupted when the bridge is inserted into the circuit. The OIB-1 or OIB-3 is inserted directly in series with the transmission line, network or antenna. The transmitter power is applied and a bridge balance is obtained by manipulating two dials on the face of the bridge. Balance is indicated by a null reading on the meter on the front panel. Operating resistance and reactance are then read directly from the bridge dials.

PRICES ON APPLICATION

RECORDERS

OTARI
MX5050B-II

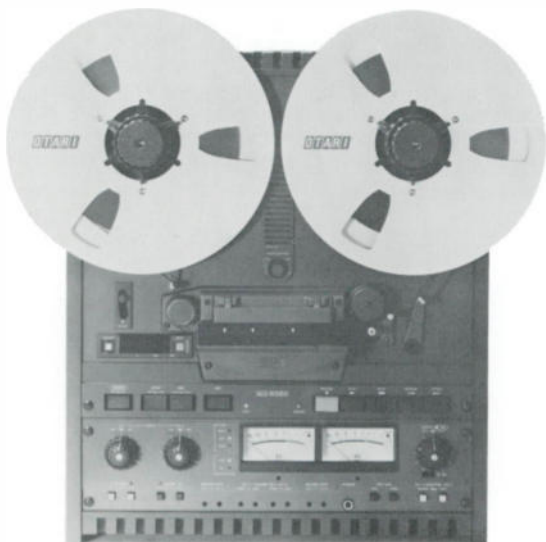

1/4" two channel half track recorder/reproducer with extra quarter track reproduce head. DC-servo capstan, with $\pm 7\%$ vari-speed. Three speeds in 15-7 1/2 or 7 1/2-3 3/4 ips field selectable. Transformerless balanced inputs and outputs. +4 or -10 dB output level select. Real time tape counter with LED display. Headphone output. Test oscillator (1 kHz or 10 kHz). NAB/IEC equalization select. 185/250/320 nWb/m calibration select. Integral splicing block. The world's most popular recorder. Available in 1/4 track stereo or full track versions. Optional rack mount available.

MANUFACTURER'S SUGGESTED LIST PRICE.....\$2295.00

ALLIED PRICE \$ _____

MX5050BQ-II



1/4" four channel, quarter track recorder/reproducer. DC-servo capstan with $\pm 7\%$ vari-speed. 15-7 1/2 ips speed. +4 or -10 dB input/output level select. Real time tape counter with LED display. Zero return. Headphone output with channel select. Test oscillator (1 kHz or 10 kHz). Microprocessor controlled transport logic. Dynamic braking. Integral splicing block. External machine control interface connector for synchronizers.

MANUFACTURER'S SUGGESTED LIST PRICE.....\$2995.00

ALLIED PRICE \$ _____

MX5050-Mark III-2



1/4" two channel, half track recorder/reproducer with extra quarter track playback head. Includes a microprocessor transport logic and dynamic braking. Zero return. External machine control interface connector for synchronizers or the optional CB-116 auto-locator.

MANUFACTURER'S SUGGESTED LIST PRICE.....\$2795.00

ALLIED PRICE \$ _____

MX5050-Mark III-4



1/2" four channel recorder/reproducer. Tabletop console. 1/2" configuration of the BQ-II. External machine control interface connector for synchronizers or the optional CB-116 auto-locator. Otherwise identical to BQ-II.

MANUFACTURER'S SUGGESTED LIST PRICE.....\$3895.00

ALLIED PRICE \$ _____

RECORDERS

OTARI
MX5050-Mark III-8



1/2" eight channel recorder/reproducer. DC-servo capstan with $\pm 7\%$ vari-speed. 15-7 1/2 ips speed. +4 or -10 dB input/output level select. Real time tape counter with LED display. Zero return. Test oscillator (1 kHz or 10 kHz). Microprocessor controlled transport logic and dynamic braking. Full function channel status select panel with individual or master control. Automatic monitor switching. Headphone output with channel select. External test input. Integral splicing block. External machine control interface connector for synchronizers or the optional CB-116 auto locator.

MANUFACTURER'S SUGGESTED LIST PRICE.....\$5295.00

ALLIED PRICE \$ _____

OTARI
ARS1000DC/ARS1000DS

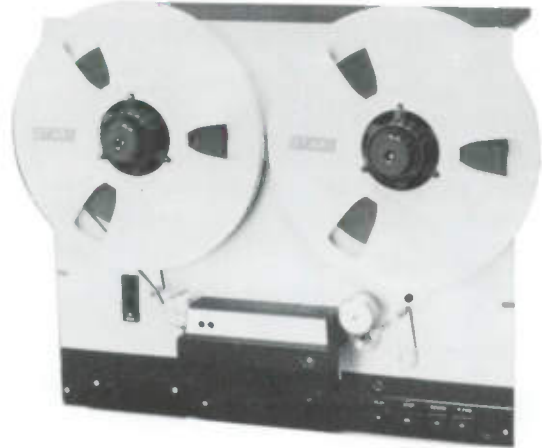

1/4" two channel, half track reproducer with 25 Hz tone sensor, end of message and cuetone relays with adjustable delay (100 milliseconds to 15 seconds). 7 1/2-3 3/4 ips speeds. 19" rack mount. Designed for automated broadcast systems and other high reliability reproduce only applications. 15-7 1/2 ips speeds available on special order.

Model	Description	Price
ARS1000DC	with 25 Hz tone sensor.....	\$1595.00
		ALLIED PRICE \$ _____
ARS1000DS	without 25 Hz tone sensor.....	\$1535.00
		ALLIED PRICE \$ _____

OTARI PRICES ABOVE ARE MFGR'S SUGGESTED LIST PRICES. CALL FOR TODAY'S ALLIED PRICE.

SCOTCH/3M



When recording tape is considered, Scotch/3M is a prime contender. As an authorized Scotch audio tape dealer, Allied can quote prices for any requirement. Quantity discounts are available.

CALL FOR THE ALLIEDEAL

DP4050C-2-1



8:1 cassette duplicator with cassette master and three slaves. Expandable to 11 slaves with the addition of (3) DP-4050Z-3 slave units.

Model	Description	Price
DP4050C-2-1	Master & two slaves.....	\$3295.00
		ALLIED PRICE \$ _____
DP4050Z-3	Three slaves for C-2.....	\$3095.00
		ALLIED PRICE \$ _____

OTARI PRICES ABOVE ARE MFGR'S SUGGESTED LIST PRICES. CALL FOR TODAY'S ALLIED PRICE.

"PRICES ARE SUBJECT TO CHANGE WITHOUT NOTICE"

OTARI
MTR-10

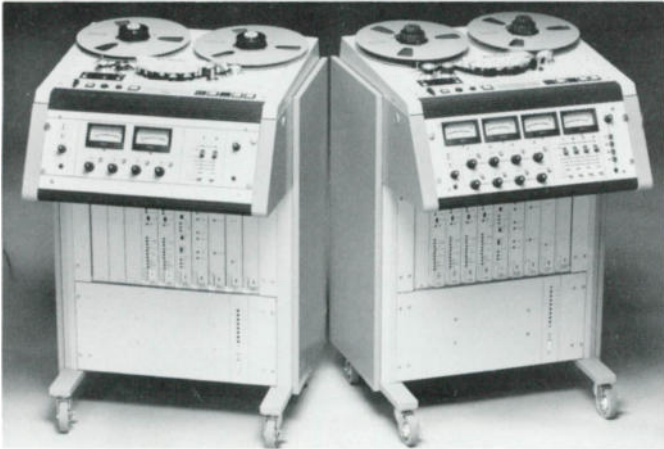

MTR-10-2-SC

MTR-10-4-SC

The Otari MTR-10 Series are microprocessor controlled 1/4" and 1/2" professional tape recorders offered in full, two and four track formats. Consoles feature a transport assembly that is hinged to allow easy access for maintenance. Audio and transport control circuit boards are located in a separate card frame. The power supply is also contained in a fully modular unit enabling fast diagnosis and repair. Transport control and extensive editing functions are located on the top transport operating surface while audio control switching is contained on a separate master audio control card. ACCESSORY, SPARE PARTS, CONVERSION KIT AND HEAD ASSEMBLY PRICING ON APPLICATION.

Model	Description	ALLIED PRICE \$
MTR10-1-OB	1/4" full-track prewired for two channels in an overbridge cabinet. 7 1/2-15-30 ips.....\$6250.00	_____
MTR10-2-OB	1/4" two channel in overbridge cabinet. 7 1/2-25-30 ips.....\$6550.00	_____
MTR12-2-OB	1/4" two channel 12.5" reel size in overbridge cabinet. 7 1/2-15-30 ips.....\$6900.00	_____
MTR12 1/2-2-OB	1/2" two channel 12.5" reel size in overbridge cabinet. 7 1/2-15-30 ips only.....\$8500.00	_____
MTR12 1/2-4-OB	1/2" four channel 12.5" reel size in overbridge cabinet. 7 1/2-15-30 ips.....\$8900.00	_____
MTR12-ILX	1/2" four channel low speed special duplicator master maker with extended performance. 3.75-7.5-15 ips only.....\$9150.00	_____

OTARI PRICES ABOVE ARE MFGR'S SUGGESTED LIST PRICES. CALL FOR TODAY'S ALLIED PRICE.

REVOX
B77



- Integrated Drive Logic
- Operation by computer-type push keys
- Cutter device to facilitate tape editing

MANUFACTURER'S SUGGESTED LIST PRICE.....\$1799.00

ALLIED PRICE \$ _____

PR99 MK II



As a broadcaster you know the value of Studer reliability and importance of Revox economy. Now both are built into the Revox PR99 MK II. And what's more, it's designed specifically for your needs. The PR99 MK II offers balanced inputs and outputs; XLR-type connections, with calibrated and uncalibrated levels; and ASA-VU metering with LED peak indicators. The rugged die-cast chassis is designed for rack or console mounting. Reel capacity is 10.5 inches and tape speeds are selectable at 3.75, 7.5 or 15 ips with a vari-speed remote control option. Complete editing facilities include dump editing, full head access and 2-way self-sync which make the PR99 MK II one of the best in its class. The Studer designed transport and die-cast head assembly block and tension arms provide instant smooth start-up and outstanding tape handling. Here's traditional Studer quality built into the Revox PR99 MK II. Perfect for broadcasters or any professional.

MODEL	DESCRIPTION	ALLIED PRICE \$
PR99 MK II	Recorder/Producer.....	\$2250.00
PR 99	Reproduce Only.....	\$1449.00

REVOX PRICES ABOVE ARE MFGR'S SUGGESTED LIST PRICE. CALL FOR TODAY'S ALLIED PRICE.

TASCAM
22-2



The basic half-track recorder/reproducer with independent record mode selector and 1 tape/source monitor for each channel. Independent mic/line mixing and output level control for each channel. Remote pause function for record and play. 7 1/2-15 ips speeds.

MANUFACTURER'S SUGGESTED LIST PRICE.....\$775.00

ALLIED PRICE \$ _____

RECORDERS

TASCAM
122/122B



The 122B is a world standard cassette deck in broadcast studios. It has the same superb audio quality, reliability and features of the 122 except the 122B offers balanced XLR input and output connectors that operate +4 dBm nominal level/+18 dBm maximum. The 122 has unbalanced -14 dBV nominal level RCA input and -10 dBV output jacks.

122 unbalanced input/output.....\$725.00
ALLIED PRICE \$ _____

122B balanced in/out broadcast levels & Impedances.....\$825.00
ALLIED PRICE \$ _____

TASCAM PRICES ABOVE ARE MFR'S SUGGESTED LIST PRICES. CALL FOR TODAY'S ALLIED PRICE.

32



A half-track 1/4" master recorder/reproducer with 10 1/2" reel capacity, 15-7 1/2 ips speeds, independent L & R record mode, simul-sync, full frequency response in sync mode, function and output select and punch in/out recording. The 32 also features ±12% pitch control, dump edit, mic inputs, independent input/output level controls, headphone jack with volume control, cue control, FL tape counter and zero return.

MANUFACTURER'S SUGGESTED LIST PRICE.....\$1300.00
ALLIED PRICE \$ _____

34B



A 4-track 1/4" recorder/reproducer with 15-7 1/2 ips speeds, 10 1/2" reel capacity, full frequency response in sync mode, function and output select and punch in/out recording. The 34 also features ±12% pitch control, dump edit, cue control, FL tape counter and zero return.

MANUFACTURER'S SUGGESTED LIST PRICE.....\$1700.00

ALLIED PRICE \$ _____

38



An 8-track 1/2" recorder/reproducer with 8 tracks on 1/2" tape, 10 1/2" reel capacity, 15 ips speed, ±12% pitch control and function and output select. The 38 also features punch in/out recording, dump edit, cue control, FL tape counter and zero return.

MANUFACTURER'S SUGGESTED LIST PRICE.....\$2995.00

ALLIED PRICE \$ _____

42



A 2-track 1/4" 2 channel half track mastering and broadcasting recorder/reproducer with 10 1/2" reel capacity, sync capability, full servo, SMPTE interlock capability through accessory connector and punch in/out recording. The 42 also features NAB or IEC equalization, dump edit, search to zero and search to cue, 7 1/2-15 ips speeds and +4/-10 input/output.

MANUFACTURER'S SUGGESTED LIST PRICE.....\$2295.00

ALLIED PRICE \$ _____

TASCAM
52



A 2-track 1/4" 2 channel half track mastering and broadcasting recorder/reproducer with +4 XLR/-10 RCA input/output, 10 1/2" reel capacity, sync capability, full servo and SMPTE interlock capability through an accessory connector. The 52 also features punch in/out recording, pitch control (15% coarse/0.7% fine), manual tach wheel edit, dump edit, search to zero and search to cue and 7 1/2-15 ips speeds.

MANUFACTURER'S SUGGESTED LIST PRICE.....\$3495.00

ALLIED PRICE \$ _____

58



An 8-track 1/2" 8 channel production recorder/reproducer with -10 RCA input/output, 10 1/2" reel capacity, full frequency response in sync mode, full servo, SMPTE interlock capability through an accessory connector and punch in/out recording. The 58 also features pitch control (15% coarse/0.7% fine), manual tach wheel edit, dump edit, search to zero and search to cue and 15 ips speed.

MANUFACTURER'S SUGGESTED LIST PRICE.....\$5995.00

ALLIED PRICE \$ _____

MARANTZ PORTABLE CASSETTE SYSTEMS



The 201 and 221 by Marantz offer more to the Broadcast News Operation than ever before available.

- Outstanding Features Include: 15/16 ips (1/2 speed) or regular 1-7/8 ips
- Vari-speed control which allows correction of tapes which may have been recorded with less-than-full battery power
- PA/Play mix permits one of the most sought-after abilities: Live intro with optional microphone, actuality on tape, then back to live. (Using the cassette machine as an integral part of a telephone report)

In addition to features listed which are common to both machines, the 221 also has three heads and variable bias for normal, CrO₂, and FeCr Tape. FeCr tape permits a frequency response of up to 14 kHz.

201 2 heads.....	\$219.95
221 3 heads.....	\$279.95

MARANTZ PRICES ABOVE ARE MFGR'S SUGGESTED LIST PRICES. CALL FOR TODAY'S ALLIED PRICE.

REMOTE CONTROL

MOSELEY
MRC 1600

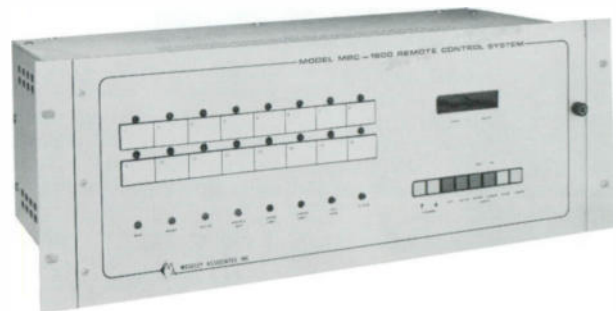

Microprocessor Remote Control System, consisting of one Control Terminal, one Remote Terminal. System is equipped with 32 command relays, 16 status channels (TTL/contact closure), and 16 digital telemetry channels. FCC acceptable for AM and FM broadcast transmitter remote control. Includes audible telco/telco data interface on each terminal.

MANUFACTURER'S SUGGESTED LIST PRICE.....\$4395.00

ALLIED PRICE \$ _____

"DISCOUNTS ARE AVAILABLE ON MOST EQUIPMENT"

REMOTE CONTROL

MOSELEY
CRT OPTION-MRC 1600



Option for cathode-ray tube (CRT) Terminal. Duplicates all panel functions of the MRC-1600 Control Terminal. Allows simultaneous display for 16 channels, including telemetry readings, status conditions, time of day, operation and error-oriented messages.

MANUFACTURER'S SUGGESTED LIST PRICE.....\$1175.00

ALLIED PRICE \$ _____

AUTOMATIC LOGGING OPTION-MRC 1600



Option for automatic logging. Includes I/O modules, software and Texas Instruments Model 850 Desktop Printer. Log headings and command are entered through CRT keyboard. Requires option for CRT terminal.

MANUFACTURER'S SUGGESTED LIST PRICE.....\$895.00

ALLIED PRICE \$ _____

MRC-1

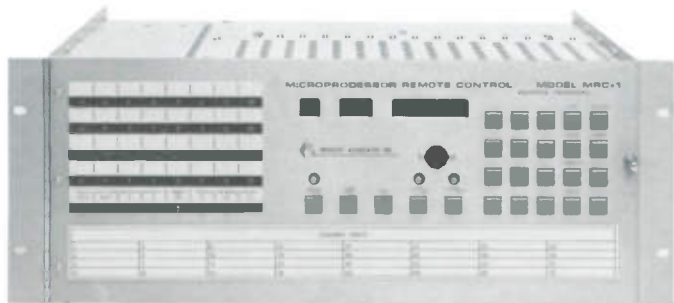

Microprocessor Remote Control System. Includes one Control Terminal and one Remote Terminal. Up to nine Remote Terminals function with a single Control Terminal. For 2-wire or 4-wire dedicated wireline or equivalent interconnecting circuits. Basic system equipped for 16 command lines (open collector electronic switching), 16 status channels (TTL/contact closure), and 16 telemetry channels indicated as 16/16/16. OPTIONS PRICES UPON APPLICATION.

MANUFACTURER'S SUGGESTED LIST PRICE.....\$7995.00

ALLIED PRICE \$ _____

MRC-2



Microprocessor Remote Control System with stand-alone Remote Terminal, consisting of one Control Terminal, one Remote Terminal. Remote Terminal includes data acquisition/command capability, precludes CRT, MDC, MSD capability for terminal. System is configured with 16 command lines (open collector electronic switching), 16 status channels (TTL/contact closure), and 16 analog telemetry channels (indicated as 16/16/16). System includes two sets of modems for main-backup wire interconnections. OPTIONS PRICES UPON APPLICATION.

MANUFACTURER'S SUGGESTED LIST PRICE.....\$12,095.00

ALLIED PRICE \$ _____

POTOMAC



Remote Control System. Includes SU-16 Studio Unit (16 channels): This unit contains the master controller and time clock. It sends commands to the transmitter unit and receives data from it. It is pre-programmed for each station according to user specifications. It provides manual or automatic surveillance and control at the option of the operator. Front panel indicators provide channel number, telemetry data, time and status indications. It also includes the TU-16 transmitter unit (16 channels). This unit accepts analog telemetry and status inputs and provides relay closure control outputs. It receives its instructions from the studio unit and operates the relays to control each function. Individual telemetry adjustments are provided for one person calibration under local control. OPTIONS PRICES UPON APPLICATION.

MANUFACTURER'S SUGGESTED LIST PRICE.....\$4995.00

ALLIED PRICE \$ _____

**“PUT OUR PAST EXPERIENCES
TO WORK IN YOUR
FUTURE SUCCESS”**

DELTA
RCS-1



Delta Electronics has developed a Remote Control/ATS System intended primarily for unattended monitoring and control of standard broadcast, FM and TV stations. Emphasis has been placed on simplicity of operation, reliability, and cost effectiveness in the design of this equipment. The latest proven microprocessor technology has been employed to accomplish the many attractive features of this system with a minimum of hardware. Three basic components are required in this system: a control unit at the control point, a control unit at the transmitter site, and an I/O unit at the transmitter location.

PRICES UPON APPLICATION

HALLIKAINEN
TEL-171



The TEL-171 converts your Moseley TRC-15AW, TRC-15AR or PBR30 to digital metering transmission, a method that eliminates the offset and gain drift in the analog metering. A local display in the transmitter control unit duplicates the readings displayed by the studio control unit. This permits one-man weekly meter calibration. The system consists of printed circuit boards which substitute directly for the audible metering generator, the audible metering demodulator, and the meter. The local display for the transmitter control unit includes a replacement front panel and a liquid crystal display printed circuit board. Installation is quick and simple since the PC mounting hardware is used, and the same wiring harness connects to the new boards. 3½ digit (-1999 to +1999) display is used. These easily read displays are updated twice a second. Should the metering carrier be lost, or a framing or parity error occur, the display at the studio will blank and front panel LED will indicate the problem. Through the use of digital transmission and display, the TEL-171 eliminates the error inherent in analog transmission, and simplifies the task of remote calibration and meter reading.

Model	Description	ALLIED PRICE \$
TEL-171	for TRC-15A.....	\$800.00
TEL-171	for PBR-30.....	\$920.00

HALLIKAINEN PRICES ABOVE ARE MFGR'S SUGGESTED LIST PRICES. CALL FOR TODAY'S ALLIED PRICE.

MARTI

Marti Electronics, Inc. is recognized world wide as a manufacturer and supplier of quality products for the radio broadcaster. The Marti product line is the outgrowth of the needs of our founder and President, George Marti. As a radio station owner, in the late 1940's through the 1960's, Mr. Marti had programming desires that required equipment that was not available, or if it was available it was not at a reasonable cost. Because of his own needs, he designed and built equipment which satisfied his own programming requirements. These products were successful. Others saw, used and liked the products. Marti Electronics was begun using the same philosophy that emerged in building those first products... "Build a quality product that is reliable, meets a basic need, performs as it is designed to and is priced to give the user good value for his money." Marti equipment is manufactured to meet several basic needs of the radio broadcaster.

Marti Remote Pick-Up Systems...The Marti remote broadcast system (RPU) has for years been regarded as the standard for the industry. Broadcasters use RPU equipment to originate programs from events and locations away from their studios. The Marti system of transmitters, receivers and mobile or fixed relay stations allow a live program to be transmitted from the event to the studio with broadcast quality sound. Once the program is received at the studio, it is rebroadcast or recorded for future use.

TSL-2

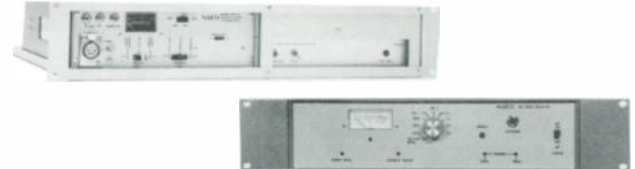

The Marti TSL-2 Telemetry link provides reliable telemetry circuits for AM, FM and TV stations. Expensive and unreliable FM Subcarrier and Telco lines can now be replaced with a cost effective Marti TSL System. This link is simple to install, easy to operate and maintain. The 2.5 watt transmitter is for solar power or other limited power source applications.

TSL-2 RPT2/450P/RMH-3/RR10-450
PRICE UPON APPLICATION

TSL-15



The Marti TSL-15 Telemetry Link provides reliable telemetry circuits for AM, FM and TV stations. Expensive and unreliable FM Subcarrier and Telco lines can now be replaced with a cost effective Marti TSL System. This link is simple to install, easy to operate and maintain. The 15 watt transmitter is recommended for use on medium to long paths having high signal attenuation.

TSL-15 RPT15-450P/RMH-3B/RR30-450
PRICE UPON APPLICATION

**“PROFESSIONAL PEOPLE,
SALES, SERVICE
& PRODUCT”**

**MARTI
RPT-2**



The RPT-2 is a hand-carried broadcast quality continuous duty transmitter. It will operate from its internal ni-cad battery, from 115 VAC power or from external 12 VDC power. A special subaudible encoder enables the RPT-2 to access Marti mobile repeaters for coverage of indoor events.

Model	Freq. Band	
RPT2-150L	152-172 mHz (25F3).....	\$835.00
RPT2-450R	450-456 mHz (50F3).....	\$835.00
RPT2-450N	450-456 mHz (25F3).....	\$835.00
RPT2-450P	450-456 mHz (10F3).....	\$835.00
RPT2-450S	450-456 mHz (100F3).....	\$835.00

BR-10



Model BR-10 is a rack-mounted VHF or UHF base station receiver designed for broadcast remote pickup service. This receiver has dual frequency capability built in. Marti Technology has provided the highest frequency response with the lowest noise and distortion possible for the assigned channel band width. Special attention has been given to solving today's high interference problems. The BR-10 features a built-in test meter, squelch relay, optional DC operation, built-in sub-audible tone decoder, special noise reduction circuit, 90 dB spurious rejection.

BR-10 Single Freq.	\$1015.00
CR-10 Single Freq. w/monitor speaker.....	\$1045.00

AR-10



The Marti AR-10 Series receiver is a portable or mobile repeater receiver. This receiver has a built-in AC power supply, and will operate from an external source of 12-15 volts DC. A built-in sub-audible tone decoder meets FCC rule 74.431 allowing this receiver to automatically turn on a mobile transmitter upon receiving an encoded signal from a hand-carried portable transmitter, thus automatically relaying a broadcast to the base station receiver over a greater distance. The receiver operates on all remote pickup frequencies and band widths. Other built-in features include dual frequency capabilities, monitor speaker, and terminals for feeding telephone lines in portable operations. The unit weighs only 5½ pounds.

AR-10 Single Freq.	\$1045.00
AR-10 Dual Freq.	\$1075.00

RPT-15



The Model RPT-15 is a compact 15 watt transmitter designed for portable or mobile remote broadcast service. It delivers the maximum power allowed by the Commission for airborne remotes such as traffic reports. The RPT-15 has a built in power supply for operation on 115 VAC. It will also operate on an external 12-14 VDC supply. Standard features include dual frequency and subaudible encoder for use with Marti mobile repeaters and automatic repeaters. All this plus famous Marti broadcast quality and continuous duty operation.

Model	Freq. Band	
RPT15-150L	152-172 mHz (25F3).....	\$945.00
RPT15-450R	450-456 mHz (50F3).....	\$945.00
RPT15-450N	450-456 mHz (25F3).....	\$945.00
RPT15-450P	450-456 mHz (10F3).....	\$945.00
RPT-15-450S	450-456 mHz (100F3).....	\$945.00

RPT-25/40

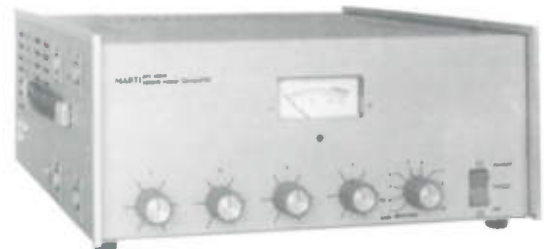

The Model RPT-25 transmitter provides uncompromised performance in portable and mobile remote broadcast service. This transmitter delivers 25 watts output under continuous duty conditions. Plug in modular construction simplifies field repairs. Available in dual frequency model. (RPT-40 delivers 40 watt output.)

Model	Freq. Band	
RPT-25P	450-456 mHz (10F3).....	\$1745.00
RPT-25P-2	450-456 mHz (10F3)(Dual).....	\$1895.00
RPT-25R	450-456 mHz (50F3).....	\$1745.00
RPT-25R-2	450-456 mHz (50F3)(Dual).....	\$1895.00
RPT-25N2	450-456 mHz (25F3).....	\$1745.00
RPT-25N2-2	450-456 mHz (25F3)(Dual).....	\$1895.00
RPT-25S	450-456 mHz (100F3).....	\$1745.00
RPT-25S-2	450-456 mHz (100F3)(Dual).....	\$1895.00
RPT-40K	152-162 mHz (30F3).....	\$1495.00
RPT-40K-2	152-162 mHz (30F3)(Dual).....	\$1645.00
RPT-40L	166-170 mHz (25F3).....	\$1495.00
RPT-40L-2	166-170 mHz (25F3)(Dual).....	\$1645.00

MARTI PRICES ABOVE ARE MFGR'S SUGGESTED LIST PRICES. CALL FOR TODAY'S ALLIED PRICE.

FAIRCHILD
DIGITAL AUDIO RECEIVER TERMINAL DART - 384



For Digital Satellite reception we recommend the FAIRCHILD DART 384 (formerly known as the COMTECH DART 384). The DART 384 receiver consists of down-converter, receiver-demodulator shelf, audio program channels, voice cue channels, and data program channels.

The down-converter is an environmentally sealed unit which mounts at the antenna. It converts the 3.7 to 4.2 GHz output of the LNA to a 70 MHz IF signal for use by the demodulator shelf electronics. With the down-converter mounted outside at the antenna a low cost RG-6 type cable can be utilized while at the same time allowing two to three times the distance between the antenna and the receiver-demodulator shelf. A feature only the FAIRCHILD has!

Other features include crystals for all four active digital satellite transponders *standard* in all receivers. And at no additional charge a transponder crystal select switch is *standard* on the FAIRCHILD DART! Need remote channel or transponder switching? No problem, again *standard* in all FAIRCHILD DARTS via 'D' connectors on the rear of the unit.

THE COMTECH "OFFSAT" ANTENNA



Here's a unique one-piece antenna design with an innovative offset feed that makes the "Offsat" the ONLY antenna in its size category capable of **exceeding all FCC specifications for 2 degree spacing.**

COMTECH'S "OFFSAT" is the intelligent response to the new stricter requirements and it has the surface tolerance necessary for Ku-Band.

As all COMTECH antennas, the "OFFSAT" is precision made of fiberglass and is available for uplink and downlink applications in AZ/EL, Polar or Transportable configurations, both C-band and Ku-Band.

WEGENER
SATELLITE SUBCARRIER RECEIVER

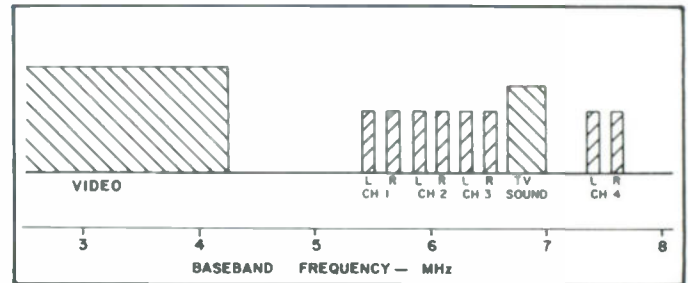
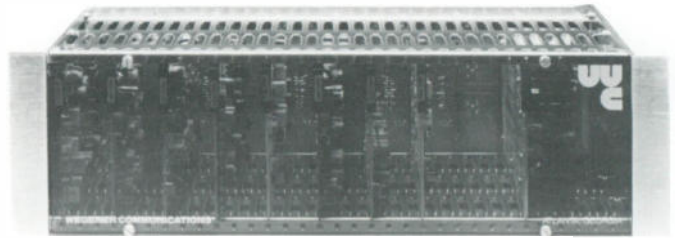

The Model 1606 Subcarrier Receiver consists of a down-converter shelf and a plug-in IF demodulator. The RF down-converter shelf mounts on the rear of the 1601 Mainframe. The down-converter accepts 4 GHz RF input, provides a 70 MHz IF output, and is designed to interface to the IF wideband demodulator. The IF demodulator is plug-in compatible with the 1601 Mainframe. Bandwidth is optimized for subcarrier reception characteristics. Thumb-wheel selection of transponders is available on the front panels. Provisions are made for LNA powering and polarity switch relay interfacing. Output of the 1606 is wideband-baseband designed to connect to the 1600 family of subcarrier demodulators.

COMTECH
3.8M ANTENNA



The 3.8M is the perfect antenna for reception of any format audio network, whether the transmission be Digital, Sub-Carrier, or SCPC.

Comtech's antennas are easy to assemble, install and align. Simplified installation design for both the AZ/EL mount and the polar mount permit rapid, money-saving installations.

Careful tight tolerance construction assures maximum gain and minimum beamwidth so necessary for today's crowded satellite arc. Range tested gain spec of 42.9 dB!

MICRODYNE
1100 BDC/DCR VIDEO RECEIVER



Looking for KU-Band? Allied has the most popular Microdyne 1100 BDC/DCR series! The first half of this receiver is the block down-converter (BDC) which converts the KU-Band frequencies, at the antenna, to a range of 270-770 MHz. Lower cost cable can then be utilized between the satellite antenna and the receiver. Also the BDC is available in a C-Band version which allows you to get double service from your DCR receiver!

The DCR features a double conversion tuner for the best possible image rejection, noise figure and high temperature range stability. The DCR features automatic polarity switching, dual video outputs, and two audio demods. The Microdyne DCR is available in either half, full or dual transponder configurations. Audio subcarriers can be specified to match any frequencies that are used by your network.

MICRODYNE
1100 FFC-X1 (RDC) L DOWN-CONVERTER



The 1100 FFC rack-mounted down-converter reduces the 3.7 to 4.2 GHz received signal to 70 MHz (center frequency). These crystal-controlled converters are ideal for either single-channel or multi-channel applications, where one 1100 FFC can accommodate up to thirteen 1100 PCDR demodulators. A simple front panel crystal change allows the use of any transponder on the satellite with no internal adjustment required. Note: This is the ultra-stable down-converter required by most SCPC demodulators!

MICRODYNE
1100 PCDR-5 SCPC DEMODULATOR



The PCDR-5 is the latest design in a frequency agile SCPC demodulator from Microdyne. Exceptional flexibility is provided by the front panel five-section push-button switch assembly, which allows you to select wideband (high fidelity) or narrow band (broadcast voice grade), choose de-emphasis from 0 to 75 usec in 25 usec increments, and set expander ratios for 2:1 or 3:1. The PCDR-5 will receive 15 kHz audio for stereo broadcasts as well as 5 kHz or 7.5 kHz audio programming. Other features include synthesized 10 kHz step tuning, input loop through, loss-of-carrier contact alarm and two 600 ohm balanced audio outputs standard. This is the demodulator recommended most often!

ESE
750E PROGRAMMER/COMPARATORS



When programming up to four time events, the 750E Series or expanded versions are recommended, for economy and ease of use. Thumbwheel switches are set to compare the time information from an ESE Clock or Timer.

An output (event) occurs each time the thumbwheel switch setting agrees with the time display, and as long as the two agree, the output is maintained. This output is usually a single pole, form A, 1/2 amp, reed relay contact closure, but other outputs may be specified.

One set of Thumbwheels is required for each event. The standard 750E Series units are enclosed in a 19 inch Wide x 3 1/2 inch High x 8 inch Deep relay rack panel and chassis with brushed aluminum finish.

Standard Units

- ES 750E — ES 112E and one 6 Digit Program
- ES 751E — ES 124E and one 6 Digit Program
- ES 753E — ES 112E and two 4 Digit Programs (Hrs & Min)
- ES 754E — ES 124E and two 4 Digit Programs (Hrs & Min)
- ES 756E — ES 510E and one 4 Digit Program (Min & Sec)
- ES 758E — ES 510E and two 4 Digit Programs (Min & Sec)

MONROE
MODEL 5002 REMOTE CONTROL



The Model 5002 Remote Control provides remote control channel selection of two dual audio modules or voice cue modules for the Comtech/Fairchild DART-384® and other digital audio receivers.

In addition, it will permit remote transponder selection for the Comtech/Fairchild DART-384.

It includes an integral, FCC registered telephone line interface and utilizes DTMF signalling to permit access and control from any Touch-Tone® telephone.

A two-wire, 600-ohm balanced audio input permits access and control from a non-switched communications path.

Tone responses are returned to advise the calling party that the remote control sequence has been accepted.

The remote control retains the channel configurations in memory during power interruptions and returns to these configurations when power is restored to the instrument.

The remote control is housed in a 3 1/2-inch high, 19-inch wide EIA rack mountable enclosure and includes front panel indicators that provide system status information.

“The Satellite Equipment Shown Here Is But A Small Portion Of The Audio/Video Satellite Equipment Offered By Allied Satellite Division. Please Request The Allied Satellite Catalog!”

MODULATION SCIENCES



The Sidekick SCA Generator has the first crystal controlled SCA generator in the industry. Because it is crystal controlled, Sidekick has a frequency stability of $\pm 0.01\%$ over 0 to 50 degrees C. The SCA carrier is derived from a frequency synthesizer. Any frequency in the the SCA region can be selected by user programmable straps. New crystals will never be needed. A built-in modulation meter eliminates the need to purchase an additional modulation monitor for the sub-band. Audio processing has always been a weak link in SCA. Sidekick is designed for 150 microsecond pre-emphasis, with 75 and zero strap-selectable options. The lowpass audio filter, engineered as an integral part of the system, is overshoot corrected for maximum modulation and minimum crosstalk. Designed into the Sidekick is a random noise generator and incidental AM noise meter. The entire baseband is noise loaded and incidental AM measured from an RF sample. All the devices need to do minimum AM tuning are built into Sidekick, no additional equipment is needed.

MANUFACTURER'S SUGGESTED LIST PRICE.....\$2450.00

ALLIED PRICE \$ _____

CRL



The SCA 300 will improve the received fidelity and absolutely prevent main channel interference. It provides both the final audio peak control for maximum coverage and loudness plus a very low distortion generator. The SCA 300 features a quartz crystal controlled, low distortion oscillator, user programmable deviation from 2 to 8 kHz, special frequency shaping filters that permit low frequency rolloff below 100 Hz, programmed controlled muting, audio bypass, a data input port, unique multiband pre-emphasis control and a distortion anticipating AGC. In addition, the SCA 300 offers optional remote control operation, active balanced input and front panel injection level control.

MANUFACTURER'S SUGGESTED LIST PRICE.....\$1500.00

ALLIED PRICE \$ _____

MOSELEY

SCG-8



A Multiplex FM Subcarrier Generator with automatic muting and front panel peak-deviation meter, including self contained power supply. Available for operation at a specific frequency in the 26 kHz to 186 kHz spectrum.

MANUFACTURER'S SUGGESTED LIST PRICE.....\$1495.00

CALL FOR TODAY'S ALLIED PRICE

SCD-8



A Subcarrier Demodulator with automatic muting and front panel peak deviation meter, including a self contained power supply. Available for operation at a specific frequency in the 26 kHz to 186 kHz spectrum.

MANUFACTURER'S SUGGESTED LIST PRICE.....\$1295.00

CALL FOR TODAY'S ALLIED PRICE

POWERPAK

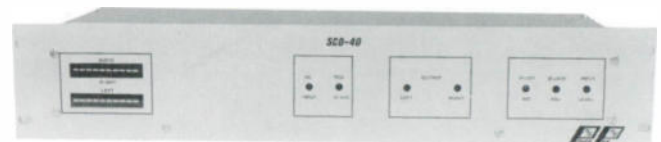

The POWERPAK SCD-40 is a Stereo Composite Demodulator used for demodulating wideband, composite stereo program, back into discreet left and right monaural channels.

Functional as a piece of test equipment, the SCD-40 finds many applications for performing various testing procedures around the station.

With the advent of AM Stereo some remote controlled stations are finding it desirable to transmit program over a single, wideband composite STL, demodulating the composite audio at the AM transmitter. The SCD-40 performs this task with a minimum loss of fidelity, faithfully restoring the original left and right channels.

Using Phase Lock Loop technology, the demodulator is furnished with 15 kHz Low Pass Filters and Dual LED/Bar peak modulation indication.

MANUFACTURER'S SUGGESTED LIST PRICE.....\$895.00

ALLIED PRICE \$ _____

SPEAKERS

ALC

10302

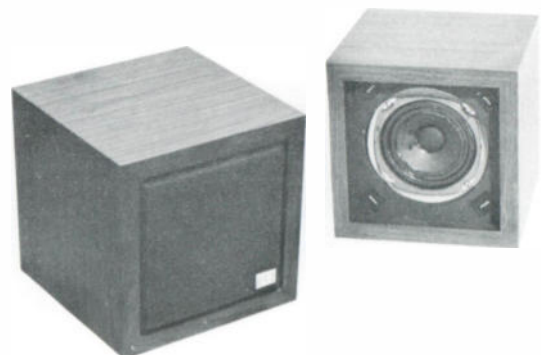

The ANNOUNCER full range loudspeaker is the ultimate in performance in a compact size. The wood cabinet is covered in walnut-grained vinyl and is perfectly square. As with all ALC loudspeakers, the grill snaps away and the system has an overall fuse. The high-compliant full range transducer produces quality sound from below 60 Hz to beyond 15 kHz.

MANUFACTURER'S SUGGESTED LIST PRICE.....\$53.00

ALLIED PRICE \$ _____

SPEAKERS

ALC
20306



The MONITOR loudspeaker system provides a flat response from below 50 Hz to beyond 20 kHz. Its high compliance surround on the 8" woofer and phenolic tweeter combine to enhance any type of music. The tweeter control and the system fuse are behind the snap-away grille. It will handle 25 watts RMS continuous, 45 watts integrated program material at 8 ohms.

MANUFACTURER'S SUGGESTED LIST PRICE.....\$116.00

ALLIED PRICE \$ _____

ALLIED CARRIES THE FULL ALC LINE

TOA
RS21M

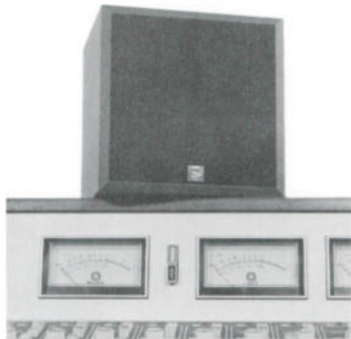

The RS21M is a compact speaker system incorporating a full range 5 inch cone speaker in a sealed enclosure of compact size. Featuring a high power capacity and smooth extended frequency response, the RS21M is ideally suited for recording studio monitoring.

MANUFACTURER'S SUGGESTED LIST PRICE.....\$59.50

ALLIED PRICE \$ _____

ELECTROVOICE
SENTRY 100A



The SENTRY 100A monitor speaker system is a no-nonsense system that speaks to the needs of professionals with specific requirements. It offers high efficiency with extended low frequency response, high power capacity across the entire frequency range, uniform frequency response and dispersion, all in a compact no frills package. The SENTRY 100A features the SUPER-DOME™ tweeter capable of handling 25 watts of input power and an 8" direct radiator woofer.

MANUFACTURER'S SUGGESTED LIST PRICE.....\$249.00

ALLIED PRICE \$ _____

SENTRY 500



The SENTRY 500 no-nonsense design meets the needs of professionals by combining high efficiency with extended low frequency response, high power capacity across the entire frequency range, uniform frequency response and constant directivity, all in a well thought-out attractive package. The SENTRY 500 employs the SUPER-DOME™ tweeter capable of handling 25 watts of input power and an 8" direct radiator woofer.

MANUFACTURER'S SUGGESTED LIST PRICE.....\$499.00

ALLIED PRICE \$ _____

ALLIED CARRIES THE FULL ELECTROVOICE LINE

JBL
4401



The most compact of the JBL studio monitors, the 4401 is ideal for use as a main monitor in applications where space is at a premium. The tight driver cluster gives the 4401 outstanding coherency in the near field, making it also an excellent choice for a console-mount secondary monitor. The 4401 offers smooth response over a wide coverage angle, with wide dynamic range and clear, open sound.

MANUFACTURER'S SUGGESTED LIST PRICE.....\$189.00

ALLIED PRICE \$ _____

JBL
4411



The 4411 is JBL's most sophisticated 3-way direct radiator monitor loudspeaker system. Applying the knowledge gained in the design of other models, JBL has created a compact monitor especially well suited to the demands of the digital age. The three transducers of the 4411 are arranged in a tight cluster to provide coherency of sound for close-in monitoring, while assuring minimal off-axis variation in the far field.

MANUFACTURER'S SUGGESTED LIST PRICE.....\$570.00

ALLIED PRICE \$ _____

4301



A compact monitor loudspeaker system designed specifically for broadcast applications, the 4301B delivers the wide band sound reproduction, accuracy and efficiency required by improved broadcast technology. Use of the 4301B is particularly relevant in light of the most recent developments including digital disc playback and TV and AM stereo.

MANUFACTURER'S SUGGESTED LIST PRICE.....\$243.00

ALLIED PRICE \$ _____

ALLIED CARRIES THE ENTIRE JBL LINE

AURATONE 5C



Recording/Broadcast standard mixdown/comparative monitors and extension speakers. Walnut woodgrain vinyl finish, black foam grille. The little powerhouse. They tell you exactly what's going on.

MANUFACTURER'S SUGGESTED LIST PRICE, PER PR.....\$95

ALLIED PRICE \$ _____

STANDBY POWER

TOPAZ
POWERMAKER MICRO UPS™

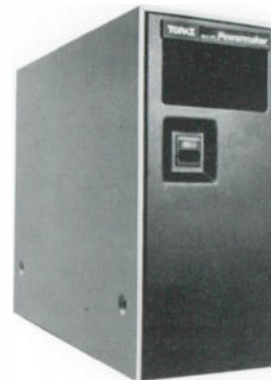

The TOPAZ POWERMAKER Micro UPS provides standby power for microcomputers and microprocessor based volatile memory. The POWERMAKER is totally effective against blackouts, brownouts and sudden voltage dips that can shut you down. The POWERMAKER also protects against noise transients and spikes that can damage your valuable equipment. It responds in less than a half cycle so that your equipment never notices a lapse in power. The POWERMAKER provides a sine wave output for meeting the power requirements of even the most sensitive equipment.

PRICES UPON APPLICATION

KAY
PHASEMASTER



The Phasemaster T-Series Rotary Phase Converter is specially designed and engineered for use with all types of radio transmitters for the conversion of single phase power to 3-phase in locations which are not serviced by 3-phase lines. Phasemaster is particularly suitable for application in situations where the high cost of installing utility supplied 3-phase power is prohibitive. A Phasemaster T-Series Rotary Phase Converter can be installed for a small fraction of the cost of installing utility supplied 3-phase power.

PRICES UPON APPLICATION

KOHLER

Kohler supports the telecommunications industry in the U.S. and world wide with prime and/or standby electric generator systems offering flexible operating capabilities (fuel, cooling, control & accessories), broad power ranges (1.75 to 1000 KW) and patented, state-of-the-art features in protection and transfer. Protect your investment with proven and reliable Kohler power for your power spectrum needs.

PRICES UPON APPLICATION — CALL FOR ALLIED'S PRICE

ONAN

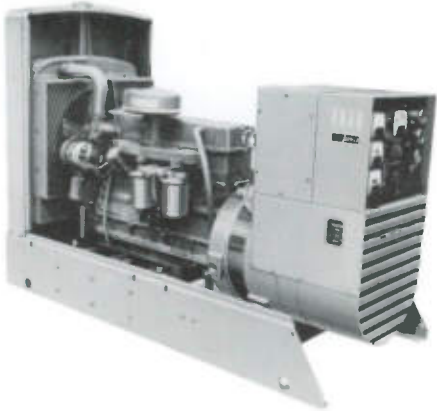

Standby electric power systems are increasingly essential to all broadcasting facilities. Allied provides a complete line of standby electric generating sets ranging in capacity from 1 to 75 KW with over forty different series and hundreds of models from which to select. Choose from gas, gasoline or diesel models. ONAN generators from Allied provide automatic switchover to insure power source reliability to your operation. An ONAN standby electric system from Allied provides air or liquid cooled engines from such large manufacturers as FORD, ONAN, ALLIS CHALMERS, CUMMINS or JOHN DEERE.

PRICES UPON APPLICATION

STL

MOSELEY

PCL-606



The PCL-606 is an all solid-state STL consisting of a transmitter and receiver with self contained power supplies, crystals and tested on the operating frequency. Versions are available for all commonly used bands from 148 to 960 mHz. Discrete.

MANUFACTURER'S SUGGESTED LIST PRICE.....\$9795.00

ALLIED PRICE \$ _____

PCL-606C

The PCL-606/C is an all solid-state Composite STL consisting of a transmitter and receiver with self-contained power supplies, crystals and tested on the operating frequency. Transmits a composite stereo waveform on a single STL. Versions available for all commonly used bands from 148 to 960 mHz.

MANUFACTURER'S SUGGESTED LIST PRICE.....\$9795.00

ALLIED PRICE \$ _____

PCL-505



The PCL-505 is an all solid-state STL consisting of a transmitter and receiver with self-contained power supplies, crystals and tested on the operating frequency. Versions available for all commonly used bands from 148 to 960 mHz. Discrete.

MANUFACTURER'S SUGGESTED LIST PRICE.....\$7195.00

ALLIED PRICE \$ _____

PCL-505/C

The PCL-505/C is a Composite STL consisting of a transmitter and receiver with self-contained power supplies, crystals and tested on the operating frequency. Transmits a composite stereo waveform over a single STL. Versions available for all commonly used bands from 148 to 960 mHz.

MANUFACTURER'S SUGGESTED LIST PRICE.....\$7195.00

ALLIED PRICE \$ _____

TRL-1



The TRL-1 is a Telemetry Return Link consisting of an all solid-state transmitter and receiver. Tuned and tested on the operating frequency. Nominal one watt transmitter output. Receiver designed specifically for narrowband service. For 10F2/10F3 channels FCC group P.

MANUFACTURER'S SUGGESTED LIST PRICE.....\$3495.00

ALLIED PRICE \$ _____

MARTI

STL-10



The Marti Studio-Transmitter Link/Intercity relay is a line-of-sight FM communications system providing a high quality broadcast audio channel with two optional sub-channels. A dual link for stereo provides two identical broadcast quality channels with better than 60 dB stereo cross talk and four optional sub-channels. This system offers greater rejection of interference, superior noise performance, low channel cross talk, greater redundancy, and lower cost.

Model Description

STL-10/950 10 watt transmitter, complete with crystal and tuned to frequency. 120/220VAC. for AM or FM broadcast application.

R-10/950 Receiver, complete with crystal and tuned to frequency, 120/220 VAC. for AM or FM broadcast application. Includes down-converter

STL-10 MONO SYSTEM, TYPICAL \$2990.00

STL-10 STEREO SYSTEM, TYPICAL \$6095.00

TSL-15



The Marti TSL-15 Telemetry Link provides reliable telemetry circuits for AM-FM and TV stations. Expensive and unreliable FM Subcarrier and Telco lines can now be replaced with cost effective Marti TSL systems. This link is simple to install, easy to operate and maintain. Marti has assembled complete equipment packages.

TSL-15 Telemetry Link, TYPICAL \$2992.50

DBX 700 DIGITAL AUDIO PROCESSOR



Precision Companding solves a major problem with delta modulation—limited dynamic range. The dbx 700 offers a dynamic range of more than 110 dB, resulting in an unbelievably low noise floor that's completely neutral-sounding. The compander's novel design and the direct digital link between encoder and decoder guarantee its overall performance is absolutely transparent.

Linear Prediction estimates a signal's future by monitoring its recent past. It does this 700,000 times a second. This further increases the dynamic range of our fixed delta modulator and prevents the audible noise modulation common in other forms of DM.

You can create a digital remote transmission system with the dbx 700 Digital Audio Processor and the MA/COM system that will rival live performance.

PRICES UPON APPLICATION

2 REQUIRED FOR STL

M/A-COM 23VFM 23 GHZ MICROWAVE LINK

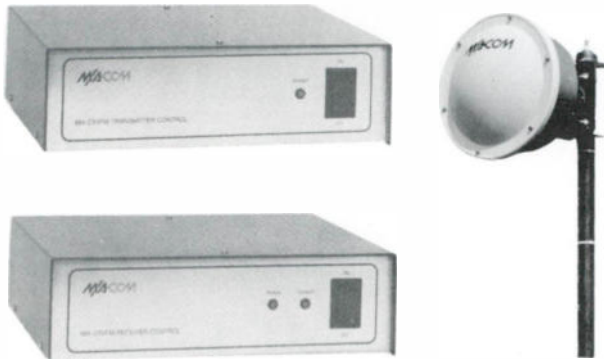

The M/A-COM 23VFM system is a budget priced solid-state FM microwave link that provides reliable, short range digital audio links in the 21.8 to 22.0 GHz and 23.0 to 23.2 GHz frequency bands. With the addition of a digital processor(s), systems can be configured as Stereo Digital only, or, with optional subcarriers, Stereo Digital and up to two additional 15 kHz analog channels. Perfect for FM SCA audio, FM/SCA data, or transmitter remote control.

PRICES UPON APPLICATION

MARK PRODUCTS



Mark Products offers a variety of sizes of Heli-Arc welded aluminum Multi-element Grid Parabolas for point to point relay operation in the 400 to 2700 mHz frequency range. The patented grid of construction is lightweight, yet extremely strong. One of the outstanding advantages of the grid antenna is that it has wind loading characteristics of only 25 to 40% of comparable size solid parabolas.

PRICES UPON APPLICATION

SCALA

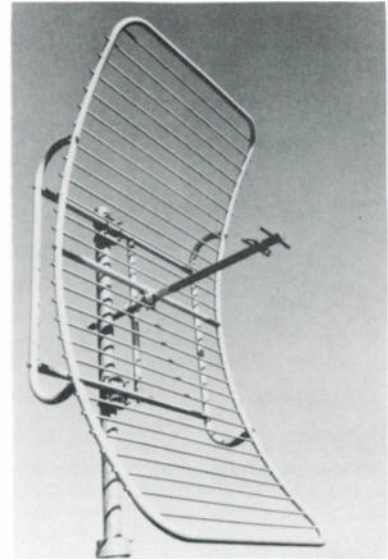

The Scala PR-450-U™ is widely used in point to point communications and telemetry systems in the 350 to 1000 mHz spectrum. Paraflector™ performance approximates that of a parabolic dish of the same aperture, and is easier to assemble and install. The PR-450U offers rugged construction for reliable long-term service, even in severe environmental conditions.

MANUFACTURER'S SUGGESTED LIST PRICE.....\$500.00

ALLIED PRICE \$ _____

SWITCHERS

ARRAKIS RS SERIES

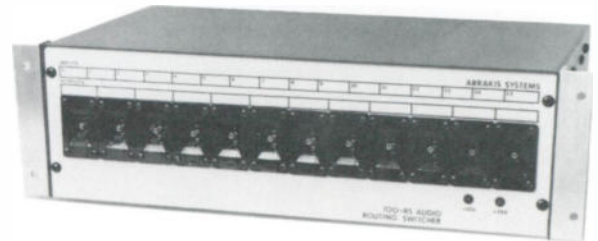

The RS Audio Routing Switchers are the professional alternative to patch panels, mechanical switches and distribution amplifiers. Ultra reliable, the power supply is regulated, protected and has a 10 year meantime before failure. LSI integrated circuits reduce parts count to a minimum. All IC's are socketed for ease of replacement. The thumbwheel control switches are 1,000,000 operation. Due to the ultra reliable design redundant power supplies are unnecessary. These switchers may be used in the most critical sections of the audio chain with total confidence.

Model	Description	Price
100RS	16 in by 12 out mono, 8 in by 12 out stereo.....	\$1500.00 ALLIED PRICE \$ _____
1100A-RSS	16 in by 4 out stereo.....	\$995.00 ALLIED PRICE \$ _____
1100B-RSS	16 in by 8 out stereo.....	\$1695.00 ALLIED PRICE \$ _____
2100A-RSM	32 in by 4 out mono.....	\$1695.00 ALLIED PRICE \$ _____
2100B-RS	32 in by 8 out stereo.....	\$3495.00 ALLIED PRICE \$ _____

ALL ARRAKIS PRICES ABOVE ARE MFGR'S SUGGESTED LIST PRICES. CALL FOR TODAY'S ALLIED PRICE.

**GENTNER
TELEMIX IX**

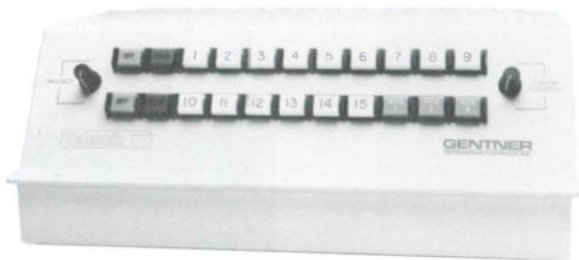

Telephone talk shows just became technically simple. Allied can now supply the newest generation of multi-line telephone systems. TELEMIX IX is a 15-line microprocessor based telephone system that provides high quality telephone audio for use in all types of broadcast talk shows. This desktop unit can be operated by the talk show talent, engineer or both.

The front panel switches look and respond exactly as a standard 10-button telephone set. But their effect on the telephone line is dramatically different!

TELEMIX IX is a totally software driven system. When any button is depressed or an external pin is grounded, a command is sent to the central processing unit (CPU). The CPU interprets this command, and depending on the internal software (1 chip EPROM) executes an appropriate response. This allows TELEMIX IX to do virtually anything. It can be re-programmed by anyone with an EPROM burner and the ability to write assembly language programs to accommodate any custom function.

Since TELEMIX IX is software driven, any combination of responses is possible. Let's explore several of its mechanical and electrical possibilities.

TELEMIX IX connects directly to MA Bell's 500 series KSU using two 25-pair cables and will interface 15 lines. Solid state switching of phone, A-leads, and lamp flashing permits total non-mechanical connection to the outside world.

A total of twelve input and output access ports are provided for software driven external interaction. This interaction can be, but is not limited to, timer starts and stops, producer cueing, and/or turning off the local coffee pot. The external ports are accessed through a rear panel DB-25.

The CPU can be accessed via an on-board RS-232 serial port. This port allows single pair control of the entire device from almost anywhere. It also permits programming the device via any minicomputer. This allows the user to operate all functions of TELEMIX IX externally.

The use of a video display is beneficial to the producer, talent and ultimately the listener. Cueing information such as length of calls, length of callers on hold, etc. can be easily programmed and displayed on the microcomputer.



Thus far we have concerned ourselves with the manipulation of telephone lines. Let's explore the processing of the telephone line once it's been directed to the audio board.

There are two groups of telephone lines that the CPU can direct to the input of the audio board. Each input incorporates an active hybrid that separates send and receive audio. Both the send and receive circuits use critically designed filter circuits providing the very best audio from the telephone line. All callers are cross-fed opposite caller audio for true least-loss conferencing.

Depression of any line button results in the following:

- (1) The CPU tells the audio board to mute the receive amplifier during line termination sequence.
- (2) The CPU pulls in the appropriate solid-state line switch and A-lead.
- (3) The CPU tells the audio board to beep the caller, telling them they're on the air. This occurs for 400 milliseconds.
- (4) The CPU then unmutes the receive amplifier and the caller is "on the air".

The entire sequence takes less than 500 milliseconds providing clean, clear, transient free telephone audio.

As the talent speaks, the caller may be reduced in level. The amount of caller reduction is controlled by the front panel caller control knob and is continuously adjustable from 0 to 30 dB of reduction.

The audio output appears on two rear panel XLR's and provides mixed audio from both line groups. The balance of audio between groups is front panel adjustable by rotating the front panel balance control.

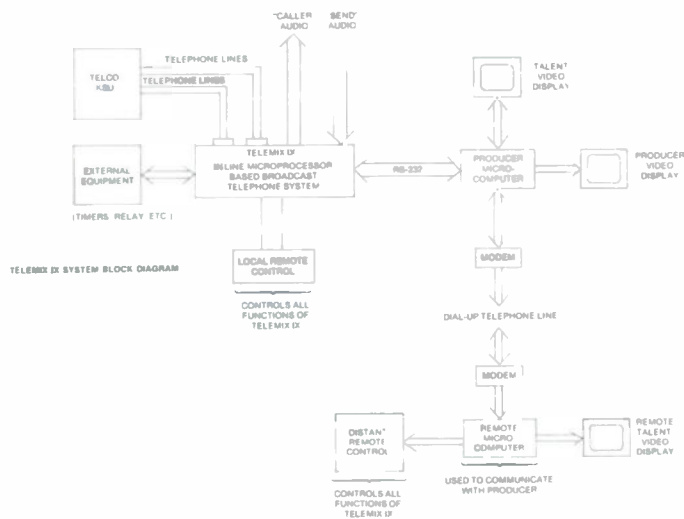

In summary, TELEMIX IX is a software driven, microprocessor based, multi-line telephone system that provides high quality telephone audio. The system is software driven, allowing maximum flexibility in processing telephone lines. The RS-232 port permits long distance remotability and in-house programming via a minicomputer. The system uses an advanced design telephone hybrid that produces clean, clear audio.

MANUFACTURER'S SUGGESTED LIST PRICE..... \$3295.00

ELGIN



The EC30A is a totally passive voice coupler that's also known as the "QKT". Total protection is afforded to the phone company's circuits by installation of the EC30A. ELGIN was the original manufacturer for the Bell "QKT".

MANUFACTURER'S SUGGESTED LIST PRICE.....\$52.00

ALLIED PRICE \$ _____

ELGIN
19645 SERIES



The news department in particular can benefit from the advantages of the ELGIN 19645 series. It's especially good for actualities, interviews, remotes and many other functions.

The 19645 RCZ recorder connector provides interface between the telephone and/or multi-line key pad and the input to your audio equipment. A defeatable "beep" occurs every 15 seconds and AGC keeps both sides of the conversation just about equal in level.

The 19645 RCZ amplifies both sides of conversation just about equal in level but isn't designed for sending audio back down a telephone line.

The 19645 requires the optional 2012B transformer for power, and connections are made via a barrier strip. A RJ-32X jack must be ordered from the phone company for single line installation. A RJ-35X jack is required for multi-line access.

Model	Description	
19645-4	Recorder connector.....	\$208.00
2012B	Transformer.....	\$10.00

20721 SERIES



Also known as the "listen line", the 20721 is expressly for use as an automatic answer device. The 20721 can be used at your station for an out-of-town audition of your program by a major time buyer by simply feeding the unit with on-air audio.

The 20721 will automatically connect your mass feed to a network station simply by having the station call the number assigned to the 20721.

This permits the caller to take advantage of much less expensive direct-dialing and allows him access to your feed without an engineer or technician at the feed end.

Audio from news networks, sporting events and more is fed to a bank of 20721 units. One unit is required per subscriber network station. The subscribing station orders a telephone hook-up from the local telephone company in the originating station's city and simply calls the assigned number when they need a feed. The 20721 takes care of everything else. A lot of major league sports networks are handled this way, including the Cincinnati Reds broadcasts all the way to Florida.

The 20721 must see a battery reversal or momentary open from the originating city's local central office. The absence of both of these functions will not permit the use of the 20721.

When the caller hangs up the line will not be released. Use of the Allied DTD-5 will alleviate this problem. The DTD-5 can be retrofitted into the 20721 case and needs no external power source.

Multi-connector DA19603403-51225-1 plug and hood assembly(12) and telco jack RJ-11W or jack number RJ-32X (for use with associated telephone sets) are required.

Model	Description	
20721-1	Coupler.....	\$237.00
DTD-5	Line release.....	\$64.00
DA19603403-51225	Multi-pin connectors.....	\$12.00

GENTNER
DTD-5



+



=

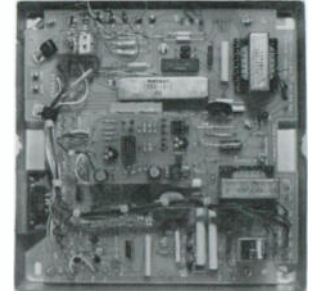

The DTD-5 is a dialtone/busy detector for use in those telephone systems which do not provide momentary open/battery reversal, the actions necessary to implement the ELGIN 20721 "Listen Line."

As the caller finishes listening to the message on the "Listen Line" and hangs up, the DTD-5 detects the dialtone, pulse, or "off the hook" sounds and sends a command to the "Listen Line" to release the line, ready for next call.

DTD-5 requires no external power supply, but retrofits into the 20721 and takes its power from the host unit.

MANUFACTURER'S SUGGESTED LIST PRICE.....\$64.00

ALLIED PRICE \$ _____

GENTNER SPH-3A



The GENTNER SPH-3A from Allied provides an easy and inexpensive method of interfacing broadcast equipment with an existing telephone system. Separate adjustable volume control of caller audio and monitor audio is featured, plus one-time-adjustment of null and feed to caller.

MANUFACTURER'S SUGGESTED LIST PRICE.....\$499.00

ALLIED PRICE \$ _____

SPH-4



From GENTNER, the SPH-4 is a self contained telephone interface system designed to provide clean, clear, phone audio for a variety of uses. Incorporates one-time-set controls of audio volume to caller (with LED level indication) squelch, hybrid null as well as separate volume controls for caller level and monitor. An exclusive feature is the caller control — a compromise between a full duplex hybrid and a speaker phone.

MANUFACTURER'S SUGGESTED LIST PRICE.....\$699.00

ALLIED PRICE \$ _____

SYMETRIX TI-101



A console-to-telephone interface for talk show, ENG, production and a host of other applications.

MANUFACTURER'S SUGGESTED LIST PRICE.....\$495.00

ALLIED PRICE \$ _____

TELLABS

A typical stereo application would consist of:

- (1) #4425 dual repeat coil card
- (1) #1911 single card repeat coil housing
- (1) #1913 dual housing for 2 equalizer modules*
- (2) #4008 equalizer modules
- (1) #1913-L4 power transformer

* (RF at the receive end may necessitate a 248RF cabinet which is designed with suppression and bypassing especially for use in RF-intense applications.)

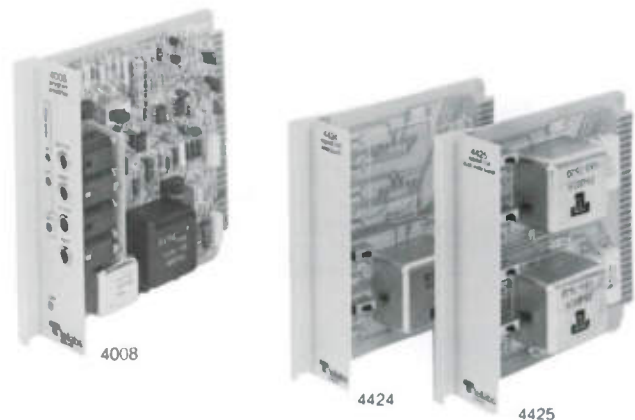
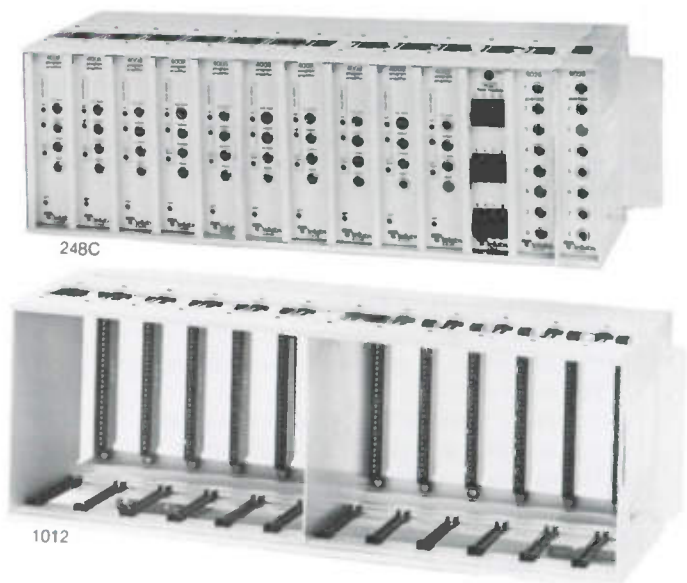

The TELLABS line of equalization equipment was designed expressly for use with telephone circuits. No other form of equalization can offer the flexibility or specs necessary to achieve the quality for AM and/or FM (stereo) feeds via leased telephone circuits. Bell standard for this application.

If a circuit is unloaded and if the length vs. gauge criterion is not exceeded, you can install your own equalization and pay for it in a very short time. The only alternative is to pay the telephone company a monthly fee for the same equipment. If telephone circuit lines are a necessity in your operation, there's no reason for you to also pay for the equalization on a monthly basis.

All TELLABS equipment is connected via the wire wrap method and all cabinets must be wired for application by the user. Wrap terminals .075".

A typical mono application would consist of:

- (1) #4424 single repeat coil card
- (1) #1911 single card repeat coil housing
- (1) #1912 housing for equalizer module*
- (1) #4008 equalizer module
- (1) #1913-L4 power transformer

TELEPHONE LINE EQUALIZATION

TYPICAL ARRANGEMENT TO UPGRADE ANY LOOP WHICH MEETS INDICATED CRITERIA

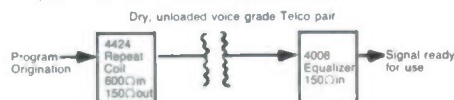

Up to 30 dB loss differential 50-15 kHz
(22 ga. cable typically 5.9 mi. max @ 15 kHz)

UP TO 3 UNITS MAY BE CASCADED AT APPROX. 5 MI. INTERVALS WITH MAINTENANCE OF ACCEPTABLE NOISE & DISTORTION SPECS (RE 22 GA. CABLE)

TYPICAL EQUALIZATION LIMITS — 15 KHZ

CABLE GA.	MAX. LENGTH
19	8.7 mi.
22	5.9 mi.
24	4.2 mi.
26	3.4 mi.

If you wish to equalize a number of circuits you may wish to use 248C rack mount housing which will accommodate up to eight (8) #4008 modules. (9 with user wiring.)

If several repeat coils are to be used, the #1012 housing will hold up to 12 cards.

Repeat coils and #4008 modules may be mixed in the 248C housing when wired accordingly. All terminals are .075" wire wrap and user wired.

Model	Description	
#4008	EQ. module.....	\$214.63
#4424	Repeat coil/single.....	\$54.19
#4425	Repeat coil/dual.....	\$73.31
#1913	Dual card housing.....	\$69.07
#1911	Single card housing.....	\$20.19
1913-L4	Transformer.....	\$9.57
248RF	Dual amp mounting, RF shielded.....	\$325.13
248C	housing.....	\$385.69
8003A	power supply.....	\$183.81
1012	housing.....	\$106.25

ESE ES212



ES212 uses a "heavy iron" transformer hybrid network, 600 Ohm balanced line level inputs and outputs, switched metering, with full level and dynamics control. Best of all, the patch reproduces telephone audio cleanly and quietly. Have you ever experimented with the bridging of phone signals into broadcast consoles and wondered why the voices sounded so much better over the phone itself? On the ES212, the voices will sound better over the patch. The response is carefully tailored in the receive channel and no AGC is used to "suck up" line noise. The sound is not tiny, spitting, compressed, noisy, or narrow. It is as clear, wide, and natural as the phone line will permit. The send (announcer's voice) signal is squelched during listening periods so as not to add noise. The receive channel may be adjusted to depress the gain of the caller as the announcer speaks. The ESE PHONE PATCH is not just another interface device, it is a quality broadcast instrument, fully compatible with the requirements of fine audio.

MANUFACTURER'S SUGGESTED LIST PRICE.....\$995.00
ALLIED PRICE \$

DELTA



The Common Point Impedance Bridge is an invaluable device for directional array maintenance. The CPB-1 is designed for permanent installation in existing phasing equipment to provide an accurate indication of the common point impedance. The CPB-1 will handle common point powers of up to 5 kW with 100% modulation. The CPB-1A is designed for powers up to 50 kW.

Model	Description	ALLIED PRICE \$
CPB-1	to 5 kW.....\$1850.00	_____
CPB-1A	to 50 kW.....\$2200.00	_____

DELTA PRICES ABOVE ARE MFGR'S SUGGESTED LIST PRICES. CALL FOR TODAY'S ALLIED PRICE.

POTOMAC QA 100

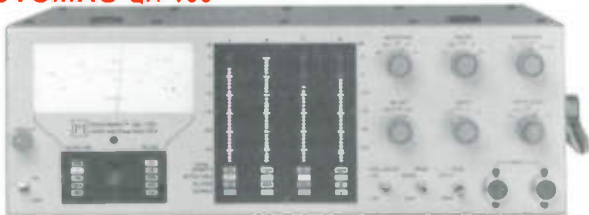

The Potomac "QuantAural" QA 100 is a first class audio program analyzer for evaluating your own station sound, competitive stations sound and measuring audio processing from numerous sources. Naturally your ears will always be the best judge of sound, but now this instrument is designed especially for professional broadcast sound analysis. You can now measure maximum peak level, audio processing effectiveness, tightness of sound, tonal balance and consistency, stereo bandwidth, preemphasis and "punch." This portable unit utilizes meter and LED readouts, weighs 12½ lbs. and measures 15"W x 5¼"H x 10½"D.

MANUFACTURER'S SUGGESTED LIST PRICE.....	\$3500.00
ALLIED PRICE \$	_____

AT-51



Designed primarily for commercial broadcast proof-of-performance measurements and equipment maintenance. The AG-51 Audio Generator and AA-51 Audio Analyzer are packaged separately for remote measurements requiring physical separation of signal source and signal analyzer. Both units are RFI shielded to enable accurate measurements in high level radio frequency environments typical of broadcast transmitter facilities. Signal input and output connectors are also RFI shielded.

The AT-51 measures harmonic distortion, intermodulation distortion, volts, dB, signal to noise ratio, wow and flutter, stereo phasing, and differential gain in stereo channels.

FEATURES:

- * Separate generator and analyzer
- * Transformerless stereo outputs balanced or unbalanced
- * Source resistance of 150 or 600 ohms
- * Automatic signal leveling
- * Precision 10 dB, 1 dB and .1 dB step attenuators
- * RFI shielding
- * Automatic "set level" and "balance" circuits
- * Scope display of distortion products output
- * Output level monitor

Model	Description	ALLIED PRICE \$
AT-51	Complete system including AA-51 and AG-51.....\$3575.00	_____
IX-51	Optional balancing transformer (ea.).....\$175.00	_____
AA-51	Analyzer only.....\$2125.00	_____
AG-51	Generator only.....\$1875.00	_____

POTOMAC PRICES ABOVE ARE MFGR'S SUGGESTED LIST PRICES. CALL FOR TODAY'S ALLIED PRICE.

DIGIMAX



The Digimax Digital Frequency Counter meets or exceeds all FCC requirements.

SPECIFICATIONS

- FREQUENCY RANGE:** 20 Hz - 1.0 GHz
- ACCURACY OVER TEMPERATURE:** 0.1 PPM (+55 to 85 degrees F) proportional 10 MHz oven
- READOUTS:** Full 9 digits
- SENSITIVITY:** 5 to 50 mV from 50 Hz to 25 MHz
15 to 75 mV at 1 GHz
- ACCURACY:** ±.1 Hz at 1 MHz
± 1 Hz at 10 MHz
± 100 Hz at 1 GHz
- POWER REQUIREMENTS:** AC-12 required for 110VAC, 8-15VDC at 500 ma.

Order the package including D-1200-AC-12, BAC12 and TI200. Package includes AC adapter, rechargeable battery pack and antenna.

MANUFACTURER'S SUGGESTED LIST PRICE.....	\$352.00
ALLIED PRICE \$	_____

TEST EQUIPMENT

DIGIMAX LCD-1000



The Digimax LCD-1000 is a 1 GHz frequency counter with LED resolution and .0001% accuracy. It has VHF-UHF sensitivity. Comes with Ni-Cad battery and AC adapter.

MANUFACTURER'S SUGGESTED LIST PRICE.....\$189.00

ALLIED PRICE \$ _____

PA1300

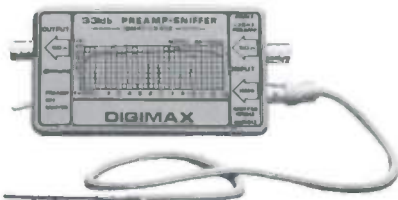

The Digimax PA1300 is a 33 dB preamp sniffer with a frequency range of 10 mHz to 1.3 GHz. Comes with sniffer probe and AD adapter.

MANUFACTURER'S SUGGESTED LIST PRICE.....\$89.00

ALLIED PRICE \$ _____

CROWN RTA-2 AUDIO SPECTRUM ANALYZER



The Crown RTA-2 is designed for audio-range real-time spectrum analysis in 1/3 and full octave bands. All the sub-systems needed to perform quick, accurate on-site equalization of sound-reinforcement systems are included in the RTA-2.

The Crown RTA-2 weighs only 22 pounds (39 with optional carrying case which qualifies as carry-on luggage for air travel, 50 in optional shipping container which is recommended for air travel as checked baggage).

MANUFACTURER'S SUGGESTED LIST PRICE.....\$2450.00
Cases optional at extra cost.

ALLIED PRICE \$ _____

"ONE STOP SHOPPING @ ALLIED"

WHITE INSTRUMENTS

151



The 151 is a compact battery powered digitally operated pink noise generator.

FEATURES:

- * 268,000 bit word length
- * Flat 20 Hz through 20 kHz
- * Mic or line level output
- * Rugged
- * Inexpensive

MANUFACTURER'S SUGGESTED LIST PRICE.....\$140.00

ALLIED PRICE \$ _____

TEKTRONIX

2235/2236



2235



2236

With the 2235 and 2236 oscilloscopes, Tektronix takes the high-value high-performance design concept of the 2200 Series even further. Both scopes feature a low price made possible by the 2200 Series' innovative, reduced-component architecture. (Yet both scopes offer advances in performance, operational simplicity and — not least — in solid reliability. All backed by the industry's first three-year warranty on all parts and labor, including the CRT.) The 2236 introduces a new concept in waveform measurement: a counter/timer/DMM, integrated into the scope's vertical, horizontal and trigger systems. Its capabilities simplify set-up, heighten measurement confidence and expand scope versatility in innumerable ways. The scope and DMM also can be applied simultaneously, with concurrent CRT and digital readout displays. DMM auto ranging simplifies set-up. An ohm-meter range of 2GΩ — a hundred times the range of most such devices — lets the technician quickly pinpoint even small amounts of transformer leakage. The 2235 ensures measurement quality and reliability while reducing instrument cost.

MANUFACTURER'S SUGGESTED LIST PRICE...2235.....\$1750.00

MANUFACTURER'S SUGGESTED LIST PRICE...2236.....\$2650.00

ALLIED PRICE \$ _____

GOLD LINE

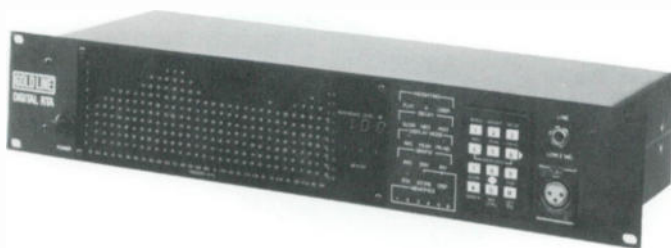

The Gold Line Digital Model 30 Real Time Analyzer uses microprocessor technology allowing extreme accuracy and stability. Pink Noise: The Model 30 incorporates a pseudo randomly generated pink noise source. This stable display of equal energy across the entire audio spectrum makes equalization adjustments far easier.

MANUFACTURER'S SUGGESTED LIST PRICE.....\$1895.00

ALLIED PRICE \$ _____

LOFTECH

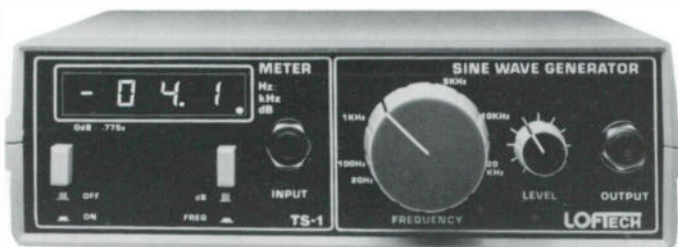

The Loftech TS-1 provides a combination of three precision test instruments. This provides the user with a powerful tool that is capable of making audio frequency tests and measurements with a high degree of accuracy and in less time than conventional test instruments.

The TS-1 features a current controlled, state-variable oscillator. This is a true sine wave oscillator and not a function generator. Distortion components are typically 0.1%. Full frequency sweeps can be made from 20 Hz to 20 kHz in a single range. The output impedance is 50 ohms, unbalanced.

The frequency counter is internally connected to the oscillator until a signal is plugged into the meter input. It then displays the frequency of the input signal. The input impedance is greater than 100,000 ohms electronically balanced.

The TS-1 dB meter is a wideband, average responding AC voltmeter. The output of this meter circuit is electronically converted to decibels for display. The logarithmic nature of decibels eliminate the need for range switches. A reference level for "0 dB" is factory set for 0.775 v which can be user adjusted ± 10 dB with a rear panel control. The input impedance is greater than 100,000 ohms unbalanced.

MANUFACTURER'S SUGGESTED LIST PRICE.....\$299.00

ALLIED PRICE \$ _____

TEKTRONIX AA501/SG505



Used together, the AA 501 Distortion Analyzer and SG 505 Oscillator provide the *automatic* solution to your distortion measurement needs. The AA 501 is so automatic, that no level setting, tuning or nulling is necessary.

An optional package would be the SG 505 option 2 audio oscillator (balanced, +28 dBm, multi-impedance) and AA 501 option 1 distortion analyzer (level, THD, plus multi impedance) in the TM503 mainframe. Since the instruments are plug-in modules, a split-site station could mount the RTM 506 rackmount at the transmitter and either carry both instruments in the more portable TM 503 when testing individual items of equipment, or plug the analyzer into the rackmount and take the oscillator in the TM 503 to the studio for full system proofs.

The AA 501 and SG 505 combination permits harmonic distortion, intermodulation distortion, frequency response, gain/loss, and signal-to-noise measurements to be accomplished with minimal operator skill. At the same time, both instruments feature state-of-the-art performance in residual noise and distortion.

Total system harmonic distortion plus noise is .0025%. Oscillator distortion is .0008% (THD). Analyzer residual noise level is less than 3 microvolts. The AA 501 offers a novel analog-like "bar graph" plus complete digital readout, it reads true RMS or average response in all modes.

SG505 OSCILLATOR W/OPTION 2.....\$1525.00

AA501 DISTORTION ANALYZER....\$2400.00

ALLIED PRICE \$ _____

2213A/2215A

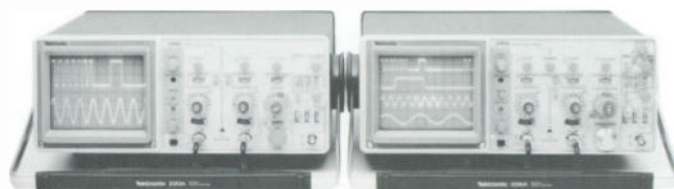

With the 2213A and 2215A oscilloscopes, Tektronix continues a winning tradition: low cost value for performance that's best in its class. All backed by the industry's first 3-year warranty.

The new 60 MHz 2213A/2215A offer significant enhancements over the older 2213/2215A. You'll see brighter, crisper displays, thanks to reduced trace noise and to an increased accelerating potential of 14 kV. A 10 MHz bandwidth limit switch has been added to the 2213A/2215A, allowing crisper traces and cleaner triggering in noisy environments.

Both scopes feature full-size, 8 x 10 cm CRT's with camera bezel for easy viewing and photography.

The 2213A/2215A now offer improved trigger sensitivity to .3 div at 5 mHz (10 mHz for the 2235), for easy triggering and increased measurement confidence in everything from measuring power supplies to transistor noise. Using their single sweep trigger function, now standard on 2200 Series scopes, you can set up your scope to babysit signals, triggering only when a specified transient occurs. Single sweep trigger also provides an excellent way to set up your scope for photographing infrequent signals.

An improved delayed sweep allows you to make measurements with less jitter and more confidence: with a single time base in the 2213A; and with two time bases and alternate sweep switching in the 2215A. Using delayed sweep, you can examine any part of a waveform in the exacting detail you need.

Other 2213A/2215A enhancements include improved accuracy for both channels 1 and 2, opening a full range of sensitivities for making accurate X-Y measurements. And improved Z-axis input, allowing a usable 10 MHz bandwidth for applications requiring frequency markers.

Also added is a power-on light. Improved vertical and horizontal accuracy. Increased chop rate to 500 kHz. Reduced input capacitance to 20 pF. And much more.

2213A Oscilloscope....\$1275.00 • 2215A Oscilloscope....\$1525.00

TEKTRONIX PRICES ABOVE ARE MFR'S SUGGESTED LIST PRICES. CALL FOR TODAY'S ALLIED PRICE

STL



STL Test Tapes are recorded directly from precision generating equipment to provide the most accurate reference possible. An independent standards laboratory, STL provides a completely objective service, with test tapes available to major manufacturers, governments, and all who need a precision reference tool.

STL provides the following tapes:

REPRODUCE ALIGNMENT

Contains Azimuth tone, voice announced frequency run and level set tone.

PINK NOISE

20-20,000 Hz for phase alignment of multi-trak systems, and response check with 1/3 octave filters.

SWEEP

Log 100ms, 700-15,000 Hz with adequate dead section between sweeps to facilitate scope synchronization.

FREQUENCY CHECK

Contains 2-second spot check tones. No voice.

AZIMUTH

Single tone

LEVEL SET

Single tone

FLUTTER AND SPEED

A crystal controlled frequency source recorded at low flutter and accurate speed.

PRICES UPON APPLICATION STL LAB TAPE SALES ARE FINAL

McCURDY

SA14023

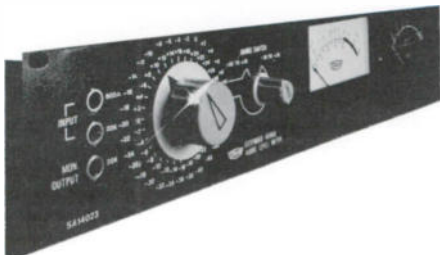

The SA14023 extended range audio level meter is a self contained instrument designed for the measurement of peak and average audio system transmission levels in dBm. A two position range switch and precision attenuator allow the accommodation of audio input levels from -50 dBm to +30 dBm, in 2 dB steps, for a zero meter reading (sine wave).

PRICES UPON APPLICATION

PPMO2

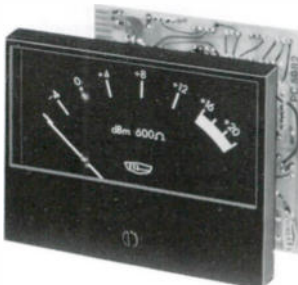

The PPM02 peak program meter is designed for peak audio level measurement in a wide range of broadcast and professional applications, in place of the conventional average-reading VU meter. Because of its peak reading characteristic, the PPM provides a much more accurate representation of the maximum audio level present than would a VU meter. Thus, allowing optimum performance of audio facilities to be realized by more precise control of levels and prevention of clipping and distortion due to line or equipment overload conditions.

As standard, the PPM02 is supplied with the McCurdy standard "C" scale, with an input level of +8 dBm giving a center scale reading. The British standard "B" scale and European standard "E" scales as well as input levels of -10 dBm, -6 dBm, -4 dBm, 0 dBm and +4 dBm for center scale reading are optionally available and must be specified when ordering.

PRICES UPON APPLICATION

TOWERS

DURO-TEST TOWER LIGHTING

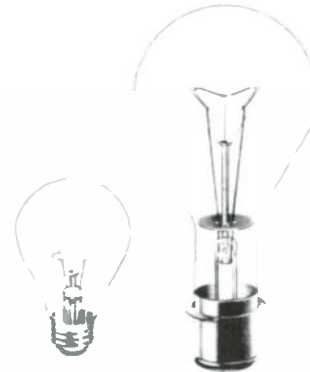

You need rugged, dependable, long-lasting, quick-to-see bulbs where there are tall traffic hazards. The best bulbs that money can buy are built by Duro-Test.

Model	Description	ALLIED PRICE \$
DT/682	BEACON PS-40 620 watt, mogul base, clear, 125/130 VAC, 10,500 lumens, rated 4500-5500 hours.....\$28.96	_____
DT/684	BEACON-40 700 watt, mogul base, duxex, clear 125/130 VAC, 11,200 lumens, rated 7500-8500 hours.....\$41.91	_____
DT/424	OBSTRUCTION A-21 116 watt, medium base, clear, 125/130 VAC, 1260 lumens, rated 7500-8500 hours.....\$4.15	_____

DURO-TEST PRICES ABOVE ARE MFGR'S SUGGESTED LIST PRICES. CALL FOR TODAY'S ALLIED PRICE.

**"ENTIRE CONTENTS COPYRIGHT
ALLIED BROADCAST
EQUIPMENT, INC."**

PI-ROD

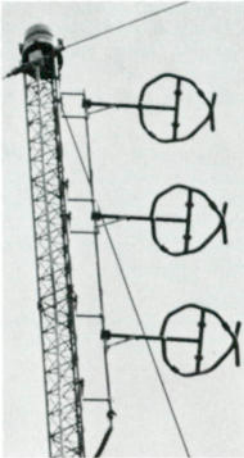

- Solid rod, all-welded construction provides greatest strength with minimum surface exposure to wind and icing conditions. Slim Line design offers minimized air resistance.
- A complete line of standard (proven performance) models
- Computerized analysis of loading factors for structure conformity to meet and exceed customer specifications. Working with this data, licensed professional engineers review your specific requirements and determine the ultimate solution.
- Engineered concepts utilizing minimum space requirements. We design systems to meet critical space limitations, with 50% and small guy radii available.
- Minimized interference with reduced face width design improves transmission...another PI-ROD engineering innovation.

PRICES ON APPLICATION

UNION METAL



Pole and accessories assembled on ground prior to erection.



Pole in position to be lowered on plumbing nuts.

- No guy wires required
- 25'-300'
- Also suitable for top-mounting FM antennas on towers

CONTACT ALLIED FOR PRICING

TRANSMISSION LINES

CABLEWAVE

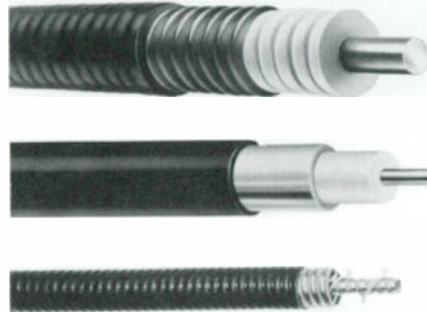

Cablewave Systems semi-flexible coaxial cables are used in electronics and communications systems operating from VLF through the microwave frequency bands. Since each basic cable construction offers specific advantages, the company manufactures both smooth wall aluminum and corrugated copper coaxial cables in foam and air dielectric. This allows the user engineer to consider technical and economic factors for each type, and select the best construction for his requirements. Cables are cut to length and connectors factory attached upon request. ALLIED CARRIES THE COMPLETE CABLEWAVE LINE, INCLUDING CONNECTORS.

PRICES UPON APPLICATION

ANDREW

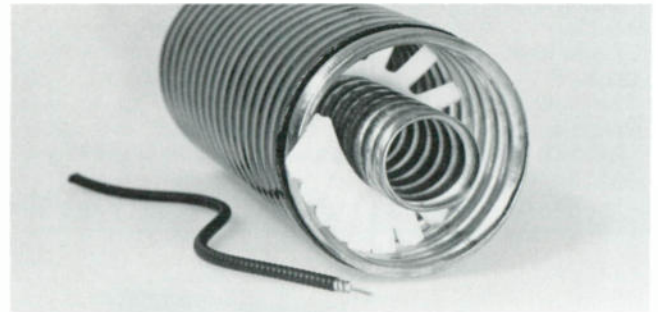

For more than 40 years, Andrew has offered a comprehensive line of broadcast products. These include both foam and air dielectric HELIAX™ flexible coaxial cables, rigid line components, pressurization equipment and installation accessories. Detailed information on the Andrew line of products is available upon request. ALLIED CARRIES THE COMPLETE ANDREW LINE.

PRICES UPON APPLICATION

ALLIED JUMPER CABLES



Prefabricated N to N cables cost less than your labor and materials. Allied jumper cables feature RG-213U coaxial cable, N-Male connectors with shrink-tube weatherproofing. Special lengths available on request. 7.8 dB loss per 100 feet at 900 MHz.

Model	Length	
213NN-2	2 ft.	\$10.00
213NN-12	12 ft.	\$13.85
213NN-15	15 ft.	\$14.39

OTHER LENGTHS UPON APPLICATION

TRANSMITTING EQUIPMENT

ALLIED
Broadcast Equipment

MOTOROLA



In the MOTOROLA C-QUAM AM STEREO SYSTEM, as in present AM broadcast standards, the angle modulated carrier is amplitude modulated with the sum of the audio information present in the program source. Thus to a monophonic receiver, the signal is no different from the signals being received under the present standards. This sum signal is comprised of two signals, left (L) and right (R).

To provide stereophonic information, angle modulation results from straight forward quadrature modulation followed by limiting. That is the monophonic (L + R) provides in-phase modulation while (L-R) provides quadrature phase modulation. The limiter assures constant level exciter drive to the transmitter.

A separate signal, a 25 Hz pilot tone, is added to the quadrature difference (L-R) signal for indicating the presence of a received stereophonic broadcast.

Existing AM broadcast transmitters may be used with relatively simple and inexpensive modifications.

Model	Description
1300	C-Quam AM Stereo Exciter &
1310	C-Quam AM Stereo Modulation Monitor...\$11,700.00
	Day/night 2 transmitter option board.....\$1000.00

These single-tube FM transmitters incorporate a unique folded half-wave dipole cavity power amplifier design, a digitally programmed FX-30 ultra-linear exciter and a microprocessor based control system.

The high power cavity employs a half-wavelength folded tank circuit. This cavity design eliminates the need for a plate blocking capacitor and all sliding contacts. The result is much higher reliability, higher efficiency, and lower maintenance costs.

The grid input circuit optimizes the impedance transformation between the solid state driver and the power tube grid.

All transmitter control and status functions are performed by the built-in microprocessor based controller. This controller is the "brain" that monitors the operating parameters and then determines what control actions are required. By its continuous scanning action, it provides 127 different status indications, including 123 codes on two large seven segment LED displays.

Broadcast Electronics FM transmitters also feature automatic restart, separate* high voltage power supplies, extensive metering and remote control capability.

(* certain models)

Model	Description
FM 1.5A	One tube 1500 watt transmitter complete with FX-30 exciter.....\$22,950.00 ALLIED PRICE \$ _____
FM 3.5A	One tube 3500 watt transmitter complete with FX-30 exciter.....\$27,950.00 ALLIED PRICE \$ _____
FM 5A	One tube 5000 watt transmitter complete with FX-30 exciter.....\$29,950.00 ALLIED PRICE \$ _____
FM 30	One tube 30,000 watt transmitter complete with FX-30 exciter.....\$61,950.00 ALLIED PRICE \$ _____

All BE 30 transmitters must be used only with closed delta or WYE 3- or 4- wire to validate warranty.

BROADCAST ELECTRONICS PRICES ABOVE ARE MFR'S SUGGESTED LIST PRICES. CALL FOR TODAY'S ALLIED PRICE.

FX-30

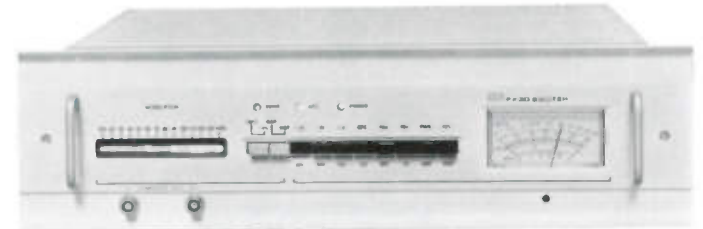

The heart of any Broadcast Electronics FM Transmitter is the FX-30 synthesized exciter.

This solid state exciter is completely broadband and requires no tuning adjustments for a conservative 30 watt output. With 30 watts output, this is all the drive power required.

The FX-30 is mounted on a slide-out assembly making all components accessible for easy servicing.

The FX-30 accepts multiple wideband composite inputs as well as a 600 ohm balanced input. When used for wideband, stereo or monaural operation, the FX-30 exciter produces a distinctively clean and superb FM sound.

MANUFACTURER'S SUGGESTED LIST PRICE.....\$5595.00

ALLIED PRICE \$ _____

BROADCAST ELECTRONICS



FM-30

FM3.5

ELCOM BAUER AM TRANSMITTERS

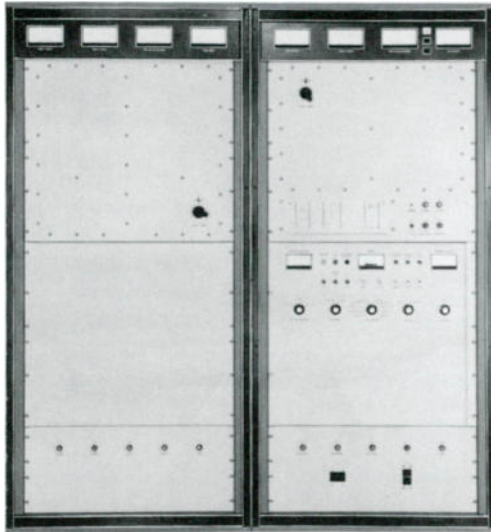

- * 125% positive peak capability
- * Stable high level plate modulation
- * Three tube types
- * Plug in solid state low level audio and RF driver stages
- * Adaptable for AM stereo
- * Oil-filled modulation transformer
- * Two ovenless crystals (switchable)
- * Unexcelled accessibility
- * Remote ready-wire or STL
- * Interface for standard telemetry control equipment
- * Step start
- * Three step overload
- * FCC primary circuits metered and continuously monitored
- * Secondary operating parameters with multimeter readout
- * Front panel circuit breakers
- * Fuses with fault indicators
- * Tally light fault indicator with memory system
- * Remote resettable fault indicator
- * Automatic return to air after power failure
- * Available medium wave, 250 watts to 50,000 watts
- * Available high frequency, 500 watts to 15,000 watts

PRICES UPON APPLICATION

FM TRANSMITTERS

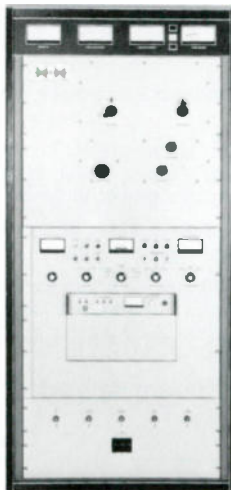

- * Solid State direct FM phase lock loop exciter
- * AFC status indication
- * Grounded grid power amplifier
- * No neutralization required
- * VSWR protection
- * Automatic power output control
- * Remote ready-wire or STL
- * Interface for standard telemetry control equipment
- * ATS interface
- * Built-in standby, many models
- * Front panel circuit breaker
- * Fuses with fault indicator
- * Three tube types
- * FCC primary circuits metered and continually monitored
- * Secondary operating parameters with multimeter readout
- * Solid state timing-diode logic and relays
- * Tally light fault indicator with memory system
- * Tuning controls with counter indicators
- * Unexcelled accessibility
- * Available 250 watts to 54,000 watts

PRICES UPON APPLICATION

690PLL

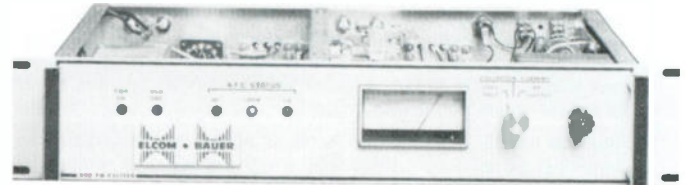

The 690PLL Exciter from Ecom Bauer combines all of the high-performance, high reliability features most wanted by FM broadcasters.

Frequency stability is excellent: ± 300 Hz, with ± 100 Hz typical. Noise and distortion levels are very low. 690PLL accepts signals from monaural programming, composite signal sources, and SCA generators. It is compatible with, and will enhance, any audio processing system.

Frequency modulation is direct, and incorporates phase-locked loop technology. Power supplies are controlled by integrated circuit voltage regulators for stability and reliability.

Output frequency range is 88 MHz to 108 MHz, programmable in 100 kHz steps. RF power output is 1 to 15 watts, continuously variable.

MANUFACTURER'S SUGGESTED LIST PRICE.....\$2850.00

ALLIED PRICE \$ _____

ALLIED CARRIES THE COMPLETE ELCOM BAUER LINE OF TRANSMITTERS

POWER PAK

SMX-40



The SMX-40 is a full frequency synthesized world class FM exciter with up to 30 watts of absolute RF drive power, extensive status indications and protection. The SMX-40 rivals all competitive exciters available at any price.

MANUFACTURER'S SUGGESTED LIST PRICE.....\$3995.00

ALLIED PRICE \$ _____

TRANSMITTING EQUIPMENT

POWER PAK SMG-40 STEREO GENERATOR

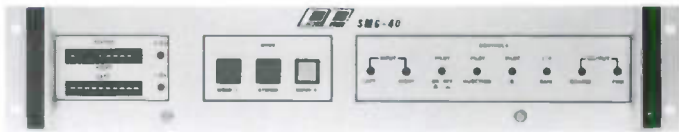

The perfect complement to the SMX-40, this high-tech generator assures transparency and transmission quality with the performance characteristics to meet the stringent demands of today's high quality FM transmission equipment.

MANUFACTURER'S SUGGESTED LIST PRICE.....\$1895.00

ALLIED PRICE \$ _____

CSI AM & FM TRANSMITTERS



T-5-F



T-1-F

CSI transmitters feature excellent design, economy, and ease of maintenance. FM levels from 1,000 to 50,000 watts feature proven grounded grid circuitry.

AM transmitters are straightforward and dependable. Powers from .25 to 50 kw.

You'll find CSI transmitters efficient, dependable, and economically priced.

A complete selection of accessories will permit you to custom modify the CSI transmitter of your choice to your exact requirements.

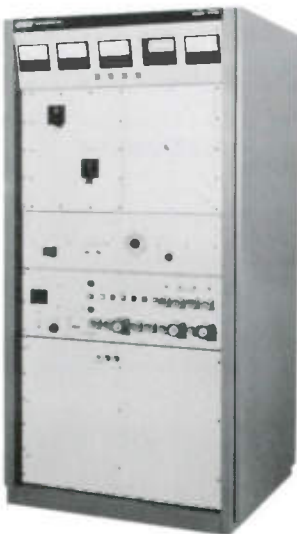

T-1-A1

CALL FOR TODAY'S ALLIED PRICE

KAHN

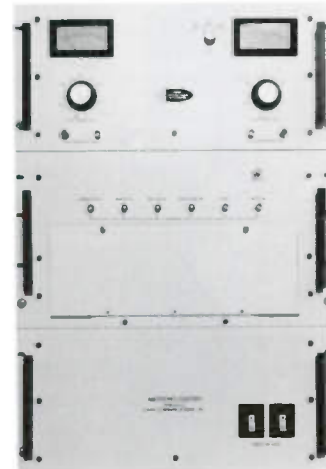

The Kahn/Hazeltine patented AM Stereo System brings the advantages of Stereo transmission to the AM broadcasting industry.

Now, after 20 years of research, the AM Broadcaster may transmit Stereo programs with any conventional AM transmitter. Furthermore, true STEREO reception can be achieved by the use of two standard AM receivers, even inexpensive portables. This type of signal is completely compatible with all types of monophonic receivers and full mono coverage is guaranteed. Broadcasters have reported to the FCC that their stereo coverage equals 100% of their normal mono range.

The Kahn/Hazeltine Stereo has the unique advantage that the public has nothing to buy to be introduced to stereo reception on the widest possible scale prior to listeners purchasing new Stereo receivers.

The Kahn/Hazeltine system causes your two sidebands to be independently modulated by the left and right stereo channels. The resulting wave has essentially the same spectrum occupancy as conventional AM and is theoretically free of envelope distortion.

PRICES UPON APPLICATION

MODULATION SCIENCES



The CP-803 Composite Processor corrects the distortion that conventional processors sometimes create. Conventional audio processors work with the left and right audio. But the CP-803 deals with the stereo composite signal that comes out of the stereo generator.

This baseband signal is made up of the L + R main channel, the 19 kHz pilot and the L-R subcarrier. By working on this signal instead of left and right audio, many audio problems are avoided.

The CP-803 gives you the few dB of loudness with no audible increase in distortion. The amount of free dB's you obtain depends on the pre-processing of the audio before it reaches the unit. The less pre-processing beforehand, the more you get from the CP-803. RACK MOUNT IS EXTRA.

MANUFACTURER'S SUGGESTED LIST PRICE.....\$889.00

ALLIED PRICE \$ _____

BIRD



The first of a new series of dry, forced air cooled high power Load Resistors, model 8572 is a well-matched termination for 50 ohm rigid line systems to 25,000 watts for testing and alignment of transmitters. The RF power is dissipated in a large number of rugged parallel/series connected resistor elements, which not only provide an extensive total surface for heat transfer, but assure that the Load is not rendered inoperative due to the unlikely failure of one or two of the elements.

The outer conductor is designed not only for lower VSWR over a much wider band of frequencies than is typical for this type of termination, but also with advance fluid dynamics for lower operating noise.

Adjustments and tests to transmitting equipment require the measurement of power dissipated in the Load. Because the design of the new model 8572 makes its input connector the coolest part in operation, a Thru-line® Wattmeter can be safely and conveniently bolted right to the termination.

As a dry Load, model 8572 is very nearly maintenance-free, and presents fewer problems, should servicing ever become necessary. The units are repairable in the field. A special option permits ducting hot air away from the Load, and out of your work environment.

PRICES UPON APPLICATION **15KW model now available**

8645

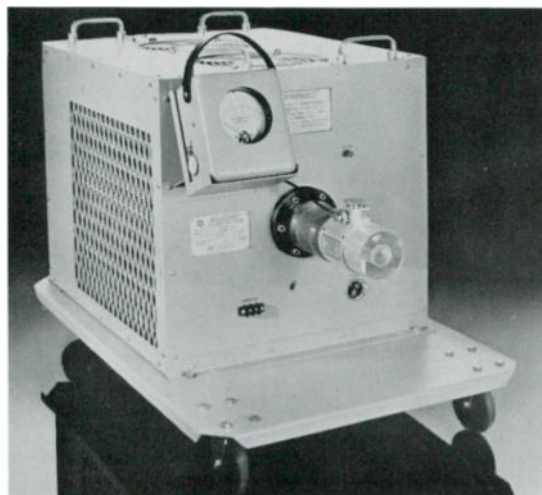

- * Power rating 25 kW continuous duty up to 900 mHz
- * Weight 155 lbs
- * Distilled water or Ethylene Glycol
- * 10 kW and 80 kW in this series plus 2½ to 7 kW dry loads and Econo wet loads up to 80 kW.

PRICES UPON APPLICATION

BIRD ELECTRONICS



Bird Electronics known for accuracy for more than a quarter of a century, offers Thru-line® RF directional watt meters, RF load resistors, up to 80 kW and Watcher® protection systems.

ALLIED CARRIES THE ENTIRE BIRD LINE

ELECTRONIC RESEARCH

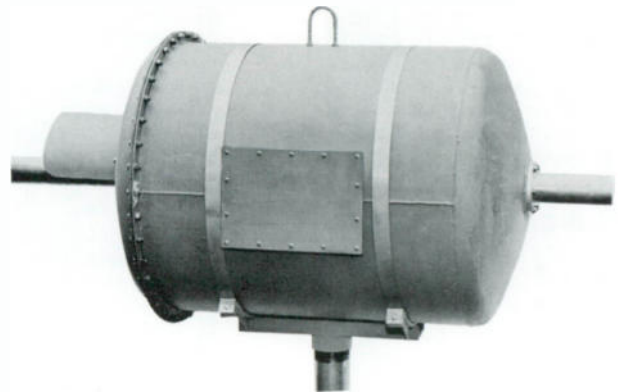

ERI isolation transformers are designed to couple the FM power across the base insulator of a transmitting tower used jointly for AM or FM antennae without introducing objectionable mismatch into the FM feed line.

An isolation transformer is highly desirable for feeding high impedance AM radiators or AM radiators which are part of an AM directional array which might be adversely affected by a "bazooka" isolation system. Captive bullets in and out.

Model	Description	Price	Allied Price \$
403	10 kW, 1 5/8".....	\$2200.00	_____
403A	10 kW, 3 1/8".....	\$2400.00	_____
425	25 kW, 3 1/8".....	\$6133.00	_____
426	40 kW, 3 1/8".....	\$6533.00	_____
427	50 kW, 4 1/8".....	\$8000.00	_____

ERI PRICES ABOVE ARE MFR'S SUGGESTED LIST PRICES. CALL FOR TODAY'S ALLIED PRICE.

"DISCOUNTS ARE AVAILABLE ON MOST EQUIPMENT"

KINTRONICS
FMC SERIES ISOCOUPERS

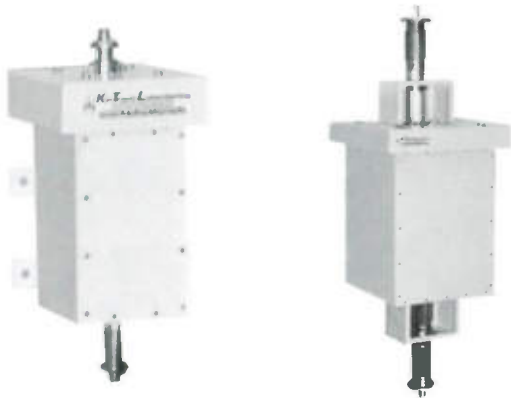

The use of these units at the base of an AM tower permit the installation of an FM antenna and connecting transmission line on the tower without requiring insulation and tuning of the transmission line. Since the shunting capacity of these units across the base insulator of the AM tower is less than 150 pf, the effect on the base input impedance of the tower will be negligible for most single radiators or directional elements. The transmission line may be fastened to the tower for its full length permitting the tower to operate with normal radiation characteristics. Many of these isocouplers are now in service at permanent installations having stereo operation and judged by the user to be of superior quality. 4 units available from 10 watts through 30 kilowatts.

Kintronics also offers sampling and transmission coaxial cables, control circuit cables, copper wire and strap, common point bridge, antenna phase monitors, and remote control and phasing systems.

PRICES UPON APPLICATION

DELTA



C-QUAM AM STEREO Generator/Monitor. Price includes installation and day/night switch.

MANUFACTURER'S SUGGESTED LIST PRICE.....\$11,700

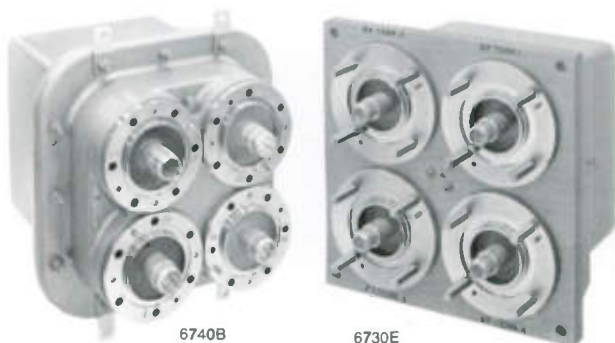

The 6700 series of Coaxial Transfer Switches provides the engineer with the capability to switch between transmitters, antennas, or dummy loads with a minimum of off-the-air time. Both models can

be operated by remote control or manually. Remote operation can be achieved using either 120V or 220/240V, 50/60 Hz. The transfer switch is fully interlocked with two isolated interlock circuits that duplicate the RF path exactly. The 6730/6732E is a 1-5/8 inch switch. The 6740B/6742B is a 3-1/8 inch switch and may be pressurized up to 16 lb./sq. in. A gas barrier is built into each terminal, and an air inlet port is also provided in the 6740B/6742B model.

PRICES UPON APPLICATION

ELECTRO IMPULSE



DPTC 50KFM

DPTC 10KFM

The Electro Impulse product line of loads includes many state-of-the-art designs. They pioneered the development of dry, forced air cooled loads for use up through FM frequencies, which are now extremely popular in the broadcast industry.

Their DACT series of loads was the first dry, convection cooled series with power ratings up to 25 kW average power. Both of these types of loads are very popular as the availability of water for load cooling decreases.

Electro Impulse water cooled coaxial load resistors offer exceptionally low VSWR and have the distinct advantage of a field replaceable resistor element. The CLW series loads are provided with a spare resistor which can be easily replaced in the field.

DC loads for high voltage use can be custom made to your specifications. These loads include built in test circuit, low level sampling outputs and other logic circuits. They contain the equivalent of numerous loads and are liquid cooled.

ELI offers RF coaxial loads with oil dielectric, twin line loads in a balanced input configuration, coaxial water loads, waveguide coaxial water loads, dry baluns, calorimeters, automatic test equipment, high power RF attenuators, RF power meters, in-line directional wattmeters and special cooling systems.

PRICES UPON APPLICATION

**“PRODUCT AND SERVICE
FOR THE INDUSTRY”**

MCI

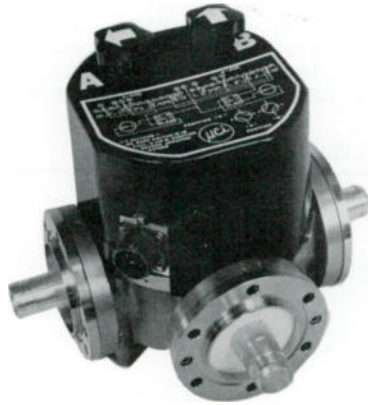

Micro Communications Incorporated offers a wide range of products and services for the broadcast industry. The MCI product line includes complete RF systems, rectangular and circular waveguide transmission line systems, VHF, UHF, LPTV, MDS and ITFS combiners, multi-channel TV and FM combiners, VHF, UHF, LPTV, FM, MDS and ITFS diplexers, filters, directional couplers, loads, hybrids and switching systems.

PRICES UPON APPLICATION

COMARK ANTENNAS

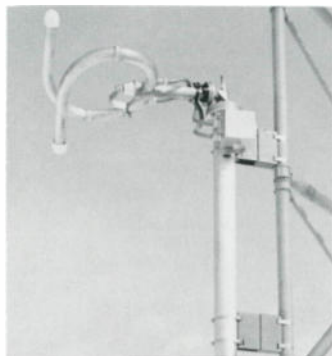

The Comark series of FM circularly polarized antennas utilize identical radiating elements for both the lower power and high power series. The low power series utilizes 1 5/8" feedlines while the high power series uses 3 1/8" feedline. Both series of antennas are available in systems that incorporate 1 to 14 elements. Normally, systems with 8 or less elements are fed at the bottom, while above 8 the system is center fed. This series is basically a 1 1/2 turns helix separated one wavelength apart. The radiation centers of both the vertical and horizontal components are identical, thus the FM antennas are one of the few antennas with the phase coincidence so essential for true circular polarization. De-icers are available.

Comark educational antennas utilize the same basic design as the high and low power models. However, due to their low power requirements, the radiating elements are constructed from a single piece of 7/8" stainless steel tubing. Educational antennas come complete with flexible coaxial interconnect cables and mounting hardware.

PRICES UPON APPLICATION

**"THE FIRST FAMILY OF
BROADCAST EQUIPMENT"**

COMARK ACCESSORIES

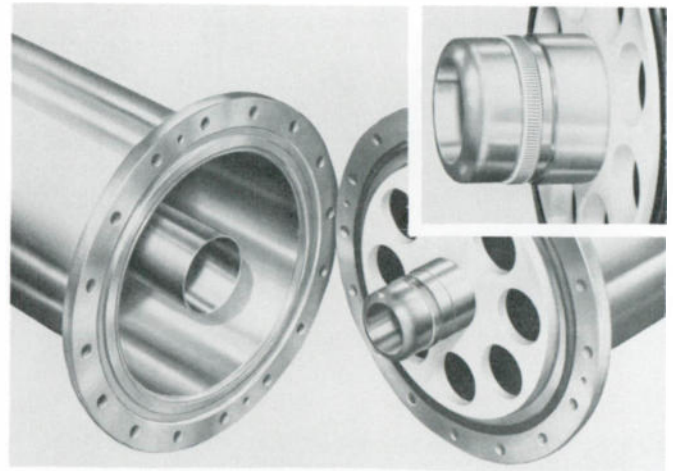

Comark rigid coaxial transmission line provides outstanding features such as constant impedance, high power capacity, and low insertion loss. Sizes to 8 3/16" Heliarc-welded flanges and wrist band bullet construction 3 1/8" and above.

PRICES UPON APPLICATION

PATCH PANELS

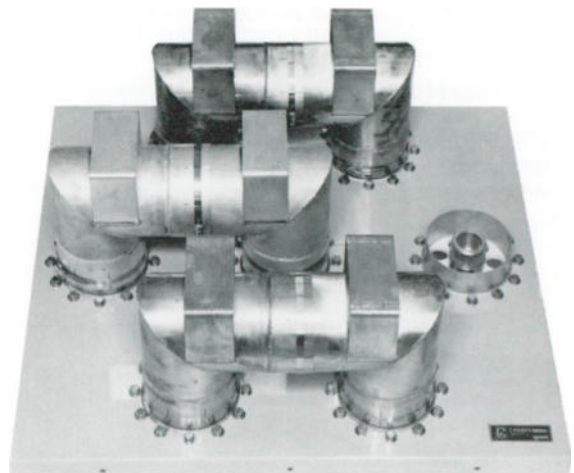

Coaxial patch panels are available in all standard transmission line sizes in three, four, five and seven port standard configurations. The patch link construction allows the patch link to self align with the panel ports for ease of operation.

PRICES UPON APPLICATION

COAXIAL TRANSFER SWITCH



Low VSWR and low insertion loss combined with maximum isolation make Comark coaxial switches the ideal instrument for routing RF, especially in remote control applications. The positive action switching solenoid may be remotely controlled or overridden manually.

PRICES UPON APPLICATION

JAMPRO



Jampro offers the CETEC line of broadcast antennas.

The Cetec JSCP Series B FM broadcast antennas offer rugged construction, low wind loading, excellent performance for stereo, SCA broadcasting, excellent VSWR bandwidth, true circular polarization, and are available with from 1 to 16 bays with de-icers and radomes.

The JBCP series is a circularly polarized FM antenna designed for applications requiring relative insensitivity to icing along with high antenna input power. The JBCP antenna will handle up to 40 kW per bay and up to 120 kW per system depending upon the number of bays, shunt line size and input connector. The JBCP is available with from 1 to 8 bays.

The JLCP series 2 gives the Class A station several good choices. Power rating is 3 kW per bay or maximum 7.5 kW above two bays. Standard or radome cover is provided if needed, at extra cost.

The JLLP series elements are cable fed from a central power divider. They are rated at 1 kW per bay and provided as a standard antenna or with de-icers, at extra cost.

PRICES UPON APPLICATION

CELWAVE



Celwave circularly and horizontally polarized antennas are available with any combination of null fill and beam tilt. The high power and low power antennas utilize identical radiating elements.

The low power series utilizes 1 5/8" feedline, the high power series 3 1/8" feedline.

Both series of antennas are available in systems which incorporate 1 to 16 elements. Normally systems with 8 or less elements are bottom-fed, with 8 or more elements, center-fed. De-icers are available.

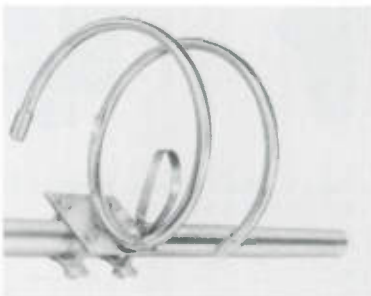

Educational FM antennas differ from the commercial versions in that they are fabricated of 7/8" stainless steel tube and due to lower power requirements are fed with flexible solid dielectric cables.

PRICES UPON APPLICATION

TUNERS

NAD 4020A



A sensitive, low distortion, high performance AM-FM tuner with a minimum of frills. In real use conditions the 4020A equals the performance of many tuners costing two or three times more.

- * 1.8 microvolt (10.3dBf) IHF sensitivity
- * 50 dB quieting sensitivity: 16 dBf mono, 38.3 dBf stereo
- * 70 dB S/N ratio in stereo, 75 dB in mono
- * Selectivity 62 dB, alternate channel
- * Dual-gate MOSFET front end, phase-locked loop multiplex decoder

decoder

RACK MOUNTS EXTRA & ARE LESS HANDLES

MANUFACTURER'S SUGGESTED LIST PRICE..... \$178.00

ALLIED PRICE \$ _____

PROTON



The RADIO from Proton is unlike any other radio in history! What other radio has two amplifiers, one for treble, one for bass? To achieve uncompromising fidelity with plenty of power the RADIO employs two separate amplifiers with a total of 25 watts. Such bi-amplification is an unusual feature even in large audio systems, let alone a monitor.

The FM tuner section offers 1 uv sensitivity, greater than 40 dB separation, 1 dB capture ratio, greater than 60 dB selectivity, 80 dB mono, 77 dB stereo signal to noise ratio, THD less than .1% mono/.15% stereo, greater than 60 dB of AM suppression, JFET RF amplification, digital tuning display and PLL tuning.

The AM tuner section features 250 uv sensitivity, 30 dB of selectivity, PLL tuning, and digital tuning display.

The RADIO from Proton, a cut above the rest at a down to earth price. RACK MOUNTS ARE EXTRA.

MANUFACTURER'S SUGGESTED LIST PRICE..... \$280.00

ALLIED PRICE \$ _____

**“PROFESSIONAL PEOPLE,
SALES, SERVICE
& PRODUCT”**

CROWN

FM THREE



The Crown FM Three uses a true digital detector section tuner which cannot go out of alignment, drift with age, or add mis-tuning distortion; thus providing outstanding performance in the AM and FM bands. It also incorporates a new Dual-Quartz system for improved signal-to-noise ratio, a toroidal transformer for reduced hum and noise, a "scan level" control for tuner strength prior to scan stop and look. Also includes six each AM and FM presets, a multipath indicator and a calibrated signal-strength indicator.

MFG'S SUGGESTED LIST PRICE (less cabinet).....\$795.00

ALLIED PRICE \$ _____

TURNTABLES

KEITH MONKS

MKII PROFESSIONAL



The Record Cleaning Machine is a tried and tested product which is used by broadcasting authorities and record libraries all over the world.

It is only advisable to clean a record with the Keith Monks record cleaning machine every 15 — 20 playings.

Records are cleaned using a mixture of 50% distilled water and 50% industrial methylated spirits which will remove grease, hardened sludge and loosen embedded grit. The drying process removes all traces of the cleaning liquid along with the foreign material leaving the record clean and dry.

During the process, the turntable revolves at speed and the liquid solvent is applied by swinging the brush over the record and depressing the applicator plunger. Having thus wetted the record, dissolved the grease and loosened any embedded material, the suction arm is simply moved to the centre of the record. As the liq-

uid on the record is moving to the edge, it is advisable to vacuum from the centre outwards rather than inwards. As it passes over the surface the suction removes all liquid along with the suspended foreign matter. The whole process can be completed in about 1½ minutes per side of record.

SPECIFICATIONS:

SIZE: 16½" x 19" x 18"

NET WEIGHT: 65 lbs

MFGR'S SUGGESTED LIST PRICE.....\$1295.00

MARK 3 PROFESSIONAL



Double Deck Version

The Studio Mark 3 double record cleaning machine is designed for the user with regular cleaning of quantities of records. The twin decks enable one record to be cleaned while the other is being dried. Records can be cleaned twice as quickly with the double machine.

There are 2 applicators and cleaning brushes and the suction arm is switched to operate on either turntable.

The arm reverse switch has 3 positions, the center is in the off position, the left side operates the left turntable while the right side operates the right turntable. Larger versions are made to special order.

SIZE: Height 14¼"; Width 29¼"; Depth 18¾"

NET WEIGHT: 96 lbs

VOLTAGE: 115 volts A.C. 60 cycles

MFGR'S SUGGESTED LIST PRICE.....\$1781.00

DISCWASHER



Some of the standard products for record care in broadcast facilities is the DISCWASHER line.

Model	Description	
Cleaning system.....		\$16.50
Disckit.....		\$55.00
ZeroStat	Destaticizer.....	\$23.00
Fluid	16 oz.....	\$17.00
	6 oz.....	\$10.00
	1.25 oz.....	\$2.50

TURNTABLES

TECHNICS

SP-15



- * Setting high standards for professional performance and flexibility.
- * Quartz Synthesizer Pitch Control in 0.1% steps up to $\pm 9.9\%$ at all three standard speeds-with digital display
- * Instant starts (0.4 sec.) (About $\frac{1}{3}$ revolution)
- * Heavy duty construction stands up to long term professional use
- * Three precision speeds, 33 $\frac{1}{3}$, 45 and 78.26 rpm make this unit perfect for all phono reproduction applications.

MANUFACTURER'S SUGGESTED LIST PRICE.....\$700.00

ALLIED PRICE \$ _____

SP-25



The SP-25 offers you a high professional standard of excellence, plus the kind of flexibility and convenience that is important for any use. Features include total quartz-locked pitch control within $\pm 6\%$ range from rated speeds, full cycle detection FG, extremely high torque for fast starts and load stability, large turntable platter with extra-high moment of inertia, electronic braking system, integral rotor/platter motor construction, and high effective damping.

- * 45 and 33 rpm
- * about $\frac{1}{2}$ revolution to full speed

MANUFACTURER'S SUGGESTED LIST PRICE.....\$400.00

ALLIED PRICE \$ _____

SP10-MK II



The first with instant torque and no rumble. The world's best and most desired professional turntable. Used by 80 of the 100 top U.S. Radio Stations.

MANUFACTURER'S SUGGESTED LIST PRICE.....\$1100.00

ALLIED PRICE \$ _____

SP10-MK III



The SP-10 MK III is the most advanced quartz synthesizer DD turntable from Technics, the acknowledged hi-fi turntable leader. Both specifications and sound quality reveal that the SP-10 MK III extends the frontiers of excellence. For example, starting torque is 16 kg/cm and only one quarter of a second is required to reach rated speed. Moment of inertia is 1.1 ton/cm, wow and flutter is 0.15% WRMS, rumble is -92 dB (DIN-B), and quartz locked pitch is adjustable in 0.1% step increments or decrements up to $\pm 9.9\%$. For serious professionals, this is the turntable by which all the others must be judged.

A separate control unit houses the power supply and all circuitry except the motor itself, thereby assuring more reliable operation with freedom from noise. On the smoked acrylic front panel are high visibility LED displays (speed and pitch setting) as well as the on/off switch and soft touch switches for speed selection and pitch control (with tactile switch feel). Start/stop and speed selector switches are provided on the turntable itself as well.

MANUFACTURER'S SUGGESTED LIST PRICE.....\$1700.00

ALLIED PRICE \$ _____

ADC PRO-PATCH/ULTRA-PATCH



ADC's new Pro-Patch jackfield is truly state-of-the-art. Incorporating the split cylinder contacts. Pro-Patch units are reusable and especially suited for remotes, special broadcasts and advance builds. With the ability to change circuits and normalizing configurations in seconds. Pro-Patch jackfields provide the ultimate in time and labor savings, flexibility, and ease of installation and maintenance.

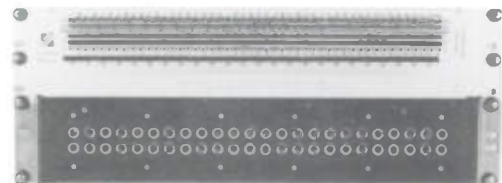

Ultra-Patch panels, another innovative product utilizing ADC's split cylinder technology, were designed to provide yet another set of options for audio patching and interconnect requirements.

Ultra-Patch panels can be terminated at the factory to any of ADC's standard or custom jackfields and may be rack or wall mounted. Accessory brackets are available for racks with nonadjusting rear supports as well as for wall mount applications. Cable troughs, front and rear, provide for a clean and professional look for any system. Ultra-Patch panels are available separately.

PRICES UPON APPLICATION

SONY



The CDP-3000/CDS-3000 is a modular professional compact disc player system with unsurpassed quality music which is brought to life with stunning clarity and realism. It allows instant and programmed play with the extra convenience of controlling two CDP-3000 players. The control unit is independent of the player(s) — only a single cable is required for control interface. All controls and indications, except the eject button, are functionally arranged on the desk-top control unit. The player(s) is exceptionally compact. Its front loading design permits mounting of two units side by side in a standard 19" rack. It features 10-key direct access and bi-directional search, programmed play, flexible monitoring, digital time display, remote start/stop.

MANUFACTURER'S SUGGESTED LIST PRICE.....\$5400.00

ALLIED PRICE \$ _____

RUSSCO STUDIO PRO



- * Unit is powered by a heavy duty Bodine synchronous motor
- * 2 speeds 45 and 33 rpm

MANUFACTURER'S SUGGESTED LIST PRICE.....\$479.00

ALLIED PRICE \$ _____

CUE MASTER



- * The unit is powered by a heavy duty Bodine synchronous motor.

MANUFACTURER'S SUGGESTED LIST PRICE.....\$425.00

ALLIED PRICE \$ _____

MARK V



The Russco Mark V offers precision variable $\pm 10\%$ at 33 or 45 rpm. The Mark V is instant starting, less than one inch back cue required at 45 rpm. There's more good news...remote start and stop and digital speed readout.

This dandy RUSSCO RUGGED low profile turntable also features an attractive antique silver no mar finish that makes the studio deluxe.

MANUFACTURER'S SUGGESTED LIST PRICE.....\$756.00

ALLIED PRICE \$ _____

RTQ-7



The new RUSSCO direct drive turntable is equipped with a unique magnetic induction braking system which disengages automatically after bringing the platter to a stop. Speed controls use quartz synthesized PLL techniques. All controls are on a slanting front panel within view of the operator.

FEATURES:

- * Direct drive turntable
- * Outer rotor AC motor, amplitude modulated with PLL servo circuit
- * Turntable platter moment of inertia is 79.6 pounds
- * 3 pounds starting torque
- * .1909 seconds start up time at 33 1/3 rpm, .2581 seconds at 45 rpm
- * .025% WRMS wow and flutter
- * -70 dB (DIN 455398) rumble

MANUFACTURER'S SUGGESTED LIST PRICE.....\$850.00

ALLIED PRICE \$ _____

**"ENTIRE CONTENTS COPYRIGHT
ALLIED BROADCAST
EQUIPMENT, INC."**

TURNTABLES

RUSSCO RTA-12 TONE ARM

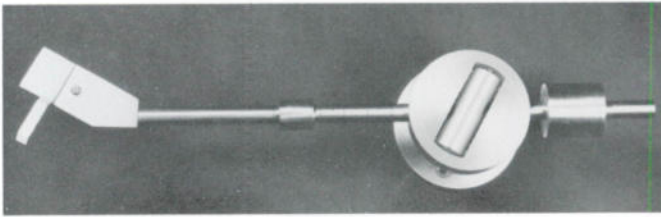

- * Rugged aluminum and chromed brass construction
- * Length: 13"
- * 5 grams maximum tracking force
- * 1 gram minimum tracking force
- * less than 2 degrees tracking error
- * Range of height adjustment is 1.8"
- * Mounting flange diameter: 2.74"
- * Mounting hole diameter: 7/8"
- * Distance from arm pivot point to turntable spindle: 8.31"
- * 4" overhang from pivot to rear
- * Cable capacity: 135 pf
- * Shipping weight 3 lb.

MANUFACTURER'S SUGGESTED LIST PRICE.....\$199.00

ALLIED PRICE \$ _____

FP SERIES TURNTABLE PREAMPS

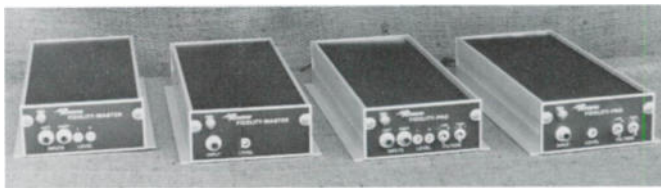

Mono or stereo versions available with balanced or unbalanced output. The FIDELITY-MASTER series offers RIAA equalization. The FIDELITY-PRO units feature switchable high and low frequency filters. The balanced output models include highest quality transformers for true line isolation.

Model	Description
FPMU	mono unbalanced 600 ohm output.....\$172.00
	ALLIED PRICE \$ _____
FPMB	mono balanced 600 ohm output.....\$205.00
	ALLIED PRICE \$ _____
FPSU	stereo unbalanced 600 ohm output.....\$257.00
	ALLIED PRICE \$ _____
FPSB	stereo balanced 600 ohm output.....\$309.00
	ALLIED PRICE \$ _____

RUSSCO PRICES ABOVE ARE MFG'R'S SUGGESTED LIST PRICES.
CALL FOR TODAY'S ALLIED PRICE.

PHONO MATE TURNTABLE PREAMPS

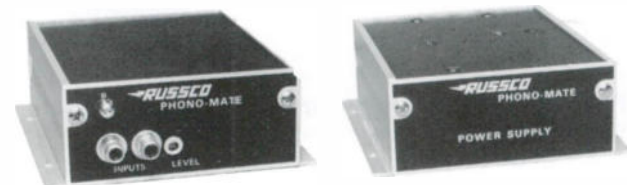

Consider these value-packed features of the PHONO-MATE Pre-Amps:

- * Full solid-state circuitry

- * Lots of headroom at +16 dBm
- * RIAA equalization
- * Mono or stereo versions are available with balanced or unbalanced output
- * The balanced output models include highest quality transformers for true line isolation

Model	Description
1U	unbalanced mono 600 ohm output.....\$96.00
	ALLIED PRICE \$ _____
1B	balanced mono 600 ohm output.....\$113.00
	ALLIED PRICE \$ _____
2U	unbalanced stereo 600 ohm output.....\$148.00
	ALLIED PRICE \$ _____
2B	balanced stereo 600 ohm output.....\$177.00
	ALLIED PRICE \$ _____
PS	external power supply.....\$68.00
	ALLIED PRICE \$ _____

RUSSCO PRICES ABOVE ARE MFG'R'S SUGGESTED LIST PRICES.
CALL FOR TODAY'S ALLIED PRICE.

REVOX B225



In designing the B225 CD-Player, REVOX has clearly demonstrated the development and production experience which has made the company world famous as audio specialists.

Almost every conceivable feature has been realized by REVOX: professional programming capacity with 19 program steps, extremely short cueing times, calibration tone for adjustment of system levels, adjustable headphones output and two audio outputs. The "oversampling" technique developed in Europe, eliminates distortion of frequencies above half of the sampling rate without affecting phase relationship and guaranteeing highest sound resolution.

MANUFACTURER'S SUGGESTED LIST PRICE.....\$1150.00

ALLIED PRICE \$ _____

APT-HOLMAN P2



Apt has successfully created the P-2 pre-amplifier as a modest priced unit, combined with practical and simple controls, making it the logical choice for audiophiles and music lovers for long-term value. It contains current state-of-the-art circuitry technology plus features such as quiet moving coil, dedicated phono balance, "digital-ready" dynamic range, precise infrasonic filtering, stepped volume control, stereo image control & tone control, full-mute switch. RIAA equalization accuracy of ± 0.2 dB. Optional rack mounts are available.

MANUFACTURER'S SUGGESTED LIST.....\$450.00

ALLIED PRICE \$ _____

HENRY
REMOTE CONTROL INTERFACE



The universal turntable controller (UTC) by HENRY is a remote control interface device that allows full remote control of popular direct-drive turntables, such as Technics SP10, SP15, and the new Russco RT-700. The UTC easily connects to the turntable with just three wires, and provides CMOS/contact closure compatible outputs for separate START and STOP switches plus RUN and STOP tally lamps. The turntables own start/stop switch can still be used for cueing records, and the UTC always stays in SYNC with the turntable. One UTC will control two turntables.

MANUFACTURER'S SUGGESTED LIST PRICE.....\$195.00

ALLIED PRICE \$ _____

BROADCAST ELECTRONICS
12C-U



The QRK 12C is a three speed, rugged, reliable turntable which can come up to speed in a fraction of a second, but can still operate free from rumble, wow and flutter.

Outer rim drive has been demonstrated by QRK in over 34 years of usage as the best method for achieving "instant start" with a minimum of vibration effects. Center hub drive does not have the mechanical advantage of outer rim drive, it requires substantial motor with attendant isolation problems. ALLIED CARRIES THE ENTIRE BROADCAST ELECTRONICS LINE.

MANUFACTURER'S SUGGESTED LIST PRICE.....\$350.00

ALLIED PRICE \$ _____

S-320 TONE ARM



This attractive tone arm is constructed of tubular aluminum with a die-cast cartridge shell, that accepts all standard stereo or mono cartridges. It has a vertical height adjustment and friction-free chrome steel ball vertical movement. It tracks at 1 gram or less and includes a counterweight. Connects with standard plugs.

MANUFACTURER'S SUGGESTED LIST PRICE.....\$150.00

ALLIED PRICE \$ _____

MICROTRAK
303 TONE ARM

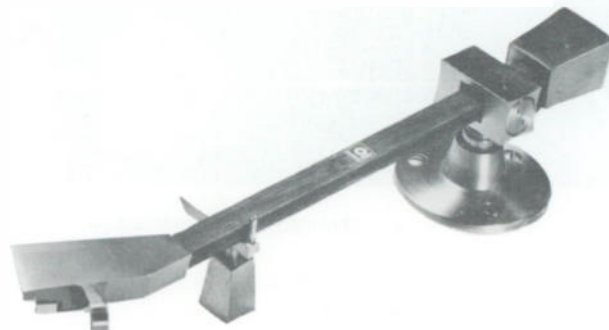

This tone arm features modern styling, plug-in memory balance head; laminated wood and epoxy body make for rugged, lightweight construction. Stylus force once set is tamper proof, and adjusted by counter-weight. A standard of the industry.

MANUFACTURER'S SUGGESTED LIST PRICE.....\$129.50

ALLIED PRICE \$ _____

ST-11



The ST-11 Pro-eminece phono pre-amp by Micro-Track is a super high performance unit. It is RFI resistant for use in AM, FM or TV. It is very compact and designed to match a 47K ohm magnetic stereo phono cartridge. Provision for a nominal 0 dBm output with headroom to a max. of +22 dBm. Distortion is .05 or less, THD and IM. The signal to noise ratio is -72 dB or better, also has a jumper selectable rumble filter internally.

MANUFACTURER'S SUGGESTED LIST PRICE.....\$169.50

ALLIED PRICE \$ _____

AUDIO TECHNICA
ATP-12T



- * Fits wide range of turntable heights and base thicknesses
- * Sealed horizontal and vertical ball bearing pivots
- * Accurate, built-in VTF gauge, no accessory gauge needed
- * Low resistance, anti-corrosion, gold plated connector throughout

MANUFACTURER'S SUGGESTED LIST PRICE.....\$175.00

ALLIED PRICE \$ _____

TURNTABLES

AUDIO TECHNICA

AT-1010



The AT-1010 tone arm is a radically different approach to inherent problems of conventional tone arms. Emphasis was placed on tracking performance as opposed to bearing sensitivity and total tonearm mass. As a result, the arm is ideal for broadcast application, where it's important to keep the stylus in contact with the record without adding stylus pressure above manufacturer's recommended tracking force.

The design of the AT-1010 arm enables the stylus to maintain stable tracking no matter how great the amplitude of the modulated groove of a record.

A plus with this arm is the ease of adjustment after the arm has been set up.

MANUFACTURER'S SUGGESTED LIST PRICE.....\$375.00

ALLIED PRICE \$ _____

AUDIOMETRICS

S-220



The stylish, practical and economical professional S-220 tonearm has a light alloy arm, with low mass cartridge shell and precision ball bearing rotation. Also has adjustable lateral balance and weight adjustment for tracking force. Arm height is adjustable from 1 9/16" to 2 3/8" and removable cartridge shell uses standard 4 pin connector. Stylus pressure adjustable from 1 to 6 grams depending on cartridge. Tracking error is rated at +4°, -1°.

MANUFACTURER'S SUGGESTED LIST PRICE.....\$99.00

ALLIED PRICE \$ _____

STANTON

500 MK II



The 500 MK II series of cartridges comes in three variations, primarily differing in grams of tracking force. Its design is to deliver superb sound quality, ruggedness and reliability, yet not compromise professional broadcast standards.

Model	Description	Price
500EE MKII	.75 to 1.5 grams, elliptical.....	\$21.25
		ALLIED PRICE \$ _____
500E MKII	1 to 2 grams, elliptical.....	\$18.38
		ALLIED PRICE \$ _____
500A MKII	1 to 2 grams, spherical.....	\$15.75
		ALLIED PRICE \$ _____

600A



In all broadcast usages, the 600A is applicable to those situations that demand a spherical stylus tip, and a cartridge that tracks at 2 to 4 grams. It has been successfully employed by many hundreds of radio stations for on-the-air usage, and it performs with great excellence and dependability. It possesses outstanding frequency response, and channel separation easily surpasses the requirements of most broadcast standards.

MANUFACTURER'S SUGGESTED LIST PRICE.....\$24.20

ALLIED PRICE \$ _____

681A



This cartridge is indispensable for the recording engineer as a calibration standard for recording system checkout. Features extreme linearity plus widest and flattest possible response essential for precise alignment of cutting heads. Its factory calibrated frequency response meets the most rigid tolerances. Built-in longhair brush keeps dust away from stylus, protects record grooves and reduces noise, all without affecting stylus force.

MANUFACTURER'S SUGGESTED LIST PRICE.....\$55.00

ALLIED PRICE \$ _____

STANTON

310

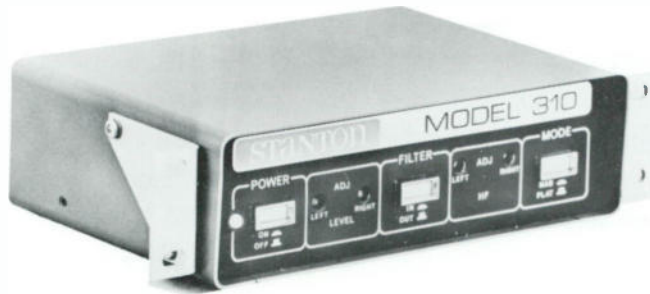

The Stanton Model 310 professional phono preamplifier-equalizer was designed to correctly interface all Stanton and selected magnetic phonograph cartridges for optimum playback of disc records and calibration of audio systems.

The Stanton 310 preamp features universal mounting by special brackets, instant selection of flat or NAB postemphasis curves, switchable effective rumble filter, individual adjustment of gains and high frequency responses, trimming of the capacitive cartridge loading at the input, provision for setting the power transformer for either 117 or 230 VAC 50/60 Hz operation and immunity to external magnetic AC fields. ALLIED CARRIES THE ENTIRE STANTON LINE.

MANUFACTURER'S SUGGESTED LIST PRICE.....\$190.00

ALLIED PRICE \$ _____

STANTON PRICES ABOVE ARE MFR'S SUGGESTED LIST PRICES. CALL FOR TODAY'S ALLIED PRICE.

SHURE

SC35C



The SC35C is designed for use on the heaviest and most rugged tone arms which require a tracking force of 4 to 5 grams. The stylus assembly of the SC35C is rigid enough to withstand the punishment of continuous backcueing, yet compliant enough to offer excellent mid and high frequency reproduction. The SC35C is the spherical replacement stylus for this cartridge.

MANUFACTURER'S SUGGESTED LIST PRICE.....\$45.00

ALLIED PRICE \$ _____

SC39B

Up to now, it was necessary to compromise true hi-fi performance to get the ruggedness required for professional use. To identify precisely the use and abuse to which professional phono cartridges were subjected in actual work situations, Shure engineers went into the field where they virtually "lived with" the professionals. They sat up with the all-night man in broadcast stations, worked in recording labs and shared the booth in "Discos". ALLIED CARRIES THE ENTIRE SHURE LINE.

- * Built to stand up to professional use
- * Designed to stand up to a professional's critical listening

Model	Description
SC39B	1.5 to 3 grams, spherical.....\$62.50
	ALLIED PRICE \$ _____

SC39ED .75 to 1.5 grams, biradial....\$80.00

ALLIED PRICE \$ _____

SC39EJ 1.5 to 3 grams, biradial.....\$70.00

ALLIED PRICE \$ _____

V-15 TYPE V

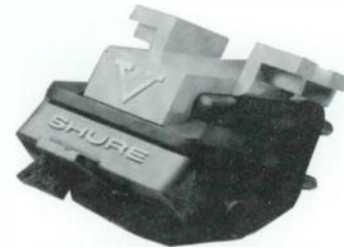

The Shure V-15 Type V cartridge comes in three styles, the MR (micro ridge) model, the 15B and 15P. The micro ridge version is radically different from the hyperelliptical tips (which generally reduce harmonic distortion dramatically), and geometrically is longer and more pointed, therefore running deeper in the LP groove. It's said to reduce harmonic distortion by another 50% over equivalent hyperelliptical styli in the line. There's a de-staticizer and damping mechanism which reduces low frequency resonance and susceptibility to warp in LP's.

The "B" version is the same V-15 without the "MR" refinement. You might think of it as the original with the destaticizer brush. The "P" version is a P-mount V-15, for mounting on P-mount arms and does not include the destaticizer and damping mechanism.

Model	Description	
V15 V-B	Hyperelliptical.....\$220.00	ALLIED PRICE \$ _____
V15 V-MR	Micro ridge.....\$275.00	ALLIED PRICE \$ _____
V15 V-P	Hyperelliptical.....\$205.00	ALLIED PRICE \$ _____

SHURE PRICES ABOVE ARE MFR'S SUGGESTED LIST PRICES. CALL FOR TODAY'S ALLIED PRICE.

AUDIOMETRICS

TP-84



The Audiometrics TP-84 is a proven, high quality stereo turntable preamplifier which will provide many years of dependable service because it meets the specification requirements demanded by broadcasters worldwide. The TP-84 follows the RIAA curve to within 1 dB in its entire bandwidth while maintaining a signal to noise level of 70 dBm. Distortion figures of .08% make the TP-84 transparent to your turntable cartridge.

MANUFACTURER'S SUGGESTED LIST PRICE.....\$270.00

ALLIED PRICE \$ _____

**"OUR SUCCESS IS IN SERVING —
JUST NOT SELLING!"**

**RTS
405**



The Model 405 is a high-quality two-channel phono preamplifier designed for professional applications, including disc mastering rooms, broadcast stations and high quality commercial installations. It features adjustable cartridge termination, switchable rumble filter, two selectable sets of level controls and two output formats.

FREQUENCY REPOSE: Re RIAA ± 0.5 dB
 SIGNAL/NOISE RATIO: -72 dB
 TOTAL HARMONIC DISTORTION: -90 dB/0.003%
 MAXIMUM OUTPUT LEVEL, BALANCED: +24 dBm

MANUFACTURER'S SUGGESTED LIST PRICE.....\$416.00

ALLIED PRICE \$ _____

STRAIGHT WIRE AUDIO

PH-2B CARD

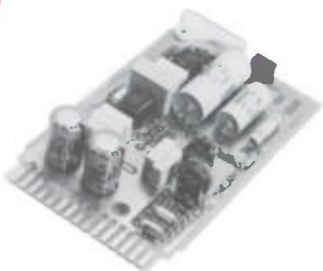

The PH-2 phono preamp is being compared to the best sounding tube-type preamps. Its unique balanced front end operates without negative feedback. This virtually eliminates TIM. The balanced input stage eliminates hum and RF from phono inputs. It has variable cartridge loading and a fully buffered passive precision e.q. network. The output level is adjustable from a -5 dBm to a +12 dBm with an output clipping level of +22 dBm into 600 ohms or +28 dBm into a bridging input. A conductive plastic trimpot, custom made for SWA, adjusts the gain of the output stage. The proper RIAA curve is rigidly maintained by 0.1% custom-made odd value resistors and 1% tolerance polystyrene capacitors. There are parallel padding capacitors which allow you to use any moving magnet cartridge. The modular circuit board fits standard 15 pin double sided edge connectors. Optional housing required.

MANUFACTURER'S SUGGESTED LIST PRICE.....\$110.00

ALLIED PRICE \$ _____

MTX-2

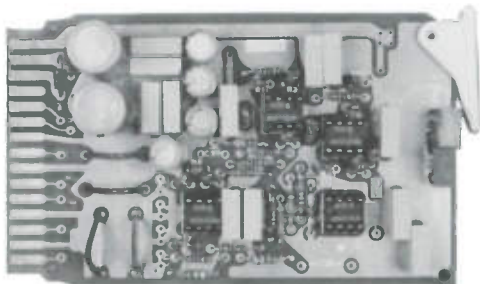

The MTX-2 allows you to optimize FM stereo coverage without smashing the audio. The reason heavy audio processing improves coverage is because of its effect in stereo. Stereo FM's coverage is sensitive to processing because the L-R signal is an AM suppressed carrier, double side band signal which makes the receiver sensitive to AM noise. Just turning on the stereo generator

degrades the signal to noise ratio in the grade A contour by 23 dB. A heavily processed one with composite clipping might see an L-R level of 30-35%. You will also get improved STL performance and reliability, both land line and dual microwave—never lose a full mono signal with one link down. The modulator circuit board fits standard 15 pin double sided edge connectors.

MANUFACTURER'S SUGGESTED LIST PRICE.....\$579.00

ALLIED PRICE \$ _____

UA-2

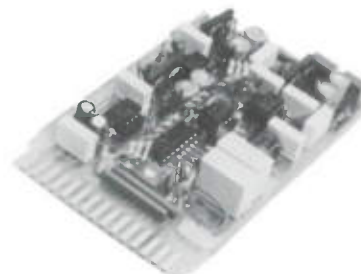

The UA-2 consists of two independent amplifiers on a single card, a balanced input and a balanced output stage. Each circuit card provides space and wiring accommodations for input pads and terminations, including a center tap pair of resistors that can be used for phantom power or true balanced to ground operation. The input stage has a balanced bridging input with 90 dB of common mode rejection and an unbalanced output which has a maximum output power of 250 mW into a 10 ohm load. The input stage also has differential summing points brought to the edge connector which can be used for external gain control or mixing balanced signals.

The other half of the UA-2 card, the output stage, has a high impedance unbalanced input and a zero impedance summing point input available which can also be used as an external gain control. The outputs are differential drivers which can feed a 10 ohm load with 500 mW in the balanced bridged mode. There are eight 600 ohm outputs on the card which are source isolated from each other by 80 dB and are therefore essentially independent feeds. This arrangement can feed balanced and unbalanced loads simultaneously with a maximum of sixty 600 ohm terminations on the bus.

Each stage has an independent gain control adjustment available at the front end of the card. SWA uses sealed, long lasting conductive plastic reverse log trim pots. Typical THD is less than 0.0015%, IMD below 0.003%, S/N Ratio at Unity Gain is better than 90 dB with more than 20 dB of headroom. Optional housing required.

MANUFACTURER'S SUGGESTED LIST PRICE.....\$199.00

ALLIED PRICE \$ _____

RP/3D

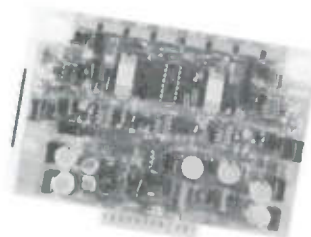

The SWA 3D/RP Retrofit Card is the result of a 2-year effort to advance the art of tape playback sonics. The excellent mechanical quality and reliability of the ITC 3D and RP series machines is now complemented by the SWA 3D/RP Amplifier. These machines should, with proper maintenance, provide another 20 years or more of service. The SP machines can even be run at 15 IPS by replacing the motor with one from a 750 reel-to-reel deck which has the same size and motor mounting template. But the original program amplifier board is an early classic transistor textbook AC coupled design. Until now, the only way to remedy this problem was to buy a new machine, which left a mechanically excellent item sitting on the shelf.

MANUFACTURER'S SUGGESTED LIST PRICE.....\$299.00 Stereo
 \$175.00 Mono

ALLIED PRICE \$ _____

ATI
P-1000 SERIES PHONO AMPLIFIERS



P-1000-1 Dual/Stereo Transformer Outputs
 P-1000-2 Dual/Stereo Balanced Differential Outputs
 P-1000-3 Dual/Stereo Single Ended (Unbalanced) Outputs
OUTPUT CLIPPING LEVEL:
 +22dBm/600 ohms (P-1000-1,3)
 +26dBm/600 ohms (P-1000-2)
DISTORTION at +20 dBm output: .2%
SIGNAL TO NOISE RATIO Unweighted, ref. 10mVrms 1kHz input:
 80dB, 20kHz bandwidth
FREQUENCY RESPONSE: RIAA Curve ± 25 dB, 30 to 20,000Hz
SIZE: 8½"Wx1¼"Hx7"D, 2½ lbs.
MOUNTING: Brackets supplied for internal turntable cabinet or desk top mounting. Single and dual rack mount kits available.

Model	Description	Price
P1000-1	transformer outputs.....	\$345.00
		ALLIED PRICE \$ _____
P1000-2	balanced differential outputs.....	\$345.00
		ALLIED PRICE \$ _____
P1000-3	unbalanced outputs.....	\$325.00
		ALLIED PRICE \$ _____

ATI PRICES ABOVE ARE MFGR'S SUGGESTED LIST PRICES. CALL FOR TODAY'S ALLIED PRICE.

ENCORE PREAMP

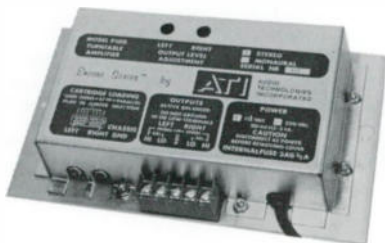

- * Input impedance: programmable 50 k to 100 k ohms, 50 to 400 pf in 50 pf steps
- * Input level: 5 mV nominal for +4 dBm output, 250 mVRMS maximum at 1 kHz
- * Noise: S/N 80 dB minimum unweighted, 90 dB "A" weighted, ref. 10 mVRMS at 1 kHz, 600 ohm input termination and 20 kHz measurement band
- * Output level: +18 dBm into 600 ohm balanced or unbalanced loads. 10VRMS into high impedance loads
- * Output impedance: 400 ohms balanced, 200 ohms single ended, split and RF bypassed.

Model	Description	Price
P100M	+18 dBm active balanced mono.....	\$199.00
		ALLIED PRICE \$ _____
P100S	+18 dBm active balanced stereo.....	\$219.00
		ALLIED PRICE \$ _____

ALLIED RADIO BASE



A table top turntable base that will accommodate all the popular turntable/toner combinations. Comes in standard walnut or black laminate. Special laminates are available at extra cost. (Turntable & tone arm not included.)

MANUFACTURER'S SUGGESTED LIST PRICE.....\$125.00

EMT



The EMT 938 is a complete turntable system intended for professional applications, consisting of a direct drive turntable, and especially developed shock/insulation mount, the EMT 929 high performance tone arm and built-in equalizer amplifiers for line level audio output.

The direct driven turntable platter accelerates to operating speed in under ½ second, thus enabling the rapid starts so necessary for broadcast programming. Like all EMT turntables, the 938 audio output is muted during this quick startup to allow accurate cueing in the middle of program material.

Fixed speeds of 33½, 45 and 78 rpm are referenced to an internal quartz oscillator. Variable speed is available through an optional potentiometer, via rear panel connections. These connections also allow start/stop and remote stereo/mono output switching.

Wow and flutter at 33½, weighted per DIN 45507 is a maximum of $\pm 0.075\%$. Rumble, weighted per DIN 45539 is a minimum of 70 dB. The EMT 938 motor drive circuitry and audio amplifiers are built into the turntable base and swivel out for easy servicing.

Audio out is +4 dBm nominal into 200 ohms with a maximum output capability of +21 dBm. Model 948 is also available. Both models are available with a 47K ohm input for magnetic cartridges or low impedance version with active input transformer for moving coil cartridges.

Model	Description	Price
938/47K	47K ohm Input.....	\$2550.00
		ALLIED PRICE \$ _____
938	moving coll input.....	\$2535.00
		ALLIED PRICE \$ _____
948/47K	47K ohm Input.....	\$3810.00
		ALLIED PRICE \$ _____
948	moving coll input.....	\$3835.00
		ALLIED PRICE \$ _____

EMT PRICES ABOVE ARE MFGR'S SUGGESTED LIST PRICES. CALL FOR TODAY'S ALLIED PRICE.

SI-TEX CR-1011



The new CR-1011 Color Weather Radar displays absolutely brilliant color pictures of weather intensity that conventional radars can't touch—frontal systems, severe weather and just plain rain or snow.

The cathode ray tube presents weather in six different colors, based on intensity of return echoes. On a television type screen. With more brightness, crispness, definition and clarity than most color televisions.

There are eight selectable range scales, from 64 nautical miles out, down to a half-mile from your station. A unique plotting feature can establish the history of a weather system so station personnel can easily track direction and speed. And alert listeners accordingly.

An audible alarm warns of strong systems entering pre-established guard zones, which can be as far away as 64 nautical miles or any lesser distance desired.

Transceiver and antenna drive are both housed in the antenna assembly. Antenna operates in relative winds up to 80 knots.

A remote color monitor (CRM-1) is available to provide an additional radar screen for remote positioning up to 65 feet from primary CR-1011 radar.

MANUFACTURER'S SUGGESTED LIST PRICE.....\$7999.00

ALLIED PRICE \$ _____

GORMAN REDLICH



Take advantage of the expanding network of National Weather Service VHF weather stations. This sensitive, selective (and reasonably priced) receiver can bring you accurate local weather, national weather, weather radar data, emergency alert messages, plus farming and marine information where applicable. Its capability for unattended recording of emergency alert messages and update forecasts can save time and money. Rebroadcast is FCC authorized.

Receiver is rack mountable, remotable, with an attractive black anodized panel. Demuting and remote alarm are initiated by 1050 Hz "Alert" tone. A relay closure is initiated by either the 1050 Hz tone or a 1650 Hz forecast update signal tone. These are the only tone signals NWS uses. 600 OHM output available.

Crystal and ceramic IF filters, plus double tuned dual gate MOSFET RF stage, give excellent interference rejection and high sensitivity (.28 microvolts for 12 dB. (S + N). Whip antenna, jack and terminals for external antennas. Guaranteed to work where others won't. Selective enough to perform in downtown Chicago.

MANUFACTURER'S SUGGESTED LIST PRICE.....\$475.00

ALLIED PRICE \$ _____

TEPCO

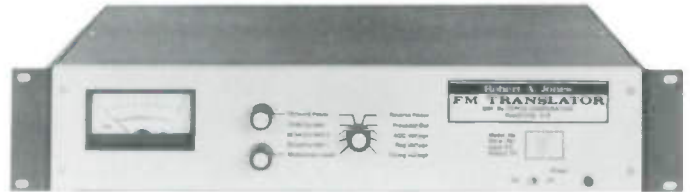

Tepeco manufactures efficient, small one and ten watt rebroadcasting systems for reliable year-in and year-out service in the 88 to 108 MHz FM band. Their modern 100% solid-state design provides freedom of signal selectivity and overload problems.

These FM translators use MOSFET front ends, dual gate mixing, superb IF filter networks, two independent AGC loops, five stages of limiting and positive muting action.

RF output is regulated for signal variation and line voltage changes, monitored with built-in reflectometers, and protected in the event of serious load changes.

The construction is compartmentalized and thoroughly shielded, using plug-in type circuit boards. Complete metering in all important stages. Each translator is factory tested for environmental performance, and warranted to be free of component and workmanship failure for a period of one year.

The only FM translators which may be ordered with a provision for locally-originated program input for permitted announcements.

Model	Description	
J-316	1 watt.....	\$2487.00
	ALLIED PRICE \$ _____	
J-316M	1 watt/w local mod.	\$3025.00
	ALLIED PRICE \$ _____	
J-317	10 watt.....	\$2622.00
	ALLIED PRICE \$ _____	
J-317M	10 watt/w local mod.	\$3159.00
	ALLIED PRICE \$ _____	

TEPCO PRICES ABOVE ARE MFGR'S SUGGESTED LIST PRICES. CALL FOR TODAY'S ALLIED PRICE

CATEL FMX-2100S



The FMX-2100S FM Modulator is a modular packaged frequency modulation cable transmitter designed specifically for CATV and CCTV applications. When used with the SM-2200 Stereo Generator it makes possible the origination of stereo programming. With direct audio sources it can add varied FM signals to the cable system.

In addition to the retransmission of audio signals the wide band deviation makes the unit ideal for multiplexed voice or data transmission.

MANUFACTURER'S SUGGESTED LIST PRICE.....\$985.00

ALLIED PRICE \$ _____

CATEL
FMX/SM2200S



The SM2200 Stereo Generator consists of a sub-carrier oscillator, balanced modulator and channel amplifier, packaged in a modular unit for use with the FMX-2200S.

The stereo generator produces a L-R double sideband suppressed carrier signal along with the L + R signal and the 19 kHz pilot signal. The resultant output is a multiplexed audio signal which is fully compatible with "off-air" monaural and stereo signals when used with the FM modulator. A complete stereo modulator.

MANUFACTURER'S SUGGESTED LIST PRICE.....\$1705.00

ALLIED PRICE \$ _____

WEGENER
1691 SW

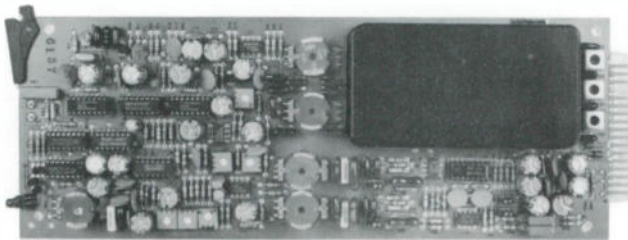

The Model 1691 SW FM Modulator is used to transmit FM stereo audio programming over cable systems. The Model 1691 SW contains a complete FM stereo generator capable of accepting left and right channel audio inputs and provides multiplex output at a crystal-controlled RF frequency between 88 and 108 MHz. Other frequencies are also available. An external audio input feature permits the insertion of locally generated audio programming during specified breaks in the network program or upon command from an external switch closure.

The Model 1691 SW FM Modulator plugs into Wegener Model 1601 or 1602 Mainframes.

MANUFACTURER'S SUGGESTED LIST PRICE.....\$700.00

ALLIED PRICE \$ _____

RAZOR BLADES



SINGLE EDGE RAZOR BLADE
\$10.00 per 100

COTTON SWABS



WOOD STICK TYPE
\$18.00 per 1000

PROOF KIT

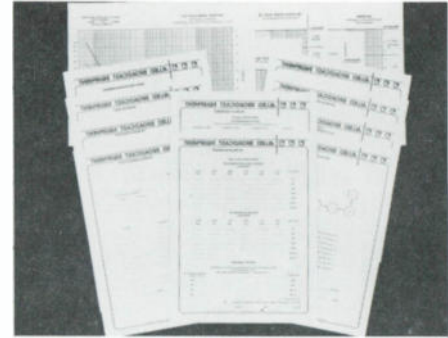

Everything you need to do a proof of performance report. Forms, graphs and information.

\$2.00 each

SCOTCH AVX



Superior design and performance make Scotch AVX truly dependable. Scotch AVX Studio Master Cassettes bring you one step closer to perfection in your search for exceptional performance and sound reproduction. The cassette shell and internal components have been engineered to deliver outstanding mechanical reliability. The superior electromagnetic capabilities of the tape formulation guarantees superb sound under the most severe conditions. Available in bulk or individual boxes.

PRICES UPON APPLICATION

CLEAR-COM



Clear-Com's "no-fail"© broadcast-standard system design, high output, wide bandwidth, and extensive variety of closed-circuit intercoms satisfy the most demanding communications requirements.

A basic Clear-Com System includes one main station or power supply with the capacity to support 100 remote stations distributed along one mile of standard, two-conductor mic cable. It is off-the-shelf expandable to suit your needs.

The Clear-Com line includes portable, custom-mount, and rack-mount intercoms, IFB systems, interfaces, headsets and accessories designed specifically for audio broadcast applications.

PRICES UPON APPLICATION

CALL ALLIED FOR DETAILS & PRICE

AUDISAR REPEAT COIL

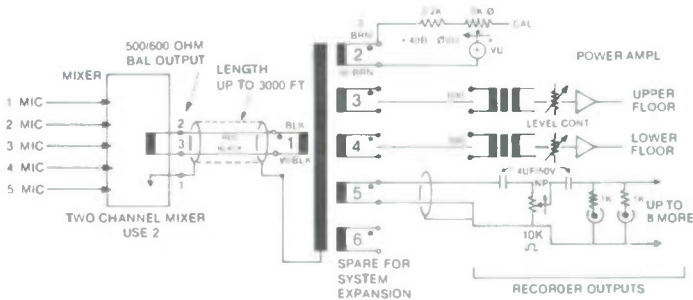
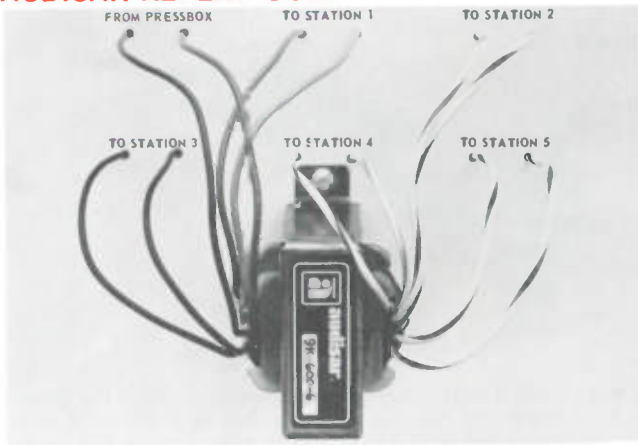

The Answer to:

- * Mass Feeds
- * Telephone Conferencing
- * Distribution

FREQUENCY RESPONSE: 50 Hz to 20 kHz

INSERTION LOSS: 0.75 dB

HEAD ROOM: +30 dB at 1 kHz

WEIGHT: 11.5 oz.

IMPEDANCE: 600 ohm x 6 (1 in, 5 out)

MANUFACTURER'S SUGGESTED LIST PRICE.....\$77.00

DALE® SPA SURGE PROTECTORS



- * Three basic models provide optimum protection for most secondary power installations: SPA-100 for 120 volt AC circuits, SPA-200 for 208-277 volt AC circuits and SPA-400 for 480 volt AC circuits.
- * Automatically resets - has multi-stroke protection capability.
- * Weatherproof housing for indoor or outdoor use.
- * Easy installations.
- * Maintenance free.
- * No power consumption.

SPECIFICATIONS:

- * Shunt capacitance (line to ground).
- * 25 pf max. SPA-100 and 200.
- * 50 pf max. SPA-400.
- * Insulation resistance: 10 megohms minimum.
- * Operating temperature range: -40 to +70 degrees C.
- * Construction: Weatherproof, hermetically sealed in steel case.
- * Leads: #12 AWG stranded leads, PVC insulation, 18" long. Black line for line (phase) connection, green lead for ground.
- * Mounting: 1. 1/2-14 NPSL nipple for fuse or junction box mounting.

2. L bracket for wall or pole mounting. Mount with two #8 screws spaced 1" apart.

PRICES UPON APPLICATION

ASSOCIATE PRODUCER®



Allied's Associate Producer facilitates and centralizes your dubbing needs. The turntable mount is our famous shock absorber. (Page 39).

We invite you to select and customize components. The cartridge tonearm of your choice; a Technics SP15, SP25, or SP10 turntable (Page 89); A CD player of your choice (Page 90, 91); a cassette deck (Page 61); an amplifier (Pages 1, 2, 3, 4); speakers such as TOA, JBL, or ALC (Pages 68, 69, 70) and a pair of Omnimounts (Page 42) to mount the speakers to sides or top. You may choose an Audicord, BE, Fidelipac, Ramko or ITC cart machine.

Put it all together with Phase Audio's cart dubbing center.



Allied can supply all the separate components or assemble, prewire, and test as a complete system for you.

PRICE UPON APPLICATION

OKIESOFT TINY DRAFTER



Tiny Drafter is an innovative program that enables the user to generate scale drawings using an Apple II series micro-computer.

Tiny Drafter is capable of operation in a variety of modes; such as drawing by specification, drawing manually using the keyboard or joystick, drawing filled or empty boxes or a scale legend or even drawing grids to user specifications.

Tiny Drafter was written to meet the needs of the Modern Broadcast Engineer or Consultant who requires the ability to quickly generate scale drawings for equipment, room or building layouts, with reasonable precision.

MANUFACTURER'S SUGGESTED LIST PRICE.....\$79.95

ALLIED PRICE \$_____

PRO RAX
CD-40LS/CD20W



CD-40LS Carousel

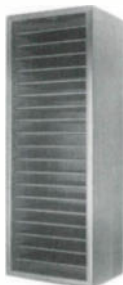

CD-20W Wall or Desk

These unique racks are designed to store, protect and keep handy your compact disks (CD). The cabinetry is mahogany finish and the price also includes crating for delivery to you.

Model Description

- CD-40LS Carousel (Capacity 40)**
11 1/2"W x 9 1/4"H x 11 3/8"D.....\$69.95
- CD-20W Wall or Desk (Capacity 20)**
6 1/4"W x 16 1/2"H x 4 3/4"D.....\$39.95

PRO RAX PRICES ABOVE ARE MFGR'S SUGGESTED LIST PRICES. CALL FOR TODAY'S ALLIED PRICE.

WINGET
TAPE SENTRY



The TAPE SENTRY is a sensing device intended for use in broadcast automation systems to alert station personnel that the end of an audio tape has been reached.

It simultaneously monitors up to six tape machines and at the end of any tape provides a relay contact closure which may be used to trigger external audible and/or visible alarms.

Detector circuitry is triggered by sub-audible 25 Hz tones of six second (or greater) duration. This makes TAPE SENTRY compatible with most music programming formats. Quick and easy rear panel connections via "Molex" type connectors (mating ends supplied).

MANUFACTURER'S SUGGESTED LIST PRICE.....\$295.00

ALLIED PRICE \$ _____

AIR SENTRY



The AIR SENTRY is designed to constantly monitor the presence of an audio signal and to energize a relay when the audio is absent. Activation of the relay is front panel adjustable from 4 to 20 seconds. The relay may in turn be used to activate an external audible or visible alarm to notify station personnel of the absence of broadcast signal. It may be used to monitor any stereo or mono audio source such as audio from an AM/FM tuner, TV receiver or modulation monitor. AIR SENTRY is built to broadcast standards of reliability. Quick and easy rear panel connections via "Molex" type connectors (mating ends supplied).

MANUFACTURER'S SUGGESTED LIST PRICE.....\$295.00

ALLIED PRICE \$ _____

BENCHMARK
DIA-1B & DIA-2A

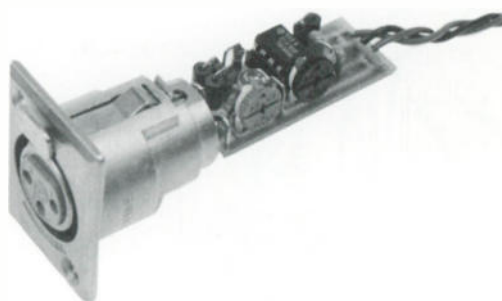

The need for balanced inputs on *all* audio equipment is not universally understood. The result is that many pieces of otherwise good audio equipment are unable to reject the *normal* power line related voltage differences found between chassis of equipment. These voltage differences add with the desired signal, and the result is always less than pleasant. Because they; *retrofit* into existing equipment, may be obtained in many \pm gain configurations and may be used with virtually any (up to \pm 200 volts) existing supply voltages the DIA-1B & DIA-2A differential input amplifiers, provide the optimum answer to the need for balanced inputs in your equipment. The problems of space, mounting, wiring and A.C. requirements found with external balancing systems, are eliminated. The DIA-1B uses split (\pm) supplies, the DIA-2A uses a single + supply.

MANUFACTURER'S SUGGESTED LIST PRICE

- 1B\$48.40** **ALLIED PRICE \$ _____**
- 2A\$48.40** **ALLIED PRICE \$ _____**

DOA-1A & DPA-2A

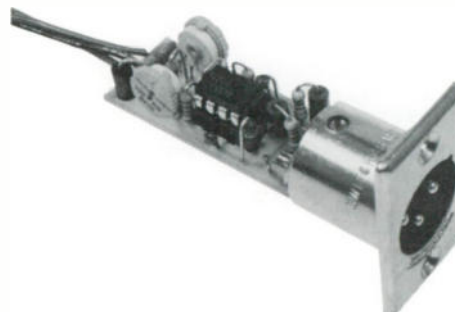

Interfacing a Compact Disk player, FM tuner, audio or video cassette machine to the professional audio environment can be very frustrating. The DOAs-1 & 2 provide the optimum answer to the need for a professional level interface, and at less than half the price of an external device. With variable gain from off to +26 dB and by mounting inside your equipment, they turn your gear "pro." External interface devices usually include input stages that may be superfluous. Their output stages are restricted to a fixed gain of 14 dB, which is often inadequate, particularly with CD players. With the DOAs-1 & 2, cabling, space, mounting and AC power problems are eliminated. The DOA-1A uses split power from \pm 9V to \pm 22V D.C. The DOA-2A uses a single + supply from +18V to +44V D.C.

MANUFACTURER'S SUGGESTED LIST PRICE

- 1A \$48.40** **ALLIED PRICE \$ _____**
- 2A \$48.40** **ALLIED PRICE \$ _____**

ALLIED CARRIES ADDITIONAL BENCHMARK PRODUCTS

"IT DOESN'T GET ANY BETTER THAN THIS!"

**GENTNER
IC-20**

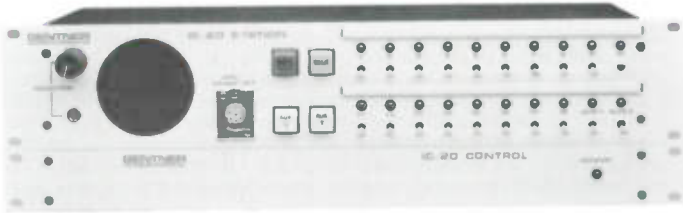

The IC-20 Radio Station Intercom offers a unique solution to the internal communication needs of the radio broadcaster. Along with the ability for any user to communicate with any other user, the IC-20 allows INDEPENDENT, simultaneous communication paths. In addition, the IC-20 features conference and "party line" communication as well as interfaces to your two-way radio and telephone interface systems.

The IC-20 is able to expand with your needs; you may buy additional stations as required and simply "plug them in" to the existing system, up to the maximum of 20 stations (Stations 19 and 20 are exclusively used for interfacing to your two-way and telephone systems).

PRICES UPON APPLICATION

EFT-1000



The EFT-1000 Extended Frequency Transceiver improves the sound of your telephone remotes by recovering the low frequencies normally lost on telephone lines. Audio frequencies are shifted up by 250 Hz on the transmitting end and back down on the receiving end. This preserves the low frequencies, dramatically improving the quality of the broadcast.

The EFT-1000 is a complete, self-contained transceiver that is able to transmit, receive, or operate full duplex as a transceiver. This allows you to run your remote broadcasts with a single telephone line! However, if you prefer to use two lines (single paths for transmit and receive), the EFT-1000 can do this with no extra equipment.

The EFT-1000 was designed for easy hook-up and simple operation and is able to enter or exit the encode/decode mode and couple to the telephone line automatically.

MANUFACTURER'S SUGGESTED LIST PRICE.....\$1899.00

ALLIED PRICE \$ _____

SWITCHERS 10x2 and 20x1

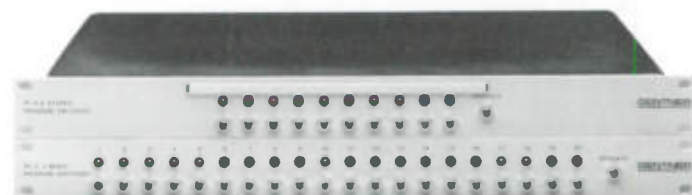

Gentner Program switchers are very useful in applications which require passive switching of signal sources. Internal switching is accomplished by sealed socket-mounted relays that are magnetically latched. This latching makes the switcher insensitive to line voltage fluctuations (the selected source remains selected even in power failure) and since the coils are only energized during switching, a longer relay life is achieved. Programmable Arrayed Logic (PAL) circuits form the heart of the firmware within the system. The 10x2 Stereo selects ten stereo channel inputs to a single stereo channel output; the 20x1 Mono selects twenty mono channel inputs to a single mono channel output.

Model	Description	MFGR'S SUGGESTED LIST PRICE.....
10x2	Stereo	\$849.00

ALLIED PRICE \$ _____

20x1	Mono	\$849.00
------	------	----------

ALLIED PRICE \$ _____

VERSAPATCH

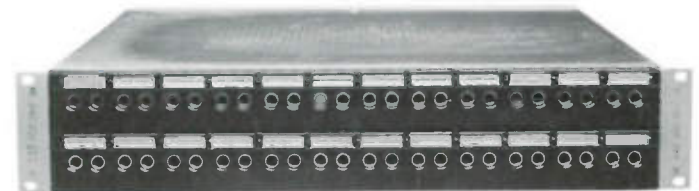

Front View

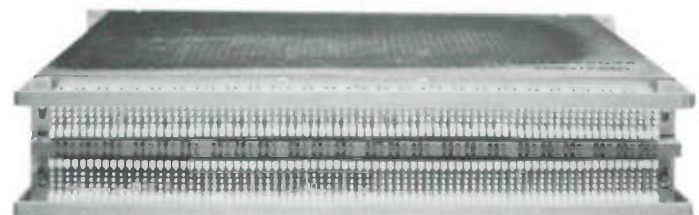

Rear View

Flexiblock makes downsize Versapatch the most versatile, flexible prewired patch panel you can buy.

Gentner's Versapatch is a prewired patch panel enclosed in a chassis. The rear of the chassis gives easy access to the jacks; stranded wire cables are neatly bundled across the hinge and terminated on Flexiblock punch blocks. Individual designation strips allow you to change one circuit's designation quickly and neatly - no need to remove and re-do an entire row's designation for one change.

Versapatch is available with Tip-ring jacks; normals are jumpered at bay or Top-row bridged for monitoring capability. Various bay types from 24 to 96 jacks with various termination types are selectable.

Prices upon configuration selected, Call for details and ALLIED pricing.

Allied carries the entire Gentner product line. You will find them in various locations in this catalog.

GENTNER PRICES ABOVE ARE MANUFACTURER'S SUGGESTED LIST PRICES. CALL NOW FOR TODAY'S ALLIED PRICE.

**"THERE'S MORE TO ALLIED
THAN BROADCAST EQUIPMENT"**

Terms and Conditions of Sale

BY TELEPHONE: The most convenient way to order from Allied is by telephone, confirmed with a written purchase order. When placing an order, call the Allied office that serves your area. (See inside back cover.) Allied provides toll free ordering service where possible - collect calls are not acceptable. Office hours are 8 AM to 5 PM local time per office. Written purchase orders, sent to confirm a telephone order, must be noted as **CONFIRMING**. Failure to do so could result in additional charges for freight and handling.

CREDIT TERMS: We will ship open account to firms *rated* high by Dun & Bradstreet Inc. If only listed and *not* rated by D & B, Allied will require 3 vendor references, plus 1 bank reference. Any credit accommodations must be arranged through the Allied credit department. Orders and requests for credit accommodations should be placed with your local Allied sales office listed on the inside back cover. If in the judgment of Allied, the financial condition or payment record of the Buyer at any time does not justify placement/shipment of an order on the payment terms requested, Allied may refuse to accept/ship unless advance payment is received. Otherwise, payment terms are cash with order or chargeable to Visa or Master Card with bank approval or net 30 days (when approved by Allied) or 50% cash with order and balance net 30 days or 50% cash with order and balance due prior to shipment or 25% cash with order and balance net 30 days (when approved by Allied) or 25% cash with order and balance due prior to shipment. There are times with significant monetary value orders (as determined by Allied) when an order must be accompanied by a Security Agreement. COD orders - when authorized by Allied, require payment by cash, certified check, cashier's check or bank money order - **ONLY!**

PARTIAL BILLING: Payment is due Net/30 days firm on *each* invoice rendered. Due to time differential in shipment of various items, *each* invoice becomes due and payable within 30 days of the date of the invoice. If this is not possible, we will be glad to ship all equipment at one time with one invoice becoming due Net/30 days firm. Please advise which method is desired. Government funded purchase orders *must* include a copy of the instrument of funding. **ALLIED ACCEPTS NO PENALTY CLAUSES!**

TRIALS & SALES ON APPROVAL: Trials and sales on approval require a firm purchase order or payment in advance or deposit at our option unless otherwise specified. Approval terms are applicable only if specified in advance on the order and accepted by our Sales and Credit Department. Goods must be returned within the specified time on the invoice or the sale is considered final. Normal trial period is 10 days. Charges will be assessed for any damage or loss.

LEASING: Allied offers several Leasing Plans from various companies arranged to suit your individual needs in standard six month increments, from 6 months to 60 months. The customer is responsible for all taxes, transportation and insurance charges unless arranged in advance with the Leasing company. Under a Lease agreement, the customer pays for the use of the product for the term of the agreement. It is *not* a month-to-month rental . . . it is a non-cancelable, fixed term lease. At the expiration of the lease, there is the opportunity to update, to renew the existing lease, or to return the equipment. Customer may also exercise an option to purchase the equipment at any time during the term of the lease, provided thirty (30) day written notice of their intention is given. A *portion* of the installments will be credited toward the purchase price as negotiated with the leasing company.

USED EQUIPMENT: Used equipment offered and purchased "as-is, no-return," must be paid for in advance or sent COD. Allied will make a fair representation and the customer will buy at his own risk. Allied will authorize returns on repaired used equipment within 10 days of delivery in which the customer will be credited full amount of purchase, less all shipping and packing charges.

BACK ORDERS: Items ordered that are temporarily out of stock or have to be drop shipped from the manufacturer, will be placed on back order.

TAXES: Allied shall invoice and you agree to pay all required taxes or other like charges required to be collected by Allied with regard to transactions between seller and purchaser with specific reference to state and local taxes imposed by law in the various States, Commonwealth and Protectorates of the United States. Firms operating under tax free conditions must state applicable license certificate or contract numbers and be prepared to furnish necessary certificates of proof. Allied *must* collect tax in TX, GA, IL, IN and WA unless tax exempt documents are provided.

SHIPMENT: Your order will be shipped via UPS, if possible. Otherwise, equipment will be shipped via Parcel Post, Truck or Air Freight. If you require a special or particular form of shipment, please specify. Please be aware that there are insurance limitations on certain forms of shipments and that we may not be able to follow your exact shipping requests due to limitations on services available in various parts of the country and tariff restrictions. Allied will make every effort to ship your merchandise in a fast and inexpensive manner. Merchandise in stock will be shipped within 24 hours of receipt of order. If it is a drop shipment from the manufacturer, a request will be made via telephone to expedite shipment. Pickups are made several times

a day from our facility to expedite service. Please allow extra time for truck shipments and Parcel Post. Overnight shipments a specialty (as requested).

GUARANTEE: All merchandise is covered by the manufacturer's warranty. Allied backs these warranties with personal interface between the problem and the factory solution. Many parts and replacement units are available from our stock or will be expedited from the manufacturer at Allied's direction as the customer requests. Allied or the manufacturer will, at their option, repair or replace defective parts or merchandise in warranty. The customer will be billed for the replacement or repair and full credit will be issued, less the freight, upon satisfactory return of the defective unit in the time period specified.

CLAIMS & RETURNS: Inspect all shipments immediately upon receipt. Missing cartons or obvious damage to cartons, shipped by common carrier, should be noted on the delivery receipt. Concealed damage or loss should be reported at once to the carrier and an inspection requested. Losses or damage to Parcel Post shipments should be reported to our Customer Service Dept. All claims for shortage or damage must be made within two days after receipt of shipment. Claims for lost shipments must be made within 10 days of receipt of invoice or other notification of shipment. Save damaged or pilfered cartons until claim is settled. Do not return any goods to Allied without obtaining a **Return Authorization Number** and instructions from our Customer Service Dept. Goods returned unauthorized by collect freight will be refused. Goods returned which were ordered by customers in error are subject to a restocking charge. **IMPORTANT** - Under present rules and regulations by most carriers it is the end user's responsibility to inspect and report losses and damage. It is essential you follow correct procedure in applying for claims and most of all, do it promptly. Any adjustment and/or replacement must be requested within seven (7) working days of your receiving agent's receipt of shipment. You may be compensated only if all accompanying boxes, packing materials, and documentation are available for inspection and used for the return.

DELIVERY: Any delivery dates indicated are approximate and subject to availability of inventory and refer to the date on which the goods will be ready for dispatch from our warehouse and/or the manufacturer. The delivery time/date indicated is without obligation insofar as it may be delayed due to labor difficulties, fires, casualties, accidents, acts of the elements, acts of the public enemy, transportation difficulties, acts of the Government in its sovereign capacity; in the event of non-compliance with our terms of payment, or other causes beyond Allied control. **Allied accepts no penalty clauses.**

PRICES: Prices found in this catalog are understood to be domestic only and in U.S. dollars; they are the suggested manufacturers price, therefore are subject to change or correction without notice. As such, the prices serve as a basis for orders and are *not* offered as quotations. When definite quotations are necessary, please call, write or consult our sales representative at the nearest Allied office (reference inside back cover). All applicable local, State or Federal taxes of any nature must be added to quoted prices, unless previously defined as included. All prices are FOB place of shipment, exclusive of freight charges; therefore shipping charges to your destination will be added, unless otherwise stated.

REPAIRS & WARRANTY SERVICE: Contact our Customer Service Dept. at 317-962-8596 for instructions on repair. Do not return goods without a **Return Authorization Number** and make sure proper documentation is enclosed stating the problem encountered. If you feel your problem can be solved by conversation with a technician, please ask our Customer Service Dept. to connect you with the Repair Dept.

PERSONAL SERVICE: Regardless of quantity, it's our Company policy to treat each order and inquiry as a person-to-person encounter. Your questions, comments and criticisms are welcome. Our staff is made up entirely of professionals willing to give you helpful assistance and work out possible problems to your full satisfaction.

CORPORATE REFERENCES & POLICIES: Allied Broadcast Equipment is a division of Allied Advertising Corporation, an Indiana Corporation since 1966. It is our sincere desire to give the broadcast and recording industry the best possible service anywhere. Please direct any comments concerning service and policy to . . . **President, Allied Broadcast Equipment, PO Box 1487, Richmond, Indiana, 47375 USA.**

NO INSTALLATION: Installation is not included. Certain items do not come factory-assembled and Allied makes no representation to the contrary.

NOTE: Prices are manufacturer suggested list and are for reference only. Discounts are available to qualified clients on many items. Terms are cash, Net/30 days on approved credit, Visa or Master Card. Freight and handling charges will be added to all shipments. Prices subject to change without notice. Typographical and clerical errors are subject to correction. Illustrations, drawings and descriptions contained in our catalogs, quotes, contracts and brochures, as well as indicated measurements and weights, are subject to changes without notice due to technical improvements or modifications. All terms and conditions defined in above paragraphs supersede and replace **all** previously printed catalog terms and conditions.

The United States of Allied

**Order
Toll-
Free**



**Customer
Service
&
Repair
317-962-8596**

To Order — Please Call The Number For Your State

Call the **TOLL FREE** number listed for your state — Thank You

RICHMOND, IN Sales Office

Serving:

Connecticut
Delaware
Indiana
Kentucky
Maine
Maryland
Massachusetts
New Hampshire
New Jersey
New York
Ohio
Pennsylvania
Rhode Island
Vermont
Virginia
West Virginia

635 South E Street, Box 1487
Richmond, IN 47374 USA

ORDERS	INDIANA
	800-382-6907
ORDERS	ALL OTHER STATES
INQUIRIES	800-428-6954
	317-962-8596
Telex II	810 345 1394
Telex I	380474
W.U.EZ Link	621 267 20 +
TTY DDD	317 935 7466
FAX	317 962 8961
INT'L	317-935-1704

CHICAGO, IL Sales Office

Serving:

Iowa
Illinois
Michigan
Minnesota
Missouri
Nebraska
North Dakota
South Dakota
Wisconsin

5097 N. Elston Ave., Suite 303
Chicago, IL 60630

ORDERS	ILLINOIS
	800-572-9138
ORDERS	ALL OTHER STATES
INQUIRIES	800-621-3726
	312-794-0224
W.U.EZ Link	621 284 30 +
TTY DDD	312 545 7408
FAX	312 282 3753
TELEX	888008

ATLANTA, GA Sales Office

Serving:

Alabama
Florida
Georgia
Mississippi
North Carolina
South Carolina
Tennessee

Shannon Towers, 4405 Mall Blvd.
Suite 314, Union City, GA 30291

ORDERS	GEORGIA
	800-282-0246
ORDERS	ALL OTHER STATES
INQUIRIES	800-241-0192
	404-964-1464
W.U.EZ Link	621 284 60 +
TTY DDD	404 964 1466
FAX	404 964 2820
TELEX	317127

DALLAS, TX Sales Office

Serving:

Arkansas
Colorado
Kansas
Louisiana
New Mexico
Oklahoma
Texas

Richardson Credit Union Bldg.
1101 East Plano Parkway, Suite B
Plano, TX 75074

ORDERS	TEXAS
	800-442-4741
ORDERS	ALL OTHER STATES
INQUIRIES	800-527-4392
	214-423-8667
W.U.EZ Link	621 284 50 +
TTY DDD	214 423 8681
FAX	214 578 9162
TELEX	317128

SEATTLE, WA Sales Office

Serving:

Alaska
Arizona
California
Hawaii
Idaho
Montana
Nevada
Oregon
Utah
Washington
Wyoming

33430 13th Place South-Suite 120
Federal Way, WA 98003

ORDERS	WASHINGTON
	800-562-8178
ORDERS	ALL OTHER STATES
INQUIRIES	800-426-9781
	206-838-2705
W.U.EZ Link	621 284 40 +
TTY DDD	206 952 8018
FAX	206 952 8567
TELEX	317129

ALLIED
Broadcast Equipment

INTERNATIONAL INQUIRIES and ORDERS from outside the 50 United States are received at Richmond address above or (U.S.) 317-935-1704. Telex 380 474 FAX 317-962-8961. PRICES in this catalog are U.S., Domestic only. Prices & specifications are subject to change without notice.

— Satellite Eq. Catalog Available —

— World's #1 Broadcast Distributor —

— International Catalog Available —

ALLIED 
Broadcast Equipment

Corporate Office:

P.O. Box 1487 • 635 South E Street • Richmond, Indiana 47375
Phone 317-962-8596 • Fax 317-962-8961 • Telex 810 345 1394
EZ Link 62126720 • TTY DDD 317-935-7466



**ALLIED BROADCAST
EQUIPMENT**

800-621-3726 IL 800-572-9138

ALLIED

Broadcast Equipment

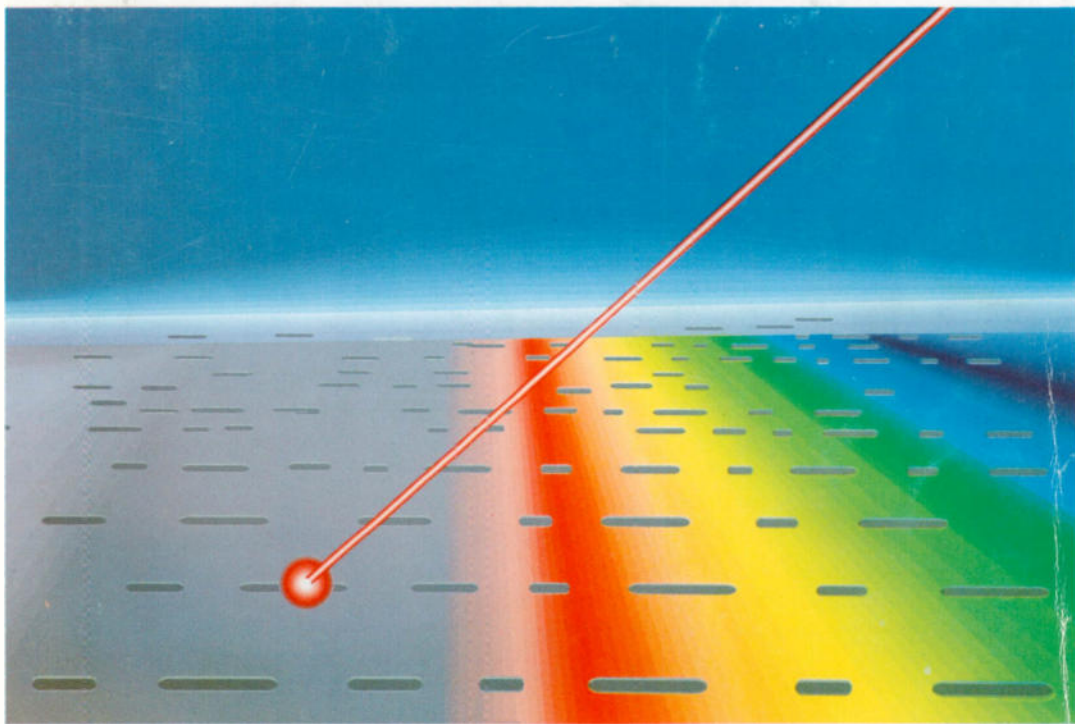

1987 CATALOG

THE NEW ALLIED CORPORATE HEADQUARTERS



Located: 3712 National Road West • P.O. Box 1487 • Richmond, IN 47375

To the broadcast community:

Allied is on the move! We're excited, proud and confident that our leading position in the audio and RF broadcast equipment marketplace means bigger, better and the latest state-of-the-art equipment for you to enhance your air image!

Allied's visible, controlled and well-managed growth now encompasses six (6) thriving divisions dedicated to serving the broadcast, telecommunications and graphic arts communities.

This past year brought about a new, expanded corporate facility as well as the establishment of the Allied Telecommunications Division. A sales office was also opened in the Los Angeles area. Three regional sales offices were moved into new, enlarged facilities.

We have been successful by concentrating and specializing in the things we do best. No small part of this task is accomplished by maintaining the personal touch in an atmosphere of friendliness and integrity. This philosophy of serving you with the golden rule in mind has, is, and always will be the Allied advantage.

We hope this new-format, 1987 catalog will meet with your approval and your needs. We can help alleviate your broadcast problems with good advice and the right equipment — please call today!

Yours for better broadcasting,

ROY M. RIDGE
President
Allied Corporation

DAVID C. BURNS
National Sales Manager
Allied Broadcast Equipment

RESERVATION OF RIGHTS

The unique design and layout of this catalog and the broadcast equipment depicted herein, as well as the arbitrary sectionalization, pricing parameters and identification are the result of Allied research to determine not only what our customer clientele wanted, but how we could best present to our customers the wide range of equipment available from Allied. No copying or reproduction of the format of this catalog or any of the designs, layouts, copy or pictures is permissible without the express written consent of Allied Broadcast Equipment. Copyright form SE has been submitted, and any and all acts of copyright infringement shall be legally pursued by Allied Broadcast Equipment toward complete recovery and relief.

ALLIED
Broadcast Equipment

— TABLE of CONTENTS —

NOMENCLATURE (ALPHABETICAL SEQUENCE)	PAGE
AMPLIFIERS	1-3
AUTOMATION	16-18
CART ACCESSORIES.....	26,27
CARTRIDGE MACHINES.....	19-24
CD PLAYERS.....	120
CLOCKS & TIMERS.....	28
CONSOLES.....	29-37
DELAY LINES.....	14,15
DISTRIBUTION AMPS.....	39-41
EQUALIZATION.....	12-14
FURNISHINGS.....	43-59
HEADSETS.....	59,60
INTERCOMS.....	61,62
INTERFACES.....	15
MICROPHONES.....	62-67
MISCELLANEOUS.....	121-125
MONITORS.....	67-73
NOISE REDUCTION.....	11,12
PORTABLE MIXERS.....	37-39
PROCESSORS.....	3-11
RECORDERS.....	74-78
REMOTE CONTROL.....	79-81
ROUTING SWITCHERS.....	41,42
RPU.....	81,82
SATELLITE.....	84,85
SCA.....	86
SPEAKERS.....	86-89
STANDBY POWER.....	89,90
STL.....	91,92
TAPE CARTRIDGES.....	25,26
TELEPHONE.....	94-98
TEST EQUIPMENT.....	98-101
TRANSMISSION LINES.....	102
TRANSMITTING EQUIPMENT.....	103-109
TUNERS.....	111
TURNTABLES.....	112-120
WEATHER EQUIPMENT.....	121

NOMENCLATURE (PAGE SEQUENCE)	PAGE
AMPLIFIERS	1-3
PROCESSORS.....	3-11
NOISE REDUCTION.....	11,12
EQUALIZATION.....	12-14
DELAY LINES.....	14,15
INTERFACES.....	15
AUTOMATION.....	16-18
CARTRIDGE MACHINES.....	19-24
TAPE CARTRIDGES.....	25,26
CART ACCESSORIES.....	26,27
CLOCKS & TIMERS.....	28
CONSOLES.....	29-37
PORTABLE MIXERS.....	37-39
DISTRIBUTION AMPS.....	39-41
ROUTING SWITCHERS.....	41,42
FURNISHINGS.....	43-59
HEADSETS.....	59,60
INTERCOMS.....	61,62
MICROPHONES.....	62-67
MONITORS.....	67-73
RECORDERS.....	74-78
REMOTE CONTROL.....	79-81
RPU.....	81,82
SATELLITE.....	84,85
SCA.....	86
SPEAKERS.....	86-89
STANDBY POWER.....	89,90
STL.....	91,92
TELEPHONE.....	94-98
TEST EQUIPMENT.....	98-101
TRANSMISSION LINES.....	102
TRANSMITTING EQUIPMENT.....	103-109
TUNERS.....	111
TURNTABLES.....	112-120
CD PLAYERS.....	120
WEATHER EQUIPMENT.....	121
MISCELLANEOUS.....	121-125

The rest of the **Allied** family —
— serving the Broadcast Industry



ATLANTA SALES OFFICE



CHICAGO SALES OFFICE



DALLAS SALES OFFICE



LOS ANGELES SALES OFFICE



RICHMOND SALES OFFICE



SEATTLE SALES OFFICE

BGW

The **BGW 85** is a rack-mounted power amplifier rated at 35 watts per channel at 8 ohms, with 0.1% T.H.D. 20 Hz to 20 kHz, 90 watts into 8 ohms mono, with 0.15% T.H.D. (The Model 85 features modular circuit assembly, toroidal mains transformer, packaged & cased transistors.)

MANUFACTURER'S SUGGESTED LIST PRICE.....\$449.00

ALLIED PRICE \$ _____



The **BGW 150** is a rack mounted power amplifier rated at 50 watts per channel into 8 ohms, 150 watts into 8 ohms mono, with intermodulation distortion of less than .02%, a frequency response of -25 dB 20 Hz to 20 kHz and is designed for any load impedance equal to or greater than 4 ohms.

MANUFACTURER'S SUGGESTED LIST PRICE.....\$699.00

ALLIED PRICE \$ _____



The **BGW 250E** offers a level of performance and reliability that has established it as the most advanced dual-channel, solid-state power amplifier available to the audio professional. In tests, performed by the US Army Air Force Exchange, of comparably rated power amplifiers, the BGW 250D received the highest score of all amplifiers tested. 100 watts minimum sine wave continuous average power output per channel.

MANUFACTURER'S SUGGESTED LIST PRICE.....\$989.00

ALLIED PRICE \$ _____

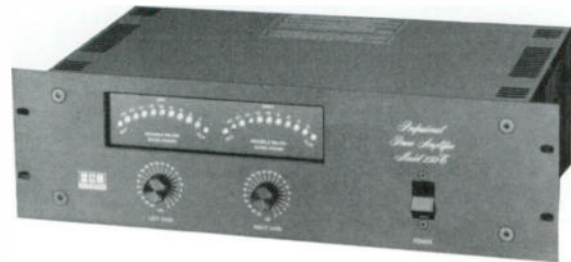

In 1985, after 13 years of continuous progress in the development of professional audio power amplifiers, BGW Systems now has the third generation Model **750E**. Although the front panel appearance, with its heavy diecast handles and model designation are similar, almost every other aspect of the 750 has been redesigned and improved. 250 watts per channel.

MANUFACTURER'S SUGGESTED LIST PRICE.....\$1699.00

ALLIED PRICE \$ _____



CROWN

The **CROWN D-75** offers significant benefits to the professional user, benefits like IOC input/output comparator that reports all forms of signal overload, lockable level control shafts, active-balanced XLR connectors as well as unbalanced 1/4" phone plugs and signal presence indicators that notify the user whenever the D-75 output signal is greater than 1/8 watt. 35 watts per channel.

MANUFACTURER'S SUGGESTED LIST PRICE.....\$524.00

ALLIED PRICE \$ _____



Retaining the D-150A tradition for sonic accuracy and reliability, the **CROWN D-150A Series II** is rated at 80 watts per channel into 8 ohms, 250 watts into 8 ohms mono. The frequency response is ± 0.1 dB DC to 20 kHz at one watt into 8 ohms; ± 1 dB DC to 100 kHz., less than .001% harmonic distortion, less than .01 I.M. distortion and 6 volts per microsecond slew rate.

MANUFACTURER'S SUGGESTED LIST PRICE.....\$699.00

ALLIED PRICE \$ _____





CROWN

Since its introduction, the **DC-300** and its modifications have been a standard of sonic accuracy, power and reliability. The 300A is FTC rated at 250 watts per channel into 8 ohms; 500 watts into 8 ohms mono.

MANUFACTURER'S SUGGESTED LIST PRICE.....\$999.00

ALLIED PRICE \$ _____



UREI

The **UREI 6500** features two channels on an independent, modular plug-in chassis with front panel access. The 6500 is rated at 275 watts into 8 ohms per channel output with .1 THD.

MANUFACTURER'S SUGGESTED LIST PRICE.....\$2996.00

ALLIED PRICE \$ _____

UREI 6505 spare power module for the 6500.

MANUFACTURER'S SUGGESTED LIST PRICE.....\$966.00

ALLIED PRICE \$ _____

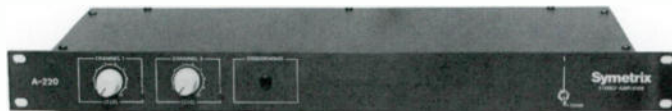

SYMETRIX

The **SYMETRIX A-220** is a rack-mounted stereo amplifier rated at 20 watts per channel into 8 ohms, 40 watts mono into 8 ohms with .08% maximum distortion.

MANUFACTURER'S SUGGESTED LIST PRICE.....\$315.00

ALLIED PRICE \$ _____



ATI

The **ATI M-1000** dual microphone and L-1000 dual line series of Micro Amps are rackable, micro-sized, stackable, versatile and RF protected. The series provide +22 dBm at clipping for transformer and single ended outputs, +26 dBm for balanced differential outputs. They're quiet, total amplifier noise is typically within 1 dB of the thermal noise of source impedance. A 13 microsecond slew rate minimizes the irritating harshness of TIM distortion. Typical circuit harmonic distortion held below .005% even at 20 kHz.

L1000-1 dual transformer outputs.....\$315.00

L1000-2 balanced differential outputs.....\$315.00

M1000-1 dual transformer outputs.....\$345.00

M1000-2 balanced differential outputs.....\$345.00

ATI PRICES ABOVE ARE MFR'S SUGGESTED LIST PRICES. CALL FOR THE ALLIED PRICE.



NAD

NAD amplifiers are noted for transparent musicality, solid speaker-driving power, and economical no-frills design. The **NAD 3130** stereo amplifier, while rated at a modest 30 watts per channel, has a high-current output stage that delivers short-term bursts of 60 to 80 W/ch, not only at 8 ohms but also with the complex impedances of real loudspeakers.

MANUFACTURER'S SUGGESTED LIST PRICE.....\$228.00

ALLIED PRICE \$ _____



HAFLER

So rugged is the design that the **HAFLER P-500** rack mounted amplifier can deliver over 20 amperes into a short circuit (before the supply fuses open!) When switched to mono operation, the amplifier's rated output is 800 watts into 8 ohms, which is capable of driving a 70 volt line distribution system directly. In practice, well over 900 watts of mono power is available.

MANUFACTURER'S SUGGESTED LIST PRICE.....\$995.00

ALLIED PRICE \$ _____

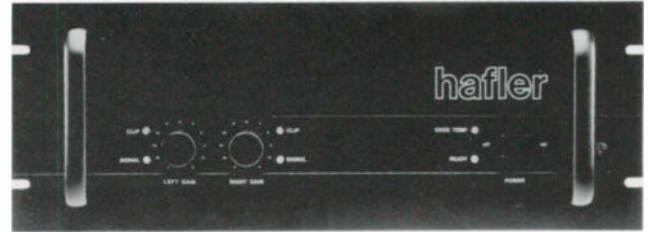

— PROCESSORS —

ORBAN

The **ORBAN 8100A FM OPTIMOD®** offers wideband or multiband operation, more versatile setup controls that permit precise "tuning" for different formats, improved voice/music balances, an improved stereo generator with cleaner baseband, new overshoot compensation that permits full modulation at all frequencies, yet doesn't increase low frequency IM distortion, plus a dual-chassis option, built-in crosstalk test generator, rigorous RFI shielding and true VC gain control. FM's favorite processor!

MANUFACTURER'S SUGGESTED LIST PRICE.....\$4995.00

ALLIED PRICE \$ _____



OPTIMOD-FMX is a complete, self-contained stereo generator. It combines a newly-designed ultra-high-performance stereo encoder, an FMX compander and sub-carrier generator, FMX over modulation control circuitry, setup controls, remote control capability, and an integral power supply.

It works with OPTIMOD-FM of any vintage, even our earliest Model 8000A. OPTIMOD-FMX can also work with non-Orban broadcast processors that have effective peak and bandwidth control.

MANUFACTURER'S SUGGESTED LIST PRICE.....TBA

ALLIED PRICE \$ _____

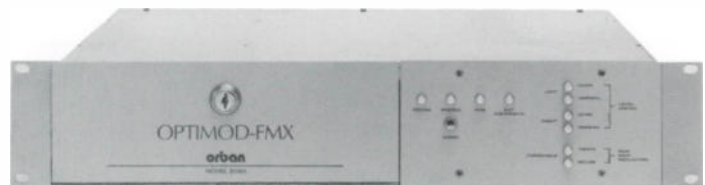

The **9100A/1** and **A/2 ORBAN OPTIMOD®** was designed for the state-of-the-art AM broadcaster. If your station has an AM transmitter and audio chain which will come close to passing an FM proof, an STL good out to 15 kHz (for co-located facilities) and an antenna system capable of 11 kHz minimum bandwidth there is not a better AM processor made.

9100A/1 mono.....\$3995.00 ALLIED PRICE \$ _____

9100A/2 stereo.....\$5395.00 ALLIED PRICE \$ _____



ORBAN



The new, second-generation **ORBAN OPTIMOD® TV 8182A**. Licensed from CBS TECHNOLOGY CENTER, and incorporating the latest research technology, the in-built loudness controller automatically recognizes program material whose perceived loudness exceeds a certain threshold, then quickly and indiscernably lowers the gain until the loudness is consistent with the rest of the program. The result is smoother more easily-listenable audio, operator errors are corrected and obnoxious commercials are tamed. TV's most popular stereo system.

MANUFACTURER'S SUGGESTED LIST PRICE.....\$4995.00

ALLIED PRICE \$ _____

This fresh "out of the box" **ORBAN 8182A/SG** OPTIMOD TELEVISION STEREO GENERATOR when mated to your existing 8182A stereo audio processor for precise harmonization, gives you: left and right computer-optimized filters, a dbx encoder card, sum-and-difference 11-pole 15 kHz low pass filters, sync bus to simplify installation, video loop through, built in monitor, stereo base band generator, user-adjustable base band clipper. For audio processing and base band generation in TV stereo, this is it!!

MANUFACTURER'S SUGGESTED LIST PRICE.....\$4995.00

ALLIED PRICE \$ _____



The **ORBAN 424A** has a compression ratio control for those few times when you want to maintain some real dynamic range. However you will be astonished at the openness and apparent dynamic range available even at the infinite ratio. You may be even more astonished when you discover the apparent loudness increase achieved without the usual side effects.

422A single channel.....\$629.00 ALLIED PRICE \$ _____

424A dual channel.....\$989.00 ALLIED PRICE \$ _____



The new **ORBAN 536A** Dynamic Sibalance Controller is an improved, two-channel version of our popular single-channel 526A (but without the mic input). The 526A and its ancestor the 516EC, are considered to be the industry-standard de-essers and are found in professional audio facilities throughout the world.

MANUFACTURER'S SUGGESTED LIST PRICE.....\$539.00

ALLIED PRICE \$ _____

MOSELEY



The **MOSELEY SCD-9** stereo demodulator transforms a composite stereo waveform into discrete left and right channels for AM stereo and FM broadcast. It includes de-emphasis circuitry, 15 kHz low pass filters and front panel and stereo indication, with a SPDT relay for external control. An easy way to take advantage of composite STLs for AM Stereo.

MANUFACTURER'S SUGGESTED LIST PRICE.....\$1695.00

ALLIED PRICE \$ _____

US AUDIO



The **US AUDIO GATEX®** audio processing tool is an innovative way to offer state-of-the-art technology that is highly effective. At your fingertips, control: reverberation decay time, background noise in multiple mic conferences, program feed line noise reduction as well as unused open mics during live performances.

MANUFACTURER'S SUGGESTED LIST PRICE.....\$435.00

ALLIED PRICE \$ _____

TEXAR

The **TEXAR AUDIO PRISM** is a very high-performance multi-band audio processor designed for major market broadcast use and other applications where sophisticated program handling is required. It utilizes four intelligent digitally-controlled processor cards to achieve high apparent loudness while producing few processing artifacts. Use with your OPTIMOD® in pursuit of top ratings.

AM or FM Audio Prism.....\$1995 per channel



APHEX

The **COMPELLOR™** is a revolutionary audio processor. It delivers intelligent compression, leveling, peak limiting simultaneously! The control circuits are actually analog computers that constantly monitor the input, adapt and control a single VCA per channel for minimal signal path. This versatile, cost effective processor is at home in broadcast pre-processing, microphone control, audio production, and tape duplicating.

MANUFACTURER'S SUGGESTED LIST PRICE.....\$1195.00

ALLIED PRICE \$ _____



The remarkable **APHEX AURAL EXCITER IIB** is a unique proprietary audio processing device that makes use of highly advanced psycho-acoustic principles to effectively restore and enhance audio presence, brightness and intelligibility. Designed specifically for on-air use, this unit provides AM stations with the clarity and brightness of FM.

MANUFACTURER'S SUGGESTED LIST PRICE.....\$2950.00

ALLIED PRICE \$ _____



The Model **700 STUDIO DOMINATOR** provides absolute peak ceiling. Total transparency below processing threshold during processing. Increased loudness, no hole punching, freedom from spectral gain intermodulation, minimal loss of transient feel, high density capability.

MANUFACTURER'S SUGGESTED LIST PRICE.....\$1195.00

ALLIED PRICE \$ _____



STUDIO TECHNOLOGIES

Unlike most outboard devices such as time delays, harmonizers and equalizers, the **AN-2** Stereo Simulator is fully mono compatible. This means recordings produced with the Stereo Simulator suffer no balance distortion when heard on mono radio. It is also a valuable resource for television broadcasters that offer stereo transmission using monaural material.

MANUFACTURER'S SUGGESTED LIST PRICE.....\$650.00

ALLIED PRICE \$ _____



EMT

The **EMT 266 & 277 DX** transient limiters were designed for absolute prevention of overdriving through use of the transient-limiter principle. Basic achievement is realized by means of predelay of the signal to be controlled. The EMT approach solves brief overshoot problems with 2 interesting circuit configurations:

- predelay of the program signal
 - an additional feedback regulated control limiter
- Mono and Stereo configurations available.

PRICES UPON APPLICATION

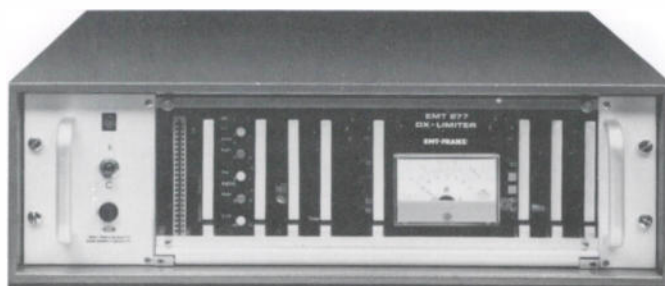



**SO NEW THAT PHOTOS
ARE NOT AVAILABLE**

CRL

This four band system will outperform any other multi-band compressor. It provides maximum density to increase coverage and pre-emphasis for improved fidelity. The **AM-4** stereo package contains the SPP800 PREPARATION PROCESSOR, a two band AGC unit that is gated to prevent noise pull-up, one SEP800 STEREO SPECTRAL ENERGY PROCESSOR, four band compressor/expanders with gating in each band, and an SMP900 AM STEREO MATRIX PROCESSOR, a state-of-the-art limiter which processes L + R and L-R separately.

MANUFACTURER'S SUGGESTED LIST PRICE.....\$5950.00

ALLIED PRICE \$ _____

This is the ultimate FM system. Maximum fidelity, maximum loudness and maximum control. The **FM-4** connects to your stereo generator and includes SPP800, a PREPARATION PROCESSOR, a two band AGC that is gated to prevent noise pull up, SMP800, an FM STEREO MODULATION PROCESSOR that provides absolute peak control and maximum fidelity, and one SEP800 SPECTRAL ENERGY PROCESSOR, a four band compressor/expander with gating in each band.

MANUFACTURER'S SUGGESTED LIST PRICE.....\$6750.00

ALLIED PRICE \$ _____

Circuit Research Labs has had an important part in the development of FMX. In cooperation with CBS Labs, the first 21 prototype quadrature generators were manufactured by CRL. **CRL FMX** will free your FM signal to the limits of normal mono reception, but in full stereo.

PRICE ON APPLICATION

UREI

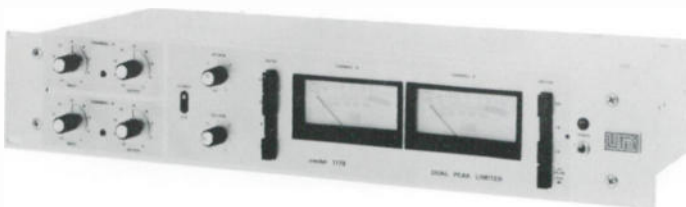
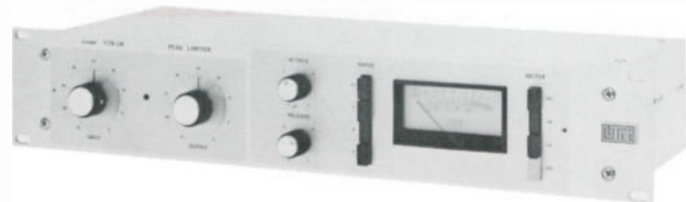

The **UREI 1176LN** single channel limiter features FET gain reduction ahead of the first stage. No tricky balancing required ever, there's no distortion adding active element in the gain reduction circuit, pushbutton selection of four different compression ratios and ultra fast attack time independent of peak duration or frequency and it's fully adjustable from the front panel.

MANUFACTURER'S SUGGESTED LIST PRICE.....\$596.00

ALLIED PRICE \$ _____

The **UREI 1178** dual peak limiter is a two channel version of the 1176LN. Limiting is accomplished by utilizing FET's as voltage variable resistors.

MANUFACTURER'S SUGGESTED LIST PRICE.....\$896.00

ALLIED PRICE \$ _____

VALLEY PEOPLE



The **Model 610** dual compressor/expander offers the convenience of two high-quality compressors with flexibility of multi-function dynamics processing in an attractive rack package. Each of the two channels consists of a compressor section and an expander section both controlling the common channel VCA. A special release coupling circuit provides symmetrical release characteristics for both the compressor and expander making interactive processing possible, thus eliminating the problems associated with using separate dedicated-function units.

MANUFACTURER'S SUGGESTED LIST PRICE.....\$995.00

ALLIED PRICE \$ _____

DBX

The **DBX 160X** compressor/limiter provides the broadcaster with outstanding performance and operational flexibility in a slim-line rack mount package. The 160X has all the features of the famous 160 and more. It is the only compressor/limiter that offers you the choice of OVER EASY or hard-knee operation, regardless of the compression ratio selected.

MANUFACTURER'S SUGGESTED LIST PRICE.....\$429.00

ALLIED PRICE \$ _____

The **DBX 166** Compressor/Limiter/Noise Gate. The concept is total dynamics control — every needed processing function, every point in the signal path, from input to output. The combination of noise gate, OverEasy compressor, and PeakStop limiting provides for complete manipulation of the dynamics of the input. For recording, broadcasting, producing, and other sound installation, the 166 gives you what you have to have.

MANUFACTURER'S SUGGESTED LIST PRICE.....\$549.00

ALLIED PRICE \$ _____

The **DBX 163X** Compressor/Limiter/Preamp provides traditional dbx sonic quality and performance in a rugged, easy-to-use package at a very untraditional price. It's designed for the small-studio operator, disco DJ — anyone who needs a low-cost, friendly compressor/limiter/pre-amp.

MANUFACTURER'S SUGGESTED LIST PRICE.....\$149.00

ALLIED PRICE \$ _____

The **DBX 263X** is the simplest, easiest-to-use de-esser on the market. (It's also easy on the budget.) Modeled after the dbx 902 module, the 263X is designed for the announcer, DJ, small-studio recordist, and anyone else who needs a friendly signal processor that completely and effectively controls sibilance (excessive "ess" sounds).

MANUFACTURER'S SUGGESTED LIST PRICE.....\$149.00

ALLIED PRICE \$ _____

The **DBX 463X** is the simplest, easiest-to-use noise-gate expander on the market. (It's also easy on the budget.) Modeled after our 904 modular noise gate, the 463X is designed for the recordist/mixer, ENG technician — indeed, for anyone who needs a friendly processor that gets rid of unwanted noise between notes or sounds.

MANUFACTURER'S SUGGESTED LIST PRICE.....\$149.00

ALLIED PRICE \$ _____

The **DBX 165A** is a result of combining the 165 and PEAKSTOP. The PEAKSTOP circuit which follows the compressor/limiter circuitry is a specially "soft clipper" that rounds the leading and trailing edges off the peak being clipped. By avoiding the normally sharp edges of a clipped peak, far fewer higher order harmonics are generated making PEAKSTOP less audible than other types of clippers.

MANUFACTURER'S SUGGESTED LIST PRICE.....\$699.00

ALLIED PRICE \$ _____

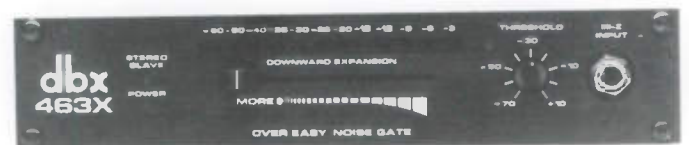
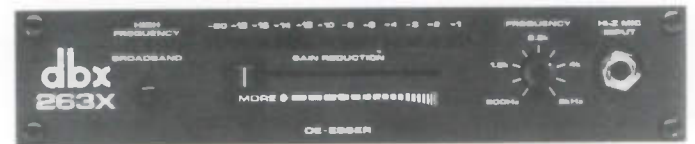

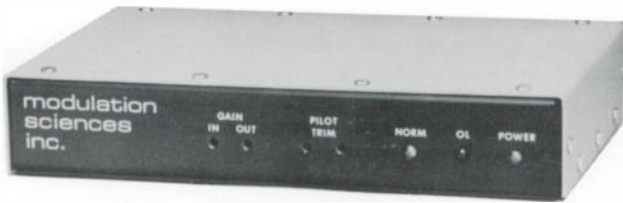

MODULATION SCIENCES

The **CP-803** Composite Processor corrects the distortion that conventional processors sometimes create. Conventional audio processors work with the left and right audio. But the CP-803 deals with the stereo composite signal that comes out of the stereo generator. By working on this signal instead of left and right audio, many audio problems are avoided. RACK MOUNT IS EXTRA.

MANUFACTURER'S SUGGESTED LIST PRICE.....\$960.00

ALLIED PRICE \$ _____

ORBAN



The ORBAN Model **245F** Stereo Synthesizer has been designed to take any mono signal and create lifelike pseudo-stereo. The patented Orban stereo synthesis technique causes no change in spectral balance, does not blur the transient definition, and adds not the slightest audible noise or distortion to the mono original. The major new features added to the 245F are a standard active balanced input and provisions for mounting optional output transformers.

MANUFACTURER'S SUGGESTED LIST PRICE.....\$399.00

ALLIED PRICE \$ _____



The ORBAN Model **275A** automatic stereo synthesizer has stereo inputs and outputs designed to be placed permanently in the program line. It has two methods of automatic mono recognition. Automatic switching between true and synthesized stereo by smooth cross-fade that avoids clicks, pops, and abrupt sensations. It has two stereo synthesis modes to allow matching the spatial perspective to the program material. Synthesizer uses phase-shift derived comb filter stereo synthesis technique.

MANUFACTURER'S SUGGESTED LIST PRICE.....\$1895.00

ALLIED PRICE \$ _____

TITUS

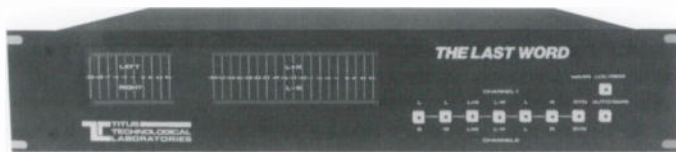

THE LAST WORD senses when channels are out-of-phase, corrects the error, and signals a warning to the operator on duty. It also senses when a channel is missing and instantly switches both outputs to the channel with audio. It will also warn your operating staff when a "stereo" program is really a mono program. **THE MICROPROCESSOR BASED LAST WORD** makes the "intelligent" decision and inaudibly "cross fades" the right answer into the audio chain.

MANUFACTURER'S SUGGESTED LIST PRICE.....\$2975.00

ALLIED PRICE \$ _____

VALLEY PEOPLE



The **VALLEY PEOPLE 440** limiter/compressor/dynamic sibilance processor offers the convenience of a peak limiter, a high quality compressor/expander package and a dynamic sibilance processor section, each controlling a common voltage controlled amplifier. The employment of linear integration allows the unit's detector to emulate the response of the human ear in order to maintain correct musical relationships in processed material.

MANUFACTURER'S SUGGESTED LIST PRICE.....\$599.00

ALLIED PRICE \$ _____

VALLEY PEOPLE

Transparent, low-noise, distortion-free operation is what the **QLZ 813** transformerless quad mic. preamp delivers. Each of the four independent, low impedance inputs is adjustable from 20 dB to 60 dB of gain. An LED clip indicator and phase reverse switch are provided for each input. The QLZ is also equipped with 48 volt 'phantom' powering.

MANUFACTURER'S SUGGESTED LIST PRICE.....\$550.00

ALLIED PRICE \$ _____

The wide 7-octave range on each of the **MAXI-Q (812's)** 3 frequency bands results in a 6-octave overlap insuring effective spectrum coverage. Series filters are used to eliminate filter interaction and reduce noise and distortion usually developed in the summing stage. The exclusive 'tune' mode allows the operator to 'solo' filter settings prior to affecting equalization.

MANUFACTURER'S SUGGESTED LIST PRICE.....\$420.00

ALLIED PRICE \$ _____

Beyond its unsurpassed noise gating capability, the **KEPEX II (810)** handily eliminates tape hiss, equipment hum and buzz and undesirable ambient noise. Increased dynamic range is recognized via the 810's active expansion mode.

MANUFACTURER'S SUGGESTED LIST PRICE.....\$420.00

ALLIED PRICE \$ _____

This limiter/compressor preserves program dynamic integrity because it understands music and speech. The **GAIN BRAIN 811** does not respond to arbitrary voltage or power levels; its response is variable depending upon the degree of waveform complexity.

MANUFACTURER'S SUGGESTED LIST PRICE.....\$420.00

ALLIED PRICE \$ _____

The **PR-10** rack processing package is designed to house and power up to 10 single-card "800" series modules. This rack mounting scheme is the most cost effective means of implementing the full complement of Valley People "800" series equipment. A PR-10 unit fits into a 5¼" x 19" rack space.

MANUFACTURER'S SUGGESTED LIST PRICE.....\$550.00

ALLIED PRICE \$ _____

Finally, a mic processor that needs nothing else. The new model **400** mic processor features:

- Mic level in . . . Hi-or Lo-level out
- Extra Hi level send & return for further processing or effects
- Eq. compress, gate, de-ess, PROCESS
- Flexibility in interfacing your signal chain

MANUFACTURER'S SUGGESTED LIST PRICE.....\$595.00

ALLIED PRICE \$ _____

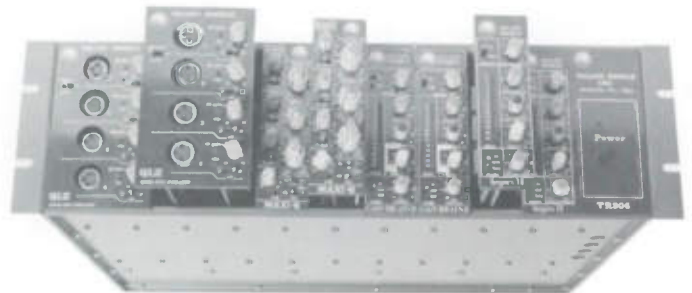

800 SERIES



PRICES ARE US DOMESTIC ONLY

VALLEY PEOPLE

Design criteria dictated that the "400" series do all things exceedingly well to outperform the very best "dedicated-purpose equipment." Proprietary circuitry evolved through exhaustive studies of the physics and psycho-acoustics of dynamic manipulation. The "400" series remains the most versatile and cost-efficient approach to multi-function signal processing on the market today!



400 SERIES

The Dyna-Mite (430), available in mono or stereo, performs several variations of 18 specific operating modes, including: limiting; expanding; noise gating; keying; FM limiting; de-essing; and "voice-over".

MANUFACTURER'S SUGGESTED LIST PRICE.....\$460.00

The Dyna-Mic/Mite (431), combination adds transformerless brilliance to a variety of input impedances and optimizes them for routing through the 3-band EQ section and/or the Dyna-Mite. The signal then appears at the output enhanced by processing which only a device of this caliber can deliver.

MANUFACTURER'S SUGGESTED LIST PRICE.....\$560.00

The Dyna-Mic (432), available in mono or stereo, offers 2 independent, transformerless preamps, with on-board 3-band tone control. Each of the 2 inputs on a Dyna-Mic card may be optimized for microphone, line or musical instrument impedances and levels. The single output of each card is switchable to +4 dBm, -10 dBv or -20 dBv nominal line levels.

MANUFACTURER'S SUGGESTED LIST PRICE.....\$560.00

CALL FOR THE ALLIED PRICE

BARCUS-BERRY

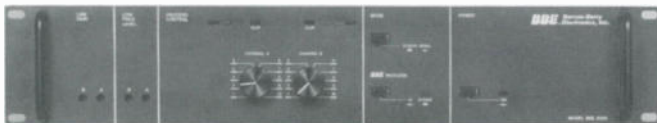

The **Barcus-Berry 202R** uses a sound technology which is based on load reactance compensation and specifically designed to enhance overall quality of sound produced by any dynamic speaker. The 19-inch rack-mountable chassis occupies two standard EIA spaces; adding the piece requires nothing more than insertion between the program source and the transmission line. A simple adjustment is all that is required for normal set-up.

MANUFACTURER'S SUGGESTED LIST PRICE.....\$750.00

ALLIED PRICE \$ _____

EVENTIDE



The **EVENTIDE H949** Harmonizer is used by top bands and top recording organizations around the world. They are incredibly versatile units combining digital delay, pitch change, and a variety of other features. Harmonizers can be used for doubling vocals, for delay equalization in sound reinforcement, and for many types of reverb/echo.

MANUFACTURER'S SUGGESTED LIST PRICE.....\$3500.00

ALLIED PRICE \$ _____



Eventide presents "the next step in pitch change technology" with its **PRO PITCH HARMONIZER H969** giving you the cleanest, highest quality pitch change ever. The digital electronic-splicing algorithm attains glitch-free pitch changes. Its 16 bit linear PCM circuitry delivers superb audio quality in all modes. Wide range delay — up to 3 seconds, variable time presets and, delays, plus flanging and doppler features. This is Eventides best harmonizer ever!

MANUFACTURER'S SUGGESTED LIST PRICE.....\$4500.00

ALLIED PRICE \$ _____

DBX

Digital audio encoding/decoding is achieved two different ways. One way is PCM (pulse-code modulation). It's the accepted and great-sounding (but very expensive) circuit you find in digital recording systems right now. The other way is DM (delta modulation). It's less expensive but produces less-than-acceptable sound. So when dbx entered the digital ring, they knew their task was to create the best of both worlds. dbx engineers did just that.

Precision Companding solves a major problem with delta modulation—limited dynamic range. The **dbx 700** offers a dynamic range of more than 110 dB, resulting in an unbelievably low noise floor that's completely neutral-sounding. The compander's novel design and the direct digital link between encoder and decoder guarantee not just that it cannot mistrack but that its overall performance is absolutely transparent.

Linear Prediction estimates a signal's future by monitoring its recent past. It does this 700,000 times a second. This further increases the dynamic range of our fixed delta modulator and prevents the audible noise modulation common in other forms of DM.

The bottom line is the extraordinary sound quality of digital at a fraction of the cost of the competition. You can create a digital remote transmission system with the dbx 700 Digital Audio Processor and the MA/COM system that will rival live performance.

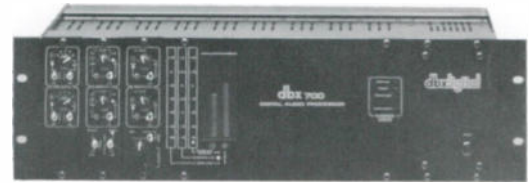

700 Series

SPECIFICATIONS:

Channels:	two
Frequency response:	10 Hz-20 kHz \pm 1/2 dB
Dynamic range:	(unweighted, maximum rms signal to noise floor, input shorted, noise bandwidth 20 kHz): greater than 110 dB
Wow/flutter:	less than 0.01% unweighted; less than 0.006% wrms
THD:	less than 0.03% total harmonic distortion, 1 kHz, 1 V rms input
Sampling rate:	700 k bits/sec
A/D conversion:	precision-companded, linear-predictive delta modulation
Console connections:	Line in, balanced, 10 k-ohms. Line out, electronically balanced; will drive 600 ohms to +24 dBm
Dimensions:	5 1/4" H x 19" W x 11 1/2" D
Weight:	approx. 20 lbs

CRL

The CRL Dynafex model **DX-2** incorporates patent pending noise reduction circuitry that provides up to 30dB of noise reduction.

The DX-2 is a two-channel device that will operate as a full stereo unit with both channels tracking together, or it may be used in the mono mode.

The DX-2 can be utilized with -10, 0, +4 and +8 dB reference levels. Selection of the proper reference level is made by a front panel switch on each channel enabling the unit to be interfaced easily with consumer, sound reinforcement, recording and broadcast levels.

Input and output connections on the DX-2 are made via XLR connectors located on the rear panel and are active balanced. Complete RFI filtering is provided on the inputs and outputs.



MANUFACTURER'S SUGGESTED LIST PRICE.....\$800.00

ALLIED PRICE \$ _____

— NOISE REDUCTION —

DBX

DBX has created the **Series 900** modular signal processing system. The Model **902 De-esser** can be used as a conventional broadband de-esser or for attenuating only a user-determined portion of the high frequency range. The **Model 903 Compressor** with its **OVER EASY** compressor gives smoother, more listenable compression. The **Model 904 Noise Gate** is the ultimate noise gate, with a combination of features not found on any other noise gate. Features like adjustable attack and release rates, threshold adjustment from -30 to +30 dB, attenuation limit adjustment from 0 to 60 dB.

DBX 902.....\$359.00 **ALLIED PRICE \$ _____**

DBX 903.....\$359.00 **ALLIED PRICE \$ _____**

DBX 904.....\$359.00 **ALLIED PRICE \$ _____**

DBX PRICES ABOVE ARE MFR'S SUGGESTED LIST PRICES. CALL FOR THE ALLIED PRICE



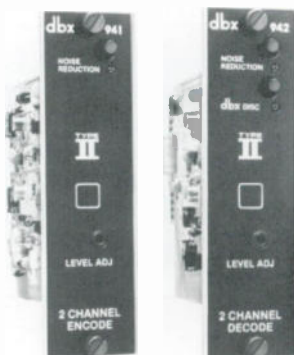

DBX

The **DBX Models 941A** and **942A** provide broadcasters with Type II noise reduction in the convenient Series 900 modular format. The 941A is a two-channel encode only Type II noise reduction unit, the 942A is a two channel decode only Type II noise reduction module which features an additional switchable provision for decoding DBX encoded discs.

DBX 941A.....\$269.00 **ALLIED PRICE \$** _____

DBX 942A.....\$279.00 **ALLIED PRICE \$** _____

Housing including power supply.....\$525.00
ALLIED PRICE \$ _____

Blank panels (each).....\$10.00 **ALLIED PRICE \$** _____

DBX PRICES ABOVE ARE MFR'S SUGGESTED LIST PRICES. CALL FOR THE ALLIED PRICE

The **DBX 140A** simultaneous encode/decode broadcast noise reduction system is a two channel compressor/expander providing a minimum of 30 dB broadband audio noise reduction with a 10 dB increase in system headroom. The two channels feature independent encode and decode circuitry. Not compatible with Type I. The DBX system eliminates tape hiss in recording, and prevents the noise build-up normally encountered in transferring information from one recorded medium to another. L. R/P + R. R/P switchable.

MANUFACTURER'S SUGGESTED LIST PRICE.....\$589.00

ALLIED PRICE \$ _____

— EQUALIZATION —

ORBAN

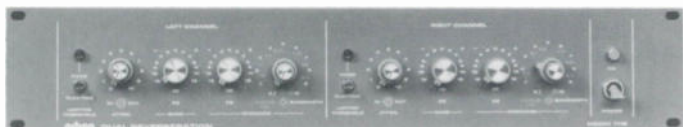

The versatility of the quasi-parametric midrange equalizer complements the simple, inflexible equalization found on many low-cost mixers, and permits the owners of such systems to get the exact reverb sound they want. In addition, the **111B** has very high basic input sensitivity (-30 dBm), and a front-panel input gain control makes it usable with all mixers—even those with unusually low level sends.

This versatility is complemented by a fully-professional 0 dBm balanced, floating output. This arrangement vastly improves immunity to RF interference, and assures easy integration into any system without introducing ground loops and hum.

PRICE UPON APPLICATION

The **622** parametric equalizer consists of a balanced input buffer amplifier, and input attenuator, and four peak/dip equalization sections connected in series, assuring no interaction between sections. The final section contains a current booster capable of driving 600 ohm loads. The output of the input buffer and each of the equalization sections is monitored at all times by the overload indicator. The EQ IN/OUT switch bypasses all circuitry but the input buffer and output amplifier. It is arranged so that the gain and signal polarity are maintained constant in the IN and OUT modes.

622A single channel.....\$569.00 **ALLIED PRICE \$** _____

622B dual channel.....\$879.00 **ALLIED PRICE \$** _____

RET-5 optional output balancing transformer
(1 per channel).....\$16.00

ORBAN PRICES ABOVE ARE MFR'S SUGGESTED LIST PRICES. CALL FOR THE ALLIED PRICE.

ORBAN

The **ORBAN mono Model 672A** and **stereo Model 674A** are cost effective, professional, quasi-parametric equalizers with the convenience of graphic type EQ controls. Wide range high and low pass filters with 12 dB/octave Butterworth slopes follow the graphic section for added versatility. Each feature has been thoughtfully chosen and cleverly implemented to make the equalizer a particularly powerful tool in nearly all areas of audio.

672A mono.....\$689.00 **ALLIED PRICE \$** _____

674A stereo.....\$1299.00 **ALLIED PRICE \$** _____

Optional output balancing transformer, per channel.....\$16.00

ORBAN PRICES ABOVE ARE MFR'S SUGGESTED LIST PRICES. CALL FOR THE ALLIED PRICE.

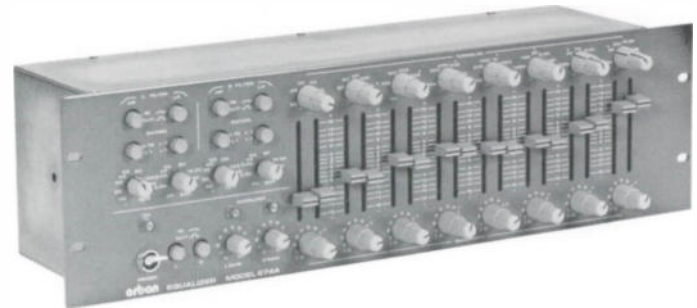
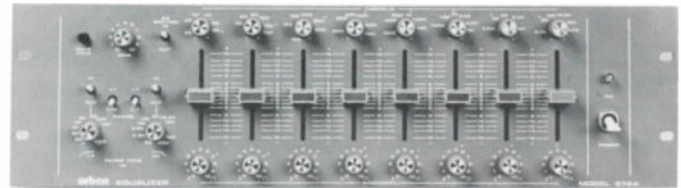

RANE

The **GE 30** 1/3-octave graphic equalizer is a new functional concept which allows one single unit to provide all the capabilities that previously required two separate equalizers. It's the first graphic equalizer ever to let you switch from a +12/-15db boost-cut mode to a 0/-20dB cut-only mode by simply pushing a button on the back. The first with 60mm sliders, for maximized resolution in a 3.5" format. And the first with a user-switchable active direct-coupled or transformer-coupled complementary balanced output configuration as standard. Using 2nd generation Constant-Q filters, it provides all the proven advantages of constant bandwidth performance with even less overall ripple.

GE 30.....\$699.00 **ALLIED PRICE \$** _____

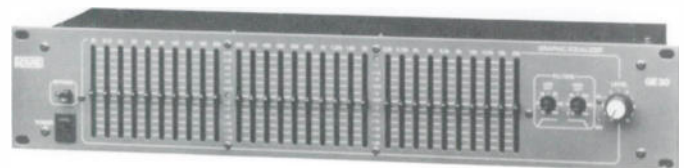

KLARK-TEKNIK

Primarily the **DN300** 1/3 octave 30 band mono equalizer is used for tonal control, but the unit can be used in virtually any situation where equalization is required -- particularly studio listening rooms to improve the overall frequency response of the monitoring sound system.

DN300 1/3 octave mono, 30 band equalizer.....\$995.00

ALLIED PRICE \$ _____

The **DN332** dual 2/3 octave 16 band equalizer is used for stereo tonal control, and particularly in outside broadcasting to equalize lines. The use of the DN332 can provide the engineer with two full frequency range 2/3 octave channels of equalization.

DN332 Dual 2/3 octave, 16 band.....\$1095.00

ALLIED PRICE \$ _____

DN332B DN332 with balanced outputs.....\$1245.00

ALLIED PRICE \$ _____

Primarily the **DN360** dual 1/3 octave 30 band equalizer is used for stereo tonal control, but particularly in Audio and Video cassette duplication to correct for frequency response or tonal irregularities during mastering and to adjust for tape loading characteristics.

DN360 dual 1/3 octave, 30 band equalizer.....\$1625.00

ALLIED PRICE \$ _____

DN360B DN360 with balanced output.....\$1775.00

ALLIED PRICE \$ _____

KLARK-TEKNIK PRICES ABOVE ARE MFR'S SUGGESTED LIST PRICES. CALL FOR TODAY'S ALLIED PRICE.





UREI

The **UREI 535** dual graphic equalizer offers 10 filter sections per channel with increased control range, and more output capability. The 535 provides 12 dB of boost or cut at each of its 10 frequencies, which are centered at ISO one-octave increments from 31.5 Hz to 16 kHz, with balanced bridging differential amplifier inputs, variable gain, floating transformer isolated outputs of 150 ohms or greater load and is rack-mountable.

MANUFACTURER'S SUGGESTED LIST PRICE.....\$546.00

ALLIED PRICE \$ _____

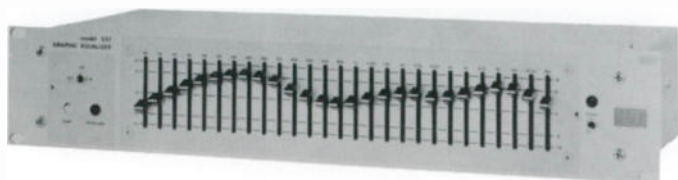

The **Model 537** is a 1/3 octave equalizer set for general purpose frequency response adjustment of audio signals. It offers 27 adjustable equalizers on ISO 1/3 octave center frequencies, 12 dB boost or attenuation at each center frequency, stepless-noiseless controls, precision calibrated, state-of-the-art L-C filter circuitry, low distortion-low noise with minimum phase shift, zero insertion loss and is rack-mountable.

MANUFACTURER'S SUGGESTED LIST PRICE.....\$996.00

ALLIED PRICE \$ _____

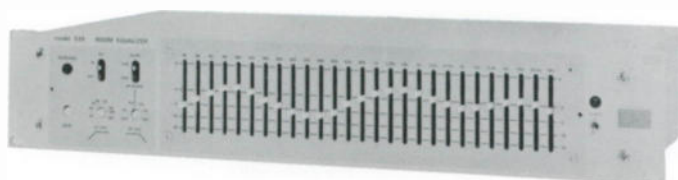

The **Model 539** is an active filter set specifically designed for room "equalization" or tuning. The 539 utilizes advanced circuit technology and latest state-of-the-art components to achieve quantum improvements in performance and at lower cost. Signal to noise ratio is better than 110 dB at maximum output. Filter parameters have been optimized to produce excellent combining and minimum phase shift.

MANUFACTURER'S SUGGESTED LIST PRICE.....\$1096.00

ALLIED PRICE \$ _____

— DELAY LINES —



EVENTIDE

EVENTIDE, the world leader in digital broadcast audio delays, presents the "no compromise" economy obscenity delays, the mono **BD931** and stereo **BD932** each in 3.2 and 6.4 second configurations. Priced to be cost effective even for stations that air only limited talk programming. Digital RAM based circuitry eliminates all the problems of tape loop delays. 16 kHz band width.

BD931 mono 3.2 sec.....\$1795.00 ALLIED PRICE \$ _____

BD931 mono 6.4 sec.....\$2295.00 ALLIED PRICE \$ _____

BD932 stereo 3.2 sec.....\$2595.00 ALLIED PRICE \$ _____

BD932 stereo 6.4 sec.....\$4495.00 ALLIED PRICE \$ _____



The **Model BD955** was designed specifically for policing of live talk shows. It is a RAM based digital delay line, available in two frequency ranges, 7.5 kHz for reproduction of telephone audio and 15 kHz for quality reproduction of the full spectrum. There are two maximum delay times available, 3.2 or 6.4 seconds. The unit has a unique "catch up" feature which enables it, after the objectionable material has been dumped, to regain its delay safety margin automatically. Two of the same model are required for stereo.

BD955 7.5 kHz 6.4 sec.....\$3350.00 ALLIED PRICE \$ _____

BD955 15 kHz 3.2 sec.....\$3350.00 ALLIED PRICE \$ _____

BD955 15kHz 6.4 sec.....\$4300.00 ALLIED PRICE \$ _____

Stereo interconnect add \$150

EVENTIDE PRICES ABOVE ARE MFR'S SUGGESTED LIST PRICES. CALL FOR THE ALLIED PRICE.

EVENTIDE

The **BD980** features an advanced, de-glitched CATCH-UP system. When objectionable program audio is "DUMP"ed with the BD980, delay catch-up is fast and audio quality is clean. Contributing to the unit's superb audio quality is the 16-bit linear PCM design and 50kHz sampling rate. Frequency response extends to 20kHz.

Two independent stereo channels of delay are standard. Maximum delay time is an unprecedented 10 seconds. Delay time can also be manually selected with resolution to one millisecond. A DELAY MAX switch permits instant return to maximum delay.

The BD-980 is also the first and only broadcast delay to feature time compression capabilities.

MANUFACTURER'S SUGGESTED LIST PRICE.....\$5495.00

ALLIED PRICE \$ _____



AUDIO DIGITAL

The **TC-4** Broadcast Digital Processor is a state-of-the-art advancement in broadcast profanity delay. It features delay time of 6.8 seconds, with a 15kHz bandwidth and 85dB dynamic range. The optional (user-installable) auxiliary card allows memory dump in less than two seconds, as well as a delay time catch-up feature to allow starting in near real time.

CALL FOR THE ALLIED PRICE



— INTERFACES —

VALLEY PEOPLE

The HH 2 x 2 level matching interface is the most cost effective and reliable product to solve the age old dilemma of interfacing -10 dB equipment to the studio and broadcast standards of +4 and +8 dB. In response to RF field situations, VALLEY PEOPLE has designed the **HH 2 x 2B**. In addition to the original features the 2 x 2B offers electronic balancing for the +4/+8 outputs and improved RFI rejection.

MANUFACTURER'S SUGGESTED LIST PRICE.....\$250.00

ALLIED PRICE \$ _____

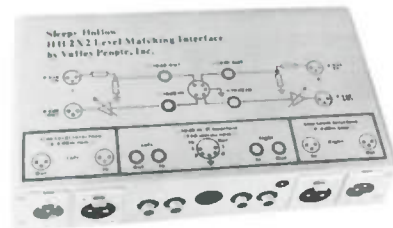

HENRY

The **MATCHBOX** is the ideal, inexpensive way to correctly interconnect semi pro equipment with pro studio gear. The MATCHBOX is bi-directional, with four independent amplifiers for stereo input and output interface. Two amplifiers convert a stereo IHF HI-Z unbalanced source to LO-Z balanced outputs at studio level. A second pair of amplifiers converts the stereo balanced studio line source to unbalanced IHF outputs to feed the inputs of an IHF device. All circuitry is active and direct coupled for absolute sonic transparency.

MANUFACTURER'S SUGGESTED LIST PRICE.....\$195.00

ALLIED PRICE \$ _____



RTS

The **Model 444** is a dual, two channel buffer amplifier designed to interface professional systems with semi-pro and high fidelity equipment. Although components designed for home use offer desirable features for studio applications, interconnections between the two kinds of equipment are complicated by differences in levels, impedances and balanced and unbalanced modes of operation. The 444 corrects these problems while maintaining signal integrity.

MANUFACTURER'S SUGGESTED LIST PRICE.....\$368.00

ALLIED PRICE \$ _____



TRISTECH AUDIO

The price is right on the **FX-100** matching box and we ran our own tests, so here are the results:



	<u>Unbal IHF In/Bal Out</u>	<u>Bal In/Unbal IHF Out</u>
Maximum Output	+ 25 DBM	+ 19 DBM
Maximum Input	+ 19 DBM	+ 25 DBM
THD	.002%	.003%
IMD	.005%	.003%
Noise	100 dB (unweighted) 90 dB (unweighted)	98 dB (unweighted) 80 dB (unweighted)

MANUFACTURER'S SUGGESTED LIST PRICE..... \$129.95

ALLIED PRICE \$ _____

SENTRY SYSTEMS

The **AIR SENTRY** is designed to constantly monitor the presence of an audio signal and to energize a relay when the audio is absent. Activation of the relay is front panel adjustable from 4 to 20 seconds. The relay may in turn be used to monitor any stereo or mono audio source such as audio from an AM/FM tuner, TV receiver or modulation monitor. AIR SENTRY is built to broadcast standards of reliability. Quick and easy rear panel connections via "Molex" type connectors (mating ends supplied).



MANUFACTURER'S SUGGESTED LIST PRICE..... \$295.00

ALLIED PRICE \$ _____

CONEX

The **CONEX CG-25** Hz tone generator has built-in high pass filters for both the left and right channels, front panel LED indication of tone duration, silence and maximum length of untimed tone. All timing intervals, tone lengths and audio levels are easily adjustable from the rear panel. Standard six-pin "Cinch Jones" type connectors are provided for simple connection between the console and the recorder. The tone is switch-selectable to allow recording tone on either channel. For ease of servicing all integrated circuits are socket mounted. The CG-25 offers low distortion circuitry, the oscillator and audio have less than .5% total harmonic distortion. Also rack mountable - Call for details.



MANUFACTURER'S SUGGESTED LIST PRICE..... \$350.00

ALLIED PRICE \$ _____

The **Conex CS-25** dual 25 Hz tone sensor is a compact and reliable bridging-type 25 Hz tone sensor for use in broadcast automation and tape control systems. The unit features two independent sensors, allowing very economical expansion of existing systems. The CS-25 offers front panel stop-delay adjustment to accommodate any tape format, indicator lights on the front panel to indicate presence of tone, front panel disable switches which inhibit the relays allowing the tape to run without stopping at tones or signalling of the automation system.



MANUFACTURER'S SUGGESTED LIST PRICE..... \$395.00

ALLIED PRICE \$ _____

**Entire Contents Copyright
Allied Broadcast Equipment, Inc.**

SONOMAG (SMC)

The industry's most cost effective programming tool, the **ESP-2**, will operate fully automated, satellite fed, live assist, or in any combination.

The ESP-2's 4,000 event memory (expandable to 8,000) allows programming days in advance. With its 682 step, seven day, user programmable clock, the ESP-2 executes time instructions for up-dates, network joins or external time functions with ease.

The ESP-2 gives the operator full manual control of up to 20 audio sources for live assist operation or semi-auto operation.

TYPICAL MUSIC SERVICE SYSTEM

ESP-2 Programmer (Rack Mounted, with Remote Control Head)

3-Random Access Carousels

3-SMC/OTARI ARS-1000 Reel to Reel Reproducers with SMC exclusive Auto-Rewind/Recue and 25 Hz tone sensors

2-721 Dual Cartridge Playbacks (4 single play sources)

3-System Racks, fully cabled

PRICES VARY WITH APPLICATION CONTENT - CALL ALLIED

The **MSP-1** is an inexpensive microprocessor controlled computer with all the ability and sophistication expected in any high level automatic programmer, including: Network Join on a real time basis, Backfill Control, full random access control of Carousels and multi-cartridge reproducers up to 99 trays, sub-routines, silence sense, built in 25 Hz filters, full clear-text logging capability and external time flag for Network delay recording.

- Deep 2,000 event memory non-expandable with full sub-routine capability and 250 step user programmable clock.
- Directly interfaces to Satellite Receiver Tone Decoders.

MFR. SUG. LIST PRICE FOR BASIC SYSTEM.....\$7100.00

ALLIED PRICE \$ _____

The **MINI-PRO I** fulfills the need for a practical programmer fully capable of providing automated operation of Satellite and conventional syndicated music services as well as live assist functions. The MINI-PRO and its exclusive 'Electronic Console' puts full remote control at the operator's fingertips.

The microprocessor controlled digitally programmed MINI-PRO is designed to be connected to any standard piece of broadcast source equipment (Multi-cartridge reproducers, Reel to Reel Reproducers, Satellite Receivers and their tone decoders, Network Lines and Live Studios) without cumbersome interfaces and 'black-boxes'!

MFR. SUG. LIST PRICE FOR BASIC SYSTEM.....\$4900.00

ALLIED PRICE \$ _____

The proven features of earlier SMC Carousels have been retained including cast aluminum drum, steel cartridge trays and ball bearing cross shaft. Now the Model **450 (Mono)** and **452 (Stereo)** combine microprocessor flexibility for Bi-directional operation, front monitoring lights, and enable system to allow off-air audition. The tape deck, the drive motors, and the electronic chassis are all readily field-serviceable.

CALL ALLIED FOR PRICE SPECIFICS

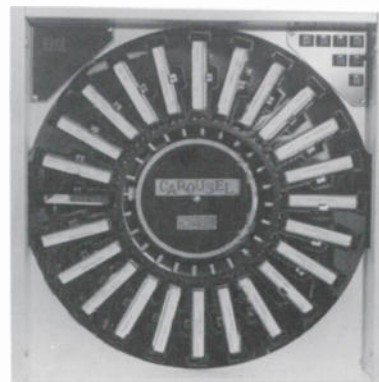
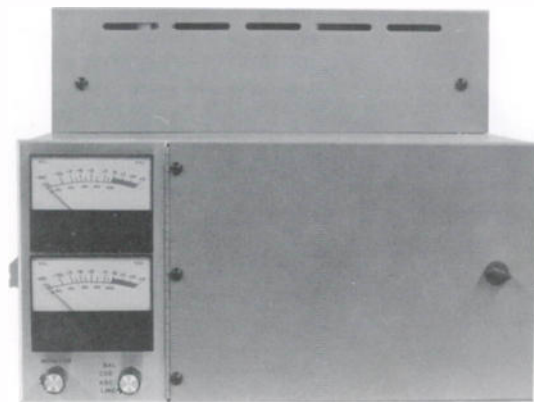
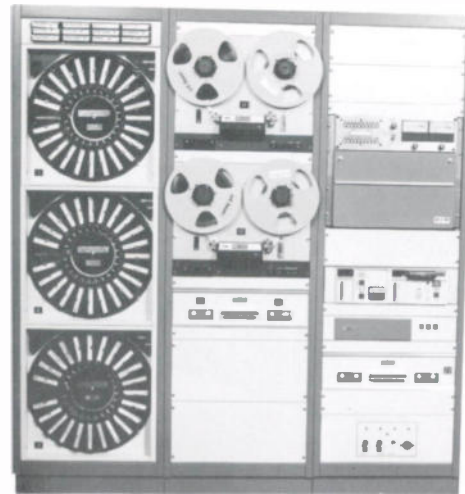

MPA



The **PROGRAMMER 3A** is the latest in a series of highly successful radio music programming aids. The 3A allows the stations to take advantage of music formats which have been recorded on reel-to-reel tape for automation systems. Up to four reel-to-reel tape decks can be controlled by PROGRAMMER 3. The outputs can be wired mono or stereo directly to program and cue buses of a studio console eliminating the need for additional console inputs. A memory circuit allows the operator to select the music deck he will play next.

MANUFACTURER'S SUGGESTED LIST PRICE.....\$990.00

ALLIED PRICE \$ _____



Designed and built to fill a need in the broadcast field, the **PERSONS 25** Hz tone processor performs all the tone handling functions required to interface a reel-to-reel recorder with an automation or "live assist" system. One 25 Hz tone processor will handle one stereo or two mono tape decks. Each 25 Hz tone processor consists of two 25 Hz tone decoders tied to two program amplifiers with 25 Hz notch filters. The 25 Hz tone detectors offer accurate, false-free recognition of tones. The stop/delay timers are precise and repeatable. All logic circuits are relay contacts for interfacing with any tape deck and system. Incoming and outgoing terminations are brought to a convenient, clearly marked terminal strip on the rear.

MANUFACTURER'S SUGGESTED LIST PRICE.....\$399.00

ALLIED PRICE \$ _____

JUKEBOX

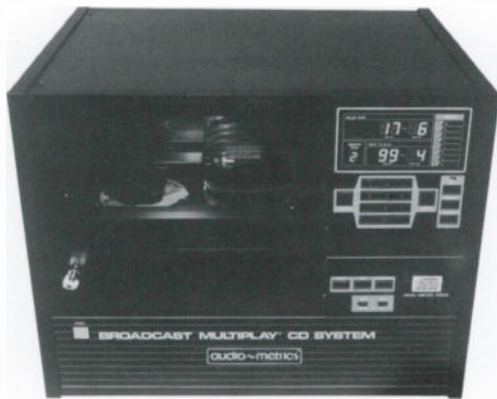

The model **AMCDS — 1000A** is equipped with a main microprocessor for system control and a sub-microprocessor for CD playback operations. The player holds 100 CDs* and features automatic random access to any disc and any cut either through its self contained 8 step memory or by connection to an external programmer or computer. Cues to music within 300 ms. Back to back capability with 2nd player and external programmer allows 2000-song capability.

*under lock & key

CALL TODAY FOR THE ALLIED PRICE

COMPUSONICS



CompuSonics created the **DSP-2002** for professional radio and television broadcasting service. Functionally, the DSP-2002 equals or exceeds conventional tape recorders with the additional benefits of digital sound quality, random access and interactive editing.

CALL FOR ALLIED PRICE SPECIFICS

Illustrations, descriptions and prices are subject to change without notice.

OTARI

The **Otari CTM-10** series consists of NAB audio cartridge players and recorders designed for broadcast and audio post-production professionals. The series consists of three models: the CTM-10R stereo record/play deck, and the CTM-10RM mono record/play deck, and the CTM-10 mono + stereo playback deck, to which recording capability is a simple retrofit. Three CTM-10 series decks may be rack mounted side-by-side in only 5 1/4" of 19" rack space. The record electronics unit, housed in a separate chassis, is the same size. The tape speed of CTM-10 transports may be user-converted to 15, 7.5 or 3.75 ips by means of internal jumpers.

The CTM-10 record electronics unit incorporates Dolby HX-Pro* bias optimization circuitry.

All CTM-10 transports feature long-life heads, brushless DC PLL servo capstan motors, dynamic braking, active balanced inputs and outputs, ceramic capstan shafts, and precision milled alloy deckplates for reliability and stable performance. (*HX-Pro is a trademark of the Dolby Licensing Corp.)

Model

CTM-10 R Stereo Record/Play.....\$4295.00
ALLIED PRICE \$ _____

CTM-10 RM Mono Record/Play.....\$3945.00
ALLIED PRICE \$ _____

CTM-10 M&S Mono + Stereo Playback.....\$2770.00
ALLIED PRICE \$ _____



FIDELIPAC

The **DYNAMAX CTR10** Series of cartridge players and recorders features all of the mechanical advances introduced in the Dynamax CTR100 Series, and all but the most esoteric electronic features, as well.

With the advent of the the Dynamax CTR10 Series, studios will be able to replace older equipment, in a most cost effective way, and meet the critical demands of engineers, programmers, and listeners. And do it because the advanced features of the Dynamax CTR10 are all standard, not extra cost options.

The CTR10 Series includes both Mono and Stereo units, with secondary (150Hz) and tertiary (8kHz) cue tones. There is also a Fast Forward mode, which can be used manually or controlled automatically by the secondary cue tone.

The head nest arrangement of the CTR10 allows geometrically correct azimuth adjustment — independent of height and zenith. And like the CTR100, the new CTR10 incorporates a unique audio switcher and a mixer. Features never before found at such a low price.

The **CTR100 Series** offers features no other tape cartridge machines provide. The CTR100 is the machine by which all others must be judged.

Among the outstanding features the CTR100 offers are the exclusive **CARTSCAN** System, which allows the operator to intermix cartridges recorded in various audio formats. The system also provides an auxiliary output to activate equipment such as a Dolby® encoder or decoder.

Vary Speed allows the operator to continuously vary the motor speed, yet maintain cue tone tracking.

A real time digital tape counter displays total elapsed time, regardless of tape speed.



PRICES ON APPLICATION FOR CTR10 & CTR100

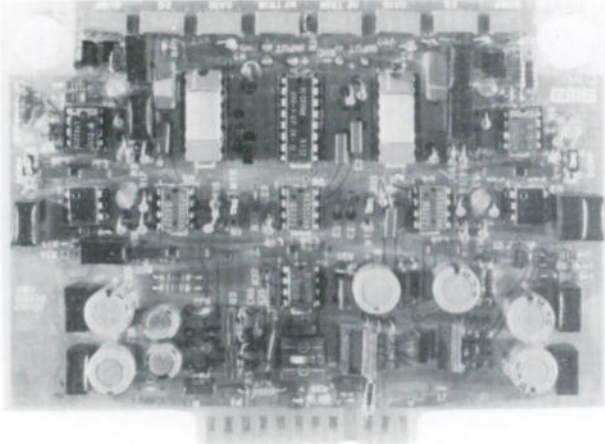

SWA

The **SWA 3D/RP Retrofit Card** is the result of a 2-year effort to advance the art of tape playback sonics. The excellent mechanical quality and reliability of the ITC 3D and RP series machines is now complemented by the SWA 3D/RP Amplifier. These machines should, with proper maintenance, provide another 20 years or more of service. The SP machines can even be run at 15 IPS by replacing the motor with one from a 750 reel-to-reel deck which has the same size and motor mounting template. But the original program amplifier board is an early classic transistor textbook AC coupled design. Until now, the only way to remedy this problem was to buy a new machine, which left a mechanically excellent item sitting on the shelf.

MANUFACTURER'S SUGGESTED LIST PRICE.....\$299.00 Stereo
\$176.00 Mono
ALLIED PRICE \$ _____

RADIO SYSTEMS

KEY CART



The **KEY/CART** secret for its low profile compact packaging, is the toroidal power supply giving it a 3 3/4" height. It features quality construction with plug-in electronics. Playback circuitry features a unique auto-mute feature that reduces noise by muting the output until a cart has been inserted and the machine is in the "ready" mode. Tape speed stability is assured by the large, solid brass flywheel assembly and precision ground steel capstan shaft with self lube sintered-bronze steel bearings.

KC-1000 P: mono-playback unit.....\$595.00
ALLIED PRICE \$ _____

KC-1000 PS: stereo-playback unit.....\$795.00
ALLIED PRICE \$ _____

KC-1000 RP: mono-record/playback unit.....\$795.00
ALLIED PRICE \$ _____

KC-1000 RPS: stereo-record/playback unit.....\$1095.00
ALLIED PRICE \$ _____

BROADCAST ELECTRONICS



The **2100** family of tape cartridge machines combines versatile operation, quality components and top specifications, all at an economical price. There's more value in the 2100 series than ever found before in any professional cart machine. The combination of advanced engineering and cost saving production methods produces a cart machine with double value for the most quality-minded users.

2100P Play, Mono...\$1175.00 **ALLIED PRICE \$ _____**

2100RP Rec/Play, Mono...\$1795.00
ALLIED PRICE \$ _____

2100PS Play, Stereo...\$1275.00
ALLIED PRICE \$ _____

2100RPS Rec/Play, Stereo...\$2095.00
ALLIED PRICE \$ _____

Accessory prices upon request

BROADCAST ELECTRONICS PRICES ABOVE ARE MFR'S SUGGESTED LIST PRICES. CALL FOR TODAY'S ALLIED PRICE.

BROADCAST ELECTRONICS
3000 SERIES

Series 3000 machines have all the standard features: a direct drive hysteresis synchronous motor, an air damped solenoid with excellent reserve capability, and a 1/2" thick machined aluminum deck. In addition, these machines are loaded with extras like the Phase Lok III head bracket, low voltage solenoid switching, advanced integrated circuit/solid state design with exceptionally wide dynamic operating ranges, long life NORTRONICS DURACORE heads, and an outstanding set of performance specifications.

3100P Play, Mono...\$1300.00	ALLIED PRICE \$ _____
3100PS Play, Stereo...\$1450.00	ALLIED PRICE \$ _____
3200P Play, Mono...\$1325.00	ALLIED PRICE \$ _____
3200RP Rec/Play, Mono...\$2275.00	ALLIED PRICE \$ _____
3200PS Play, Stereo...\$1475.00	ALLIED PRICE \$ _____
3200RPS Rec/Play, Stereo...\$2625.00	ALLIED PRICE \$ _____
3300P Play, Mono...\$1400.00	ALLIED PRICE \$ _____
3300RP Rec/Play, Mono...\$2325.00	ALLIED PRICE \$ _____
3300PS Play, Stereo...\$1575.00	ALLIED PRICE \$ _____
3300RPS Rec/Play, Stereo...\$2675.00	ALLIED PRICE \$ _____
3400P Play, Mono...\$1450.00	ALLIED PRICE \$ _____
3400PS Play, Stereo...\$1600.00	ALLIED PRICE \$ _____
3400RP Rec/Play, Mono...\$2325.00	ALLIED PRICE \$ _____
3400RPS Rec/Play, Stereo...\$2675.00	ALLIED PRICE \$ _____

Accessory prices upon request

BROADCAST ELECTRONICS PRICES ABOVE ARE MFR'S SUGGESTED LIST PRICES. CALL FOR TODAY'S ALLIED PRICE.

5300 SERIES

The **Model 5300B** is the most advanced multi-deck cartridge machine on the market. It is a top-of-the-line pro machine that features solid-state integrated circuit design, a direct drive hysteresis synchronous motor, air damped solenoid, 1/2" thick machined aluminum deck and long life NORTRONICS DURACORE heads. Features unique to this multi-deck design are plug in decks, computer ribbon cabling, rear panel LED service aids, and run lights adjacent to each deck.

5301B Play, Mono ..\$3100.00	ALLIED PRICE \$ _____
5302B Cue Tones/Play, Mono...\$3300.00	ALLIED PRICE \$ _____
5303B Play, Stereo...\$3600.00	ALLIED PRICE \$ _____
5304B Cue Tones/Play, Stereo...\$3800.00	ALLIED PRICE \$ _____

Accessory prices upon request

BROADCAST ELECTRONICS PRICES ABOVE ARE MFR'S SUGGESTED LIST PRICES. CALL FOR TODAY'S ALLIED PRICE.

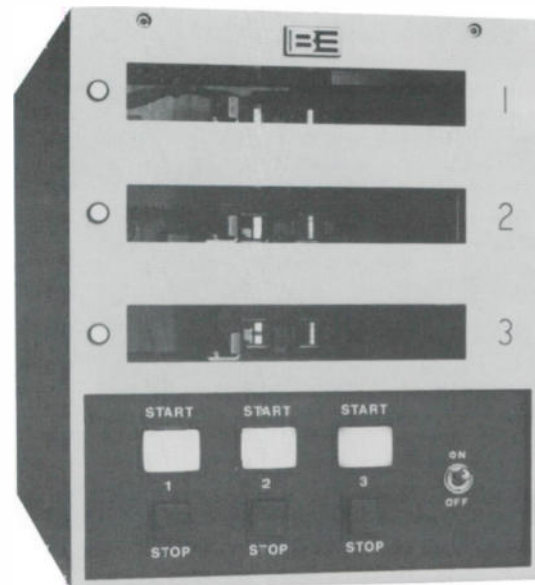

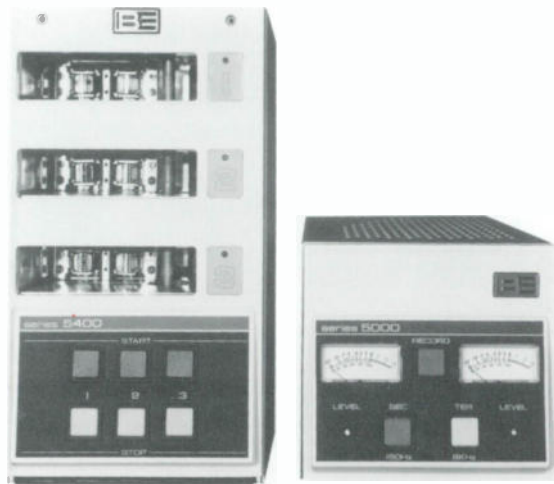

BROADCAST ELECTRONICS

The **5400 Series** is a new, compact "AA" size 3-deck machine designed for the purist. Superb electronics produce 'clean' sound because of low wow & flutter from the direct drive synchronous motor, 52dB stereo S/N, the Phase Lok IV head bracket for optimum stereo phasing, and the solid 1/2" aluminum precision machined deck for stable cartridge positioning. Silent, cool operation is a key feature of the 5400.

- 5401 Play, mono.....\$3200.00 ALLIED PRICE \$ _____
- 5402 Cue Tones/Play, mono.....\$3400.00
ALLIED PRICE \$ _____
- 5403 Play, stereo.....\$3700.00 ALLIED PRICE \$ _____
- 5404 Cue Tones/Play, stereo.....\$3900.00
ALLIED PRICE \$ _____

AUDICORD



The **Models E-10** through **E16** offer modular construction, interchangeable transports and other assemblies, 1 or 3 tones in mono or stereo, a replay reminder system, full remote control that's automation compatible with latching connectors, and a slip/lift cover.

- E-10 mono, 1 cue, desk.....\$819.00 ALLIED PRICE \$ _____
- E-10R mono, 1 cue, rack mount.....\$819.00
ALLIED PRICE \$ _____
- E-11 mono, 3 cue, desk.....\$849.00 ALLIED PRICE \$ _____
- E-11R mono, 3 cue, rack mount.....\$849.00
ALLIED PRICE \$ _____
- E-15 stereo, 1 cue, desk.....\$889.00 ALLIED PRICE \$ _____
- E-15R stereo, 1 cue, rack mount.....\$889.00
ALLIED PRICE \$ _____
- E-16 stereo, 3 cue, desk.....\$919.00 ALLIED PRICE \$ _____
- E-16R stereo, 3 cue, rack mount.....\$919.00
ALLIED PRICE \$ _____

Accessory prices upon request

The **Models E-20** through **E-26** offer a unique slide out panel for control access, mono or stereo record/playback, 1 or 3 cue tones, and auto switching meters. If top quality recording and playback is what you're looking for, try AUDICORD first.

- E-20 mono, 1 cue, desk.....\$1379.00 ALLIED PRICE \$ _____
- E-20R mono, 1 cue, rack mount.....\$1379.00
ALLIED PRICE \$ _____
- E-21 mono, 3 cue, desk.....\$1419.00 ALLIED PRICE \$ _____
- E-21R mono, 3 cue, rack mount.....\$1419.00
ALLIED PRICE \$ _____
- E-25 stereo, 1 cue, desk.....\$1619.00 ALLIED PRICE \$ _____
- E-25R stereo, 1 cue, rack mount.....\$1619.00
ALLIED PRICE \$ _____
- E-26 stereo, 3 cue desk.....\$1659.00 ALLIED PRICE \$ _____
- E-26R stereo, 3 cue, rack mount.....\$1659.00
ALLIED PRICE \$ _____

Accessory prices upon request

AUDICORD PRICES ABOVE ARE MFR'S SUGGESTED LIST PRICES. CALL FOR TODAY'S ALLIED PRICE.



AUDICORD

The **Models E-30** through **E-36** are three playback configurations that feature modular construction, interchangeable transports, 1 or 3 cue tones mono or stereo, replay reminder system, full remote control that's automation compatible, latching connectors, and slip/lift cover. These models offer three independent outputs and three independent control systems.

- E-30 mono, 1 cue, desk.....\$2429.00 ALLIED PRICE \$ _____
- E-30R mono, 1 cue, rack mounted.....\$2429.00
ALLIED PRICE \$ _____
- E-31 mono, 3 cue, desk.....\$2519.00 ALLIED PRICE \$ _____
- E-31R mono, 3 cue, rack mounted.....\$2519.00
ALLIED PRICE \$ _____
- E-35 stereo, 1 cue, desk.....\$2629.00 ALLIED PRICE \$ _____
- E-35R stereo, 1 cue, rack mounted.....\$2629.00
ALLIED PRICE \$ _____
- E-36 stereo, 3 cue, desk.....\$2719.00 ALLIED PRICE \$ _____
- E-36R stereo, 3 cue, rack mounted.....\$2719.00
ALLIED PRICE \$ _____

Accessory prices upon request

The **Models E-50** through **E-56** are dual transport record/playback machines which allow single deck or dual deck recording, sound on sound, composites and stereo to mono mix dubs. Features include a slide out front panel, interchangeable transports and other assemblies, 1 or 3 cue tones mono or stereo, a replay reminder system, full remote control that's automation compatible and latching connectors, and slip/lift cover.

- E-50 mono, 1 cue, desk.....\$2219.00 ALLIED PRICE \$ _____
- E-50R mono, 1 cue, rack mounted.....\$2219.00
ALLIED PRICE \$ _____
- E-51 mono, 3 cue, desk.....\$2279.00 ALLIED PRICE \$ _____
- E-51R mono, 3 cue, rack mounted.....\$2279.00
ALLIED PRICE \$ _____
- E-55 stereo, 1 cue, desk.....\$2539.00 ALLIED PRICE \$ _____
- E-55R stereo, 1 cue, rack mounted.....\$2539.00
ALLIED PRICE \$ _____
- E-56 stereo, 3 cue, desk.....\$2599.00 ALLIED PRICE \$ _____
- E-56R stereo, 3 cue, rack mounted.....\$2599.00
ALLIED PRICE \$ _____

Accessory prices upon request

These new cartridge machines are more than just attractive. They were designed new from the cabinet feet up, selecting the materials which offered the best manufactured cost consistent with functional integrity to insure the most machine for the dollar. Still, the "**S-Series**" contains new operating features, maintenance access and rugged construction to keep pace with modern broadcast operations.

PLAYBACK

- S-11 mono, 3 cue, desk.....\$1029.00 ALLIED PRICE \$ _____
- S-11R mono, 3 cue, rack mounted.....\$1029.00
ALLIED PRICE \$ _____
- S-16 stereo, 3 cue, desk.....\$1119.00 ALLIED PRICE \$ _____
- S-16R stereo, 3 cue, rack mounted.....\$1119.00
ALLIED PRICE \$ _____

AUDICORD PRICES ABOVE ARE MFR'S SUGGESTED LIST PRICES. CALL FOR TODAY'S ALLIED PRICE.



E-SERIES THREE TRANSPORT PLAYBACK



E-SERIES DUAL TRANSPORT RECORD/PLAYBACK



S-SERIES PLAYBACK



S-SERIES RECORD/PLAYBACK



TDS MACHINES

AUDICORD

- S-21 mono, 3 cue, timer, desk.....\$1799.00
ALLIED PRICE \$ _____
- S-21R mono, 3 cue, timer, rack.....\$1799.00
ALLIED PRICE \$ _____
- S-26 stereo, 3 cue, timer, desk.....\$1989.00
ALLIED PRICE \$ _____
- S-26R stereo, 3 cue, timer, rack.....\$1989.00
ALLIED PRICE \$ _____

DELAY MACHINES

- S-32 mono network delay, 3 cues + timer, desk.....\$1889.00
ALLIED PRICE \$ _____
- S-32R mono network delay, 3 cues + timer,
rack mounted.....\$1889.00 ALLIED PRICE \$ _____

The premium A.C. Hysteresis Synchronous Motor used by Audi-Cord in the **Twin Deck** is so low in heat and escape field that the addition of the double-ended shaft was a natural practicality. With this design, the lower deck can easily be positioned and adjusted to duplicate the results of the upper traditional deck. A side azimuth adjust head mount was designed to facilitate running adjustment of phase and azimuth.—This makes for a true "Twin Deck" operation!

- TDS-1 twin transport, mono, 3 cues, desk.....\$1499.00
ALLIED PRICE \$ _____
- TDS-1R twin transport, mono, 3 cues, rack mount.....\$1538.00
ALLIED PRICE \$ _____
- TDS-6 twin transport, stereo, 3 cues, desk.....\$1679.00
ALLIED PRICE \$ _____
- TDS-6R twin transport, stereo, 3 cues, rack mount....\$1718.00
ALLIED PRICE \$ _____

Accessory prices upon request

AUDICORD PRICES ABOVE ARE MFR'S SUGGESTED LIST PRICES. CALL FOR TODAY'S ALLIED PRICE.

TAPECASTER

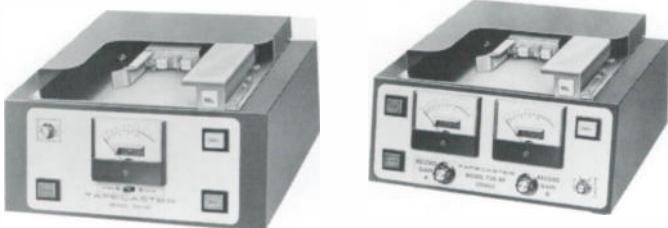

For the broadcaster who doesn't need an expensive multi-deck cart machine configuration, the TAPECASTER line has become a standard. With either stereo or mono playback or playback/record machines available, the dependable, sturdy TAPECASTER line is more machine for the dollar.

- X700RP mono record/play.....\$995.00 ALLIED PRICE \$ _____
- X700P mono play.....\$695.00 ALLIED PRICE \$ _____
- X700RPD mono record/play/delay.....\$1150.00
ALLIED PRICE \$ _____
- X700RPS stereo record/play.....\$1295.00
ALLIED PRICE \$ _____
- X700PS stereo play.....\$895.00 ALLIED PRICE \$ _____

Accessory prices upon request

TAPECASTER PRICES ABOVE ARE MFR'S SUGGESTED LIST PRICE. CALL FOR TODAY'S ALLIED PRICE.

"Shipping and Handling will be added."

CAPITOL

The audio cartridge tape that has become a standard for broadcasters the world over is the **CAPITOL A2**. For stations who really care about how they sound, the A2 is the logical answer to better sound.

CALL FOR TODAY'S ALLIED PRICE

The key feature of the **Capitol AA4** is the new SGS-4 broadcast mastering tape. When recorded on a high quality cartridge recorder, the SGS-4 tape can produce virtually identical copies of the best analog or digital mastering tapes.

CALL FOR TODAY'S ALLIED PRICE

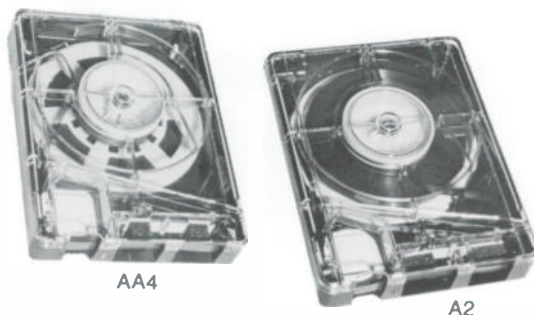

FIDELIPAC

The **Model 300** broadcast audio cartridge provides performance at a price that is within the budget of all radio and TV broadcasters. Its endurance under severe operating conditions in everyday studio operations is surprising, frequently lasting over five years with only replacement of worn tape and pressure pads.

CALL FOR TODAY'S ALLIED PRICE

The **Master Cart**, unlike conventional cartridges, does not rely upon the cartridge for precision tape guidance. Master Cart's tape path is controlled primarily by the tape guides in the cartridge machine. This neutrality of tape flow is assured by a unique tape path plus precision molding of the cartridge base, reel and top cover. Performance is repeatable each time the cartridge is used and also from cartridge to cartridge.

CALL FOR TODAY'S ALLIED PRICE

Master Cart II is a cartridge that will work in most tape machines including multiple slot automation devices while providing the highest possible level of stereo performance. Master Cart II features a new and unique front corner post design. This precision molded upper and lower tape limiting device does not interfere with the neutral tape handling concept. It does provide an upper and lower limit to tape travel when the cart is used in less-than-perfectly aligned machines.

CALL FOR TODAY'S ALLIED PRICE



SCOTHCART

The **ScotchCart II®** broadcast cartridge represents a breakthrough in technology beyond anything previously experienced in the industry. A revolutionary design eliminates pressure pads, utilizes a non-rotating hub, and now includes a new, high output, low-noise, lubricated tape for recording at high levels without performance loss. Tape and cartridge complement each other like never before in the ScotchCart II® broadcast cartridge.

Setting an industry precedent, the ScotchCart II® broadcast cartridge utilizes a passive system of internal tape guidance, which allows your cartridge machine to do a much more precise job. With five times the average life of its nearest premium grade cartridge competitor and superior audio performance, the ScotchCart II® broadcast cartridge is the best value ever.



“Prices are subject to change without notice”



FIDELIPAC

The **DYNAMAX ESD10** gives you reliable splice detection and deep cart erasure, for flawless sound reproduction. It achieves an erase depth of 75dB or more. Dual erase heads are used. A patented splice find system — the most reliable detector ever built, requires no sensitivity adjustments.

MANUFACTURER'S SUGGESTED LIST PRICE.....\$1050.00

ALLIED PRICE \$ _____



ALLIED CART LABELS

For labeling those all important commercial, music and program audio cartridge tapes, the Allied Cart Label will stick. If label peeling is a problem, then you need a label from ALLIED! They stay when they should. They come off completely when they should.

CART LABELS.....\$0.20 per sheet



SCOTCH AVX

Superior design and performance make Scotch AVX truly dependable. Scotch AVX Studio Master Cassettes bring you one step closer to perfection in your search for exceptional performance and sound reproduction. The cassette shell and internal components have been engineered to deliver outstanding mechanical reliability. The superior electromagnetic capabilities of the tape formulation guarantees superb sound under the most severe conditions.

PRICES UPON APPLICATION

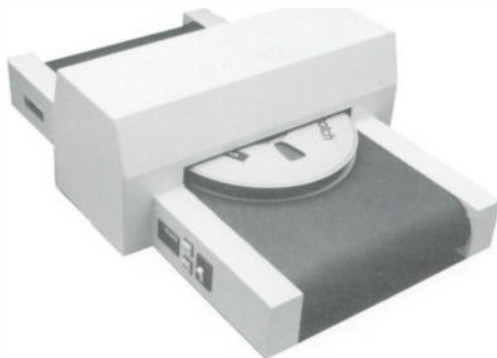

GARNER

Imagine erasure depth of video tape that exceeds professional standards in 5 to 16 seconds in just one pass (two for larger units) — doesn't matter if it's video cassette, cartridge or reel. You're assured of superb, clean, quiet erasure to the most stringent recording standards.

MODEL DESCRIPTION	PRICE
270 1" x 8 1/2" dia. reel	\$2985.00..ALLIED PRICE \$ _____
1100* 1" x 10 1/2" dia. reel	\$4450.00..ALLIED PRICE \$ _____
1400* 1" x 14" dia. reel	\$5750.00..ALLIED PRICE \$ _____

* Erases 1" high coercivity video tape and video cassettes



It takes just four seconds to erase all sizes and types of audio tape up to 16" with GARNER degaussers. GARNER has designed their units to automate your tape erasing operations and eliminate residual noise problems, and their customers say they have a winner!

MODEL DESCRIPTION	PRICE
70A up to 7" reel	\$990.00....ALLIED PRICE \$ _____
105A up to 10 1/2" reel	\$1390.00..ALLIED PRICE \$ _____
114 up to 14" reel	\$2190.00..ALLIED PRICE \$ _____
116 up to 16" reel	\$2390.00..ALLIED PRICE \$ _____

GARNER PRICES ABOVE ARE MFR'S SUGGESTED LIST PRICES. CALL FOR TODAY'S ALLIED PRICE.

AUDIOLAB

The **AUDIOLAB TD-1B** tape degausser with automatic overhead thermal protection erases audio tape, carts and cassettes. It erases up to 3/4" tape widths, accommodates up to 10 1/2" reels, provides a wide focused magnetic field to assure complete erasure and positive results every time with a simple two pass operation for broadcast NAB audio cartridges.

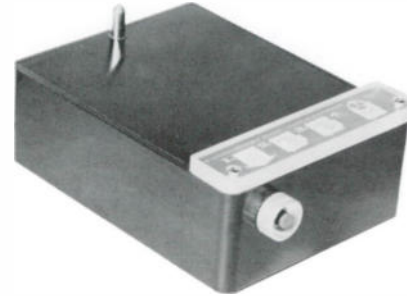

MANUFACTURER'S SUGGESTED LIST PRICE.....\$119.00

ALLIED PRICE \$ _____

FIDELIPAC

If you need blank tape fast and are worried about recorder erase head wear, then worry no more. With the easy to handle "**BLANK-IT**" eraser from FIDELIPAC, you'll save time - no need to run the tape through your recorder. You'll save money - it allows instant reuse of the erased tape without worry about program residue or those mind destroying "whomps". "BLANK-IT" is hand-held for rapid, accurate tape erasing in any setting.



MANUFACTURER'S SUGGESTED LIST PRICE.....\$64.75

BROADCAST ELECTRONICS

The **BROADCAST ELECTRONICS TW-120T** cartridge winder with timer is a rugged, dependable and field tested tape cart winder which fills a need in every station using cartridge equipment. It's no longer necessary to limit your cartridge operation by using only stock sizes or to tie up your conventional tape equipment to load tape cartridges. Worn tape in old tape cartridges is easily replaced to any length you desire.

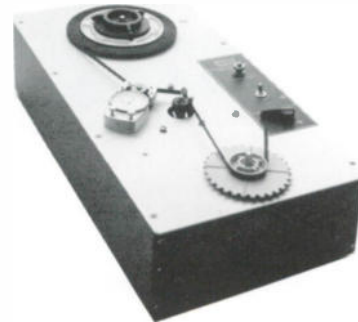

MANUFACTURER'S SUGGESTED LIST PRICE.....\$475.00

ALLIED PRICE \$ _____

TAPECASTER

The **TAPECASTER X-100** features "state-of-the-art" technology for the serious broadcaster who has an eye to saving. It has two direct-drive motors and a floating aluminum tape supply disc which holds a 7" reel or 10 1/2" pancake of lubricated tape. The solenoid brake stops the supply disc at the end of the wind. The X-100 has adjustable tension control for the supply disc brake, ramp design tape guides and four gold-contact rotary switches to program the wind to 7.5 ips. The wind time is accurately metered by the light copper and nylon counter wheel.



MANUFACTURER'S SUGGESTED LIST PRICE.....\$495.00

ALLIED PRICE \$ _____

FIDELIPAC

The **Model 400** features a removable guide pin, a scuff resistant top, a power-on indicator and hand rubbed hardwood case. It can erase all audio, video and computer tapes up to 1" wide, and it has a thermal protected core that will not burn out.

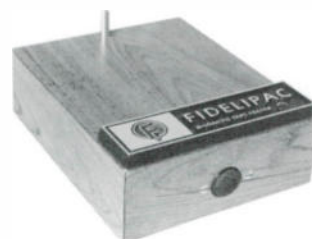

MANUFACTURER'S SUGGESTED LIST PRICE.....\$99.50



ALLIED

The standard in studios and control rooms around the world are the **ALLIED** broadcast quartz line of clocks. Where accuracy and visibility are a must the ALLIED line is just what the announcer or engineer ordered. Available in 12" face size.

12" \$34.95.....ALLIED PRICE \$ _____
PRICE ABOVE IS MFR'S SUGGESTED LIST PRICE.



ESE

The **ES-302E** is a four digit, 100 minute timer with six controls: count up, count down, stop, minutes advance, seconds advance and reset. Minutes and seconds can be advanced simultaneously or independently in order to preset for a specified countdown. With the ES-302E, the user can preset times much faster because lever wheel type switches are used for the preset feature. The ES-302E can drive 80 series and 90 series slaves. Options prices available upon request.

MANUFACTURER'S SUGGESTED LIST PRICE.....\$333.00
ALLIED PRICE \$ _____

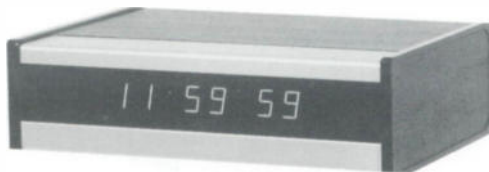

The **ES-112E** is a solid-state 12 hour CMOS, six digit clock. It features three simple controls: fast advance, slow advance and hold which make setting to the precise second easy. The display is a bright orange, gas-discharge, seven segment, .55" high digital. An optional CMOS compatible BCD output can drive two .55" slaves or two 80 series slaves or one 90 series slave. Options prices are available upon request.

MANUFACTURER'S SUGGESTED LIST PRICE.....\$182.00
ALLIED PRICE \$ _____

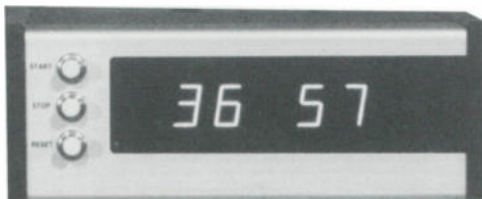

The **ES-510E** is a four digit, 60 minute timer with start, stop and reset controls. Runs continuously unless stopped or reset. If stopped, display will hold time reading and when restarted will continue with next count from last displayed figure. Reset returns display to all zeros. Can reset while running or stopped. If reset while running, timer will continue to run. ES-510E can drive two 80 series or one 90 series slave. Displays are .55" bright orange gas-discharge digital. Remote ready. Options prices are available upon request.

MANUFACTURER'S SUGGESTED LIST PRICE.....\$174.00
ALLIED PRICE \$ _____



The **ES-562E** is a combination six-digit clock and 12 hour timer with memory, allowing the user to set the clock to the correct time of day, switch to timer mode, then by pushing one button switch back to time of day. The time of day will be correctly displayed in hours, minutes and seconds. The controls on the ES-562E may be remoted. Options prices are available upon request.

MANUFACTURER'S SUGGESTED LIST PRICE.....\$345.00
ALLIED PRICE \$ _____



The **ES-172** is a console mount clock/timer in compact enclosure, with bright easy to read six digit .4" red LED's. The controls consist of three settings: Fast Advance, Slow Advance, and Hold. The unit has access to control inputs on rear mounted connector and is entirely enclosed in a high impact black plastic case. Option prices are available upon request.

MANUFACTURER'S SUGGESTED LIST PRICE.....\$174.00
ALLIED PRICE \$ _____

BROADCAST AUDIO

System 6-IV is a modular audio console, utilizing the same electronic modules as the larger SERIES IV consoles. The concept is to offer a premium quality console for newsrooms and production. Monitor and Cue muting is standard. Extra on/off contacts are provided for remote control. SYSTEM 6 is also available as a low-cost console extender, without the output amplifiers, meters, and monitor controls.

MANUFACTURER'S SUGGESTED LIST PRICE.....\$4450.00
includes 4 mixers

ALLIED PRICE \$ _____

System 8-IV is an expandable, completely modular broadcast mixer, with unprecedented features and performance. It was designed exclusively for broadcast and performs flawlessly even in high RF environments. An elegant low profile appearance is accented by solid walnut end panels and armrest. This mixer sets on top of the desk, so it's easy to install, with all connections made from the top. Two stereo and one mono output. Accessory and module prices on request.

MANUFACTURER'S SUGGESTED LIST PRICE.....\$7550.00
includes 6 mixers

ALLIED PRICE \$ _____

System 12-IV is a model of engineering simplicity, using motherboard construction with only two types of amplifier modules and a plug-in interconnecting harness. Two independent industrial grade power supplies are rack mounted in a common housing with front AC and DC status indicators. The power supply is short-circuit proof and an optional redundant supply is also available. Operator conveniences include 4 inch log taper slide faders for extremely accurate tracking between channels. In addition to a cue detent position on the fader, there is a separate button for cueing when the fader is up. Three stereo and one mono output. Accessory and module prices upon request.

MANUFACTURER'S SUGGESTED LIST PRICE.....\$9950.00
with 8 modules

ALLIED PRICE \$ _____

System 14 is the latest and most technically sophisticated console in the line. A digital slide fader and digitally controlled CMOS high resolution logarithmic audio attenuator significantly reduce signal paths. Three plug-in mixers are available. Noiseless DC audio switching is used for all program and monitor functions, which also enables each mixing channel to be turned off and on from a remote location, such as an announce studio, news booth, or video switcher. Three stereo and one mono output. Accessory and module prices upon request.

MANUFACTURER'S SUGGESTED LIST PRICE....\$16,530.00
with 12 modules

ALLIED PRICE \$ _____

System 16-IV features DC audio switching, using LCR's for completely quiet audio control. This also enables each mixing channel to be turned off and on from a remote location. Ten plug-in relays, with switch selection of maintained or momentary contacts, can be used for muting or remote start from any combination of mixers. Operator conveniences include 4" long taper slider faders for extremely accurate tracking between channels. Three stereo and one mono output. Accessory and module prices upon request.

MANUFACTURER'S SUGGESTED LIST PRICE....\$10,950.00
with 8 modules

ALLIED PRICE \$ _____





BROADCAST AUDIO

System 20 has options that enable you to virtually design your own audio console, for on-air use or production. Three plug-in mixers are available. Each mixer has a transformer balanced mic input and a differential balanced line level input. Motherboards and mixers are all double-sided with extensive ground planes for optimum noise and crosstalk, plus RFI rejection. All integrated circuits have sockets and are brand name off-the-shelf devices. Three stereo and one mono output. Accessory and module prices upon request.

MANUFACTURER'S SUGGESTED LIST PRICE....\$25,345.00 with 18 modules

ALLIED PRICE \$ _____

BROADCAST ELECTRONICS



The **4S50A** and **4S50AR** consoles accommodate 12 stereo input sources. Features high/low input sensitivity selection, has cue switches on all mixers and individual monitor, cue and headphone amplifiers. R series for rack mounting.

4S50A stereo, 4 mixer.....\$2095.00...ALLIED PRICE \$ _____

4S50AR stereo, 4 mixer.....\$2150.00..ALLIED PRICE \$ _____

4M50A mono, 4 mixer.....\$1095.00...ALLIED PRICE \$ _____

4M50AR mono, 4 mixer.....\$1195.00..ALLIED PRICE \$ _____



The **5S150A**, **5M150A**, **8S150A** and **8M150A** consoles feature sealed pots, 3600 series electronics and contact free FET bus selection. Each mixing channel accommodates two pushbutton selected inputs and may be preset for mic or line level input.

5S150A stereo, 5 mixer.....\$2950.00..ALLIED PRICE \$ _____

5M150A mono, 5 mixer.....\$2395.00..ALLIED PRICE \$ _____

8S150A stereo, 8 mixer.....\$3650.00..ALLIED PRICE \$ _____

8M150A mono, 8 mixer.....\$2895.00..ALLIED PRICE \$ _____



The **5S250A**, **5M250A**, **8S250A**, **8M250A**, **10S250A** and **10M250A** consoles feature ladder-type step attenuators with cue bus switching, telephone type channel keys and contact-free FET bus selection. Field proven 3600 plug-in electronics make this a truly outstanding line of consoles for any broadcast application.

5S250A stereo, 5 mixer.....\$3650.00..ALLIED PRICE \$ _____

5M250A mono, 5 mixer.....\$2795.00..ALLIED PRICE \$ _____

8S250A stereo, 8 mixer.....\$4750.00..ALLIED PRICE \$ _____

8M250A mono, 8 mixer.....\$3695.00..ALLIED PRICE \$ _____

10S250A stereo, 10 mixer...\$5895.00....ALLIED PRICE \$ _____

10M250A mono, 10 mixer...\$4795.00....ALLIED PRICE \$ _____



BROADCAST ELECTRONICS PRICES ABOVE ARE MFR'S SUGGESTED LIST PRICES. CALL FOR TODAY'S ALLIED PRICE.

ARRAKIS

The **150SC** is designed for use in small studio or portable applications. Utilizes Allen-Bradley mod pots, VCA audio control, ITT "Schadow" switches, Electrovert self crimping input and output connectors, active balanced circuitry inputs and outputs.

150SC mono, active in/out.....\$1895.00
ALLIED PRICE \$ _____

150SC stereo, active in/out.....\$1995.00
ALLIED PRICE \$ _____

The **500SC** is a rugged and versatile console designed for broadcast applications. Utilizes Allen-Bradley mod pots, VCA audio control, ITT "Schadow" switches, Electrovert screw terminal strip input and output connectors and active balanced circuitry inputs and outputs.

500SC mono, active in/out.....\$2995.00
ALLIED PRICE \$ _____

500SC stereo, active in/out.....\$2995.00
ALLIED PRICE \$ _____

The **600SC** deluxe console is engineered to combine the ultimate in mechanical reliability with the remarkable sound and performance of today's high-tech consoles. It features Penny and Giles rotary faders and ITT Schadow switches. The remarkable electronic performance of the 600 is achieved through the use of VCA technology and DC control. There is no audio on the pots or switches. 50 million operation reed relays perform the channel on/off functions.

600SC Mono.....\$4299.00 **ALLIED PRICE \$ _____**

600SC Stereo.....\$4399.00 **ALLIED PRICE \$ _____**

Designed for ease of operation, uncompromising performance and durability, is the **2000SC** console. Each of the 12 channels features a single input per channel. Two remote select switches bring in an additional 14 inputs. Cue is accomplished by a detent on the Penny & Giles fader while lighted momentary reed relay switches actuate the program and audition busses which are simultaneously monitored with VU meters. Rugged aluminum and wood construction, with reliable motherboard electronics.

2000SC mono, active in/out.....\$4495.00
ALLIED PRICE \$ _____

2000SC stereo, active in/out.....\$4695.00
ALLIED PRICE \$ _____

The **2100SC** has few peers in professional broadcasting. Each of the 12 channels features a dual input per channel. Two remote select switches bring in an additional 14 inputs. The 2100SC features the Signetics NE5532 Op Amp. The only audio switches in the audio path are reed relays which produce no audio degradation at all. It is constructed of heavy hardened aluminum panels complemented by solid oak end pieces and armrest. The 2100SC uses the Penny and Giles 3000 Series slide faders. All front panel switches are Schadow by ITT.

2100SC Mono.....\$5495.00 **ALLIED PRICE \$ _____**

2100SC Stereo.....\$5695.00 **ALLIED PRICE \$ _____**

ARRAKIS PRICES ABOVE ARE MFR'S SUGGESTED LIST PRICES. CALL FOR TODAY'S ALLIED PRICE.

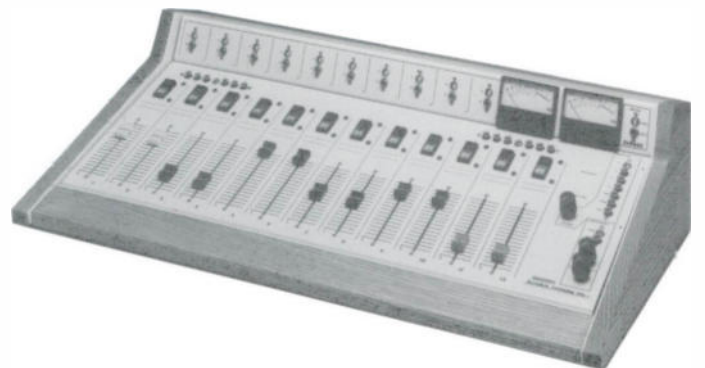
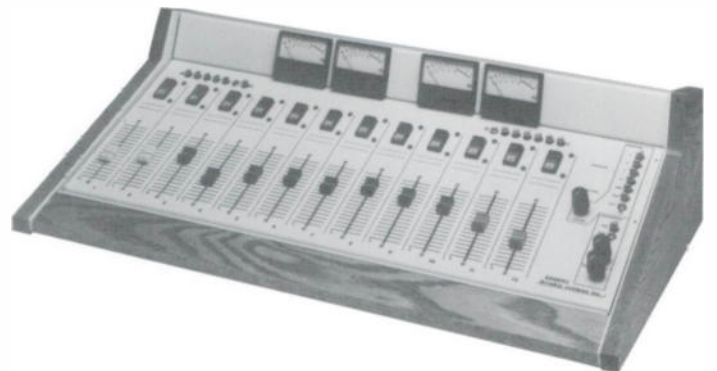
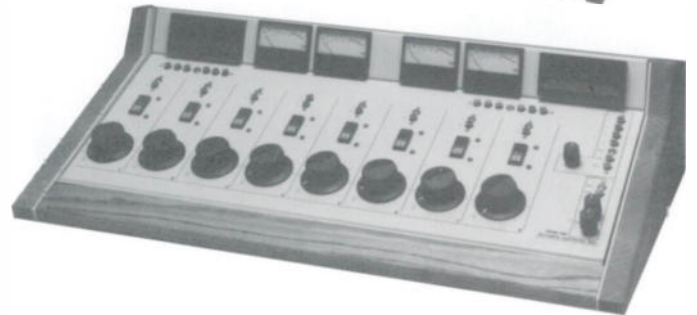
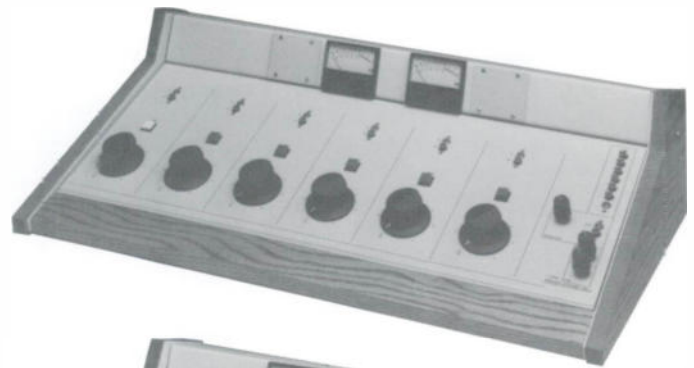



ARRAKIS

The new **Arrakis 5000 Series Console** is the first, full featured, modular console for under \$10,000. The main-frame features 16 channels plus a channel for accessory modules and the standard Control Room Monitor module.

Features include:

16 modular stereo channels, Telephone mix-minus, Full monitoring facilities, Remote equipment start/stop, Standard digital clock & timer, Superb audio performance specs., Penny & Giles slide faders — and much more!

PRICES DEPEND UPON MODULE CONTENT — PLEASE CALL

AUTOGRAM

AUTOGRAM AC and **IC** consoles are built in only one series. A premium-grade series which features ladder-type attenuators, engraved numbers and letters, ¼" front panel, and fully balanced and floating inputs and outputs. They're flexible, functional and "bullet proof"!

AC-6 typical stereo.....\$5114.00

ALLIED PRICE \$ _____

AC-6 typical mono.....\$4485.00

ALLIED PRICE \$ _____

AC-8 typical stereo.....\$6405.00

ALLIED PRICE \$ _____

AC-8 typical mono.....\$5676.00

ALLIED PRICE \$ _____

IC-10 typical stereo.....\$8614.00

ALLIED PRICE \$ _____

IC-10 typical mono.....\$7803.00

ALLIED PRICE \$ _____

AUTOGRAM PRICES ABOVE ARE MFR'S SUGGESTED LIST PRICES. CALL FOR TODAY'S ALLIED PRICE.



AUTOGRAM'S "Microgram" microprocessor controlled audio console is a powerful addition for any broadcast control room. It's built to handle board functions with ease while signalling and mixing numerous prescheduled events simultaneously. The Microgram console can handle 3 stereo buses simultaneously, or run two completely separated automation systems on AM and FM.

PRICES ON APPLICATION

The **R/TV-20** Stereo Audio Console is one of the latest innovations from Autogram with features such as:

18 Dedicated pots, 2 Pots with 8 inputs each, Electronic switching, No audio transformers, Penny and Giles linear conductive plastic pots, Schadow selector switches, Plug-gable miniature terminal strips, Up to eight patchable microphone preamplifiers, Each channel remotely controllable, Easy input level selection.

MANUFACTURER'S SUGGESTED LIST PRICE....\$11,995.00

ALLIED PRICE \$ _____

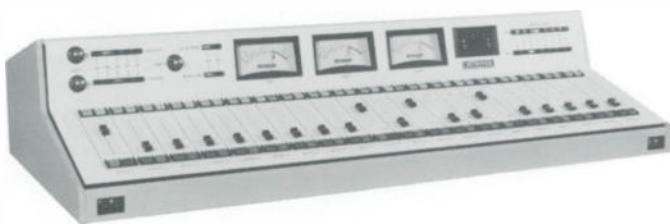
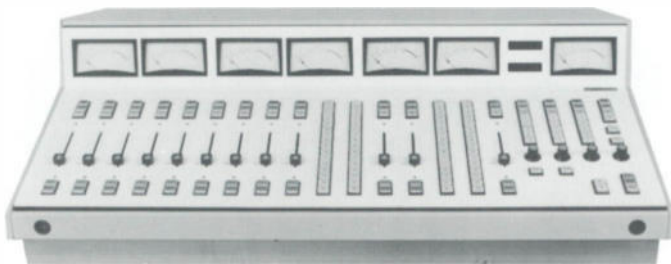

RUSSCO

The **RUSSCO** line of consoles packs a terrific value into a compact size at an unheard of bargain price. Designed for broadcast studio use, this terrific five channel mixing console is as modern as tomorrow, with sophisticated features and fully integrated circuitry for dependability. They're engineered for easy operation and simple servicing and they're as good looking as they are good working.

505 Mono, built in monitor amp.....\$1469.00
ALLIED PRICE \$ _____

505S Stereo, without monitor amp.....\$2150.00
ALLIED PRICE \$ _____

RUSSCO PRICES ABOVE ARE MFR'S SUGGESTED LIST PRICES. CALL FOR TODAY'S ALLIED PRICE.



QUANTUM

For over ten years **QUANTUM** has dedicated itself to the building of small to medium sized studio consoles for highest professional demands. No component used in **QUANTUM** consoles are of any lesser quality than in the products of other manufacturers. The Series 22 consoles feature transformer balanced and floating mic inputs, differentially balanced line level inputs and differentially balanced echo return inputs. The outputs are transformer balanced and floating and strappable for other nominal levels.

CALL FOR TODAY'S ALLIED PRICE.



SENNHEISER

The **Sennheiser M8** professional console has 8 input modules, 1 master module, 1 powering module, 1 display module and 1 chassis. (other versions available with 6, 10 or 12 input modules) Significant features include gain selector with 5 steps of 10 dB each. . . 0 to 50; switchable equalizer for bass & treble; Penny & Giles faders with 104 MM throw and integrated dust protection. All mixers can be powered from main supply, external 12V to 24V DC or by batteries.

CALL TODAY FOR THE ALLIED PRICE.



AUDITRONICS

The **200 Series** on-air broadcast control console represents the culmination of latest technology applied for broadcast use. The design is based on information gathered during extensive research conducted throughout the broadcast industry and the expertise of Auditronics' 15-year history in this business. The 200 series offers a high degree of reliability together with simplicity of use in a compact, operator oriented package.

Typical pricing with typical input modules.

206MF typical 6 input mainframe.....\$9000.00
ALLIED PRICE \$ _____

212MF typical 12 input mainframe.....\$14,000.00
ALLIED PRICE \$ _____

218MF typical 18 input mainframe.....\$19,000.00
ALLIED PRICE \$ _____

224MF typical 24 input mainframe.....\$23,500.00
ALLIED PRICE \$ _____

Module pricing upon request.

AUDITRONICS PRICES ABOVE ARE MFR'S SUGGESTED LIST PRICES. CALL FOR TODAY'S ALLIED PRICE.



AUDITRONICS



The **300 Series** Audio Production Console is a totally new concept in audio processing and control. Specific attention has been given to not only the audio quality, but to logically located and labeled controls, and implementation of a comprehensive, built-in, user-programmable logic system simplifying the operation of many internal and external functions. External control ports have been included to provide the possibility of interface to any of several types of external equipment such as video switchers, editors, etc.

Designed as a building-block system to satisfy the requirements of both small and large facilities, the 300 Series is easily expandable in capabilities, at no sacrifice of initial performance specifications. All Input Modules include multiple source selections, and each input has dedicated active balanced input circuitry for optimization of level, noise, common mode rejection, and cross-talk. All output bussing assignments are made via CMOS "Load-Lift" networks which follow their source circuitry's on/off status, thereby ensuring optimum noise specifications throughout the system at all times.

Adequate space is reserved for accessory mounting, both in the operational area where signal processing equipment, line selectors, remote controls, VCA grouping or video control selectors may be mounted, and under the console in conveniently located 19 inch equipment rack spaces. All module sizes are to DIN standard width and length, allowing the installation of many remote controls or signal conditioners.

- | | |
|---|---|
| <ul style="list-style-type: none"> <input type="checkbox"/> 4 or 8 Outputs, plus discrete Stereo and Mono Mix <input type="checkbox"/> Output Submastering, with Mix-Minus Capability <input type="checkbox"/> Mono and/or Stereo inputs, with or without Equalization <input type="checkbox"/> Hi Cut and Lo Cut Filters on each Input <input type="checkbox"/> VCA Level Control on all Inputs and Stereo Mix Outputs <input type="checkbox"/> 4 Auxiliary Sends <input type="checkbox"/> Auxiliary Returns <input type="checkbox"/> Built-In Monitor Mixer | <ul style="list-style-type: none"> <input type="checkbox"/> Control Room Monitoring <input type="checkbox"/> Stereo Solo System <input type="checkbox"/> Aural Phase Check Capability <input type="checkbox"/> Cue System with Built-in Speaker, Amplifier, and Metering <input type="checkbox"/> Stereo Headphone Monitoring <input type="checkbox"/> External Level and Mute Control Capability <input type="checkbox"/> On-Board Power Regulation on each Individual Module <input type="checkbox"/> Output Metering <input type="checkbox"/> Microphone Phantom Power Supply |
|---|---|

LPB

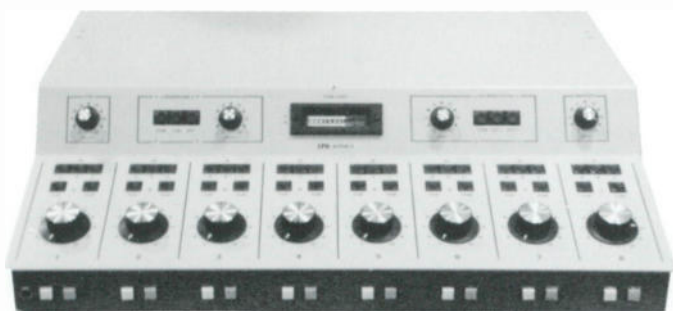

The new **LPB Alpha Series** broadcast audio consoles are designed to be cost effective, yet completely "state-of-the-art." VCA level control and DC solid-state switching keep the audio signal path short to virtually eliminate signal degradation through the console. Three inputs per mixer, user-programmable monitor and cue muting, transformerless design (output transformers optional), mono mixdown output, built-in 8-watt per channel monitor amplifier, headphone and monitor switching, +8dBm/600 ohm auxiliary outputs, all input plug-ins capable of mic or line level, screw barrier terminal input and output connections, long-life pushbuttons, LED status indicators, fluorescent level meters, 15dB output headroom above +8dBm, momentary remote start pushbuttons, tally contacts and ease of studio interconnection all add up to make these stereo consoles a superior value.

ALPHA 6 channel stereo.....\$2795.00 ALLIED PRICE \$ _____

ALPHA 8 channel stereo.....\$3795.00 ALLIED PRICE \$ _____

ALPHA 10 channel stereo.....\$4795.00 ALLIED PRICE \$ _____

LPB PRICES ABOVE ARE MFR'S SUGGESTED LIST PRICES. CALL FOR TODAY'S ALLIED PRICE.

"Discounts are available on most equipment"

LPB

The **LPB SIGNATURE II** consoles feature transformer audio inputs. Monitor speaker muting and on-air light relays are provided. A cue position is provided in each mixer and all models include an internal cue system consisting of a cue amplifier, level control and 5" speaker. The internal monitor amplifier is switch selectable to monitor program or two external monitor inputs. The illuminated VU meter reads the program output at all times.

- S-12 5 channel stereo.....\$3495.00....ALLIED PRICE \$ _____
- S-13C 8 channel mono/stereo.....\$4695.00
ALLIED PRICE \$ _____
- S-14A 5 channel mono.....\$2795.00...ALLIED PRICE \$ _____
- S-15A 8 channel dual out/mono.....\$3995.00
ALLIED PRICE \$ _____
- S-20 10 channel dual out/stereo.....\$5595.00
ALLIED PRICE \$ _____

(NOTE: add \$95 for mono mixdown)

- S-21B 10 channel dual out/mono.....\$4595.00
ALLIED PRICE \$ _____

The **LPB CITATION** consoles come in only stereo and in only two configurations, 8 channel and 10 channel. The series features transformer balanced inputs and outputs, with three inputs per mixer, program, audition, mono mix-down, monitor, cue, headphone and tape outputs. The CITATION console features a signal to noise ratio of better than 74 dB below +18 dBm output "referenced to" -50 dBm input 20 Hz to 20 kHz.

- C-8S 8 channel dual stereo.....\$8495.00
ALLIED PRICE \$ _____
- C-8SL 8 channel dual stereo.....\$8995.00
ALLIED PRICE \$ _____
- C-10S 10 channel dual stereo.....\$8995.00
ALLIED PRICE \$ _____
- C-10SL 10 channel dual stereo.....\$9995.00
ALLIED PRICE \$ _____

Accessory and spares prices upon request.

LPB PRICES ABOVE ARE MFR'S SUGGESTED LIST PRICES. CALL FOR TODAY'S ALLIED PRICE.

UREI

The **UREI 1650** and **1680 series** broadcast consoles have the features most requested by engineers and consultants, priced within the budget of small market stations and built with UREI quality. The new consoles offer a choice of five or eight mixers and a choice of attenuator types: rotary conductive plastic, Shallco precision rotary or Penny and Giles straight line. Provisions are for customization to fit the individual station needs, but no accessories are required to put them on the air as they are shipped.

- 1651 5 mixer, conductive.....\$2896.00
ALLIED PRICE \$ _____
- 1652 5 mixer, Shallco.....\$3596.00
ALLIED PRICE \$ _____
- 1653 5 mixer, Penny & Giles.....\$3896.00
ALLIED PRICE \$ _____
- 1681 8 mixer, conductive.....\$3596.00
ALLIED PRICE \$ _____
- 1682 8 mixer, Shallco.....\$4796.00
ALLIED PRICE \$ _____
- 1683 8 mixer, Penny & Giles.....\$5196.00
ALLIED PRICE \$ _____

Accessory and spares prices upon request.

UREI PRICES ABOVE ARE MFR'S SUGGESTED LIST PRICES. CALL FOR TODAY'S ALLIED PRICE.



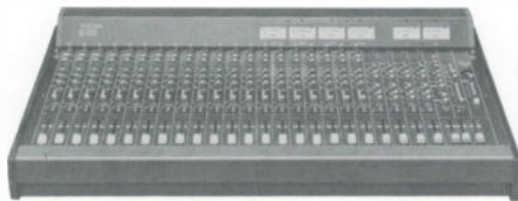

TASCAM

Sound reinforcement. Studio recording. Broadcast and video production/post production. These professional mixing jobs are as different as they are demanding. The TASCAM **200 Series** mixers were designed to handle all of these tough assignments — conveniently and dependably. There are no shortcuts in the design or construction of the 200 Series. Each channel is built on its own circuit card for better isolation. Then it's mounted on a steel chassis for optimum strength and security. The 200's are built to accept inputs from any source. A generous power supply affords ample headroom for full dynamics and low distortion.

M-208, 8 channel mixer.....\$1095.00

ALLIED PRICE \$ _____

M-216, 16 channel mixer.....\$1695.00

ALLIED PRICE \$ _____

ABOVE ARE MFR'S SUGGESTED LIST PRICES.

TASCAM designed the **300 Series** to meet the demands of both studio recording and live soundmixing. From the 8-channel M-308 to the 12-channel M-312 and 20-channel M-320 — these mixers perform at their peak in any situation. A sophisticated signal routing system takes care of the most complex foldback, effects mixing, subgrouping and monitoring requirements. The 300 Series was designed to make mixing easy. Ample back-panel inputs and outputs combined with top-panel switching matrix virtually eliminate the need for patching. The consoles deliver clean, dynamic sound thanks to transformerless balanced differential input design.

M-308, 8 channel mixer.....\$1795.00

M-312, 12 channel mixer.....\$2795.00

M-320, 20 channel mixer.....\$3795.00

ABOVE ARE MFR'S SUGGESTED LIST PRICES. CALL FOR THE ALLIED PRICE.

ELECTRO VOICE



The **ELECTRO VOICE C-12 SERIES TWO** console is a compact, high performance 12 in/4 subgroup/stereo and mono output mixer designed for musical, speed, theatrical sound reinforcement, and recording applications. A new balanced output option uses highest quality transformers and circuitry with XLR connectors on all 10 outputs (Mono, L/R Stereo, 4 Subgroups, Monitor, Aux, and Hi Effects Sends) for lowest noise and distortion. These may be used either singly, or in any combination with the normally provided unbalanced (1/4" phone) outs. This variety of outputs and the versatility provided by having access jacks at almost every point in the signal path makes the mixer equally at home in broadcast, recording or production environments.

C-12/2.....\$3855.00

ALLIED PRICE \$ _____

ELECTRO VOICE PRICES ABOVE ARE MFR'S SUGGESTED LIST PRICES. CALL FOR TODAY'S ALLIED PRICE.

TOA



The **RXA-212** is a powered mixing console with 12 inputs; the **RXA-216** is powered with 16 inputs; 2 program outputs, 2 foldback outputs, and 1 echo output. Each input channel and line output has a balanced, low impedance, transformer-isolated, XLR connector, and an unbalanced 1/4" jack. An input level switch and trim control on each input channel is provided. A four-band equalizer is included on each input channel. A peak indicator LED on each input detects excessive inputs and helps avoid clipping. All faders are long-linear type with 60mm of travel. Additional stereo inputs are used to connect a stereo playback deck, disc player and other auxiliary equipment.

CALL TODAY FOR THE ALLIED PRICE.

TAPECASTER STATIONMASTER

The TAPECASTER STATIONMASTER dual stereo air console series encompasses 4 models (6, 8, 12 and 16 input mainframes) offering quality, performance, dependability, premium state-of-the-art technology. Features: plug-in circuit boards, no internal transformers, any input may be Stereo or Mono, three source selection for each input, DC input switching logic, plus 24 dBm output.

- 1006, 6 input mainframe \$4895.00
- 1008, 8 input mainframe \$5695.00
- 1012, 12 input mainframe \$7995.00
- 1016, 16 input mainframe \$9895.00

ABOVE ARE MFR'S SUGGESTED LIST PRICES.
CALL FOR THE ALLIED PRICE.



— PORTABLE MIXERS —

SHURE

The **M-67** is a transistorized microphone mixer/remote amplifier specifically designed for professional applications. The excellent performance and versatility of this complete, compact console make it an ideal choice for studio, remote, or original sound reinforcement use, and as an "add-on" mixer for expanding existing facilities. It is also ideally suited for use with tape recorders and VTR's to provide multiple microphone inputs.

MANUFACTURER'S SUGGESTED LIST PRICE.....\$400.00

ALLIED PRICE \$ _____



The **SHURE Model M-267** is a professional microphone mixer/remote amplifier. The excellent performance, versatility and features of this complete, compact console make it suitable for studio, remote, or sound reinforcement use, and as an add-on mixer for expanding existing facilities. It is also ideally suited for use with audio and video tape recorders to provide multiple microphone inputs.

MANUFACTURER'S SUGGESTED LIST PRICE.....\$475.00

ALLIED PRICE \$ _____



The **Model FP-31** is a compact, portable microphone mixer specially designed for electronic news gathering (ENG) and electronic field production (EFP) use including film, video and remote broadcast applications. The FP-31 provides a wide, flat frequency response, low distortion, and up to +18 dBm output. The unit features extremely low internal noise and switchable low-cut filters for each input that effectively rejects low-frequency handling and wind noise. 400 Hz slate tone, 1 kHz cue tone.

MANUFACTURER'S SUGGESTED LIST PRICE.....\$830.00

ALLIED PRICE \$ _____



The **FP-32 Stereo Field Production Mixer** features two transformer-isolated outputs and three transformer-isolated input channels, each of which includes a level control, center-detented stereo pan pot, and a switch permitting microphone or line-level operation. The mixer's stereo capability is further enhanced by a concentric clutched stereo master gain control. The model FP-32 mixer also includes a built-in slate microphone with automatic gain control and a slate tone for identifying take. Field users will appreciate the built-in slate microphone, tone oscillator, and phantom (simplex) and A-B(T) power for condenser microphones. There's much more in this extremely compact package.

MANUFACTURED SUGGESTED LIST PRICE.....\$1200.00
CALL FOR DETAILS AND THE ALLIED PRICE.





ELECTRO VOICE

The **Electro-Voice ELX-1** Microphone Mixer packs the features you've asked for in a "friendly" format that's easy to use. In the studio or on the scene, the ELX-1 delivers the same exceptional performance, with versatility and dependability. You can RACK IT . . . PACK IT . . . STACK IT! Has built in battery power rack with LED to indicate AC or DC power. Also has calibrated RPM LED bargraph. Many, many more exciting features.

MANUFACTURER'S SUGGESTED LIST PRICE.....\$532.00

ALLIED PRICE \$ _____



GENTNER

The **Microtel MT-1** is an ultra light, battery-operated mixing console for use in a variety of applications.

It consists of a small box with an input for a microphone, a mini-jack input for another source such as a cassette deck, a jack for a headset, a mini-jack for direct output to a tape recorder or similar device and a modular jack for direction connection to the telephone line.

Totally modular in design, uses two 9 volt batteries (not included), measures 2½" wide by 5" long by 2½" high and weighs less than 1 lb.

MANUFACTURER'S SUGGESTED LIST PRICE.....\$199.00

ALLIED PRICE \$ _____



TELFAX

From **TELFAX**, manufacturers of the most widely used miniature phone remote units comes a new unit for the professional broadcaster, the TFX-131B. Features include switchable tone or pulse dialing, built-in rechargeable Ni-Cad battery pack, LCD clock/stopwatch with alarm function, closed circuit spotter channel, modular phone connectors and much more.

MANUFACTURER'S SUGGESTED LIST PRICE.....\$795.00

ALLIED PRICE \$ _____



This is the new standard in remote broadcasting, the Telfax **TFX-31C** phone remote unit. It is the smallest, lightest and most feature-packed unit on the market. Just connect it to the phone line, plug in your headset and you're ready to broadcast with superior audio quality. Compare size, features and price carefully, the Telfax TFX-31C is the only wise choice.

MANUFACTURER'S SUGGESTED LIST PRICE.....\$595.00

ALLIED PRICE \$ _____



ZERCOM

MAX-Z is a remote broadcast console that provides MAXimum flexibility, utility, and above all, audio quality. When it comes to convenience features that help make a remote broadcast run smoothly and sound professional the MAX-Z has no equal. A short list of standard features includes . . . carrying case, built in rechargeable batteries and charger, clock stopwatch/timer, V.U. meter, WIDE RANGE AUDIO INPUTS (will match almost anything), cue channel, phone line alarms, memory dialing (tone or pulse), etc.

MANUFACTURER'S SUGGESTED LIST PRICE.....\$1095.00

ALLIED PRICE \$ _____

RUSSCO

Here's the Remote Mixer you've been waiting for! The **STELLAR SERIES TELEMOTE 321** gives you two low impedance microphone inputs and one medium impedance tape recorder input in a handy-dandy 3 pound package. The **RUSSCO TELEMOTE 321 3 CHANNEL MIXER** makes life easy for you. No batteries or AC plugs to worry about. Just hook up to your phone line and you're on the air!

MANUFACTURER'S SUGGESTED LIST PRICE.....\$550.00

ALLIED PRICE \$ _____



BONNEVILLE — DISTRIBUTION AMPS —

The **DA-106** is a premium-quality general-purpose audio distribution amplifier. It is suitable for multiple line-level feeds of audio or real-time SMPTE time-code signals from a single source.

The unit features a balanced, bridging transformer input complete with static shield and R-F bypassing. Up to 30 dB of gain is adjustable by a front-panel control. The amplifier and power supply modules are easily removable from the front of the unit.

All outputs are transformer-isolated and are fully protected against short-circuits. Outputs are isolated from each other by a minimum of 60 dB across the entire audio bandwidth. Outputs can be strapped for 150 or 600-ohm source impedances. The individually-calibrated VU meter can be set for either +4 or +8 dBm systems. A front-panel headphone jack is provided for aural monitoring. A bi-polar regulated power supply is self-contained. The rectifier/regulator module is removable from the front of the unit. The amplifiers and power supply are designed for continuous sine-wave duty. The distribution system is engineered to interface with a system without introducing ground loops.

The DA-106 offers some of the most enviable features available in audio distribution at the most reasonable pricing in its class.

DA 106 Stereo.....\$1095.00 ALLIED PRICE \$ _____

DA 106 Mono.....\$695.00 ALLIED PRICE \$ _____

The **DA-108** is particularly suited to provide multiple microphone or line-level outputs to reporters and sound cameramen at press conferences. It is also suited for multiple feeds in portable sound reinforcement systems. The DA-108 features XLR connectors in and out, transformer inputs and outputs, a 20K bridging input, up to +24 dBm outputs, selectable line or mic outputs, adjustable gain to +30 dB and a self contained power supply.

MANUFACTURER'S SUGGESTED LIST PRICE.....\$695.00

ALLIED PRICE \$ _____

The **"Press Corps 2" (PC-2)** audio distribution package combines two DA-108 distribution amplifiers in a rugged carrying case. The two DA's may be bridged from a single input line using the cable supplied, or may be operated independently as separate 1 x 8 units. The carrying case has a detachable front and back cover to completely protect the distribution system during transportation. Transformer isolation on all inputs and outputs protects against AC ground loop current and RFI.

MANUFACTURER'S SUGGESTED LIST PRICE.....\$1495.00

ALLIED PRICE \$ _____



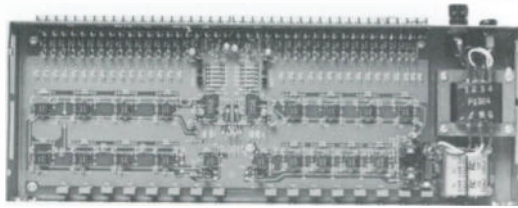

AUDIOMETRICS

The **AUDIOMETRICS** distribution amplifier combines solid-state electronics and functional flexibility into one small package. A single high quality audio op amp provides balanced output, and individual gain adjustments for each channel. Excellent isolation is provided between outputs. Audio sources can be routed to multiple locations with various level requirements and impedances.

DA8x2.....\$409.00 **ALLIED PRICE \$** _____
AUDIOMETRICS PRICES ABOVE ARE MFR'S SUGGESTED LIST PRICES. CALL FOR TODAY'S ALLIED PRICE.

TELLABS MODULAR



Each **Tellabs 4018** module provides a 1 x 8 distribution amplifier with high impedance bridging or 600 ohms input and 600 ohms each port output. The 1012 housing permits mounting of up to eleven 4018 modules plus a 9021 fuse protection module. Combine this package with a rack-mounted 8003A power supply, and you have up to 11 x 88 distribution amplifier. Cabinets must be wired by user.

4018 DA module.....\$133.00 **ALLIED PRICE \$** _____
1012 Housing.....\$100.00 **ALLIED PRICE \$** _____
8003A Power supply....\$173.00 **ALLIED PRICE \$** _____
TELLABS PRICES ABOVE ARE MFR'S SUGGESTED LIST PRICES. CALL FOR TODAY'S ALLIED PRICE.

BGW



The **BGW 2242** is an ultra high performance, all electronic distribution amplifier, configured as two single input/four output amplifiers in a 1 3/4" high rack mount enclosure. All inputs and outputs are active balanced. Eight miniature bridge connected audio power amplifiers built with discrete transistors for output devices are incorporated. The rugged output stages drive impedances as low as 50 ohms, permitting very long lines using twinax to be handled with ease. The internal power supply features a toroidal power transformer and low noise discrete regulator circuitry.

MANUFACTURER'S SUGGESTED LIST PRICE.....\$799.00
ALLIED PRICE \$ _____

HEACO



The new **5002B** audio distribution amplifier from HEACO offers a 15K ohm transformer balanced input. The frequency response of the amplifier is down less than .25 dB over a frequency range of 20 Hz to 20 kHz. Distortion is less than .25% over the same range. Eighteen 600 ohm balanced outputs are provided that are isolated by greater than 80 dB. The output level, as well as input level, can be monitored by an LED meter allowing the operator to check the operation of the DA as well as accurately set the audio level to the outputs.

MANUFACTURER'S SUGGESTED LIST PRICE.....\$549.50
ALLIED PRICE \$ _____



The new dual **5004B** distribution amplifier from HEACO is what can accurately be described as "developed technology" carried to its highest. The 5004B consists of dual, extremely low distortion amplifiers. Each amplifier has a differential, balanced bridging input. The frequency response is less than .25 dB over a frequency range of 20 Hz to 20 kHz. Distortion is less than .25% over the same range. The 5004B offers a choice of 1 x 8 or 2 x 16 operation.

MANUFACTURER'S SUGGESTED LIST PRICE.....\$687.50
ALLIED PRICE \$ _____

AUDITRONICS

Designed to meet the requirements of the modern broadcast facility, the **1100 SERIES** audio distribution amplifier systems from AUDITRONICS include the mainframe, power supply and a 1 x 6 distribution amplifier module. The DA-6/LC module includes one balanced input with internally accessed master gain control and six balanced outputs each module with individual front panel accessible attenuation controls.



1100-MFP 8 input mainframe with integral PS-1100 power supply.....\$895.00

1100-MF 10 input mainframe exclusive of power supply.....\$525.00

DA-6/LC 1 input with gain control + 6 outputs with individual attenuation controls.....\$190.00

PS-60 Rack mount external power supply system.....\$500.00

Prices shown above are based on a system. Individual components will be higher.

PSI-60 Rack mount power supply isolator.....\$265.00
ALLIED PRICE \$ _____

PS-1100 Spare integral power supply for 1100 MFP mainframe.....\$375.00
ALLIED PRICE \$ _____

AUDITRONICS PRICES ABOVE ARE MFR'S SUGGESTED LIST PRICES. CALL FOR TODAY'S ALLIED PRICE.

— ROUTING SWITCHERS —

RAMKO

The new **PRIMUS RS-1616** is an audio thru data routing/amplifying system with performance and versatility unmatched by any similar units on the market. In addition to performance that will surpass the requirements of even the most critical studio professional, the user friendly controls provide you with the power to program or control these units, limited only by your imagination. The system can be configured from as little as 8 mono/4 stereo in by 2 out, to as large as 128 mono/64 stereo in by 64.

PRICE ON APPLICATION



GENTNER

Gentner Program Switchers are very useful in applications which require passive switching of signal sources. Internal switching is accomplished by sealed socket-mounted relays that are magnetically latched. Programmable Arrayed Logic (PAL) circuits form the heart of the firmware within the system. The 10x2 Stereo selects ten stereo channel inputs to a single stereo channel output; the 20x1 Mono selects twenty mono channel inputs to a single mono channel output.

PRICE UPON APPLICATION

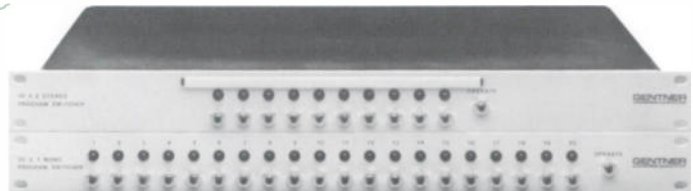

UTAH SCIENTIFIC

The **AVS-1 Switching System** has been developed for reliable, distortion-free routing of audio, video, tally, time code or machine control signals. Standard configurations are offered in matrix sizes from 10 x 10 to 150 x 160 providing video only, audio only, or audio follow video switching. Redundant cooling fans are employed. Four redundant party lines are provided. A standby control and memory card are available to permit instant replacement of 100% of the shared components.

PRICE UPON APPLICATION.

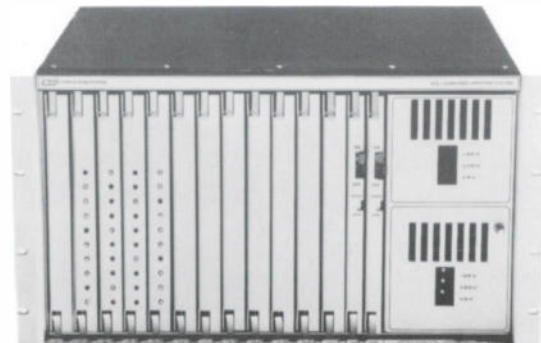

ARRAKIS

The **RS Audio Routing Switchers** are the professional alternative to patch panels, mechanical switches and distribution amplifiers. Ultra reliable, the power supply is regulated, protected and has a 10 year meantime before failure. LSI integrated circuits reduce parts count to a minimum. All IC's are socketed for ease of replacement. The thumbwheel control switches are 1,000,000 operation. Due to the ultra reliable design redundant power supplies are unnecessary. These switchers may be used in the most critical sections of the audio chain with total confidence.

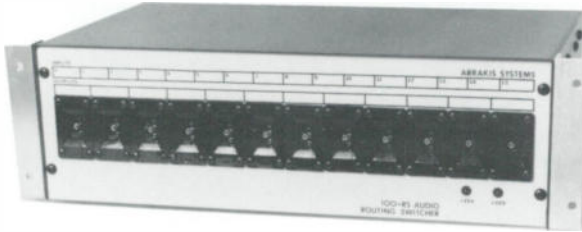

Model	Description	Price
100RSM	16 in by 12 out mono.....	\$1500.00 ALLIED PRICE \$ _____
1100A-RSS	16 in by 4 out stereo.....	\$995.00 ALLIED PRICE \$ _____
1100B-RSS	16 in by 8 out stereo.....	\$1695.00 ALLIED PRICE \$ _____
2100A-RSM	32 in by 4 out mono.....	\$1695.00 ALLIED PRICE \$ _____
2100B-RSS	32 in by 8 out stereo.....	\$3495.00 ALLIED PRICE \$ _____

ALL ARRAKIS PRICES ABOVE ARE MFR'S SUGGESTED LIST PRICES. CALL FOR TODAY'S ALLIED PRICE.

CONEX

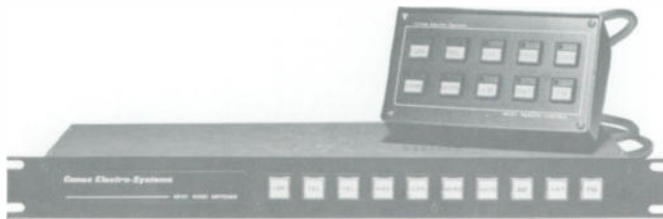

The **Conex AS-101** Audio Switcher allows any one of 10 stereo sources to be switched to the stereo output channel. Switching is accomplished by pressing one of the illuminated buttons on the front panel, or remotely, via the remote control connector on the rear panel. Several remote control devices may be connected in parallel, and all will indicate the selected channel. Typical uses include program line source selection from multiple studios, recorder input selection, live-assist operation, and general audio routing applications.

MANUFACTURER'S SUGGESTED LIST PRICE.....\$895.00
ALLIED PRICE \$ _____



The **CONEX UM-33 Cue-Amp** is a stereo, eight channel in, one channel out general purpose cue, monitor, and line amplifier.

The Cue-Amp provides the easiest, least expensive, and most compact way of handling a variety of common monitoring, cueing, amplifying, and switching situations in any audio installation.

Special Features:

- * 8 balanced bridging stereo inputs
- * 600 Ohm and direct switched outputs
- * Stereo LED VU meters with front panel calibration (-20 to +8)
- * Stereo monitor amplifier drives external speakers at 2 watts per channel
- * Two built-in speakers
- * Front panel headphone jack and speaker switch
- * Built-in low-distortion 3 frequency test oscillator with level control
- * Self-contained in a compact 1 3/4" rack mounting package

MANUFACTURER'S SUGGESTED LIST PRICE.....\$495.00
ALLIED PRICE \$ _____

A-LINE CART RACKS

STANDARD

Model	Cap.	H x W	Mfr's List	ALLIED PRICE \$
A/L 20	20	24¼ x 5¼	\$44.00	ALLIED PRICE \$ _____
A/L 40	40	24¼ x 9¼	\$44.00	ALLIED PRICE \$ _____
A/L 50	50	24¼ x 12	\$52.00	ALLIED PRICE \$ _____
A/L 60	60	24¼ x 14¼	\$63.00	ALLIED PRICE \$ _____
A/L 100A	100	24¼ x 22¼	\$91.00	ALLIED PRICE \$ _____
(Rows 5 wide, 20 high - as picture shows)				
A/L 100B	100	47½ x 12	\$91.00	ALLIED PRICE \$ _____
(Rows 10 wide, 10 high)				
A/L 150	150	47½ x 17¼	\$139.00	ALLIED PRICE \$ _____
A/L 200	200	47½ x 22¼	\$183.00	ALLIED PRICE \$ _____



N-SERIES

For audio cartridge storage Allied offers the high-quality, highly flexible A-LINE of cart racks. From the standard wall mount to the most exotic lazy susan models, everything is available from Allied. All cart racks are normally supplied with walnut, pecan, gold or black laminate. Special laminates and sizes are available, call or write for prices.

Model	Cap.	H x W	Mfr's List	ALLIED PRICE \$
A/L 100N	100	10½ x 67	\$95.00	ALLIED PRICE \$ _____
A/L 150N	150	15 x 67	\$139.00	ALLIED PRICE \$ _____
A/L 200N	200	19¼ x 67	\$183.00	ALLIED PRICE \$ _____
A/L 250N	250	24¼ x 67	\$238.00	ALLIED PRICE \$ _____
A/L 300N	300	38¼ x 67	\$279.00	ALLIED PRICE \$ _____
A/L 350N	350	34¼	\$329.00	ALLIED PRICE \$ _____
A/L 400N	400	39¼ x 67	\$370.00	ALLIED PRICE \$ _____
A/L 450N	450	43¼	\$421.00	ALLIED PRICE \$ _____
A/L 500N	500	48½ x 67	\$470.00	ALLIED PRICE \$ _____
A/L 600N	600	58¼ x 67	\$532.00	ALLIED PRICE \$ _____
A/L 800N	800	78½ x 67	\$700.00	ALLIED PRICE \$ _____
A/L 1000N	1000	97 x 67	\$915.00	ALLIED PRICE \$ _____



Lazy susan cart racks are normally supplied with standard 4" base. However, any size base up to 30" is available. Special size racks are available. Walnut, pecan, gold or black laminate are standard. Call or write for prices on special bases, sizes or laminates.

Model	Cap.	H x W	Mfr's List	ALLIED PRICE \$
A/L 100LS	100	10¼ x 32¼	\$180.00	ALLIED PRICE \$ _____
A/L 160LS	160	15 x 27	\$270.00	ALLIED PRICE \$ _____
A/L 240LS	240	19½ x 27	\$314.00	ALLIED PRICE \$ _____
A/L 400LS	400	24¼ x 32¼	\$540.00	ALLIED PRICE \$ _____
A/L 800LS	800	24¼ x 58¼	\$911.00	ALLIED PRICE \$ _____
A/L 1000LS	1000	29 x 58¼	\$1415.00	ALLIED PRICE \$ _____
A/L 1200LS	1200	29 x 69¼	\$1638.00	ALLIED PRICE \$ _____

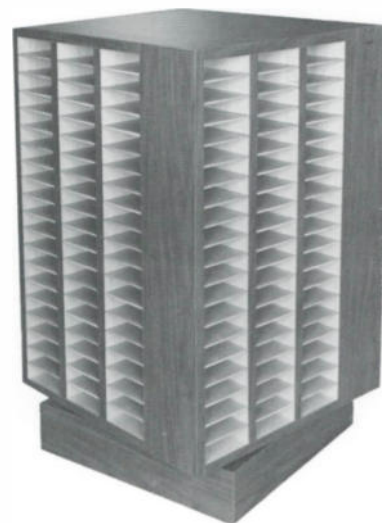



ALLIED WIRE LAZY SUSAN CART RACKS

Where strength and capacity are required at a minimal cost, the Allied line of welded, durable wire lazy susan cart racks can fill the need. Available in a choice of 50, 300 or 500 capacity, these industrial quality cart racks will give many years of dependable service.

Model	Cap	Mfr's List	ALLIED PRICE \$
50	50	\$45.46	_____
300	300	\$354.23	_____
500	500	\$539.08	_____

-Dimensions-

- #50 is 4½" W x 6" D x 65¼" L
- #300 is 6' High and has a 19" Diameter
- #500 is 6' High and has a 21" Diameter

NOTE: "Handle" Ring diameter of #300 is 22" and #500 is 27"

For the broadcaster who has more carts than space, the answer very likely is Allied wire racks.

These high quality, reinforced wire racks give you all the storage space you will need to hold all your program and commercial carts.

COPPER

ALLIED IS A MAJOR SUPPLIER OF COPPER

ALLIED stocks and sells more copper strap than any other broadcast supplier. We also supply copper flyscreen for room or equipment shielding.

Call for current price due to fluctuating market

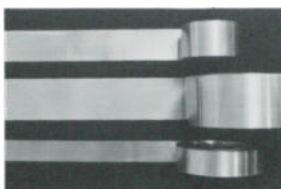

for RF Management,
COPPER STRAP
.020 or .032 thickness,
all widths

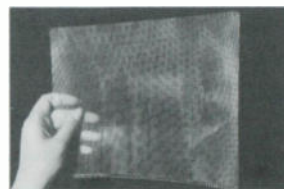

for equipment or
room shielding,
COPPER FLYSCREEN



for tower counterpoise,
COPPER GROUNDSCREEN

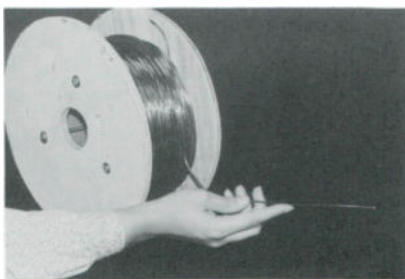

for construction wiring,
SOFT #10 COPPER WIRE



CALL FOR TODAY'S ALLIED PRICE

FIDELIPAC

The Fidelipac line gives you a choice of styles and sizes.

WR25 Wall mount-25 carts...\$30.60 ALLIED PRICE \$ _____

MRB-1 rack base (8-WR25)...\$74.20 ALLIED PRICE \$ _____

MR-200 mobile rack holds 200...\$319.00
ALLIED PRICE \$ _____

TR-48 tabletop rack holds 48...\$91.00
ALLIED PRICE \$ _____

TR-96 tabletop rack holds 96...\$162.75
ALLIED PRICE \$ _____

FIDELIPAC PRICES ABOVE ARE MFR'S LIST PRICES. CALL FOR TODAY'S ALLIED PRICE.

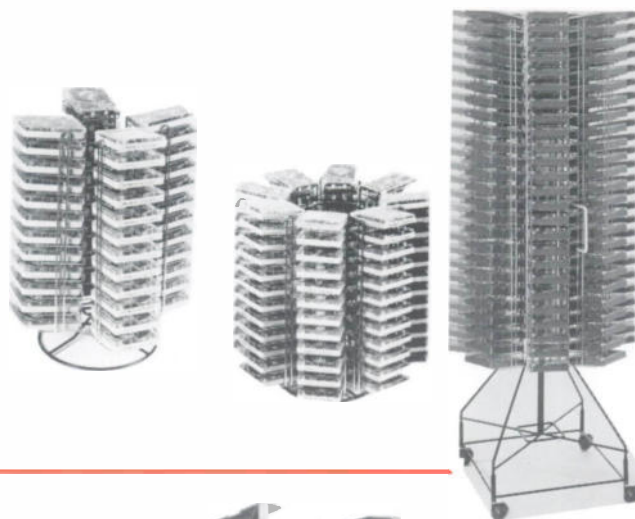

SIMPAC

For a cart rack that will mount anywhere and will hold up to 10 carts, the SIMPAC line from Allied is just what the engineer ordered. Black only.

MANUFACTURER'S SUGGESTED LIST PRICE.....\$7.00 per module

ALLIED PRICE \$ _____

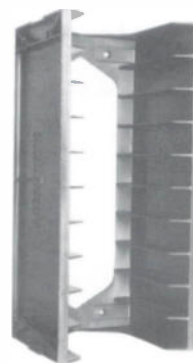

A-LINE 19" EIA EQUIPMENT RACKS

Model	Panel Ht	Depth	Mfgr's List	ALLIED PRICE \$
A/L R100	7"	17"	\$85.00	_____
A/L R100	7"	23"	\$89.00	_____
A/L R101	8¾"	17"	\$92.00	_____
A/L R101	8¾"	23"	\$97.00	_____
A/L R102	10½"	17"	\$99.00	_____
A/L R102	10½"	23"	\$105.00	_____
A/L R103	12¼"	17"	\$114.00	_____
A/L R103	12¼"	23"	\$120.00	_____
A/L R104	14"	17"	\$128.00	_____
A/L R104	14"	23"	\$135.00	_____
A/L R105	15¾"	17"	\$141.00	_____
A/L R105	15¾"	23"	\$148.00	_____
A/L R106	17½"	17"	\$156.00	_____
A/L R106	17½"	23"	\$174.00	_____
A/L R107	19¼"	17"	\$175.00	_____
A/L R107	19¼"	23"	\$181.00	_____
A/L R108	21"	17"	\$185.00	_____
A/L R108	21"	23"	\$190.00	_____
A/L R109	24½"	17"	\$189.00	_____
A/L R109	24½"	23"	\$197.00	_____
A/L R110	31½"	17"	\$199.00	_____



All rack cabinets are made of ¾" high-density particle board and covered with walnut, honey gold, pecan or black laminate. However, any color or wood grain laminate is available. Backs of all equipment racks feature an exclusive snap-out panel for easy access to equipment. Custom heights are available. Optional casters are \$37.00 per set. For overall dimensions add 4" to the panel height, all units are 23¼" wide overall, 17" depth racks are 18" deep overall, 23" depth racks are 24" deep overall.

A/L R110	31½"	23"	\$207.00	ALLIED PRICE \$ _____
A/L R111	35"	17"	\$206.00	ALLIED PRICE \$ _____
A/L R111	35"	23"	\$214.00	ALLIED PRICE \$ _____
A/L R112	42"	17"	\$219.00	ALLIED PRICE \$ _____
A/L R112	42"	23"	\$231.00	ALLIED PRICE \$ _____

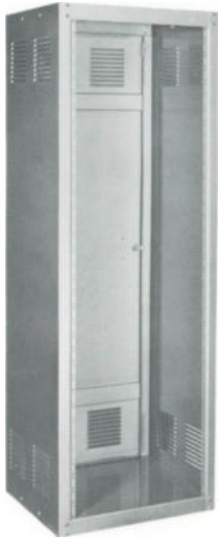

SOUNDOLIER

Soundolier Cabinet Relay Racks are designed for standard 19" rack panels. A rear door is provided as standard equipment and is hung on slip jointed hinges. Knockouts and internal louvers are among the exclusive features offered by Soundolier.

PRICE ON APPLICATION. CALL TODAY FOR THE ALLIED PRICE.



H.O.M.E.



The **DR Series** of H.O.M.E. 19" modular racks includes several features including sturdy welded construction of 16 gauge CRS, optional side panels that are removable for multiple bolt-together assemblies, adjustable 11 gauge angles tapped for 10-32 screws on standard EIA spacing that makes panel mounting easy. A cable opening is provided in the bottom panel. A rear door with lock and handle is provided. You can choose from 20 standard baked enamel colors. Depths to 24" available.

CALL FOR TODAY'S ALLIED PRICE

A-LINE

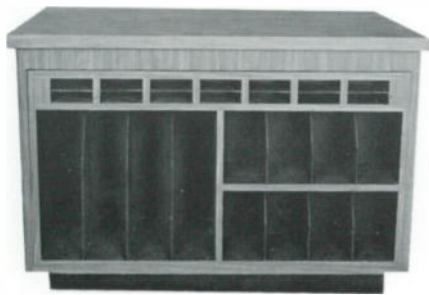

A-LINE Turntable Bases are constructed of 3/4" high-density particle board covered with standard laminates. Tops are 1 1/4" thick. Turntable bases are normally supplied with rack rails constructed of 11 gauge steel, tapped to accept 10-32 standard EIA rack panel screws. Cover panels are available at \$37 per bay. Custom cabinets with record and/or tape storage inserts shown here are available at extra cost.

Model	Description	
A/L 201A	Single turntable base.....	\$246.00
A/L 201B	Double turntable base.....	\$382.00
A/L 201C	Triple turntable base.....	\$490.00



The **SHOCK ABSORBER JR.** is a turntable isolation platform designed for retrofit and OEM installations. It consists of a turntable mount plate and a base plate separated by four live rubber mounts. The mount plate is high density particle board with a lead strip inlaid around the perimeter. This massive plate is isolated from the base plate by four live rubber shock mounts to further reduce resonance and vibrations. The unit can accommodate all popular direct-drive turntable/toner combinations, providing up to 8-10 dB of feedback headroom and 20 dB of isolation. Standard finishes include walnut, pecan, black or gold laminate. The mount plate will be precut if the turntable/toner combination is specified with this order.

SHOCK ABSORBER JR.	\$305.00
SHOCK ABSORBER JR. for SP10 MARK III	\$359.00

SHOCK ABSORBER

Allied's turntable isolator has been integrated into a package known as the **Shock Absorber**. This approach attacks head-on the many problems associated with protecting otherwise noise free turntable-tone arm combinations from all types of interference. Gives 8 to 10 dB of feedback headroom improvement and up to 20 dB of isolation. Turntable and tone arm not included.

SHOCK ABSORBER.....\$516.00

SHOCK ABSORBER for SP10 MARK III.....\$580.00



ALLIED RADIO BASE

A table top turntable base that will accommodate all the popular turntable/tone arm combinations. Comes in standard walnut or black laminate. Special laminates are available at extra cost. (Turntable and tone arm not included.)

MANUFACTURER'S SUGGESTED LIST PRICE.....\$125.00



SIMS VIBRATION DYNAMICS

The **GSP-1000E Electric Audio Wide Band Isolator** eliminates feedback over the entire audio spectrum, from 20-20,000 Hz at any volume level and reduces transit vibration over 90% at audio frequency levels up to 98db. Airborne echo and low bass rumble are virtually eliminated. It is designed to function when subjected to variable disturbing forces such as blowers and air conditioners and is not just limited to narrow bands of isolation, but throughout the entire audible frequency range.

MANUFACTURER'S SUGGESTED LIST PRICE.....\$799.00

ALLIED PRICE \$ _____

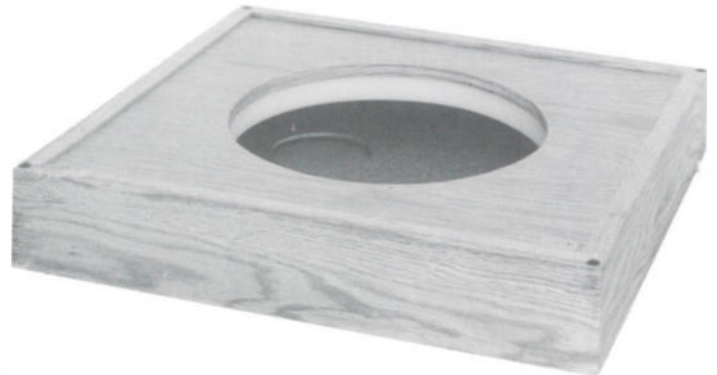

For use where concert levels must be produced without feedback, the **GSP-1000M** with its patented neo-gas foot provides excellent isolation from feed-back, footfall shock, airborne echo, and vibration from air handling systems as well as from building movement caused by elevators and earth movement from motor vehicles. Eliminates feedback with 7 lbs. of technology more efficiently than with 800 lbs. of sand.

MANUFACTURER'S SUGGESTED LIST PRICE.....\$273.00

ALLIED PRICE \$ _____



**Here's Why We're Confident You'll Choose
MODULUX Cabinetry For Your Next Studio**



Choose MODULUX by Arrakis for all the quality of custom cabinetry at half the price.

MODULUX is better by design. Until MODULUX studio cabinetry, you had to choose: You could pay high prices for strong and durable, well-finished custom-built cabinetry. Or you could pay less, and settle for considerably lower quality. Now there's a third choice, a better choice — MODULUX, built by Arrakis Systems exclusively for Allied Broadcast Equipment.

Why Quality Cabinetry Costs So Much (And Takes So Long to Get).

Most quality cabinets are fabricated one-at-a-time. You tell the manufacturer what you want, and they make it up. It sounds like an expensive way to make a cabinet, and it is. Finally, each fully assembled unit is boxed and trucked to you. But because the boxes are so large, they can't be sent by U.P.S. or express carriers. So you pay extra shipping charges, and delivery takes extra time.

Now MODULUX Cuts The Price Of Custom Quality Cabinetry In Half.

There's no magic. Just common sense. You see, MODULUX cabinetry is custom quality but each cabinet need not be custom made. Arrakis has created a unique aluminum post internal frame and wood outer panel system for MODULUX. These standardized elements are produced in quantity and stocked in depth at the factory.

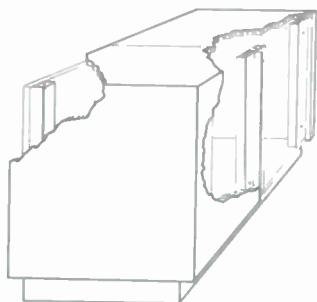

Cutaway view shows how Polybond wood panels bolt to rigid aluminum post internal frame.

MODULUX Is An Allied Exclusive.

Innovative answers to broadcasters' needs are what you expect from Allied Broadcast Equipment. All units are immediately available as shown, with cream color laminate side panels and dark brown "leather-look" laminate tops, all trimmed in natural oak. Other colors and finishes can be ordered at a moderate up charge. With MODULUX, there's no need to compromise on style, quality, delivery and especially — value.



But Is The Quality Really There?

Absolutely. With MODULUX, your money goes for quality materials and construction, not for inefficient manufacturing methods. All panels are 1/4" wood polyboard, permanently laminated on both sides at the factory and guaranteed not to delaminate in the field. Access panels are securely attached, yet easily removed, with quarter-turn fasteners. MODULUX'S .125 inch thick aluminum post and solid wood panel construction provides superior durability.



Natural oak trim complements color-keyed laminate panels and tops for style and durability.

Designed With The Future In Mind.



MODULUX makes studio updates easy. Shown, a second turntable base being added alongside an existing base.

Another key advantage of the MODULUX system is flexibility. Since panels can be interchanged, the system can be reconfigured, or expanded as your needs change.



Locking the existing and new bases together and adding an overbridge creates a single integrated unit.

MODULUX Cabinets are shipped in Strong and Compact U.P.S.able boxes.

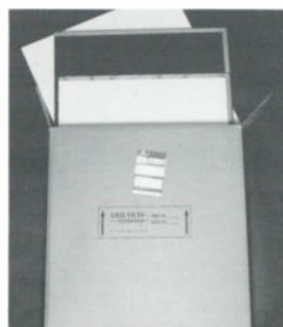

Each MODULUX cabinet is shipped knocked-down, via U.P.S. Assembles fast and easy with just a few hand tools.

GRAPHIC EXPRESS

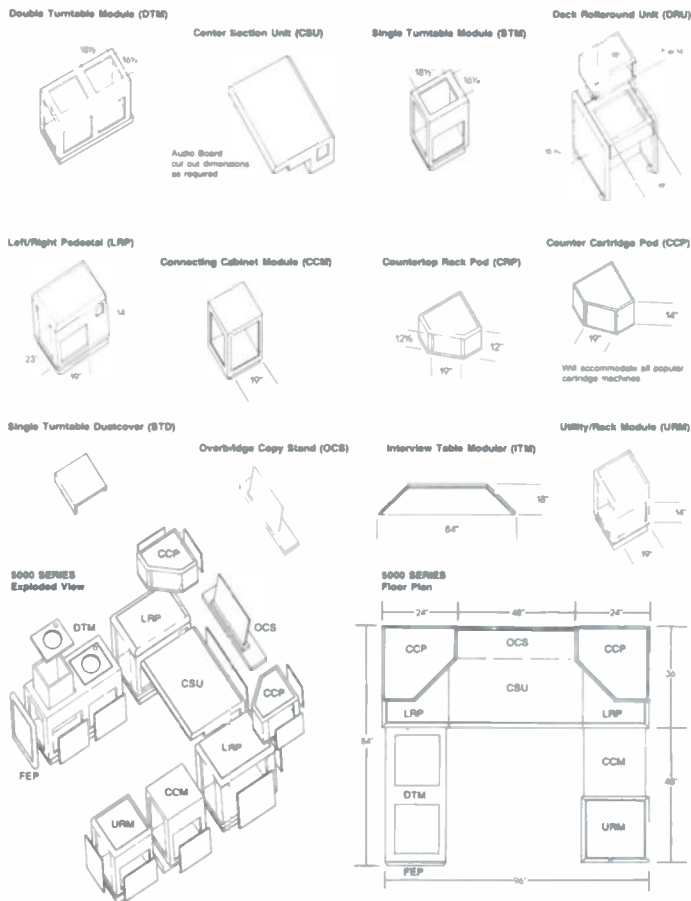

Our audio cabinet, developed through years of experience, offers both ergonomically and functionally correct designs, extreme flexibility, competitive price and is available for immediate delivery.

The ability to choose precisely the modular components needed means added flexibility for studio layouts. You can have exactly the design you want—and you can expand or modify the system later should your needs change. The modular design insures compatibility with new or existing studios. Premium quality materials are used throughout. Our work stations for on the air studios and production rooms are designed to maximize the efficiency of the operator and station's engineer. The stylish image that the consoles project, not only enhance your station's look to potential advertisers and the visiting public, but also improve the working environment.

The large number of access panels, held in place with quarter turn fasteners, allow easy cable handling and quick access to cable runs. All units provide access through cabinet bottoms for sub-floor cable ducting. Rack rails are included where specified.

Revitalize your studio and increase your efficiency through proven design and modular flexibility.

We also offer design and fabrication of custom studio cabinetry built to your specifications. Contact us for details.

PRICES UPON APPLICATION

ALLIED

The **ALLIED STUDIO PACKAGE** is the answer for remote broadcasts, news and production studio establishment, or disco operations. This convenient portable package is available wired and equipment ready in either mono or stereo with turntables, phono preamps, tonearms, phono cartridges and rugged cabinetry with solid oak trim. Design a system around equipment you already own or select your favorite brand equipment for installation. Overbridge is an optional feature. You'll find this package to be a space saving solution to many of your production problems.

PRICES VARY DEPENDING ON EQUIPMENT SELECTED. CALL FOR YOUR ALLIED PACKAGE PRICE.

NOTE: (If not picked up at Richmond Warehouse--add \$150 packing charge)



**"Products & Service
for the Industry"**

CONSOLE TABLE

The **A-LINE console table** comes in a standard size 30" x 96" table top with legs and modesty panel available.

- A/L 202 Console tabletop 30" x 96".....\$167.00
ALLIED PRICE \$ _____
- A/L 1111 Legs for console tabletop.....\$202.00
ALLIED PRICE \$ _____
- A/L 2222 Modesty panel for tabletop.....\$39.00
ALLIED PRICE \$ _____

STANDARD BROADCAST DESK



A heavily-built "real" piece of control room furniture. Standard in 29" height with tabletop of 30" x 96", this unit can be varied in size to meet your precise needs. Shipped modular for rapid assembly. A pullout kneewell back affords easy access to hidden wiring compartments. Amplifier optional.

- | Model | Description |
|----------|---|
| A/L 230 | Console desk, no drawers.....\$657.00
ALLIED PRICE \$ _____ |
| A/L 2300 | Console desk, two drawers.....\$712.00
ALLIED PRICE \$ _____ |

ELECTRO-DUCT®

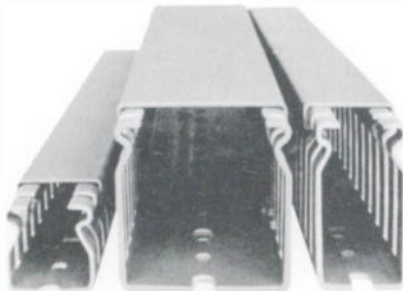

ELECTROVERT

This plastic duct has more positive features than any other. If you've had to fight cover-on & cover-off with inferior brands, you'll appreciate the zip-on, zip-off ability of Electro-Duct's cover.

When you buy Electro-Duct, the cover is included in the price. Allied stocks 1" x 1", 2" x 2", 3" x 3", and 5" x 3". Length: 6½ ft. Color: gray.

We went for the best so you can have the best. There are many PVC Duct manufacturers. There's only one Electrovert.

PRICE UPON APPLICATION

RECORD STORAGE CABINETS



ALLIED

Now your music or transcription library can be put in alphabetical or numerical order with standard or custom size record storage cabinets from Allied.

Model	Record Cap Size	Mfr's List	ALLIED PRICE \$
A/L 1000A	7" 1000	\$250.00	ALLIED PRICE \$ _____
A/L 1500A	7" 1500	\$296.00	ALLIED PRICE \$ _____
A/L 3000A	7" 3000	\$354.00	ALLIED PRICE \$ _____
A/L 750B	12" 750	\$256.00	ALLIED PRICE \$ _____
A/L 1000B	12" 1000	\$297.00	ALLIED PRICE \$ _____
A/L 1500B	12" 1500	\$363.00	ALLIED PRICE \$ _____

REEL TAPE STORAGE CABINETS

Every station has a room running over with reel-to-reel tapes, commercials, programs, and a widely assorted variety of other types of taped material. The A-LINE reel tape storage cabinets are available in standard or custom sizes for every application.

Model	Tape Cap Size	Mfr's List	ALLIED PRICE \$
A/L 350TB	7" 350	\$216.00	ALLIED PRICE \$ _____
A/L 500TB	7" 500	\$340.00	ALLIED PRICE \$ _____
A/L 175TC	10½" 175	\$295.00	ALLIED PRICE \$ _____
A/L 250TC	10½" 200	\$352.00	ALLIED PRICE \$ _____

RUSLANG



For mounting any standard 19" x 15 3/4" tape transport, the Ruslang **RL-500** is constructed with the same care as other top name consoles constructed over the past few years. Accepts Ampex, MCI, Otari and Tascam transports and includes the tilt feature.

CALL FOR TODAY'S ALLIED PRICE



The **Ruslang RL-600** accepts tape transports which are 19" by up to 21". This console was designed specifically for the newer generation of decks which have their electronics integrated with the transport including the Otari 5050B and others. The RL-600 is built with the same quality concern that has identified the Ruslang name for years.

CALL FOR TODAY'S ALLIED PRICE

PRO RAX

These unique racks are designed to store, protect and keep handy your compact disks (CDs). The cabinetry is mahogany finish and the price also includes crating for delivery to you.

Model Description

CD-40LS Carousel (Capacity 40)
11 1/2"W x 9 1/4"H x 11 3/8"D.....\$69.95

CD-20W Wall or Desk (Capacity 20)
6 1/4"W x 16 1/2"H x 4 3/4"D.....\$39.95

PRO RAX PRICES ABOVE ARE MFR'S SUGGESTED LIST PRICES. CALL FOR TODAY'S ALLIED PRICE.



CD-40LS Carousel



CD-20W Wall or Desk

OMNIMOUNT

The **Omnimount mounting system** puts added flexibility into a wide variety of equipment mounting functions including speakers, clocks, and some types of equipment including monitors. Omnimount is of industrial quality, built to last a long time. A key to its remarkable performance is the ball joint design. The ball is molded of an ebonite polymer compound, with excellent memory-return and is just about indestructible. The ball is bonded to the thick-walled carbon steel tube the same way that heavy duty motor mounts are bonded. You can mount Omnimount on the wall or ceiling and it does its job with extraordinary flexibility, not limited to the usual "pan and tilt" functions. A wide variety of models is available to choose from.

CALL FOR TODAY'S ALLIED PRICE



Wall



Ceiling

“Buy or Lease from Allied”

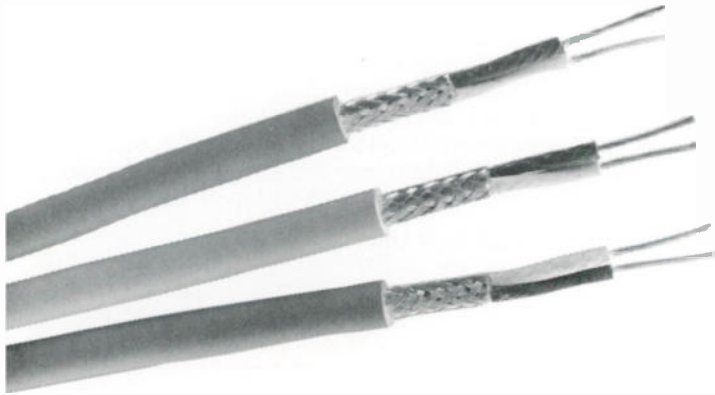
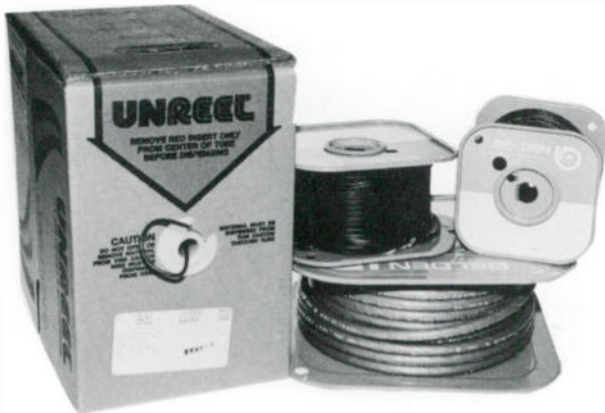

BELDEN WIRE

Belden is recognized as the leader in the wire/cable/cord industry and manufactures thousands of different electronic cable and cord constructions utilized in a vast assortment of applications. Many cables are custom designed/manufactured for specific applications prior to becoming standardized for systems in data processing, computers, medical applications, broadcasting, etc. Belden Black 8451 is especially popular with broadcasters as well as 8728. With Belden in our "back yard," we offer you the world's largest inventory of wire/cable/cord available to anyone, anywhere because Allied distributes the entire Belden product line.

Just a sample of broadcast applicable cable:

- #8766-22 Gauge Solid Conductor - .64 mm dia. U.L. style 2464 300V 80C available in lengths of 100, 500 or 1000 ft., 15 pairs, with .013 insulation, jacket thickness of .045 and nominal OD of .525
- #8776-22 Gauge Stranded Conductor - .76 mm dia U.L. style 2493 60C. Available in lengths of 100, 250, 500 or 1000 ft., nominal center cond. 15Ω/M' with nominal shield of 163Ω/M', 15 pairs, with chrome PVC jacket and nominal OD of .580

CALL TODAY FOR SPECIFICATIONS & ALLIED ECONOMICAL PRICING

MONSTER



MONSTER speaker cables are designed specifically for handling complex music signals. By using more copper for better power transfer, finer strands for improved highs, and a unique winding configuration for greater overall clarity, we're able to minimize signal degradation and produce durable cables with exceptional sonic capabilities. The outer jacket is designed to be used under the most adverse conditions of temperature, weather, abrasion, chemicals, and UV radiation. Monster cables remain extremely flexible, attractive, and easy to run along baseboards and walls. Available by the foot. Gold plated spades and banana terminals also available. Capacitance = 22pF/ft., resistance = 66 milliohms/ft., Size = 10AWG.

CALL ALLIED FOR YOUR PRICE DETAILS

WEST PENN WIRE



Put some color into your life by using **WEST PENN** easy to strip color shielded cable. A particular favorite of broadcasters is #291 two conductor twisted pair shielded cable. #291 comes in 22 AWG stranded with a 24 AWG drain wire with insulation colors of white, red, brown, black, yellow, green, gray, blue, violet and orange. This product is comparable to the leading manufacturers, but with reduced price structure.

ALLIED OFFERS THE ENTIRE WEST PENN LINE ON A VERY COMPETITIVE PRICE STRUCTURE.

CALL FOR TODAY'S ALLIED PRICE.

ALLIED TERMINATION SYSTEM

Allied can offer everything you need to establish a type "66" punch block wiring system in your studio or station.

"O" PADS

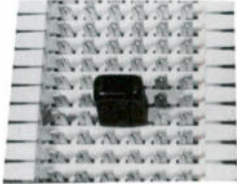

Where specific attenuation is needed the Allied "O" pad can provide a choice of 3, 6, 10, 17, or 23 dB attenuation.

TERMINATION



Your choice of vertical or horizontal termination 300, 600 or 10K ohms. Terminating, bridging, or build-out.

"SA-1" BRIDGE CLIPS



For jumper application in use of "66" punch block wiring.

PUNCH TOOLS



Model	Description
S66MT	spring loaded
S66BT	manual
S714	automatic

For punch board wiring applications, this is the most efficient method utilized.

"66" PUNCH BLOCKS

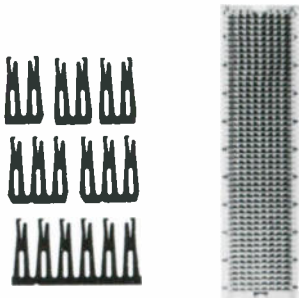

Model	Description
S66B3-75	Group of 2 clips
S66B3-50	Group of 3 clips
S66B4-25	Group of 6 clips

Absolutely the easiest way to accomplish complex wiring projects. A must for efficient console, rack mounted equipment or other types of wiring installations.

"ST" CONNECTOR

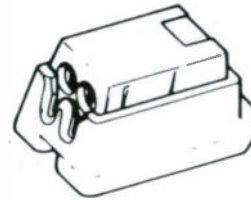

Easy punch block hook-up is available with the standard of the industry, the 3M "ST" connector.

"E9E" CRIMP TOOL



The perfect tool for use with "ST" connectors and for other crimp applications.

SNAP-IN WALL MOUNT



Perfect for mounting a type "66" punch block on the wall or any available space. The model S66B6 will fit most standard punch blocks.

WIRE AND CABLE HANGERS



S66145

S66147

Model	Description
S66147	Cable hanger
S66145	Cable hanger

Allied has wire and cable hangers for every application.

CALL FOR TODAY'S ALLIED PRICE ON TERMINATION COMPONENTS.

**When only the best
will do . . .
ALLIED will supply it.**

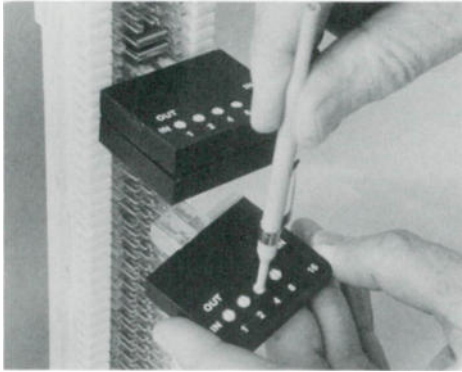

LARUS

The **66 SwitchPad** features compact plug-in switch selectable attenuators that install directly onto split 66M type connecting blocks to provide flexibility in establishing circuit loss levels on dry voice or data circuits.

Space saving 66 SwitchPads provide 0 to 31 dB attenuation in 1 dB steps, offer installation simplicity, and require no additional mounting assemblies or hardware. The attenuators plug directly onto two vertically adjacent rows of installation displacement terminals of the connecting block in place of the Tip and Ring bridging clips.

Attenuation level set is accomplished by setting the miniature switches to insert the required attenuator sections into the circuit.

ALLIED



Action responsive, secure comfort that's built to withstand years of constant use. The **ALLIED Chair** features an upholstered floating action back attached to a solid steel back brace. The upholstered waterfall seat rotates a full 360° on a solid steel threaded stem. The base is made of heavy gauge tubular steel with an electronically welded footing for added stability and comfort. Finally, every metal part is finished with top grade baked enamel to insure scratch and chip resistance. Stock chair includes chrome legs and footing, black frame finish with either brown or black upholstery, and casters.

MODEL 2200 "LOW" CHAIR . . . adjusts 19" - 24" Shipping box: 20¼" x 21" x 16½". Shipping weight: 28 lbs.

MODEL 2600 "HIGH" CHAIR . . . adjusts 24" - 29" Shipping box: 20¼" x 21" x 18¼". Shipping weight: 29 lbs.

GENTNER



The **Gentner Flexiblock** is an insulation-displacement punch block system made specifically for stranded wire. Connections to Flexiblock are fast, easy and reliable. A high number of connections may be made in a small space (up to eight connections per circuit) and connections are virtually short-circuit proof. Standard size is 10"L x .56"H x 3.37"W with 50 terminals. (Variables available)

FB25 MANUFACTURER'S SUGGESTED LIST PRICE..\$14.06

ALLIED PRICE \$ _____

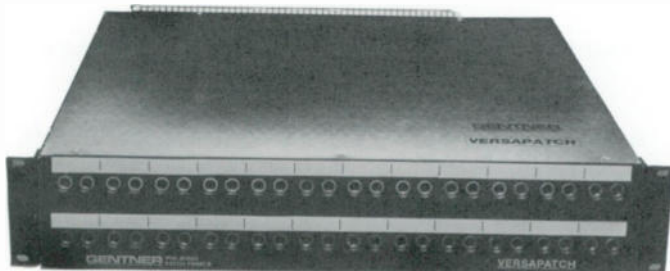

Flexiblock makes downsize Versapatch the most versatile, flexible prewired patch panel you can buy.

Gentner's Versapatch is a prewired patch panel enclosed in a chassis. The rear of the chassis gives easy access to the jacks; stranded wire cables are neatly bundled across the hinge and terminated on Flexiblock punch blocks. Individual designation strips allow you to change one circuit's designation quickly and neatly - no need to remove and redo an entire row's designation for one change.

Versapatch is available with Tip-ring jacks; normals are jumpered at bay or Top-row bridged for monitoring capability. Various bay types from 24 to 96 jacks with various termination types are selectable.

Prices upon configuration selected. Call for details and ALLIED pricing.

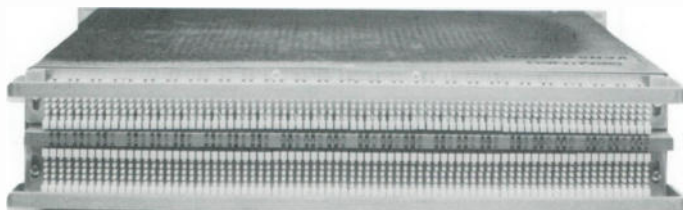

GENTNER

The **Gentner pre-wired patch panel** allows you to specify exactly the composition configuration you need for your application by selecting from five (5) bay types, two (2) jack types, five (5) normals, six (6) terminations plus cable and bundle length. What could be nicer?

ALLIED pricing must be quoted due to variables.

ALLIED carries the entire Gentner product line. You will find them in various locations in this catalog.

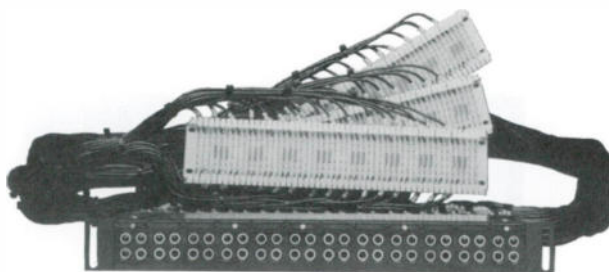

ADC

ADC's new **Pro-Patch** jackfield is truly state-of-the-art, incorporating the split cylinder contacts. Pro-Patch units are reusable and especially suited for remotes, special broadcasts and advance builds, with the ability to change circuits and normaling configurations in seconds. Pro-Patch jackfields provide the ultimate in time and labor savings, flexibility, and ease of installation and maintenance.

Ultra-Patch panels, another innovative product utilizing ADC's split cylinder technology, were designed to provide yet another set of options for audio patching and interconnect requirements.

Ultra-Patch panels can be terminated at the factory to any of ADC's standard or custom jackfields and may be rack or wall mounted. Accessory brackets are available for racks with nonadjusting rear supports as well as for wall mount applications. Cable troughs, front and rear, provide for a clean and professional look for any system. Ultra-Patch panels are available separately.

ADC's standard line of **AUDIO JACKFIELDS** features an extensive selection. Choice of jacks, panel size, normal line options, cable length (3 to 8 feet) and variety of terminations (stub end with leads identified, Christmas tree, Telco "punch down" terminal block, or ADC's new ultra patch panel) combine to give you more than 280 possible configurations.

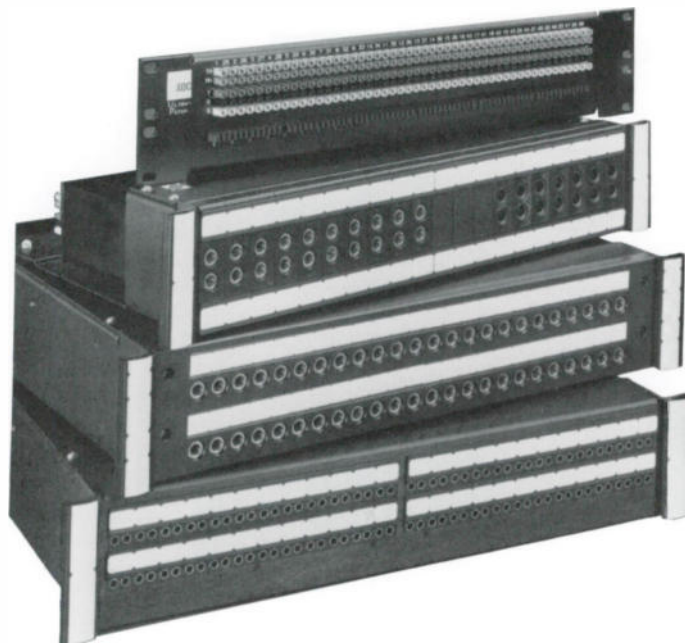

ALLIED WARNING LIGHTS



An adaptation of technology to a unique application is the 70,000 candlepower **"STROBE SERIES"** of telephone and "ON AIR" warning lights from Allied. These bright attention drawing lights come in a variety of lens colors including white, blue, red, amber and green, lettered with "PHONE" or "ON AIR." 12 and 24 volt DC and 115 VAC "ON AIR" models are available. Only 115 volt AC models available for "PHONE." Size: 4½"H x 2¾"W x 1½"D



The Allied **"MICRO SERIES"** warning light is supplied with one 1820/28 volt lamp. The unit is designed for use with 24 volts for extended life. All models mount on standard single gang wall boxes or plaster rings. The wedge shaped translucent cover is available in red or white.

Model	Voltage	Message	Price
WHI-12	12VDC	ON AIR	\$68.00
WHI-24	24VDC	ON AIR	\$68.00
WHI-115	115VAC	ON AIR	\$68.00
PS11AWA	115VAC only	PHONE	\$84.00

Model	Voltage	Message	Price
L-101	24 VDC	ON AIR	\$28.80
L-101	24 VDC	BLANK	\$22.50



FLAT WALL



EXTENDED
OR
CEILING MOUNT



ALLIED WARNING LIGHTS

Enhance the environment of any broadcast application with the Allied "**ARCHITECTURAL SERIES**" of warning lights. The series includes flat wall and wall or ceiling mounted models. These are well constructed warning lights made in a one piece die cast aluminum housing of 1/8" minimum wall thickness. There's no external hardware. The spring clip mechanisms firmly secure the directional panel to the housing eliminating light leaks. The extending bracket and ceiling units have a cast aluminum canopy.

Type	Message	Price
Flat Wall-7½"x7½"	ON THE AIR	\$66.00
Ceiling-7½"x8½"	ON THE AIR	\$75.00

The model of warning light that has served the broadcast industry for many years is the Allied "**STANDARD**" model. This durable, highly visible and efficient on air warning light is available now. Size: 7⁵/₈"H x 5¹/₄"W x 4³/₈"D.

FIDELIPAC



Your broadcast or recording studio will really be "off limits" when **Fidellpac Studio Warning Lights** are lit. Their brilliant red lettering on jet black background can be seen even in the brightest ambient light conditions. With a faceplate of unbreakable plexiglas, the light includes lamps and mounting hardware. Custom legend minimum 6 pieces. Size: 5"H x 10" W x 2½"D.

Model Message

340-S ON AIR-English, French, German, Greek, Japanese, Polish, Russian, Spanish or Swedish.

MANUFACTURER'S SUGGESTED LIST PRICE.....\$50.00

ALLIED PRICE \$ _____

TITUS



This flush mounted **ON AIR LIGHT** from **TITUS** was designed to provide the broadcaster with a low voltage device which can be mounted horizontally or vertically and have simple bulb replacement. Unit uses #1819 bulbs for 24V operation and #1815 for 12V operation, and measures 8¹/₄" by 4¹/₄".

MANUFACTURER'S SUGGESTED LIST PRICE.....\$99.00

ALLIED PRICE \$ _____

LUXO



The **Model LM-1** from Allied is a high quality piece of studio furniture. The LM-1 will hold any microphone up to 3 pounds maximum. You have a choice of three mounting bases. Please specify base A, B or C. Color selection: Oyster or Black.

MANUFACTURER'S SUGGESTED LIST PRICE.....\$46.35

ALLIED PRICE \$ _____

AUDIOMETRICS



MODEL M2MDU
Single mic arm
(Black or Gray)



MODEL M2MDU
Single mic arm with optional
Model EB-1 Extension Arm
(Black or Gray)



MODEL MJRM1
Single mic arm
(Light weight version of M2MDU)
(Gray only)

**CALL FOR THE ALLIED PRICE ON
THESE MIC ARMS & ACCESSORIES**

(All models shown with optional riser)



MODEL M3MDRU
Two joint single mic arm
(Gray only)



MODEL TMA
Triple mic arm
(Gray only)



**Hold Everything
M2MD-U Mic Arm**

ACCESSORIES FOR AUDIOMETRICS MIC ARMS



HEAVY SPRINGS



MODEL 14100
RISER
(Black or Gray)



MODEL EB-1
EXTENSION ARM
(Black or Gray)



MODEL 11426
WALL MOUNT
(Black or Gray)



MODEL 11427
BENCH MOUNT
(Black or Gray)



MODEL 14005
CLAMP MOUNT
(Black or Gray)

SONEX by ALPHA AUDIO

With its patented anechoic foam wedge, SONEX absorbs and diffuses unwanted sound in your studio. And it can effectively replace traditional acoustic materials at a fraction of the cost. SONEX blends with almost any pro audio decor and looks clean, sharp, professional. Check into this attractive alternative for sound control. Call or write us for all the facts and prices.

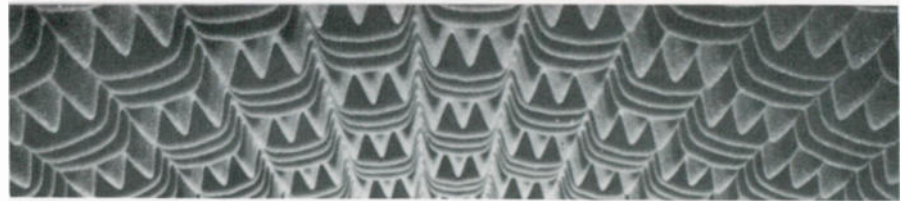

SHEETS



4'x4'

AUDIO TILES

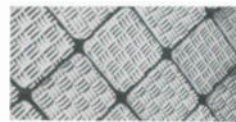

15"x15"

	Depth	Sheets Per Box	Sq. Ft. Per Box	Pricing*
Natural Colors Charcoal, Brown, Tan (Natural Brown & Tan not available in 4" depth)	2"	8	128	\$277.00/box
	3"	6	96	\$271.00/box
	4"	4	64	\$266.00/box
Painted Colors Silver, Blue, Brown, Orange	2"	8	128	\$356.00/box
	3"	6	96	\$348.00/box
	4"	4	64	\$341.00/box
Natural Colors Charcoal, Brown, Tan	2"	28	50	\$220.00/box
	2"	28	50	\$276.00/box
Painted Colors Silver, Blue, Brown, Orange				
Boxes of Tiles include 3 tubes of adhesive.				

*Subject to pkg. discounts.

ATLAS

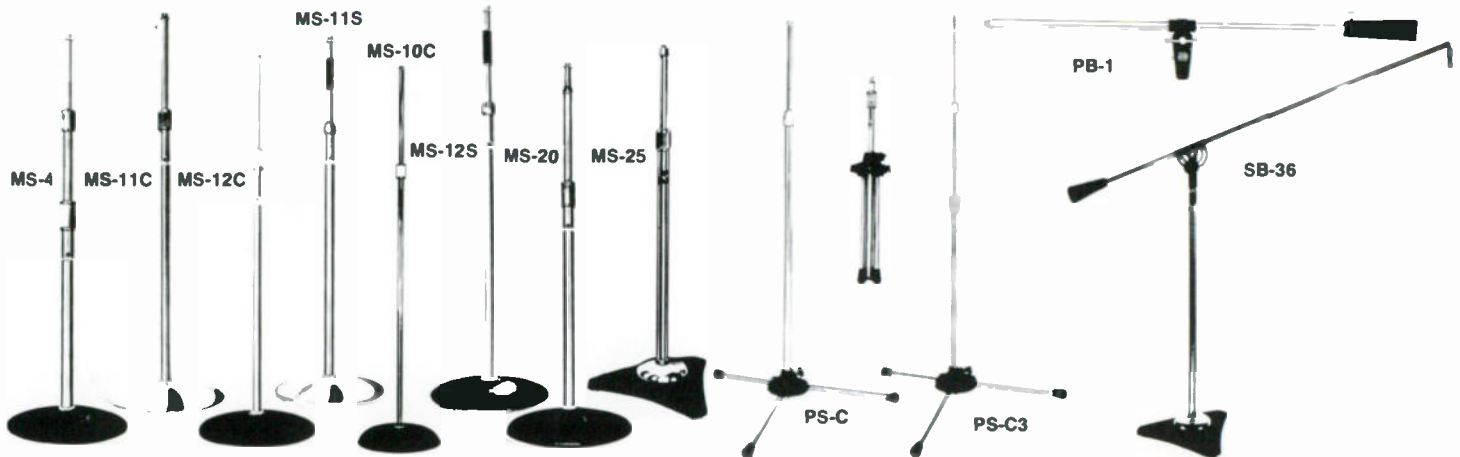

GRIP-ACTION MICROPHONE FLOOR STANDS

Include self-leveling, shock-absorbing pads and stabilizers. Tube assemblies and clutch are chrome plated. Threaded for use with any 5/8"-27 microphone or microphone holder.

Model	Application/Features	Height	Base Dia.	Wt/Lbs
MS-10C	General Purpose	35"- 63"	10"	10
MS-12C	Low Profile Base	34"- 62"	10"	11
MS-11C	Chrome Base	34"- 62"	10"	12
MS-4‡	Special Height	25"- 65"	10"	11
MS-20	Heavy Duty/Stage	37"- 66"	12"	14
MS-25	Professional/Studio	38"- 67"	17"	23

TOUCH-CONTROL MICROPHONE FLOOR STANDS

Unique, automatic sleeve-action clutch for effortless, instantaneous height adjustment at any level.

MS-11S	Chrome Base	39"- 62"	10"	13
MS-12S	Charcoal Base	39"- 62"	10"	13

‡ 3-Section Tube, 2 Grip-Action Clutches

MICROPHONE DESK STANDS

Model	Application	Height	Base Size	Wt/Lbs
DS-1	Executive Desk	4"	7" x 5"	2
DS-2	Vibration-Isolating	4"	5 3/4" x 4 3/4"	2
DS-4	Lightweight	4"	5" Dia.	1/2

PORTA-SERIES MICROPHONE FLOOR STANDS

Unitized construction for fast set-up and storage-convenience.

Model	Application/Features	Height	Wt/Lbs
PS-C	General Purpose	35"- 63"	6
PS-C3†	Special Height	25"- 66"	6
PS-S	Touch-Control Clutch	40"-63"	7

MICROPHONE BOOM STANDS AND BOOM ATTACHMENTS

SB-36 General Purpose Studio Boom - Secure and dependable. "Air-Lock Cushion" and swivel joint at mic end. Boom 62" long; adjustable 48" to 72" vertically. All tubular section chrome plated. Modern base. Weight 36 lbs.

SB-36W Mobile-Identical to Model SB-36, equipped with rubber casters on base. Shipping Weight, 38 lbs.

BB-44 Contemporary Boom Arm-One-piece swivel. Length, 31"

PB-1 Porta-Series Boom Arm-Chrome tube, 31" long. Tapered counterweight.

PB-1X Microphone Boom with Extension-2-section tube. Adjusts from 31" to 50." With counterweight.

PB-2X Microphone Boom with Extension-For portable application. 2-section tube. Adjusts from 21" to 40."

Model	Application	Height	Base Dia.	Wt/Lbs
DS-5	General Purpose	4"	6"	2
DS-7	Adjustable Height	8"-13"	6"	3
DS-14	Contemporary Style	3"	—	1 1/2

ALLIED CARRIES THE ENTIRE ATLAS LINE

KEITH MONKS

Fish poles or **hand booms** are ideal for miking up audience reaction and comment when a normal stand cannot be used. All four models are finished in matte black for T.V. and film use.

Model	Minimum Length	Maximum Length	Number of Sections
FP 363	25"	65"	3
FP 364	37"	106"	4
FP 365	45"	114"	3
FP 367	53"	186"	4



AKG

— HEADSETS —

The **K-45** is an excellent choice whenever an economical, rugged headphone is preferred which is high in performance, supra-aural and is a true "open air" design. It's equipped with large transducers such as those found in higher-end models. Provides supreme clarity and definition throughout the entire frequency spectrum. It's vented acoustical foam earpads are cardan-coupled on a flexi-plastic headband.

MANUFACTURER'S SUGGESTED LIST PRICE\$45.00

ALLIED PRICE \$ _____

The **K-18** is an ultra-lightweight boom set. It consists of two monophonically connected dynamic earphones and boom arm with noise-cancelling dynamic microphone. The headphone matches with 4 to 300 ohm outputs and comes with a 3¼ ft. cable with stripped and tinned leads.

ALLIED CARRIES THE ENTIRE AKG HEADPHONE LINE.

MANUFACTURER'S SUGGESTED LIST PRICE.....\$59.00

ALLIED PRICE \$ _____



K-45



K-18

ASTROLITE

The **2637-G1** has a noise cancelling electret mic with performance equalling fine studio microphones. Its noise cancellation properties make it suitable for use in noisy environments. The 2637-G1 features phantom or battery power.

MANUFACTURER'S SUGGESTED LIST PRICE.....\$259.00

ALLIED PRICE \$ _____

The **2636-G1** features ear-enveloping cushions which provide attenuation for use in noisy environments. The close-talking dynamic mic equals the performance of studio microphones—even in high ambient noise levels. Comes with ventilated or standard earphone cushions. Ventilated cushions optional.

MANUFACTURER'S SUGGESTED LIST PRICE.....\$208.00

ALLIED PRICE \$ _____



KOSS

It's hard to believe that Koss could improve on the previous models, but just slip on the **PRO 4AAA** and you'll hear a clarity, brilliance and liveliness you've never heard before. Deep, rich lows and crisp, clean highs. The triple A features an extra large 1" voice coil and oversize diaphragm, special earcushions and a dual suspension headband for extra comfort.

MANUFACTURER'S SUGGESTED LIST PRICE.....\$70.00

ALLIED PRICE \$ _____





RANE

The rack-mount **HC-6** offers more performance and flexibility than you ever hoped for. Designed into the HC-6 are separate inputs for each of the six stages, which individually bypass the master stereo inputs. The HC-6 can handle up to six totally separate programs for many additional applications including custom headphone monitor mix. ALL OUTPUTS MAY ALSO BE FED FROM ONE INPUT.

MANUFACTURER'S SUGGESTED LIST PRICE.....\$349.00

ALLIED PRICE \$ _____

SENNHEISER



The **HD-410SL** is an improved version of original Sennheiser "Open-Aire" headphones offering natural sound with smooth frequency response and realistic dynamic range over the entire sound spectrum. The swivel-action headband adjusts for comfortable fit. The soft, lightweight cushions caress the ears for fatigue-free listening.

MANUFACTURER'S SUGGESTED LIST PRICE.....\$59.00

ALLIED PRICE \$ _____



Sennheiser's **HME 1410 M Series** headsets utilize the MKE 2 omni-directional microphone mounted on a rotating boom which easily facilitates wearing the mic on either the left or right side of the head. The "OPEN-AIRE" headphones are a updated design based on the HD 410 headphone. All cables enter the unit on the boom side, and the headphone elements are wired from above the ear making the HME 1410 M Series much less cumbersome to use than other headsets.

HME 1410 M1 (mono) 1/4" mono plug.....\$300.00

HME 1410 M2 (stereo) 1/4" stereo plug.....\$300.00

HME 1410 M3 (stereo) 1/4" stereo plug.....\$300.00

CALL FOR TODAY'S ALLIED PRICE

ALLIED CARRIES THE ENTIRE SENNHEISER HEADPHONE LINE.

TELEX



The **CS-91** "Sportcaster II" is a professional sports announcers headset designed specifically for live, remote broadcasting. Omnidirectional dynamic boom microphone allows full freedom of head movement while the circumaural ear cushions screen out ambient noise.

MANUFACTURER'S SUGGESTED LIST PRICE.....\$165.00

ALLIED PRICE \$ _____

The **HD-4** "Hearing Protector Sportscaster" is a new concept. The noise attenuating earcups provide up to 45 dB attenuation in a motor racing pit or the midst of a screaming basketball crowd. A close-talking electret microphone is noise cancelling to assure intelligible sports broadcasting.

MANUFACTURER'S SUGGESTED LIST PRICE.....\$165.00

ALLIED PRICE \$ _____



The **PH Series** is an extremely comfortable, lightweight boom mike headset for on-the-air announcers and sports-casters. It features a unique differential microphone that produces a polar pattern to help create sound equal to a controlled studio set-up. Quality dynamic earphones utilize an ultra-thin mylar diaphragm, a precision wound fine copper voice coil, and a rare earth samarium cobalt magnet. A small, multi-function in-line power package with belt clip provides true balanced line audio output for maximum system compatibility and lowest noise.

CALL FOR THE ALLIED PRICE

RTS

The new **Model 802** Master Station represents a major advance in inter-communications systems. This unique, microprocessor-assisted control station provides 22 independent signal paths operating in up to six separate modes. And that's just the beginning. It features conference-line, dedicated-line, squawk, IFB/SA, station-iso, control functions and signaling capabilities. And user programming can adapt the operating format to individual needs in a variety of applications . . . The 802: Consider the possibilities.



The **TW Intercom System** is a high performance conference line intercommunications system that features over 30 different components to allow a broad variety of system configurations. The system is designed for teleproduction and broadcast operations as well as industrial and commercial applications. Proven performance by demanding professionals has established the TW Intercom System as a standard in the field of intercommunications.

PRICES UPON APPLICATION

CALL FOR TODAY'S ALLIED PRICE

TELEX

The **Audiocom** is a closed circuit headset intercom system of exceptional versatility. Components may be selected for a single or multiple line intercom, suitable for small or large, indoor or outdoor, portable or permanent installations. The system provides clear two-way communications "behind the scenes" at concerts and stage productions, film or TV studios, sports stadiums or race tracks, industrial, military, public safety and security applications.

PRICE UPON APPLICATION

CALL FOR TODAY'S ALLIED PRICE



CLEARCOM

Clear-Com's "no-fail"© broadcast-standard system design, high output, wide bandwidth, and extensive variety of closed-circuit intercoms satisfy the most demanding communications requirements.

A basic **Clear-Com System** includes one main station or power supply with the capacity to support 100 remote stations distributed along one mile of standard, two-conductor mic cable. It is off-the-shelf expandable to suit your needs.

The Clear-Com line includes portable, custom-mount, and rackmount intercoms, IFB systems, interfaces, headsets and accessories designed specifically for audio broadcast applications.

PRICES UPON APPLICATION

CALL ALLIED FOR DETAILS & PRICE



GENTNER

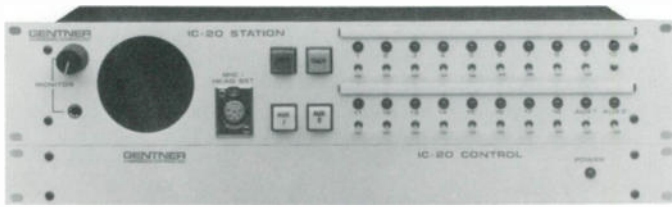

The **IC-20 Radio Station Intercom** offers a unique solution to the internal communication needs of the radio broadcaster. Along with the ability for any user to communicate with any other user, the IC-20 allows INDEPENDENT, simultaneous communication paths. In addition, the IC-20 features conference and "party line" communication as well as interfaces to your two-way radio and telephone interface systems.

The IC-20 is able to expand with your needs; you may buy additional stations as required and simply "plug them in" to the existing system, up to the maximum of 20 stations (Stations 19 and 20 are exclusively used for interfacing to your two-way and telephone systems).

PRICES UPON APPLICATION

— MICROPHONES —

AKG



The **D-80** is a cardioid dynamic microphone which was designed for both vocal and music applications. It is particularly suited for use with high quality sound reinforcement systems and cassette decks. A foam wind and pop filter eliminates pop and breath noise, as well as wind noise when the microphone is used in the open.

MANUFACTURER'S SUGGESTED LIST PRICE.....\$90.00

ALLIED PRICE \$ _____

The **C-451E/CK-1** is a cardioid polar pattern microphone. The C-451E preamp with interchangeable capsules creates a modular system which can be changed to suit any studio or recording application. Special feature is low noise and high reliability. Includes foam windscreen, SA-30 stand adaptor and foam lined vinyl case.

MANUFACTURER'S SUGGESTED LIST PRICE.....\$380.00

ALLIED PRICE \$ _____

The **C-414EB/P48** pressure gradient condenser microphone has an exceptionally wide dynamic range. A unique feature is four selectable polar patterns on the mic. Thus four different types of microphones are combined into one all-metal housing with black chrome finish. This unit has low current consumption as well as low self noise. Includes foam windscreen, SA-18/3 clamp-type stand adapter and foam lined vinyl case. Unsurpassed for digital recordings.

MANUFACTURER'S SUGGESTED LIST PRICE.....\$795.00

ALLIED PRICE \$ _____

The world renowned **451 System**. Universal phantom powering, 9-52V. Three-step bass control with corner frequency adjustments at 75 or 150 Hz. Variables of the 451 system are available less bass control and with 48-V only powering. Assemble your system omni-, uni-, or super-directional with a great selection of pickup heads including shotgun.

ALLIED PRICE DEPENDS UPON CONTENT.

The **D-1200E** is a boom or hand held dynamic cardioid polar pattern microphone. Electric impedance @1,000 Hz is a low 200 ohms. The three-position BMS switch permits changing response to suit individual performer and environment. Elastically suspended capsule reduces handling noise in this ruggedly constructed microphone. The SA-31 "quick-release" stand adapter is also included.

MANUFACTURER'S SUGGESTED LIST PRICE.....\$140.00

ALLIED PRICE \$ _____

"ALLIED carries the entire AKG microphone line."

ELECTROVOICE



The **635A** dynamic omnidirectional is a rugged, durable microphone manufactured by Electrovoice. The sound of the 635A is the standard against which other up-close omnidirectional vocal microphones are compared.

MANUFACTURER'S SUGGESTED LIST PRICE.....\$106.00

ALLIED PRICE \$ _____

The **DO-56** is a shock mounted omnidirectional dynamic microphone for hand-held broadcast applications. All handling noises and cord vibration are isolated from the microphone element. Shock isolation is enhanced by having the main acoustic cavity and the diaphragm/voice-coil assembly isolated as a unit from the case making capsule/case collision impossible.

MANUFACTURER'S SUGGESTED LIST PRICE.....\$134.00

ALLIED PRICE \$ _____

A fine, moderate cost microphone for sound reinforcement, broadcast and stage work. The **RE-10** is similar in design to the RE-15, but meets requirements where somewhat more unit-to-unit variability is acceptable. It has effective directional control, little off-axis coloration, greatest rejection of unwanted sounds at 150 degrees off axis and a bass roll-off switch.

MANUFACTURER'S SUGGESTED LIST PRICE.....\$184.00

ALLIED PRICE \$ _____

An excellent microphone for broadcast and quality sound reinforcement, the **RE-11** is a modestly priced unit with many features of the R-16 but where the most precise unit-to-unit matching is not necessary. It has a built-in blast filter, Memraflex grille screen, a high degree of directional control, little off axis coloration and a bass roll-off switch.

MANUFACTURER'S SUGGESTED LIST PRICE.....\$196.00

ALLIED PRICE \$ _____

Literally born in a TV studio, the performance and reliability of the **RE-15** have made it a workhorse directional microphone for broadcast. Two nulls at 150 degrees off axis provide greater average rejection over the microphone's rear hemisphere than a traditional single-null cardioid pattern, particularly useful on the boom and on-stage.

MANUFACTURER'S SUGGESTED LIST PRICE.....\$276.00

ALLIED PRICE \$ _____

The **RE-20** was created especially for critical recording, broadcast, and sound reinforcement applications which require response that extends to the frequency extremes. The RE-20 provides performance heretofore available only from the most expensive condenser microphones.

MANUFACTURER'S SUGGESTED LIST PRICE.....\$532.00

ALLIED PRICE \$ _____

The **RE-50** was designed expressly for hand-held ENG. It has the same tailored frequency response and high output level as the famous 635A. The RE-50 rubber shock mount "mike-within-a-mike" design achieves a degree of shock isolation never before known in the industry. The construction is also highly resistant to damage from mechanical shock.

MANUFACTURER'S SUGGESTED LIST PRICE.....\$161.00

ALLIED PRICE \$ _____

"ALLIED CARRIES THE ENTIRE LINE OF E-V MICROPHONES"

SENNHEISER

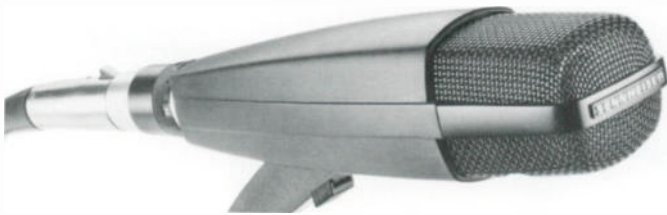

This is the microphone which has become a broadcast standard. Ruggedly constructed to precision standards, the **MD-421-U-5** withstands hard use with Sennheiser's legendary reliability. Its pressure gradient dynamic transducer provides faultless performance both in the protected confines of the studio and the often hostile environment outdoors. Less cable.

MANUFACTURER'S SUGGESTED LIST PRICE.....\$332.00

ALLIED PRICE \$ _____

Measuring a mere 5.9 millimeters in diameter and 11 millimeters in length, the **MKE-2R** represents Sennheiser's thoughtfully conceived answer to the increasing demand for small and less conspicuous lavalier microphones. Its exceedingly small size, finish and the multitude of mounting options provide the video, movie and television professions with a broad choice of inconspicuous or concealed microphone placement possibilities.

MANUFACTURER'S SUGGESTED LIST PRICE.....\$242.00

ALLIED PRICE \$ _____



Sennheiser has virtually re-invented the **CONDENSER MICROPHONE** by making the capacitive transducer part of the RF bridge - without need for DC bias or high impedance. The transformerless, low-impedance FM design provides RFI protection at the capsule, immunity from hum pickup & interference by stray magnetic fields, superior response with long cables, and direct connection to most equipment. They also have better vibration immunity than ordinary condenser units, improved acoustical properties - especially directionality, and with no DC bias, the capsule is completely immune to arc-over or performance problems due to reduction of capsule isolation resistance.

MKH 406.....\$678.00

MKH 416.....\$723.00

MKH 816.....\$954.00

"ALLIED CARRIES THE ENTIRE LINE OF SENNHEISER MICROPHONES"

NEUMANN



The model **U 87** is the best known and most widely used of the fet 80^o series. Its high frequency response is practically linear in its cardioid and figure-8 positions even close-up. The response below 40 Hz is purposely rolled off to prevent low frequency blocking. This roll-off may be switched to 200 Hz to allow compensation for the bass rise common to all good directional microphones when used at close range. The U 87 is specifically designed for close miking studio applications. This is *THE* world class microphone! 48 volt power supply required. Wind screen and shock mounting optionally available.

PRICES UPON APPLICATION

The **KM 83 i** omnidirectional miniature condenser microphone is a pressure transducer with gold sputtered polyester membrane and omnidirectional pattern. The free field frequency response of the KM 83 i is linear except for a desirable slight rise at the high frequency end, which results in a flat response in the diffuse sound field.

MANUFACTURER'S SUGGESTED LIST PRICE.....\$398.00

ALLIED PRICE \$ _____

The **KM 84 i** miniature microphone has a cardioid directional pattern and is outstanding because of its nearly frequency-independent directivity.

The resulting frequency response at an angle of ± 135 degrees is almost parallel to the 0^o on-axis curve. Attenuation at 135^o is about 14 dB between 100 Hz and 18 kHz. As a result, a sound source impinging on the microphone anywhere within a 3/4 arc around it will have identical sound quality, even though at different levels.

MANUFACTURER'S SUGGESTED LIST PRICE.....\$349.00

ALLIED PRICE \$ _____

The **KM 85 i** miniature microphone has a cardioid directional pattern and is a special version of the KM 84 i with its virtually frequency-independent directivity. In addition, the KM 85 i intentionally attenuates more distant low-frequency sounds such as undesirable sound from sources nearby as well as wind noise (12 dB at 50 Hz), while close-up sound sources will be recorded with linear frequency response.

MANUFACTURER'S SUGGESTED LIST PRICE.....\$398.00

ALLIED PRICE \$ _____

SHURE



Specifically designed to minimize boom microphone problems in television studio and location applications, the **SM-5B** is also excellent for radio deejay use. A smooth, wide-range frequency response with moderate presence rise makes it especially suitable for vocal pickup as well as scoring assignments. The SM-5B has a cardioid pickup pattern with exemplary off-axis uniformity, even at the extreme low end, giving minimal coloration and maximum rejection of unwanted sounds. Popular for its "warmth." Less cable.

MANUFACTURER'S SUGGESTED LIST PRICE.....\$551.75
ALLIED PRICE \$ _____

The **SM-7** designed in conjunction with professional users, is among the finest studio professional dynamic microphones in use today. Its "smooth and silky" sound has made it extremely popular for voice-over recording in radio and television. Announcers love its "mellow" sound. Less cable.

MANUFACTURER'S SUGGESTED LIST PRICE.....\$510.00
ALLIED PRICE \$ _____

Tiny, rugged, with wide-range frequency response, the **SM-11** is one of the world's smallest dynamic element lavalier microphones. Less than half the size of a standard microphone connector, it is ideal for on-camera TV and movie applications.

MANUFACTURER'S SUGGESTED LIST PRICE.....\$98.00
ALLIED PRICE \$ _____

The world-standard professional stage microphone, with the distinctive Shure upper mid-range presence peak for an intelligible, lively sound. A tough, handsome microphone that weighs less than 11 ounces, the **SM-58** is often imitated in appearance, but never duplicated in performance, ruggedness or reliability. Cable included.

MANUFACTURER'S SUGGESTED LIST PRICE.....\$186.50
ALLIED PRICE \$ _____

A matchless standard in high-quality professional condenser microphones, the **SM-81** is a superb studio instrument that also meets the most demanding needs of location recording and sound reinforcement. Less cable.

MANUFACTURER'S SUGGESTED LIST PRICE.....\$336.75
ALLIED PRICE \$ _____

A hand-held, self-contained, unidirectional condenser microphone with a built-in line level amplifier, peak limiter and battery. The exceptional performance and unique features of the **SM-82** make it an outstanding choice for on-the-spot broadcasting applications. It's also excellent for long line (up to 1 mile) runs for sporting events, parades and political conventions. Less cable.

MANUFACTURER'S SUGGESTED LIST PRICE.....\$365.00
ALLIED PRICE \$ _____

"ALLIED CARRIES THE ENTIRE SHURE MICROPHONE LINE"

CROWN

The pressure recording process, invented by Long and Wickersham, introduced a bright new concept to audio engineering. They discovered that sound approaching a boundary such as a floor, wall, table, podium, etc. creates a thin zone in which the direct and reflected signals are coherently in phase and reinforce each other. The **Crown PZM** microphone creatively realizes the potentials of that invention offering significant improvements in signal clarity and range. Comb filtering is eliminated.

PRICES UPON APPLICATION
CALL FOR TODAY'S ALLIED PRICE

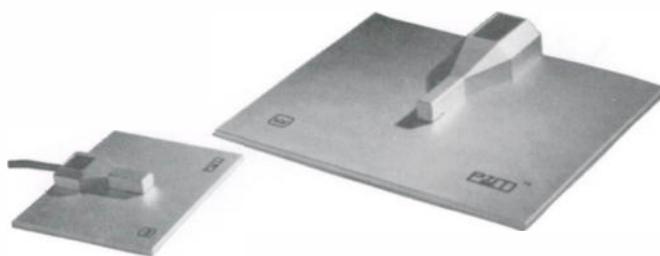

SONY

A new edition of Sony's highly acclaimed and widely used professional miniature lavalier microphone offers a choice of either the familiar silver finish or a new, non-reflective matte black finish. Other improvements include both a double and single tie clip in the provided accessories. The new model **ECM-55** provides omnidirectional high performance vocal pickup and operates from battery or phantom power.

MANUFACTURER'S SUGGESTED LIST PRICE.....\$260.00
ALLIED PRICE \$ _____

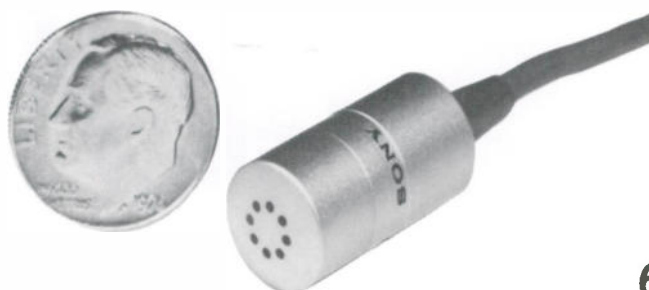

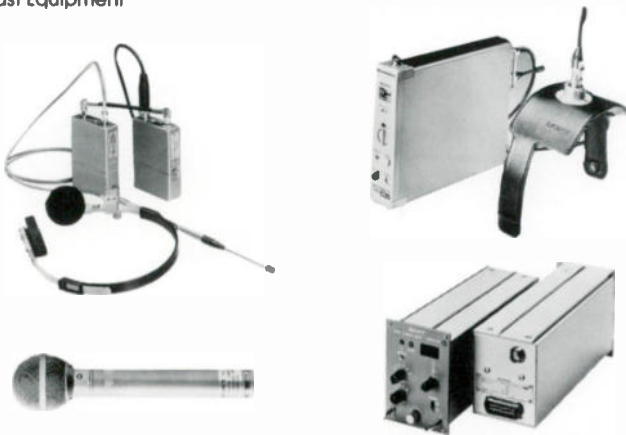

SONY

The **Sony Wireless Microphone System** was designed to be able to withstand the most strenuous of professional applications. The system in no way compromises sound quality. Every possible obstacle arising from wireless design was thoroughly examined and solved, using Sony's advanced transducer and FM tuner technologies. With this reliable, high quality Sony system, wireless operation will never again be a risky proposition.

PRICES UPON APPLICATION

CALL FOR TODAY'S ALLIED PRICE

"ALLIED CARRIES THE ENTIRE SONY WIRELESS LINE"

TELEX



The professional **TELEX Wireless System** transmits the microphone signal via FM radio transmission to a receiving station. The user of the microphone is thus able to move without the encumbrance or limitations of a microphone cable.

In addition to mobility, the TELEX wireless system offers other advantages such as the elimination of hum and noise pickup through the microphone cable and connectors, avoidance of microphone boom shadows, elimination of shock hazard from poor grounding, and most important, elimination of sound mixing problems as the performer moves about the stage.



The **FMR-50** Musician Series wireless microphone system provides a cleaner, better sounding signal for longer distances from the receiver. Other systems experience signal degradation within 100 feet of the receiver, while the FMR-50 signal remains crisp and strong at 500 feet or more. It operates on high band VHF frequencies between 150 and 186 MHz so there is no danger of picking up interference from low band channels such as CB, garage door openers, etc. A peak reading volume indicator allows sound pros to check volume levels quickly, and balanced mike level with associated volume control permits easy connection to existing sound systems.

PRICE UPON APPLICATION

CALL FOR TODAY'S ALLIED PRICE

VEGA



The **Cetec-Vega Wireless System** has led the way in this field for years. Recent developments in the Vega wireless line have made this reputation grow even more. The Vega system uses Electrovoice and Shure mic elements to insure the high quality sound reproduction. New designs have gotten rid of the now infamous "rubber ducky" antenna, added new dimensions to "wireless" applications and made the use of this type equipment more widespread than ever before in the broadcast field.

Cetec-Vega's quality **"PRO" Wireless Systems** are ideal for broadcasting and entertainment applications as well as for use in audio-visual systems for industrial seminars, church and school sound systems. The PRO systems feature the DYNEX® II audio processor for the highest signal-to-noise ratio, widest dynamic range and most natural sound. The R-31A PRO receiver features 2 LED bar graph displays - one for RF signal level and one for audio level. Either line- or mic-level outputs may be selected through the rear panel XLR connector. The receiver can be powered by either AC or external DC.

PRICE UPON APPLICATION

CALL FOR TODAY'S ALLIED PRICE

QEI

The **691 FM Monitor/Test Set** is a high technology, precision instrument employing a combination of new techniques in a single, highly versatile, but very compact package. It is a complete FM test package with facilities for all proof-of-performance measurements and a wide range of troubleshooting tests. Operator convenience and simplicity of use were primary considerations in the design of the system. It occupies only 10½" of vertical rack space in a standard 19" rack. Oscilloscope not included.

Model	Description
691	Modulation monitor/test set.....\$5295.00 ALLIED PRICE \$ _____
691/01	Modulation monitor/test set with 1 SCA.....\$6295.00 ALLIED PRICE \$ _____
691/02	Modulation monitor/test set with 2 SCA.....\$6695.00 ALLIED PRICE \$ _____

QEI PRICES ABOVE ARE MFR'S SUGGESTED LIST PRICES. CALL FOR TODAY'S ALLIED PRICE.

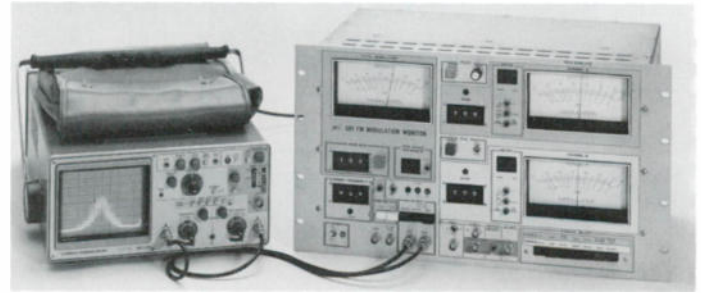

BELAR

Belar FM monitors are designed as totally integrated, solid-state systems to fulfill monitoring equipment requirements as the need arises. The **FMM-1 Frequency and Modulation Monitor** is a wideband, all solid-state FM monitor expressly designed for monaural monitoring as well as to provide a virtually pure, distortion-free signal to drive the companion FMS-1 and SCM-1 for multiplex monitoring.

PRICE UPON APPLICATION

The **FMS-1** when added to the FMM-1 provides complete monitoring and test functions to meet the daily requirements for stereo monitoring, and provides additional facilities for making the proper tests for weekly and monthly maintenance checks to insure maximum performance from stereo transmitters.

PRICE UPON APPLICATION

The **FMM-2** is the first to incorporate a sample hold peak modulation meter circuit independent of modulation polarity to allow the meter to respond to program peaks of the shortest duration. The heart of the FMM-2 is an ultra-linear digital discriminator which provides a distortion-free base-band signal for accurate monitoring as well as precise stereophonic and SCA decoding.

MANUFACTURER'S SUGGESTED LIST PRICE.....\$1350.00
ALLIED PRICE \$ _____

Working in conjunction with the FMM-2, the **FMS-2** offers two independent peak modulation meters for simultaneous monitoring of left and right channels or L+R and L-R. It also has two independent auto-ranging voltmeters with LED displays for simplified automatic measurements of channel separation, crosstalk, sub-carrier suppression and noise.

MANUFACTURER'S SUGGESTED LIST PRICE.....\$1550.00
ALLIED PRICE \$ _____

The **AMM-2B Modulation Monitor** sets standards in accurate AM monitoring. It's the first AM monitor to incorporate true ratio-type peak indicators. The AMM-2 contains a unique modulation cancellation scheme to recover unmodulated carrier to reference the modulation peaks to. True carrier is indicated with asymmetrical modulation and peaks are automatically referenced to this true carrier.

MANUFACTURER'S SUGGESTED LIST PRICE.....\$1095.00
ALLIED PRICE \$ _____





BELAR

The **AMM-3 Modulation Monitor** is basically the same as the AMM-2B except for an ability to read both positive and negative modulation peaks.

MANUFACTURER'S SUGGESTED LIST PRICE.....\$1400.00

ALLIED PRICE \$ _____

The **AMM-4 Frequency Monitor** is designed especially for ATS. Any frequency from 10 KHZ to 50 MHz may be monitored for deviation.

MANUFACTURER'S SUGGESTED LIST PRICE.....\$1095.00

ALLIED PRICE \$ _____

The **SCM-1 SCA Frequency and Modulation Monitor**, when added to the FMM-1, provides complete monitoring and test functions for SCA broadcasting and remote telemetering applications. Up to four crystal switch positions allow four channels to be operated and tested.

MANUFACTURER'S SUGGESTED LIST PRICE.....\$1650.00

ALLIED PRICE \$ _____

The **RFA-1 FM RF Amplifier** allows for remote monitoring of the transmitter in conjunction with Main and SCA FM modulation monitoring equipment. It offers an RF input sensitivity of 100 microvolt for full output, 50 to 75 ohms of input impedance and operates from 88 to 108 MHz.

MANUFACTURER'S SUGGESTED LIST PRICE.....\$575.00

ALLIED PRICE \$ _____

The **RFA-2 AM RF Amplifier** offers a selective, high gain, all silicon solid-state unit with AGC and makes it possible to monitor off-the-air AM signals accurately and conveniently without the problems associated with changes in transmitter power level, antenna patterns and signal fading. The RFA-2 when used in conjunction with AMM-2B, AMM-3 or AMM-4 allows monitoring of modulation characteristics at a remote point.

MANUFACTURER'S SUGGESTED LIST PRICE.....\$595.00

ALLIED PRICE \$ _____

DAV TRONICS

The **RFA-5 AM RF Amplifier** is designed to operate frequency and modulation monitors at a location remote from the transmitter, typically at the studio. When driven by a local antenna with an RF signal as low as 0.6 mv, the RFA-5 will drive most contemporary AM monitoring equipment, as well as provide a low-level output for an oscilloscope, and a clipped/limited output for a standard frequency counter.

PRICES UPON APPLICATION

GORMAN REDLICH

The Model **CM** is a stable, accurate monitor for DA installations not requiring telemetering of antenna readings. It offers true ratio readout. Non-reference and reference amplitudes are separately measured and divided electronically to give a digital readout that will not change with transmitter power and is exceptionally stable under conditions of asymmetric modulation. Stability of the readout makes readings accurate and easy to read.

PRICES ON APPLICATION

BELAR

The **TVM-1 Television Aural Modulation Monitor** is a wide-band, all solid-state TV aural monitor designed to provide accurate modulation monitoring for the TV Broadcaster, UHF or VHF. The state-of-the-art TVM-1 measures *both* positive and negative peaks simultaneously and automatically selects and registers the higher of the two on *both* the true peak meter and peak flasher. Exclusive polarity lamps indicate the instantaneous polarity of the peaks registered on the peak meter and peak flasher. Calibration accuracy may be checked at any time with the front panel push-button modulation calibrator.

MANUFACTURER'S SUGGESTED LIST PRICE.....\$2195.00

ALLIED PRICE \$ _____

The Belar Model **TVM-100 Television Aural Modulation Monitor** is a precision wideband monitor designed to measure the total modulation characteristics of mono as well as multi-channel television audio. Utilizing split sound and quasi-parallel detection modes, automatic deviation calibrators for 25 KHz (mono) and 73 KHz (BTSC Stereo) and a digital display for indication of actual deviation, the TVM-100 satisfies all requirements for mono and stereo baseband monitoring and test.

MANUFACTURER'S SUGGESTED LIST PRICE.....\$2695.00

ALLIED PRICE \$ _____

The Belar Model **TVM-200 TV Stereo Modulation Monitor** is designed to operate in conjunction with the Belar model TVM-100 TV Baseband Modulation Monitor to provide complete monitoring of BTSC stereo transmission systems. The test and measurement capabilities are enhanced by the integration of two auto-ranging voltmeters, allowing automatic measurement of channel separation, crosstalk, pilot phase and pilot level. An equivalent mode test function is also provided, which bypasses the DBX decoder for non-encoded transmitter testing. Multiple metering allows full-time monitoring of L + R and stereo composite modulation and selectable metering of total and L - R modulation along with left and right channel audio.

MANUFACTURER'S SUGGESTED LIST PRICE TVM 100....\$2495.00

MANUFACTURER'S SUGGESTED LIST PRICE TVM 200....\$4295.00

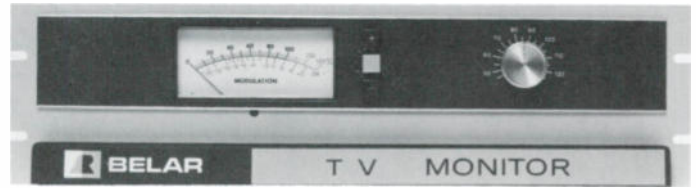

GORMAN REDLICH

The **CEB** offers in a single rack mounting chassis, everything necessary for the two-frequency EBS system required by the commission except a receiver that can be tuned to the station monitored.

Model Description

CEB	Encoder-decoder.....\$475.00	ALLIED PRICE \$ _____
CE	Encoder only.....\$330.00	ALLIED PRICE \$ _____
CE	Encoder stereo opt...\$360.00	ALLIED PRICE \$ _____
CD	Decoder only.....\$280.00	ALLIED PRICE \$ _____

GORMAN REDLICH PRICES ARE MFR'S SUGGESTED LIST PRICES. CALL FOR TODAY'S ALLIED PRICES.



**There's more to
ALLIED than broadcast
equipment**

**"Prices and Specifications
Subject to Change
Without Notice"**

INOVONICS

The **INOVONICS "TVU"** displays stereo audio level metering on the screen of a video monitor.

FEATURES:

- VU/PPM Switchable** with adjustable Peak Flasher in VU mode.
- High Accuracy and Resolution** for precise level setting and program gain-riding.
- Fully Annotated Display** with complete and proper scale designations. Special scales possible with custom plug-in PROMs.
- Separate Inputs** for balanced studio lines and "semi-pro" equipment.
- Self Contained** in small, "mount anywhere" box chassis. Optional rack-mount panel available.



KINTEK

The **Kintek KT-903 Stereo Converter** is a three-part automatic system which provides continuous dynamic conversion of mono to stereo for the TV Broadcaster. The KT-903 offers the opportunity to convert all programming to stereo format immediately at minimal cost. The core of the KT-903 is a high density phase and amplitude modifier, which introduces continuous complementary psycho-acoustic cues into left and right channels. The second part of the KT-903 system is the auto-centering dialogue control. Auto-centering adds a dynamic dimension in which dialogue remains centered. This new Kintek technique makes dialogue centrally focused, while keeping crowd noise, music and effects in stereo. The third feature of the KT-903 is the mono-stereo sense switch. In the presence of stereo input the system automatically bypasses through a soft cross-fade electronic switch. Its primary purpose is elimination of operator errors under varying input program formats. Voice and stereo width limit controls are mounted on the system's front panel. The system can be installed at the transmitter site since it is totally automatic.



GORMAN REDLICH

The Model **CMR** is the latest in "developed technology" from G-R at a price comparable to analog monitors. With typical modulation, the CMR's true ratio readout is a factor of 10 more stable than instruments that measure normalized amplitude, and its phase readout is rock solid. Phase sign is automatic with no extra operations. Practically speaking, these features mean quick, accurate log or remote calibration readings. The CMR is fully remotable via land line or telemetry, using standard remote control equipment.

PRICES ON APPLICATION

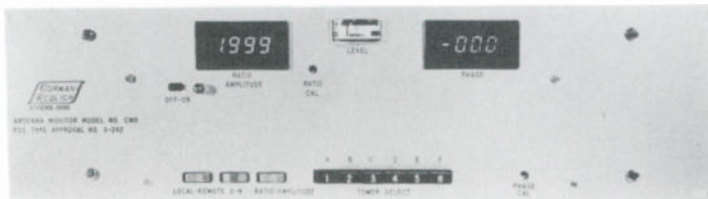

POTOMAC

The Potomac line of **Field Strength Meters** represents a new generation of precision instruments for direct measurement of electromagnetic fields in the 100 kHz to 960 MHz frequency spectrum. These units are intended for portable field use and include a laboratory quality receiver, integral shielded loop antenna, precision attenuator, internal calibration source, and voltage regulated battery power supply. An interlock switch prevents inadvertent battery discharge when the cover is closed. Batteries are not included.



Model	Description	ALLIED PRICE \$
FIM-21	535-1605 kHz.....	\$1950.00
FIM-22	200-550 kHz.....	\$2600.00
FIM-41	540-5000 kHz.....	\$2600.00
FIM-71	45-225 MHz.....	\$3825.00
FIM-72	470-960 MHz.....	\$5250.00

POTOMAC

The **AM-19** is the current model of the industry's most widely used solid-state antenna monitor. It provides direct meter readout of phase angle and loop current ratio. Tower selection is accomplished with push buttons on the front panel or by external contact closure in remote operation. Directional antenna arrays of from 2 to 12 towers with DA-1, DA-2 or DA-3 patterns may be monitored with this instrument.

The **AM-19D** is identical to the AM-19 (204) except for the digital panel meters and associated circuitry. Four digit LED numeric displays provide resolution of 1/10 of one degree (phase angle) and 1/10 of one percent (current ratio). The digital readout feature of this instrument virtually eliminates operator error related to meter interpretation.

The **PMA-19 Precision Monitor Adaptor** is used in conjunction with either of the above monitors. This unit is required, for the most part, in very critical arrays. The current deviation mode provides a third measured parameter which displays directly the deviation of the current ratio from the licensed ratio.

Model	#Towers	ALLIED PRICE \$
AM-19	2.....\$2550.00	_____
AM-19D	2.....\$3250.00	_____
PMA-19	2.....\$6100.00	_____

Additional prices upon application.
POTOMAC PRICES ABOVE ARE MFR'S SUGGESTED LIST PRICES. CALL FOR TODAY'S ALLIED PRICE.



DELTA

The **DAM-1** is a true digital antenna monitor designed specifically for measuring the parameters of broadcast frequency directional antenna systems. Digital data is not obtained by adding an A/D converter to the output of conventional analog circuitry. Instead, the latest digital techniques and TTL components are applied to achieve a truly digital approach to phase and current ratio measurements. Data is displayed on front panel seven-segment digital readouts to minimize reading error. A simplified selection system reduces operation of the DAM-1 to a straight-forward procedure.

PRICES ON APPLICATION

The **AAM-1 Analog Antenna Monitor** is designed specifically for measuring the parameters of AM broadcast frequency directional antenna systems. The monitor measures the relative current in each tower, the ratio of the current in each tower to that of a reference tower and the phase of the current in each tower relative to that of the reference tower. The AAM-1 can be equipped for up to eight input samples without external switching. Two reference towers can also be selected for DA-2 applications.

PRICES ON APPLICATION

By continuously sampling the modulation levels at the AM transmitter output and comparing these levels with internal preset minimum and maximum modulation thresholds, the **AMC-1 Amplitude Modulation Controller** detects conditions of under or over modulation. The AMC-1 then uses a digital logic process to adjust the audio level of the transmitter. The audio control circuit is strictly linear so that no compression or asymmetry is added to the program.

PRICES ON APPLICATION

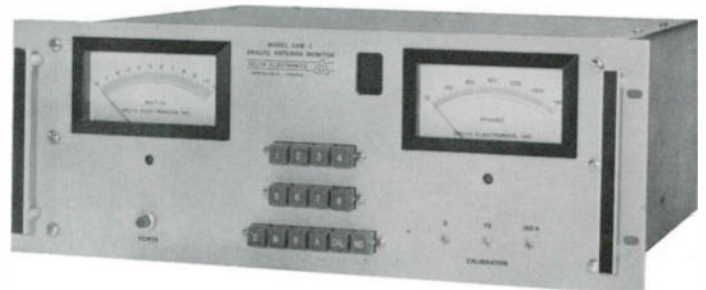



DELTA
The **FMC-1 Frequency Modulation Controller** provides automatic control of the modulation levels of an FM broadcast transmitter or audio channel of a TV transmitter. The FMC-1 provides a closed loop system around the transmitter which allows the broadcast engineer to maintain modulation at the desired level despite variations in the audio level from different program sources and other system variances. Through gain is controlled by a digital attenuator maintaining true transparency at all gain settings. No clipping or compression is used.

PRICES ON APPLICATION



The **APC-1 Automatic Power Controller** measures the operating power of an AM or FM station, and by interconnection to the transmitter's RAISE/LOWER controls causes the power to remain well within limits. The unit monitors a DC voltage from an external linear rectifier driven by an RF sample of the common point or base antenna current in AM applications, or a similar linear DC sample from the FM power meter or directional coupler. A special long time constant circuit removes modulation components and averages carrier shift variations in AM applications.

PRICES ON APPLICATION



The **RG-4 Receiver/Generator** couples precision with reliable performance, providing an indispensable piece of test gear for broadcast engineers. An RF signal generator to excite the impedance bridge and a sensitive receiver for external null detection are housed in a single rugged case. With an OIB-1 or OIB-3, the RG-4 forms a portable impedance measuring system. Operates from 100 kHz to 29.999 MHz in 1 kHz increments. Runs off batteries, 115/230 VAC 50/60 Hz with 35 watts input power.

PRICES ON APPLICATION



Delta OIB Operating Impedance Bridges measure the operating impedance of the individual radiators, networks, transmission line sections, and common point of directional antenna systems while they are functioning under normal power. This "operating impedance" cannot be measured by usual impedance bridge methods because the system characteristics are disrupted when the bridge is inserted into the circuit. The **OIB-1** or **OIB-3** is inserted directly in series with the transmission line, network or antenna. The transmitter power is applied and a bridge balance is obtained by manipulating two dials on the face of the bridge. Balance is indicated by a null reading on the meter on the front panel. Operating resistance and reactance are then read directly from the bridge dials.

PRICES ON APPLICATION



The **Common Point Impedance Bridge** is an invaluable device for directional array maintenance. The **CPB-1** is designed for permanent installation in existing phasing equipment to provide an accurate indication of the common point impedance. The CPB-1 will handle common point powers of up to 5 kW with 100% modulation. The **CPB-1A** is designed for powers up to 50 kW.

Model	Description	ALLIED PRICE \$
CPB-1	to 5 kW.....	\$1998.00
CPB-1A	to 50 kW.....	\$2375.00

DELTA PRICES ABOVE ARE MFR'S SUGGESTED LIST PRICES. CALL FOR TODAY'S ALLIED PRICE.

B & B SYSTEMS

B & B Systems **Phasescope AM-1B** is the complete tool for post production. It features CRT X/Y display with calibrated graticule for phase and studio operating level, SMPTE time code display of phase and genlock, CRT display of individual channel levels with calibrated graticule for studio operating level, ANSI calibrated VU meters & peak meters for each channel, and magnetic shielding. The AM-1B is self-contained in only 3 EIA rack units.

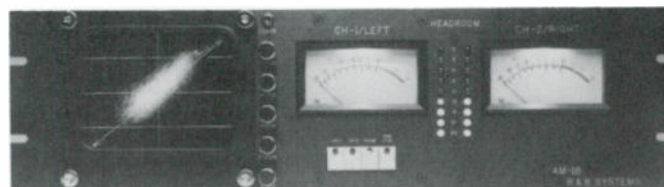

The **Phasescope AM-2** and **AM-2B** give a complete "picture" of the stereo audio signal at a quick glance. For AM and FM stereo radio broadcasters and sound recording studios, the AM-2 features CRT X/Y display of stereo audio phase, LED display of peak audio levels for left and right channels showing headroom availability, VU level meters for left and right channels, and magnetic and EMI/RF shielding. The AM-2 is self-contained in 3 EIA rack units, and the space-saving AM-2B in 2 EIA rack units.

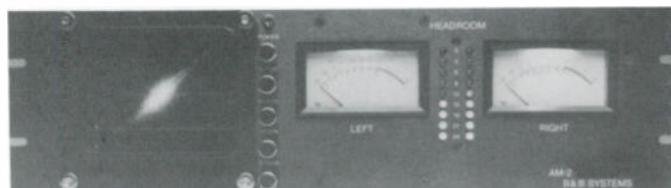

For BTSC/MTS stereo audio applications, B & B Systems makes the **Phasescope AM-3**. On the AM-3 you can verify stereo separation on the scope display, check stereo phase on the CRT X/Y display, watch the VU meters for left, right and SAP, and monitor LED peak displays for all three channels showing headroom availability. The AM-3 is self-contained in 4 EIA rack units.

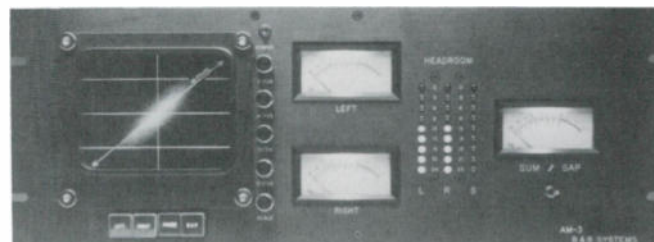

In one affordable, simple, self contained package, **IMAGESCOPE®** gives you a true visual representation, in real time, of the balance, separation, and level of the stereo signal. The B & B Systems **IMAGESCOPE®** graphically displays the complex stereo audio signal, showing you the dispersion of energy as it will sound in the typical listening environment. It gives you an instant indication of L + R phase errors which lead to "flat" and "mushy" mono playback and transmissions. **IMAGESCOPE®** is used to position, precisely, any track or tracks within the stereo image. Stereo phase errors are now easily avoided.



**BROADCAST IS
OUR
MIDDLE NAME**

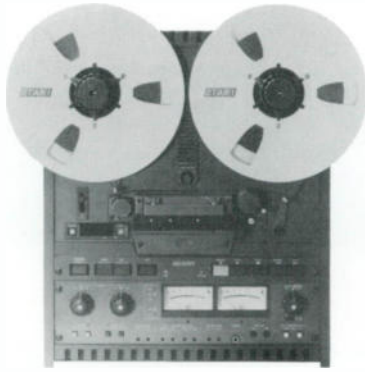

OTARI

The OTARI **MX5050B-II** is a 1/4" two channel half track recorder/reproducer with extra quarter track reproduce head. DC-servo capstan, with $\pm 7\%$ vari-speed. Three speeds in 15-7 1/2 or 7 1/2-3 3/4 ips field selectable pairs. Transformerless balanced inputs and outputs. +4 or -10 dB output level select. Real time tape counter with LED display. Headphone output. Test oscillator (1 kHz or 10 kHz). NAB/IEC equalization select. 185/250/320 nWb/m calibration select. Integral splicing block. The world's most popular recorder. Available in 1/4 track stereo or full track versions. Optional rack mount available.

MANUFACTURER'S SUGGESTED LIST PRICE..... \$2595.00

ALLIED PRICE \$ _____



The **MX5050BQ-II** 1/4" four channel, quarter track recorder/reproducer. DC-servo capstan with $\pm 7\%$ vari-speed. 15-7 1/2 ips speed. +4 or -10 dB input/output level select. Real time tape counter with LED display. Zero return. Headphone output with channel select. Test oscillator (1 kHz or 10 kHz). Microprocessor controlled transport logic. Dynamic braking. Integral splicing block. External machine control interface connector for synchronizers.

MANUFACTURER'S SUGGESTED LIST PRICE..... \$3595.00

ALLIED PRICE \$ _____

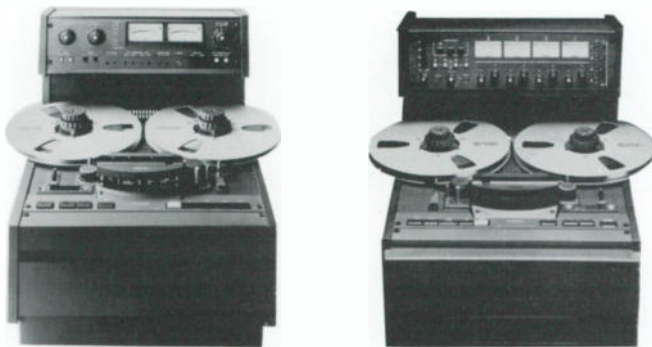

The **MX5050-Mark III-2** is a 1/4" two channel, half track recorder/reproducer with extra quarter track playback head. Includes microprocessor transport logic and dynamic braking. Zero return. External machine control interface connector for synchronizers or the optional CB-116 auto-locator.

MANUFACTURER'S SUGGESTED LIST PRICE..... \$3295.00

ALLIED PRICE \$ _____

The **MX5050-Mark III-4** is a 1/2" four channel recorder/reproducer. Tabletop console. 1/2" configuration of the BQ-II. External machine control interface connector for synchronizers or the optional CB-116 auto-locator. Otherwise identical to BQ-II.

MANUFACTURER'S SUGGESTED LIST PRICE..... \$4795.00

ALLIED PRICE \$ _____



The **MX5050-Mark III-8** is a 1/2" eight channel recorder/reproducer. DC-servo capstan with $\pm 7\%$ vari-speed. 15-7 1/2 ips speed. +4 or -10 dB input/output level select. Real time tape counter with LED display. Zero return. Test oscillator (1 kHz or 10 kHz). Microprocessor controlled transport logic and dynamic braking. Full function channel status select panel with individual or master control. Automatic monitor switching. Headphone output with channel select. External test input. Integral splicing block. External machine control interface connector for synchronizers or the optional CB-116 auto locator.

MANUFACTURER'S SUGGESTED LIST PRICE..... \$5835.00

ALLIED PRICE \$ _____

OTARI

The OTARI **ARS1000DC** is a 1/4" two channel, half track reproducer with 25 Hz tone sensor, end of message and cue tone relays with adjustable delay (100 milliseconds to 15 seconds). 7 1/2-3 3/4 ips speeds. 19" rack mount. Designed for automated broadcast systems and other high reliability reproduce only applications. 15-7 1/2 ips speeds available on special order.

Model	Description
ARS1000DC	with 25 Hz tone sensor..... \$1785.00 ALLIED PRICE \$ _____

OTARI'S **DP4050-C2** is a compact 8:1 cassette duplicator with cassette master and three slaves. Expandable to 11 slaves with the addition of (3) DP-4050Z-3 slave units.

Model	Description
DP4050-C2	Master & two slaves.....\$3595.00 ALLIED PRICE \$ _____
DP4050-Z3	Three slaves for C-2.....\$3295.00 ALLIED PRICE \$ _____

The OTARI **MTR-10/12 Series** are microprocessor controlled 1/4" and 1/2" professional tape recorders offered in full, two and four track formats. Consoles feature a transport assembly that is hinged to allow easy access for maintenance. Audio and transport control circuit boards are located in a separate card frame. The power supply is also contained in a fully modular unit enabling fast diagnosis and repair. Transport control and extensive editing functions are located on the top transport operating surface while audio control switching is contained on a separate master audio control card. ACCESSORY, SPARE PARTS, CONVERSION KIT AND HEAD ASSEMBLY PRICING ON APPLICATION.

Model	Description
MTR-10-B	1/4" full-track prewired for two channels in an overbridge cabinet. 7 1/2-15-30 ips..... \$6895.00 ALLIED PRICE \$ _____
MTR-10-C	1/4" two channel in overbridge cabinet. 7 1/2-15-30 ips..... \$7295.00 ALLIED PRICE \$ _____
MTR-12-C	1/4" two channel 12.5" reel size in overbridge cabinet. 7 1/2-15-30 ips..... \$7895.00 ALLIED PRICE \$ _____
MTR-12-H	1/2" two channel 12.5" reel size in overbridge cabinet. 7 1/2-15-30 ips.....\$9100.00 ALLIED PRICE \$ _____
MTR-12-I	1/2" four channel 12.5" reel size in overbridge cabinet. 7 1/2-15-30 ips..... \$10,175.00 ALLIED PRICE \$ _____

OTARI PRICES ABOVE ARE MFR'S SUGGESTED LIST PRICES. CALL FOR TODAY'S ALLIED PRICE.

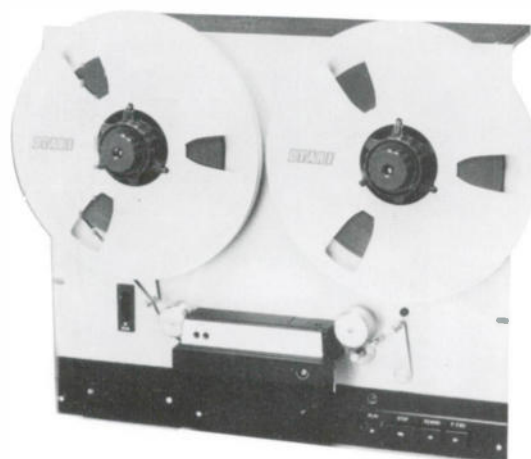

SCOTCH/3M

When recording tape is considered, **Scotch/3M** is a prime contender. As an authorized Scotch audio tape dealer, Allied can quote prices for any requirement. Quantity discounts are available.

CALL FOR THE ALLIED PRICE

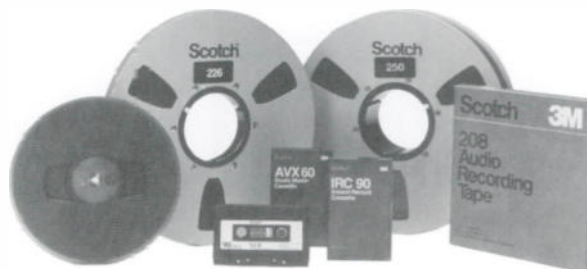



REVOX

The REVOX **B77 Tape Recorder** features:

- Integrated Drive Logic
- Operation by computer-type push keys
- Cutter device to facilitate tape editing

MANUFACTURER'S SUGGESTED LIST PRICE.....\$1999.00

ALLIED PRICE \$ _____

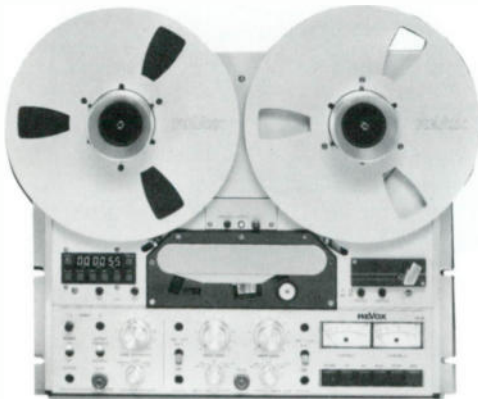

As a broadcaster you know the value of Studer reliability and importance of Revox economy. Now both are built into the **Revox PR99 MK II**. And what's more, it's designed specifically for your needs. The PR99 MK II offers balanced inputs and outputs; XLR-type connections, with calibrated and uncalibrated levels; and ASA-VU metering with LED peak indicators. The rugged die-cast chassis is designed for rack or console mounting. Reel capacity is 10.5 inches and tape speeds are selectable at 3¾, 7.5 or 7.5/15 ips with a vari-speed remote control option. Complete editing facilities include dump editing, full head access and 2-way self-sync which make the PR99 MK II one of the best in its class. The Studer designed transport and die-cast head assembly block and tension arms provide instant smooth start-up and outstanding tape handling. Here's traditional Studer quality built into the Revox PR99 MK II. Perfect for broadcasters or any professional.

MODEL DESCRIPTION

PR99 MK II Recorder/Producer Hi or Lo speed...\$2250.00

PR 99 Reproduce Only.....\$1449.00

REVOX PRICES ABOVE ARE MFR'S SUGGESTED LIST PRICE. CALL FOR TODAY'S ALLIED PRICE.

TASCAM



The TASCAM **22-2** is the basic half-track recorder/ reproducer with independent record mode selector and 1 tape/source monitor for each channel. Independent mic/line mixing and output level control for each channel. Remote pause function for record and play. 7½-15 ips speeds.

MANUFACTURER'S SUGGESTED LIST PRICE.....\$895.00

ALLIED PRICE \$ _____

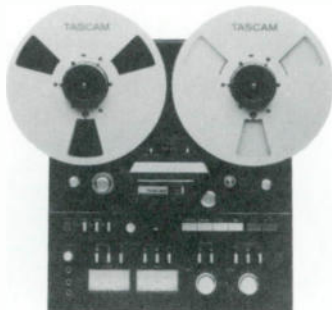

TASCAM's **32** is a half-track ¼" master recorder/reproducer with 10½" reel capacity, 15-7½ ips speeds, independent L & R record mode, simul-sync, full frequency response in sync mode, function and output select and punch in/out recording. The 32 also features ± 12% pitch control, dump edit, mic inputs, independent input/output level controls, headphone jack with volume control, cue control, FL tape counter and zero return.

MANUFACTURER'S SUGGESTED LIST PRICE.....\$1495.00

ALLIED PRICE \$ _____

TASCAM

The TASCAM **34B** is a 4-track 1/4" recorder/reproducer with 15-7 1/2 ips speeds, 10 1/2" reel capacity, full frequency response in sync mode, function and output select and punch in/out recording. The 34 also features ± 12% pitch control, dump edit, cue control, FL tape counter and zero return.

MANUFACTURER'S SUGGESTED LIST PRICE.....\$1795.00

ALLIED PRICE \$ _____



The **38** is an 8-track 1/2" recorder/reproducer with 8 tracks on 1/2" tape, 10 1/2" reel capacity, 15 ips speed, ± 12% pitch control and function and output select. The 38 also features punch in/out recording, dump edit, cue control, FL tape counter and zero return.

MANUFACTURER'S SUGGESTED LIST PRICE.....\$2750.00

ALLIED PRICE \$ _____



The **42B** is a 2-track 1/4" 2 channel half track mastering and broadcasting recorder/reproducer with 10 1/2" reel capacity, sync capability, full servo, SMPTE interlock capability through accessory connector and punch in/out recording. The 42B also features NAB or IEC equalization, dump edit, search to zero and search to cue, 7 1/2-15 ips speeds and +4/-10 input/output.

MANUFACTURER'S SUGGESTED LIST PRICE.....\$2695.00

ALLIED PRICE \$ _____



TASCAM's **52** is a 2-track 1/4" 2 channel half track mastering and broadcasting recorder/reproducer with +4 XLR/-10 RCA input/output, 10 1/2" reel capacity, sync capability, full servo and SMPTE interlock capability through an accessory connector. The 52 also features punch in/out recording, pitch control (15% coarse/0.7% fine), manual tach wheel edit, dump edit, search to zero and search to cue and 7 1/2-15 ips speeds.

MANUFACTURER'S SUGGESTED LIST PRICE.....\$3495.00

ALLIED PRICE \$ _____





TASCAM

TASCAM's **58** is an 8-track 1/2" 8 channel production recorder/reproducer with -10 RCA input/output, 10 1/2" reel capacity, full frequency response in sync mode, full servo, SMPTE interlock capability through an accessory connector and punch in/out recording. The 58 also features pitch control (15% coarse/0.7% fine), manual tach wheel edit, dump edit, search to zero and search to cue and 15 ips speed.

MANUFACTURER'S SUGGESTED LIST PRICE.....\$5995.00

ALLIED PRICE \$ _____



The **122B** is a world standard cassette deck in broadcast studios. The 122B offers balanced XLR input and output connectors that operate +4 dBm nominal level/ +18 dBm maximum.

**122B balanced in/out broadcast levels
& impedances.....\$849.00**

ALLIED PRICE \$ _____

TASCAM PRICES ABOVE ARE MFR'S SUGGESTED LIST PRICES. CALL FOR TODAY'S ALLIED PRICE.

TECHNICS



The **RS-B100** from TECHNICS employs a closed-loop double capstan system which completely isolates the tape from adverse influence. It also features quartz lock and direct-drive. The recording and playback head gaps are separated. Optimized, amorphous-alloy, laminated construction offers excellent frequency response and distortion characteristics. A direct-coupled recording and playback amp circuit system is enhanced with phase compensation and linear feedback—real waveform fidelity. It's the Technics flagship. The RS-B100 employs three noise reduction systems—dbx & Dolby B-C NR. The result—an uncompromising deck that's designed for almost any serious broadcaster.

MANUFACTURER'S SUGGESTED LIST PRICE.....\$835.00

ALLIED PRICE \$ _____

MARANTZ



The **201** and **221** by Marantz offer more to the Broadcast News Operation than ever before available.

- * Outstanding Features Include: 15/16 ips (1/2 speed) or regular 1-7/8 ips
- * Vari-speed control which allows correction of tapes which may have been recorded with less-than-full battery power
- * PA/Play mix permits one of the most sought-after abilities: Live intro with optional microphone, actuality on tape, then back to live. (Using the cassette machine as an integral part of a telephone report)

In addition to features listed which are common to both machines, the 221 also has three heads and variable bias for normal, CrO₂, and/FeCr Tape. FeCr tape permits a frequency response of up to 14 kHz.

201 2 heads.....\$279.95
221 3 heads.....\$329.95

MARANTZ PRICES ABOVE ARE MFR'S SUGGESTED LIST PRICES. CALL FOR TODAY'S ALLIED PRICE.

GENTNER

The **VRC-1000 Voice Remote Control** operates on the dial-up telephone system to allow you the freedom of remote control from anywhere. You communicate with the VRC-1000 by listening to its synthesized voice and commanding it with a Touch-Tone® (DTMF) key pad or portable automatic dialer. The VRC-1000 can be controlled from any location with a telephone - your home, a car, a pay phone, the studio, etc. It literally talks to you to report conditions. With over 500 English words in memory, it can be programmed (using a simple set-up procedure) to say what you need it to say in reporting conditions at your transmitter.



ADVANCED MICRODYNAMICS

The Advanced Micro-Dynamics **TC-8** is designed to provide highly reliable transmitter control at a modest cost. Eight metering channels are displayed on a large, easy to read dot-matrix array. The status display provides continuous tally for eight on/off inputs. Controls are easy for non-technical operators to learn and push button setup and calibration makes the TC-8 a dream to install and operate. Non-volatile memory stores all setup and calibration data for ten years without power, allowing convenient maintenance and providing orderly recovery from power outages.



MOSELEY

The **MRC 1600 Microprocessor Remote Control System**, consists of one Control Terminal, one Remote Terminal. System is equipped with 32 command relays, 16 status channels (TTL/contact closure), and 16 digital telemetry channels. FCC acceptable for AM and FM broadcast transmitter remote control. Includes audible telco/telco data interface on each terminal.

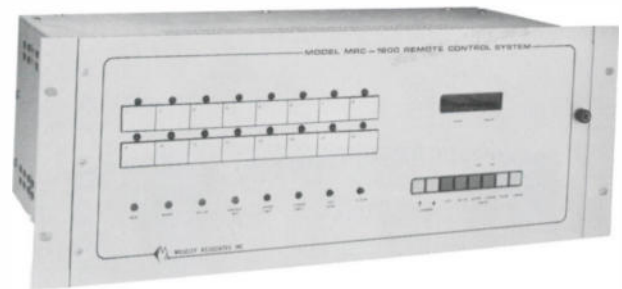

MANUFACTURER'S SUGGESTED LIST PRICE.....\$4595.00

ALLIED PRICE \$ _____

Option for cathode-ray tube (CRT) Terminal. Duplicates all panel functions of the MRC-1600 Control Terminal. Allows simultaneous display for 16 channels, including telemetry readings, status conditions, time of day, operation and error-oriented messages.

MANUFACTURER'S SUGGESTED LIST PRICE.....\$1095.00

ALLIED PRICE \$ _____



Option for automatic logging. Includes I/O modules, software and Texas Instruments Model 850 Desktop Printer. Log headings and command are entered through CRT keyboard. Requires option for CRT terminal.

MANUFACTURER'S SUGGESTED LIST PRICE.....\$995.00

ALLIED PRICE \$ _____



MOSELEY

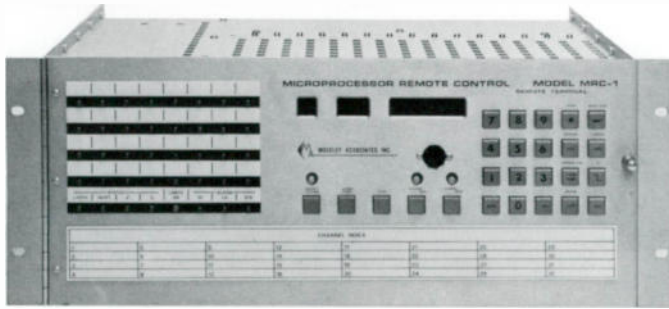

MRC-1 Microprocessor Remote Control System. Includes one Control Terminal and one Remote Terminal. Up to nine Remote Terminals function with a single Control Terminal. For 2-wire or 4-wire dedicated wireline or equivalent interconnecting circuits. Basic system equipped for 16 command lines (open collector electronic switching), 16 status channels (TTL/contact closure), and 16 telemetry channels indicated as 16/16/16. PRICES AND OPTIONS UPON APPLICATION.



MRC-2 Microprocessor Remote Control System with stand-alone Remote Terminal, consisting of one Control Terminal, one Remote Terminal. Remote Terminal includes data acquisition/command capability, precludes CRT, MDC, MSD capability for terminal. System is configured with 16 command lines (open collector electronic switching), 16 status channels (TTL/contact closure), and 16 analog telemetry channels (indicated as 16/16/16). System includes two sets of modems for main-backup wire interconnections. PRICES AND OPTIONS UPON APPLICATION.

POTOMAC



RC16+ Remote Control System. Includes SU-16 Studio Unit (16 channels): This unit contains the master controller and time clock. It sends commands to the transmitter unit and receives data from it. It is pre-programmed for each station according to user specifications. It provides manual or automatic surveillance and control at the option of the operator. Front panel indicators provide channel number, telemetry data, time and status indications. It also includes the TU-16 transmitter unit (16 channels). This unit accepts analog telemetry and status inputs and provides relay closure control outputs. It receives its instructions from the studio unit and operates the relays to control each function. Individual telemetry adjustments are provided for one person calibration under local control. OPTIONS PRICES UPON APPLICATION.

MANUFACTURER'S SUGGESTED LIST PRICE.....\$4995.00

ALLIED PRICE \$ _____

DELTA



Delta Electronics has developed a **Remote Control/ATS System** intended primarily for unattended monitoring and control of standard broadcast, FM and TV stations. Emphasis has been placed on simplicity of operation, reliability, and cost effectiveness in the design of this equipment. The latest proven microprocessor technology has been employed to accomplish the many attractive features of this system with a minimum of hardware. Three basic components are required in this system: a control unit at the control point, a control unit at the transmitter site, and an I/O unit at the transmitter location.

PRICES UPON APPLICATION

HALLIKAINEN

The **TEL-171** converts your Moseley TRC-15AW, TRC-15AR or PBR30 to digital metering transmission, a method that eliminates the offset and gain drift in the analog metering. A local display in the transmitter control unit duplicates the readings displayed by the studio control unit. This permits one-man weekly meter calibration.

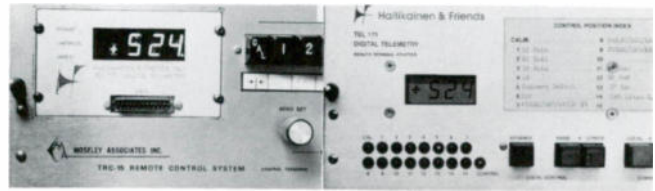

Model	Description	ALLIED PRICE \$
TEL-171	for TRC-15A.....\$800.00	_____
TEL-172	for PBR-30.....\$920.00	_____

HALLIKAINEN PRICES ABOVE ARE MFR'S SUGGESTED LIST PRICES. CALL FOR TODAY'S ALLIED PRICE.

MARTI

Marti Electronics, Inc. is recognized world wide as a manufacturer and supplier of quality products for the radio broadcaster. The Marti product line is the out growth of the needs of founder and President, George Marti. As a radio station owner, in the late 1940's through the 1960's, Mr. Marti had programming desires that required equipment that was not available, or if it was available it was not at a reasonable cost. Because of his own needs, he designed and built equipment which satisfied his own programming requirements. These products were successful. Others saw, used and liked the products. Marti Electronics was begun using the same philosophy that emerged in building those first products..."Build a quality product that is reliable, meets a basic need, performs as it is designed to and is

priced to give the user good value for his money." Marti equipment is manufactured to meet several basic needs of the radio broadcaster.

Marti Remote Pick-Up Systems...The Marti remote broadcast system (RPU) has for years been regarded as the standard for the industry. Broadcasters use RPU equipment to originate programs from events and locations away from their studios. The Marti system of transmitters, receivers and mobile or fixed relay stations allow a live program to be transmitted from the event to the studio with broadcast quality sound. Once the program is received at the studio, it is rebroadcast or recorded for future use.

The **Marti TSL-2 Telemetry Link** provides reliable telemetry circuits for AM, FM and TV stations. Expensive and unreliable FM Subcarrier and Telco lines can now be replaced with a cost effective Marti TSL System. This link is simple to install, easy to operate and maintain. The 2.5 watt transmitter is for solar power or other limited power source applications.



TSL-2 RPT2/450P/RMH-3/CR10-450
PRICE UPON APPLICATION

The **Marti TSL-15 Telemetry Link** provides reliable telemetry circuits for AM, FM and TV stations, with easy installation, operation and maintenance. The 15 watt transmitter is recommended for use on medium to long paths having high signal attenuation.

TSL-15 RPT15-450P/RMH-3B/RR30-450
PRICE UPON APPLICATION

The **RPT-2** is a hand-carried broadcast quality continuous duty transmitter. It will operate from its internal ni-cad battery, from 115 VAC power or from external 12 VDC power. A special subaudible encoder enables the RPT-2 to access Marti mobile repeaters for coverage of indoor events.

Model	Freq. Band	ALLIED PRICE \$
RPT2-150L	152-172 MHz (25F3).....	\$835.00
RPT2-450R	450-456 MHz (50F3).....	\$835.00
RPT2-450N	450-456 MHz (25F3).....	\$835.00
RPT2-450P	450-456 MHz (10F3).....	\$835.00
RPT2-450S	450-456 MHz (100F3).....	\$835.00

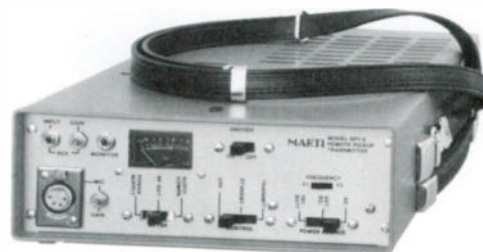

MARTI



Model CR-10 is a rack-mounted VHF or UHF base station receiver designed for broadcast remote pickup service. This receiver has dual frequency capability built in. Marti Technology has provided the highest frequency response with the lowest noise and distortion possible for the assigned channel band width. Special attention has been given to solving today's high interference problems. The CR-10 features a built-in test meter, squelch relay, optional DC operation, built-in sub-audible tone decoder, special noise reduction circuit, 90 dB spurious rejection.

CR-10 Single Freq. w/monitor speaker.....\$1045.00



The **Marti AR-10 Series** receiver is a portable or mobile repeater receiver. This receiver has a built-in AC power supply, and will operate from an external source of 12-15 volts DC. A built-in sub-audible tone decoder meets FCC rule 74.431 allowing this receiver to automatically turn on a mobile transmitter upon receiving an encoded signal from a hand-carried portable transmitter, thus automatically relaying a broadcast to the base station receiver over a greater distance. The receiver operates on all remote pickup frequencies and band widths. Other built-in features include dual frequency capabilities, monitor speaker, and terminals for feeding telephone lines in portable operations. The unit weighs only 5½ pounds.

AR-10 Single Freq.\$1045.00

AR-10 Dual Freq.\$1075.00



The **Model RPT-15** is a compact 15 watt transmitter designed for portable or mobile remote broadcast service. It delivers the maximum power allowed by the Commission for airborne remotes such as traffic reports. The RPT-15 has a built in power supply for operation on 115 VAC. It will also operate on an external 12-14 VDC supply. Standard features include dual frequency and subaudible encoder for use with Marti mobile repeaters and automatic repeaters. All this plus famous Marti broadcast quality and continuous duty operation.

Model	Freq. Band	
RPT-15-150L	152-172 MHz (25F3).....	\$945.00
RPT-15-450R	450-456 MHz (50F3).....	\$945.00
RPT-15-450N	450-456 MHz (25F3).....	\$945.00
RPT-15-450P	450-456 MHz (10F3).....	\$945.00
RPT-15-450S	450-456 MHz (100F3).....	\$945.00

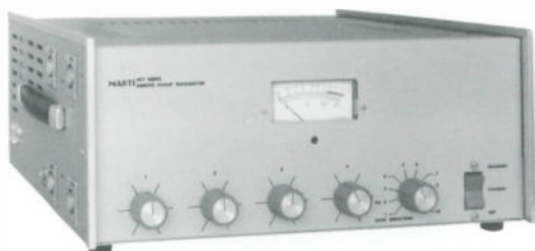

Model	Freq. Band	
RPT-25P	450-456 MHz (10F3).....	\$1795.00
RPT-25P-2	450-456 MHz (10F3)(Dual).....	\$1970.00
RPT-25R	450-456 MHz (50F3).....	\$1795.00
RPT-25R-2	450-456 MHz (50F3)(Dual).....	\$1970.00
RPT-25N2	450-456 MHz (25F3).....	\$1795.00
RPT-25N2-2	450-456 MHz (25F3)(Dual).....	\$1970.00
RPT-25S	450-456 MHz (100F3).....	\$1795.00
RPT-25S-2	450-456 MHz (100F3)(Dual).....	\$1970.00
RPT-40K	152-162 MHz (30F3).....	\$1595.00
RPT-40K-2	152-162 MHz (30F3)(Dual).....	\$1770.00
RPT-40L	166-170 MHz (25F3).....	\$1595.00
RPT-40L-2	166-170 MHz (25F3)(Dual).....	\$1770.00

MARTI PRICES ABOVE ARE MFR'S SUGGESTED LIST PRICES. CALL FOR TODAY'S ALLIED PRICE.

The **Model RPT-25** transmitter provides uncompromised performance in portable and mobile remote broadcast service. This transmitter delivers 25 watts output under continuous duty conditions. Plug in modular construction simplifies field repairs. Available in dual frequency model. (RPT-40 delivers 40 watt output.)

audio~metrics®

MODEL AMCDS-1000A



PROGRAMMABLE CD PLAYER

**Store 100 compact discs under lock & key
Cues to music**

See Pg. 18 for more details

— Another ALLIED exclusive —

FAIRCHILD

DIGITAL AUDIO RECEIVER TERMINAL DART - 384, ABC, CBS, NBC, WESTWOOD, US, MUTUAL, CNN

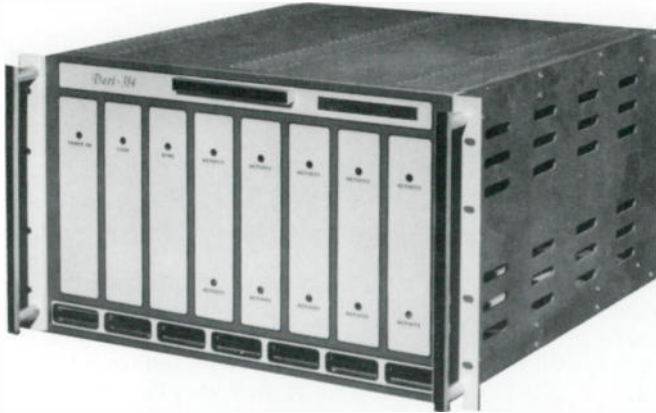

For Digital Satellite reception we recommend the **FAIRCHILD DART 384** (formerly known as the COMTECH DART 384). The DART 384 receiver consists of down-converter, receiver-demodulator shelf, audio program channels, voice cue channels, and data program channels.

The down-converter is an environmentally sealed unit which mounts at the antenna. It converts the 3.7 to 4.2 GHz output of the LNA to a 70 MHz IF signal for use by the demodulator shelf electronics. With the down-converter mounted outside at the antenna a low cost RG-6 type cable can be utilized while at the same time allowing two to three times the distance between the antenna and the receiver-demodulator shelf. A feature only the FAIRCHILD has!

Other features include crystals for all four active digital satellite transponders *standard* in all receivers. And at no additional charge a transponder crystal select switch is *standard* on the FAIRCHILD DART! Need remote channel or transponder switching? No problem, again *standard* in all FAIRCHILD DARTS via 'D' connectors on the rear of the unit. Available with: 15 kHz, 7.5 kHz and voice-cue channel modules.

WEGENER

SUB-CARRIER AUDIO RECEIVER

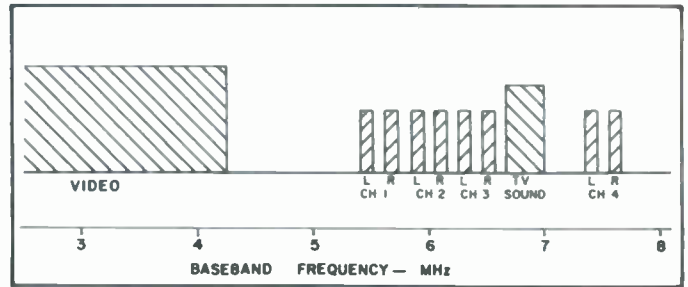
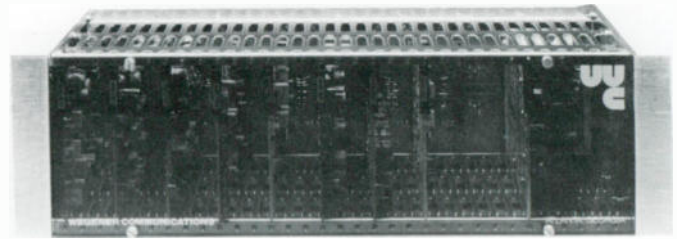

The **Model 1606 Subcarrier Receiver** consists of a down-converter shelf and plug-in IF demodulator. The RF down-converter shelf mounts on the rear of the 1601 Mainframe. The down-converter accepts 4 GHz RF input, provides a 70 MHz IF output, and is designed to interface to the IF wideband demodulator. The IF demodulator is plug-in compatible with the 1601 Mainframe. Bandwidth is optimized for sub-carrier reception characteristics. Thumbwheel selection of transponders is available on the front panels. Provisions are made for LNA powering and polarity switch relay interfacing. Output of the 1606 is wideband-baseband designed to connect to the 1600 family of subcarrier demodulators. Allied stocks Wegener SCPC Sub-Carrier and other fine Wegener products.

COMTECH



"OFFSAT" ANTENNA

Here's a unique one-piece antenna design with an innovative offset feed that makes the **"Offsat"** the **ONLY** antenna in its size category capable of **exceeding all FCC specifications for 2 degree spacing for both transmit and receiving.**

COMTECH'S "OFFSAT" is the intelligent response to the new stricter requirements and it has the surface tolerance necessary for Ku-Band. Call Allied for the full story.



3.8M ANTENNA

The **3.8M** is the perfect antenna for reception of any format audio network, whether the transmission be Digital, Sub-Carrier, or SCPC. Comtech's antennas are easy to assemble, install and align. Simplified installation design for both the AZ/EL mount and the polar mount permit rapid, money-saving installations. Careful tight tolerance construction assures maximum gain and minimum beamwidth so necessary for today's crowded satellite arc. Range tested gain spec of 42.9 dB!

MICRODYNE

1100 BDC/DCR VIDEO RECEIVER



Looking for KU-Band? Allied has the most popular Microdyne 1100 BDC/DCR series! The first half of this receiver is the block down-converter (BDC) which converts the KU-Band frequencies, at the antenna, to a range of 270-770 MHz. Lower cost cable can then be utilized between the satellite antenna and the receiver. Also the BDC is available in a C-Band version which allows you to get double service from your DCR receiver!

The DCR features a double conversion tuner for the best possible image rejection, noise figure and high temperature range stability. The DCR features automatic polarity switching, dual video outputs, and two audio demods. The Microdyne DCR is available in either half, full or dual transponder configurations. Audio subcarriers can be specified to match any frequencies that are used by your network.

1100 FFC-X1 (RDC) L DOWN-CONVERTER



The 1100 FFC rack-mounted down-converter reduces the 3.7 to 4.2 GHz received signal to 70 MHz (center frequency). These crystal-controlled converters are ideal for either single-channel or multi-channel applications, where one 1100 FFC can accommodate up to thirteen 1100 PCDR demodulators. A simple front panel crystal change allows the use of any transponder on the satellite with no internal adjustment required. Note: This is the ultra-stable down-converter required by most SCPC demodulators!

1100 PCDR-5 SCPC DEMODULATOR



The PCDR-5 is the latest design in a frequency agile SCPC demodulator from Microdyne. Exceptional flexibility is provided by the front panel five-section push-button switch assembly, which allows you to select wideband (high fidelity) or narrow band (broadcast voice grade), choose de-emphasis from 0 to 75 usec in 25 usec increments, and set expander ratios for 2:1 or 3:1. The PCDR-5 will receive 15 kHz audio for stereo broadcasts as well as 5 kHz or 7.5 kHz audio programming. Other features include synthesized 10 kHz step tuning, input loop through, loss-of-carrier contact alarm and two 600 ohm balanced audio outputs standard. No more flexibility can be found at any price. Call Allied Satellite for details. This is the demodulator recommended most often!

1100 HDR



Microdyne's new **1100 HDR** 96-channel satellite video receiver and block downconverter (LNC) system offers flexible access to virtually any satellite format available world wide. The 1100 HDR receiver has an input band 750 MHz wide, providing access to any satellite around the world. When used with the corresponding C-or Ku-band LNC, the receiver allows front panel selection of up to 96 channels, 48 of which are factory set and 48 customer specified. This enables broadcasters and cable system operators to take advantage of all future satellite programming. Available from stock at Allied.

MONROE

MODEL 5002 REMOTE CONTROL



The Model 5002 Remote Control provides remote control channel selection of two dual audio modules or voice cue modules for the Comtech/Fairchild DART-384® and other digital audio receivers. Allied stocks both models.

In addition, it will permit remote transponder selection for the Comtech/Fairchild DART-384.

It includes an integral, FCC registered telephone line interface and utilizes DTMF signalling to permit access and control from any Touch-Tone® telephone.

A two-wire, 600-ohm balanced audio input permits access and control from a non-switched communications path.

Tone responses are returned to advise the calling party that the remote control sequence has been accepted.

The remote control retains the channel configurations in memory during power interruptions and returns to these configurations when power is restored to the instrument.

The remote control is housed in a 3½-inch high, 19-inch wide EIA rack mountable enclosure and includes front panel indicators that provide system status information.

"The Satellite Equipment Shown Here Is But A Small Portion Of The Audio/Video Satellite Equipment Offered By Allied Satellite Equipment. Please Request The Allied Satellite Catalog!"

MODULATION SCIENCES

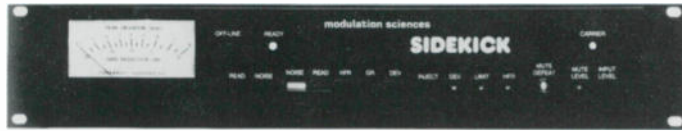

The **Sidekick SCA Generator** has the first crystal controlled SCA generator in the industry. Because it is crystal controlled, Sidekick has a frequency stability of $\pm 0.01\%$ over 0 to 50° C. The SCA carrier is derived from a frequency synthesizer. Any frequency in the the SCA region can be selected by user programmable straps. Sidekick is designed for 150 microsecond pre-emphasis, with 75 and zero strap-selectable options. The lowpass audio filter is engineered as an integral part of the system. Designed into the Sidekick is a random noise generator and incidental AM noise meter.

MANUFACTURER'S SUGGESTED LIST PRICE.....\$2875.00

ALLIED PRICE \$ _____

CRL



The **SCA 300A** will improve the received fidelity and absolutely prevent main channel interference. It provides both the final audio peak control for maximum coverage and loudness plus a very low distortion generator. The SCA 300A features a quartz crystal controlled, low distortion oscillator, user programmable deviation from 2 to 8 kHz, special frequency shaping filters, programmed controlled muting, audio bypass, a data input port, unique multiband pre-emphasis control and a distortion anticipating AGC.

MANUFACTURER'S SUGGESTED LIST PRICE.....\$1500.00

ALLIED PRICE \$ _____

MOSELEY



The Moseley **SCG-8** is a Multiplex FM Subcarrier Generator with automatic muting and front panel peak-deviation meter, including self contained power supply. Available for operation at a specific frequency in the 26 kHz to 186 kHz spectrum.

MANUFACTURER'S SUGGESTED LIST PRICE.....\$1495.00

CALL FOR TODAY'S ALLIED PRICE



The **SCD-8** is a Subcarrier Demodulator with automatic muting and front panel peak deviation meter, including a self contained power supply. Available for operation at a specific frequency in the 26 kHz to 186 kHz spectrum.

MANUFACTURER'S SUGGESTED LIST PRICE.....\$1295.00

CALL FOR TODAY'S ALLIED PRICE

— SPEAKERS —

AUDISAR

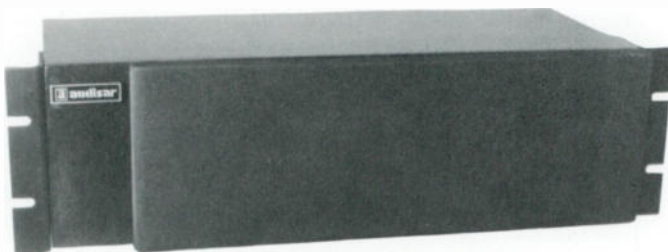

Audisar's Model 14K100, 5.25" rack mount monitor loudspeaker includes mounting hardware for both rack and shelf use. The two-way convertible monitor system has a frequency response of 68 Hz to 12.5 kHz 3dB and a power rating of 30 watts. Its polypropylene woofer is matched carefully to its "Thiele" parameter design enclosure. The crossover network is a parallel 12 dB/octave type, specifically matched to the transducer's characteristics. The network includes high-frequency protection to prevent high-energy burst burn-out.

MANUFACTURER'S SUGGESTED LIST PRICE.....\$166.00

ALLIED PRICE \$ _____

ALC

The **ANNOUNCER** full range loudspeaker is the ultimate in performance in a compact size. The wood cabinet is covered in walnut-grained vinyl and is perfectly square. As with all ALC loudspeakers, the grill snaps away and the system has an overall fuse. The high-compliance full range transducer produces quality sound from below 60 Hz to beyond 15 kHz.

MANUFACTURER'S SUGGESTED LIST PRICE.....\$53.00

ALLIED PRICE \$ _____

10302



The **MONITOR** loudspeaker system provides a flat response from below 50 Hz to beyond 20 kHz. Its high compliance surround on the 8" woofer and phenolic tweeter combine to enhance any type of music. The tweeter control and the system fuse are behind the snap-away grille. It will handle 25 watts RMS continuous, 45 watts integrated program material at 8 ohms.

MANUFACTURER'S SUGGESTED LIST PRICE.....\$116.00

ALLIED PRICE \$ _____

"ALLIED CARRIES THE FULL ALC LINE"

20306



TOA

The **RS21M** is a compact speaker system incorporating a full range 5 inch cone speaker in a sealed enclosure of compact size. Featuring a high power capacity and smooth extended frequency response, the RS21M is ideally suited for recording studio monitoring.

MANUFACTURER'S SUGGESTED LIST PRICE..... \$66.50

ALLIED PRICE \$ _____

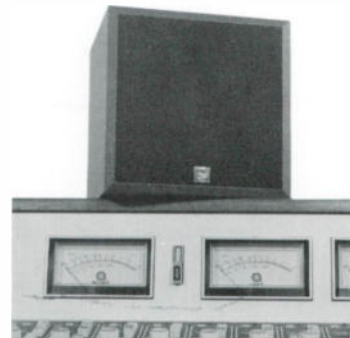

**ALLIED has six (6) offices to serve the broadcast industry:
Atlanta, Chicago, Dallas, Los Angeles, Richmond, IN & Seattle
ALLIED has 800 numbers at all locations for your order entry.
ALLIED has EZ LINK, TTY DDD, FAX, TELEX and FED X ZAP for
communication.
ALLIED carries over 230 manufacturer product lines.
ALLIED has Satellite, International and Canadian Divisions.
ALLIED serves the broadcast world — may we serve you?**

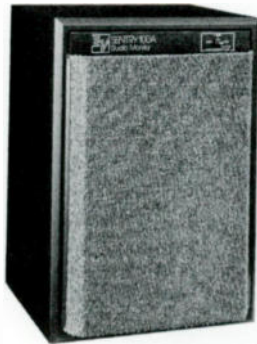

ELECTROVOICE

The **SENTRY 100A** monitor speaker system is a no-nonsense system that speaks to the needs of professionals with specific requirements. It offers high efficiency with extended low frequency response, high power capacity across the entire frequency range, uniform frequency response and dispersion, all in a compact no frills package. The SENTRY 100A features the SUPER-DOME™ tweeter capable of handling 25 watts of input power and an 8" direct radiator woofer.

MANUFACTURER'S SUGGESTED LIST PRICE.....\$255.00

ALLIED PRICE \$ _____



The **SENTRY 500** no-nonsense design meets the needs of professionals by combining high efficiency with extended low frequency response, high power capacity across the entire frequency range, uniform frequency response and constant directivity, all in a well thought-out attractive package. The SENTRY 500 employs the SUPER-DOME™ tweeter capable of handling 25 watts of input power and an 8" direct radiator woofer.

MANUFACTURER'S SUGGESTED LIST PRICE.....\$499.00

ALLIED PRICE \$ _____

"ALLIED CARRIES THE ENTIRE ELECTROVOICE LINE"

JBL



JBL's 4400 Series Studio Monitors achieve a new "truth" in sound with an extended high frequency response that remains effortlessly smooth through the critical 3,000 to 20,000 Hz range. And even extends beyond audibility to 27 kHz, reducing phase shift within the audible band for a more open and natural sound. The JBL 4400 Studio Monitor Series captures the full dynamic range, extended high frequency, and precise character of your sound as no other monitors in the business.

MODELS:

- 4406 \$180.00**
- 4408 \$225.00**
- 4410 \$357.00**
- 4412 \$549.00**

CALL FOR THE ALLIED PRICE

ANCHOR

The **AN-1400 Powered Speaker** with 50 watt (RMS) MOSFET Amplifier, mounts directly into Tektronix® side-by-side rack. Input; Balanced 600 ohm transformer (fem. XLR), front headphone jack, cast aluminum face plate, & metal grill. Shipping Size: 6" x 9" x 11" Shipping Wt.: 12 lbs.

MANUFACTURER'S SUGGESTED LIST PRICE.....\$429.00

ALLIED PRICE \$ _____

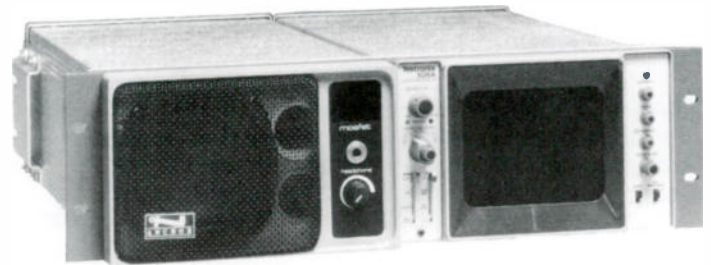

AURATONE

Recording/Broadcast standard **mixdown/comparative monitors** and **extension speakers**. Walnut woodgrain vinyl finish, black foam grille. The little powerhouse. They tell you exactly what's going on.

MANUFACTURER'S SUGGESTED LIST PRICE, PER PR..\$99

ALLIED PRICE \$ _____



— STANDBY POWER —

TOPAZ

The **TOPAZ POWERMAKER Micro UPS™** provides standby power for microcomputers and microprocessor based volatile memory. The POWERMAKER is totally effective against blackouts, brownouts and sudden voltage dips that can shut you down, protects against noise transients and spikes. It responds in less than a half cycle. It provides a sine wave output for meeting the power requirements of even the most sensitive equipment.

The **TOPAZ POWER CONDITIONERS** combine the performance characteristics of a voltage regulator and a noise suppressor in one convenient unit. Available in single-phase with power rating from 2 kVA to 400 VA and numerous features.

PRICES UPON APPLICATION



KAY

The **Phasemaster® T-Series Rotary Phase Converter** is specially designed and engineered for use with all types of radio transmitters for the conversion of single phase power to 3-phase in locations which are not serviced by 3-phase lines. A Phasemaster T-Series Rotary Phase Converter can be installed for a fraction of the cost of installing utility supplied 3-phase power.

PRICES UPON APPLICATION



KOHLER FAST RESPONSE™ 180 KW to 275 KW

The most advanced generator design in the U.S. and on the international scene, KOHLER Fast-Response™ units have a combination of important performance advantages, including: 1. Exceptional motor starting; 2. Instant recovery from voltage transients; 3. Sustained short circuit protection.

In addition, Fast Response™ engine generators eliminate high frequency spikes thereby preventing disruption of telephone and electronic equipment.

Model	Standby Rating 60 Hz	Prime Rating 60Hz	Dimensions L x W x H	Weight Lbs.
180ROZ	180 KW	180 KW	120x50x79¾"	5780
230ROZ	230 KW	205 KW	120x50x88¾"	5875
250ROZ	250 KW	225 KW	120x50x88½"	5990
275ROZ	275 KW	250 KW	120x50x88¾"	5990

Available voltages: 120/240 1 phase through 100 KW, 120/208 3 phase, 4 wire through 347/600 3 phase, 4 wire models.

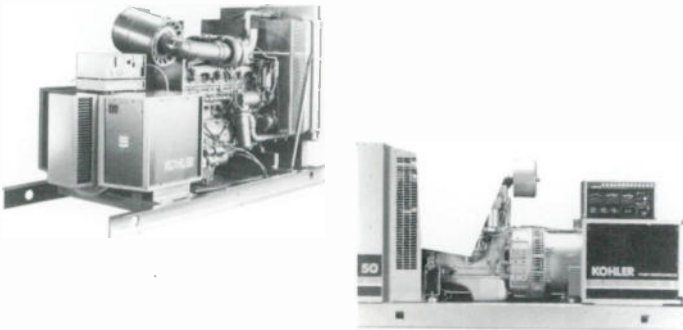

FAST RESPONSE II™ 20 KW to 150 KW

The KOHLER Fast Response II™ Engine Generator System: More advanced features, more reliability in a leaner, more efficient package.

KOHLER Fast Response II™ systems represent a highly refined second generation of the patented Fast Response™ design, offering these standard performance features: Instant response to load change, sustained short circuit capability, superior motor starting performance. KOHLER Fast Response II™ is America's first engine generator system to incorporate the reliability and efficiency of advanced microcomputer logic. The KOHLER Microcomputer Decision Maker™ executes instructions in *microseconds* and is virtually immune to false input signals.

Model	Standby Rating 60 Hz	Prime Rating 60 Hz	Dimensions L x W x H	Weight Lbs.
Fast Response II Liquid-Cooled Gas/Gasoline				
20RZ	20 KW	18 KW	72x29x43"	1142
30RZ	30 KW	27.5 KW	84x29x45"	1360
45RZ	45 KW	40 KW	84x29x45"	1465
60RZ	60 KW	54 KW	88½x34x44"	2009
70RZ	70 KW	63 KW	88½x34x44"	2100
80RZ	80 KW	72 KW	88½x34x46"	2400
100RZ	100 KW	90 KW	88½x34x46"	2550
Fast Response II Liquid-Cooled Diesel				
20ROZ	22 KW	20 KW	72x29x37.5"	1256
30ROZ	30KW	27 KW	78x29x45"	1440
40ROZ	37 KW	34 KW	78x29x45"	1449
50ROZ	50 KW	46 KW	78x29x45"	1514
60ROZ	60 KW	54 KW	88½x29x44"	1875
80ROZ	80 KW	72 KW	88½x29x44"	2065
100ROZ	100 KW	90 KW	88½x29x44"	2150
125ROZ	125 KW	112 KW	99x34x57½"	3900
150ROZ	150 KW	135 KW	99x34x57½"	3950

Available voltages: 120/240 1 phase, 120/208 3 phase, 4 wire through 347/600 3 phase, 4 wire all models.

TR-SERIES™ 300 KW to 1000 KW

Diesel power with your choice of cooling, fuel system and exhaust system options. All models in this series are equipped with KOHLER's Microcomputer Decision Maker controller for full monitoring instrumentation, automatic protection features, and a broad range of accessories.

Engines for this series are supplied by Cummins. All are turbocharged, and the majority are also after-cooled.

With isochronous governors as standard equipment, steady-state frequency regulation from no load to full load is plus or minus .25%.

NEMA class F insulation system with epoxy coating for moisture and abrasion resistance.

Model	Standby Rating 60 Hz	Prime Rating 60 Hz	Dimensions L x W x H	Weight Lbs.
300ROZ	300 KW	275 KW	120 ² / ₃₂ x45 ¹ / ₂ x70"	5525
350ROZ	350 KW	325 KW	120 ² / ₃₂ x45 ¹ / ₂ x70"	6850
400ROZ	400 KW	335 KW	133x45 ¹ / ₂ x79 ¹ / ₂ "	9500
450ROZ	450 KW	410 KW	142 ⁷ / ₈ x59 ¹ / ₈ x96 ³ / ₈ "	11550
500ROZ	500 KW	455 KW	145 ⁵ / ₈ x59 ¹ / ₈ x82 ³ / ₈ "	11850
600ROZ	600 KW	535 KW	145x62x87"	13465
750ROZ	750 KW	675 KW	177x67x45"	18400
800ROZ	800 KW	725 KW	177x67x95"	18400
1000ROZ	1000 KW	900 KW	213 ¹ / ₁₆ x84x112"	21000

Available voltages: 120/208 3 phase, 4 wire through 347/600 3 phase, 4 wire

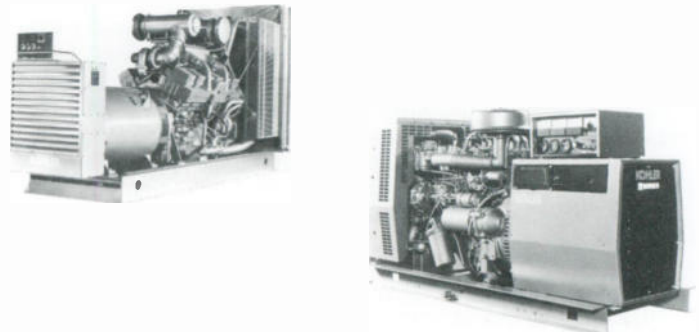

R-SERIES™ 5 KW to 17.5 KW

R-Series™ generator sets above 10 KW provide many of the features of the Fast-Response models including voltage regulation with ±2%, and a broad range of voltage combinations including 347/600. Voltages from 120/240 through 277/480 are field reconnectable. The exclusive KOHLER solid-state volts per-hertz regulator has three-phase sensing.

The standard controller is a relay model with a meter box option. An optional solid-state controller has a hospital lamp group to meet NFPA-76A.

Model	Standby Rating 60 Hz	Prime Rating 60 Hz	Dimensions L x W x H	Weight Lbs.
R-Series Air-Cooled Gas/Gasoline				
5RMY	5 KW		26½x18½x21½"	234
7RMY	7 KW		28½x21½x26½"	450
15RMY	15 KW		38 ¹ / ₁₆ x21½x29 ⁷ / ₈ "	696
R-Series Air-Cooled Diesel				
5RMOY	5 KW	5KW	34x34¼x20"	547
10RMOY	10 KW	10 KW	46x28x41"	831
15RMOY	15 KW	14 KW	51x26x34½"	965
R-Series Liquid-Cooled Gas/Gasoline				
7.5R	7.5 KW		43 ¹ / ₈ x19 ¹ / ₈ x25 ¹ / ₂ "	450
R-Series Liquid-Cooled Diesel				
17.5ROY	17.5 KW	15 KW	61x26x34 ¹ / ₁₆ "	940

Available voltages: 120/240 1 phase, 3 wire through 347/600 3 phase, 4 wire. Models 5RMOY, 5RMY, 7RMY and 7.5R are 120 volt or 120/240 volt, 1 phase.

MOSELEY

The **PCL-606** is an all solid-state STL consisting of a transmitter and receiver with self contained power supplies, crystals and tested on the operating frequency. Versions are available for all commonly used bands from 148 to 960 MHz. Discrete.

MANUFACTURER'S SUGGESTED LIST PRICE....\$10,395.00

ALLIED PRICE \$ _____

The **PCL-606/C** is an all solid-state Composite STL consisting of a transmitter and receiver with self-contained power supplies, crystals and tested on the operating frequency. Transmits a composite stereo waveform on a single STL. Versions available for all commonly used bands from 148 to 960 MHz.

MANUFACTURER'S SUGGESTED LIST PRICE.....\$9995.00

ALLIED PRICE \$ _____

The **PCL-505** is an all solid-state STL consisting of a transmitter and receiver with self-contained power supplies, crystals and tested on the operating frequency. Versions available for all commonly used bands from 148 to 960 MHz. Discrete.

MANUFACTURER'S SUGGESTED LIST PRICE.....\$7195.00

ALLIED PRICE \$ _____

The **PCL-505/C** is a Composite STL consisting of a transmitter and receiver with self-contained power supplies, crystals and tested on the operating frequency. Transmits a composite stereo waveform over a single STL. Versions available for all commonly used bands from 148 to 960 MHz.

MANUFACTURER'S SUGGESTED LIST PRICE.....\$6995.00

ALLIED PRICE \$ _____

The **TRL-1** is a Telemetry Return Link consisting of an all solid-state transmitter and receiver. Tuned and tested on the operating frequency. Nominal one watt transmitter output Receiver designed specifically for narrowband service. For 10F2/10F3 channels FCC group P.

MANUFACTURER'S SUGGESTED LIST PRICE.....\$3795.00

ALLIED PRICE \$ _____

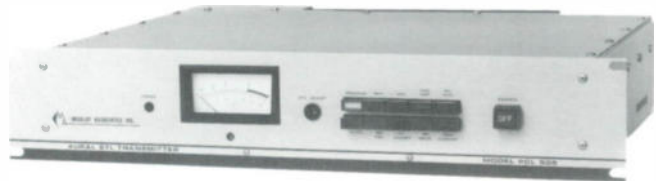
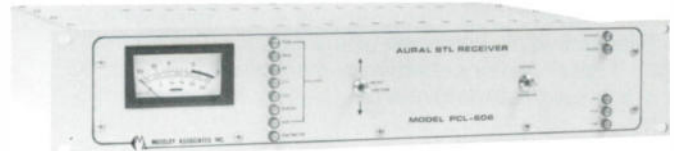
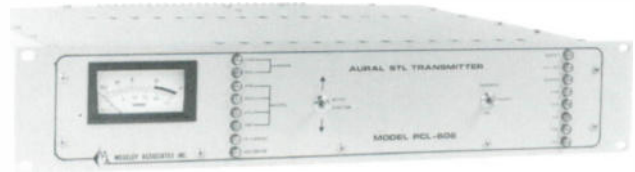

MARTI

The **Marti Studio-Transmitter Link/Intercity** relay is a line-of-sight FM communications system providing a high quality broadcast audio channel with two optional sub-channels. A dual link for stereo provides two identical broadcast quality channels with better than 60 dB stereo cross talk and four optional sub-channels. This system offers greater rejection of interference, superior noise performance, low channel cross talk, greater redundancy, and lower cost.

Model	Description	
STL-10/950	10 watt transmitter, complete with crystal and tuned to frequency. 120/220VAC. for AM or FM broadcast application.	
R-10/950	Receiver, complete with crystal and tuned to frequency, 120/220 VAC. for AM or FM broadcast application. Includes down-converter.	
STL-10	MONO SYSTEM, TYPICAL	\$3190.00
STL-10	STEREO SYSTEM, TYPICAL	\$6775.00

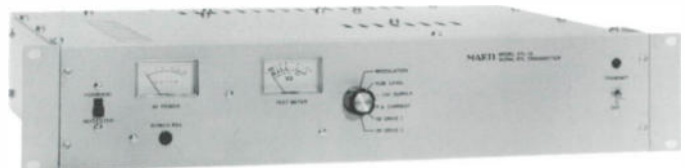

MARTI



Marti Electronics has announced the availability of their new **UPS-12** uninterruptible power system. The DC-DC system provides automatic battery backup for Marti STL-10/R-10 radio link systems as well as Marti RPT-15/CR-10 automatic relay stations and TSL-15 data links. The UPS-12 is equipped with a precision constant voltage "Taper" battery charger to maintain a 24, 36 or 60 amp-hour sealed maintenance free battery in a charged condition.

CALL FOR THE ALLIED PRICE



Marti's MW-500 Microwave Booster is designed to receive, amplify and re-direct an aural STL signal over or around an obstructing object in the direct path between the transmitting and receiving antennas. Since the booster uses the same frequency for re-transmitting, scarce spectrum is conserved. The booster will provide a maximum of 500 milliwatts output power. It will also provide 60 dB power gain at any point it is inserted in the microwave path.

CALL FOR THE ALLIED PRICE

DBX

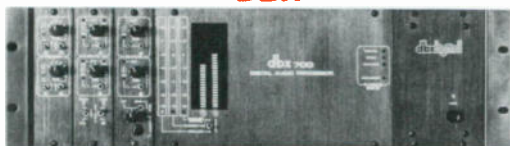

Precision Companding solves a major problem with delta modulation—limited dynamic range. The **dbx 700** offers a dynamic range of more than 110 dB, resulting in an unbelievably low noise floor that's completely neutral-sounding. The compander's novel design and the direct digital link between encoder and decoder guarantee its overall performance is absolutely transparent.

Linear Prediction estimates a signal's future by monitoring its recent past. It does this 700,000 times a second. This further increases the dynamic range of our fixed delta modulator and prevents the audible noise modulation common in other forms of DM.

You can create a digital remote transmission system with the dbx 700 Digital Audio Processor and the MA/COM system that will rival live performance.

PRICES UPON APPLICATION 2 REQUIRED FOR STL

M/A-COM



The **M/A-COM 23VFM** system is a budget priced solid-state FM microwave link that provides reliable, short range digital audio links in the 21.8 to 22.0 GHz and 23.0 to 23.2 GHz frequency bands. With the addition of a digital processor(s), systems can be configured as Stereo Digital only, or, with optional subcarriers, Stereo Digital and up to two additional 15 kHz analog channels. Perfect for FM SCA audio, FM SCA data, or transmitter remote control.

PRICES UPON APPLICATION

MARK PRODUCTS

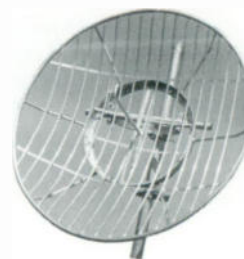

Mark Products offers a variety of sizes of Heli-Arc welded aluminum multi-element grid parabolas for point to point relay operation in the 400 to 2700 mHz frequency range. The patented grid of construction is lightweight, yet extremely strong. One of the outstanding advantages of the grid antenna is that it has wind loading characteristics of only 25 to 40% of comparable size solid parabolas.

PRICES UPON APPLICATION

SCALA

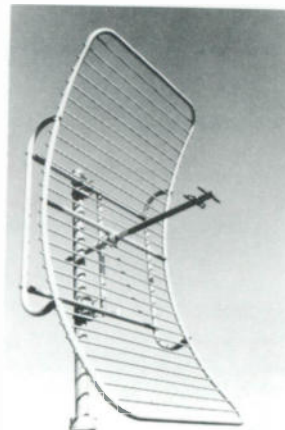

The **Scala PR-450-U™** is widely used in point to point communications and telemetry systems in the 350 to 1000 mHz spectrum. Paraflector™ performance approximates that of a parabolic dish of the same aperture, and is easier to assemble and install. The PR-450U offers rugged construction for reliable long-term service, even in severe environmental conditions.

MANUFACTURER'S SUGGESTED LIST PRICE.....\$500.00

ALLIED PRICE \$ _____

Wave goodbye to your old phone system and say hello to the

Telnox L-O

Broadcasting has a brand new beat!

The **Telnox L-O** is another telephone system like the Rolls is another car. There's no question it can change the way you are presently using your telephone. This is because the Telnox L-O is more than a telephone system. It is a way of thinking. Your way.



What does this mean? It means the Telnox L-O hasn't been fancied up to "adapt" to broadcasting, it has been designed for it. Here's a system that finally tackles the unique demands of your industry head on.



The Telnox L-O comes from Normex. And it isn't just a clever package that has eliminated some of the usual problems of telephone broadcasting. It has been developed with exceptional features like; **CONFERENCE ON AIR** that can open up brand new programming vistas.

Close encounters

With a feature like **CONFERENCE ON AIR**, you can rewrite the book on telephone programming. Because you now have the freedom to organize formats anytime, and

anyway you want. You no longer have to go through an operator and the Telnox L-O can "assemble" up to 8 people to take part simultaneously in the same show.

This is the kind of flexibility that just used to be talked about. It's now a reality and can help you cash in on the spontaneity that is so vital to effective telephone broadcasting.



Yes, the Telnox L-O is state-of-the-art. And yes, it could easily replace each and every set you are presently using in your studios and control rooms. It also gives you the works. Access to features that used to be the preserve of big business systems only, including new ones like: **AUTO-HOLD, VOCAL, AUTO-ON AIR, LINE LEVEL ADJUST, PRIORITY, HANDSFREE, BATTERY BACK-UP** and many more.

The Telnox L-O may be ultra-sophisticated technology, but it couldn't be simpler to use. All its features are automatic and easily accessible and they've been packaged into an extremely compact, low-profile system that can accommodate up to 10 telephone lines and 8 consoles.

This is a system that was meant for the pressure and intensity of a studio environment. And when it comes to the price you have to pay for this terrific technology, you can be sure you can afford it.

A challenge all its own

It was broadcasters who got us working on the Telnox L-C in the first place. The project became an inspired collaboration between radio and television engineers from the industry and Normex's electronic experts.

And the result was more than anyone had anticipated. A breakthrough, not just a new system. The Telnox L-O has eliminated the hassle and the headaches but that's not what broadcasters are excited about. At last, they have a system with potential. A system that's as creative as they are and can point the way to bright new broadcasting ideas.



COMREX

COMREX 2X: Two-Line Frequency Extenders

The Comrex 2X systems give you a full 50 to 5 kHz of program audio using two standard telephone lines. On one line, input audio is shifted upward by 250 Hz, so program audio as low as 50 Hz can pass through the 300 Hz telephone cutoff. On the second line, program is shifted down by 2000 Hz to pass frequencies as high as 5000 Hz.



PTLX: Portable Two-Line Encoder

For use with an external console. The PTLX contains all features necessary to transmit 5 kHz over two dial or dedicated lines. There is built-in telephone interface for two program lines with a third for communications. An optional road case is available.

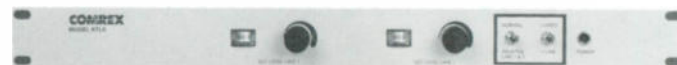

RTLX: Rack-Mount Two-Line Decoder

The RTLX is compatible with both PTLX and STLX encoders. For unattended operation, the RTLX may be used with TCB 2A Auto Answer telephone couplers, with line levels set automatically by the Comrex LXL Auto Leveler. The RTLX is also compatible with TCB 1A telephone couplers where phones will be answered manually.

COMREX IX: One-Line Frequency Extenders

Because they require only a single telephone line, our One-Line series offers increased flexibility with only a small decrease in program quality. The encoder shifts the audio up by 250 Hz to pass frequencies down to 50 Hz. At the receiving end, the decoder shifts the program back down.



Model RLX II: Desk Top Decoder

The desk-top decoder features a built-in TCB-1A coupler for quick, easy connection to the telephone line and may be used as a general purpose telephone coupler for unencoded as well as encoded feeds. It contains the same input gain adjust and LED overload indicator as the RLX and is also compatible with all single-line encoders.



Model PLX II: Desk Top Encoder

The PLX II is designed to operate from the output of a remote mixer. It includes a built-in TCB-1A telephone coupler and features the same encoding circuitry as the PLX, but without the mic preamp and AGC.



Model PLX: Portable Encoder

This "stand alone" encoder is designed for use in the field. Mic and tape inputs are provided and the mic ducks the tape so that live "wraparounds" may be added to a taped report. An AGC system is incorporated, featuring a peak limiter with program controlled released time. It can operate from its internal batteries, or from one of Comrex's AC power supplies (LX-PC or LX-P). The PLX is ideal for use where non-technical personnel are handling feeds under widely varying conditions.



Model SLX: Encoder/Console

The SLX is a complete, self-contained remote broadcast package. Features:

- Single-line encode circuitry
- 4 mixing channels (2 mic/line)
- 3 headphone channels for monitoring and intercom
- PA feed out/External monitor in
- Built in compressor/limiter
- Conductive plastic slide faders (Penny & Giles, optional)
- Telephone interface for program, talk-back and communications
- Optional road case and battery pack

COMREX



Model TLX: Rack Mount Encoder

A single-line encoder for fixed installations (master control, ENG vans, network distribution points, etc.), the TLX accepts the output of a studio console and feeds either dial or dedicated circuits. Input gain is adjustable on the front panel and an LED overload indicator monitors input drive level. Dial telephone lines may be connected to the TLX with either TCB-1A or TCB-2A.



Model RLX: Rack Mount Decoder

The RLX is a rack-mount decoder which is compatible with all Comrex single-line encoders. Input gain is adjustable on the front panel and an LED overload indicator monitors input drive level. The RLX requires an external coupler such as the TCB-1A to TCB-2A to hold the telephone line.



LX-T and LX-R Basic Extender System

The Basic Extender system was specifically designed for smaller-market stations. The LX-T encoder/LX-R decoder don't offer the extra features that some users find unnecessary. What they do offer is a distinct improvement in program quality sent over telephone lines. Both encoder and decoder are completely compatible with other Comrex One-Line Frequency Extenders.



LX-L Auto Leveler

A digital automatic level adjust system which matches gains of the two telephone lines to equality, and provides the proper input level to the RTLX. Ideal for satellite uplinks or other unattended operation.

ALLIED CARRIES THE ENTIRE COMREX LINE

SYMETRIX

The **Model 104 Multi-Line Interface** and **Model 108 Broadcast Telephone System** can connect your audio console directly to incoming phone lines and both are fully stand-alone systems, designed to bridge the gap between bi-directional telephone lines and uni-directional audio mixing consoles. Both are equipped with electronic hybrids which provide full duplex conversation between host and callers. In conjunction with the hybrid, a sophisticated AGC (Automatic Gain Control) assures that each caller comes through loud and clear. Both the 104 and 108 systems are operated from small (8 x 10 inch) desk consoles.

MFR'S SUGGESTED LIST PRICE Model 104.....\$1450.00

ALLIED PRICE \$ _____

MFR'S SUGGESTED LIST PRICE Model 108.....\$2650.00

ALLIED PRICE \$ _____

The **Symetrix TI-101** is a console-to-telephone interface for talk show, ENG, production and a host of other applications.

MANUFACTURER'S SUGGESTED LIST PRICE.....\$495.00

ALLIED PRICE \$ _____



GENTNER

The **DTD-5** is a dialtone/busy detector for use in those telephone systems which do not provide momentary open/battery reversal, the actions necessary to implement the ELGIN 20721 "Listen Line." As the caller finishes listening to the message on the "Listen Line" and hangs up, the DTD-5 detects the dialtone, pulse, or "off the hook" sounds and sends a command to the "Listen Line" to release the line, ready for next call. DTD-5 requires no external power supply, but retrofits into the 20721 and takes its power from the host unit.

MANUFACTURER'S SUGGESTED LIST PRICE.....\$64.00

ALLIED PRICE \$ _____

The **TC-100** is the most versatile telephone coupler you'll find. The design not only gives you auto-answer/auto-disconnect and latching or momentary tape starts; it allows you to use the unit as a hybrid for on-air calls . . . as a remote controller, and private party line telephone intercom. Easy to install and operate.

MANUFACTURER'S SUGGESTED LIST PRICE.....\$349.00

ALLIED PRICE \$ _____

The GENTNER **SPH-3A** provides an easy and inexpensive method of interfacing broadcast equipment with an existing telephone system. Separate adjustable volume control of caller audio and monitor audio is featured, plus one-time adjustment of null and feed to caller.

MANUFACTURER'S SUGGESTED LIST PRICE.....\$499.00

ALLIED PRICE \$ _____

From GENTNER, the **SPH-4** is a self contained telephone interface system designed to provide clean, clear phone audio for a variety of uses. Incorporates one-time set controls of audio volume to caller (with LED level indication) squelch, hybrid null as well as separate volume controls for caller level and monitor. An exclusive feature is the caller control.

MANUFACTURER'S SUGGESTED LIST PRICE.....\$699.00

ALLIED PRICE \$ _____

GENTNER'S **EFT-900** makes your remotes easy and inexpensive. The unit gives you the convenience of a standard telephone line, with better quality than you thought possible from the dial-up circuit. The EFT-900 improves telephone audio quality by recovering 2½ octaves of low-end frequency response. The unit's SHARP filters reduce line noise while Aphex® processing regenerates higher frequencies above 3 kHz. Easy to hook up and easy to use.

MANUFACTURER'S SUGGESTED LIST PRICE.....\$849.00

ALLIED PRICE \$ _____

The **EFT-1000 Extended Frequency Transceiver** improves the sound of your telephone. Audio frequencies are shifted up by 250 Hz on the transmitting end and back down on the receiving end. This dramatically improves the quality of the broadcast. It is a complete, self-contained transceiver that is able to transmit, receive, or operate full duplex as a transceiver. This allows you to run your remote broadcasts with a single telephone line! Designed for easy hook-up and simple operation it is able to enter or exit the encode/decode mode and couple to the telephone line automatically.

MANUFACTURER'S SUGGESTED LIST PRICE.....\$1899.00

ALLIED PRICE \$ _____

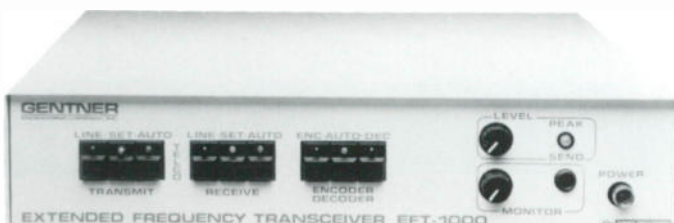
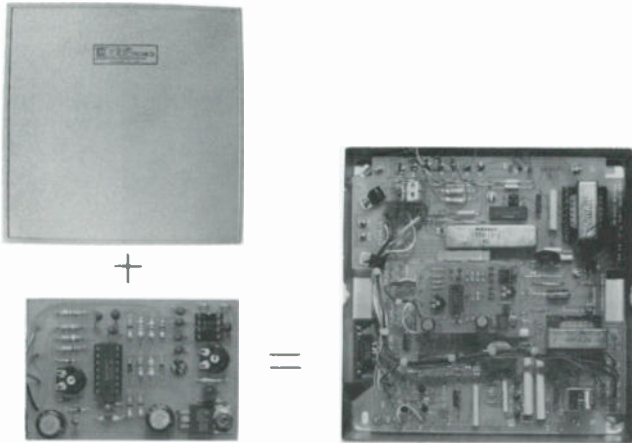

GENTNER

Gentner's new **TELEPROCESSOR** improves the sound of any telephone system. Use in conjunction with telephone hybrids, frequency extenders or other interface equipment to enhance your telephone audio. Features: Maintains average send level to caller, has Aphex® Processing, Lo and Hi band EQ adjustments and easy to install.

MANUFACTURER'S SUGGESTED LIST PRICE..... \$499.00

ALLIED PRICE \$ _____



TELLABS

The **TELLABS line** of equalization equipment was designed expressly for use with telephone circuits. No other form of equalization can offer the flexibility or specs necessary to achieve the quality for AM and/or FM (stereo) feeds via leased telephone circuits. Bell standard for this application.

If a circuit is unloaded and if the length vs. gauge criterion is not exceeded, you can install your own equalization and pay for it in a very short time. The only alternative is to pay the telephone company a monthly fee for the same equipment. If telephone circuit lines are a necessity in your operation, there's no reason for you to also pay for the equalization on a monthly basis.

All TELLABS equipment is connected via the wire wrap method and all cabinets must be wired for application by the user. Wrap terminals .075".

A typical mono application would consist of:

- (1) #4425 dual repeat coil card
- (1) #1911 single card repeat coil housing
- (1) #1912 housing for equalizer module*
- (1) #4008 equalizer module
- (1) #1913-L4 power transformer

A typical stereo application would consist of:

- (1) #4425 dual repeat coil card
- (1) #1911 single card repeat coil housing
- (1) #1913 dual housing for 2 equalizer modules*
- (2) #4008 equalizer modules
- (1) #1913-L4 power transformer

* (RF at the receive end may necessitate a 248RF cabinet which is designed with suppression and bypassing especially for use in RF-intense applications.)



4008

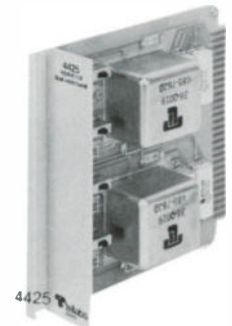

4425

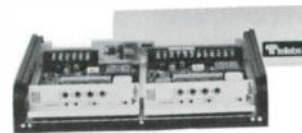

1913

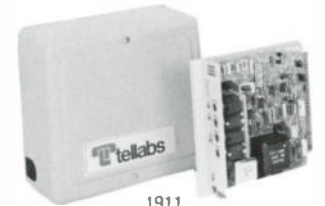

1911

TELEPHONE LINE EQUALIZATION

TYPICAL ARRANGEMENT TO UPGRADE ANY LOOP WHICH MEETS INDICATED CRITERIA

Dry, unloaded voice grade Telco pair



Up to 30 dB loss differential 50-15 kHz
(22 ga cable typically 5.9 mi max @ 15 kHz)

UP TO 3 UNITS MAY BE CASCADED AT APPROX 5 MI INTERVALS WITH MAINTENANCE OF ACCEPTABLE NOISE & DISTORTION SPECS (RE 22 GA CABLE)

TYPICAL EQUALIZATION LIMITS — 15 kHz

CABLE GA	MAX LENGTH
19	8.7 mi
22	5.9 mi
24	4.2 mi
26	3.4 mi

Model	Description	Price
#4008	EQ. module.....	\$202.00
#4425	Repeat coil/dual.....	\$69.00
#1913	Dual card housing.....	\$65.00
#1911	Single card housing.....	\$19.00
1913-L4	Transformer.....	\$9.00
248RF	Dual amp mounting, RF shielded.....	\$306.00
248C	housing.....	\$363.00
8003A	power supply.....	\$173.00
1012	housing.....	\$100.00

ELGIN

The **EC30A** is a totally passive voice coupler that's also known as the "QKT." Total protection is afforded to the phone company's circuits by installation of the EC30A. ELGIN was the original manufacturer for the Bell "QKT."

MANUFACTURER'S SUGGESTED LIST PRICE.....\$52.00

ALLIED PRICE \$ _____





ELGIN

The **19645 RCZ** recorder connector provides interface between the telephone and/or multi-line key pad and the input to your audio equipment. A defeatable "beep" occurs every 15 seconds and AGC keeps both sides of the conversation just about equal in level. It amplifies both sides of conversation but isn't designed for sending audio back. It requires the optional 2012B transformer for power, and connections are made via a barrier strip. A RJ-32X jack must be ordered from the phone company for single line installation. A RJ-35X jack is required for multi-line access.

Model	Description	
19645-4	Recorder connector.....	\$208.00
2012B	Transformer.....	\$10.00

ALLIED PRICE \$ _____



Also known as the "listen line", the **20721** is expressly for use as an automatic answer device. It can be used at your station for an out-of-town audition of your program. It will automatically connect your mass feed to a network station simply by having the station call the number assigned to it. The 20721 must see a battery reversal or momentary open from the originating city. The absence of both of these functions will not permit it's use. When the caller hangs up the line will not be released. Use of the Allied DTD-5 will alleviate this problem. The DTD-5 can be retrofitted into the 20721 case and needs no external power source. Multi-connector DA19603403-51225-1 plug and hood assembly and telco jack RJ-11W or RJ-32X are required.

Model	Description	
20721-1	Coupler.....	\$237.00
DTD-5	Line release.....	\$64.00
DA19603403-51225	Multi-pin connectors.....	\$12.00

ALLIED PRICE \$ _____

— TEST EQUIPMENT —

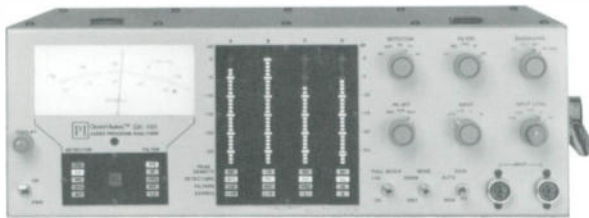

POTOMAC

The Potomac "**QuantAural**" **QA 100** is an audio program analyzer for evaluating your own station's sound, competitive stations' sound and measuring audio processing from numerous sources. This instrument is designed especially for professional broadcast sound analysis. You can now measure maximum peak level, audio processing effectiveness, tightness of sound, tonal balance and consistency, stereo bandwidth, preemphasis and "punch." This portable unit utilizes meter and LED readouts.

MANUFACTURER'S SUGGESTED LIST PRICE.....\$3500.00

ALLIED PRICE \$ _____



Designed primarily for commercial broadcast proof-of-performance measurements and equipment maintenance. The **AG-51 Audio Generator** and **AA-51 Audio Analyzer** are packaged separately for remote measurements requiring physical separation of signal source and signal analyzer. Both units are RFI shielded to enable accurate measurements in high level radio frequency environments. The AT-51 measures harmonic distortion, intermodulation distortion, volts, dB, signal to noise ratio, wow and flutter, stereo phasing, and differential gain in stereo channels.

Model	Description	
AT-51	Complete system including AA-51 and AG-51.....	\$3575.00
IX-51	Optional balancing transformer (ea.).....	\$175.00

ALLIED PRICE \$ _____

ALLIED PRICE \$ _____

POTOMAC PRICES ABOVE ARE MFR'S SUGGESTED LIST PRICES. CALL FOR TODAY'S ALLIED PRICE.

DIGIMAX

The **Digimax Digital Frequency Counter** meets or exceeds all FCC requirements. D-1200

SPECIFICATIONS

- FREQUENCY RANGE:** 20 Hz - 1.0 GHz
- ACCURACY OVER TEMPERATURE:** 0.1 PPM (+55 to 85 degrees F) proportional 10 MHz oven
- READOUTS:** Full 9 digits
- SENSITIVITY:** 5 to 50 mV from 50 Hz to 25 MHz
15 to 50 mV from 25 MHz to 450 MHz
50 to 75 mV at 1 GHz
- ACCURACY:** ±.1 Hz at 1 MHz
±1 Hz at 10 MHz
±100 Hz at 1 GHz
- POWER REQUIREMENTS:** AC-12 required for 110VAC,
8-15VDC
at 500 ma.

Package includes AC adapter, rechargeable battery pack and antenna.

MANUFACTURER'S SUGGESTED LIST PRICE.....\$352.00

ALLIED PRICE \$ _____



The **Digimax LCD-1000** is a 1 GHz frequency counter with LED resolution and .0001% accuracy. It has VHF-UHF sensitivity. Comes with Ni-Cad battery and AC adapter.

MANUFACTURER'S SUGGESTED LIST PRICE.....\$189.00

ALLIED PRICE \$ _____

The **Digimax PA1300** is a 33 dB preamp sniffer with a frequency range of 10 MHz to 1.3 GHz. Comes with sniffer probe and AD adapter.

MANUFACTURER'S SUGGESTED LIST PRICE.....\$89.00

ALLIED PRICE \$ _____



TEKTRONIX

With the **2235** and **2236 Oscilloscopes**, Tektronix takes the high-value high-performance design concept of the 2200 Series even further. Both scopes feature a low price made possible by the 2200 Series' innovative, reduced-component architecture. (Yet both scopes offer advances in performance, operational simplicity and — not least — in solid reliability. All backed by the industry's first three-year warranty on all parts and labor, including the CRT.) The 2236 introduces a new concept in waveform measurement: a counter/timer/DMM, integrated into the scope's vertical, horizontal and trigger systems. Its capabilities simplify set-up, heighten measurement confidence and expand scope versatility in innumerable ways. The scope and DMM also can be applied simultaneously, with concurrent CRT and digital readout displays. DMM auto ranging simplifies set-up. An ohm-meter range of 2GΩ — a hundred times the range of most such devices — lets the technician quickly pinpoint even small amounts of transformer leakage. The 2235 ensures measurement quality and reliability while reducing instrument cost.

MANUFACTURER'S SUGGESTED LIST PRICE...2235.....\$1575.00

MANUFACTURER'S SUGGESTED LIST PRICE...2236.....\$2650.00

ALLIED PRICE \$ _____



2235

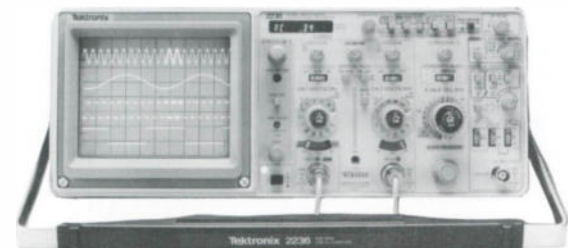

2236

TEKTRONIX

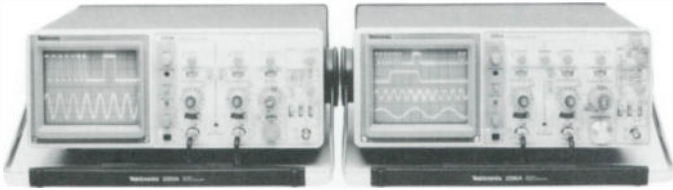

With the **2213A** and **2215A Oscilloscopes**, Tektronix continues a winning tradition: low cost value for performance that's best in its class. All backed by the industry's first 3-year warranty.

The new 60 MHz 2213A/2215A offer significant enhancements over the older 2213/2215. You'll see brighter, crisper displays, thanks to reduced trace noise and to an increased accelerating potential of 14 kV. A 10 MHz bandwidth limit switch has been added to the 2213A/2215A, allowing crisper traces and cleaner triggering in noisy environments. Both scopes feature full-size, 8 x 10 cm CRT's with camera bezel for easy viewing and photography.

The 2213A/2215A now offer improved trigger sensitivity to .3 div at 5 MHz (10 MHz for the 2235), for easy triggering and increased measurement confidence in everything from measuring power supplies to transistor noise. Using their single sweep trigger function, now standard on 2200 Series scopes, you can set up your scope to babysit signals, triggering only when a specified transient occurs. Single sweep trigger also provides an excellent way to set up your scope for photographing infrequent signals.

An improved delayed sweep allows you to make measurements with less jitter and more confidence: with a single time base in the 2213A; and with two time bases and alternate sweep switching in the 2215A.

2213A Oscilloscope....\$1275.00 • 2215A Oscilloscope....\$1525.00

TEKTRONIX PRICES ABOVE ARE MFR'S SUGGESTED LIST PRICES. CALL FOR TODAY'S ALLIED PRICE



Used together, the **AA 501 Distortion Analyzer** and **SG 505 Oscillator** provide the *automatic* solution to your distortion measurement needs. The AA 501 is so automatic that no level setting, tuning or nulling is necessary.

An optional package would be the SG 505 option 2 audio oscillator (balanced, +28 dBm, multi-impedance) and AA 501 option 1 distortion analyzer (level, THD, plus multi impedance) in the TM503 mainframe. Since the instruments are plug-in modules, a split-site station could mount the RTM 506 rackmount at the transmitter and either carry both instruments in the more portable TM 503 when testing individual items of equipment, or plug the analyzer into the rackmount and take the oscillator in the TM 503 to the studio for full system proofs.

The AA 501 and SG 505 combination permits harmonic distortion, intermodulation distortion, frequency response, gain/loss, and signal-to-noise measurements to be accomplished with minimal operator skill. At the same time, both instruments feature state-of-the-art performance in residual noise and distortion.

Total system harmonic distortion plus noise is .0025%. Oscillator distortion is .0008% (THD). Analyzer residual noise level is less than 3 microvolts. The AA 501 offers a novel analog-like "bar graph" plus complete digital readout, it reads true RMS or average response in all modes.

SG505 OSCILLATOR W/OPTION 2.....\$1590.00

AA501 DISTORTION ANALYZER....\$2525.00

ALLIED PRICE \$ _____

GOLD LINE

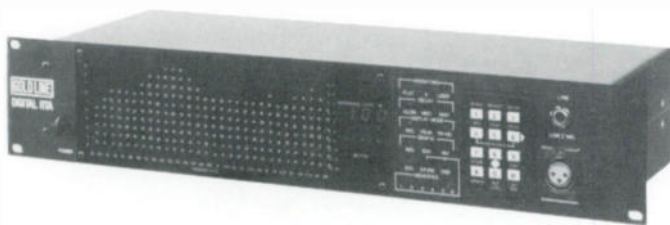

The **Gold Line Digital Model 30 Real Time Analyzer** uses microprocessor technology allowing extreme accuracy and stability and incorporates a pseudo randomly generated pink noise source. This stable display of equal energy across the entire audio spectrum makes equalization adjustments far easier.

MANUFACTURER'S SUGGESTED LIST PRICE.....\$2150.00

ALLIED PRICE \$ _____

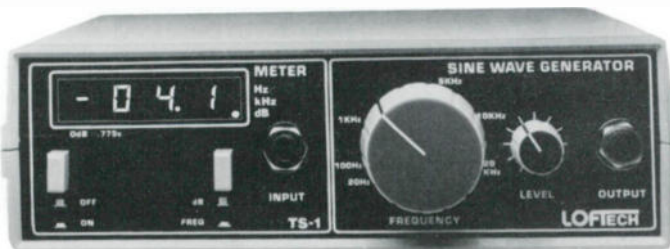

The **Gold Line TS-1** provides a combination of three precision test instruments. Capable of making audio frequency tests and measurements quickly with a high degree of accuracy. The TS-1 features a current controlled, state-variable oscillator. Distortion components are typically 0.1%. Full frequency sweeps can be made from 20 Hz to 20 kHz in a single range. The frequency counter is internally connected to the oscillator until a signal is plugged into the meter input. It then displays the frequency of the input signal. The TS-1 dB meter is a wideband, average responding AC voltmeter. The output of this meter circuit is electronically converted to decibels for display. A reference level for "0 dB" is factory set for 0.775 v which can be user adjusted ± 10 dB.

MANUFACTURER'S SUGGESTED LIST PRICE.....\$299.00

ALLIED PRICE \$ _____

STL

STL Test Tapes are recorded directly from precision generating equipment to provide the most accurate reference possible. An independent standards laboratory, STL provides a completely objective service, with test tapes available to major manufacturers, governments, and all who need a precision reference tool.

STL provides the following tapes:

REPRODUCE ALIGNMENT

Contains Azimuth tone, voice announced frequency run and level set tone.

PINK NOISE

20-20,000 Hz for phase alignment of multi-track systems, and response check with 1/3 octave filters.

SWEEP

Log 100ms, 700-15,000 Hz with adequate dead section between sweeps to facilitate scope synchronization.

FREQUENCY CHECK

Contains 2-second spot check tones. No voice.

AZIMUTH & LEVEL SET

Single tone

FLUTTER AND SPEED

A crystal controlled frequency source recorded at low flutter and accurate speed.

PRICES UPON APPLICATION STL TAPE SALES ARE FINAL



McCURDY

The **SA14023 Extended Range Audio Level Meter** is a self contained instrument designed for the measurement of peak and average audio system transmission levels in dBm. A two position range switch and precision attenuator allow the accommodation of audio input levels from -50 dBm to +30 dBm, in 2 dB steps, for a zero meter reading (sine wave).

PRICES UPON APPLICATION

The **PPM 903A Peak Program Meter** is designed for peak audio level measurement in a wide range of broadcast and professional applications. The PPM provides a much more accurate representation of the maximum audio level present than would a VU meter. Thus, allowing more precise control of levels and prevention of clipping and distortion. As standard, the PPM 903A is supplied with the McCurdy standard "C" scale, with an input level of +8 dBm giving a center scale reading. The British standard "B" scale and European standard "E" scales as well as several input levels are optionally available and must be specified when ordering.

PRICES UPON APPLICATION



DENON

This compact disc (**CD**) contains a large number of test signals and musical excerpts which can be used not only to thoroughly check the playback performance of a CD player but to evaluate other audio components such as amplifiers, tape decks, loudspeakers, etc. It can further be used to measure the acoustic properties of a listening room and to carry out comparative listening tests.

All tracks on the CD except for the musical excerpts and several signals were produced by a high-precision digital 16-bit signal processor controlled by a computer, and recorded in digital form on the compact disc. There were no intermediate analog steps involved.

DENON CD PRICE.....\$25.00



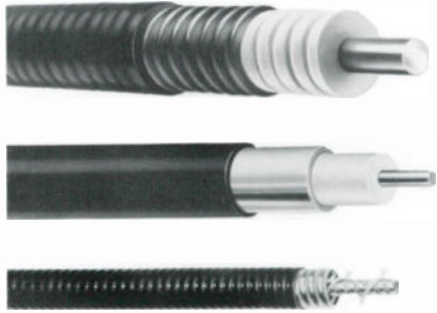

CABLEWAVE

Cablewave Systems Semi-flexible Coaxial Cables are used in electronics and communications systems operating from VLF through the microwave frequency bands. Since each basic cable construction offers specific advantages, the company manufactures both smooth wall aluminum and corrugated copper coaxial cables in foam and air dielectric. This allows the user engineer to consider technical and economic factors for each type, and select the best construction for his requirements. Cables are cut to length and connectors factory attached upon request. ALLIED CARRIES THE COMPLETE CABLEWAVE LINE, INCLUDING CONNECTORS.

PRICES UPON APPLICATION

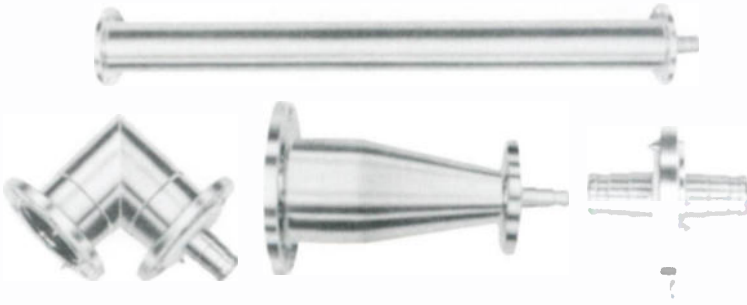

CELWAVE

Celwave Coaxial Transmission Line is fabricated from high conductivity hard-drawn copper tubing with precision machined, pin-type, Teflon dielectric insulators. The standard 50 ohm line is offered in sizes from 7/8" through 6 1/8". The EIA bolt type flanges and inner connectors are compatible with EIA standards, US MIL specifications, and international IEC recommendations. Aluminum outer conductor 50 ohm and copper 75 ohm lines are available on special order.

PRICES UPON APPLICATION



ALLIED

Prefabricated N to N cables cost less than your labor and materials. **Allied Jumper Cables** feature RG-213U coaxial cable, N-Male connectors with shrink-tube weatherproofing. Special lengths available on request. 7.8 dB loss per 100 feet at 900 MHz.

Model	Length	
213NN-2	2 ft.	\$10.00
213NN-12	12 ft.	\$13.85
213NN-15	15 ft.	\$14.39

OTHER LENGTHS UPON APPLICATION



COMARK

Comark Rigid Coaxial Transmission Line provides outstanding features such as constant impedance, high power capacity, and low insertion loss. Sizes to 8 3/16" Heliarc-welded flanges and wrist band bullet construction 3 1/8" and above.

PRICES UPON APPLICATION

ANDREW

For more than 40 years, **Andrew** has offered a comprehensive line of broadcast products. These include both foam and air dielectric HELIAX™ flexible coaxial cables, rigid line components, pressurization equipment and installation accessories. Detailed information on the Andrew line of products is available upon request. ALLIED CARRIES THE COMPLETE ANDREW LINE.

PRICES UPON APPLICATION



MCI

Micro Communications Incorporated offers a wide range of products and services for the broadcast industry. The MCI product line includes complete RF systems, rectangular and circular waveguide transmission line systems, VHF, UHF, LPTV, MDS and ITFS combiners, multi-channel TV and FM combiners, VHF, UHF, LPTV, FM, MDS and ITFS diplexers, filters, directional couplers, loads, hybrids and switching systems.

PRICES UPON APPLICATION

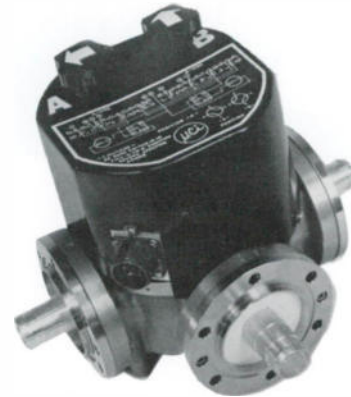

COMARK

Comark Patch Panels are available in all standard transmission line sizes in three, four, five and seven port standard configurations. The patch link construction allows the patch link to self align with the panel ports for ease of operation.

PRICES UPON APPLICATION

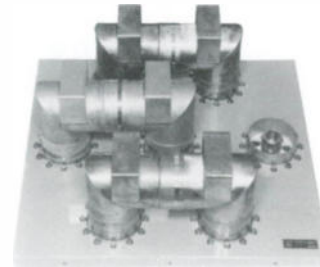

Low VSWR and low insertion loss combined with maximum isolation make **Comark Coaxial Switches** the ideal instrument for routing RF, especially in remote control applications. The positive action switching solenoid may be remotely controlled or overridden manually.

PRICES UPON APPLICATION



DELTA

The **Delta 6700 Series** of Coaxial Transfer Switches provides the engineer with the capability to switch between transmitters, antennas, or dummy loads with a minimum of off-the-air time. Both models can be operated by remote control or manually. Remote operation can be achieved using either 120V or 220/240V, 50/60 Hz. The transfer switch is fully interlocked with two isolated interlock circuits that duplicate the RF path exactly. The 6730/6732E is a 1-5/8 inch switch. The 6740B/6742B is a 3-1/8 inch switch and may be pressurized up to 16 lb./sq. in. A gas barrier is built into each terminal, and an air inlet port is also provided in the 6740B/6742B model.

PRICES UPON APPLICATION

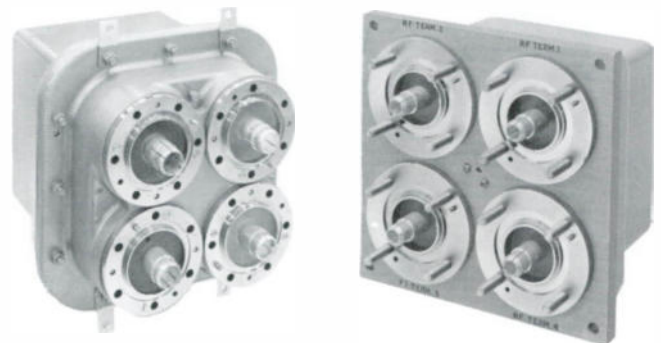

MOTOROLA



In the **MOTOROLA C-QUAM AM STEREO SYSTEM**, as in present AM broadcast standards, the angle modulated carrier is amplitude modulated with the sum of the audio information present in the program source. Thus to a monophonic receiver, the signal is no different from the signals being received under the present standards. This sum signal is comprised of two signals, left (L) and right (R). To provide stereophonic information, angle modulation results from straight forward quadrature modulation followed by limiting. That is, the monophonic (L + R) provides in-phase modulation while (L-R) provides quadrature phase modulation. The limiter assures constant level exciter drive to the transmitter. A separate signal, a 25 Hz pilot tone, is added to the quadrature difference (L-R) signal for indicating the presence of a received stereophonic broadcast. Existing AM broadcast transmitters may be used with relatively simple and inexpensive modifications.

1300 C-Quam AM Stereo Exciter & 1310 C-Quam AM Stereo Modulation Monitor.....\$11,700.00
Day/night 2 transmitter option board.....\$1000.00
CALL FOR THE ALLIED PRICE.

DELTA



C-QUAM AM STEREO Generator/Monitor. Price includes installation and day/night switch.

MANUFACTURER'S SUGGESTED LIST PRICE....\$11,700.00
CALL FOR THE ALLIED PRICE.

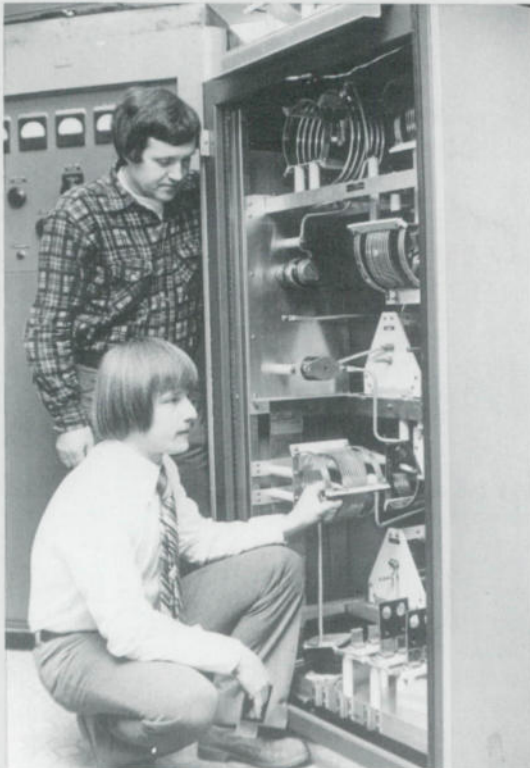

As a complement to the supply of broadcast equipment, we realize the need that exists for installation of this equipment. **ALLIED TURNKEY SERVICES** offers your operation the option of a complete supply and installation service.

Tailored to your needs, this installation service can include as much or as little as desired. Pre-assembly of certain components can be achieved at one central location, to be shipped to your selected destination for installation by your personnel. Or, we'll do it all.

We don't stop at audio. Complete radio station builds or re-builds are a part of our capabilities. Engineering experts in audio components, STL and remote control, and RF facilities will turn your plans and dreams into reality with full documentation.

The physical and on-air product image you're positioning for are our mutual goals. We're highly experienced at working with your people and your consultant.

Most of the equipment you need is within the pages of this catalog. We want to supply it . . . and we'll be happy to discuss its installation, too.



ELCOM BAUER

Elcom Bauer AM Features:

- 125% positive peak capability
- Stable high level plate modulation
- Three tube types
- Plug in solid state low level audio and RF driver stages
- Adaptable for AM stereo
- Oil-filled modulation transformer
- Two ovenless crystals (switchable)
- Unexcelled accessibility
- Remote ready-wire or STL
- Interface for standard telemetry control equipment
- Step start
- Three step overload
- FCC primary circuits metered and continuously monitored
- Secondary operating parameters with multimeter readout
- Front panel circuit breakers
- Fuses with fault indicators
- Tally light fault indicator with memory system
- Remote resettable fault indicator
- Automatic return to air after power failure
- Available medium wave, 250 watts to 50,000 watts
- Available high frequency, 500 watts to 15,000 watts

PRICES UPON APPLICATION

Elcom Bauer FM Features:

- Solid State direct FM phase lock loop exciter
- AFC status indication
- Grounded grid power amplifier
- No neutralization required
- VSWR protection
- Automatic power output control
- Remote ready-wire or STL
- Interface for standard telemetry control equipment
- ATS interface
- Built-in standby, many models
- Front panel circuit breaker
- Fuses with fault indicator
- Three tube types
- FCC primary circuits metered and continually monitored
- Secondary operating parameters with multimeter readout
- Solid state timing-diode logic and relays
- Tally light fault indicator with memory system
- Tuning controls with counter indicators
- Unexcelled accessibility
- Available 250 watts to 54,000 watts

PRICES UPON APPLICATION

AM TRANSMITTERS

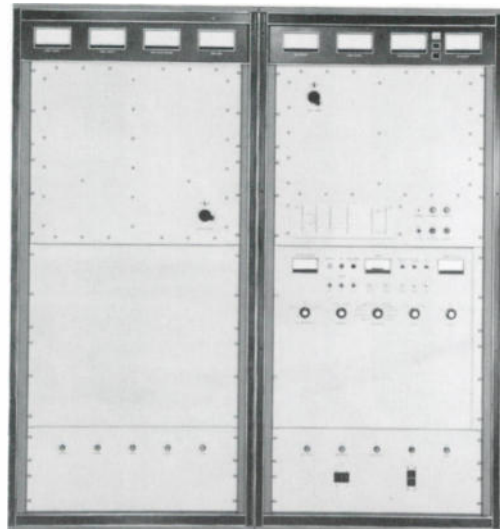

FM TRANSMITTERS

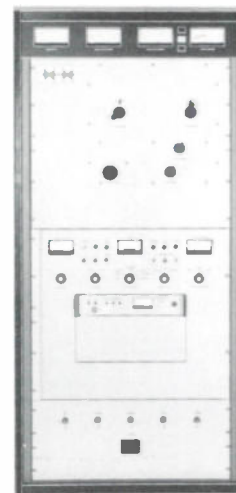

ELCOM BAUER

The **690PLL Exciter** from Elcom Bauer combines all of the high-performance, high-reliability features most wanted by FM broadcasters.

Frequency stability is excellent: ± 300 Hz, with ± 100 Hz typical. Noise and distortion levels are very low. 690PLL accepts signals from monaural programming, composite signal sources, and SCA generators. It is compatible with, and will enhance, any audio processing system.

Frequency modulation is direct, and incorporates phase-locked loop technology. Power supplies are controlled by integrated circuit voltage regulators.

Output frequency range is 88 MHz to 108 MHz, programmable in 100 KHz steps. RF power output is 1 to 15 watts, continuously variable.

CALL FOR TODAY'S ALLIED PRICE

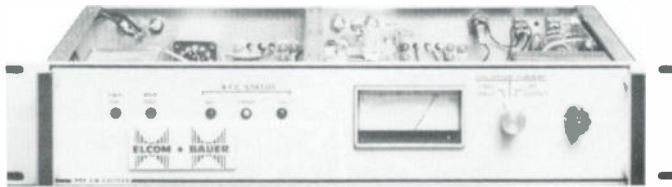

CSI

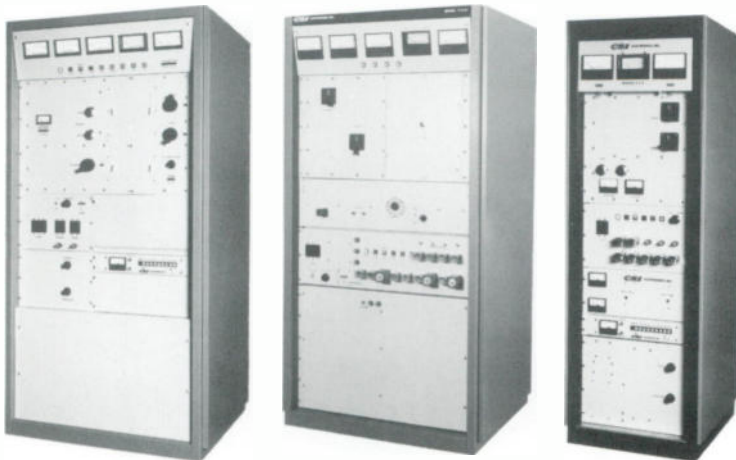

T-5-F

T-1-A1

T-1-F

CSI Transmitters feature excellent design, economy, and ease of maintenance. FM levels from 1,000 to 50,000 watts feature proven grounded grid circuitry.

AM transmitters are straightforward and dependable. Powers from .25 to 50 kw.

You'll find CSI transmitters efficient, dependable, and economically priced.

A complete selection of accessories will permit you to custom modify the CSI transmitter of your choice to your exact requirements.

CALL FOR TODAY'S ALLIED PRICE

KAHN

The **Kahn/Hazeltine patented AM Stereo System** brings the advantages of Stereo transmission to the AM broadcasting industry.

The AM Broadcaster may now transmit Stereo programs with any conventional AM transmitter. True STEREO reception can be achieved by the use of two standard AM receivers. This type of signal is completely compatible with all types of monophonic receivers and full mono coverage is guaranteed.

The Kahn/Hazeltine system causes your two sidebands to be independently modulated by the left and right stereo channels. The resulting wave has essentially the same spectrum occupancy as conventional AM and is theoretically free of envelope distortion.

PRICES UPON APPLICATION

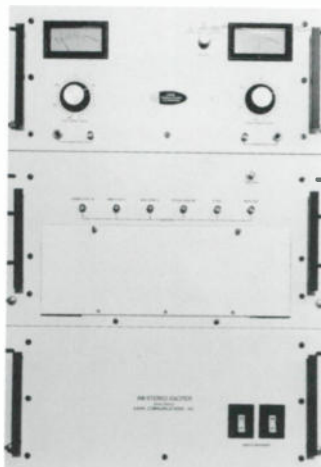

Do you have a copy of our RF catalog?

QEI

The **QEI 695 Series** is available at power levels of 1, 3.5, 20 and 30 KW.

Features:

- ALL SOLID-STATE
- SUPER LOW DISTORTION EXCITER
- OPERATIONAL IN ONE SECOND
- REMOTE CONTROL (STUDIO) UNIT IS INCLUDED
- "AUTOMOD" AUTOMATIC MODULATION CONTROL
- AUTOMATIC POWER CONTROL
- SOLID-STATE RELAY CONTROL LOGIC
- FACTORY COMPUTER FAULT ANALYSIS...BY TELEPHONE
- MICROPROCESSOR BASED DIAGNOSTICS
- FULL REMOTE CONTROL OPERATION
- LOW-PASS FILTER AND DIRECTIONAL COUPLER MOUNTED INSIDE THE CABINET

CALL FOR THE ALLIED PRICE



The **675T300** uses two conservatively rated power transistors in the output stage. A driver transistor is used to allow an Exciter of 20W output to drive the final stage to 300W. The unit is forced air cooled for maximum reliability. The power supply is current limited to prevent the output stage from drawing excessive current.

The 675T300 Amplifier is available separately. Power levels of 150 & 500 watts are also available.

CALL FOR THE ALLIED PRICE

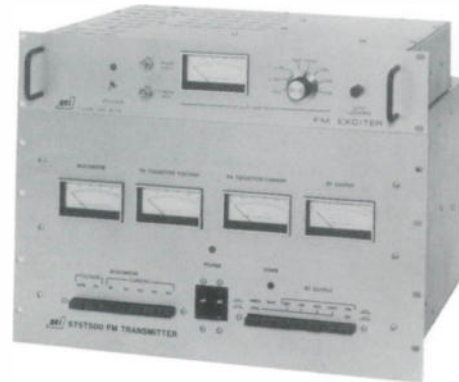

The **695** is QEI's new advanced technology FM exciter with more features and better performance than heretofore available. It is designed for unparalleled transparency in the transformation of program material to an FM signal. Noise and distortion of all kinds are reduced to a point where they become difficult to measure.

CALL FOR THE ALLIED PRICE



COAXIAL DYNAMICS

Coaxial Dynamics, Inc. is a leading manufacturer of economical precision equipment for the measurement and termination of RF power. Several models of Wattmeters and RF loads (dry, liquid, water cooled & heat exchanger types) are available for power ranges of 0.1 watt to 50,000 watts.

ALLIED CARRIES THE ENTIRE COAXIAL DYNAMICS LINE.

CALL FOR THE ALLIED PRICE





BIRD

The first of a new series of dry, forced air cooled high power Load Resistors, **Model 8572** is a well-matched termination for 50 ohm rigid line systems to 25,000 watts for testing and alignment of transmitters. The RF power is dissipated in a large number of rugged parallel/series connected resistor elements, which not only provide an extensive total surface for heat transfer, but assure that the Load is not rendered inoperative due to the unlikely failure of one or two of the elements.

As a dry Load, model 8572 is very nearly maintenance-free, and presents fewer problems, should servicing ever become necessary. The units are repairable in the field. A special option permits ducting hot air away from the Load, and out of your work environment.

PRICES UPON APPLICATION 15KW model now available

Model 8645

- Power rating 25 kW continuous duty up to 900 MHz
- Weight 155 lbs
- Distilled water or Ethylene Glycol
- 10 kW and 80 kW in this series plus 2½ to 7 kW dry loads and Econo wet loads up to 80 kW.

PRICES UPON APPLICATION



Bird Electronics known for accuracy for more than a quarter of a century, offers **Thru-line® RF Directional Watt Meters, RF Load Resistors**, up to 80 kW and **Watcher® Protection Systems**.

ALLIED CARRIES THE ENTIRE BIRD LINE

ELECTRO IMPULSE

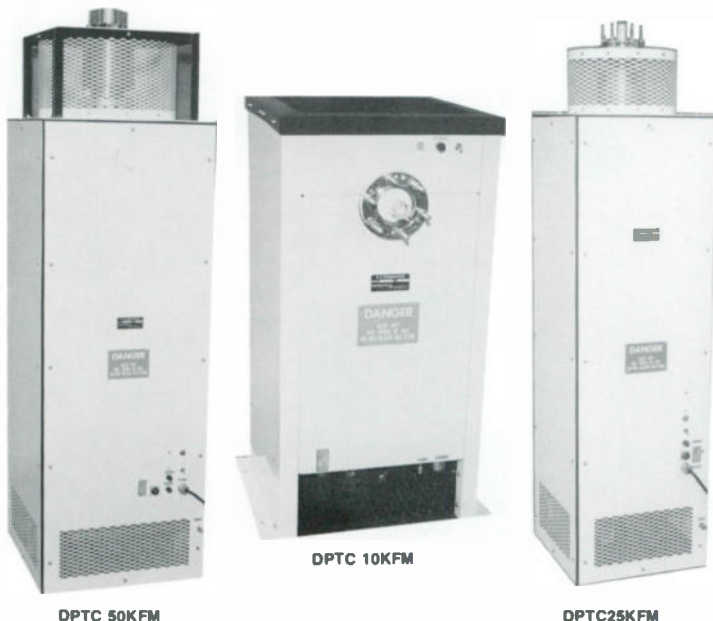

The **Electro Impulse product line** of loads includes many state-of-the-art designs. They pioneered the development of dry, forced air cooled loads for use up through FM frequencies, which are now extremely popular in the broadcast industry.

Their DACT series of loads was the first dry, convection cooled series with power ratings up to 25 kW average power. Both of these types of loads are very popular as the availability of water for load cooling decreases.

ELI offers RF coaxial loads with oil dielectric, twin line loads in a balanced input configuration, coaxial water loads, waveguide coaxial water loads, dry baluns, calorimeters, automatic test equipment, high power RF attenuators, RF power meters, in-line directional wattmeters and special cooling systems.

PRICES UPON APPLICATION

ELECTRONIC RESEARCH

ERI Isolation Transformers are designed to couple the FM power across the base insulator of a transmitting tower used jointly for AM or FM antennae without introducing objectionable mismatch into the FM feed line. An isolation transformer is highly desirable for feeding high impedance AM radiators or AM radiators which are part of an AM directional array which might be adversely affected by a "bazooka" isolation system. Captive bullets in and out. 10, 25, 40 & 50 KW sizes.

PRICES UPON APPLICATION



KINTRONICS

The use of **Kintronics FMC Series Isocouplers** at the base of an AM tower permit the installation of an FM antenna and connecting transmission line on the tower without requiring insulation and tuning of the transmission line. Since the shunting capacity of these units across the base insulator of the AM tower is less than 150 pF, the effect on the base input impedance of the tower will be negligible for most single radiators or directional elements. The transmission line may be fastened to the tower for its full length permitting the tower to operate with normal radiation characteristics. Many of these isocouplers are now in service at permanent installations having stereo operation and judged by the user to be of superior quality. 4 units available from 10 watts through 30 kilowatts. Kintronics also offers sampling and transmission coaxial cables, control circuit cables, copper wire and strap, common point bridge, antenna phase monitors, and remote control and phasing systems.

PRICES UPON APPLICATION



DURO-TEST

You need rugged, dependable, long-lasting, quick-to-see **bulbs** where there are tall traffic hazards. The best bulbs that money can buy are built by Duro-Test.

Model Description

DT/682	BEACON PS-40 620 watt, mogul base, clear, 125/130 VAC, 10,500 lumens, rated 4500-5500 hours.....\$30.12	ALLIED PRICE \$ _____
DT/684	BEACON-40 700 watt, mogul base, durex, clear 125/130 VAC, 11,200 lumens, rated 7500-8500 hours.....\$43.59	ALLIED PRICE \$ _____
DT/424	OBSTRUCTION A-21 116 watt, medium base, clear, 125/130 VAC, 1260 lumens, rated 7500-8500 hours.....\$4.32	ALLIED PRICE \$ _____

DURO-TEST PRICES ABOVE ARE MFR'S SUGGESTED LIST PRICES. CALL FOR TODAY'S ALLIED PRICE.



PI-ROD

- Solid rod, all-welded construction provides greatest strength with minimum surface exposure to wind and icing conditions. Slim Line design offers minimized air resistance.
- A complete line of standard (proven performance) models
- Computerized analysis of loading factors for structure conformity to meet and exceed customer specifications. Working with this data, licensed professional engineers review your specific requirements and determine the ultimate solution.
- Engineered concepts utilizing minimum space requirements. We design systems to meet critical space limitations, with 50% and small guy radii available.
- Minimized interference with reduced face width design improves transmission...another PI-ROD engineering innovation.

PRICES ON APPLICATION

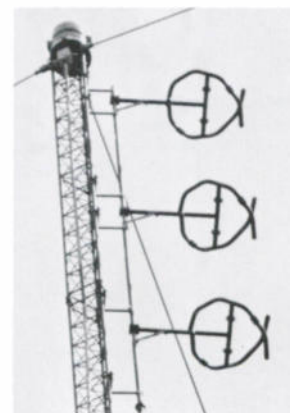



COMARK

The **Comark Series** of FM circularly polarized antennas utilize identical radiating elements for both the lower power and high power series. The low power utilizes 1 5/8" feedlines while the high power uses 3 1/8" feedline. Both series of antennas are available in systems that incorporate 1 to 14 elements. This series is basically a 1 1/2 turn helix separated one wavelength apart. The radiation centers of both the vertical and horizontal components are identical. De-icers are available. Comark educational antennas utilize the same basic design as the high and low power models. However, due to their low power requirements, the radiating elements are constructed from a single piece of 7/8" stainless steel tubing, complete with flexible coaxial inter-connect cables and mounting hardware.

PRICES UPON APPLICATION

CETEC



The **Cetec JSCP Series B FM** broadcast antennas offer rugged construction, low wind loading, excellent performance for stereo, SCA broadcasting, VSWR bandwidth, true circular polarization, and are available with from 1 to 16 bays with de-icers and radomes. The JBCP series is a circularly polarized FM antenna designed for applications requiring relative insensitivity to icing along with high antenna input power. The JBCP antenna will handle up to 40 kW per bay and up to 120 kW per system. The JBCP is available with from 1 to 8 bays. The JSCP series 2 gives the Class A station several good choices. Power rating is 3 kW per bay or maximum 7.5 kW above two bays. The JLLP series elements are cable fed from a central power divider. They are rated at 1 kW per bay and provided as a standard antenna.

PRICES UPON APPLICATION

CELWAVE

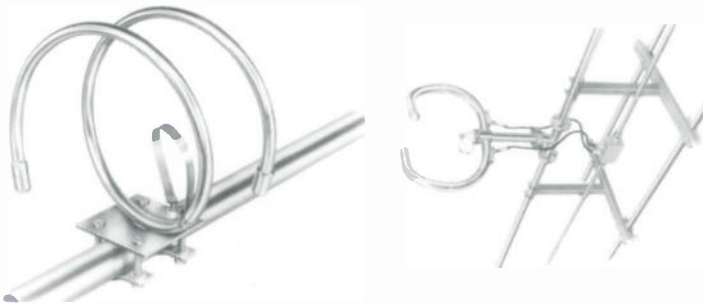

Celwave Circularly and **Horizontally Polarized Antennas** are available with any combination of null fill and beam tilt. The high power and low power antennas utilize identical radiating elements. The low power utilizes 1 5/8" feedline, the high power 3 1/8" feedline. Both series of antennas are available in systems which incorporate 1 to 16 elements. Educational FM antennas differ from the commercial versions in that they are fabricated of 7/8" stainless steel tube, and fed with flexible solid dielectric cables.

PRICES UPON APPLICATION

YAGI

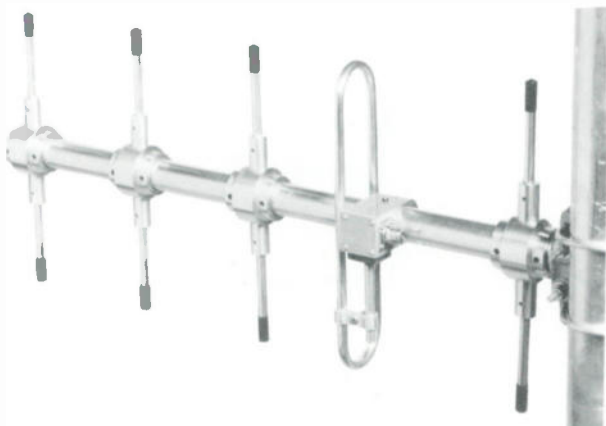

The **MOBILE MARK YA 450 YAGI Series Antennas** have been designed for maximum reliability, long life and optimum performance. The feed system utilizes a completely grounded element, and a gamma feed system. All materials used are irradiated aluminum with stainless steel hardware. Termination is a type N female connector facing to the rear. The mounting assembly allows the antenna to be vertically or horizontally polarized at the time of installation.

MODELS AND ARRAYS

- **YA 450** Single YAGI, H or V polarized, 10 dB gain.....\$180
- **2YA 450H** Two antenna array, H polarized, vertically stacked 12.5 dB gain includes phasing harness.....\$433
- **2YA 450V** Two antenna array, V polarized, horizontally stacked, 12.5 dB gain includes crossarm, hardware, and precision phasing harness.....\$433
- **4YA 450** Four antenna array, H or V polarized, quad stack, 15 dB gain, includes quad mounting frame and precision phasing harness.....\$1022

ABOVE PRICES ARE MFR'S SUGGESTED LIST PRICES. CALL FOR THE ALLIED PRICE.

NAD

The **NAD 4300** Monitor Series tuner establishes new standards for FM tuner performance. It is the world's first tuner with built-in decoding for FMX™ extended-range stereo broadcasts. It exemplifies today's most advanced audio technology. Even without FMX the 4300 stands among the world's finest "super-tuners" with regard to sensitivity and immunity to interference. Very few tuners at any price can equal the 4300's ability to pull in weak FM signals and recover clean, quiet sound from them. State-of-the-art performance: 55dB stereo separation, 80dB selectivity, 120dB image rejection. The signal-to-noise ratio exceeds 80dB in strong signals, even without FMX.



CALL FOR TODAY'S ALLIED PRICE.

PROTON

To achieve uncompromising fidelity with plenty of power, **the Radio** from **Proton** uses one 20-watt amplifier to power the 4½ inch woofer, and a second 5-watt amp drives the efficient 1¾ inch dome tweeter. Since each amplifier functions best within its own portion of the frequency spectrum, the radio's 25-watts is equivalent to over 40 watts from a conventional amplifier. The Schotz variable bandwidth PLL detects or gives a revolutionary and dramatic effect on reception. Optional rack mount available.



MANUFACTURER'S SUGGESTED LIST PRICE.....\$280.00

ALLIED PRICE \$ _____

POTOMAC

The **SMR-11** is an AM broadcast band receiver of superior performance with many capabilities useful to the broadcaster. Receiver tuning is continuous from 530 to 1700 kHz, and can be locked with crystal accuracy at any desired frequency. The antenna can be a remotely located tunable ferrite rod unit (ANT-11), broadband wire or a whip. Bandwidth is determined by two switch-selected 455 kHz ceramic filters with bandwidths of 28 kHz and 12 kHz. Other special filters are available and can be installed.



Model Description
SMR-11R Rack mount version.....\$1575.00
ALLIED PRICE \$ _____

SMR-11D Desk mount version.....\$1675.00
ALLIED PRICE \$ _____

ANT-11 Remote, tunable ferrite rod antenna with internal, low noise preamplifier.....\$500.00
ALLIED PRICE \$ _____

C/Quam demodulator also available.

POTOMAC PRICES ABOVE ARE MFR'S SUGGESTED LIST PRICES. CALL FOR TODAY'S ALLIED PRICE.



CROWN

The **Crown FM Three** uses a true digital detector section tuner which cannot go out of alignment, drift with age, or add mis-tuning distortion; thus providing outstanding performance in the AM and FM bands. It also incorporates a new Dual-Quartz system for improved signal-to-noise ratio, a toroidal transformer for reduced hum and noise, a "scan level" control for tuner strength prior to scan stop and lock. Also includes six each AM and FM presets, a multipath indicator and a calibrated signal-strength indicator.



MFR'S SUGGESTED LIST PRICE (less cabinet).....\$795.00

ALLIED PRICE \$ _____

KEITH MONKS



The **MK II Professional Record Cleaning Machine** is a tried and tested product which is used by broadcasting authorities and record libraries all over the world. It is only advisable to clean a record with the Keith Monks record cleaning machine every 15 — 20 playings. Records are cleaned using a mixture of 50% distilled water and 50% industrial methylated spirits which will remove grease, hardened sludge and loosen embedded grit. The drying process removes all traces of the cleaning liquid along with the foreign material leaving the record clean and dry. During the process, the turntable revolves at speed and the liquid solvent is applied by swinging the brush over the record and depressing the applicator plunger. Having thus wetted the record, dissolved the grease and loosened any embedded material, the suction arm is simply moved to the center of the record. As the liquid on the record is moving to the edge, it is advisable to vacuum from the center outwards rather than inwards. As it passes over the surface the suction removes all liquid along with the suspended foreign matter. The whole process can be completed in about 1½ minutes per side of record.

SIZE: 16½"H x 19"W x 18"D; NET WEIGHT: 65 lbs
MFR'S SUGGESTED LIST PRICE.....\$1899.00



The **Studio Mark 3** double record cleaning machine is designed for the user with regular cleaning of quantities of records. The twin decks enable one record to be cleaned while the other is being dried. Records can be cleaned twice as quickly with the double machine. There are 2 applicators and cleaning brushes and the suction arm is switched to operate on either turntable. The arm reverse switch has 3 positions; the center is in the off position, the left side operates the left turntable while the right side operates the right turntable. Larger versions are made to special order.

SIZE: 14¼"H x 29¼"W x 18¾"D; NET WEIGHT: 96 lbs;
VOLTAGE: 115 volts A.C. 60 cycles
MFR'S SUGGESTED LIST PRICE.....\$2579.00

DISCWASHER



DISCWASHER manufactures fine products for record care in broadcast facilities.

- Cleaning system.....\$16.50
- Disckit.....\$55.00
- ZeroStat Destaticizer.....\$23.00
- Fluid
 - 16 oz.....\$17.00
 - 6 oz.....\$10.00
 - 1.25 oz.....\$2.50
- CD Cleaner.....\$19.95

TECHNICS



The **TECHNICS SP-15 turntable** features:

- Quartz Synthesizer Pitch Control in 0.1% steps up to ±9.9% at all three standard speeds-with digital display
- Instant starts (0.4 sec.) (About 1/3 revolution)
- Three precision speeds, 33 1/3, 45 and 78.26 rpm make this unit perfect for all phono reproduction applications.

MANUFACTURER'S SUGGESTED LIST PRICE.....\$750.00

ALLIED PRICE \$ _____

TECHNICS

The **SP-25** offers you a high professional standard of excellence, plus the kind of flexibility and convenience that is important for any use. Features include total quartz-locked pitch control within $\pm 6\%$ range from rated speeds, extremely high torque for fast starts and load stability.

- 45 and 33 rpm
- about $\frac{1}{2}$ revolution to full speed

MANUFACTURER'S SUGGESTED LIST PRICE.....\$425.00

ALLIED PRICE \$ _____



The first with instant torque and no rumble is the **SP10-MKII** by TECHNICS. The world's best and most desired professional turntable. Used by most top U.S. Radio Stations.

MANUFACTURER'S SUGGESTED LIST PRICE.....\$1150.00

ALLIED PRICE \$ _____



The **SP-10 MK III** is the most advanced quartz synthesizer DD turntable from Technics, the acknowledged hi-fi turntable leader. Both specifications and sound quality reveal that the SP-10 MK III extends the frontiers of excellence. For example, starting torque is 16 kg/cm and only one quarter of a second is required to reach rated speed.

MANUFACTURER'S SUGGESTED LIST PRICE.....\$1850.00

ALLIED PRICE \$ _____

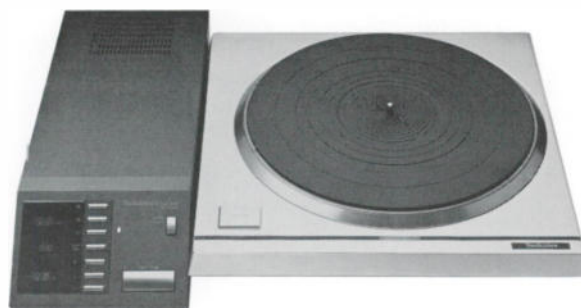

The **SL-1200MK2** incorporates numerous improvements. In addition to being quartz-locked direct drive, it permits continuous speed adjustment under quartz control (within a range of $\pm 8\%$). Its starting torque is a high 1.5 kg cm (1.3 lb in), with the platter reaching rated speed within 0.7 second from standstill. It also maintains a tight lock on the selected speed. The SL-1200MK2 should also be virtually feedback-proof because of its special base design. The platter itself is damped on both sides to avoid ringing.

CALL FOR THE ALLIED PRICE



RUSSCO

STUDIO PRO

- Unit is powered by a heavy duty Bodine synchronous motor
- 2 speeds - 45 and 33 rpm

MANUFACTURER'S SUGGESTED LIST PRICE.....\$479.00

ALLIED PRICE \$ _____





RUSSCO

CUE MASTER

- The unit is powered by a heavy duty Bodine synchronous motor.

MANUFACTURER'S SUGGESTED LIST PRICE.....\$425.00

ALLIED PRICE \$ _____

The **Russco Mark V** offers precision variable $\pm 10\%$ at 33 or 45 rpm. The Mark V is instant starting, less than one inch back cue required at 45 rpm. There's more good news...remote start and stop and digital speed readout.

This dandy RUSSCO RUGGED low profile turntable also features an attractive antique silver no mar finish that makes the studio deluxe.

MANUFACTURER'S SUGGESTED LIST PRICE.....\$756.00

ALLIED PRICE \$ _____



The **Russco RTQ-7** direct drive turntable is equipped with a unique magnetic induction braking system which disengages automatically after bringing the platter to a stop. Speed controls use quartz synthesized PLL techniques. All controls are on a slanting front panel within view of the operator.

FEATURES INCLUDE:

- Direct drive turntable
- Outer rotor AC motor, amplitude modulated with PLL servo circuit
- 3 pounds starting torque
- .1909 seconds start up time at 33 1/3 rpm, .2581 seconds at 45 rpm
- -70 dB (DIN 455398) rumble

MANUFACTURER'S SUGGESTED LIST PRICE.....\$850.00

ALLIED PRICE \$ _____



BROADCAST ELECTRONICS



The **QRK 12C** is a three speed, rugged, reliable turntable which can come up to speed in a fraction of a second, but can still operate free from rumble, wow and flutter.

Outer rim drive has been demonstrated as the best method for achieving "instant start" with a minimum of vibration effects. Center hub drive does not have the mechanical advantage of outer rim drive. ALLIED CARRIES THE ENTIRE BROADCAST ELECTRONICS LINE.

MANUFACTURER'S SUGGESTED LIST PRICE.....\$395.00

ALLIED PRICE \$ _____

HENRY



The **Universal Turntable Controller (UTC)** by HENRY is a remote control interface device that allows full remote control of popular direct-drive turntables, such as Technics SP10, SP15, SL1200MKII, and Russco RT-700. The UTC easily connects to the turntable with just three wires, and provides CMOS/contact closure compatible outputs for separate START and STOP switches plus RUN and STOP tally lamps. One UTC will control two turntables.

MANUFACTURER'S SUGGESTED LIST PRICE.....\$195.00

ALLIED PRICE \$ _____

EMT

The **EMT 938** is a complete turntable system intended for professional applications, consisting of a direct drive turntable, and especially developed shock/insulation mount, the EMT 929 high performance tone arm and built-in equalizer amplifiers for line level audio output. The direct driven turntable platter accelerates to operating speed in under 1/2 second, thus enabling the rapid starts so necessary for broadcast programming. Like all EMT turntables, the 938 audio output is muted during this quick startup to allow accurate cueing in the middle of program material. Fixed speeds of 33 1/3, 45 and 78 rpm are referenced to an internal quartz oscillator. Variable speed is available through an optional potentiometer, via rear panel connections. These connections also allow start/stop and remote stereo/mono output switching. Wow and flutter at 33 1/3, weighted per DIN 45507 is a maximum of ±0.075%. Rumble, weighted per DIN 45539 is a minimum of 70 dB. The EMT 938 motor drive circuitry and audio amplifiers are built into the turntable base and swivel out for easy servicing. Audio out is +4 dBm nominal into 200 ohms with a maximum output capability of +21 dBm. Model 948 is also available. Both models are available with a 47K ohm input for magnetic cartridges or low impedance version with active input transformer for moving coil cartridges.



- 938 7K ohm input.....\$2785.00 ALLIED PRICE \$ _____**
- 938 moving coil input...\$2770.00 ALLIED PRICE \$ _____**
- 948 47K ohm input.....\$4190.00 ALLIED PRICE \$ _____**
- 948 moving coil input...\$4160.00 ALLIED PRICE \$ _____**

EMT PRICES ABOVE ARE MFR'S SUGGESTED LIST PRICES. CALL FOR TODAY'S ALLIED PRICE.

ATI

P-1000-1 Dual/Stereo Transformer Outputs
 P-1000-2 Dual/Stereo Balanced Differential Outputs
OUTPUT CLIPPING LEVEL:
 +22dBm/600 ohms (P-1000-1); +26dBm/600 ohms (P-1000-2)
DISTORTION at +20 dBm output: .2%
SIGNAL TO NOISE RATIO Unweighted, ref. 10mVrms 1kHz
 input: 80dB, 20kHz bandwidth
FREQUENCY RESPONSE: RIAA Curve ±25dB, 30 to 20,000Hz
SIZE: 8 1/2"Wx1 3/4"Hx7"D, 2 1/2 lbs.
MOUNTING: Brackets supplied for internal turntable cabinet or desk top mounting. Single and dual rack mount kits available.



P-1000 SERIES PHONO AMPLIFIERS

- P1000-1 transformer outputs.....\$345.00 ALLIED PRICE \$ _____**
- P1000-2 balanced differential outputs.....\$345.00 ALLIED PRICE \$ _____**

- Input impedance: programmable 50 k to 100 k ohms, 50 to 400 pf in 50 pf steps
- Input level: 5 mV nominal for +4 dBm output, 250 mVRMS maximum at 1 kHz
- Noise: S/N 80 dB minimum unweighted, 90 dB "A" weighted, ref. 10 mVRMS at 1 kHz, 600 ohm input termination and 20 kHz measurement band
- Output level: +18 dBm into 600 ohm balanced or unbalanced loads. 10VRMS into high impedance loads
- Output impedance: 400 ohms balanced, 200 ohms single ended, split and RF bypassed.

- P100S +18 dBm active balanced stereo.....\$239.00 ALLIED PRICE \$ _____**

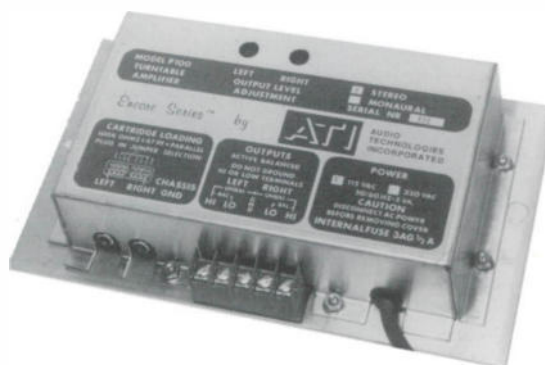

ENCORE PREAMP

AUDIOMETRICS



The **Audiometrics TP-84** is a proven, high quality stereo turntable preamplifier which will provide many years of dependable service because it meets the specification requirements demanded by broadcasters worldwide. The TP-84 follows the RIAA curve to within 1 dB in its entire bandwidth while maintaining a signal to noise level of 70 dBm. Distortion figures of .08% make the TP-84 transparent to your turntable cartridge. Rack mountable.

MANUFACTURER'S SUGGESTED LIST PRICE.....\$270.91

ALLIED PRICE \$ _____

RTS



The **Model 405** is a high-quality two-channel phono preamplifier designed for professional applications, including disc mastering rooms, broadcast stations and high quality commercial installations. It features adjustable cartridge termination, switchable rumble filter, two selectable sets of level controls and two output formats.

FREQUENCY RESPONSE: Re RIAA ± 0.5 dB
 SIGNAL/NOISE RATIO: -72 dB
 TOTAL HARMONIC DISTORTION: -90 dB/.003%
 MAXIMUM OUTPUT LEVEL, BALANCED: +24 dBm

MANUFACTURER'S SUGGESTED LIST PRICE.....\$437.00

ALLIED PRICE \$ _____

RUSSCO



Mono or stereo versions available with balanced or unbalanced output. The **FIDELITY-MASTER** series offers RIAA equalization. The **FIDELITY-PRO** units feature switchable high and low frequency filters. The balanced output models include highest quality transformers for true line isolation.

Model	Description
FPMU	mono unbalanced 600 ohm output.....\$172.00 ALLIED PRICE \$ _____
FPMB	mono balanced 600 ohm output.....\$205.00 ALLIED PRICE \$ _____
FPSU	stereo unbalanced 600 ohm output.....\$257.00 ALLIED PRICE \$ _____
FPSB	stereo balanced 600 ohm output.....\$309.00 ALLIED PRICE \$ _____

Consider these value-packed features of the **PHONO-MATE Pre-Amps:**

- Full solid-state circuitry
- Lots of headroom at +16 dBm
- RIAA equalization
- Mono or stereo versions are available with balanced or unbalanced output
- The balanced output models include highest quality transformers for true line isolation

Model	Description
1U	unbalanced mono 600 ohm output.....\$96.00 ALLIED PRICE \$ _____
1B	balanced mono 600 ohm output.....\$113.00 ALLIED PRICE \$ _____
2U	unbalanced stereo 600 ohm output.....\$148.00 ALLIED PRICE \$ _____
2B	balanced stereo 600 ohm output.....\$177.00 ALLIED PRICE \$ _____
PS	external power supply.....\$68.00 ALLIED PRICE \$ _____

RUSSCO PRICES ABOVE ARE MFR'S SUGGESTED LIST PRICES. CALL FOR TODAY'S ALLIED PRICE.

APT-HOLMAN

The **P-2 pre-amplifier** is a modest priced unit, combined with practical and simple controls. It contains current state-of-the-art circuitry technology plus features such as quiet moving coil, dedicated phono balance, "digital-ready" dynamic range, precise infrasonic filtering, stepped volume control, stereo image control & tone control, full-mute switch. RIAA equalization accuracy of ± 0.2 dB. Optional rack mounts are available.



MANUFACTURER'S SUGGESTED LIST PRICE.....\$450.00
ALLIED PRICE \$ _____

STANTON

The **Stanton Model 310B** professional phono preamplifier-equalizer was designed to correctly interface all Stanton and selected magnetic phonograph cartridges for optimum playback of disc records and calibration of audio systems. The Stanton 310B preamp features universal mounting by special brackets, instant selection of flat or NAB post-emphasis curves, switchable effective rumble filter, individual adjustment of gains and high frequency responses, trimming of the capacitive cartridge loading at the input, provision for setting the power transformer for either 117 or 230 VAC 50/60 Hz operation and immunity to external magnetic AC fields. ALLIED CARRIES THE ENTIRE STANTON LINE.



MANUFACTURER'S SUGGESTED LIST PRICE.....\$225.00
ALLIED PRICE \$ _____

STRAIGHT WIRE AUDIO

The **PH-2 Phono Preamps'** unique balanced front end operates without negative feedback. This virtually eliminates TIM. The balanced input stage eliminates hum and RF from phono inputs. It has variable cartridge loading and a fully buffered passive precision e.q. network. The output level is adjustable from a -5 dBm to a +12 dBm with an output clipping level of +22 dBm into 600 ohms or +28 dBm into a bridging input. A conductive plastic trimpot adjusts the gain of the output stage. The proper RIAA curve is rigidly maintained by 0.1% custom-made resistors and capacitors. The modular circuit board fits standard 15 pin double sided edge connectors. Optional housing required. Two required for stereo.

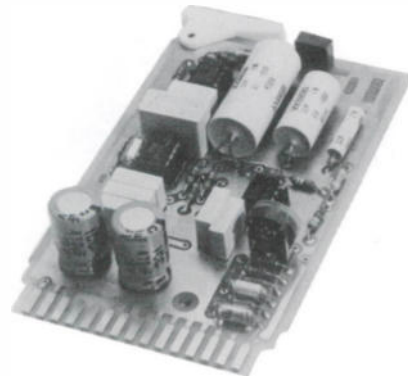

MANUFACTURER'S SUGGESTED LIST PRICE.....\$137.00
ALLIED PRICE \$ _____

The **UA-2** consists of two independent amplifiers on a single card, a balanced input and a balanced output stage. Each circuit card provides space and wiring accommodations for input pads and terminations, including a center tap pair of resistors that can be used for phantom power or true balanced to ground operation. The input stage has a balanced bridging input with 90 dB of common mode rejection and an unbalanced output which has a maximum output power of 250 mW into a 10 ohm load. The input stage also has differential summing points brought to the edge connector. The other half of the UA-2 card, the output stage, has a high impedance unbalanced input and a zero impedance summing point input available which can also be used as an external gain control. The outputs are differential drivers which can feed a 10 ohm load with 500 mW in the balanced bridged mode. There are eight 600 ohm outputs on the card which are source isolated from each other by 80 dB and are therefore essentially independent feeds. Each stage has an independent gain control adjustment available at the front end of the card. Optional housing required.

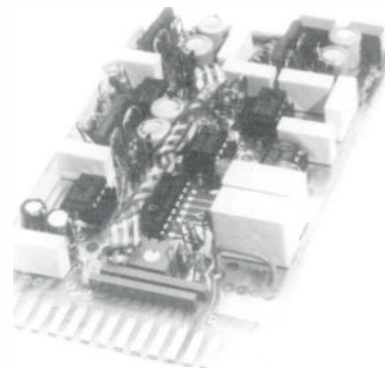

MANUFACTURER'S SUGGESTED LIST PRICE.....\$227.00
ALLIED PRICE \$ _____

PHOTO NOT AVAILABLE

STRAIGHT WIRE AUDIO

PH-UP is SWA's premium phono preamplifier. It is the finest commercially built phono preamp anywhere. The PH-UP has the industry's only fully discreet open loop precision matched FET front end, employing feed forward distortion cancelling techniques and DC servo offset management. A strappable high performance subsonic filter is included which effectively eliminates record warp problems. The filter is a 45dB or better Tee notch centered at 10Hz with an asymmetrical characteristic recovering to -30 at 3Hz and within 1dB at 30Hz.

PH-UP unit.....\$787.00
PH-UP amplifier card (single channel).....\$286.00

"ALLIED CARRIES THE ENTIRE SWA LINE"

AUDIO TECHNICA



ATP-12T

- Fits wide range of turntable heights and base thicknesses
- Sealed horizontal and vertical ball bearing pivots
- Accurate, built-in VTF gauge, no accessory gauge needed
- Low resistance, anti-corrosion, gold plated connector throughout

MANUFACTURER'S SUGGESTED LIST PRICE.....\$195.00

ALLIED PRICE \$ _____



The **AT-1010 tone arm** is a radically different approach to inherent problems of conventional tone arms. Emphasis was placed on tracking performance as opposed to bearing sensitivity and total tonearm mass. As a result, the arm is ideal for broadcast application, where it's important to keep the stylus in contact with the record without adding stylus pressure above manufacturer's recommended tracking force.

MANUFACTURER'S SUGGESTED LIST PRICE.....\$375.00

ALLIED PRICE \$ _____

AUDIOMETRICS



The stylish, practical and economical professional **S-220 Tonearm** has a light alloy arm, with low mass cartridge shell and precision ball bearing rotation. Also has adjustable lateral balance and weight adjustment for tracking force. Arm height is adjustable from 1 9/16" to 2 3/8" and removable cartridge shell uses standard 4 pin connector. Stylus pressure adjustable from 1 to 6 grams depending on cartridge. Tracking error is rated at +4°, -1°. Cable rated at 100 pF capacitance.

MANUFACTURER'S SUGGESTED LIST PRICE.....\$99.00

ALLIED PRICE \$ _____

BROADCAST ELECTRONICS



The **BROADCAST ELECTRONICS S-320** 12" tone arm is constructed of tubular aluminum with a die-cast cartridge shell, that accepts all standard stereo or mono cartridges. It has a vertical height adjustment and friction-free chrome steel ball vertical movement. It tracks at 1 gram or less and includes a counterweight. Connects with standard plugs.

MANUFACTURER'S SUGGESTED LIST PRICE.....\$150.00

ALLIED PRICE \$ _____

STANTON

The **500 MK II series** of cartridges comes in three variations, primarily differing in grams of tracking force. Its design is to deliver superb sound quality, ruggedness and reliability, yet not compromise professional broadcast standards.

Model	Description
500EE MKII	.75 to 1.5 grams, elliptical.....\$21.25
500E MKII	1 to 2 grams, elliptical.....\$18.38
500A MKII	1 to 2 grams, spherical.....\$15.75

CALL FOR THE ALLIED PRICE

In all broadcast usages, the **600A** is applicable to those situations that demand a spherical stylus tip, and a cartridge that tracks at 2 to 4 grams. It has been successfully employed by many hundreds of radio stations for on-the-air usage, and it performs with great excellence and dependability. It possesses outstanding frequency response, and channel separation easily surpasses the requirements of most broadcast standards.

MANUFACTURER'S SUGGESTED LIST PRICE.....\$24.20

ALLIED PRICE \$ _____

The **681A Cartridge** is indispensable for the recording engineer as a calibration standard for recording system checkout. Features extreme linearity plus widest and flattest possible response essential for precise alignment of cutting heads. Its factory calibrated frequency response meets the most rigid tolerances. Built-in longhair brush keeps dust away from stylus, protects record grooves and reduces noise, all without affecting stylus force.

MANUFACTURER'S SUGGESTED LIST PRICE.....\$55.00

ALLIED PRICE \$ _____



SHURE

The **SC35C** is designed for use on the heaviest and most rugged tone arms which require a tracking force of 4 to 5 grams. The stylus assembly of the SC35C is rigid enough to withstand the punishment of continuous backcueing, yet compliant enough to offer excellent mid and high frequency reproduction. The SS35C is the spherical replacement stylus for this cartridge.

MANUFACTURER'S SUGGESTED LIST PRICE.....\$45.00

ALLIED PRICE \$ _____

SC39 Series

Up to now, it was necessary to compromise true hi-fi performance to get the ruggedness required for professional use. To identify precisely the use and abuse to which professional phono cartridges were subjected in actual work situations, Shure engineers went into the field where they virtually "lived with" the professionals. They sat up with the all-night man in broadcast stations, worked in recording labs and shared the booth in "Discos."

- * Built to stand up to professional use
- * Designed to stand up to a professional's critical listening

SC39B	1.5 to 3 grams, spherical.....\$62.50
SC39EJ	1.5 to 3 grams, biradial.....\$70.00

CALL FOR THE ALLIED PRICE



SHURE

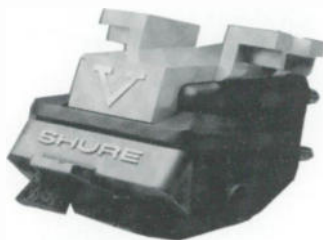

The **Shure V-15 Type V** cartridge comes in three styles, the MR (micro ridge) model, the 15B and 15P. The micro ridge version is radically different from the hyperelliptical tips (which generally reduce harmonic distortion dramatically), and geometrically is longer and more pointed, therefore running deeper in the LP groove. It's said to reduce harmonic distortion by another 50% over equivalent hyperelliptical styli in the line. There's a de-staticizer and damping mechanism which reduces low frequency resonance and susceptibility to warp in LP's. The "B" version is the same V-15 without the "MR" refinement. You might think of it as the original with the destaticizer brush. The "P" version is a P-mount V-15, for mounting on P-mount arms and does not include the destaticizer and damping mechanism.

Model	Description		
V15 V-B	Hyperelliptical.....	\$220.00	ALLIED PRICE \$ _____
V15 V-MR	Micro ridge.....	\$275.00	ALLIED PRICE \$ _____
V15 V-P	Hyperelliptical.....	\$205.00	ALLIED PRICE \$ _____

SHURE PRICES ABOVE ARE MFR'S SUGGESTED LIST PRICES. CALL FOR TODAY'S ALLIED PRICE.

"ALLIED CARRIES THE ENTIRE SHURE LINE"

— CD PLAYERS —

STUDER



Almost every conceivable feature has been realized in the **A725 CD PLAYER** by STUDER: professional programming capacity with 19 program steps, extremely short cueing times, calibration tone for adjustment of system levels, adjustable headphones output and two audio outputs. The "oversampling" technique, eliminates distortion of frequencies above half of the sampling rate without affecting phase relationship and guaranteeing highest sound resolution.

MANUFACTURER'S SUGGESTED LIST PRICE.....\$1835.00

ALLIED PRICE \$ _____

SONY



The **CDP-3000/CDs-3000** is a modular professional compact disc player system with unsurpassed quality music. It allows instant and programmed play with the extra convenience of controlling two CDP-3000 players. The control unit is independent of the player(s) — only a single cable is required for control interface. All controls and indications, except the eject button, are functionally arranged on the desk-top control unit. Its front loading design permits mounting of two units side by side in a standard 19" rack. It features 10-key direct access and bi-directional search, programmed play, flexible monitoring, digital time display, remote start/stop.

MANUFACTURER'S SUGGESTED LIST PRICE.....\$5400.00

ALLIED PRICE \$ _____

STRAIGHT WIRE AUDIO

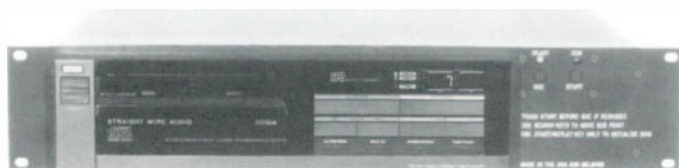

Straight Wire Audio's "**CDQue**" — a professional compact, disc player with a unique broadcaster-friendly one button cueing system. Dual D to A converters, phase perfect digital filtering, four times oversampling (176kHz sample rate). The high current balanced outputs can drive over 1000 ft. of twisted pair (enough to power speakers). Optoisolated remote controls and indicators. This deck features the renowned Phillips transport with Straight Wire Audio's uncompromised state-of-the-art electronics.

MANUFACTURER'S SUGGESTED LIST PRICE.....\$790.00

ALLIED PRICE \$ _____

SI-TEX

The new **CR-1011 Color Weather Radar** displays absolutely brilliant color pictures of weather intensity that conventional radars can't touch—frontal systems, severe weather and just plain rain or snow

The cathode ray tube presents weather in six different colors, based on intensity of return echoes. On a television type screen. With more brightness, crispness, definition and clarity than most color televisions.

There are eight selectable range scales, from 64 nautical miles out, down to a half-mile from your station. A unique plotting feature can establish the history of a weather system so station personnel can easily track direction and speed. And alert listeners accordingly.

An audible alarm warns of strong systems entering pre-established guard zones, which can be as far away as 64 nautical miles or any lesser distance desired.

Transceiver and antenna drive are both housed in the antenna assembly. Antenna operates in relative winds up to 80 knots.

A remote color monitor (CRM-1) is available to provide an additional radar screen for remote positioning up to 65 feet from primary CR-1011 radar.



MANUFACTURER'S SUGGESTED LIST PRICE.....\$6995.00

ALLIED PRICE \$ _____

GORMAN REDLICH

The **CRW** weather receiver is rack mounted, remotable with a black anodized rack panel. Demuting and remote alarm are initiated by a 1050 Hz "alert" tone. A relay closure is initiated by either the 1050 Hz tone or a 1650 Hz forecast update signal tone. The CRW features crystal and ceramic IF filters, plus a double tuned dual gate MOSFET RF stage.



MANUFACTURER'S SUGGESTED LIST PRICE.....\$475.00

ALLIED PRICE \$ _____

— MISCELLANEOUS —

ULTIMETER

The **ULTIMETER Model 20** has been greeted enthusiastically by a broad cross section of professional and recreational outdoorsmen, because it is three fine instruments in one:

A comprehensive electronic weather station for making accurate local weather forecasts; monitoring cold or wind conditions that could damage plants or crops; advising winter sports enthusiasts of wind-chill temperatures, etc.

A revolutionary electronic altimeter that is truly more valuable than a compass - and easy to use. It can add an interesting new dimension of pleasure to cross country driving to remotes.

A precise, quartz clock that includes a 4 year calendar and a stop watch that can time events up to 60 hours.

Battery operation, automatic scanning and alarm capabilities further enhance the instrument's exceptional versatility.

MANUFACTURER'S SUGGESTED LIST PRICE

Basic Ultimeter W/Temp Sensor.....\$300.00

ALLIED PRICE \$ _____

Complete system includes Ultimeter Model 20, Anemometer & Wind Vane, Rain Gauge.....\$489.00

ALLIED PRICE \$ _____





CATEL

The **FMX-2100** FM Modulator is a modular packaged frequency modulation cable transmitter designed specifically for CATV and CCTV applications. With direct audio sources such as AM/FM tuners, tape decks, microphone preamplifiers and short wave receivers. It can add varied FM signals to the cable system.

MANUFACTURER'S SUGGESTED LIST PRICE.....\$1015.00

ALLIED PRICE \$ _____

PHOTO NOT AVAILABLE

The **FMS-2000** FM Stereo Modulator is a complete stereo modulator in a compact 1.75 by 19 inch cabinet. The unit contains a power supply, stereo generator and frequency agile modulator.

It produces a L-R double sideband suppressed carrier signal, together with a L + R signal and a crystal controlled 19kHz pilot signal. The resulting output is a multiplexed signal, FM modulated in the 87-108mHz band. The FMS-2000 is completely agile, field tunable in steps of 100kHz.

MANUFACTURER'S SUGGESTED LIST PRICE.....\$995.00

ALLIED PRICE \$ _____

WEGENER

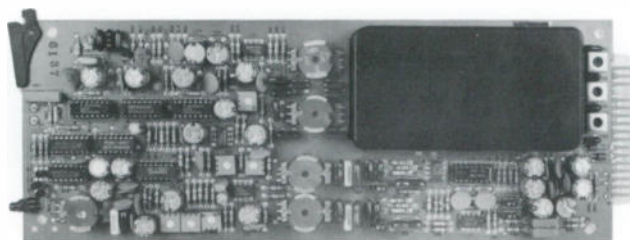

The **Model 1691 SW FM Modulator** is used to transmit FM stereo audio programming over cable systems. The Model 1691 SW contains a complete FM stereo generator capable of accepting left and right channel audio inputs and provides multiplex output at a crystal-controlled RF frequency between 88 and 108 mHz. Other frequencies are also available. An external audio input feature permits the insertion of locally generated audio programming during specified breaks in the network program or upon command from an external switch closure.

The Model 1691 SW FM Modulator plugs into Wegener Model 1601 or 1602 Mainframes.

MANUFACTURER'S SUGGESTED LIST PRICE.....\$700.00

ALLIED PRICE \$ _____

AUDISAR

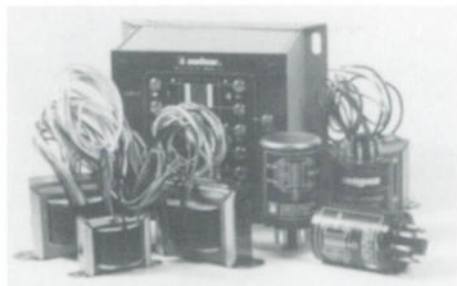

The **Audisar 9000 Series Audio Transformers** provide many unique problem solving solutions for the broadcast and industrial audio user. For example, the 9K-600-6 in many cases will directly replace an expensive distribution amplifier. Highest quality standards are maintained throughout the manufacturing process, with each unit individually hand made to insure reliability and consistency of performance. Every core assembly is varnish impregnated for protection from moisture and corrosion. Both open frame and shielded units are available.

Part Number	Type/Use	Frequency Response ₂	Max. Oper. Level ₃	Impedance, OHMS
9K-600-2	1:1 Isolation	17Hz ~ 50Hz ± 0.5dB	+ 24dBm	600:600Ω
9K-600-3	1:2 Isolation Splitting	17Hz ~ 50Hz ± 0.5dB	+ 24dBm	Z in:600x2
9K-600-6	1:5 Isolation Distribution	17Hz ~ 50Hz ± 0.5dB	+ 24dBm	IMP is configuration dependent. (Note 4)
9K-600-15KP ₁	Shielded Input, Line Level, Isolation	20Hz ~ 50Hz ± 0.25dB	+ 20dBm	600:15K(R _L = 27KΩ)
9K-600-2P ₁	1:1 Line Level Shielded Input	20Hz ~ 20Hz ± 0.4dB	+ 18dBm	600:600Ω

1. Denotes octal base, plug-in type

2. Measured at +10dBm except 9K-150X2-150P re 0 = 0.775Vrms

3 Measured @ 20Hz, except where noted

4 Insertion loss = 5dB all sec loaded 600Ω

ROBERT A. JONES

Tepeco manufactures for **Robert A. Jones** efficient, small one and ten watt rebroadcasting systems for reliable year-in and year-out service in the 88 to 108 mHz FM band. Their modern 100% solid-state design provides freedom of signal selectivity and overload problems. These FM translators use MOSFET front ends, dual gate mixing, superb IF filter networks, two independent AGC loops, five stages of limiting and positive muting action. RF output is regulated for signal variation and line voltage changes, monitored with built-in reflectometers, and protected in the event of serious load changes. The only FM translators which may be ordered with a provision for locally-originated program input for permitted announcements.

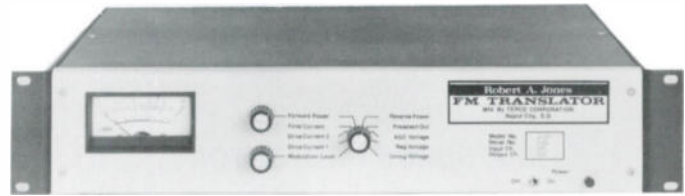

Model	Description	ALLIED PRICE \$
J-316	1 watt.....	\$2487.00
J-316M	1 watt/w local mod.	\$3025.00
J-317	10 watt....	\$2622.00
J-317M	10 watt/w local mod.	\$3159.00

PRICES ABOVE ARE MFR'S SUGGESTED LIST PRICES.

BENCHMARK

The need for balanced inputs on *all* audio equipment is not universally understood. The result is that many pieces of otherwise good audio equipment are unable to reject the *normal* power line related voltage differences found between chassis of equipment. These voltage differences add with the desired signal, and the result is always less than pleasant. The **DIA-1A** and **DIA-2A** retrofit into existing equipment and may be used with virtually any existing supply voltages up to ± 200 volts. These differential input amplifiers provide the optimum answer for balanced inputs in your equipment. The problems of space, mounting, wiring and A.C. requirements found with external balancing systems, are eliminated. The DIA-1B uses split (\pm) supplies, the DIA-2A uses a single (+) supply.

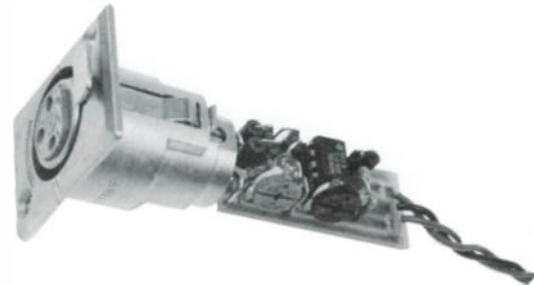

DIA-1B & DIA-2A

MANUFACTURER'S SUGGESTED LIST PRICE		ALLIED PRICE \$
1B	\$55.56	
2A	\$55.56	

Interfacing a Compact Disc player, FM tuner, audio or video cassette machine to the professional audio environment can be very frustrating. The **DOAs-1 & 2** provide the optimum answer to the need for a professional level interface, and at less than half the price of an external device. With variable gain from off to +26 dB and by mounting inside your equipment, they turn your gear "pro." External interface devices usually include input stages that may be superfluous. Their output stages are restricted to a fixed gain of 14 dB, which is often inadequate, particularly with CD players. With the DOAs-1 & 2, cabling, space, mounting and AC power problems are eliminated. The DOA-1A uses split power from $\pm 9V$ to $\pm 22V$ D.C. The DOA-2A uses a single (+) supply from +18V to +44V D.C.

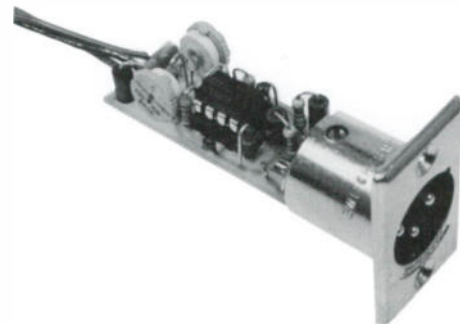

DOA-1A & DOA-2A

MANUFACTURER'S SUGGESTED LIST PRICE		ALLIED PRICE \$
1A	\$55.66	
2A	\$55.66	

ALLIED CARRIES ADDITIONAL BENCHMARK PRODUCTS

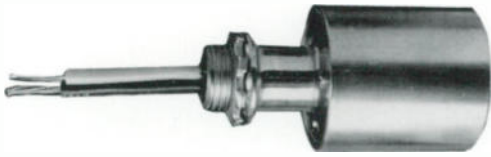

SPA SURGE PROTECTORS

DALE

- * Three basic models provide optimum protection for most secondary power installations: **SPA-100** for 120 volt AC circuits, **SPA-200** for 208-277 volt AC circuits and **SPA-400** for 480 volt AC circuits. Up to 50,000 AMP discharge rating.
- * Automatically resets - has multi-stroke protection capability.
- * Weatherproof housing for indoor or outdoor use.
- * Easy installations; Maintenance free; No power consumption.
- * Shunt capacitance (line to ground): 25 pf max. SPA-100 and 200; 50 pf max. SPA-400.
- * Insulation resistance: 10 megohms minimum.
- * Operating temperature range: -40 to +70 degrees C.
- * Leads: #12 AWG stranded leads, PVC insulation, 18" long. Black line for line (phase) connection, green lead for ground.
- * Mounting: 1. 1/2-14 NPSL nipple for fuse or junction box mounting.
2. L bracket for wall or pole mounting. Mount with two #8 screws spaced 1" apart.

PRICES UPON APPLICATION

SKIM MASTER



The **SKIM-MASTER** is the compact portable skimmer that allows you to easily monitor any radio station. Great for the PD or Music Director who wants to monitor the competition, or for the record company rep who wants to know for sure if a station is playing their music. With the SKIM-MASTER, a radio station can be monitored for up to 24 hours using just one 90 minute cassette. The SKIM-MASTER fits in the palm of your hand and weighs less than 2 pounds making it ideal for the consultant on the go or PD who must monitor client stations. The SKIM-MASTER gives you complete control of both the frequency (offtime) and record (ontime). You set the easy to adjust front-mounted controls for your desired setting. Offtime from 1 minute 20 seconds to 3 minutes 10 seconds, ontime from 4 seconds to 20 seconds. The SKIM-MASTER also features a record light to let you know when it's in the recording sequence. SKIM-MASTER works off any radio cassette deck with a remote plug in. The SKIM-MASTER is available with 1, 2, or 4 outputs so you can monitor up to 4 radio stations at once. A battery operated SKIM-MASTER is also available with one output.
Models from under \$80.00

ALTAIR

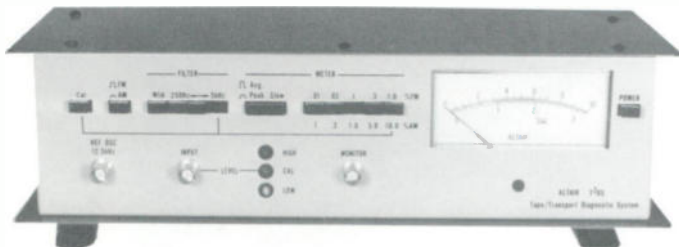

When a pure tone is recorded and reproduced, extraneous sideband frequency components are added to the original signal by transport and tape imperfections, producing a fuzziness or lack of clarity. The **T2DS** Tape/Transport Diagnostic System circuitry not only measures these sidebands, but it also identifies whether they are caused by speed changes or amplitude changes. By defecting "inphase" and "quadrature" sideband components independently in the frequency band from .5 Hz to 5000 Hz, the T2DS unit presents a more complete picture of recorder and tape composite performance.

MANUFACTURER'S SUGGESTED LIST PRICE.....\$895.00

ALLIED PRICE \$ _____

FOR A



The **SIRIUS-100** Digital Audio Memory gives an exciting digital future for audio processing in radio, TV & motion picture industries. The mainframe connected by coax to remote controlled playback & record/playback units (plus hard disc drives) allows instant random access for up to 1,000 minutes of high quality digital audio for production, editing, play list or air studio use.

CALL ALLIED TODAY FOR PRICE & SPEC DETAILS.

ASSOCIATE PRODUCER®

Allied's Associate Producer facilitates and centralizes your dubbing needs. The turntable mount is our famous shock absorber. (Page 47).

We invite you to select and customize components. The cartridge and tonearm of your choice; a Technics SP15, SP25, or SP10 turntable (Page 112, 113); a CD player of your choice (Page 120); a cassette deck (Page 78); an amplifier (Pages 1, 2, 3); speakers such as TOA, JBL, or ALC (Pages 87, 88,) and a pair of Omnimounts (Page 51) to mount the speakers to sides or top. You may choose an Audicord, BE, Key Cart, Otari, Fidelipac, or Tapecaster cart machine.



SPOOL TOOL

Great for mic, coax, and electrical cable. Spacers included will adapt, your **SPOOL TOOL SR**. Model 105 core from 1½" wide to 3" wide. Handles and all hardware are included. Easy to assemble. Made of high impact polyethylene plastic, SPOOL TOOL SR. is lightweight, easy to clean and never rusts. It can be hung, stored upright or on its side in any space that measures 16" by 5" to 7½" (including handles) depending on spacers used.

- Model 103 JR. (11½" Dia.).....\$10.95
- Model 105 SR. (15½" Dia.).....\$14.95

Extra spacer kits available for even larger capacities.



NEON SIGNS

Colors of neon available include: red, green, blue, yellow, pink. KIS principle applies. It is intended that we sell primarily the pictured models with appropriate call letters. Custom designs are available; contact Allied for price and availability. A switch on the back of the box makes the neon light move within the tubes or remain constantly on. The rate of movement is also adjustable by a separate rotary pot. 2 units alike, minimum order.

- A/LNEON 8"x 10" simple neon light in 3 colors
- A/LNEONL 8"x 20" or 10"x 16" large neon light in 3 colors.



PRICES ON DESIGN APPLICATION

RAZOR BLADES



SINGLE EDGE RAZOR BLADE
\$10.00 per 100

COTTON SWABS



WOOD STICK TYPE
\$18.00 per 1000

PROOF KIT



Everything you need to do a proof of performance report. Forms, graphs and information.

\$2.00 each

INDEX

- A -	
AC LINE CONDITIONERS.....	89
ACOUSTIC MATERIAL.....	58
ADC.....	55
ADVANCED MICRODYNAMICS.....	79
AKG.....	59, 62
ALC.....	87
A-LINE.....	43, 45-47, 50
ALLIED.....	26, 28, 44, 49, 53-56, 102, 104, 105, 125
ALLIED STUDIO PACKAGE.....	49
ALTAIR.....	124
AM RECEIVER/GENERATOR.....	72
AM STEREO.....	104, 106
AMPLIFIERS	
Buffer.....	15, 16, 123
Distribution.....	39-41
Microphone.....	2, 9
Monitor.....	1, 2, 3
RF.....	68
ANCHOR.....	89
ANDREW.....	103
ANIXTER-MARK (see Mark)	
ANTENNAS	
FM.....	110
Satellite.....	84
STL.....	92
ANTENNA MONITORS.....	68, 70, 71
APHEX.....	5
APT-HOLMAN.....	117
ARCHITECTURAL SERIES LIGHTS.....	56
ARRAKIS.....	31, 32, 42
ASSOCIATE PRODUCER.....	125
ASTROLITE.....	59
ATI.....	2, 115
ATLAS.....	58
ATS.....	71, 72, 79-81
AUDICORD.....	22-24
AUDIO-DIGITAL.....	15
AUDIOLAB.....	27
AUDIO METERING.....	70, 73, 83
AUDIOMETRICS.....	18, 40, 57, 116, 118
AUDIO-TECHNICA.....	118
AUDISAR.....	86, 122
AUDITRONICS	
Consoles.....	33,34
Distribution Amp.....	41
AURATONE.....	89
AUTOGRAM.....	32
AUTOMATION.....	16-18, 75, 76
AUTOMATION CD PLAYER.....	18, 83
- B -	
B & B SYSTEMS.....	73
B.E. (See Broadcast Electronics)	
B.G.W.....	1, 40
BASES, TURNTABLE.....	46-49
BAUER (See Elcom-Bauer)	
BEACONS, TOWER.....	109
BEEPER, TELEPHONE.....	98
BELAR.....	67-69
BELDEN.....	52
BENCHMARK.....	123
BEVCO.....	54
BIRD.....	108
BONNEVILLE.....	39
BRIDGING CLIPS.....	53
BROADCAST AUDIO.....	29, 30
BROADCAST ELECTRONICS.....	20-22, 27, 30, 114, 118
BUFFER AMPLIFIERS.....	15, 16, 123
- C -	
CABINETS, STORAGE.....	50
CABLE	
Audio.....	52
Coaxial.....	102, 103
CABLE MODULATORS.....	122
CABLEWAVE SYSTEMS.....	102

CAPITOL MAGNETICS.....	25
CARTRIDGE ACCESSORIES.....	26, 27, 43-45
CARTRIDGE MACHINES.....	19-24
CARTRIDGE RACKS.....	43-45
CARTRIDGE TAPES.....	25
CARTRIDGES, PHONO.....	119, 120
CASSETTES.....	26
CASSETTE DUPLICATORS.....	75
CASSETTE RECORDERS.....	78
CATEL.....	122
CELWAVE.....	102, 110
CETEC ANTENNA (See Jampro)	
CETEC/VEGA.....	66
CD CLEANER.....	112
CD PLAYERS.....	18, 83, 120
CD STORAGE.....	51
CD TEST DISC.....	101
CHAIR.....	54
CLEAR-COM.....	61
CLIPPERS.....	8
CLOCKS, TIMERS.....	28
COAXIAL DYNAMICS.....	107
COAXIAL SWITCHES.....	103
COMARK.....	102, 103, 110
COMPACT DISC CLEANER.....	112
COMPACT DISC PLAYERS.....	18, 83, 120
COMPACT DISC STORAGE.....	51
COMPACT TEST DISC.....	101
COMPELLOR.....	5
COMPRESSOR-LIMITER.....	4
COMREX.....	94, 95
COMTECH.....	84
CONEX.....	16, 42
CONSOLE DESK TABLE.....	50
CONSOLES.....	29-39
COPPER.....	44
CRL.....	6, 11, 86
CROWN.....	1, 65, 111
CSI.....	106
- D -	
DALE.....	124
DART SATELLITE RECEIVER.....	84
DAVTRONICS.....	68
DBX.....	7, 11, 12, 92
DE-ESSER.....	4, 7, 11
DELAY, BROADCAST, DIGITAL.....	14, 15
DELAY, TAPE.....	24
DELTA ELECTRONICS.....	71, 72, 80, 103, 104
DENON.....	101
DIGIMAX.....	99
DIGITAL AUDIO.....	11, 124
DIGITAL PROCESSOR.....	11, 92
DISHES, SATELLITE.....	84
DISTRIBUTION AMPLIFIERS.....	39-41
DOMINATOR.....	5
DUCT, WIRING.....	50
DUMMY LOADS.....	107, 108
DURO-TEST.....	109
DYNAFEX.....	11
DYNA-MITE.....	10
- E -	
EBS EQUIPMENT.....	69
ELCOM-BAUER.....	105, 106
ELECTRODUCT.....	50
ELECTRO-VOICE.....	36, 38, 63, 88
ELGIN.....	97, 98
EMT.....	5, 115
EQUALIZERS.....	12-14, 97
EQUIPMENT RACKS.....	45, 46
ERASERS.....	26, 27
ERI.....	109
ESE.....	28
EVENTIDE.....	10, 14
EXCITER, AURAL.....	5
EXCITER, RF.....	106-107

- F -	
FAIRCHILD.....	84
FIDELIPAC.....	25, 27, 45, 46
FIELD STRENGTH METERS.....	70
FLEXIBLOCK.....	54
FOR-A.....	124
FREQUENCY COUNTERS.....	99, 100
FREQUENCY EXTENDERS.....	94-96
FURNITURE.....	43-51, 125
- G -	
GAIN-BRAIN.....	9
GARNER.....	26
GATEX.....	4
GENERATORS.....	90
GENTNER.....	38, 41, 54, 55, 62, 79, 96, 97
GOLDLINE.....	100
GORMAN-REDLICH.....	68, 69, 70, 121
GRAPHIC EXPRESS.....	49
- H -	
HAFLER.....	3
HALLIKAINEN.....	81
HARMONIZER.....	10
HARRIS.....	
HEACO.....	40
HEADPHONES.....	59, 60
HEADPHONE AMPLIFIERS.....	60
HENRY ENGINEERING.....	15, 114
HELIAX.....	103
H.O.M.E.....	46
- I -	
IMAGESCOPE.....	73
IMPEDANCE BRIDGES.....	72
INOVONICS.....	70
INTERCOMS.....	61, 62
INTERFACES, AUDIO.....	15, 16, 123
ISOCOUPERS.....	109
ISOLATORS, TURNTABLE.....	46, 47
ITW.....	53
- J -	
JACKFIELDS.....	54, 55
JAMPRO.....	110
JBL.....	88
JUKEBOX, CD.....	83
JUMPERS, RF.....	102
- K -	
KAY PHASEMASTER.....	89
KEITH MONKS.....	112
KEPEX.....	9
KEY-CART.....	20
KINTEK.....	70
KINTRONICS.....	109
KLARK-TEKNIK.....	13
KOHLER.....	90
KOSS.....	59
- L -	
LABELS.....	26
LARUS.....	53, 54
LAST WORD.....	8
LAZY SUSAN CART RACKS.....	43-45
LIGHTNING ARRESTORS.....	124
LIMITERS.....	3-11
LISTEN LINE.....	88
LOFTECH (See Goldline)	
LPB.....	34, 35
LUXO.....	56
- M -	
M/A-COM.....	92
MARANTZ.....	78
MARK ANTENNA.....	92
MARTI	
Remote Pick-Up.....	81, 82
STL, TSL.....	81, 91, 92

INDEX

MATCHBOX..... 15
McCURDY..... 101
METERS, AUDIO..... 70, 73, 101
METERS, RF..... 107, 108
MIC BOOMS..... 56, 57
MIC PROCESSORS..... 9, 10
MIC STANDS..... 56-58
MICRODYNE..... 85
MICROPHONES..... 62-66
MICROPHONES, WIRELESS..... 66
MICROTEL..... 38
MIXERS..... 29-39
MOBILE MARK..... 110
MODULATION CONTROLLER..... 71, 72
MODULATION SCIENCES..... 8, 86
MODULUX..... 48
MONITORS, ANTENNA..... 68, 70, 71
MONITORS, AUDIO (See Speakers)
MONITORS, MODULATION..... 67-69
MONROE..... 85
MONSTER CABLE..... 52
MOSELEY..... 4, 79, 80, 86, 91
MOTOROLA..... 104

- N -

NAD..... 3, 111
NAKAMICHI..... CALL ALLIED
NATIONAL ELECTROLAB..... 68
NEON SIGNS..... 125
NEUMANN..... 64
NEWSROOM SWITCHER..... 42
NOISE GATE..... 4, 7, 9
NOISE REDUCTION..... 11, 12

- O -

OBSCENITY DELAY..... 14, 15
OMNIMOUNT..... 51
ON-AIR LIGHTS..... 55, 56
OPTIMOD
AM..... 3
FM..... 3
TV..... 4
ORBAN..... 3, 4, 8, 12, 13
OSCILLOSCOPES..... 99, 100
OTARI
Cart Machines..... 19
Duplicators..... 75
Reel-to-Reel..... 74, 75

- P -

PADS, ATTENUATOR..... 53, 54
PARAFLECTOR (See Scala)
PARAMEDICS..... 911
PATCH PANELS..... 54, 55
PEET BROS...... 121
PERSONS..... 18
PHASE CONVERTOR, AC..... 89
PHASE MONITORS..... 68, 70, 71
PHASEMASTER..... 89
PHASESCOPE..... 73
PHELPS-DODGE (See Celwave)
PHONO CARTRIDGES..... 109
PHONO PREAMPS..... 115-118
PIGTAILS..... 102
PI-ROD..... 109
PORTABLE STUDIO..... 49
POTOMAC INSTRUMENTS..... 70, 71, 80, 98, 111
PRESS CORPS..... 39
PROCESSORS..... 3-12, 97
PROOF OF PERFORMANCE..... 98, 100, 125
PRO PATCH..... 55
PRO-RAX..... 51
PROTON..... 111
PUNCH BLOCKS & ACCESSORIES..... 53, 54
PZM Microphones..... 65

- Q -

Q-TIPS..... 125
QEI..... 67, 107
QKT Coupler..... 97
QRK (See Broadcast Electronics)
QUANTUM AUDIO..... 33

- R -

RACKS, EQUIPMENT..... 45, 46
RADAR..... 121
RADIO BASE..... 47
RAMKO..... 41
RANE..... 13, 60
RAZOR BLADES..... 125
REAL-TIME ANALYZERS..... 100
RECORDERS (See Tape Recorders)
RECORD CLEANERS..... 112
RECORD STORAGE CABINETS..... 50
REMOTE CONTROL..... 79-81, 85
REMOTE PICKUP..... 81, 82
REPEAT COILS..... 97, 122
REVOX..... 77, 120
RF AMPLIFIERS..... 68
RF PATCH PANELS..... 103
RF RECEIVER/GENERATOR..... 72
RIGID LINE..... 102
ROLL-AROUND STANDS, RECORDER..... 51
ROUTING SWITCHERS..... 41, 42
RPU..... 81, 82
RTS..... 15, 61, 116
RUSLANG..... 51
RUSSCO..... 33, 39

- S -

SATELLITE EQUIPMENT..... 84, 85
SCA EQUIPMENT..... 86
SCALA..... 92
SCOTCH
Carts..... 25
Cassettes..... 26
ST Connectors..... 53
Reel Tape..... 75
SENNHEISER..... 33, 60, 64
SENSOR
Silence..... 16
Twenty-five Hertz (E.O.M.)..... 16, 18
SENTRY SYSTEMS..... 16
SHOCK ABSORBER..... 47
SHOCK ABSORBER, JR...... 46
SHURE BROTHERS..... 37, 65, 119, 120
SIDEKICK..... 86
SIEMON..... 53
SILENCE SENSOR..... 16
SIMPAC..... 45
SIMS..... 47
SITEX..... 121
SKIM-MASTER..... 124
SKIMMER..... 124
SMC..... 17
SONEX..... 58
SONY..... 65, 66, 120
SOUNDOLIER..... 46
SOUND TREATMENT..... 58
SPEAKER MOUNTS..... 51
SPEAKERS..... 86-89
SPOOL TOOL..... 125
SPORTSCASTER HEADPHONE/MICS..... 59, 60
STANDARD TAPE LABS (S.T.L.)..... 101
STANDBY GENERATOR..... 90
STANTON..... 117, 119
ST CONNECTORS..... 53
ST CRIMP TOOL..... 53
STEREO DEMODULATOR..... 4
STEREO GENERATORS..... 3
STEREO SYNTHESIZER..... 5, 8, 70
STRAIGHT WIRE AUDIO (SWA)..... 20, 117, 118, 120
STROBE WARNING LIGHT..... 55, 56

STUDIO PACKAGE SYSTEM..... 49
STUDIO TECHNOLOGIES..... 5
STUDIO-TRANSMITTER-LINK (S.T.L.)..... 91, 92
SURGE SUPPRESSORS (A.C.)..... 124
SWABS, LONG..... 125
SYMETRIX..... 95
SYNTHESIZER, STEREO..... 5, 8

- T -

TAPE
Calibration..... 101
Cartridges..... 25
Cart Winder..... 27
Cassette..... 26
Reel..... 75
TAPE RECORDERS..... 74-78
Cartridge..... 19-24
Cassette..... 78
Duplicators..... 75
Reel..... 74, 76, 77, 78
Winder..... 27
TAPECASTER..... 24, 27, 37
TAPE DELAY..... 24
TAPE STORAGE CABINETS..... 50
TASCAM..... 36, 76, 77, 78
TEAC (See Tascam)
TECHNICS..... 78, 112, 113
TEKTRONIX..... 99, 100
TELEMETRY RETURN LINK (T.S.L. or T.R.L.)..... 81, 91
TELEPHONE INTERFACES..... 93-98
TELEPHONE MIXERS..... 38, 39, 94
TELEPHONE SYSTEMS..... 93, 95
TELEX..... 60, 61, 66
TELFAX..... 38
TELLABS..... 40, 97
TELNOX..... 93
TEPCO..... 123
TERMINATION EQUIPMENT..... 53, 54
TEST CD..... 101
TEST EQUIPMENT..... 98-101, 107, 108, 124
TEST TAPES..... 101
TEXAR..... 5
TIMERS..... 28
TITUS..... 8, 56
TOA..... 36, 87
TOPAZ..... 89
TOWER LIGHTING (lamps)..... 109
TOWERS..... 109
TRANSFORMERS, AUDIO..... 97, 122
TRANSLATORS..... 123
TRANSMITTING EQUIPMENT..... 104-110
TRISTECH..... 16
TUNERS..... 111
TURNTABLE BASE..... 46-49
TURNTABLE CONTROLLERS..... 114
TURNTABLES..... 112-115

- U -

ULTRAPATCH..... 55
UNINTERRUPTIBLE POWER SUPPLY
(U.P.S.)..... 89, 92
UREI..... 2, 6, 14, 35
UTAH SCIENTIFIC..... 41

- V -

VALLEY PEOPLE..... 6, 8-10, 15
VEGA..... 66
VERSAPATCH..... 54

- W -

WARNING LIGHTS..... 55, 56
WEATHER RADAR..... 121
WEATHER RECEIVER..... 121
WEST PENN WIRE..... 52
WIRE..... 52
WIRELESS MICROPHONE..... 66

- Z -

ZERCOM..... 38



Terms and Conditions of Sale

BY TELEPHONE: The most convenient way to order from Allied is by telephone, confirmed with a written purchase order. When placing an order, call the Allied office that serves your area. (See inside back cover.) Allied provides toll free ordering service where possible - collect calls are not acceptable. Office hours are 8 AM to 5 PM local time per office. Written purchase orders, sent to confirm a telephone order, must be noted as **CONFIRMING**. Failure to do so could result in additional charges for freight and handling.

CREDIT TERMS: We will ship open account to firms *rated* high by Dun & Bradstreet Inc. If only listed and *not* rated by D & B, Allied will require 3 vendor references, plus 1 bank reference. Any credit accommodations must be arranged through the Allied credit department. Orders and requests for credit accommodations should be placed with your local Allied sales office listed on the inside back cover. If in the judgment of Allied, the financial condition or payment record of the Buyer at any time does not justify placement/shipment of an order on the payment terms requested, Allied may refuse to accept/ship unless advance payment is received. Otherwise, payment terms are cash with order or chargeable to Visa or Master Card with bank approval or net 30 days (when approved by Allied) or 50% cash with order and balance net 30 days or 50% cash with order and balance due prior to shipment or 25% cash with order and balance net 30 days (when approved by Allied) or 25% cash with order and balance due prior to shipment. There are times with significant monetary value orders (as determined by Allied) when an order must be accompanied by a Security Agreement. COD orders - when authorized by Allied, require payment by cash, certified check, cashier's check or bank money order - **ONLY!**

PARTIAL BILLING: Payment is due *Net/30* days firm on *each* invoice rendered. Due to time differential in shipment of various items, *each* invoice becomes due and payable within 30 days of the date of the invoice. If this is not possible, we will be glad to ship all equipment at one time with one invoice becoming due *Net/30* days firm. Please advise which method is desired. Government funded purchase orders *must* include a copy of the instrument of funding. **ALLIED ACCEPTS NO PENALTY CLAUSES!**

TRIALS & SALES ON APPROVAL: Trials and sales on approval require a firm purchase order or payment in advance or deposit at our option unless otherwise specified. Approval terms are applicable only if specified in advance on the order and accepted by our Sales and Credit Department. Goods must be returned within the specified time on the invoice or the sale is considered final. Normal trial period is 10 days. Charges will be assessed for any damage or loss.

LEASING: Allied offers several Leasing Plans thru various companies which arrange to suit your individual needs in standard six month increments, from 6 months to 60 months. The customer is responsible for all taxes, transportation and insurance charges unless arranged in advance with the Leasing company. Under a Lease agreement, the customer pays for the use of the product for the term of the agreement. It is *not* a month-to-month rental. . . . it is a non-cancelable, fixed term lease. At the expiration of the lease, there is the opportunity to update, or renew the existing lease, or to return the equipment to the leasing company. Customer may also exercise an option to purchase the equipment at any time during the term of the lease, provided thirty (30) day written notice of his intention is given. A *portion* of the installments will be credited toward the purchase price as negotiated with the leasing company.

USED EQUIPMENT: Used equipment offered and purchased "as-is, no-return," must be paid for in advance or sent COD. The customer will buy at his own risk. Allied may authorize returns on repaired used equipment within 10 days of delivery for which the customer will be credited full amount of purchase, less all shipping and packing charges.

BACK ORDERS: Items ordered that are temporarily out of stock or have to be drop shipped from the manufacturer, will be placed on back order.

TAXES: Allied shall invoice and you agree to pay all required taxes or other like charges required to be collected by Allied with regard to transactions between seller and purchaser with specific reference to state and local taxes imposed by law in the various States, Commonwealth and Protectorates of the United States. Firms operating under tax free conditions must state applicable license certificate or contract numbers and be prepared to furnish necessary certificates of proof. Allied *must* collect tax in TX, GA, IL, IN, CA and WA unless tax exempt documents are provided.

SHIPMENT: Your order will be shipped via UPS, if possible. Otherwise, equipment will be shipped via Parcel Post, Truck or Air Freight. If you require a special or particular form of shipment, please specify. Please be aware that there are insurance limitations on certain forms of shipments and that we may not be able to follow your exact shipping requests due to limitations on services available in various parts of the country and tariff restrictions. Allied will make every effort to ship your merchandise in a fast and inexpensive manner. Merchandise in stock will usually be shipped within 24 hours of receipt of order. If it is a drop shipment from the manufacturer, a request will be made via telephone to expedite shipment. Pickups are made several times a day from our facility to expedite service. Please allow extra time for

truck shipments and Parcel Post. Overnight shipments arranged (as requested).

GUARANTEE: All merchandise is covered by the manufacturer's warranty. Allied backs these warranties with personal interface between the problem and the factory solution. Many parts and replacement units are available from our stock or will be expedited from the manufacturer at Allied's option. Allied or the manufacturer will, at their option, repair defective parts or merchandise in warranty. The customer will be billed for the replacement or repair and full credit will be issued, less the freight, upon satisfactory return of the defective unit in the time period specified.

REPAIRS & WARRANTY SERVICE: Contact our Customer Service Dept. at 317-962-8596 for instructions on repair. Do not return goods without a **Return Authorization Number** and make sure proper documentation is enclosed stating the problem encountered. If you feel your problem can be solved by conversation with a technician, please ask our Customer Service Dept. to connect you with the Repair Dept.

CLAIMS & RETURNS: Inspect all shipments immediately upon receipt. Missing cartons or obvious damage to cartons, shipped by common carrier, should be noted on the delivery receipt. Concealed damage or loss should be reported at once to the carrier and an inspection requested. Losses or damage to Parcel Post shipments should be reported to our Customer Service Dept. All claims for shortage or damage must be made within two days after receipt of shipment. Claims for lost shipments must be made within 10 days of receipt of invoice or other notification of shipment. Save damaged or pilfered cartons until claim is settled. Do not return any goods to Allied without obtaining a **Return Authorization Number** and instructions from us. Goods returned unauthorized by collect freight will be refused. Returned items with scratches, dents, literature and parts missing, etc., subject to minimum 30% restocking charge. Goods returned which were ordered by customers in *error* are subject to a 20% restocking charge. Replacement goods shipped before defective goods are returned to Allied will be billed at time of shipment. Credit will be given at time of receipt of defective goods by Allied.

IMPORTANT - Under present rules and regulations by most carriers it is the end user's responsibility to inspect and report losses and damage. It is essential you follow correct procedure in applying for claims and most of all, do it promptly.

DELIVERY: Any delivery dates indicated are approximate and subject to availability of inventory and refer to the date on which the goods will be ready for dispatch from our warehouse and/or the manufacturer. The delivery time/date indicated is without obligation insofar as it may be delayed due to labor difficulties, fires, casualties, accidents, acts of the elements, acts of the public enemy, transportation difficulties, acts of the Government in its sovereign capacity; in the event of non-compliance with our terms of payment, or other causes beyond Allied control. Allied accepts no penalty clauses.

PRICES: Prices found in this catalog are understood to be domestic only and in U.S. dollars; they are the suggested manufacturers price, and are subject to change or correction without notice. As such, the prices serve as a basis for orders and are *not* offered as quotations. When definite quotations are necessary, please call, write or consult our sales representative at the nearest Allied office (reference inside back cover). All applicable local, State or Federal taxes of any nature must be added to quoted prices, unless previously defined as included. All prices are FOB place of shipment, exclusive of freight charges; therefore shipping charges to your destination will be added, unless otherwise stated.

PERSONAL SERVICE: Regardless of quantity, it's our Company policy to treat each order and inquiry as a person-to-person encounter. Your questions, comments and criticisms are welcome. Our staff is made up entirely of professionals willing to give you helpful assistance and work out possible problems to your full satisfaction.

CORPORATE REFERENCES & POLICIES: Allied Broadcast Equipment is an Indiana Corporation which has been in business since 1966. It is our sincere desire to give the broadcast and recording industry the best possible service anywhere. Please direct any comments concerning service and policy to . . . **President, Allied Broadcast Equipment, PO Box 1487, Richmond, Indiana, 47375 USA.**

NO INSTALLATION: Installation is not included. Certain items do not come factory-assembled and Allied makes no representation to the contrary.

NOTE: Prices are manufacturer suggested list and are for reference only. Discounts are available to qualified clients on many items. Freight and handling charges will be added to all shipments. Prices subject to change without notice. Typographical and clerical errors are subject to correction. Illustrations, drawings and descriptions contained in our catalogs, quotes, contracts and brochures, as well as indicated measurements and weights, are subject to changes without notice due to technical improvements or modifications. All terms and conditions defined in above paragraphs supersede and replace *all* previously printed catalog terms and conditions.

ALLIED

Broadcast Equipment

3712 National Road West • P.O. Box 1487 • Richmond, IN. 47375 • Phone (317) 962-8596

Following are conditions required by Allied as a prerequisite to our opening an account for your Company on a net 30 day basis:

- A. That your company will pay it's obligations to Allied Net 30 days firm on each and every invoice.
- B. That you will pay a finance charge of 1.5% on any unpaid balance which exceeds 30 days of invoice.
- C. That you understand any ordered product/equipment remains the property of Allied Broadcast Equipment until it is paid for in full.
- D. That, unless other arrangements are made on a sale-to-sale basis, you will pay all freight and any required deposits for all transactions.
- E. That manufacturer's warranties prevail and begin on the day the product/equipment is invoiced.

The authorized signature below constitutes your agreement to Allied's condition of sale on a Credit basis.

Signed

Title

Date

Please type or print

Both sides of this form must be completed and signed.

COMPANY CREDIT APPLICATION



3712 National Road West • P.O. Box 1487 • Richmond, IN. 47375 • PHONE (317) 962-8596

TO

DATE

Your cooperation in providing the following confidential information will help us to establish your new company account and better serve your future business needs. Thank you.

Firm name &/or Call letters _____

Parent company, owner's or partner's name _____

Address _____ Telephone _____

City _____ State _____ Zip _____

This location since _____ Type of Business _____

Incorporated? Yes No D & B Rated? Yes No

Please list trade references that are applicable to Electronics & Radio

Bank reference _____ Contact name: _____

Address _____ Account No. _____

City _____ State & Zip _____ Telephone () _____

Trade reference _____ Contact name _____

Address _____ Account No. _____

City _____ State & Zip _____ Telephone () _____

Trade reference _____ Contact name _____

Address _____ Account No. _____

City _____ State & Zip _____ Telephone () _____

This form must be signed front and back

I hereby grant permission to you to verify this information with these references.

Signed _____ Title _____ Date _____

The United States of ALLIED

**Order
Toll-Free**

**Please
Call
The
Number
For Your State**



**Customer
Service
and
Repair
317-962-8596**

RICHMOND, IN Sales Office

Serving: Connecticut
Delaware
Indiana
Kentucky
Maine
Maryland
Massachusetts
New Hampshire
New Jersey
New York
Ohio
Pennsylvania
Rhode Island
Vermont
Virginia
West Virginia

3712 National Road West
P.O. Box 1487
Richmond, IN 47375 USA

	INDIANA	
ORDERS	800-382-6907	
	ALL OTHER STATES	
ORDERS	800-428-6954	
INQUIRIES	317-962-8596	
FAX	317 962 8961	
Telex II	810 345 1394	
Telex I	380474	
W.U.EZ Link	621 267 20 +	
TTY DDD	317 935 7466	
INT'L	317-935-1704	

ATLANTA, GA Sales Office

Serving: Alabama
Florida
Georgia
Mississippi
North Carolina
South Carolina
Tennessee

Shannon Towers, 4405 Mall Blvd.
Suite 125, Union City, GA 30291

	GEORGIA	
ORDERS	800-282-0246	
	ALL OTHER STATES	
ORDERS	800-241-0192	
INQUIRIES	404-964-1464	
FAX	404 964 2820	

SEATTLE, WA Sales Office

Serving: Alaska
Arizona
Hawaii
Idaho
Montana
Nevada
Oregon
Utah
Washington
Wyoming

33430 13th Place South, Suite 120
Federal Way, WA 98003

	WASHINGTON	
ORDERS	800-562-8178	
	ALL OTHER STATES	
ORDERS	800-426-9781	
INQUIRIES	206-838-2705	
FAX	206 952 8567	

CHICAGO, IL Sales Office

Serving: Iowa
Illinois
Michigan
Minnesota
Missouri
Nebraska
North Dakota
South Dakota
Wisconsin

ALLIED
Broadcast Equipment

800-621-3726
(IL) 800-572-9138 (Local) 312-470-0303
5215 Old Orchard Rd., Suite 970, Skokie, IL 60077

INQUIRIES	812-781-8224
FAX	312 781-8224
	470-9017

LOS ANGELES, CA Sales Office

Serving: California

3808 Riverside Drive
Suite 303
Burbank, CA 91505

	CALIFORNIA	
ORDERS	800-523-8407	
	ALL OTHER STATES	
ORDERS	800-231-2304	
INQUIRIES	818-843-5052	
FAX	818 843 5145	

DALLAS, TX Sales Office

Serving: Arkansas
Colorado
Kansas
Louisiana
New Mexico
Oklahoma
Texas

Richardson Credit Union Bldg.
1101 East Plano Parkway, Suite B
Plano, TX 75074

	TEXAS	
ORDERS	800-442-4741	
	ALL OTHER STATES	
ORDERS	800-527-4392	
INQUIRIES	214-423-8667	
FAX	214 578 9162	

- Satellite Equipment Catalog Available
- Canada Catalog Available
- International Catalog Available
- Telecommunications Catalog Available

**CALL
TODAY**

ALLIED
Broadcast Equipment

ALLIED 
Broadcast Equipment

— **CORPORATE OFFICE** —
3712 National Road West
P.O. Box 1487
Richmond, IN 47375

800-622-0022