

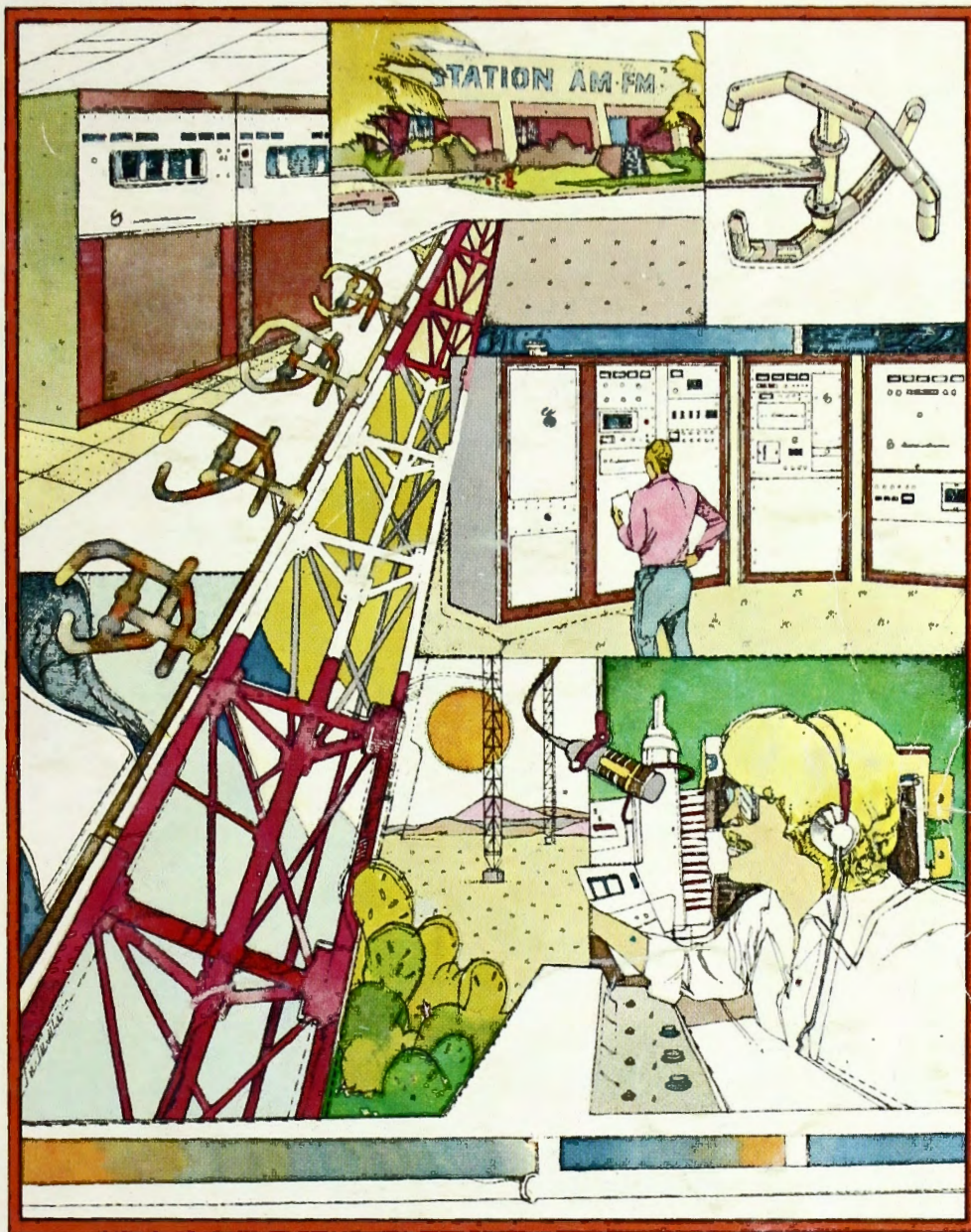

# RADIO BROADCAST EQUIPMENT



*Continental Electronics* 



### Introduction

Continental Electronics Mfg. Co. is an engineering-oriented company that specializes in the design, development and production of low, medium and high power radio frequency transmitters for radio broadcast, communications, radar and scientific research applications. The company was founded in 1946 with the express purpose of creating an extensive capability in rf product design.

Since its founding, Continental has established an unmatched record of achievement in the area of high power rf transmitters and amplifiers. Many of the Company's innovations have advanced the state-of-the-art; most of its work has been of a pioneering type and the kind of work normally associated with the leading edge of technology.

Continental's commitment to excellence is reflected in the workmanship and operational performance of numerous radio/electronic products which bridge the spectrum from ELF to UHF, ranging in power from kilowatts to megawatts.

Continental broadcast transmitters are used throughout the world by commercial and government radio stations for local, regional and international broadcasting.

In addition to high power and short wave transmitters, Continental offers broadcasters a complete line of AM and FM transmitters from 1,000 watts to 50,000 watts; combiners, diplexers, phasing, coupling and antenna systems and related rf equipment.

This catalog gives a brief product overview of the radio broadcast equipment available from Continental.

For performance data, specifications, pricing and delivery information, contact your local Continental sales representative.

All products and prices in this catalog are subject to change without notice; all products are subject to prior sale; no warranty or guarantee as to product availability or performance is given or implied.

# TABLE OF CONTENTS

---

Introduction .....	1
Table of contents .....	2
<b>Transmitters</b>	
<b>FM Transmitters</b>	
2.5 & 1.25 kW .....	6
10 kW .....	8
25 & 20 kW .....	10
50 & 40 kW .....	12
Automatic Exciter Control .....	12
Automatic Transmitter Combiner Control .....	12
Exciter .....	14
<b>AM Transmitters</b>	
1 kW .....	16
5 kW .....	18
10 kW .....	20
50 kW .....	22
<b>High-power broadcast transmitters</b>	
150 & 100 kW .....	24
250 kW .....	26
500 kW .....	28
1,000 kW .....	30
2,000 kW .....	32
<b>SW Transmitters</b>	
10 kW .....	34
50 kW .....	36
100 kW .....	38
250 kW .....	40
Transmitter Combiners .....	42
Transmitter Dummy Loads .....	44
<b>Antenna systems and accessories</b>	
AM & FM Towers .....	48
Antenna Phasing & Coupling .....	49
FM Antennas .....	53
Antenna Transmission Lines .....	66

# TABLE OF CONTENTS

---

Antenna System Accessories.....	68
<b>Audio Equipment</b>	
Consoles .....	72
Turntables .....	84
Turntable Pickup Arms .....	85
Turntable Pickup Cartridges .....	86
Turntable Preamplifiers.....	87
Turntable Cabinets .....	88
Cartridge Tape Systems.....	90
Reel-to-Reel Tape Systems.....	96
Microphones & Accessories .....	101
Studio Speakers .....	105
Headphones .....	106
Patchcords & Panels .....	107
Clocks & Warning Lights.....	108
Studio Furniture.....	109
<b>Audio Processing Equipment</b> .....	112
<b>Remote Pickup Equipment</b> .....	118
<b>STL Equipment</b> .....	122
<b>Transmitter Remote Control Equipment</b> .....	128
<b>Monitor &amp; Test Equipment</b> .....	138
<b>Engineering Data</b> .....	144
<b>Sales &amp; Service</b> .....	158



## 2.5 & 1 KW FM TRANSMITTERS

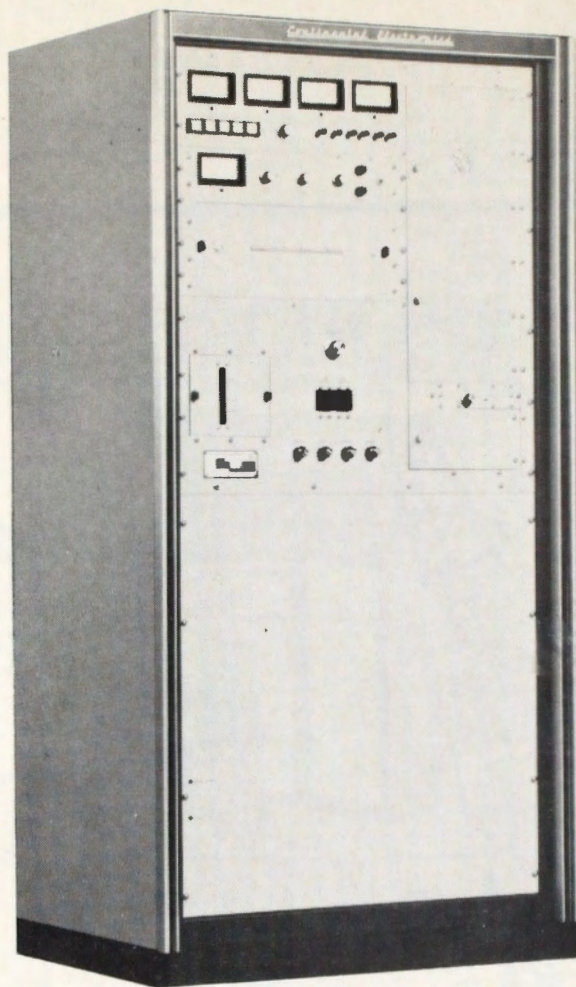

### **Type 814R-1 2,500 watt FM Transmitter**

Continental's 814R-1 is a high-performance, state-of-the-art FM transmitter that uses the 510R-1 exciter to deliver a crisp, clean signal to the antenna.

The 814R-1 offers broadcasters high stereo separation and low guaranteed intermodulation distortion.

The transmitter is solid-state except for the single 5CX1500A tube in the final amplifier. IC logic is used for all control functions; a memory circuit is used to restart the transmitter after a power failure. A built-in battery supply and charger enables the logic circuits to remember their state after a power interruption.

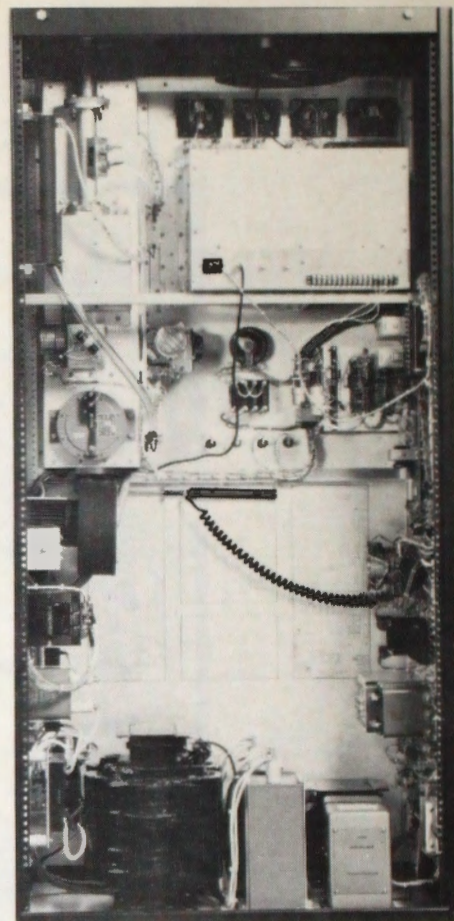

Overload conditions are indicated by an LED display.

The 814R-1 uses automatic filament voltage regulation and automatic power control for unattended operation, and has an automatic overload/recycle system.

Remote control equipment and the automatic overload/recycle system are standard equipment.

The 814R-1 is completely contained in one 35" (89 cm) cabinet.

### **Type 814R-2 1,250 watt FM Transmitter**

Continental's 814R-2 is identical in operation and specifications to the 814R-1, except for power supplies and output power.

## 2.5 & 1 KW FM TRANSMITTERS

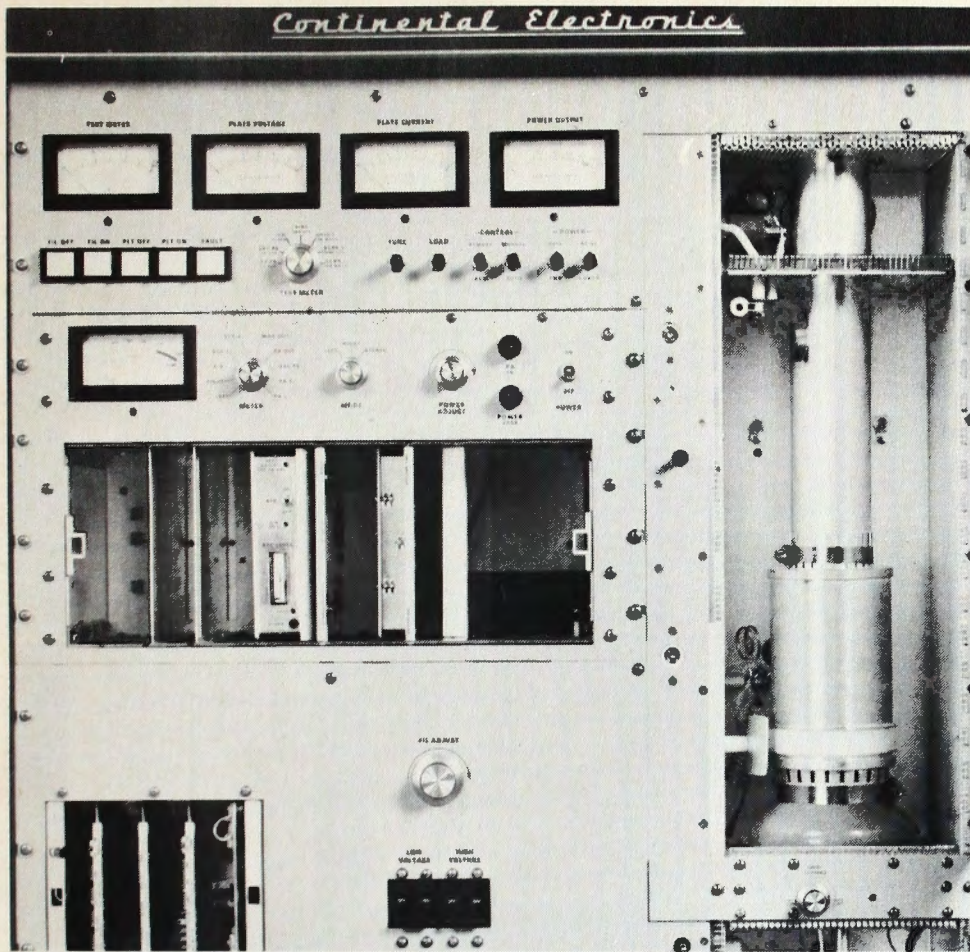

### Type 510R-1 FM exciter

Continental's 510R-1 is the industry's most popular FM exciter: more than 1200 have been sold to customers throughout the world.

The 510R-1 solid-state exciter is thoroughly field-proven and has an outstanding performance record. It produces a very clean signal: intermodulation distortion is guaranteed to be 0.5% in stereo and .25% in mono operation.

The 510R-1 uses a phase locked loop AFC to provide typical frequency stability of  $\pm 100$  Hz at any level of modulation, regardless of program input. Front panel metering includes a peak reading meter for measuring audio level. Plug-in modules facilitate servicing.

The exciter accepts a composite baseband input which is compatible with STL inputs.

Output frequency is crystal-controlled for exceptional stability. Output power can be controlled automatically from an external source, or manually adjusted over a power range from 3 to 20 watts.

### Specifications

Rated power output: 814R-1, 2.5 kW; 814R-2, 1.25 kW

Power consumption (max.) @ 97 pF:  
814R-1, 4.9 kva; 814R-2, 2 kva

Frequency range: 88 - 108 MHz

Frequency stability:  $\pm 500$  Hz

Output impedance: 50 ohms vswr, 2:1 max.

IM distortion: 0.25% max., mono; 0.5% max., stereo

RF power output control:  $\pm 2\%$  of nominal (automatic)

Modulation capability:  $\pm 150$  Hz

Audio input level: 10 dBm,  $\pm 2$  dB

Audio frequency response:  $\pm 1$  dB of pre-emphasis curve

Audio frequency distortion:  $\pm 0.25\%$  max., mono; 0.5% max., stereo

Stereo separation: 50 - 15,000 Hz, 35 dB min. reaching 50 dB @ mid range

Harmonic attenuation: exceeds FCC requirements

FM noise level: 65 dB below 100% modulation

AM noise level: -55 dB, rms

Filament regulation:  $\pm 1\%$  of optimum

Power source: 200 - 250 v ac, 50/60 Hz, single phase

Permissible line voltage variation:  $\pm 5\%$

Size, 814R-1 or 814R-2:

35" (89 cm) W

24" (61 cm) D

69" (175 cm) H

Weight, 814R-1: 750 lb (340 kg)

Weight, 814R-2: 700 lb (318 kg)

# 10 KW FM TRANSMITTER

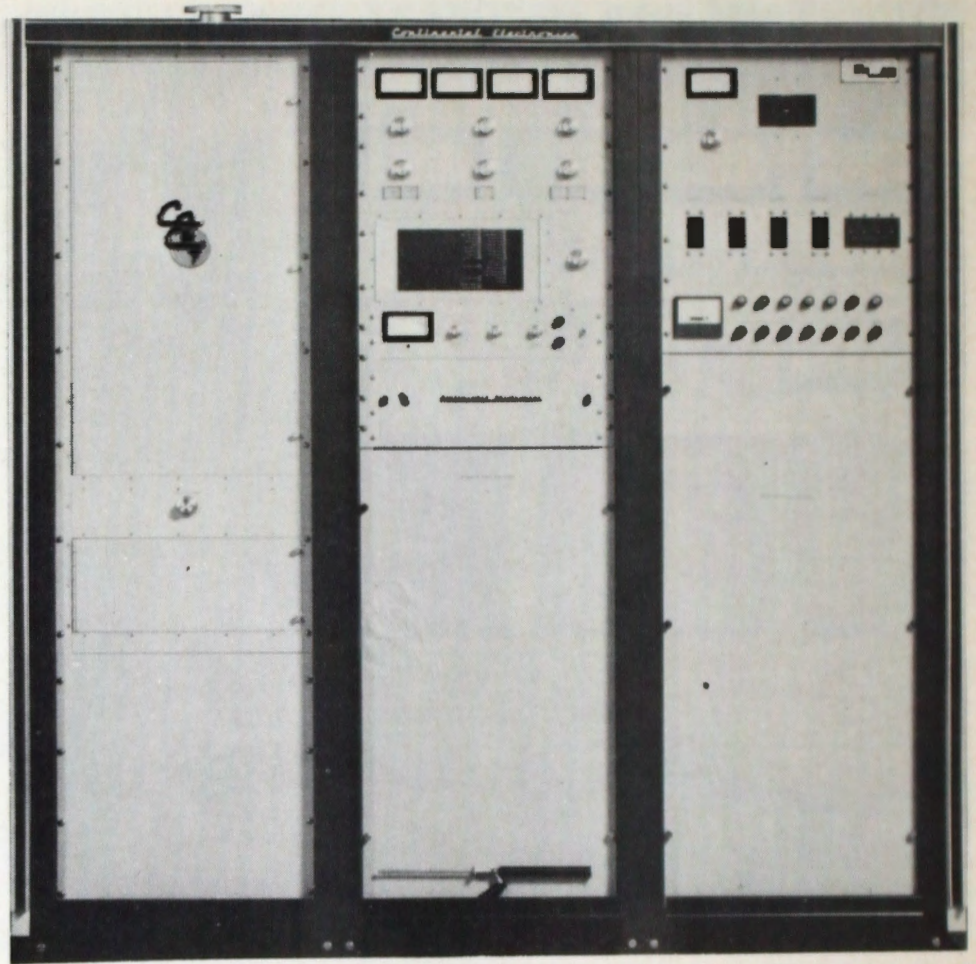

**Type 816R-1A**  
**10,000 watt FM Transmitter**  
Continental's 816R-1A is a high-performance transmitter that uses the 510R-1 exciter to deliver a crisp, clean signal to the antenna.

State-of-the-art components and straightforward design combine to provide cost-effective operation.

Auto power output control and automatic filament voltage regulation to within 2% enhance long tube life.

The 816R-1A is solid-state except for three tubes: a pair of 4CX250B drivers, and a 4CX5000A power amplifier operating at Class C. Neutralizing circuits provide stability and simplify tuning.

An automatic overload/recycle system will attempt to put the transmitter back on the air in the event of an external or internal power failure. After a predetermined number of tries (either 2 or 4), the recycle system will cease operating, thus protecting the transmitter system and components.

Filament and plate controls are located on the front panel, with a built-in 30-second delay in the plate circuit to allow tube warmup.

All interlocks, controls and indicators are operated by a 28-volt dc system, virtually eliminating problems with remote control interfacing and providing additional safety for the operator.

# 10 KW FM TRANSMITTER

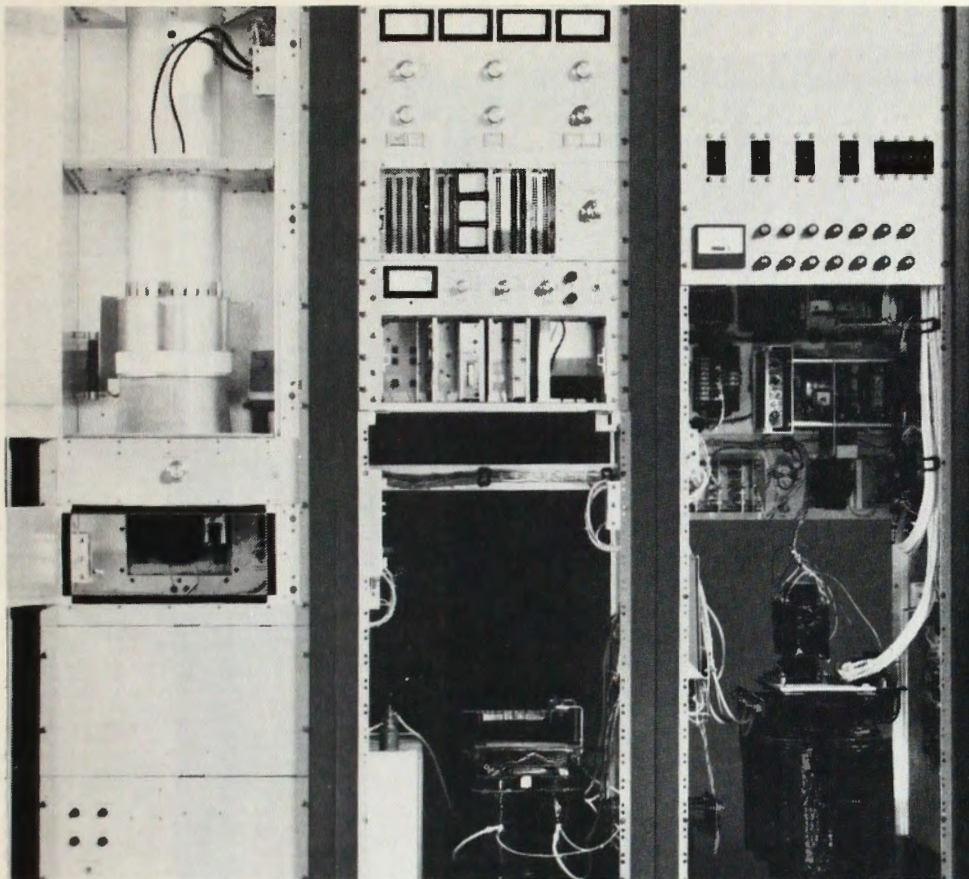

## Specifications

- Output Power: 10 kW  
Output Impedance: 50 ohms, vswr 2:1, maximum  
Frequency Range: 88 to 108 MHz  
Frequency Stability:  $\pm 500$  Hz (typical,  $\pm 100$  Hz)  
Modulation Capability:  $\pm 150$  kHz  
Audio Input Level: 10 dB mW  $\pm 2$  dB  
Audio Frequency Response:  $\pm 1$  dB at preemphasis curve  
Audio Frequency Distortion: 0.25% maximum monaural; 0.5% maximum stereo  
Stereo Separation: 35 dB minimum, 50 to 15,000 Hz (40 dB or more typical)  
Harmonic Attenuation: 80 dB, minimum  
FM Noise Level: 65 dB below 100% modulation (70 dB, typical)  
AM Noise Level: -55 dB rms (-58 dB, typical)  
Operating altitude: 7,500 ft. (2286 m) standard; optional to 10,000 ft. (3048 m) with high altitude modification kit.  
Power Source: 200 to 250 volts ac, 60 Hz, 3-phase. Available taps on transformers are for 200, 210, 220, 230, 240 and 250 volts. 50 Hz available on request.  
Permissible Line Voltage Variation:  $\pm 5\%$ . In addition, each phase voltage shall be within 5% of the average of all three phases.  
Power Requirements: Nominal 10 kW output requires 22.2 kVA at .90 pf  
Size: 68<sup>15</sup>/<sub>16</sub>" (175.1 cm)H  
71<sup>1</sup>/<sub>2</sub>" (181.6 cm)W  
27<sup>1</sup>/<sub>2</sub>" (69.8 cm)D  
Weight: 1875 lb (836 kg)

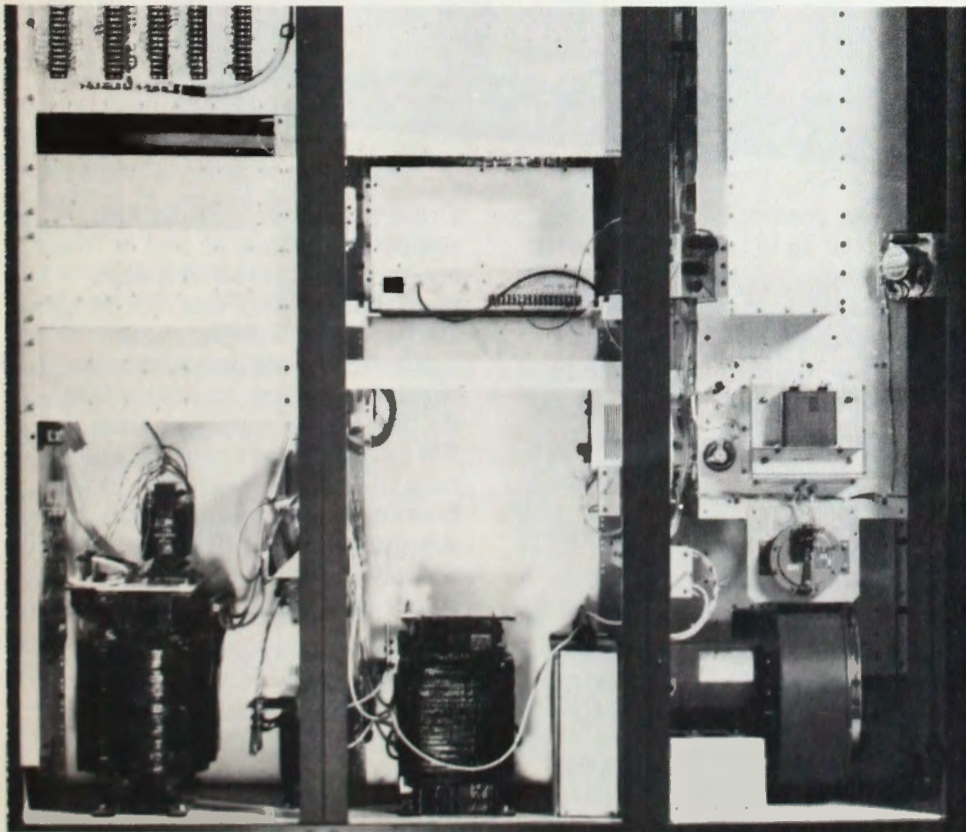



## 25 & 20 KW FM TRANSMITTERS

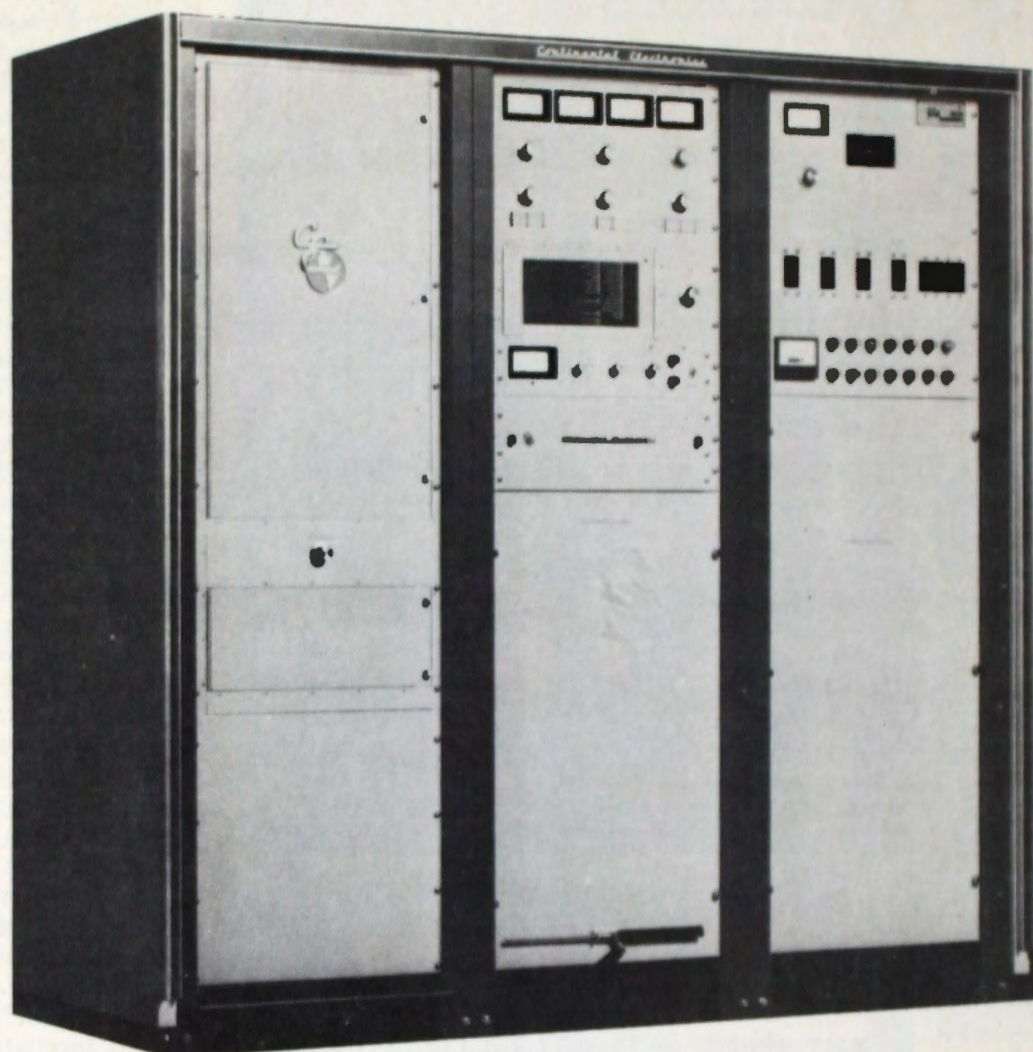

### **Type 816R-3**

#### **25,000 watt FM Transmitter**

Continental's 816R-3 is a high performance, state-of-the-art FM transmitter that uses the popular, field-proven 510R-1 exciter to deliver a crisp, clean signal to the antenna.

The 816R-1 offers broadcasters high fidelity, dynamic balance, very little noise or distortion, good stereo separation and excellent frequency stability.

#### **Modern, proven control circuits**

All control circuits are solid-state, and operate on 28-volts dc. Tuning and loading are handled with two motors. Meters and controls are set at eye level to facilitate accurate adjustments.

SCR power control brings the transmitter up to full power gently. This exclusive "soft start" is easy on the total system, and helps promote long component life.

LED status indicators are used in the control ladder.

Automatic power output control assures a steady, constant signal to the antenna.

#### **23 protection circuits**

An automatic overload/recycle system will attempt to put the transmitter back on the air in the event of a momentary external or internal power failure. After a predetermined number of tries, the recycle system will stop operating, thus protecting the transmitter system and components.

Other protection circuits and indicators include ac and dc fused exciter; selectable 2 or 4-shot overloads for PA Plate, PA Screen, Driver Plate, VSWR; phase loss/rotation; air pressure loss; overtemperature; indicator fuses for bias power supply, cabinet fan, FM exciter, power control and tube filaments; magnetic circuit breakers for ac mains supply, plate supply, screen supply, driver supply, 28-volt dc supply and blowers; safety interlocks.

#### **Proven power amplifier**

A field-proven 4CX15000A power amplifier tube is used to save on operating costs. The high plate dissipation rating and proven design enhance long-life performance. Continental's unique

# 25 & 20 KW FM TRANSMITTERS

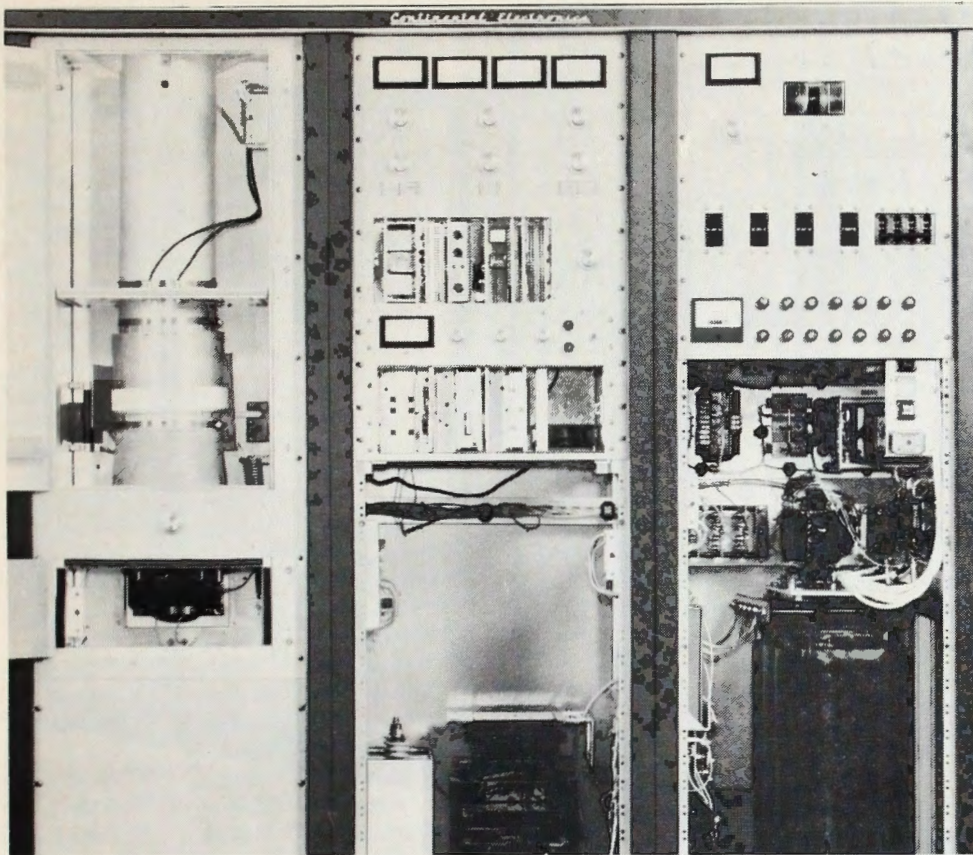

grounded screen tetrode design eliminates screen bypass capacitors and provides excellent stability.

## Designed for easy operation

Filament and plate controls are located on the front panel, with a built-in 30-second delay in the plate circuit to allow tube warmup.

Power supply and harmonic filter are mounted in the transmitter cabinet.

Indicator lights aid troubleshooting.

The 816R-3 is completely contained in one 71½" wide (1816mm) cabinet. All panels are easily removed or opened; one person can remove or replace most components.

## Type 816R-2

### 20,000 watt FM transmitter

Continental's 816R-2 is identical in operation and specifications to the 816R-3, except for power supplies and output power.

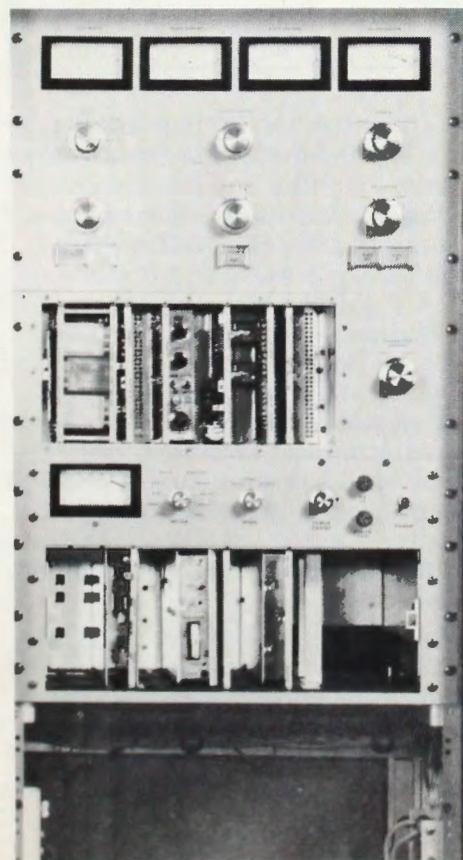

## Specifications

Rated power output: 816R-3: 25 kW;  
816R-2: 20 kW

Power consumption: 816R-3: 25 kW  
(40 kW nominal) 816R-2: 20 kW  
(32 kW nominal)

Frequency Range: 88 to 108 MHz

Output impedance: 50 ohms,  
maximum VSWR 2:1

Frequency stability: ± 500 Hz  
(typical: ± 100 Hz)

Modulation capability: ± 150 kHz

Audio input level: 10 dBm ± 2 dB

Audio frequency response: ± 1 dB of  
standard 75 us preemphasis curve

Audio frequency distortion:

0.25% maximum monaural  
(0.1 typical); 0.5% maximum  
stereo (0.15 typical)

Stereo separation: 35 dB minimum  
50 to 15,000 kHz (40 dB or  
more typical)

Harmonic attenuation:

80 dB minimum

FM noise level: 65 dB below 100%  
modulation (70 dB typical)

AM noise level: - 55 dB, rms  
(- 58 dB typical)

Power source: 200 to 250 v ac,  
60 Hz, 3-phase Available taps on  
transformer are for 200, 210, 220,  
230, 240 and 250 volts. 50 Hz  
available on request.

Permissible line voltage variation:  
± 5% (Each phase voltage shall  
be within 5% of the average of all  
three phases.)

Operating altitude: 7500 ft (2286 m)  
standard Optional to 10,000 ft  
(3048 m) with high altitude  
modification kit.

Size: 68<sup>15</sup>/<sub>16</sub>" (175.2 cm)H  
71<sup>1</sup>/<sub>2</sub>" (181.6 cm)W  
27<sup>1</sup>/<sub>2</sub>" (69.85 cm)D

Weight: approx. 1962 lb  
(890 kg)

## 50 & 40 KW FM TRANSMITTERS

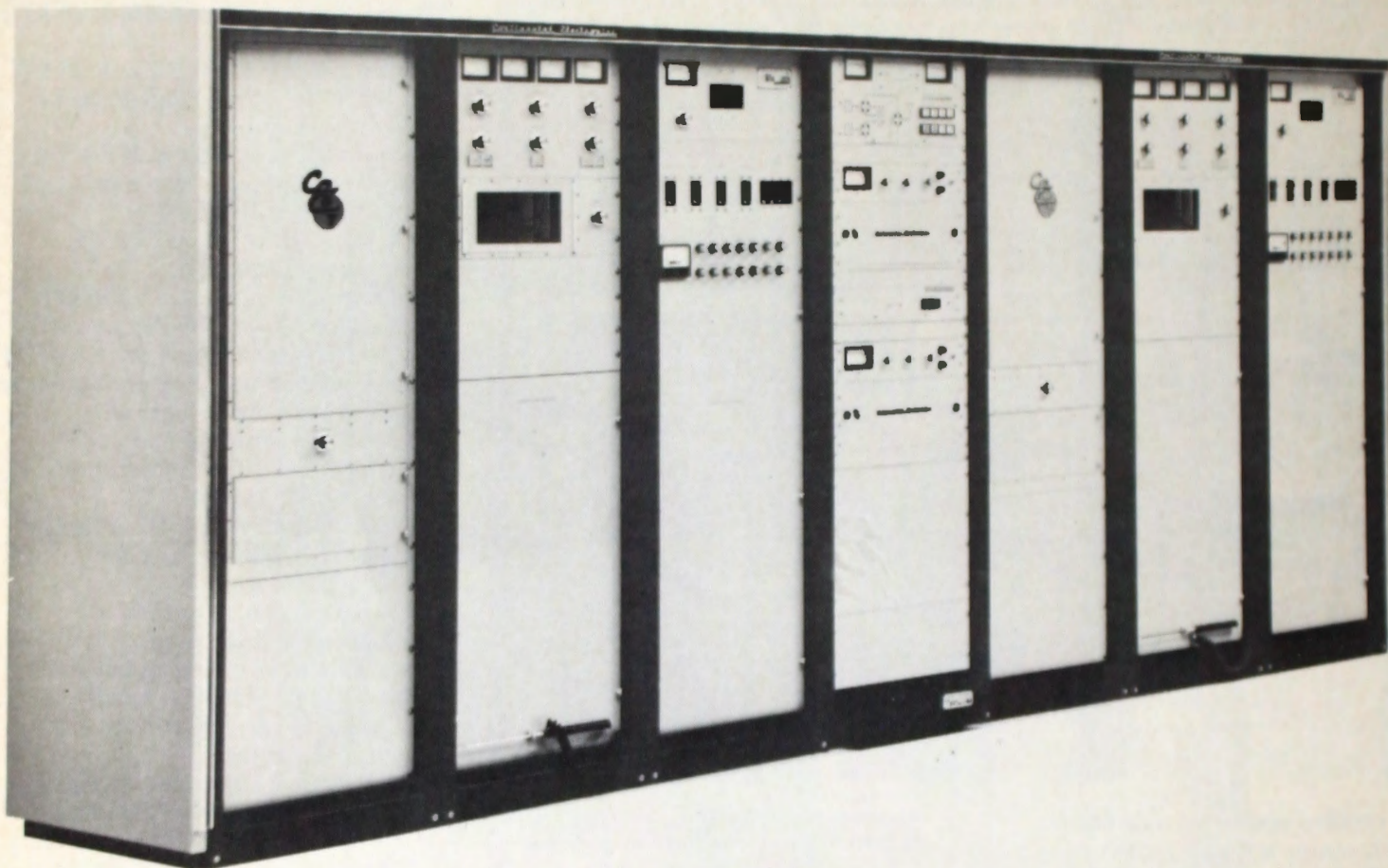

### **Type 817R-1**

#### **50,000 watt FM Transmitter**

Continental's 817R-1 is a high performance, state-of-the-art FM transmitter that uses the popular, field-proven 510R-1 exciter to deliver a crisp, clean signal to the antenna. It offers broadcasters high fidelity, dynamic balance, very little noise or distortion, good stereo separation and excellent frequency stability.

The 817R-1 consists of two 816R-3 25 kW FM transmitters whose outputs are combined in a 90 degree hybrid to achieve 50 kW output. Through the optional use of coaxial switching, either transmitter may be put on the air independently.

### **Transmitter design, operation**

Control and protection circuits, the power amplifier and general design benefits are outlined in the section describing the Type 816R-3 25 kW FM transmitter.

### **Optional automatic exciter control**

Continental's Type 377C-1 automatic exciter control provides monitoring and control for two Type 510R-1 or similar exciters. If one exciter fails, the standby exciter is automatically put on-line. Indicator lamps show which exciter is operating.

While in the hot standby mode, the standby exciter is maintained at 5 to 10% of normal power. When switched to "on-air", it comes up to full power in less than 100 milliseconds.

The control unit includes switching the station's monitoring to the exciter's dummy load for servicing and testing the standby exciter. It is designed to fit on the control panel furnished with the 817R-1 transmitter.

### **Optional automatic combiner controls**

Continental's Type 377D-1 combiner control provides automatic or manual control of two parallel FM transmitters, and automatically assures maximum available power to the antenna at all times.

If a power failure occurs in either transmitter, the remaining transmitter is switched to the antenna, and the other transmitter is switched to a dummy load.

# 50 & 40 KW FM TRANSMITTERS

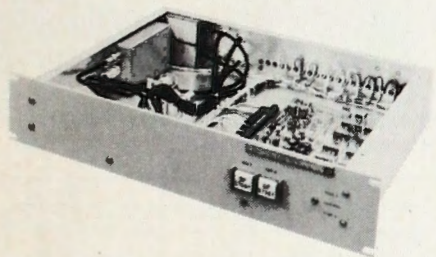
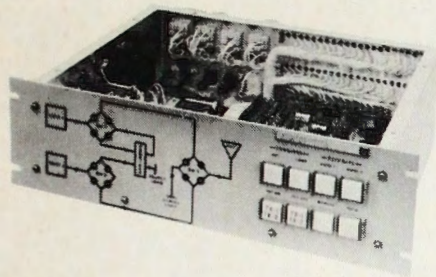

The combiner control unit provides all interlock and sequencing functions. It is designed to fit on the control panel furnished with the 817R-1 transmitter.

## Type 817R-2 40,000 watt FM transmitter

Continental's 817R-2 is identical in operation and specifications to the 817R-1, except for power supplies, external combiner and output power.

## External transmitter combiners for Type 817R-1 50 kW FM, and Type 817R-2 40 kW FM transmitters.

These two transmitter combiners are described in the "Combiner Section" of this catalog.

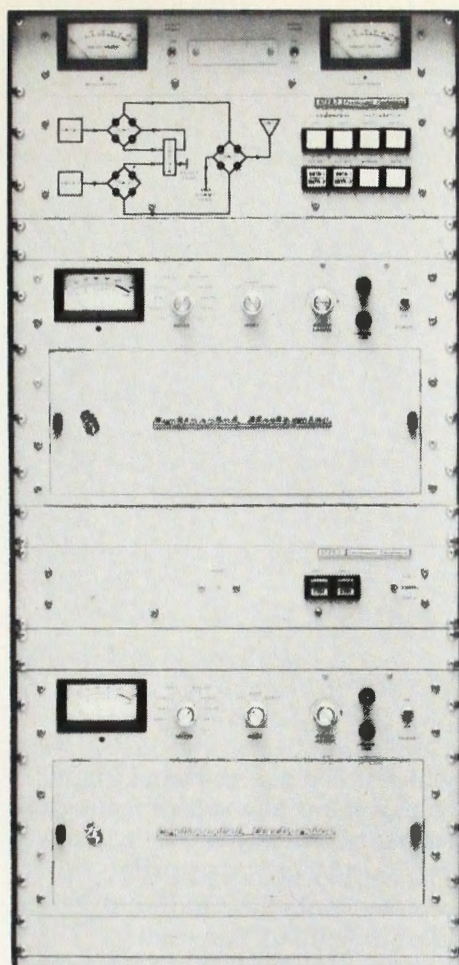

## Specifications

Rated power output: 817R-1: 50 kW;  
817R-2: 40 kW  
Power consumption: 817R-1: 80 kW  
nominal 817R-2: 64 kW nominal  
Frequency range: 88 to 108 MHz  
Output impedance: 50 ohms,  
maximum VSWR 2:1  
Frequency stability:  $\pm 500$  Hz  
(typical:  $\pm 100$  Hz)  
Modulation capability:  $\pm 150$  kHz  
Audio input level: 10 dBm  $\pm 2$  dB  
Audio frequency response:  $\pm 1$  dB of  
standard 75  $\mu$ s preemphasis curve  
Audio frequency distortion:  
0.25% maximum monaural  
(0.1 typical); 0.5% maximum  
stereo (0.15 typical)  
Stereo separation: 50 to 15,000  
Hz, 35 dB minimum (40 dB or  
more typical)  
Harmonic attenuation:  
- 80 dB minimum

FM noise level: 65 dB below 100%  
modulation (70 dB typical)  
AM noise level: - 55 dB, rms  
(- 58 dB typical)

Power source: 200 to 250 v ac,  
60 Hz, 3-phase Available  
transformer taps are 200, 210,  
220, 230, 240, 250 v ac. 50 Hz  
available on request.

Permissible line voltage variation:  
 $\pm 5\%$  (Each phase voltage shall  
be within 5% of the average of all  
three phases.)

Operating altitude: 7,500 ft (2286 m)  
standard Optional to 10,000 ft.  
(3048 m) with altitude  
modification kit.

Sizes, transmitters as pictured:

68<sup>15</sup>/<sub>16</sub>" (172.5 cm)H  
164<sup>3</sup>/<sub>16</sub>" (417.03 cm)W  
27<sup>1</sup>/<sub>2</sub>" (69.85)D

Weight: 4074 lb (1848 kg)

Combiner, 50 kW

Size: 60" (152.4 cm)H  
52" (132.08 cm)W  
46" (116.84 cm)D

Weight: 1130 lb (512.6 kg)  
nominal

Combiner, 40 kW

Size: 60" (152.4 cm)H  
48" (121.92 cm)W  
40" (101.6 cm)D

Weight: 790 lb (358.34 kg)  
nominal

Reject Load, 20 kW

Size: 63" (160.02 cm)H  
17" (43.18 cm)W  
17" (43.18 cm)D

Weight: 95 lb (43.09 kg)

Test Load, 50 kW

Size: 65" (165.1 cm)H  
21" (53.34 cm)W  
21" (53.34 cm)D

Weight: 143 lb (64.86 kg)

# FM EXCITER



## Type 510R-1 FM Exciter

Continental's Type 510R-1 exciter offers superb audio performance and unmatched field reliability.

The 510R-1 is a direct FM exciter that uses a phase locked loop AFC to provide frequency stability of  $\pm 500$  Hz at any modulation level, regardless of program material. Complete metering facilities on the front panel include a peak reading meter to measure audio level. Plug-in modules facilitate in-field servicing. The 510R-1 will accept a composite STL input or any of the proposed discrete quad systems.

All Continental FM transmitters use the 510R-1 exciter.

The 510R-1 is completely solid-state, and accepts any modulating frequency up to 100 kHz. Output frequency is determined by a digital phase lock loop with a crystal controlled oscillator.

The 510R-1 is prewired to accept an optional stereo (786V-1) and/or the SCA (786W-2) generator. Both are available in the form of plug-in modules and can be added in seconds. An optional 785E-1 card

which accepts a baseband input from a composite source is used if the stereo card (786V-1) is not used.

The 510R-1 exceeds FCC requirements for maximum allowable distortion, and Continental guarantees 0.5% IM Distortion in stereo; half that in monaural operation.

### Specifications

#### General

Ambient Temperature Range: 0° to 55° C (32° to 131° F)

Ambient Humidity Range:  
Up to 95%

Maximum Altitude: 3048  
(10,000 ft.)

Input Power Requirement: 117/234  
volts ac,  $\pm 10\%$ , single phase,  
50/60 Hz, 150 watts Nominal  
RF Power Output: 3 to 20 watts  
Output Impedance: 50 ohms  
unbalanced

Output Frequency Range: 88 to 108  
MHz, crystal-controlled (crystal  
installed and exciter adjusted at  
factory to meet customer  
requirement)

Carrier Frequency Stability: Within  
 $\pm 500$  Hz with ac line voltage of  
 $\pm 10\%$  and temperature range 0°  
to +55° C (32° to 131° F)

#### Carrier Frequency Control:

Phase-locked modulated oscillator  
operating at the output frequency

#### Harmonic and Spurious Radiation:

Any emission appearing on a  
frequency removed from the  
carrier by between 120 and 240  
kHz is attenuated at least 30 dB  
below the level of the  
unmodulated carrier

Any emission appearing on a  
frequency removed from the  
carrier by more than 240 kHz up  
to and including 600 kHz is  
attenuated at least 35 dB below  
the level of the unmodulated  
carrier

Any emission appearing on a  
frequency removed from the  
carrier by more than 600 kHz is  
attenuated at least 80 dB below  
the level of the unmodulated  
carrier, with the exception of  
harmonics of the rf carrier

Type of Modulation: Direct  
frequency modulation at carrier  
frequency

Modulating Frequencies: 20Hz to  
100 kHz

Modulation Capability:  $\pm 150$  kHz  
AM Noise Level: 55 dB below  
carrier level (70 dB typical)

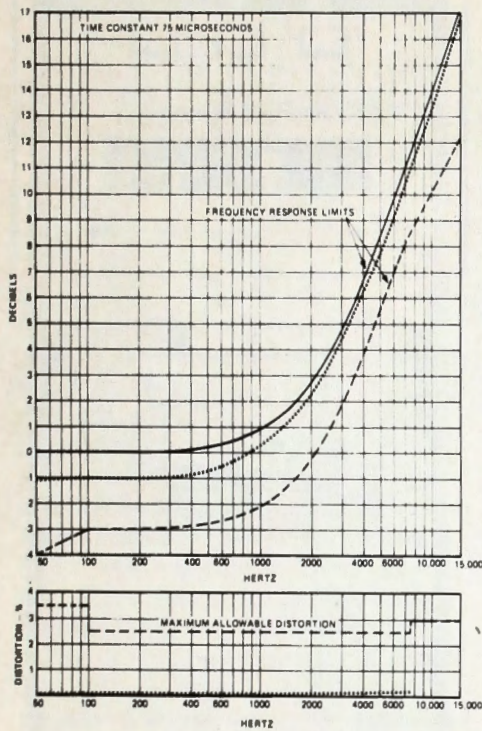

Stereo: Right Channel Response and THD

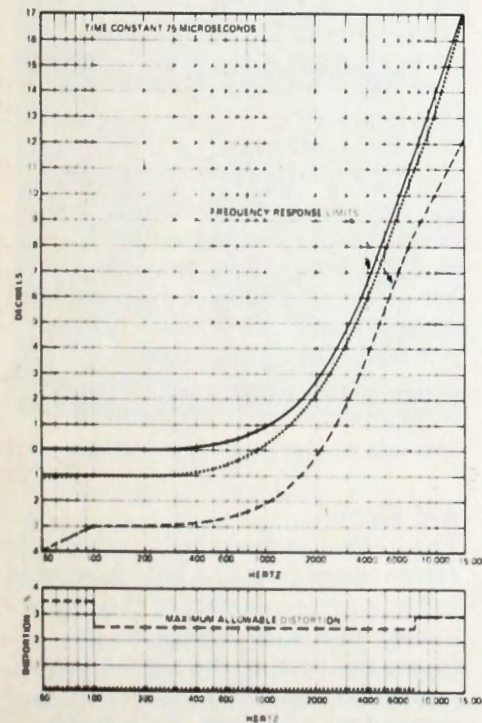

Stereo: Left Channel Response and THD

## Monaural FM

Audio Input Impedance: 600 ohms balanced

## Audio Input Levels

Monaural: +10 ± 2 dBm for 100% modulation

SCA: -10 to +15 dBm adjustable from 0% to 10% injection (67kHz and/or 41 kHz available)

Base Band Input: (with 785E-1 STL card) 3.5 Vp-p into 4700 ohms.

Frequency Response: Standard 75-microsecond pre-emphasis; others optional

Distortion: Not more than 0.25% thd (total harmonic distortion) (typical 0.1% thd)

Intermodulation Distortion Not more than 0.25% imd (typical 0.1%)

FM Noise Level: 65 dB below 100% modulation (70 dB typical)

AM Noise Level: 55 dB below carrier level (70 dB typical)

## Stereo FM With 786V-1

Audio Input Impedance: 600 ohms balanced

Audio Input Levels: +10 ± 2 dBm for 100% modulation

Frequency Response: Standard 75-microsecond pre-emphasis for both right and left channels; others optional

Distortion: Not more than 0.5% thd for 50Hz to 15-kHz audio modulation (typical 0.25% thd) Not more than 0.5% imd (typical 0.25%)

Stereophonic Subcarrier and Pilot Carrier Phasing: Phase difference between the stereophonic subcarrier and pilot carrier is within the limits required for channel separation of more than 35 dB with audio-modulating frequencies of 50 Hz to 15 kHz

Stereo Channel Separation: At least 35 dB, 50 Hz to 15 kHz (typical 40 dB or better)

Crosstalk: At least 45 dB below either single-channel level (main-to-subcarrier and subcarrier-to-main) (typical 50 dB)

## 38-kHz Stereo Subcarrier

Suppression: 45 dB below 90% modulation of the main carrier (typical 55 dB)

Pilot Carrier Frequency: 19 kHz ± 2 Hz

Pilot Carrier Level: Adjustable from 0% to 12% modulation of main carrier

## SCA

Audio Level: -10 to +15 dBm

Injection Level: 0% to 10% adjustable

Frequency: 67 kHz only

## FM Noise Level

Left Channel: 65 dB below 100% modulation (68 dB typical)

Right Channel: 65 dB below 100% modulation (68 dB typical)

AM Noise: 55 dB below carrier (typical 70 dB)

## SCA FM With 786W-2

Audio Input Impedance: 600 ohms, balanced

Audio Input Level: -10 to +15 dBm

External telemetry input: 1 V rms 20 to 30 Hz when used with 786W-2 SCA Generator

SCA Subcarrier Center Frequency: 67 kHz or 41 kHz (mono only) 67 kHz (stereo)

SCA Frequency Modulation of Main Carrier: Adjustable from 0% to 10%

SCA Generator Center Frequency Stability: Within ± 0.5%

Frequency Response: Standard 150-microsecond pre-emphasis

## SCA Filtering

Audio Input: 50 Hz to 5000 Hz low pass filter

67/41 kHz Output: Bandpass filter centered around output frequency

FM Noise Level: Less than -55 dB (typical 60 dB) on SCA Sub Carrier

Distortion: 1.0% for 50 Hz to 5 kHz with 4.0-kHz deviation

Crosstalk: Crosstalk from main channel and stereo subchannel into the SCA channel shall be 50 dB below 4.0-kHz SCA deviation. Measured with either 75- or 150-microsecond deemphasis. (typical crosstalk 55 dB)

Crosstalk from 67 -kHz SCA into stereo subchannel shall be at least 60 dB below 100% modulation of main channel (5-kHz tone deviating ± 4 kHz)

# 1 KW AM MW TRANSMITTER

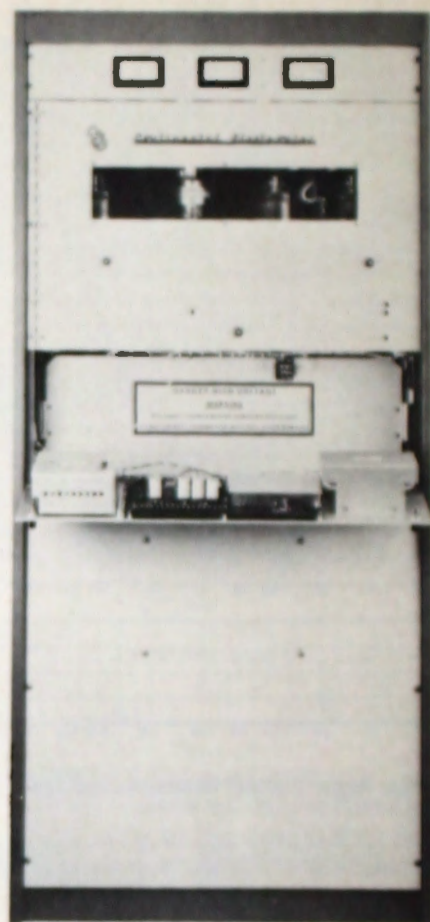
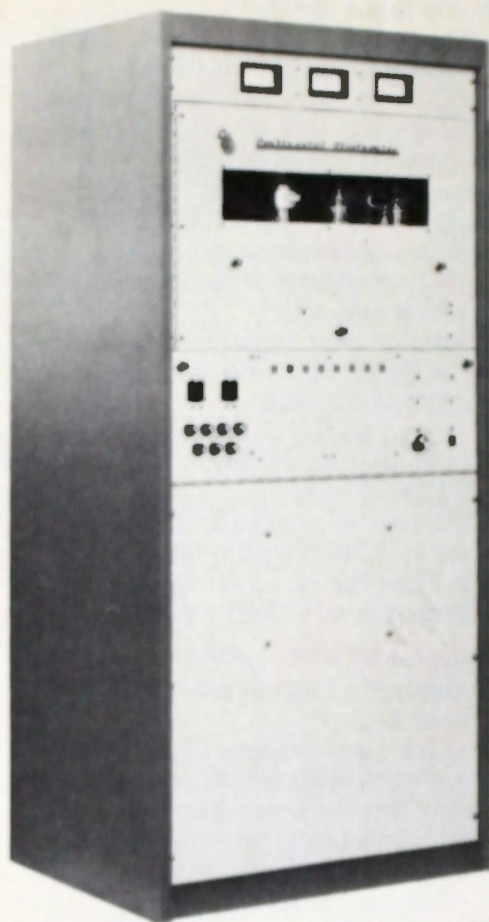

## **Type 314R-1 1,000 watt AM MW Transmitter**

Continental now offers the performance and technology of pulse width modulation in an efficient 1kW package. The 314R-1 offers AM broadcasters the efficiency and reliability of a tube-powered final and the clear, crisp sound of full transformerless modulation.

### **Designed For The User**

For day-to-day operation and routine maintenance the 314R-1 is designed with the broadcast engineer in mind. The transmitter has excellent accessibility and utilizes modular circuit boards.

LED status indicators are provided on major circuits. By broadbanding the driver only the PA need be tuned. Control and overload circuits, the exciter, driver module and the SwitchMod module are all plug-in units. The use of a 3-500Z triode for both switching modulator and final amplifier simplifies maintenance.

Built-in forward and reflected power metering with VSWR protection is easily read from the front of the cabinet as are all meters. Remote control and monitoring are made directly with no interfacing required.

For high/low power requirements, the power can be adjusted to the correct value and thereafter changes from either power levels are accomplished by a push button control which can be readily removed. The 314R-1 has the capability to come up to full power from a cold start in a matter of seconds at the push of a button.

### **AM Stereo**

The 314R-1 is designed to convert to stereo operation. The left channel is initially wired as part of the main audio chain with provisions for future addition of the right channel and audio matrix by PC board component additions. Both mono and future stereo versions of the plug-in RF Exciter Cards will be interchangeable with no transmitter modification.

# 1 KW AM MW TRANSMITTER

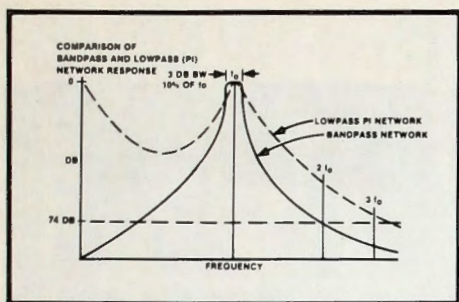

## Q-Taper Network

A Q-Taper output network provides steep skirts and an exceptional flat response across the audio pass band. Unlike conventional "Pi" networks, the skirts of the Q-Taper are nearly symmetrical with second harmonic suppression exceeding FCC requirements without the use of additional traps. The 3 dB bandwidth is approximately 10% of the operating frequency, about 100 kHz average. In addition an improved phase linearity is realized over conventional configurations.

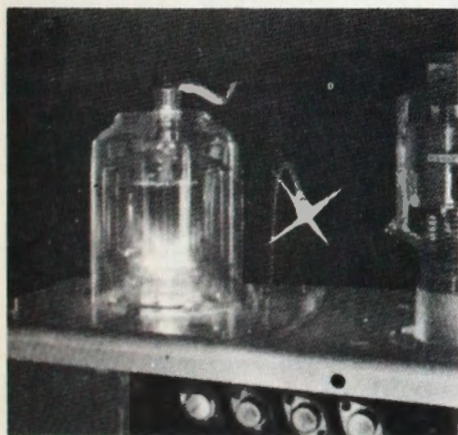

## Grounded Anode and Fiber Optics Coupling

A unique design feature of the final amplifier is a grounded anode which reduces peak voltages, with respect to the chassis, to about half the values encountered in conventional designs. This permits required metering of the final plate current and voltage to be done directly at ground reference, either locally or remotely. Problem areas such as the DC feed choke and blocking capacitor are eliminated. Audio DC coupling is maintained

throughout the audio chain by the use of advanced fiber optics to couple to the modulator driver for superior audio performance.

## Transformerless Audio

The SwitchMod System is a total concept that efficiently combines the interplay of all aspects of the transmitter system — from the audio input to the audio modulated RF output — from the main power supply to the RF output network. The 314R-1 is the only 1 kW AM transmitter to provide the combination of a built-in Instantaneous Peak Limited (IPL), an Automatic Power Control (APC), and an Automatic Modulation Control. These features provide correct output power and maximum modulation even with input line voltage variations of +5%. The IPL adjustment allows independent setting of both negative and positive limits.

The inefficient modulator using a modulation transformer is eliminated as is the conventional transformer input to the audio chain. A dc coupled OP-AMP minimizes overshoot and ringing. The 314R-1 will reproduce a 20 Hz square wave at 100% modulation.

## No-Bounce Power Supply

Power supply bounce and overshoot has been eliminated in the 314R-1 through a capacitive input filter design which eliminates the choke. Low frequency resonances are avoided and an outstanding frequency response maintained.

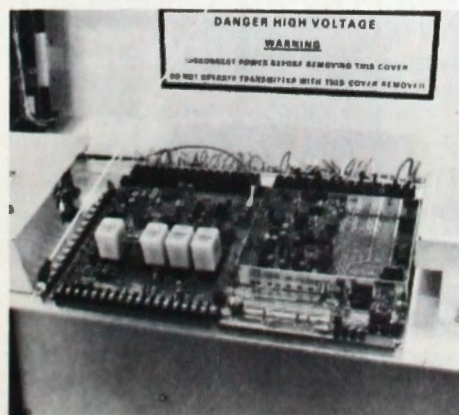

## Specifications

Frequency Range: 540 to 1600 kHz  
RF Power Output: 250W to 1100W max.

RF Output Impedance: 50 ohm, Unbalanced, Nominal

RF Output Fitting: Coax. Type LC (Optional Stud)

Harmonic and Spurious: -73.4 dB meets FCC and CCIR

Carrier Regulation: 2% max (400 Hz, 95% mod.)

Frequency Stability: ±5 Hz (0 to 50° C) ±20 Hz (-20° C to +50° C)

Audio Response: ±1 dB, 20-10 kHz, 1 KW, -95% Modulation

Audio Distortion: Less than 2%, 20-10 kHz 1 KW, 95% Modulation

Noise: -55 dB (400 Hz, 95% mod.)

Audio Input: +10 dBm ±2 dB, 600/150 ohms, Balanced

Modulation Capability: -100% +125% (1100 W, 1 kHz)

Power Requirements: 1 φ, 200/250V, 50/60 Hz

Power Consumption: 3500W at 1KW, 95% mod.

Ambient Temperature: -20° C to +50° C

Humidity: 95% Max

Altitude: 7500 Ft. (2286 m)

Size: 32 1/16" (81.4 cm)W

25 1/16" (63.6 cm)D

69" (175.3 cm)H

Weight: 760 lbs. (345 Kg)

Tubes: 3-500Z (3) (1 mod. 2rf)

Remote Control: Direct - No Interface Required

Features: IPL, Auto Power Control, Auto mod. Control



# 5 KW AM MW TRANSMITTER

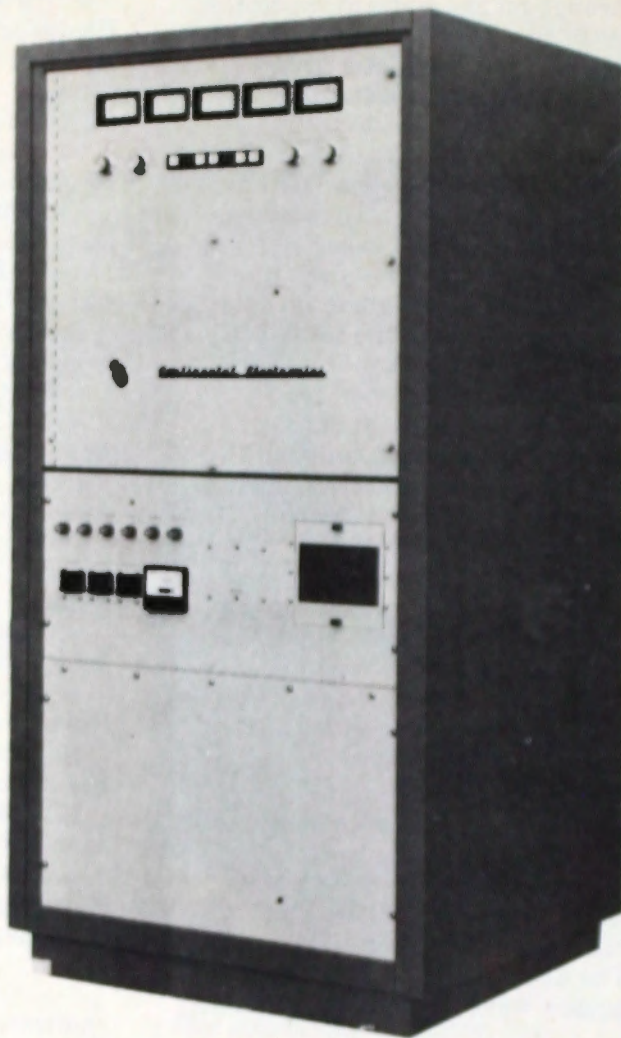

## Type 315R-1 5,000 watt AM MW Transmitter

Continental's 315R-1 offers broadcasters state-of-the-art performance, cost-effective operation and easy maintainability.

The transmitter cabinet opens for excellent accessibility. Modular circuit boards with extender cards and LED status indicators on major circuits and relays help to simplify maintenance. One tube type is used for both final PA and switchtube applications. The bottom line is a smooth, easily maintained, day-to-day operation.

## High Efficiency P.A.

Continental's 315R-1 transmitters achieve a final PA efficiency approaching 90% using the third harmonic injection technique of the proven Tyler-type. Combined with the high efficiency SwitchMod technique, overall efficiency exceeds 55%.

## SwitchMod System

The dc coupled series switching modulator with the stability of the proven 12 phase power supply, the built-in Instantaneous Peak Limiter (IPL) and the Automatic Modulation Control circuits to achieve dramatically improved AM audio performance in the areas of low frequency response, IM

distortion and overall modulation density. IPL front panel adjustments set both positive and negative limits of modulation. Working in conjunction with the Automatic Modulation Control, the maximum level of modulation is maintained at all power levels even with  $\pm 5\%$  powerline variations. Overmodulation due to powerline variations or audio peaks is effectively prevented.

# 5 KW AM MW TRANSMITTER

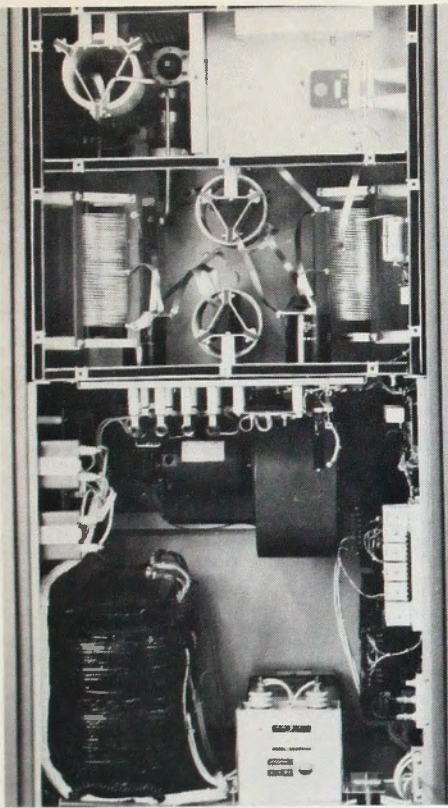

## AM Stereo

A Signal Access Card provides rear panel access to both audio and RF drive for use in either parallel operation of two 315R-1 transmitters or for future use in AM stereo. These terminals will make possible the connection of an external stereo generator to the RF drive line and to the audio chain.

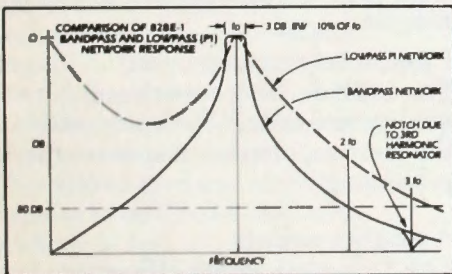

## Q-Taper Network

A Q-Taper network provides flatter response across the audio pass band and very steep skirts above and below the pass band. Unlike conventional "Pi" networks, the skirts of the Q-Taper network are nearly symmetrical with second harmonic suppression greater than 80 dB below carrier. The 3 dB

bandwidth is approximately 10% of the operating frequency, 100 kHz average. The 4 node network achieves low circulating currents by the use of low nodal Q's, on the order of 2-6. Overall system Q-Product is approximately 250. These lower circulating currents allow the use of smaller components neither sacrificing performance or conservative component rating. The Q-Taper network also has improved phase linearity over conventional networks, an important consideration for AM stereo.

## Grounded Anode

The anode of the final amplifier operates at dc ground, reducing peak RF voltages with respect to the chassis to about half the conventional configuration. Metering is accomplished at ground reference for both local and remote operation. There is no need for a blocking capacitor or feed choke. This technique is made practical by using fiber-optics to couple audio input to the audio driver. High audio performance is maintained by using dc coupling throughout the audio chain.

## 12-Phase Power Supply

The 12-phase power supply uses an Extended-Delta power transformer and two three-phase, full-wave rectifiers to develop high voltage dc with a 720 Hertz ripple frequency. Because of the high ripple frequency the absence of filter inductors and large capacitors help reduce the size of the transmitter while at the same time eliminating several expensive and failure-prone components. Inductors, which formerly cause resonances, are eliminated. Power supply sag and bounce are no longer a problem.

## Specifications

Frequency Range: 540-1600 kHz  
 RF Output Power: 500-5500 w;  
 315R-1; 250-2750 w, 314R-2  
 Output Impedance: 50 Ohm  
 nominal (others available on special order)  
 Output Fitting: 1 5/8" EIA male flange standard 7/8" EIA flange or stud output also available  
 Harmonic and Spurious: Complies with FCC and CCIR regulations  
 Carrier Amplitude Reg.: 2% max. adjustable to 0  
 Frequency Stability:  $\pm 5$  Hz. over ambient temp. range (below)  
 Power Requirements: 200-250 VAC  
 3  $\phi$  3 or 4 wire, wye or closed delta, 50/60 Hz 385-435 VAC available on special order  
 Overall Efficiency: Better than 55% at 5000 Watts, 95% sine wave modulation  
 Frequency Response:  $\pm 1$  dB, 20-10000 Hz. @ 95% modulation, 5000 Watts output  
 Total Harmonic Distortion: less than 2% 20-10000 Hz @ 95% mod, 5000 Watts output  
 Noise: Better than -60 dB reference 400 Hz., for 100% modulation @ 5000 Watts output  
 Audio Input: +10 dBm  $\pm 2$  db 600/150 ohms for 100% modulation  
 Modulation Capability: -100%, +125% standard  
 Size: 34 3/4" (88 cm)W  
 33 3/8" (85 cm)D  
 69" (176 cm)H  
 7.9 sq. ft. (0.75 sq. meters) floor space  
 Weight: 1050 lbs (476 kg)  
 Tubes: 3CX3000F7 (2)  
 Air Flow Requirement: 500 CFM  
 Humidity: 95%, max.  
 Ambient Temp. Range: To 0° C to +50° C. (meets FCC requirements to -20° C)  
 Altitude: 7,500 ft. (2280 m) above mean sea level

# 10 KW AM MW TRANSMITTER

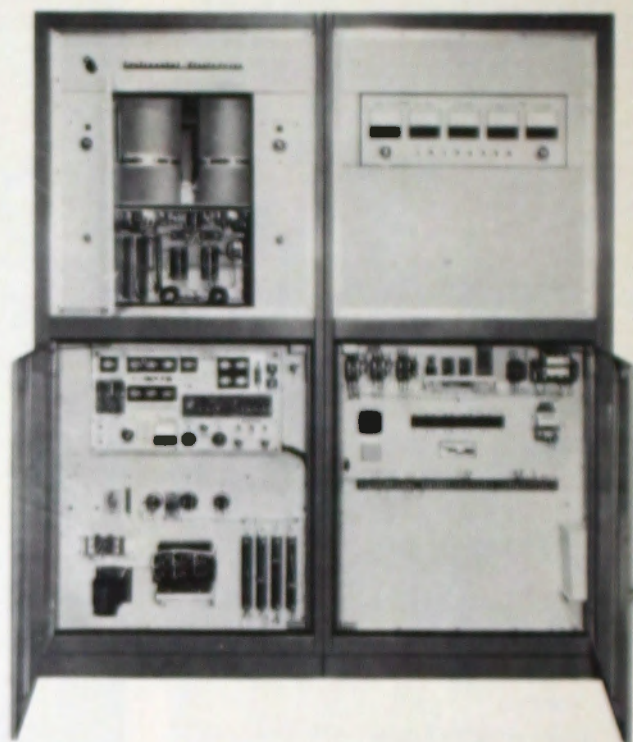
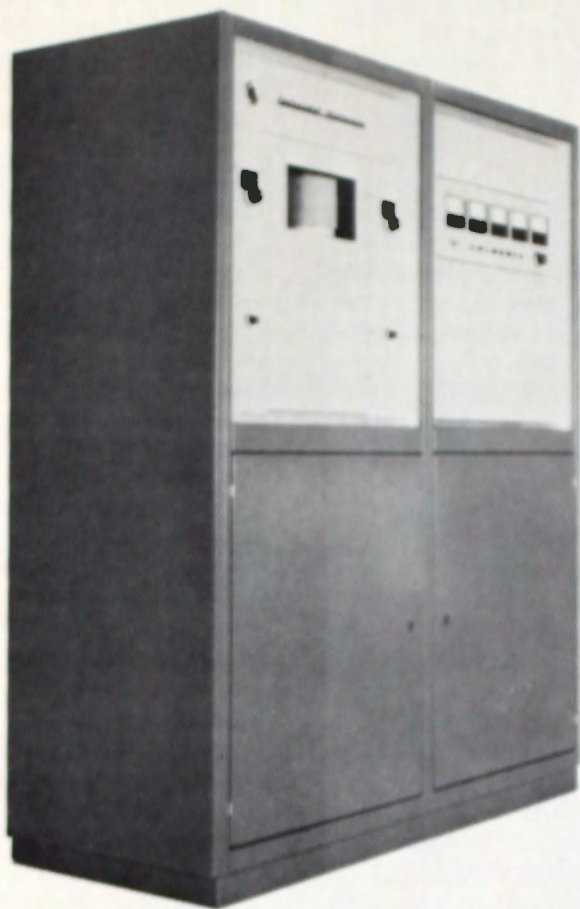

**Type 316F**  
**10,000 watt AM MW Transmitter**  
**Type 315F**  
**5,000 watt AM MW Transmitter**

Continental's Type 316F utilizes state-of-the-art concepts combined with solid-state devices to give broadcasters consistent quality and performance with high reliability. Transistors with conservative safety margins assure long-term reliability and contribute to excellent audio frequency response, low distortion and noise.

A similar model, Continental's Type 315F, operates at 5000 watts, and is identical to the 316F except for tubes and power supplies.

**Proven "on-air" reliability**

All components, output networks and power supply are rated conservatively, to provide an extra operating margin. With only two

tubes, a blower for cooling and a minimum of relay contacts, the 316F is easy to maintain and gives outstanding performance. Many broadcasters cite examples of 30,000 hours or more of transmitter operation without a moment of unscheduled down-time.

**"Collector" modulation**

The 316F has two sections: a completely transistorized exciter and a two-tube, high-efficiency amplifier.

Modulation takes place in the exciter's 40 watt output stage. This "collector-modulation" technique eliminates critical tuning adjustments and is almost identical to plate modulation except that no transformers or chokes are used.

Audio output is simultaneously applied to the RF driver and output transistors. This dual-level

modulation technique gives the 316F the capability of providing maximum positive modulation peaks allowed by the FCC (125%) with very low distortion and ample reserve.

**Completely transparent**

The 316F delivers superb audio quality and faithfully reproduces the most sophisticated audio processing.

**A quality sound**

The 316F uses a high-efficiency linear amplifier for simplicity and reliability. Two 4CX15000A tubes are used in the final amplifier. This conservative application assures long tube life.

An automatic Program Peak Limiter Controller enables broadcasters to achieve maximum loudness without overmodulation.

# 10 KW AM MW TRANSMITTER

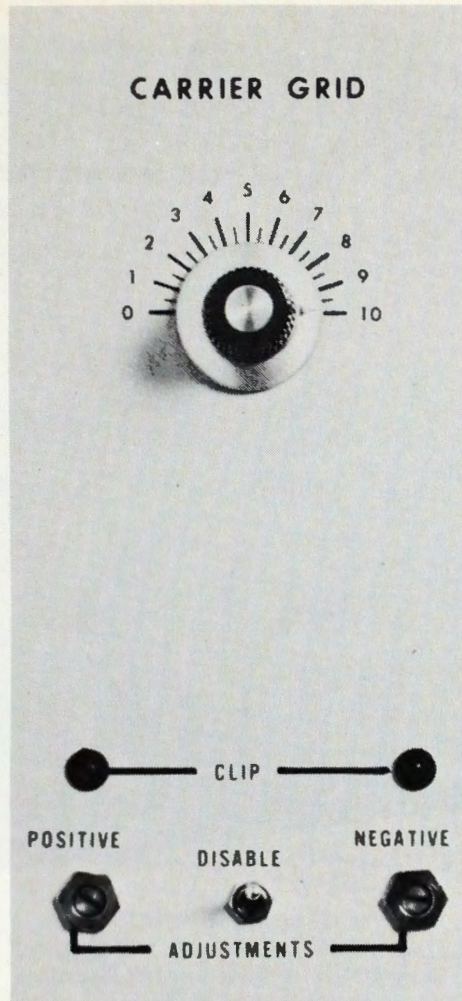

## Easy operation

The transmitter tunes easily in a straightforward manner. Modulated output from the 40-watt solid-state exciter drives the high-efficiency amplifier. Since the amplifier tubes are not driven into grid current, a stable, resistant load is used to dissipate output from the exciter. This allows grid and transistor circuits to be fixed-tuned with predetermined coil-tap settings, without variations from tube to tube.

Drive level is adjusted by meter indication and the plate circuit is adjusted by minimizing the PA plate current with the plate tuning capacitor.

## Ready for AM stereo

The 316F is built to receive a stereo exciter, and Continental guarantees compatibility with any AM stereo transmission system established by the FCC.

## Magniphase® line protection system

Continental's Magniphase system protects transmission line, antenna and tuning equipment.

## Specifications\*

Carrier Power, Type 316F:

Rated; 10 kW

Capability; 10.6 kW

Carrier Power, type 315F:

Rated; 5.5 kW

Capability; 5.5 kW

Modulation: Collector modulation of rf driver stage

Emission: A3

Frequency Range: Any single frequency 535-1620 kHz

Frequency Stability:  $\pm 5$  Hz  
Audio Input: 150/600 ohms, +10 dbm,  $\pm 2$  db for 100% modulation  
Audio Response: 50-7500 Hz  $\pm 1$  db  
30-15000 Hz  $\pm 1.5$  db  
Audio Distortion: 30-10,000 Hz, less than 3%

Carrier Shift: 2% or less at 100% modulation

Modulation Capability: 100% continuous at any frequency  
30-10,000 Hz

125% positive peak with asymmetrical program input

Noise: -60 db below 100% modulation

Spurious & Harmonic Emissions: -80 dB or better

Output Impedance: 50 to 250 ohms, unbalanced

Power Source: 208/230V, 3 phase, 50/60 Hz

Permissible Combined Voltage Variation:  $\pm 5\%$

Power Factor: 93%

Power Consumption, Type 31q16F:

23.6 kW @ 0% modulation

24.1 kW @ 30% modulation

28.4 kW @ 100% modulation

Power Consumption, Type 315F:

11.2 kW @ 0% modulation

11.5 kW @ 30% modulation

14.2 kW @ 100% modulation

Altitude: 7,500 feet (2286 meters) higher by special order.

Ambient Temperature:  $-10^{\circ}\text{C}$  to  $+45^{\circ}\text{C}$

Cooling: Forced air

Size, Type 315F or 316F:

66 $\frac{1}{8}$ " wide, 25 $\frac{1}{2}$ " deep, 77 $\frac{1}{8}$ " high  
(168 CM wide, 65 CM deep, 196 CM high)

Net Weight:

Type 315F: 1,500 lbs. (680 kilos)

Type 316F: 1,650 lbs. (748 kilos)

Export Shipping: Gross weight 2480 lbs. (1124.9 kilos); 173.1 cubic feet (4.9 cubic meters)

\*Taken from Type Acceptance data on file with FCC.

Transmitters will meet or exceed all requirements of FCC for Broadcast Service. Data taken at 10,600 watts for 316F, and at 5,500 watts for 315F.

# 50 KW AM MW TRANSMITTER

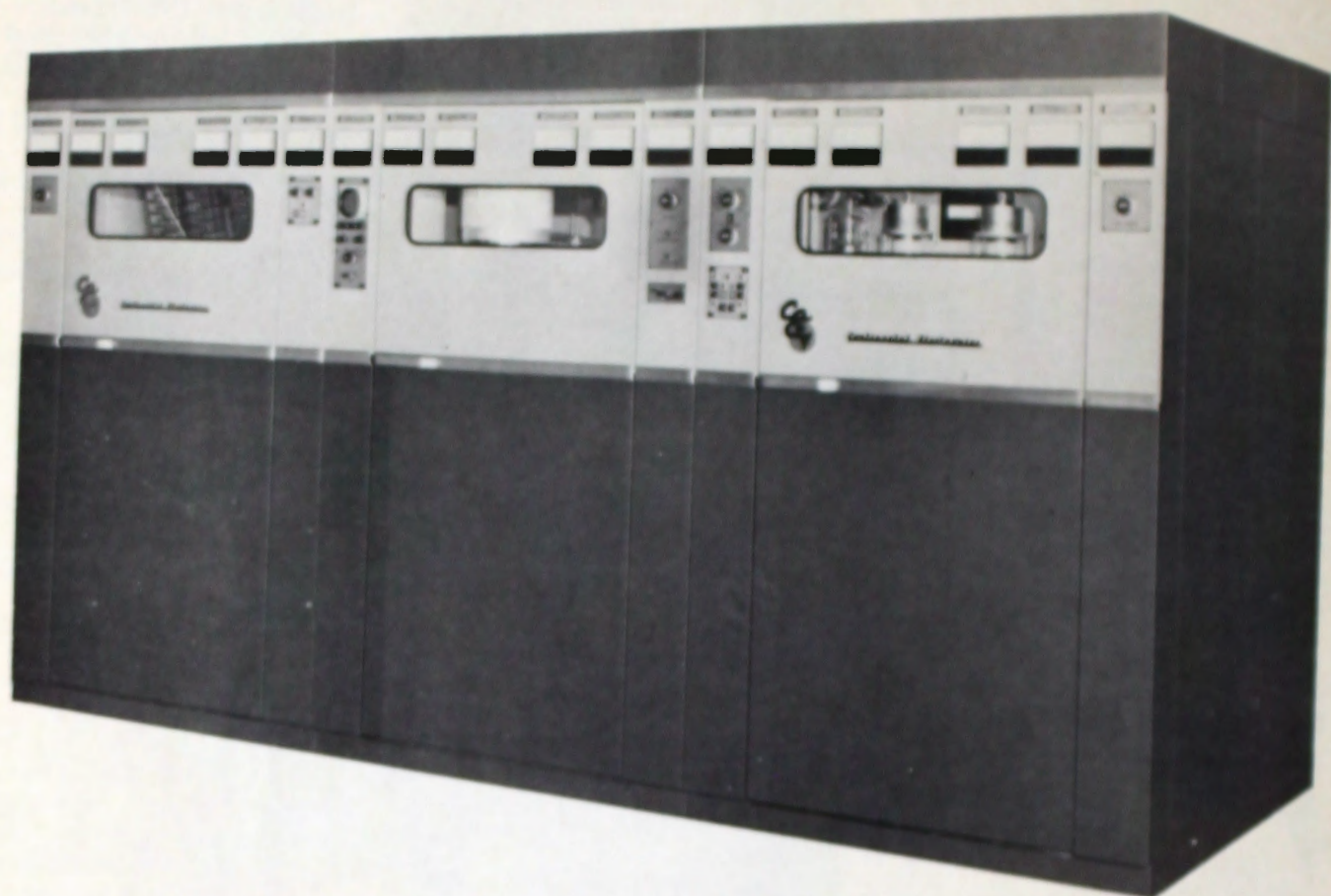

## **Type 317C-2** **50,000 watt AM MW** **Transmitter**

The 317C-2 is a field-proven design that offers broadcasters excellent performance with high overall efficiency, reliability, simplicity and easy maintainability.

The first 317C was installed in 1965. Its introduction followed an extensive review and analysis of transmitter circuit and modulation techniques. Out of this research came Continental's unique and patented\* screen-impedance modulation technique. The 317C-2 applies this system, with its current refinements, to the final amplifier tubes in the Doherty system to achieve high performance with high efficiency.

The design concept has been thoroughly tested and accepted by broadcasters around the world for transmitter requirements ranging from 50,000 to 2,000,000 watts.

Overall efficiency is better than 60% at any level of modulation. Conservative operation of the power amplifier leads to extended tube life.

### **Completely transparent**

The 317C-2 delivers superb audio quality and faithfully reproduces the most sophisticated audio processing. Yet, it can be operated very cost-effectively.

### **Proven reliability**

All components, output networks and power supplies are conservatively rated. This provides extra operating margins with extended life. 317C "on-air" performance has been proven over many years of operation.

### **Easy operation**

The 317C-2 has motor-driven tuning and power adjustments, and is designed for unattended operation by remote control. It has complete instrumentation, and is

designed for maximum personnel safety.

### **Superior audio**

Audio frequency response is a  $\pm 0.5$  dB amplitude variation from 10 to 10,000 Hz; less than 5° phase variation from 10 Hz to midband; essentially phase linear to 30 kHz.

The 317C-2 has a flat top response, with less than 5% tilt or overshoot on trapezoidal waveforms generated by clipping a sine wave 6 dB below peak amplitude from 30 Hz to 10 kHz at 90% modulation.

### **Extra power for high peaks**

A husky 12-phase plate power supply eliminates the need for a filter reactor, provides extra power for the high positive peak demands of low frequency programming, and minimizes audio phase shift. Improved regulation virtually eliminates carrier shift.

# 50 KW AM MW TRANSMITTER

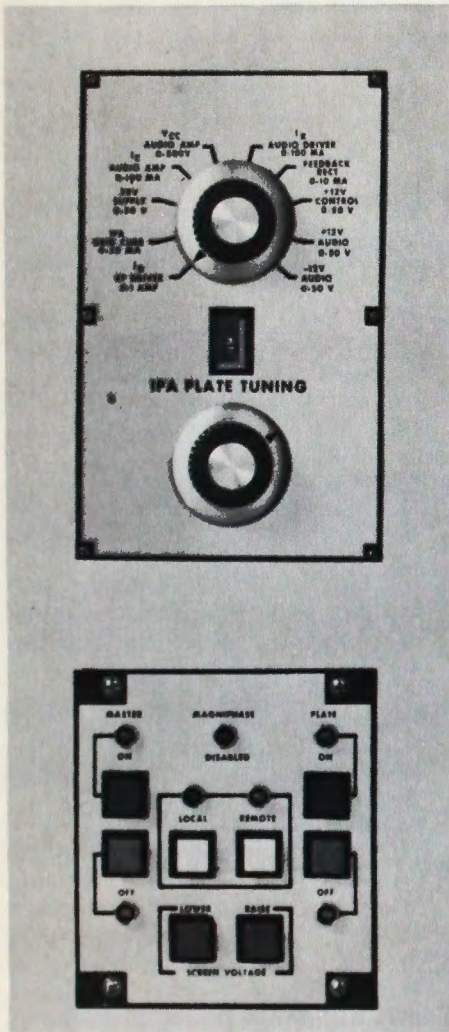

## High positive modulation

The 12-phase plate supply transformer rating and output voltage are increased to provide +125% modulation with plenty of headroom, and a 100% sinewave modulation capability down to 10 Hz.

## Program peak limiter

An automatic Program Peak Controller with adjustable positive and negative thresholds will hold peaks to limits set by station personnel. LED flashers indicate limiting.

## Ready for AM stereo

The 317C-2 is built to receive a stereo exciter, and Continental guarantees compatibility with any AM stereo transmission system established by the FCC.

## Magniphase® line protection system

Continental's Magniphase system protects transmission line, antenna and tuning equipment. It reduces power automatically and shuts down transmitter if permanent antenna fault occurs.

\*Continental Electronics Mfg. Co. holds the following patents for the high efficiency screen modulated amplifier: Canada 784,805; France 1,432,543; UK 1,044,479; USA 3,814,024.

## Specifications

### Carrier Power:

Rated	50 Kw
Capability	60 kW
Power reduction	25 kW
	or 10 kW

Modulation: High-level screen-grid impedance modulation

Emission: A3

Frequency range: Any single frequency 535-1620 kHz

Frequency stability:  $\pm 5$  Hz

Audio input:  $\pm 10$  dBm  $\pm 2.0$  dB at 100% modulation

Audio response:  $\pm 0.5$  dB, 10 Hz to 7500 Hz:  $-1.5$  dB, 15,000

Hz: ref. to 1000 Hz: at 70% modulation

Phase response:  $\pm 2^\circ$  from 10 to

1,000 Hz, and phase linear to 30 kHz with output lagging  $45^\circ$  at 15 kHz

Audio distortion: less than 2.5%, 20 to 10,000 Hz at 95% modulation

Intermodulation distortion: 3.5% at 90% total modulation by SMPTE test method using 60 and 7,000 Hz in 4:1 ratio

Carrier shift: 2% or less at 100% modulation

Tilt and overshoot:

Clipped sinewave: 5% variation in modulation percentage using 6 dB symmetrical clipping, 30 to 10,000 Hz at 90% modulation

Squarewave: 5% variation in modulation percentage, squarewave frequencies from 30 to 7,500 Hz at 60% modulation  
Modulation capability: 100% continuous at any frequency 20-10,000 Hz + 125% positive peak with asymmetrical input

Noise unweighted:  $-60$  dB below 100% modulation

Spurious & harmonic emission:  $-80$  dB

Output impedance: 40 to 300 ohms as specified by customer

Power source: 460V, 3 phase, 50/60 Hz, other available by special order

Permissible combined voltage variation:  $\pm 5\%$  voltage;  $\pm 2.5\%$  frequency

Power factor: approximately .95

Overall efficiency: better than 60% at any depth of modulation

Altitude: 7,500 feet (2286 meters) higher by special order

Ambient temperature:  $-4^\circ$  to  $122^\circ$  F ( $-20^\circ$  to  $50^\circ$  C)

Cooling: transmitter is air cooled

Size: transmitter is 144" wide, 54" deep, 78" high (365.76 cm wide, 137.16 cm deep, 198.1 cm high), plate transformer enclosure is 24" wide, 46" deep, 72" high (60.96 cm wide, 116.84 cm deep, 183.2 cm high)

Total floor space: 62 sq. ft. (5.8 sq. meters)

Net weight: transmitter (all cabinets) weighs 4,891 lbs. (2,273 kilos); plate transformer enclosure weighs 1,990 lbs. (903 kilos)

## 150/100 KW AM MW TRANSMITTER

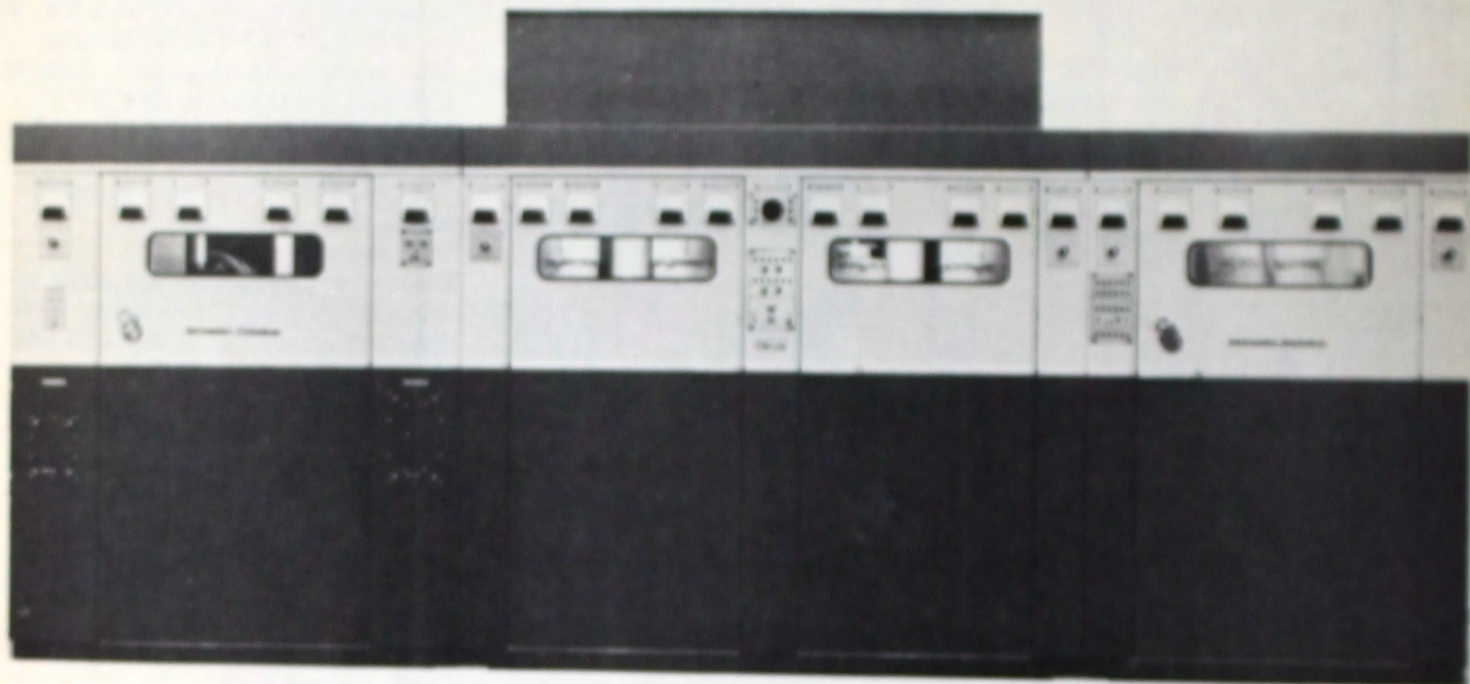

**Type 318C**  
**100,000 watt Transmitter**  
**Type 318.5C**  
**150,000 watt Transmitter**

The Type 318C is a high performance medium frequency broadcast transmitter that combines state-of-the-art components with a unique circuit design to achieve reliable operation and conservative operating costs.

The Type 318.5C 150,000 watt transmitter is identical to the 318B, except for the power supply, and output power.

### **Unique Design**

The 318C uses the straight-forward simplicity and field-proven reliability of the high-efficiency screen and impedance modulated amplifier.\*

Continental's unique design operates both carrier and peak tubes in Class "C" condition, enabling the transmitter to reach very high efficiency while limiting peak voltage to values consistent with reliable operating conditions.

The 4CX35,000A power tubes have a proven record of reliability. The transmitter uses only three tube types.

All low level stages are solid-state.

Continental's Magniphase® antenna protection circuit removes rf within microseconds following an antenna system fault that results in VSWR above a preset level.

The transmitter is air-cooled, and consists of three cabinets. External components are located behind the cabinets. Plate and low voltage distribution transformers are dry type units which do not require installation in a fireproof vault.

# 150/100 KW AM MW TRANSMITTER

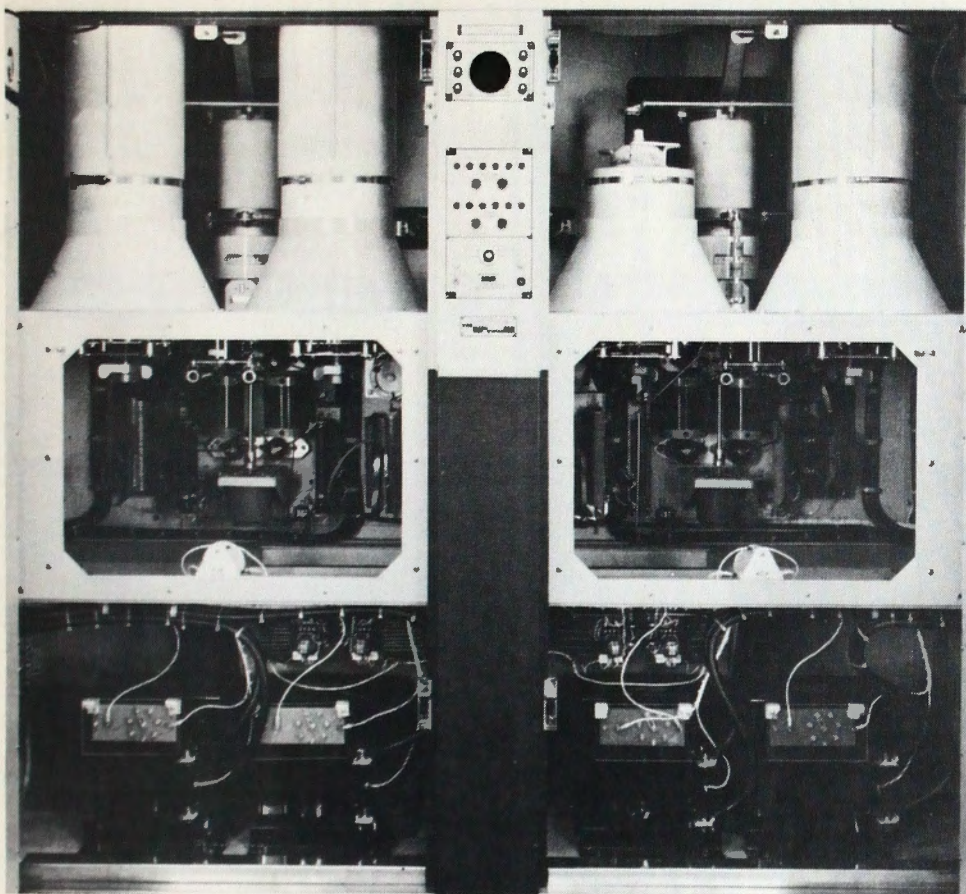

## Specifications

Carrier output power:

318C, 100,000 w; 318.5C,  
150,000 w

Frequency range:

535 - 1605 kHz

Frequency stability: assigned  
frequency  $\pm 5$  Hz

Type of power amplifier: high  
efficiency screen and impedance  
modulated

Output impedance: 200 ohms, or  
other specified

Audio frequency input impedance:  
600 ohms

Carrier shift: 4% or less up to  
100% Modulation

Audio frequency input level for  
100% modulation: 10 dBm  $\pm 2$  dB

Audio frequency response:  $\pm 0.5$  dB  
100—5,000 Hz  $\pm 1.0$  dB 50—

7,500 Hz  $\pm 1.5$  dB 30—10,000 Hz

Audio harmonic distortion: 4% or  
less 50 to 7,500 Hz @  
95% modulation

Residual carrier noise: -50 dB or  
better below 100% modulation

Harmonic radiation: exceeds  
CCIR requirements

Modulation capability: 100% 50—  
10,000 Hz

Overall efficiency: 55% or better

Power line requirements: 460 volts,  
3 phase, 3 wire, 50 or 60 Hz,  
 $\pm 5\%$  regulation

\*Continental Electronics Mfg. Co. holds the following  
patents for the high efficiency screen modulated amplifier:  
Canada 764,605; France 1,432,543; UK 1,044,479; USA  
3,314,024.

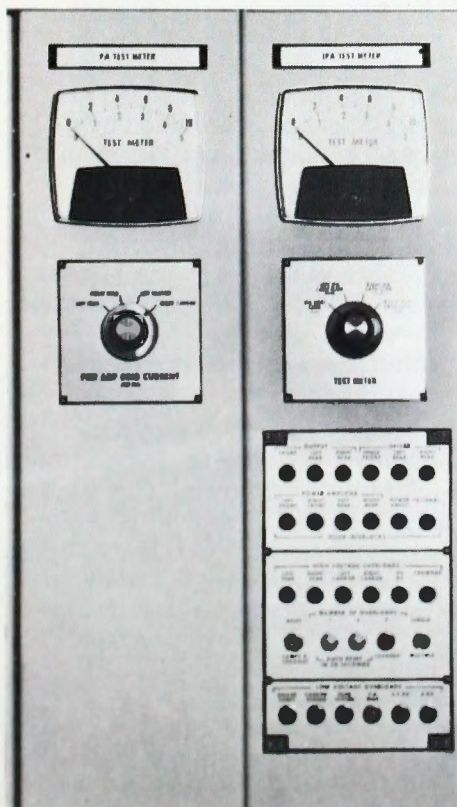



## 250 KW AM MW TRANSMITTER

---

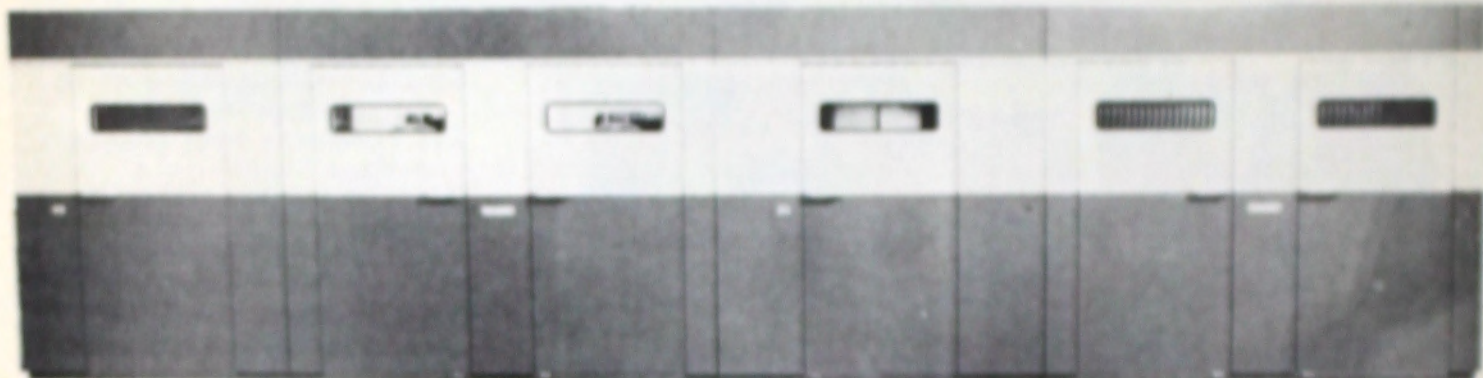

### **Type 318D 250,000 watt Transmitter**

The Type 318D is a high performance medium frequency broadcast transmitter that uses a high efficiency screen and impedance modulated final power amplifier to achieve reliable, cost-effective operation.\*

The rf driver stage utilizes two 6CX1500A tubes in a parallel configuration, and is operated Class C.

The rf driver, final power amplifier, second audio amplifier and modulator stages use vacuum tubes; all other circuits use solid state amplifiers.

The rf signal to drive the first rf amplifier stage is provided by a crystal oscillator unit. The rf amplifier and audio stages are installed in the transmitter's main cabinets. Plate transformers, rectifier assemblies, reactor, filter capacitor bank, distribution system and control circuitry system are located in an area adjacent to the main transmitter.

Continental's unique toroidal inductor is used for the carrier and peak tank inductances. This unique design achieves a much higher Q than other types of inductors, and because the coil does not produce an external magnetic field, it can be located in a small compartment within the transmitter. The inductors are adjustable for frequency change.

The transmitter is cooled by a combination of forced air and vapor-phase cooling. The water storage tank is installed within the transmitter cabinet; the heat exchanger is normally installed on the roof of the transmitter building. Vapor-phase cooling is used to cool the two 4CV2500,000B tetrode tubes used in the rf final amplifier. The remainder the transmitter is air cooled; forced air is provided by a blower unit located in a room adjacent to the transmitter room.

# 250 KW AM MW TRANSMITTER

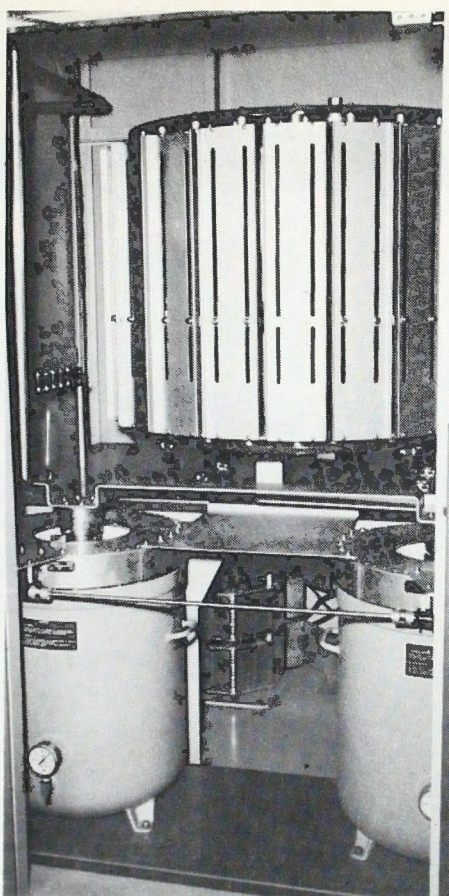

## Specifications

Carrier Output Power:

250,000 Watts

Frequency Range: 525 — 1605 kHz

Frequency Stability: assigned  
frequency  $\pm 5$  Hz.

Type of Power Amplifier:

high efficiency screen and  
impedance modulated

Output Impedance: 50 to 200 ohms,  
as specified by user

Audio Frequency Input Impedance:  
150/600 ohms

Carrier Shift: 4% or less up to  
100% modulation

Audio Frequency Input Level for  
100% Modulation: +10 dB  $\pm 5$   
dB (or other specified)

Audio Frequency Response:  $\pm 1.0$   
dB 60 — 7,500 Hz  $\pm 1.5$  dB 30 —  
10,000 Hz

Audio Harmonic Distortion:  
3.5 or less 50 to 7,500 Hz @  
90% modulation

Residual Carrier Noise:  
60 dB or better below 100%  
modulation unweighted

Modulation Capability: 100%, 50 —  
10,000 Hz

Overall Efficiency: 56%

Power Line Requirements: 4160  
volts, 3 phase, 3 wire, 50 or 60 Hz,  
 $\pm 5\%$  regulated (Other voltage if  
specified)

\*Continental Electronics Mfg. Co. holds the following  
patents for the high efficiency screen modulated amplifier:  
Canada 764,605; France 1,432,543; UK 1,044,479; USA  
3,314,024.

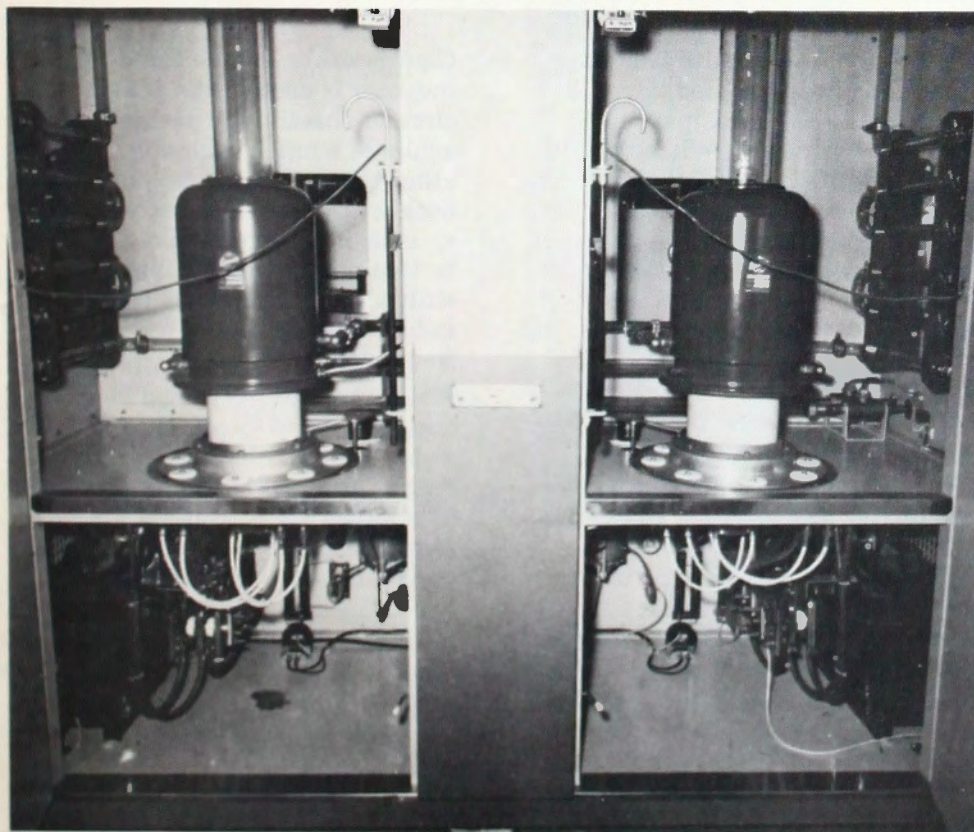

## 500 KW AM MW TRANSMITTER

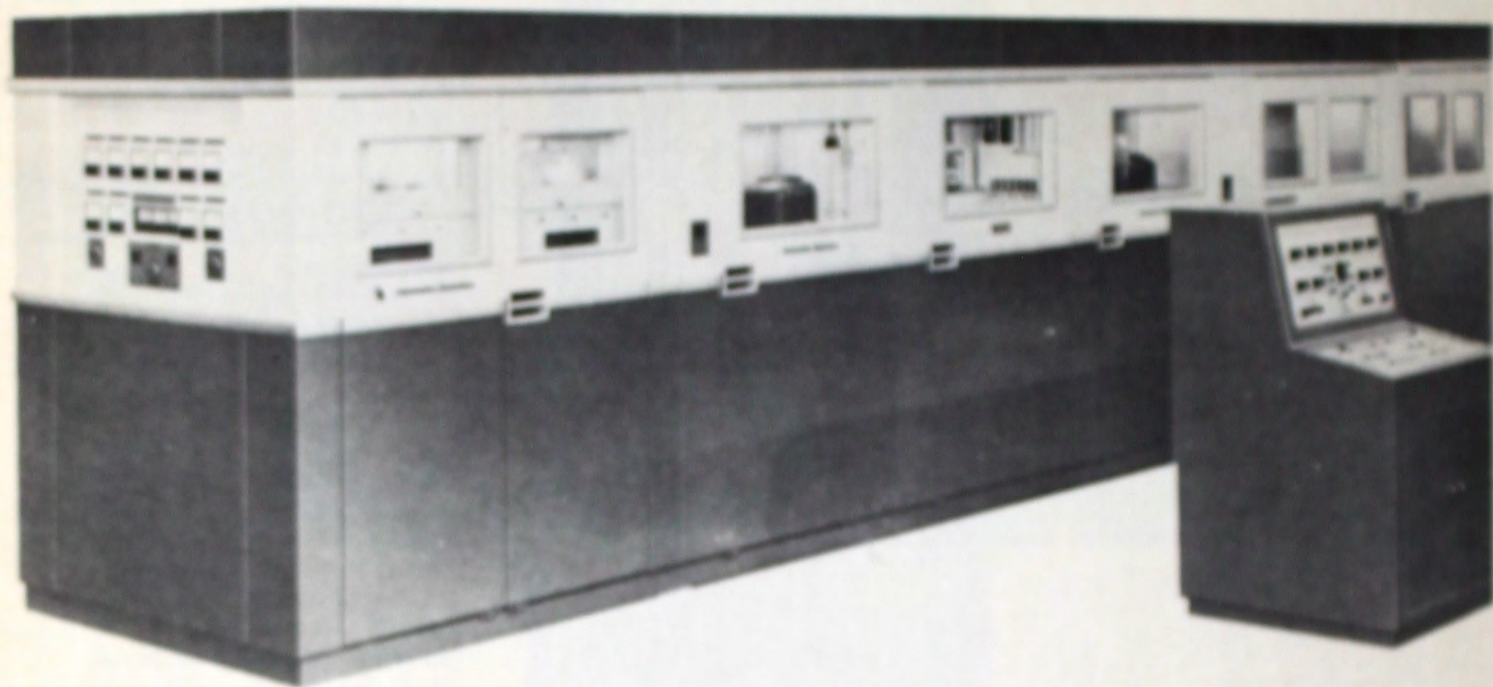

### **Type 320F** **500,000 watt Transmitter**

The Type 320F is a high performance medium frequency broadcast transmitter that uses a unique screen and impedance modulation circuit\* to achieve extremely reliable, cost-effective operation. Both carrier and peak tubes are operated in Class "C" condition, offering broadcasters very high efficiency while limiting the peak voltage to values consistent with reliable operating conditions.

The first rf amplifier uses a solid-state amplifier to drive the grid of the intermediate power amplifier.

The intermediate power amplifier consists of one 4CW25000A tetrode. The fixed power output of this stage is 10,000 watts.

The final power amplifier utilizes two X2170 water cooled tetrodes which have plate dissipation of 650,000 watts each. When used in Continental's high-efficiency screen and impedance modulated circuit\*, the maximum plate dissipation per tube is less than 200,000 watts for the carrier tube, and less than 120,000 watts for the peak tube with 100% sinewave modulation. The carrier tube provides the full 500,000 watts power output when no modulation is applied.

Two Type 4CW25,000A water-cooled tetrodes are used in the cathode follower modulator stage. When used in this configuration, the two 4CW25000A tubes have a very high overload capability and thus assure high reliability.

Continental's unique toroidal inductor is used in the peak tank circuit. This unique design achieves a much higher Q than other types of inductors, and because the coil does not produce an external magnetic field, it can be located in a small compartment within the transmitter. The inductor is adjustable for frequency changes.

The transmitter is cooled by a combination of forced air and forced water cooling. Modulator, rf driver, carrier and peak tubes are cooled by a forced water system; the remainder of the transmitter is cooled by a forced air system.

# 500 KW AM MW TRANSMITTER

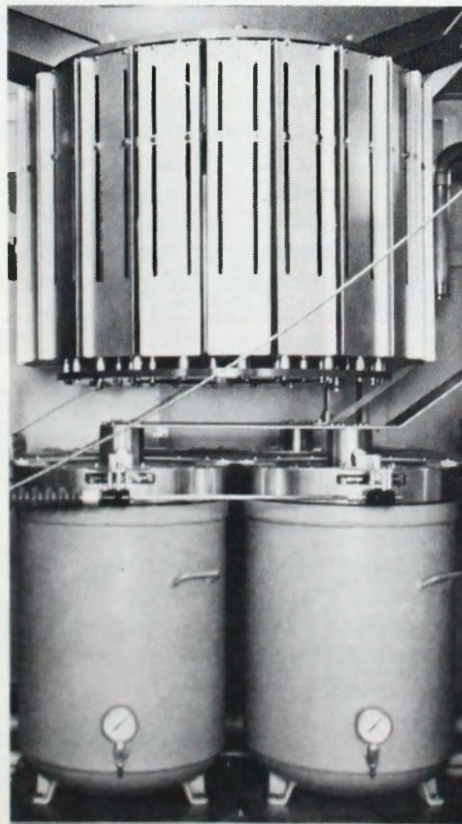
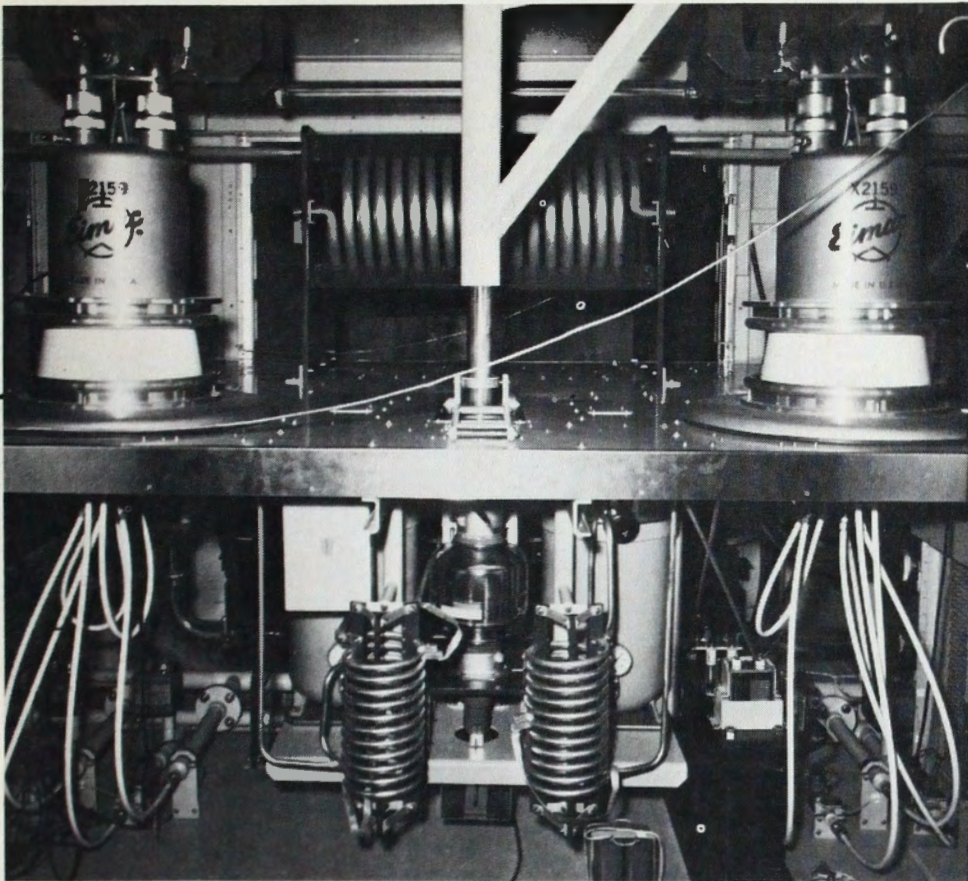

## Specifications

Carrier power output:  
525 kW

Type of emission:  
amplitude modulation (A3)

Frequency range:  
535 to 1605 kHz

Frequency stability:  
 $\pm 1$  part per  $10^7$

Modulation system:  
high efficiency screen  
and impedance\*

Output impedance:  
140 ohms, nominal  
(other available)

Audio input impedance:  
600 ohms

Audio input level for 100%  
modulation at 1 kHz:  
+8 dBm (adjustable  $\pm 5$  dB or  
as required)

Audio frequency response:  
 $\pm 1$  dB, 50 to 7,500 Hz

$\pm 1.5$  dB, 30 to 10,000 Hz

Audio harmonic distortion:  
3% or less, 50 to 7,500 Hz,  
at 90% modulation

Residual carrier noise:

-60dB, unweighted

-70 dB, C.C.I.R. weighted

Overall efficiency:  
60% or better

\*Continental Electronics Mfg. Co. holds the following  
patents for the high efficiency screen modulated amplifier:  
Canada 764,605; France 1,432,543; UK 1,044,479; USA  
3,314,024.

## 1,000 KW AM MW TRANSMITTER

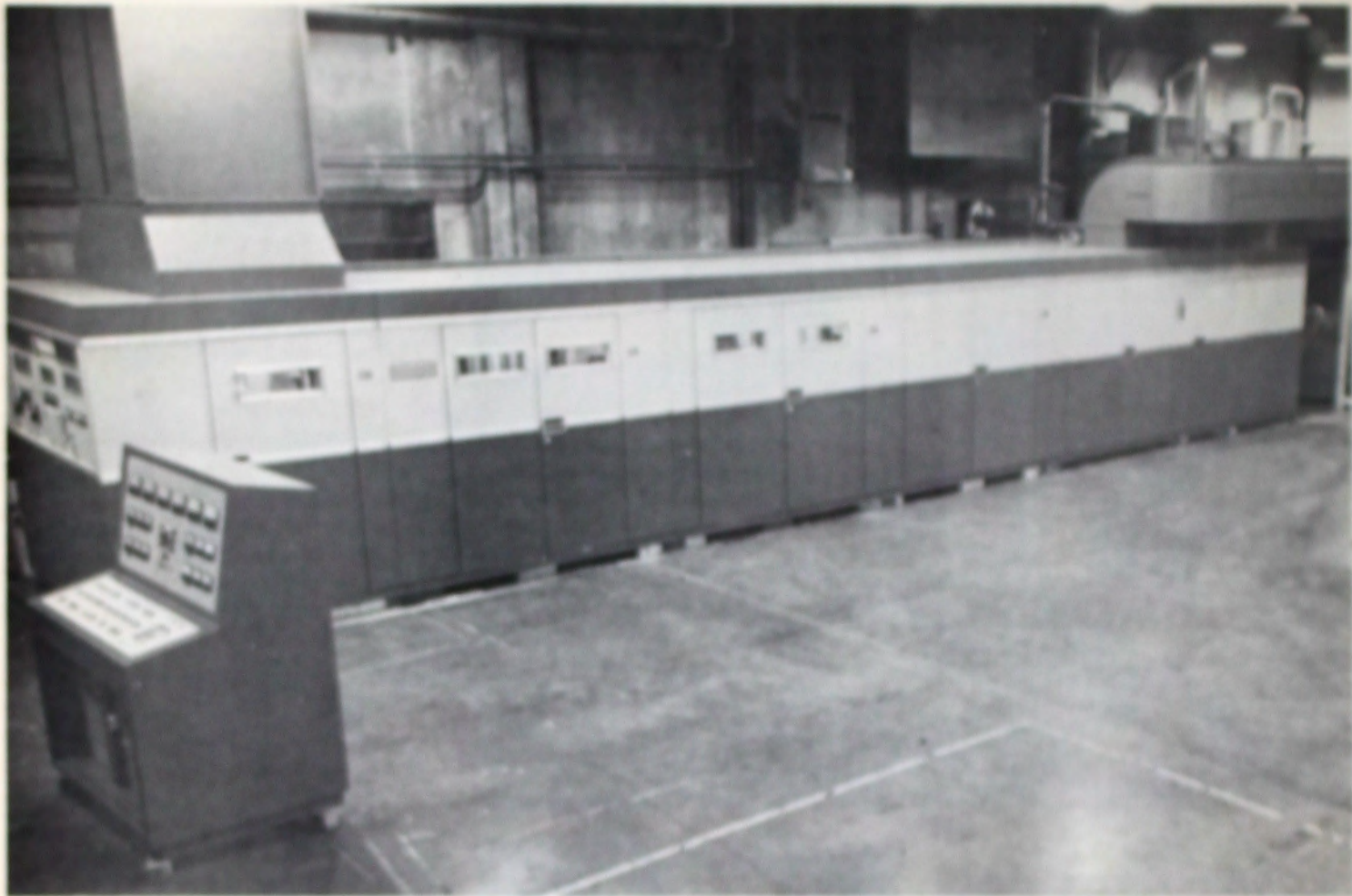

### **Type 323C 1,000,000 watt Transmitter**

The Type 323C is a high performance medium frequency broadcast transmitter that uses a unique screen and impedance modulation circuit\* to achieve extremely reliable, cost-effective operation. Both carrier and peak tubes are operated in Class "C" condition, offering broadcasters very high efficiency while limiting the peak voltage to values consistent with reliable operating conditions.

The first rf amplifier uses a solid-state amplifier to drive the grid of the intermediate power amplifier.

The intermediate power amplifier consists of one 4CW25000A tetrode. The fixed power output of this stage is 10,000 watts.

The final power amplifier utilizes two X2159 water cooled tetrodes which have a plate dissipation of 1,250,000 watts each. When used in Continental's high-efficiency screen and impedance modulated circuit\*, the maximum plate dissipation per tube is less than 400,000 watts for the carrier tube, and less than 240,000 watts for the peak tube with 100% sinewave modulation. The carrier tube provides the full 1,000,000 watts power output when no modulation is applied.

Three 4CW25000A water-cooled tetrodes are used in the cathode follower modulator. When used in this configuration, the 4CW25000A tubes have a very high overload capability and thus assure high reliability.

Continental's unique torodial inductors are used in the carrier and peak tank inductor circuits. This unique design achieves a much higher Q than other types of inductors, and because the coil does not produce an external magnetic field, it can be located in a small compartment within the transmitter. The inductors are adjustable for frequency change.

The transmitter is cooled by a combination of forced air and forced water cooling. Modulator, rf driver, carrier and peak tubes are cooled by a forced water system; the remainder of the transmitter is cooled by a forced air system.

# 1,000 KW AM MW TRANSMITTER

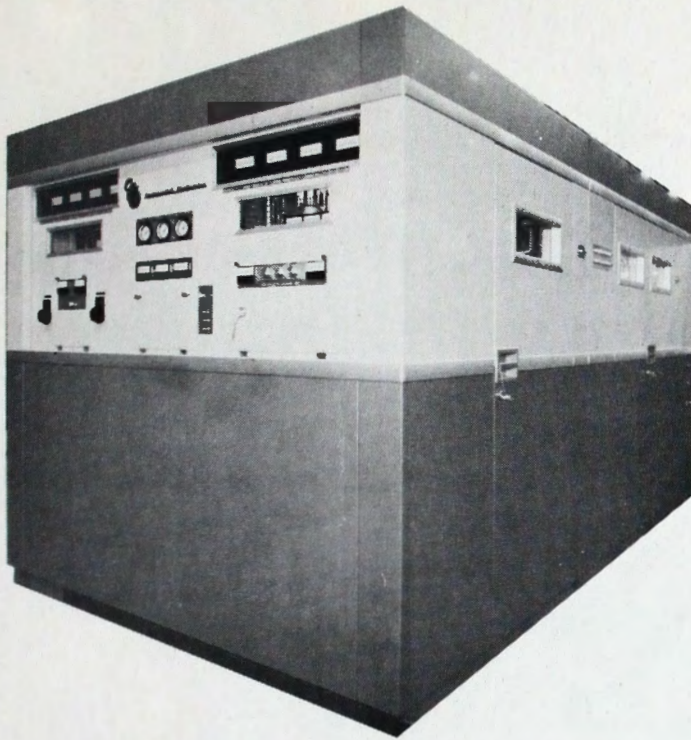

## Specifications

Carrier power output:  
1050 kW

Type of emission:  
amplitude modulation (A3)

Frequency range:  
535 to 1605 kHz

Frequency stability:  
 $\pm 1$  part per  $10^7$  per month

Modulation system:  
high efficiency screen and  
impedance\*

Output impedance:  
140 ohms, nominal  
(other available)

Audio input impedance:  
600 ohms

Audio input level for 100%  
modulation at 1 kHz:  
+8 dBm (adjustable  $\pm 5$  dB  
or as required)

Audio frequency response:  
 $\pm 1$  dB, 50 to 7,500 Hz  
 $\pm 1.5$  dB, 30 to 10,000 Hz

Audio harmonic distortion:  
3% or less, 50 to 7,500 Hz,  
at 90% modulation

Residual carrier noise:  
-60dB, unweighted  
-70 dB, C.C.I.R. weighted

Overall efficiency:  
60% or better

\*Continental Electronics Mfg. Co. holds the following  
patents for the high efficiency screen modulated amplifier:  
Canada 764,605; France 1,432,543; UK 1,044,479; USA  
3,314,024.

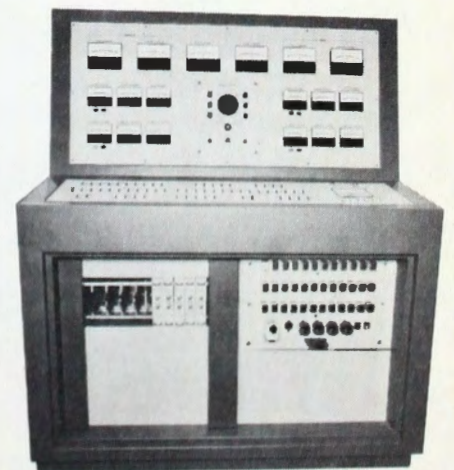
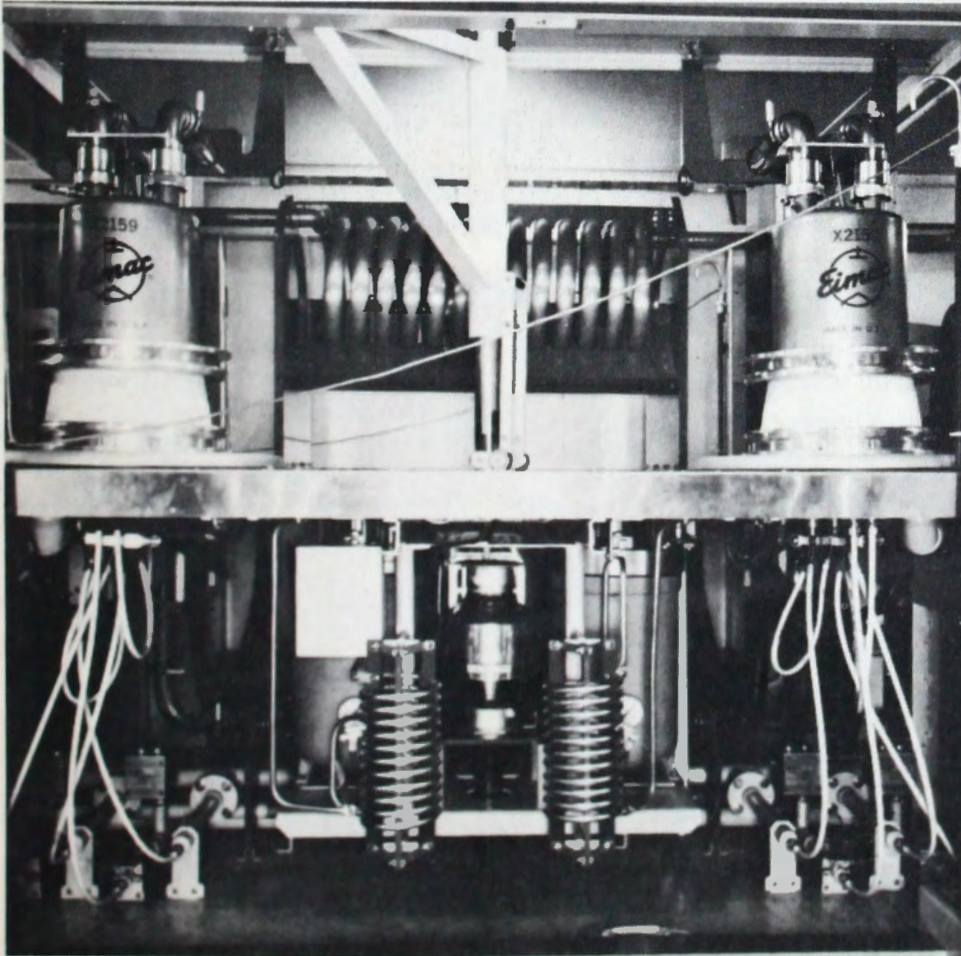

# 2,000 KW AM MW TRANSMITTER

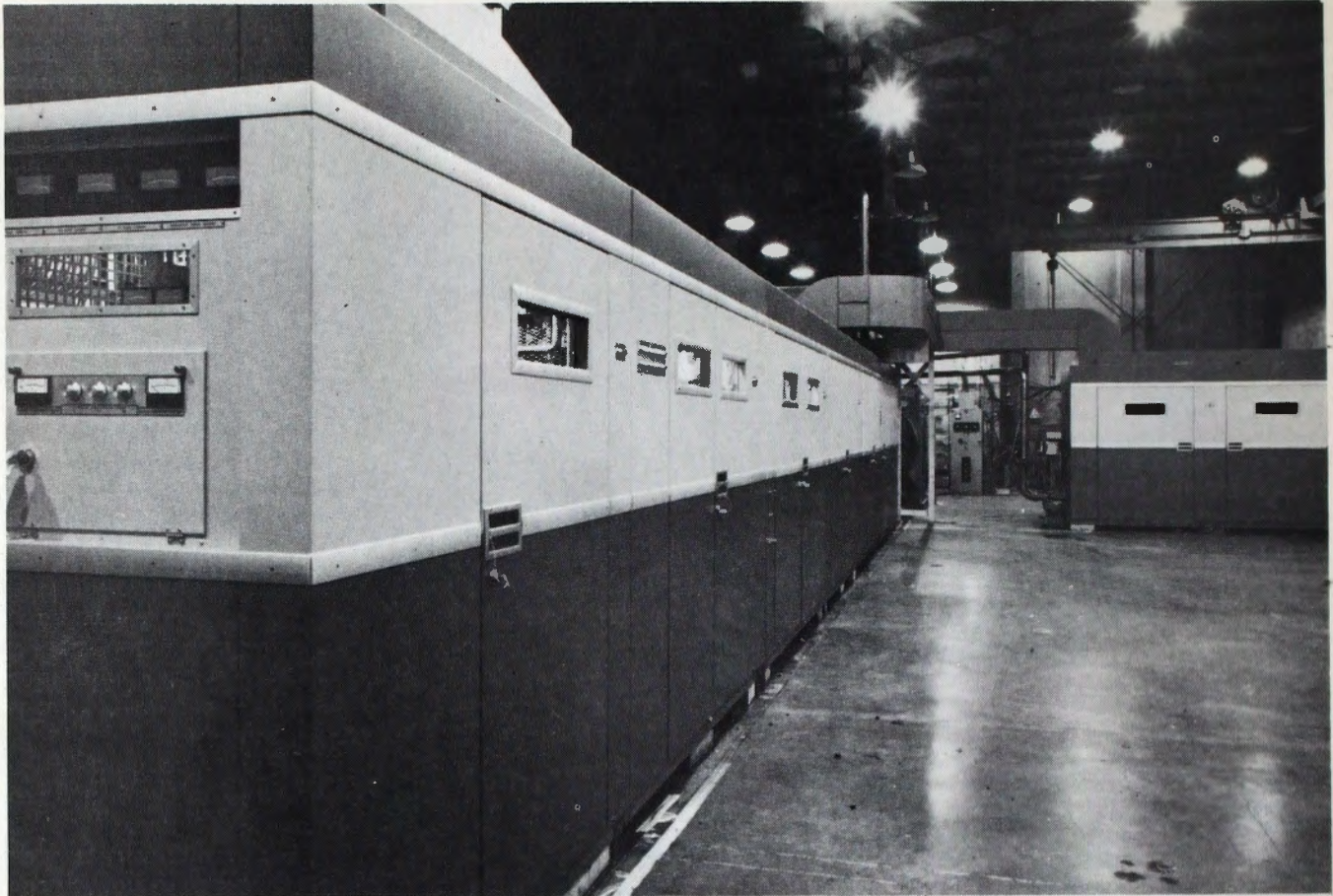

## **Type D323C 2,000,000 watt Transmitter**

The Type D323C is a high performance medium frequency broadcast transmitter that uses a unique screen and impedance modulation circuit\* to achieve extremely reliable, cost-effective operation. Both carrier and peak tubes are operated in Class "C" condition, offering broadcasters very high efficiency while limiting the peak voltage to values consistent with reliable operating conditions.

In order to increase operating flexibility while improving maintenance factors, the D323C is designed in modules of one-half the operating power level. Thus, the transmitter consists of two Type 323C 1,000,000 watt transmitters operating in parallel to achieve a total power output of 2,000,000 watts. The combiner is described in the transmitter combiner section of this catalog.

The first rf amplifier uses a solid-state amplifier to drive the grid of the rf intermediate power amplifier.

The intermediate power amplifier consists of one 4CW25000A tetrode. The fixed power output of this stage is 10,000 watts.

The final power amplifier utilizes two X2159 water cooled tetrodes which have a plate dissipation of 1,250,000 watts each. When used in Continental's high-efficiency screen and impedance modulated circuit\*, the maximum plate dissipation per tube is less than 400,000 watts for the carrier tube, and less than 240,000 watts for the peak tube with 100% sinewave modulation. The carrier tube provides the full 1,000,000 watts power output when no modulation is applied.

Continental cooperated with EIMAC Division of Varian, Inc., in the development of the X2159 tetrode, and thus has unique experience and first-hand knowledge of the effectiveness of the X2159 in high-power transmitters.

Three 4CW25000A water-cooled tetrodes are used in the cathode follower modulator. When used in this configuration, the 4CW25000A tubes have a very high overload capability and thus assure high reliability.

Continental's unique torodial inductors are used in the carrier and peak tank inductor circuits. This unique design achieves a much higher Q than other types of inductors, and because the coil does not produce an external magnetic field, it can be located in a small compartment within the transmitter. The inductors are adjustable for frequency changes.



# 2,000 KW AM MW TRANSMITTER

The transmitter is cooled by a combination of forced air and forced water cooling. Modulator, rf driver, carrier and peak tubes are cooled by a forced water system; the remainder of the transmitter is cooled by a forced air system.

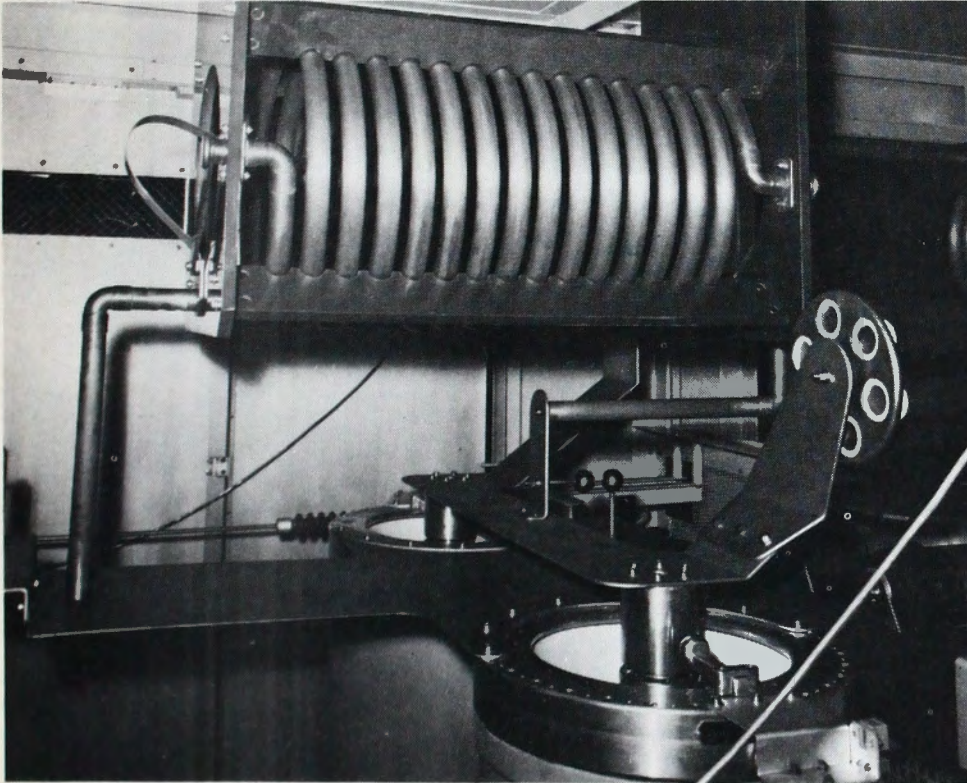

## Specifications

- Carrier power output to combiner:  
1050 kW
- Type of emission:  
amplitude modulation (A3)
- Frequency range:  
535 to 1605 kHz
- Frequency stability:  
 $\pm 1$  part per  $10^7$  per month
- Modulation system:  
high efficiency screen and impedance\*
- Output impedance:  
140 ohms, nominal  
(other available)
- Audio input impedance:  
600 ohms
- Audio input level for 100% modulation at 1 kHz:  
 $+8$  dBm (adjustable  $\pm 5$  dB or as required)
- Audio frequency response:  
 $\pm 1$  dB, 50 to 7,500 Hz  
 $\pm 1.5$  dB, 30 to 10,000 Hz
- Audio harmonic distortion:  
3% or less, 50 to 7,500 Hz, at 90% modulation
- Residual carrier noise:  
 $-60$  dB, unweighted  
 $-70$  dB, C.C.I.R. weighted
- Overall efficiency:  
60% or better

\*Continental Electronics Mfg. Co. holds the following patents for the high efficiency screen modulated amplifier: Canada 764,605; France 1,432,543; UK 1,044,479; USA 3,314,024.

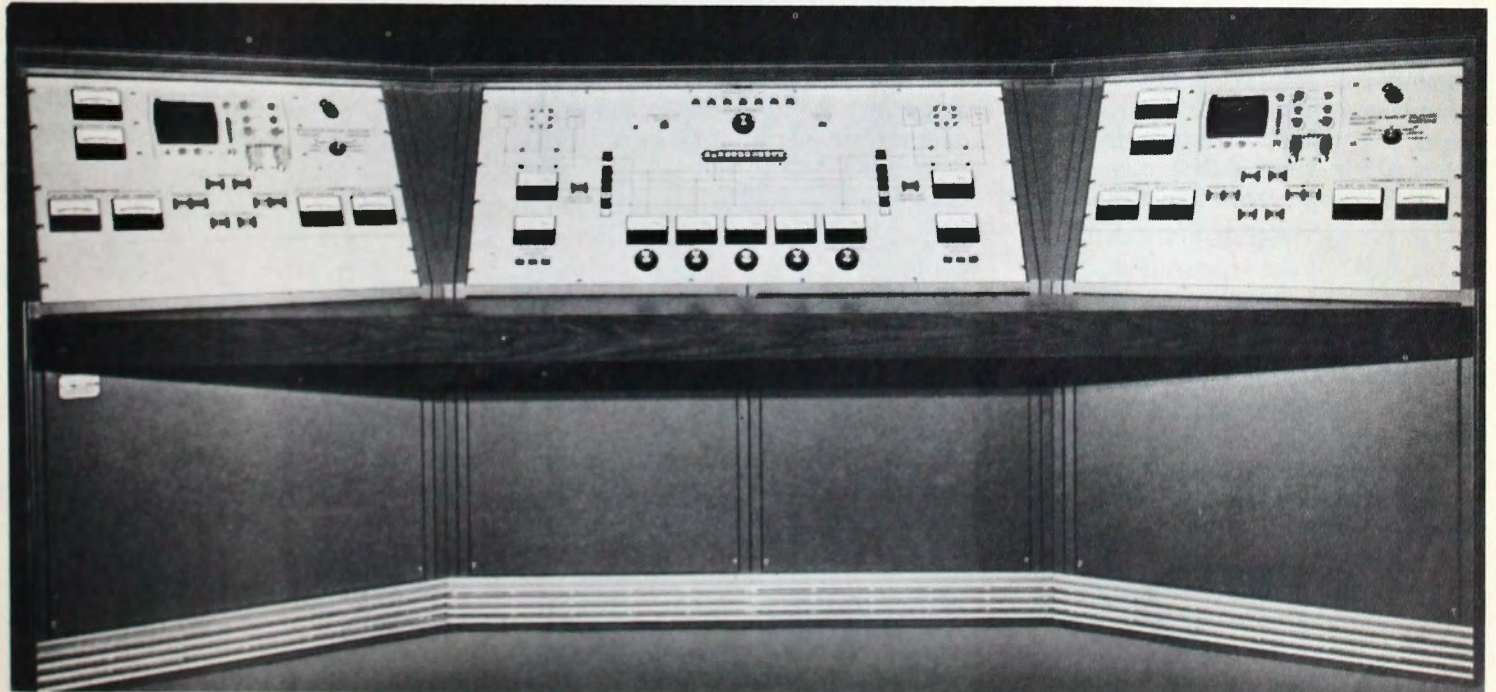



# 10 KW AM SW TRANSMITTER

---

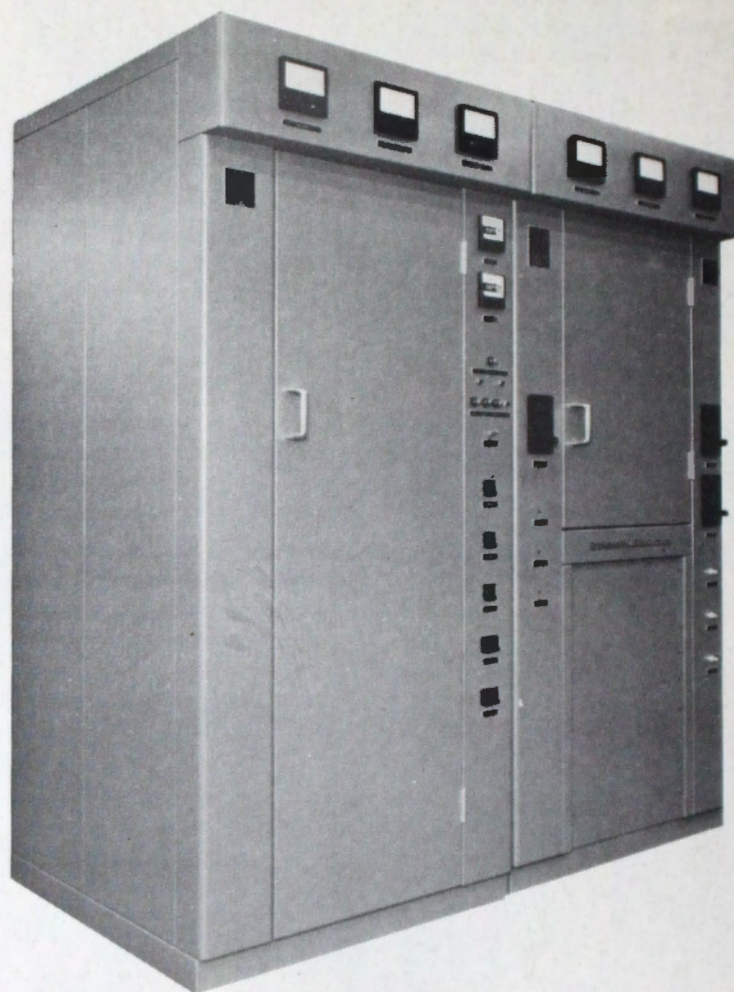

## **Type 416D**

### **10,000 watt SW Transmitter**

Continental's 10 kW short wave broadcast transmitter is a manually tuned, high quality transmitter designed for A3 operation over the frequency range from 3 to 18 MHz.

All operating controls are located on the front of the transmitter.

Front panel meters monitor all important electrical parameters.

The transmitter consists of two cabinets: one cabinet contains the power supply and control circuits, the other cabinet houses the exciter and power amplifier.

The exciter includes the modulator which provides the low-level AM signal to drive the transmitter.

The rf carrier frequency source is optional. Fixed frequency oscillators or a synthesizer can be provided.

High-gain power tetrodes are used in the linear amplifier: one 4CX350A is used for the driver stage; two 4CX15000A tetrodes, operated in parallel, make up the power amplifier.

Superior harmonic attenuation and impedance matching capability is achieved by using a "Pi-L" output network for the power amplifier.

Transmitter door interlocks and door-operated high voltage switches are used to protect operating personnel and equipment.

The 416D is self-contained, occupies approximately 1.9 sq meters of floor space, and operates efficiently in an environment of  $-10^{\circ}$  to  $+45^{\circ}\text{C}$  up to 95% relative humidity, at altitudes up to 5,000 feet (1524 m) above sea level.

# 10 KW AM SW TRANSMITTER

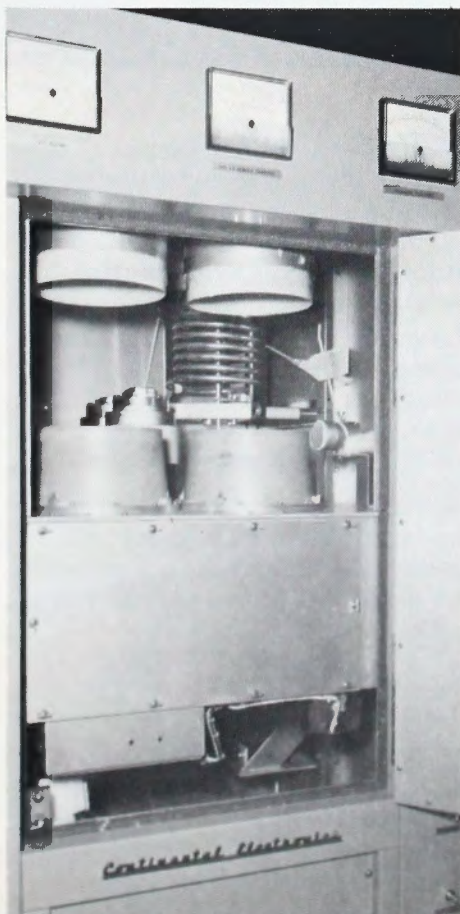
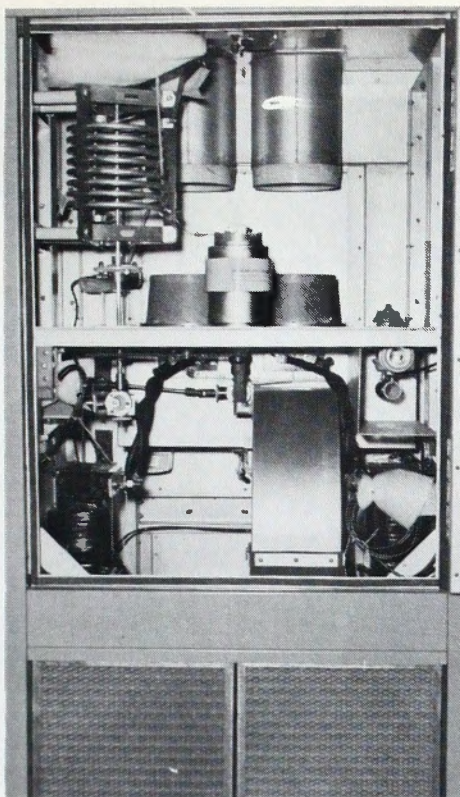
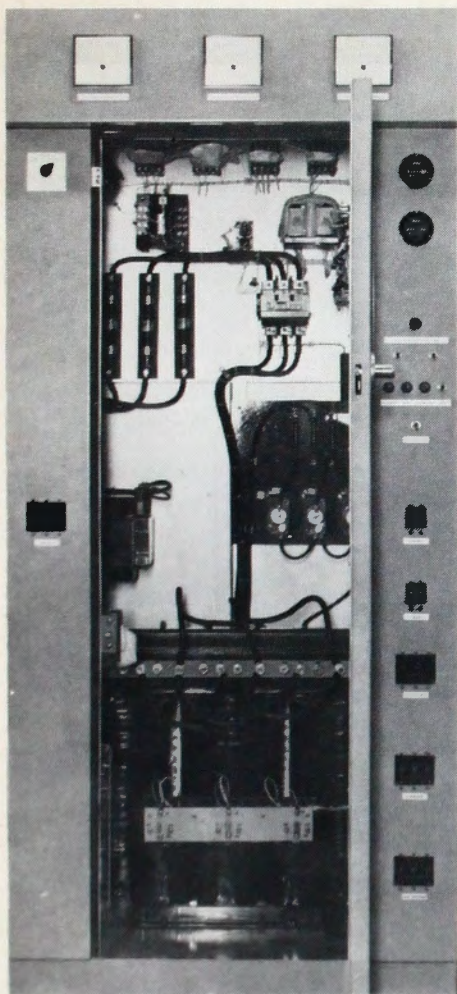

## Specifications

- RF Output Power:**  
10 kW Carrier; Reduced power optional 1 to 5 kW
- Emission:** A3
- Frequency Range:** 3 to 18 MHz
- Harmonic Attenuation:** 50 mw (complies with CCIR)
- Output Impedance:** 50 Ohm, 1 $\frac{5}{8}$ " coaxial
- Power Source:** 208/230/380 Volts, three phase, 50/60 Hz., 35 kva
- Power Factor:** .90
- Audio Input Impedance:** 150/600 Ohms, balanced or unbalanced
- Audio Input level:** (100% Modulation) + 10 dBm  $\pm$  2 dB @ 1000Hz
- Audio Frequency Response:**  $\pm$  1 dB 50 to 10,000 Hz @ 90% modulation
- Audio Frequency Distortion:** Less than 3% rms 50-7,500 Hz @ 90% modulation
- Carrier Shift:** 5% Or less @ 100% modulation
- Residual Carrier Noise:** 55 db below 100% modulation
- RF Sources:** (Optional)  
Fixed frequency oscillators or a synthesizer can be furnished
- Tuning Time:** All tuning controls are accessible from outside of the cabinet except the plug-in plate tuning coil which consists of three bands; maximum time to change from one frequency to a second frequency is approximately two (2) minutes.
- Cooling:** Forced Air
- Altitude:** 5,000 feet (1524 m)
- Ambient Temperature:** - 14°F to 113°F (- 10°C to 45°C)
- Dimensions:**  
Width 72" (183 cm)  
Depth 41" (104 cm)  
Height 78" (198 cm)
- Weight:** 2,500 lbs (1,134 Kg) net; 3,265 lbs (1,481 Kg) gross, packed for export
- Volume:** 290 cubic feet (8.2 cubic meters) packed for export

# 50 KW AM SW TRANSMITTER

---

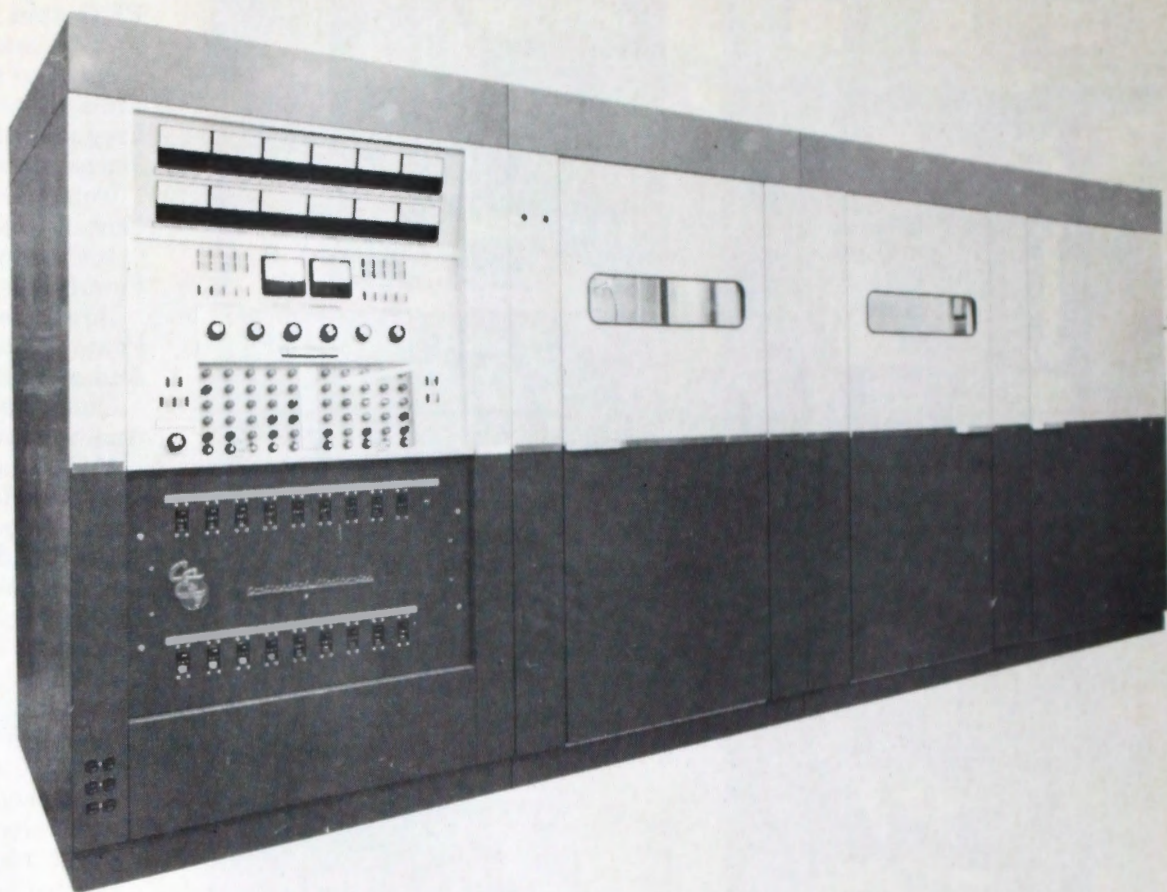

**Type 417D**  
**50,000 watt SW Transmitter**  
Continental's 50 kW SW broadcast transmitter provides high-performance with optimum efficiency.

A solid-state power hybrid circuit is used to drive the modulator; a broadband solid-state rf amplifier is used to drive the IPA amplifier. Five tuning controls make initial tuning straightforward and easy. Fast frequency change (less than one minute) over the frequency range from 3.2 to 22 MHz is provided, and up to 10 preset frequencies can be selected from the front panel without manual tuning. Two 4CX15000A air-cooled tetrodes operated in a conventional push-pull Class AB<sub>1</sub> modulator, provide high level modulation from 50 to 10,000 Hz.

The power amplifier uses a 4CX35000C air-cooled tetrode operated as a conventional grounded cathode amplifier. The resulting circuit is reliable and simple.

Large, full-width doors allow easy access for maintenance; an automatic grounding system protects operating personnel whenever an access door is opened.

The 417D uses forced-air cooling and ventilation throughout its cabinets; power vaults are cooled by natural convection and radiation.

# 50 KW AM SW TRANSMITTER

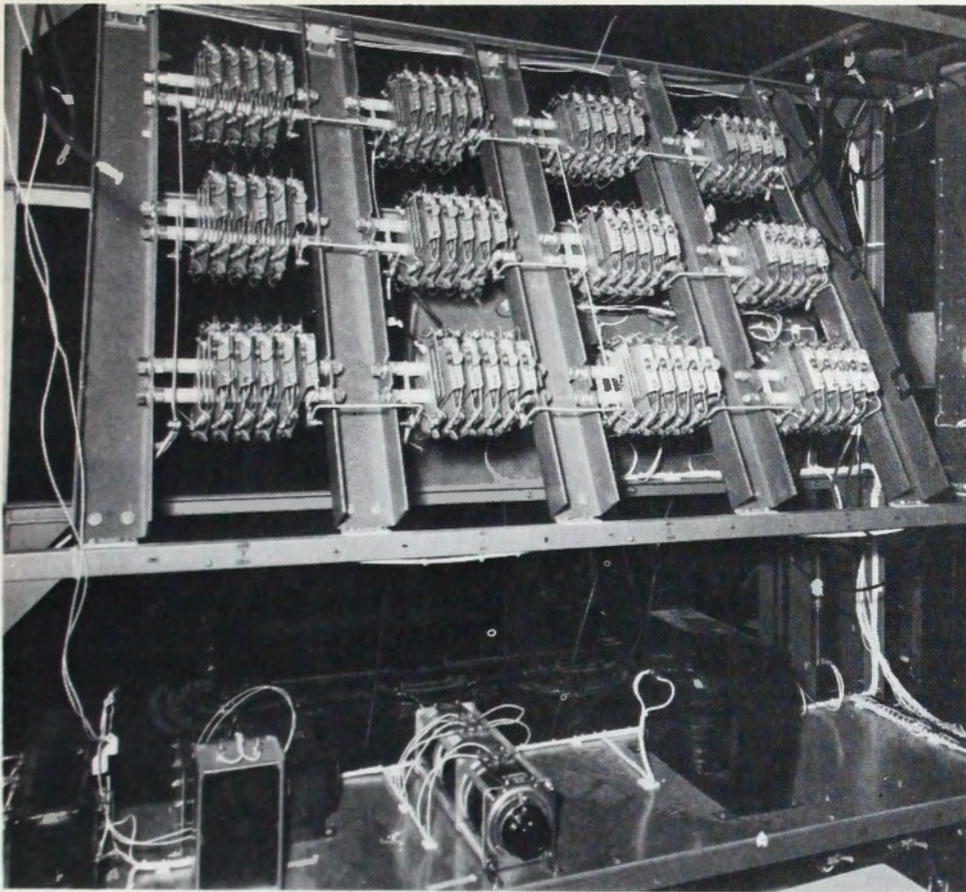

## Control system

Operation of the 417D is simplified by the use of pushbutton control switches which have built-in, lighted function labels that change color to indicate status.

Overall control circuitry is a series-parallel ladder network, with switching, timing, overloads and other interlock functions arranged in a scientific manner in the network legs to provide a comprehensive protection system.

The preset transmitter tuning system uses dc motors which are controlled by solid-state dc power amplifiers. A pushbutton switch on the control panel activates the tuning system. Multi-turn digital readout potentiometers on the control panel are used for initial positioning and manual tuning.

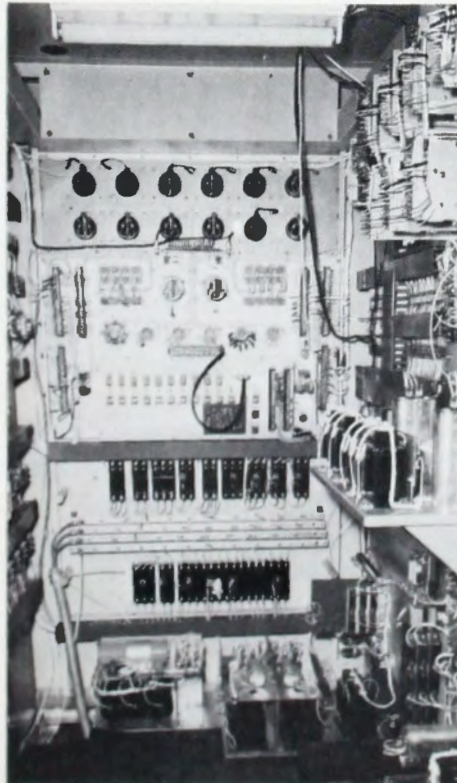

## Specifications

Carrier Output Power: 50 kilowatts

Types of Emission: Amplitude Modulation (A3) and Frequency Shift (F1)

Type of Modulation: High-level plate, Class "AB<sub>1</sub>" modulator

Final Power Amplifier: Class "C" operation

Frequency Range: 3.2 to 22 MHz

Output Impedance: 75 ohms unbalanced or 300 ohms balanced (optional). VSWR less than 1.5:1

Modulation Capability: 100%, 50 to 10,000 Hz sinusoidal.

Radio Frequency Harmonics and Spurious Radiation: Less than 50 mW (Complies with CCCIR Recommendations)

Audio Input Impedance: 600/150 ohms, balanced or unbalanced

Audio Input Levels for 100% Modulation: +10 dBm  $\pm$  2 dBm at 1000 Hz

Audio Frequency Response:  $\pm$  1 dB from 50-7500 Hz @ 90% Modulation

Audio Frequency Distortion: Less than 3% rms, 50-7500 Hz @ 90% Modulation

Residual Carrier Noise: 55 dB (unweighted) below 100% modulation level at 1000 Hz or better

Carrier Shift: Less than 3% at 100% Modulation exclusive of power line variations

Relative Humidity: 95 Percent

Altitude: 6000 feet above sea level

Power Consumption:

Unmodulated, 98 kW

Sinusoidal:

30% Modulation, 114 kW

50% Modulation, 125 kW

100% Modulation, 135 kW

Primary Power Requirements: 360 to 480 volt, ( $\pm$  5 regulation), three-phase, 50/60 Hz (other on special order)

Power Factor: 0.9 or better

Ambient Temperature Range: +5°C to +45°C

Transmitter Size:

Width 192" (487.68cm);

Depth 60" (152.40cm);

Height 84<sup>5</sup>/<sub>16</sub>" (214cm)

Transmitter Weight:

6800 lb. (3060 kg)

# 100 KW AM SW TRANSMITTER

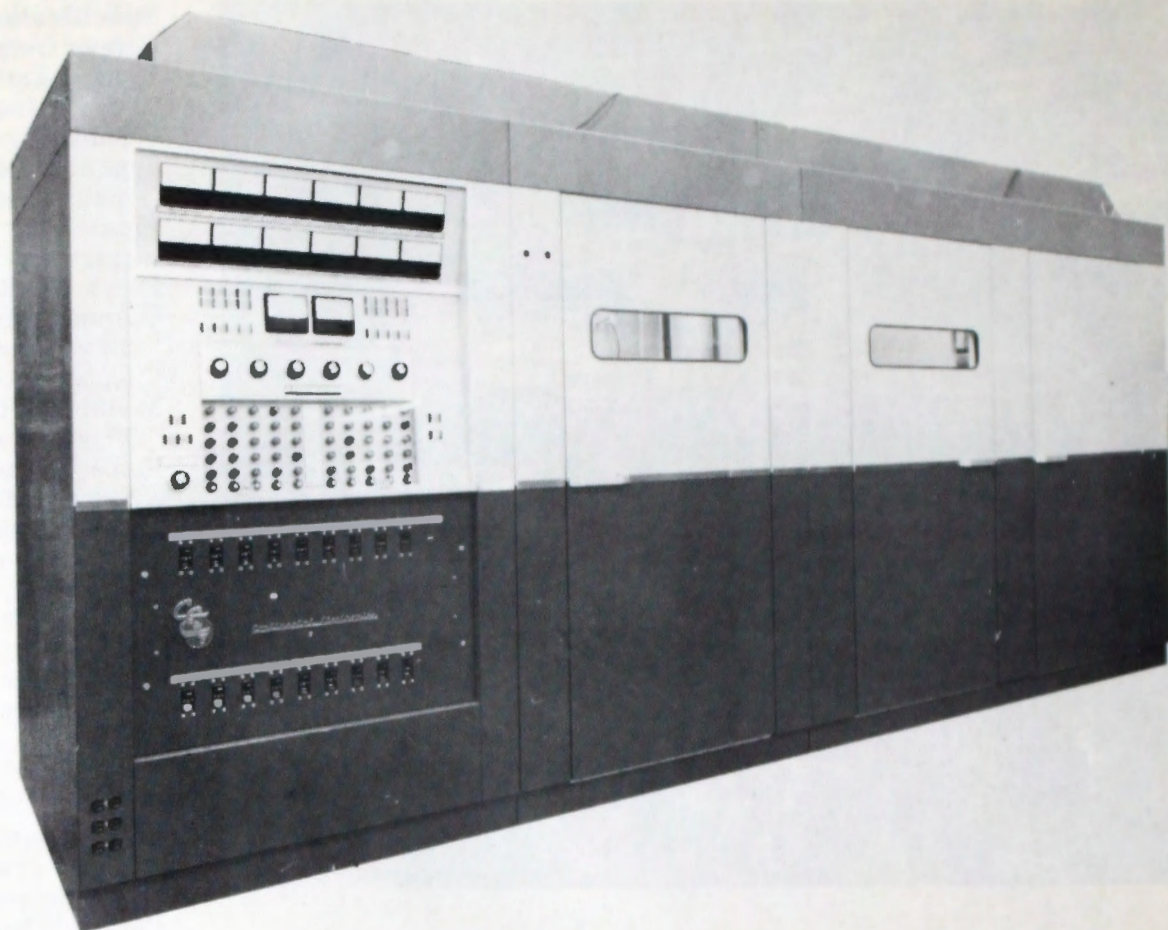

## **Type 418D-2 100,000 watt SW Transmitter**

Continental's Type 418D-2, 100 kW SW broadcast transmitter is designed for A3 operation over the frequency range of 3.2 to 22 MHz.

The 418D-2 combines the best of semiconductor technology in power supplies with the proven reliability of vacuum tube power stages to provide high-performance, cost-effective operation.

All power tubes are tetrodes. All power supplies use solid-state rectifiers.

Final amplifier and modulator tubes are 4CV100,000C vapor-cooled tetrodes that operate at 70% and 25% respectively of their dissipation capability at 100% modulation.

A 4CX3000A tetrode drives a single 4CV100,000 tetrode final amplifier in a conventional grounded cathode circuit. Solid-state amplifiers are used in all low level audio and rf stages.

Two 4CV100,000 tetrodes, operated push-pull, provide high-level, 100% modulation in Class AB<sub>1</sub>. Modulator and final amplifier tubes are vapor-phased cooled. This cooling system is greatly superior in efficiency to a water-cooled system, removing almost 20-times as much energy.

Five tuning controls make initial tuning straightforward and easy. Ten preset channels (frequencies) can be selected and activated from the front panel. After initial tuning is accomplished, frequency changes can be made in less than one minute, without additional manual tuning.

The 418D-2 uses a vapor system to cool the final rf and modulator amplifiers; forced-air cooling is used for the low level tube.

# 100 KW AM SW TRANSMITTER

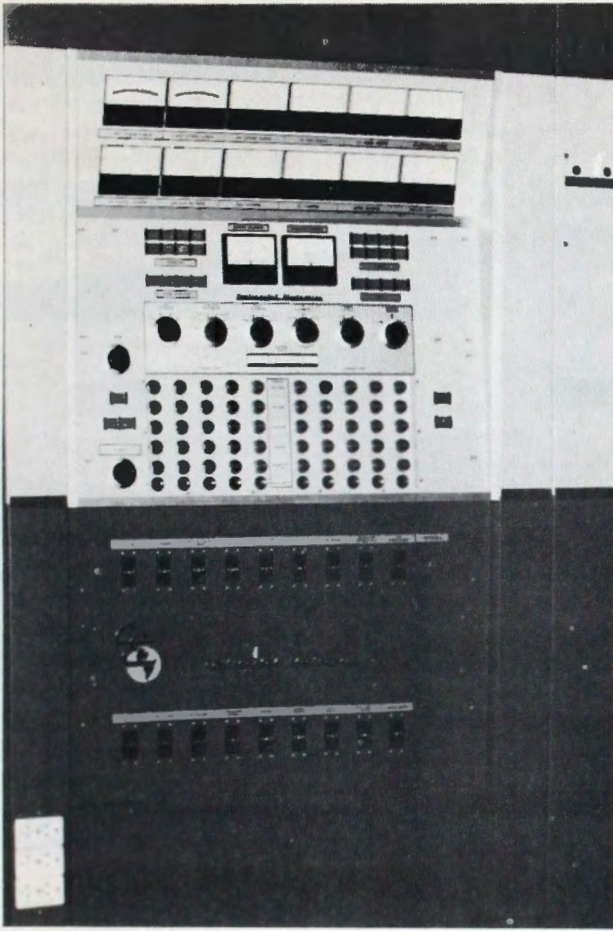

## Control system

Operation of the 418D-2 is simplified by the use of pushbutton control switches which have built-in, lighted function labels that change color to indicate status.

Overall control circuitry is a series-parallel ladder network, with switching, timing, overloads and other interlock functions arranged in a scientific manner in the network legs to provide a comprehensive protection system.

The preset transmitter tuning system uses dc motors which are controlled by solid-state dc power amplifiers. A pushbutton switch on the control panel activates the tuning system. Multi-turn digital readout potentiometers on the control panel are used for initial positioning and manual tuning.

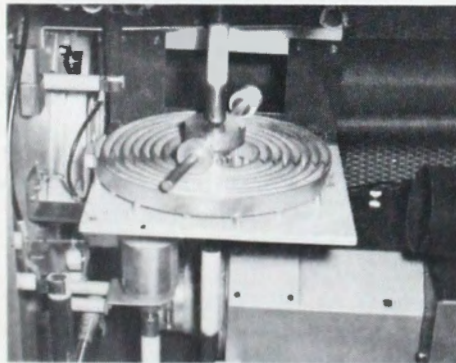

## Specifications

Carrier Output Power: 100 kilowatts

Types of Emission: Amplitude Modulation (A3) and Frequency Shift (F1)

Type of Modulation: High-level plate, Class "AB<sub>1</sub>" Modulator  
Final Power Amplifier: Class "C" operation

Frequency Range: 3.2 to 22 MHz (2.3 to 26.5 MHz optional at extra cost)

Output Impedance: 75 ohms unbalanced, 300 ohms balanced (optional at extra cost, VSWR less than 1.5:1).

Modulation Capability: 100%, 50 to 7500 Hz sinusoidal.

Radio Frequency Harmonic and Spurious Output: 50 mW (Complies with C.C.I.R. regulations)

Audio Input Impedance: 600/150 ohms, balanced or unbalanced

Audio Input Levels for 100% Modulation: +10 dBm, ±2 dBm at 1000 Hz.

Audio Frequency Response: ±1 dB from 50 to 7500 Hz

Audio Frequency Distortion: Less than 3% rms, 50-7500 Hz @ 90% Modulation

Residual Carrier Noise: 55 dB (unweighted) below 100% modulation level at 1000 Hz or better

Carrier Shift: Less than 3% at 100% modulation exclusive of power line variations

Relative Humidity: 95 percent  
Altitude: 6000 feet above sea level

Power Consumption:

Unmodulated, 175 kW

50% Modulation, 220 kW

100% Modulation, 275 kW

Power Factor: 0.95 or better

Ambient Temperature Range: +5°C to +50°C

Primary Power Requirements: 360 to 480 volts, (±5% regulation) three-phase, 50/60 Hz (other on special order)

Transmitter Size:

Width 192" (487.68cm);

Depth 60" (152.40cm);

Height 84<sup>5</sup>/<sub>16</sub>" (214cm)

Transmitter Weight:

6800 lb. (3060 kg)

# 250 KW AM SW TRANSMITTER

---

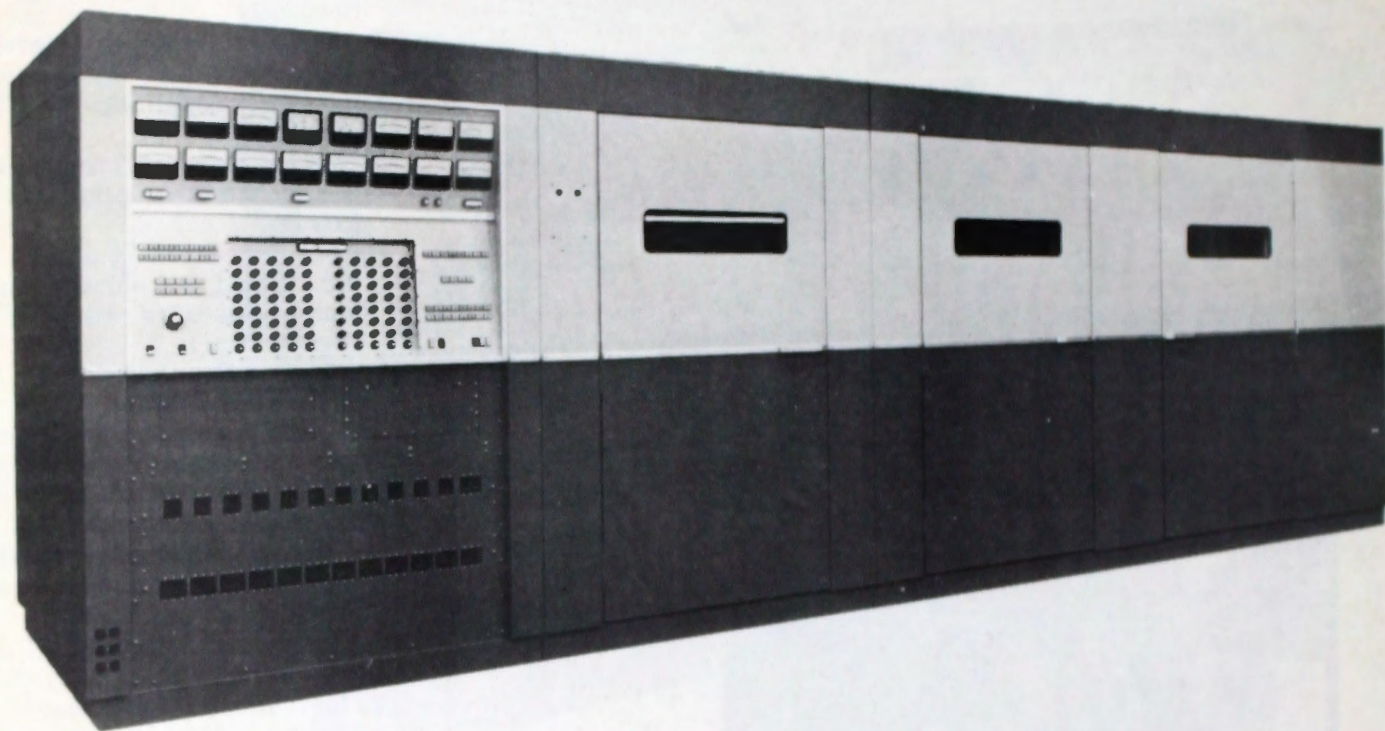

## **Type 419F**

### **250,000 watt SW Transmitter**

Continental's Type 419F is designed for A3 operation over the frequency range of 5.0 to 22.0 MHz.

The 419F combines the best of semiconductor technology in power supplies with the proven reliability of vacuum power tube power stages to achieve high-performance with cost-effective operation.

All power tubes are tetrodes. All power supplies use solid-state rectifiers.

The modulator uses two 4CV100,000C vapor-cooled ceramic tetrodes in a push-pull Class AB<sub>1</sub> circuit. All modulator components are compatible with 100% positive modulation operation.

The rf power amplifier circuit uses one 4CV250,000A tetrode. Continental's unique single-stage amplifier circuit uses special filament and screen by-pass capacitors to achieve very high stability, simplified modulation and tuning throughout the transmitter's frequency range.

All transmitter control and monitoring can be accomplished from a single front panel.

Seven tuning controls make tuning straightforward and easy.

Ten preset channels (frequencies) can be selected and activated from the front panel. After initial tuning is accomplished, frequency change can be made in less than one minute, without additional manual tuning.

The 419F uses a vapor system to cool the final rf and modulator amplifiers; the rf drive tube, output tuning and loading components are water-cooled; forced-air cooling is used for other transmitter components.

# 250 KW AM SW TRANSMITTER

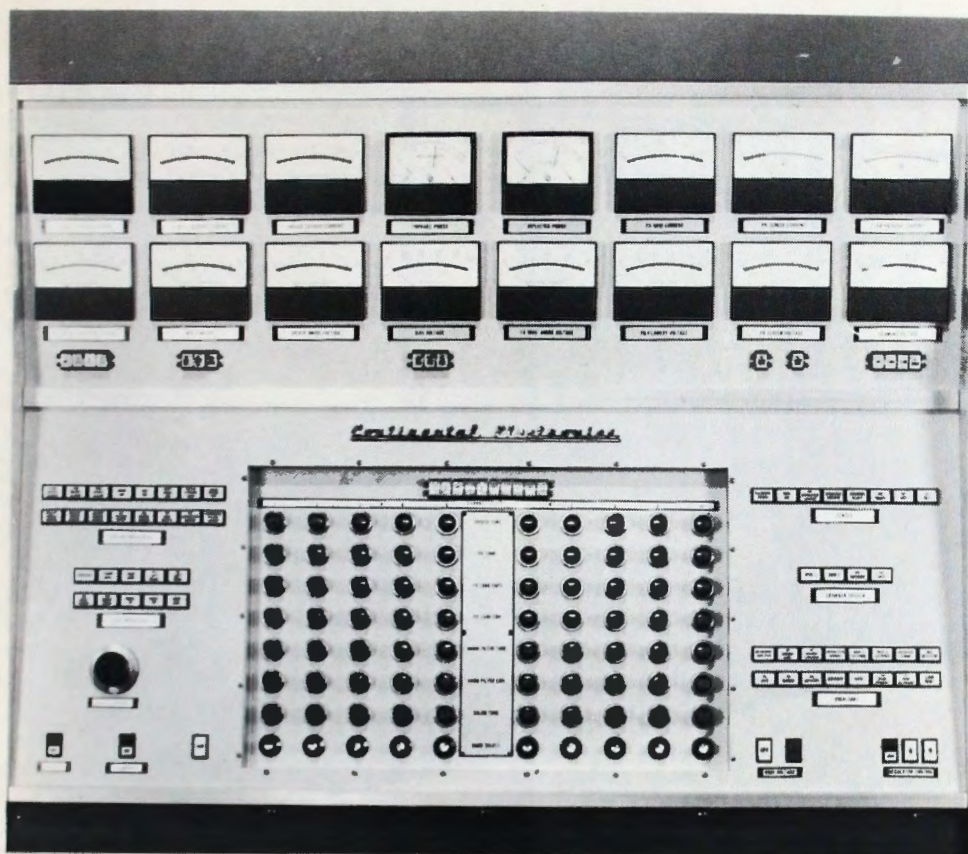

## Control system

The 419F uses a 24 volt dc control system. Most control functions use conventional electro-mechanical control logic. Basic control circuitry is in a familiar series-parallel ladder; switching, timing and interlocking functions are arranged in a logical and consistent pattern.

The transmitter has all instruments necessary for operational adjustment and maintenance procedures. All major operating parameters are displayed on easy-to-read meters which are located on the front panel. Meters are grouped in a logical and functional manner.

Multi-colored indicators on the front panel give status of various interlock and control system logic.

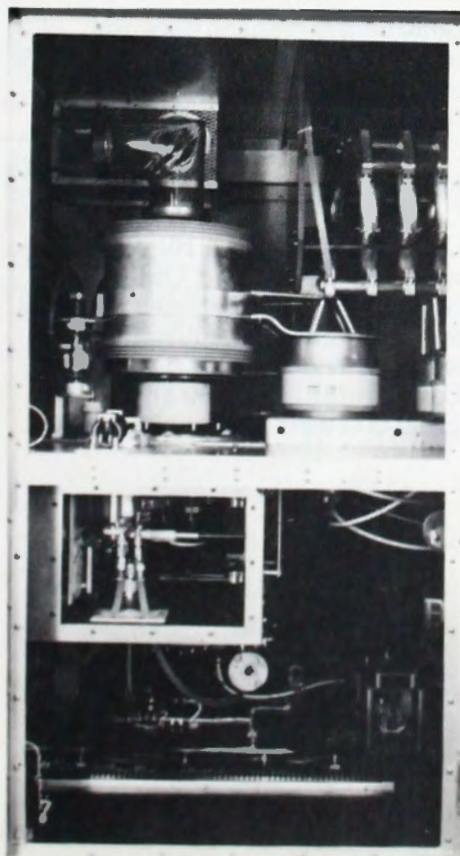

## Specifications

- Carrier Output: 250 kW
- Type of Modulation: High level plate
- Type of Emission: A3
- Frequency Range: 5.0 to 22.0 MHz
- AF Input Impedance: 600/150 ohms balanced or unbalanced
- AF Input Level for 100% Sine Wave Modulation: + 10 dBm  $\pm$  2 dBm @ 1 kHz
- AF Response:  $\pm$  2 dB 50 to 7.500 Hz @ 90% modulation
- AF Distortion: Less than 5% THD 50-7,500 Hz @ 95% modulation
- Carrier Shift: Less than 5% not including line variations
- Modulation Capability: 100% positive and negative peaks 50-7.500 Hz Sine
- Residual Carrier Noise: 50 dB (unweighted) below 100% modulation at 1 kHz or better
- RF Harmonic Output and Spurious Response: Complies with CCIR regulations
- Output Impedance: 75 ohms unbalanced or 300 ohms balanced (optional); max. VSWR 1.8
- Power Source: 4160v, 3 phase, 50/60 Hz (other on special order)
- Power Factor: 0.9 or better
- Power Consumption:
  - Carrier-unmodulated: 475 kW
  - Carrier-modulated, 100% Sine wave, 675 kW
- Altitude: 6,000 feet above sea level (1828.8m)
- Relative Humidity: 95%
- Ambient Temperature Range: 32F to 113F (0 C to 45 C)
- Exciter: Any suitable exciter with  $\frac{1}{2}$  watt output, 5.0-22.0 MHz
- Dimensions, Main Cabinet Group:
  - Width 22' (6.71 m);
  - Depth 14' (4.27 m);
  - Height 7' (2.13 m)
- Power Supply Vault:
  - Width 27' (8.23 m);
  - Depth 14' (4.27 m);
  - Height 7' (2.13 m)
- Weight: 45,600 lbs. (20,520 kg) packed for export.
- Volume: 3,000 cu. ft. (84.95 cu. m.)



# TRANSMITTER COMBINERS

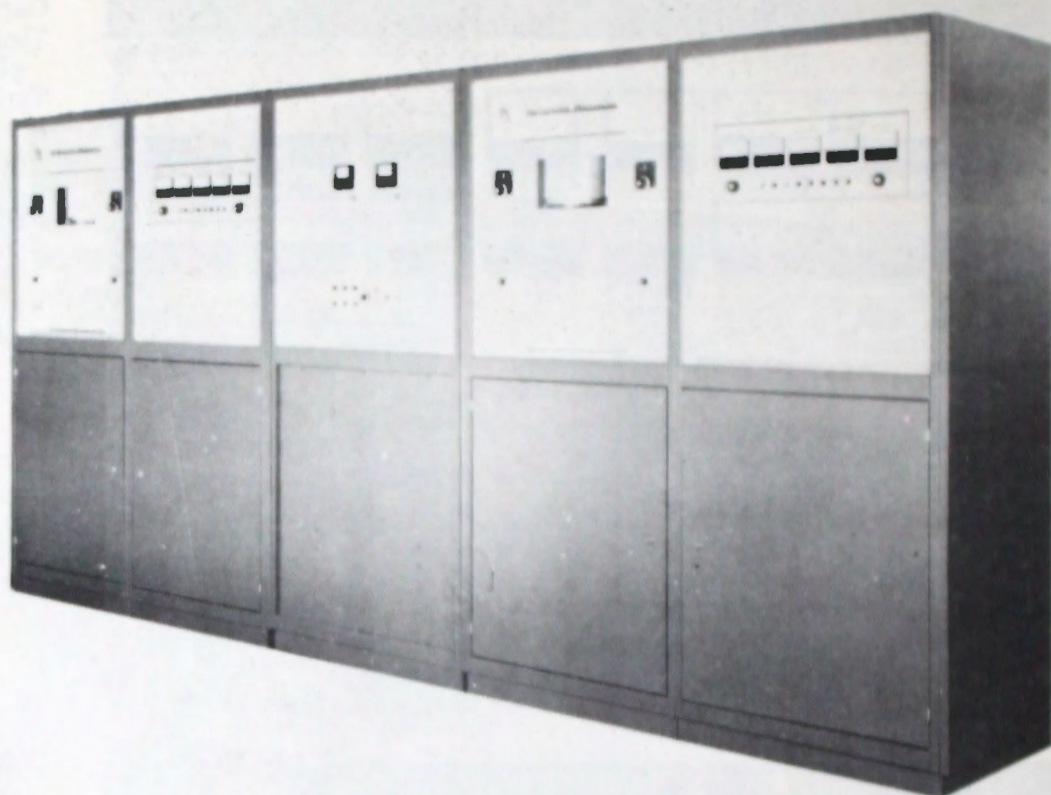

## Introduction

Many of Continental's medium power AM and FM, and high-power AM broadcast transmitters can be combined to achieve higher power output levels.

Continental 20,000 and 25,000 watt FM transmitters can be combined to develop 40,000 and 50,000 watts output. Each of these higher power transmitters are type approved by the FCC.

Continental 10,000 and 50,000 watt AM transmitters can be combined to develop 20,000 and 100,000 watts output.

Continental high-power broadcast transmitters utilize combiners to increase operating factors: Two Continental Type 320F 500,000 watt transmitters can be combined to develop 1,000,000 watts output power; Two Continental Type 323C 1,000,000 watt transmitters can be combined to develop 2,000,000 watts output power.

Continental transmitters and combiners are used by broadcasters around the world to meet unique transmitter power or station operating requirements.

Following is a brief overview of Continental's combiner for the Continental Type D316F 20,000 watt AM transmitter. Other combinations are outlined on pages for Continental 40,000 and 50,000 watt FM transmitters, and Continental 1,000,000 and 2,000,000 watt AM transmitters.

## Combiner for Type D316F 20,000 watt AM transmitter

Continental's D316F consists of two Type 316F 10,000 watt AM broadcast transmitters combined to achieve 20,000 watts of output power.

The combiner is housed in one cabinet that matches the cabinets of the two 316F transmitters, and is normally placed between the two transmitters. Other arrangements are possible.

The combiner front panel has controls for operating the two 316F transmitters: either as combined or single transmitters. Indicator lamps show system status, phase control of rf output, rf output current meter and waster load current meter.

A convection-cooled waster load is located within the combiner cabinet. This load also serves as a dummy load during single transmitter operation.

# TRANSMITTER COMBINERS

The combiner offers three modes of transmitter operation: two 316F transmitter combined for 20,000 watts output to the antenna; 316F number one operating into the antenna at 10,000 watts and 316F number two operating into the dummy load; 316F number one operating into the dummy load and 316F number two operating into the antenna.

## Combiner circuit

The combining circuit provides complete isolation of one transmitter from the other. Thus, the load resistance is constant and independent of differences between the two transmitters: the output of one transmitter may be open or short circuited without affecting the other. As an option, the combiner can be built so if one transmitter fails, the full power of the remaining transmitter will be delivered to the antenna.

## Waster load

The waster load terminates networks of the combiner from each transmitter. When both transmitters are in phase and equal in power, there will be no power in the waster load. This method allows maximum power to be delivered to the antenna.

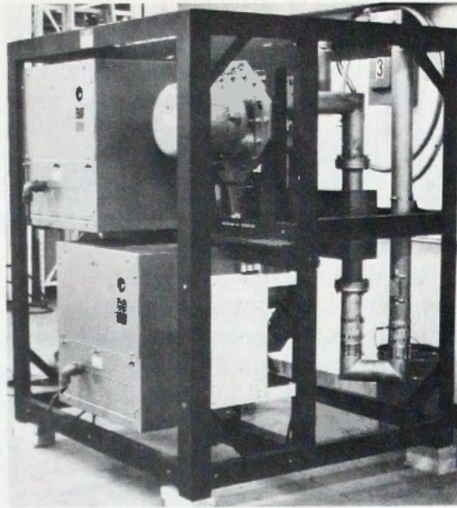

## Combiner for Type 817R-1 50,000 watt FM Transmitter

Continental's 817R-1 consists of two Type 816R-3 transmitters combined to achieve 50,000 watts of output power.

The combining is accomplished in a 90 degree hybrid coupler that may be used alone or in conjunction with motor activated coaxial switches. The motor activated switch and coupler assembly is appropriate for automatic switched operation of combined transmitters. The hybrid coupler introduces less than 0.1 dB loss and no more than a 1.1 VSWR in a 50 ohm system. Isolation between the combined transmitters is a least 30 dB.

The 50,000 watt hybrid coupler carries part number 124-3015-728; the hybrid coupler and switch assembly carries part number 124-3015-729.

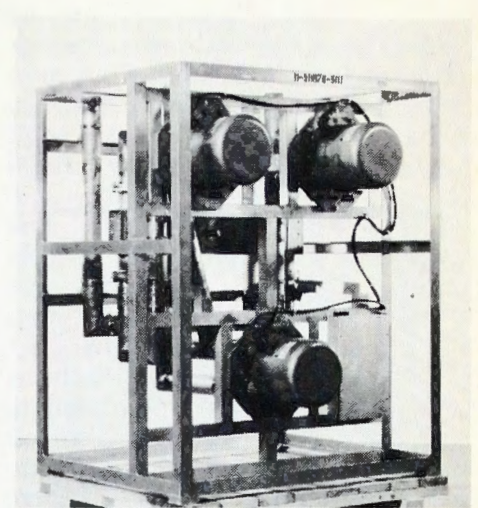

## Combiner for Type 817-2 40,000 watt FM Transmitter

Continental's 817R-2 consists of two Type 816R-2 transmitters combined to achieve 40,000 watts of output power.

The combining is accomplished in a 90 degree hybrid coupler that may be used alone or in conjunction with motor activated coaxial switches. The motor activated switch and coupler assembly is appropriate for automatic switched operation of combined transmitters. The hybrid coupler introduces less than 0.1 dB loss and no more than a 1.1 VSWR in a 50 ohm system. Isolation between the combined transmitters is at least 30 dB.

The 40,000 watt hybrid coupler carries part number 124-0052-974; the hybrid coupler and switch assembly carries part number 124-0052-972.



Continental 100 kW combiner is used to combine the output of two Continental Type 317C-2 50,000 watt AM broadcast transmitters.

# TRANSMITTER DUMMY LOADS

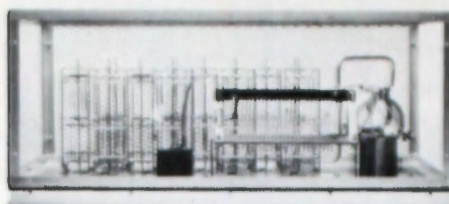
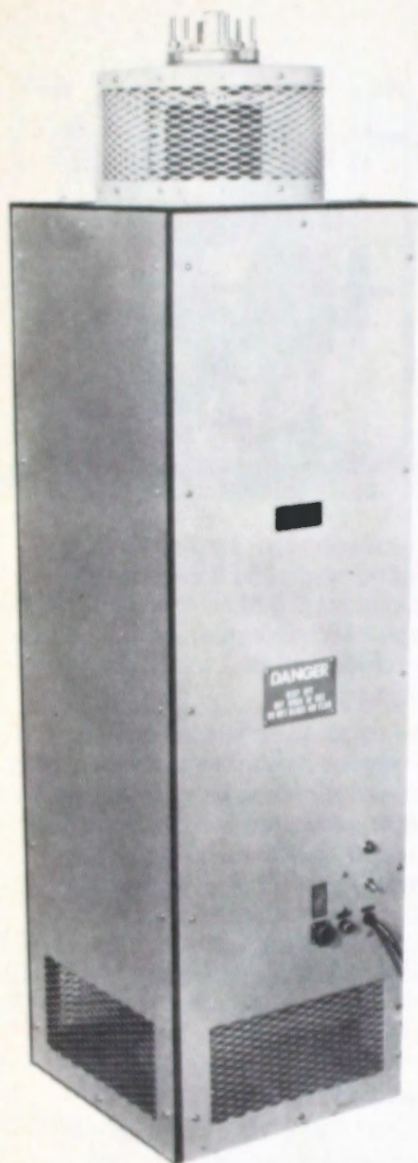

**Continental Type 516F  
5/10 kW AM Dummy Load**  
Continental's Type 516F is a convection air cooled dummy load that will handle a 10 kW transmitter at 125% modulation. It is supplied as an essentially flat load on a customer specified frequency and impedance in the standard medium wave broadcast band. An rf ammeter is optional. Size of coils and capacitors varies with frequency and impedance.

Size: 40" (101.60 cm) W  
26" (66.04 cm) D  
12" (30.48 cm) H  
Weight: 60 lb (27 kg)

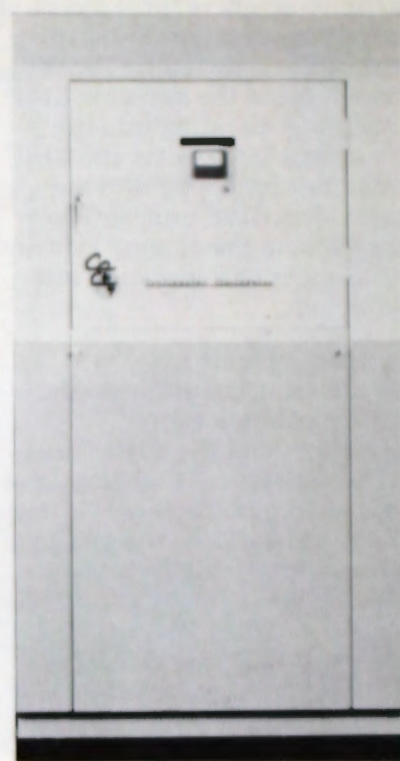

**Continental Type 517C-1  
50 kW AM Dummy Load**  
Continental's Type 517C-1 is an air-cooled rf dummy load designed for continuous and reliable operation over the frequency range from 535 to 1620 kHz. The dummy load is factory adjusted to meet customer operating frequency and rf output impedance requirements. The load is intended primarily for use with 50 KW AM broadcast transmitters to provide a load for the rf power amplifier for testing purposes, or when it is not desirable

**Electro Impulse  
Model DPTC-25KFM  
FM Dummy Load**

Model	Avg Pwr (Kilowatts)	Freq Range (dc MHz)	Max VSWR	EIA Connector in (cm)	Size			Wt lb (kg)	Reqd Pwr (v ac 1 phase)
					D in (cm)	W in (cm)	H in (cm)		
DPTC-10KFM	10/12	108	1.2:1	3 3/4 (7.9)	11 (27.9)	16 (40.6)	38 (96.5)	37 (16.8)	110
DPTC-25KFM	25	108	1.2:1	3 3/4 (7.9)	17 (43.1)	17 (43.1)	63 (160)	100 (45.4)	110
DPTC-50KFM	55	108	1.2:1	6 3/4 (15.5)	21 (53.3)	21 (53.3)	65 (165.1)	120 (54.4)	220
DPTC-75KFM	80	108	1.25:1	6 3/4 (15.5)	26 (66)	26 (66)	65 (165.1)	150 (68)	220

# TRANSMITTER DUMMY LOADS

to radiate rf output. The power dissipation rating is 75 KW. The dummy load is housed in a single cabinet having excellent shielding properties and providing easy access. An rf current meter is used for determining power and can be viewed through a glass panel in the front door. An air-flow interlock switch shuts-off transmitter plate voltage if dummy load or transmitter doors are opened, or if there is a loss in air pressure in the transmitter or dummy load cooling system.

## Specifications

Frequency range: 535 to 1620 kHz

Power dissipation: 75 KW

Resistance: Factory-adjusted to customer's transmitter rf output impedance

RF connections: Insulator "bowl" on top of cabinet

Size: Width 42" (107 cm)  
Depth 40" (102 cm)  
Height 78" (198 cm)

Weight: 950 Lbs (431 Kg)



## Continental Type DL-418 100 kW Dummy Load

Continental's Type DL-418 is a high-power rf dummy load designed for continuous and reliable operation over the frequency range from 0.1 to 100 MHz. The dummy load can be used without power derating over its full frequency

range. Measured VSWR is less than 1.1:1. The load, including its external heat exchanger and coolant tank, is equipped with an external interlock control having interface connections via a terminal board. Ambient operating temperature range is from 32° to 110°F (0° to 44°C). An ethylene glycol mixture (35%) can be used to extend lower temperature range. 50 Hz operation and a calorimeter panel are available at additional cost. Measurement accuracy of the optional calorimeter is better than 5%.

## Specifications

Power Rating: 100 kilowatt average; 200 kilowatts PEP.

Impedance: 50 OHMS (unbalanced)

Frequency Range: 0.1 to 100 MHz.

VSWR: Less than 1.1 to 1 to 100 MHz.

ac Power Required: 230 VAC, 30A, 3φ, 60 Hz (50 Hz optional)

Service: AM, FM, TV, SSB, FSK or C.W.

Duty Cycle: Continuous

Size (Load Unit Only): Width—2 feet (61 cm); Depth—1.5 feet (46 cm); Height—6 feet (183 cm)

Shipping Weight: 2500 Lbs (1134 Kg) includes load, heat exchanger and coolant tank (crated)

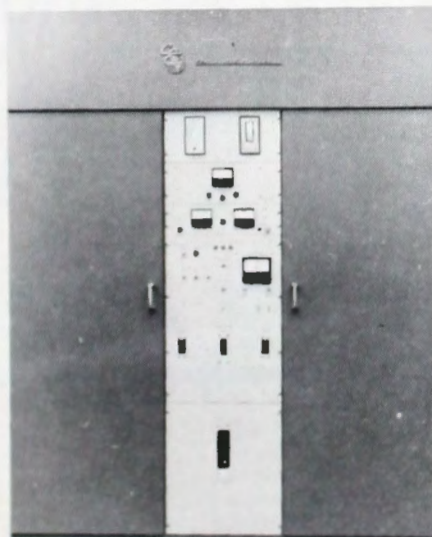

## Continental Type 4L23\* 1,000 kW Dummy Load

Continental's Type 4L23 is a high-power rf dummy load designed

for continuous and reliable operation over the frequency range from 30 Hertz to 40 MHz. The load is available in three configurations: Type 4L23-1 for 50 ohm unbalanced input; Type 4L23-2 for dual 50 ohm inputs; Type 4L23-3 for 300 ohm balanced input. Pre-heated liquid element dissipators have a VSWR of less than 1.2:1 under stabilized conditions. VSWR is less than 1.3:1 within 20 seconds after a substantial change in load dissipation (ie, 200 kW to 1000 kW). Cooling is provided by an internal liquid-to-liquid loop, and an external liquid loop. Front panel control and monitoring can be modified for remote control and monitoring. Interlock line control protects the dummy load and rf power source. Calorimetric power measurement and water flow indicator meters are mounted on front panel. Ambient operating temperature range is from 32° to 110°F (0° to 44°C).

## Specifications

Power Rating: 1000 kW Average; 2000 kW Peak

Impedance: 4L23-150 ohms\* unbalanced, 4L23-2 two 50 ohm\* unbalanced inputs, 4L23-3 300 ohm\* balanced (two 150 ohm inputs)

Frequency Range: 30 Hz to 40 MHz (broadband)

VSWR (Maximum): 1.2:1 after 20 seconds (maximum) of stable power input; 1.3:1 during first 20 seconds (maximum) after a power change of up to 5 to 1.

Duty Cycle: Continuous

Service: AM, FM, FSK, TV, SSB or CW

Input ac Power Required: 230 VAC ± 10%, 1φ, 50/60 Hz, 13 KVA. (other voltages upon request)

\*varies slightly—dependent upon dissipator temperature, refer to VSWR specification

Size: Width 6 ft (183 cm); Depth 4 ft (122 cm); Height 10 ft (305 cm).

Shipping Wt: Approximately 2000 Lbs (907 Kg) (excludes external heat exchanger)

\*U.S. Patent No: 3,742,188

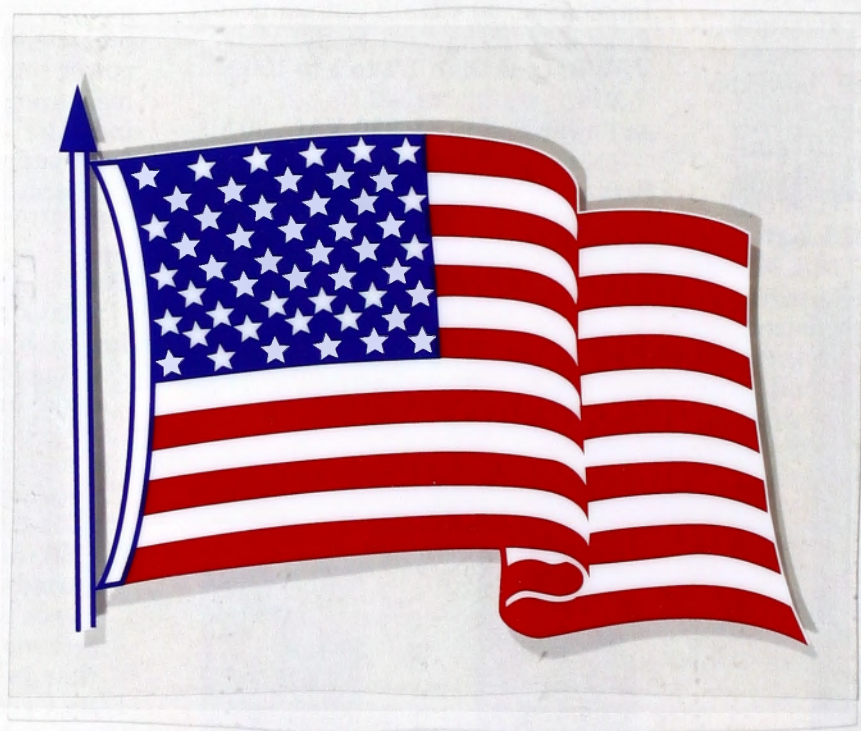

# ANTENNA SYSTEMS

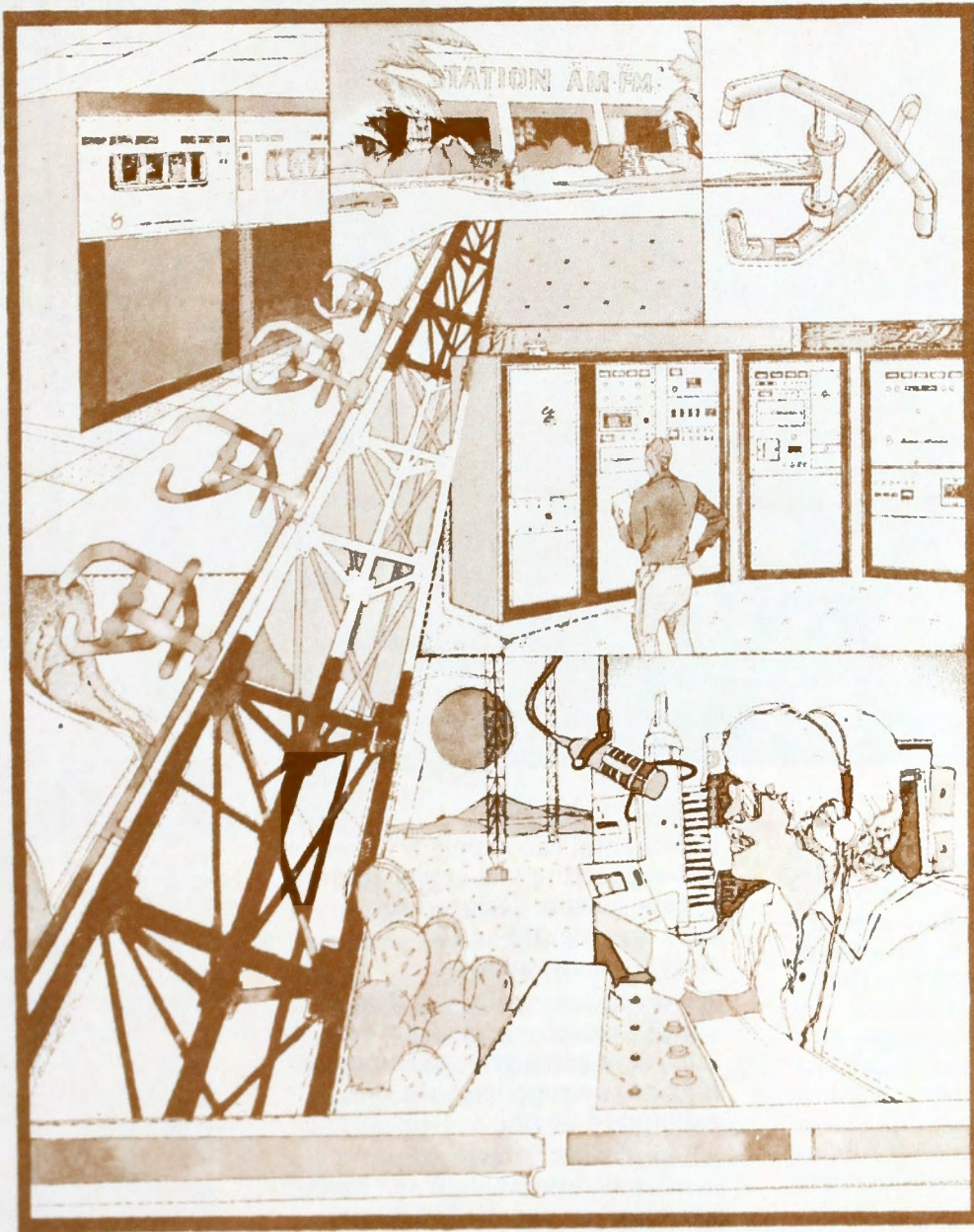

# ANTENNA SYSTEMS, AM & FM TOWERS



## Introduction

Continental offers broadcasters a complete antenna system service, including manufacturing, testing, and field supervision of directional or omni-directional AM and FM antennas; AM and FM towers; antenna phasing and coupling systems and related antenna system equipment.

## AM & FM Towers

Continental can supply a variety of self-supporting and guyed antenna towers, custom designed to meet specific AM or FM station requirements.

Towers are normally supplied with a protective coating of rust inhibitive paint prior to shipment; they can be supplied with a galvanized finish.

All hardware, fittings, guy insulators, anchor steel and base insulator are supplied with each tower. Appropriate tower lighting kits to meet FCC/FAA or ICAO requirements, are also available; see "Antenna System Accessories".

Towers available from Continental include: Pi Rod, Rohn, Stainless, Utility, V & B, and World. All of the construction capabilities and services of these companies are available to Continental customers.

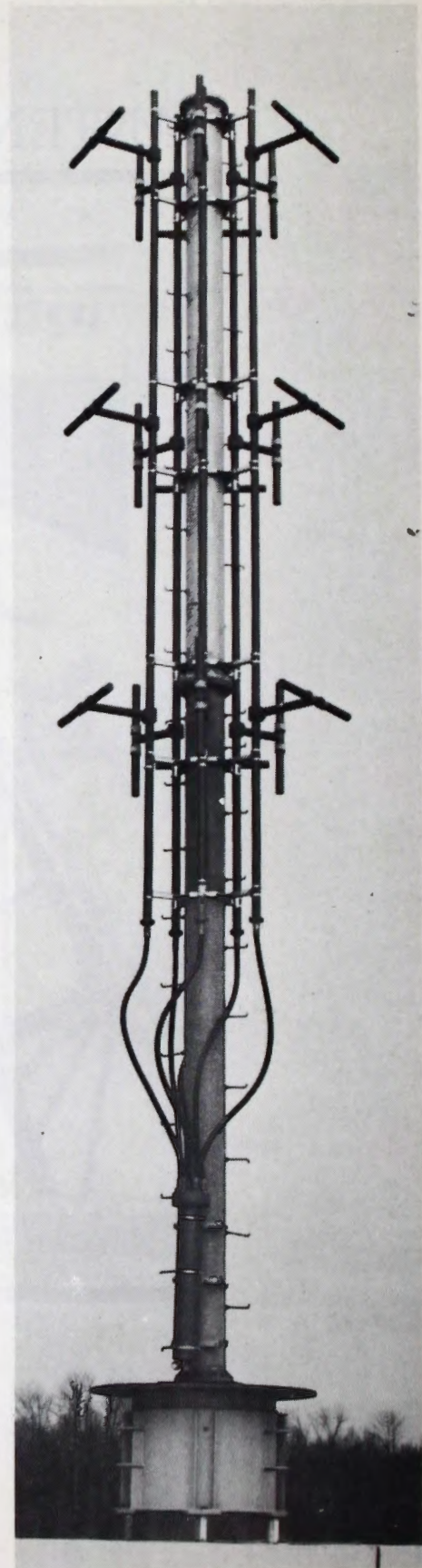

# ANTENNA PHASING & COUPLING



## Introduction

Since its founding in 1946, Continental Electronics has designed and manufactured phasing and coupling equipment to meet the needs of broadcasters around the world.

Many of the techniques used today in phaser design were pioneered, developed and refined by Continental engineers. Continental engineering and manufacturing personnel can draw upon a wide and varied experience in preparing your phasing equipment proposal: experience that includes designing, building, installing, testing and operating transmitters and related rf equipment ranging in power from 1,000 to 2,000,000 watts.

## Typical System

A directional antenna phasing and branching system consists of:

- an impedance matching circuit which matches the power divider input impedance to the common point impedance at which the power input is measured
- a branching circuit in which power is precisely divided into the amounts of power necessary to give the proper ratio of fields from individual antennas
- phase shifting networks in series with each of the transmission lines going to the individual antenna towers
- the transmission lines
- the antenna coupling unit (ACU) for impedance matching between each transmission line and its associated antenna tower.

## Continental Phaser Design Practices

Continental phasing systems offer optimal impedance and pattern bandwidths with wide adjustment range based on highly accurate, computer analysis of antenna tower impedances.

All designs avoid network configurations which directly impair bandwidth, such as those which have excessive individual phase shifts or excess tower base reactance tuning. If special bandwidth compensation networks or rejection filters are used, rf losses, voltage gradient and circulating currents are carefully calculated and their impact is included in the final system design.

All system components are carefully evaluated and selected on a best-performance/best-engineering practice basis. For example: vacuum capacitors and vacuum rf contractors are used when appropriate.

Conservatively-rated components are used throughout the design.

A static drain device is provided in the antenna coupling unit for each tower, unless this function is performed by the ground winding of an existing lighting choke, or other means.

Accuracy of network calculations is enhanced by the use of digital computers. Special system analysis is used to predict or optimize adjustment interaction, sensitivity and bandwidth. Continental's ongoing antenna systems research assures all customers that they will benefit from the most current proven designs.



# ANTENNA PHASING & COUPLING

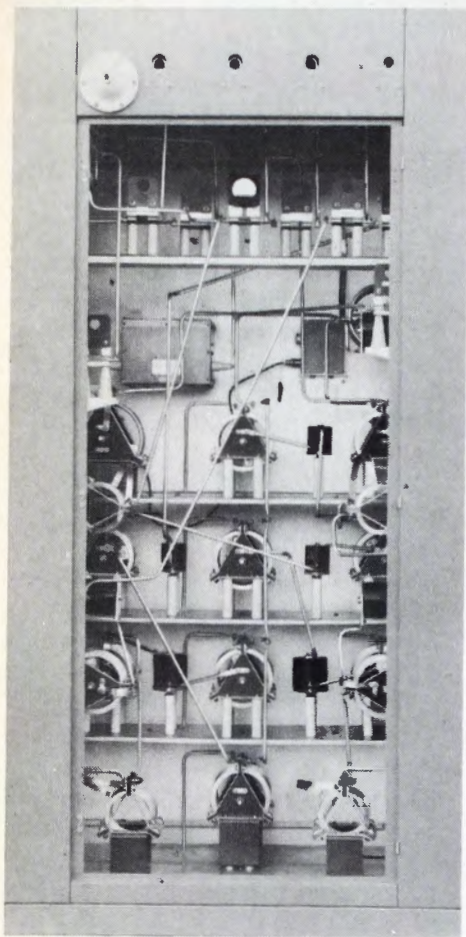

using admittance matrix algebra. Component reactances and transmission line lengths are automatically adjusted for frequency. The effects of coil Q and transmission line loss are included.

The frequency-sensitive tower impedance model answers two questions which cannot be answered if the tower system's current ratios or operating impedances are assumed to be constant. They are:

- (1) Tower currents at the sidebands.
- (2) Tower currents at the carrier during the adjustment process.

Obtaining the common-point impedance, VSWR and the tower currents, and the effect each component has on these parameters, enables Continental engineers to prepare an optimum system design. In addition to "widebanding", this technique can be used to study adjustment sensitivity at carrier. It can also be used to give advance indication when a power divider control is more of a phase control and vice-versa. Adjustment interaction can be optimized during the design process.

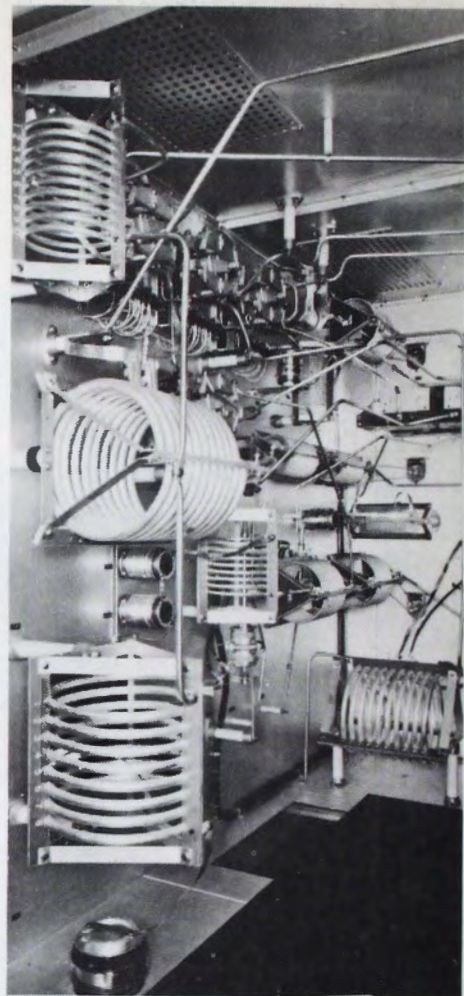

## Continental "Wideband" Phaser

Continental engineers have developed a technique that optimizes the impedance and pattern bandwidths of a phased array. Following is an overview of this technology.

After completion of the initial phaser design, the sideband self and mutual impedances are calculated based on electromagnetic propagation less than the speed of light. Because sideband parameters are frequently dependent, different tower electrical heights and spacings exist from those specified for the carrier frequency.

Then, three network models of the towers are calculated: one at carrier, and one at each sideband. The components of each network are placed in the phaser topology, and the whole system is then analyzed by a computer program

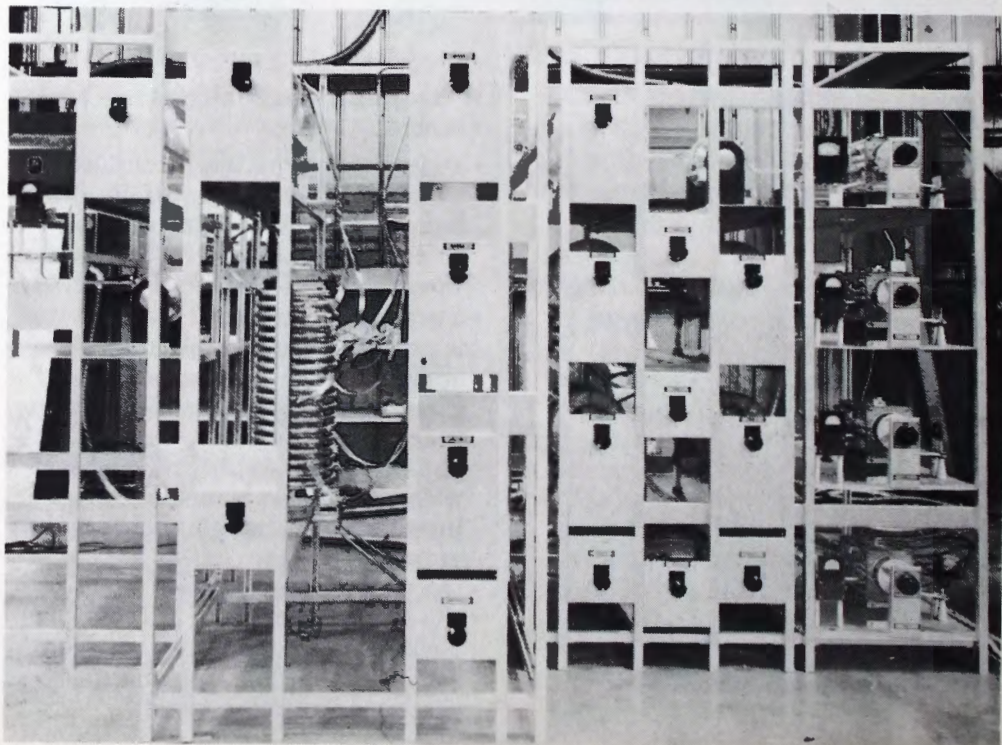

# ANTENNA PHASING & COUPLING

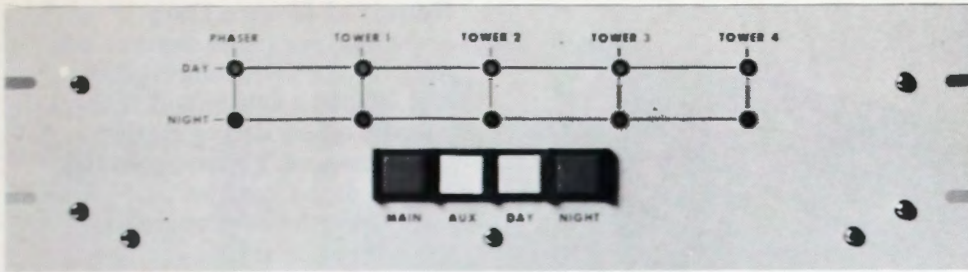

## Typical Network Construction Practice

Interconnecting bus matches associated inductor tubing, or is based on a minimum of  $\frac{1}{8}$ -inch of diameter per each 10 RMS amps of current. The smallest diameter tubing used is  $\frac{3}{8}$ -inch. Where flexible connections are required,  $\frac{1}{2}$ -inch  $\times$  20-mil copper strap is used per 10 RMS amps of current.

The bus size will be selected to minimize or optimize voltage gradient when a dielectric-heating or ionization probability exists.

All components are removeable from inside the cabinets or from the front surfaces of wall panels. All mounting screws fit in tapped holes or captive nuts, so separate nuts are not required. All hardware is non-ferrous.

Aluminum and copper parts are irridited, cadmium or silver plated, or as specified.

A cabinet that is located in a transmitting room has an interlock circuit, if requested.

Epoxy-cast mica capacitors are provided with flanges for additional heat-sinking, and to facilitate connection and mounting.

Front panel controls consist of knobs or handles, counters and insulated, flexible couplings.

Co-ax outer conductor "U" clamps are provided for transmission line termination unless other termination is specified.

Photo-etched nameplates are used on all phaser cabinet front-panel meters and controls.

Phaser cabinets use overhead grills to allow convection cooling.

Panels which act as electrical ground are aluminum, and are bonded to each other with two-inch wide copper straps.

A rolled six foot length of two-inch wide or four-inch copper strap, depending upon power level, is provided with each cabinet for connection to the customer's ground system.

The selection of stand-off insulators and insulation materials is based on strength, low dielectric dissipation factor and low moisture absorption.

Tubing indicator taps are plated, solid brass to provide good electrical connection and heat sinking.

Jacks are always positioned so that a plug-in ammeter will face the operator from a horizontal position.

All co-ax input/output connections are located to customer specifications. If the customer has no preference, input co-ax connections will be located at the top of the phaser cabinet, output co-ax connections at the bottom.

Control connections will usually be located at the bottom of all cabinets or panels. ACU inputs will usually be at the lower left; outputs at the upper right.

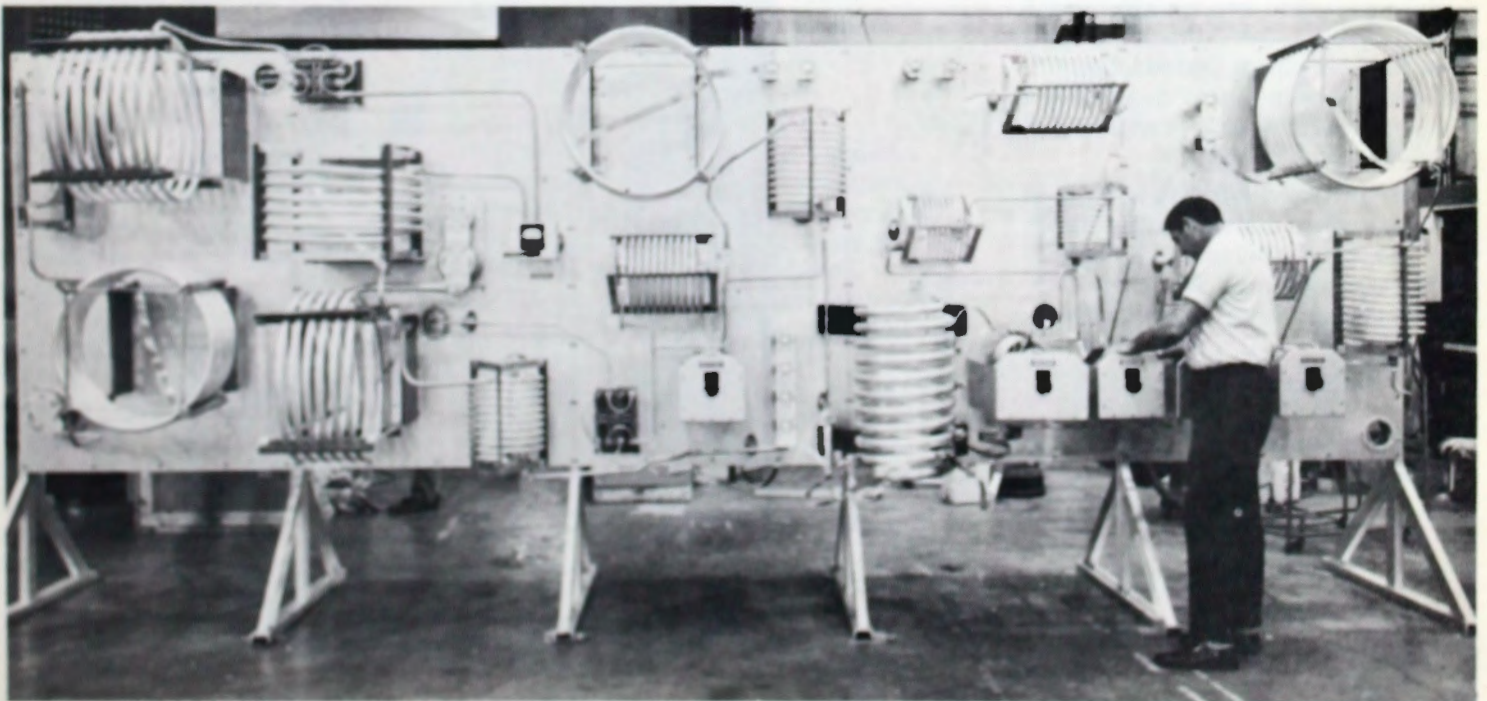

# ANTENNA PHASING & COUPLING

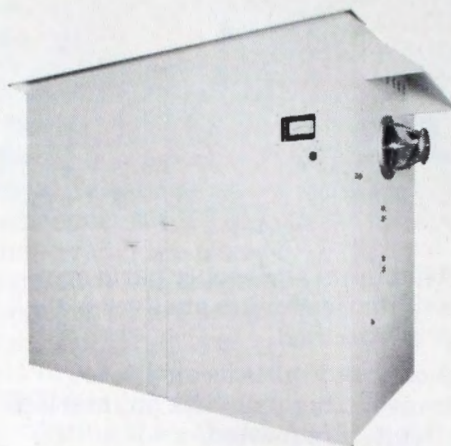
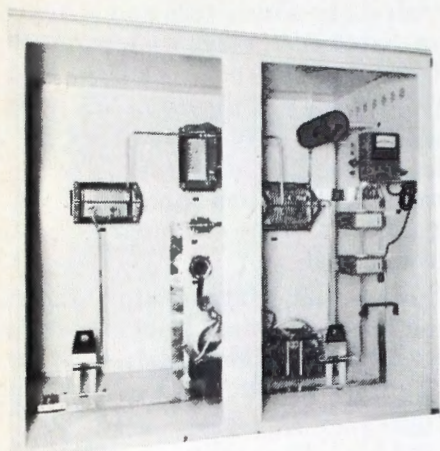

## Typical Control Circuit Design Practices

Continental's standard 28 vdc control circuit is designed for mounting in a 19-inch rack; either directly in the front panel of the phaser, or externally. Color-coded LEDs give status indications for each tower and phaser cabinet.

The momentary push-button switches must be depressed for a full second before switching will begin. This prevents accidental mode change if an operator accidentally depresses a push-button, and assures that the transmitter has adequate time to remove rf output. If desired, the full-second contact can be performed automatically with the addition of two relays.

Remote control capability is built-in to the standard circuit with a "local only" switch for personnel safety during maintenance. A separate remote control panel is available as an option.

Control lines can be specified as 28 vdc or 220 vac. Line voltage to the control panel can be specified as 120 vac or 240 vac; 50 or 60 Hz.

A "Failsafe" circuit will prevent the transmitter from returning to the air if a mode change is incomplete.

All relays are the same plug-in type. Time delay is accomplished with RC decay networks.

## Required Design Data

Continental custom designs and manufacturers antenna phasing and coupling equipment to meet specific broadcasting station requirements. Following is the typical data Continental needs in order to prepare an equipment proposal.

- call letters and station location; frequency of operation; operating power (day and night); and mode of operation
- description of towers; tower manufacturer; type number and tower height; self-supported or guyed; and cross-section dimensions
- spacing and orientation of all antennas in the array
- phase relationship and ratios of the radiation fields
- location of phasing unit
- type and length of each transmission line.

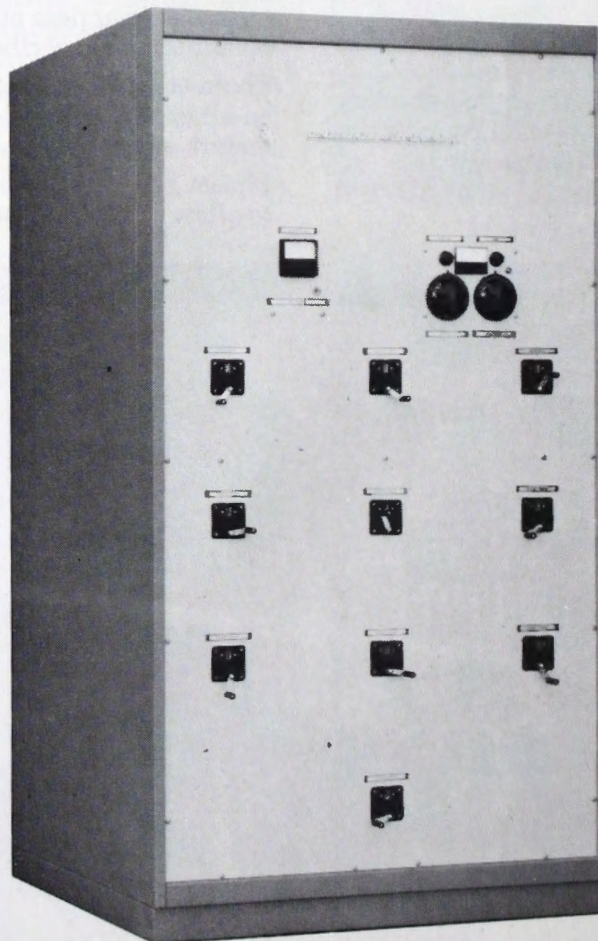

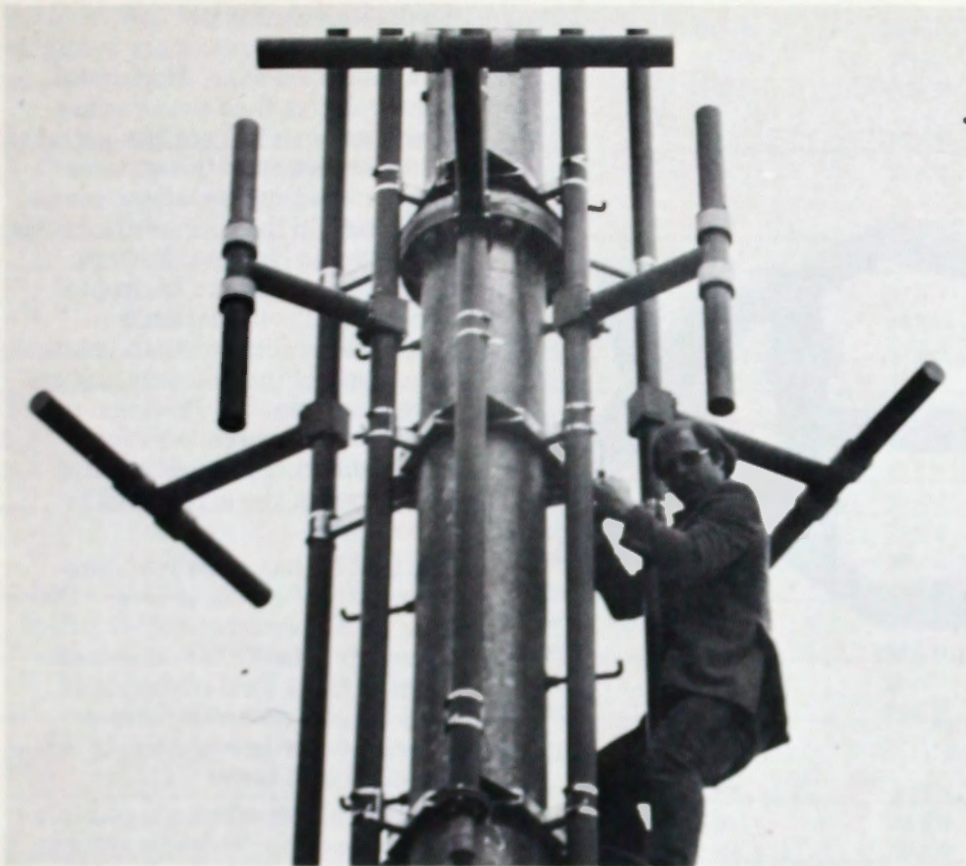

## FM Antennas

Continental offers FM broadcasters a wide variety of antennas to meet commercial and educational station requirements: from low power to high power; including circularly and horizontally polarized, and dual polarized directional antenna designs.

## G5 Series, Circularly Polarized FM Antennas

The G5 antenna was introduced in 1976. Since then, it has become the most popular FM antenna available in the United States. It is an electrically sound, mechanically rugged, thoroughly field-proven antenna design. The antenna may be purchased in any number of bays from 1 to 16 (Series A & B).

Each bay level element consists of two segmented series-fed dipoles that form a space-phased, circularly

polarized radiator. Each segmented dipole is manufactured using a custom made Wallace Bending machine. The dipoles are constructed of  $3\frac{1}{8}$ " o.d. brass which provides an excellent element bandwidth as well as protection against corona discharge failure.

The isolated feed point of the two segmented dipoles is pressurized to avoid the effects of atmospheric changes and metal corrosion on the feed point impedance. The insulators are custom made melamine insulators with machined flange fittings for bolt down "O" ring sealed flange assembly. Each feed point is silver soldered to the inner conductor inside the driven element; the entire inner conductor assembly of the element is silver plated to minimize antenna loss.

Each individual segmented dipole can be removed from any bay level element and replaced with a new segmented dipole with no change in the VSWR of the antenna.

Each segmented dipole is constructed with a captive male  $3\frac{1}{8}$ " coax 50 ohm inner conductor connector, and is connected to the antenna element using a five bolt pinned flange. This unique construction design assures proper dipole installation.

Electrically, each element in a G5 array is a 50 ohm element at the frequency of operation. When the array is matched, a quarter wave transformation section is designed for each element's feed stem, so that each element adds in shunt with the other elements in the array, with impedance of  $n \times 50$  ohms, where  $n$  equals the number of elements being added in shunt. This method of matching limits the maximum voltage and current in the antenna array interbay coax while utilizing the advantage of a 50 ohm bay level impedance.

The G5 antenna design is very flexible: it permits side, corner leg or top mounting on any type of tower.

All radiating elements and feed stem are constructed of 85-15 brass; all support brackets and hardware are made of stainless steel.

# G5CPS FM ANTENNA



## G5CPS Super Power Circularly Polarized FM Antenna

The brass radiating element has an outside diameter of 3 $\frac{1}{8}$ ". The feed point is completely internal with a pressurized environment up to the feed point.

The radiating element is rated at 40 kW, and is limited by the safe average power capability of the 3 $\frac{1}{8}$ " rigid coax line.

The heavy-wall brass tubing stem can withstand harsh environmental conditions.

Deicers are not recommended in normal environments because typical VSWR is 1.5:1 or less with  $\frac{1}{2}$ " of radial ice. Heaters or radomes are available for deicing.

All G5CPS antennas use silver-plated inner conductor connectors throughout to reduce losses and heating. Each antenna, supplied with a 6 foot input

matching section has 50-ohm EIA input. Depending on model type, the input is either a 3 $\frac{1}{8}$  inch 50 ohm EIA female input or a 6 $\frac{1}{8}$  inch 50 ohm EIA female input.

Once each antenna is completely assembled and factory-tuned to the customer's frequency, it is pressure tested at 10 lbs. pressure for one hour to ensure that the antenna is leak-free prior to shipment.

The antenna system feed point is 6 feet below the bottom bay for end fed antennas, and approximately 6 feet below the center of the antenna for center fed antenna systems.

The horizontally polarized horizontal-plane radiation pattern is omnidirectional when pole-mounted atop a tower; a  $\pm 2$  dB circularity is typical when mounted on a 14 inch diameter steel pole. When side-mounted on a tower, the antenna pattern will be affected by the tower structure.

Complete antenna pattern measurement services are available on a quotation basis. Horizontal plane relative field patterns are measured on a full scale mock up of a 20 foot section of the customer's tower, including the ladder, coaxial transmission lines, conduits, cables and antenna element. Pattern optimization for both horizontal and vertical polarization is available for improving the pattern circularity of the antenna-support tower combination. Precision model studies are also available for situations where larger vertical apertures of the array need to be analyzed.

The G5CPS has a low standing-wave ratio of 1.07:1, or less. + 200 KHz for a given channel with field trimming. The VSWR at antenna input without field trimming is 1.2:1 for pole mounting atop a tower; 1.5:1 or less when side mounted on a tower.

Multistation operation is possible using a common antenna system due to the excellent bandwidth characteristics of the G5 antenna design. Continental can quote filtering components required for the diplexing or multiplexing operation. Stations with a frequency separation as large as 4 MHz can be diplexed on a common antenna.

### Specifications.

Frequency Range: 88 to 108 MHz,

factory tuned to one frequency

Polarization: Circular (clockwise)

Power Gain: See tables

Azimuthal Pattern:  $\pm 2$  dB in free space, both horizontal and vertical

Ellipticity:  $\pm 3$  dB in free space

VSWR at input (without field tuning): 1.1:1 top mounting, 1.5:1 or better side mounting

VSWR at Input (with field tuning): 1.1:1 or better

(see tables for rest of specifications)

# G5CPS FM ANTENNA

## Series A 3 1/8" interbay line, 3 1/8" element stem

No. of Bays	Power Gain	DB Gain	Type Feed	Female 50 Ohm Input	Power Input Capability	Lbs. Calculated Weight	Lbs. Calculated Wind Load #	Approx. Length
1	0.4611	-3.3623	End	3 1/8"	32 KW	114	137	—
2	0.9971	-0.0128	End	3 1/8"	32 KW	225	304	10'
2	0.9971	-0.0128	Center	3 1/8"	39 KW	250	319	10'
2	0.9971	-0.0128	Center	6 1/8"	64 KW	301	421	10'
3	1.5588	1.9278	End	3 1/8"	32 KW	336	470	20'
4	2.1332	3.2903	End	3 1/8"	32 KW	447	637	30'
4	2.1332	3.2903	Center	3 1/8"	39 KW	472	652	30'
4	2.1332	3.2903	Center	6 1/8"	64 KW	523	758	30'
5	2.7154	4.3384	End	3 1/8"	32 KW	558	804	40'
6	3.3028	5.1888	End	3 1/8"	32 KW	669	971	50'
6	3.3028	5.1888	Center	3 1/8"	39 KW	694	986	50'
6	3.3028	5.1888	Center	6 1/8"	64 KW	745	1096	50'
7	3.8935	5.9034	End	3 1/8"	32 KW	780	1138	60'
8	4.4872	6.5197	End	3 1/8"	32 KW	891	1305	70'
8	4.4872	6.5197	Center	3 1/8"	39 KW	916	1320	70'
8	4.4872	6.5197	Center	6 1/8"	64 KW	967	1433	70'
10	5.6800	7.5435	Center	3 1/8"	39 KW	1138	1653	90'
10	5.6800	7.5435	Center	6 1/8"	64 KW	1189	1770	90'
12	6.8781	8.3747	Center	3 1/8"	39 KW	1360	1987	110'
12	6.8781	8.3747	Center	6 1/8"	64 KW	1411	2108	110'

## Series B 4 1/8" interbay line, 4 1/8" element stem

1	0.4611	-3.3623	End	6 1/8"	40 KW	159	201	—
2	0.9971	-0.0128	End	6 1/8"	56 KW	297	407	10'
2	0.9971	-0.0128	Center	6 1/8"	80 KW	336	468	10'
3	1.5588	1.9278	End	6 1/8"	56 KW	435	613	20'
4	2.1332	3.2903	End	6 1/8"	56 KW	573	818	30'
4	2.1332	3.2903	Center	6 1/8"	112 KW	612	879	30'
5	2.7154	4.3384	End	6 1/8"	56 KW	711	1024	40'
6	3.3028	5.1888	End	6 1/8"	56 KW	849	1229	50'
6	3.3028	5.1888	Center	6 1/8"	112 KW	888	1290	50'
7	3.8935	5.9034	End	6 1/8"	56 KW	987	1435	60'
8	4.4872	6.5197	End	6 1/8"	56 KW	1125	1641	70'
8	4.4872	6.5197	Center	6 1/8"	112 KW	1164	1702	70'
10	5.6800	7.5435	Center	6 1/8"	112 KW	1440	2113	90'
12	6.8781	8.3747	Center	6 1/8"	112 KW	1716	2524	110'

## Series C 6 1/8" interbay line, 4 1/8" element stem

1	0.4611	-3.3623	End	6 1/8"	40 KW	205	260	—
2	0.9971	-0.0128	End	6 1/8"	80 KW	410	520	10'
3	1.5588	1.9278	End	6 1/8"	120 KW	615	780	20'
4	2.1332	3.2903	End	6 1/8"	120 KW	820	1040	30'
5	2.7154	4.3384	End	6 1/8"	120 KW	1025	1300	40'
6	3.3028	5.1888	End	6 1/8"	120 KW	1230	1560	50'

# Wind load based on 50/33 PSF.

Note: Brackets included in weight and wind load calculations.

\*Power input capability up to 2000 feet above mean sea level, derating required above 2000 feet.

# G5CPM FM ANTENNA

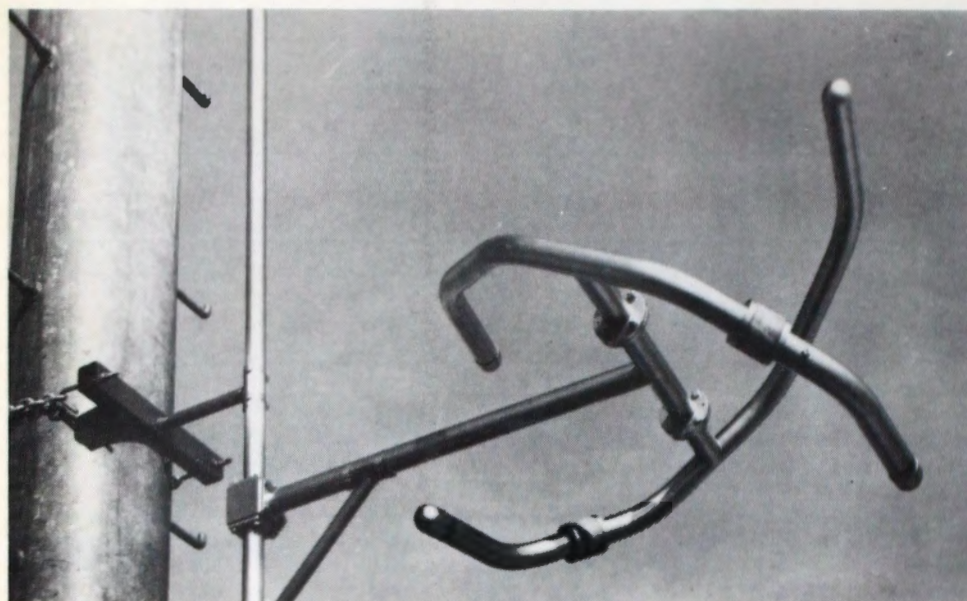

## G5CPM Medium Power Circularly Polarized FM Antenna

The G5CPM offers broadcasters the advantages and benefits of a super power antenna in a medium power size.

The heavy-duty brass radiating element has an outside diameter of 1 3/4". The internal feed point is pressurized up to the feed point. Inner conductors are constructed to reduce losses and heating.

The radiating element is rated at 9 kW, and is limited by the safe average power capability of the 1 5/8" rigid coax line.

The heavy-wall brass tubing stem can withstand harsh environmental conditions, winds up to 125 mph, and moderate ice loads.

Deicers are not available.

Radomes are available for deicing. The typical VSWR with 1/8" radial ice is 1.5:1 or less.

### Specifications:

Frequency Range: 88 to 108 MHz,

factory tuned to one frequency

Polarization: Circular (clockwise)

Power Gain: See tables

Azimuthal Pattern:  $\pm 2$  dB in free space, both horizontal and vertical

Ellipticity:  $\pm 3$  dB in free space

VSWR at Input (without field tuning): 1.1:1 top mounting, 1.5:1 or better side mounting

VSWR at Input (with field tuning): 1.1:1 or better

(see tables for rest of specifications)

No. of Bays	Power Gain <sup>1</sup>	dB Gain <sup>1</sup>	Type Feed <sup>2</sup>	Female 50-Ohm Input (mm) In.	Power Input Capability	Calculated Weight lb. (kg)	Calculated Windload <sup>3</sup> lb. (kg)	Approx. Length ft. (m) <sup>4</sup>
1	0.4611	-3.3623	End	(41.3) 1%	9 kW	57 (25.85)	102 (46.27)	
2	0.9971	-0.0128	End	(41.3) 1%	9 kW	114 (51.71)	212 (96.16)	10 (3.05)
2	0.9971	-0.0128	Center	(79.4) 3%	12 kW	147 (66.68)	289 (131.09)	10 (3.05)
3	1.5588	1.9278	End	(41.3) 1%	9 kW	170 (77.11)	323 (146.51)	20 (6.10)
3	1.5588	1.9278	Center	(79.4) 3%	12 kW	204 (92.53)	399 (180.98)	20 (6.10)
4	2.1332	3.2903	End	(41.3) 1%	9 kW	227 (102.97)	433 (196.41)	30 (9.14)
4	2.1332	3.2903	Center	(79.4) 3%	12 kW	260 (117.93)	509 (230.88)	30 (9.14)
5	2.7154	4.3384	End	(41.3) 1%	9 kW	283 (128.37)	543 (246.30)	40 (12.19)
5	2.7154	4.3384	Center	(79.4) 3%	12 kW	317 (143.79)	620 (281.23)	40 (12.19)
6	3.3028	5.1888	End	(41.3) 1%	9 kW	340 (154.22)	654 (296.65)	50 (15.24)
6	3.3028	5.1888	Center	(79.4) 3%	12 kW	373 (169.19)	730 (331.12)	50 (15.24)
7	3.8935	5.9034	Center	(79.4) 3%	12 kW	430 (195.04)	840 (381.02)	60 (18.29)
8	4.4872	6.5197	Center	(79.4) 3%	12 kW	486 (220.45)	950 (430.91)	70 (21.34)
9	5.0826	7.0608	Center	(79.4) 3%	12 kW	543 (246.30)	1060 (480.81)	80 (24.38)
10	5.6800	7.5435	Center	(79.4) 3%	12 kW	599 (271.70)	1171 (531.16)	90 (27.43)
11	6.2783	7.9785	Center	(79.4) 3%	12 kW	656 (297.56)	1281 (581.05)	100 (30.48)
12	6.8781	8.3747	Center	(79.4) 3%	12 kW	712 (322.96)	1391 (630.95)	110 (33.53)

<sup>1</sup>Power split is 50/50 vertical and horizontal only. Beam tilt and null fill, are available as extra cost options on center fed antennas, but will change the gain figures given above and may reduce the power rating.

<sup>2</sup>End feeding is done with a 6 ft (1.83m) matching transformer section. Center feeding of an odd number of bays is done at a point one-half bay below the center of the antenna. 10 ft (3.05m) matching transformer is connected to an elbow at the center feed point and extends downward.

<sup>3</sup>Windload based on 50/33 paf (244.1/161.1 kgm). Brackets are included in weight and windload calculations.

<sup>4</sup>End fed antenna lengths do not include transformer.

# G4CPH FM ANTENNA

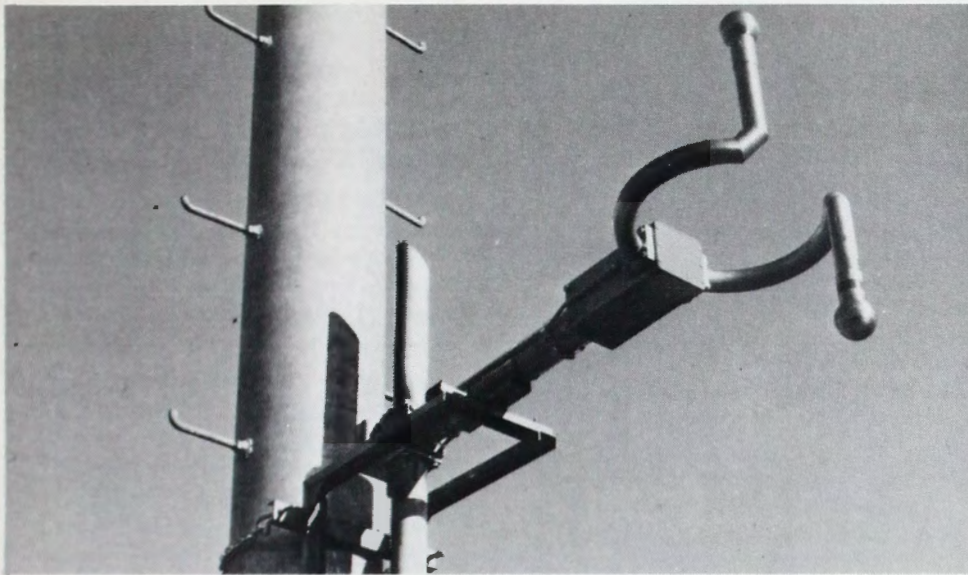

## G4CPH High Power Circularly Polarized FM Antenna

The G4CPH is a rugged, heavy-duty design capable of handling powers from 5 kW (single bay) to 40 kW (eight or more bays). The antenna may be purchased in any number of bays from 1 to 16. The antennas are end fed in combinations from one to eight bays. In center fed antenna arrays, the center fed "T" input is located one half bay spacing below the center of the array if the array consists of an odd number of bays. Antennas of one to eight bays are

end fed with a 6 foot matching section connected to the bottom bay. The rings of the antenna are mounted on 3 1/8" transmission line with a 3 1/8" input flange on standard antennas. Antennas that are to have 40 kW input are provided with a 6 1/8" flange and center feed block (at extra cost). 3" diameter Corona balls are provided at the outer extremity of the arms of each bay of the antenna. The antenna is designed to withstand wind velocities to 150 miles per hour.

Factory-installed deicers are available in powers of 300 and 500 watts per bay. Specify 120- or 230-volt operation when ordering. Shielded interbay heater cable and junction boxes are supplied as a part of the heater system. Heater weight, including junction boxes and cable, is 7 lb. per bay. Heaters are field replaceable.

Special power splits, other than 50/50 (vertical and horizontal), beam tilt and/or null fill are available at extra cost.

Radomes are also available to reduce the effect of ice on the VSWR of the antenna.

### Specifications:

Frequency Range: 88 to 108 MHz, factory tuned to one frequency  
 Polarization: Circular (clockwise)  
 Power Gain: See tables  
 Azimuthal Pattern:  $\pm 2$  dB in free space, both horizontal and vertical  
 Ellipticity:  $\pm 3$  dB in free space  
 VSWR at Input (without field tuning): 1.1:1 top mounting, 1.5:1 or better side mounting  
 VSWR at Input (with field tuning): 1.1:1 or better  
 (see tables for rest of specifications)

Type	Power Gain		dB Gain		Field Gain		Input Power Rating kW	Approx. Length (m) ft	Weight (Including Brackets) (kg) lb	Wind Load	Weight (With Radomes Incl. Brackets) (kg) lb	Wind Load
	Horiz	Vert	Horiz	Vert	Horiz	Vert				Based on 244/161 kg/sq.m (50/33 lb/sq ft)		Based on 244/161 kg/sq.m (50/33 lb/sq ft)
G4CPH-1	0.4611	0.4611	-3.3623	-3.3623	0.6790	0.6790	10	—	(38) 84	(65) 144	(47) 104	(120) 265
G4CPH-2	0.9971	0.9971	-0.0128	-0.0128	0.9985	0.9985	20	(3) 10	(83) 184	(144) 318	(102) 224	(254) 560
G4CPH-3	1.5588	1.5588	1.9278	1.9278	1.2485	1.2485	30	(6) 20	(124) 274	(223) 492	(152) 334	(388) 855
G4CPH-4	2.1332	2.1332	3.2903	3.2903	1.4605	1.4605	40	(9) 30	(165) 364	(302) 666	(201) 444	(522) 1150
G4CPH-5	2.7154	2.7154	4.3384	4.3384	1.6478	1.6478	40	(12) 40	(206) 454	(381) 840	(251) 554	(655) 1445
G4CPH-6	3.3028	3.3028	5.1888	5.1888	1.8174	1.8174	40	(15) 50	(247) 544	(460) 1014	(301) 664	(789) 1740
G4CPH-7	3.8935	3.8935	5.9034	5.9034	1.9732	1.9732	40	(18) 60	(288) 634	(538) 1187	(351) 774	(923) 2034
G4CPH-8	4.4872	4.4872	6.5197	6.5197	2.1183	2.1183	40	(21) 70	(328) 724	(617) 1361	(401) 884	(1056) 2329
G4CPH-9	5.0826	5.0826	7.0608	7.0608	2.2545	2.2545	40	(24) 80	(379) 835	(729) 1608	(460) 1015	(1223) 2697
G4CPH-10	5.6800	5.6800	7.5435	7.5435	2.3833	2.3833	40	(27) 90	(420) 925	(808) 1782	(510) 1125	(1357) 2992
G4CPH-11	6.2783	6.2783	7.9785	7.9785	2.5057	2.5057	40	(30) 100	(460) 1015	(887) 1956	(560) 1235	(1491) 3287
G4CPH-12	6.8781	6.8781	8.3747	8.3747	2.6226	2.6226	40	(34) 110	(501) 1105	(966) 2130	(610) 1345	(1625) 3582
G4CPH-13	7.4785	7.4785	8.7381	8.7381	2.7347	2.7347	40	(37) 120	(542) 1195	(1045) 2303	(660) 1455	(1758) 3876
G4CPH-14	8.0800	8.0800	9.0741	9.0741	2.8425	2.8425	40	(40) 130	(583) 1285	(1124) 2477	(710) 1565	(1892) 4171
G4CPH-15	8.6818	8.6818	9.3861	9.3861	2.9465	2.9465	40	(43) 140	(624) 1375	(1202) 2651	(760) 1675	(2026) 4466
G4CPH-16	9.2846	9.2846	9.6776	9.6776	3.0471	3.0471	40	(46) 150	(665) 1465	(1281) 2825	(810) 1785	(2160) 4761

All antenna brackets are stainless steel. All weights given include brackets, interbay line, and transformer section. Factory-installed deicers are available using either 300 watts or 500 watts per bay. Specify 120 or 230 volts. Heater elements are replaceable in the field. Shielded interbay heater cable and junction boxes are supplied. Heater weight, including junction boxes and interbay cable, is 6 lb (2.7 kg) additional per bay.



# G4CPM FM ANTENNA

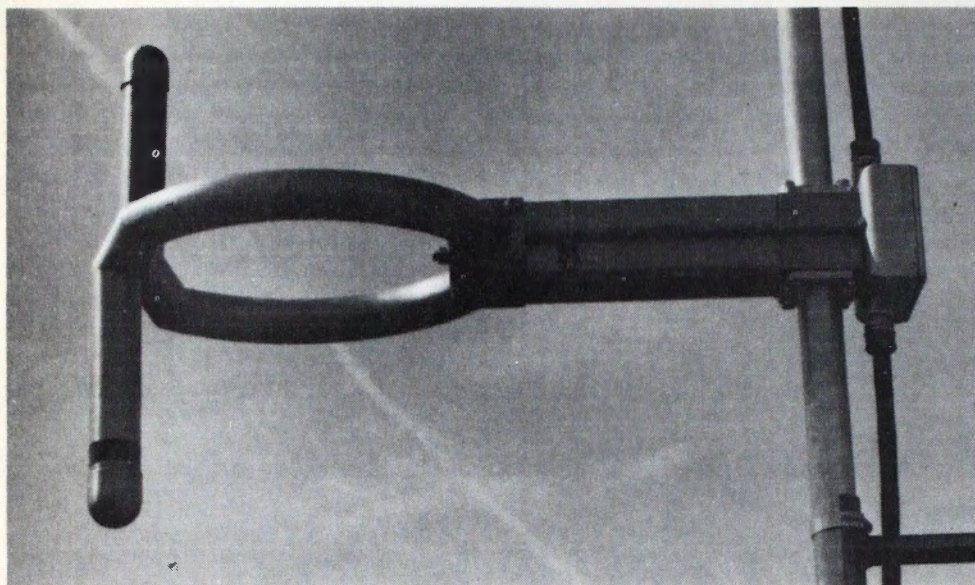

## G4CPM Medium Power Circularly Polarized FM Antenna

The G4CPM medium power antenna is a rugged antenna but lower in weight, windloading and power handling capability than the G4CPH antenna. This antenna is built in 4 to 12 bays and is designed to handle powers up to 12 kW input. The G4CPM is designed to withstand wind velocities to 150 miles per hour. All of these antennas are center fed, if an even number of bays, or at a point one-half bay below the center of the antenna if an odd number of bays. The low dead weight and wind loading make this antenna ideally suited for mounting on lightweight tower structures.

The rings of the antenna are mounted on 1 5/8" line but the center feed point is a 3 1/8" EIA, 50 ohm flange. A 10 ft. matching transformer is connected to an elbow at the center feed point and extends downward from this point.

Factory-installed deicers are available in powers of 300 and 500 watts per bay. Specify 120 or 230-volt operation when ordering. Shielded interbay heater cable and junction boxes are supplied as a part of the heater system. Heater weight, including junction boxes and cable is 7 lb per bay. Heaters are field replaceable.

Special power splits, other than 50/50 (vertical and horizontal) beam tilt and null fill are available at extra cost. Radomes are also available to reduce the effect of ice on the VSWR of the antenna.

### Specifications:

Frequency Range: 88 to 108 MHz, factory tuned to one frequency  
 Polarization: Circular (clockwise)  
 Power Gain: See tables  
 Azimuthal Pattern:  $\pm 2$  dB in free space, both horizontal and vertical  
 Ellipticity:  $\pm 3$  dB in free space  
 VSWR at Input (without field tuning): 1.1:1 top mounting, 1.5:1 or better side mounting  
 VSWR at Input (with field tuning): 1.1:1 or better  
 (see tables for rest of specifications)

Type	Power Gain		dB Gain		Field Gain		Input Power Rating kW	Approx. Length (m) ft	Weight (Including Brackets) (kg) lb	Wind Load Based on 244/161 kg/sq.m (50/33 kg/sq ft) (kg) lb	Weight (With Radomes Incl. Brackets) (kg) lb	Wind Load With Radomes Based on 244/161 kg/sq.m (50/33 lb/sq ft) (kg) lb
	Horiz	Vert	Horiz	Vert	Horiz	Vert				(kg) lb	(kg) lb	(kg) lb
G4CPM-4	2.1332	2.1332	3.2903	3.2903	1.4605	1.4605	12	(10) 30	(89) 197	(188) 415	(122) 269	(347) 764
G4CPM-5	2.7154	2.7154	4.3384	4.3384	1.6478	1.6478	12	(12) 40	(108) 238	(229) 505	(149) 328	(427) 941
G4CPM-6	3.3028	3.3028	5.1888	5.1888	1.8174	1.8174	12	(15) 50	(127) 279	(270) 595	(176) 387	(507) 1118
G4CPM-7	3.8935	3.8935	5.9034	5.9034	1.9732	1.9732	12	(18) 60	(145) 320	(311) 685	(202) 446	(588) 1296
G4CPM-8	4.4872	4.4872	6.5197	6.5197	2.1183	2.1183	12	(21) 70	(164) 361	(352) 775	(229) 505	(668) 1473
G4CPM-9	5.0826	5.0826	7.0608	7.0608	2.2545	2.2545	12	(24) 80	(182) 402	(392) 865	(256) 564	(748) 1650
G4CPM-10	5.6800	5.6800	7.5435	7.5435	2.3833	2.3833	12	(27) 90	(201) 443	(433) 955	(283) 623	(829) 1828
G4CPM-11	6.2783	6.2783	7.9785	7.9785	2.5057	2.5057	12	(30) 100	(220) 484	(474) 1045	(309) 682	(909) 2005
G4CPM-12	6.8781	6.8781	8.3747	8.3747	2.6226	2.6226	12	(34) 110	(238) 525	(515) 1135	(336) 741	(990) 2182

All antenna brackets are stainless steel. All weights given include brackets, interbay line, and transformer section. Factory-installed deicers are available using either 300 watts or 500 watts per bay. Specify 120 or 230 volts. Heater elements are replaceable in the field. Shielded interbay heater cable and junction boxes are supplied. Heater weight, including junction boxes and interbay cable, is 6 lb (2.7 kg) additional per bay.



# G4CPL FM ANTENNA

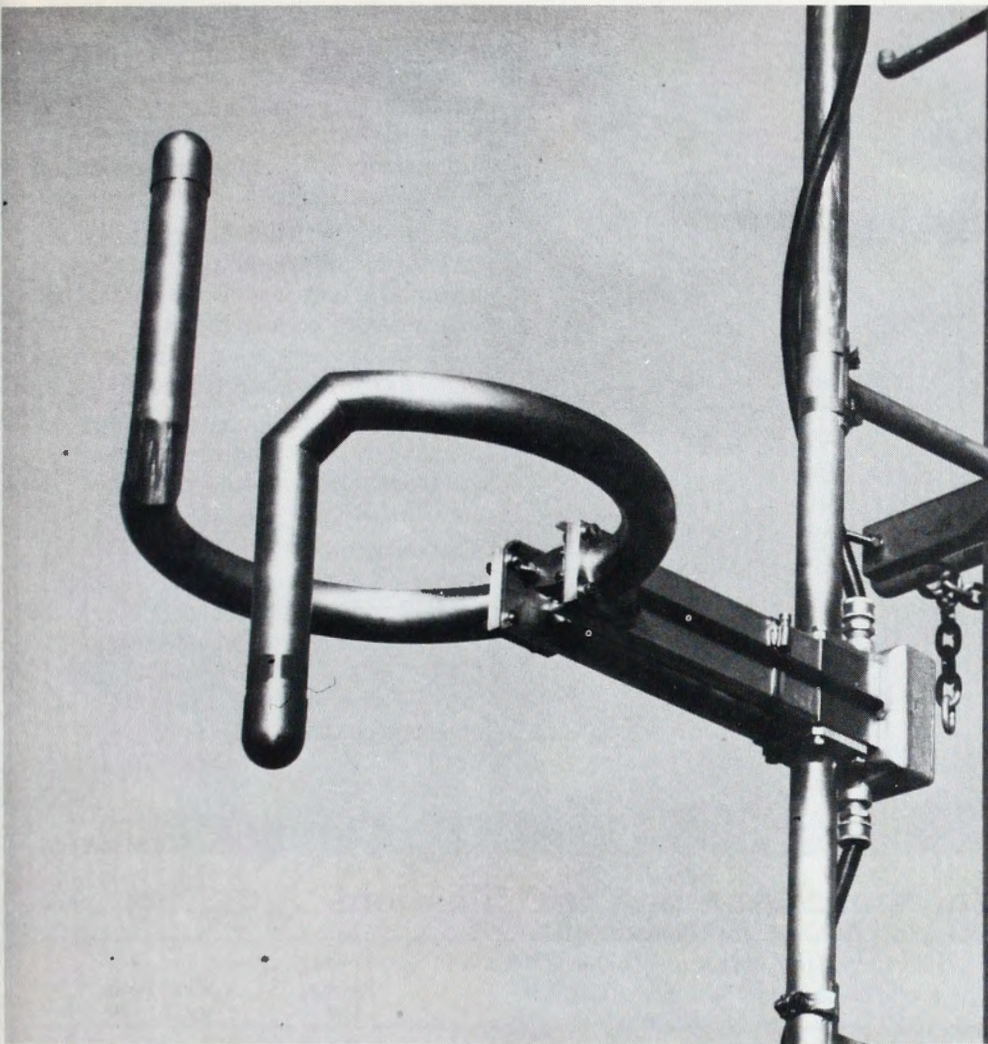

## G4CPL Low Power Circularly Polarized FM Antenna

The general construction of the G4CPL FM Antenna is the same as the G4CPM medium power antenna

except that it is only offered in one to eight bays, is end fed and has a power handling capability of 3 kW for one bay, 6 kW for two bays and 7.5 kW for antennas with three to eight bays.

The rings of the antenna are mounted on 1 $\frac{5}{8}$ " line and are end fed. A 6 ft. matching transformer extends below the lower bay and terminates in a 1 $\frac{5}{8}$ " EIA, 50-ohm flange.

Factory-installed deicers are available in powers of 300 and 500 watts per bay. Specify 120 or 230 volt operation when ordering. Shielded interbay heater cable and junction boxes are supplied as a part of the heater system. Heater weight, including junction boxes and cable, is 7 lb per bay. Heaters are field replaceable.

No special power splits other than 50/50, nor beam tilt nor null fill are offered for this antenna. Radomes are also available on the VSWR of the antenna.

### Specifications:

- Frequency Range: 88 to 108 MHz, factory tuned to one frequency
- Polarization: Circular (clockwise)
- Power Gain: See tables
- Azimuthal Pattern:  $\pm 2$  dB in free space, both horizontal and vertical
- Ellipticity:  $\pm 3$  dB in free space
- VSWR at Input (without field tuning): 1.1:1 top mounting, 1.5:1 or better side mounting
- VSWR at Input (with field tuning): 1.1:1 or better
- (see tables for rest of specifications)

Type	Power Gain		dB Gain		Field Gain		Input Power Rating kW	Approx. Length (m) ft	Weight (Including Brackets) (kg) ft	Wind Load Based on 244/161	Weight (With Radomes Incl. Brackets)	Wind Load With Radomes Based on 244/161
	Horiz	Vert	Horiz	Vert	Horiz	Vert				kg/sq.m (50/33 lb/sq ft)	(kg) ft	kg/sq.m (50/33 lb/sq ft)
G4CPL-1	0.4611	0.4611	-3.3623	-3.3623	0.6790	0.6790	3	—	(16) 36	(34) 74	(24) 54	(73) 161
G4CPL-2	0.9971	0.9971	-0.0128	-0.0128	0.9985	0.9985	6	(3) 10	(35) 77	(47) 104	(52) 115	(153) 338
G4CPL-3	1.5588	1.5588	1.9278	1.9278	1.2485	1.2485	7.5	(6) 20	(54) 118	(115) 254	(78) 172	(234) 515
G4CPL-4	2.1332	2.1332	3.2903	3.2903	1.4605	1.4605	7.5	(10) 30	(72) 159	(156) 344	(105) 231	(314) 693
G4CPL-5	2.7154	2.7154	4.3384	4.3384	1.6478	1.6478	7.5	(12) 40	(91) 200	(197) 434	(132) 290	(385) 870
G4CPL-6	3.3028	3.3028	5.1888	5.1888	1.8174	1.8174	7.5	(15) 50	(109) 241	(238) 524	(158) 349	(475) 1047
G4CPL-7	3.8935	3.8935	5.9034	5.9034	1.9732	1.9732	7.5	(18) 60	(128) 282	(279) 614	(185) 408	(555) 1224
G4CPL-8	4.4782	4.4782	6.5197	6.5197	2.1183	2.1183	7.5	(21) 70	(147) 323	(319) 704	(212) 467	(636) 1402

All antenna brackets are stainless steel. All weights given include brackets, interbay line, and transformer section. Factory-installed deicers are available using either 300 watts or 500 watts per bay. Specify 120 or 230 volts. Heater elements are replaceable in the field. Shielded interbay heater cable and junction boxes are supplied. Heater weight, including junction boxes and interbay cable, is 6 lb (2.7 kg) additional per bay.

# EDUCATIONAL LOW POWER FM ANTENNA

## Educational Low Power FM Antenna

For low power educational broadcasting applications, Continental offers the economical Educational FM antennas produced by Phelps Dodge.

Available in either horizontally or circularly polarized models, these antennas, because of the normally lower power required in the educational service, are fabricated of  $\frac{7}{8}$ " stainless steel tube.

The circularly polarized antenna is a  $1\frac{1}{2}$  turn helix and the horizontal polarized element has a U configuration.

The educational antennas are complete with a matching harness of RG type cables and are designed to mount on tower legs or support pipes  $1\frac{1}{4}$ " to  $2\frac{3}{4}$ " in diameter. The multi-element arrays have an element spacing of 10 feet.

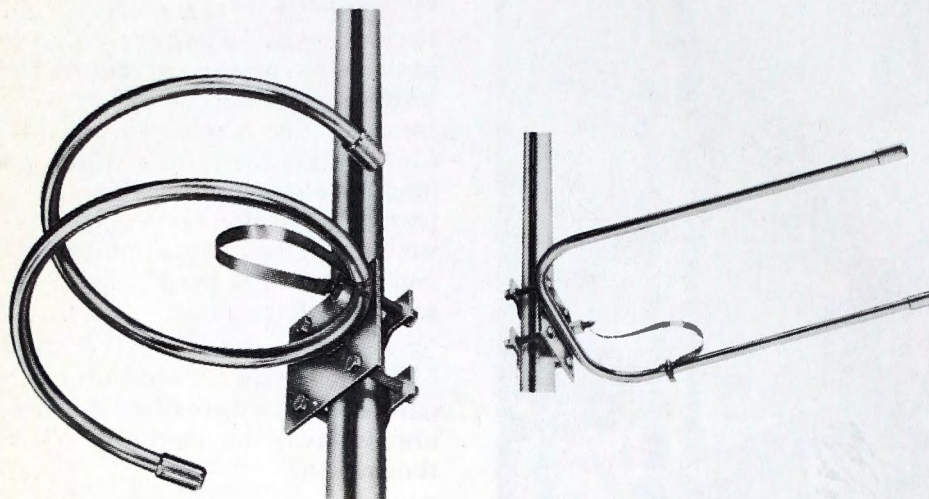

## Circularly Polarized FM Educational Antenna Specifications

Type No. And Bays	Power Gain	Gain In dB	Field Gain	FS @ 1 Mile 1 kW, $\mu$ V/ml	Net Wt. Lb	Power Rating kW	Wind Load 50/33 lb/ft <sup>2</sup>
ECFM-1	0.43	-3.68	0.65	90	9	0.2	19
ECFM-2	0.90	-0.46	0.95	131	21	0.4	40
ECFM-3	1.42	1.52	1.19	165	32	0.5	62
ECFM-4	1.95	2.9	1.39	192	43	0.5	84
ECFM-5	2.42	3.84	1.56	215	54	0.5	107
ECFM-6	2.99	4.76	1.73	239	65	0.5	130

Educational FM Antennas are designed to mount on tower legs or support pipes having diameters up to 7 cm ( $2\frac{3}{4}$ ").

The spacing between bays is 3.1 m (10 ft).

Educational FM Antennas are fed with RG-8 and RG-11 cables and all have type N Male Input Connector.

## Horizontally Polarized FM Educational Antenna Specifications

Type No. And Bays	Power Gain	Gain In dB	Field Gain	FS @ 1 Mile 1 kW, $\mu$ V/ml	Net Wt. Lb	Power Rating kW	Wind Load 50/33 lb/ft <sup>2</sup>
EHFM-1	1.0	0	1.0	138	9	0.2	19
EHFM-2	1.8	2.55	1.34	184	21	0.4	40
EHFM-3	2.8	4.47	1.67	230	32	0.5	62
EHFM-4	3.7	5.7	1.92	264	43	0.5	84
EHFM-5	4.6	6.6	2.1	289	54	0.5	107
EHFM-6	5.5	7.4	2.3	317	65	0.5	130

Educational FM Antennas are designed to mount on tower legs or support pipes having diameters up to 7 cm ( $2\frac{3}{4}$ ").

the spacing between bays is 3.1m (10 ft.)

Educational FM Antennas are fed with RG-8 and RG-11 cables and all have a type N Male Input Connector.



# G4D FM ANTENNA

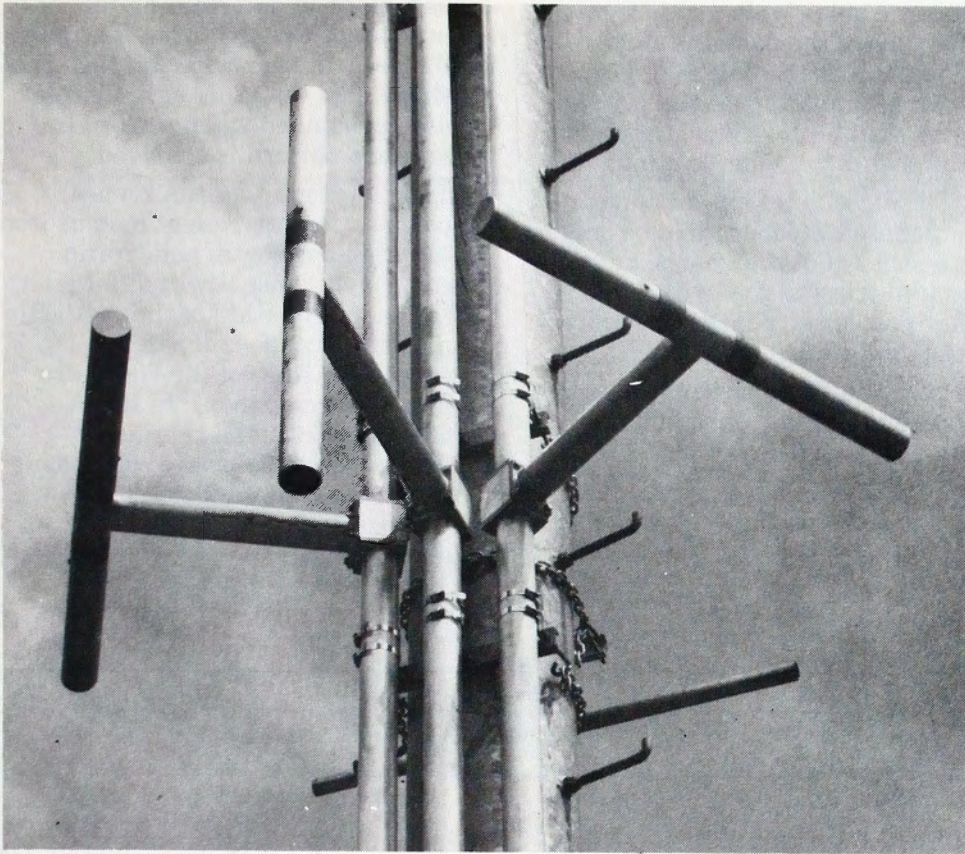

## **G4D Dual Polarized Directional FM Antenna**

The G4D supplied with a custom matching pole\* permits support pole drop shipment directly to the customer. Several poles are available at the antenna pattern range for testing.

The G4D uses broadband  $3\frac{1}{8}$ " diameter dipole elements. In normal environmental conditions, the elements do not require deicing. Each bay level normally uses two driven horizontal elements, one horizontal parasitic reflector, and one driven vertical element. In some cases, vertical parasitic elements may be used on each bay to further shape the vertical polarization component.

The G4D antenna, with maximum 8-bay availability, uses a suffix after the type number to denote the number of bays. Vertical spacing between bays is one wavelength.

The interbay lines use a  $3\frac{1}{8}$ " rigid transmission line. Three such lines are used between bays; two for horizontal element feeds and one for vertical element feeds. A combiner for the three transmission line feeds is used below the bottom bay; a 6 foot matching section is used directly below this combiner.

The G4D is available with a  $1\frac{5}{8}$ " (type number and suffix A), or  $3\frac{1}{8}$ " EIA 50 ohm female input (type number and suffix B). Maximum power input capability is 12 kW for A series; 20 kW for B series single bay; 40 kW for B series, 2 through 8 bays.

Deicers are not supplied because of the good bandwidth characteristics of the array. Typical bandwidth is approximately 5 MHz between 1.5:1 VSWR points; the VSWR during minor icing conditions should not exceed 1.5:1.

Four typical directional FM antenna patterns are shown in the following four figures. The final pattern achieved may differ slightly from the initial pattern proposed, so that the customer may be required to file an application to modify the construction permit to comply with the pattern achieved on Continental's antenna pattern range.

# G4D FM ANTENNA

Orders for the G4D should specify the desired true azimuth orientation, maximum ERP permitted, radiated power limitations and their true orientation, transmission line efficiency (or type of transmission line and length), and the transmitter power output capability. Such antenna pattern requirements are normally specified by the station consultant. A copy of the FCC construction permit should be provided with the order.

Table 1 gives typical gain figures for each of the patterns shown. Table 2 lists the pole length for each antenna type, height of the electrical center above the support tower, weight, wind loading, etc.

\*The directional antenna may be purchased without the pole only on a special quotation basis; an added engineering charge will be made, and cost of the pole deducted from the total price.

Note: The listed power gain figures are approximate only, but are useful

as a guide in determining the number of bays required. The gain figures will vary with the pattern shape, and the exact gain figures are determined when the final antenna pattern is achieved.

The power gain for the vertical polarization component may be less than the horizontal polarization component since it will differ a bit in shape. The RMS of the vertically polarized component can not exceed the RMS of the vertically polarized component. In the case of educational channels, the vertically polarized component can not exceed the horizontally polarized component at any azimuth.

## Type G4D-( ) Dual Polarized Directional FM Antenna

Number of Bays	Pattern 1		Pattern 2		Pattern 3		Pattern 4	
	Maximum Power Gain Horiz	Maximum Power Gain Vert	Maximum Power Gain Horiz	Maximum Power Gain Vert	Maximum Power Gain Horiz	Maximum Power Gain Vert	Maximum Power Gain Horiz	Maximum Power Gain Vert
1	0.81	0.72	0.79	0.70	0.76	0.70	0.72	0.69
2	1.74	1.53	1.70	1.49	1.63	1.50	1.54	1.47
3	2.71	2.39	2.64	2.33	2.54	2.34	2.39	2.29
4	3.70	3.26	3.61	3.18	3.47	3.19	3.26	3.13
5	4.71	4.14	4.58	4.03	4.40	4.05	4.14	3.98
6	5.71	5.03	5.56	4.90	5.35	4.92	5.03	4.83
7	6.73	5.92	6.55	5.77	6.29	5.79	5.92	5.68
8	7.75	6.82	7.55	6.64	7.25	6.67	6.82	6.54

Note: The listed power gain figures are approximate only, but are useful as a guide in determining the number of bays required. The gain figures will vary with the pattern shape, and the exact gain figures are determined when the final antenna pattern is achieved.

The power gain for the vertical polarization component may be less than the horizontal polarization component since it will differ a bit in shape. The RMS of the vertically polarized component can not exceed the RMS of the vertically polarized component. In the case of educational channels, the vertically polarized component can not exceed the horizontally polarized component at any azimuth.

## G4D-( ) Dual Polarized Directional FM Antennas

Type	PATTERN 1				Input Power Rating kW	Female Input Flange (cm) in	Pole Length (m) ft	Weight Pole and Antenna (kg) lb	Total Wind Load Based on 244/161 (50/33 lb/sq ft) (kg) lb		Moment (ft/lb)	Height of Electrical Center Above Top of Tower (m) ft	Bolt Circle Diameter (cm) in
	Power Gain Horiz	Power Gain Vert	dB Gain Horiz	dB Gain Vert					kg./sq.m	kg/m (ft/lb)			
G4D-1A	0.75	0.68	-1.22	-1.67	12	(4.1) 1½	(6) 20	(275) 606	(361) 796	(1327)	9595	(4.8) 16	(23) 9
G4D-1B	0.75	0.68	-1.22	-1.67	20	(7.9) 3¼	(6) 20	(284) 626	(372) 832	(1383)	10000	(4.8) 16	(23) 9
G4D-2A	1.62	1.47	2.11	1.66	12	(4.1) 1½	(9) 30	(1016) 2240	(826) 1821	(4152)	30024	(6.4) 21	(43) 17
G4D-2B	1.62	1.47	2.11	1.66	40	(7.9) 3¼	(9) 30	(1025) 2260	(842) 1856	(4231)	30593	(6.4) 21	(43) 17
G4D-3A	2.50	2.25	3.98	3.53	12	(4.1) 1½	(12) 40	(1358) 2994	(1160) 2557	(7595)	54917	(7.9) 26	(43) 17
G4D-3B	2.50	2.25	3.98	3.53	40	(7.9) 3¼	(12) 40	(1367) 3014	(1176) 2593	(7700)	55682	(7.9) 26	(43) 17
G4D-4A	3.39	3.06	5.30	4.86	12	(4.1) 1½	(15) 50	(1926) 4245	(1583) 3490	(12351)	89308	(9.4) 31	(43) 17
G4D-4B	3.39	3.06	5.30	4.86	40	(7.9) 3¼	(15) 50	(1935) 4265	(1599) 3526	(12482)	90254	(9.4) 31	(43) 17
G4D-5A	4.29	3.88	6.33	5.88	12	(4.1) 1½	(19) 62	(2677) 5901	(2123) 4680	(21189)	153210	(11.5) 38	(43) 17
G4D-5B	4.29	3.88	6.33	5.88	40	(7.9) 3¼	(19) 62	(2685) 5921	(2139) 4716	(21354)	154407	(11.5) 38	(43) 17
G4D-6A	5.19	4.68	7.15	6.70	12	(4.1) 1½	(22) 72	(3609) 7956	(2505) 5523	(28795)	208204	(13.1) 43	(43) 17
G4D-6B	5.19	4.68	7.15	6.70	40	(7.9) 3¼	(22) 72	(3618) 7976	(2522) 5559	(28985)	209581	(13.1) 43	(43) 17
G4D-7A	6.05	5.46	7.81	7.37	12	(4.1) 1½	(25) 82	(4196) 9250	(2880) 6350	(37523)	271315	(14.6) 48	(43) 17
G4D-7B	6.05	5.46	7.81	7.37	40	(7.9) 3¼	(25) 82	(4205) 9270	(2897) 6386	(37738)	272872	(14.6) 48	(43) 17
G4D-8A	6.93	6.26	8.41	7.96	12	(4.1) 1½	(28) 92	(5128) 11305	(3262) 7192	(47459)	343159	(16.1) 53	(43) 17
G4D-8B	6.93	6.26	8.41	7.96	40	(7.9) 3¼	(28) 92	(5137) 11325	(3278) 7227	(47692)	344847	(16.1) 53	(43) 17



# G4D FM ANTENNA

### Pattern 1

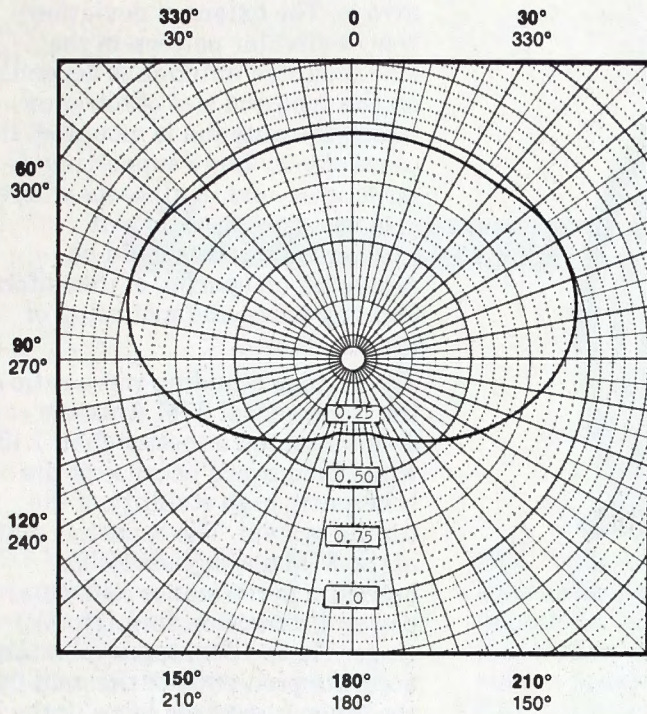

### Pattern 2

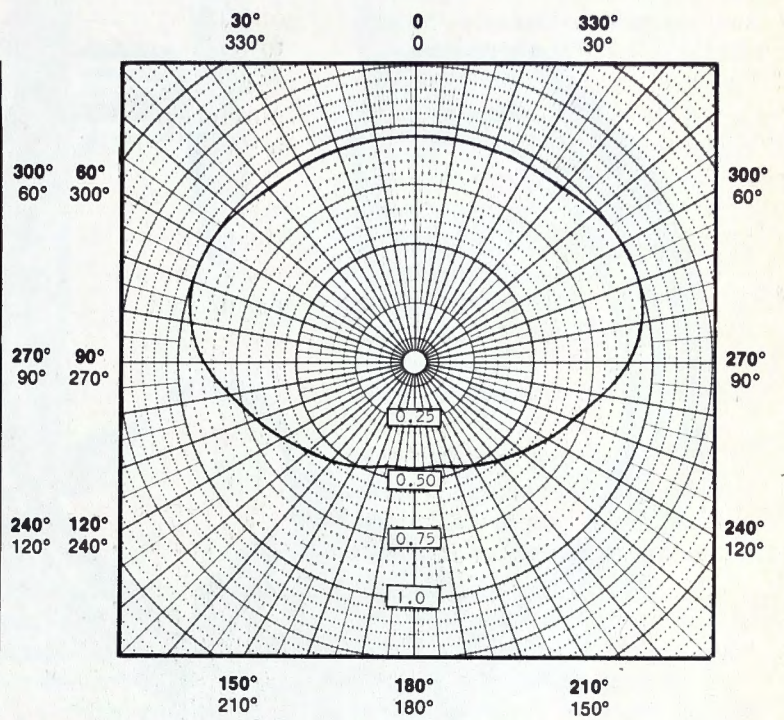

### Pattern 3

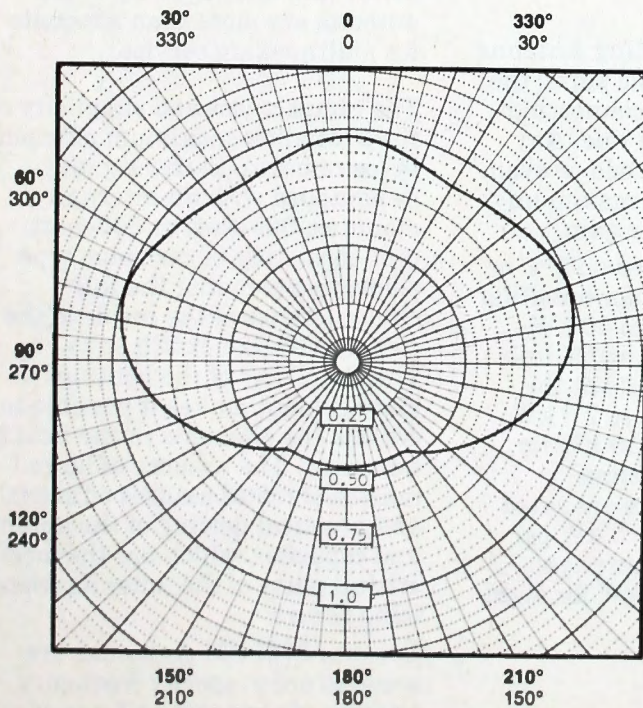

### Pattern 4

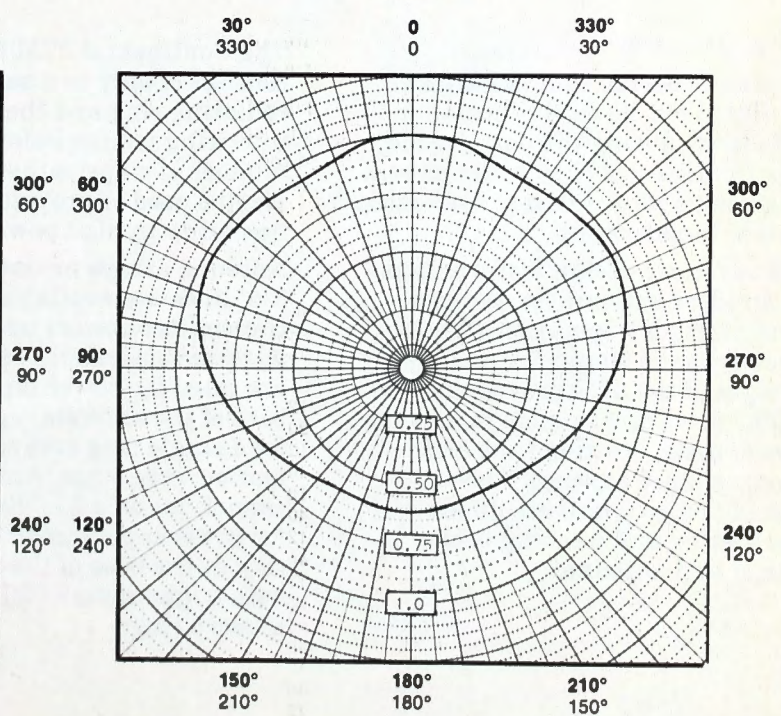

## 37M RING FM ANTENNA



### 37M Ring FM Antenna

A proven design that has been imitated but never duplicated in efficiency during the past decade, the Continental 37M Antenna still maintains its position of leadership in FM broadcasting.

Its advanced design features make it an ideal antenna for stereo and multiplex operations. The aerodynamic simplicity and low weight of the 37M provide greater efficiencies and savings in new tower costs, erection time and maintenance expense. These benefits also eliminate undue oscillating and weaving of the tower and antenna.

The Continental 37M Ring Antenna consists of only two basic parts; the radiating ring and the connecting inter-ring transmission line. Any number of rings, either odd or even, may be used to provide maximum flexibility in high power gain.

Antenna arrays mounted on 1 $\frac{5}{8}$ " or 3 $\frac{1}{8}$ " lines are available for handling transmitter powers up to 20 kW. Antenna assemblies on a 1 $\frac{5}{8}$ " line are rated for power inputs at the base of the antenna, up to 2.5 kW for a single ring array; 10 kW for four or more rings. Antenna assemblies on a 3 $\frac{1}{8}$ " line are rated for power inputs up to 2.5 kW per ring at the base of the antenna, with a maximum of 20 kW for eight or more rings.

The horizontal radiation pattern of the Continental 37M FM Antenna is essentially circular for both top-mounting and side-mounting arrays. The extent of deviation from a circular pattern in the side-mounted antenna is dependent on the type and size of tower on which the antenna is mounted. In cases of very large supporting structures, and in all cases where guy wires are used, expert recommendations should be requested on spacing of insulators and guy wires and mounting of the antenna.

The voltage standing wave ratio of the Continental 37M Antenna can be maintained at better than 1.15:1 when field tuned because of the inherently high stability of the tuning system. The capacitor plates of the 37M are adjustable for optimum performance and equal power distribution through all rings. These advantages allow an accurate prediction of the gain from the given number of loops in the array. Adequate bandwidth virtually eliminates detuning effects caused by changes in atmospheric conditions. The bandwidth and linearity of the antenna are more than adequate for multiplexing service.

The compactness and simplicity of the 37M allow maximum efficiency in ice removal. Each ring may be equipped with an internally mounted, 300-watt or 500-watt unit consisting of cartridge type elements extending the full circumference of the inside of the ring specify 120 or 230 volts. The simplicity of the heating arrangement makes it possible to replace the elements in the field if necessary. The absence of large masses of metal assures efficient and practical deicing of the antenna and capacitor, which are the most critical parts of the antenna when icing occurs.

Because 37M FM Antennas are made to order, specify frequency, number of elements and size of transmission line when ordering.

## 300C FM ANTENNA

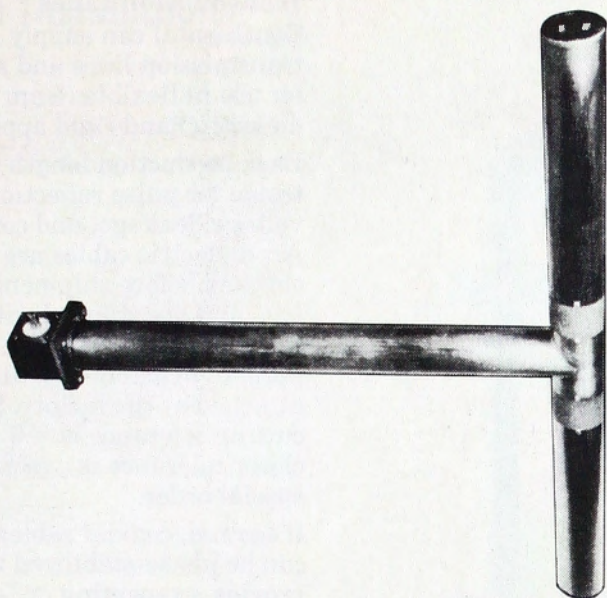

### **300C Vertically Polarized FM Antenna**

Continental 300C vertically polarized FM antennas can significantly improve present horizontal-only coverage.

FCC regulations permit simultaneous FM radiation in both horizontal and vertical planes. For example, if your station is authorized for 5 kW ERP horizontal, vertical radiation can be added up to the same power. Two methods are commonly used:

(1) A single power amplifier and transmission line to provide power for each antenna.

(2) Two power amplifiers fed from a common exciter-driver and two transmission lines. The antennas are fed separately.

The preferred method will be dictated by your power situation. If minimum initial investment is your primary concern, the first method is preferred. If redundancy is important, the second method permits either amplifier to be operated individually or both simultaneously. The recommended ratio of vertical to horizontal ERP is unity.

Continental's Type 300C FM antenna can be installed on your present tower, and is compatible with your existing FM transmitter.

Vertical polarization with Continental's 300C antenna can fill-in shadow areas, reduce null effects, improve fringe area reception, vastly improve car FM radio reception, maintain FM stereo quality and improve SCA operation.



# ANTENNA TRANSMISSION LINES

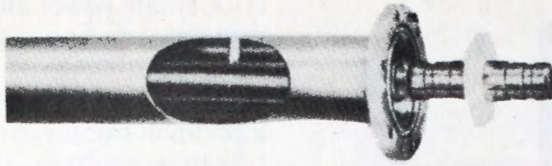

Andrew Rigid

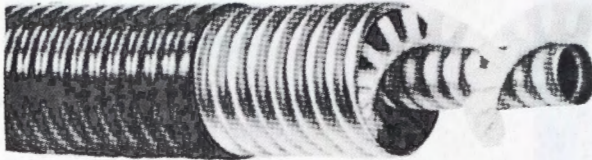

Andrew Air Heliax

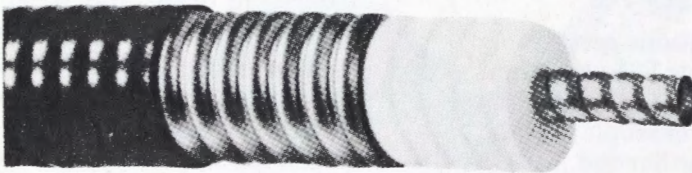

Andrew Foam Heliax



Cablewave Foam Wellflex



Cablewave Air Wellflex

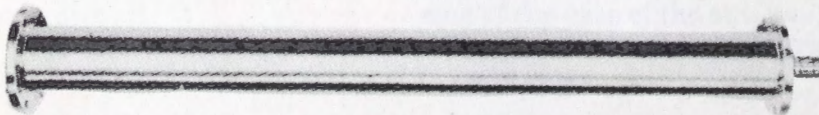

Cablewave Rigid

## Transmission Lines

Continental can supply transmission lines and accessories for use in flexible (foam or air dielectric) and rigid applications.

Each production length of cable is tested for pulse reflection, high voltage, leakage, and continuity. Air dielectric cables are pressure checked before shipment to the job site, and are shipped with dry air pressure. Cable lengths are normally custom cut; fittings are attached at the factory. Standard cutting tolerance is  $-0 + 2$  percent; closer tolerance is available on special order.

If desired, coaxial cables can be phase-stabilized to provide a repeating or "stable" phase-temperature characteristic. This stabilization is accomplished by heat-treating the cable at the factory.

Continental can supply any cable item produced by Andrew, Cablewave, Phelps Dodge, or Prodlein; including Andrew 4" air dielectric Heliax line for high power FM applications, and Cablewave Type HCC 312-50J 3½" air Wellflex cable. Following are some of the most commonly used items.

Flexible line, foam dielectric:  
¾", ½", ⅞", 1½"

Flexible line, air dielectric:  
⅞", 1½", 3", 3½", 4", 5"

Rigid line, 50 ohm: 1½", 3½", 6"

Jacks, plugs, flanges, barriers, splices, terminals, reducers.

Hangers and accessories.

Pressurizing equipment, coaxial switches.



# ANTENNA TRANSMISSION LINES

## Typical Installations

### Flexible Line

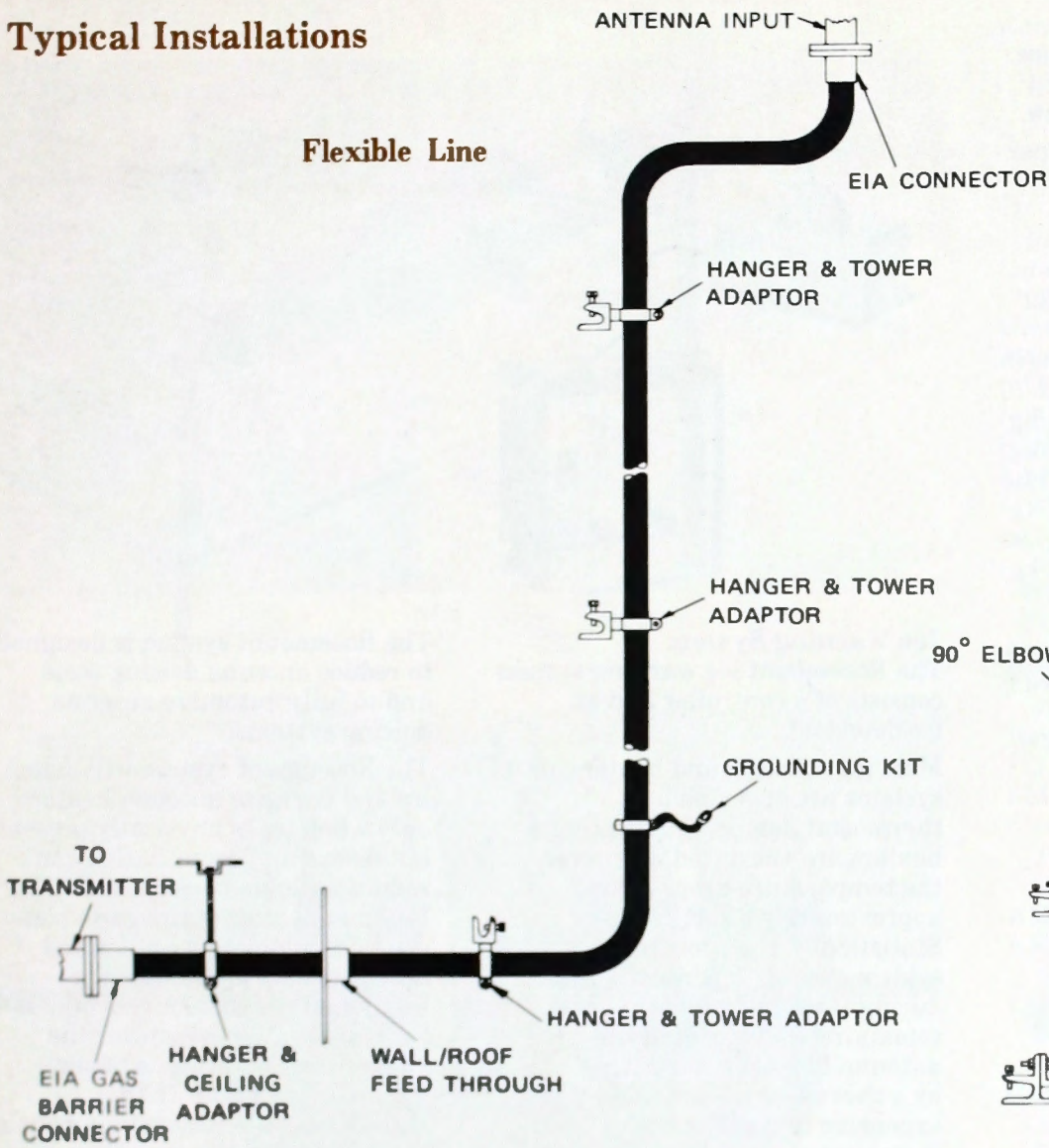

### Rigid Line

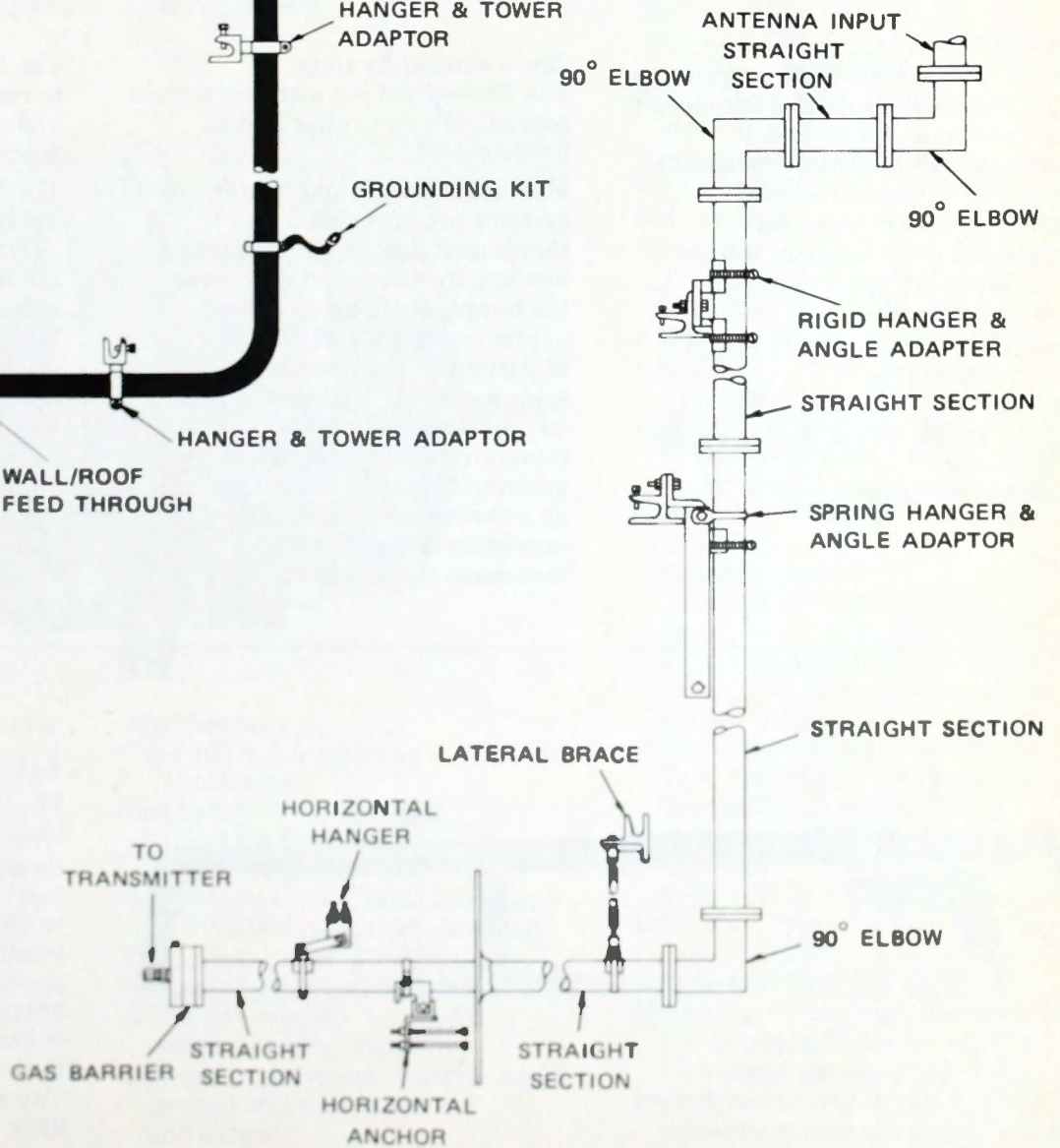

# ANTENNA SYSTEM ACCESSORIES

## Copper Ground Wire

Bare #10 AWG copper ground wire is used for ground radials. Wire attaches to mesh ground screen.

Pounds per foot: 28.81 lb (13 kg) per 1000 ft

## Copper Ground Strap

Copper ground strap is available in four widths; each width is 0.032" (0.086 cm) thick.

Strap width	Pounds per unit length
2" (5.08 cm)	4.02 ft per lb (2.70 M/kg)
3" (7.6 cm)	3.01 ft per lb (2.02 M/kg)
4" (10.1 cm)	2.01 ft per lb (1.35 M/kg)
6" (15.2 cm)	1.34 ft per lb (0.90 M/kg)

## Beacon Light Control

Fisher-Pierce 63305-DB beacon light control mounts in a standard commercial meter socket. It automatically controls broadcast tower lights directly, or with auxiliary contractors. An adjustable potentiometer allows adjustment for operation from 0 to 50 footcandles.

Power requirements: 105 to 130 volts; 50/60 Hz

Built-in load contractor: Single-pole, single throw, double break; 30 amps

Load rating: 3000 watts

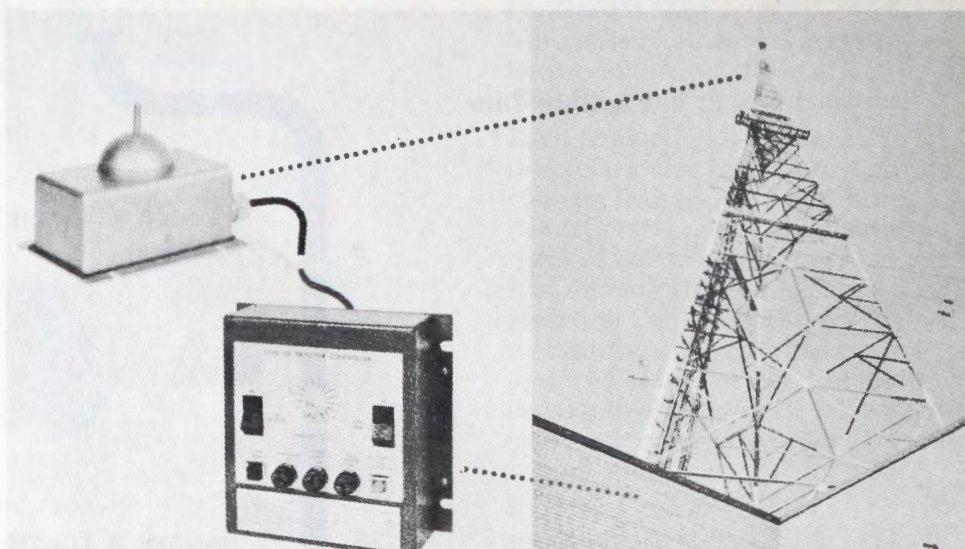

## Ice Warning System

The Rosemount ice warning system consists of a controller and an ice detector\*.

Most ice warning and heater control systems are operated by a thermostat device; thus, antenna heaters are energized whenever the temperature drops below approximately 35° F. (1.7°C). Statistically, the probability of icing seldom exceeds 3 percent, even during the winter months. The remaining 97 percent of the time, antenna heater power activated by a thermostatic device provides expensive and unnecessary insurance against icing.

The Rosemount system is designed to reduce antenna deicing costs and to fully automate antenna deicing systems.

The Rosemount system will detect ice and energize antenna heaters only when ice is physically present, but before ice accumulation can reduce antenna performance. The Rosemount system thus provides reliable, completely automated antenna icing protection at a fraction of the cost for continuous heater operation whenever the ambient temperature is below approximately 35°F (1.7°C). In many cases, the Rosemount system will pay for itself in less than one icing season.

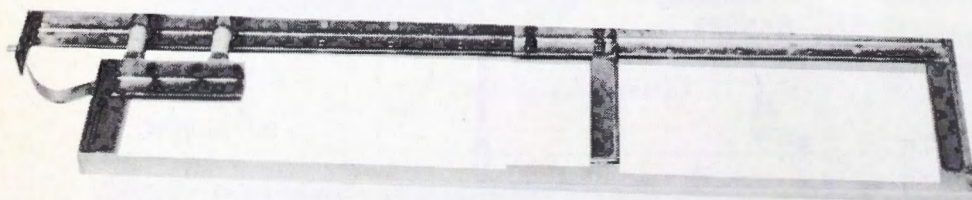

## Sampling Loop

The 601 series fixed phase sampling loops manufactured by Electronic Research, Inc., sample the phase relationship of rf energy in the 550 to 1600 kHz range. The sensitivity is adjustable by varying the fixed position of the shorting bar provided. The loops are constructed of heavy stainless steel and terminate in a Type N female plug. Two sizes are available: 48" x 12"; 91" x 12.

# ANTENNA SYSTEM ACCESSORIES



Connectors: Type 403: 1 $\frac{5}{8}$ " (2.86 cm) male swivel input; 1 $\frac{5}{8}$ " (2.86 cm) female swivel output  
 Type 403A: 3 $\frac{1}{8}$ " (7.9 cm) male swivel input; 3 $\frac{1}{8}$ " (7.9 cm) female swivel output  
 Weight: Approx. 105 lb (47.6 kg) including cradle.  
 Length: 67" to 73" (170 to 185 cm) depending on frequency.  
 Diameter: 10" (25.4 cm) maximum.  
 Mounting: Cradle supplied with 2" (5 cm) pipe flange on bottom. Pipe stand not supplied.  
 Pressurization: 10 lb (4.5 kg) line pressure maximum pass through.

## Specifications:

Type 425, 426, 427 Isolation Units  
 Frequency: 88 to 108 MHz  
 VSWR: Less than 1:05:1 at the station frequency.  
 Bandwidth: Over 2 MHz between 1.1:1 VSWR points, 50 ohm load  
 FM power: Type 425: 25 kW, 50 ohm line.  
 Type 426: 40 kW, 50 ohm line  
 Type 427: 50 kW, 50 ohm line  
 AM peak voltage: 40,000 volts.  
 AM shunt capacity to ground: Approximately 60 to 70 pf  
 Lightning protection: Heavy-duty dc shorts between inner and outer conductors on input and output  
 Connectors: Type 425: 3 $\frac{1}{8}$ " (7.9 cm) male input; 3 $\frac{1}{8}$ " (7.9 cm) female output  
 Type 426: 3 $\frac{1}{8}$ " (7.9 cm) male input; 3 $\frac{1}{8}$ " (7.9 cm) female output  
 Type 427: 6 $\frac{1}{8}$ " (15.6 cm) male input; 6 $\frac{1}{8}$ " (15.6 cm) female output

Weight: Type 425: 256 lb (116 kg)  
 Type 426: 300 lb (136 kg)  
 Type 427: 325 lb (146.25 kg)  
 Length: Type 425: 44" (111 cm)  
 Type 426: 44" (111 cm)  
 Type 427: 51" (129.54 cm)  
 Diameter: Type 425: 28 $\frac{1}{2}$ " (72 cm)  
 Type 426: 28 $\frac{1}{2}$ " (72 cm)  
 Type 427: 28 $\frac{1}{2}$ " (72 cm)  
 Mounting: Cradle supplied with 3" (7.6 cm) pipe flange on bottom. Pipe stand not supplied.  
 Pressurization: 10 lb (4.5 kg) line pressure maximum pass through.

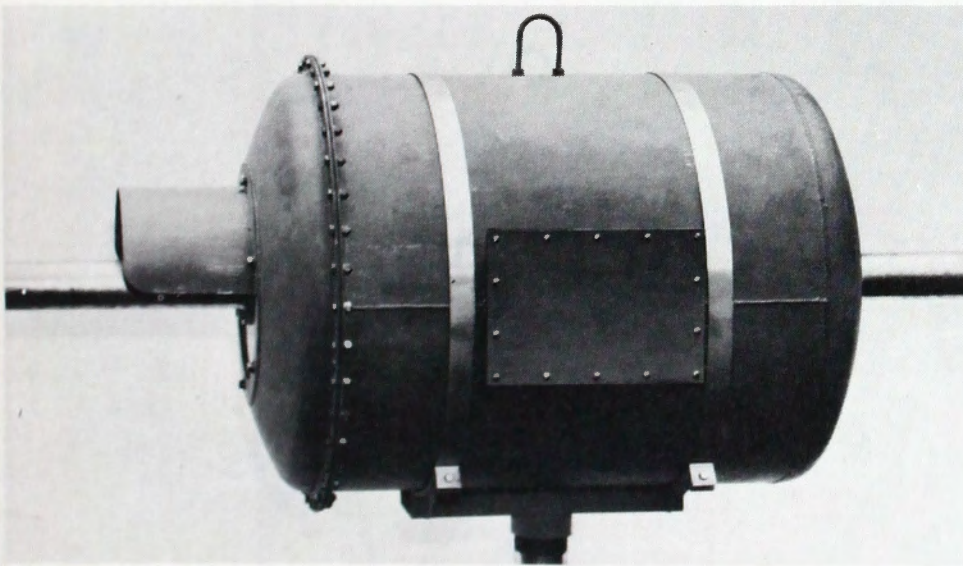

**AM/FM Isolation Transformers**  
 Isolation transformers are designed to couple the FM power across the base insulator of a transmitting tower used jointly as an AM and FM radiator without introducing a mismatch into the FM feedline. An isolation transformer is especially desirable for feeding high impedance AM directional antenna system which might be adversely affected by a "bazooka" type isolation system. Each unit is factory tuned to station FM frequency.

Specifications:  
 Type 403-403A Isolation Transformers  
 Frequency: 88 to 108 MHz  
 VSWR: Less than 1.05:1 at the station frequency.  
 Bandwidth: Over 2 MHz between 1.1:1 VSWR points, 50 ohm load  
 FM power: 10 kW, 50-ohm line.  
 AM peak voltage: 7500 volts.  
 AM shunt capacity to ground: Approximately 200 pf  
 Lightning protection: Quarter-wave shorted stubs on input and output.

# ANTENNA SYSTEM ACCESSORIES

---

## Isolation Coil

The coil provides isolation for the phase sampling loop line in AM directional antenna arrays. This coil presents a high impedance for the line across the base insulator of the tower, and consists of a phenolic coil form wound with approximately 37 turns of RG8/U or similar solid dielectric coaxial cable.

The inductance of the coil is approximately 180 microhenrys.

Size: 18" (46 cm) L, 10" (25.4 cm) D

Weight: 6 lb (2.7 kg)

## Feedthru Bowl Insulator

Designed to carry rf transmission line through a wall, assembly includes a bowl or bowls 7 in. (17.8 cm) in diameter and 5.5 in. (13.9 cm) high with stud length as described below:

#153 Bowl Insulator; single with fittings, 7 in. (17.8 cm) diameter, 5½ in. (13.9 cm) high, 10½ in. (26.6 cm) stud.

#154 Bowl Insulator; single with fittings, 7 in. (17.8 cm) diameter, 5½ in. (13.9 cm) high, 10½ in. (26.6 cm) stud.

#155 Double Bowl Insulator with fittings; bowls are each 7 in. (17.8 cm) diameter, 5½ in. (13.9 cm) high, 18 in. (45.7 cm) stud.

#156 Double Bowl Insulator with fittings; bowls are each 7 in. (17.8 cm) diameter, 5½ in. (13.9 cm) high, 18 in. (45.7 cm) hollow stud.



# AUDIO EQUIPMENT

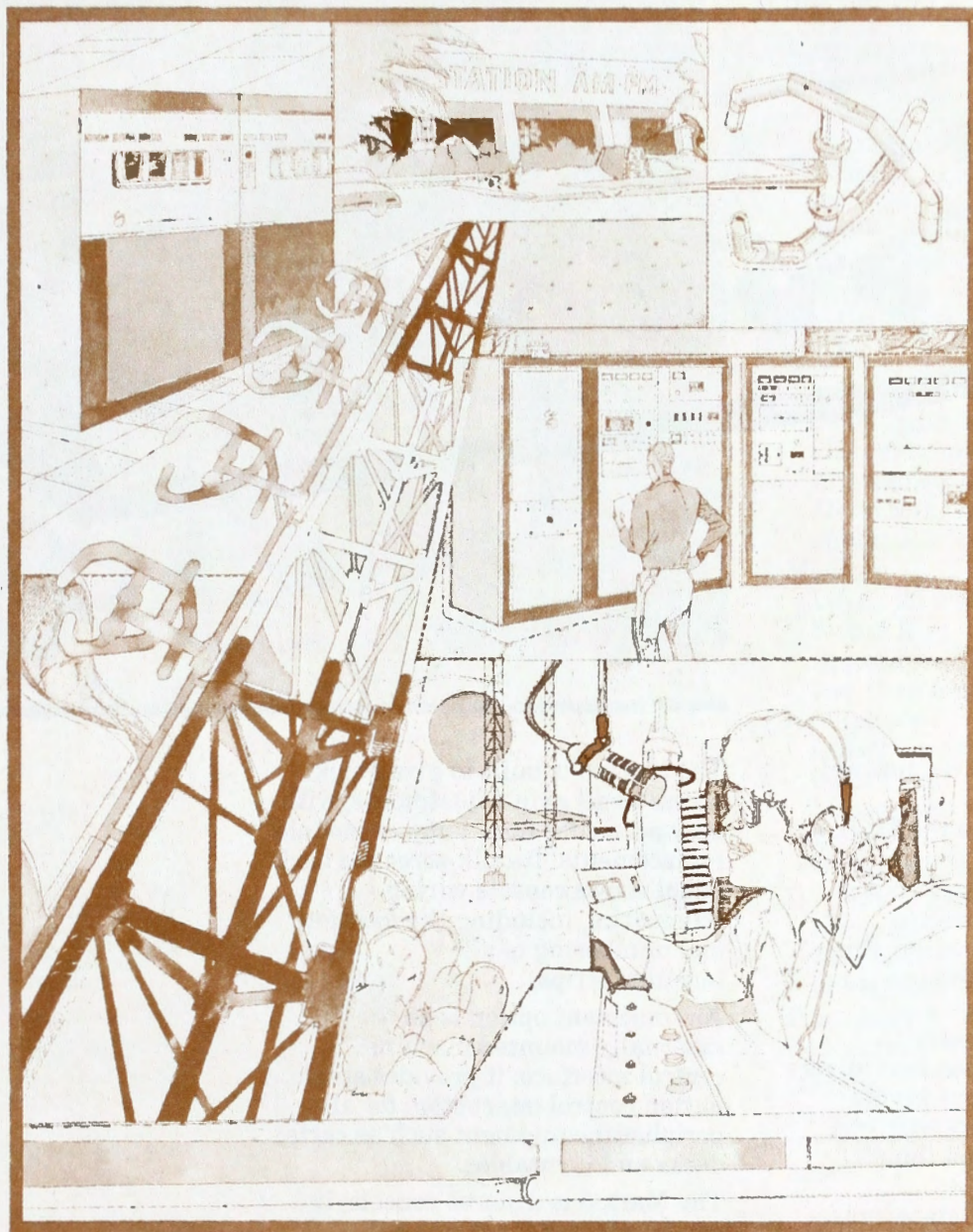

# CONSOLES



## Continental Mark 8 8-Channel Audio Console

"Value" best describes the Mark 8. This highly versatile console is not only priced competitively, but is also superbly engineered to guarantee maximum on-air time and minimum maintenance. And its features are imposing.

- It accepts 26 input pairs.
- It contains six independent mixers (with two independent inputs each) *plus* two mixers with one direct and six indirect inputs per mixer.
- It incorporates solid-state, noise-free switching circuitry; long-life, step-type ladder attenuators; and state-of-the-art switches, PC boards, and amplifiers.

And there's more: from lighted VU displays to an externally-mounted power supply to separate amplifiers for monitors, headphones and cue speaker. Muting is instantaneous for both monitor and cue.

The Mark 8 is built to give quick access to all gain adjustments, with easy access for fuse, lamp or module replacements. Its silk-screened back panel shows console wiring schematics, including the location and numbering of all terminal strips.

An important option is an externally mounted machine control interface: it provides single button control (start/stop) for all peripheral equipment such as carts, decks and turntables.

The Mark 8 is a stereo console; it can be adapted for monaural operation.



# CONSOLES

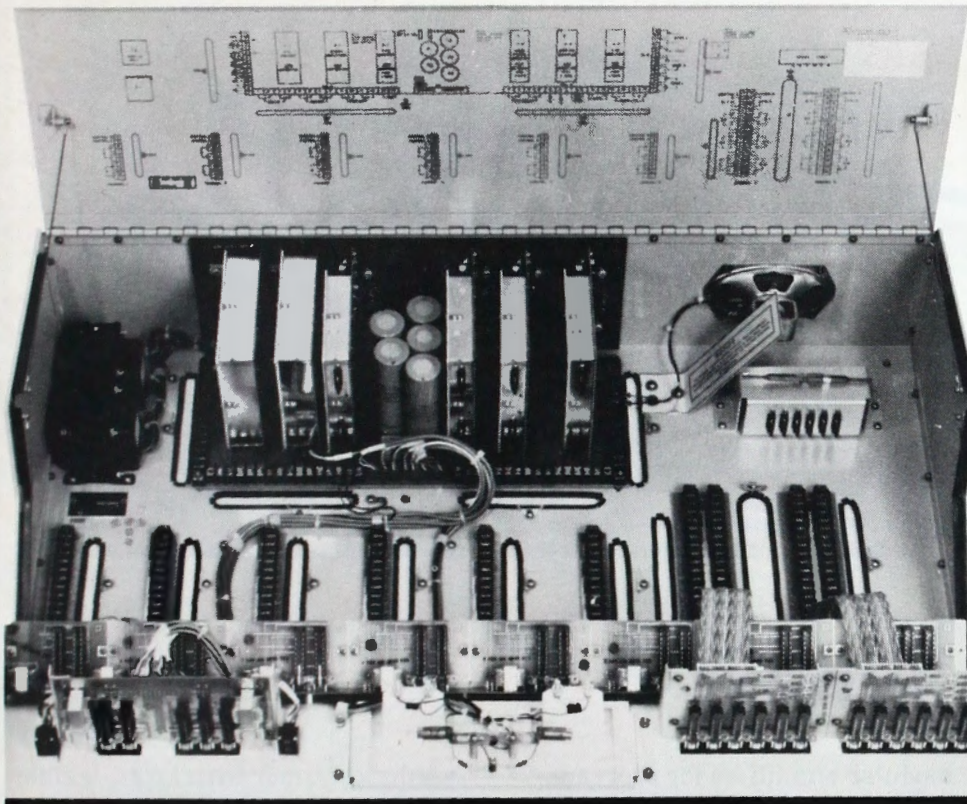

## Specifications

Mark 8

8 Channel Studio Console

### Inputs

#### Impedance

Microphones: Nominal 150 ohms

Medium Level: Nominal 150  
600 ohms

#### Level

Microphones: - 50 dBm nominal

Medium Level: - 10 dBm  
nominal

Number of Inputs: 26  
medium level

Any two inputs may be strapped  
for microphones

### Outputs

#### Program

Level:  $\pm 18$  dBm nominal  $\pm 30$   
dBm maximum

Impedance: 600 ohms

Mono Mix Output: 8 dBm - 600  
ohms (212P-2 Only)

#### Monitor

Level: 25 watts rms into  
8-ohm load

Impedance Total load must no be  
less than 8 ohms

#### Headphone

Level: 5 watts rms into  
8-ohm load

Impedance: 4 ohms minimum

#### Noise:

- 125 dBm in 20-kHz bandwidth

#### Distortion: Less than 0.5%

harmonic

Less than 0.25% IM

(60 Hz and 700 Hz: 4:1)

#### Frequency

Response:  $\pm 1.0$  dB 30 Hz to 15 kHz

#### General

Power Source: 120/240 volts 50/60  
Hz ac

Size: 9" (228.6 mm)H  
34" (863.6 mm)W  
18 $\frac{1}{4}$ " (463.55 mm)D

Weight: 65 lb (29.25 kg)

#### Power supply

Size: 10" (254 mm)H  
4.56" (115.82 mm)W  
6.72" (170.69 mm)D

Weight: 15 lb (6.75 kg)

#### Machine control (optional)

Size: 2.81" (71.37 mm)H  
8.82" (224.03 mm)W  
15.65" (397.51 mm)D

Weight: 2 lb (0.90 kg)



# CONSOLES



## Continental Rock 10 10-Channel Audio Console

The Rock 10 is an exceptionally engineered audio mixer:

- It can handle inputs from a total of 30 stereo or monaural sources (microphones, turntables, carts, cassettes, reel-to-reel decks).
- It can assign any of these inputs to one of two "programs" (for on-the-air or for taping, for example).
- And it processes these signals with virtually no distortion and an astounding transparent quality.

In the Rock 10 you'll find the best of old and new — from push-button actuated, solid-state audio switches (eliminating pops and clicks) and multi-colored LED's to Fresnel lenses and true rotary-step attenuators. It's an amazing package, the Rock 10.

And it's packed with sensible, sophisticated features, such as:

- Individual stereo meters for stereo channels Program 1 and Program 2 (internally-lit, with quick-to-spot numbers).
- Individually gain-controlled

modular amplifiers for program, monitor, headphone and cue — each with complete R.F.I. shielding and separate fusing to protect solid-state components. Gold-plated contacts assure positive, noise-free connections.

The remarkable quietness of the Rock 10 is also due to its separate external power supply which keeps transformer hum away from audio circuits. There are provisions for muting, warning lights, and even auxiliary input and output.

Options to the Rock 10 include:

- Machine control interface (MCI) gives Rock 10 ability to handle start/stop operation of turntables, cart decks, reel to reel machines. The MCI can control up to 12 internally programmed functions to provide either momentary (cart decks) or latching (turntables) action. Internal plug-in jumpers are arranged for normally-open or normally-closed contact operation. The MCI is programmed by hand wiring at installation, but can be reprogrammed for future operation changes.

- A digital timer with large, legible numbers, is located in the center of the console. Count-up timer can be strapped to automatically reset each time a new channel is selected. The timer can be started and stopped by an external machine; it can be used in production work as a cumulative timer for recording multiple cuts on a single tape; it has front panel switches for manual resetting and selecting internal or external modes.
- Additional microphone pre-amplifiers.
- Audition circuit for recording news or network feeds or adjusting inputs in advance of airing.
- Mono mix-down (providing automatic AM feed when simulcasting in stereo).



# CONSOLES

## Specifications

Rock 10  
10 Channel Studio Console

Console Program:

Inputs:

30 stereo

Mixers:

10 stereo

Input:

0 dBm 600 ohms balanced (30  
stereo) Microphone

Preamplifiers - 50 dBm 150  
ohms balanced

Outputs:

+ 18 dBm 600 ohms balanced

Response:

$\pm 0.5$  dB 50 - 15,000 Hz

Distortion:

0.25% THD 50 - 15,000 Hz

0.25% IMD (4:1 SMPTE)

Noise:

75 dB below + 18 dBm high level

- 125 dB Equivalent Input

Noise Microphone

Headphone and Monitor Amplifiers  
(stereo, per channel)

Power:

Monitor 25 watts into 8 ohms

Headphone 5 watt headphone

Response:

$\pm 1.0$  dB 50 - 15,000 Hz

Distortion:

0.25% THD

0.25% IMD (SMPTE)

Size:

10" (254 mm)H

46" (1066.8 mm)W

20" (508 mm)D

Weight:

110 lbs (49.9 kg)

including power  
supply

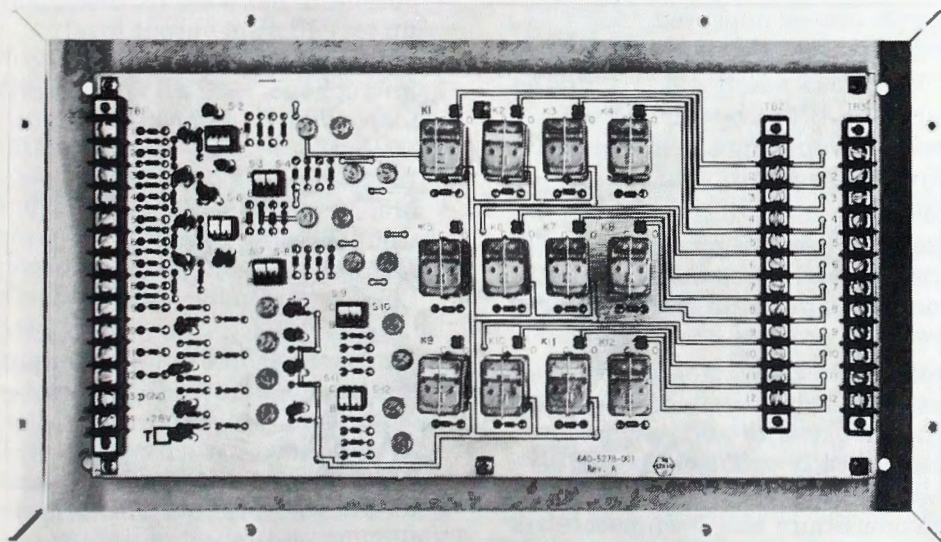
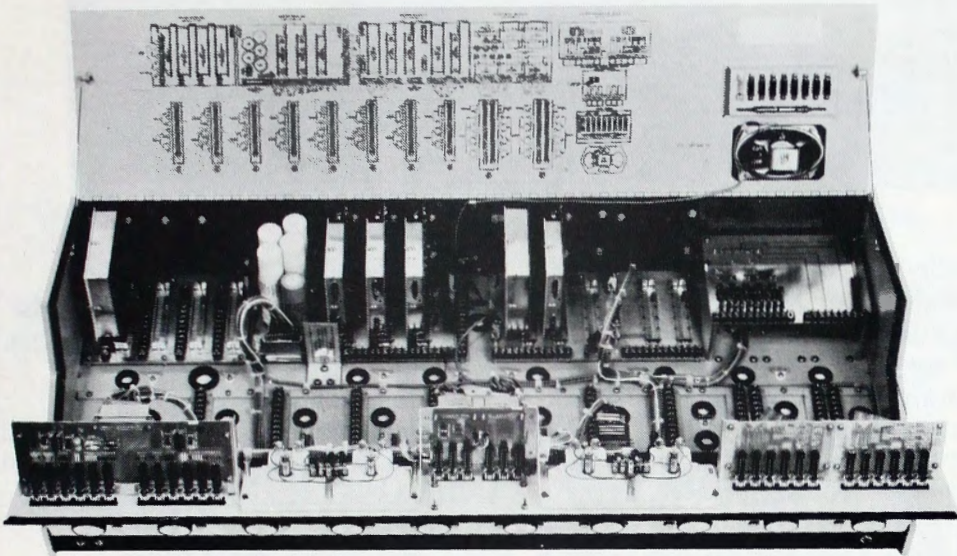

# CONSOLES

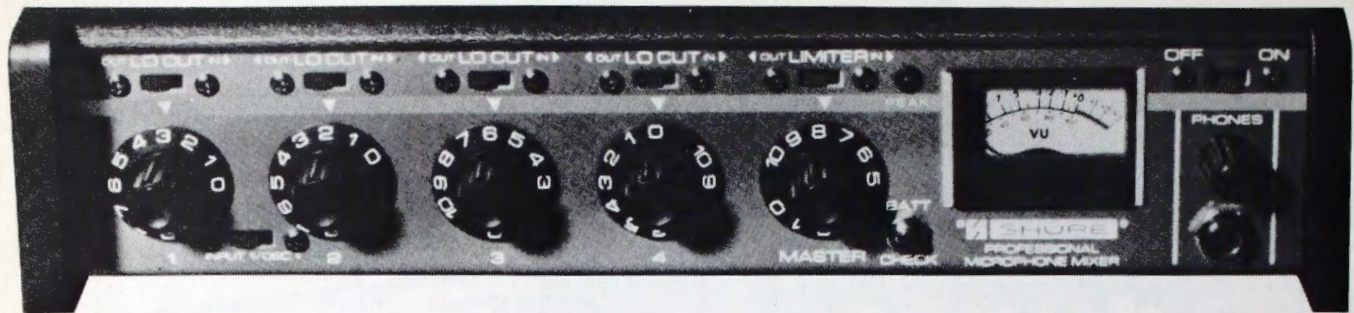

## Professional Microphone Mixer

The M267 and M268 offer excellent performance and versatility that make them ideal choices as compact mixers for studio, remote, or original sound reinforcement use and as studio quality "add-on" mixers for expanding existing facilities.

In designing these new mixers, Shure retained all the features that made the M67 and M68 the world standards—such as the wide frequency response, low RFI and line noise susceptibility, and balanced inputs and outputs. In addition to the many new features listed below, the M267 and M268 offer dramatic reduction of distortion and noise characteristics with substantial increases in gain and dynamic range.

**Low Distortion Tone Oscillator**— 1 kHz signal with front panel switch. Gold contacts!

**Active Gain Controls**— lower noise, greater dynamic range, and automatic input attenuation through the use of feedback-type volume controls.

**LED Peak Indicator**— faster than any VU meter, it warns user when program levels approach overload or indicates the onset of limiting.

**Battery Check Function**— check battery condition without interrupting the program.

**Headphone Level Control**— adjusts monitor volume to user's need.

**More Headphone Power**— improves headphone monitoring under noisy conditions; use headphone output to drive a tape deck or power amplifier.

**Mic/Line Switch**— XLR output and all four XLR inputs are switchable to Microphone or Line Level. Gold contacts!

**Simplex (Phantom) Power**— switchable 30 Vdc on all microphone inputs to power condenser microphones.

**Headphone Ampl/Line Switch**— choose Amplifier position for high level monitoring or Line position for talkback. Gold contacts!

**Low Distortion**— less than 0.35% at line level output.

**Electronic Power Supply Regulation**— improved performance on low or high ac line voltage.

**Automatic Muting Circuit**— prevents annoying clicks and thumps when unit is turned on or off.

**Peak Program Limiter**— eliminates overload distortion by monitoring program levels AND power supply level.

**Built-In Battery Pack**— operates on three readily available 9-volt alkaline batteries and switches automatically to battery power if ac fails.

The new Shure M267 compact professional microphone mixer does it all, and, with the addition of two brackets, it will fit into an M67 rack panel!

Specifications  
M267

Frequency Response:  $\pm 2$  dB from 30 to 20,000 Hz

Gain: Outputs terminated; line 600 ohms, microphone 150 ohms, mix bus 3.3K., headphone 200 ohms, tip-sleeve, ring-sleeve.

Input	Output		
	Line	Micro- phone	Mix bus
Low-impedance microphone	92 dB	42 dB	25 dB
Line	40 dB	-10 dB	-27 dB
Mix bus	56 dB	6 dB	—

Noise:

Equivalent input noise:

— 129.5 dBV

Equivalent input hum and noise:

— 127 dBV

Distortion: Under 0.35% THD from 30 to 20,000 Hz at +15 dBm output; under 0.5% IM distortion up to +15 dBm output level

Input Clipping Level:

Microphone: -32 dBV to -5 dBV (depending on input control setting)

Line: +20 dBV

Mix bus: -38 dBV

Output Clipping Level:

Microphone: -32 dBV

Line: +18 dBm

Limiter:

Threshold: +15 dBm (line output level; adapts automatically to power supply variations)

Attack Time: 3 msec typical

Recovery Time: 500 msec typical

Peak Indicator: Lights 6 dB below clipping or at onset of limiter action

Operating Voltage:

M267: 105-125 volts, 50/60 Hz

M267E: 210-250 volts, 50/60 Hz

(can be rewired for 105-125 volts)

Certifications: M267: UL Listed and CSA listed as Certified

Dimensions: 75.3 mm H  $\times$  309 mm W  $\times$  227 mm D (2<sup>31</sup>/<sub>32</sub>  $\times$  12<sup>5</sup>/<sub>32</sub>  $\times$  9 in.)

Net Weight: 2.3 kg (5 lb, 2 oz)





## Micro-Trak Model 6618 Audio Console

Eighteen stereo/mono inputs; 6 mixing channels; push-button, color-coded switching; individual LED indicators for each line switch—these features only begin to document why the 6618 is an ideal production console.

Micro-trak's top-of-the-line has been designed with voltage-controlled preamplifiers and with main pots controlling a DV voltage which—through preamplifier VCA—sets output levels. Also included are individual potentiometers which give long life and low noise. Because of its reliable latching logic, the 6618 makes possible silent, instant push-button control of each input to the mixing bus.

As you would expect, the 6618 has excellent amplifiers (10 watt per channel stereo, 2 watt headphones, cue, and an additional line level monitor for secondary studio or lobby monitor purposes). Two complete muting systems permit speakers in primary or secondary

studios to be silenced. Program outputs for both stereo and mono broadcast are provided in a balanced transformer configuration at +8dbm nominal line levels.

6618's are normally equipped with one microphone and five -20dbm high level input cards. Additional mic, high level, or turntable pre-amps are available as options.

Rugged steel is the 6618's primary metal. Its cabinet is hinged for easy service—with accessible PC boards, switches, and controls that can be conveniently removed or replaced.

### Six Mixing channels:

Input preamplifiers may be selected to be phono, high level, microphone

### Cueing:

Available on all six mixing channels.

Built-in cue speaker, 8 ohm cue available on monitor output channels with front panel switch.

### Input sensitivity:

Microphone: 1 mv rms for normal output; adjustable

High level: standard 20 dBm for

nominal output

### Frequency response:

Microphone & high level:  $\pm 1$  dB, 30 Hz to 20 kHz at 0 dBm output  
Phono: RIAA  $\pm 1$ dB

### Harmonic distortion:

Less than 0.5% at nominal output

### Noise & hum:

-60 dB or better

### Muting:

Controlled by any, all or no channels selected with internal switches. Two muting relays control cue, main monitor and secondary monitor output and provide "on air" control.

Independent control of main monitor, cue, "on air" and secondary monitor and "on air".

### Termination:

Inputs and outputs terminated with barrier screw terminals.

Size: 9 $\frac{3}{4}$ " (24.7 cm)H  
20 $\frac{1}{4}$ " (51.4 cm)W  
16" (40.6 cm)D

Weight: 34 lb (15.5 kg)

# CONSOLES

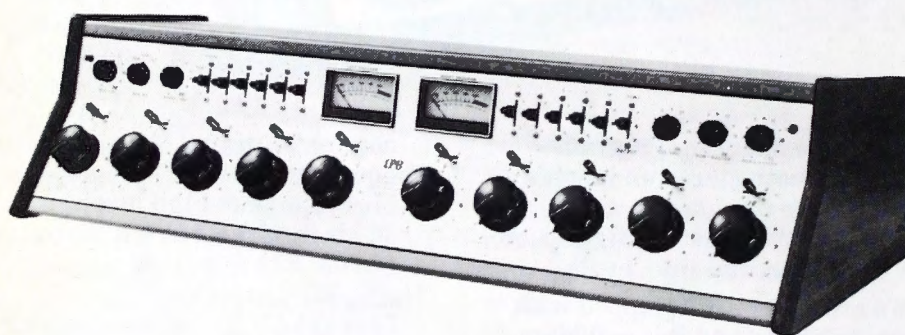
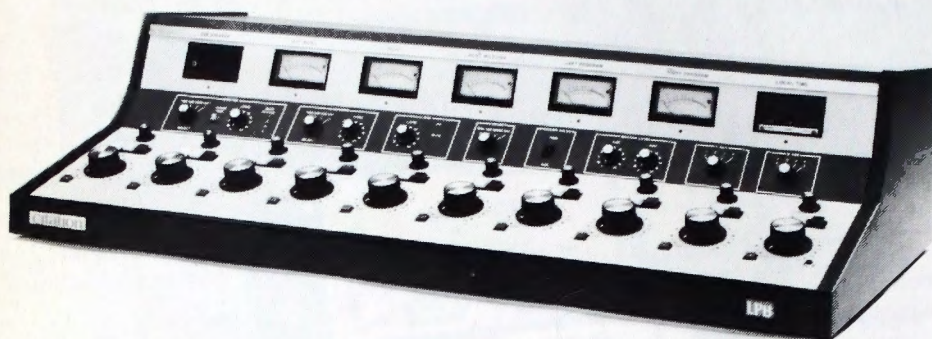

## LPB Signature II

LPB's Model S-12 and S-14A are five channel consoles (stereo or mono) with features normally found in much larger units. 14 transformer-coupled audio inputs (2 mic, 12 line) can be fed to either model. Additional mic's can be connected with simple plug-in pre-amps.

Muting monitors is a snap; the cue system is easy to operate (including level control and a 5 inch speaker); and the internal monitor amplifier is switch-selectable to monitor either "program" or two external monitor inputs.

Both the stereo and mono consoles place output master level controls within convenient reach (the same holds true for program, headphone, and cue gain controls). LED peak level indicators — located in the VU meters — are standard; they may be adjusted to fire at various thresholds.

These units from LPB have cabinets of 0.125" aluminum, with textured, scratch-resistant exteriors and gold anodized interiors.

## Specifications

### Mixers:

Total: 5 Mono

With Cue: 5

Type: Step Attenuator

### Inputs:

Standard Factory Equipped:

Mic.: 2

Hi Level: 12

Optional Maximum:

Mic.: 4

Hi-Level: 14

Total: 14

### Input Impedance:

Mic.: 150 ohms source, Trans. Bal.

Hi-Level: 600 ohms, Trans. Bal.

### Input Levels

Mic.: selectable: -45 dBm, -55

dBm, -65 dBm

Hi-Level: 10 dBm

### Outputs:

Program: (+8 dBm = 0 VU)

clipping level above +22 dBm

Monitor: 3@ 12 watts total

Cue: 1 @ 1 watt with 5" internal speaker

Headphones: 1, switchable

between Program or Cue

### Output Impedance:

Program: 600 ohms, Trans. Bal.

Monitor: 2 to 8 ohms

Headphones: 200 ohms and up

### Frequency Response:

Program:  $\pm 1.0$  dB 20 Hz + 20kHz

Monitor:  $\pm 1.5$  dB 20 Hz + 15kHz

### Power Requirements:

Voltage: 117 Vac (234 Vac available)

Frequency: 50/60 Hz

Power: 60 watts

### Size:

9" (228.6 mm)H

10 $\frac{3}{4}$ " (501.65 mm)W

15" (381 mm)D

### Weight:

29 lb (13.05 kg)



## Broadcast Audio

**Corp. System 12** is an expandable, completely modular broadcast mixer, with unprecedented features and performance. It was designed exclusively for broadcast and is not a scaled down version of recording or sound reinforcement equipment, so it performs flawlessly even in high RF environments.

An elegant low profile appearance is accented by solid walnut end panels and armrest. This mixer sits on top of the desk and does not require recessed mounting, so it's easy to install, with all connections made from the top.

**SYSTEM 12** is a model of engineering simplicity, using motherboard construction, with only 2 types of amplifier modules and a plug-in interconnecting harness. Two independent industrial grade power supplies are rack mounted in a common housing, with front panel AC and DC status indicators. The power supply is short circuit proof and an optional redundant supply is also available.

Operator conveniences include 4 inch log taper slide faders for extremely accurate tracking between channels. In addition to a cue detent position on the fader, there is a separate button for cueing when the fader is up. The stereo cue amplifier is an industry first! The panel layout is easily understood and a pleasure to operate.

**SYSTEM 12** features DC audio switching, using LCR's for completely quiet audio control. This also enables each mixing channel to be turned off and on from a remote location, such as an announce studio or news booth. Ten plug-in relays, with switch selection of maintained or momentary contacts, can be used for muting or remote start from any combination of mixers.

### Specifications

Mixers: 8 standard, 12 maximum (log taper slider).

Inputs: 24 standard, 36 maximum (3 per mixer).

Input Impedance: 150 Ohms mic, 600 ohms line. Transformer balanced, switch selected.

Input Levels: -55 dBm mic, 0 dBm line (sensitivity adjustable  $\pm 10$  dB).

Outputs: 3 balanced stereo line, 1 balanced mono line, plus stereo cue, phone and monitor outputs. Output Levels: Line Outputs 8 dBm into 600 ohms for 0 VU indication, 24 dBm maximum output. Phones 1 watt into 4 ohms. Cue 5 watts into 8 ohm external speakers. Monitor 0.5 volts into 10K load.

Frequency Response: Within 1 dB, 20-20,000 Hz, mic input to line output.

Harmonic Distortion: Line Outputs less than 0.15% THD 20-20,000 Hz (typically less than 0.05% at 1KHz).

IM Distortion: Line Outputs less than 0.05% SMPTE.

Noise: 70 dB below +8 dBm output, referenced to -55 dBm input, 20-20,000 Hz unweighted.

Equivalent input noise -125 dBm.

Power: 117 volts, 5/60 Hz (230 volts optional).

Size: 35W x 8.75H x 25D (inches).

Shipping Weight: 110 pounds.

# CONSOLES



**Broadcast Audio Corp. System 16** is an expandable, completely modular broadcast mixer, with unprecedented features and performance. It was designed exclusively for broadcast and is not a scaled down version of recording or sound reinforcement equipment, so it performs flawlessly even in high RF environments.

An elegant low profile appearance is accented by solid walnut end panels and armrest. This mixer sits on top of the desk and does not require recessed mounting, so it's easy to install, with all connections made from the top.

**SYSTEM 16** is a model of engineering simplicity, using motherboard construction, with only 2 types of amplifier modules and plug-in interconnecting harness. Two independent industrial grade power supplies are rack mounted in a common housing, with front panel AC and DC status indicators. The power supply is short circuit proof and an optional redundant supply is also available.

Operator conveniences include 4 inch log taper slide faders for extremely accurate tracking between channels. In addition to a cue detent position on the fader, there is a separate button for cueing when the fader is up. The stereo cue amplifier is an industry first! The panel layout is easily understood and a pleasure to operate.

**SYSTEM 16** features DC audio switching, using LCR's for completely quiet audio control. This also enables each mixing channel to be turned off and on from a remote location, such as an announce studio or news booth. Ten plug-in relays, with switch selection of maintained or momentary contacts, can be used for muting or remote start from any combination of mixers.

### Specifications

Mixers: 8 standard, 16 maximum (log taper slider).  
Inputs: 24 standard, 48 maximum (3 per mixer).  
Input Impedance: 150 Ohms mic, 600 ohms line. Transformer balanced, switch selected.

Input Levels: -55 dBm mic, 0 dBm line (sensitivity adjustable  $\pm 10$  dB).

Outputs: 3 balanced stereo line, 1 balanced mono line, plus stereo cue, phone and monitor outputs.  
Output Levels: Line Outputs 8 dBm into 600 ohms for 0 VU indication, 24 dBm maximum output. Phones 1 watt into 4 ohms. Cue 5 watts into 8 ohm external speakers. Monitor 0.5 volts into 10K load.

Frequency Response: Within 1 dB, 20-20,000 Hz, mic input to line output.

Harmonic Distortion: Line Outputs less than 0.15% THD 20-20,000 Hz (typically less than 0.05% at 1KHz).

IM Distortion: Line Outputs less than 0.05% SMPTE.

Noise: 70 db below +8 dBm output, referenced to -55 dBm input, 20-20,000 Hz unweighted.  
Equivalent input noise -125 dBm.

Power: 117 volts, 50/60 Hz (230 volts optional).

Size: 44W x 8.75H x 25D (inches).  
Shipping Weight: 120 pounds (2 containers).



## Russco Studio Master 505 Audio Mixer

Russco's five channel mono mixer can be rack-mounted or can stand alone as an attractive table unit. Channels 1-4 each have preamps for mike or phone inputs, while any of five balanced, high level signals can be fed to channel five. Each channel has its own cue; the cue itself drives a 3" built-in speaker.

Operation of the 505 is unusually easy, in part because of the push-button on-air switching with LED indicator lights and Allen-Bradley Mod pots which provide quiet, trouble-free performance. The built-in 25 watt amplifier (employing FET muting) controls the studio monitor, while the headphone amp accepts a stereo jack and permits either high or low impedance headphones to be used.

Russco has engineered the 505 for easy maintenance: it's quickly disassembled, and all modifiable components can be conveniently reached. Match these sensible features with the 505's lightweight (14 lbs.) and you have an excellent console for both studio and remote broadcasts.

## Specifications

Inputs: 9 Total  
 Channels 1-4 (Pre-amps)  
 (Unbalanced)  
 Hi Level  
 Sensitivity\* - 13dBm  
 Max Input + 14dBm  
 Impedance 47K  
 Microphone\*\*  
 Sensitivity\* 0.8mv  
 Max Input 13mv  
 Impedance 47K  
 Phono\*\*\*  
 Sensitivity\* 7mv  
 Max Input 100mv  
 Impedance 47K  
 Channel 5 (Balanced)  
 \*Sensitivity: - 10dBm  
 Max Input: + 18dBm  
 Impedance: 600 ohms

## Outputs:

### Monitor:

Power: 25 watts average (14.4 volts RMS across 8 ohm load at 1KHz)  
 Impedance: 8 ohms  
 Total Harmonic Distortion: Less than 1% at full rated output.  
 Program:  
 Level: + 4 or + 8dBm, for OVAu, + 17dBm maximum  
 Impedance: 600 ohms  
 Frequency Response: 20 to 15 KHz, ± 1dB

Total Harmonic Distortion: Less than 0.5% at 1KHz, + 8dBm out.  
 P.C. Interconnections: 16 pid DIP plugs and flat cable.

Power Requirements: 117 VAC, 60Hz, 100 watts

\*Allen-Bradley MOD POT, Hot-molded element, rated at 100,000 rotations

\*\*Grayhill series 46, rated at 250,000 operations.

## Size,

rack-mount 5¼" (133.35 mm)H  
 19" (482.6 mm)W  
 model: 8" (203.2 mm)D

Weight: 14 lb (6.3 kg)

## Size,

desk-mount 5¼" (133.35 mm)H  
 20¼" (514.35 mm)W  
 model: 8" (203.2 mm)D

Weight: 14 lb (6.3 kg)



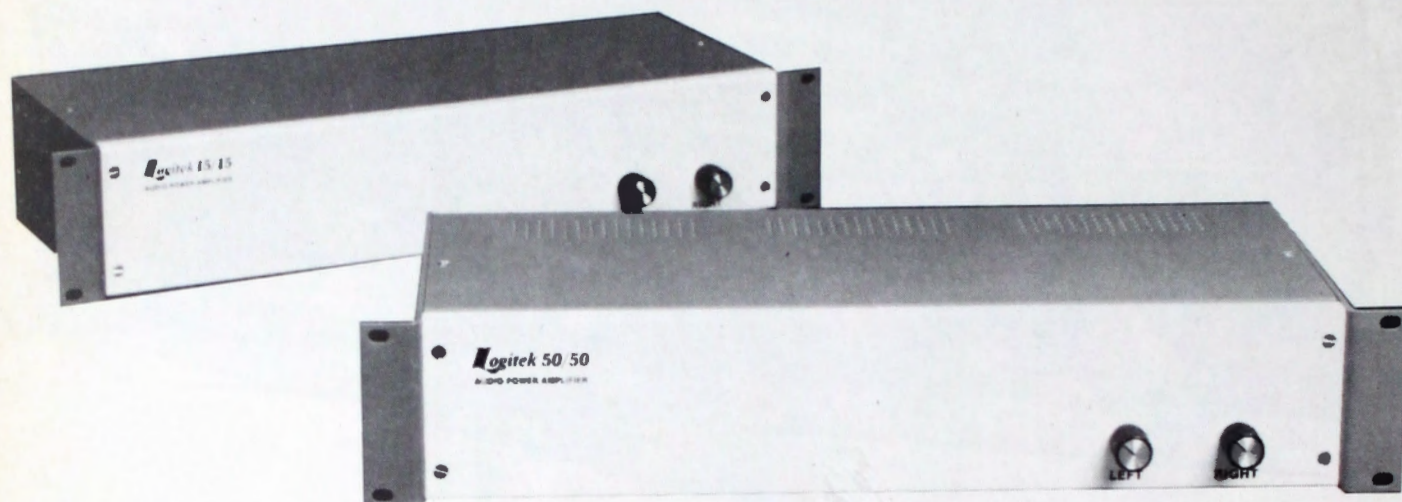

## Logitek Models 50/50 And 15/15 Audio Power Amplifiers

The extraordinary clarity and fidelity of these amplifiers from Logitek can be explained only by superb engineering and manufacturing quality control. One indication of the caliber of these units is their striking signal-to-noise ratios (92 db for the 50/50, 85 db for the 15/15); and that's over a frequency response range of 20-20 khz.

Logitek amplifiers are as dependable as they are true—whether they're part of broadcast or production systems. Their unique power-sensing protection circuits limit maximum output power to a safe level—even under improper load conditions. And they run with minimum heat—thanks to proprietary solid-state design and conservatively-rated heat sinking.

Automatic muting circuits are standard. Inputs and outputs are connected through guarded, wire-capturing terminal blocks. This means fast installation without solder or connectors.

Logitek settles for nothing less than the finest materials and components—and all circuits are easily accessible for the rare maintenance which may be required.

Logitek amplifiers are available in mono or stereo models.

### Specifications

#### MONO-50 50/50

RMS Power Per Channel (load  $\geq$  4 ohms): 50 watts

Frequency Response (20 hz-20 khz):  $\pm 0.25$  dB

Total Harmonic Distortion:

-typical: 0.08%

-maximum: 0.15%

Signal/Noise (ref. rated power): 92 dB

Gain Power Bandwidth: 200 khz

Overload Protection: Automatic power limit circuit plus speaker fuse

Muting: SPST switch- closure or 3-24 VDC control signal

Input Impedance: 50,000 ohms unbalanced

#### MONO-15 15/15

RMS Power Per Channel (load  $\geq$

4 ohms): 15 watts  
Frequency Response (20 hz-20 khz):  $\pm 0.25$  dB

Total Harmonic Distortion:

-typical: 0.03%

-maximum: 0.20%

Signal/Noise (ref. rated power): 85 dB

Gain Power Bandwidth: 100 khz

Overload Protection: speaker fuse

Muting: SPST switch- closure or 3-24 VDC control signal

Input Impedance: 50,000 ohms unbalanced

Size: 3½" (88.9 mm)H  
19" (482.6 mm)W  
7" (177.8 mm)D



# TURNTABLES

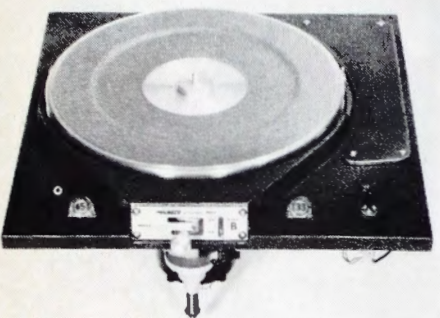
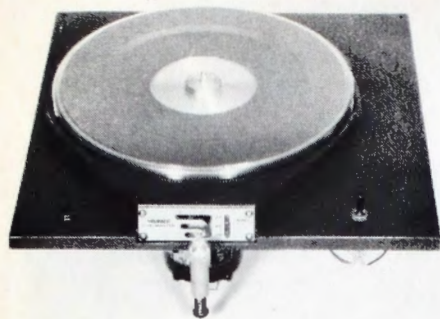

## Russco Cue-Master and Studio-Pro

RUSSCO is so confident about these turntables that they guarantee them for life. And well they should, because of outstanding features such as:

- Heavy duty Bodine synchronous motors (also available for 50 cycle operation).
- A drive system with a neoprene idler wheel which transmits power directly from the stepped capstan on the motor shaft to the inside platter rim.
- Fast acceleration ( $\frac{1}{16}$  of a revolution at 33 rpm,  $\frac{1}{10}$  at 45).
- Solid cast aluminum chassis, oilite bronze bearing, Lord shock mounts.

The Studio-Pro has both 33 and 45 rpm (Cue-Master adds 78) and is the heavier of the models (20 lbs total vs. 16 lbs, with a 6½ lbs. platter vs 5½ lbs.) Because of this added heft, the Studio-Pro has superb wow and flutter specs (less than  $\frac{2}{10}$  of 1% vs. less than  $\frac{3}{10}$  of 1% for the Cue Master). Both far exceed NAB standards for rumble (minus 38 db down and minus 36 db for the Studio-Pro and Cue-Master, respectively).

### Cue Master

Speed: 33,45,78  
 Platter Weight: 5.5 lb (2.5 kg)  
 Acceleration:  $\frac{1}{16}$  rev. at 33 rpm  
 Wow and Flutter: Less than 0.3%  
 Rumble: 36 dB below NAB level  
 Size: 15½" (39.4 cm)H  
 15½" (39.4 cm)W  
 6½" (16.5 cm)  
 below chassis  
 Unit Weight: 16 lb (7.3 kg)

### Studio Pro

Speed: 33,45  
 Platter Weight: 6.5 lb (3 kg)  
 Acceleration:  $\frac{1}{16}$  rev at 33 rpm  
 Wow and Flutter: Less than 0.3%  
 Rumble: 38 dB below NAB level  
 Size: 15½" (39.4 cm)H  
 15⅝" (39.4 cm)W  
 7½" (19 cm)  
 below chassis  
 Unit Weight: 20 lb (9 kg)



## Technics SP-15 Quartz Synthesizer Controlled Direct Drive Turntable

Excellent performance combined with the accuracy of quartz, makes the SP-15 an outstanding value.

- ultra-stable rotation
- very low rumble
- virtually perfect speed
- reaches 33⅓ rpm from standstill in 0.4 second
- quartz synthesizer pitch control which allows increases/decreases in speed in 0.1% increments within a range of  $\pm 9.9\%$

The SP-15 is acoustically dead and highly immune to feedback. The power supply is a switching or "pulsed" type supply, operating with a 20 kHz signal in place of the normal 60 Hz ac line frequency: thus avoiding potential hum-induction problems. A mechanical/electrical braking

system brings the platter to a dead stop in 0.4 second; gently holds platter until play is resumed. The platter can be stopped by hand and held indefinitely without fear of damage to the turntable. Selected speed (33⅓, 45 or 78.26) is digitally displayed along with any percentage of speed change selected.

Type: Quartz synthesizer direct drive  
 Motor: Ultra-low-noise, brushless, heteropole DC motor.  
 Turntable platter: Aluminum diecast, Diameter; 13½", Weight; 5.9 lb. (including rubber matting), Moment of inertia; 130 lb • in<sup>2</sup>  
 Turntable speed: 33⅓, 45 and 78.26 rpm  
 Speed adjustment range:  $\pm 9.9\%$  in 0.1% steps

Starting torque: 2.61 lb • in  
 Start-up time: 0.4 sec. to 33⅓ rpm  
 Braking time: 0.4 sec. from 33⅓ rpm to standstill  
 Speed fluctuation due to load torque: 0% within 2.2 lb • in (up to 500 g tracking force)  
 Wow & flutter: 0.025% WRMS (JIS C5521),  $\pm 0.035\%$  peak (IEC 98A weighted)  
 Rumble: -56 dB DIN A (IEC 98A unweighted), -78 dB DIN B (IEC 98A weighted)

Size: 3<sup>21</sup>/<sub>32</sub>" (92.87 mm)H  
 13<sup>3</sup>/<sub>4</sub>" (349.25 mm)W  
 14<sup>41</sup>/<sub>64</sub>" (371.87 mm)D  
 Weight: 13.7 lb (6.17 kg)



## TECHNICS SP-25 Quartz Synthesizer Controlled Direct Drive Turntable

Technics quality in a basic turntable without frills makes the SP-25 very cost-effective.

- Quartz-controlled servo system.
- Platter speed adjustment up or



# TURNTABLE PICK-UP ARMS

- down within  $\pm 6\%$  of rated speed.
- Reaches  $33\frac{1}{3}$  rpm from standstill in 0.7 seconds.
- Electronic braking system slows platter down quickly, then releases to permit back-cueing.
- Platter is damped on the underside to shut-out vibrations.

Type: Quartz synthesizer direct drive

Motor: Ultra-low-speed, brushless, DC motor

Pitch control: All quartz-locked control within  $\pm 6\%$  range

Turntable platter: Aluminum diecast, Diameter;  $13\frac{11}{32}$ ", Weight; 4.4 lb. (including rubber matting)

Turntable speed:  $33\frac{1}{3}$  and 45 rpm

Starting torque: 1.3 lb • in

Start-up time: 0.7 sec. to  $33\frac{1}{3}$  rpm

Braking system: Electronic brake

Speed fluctuation due to load

torque: 0% within 1.0 lb • in

Wow & flutter: 0.025% WRMS (JIS C5521),  $\pm 0.035\%$  peak (IEC 98A weighted)

Rumble: -56 dB DIN A (IEC 98A unweighted), -78 dB DIN B (IEC 98A weighted)

Size:  $3\frac{5}{32}$ " (80.17 mm)H  
 $13\frac{3}{4}$ " (349.25 mm)W  
 $14\frac{41}{64}$ " (371.87 mm)D

Weight: 10.6 lb (4.77 kg)

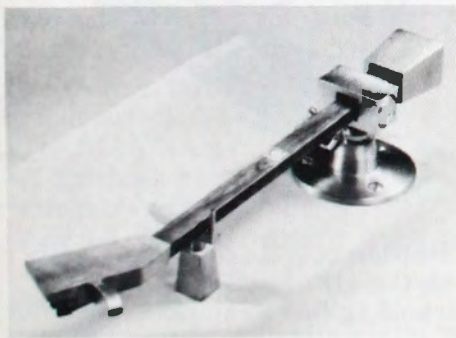

## MICRO-TRAK 303-306

Tracking is central to tone arm evaluation — and the Micro-trak Models 303 and 306 excel here. With 1/10th of a gram capabilities and resonance below 10 hz, these instruments stand out for professional broadcasters — whether they be engineers or managers (who also will find virtually no down-time an important feature).

And these are good-looking yet sturdy tone arms, too — with impregnated wood bodies, high strength lamination, plug-in memory balancing heads, sapphire jewel bearings, and fluid anti-skate mechanisms. Tracking error from 3.0 to 5.5 ranges from  $0^\circ$  to  $2^\circ$ .

303: 12" (30.4cm)

306: 16" (40.6cm)

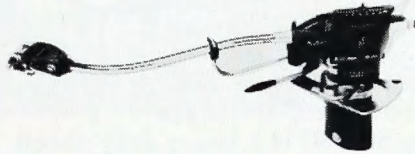

## SHURE SME-III Pickup Arm

Probably the best pickup arm in the world. Arm is constructed of Nitrogen-hardened titanium; and has a soft core with internal fibrous lining. It offers incomparable high fidelity performance.

- Unique balance system handles cartridges weighing from 0 to 12 grams
  - Positive tracking adjustment thru rack and pinion
  - Main pillar hardened and ground
  - Low friction pivots
  - Precise tracking; 0 to 15 grams fine adjustment; 1 gram coarse adjustment
  - Bias (antiskating) fine adjustment graduated from 0 to 2.5 grams
  - Fluid-damped raising and lowering control
  - Output: twin phono sockets plus separate ground
  - All electrical contacts gold-plated
- 3009: Series III  
 S3CA-1SME: Extra headshell and carrier tube

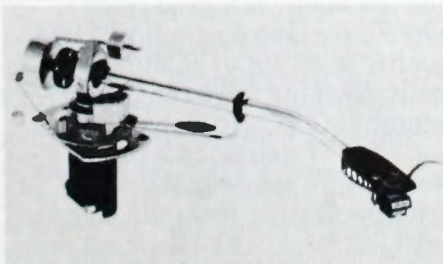

## SHURE SME-II Pickup Arm

Recommended for all high quality

systems and for use with all Shure high trackability cartridges tracking at up to  $1\frac{1}{2}$  grams.

- Ultra-low friction pivot points
  - Very low overall mass
  - Low distortion
  - Precise/accurate adjustments for every factor related to precise tracking
  - Accepts cartridges weighing 4 to 9 grams and allows positive tracking force adjustment in  $\frac{1}{4}$ -gram increments
  - Hydraulic cueing control
- 3009: Non-removeable shell  
 3009/S2: Removeable shell  
 S2: Extra shell for 3009/S2

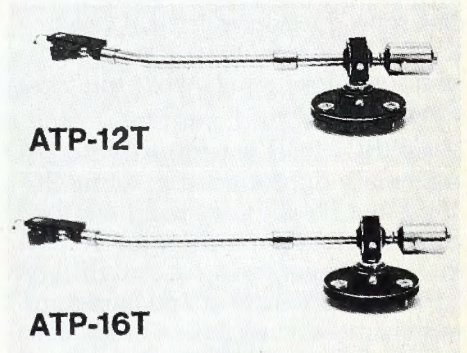

## Audio-technica Model ATP-12 and ATP-16 Stereo Tone Arms

ATP Professional Series tone arms have been specially designed to meet the needs of broadcasters. Dimensions are precise for accurate tracking. Sealed ball-bearings insure smooth movement. Installation is straightforward; compact dimensions assure maximum versatility. Wide range of adjustments permits mounting to almost any turntable.

Models ATP-12 and ATP-16 are identical except for overall length. The ATP-16 offers reduced tracking error and the ability to accommodate 16" transcriptions.

- Sealed ball-bearing pivots
- Accurate, built-in VTF gauge
- Gold-plated connectors throughout
- Pre-wired, color-coded, low capacity cable with ground lug
- Decoupled counterweight shaft for arm resonance control

ATP-12:  $14\frac{1}{16}$ " (357mm)

ATP-16:  $15\frac{9}{64}$ " (383mm)

# TURNTABLE CABINETS



Size,  
 Console table: 96" (243.84 cm)  
 1½" (3.8 cm) thick  
 Tops up to 32" (81.28 cm)  
 Panel base, 24" (60.96 cm)  
 four panels, 29" (73.66 cm)H  
 Vanity shield available

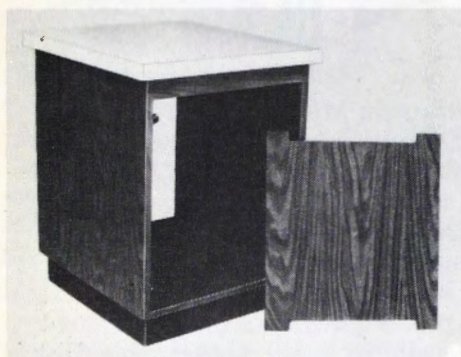

## Ruslang modular cabinets

Modular stations include single and double bay turntable cabinets, console tables and cabinets. Tops are available in variety of colors; bottoms are walnut wood grained. Customized stations are available on request. All modules are constructed from quality materials including high-pressure laminates. They are sturdy and attractive.

Size,  
 Single pedestal cabinet: 29" (73.66 cm)H  
 22" (55.88 cm)W  
 24" (60.96 cm)D  
 No charge for cut-outs, if template supplied w/order.  
 Blank panels available for front.  
 Comes with standard E.I.A. tapped rails.

Size,  
 Double pedestal cabinet: 29" (73.66 cm)H  
 42" (106.68 cm)W  
 24" (60.96 cm)D  
 No charge for cut-outs, if template supplied w/order.  
 Blank panels available for front.  
 Comes with standard E.I.A. tapped tails.



Cabinets are available in sit-down or stand-up styles. Both styles have access door in rear for easy access to wiring; the stand-up unit has additional storage space for single records.

## Cabinet for one turntable

Sit-down style, TT-2723-L:  
 47" (119.38 cm) W  
 27" (68.58 cm) D  
 30" (76.20 cm) H  
 Stand-up style, TT-2723-H:  
 47" (119.38 cm) W  
 27" (68.58 cm) D  
 40" (101.60 cm) H

## Cabinet for two turntables

Sit-down style, TT-2747-L:  
 47" (119.38 cm) W  
 27" (68.58 cm) D  
 30" (76.20 cm) H  
 Stand-up style, TT-2747-H:  
 47" (119.38 cm) W  
 27" (68.58 cm) D  
 40" (101.60 cm) H

## Cabinet for three turntables

47" (119.38 cm) W  
 7" (68.58 cm) D  
 0" (76.20 cm) H  
 Stand-up style  
 47" (119.38 cm) W  
 27" (68.58 cm) D  
 40" (101.60 cm) H



## Grinnan cabinets

Grinnan turntable cabinets have drop-down door at front of cabinet for easy access to turntables and pre-amplifiers; record storage is below access door. Shelf above turntables holds empty envelopes or next record to play. Shelf is supported by 1" square tubular steel frame above turntables.



# CARTRIDGE TAPE SYSTEMS

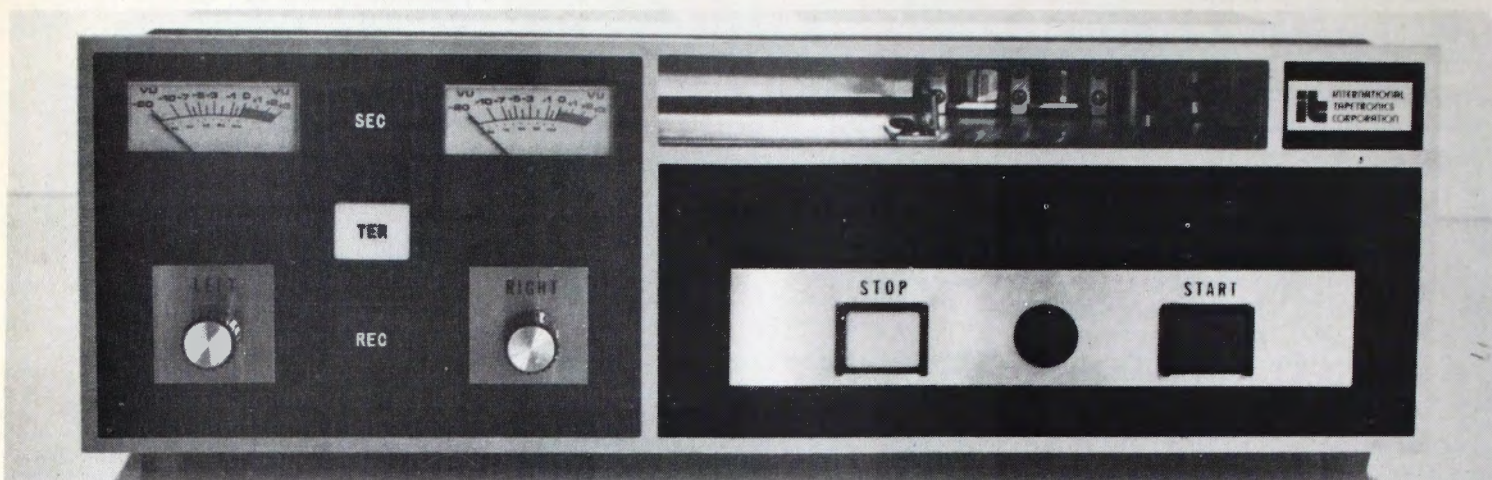

## ITC RP Series Recorder/Reproducer

Quite possibly the most outstanding feature of this ITC cartridge machine is its combination of cue tone add and defeat. With these switches, you can add a "stop" tone (1 kHz) during recording or playback — without going through the stop/record set/start routine after each cut (in this respect, it's much like an A/V cassette deck for

pulsing). The RP Series also lets you add stop tones to previously recorded materials — or erase them with the defeat switch. Optional auxiliary 150 Hz and 8 kHz tones permit the addition of "end of message" cues or controlling slide projectors in TV. Rapid cueing (4 times normal speed) lets you search quickly for the next tone.

The RP Series further features a six-position meter for operations such as peak reading, program and cue bias, cue play (to check cue tones). The ITC deck has 0.2% RMS wow and flutter, maximum 2% thd, 55 db signal-to-noise, and a frequency response range of 50 Hz to 15 kHz.

Size: 5¼" (13.3 cm)H  
17½" (44.4 cm)W  
11" (27.9 cm)D

Weight: 39 lb (17.7 kg)

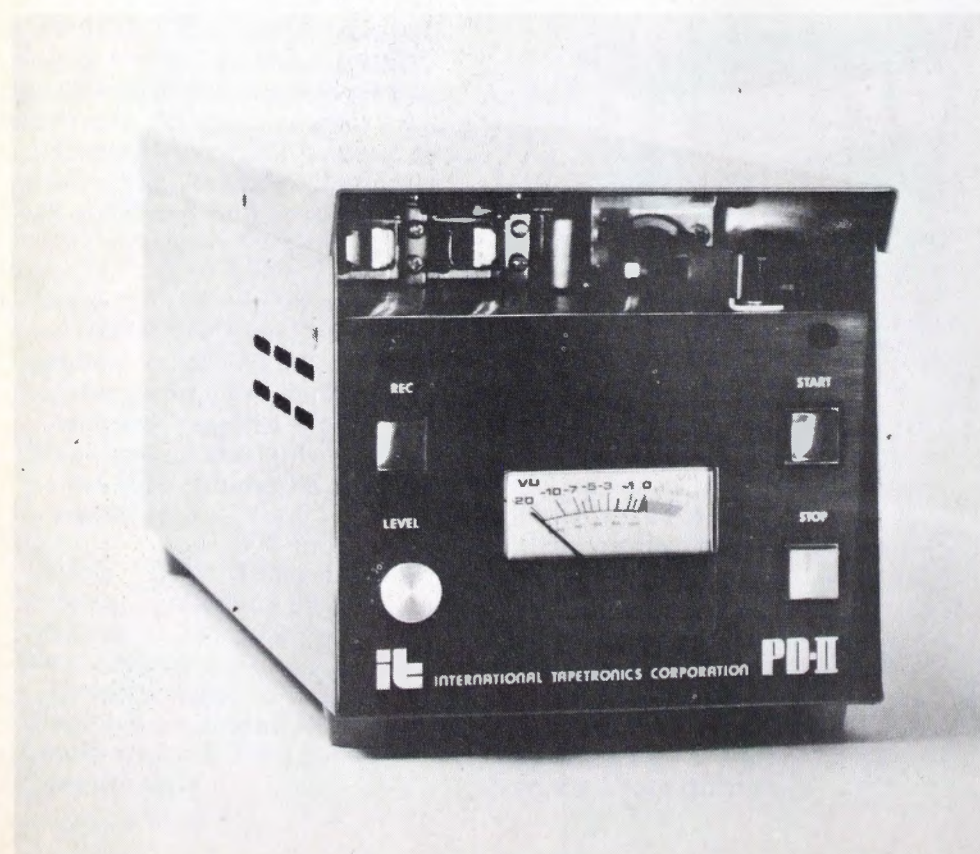

## ITC PD-II Series Cartridge Recorder/Reproducer

This is ITC's economy cart deck. The PD-II records and plays back mono tapes with a 1 kHz cue tone. It's quiet (52 dB minimum), totally automatic, sturdy (milled from a solid block of ½" thick aluminum), and quickly adjustable (due to ITC's heavy-duty micro adjustment head assembly). Wow and flutter are low (2% RMS minimum) because of the direct capstan 450 RPM hysteresis-synchronous drive motor and its electrolyzed shaft.

The PD-II's compact size means that three of the units can be rack-mounted in a standard cabinet.

Size: 5¼" (13.3 cm)H  
5¾" (14.6 cm)W  
15" (38.1 cm)D

Weight: 15 lb (6.8 kg)

# CARTRIDGE TAPE SYSTEMS

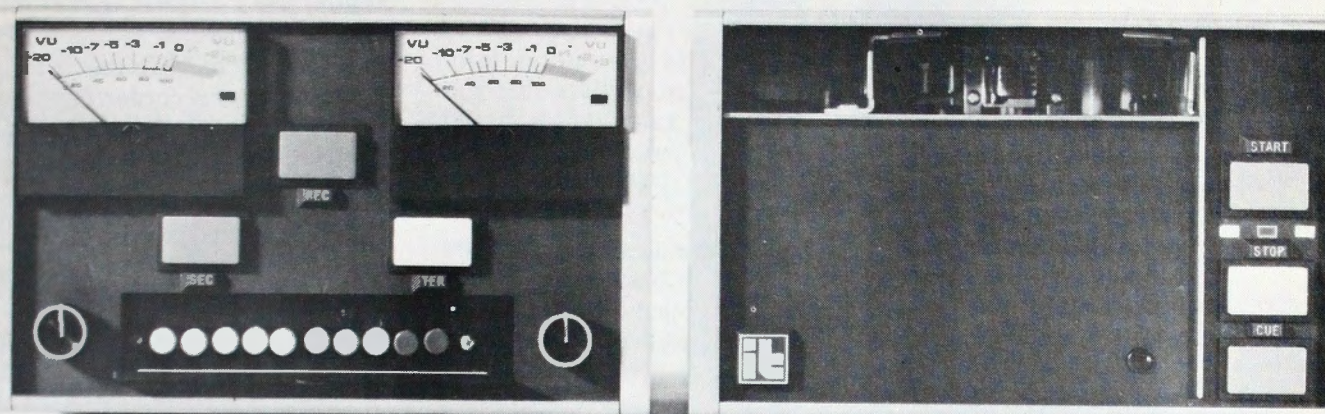

## ITC Series 99 Recorder/Reproducer

Computerized control, the latest in solid-state electronics and advanced mechanical components are combined in the ITC Series 99 Cartridge Machine to give broadcasters a reel-to-reel sound from cartridge tapes. A

microprocessor controls all electronic functions. An optional cartridge preparation automatically prepares tape for recording. The ITC Series 99 cartridge machine is destined for great acceptance if for just one reason alone: it sounds better.

### Size:

Recorder: 5¼" (13.3 cm)H  
8½" (21.6 cm)W  
15½" (39.4 cm)D

### Weight:

Reproducer: 5¼" (13.3 cm)H  
8½" (21.6 cm)W  
15½" (39.4 cm)D

### Weight:

35 lb (15.9 kg)



## ITC 3-D Series Reproducers

In the space normally needed for two cart machines, ITC has engineered the 3-D series: three machines, compact and as



professional as anything else on the market today.

All three of the decks may operate simultaneously or independently, with signals fed to one, two, or all

three machines at a time. An IC electronic "squelch" circuit turns off audio output when a deck is idle, thereby permitting the mixing of all three units into one console input—without sacrificing signal-to-noise ratio.

Lubrication and cleaning are things of the past, due to a Teflon coating which has been added to solenoid plungers. ITC's mechanical linkage between the solenoid and pressure roller assembly has led to an almost failure-proof deck—one that has been start-and-stop tested more than 1,000,000 times with no problems or needs for adjustments.

The 3-D has 55 db minimum signal-to-noise ratio, response from 50 Hz-15 khz, less than 2% thd, and wow and flutter of less than 2% RMS, unweighted.

### Size:

5¼" (13.3 cm)H  
8½" (21.6 cm)W  
11" (27.9 cm)D

### Weight:

12 lb (5.4 kg)



# CARTRIDGE TAPE SYSTEMS

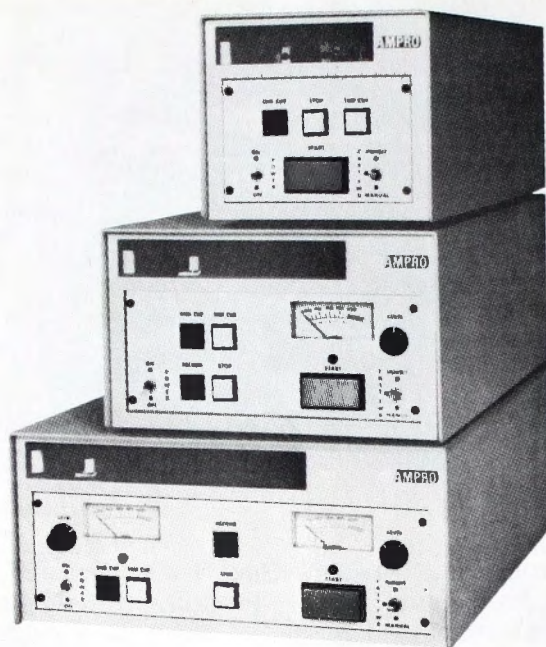

**Ampro Recorder/Reproducer:  
2500, 3500, 4500 Series**  
Ampro cartridge tape recorders/  
reproducers are designed and built  
to be equal to the finest studio  
reel-to-reel machines. Rugged  
mechanical design combined with

state-of-the-art electronics result in  
units of superior performance and  
reliability, and compact size. All  
Ampro recorder/reproducer units  
are in full compliance with NAB  
requirements.

2500 Series is available as a  
reproducer for NAB Type A and AA  
cartridges; monaural or stereo.

3500 Series is available as a  
reproducer or recorder/reproducer  
for NAB Type A, AA, B, and BB  
cartridges; monaural or stereo.

4500 Series is available as a  
reproducer or recorder/reproducer  
for NAB Type A, AA, B, BB, C and  
CC cartridges; monaural or stereo.

**2500 Series**  
Size: 5¼" (13.34 cm)H  
5⅞" (14.92 cm)W  
17" (43.18 cm)D  
Weight: 22 lb (9.9 kg)

**3500 Series**  
Size: 5¼" (13.34 cm)H  
8¾" (22.23 cm)W  
17" (43.18 cm)D  
Weight: 25 lb (11.25 kg)

**4500 Series**  
Size: 5¼" (13.34 cm)H  
11¾" (29.85 cm)W  
17" (43.18 cm)D  
Weight: 27 lb (12.15 kg)

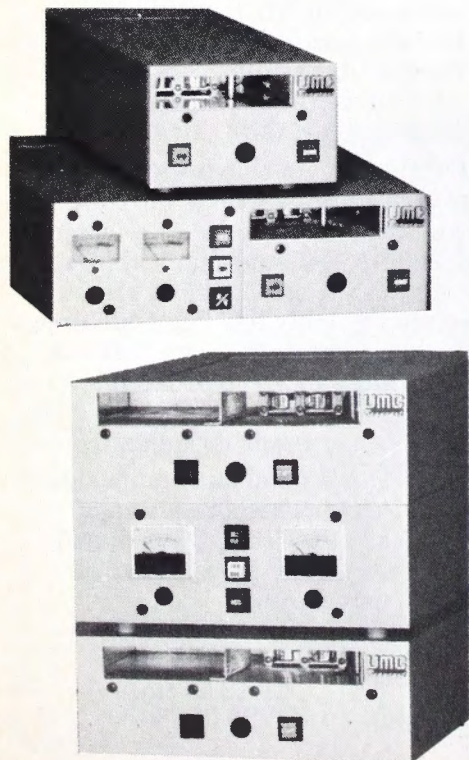

## Beucart 100 and 200 Series Recorder/Reproducers

The 100 Series from Beucart  
delivers excellent sound with  
unusual economy. Every NAB  
standard is met or exceeded because  
of Beucart's engineering ingenuity.

Particularly significant in these  
decks are:

- Advanced IC's combining high and low end EQ with a state-of-the-art amplifier—resulting in a 250-16 kHz response at ±1 dB and a signal to noise ratio of 53 dB or better.
- A 600 RPM pancake motor with wow and flutter of less than 0.15%.
- Silent, solid-state switching from TTL circuitry.
- Cool operation and low deck plate temperature.
- Modular design and use of mother board construction—eliminating point-to-point wiring.
- Complete remote control.

- Easy convertibility of mono decks to stereo.
- Diminutive size. (15 lbs., 3 + 5/8" × 5 + 3/4" × 15 + 3/4").

Beucart also offers the 200 Series  
— one with virtually identical specs,  
yet slightly different dimensions.  
(3 + 5/8" × 10 + 1/8" × 13 + 1/16").

**100 Series**  
Size: 3 5/8" (9.21 cm)H  
5 3/4" (14.61 cm)W  
15 3/4" (40.01 cm)D  
Weight: 15 lb (6.75 kg)

**200 Series**  
Size: 3 5/8" (9.21 cm)H  
10 1/8" (25.72 cm)W  
13 1/16" (33.18 cm)D  
Weight: 15 lb (6.75 kg)



# CARTRIDGE TAPE SYSTEMS

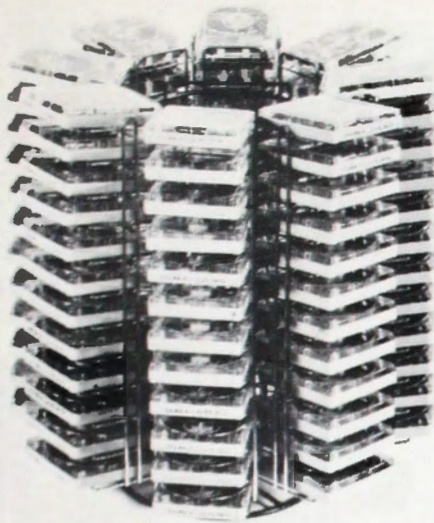

## Fidelipac Cartridge Racks (TR-96, MR-200)

Storage and easy retrieval are vital in virtually all businesses — but especially so in the fast-paced broadcast industry. With its TR-96 and MR-200 racks, Fidelipac has met this need with style and sensible design.

96 carts can be held by the sturdy TR-96 (8 separate, removable racks with 12 cartridges each). The TR-96 also swivels for quick location of carts. Racks themselves are chrome-plated welded steel; the base is black japanned steel.

As its name implies, the MR-200 can store 200 carts in its eight 25-cart packs. The MR-200 also swivels with ease and rolls conveniently, due to its 4 ball-type casters.

TR-96

Size: 20" (50.80 cm)H  
20" (50.80 cm)Dia  
Weight: 23.2 lb (10.44 kg)

Mr-200

Size: 37" (93.98 cm)H  
4½" (11.43 cm)Dia  
Weight: 4.2 lb (1.89 kg)  
Weight base unit: 16 lb (7.20 kg)

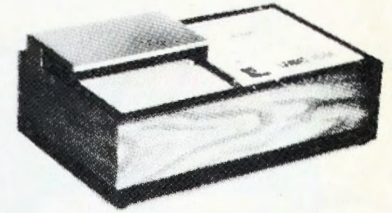
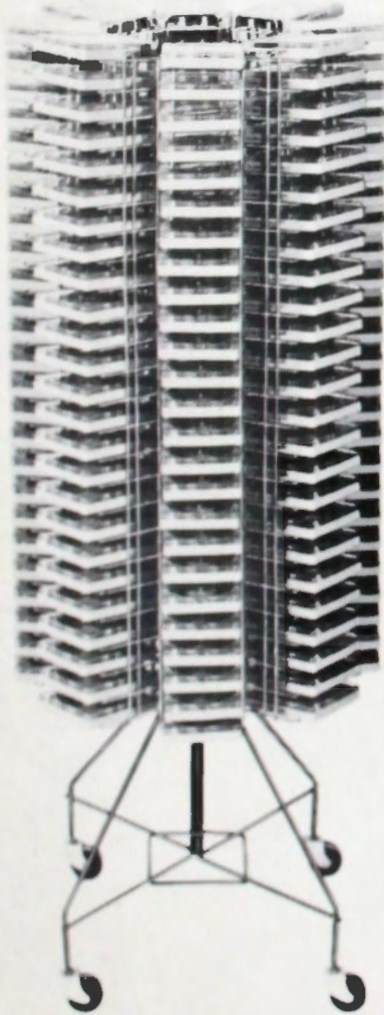

## UMC Splice Finder/Bulk Eraser

This unit is particularly valuable in finding splices in endless loop cartridges. It searches the tape and automatically stops whenever a splice (and its accompanying "blip") is discovered.

The simplified design of the UMC SFE-1 means dependable, trouble-free operation. No optics or pre-recorded tones are required. Instead, a sensing device spots splices as they pass between the capstan and pinch rollers; the cartridge is then ejected at the splice point. The SFE-1 accepts standard NAB A, B, or C-size endless loop carts.

Bulk erasing of cartridges, cassettes, and open-reels is swift and complete with this unit. And because erase and splice-finding functions are independent, accidental erasure is avoided.

The SEF-1 works at 15 ips and weighs 21 lb (9.45 kg).

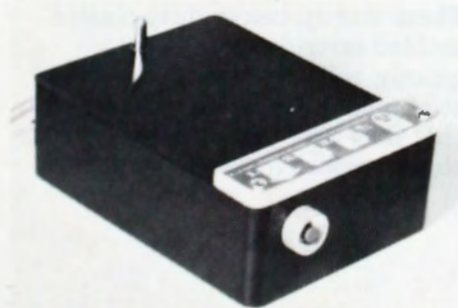

## Audiolab TD-1 Tape Eraser

This tape eraser is designed for heavy-duty service in recording and broadcast applications. It provides a strong magnetic field to ensure complete erasure of tape cartridges and all audio, video and computer tapes up to 10½" (26.6 cm) in diameter and 1" (2.54 cm) in width.

Size: 3" (7.6 cm)H  
5¼" (13.3 cm)W  
7¼" (18.4 cm)D

Weight: 9.5 lb (4.3 kg)

# CARTRIDGE TAPE SYSTEMS

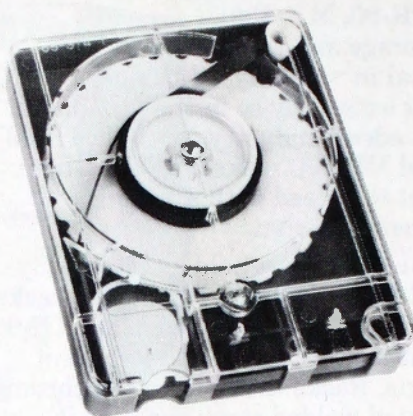

## **Fidelipac Cart-E-Rase Magnetic Eraser**

The hand-held Mark I lightweight, compact demagnetizer thoroughly removes all magnetic signals from tape, wire or filmstrip. The Mark I, in an unbreakable butyrate case, also demagnetizes record and playback heads. The 800 watt unit has momentary on-off switching.

Size:  $4\frac{3}{4}$ " (12 cm)  $\times$   
 $4\frac{1}{4}$ " (10.7 cm)

Weight: 4.5 lb (2 kg)

## **Fidelipac Model 350STA Alignment Tape**

The 350 STA tape is used to align monophonic or stereo reproducers employing the NAB track configuration for broadcast cartridge machines. The tape will establish references for standard operating level. 50-microsecond playback response and precise azimuth alignment.

## **Fidelipac Master Cartridges**

80% of all radio stations worldwide are estimated to use Fidelipac carts: no wonder, then, that the company positions itself as the industry standard.

- With precision molding.
- Rear corner post tape path.
- Circular brake.
- Simple construction for easy repair.
- Frequency range of 20-20 kHz or better.
- Wow and flutter of less than 2%.
- High quality graphite lubricated tape.

These sturdy, heavy-duty plastic molded cartridges perform — quietly, reliably, clearly — enough so to justify Fidelipac's statement that they are "the ultimate in stereo performance."



# REEL-TO-REEL TAPE SYSTEMS



## Scully 285B Tape Reproducer

The Scully 285B tape reproducer is a professional quality playback or editing system for broadcast and studio applications. Available with ac hysteresis or dc servo capstan motors. The Scully 285B offers the broadcaster an efficient, reliable and versatile means of tape production. The units come in rack, console or portable versions. They will accept either 0.6- or 1.2- cm ( $\frac{1}{4}$ " or  $\frac{1}{2}$ " tape with up to 4-channel capacity. Tape speeds are  $3\frac{3}{4}$ — $7\frac{1}{2}$  ips and  $7\frac{1}{2}$ —15 ips with other speeds available on special reels with an option on certain models for 35.5 cm. (14") reels. All functions may be remoted (option) and all usual alignment controls are front-mounted. Frequency response is  $\pm 2$ dB, 30 to 15,000 Hz (15 ips); flutter and wow at 15 ips is 0.08% rms or better. Innovative features include motion sensing system, and edit function permitting tape movement without takeup reel winding and optional selective synchronization for multichannel over dub effects; functionally illuminated controls, motion direction sensing logic and dynamic braking. All adjustments are accessible by removing the head cover. Monitor earphone jack and

level controls are mounted on the transport. 600-ohm line and speaker outputs are standard.

Configurations include full-track, 2-track or  $\frac{1}{4}$ -track stereo. Slope front consoles are offered as optional items.

### Specifications:

#### Frequency Response:

15 ips:	
30 to 18,000 Hz	..... $\pm z$ dB
$7\frac{1}{2}$ ips:	
30 to 15,000 Hz	..... $\pm z$ dB
$3\frac{1}{2}$ ips:	
30 to 10,000 Hz	..... $\pm z$ dB

#### Wow and Flutter:

	DC SERVO	AC MOTOR
15	..... 0.04% ips	0.08%
7.5	..... 0.06% ips	0.01%
3.75	..... 0.1%	0.2%

Speed Accuracy:  $\pm 0.1\%$  with dc servo;  $\pm 2\%$  with ac motor throughout reel at all speeds using 1.5 mil. tape

Outputs: Line + 17 dB mW into 600 ohms. Speaker 3.0 watts into 8 ohms

Equalization: Automatically switched with transport speed.

Specify NAB or IEC (CCIR)

Reel Size: T0 11.5" (CCIR)

Brakes: Dynamic plus disc

Power: 105 to 125 V ac 60 Hz, 250 VA, (50 Hz and/or 22 V optional extra)

#### Size:

Unmounted:	19" (48.2 cm)W
	15.75" (40 cm)H
	9" (22.8 cm)D

#### Weight:

Unmounted:	90 lb. (40.8 kg)
Empty console:	105 lb. (47.6 kg)

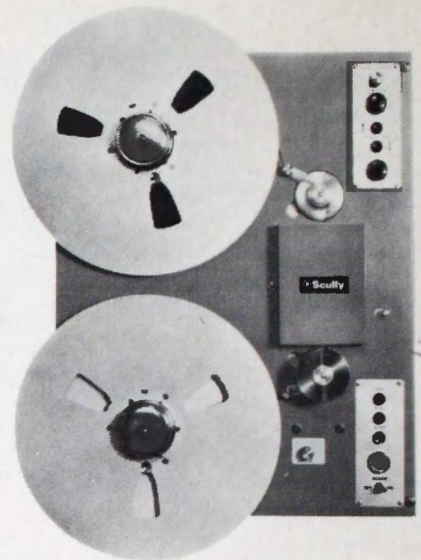

## Scully 270 Tape Reproducer

This hefty (100 lb.) unit from Scully is a playback-only instrument, specifically designed for broadcast operations where long-playing time is essential. Reels up to 14" can be accepted. Speeds are  $3\frac{3}{4}$ ,  $7\frac{1}{2}$ , and 15 ips. Automatic reversing of either  $\frac{1}{4}$  or  $\frac{1}{2}$  track material is effected through foil-sensing low current transistor switching.

The 270 is quiet (from 65 dB at stereo  $7\frac{1}{2}$  or 15 ips to 54 dB minimum at  $3\frac{3}{4}$  stereo). Its frequency response is excellent (30-15 kHz at 15 ips). And the 270 is ready to work in a flash—with starting time of 0.1 seconds. It rewinds 4800' of tape in just 105 seconds and boasts a timing accuracy for 30 minutes of tape of better than 99.7%. Distortion is less than .5% THD at +18 dbm.

### Specifications:

Frequency Response: Mono and 2 track,  $\pm$  dB 50 to 7500 Hz at  $3\frac{3}{4}$  ips, +2, -3 dB, 50 to 15,000 Hz at  $7\frac{1}{2}$  ips;  $\pm$  dB, 50 to 15,000 Hz at 15 ips

Tape Speed:  $3\frac{3}{4}$  to  $7\frac{1}{2}$  ips,  $7\frac{1}{2}$  to 15 ips

Output: +18 dB mW from 600-ohm balanced line (normally supplied +4 dB mW = Zero VU)

Equalization: Front panel switch

Reel Size: Up to 14"



# REEL-TO-REEL TAPE SYSTEMS

Power: 117 V ac, 60 Hz, 275 watts  
(50 Hz optional)

Size: 19" (48.2 cm)W  
24½" (62.2 cm)W  
8¾" (22.2 cm)D

Weight: 100 lb (45.4 kg)



## Revox PR-99

Built for the broadcaster, this half-track recorder/reproducer is intended for production and on air broadcast or any other place where quality is critical. Available at either 3 + ¾, 7 + ½, 15 ips, the PR-99 delivers sound that is unusually clear and undistorted. Frequency response ranges from 30-22 kHz at 15 ips, while signal-to-noise ratio is 63 minimum. At 15 ips THD is 0.6%.

Balanced and unbalanced inputs can be fed to this recorder. Maximum line output is +22 dBu

at 600 ohms and +20 dBu at 200 ohms.

The PR-99 is sensible in its design, with easy access to all controls. Tape editing is unusually easy to do. Features include:

- Sel-Sync on both channels.
- Internal bias, EQ, and level calibration controls mounted on a simple plane.
- Logic-controlled tape motion.
- Brushless ac motors with direct-drive, servo-controlled spooling motors.

The Revox PR-99 is functional, durable and accurate.

### Specifications:

Frequency Response measured via tape, at -20 VU:

3¾ ips:

30 Hz ... 16 kHz + 2/ -3 dB

50 Hz ..... 10 kHz ± 1.5 dB

7½ ips:

30 Hz ... 20 kHz ± 2/ -3 dB

50 Hz ..... 15 kHz ± 1.5 dB

15 ips:

30 Hz ... 22 kHz + 2/ -3 dB

50 Hz ..... 18 kHz ± 1.5 dB

Wow and Flutter: (DIN

45507/consistent with IEEE standard 193-1971):

at 3¾ ips less than 0.1%

at 7½ ips less than 0.08%

at 15 ips less than 0.06%

Equalization:

3¾ ips: NAB 90-3180 usec

7½ ips: NAB 50-3180 usec

15 ips: NAB 50-3180 usec

Reel Size: up to 10.5 inch diameter

(min. hub diameter 2.36 inches), tape tension switchable (for small hub diameters)

Electric Current Supply:

100V, 120V, 140V, 200, 220,

240V

50 Hz .... 60Hz, max. 90 watts

Size

rack-mounted 15.7 (39.88 cm)H

19" (48.26 cm)W

model: 9.2" (23.37 cm)D

Weight: 40.75 lb (18.5 kg)



## Revox B-77

Revox has designed the B-77 series to be adaptable to a variety of tape formats and recording demands (including custom configurations, if needed). But whether the speed be extremely low (<sup>15</sup>/<sub>16</sub> ips) or broadcast standard 15 ips — or whether 1, 2, or 4 tracks are required — the B-77 offers state-of-the-art technology coupled with ease of operation. Outstanding among the series numerous features are:

- 3-motor tape drives.
- Wow and flutter of less and 0.08% at 7 + ½ ips.
- 10 + ½" reels.
- 50 to 20 kHz frequency response at 7 + ½ ips.
- 67 and 63 dB signal-to-noise ratios for ½ track and ¼ track, respectively.
- Unbalanced and balanced inputs.
- Slim styling.

Additionally, the B-77 incorporates simple, accurate editing, options for variable speed motor and remote control, bright VU's (with peak-reading LED's), and many other exceptional advantages.

Size,

standard 16.3" (41.4 cm)H

model: 17.8" (45.2 cm)W

8.1" (20.7 cm)D

Weight: 37.5 lb (17 kg)

Size,

rack-mounted 15.2" (38.1 cm)H

19" (48.3 cm)W

model: 7.6" (19.1 cm)D

Weight: 38 lb (17.1 kg)

# REEL-TO-REEL TAPE SYSTEMS



## Technics RS-1520

If speed stability and precision editing are among your key concerns, consider the outstanding RS-1520 from Technics. This 1/2 track record and playback, 1/4 track playback only deck incorporates advantages seldom found outside studio units costing far more.

Quartz-locked capstan motor; complete direct-drive dual capstan tape transport system; feather-touch pushbuttons; all solid-state switching with full IC logic control — combine all these with an amazing 30-30 kHz frequency response and a 68 dB signal-to-noise ratio and you get a package that's super quiet, yet sophisticated in design, engineering, and construction.

Separate amplifiers drive each of the mic, line, and mixing circuits. Separate 3-position bias and EQ controls permit the RS-1520 to perform outstandingly with any tape.

Balanced inputs and outputs, plus "XL" connectors are two more features seldom found in recorders of this price range.

### Specifications:

#### Frequency Response:

15 ips (38 cm/s):  
30 to 30,000 Hz . . . . . ± 3 dB

(rec. level = -10 dB from OVU)

7 1/2 ips (19 cm/s):  
20 to 25,000 Hz . . . . . ± 3 dB  
(rec. level = -20 dB from OVU)

3 3/4 ips (9.5 cm/s):  
20 to 15,000 Hz . . . . . ± 3 dB  
(rec. level = -20 dB from OVU)

Wow and Flutter (recording and playback):  
15 ips (38 cm/s) 0.018% (WRMS)  
7 1/2 ips (19 cm/s) 0.03% (WRMS)  
3 3/4 ips (9.5 cm/s) 0.06% (WRMS)

Speed Deviation: ± 0.1% at 15 ips (38 cm/s)

Equalization: NAB Standard Position "2" of "EQ" and "BIAS" selectors set for 3 M type 207 tape

Tape Speed: 15 ips, 7 1/2 ips, and 3 3/4 ips (38 cm/s, 19 cm/s and 9.5 cm/s)

Reel Size: 5" to 10" (13 cm to 26.5 cm) outside diameter

Automatic tape tension control for above size of reel

Power Requirements: AC 120V, 50/60 Hz or DC 24 V, 4.5 A peak (RS-1500US/RS-1506US), 4.9 A peak (RS-1700) with optional battery adapter RP-086

Size: 19 3/8" (49.2 cm)W  
17 1/2" (44.6 cm)H  
10 1/8" (25.8 cm)D

Weight: 57 lbs. 4 oz. (26 kg)  
RS-1500US/RS-1506US)

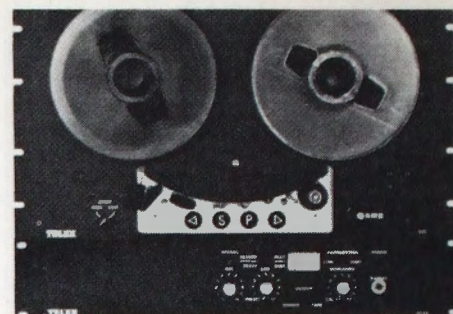

## Telex Logger 230-L

For applications where long-play is crucial, the Telex Logger 230-L is an ideal instrument. Up to 12 + 1/2 hours can be recorded — whether the data be music, police dispatching, broadcast logging, surveillance, court reporting, space/military transcription, or whatever. And with the addition of the LCC-1 cycle control unit, over 100 hours can be recorded. Simply amazing — even at 15/16 ips.

The 230-L comes in a variety of configurations — 1/2 track, 1/4 track, 4-channel. It can be rack-mounted or stand on its own. The basic unit — adaptable by Telex, if requested — accepts 7" reels and records at 15/16 and 1 + 7/8 ips.

Size,  
230-L 10.5" (26.67 cm)H  
transport: 19" (48.3 cm)W  
7.4" (18.89 cm)D

Weight: 22 lb (10 kg)

# REEL-TO-REEL TAPE SYSTEMS



## Telex-Magnecord 3000 Series Recorder/Reproducer

The 3000 Series combines current tape technology with traditional quality and reliability of professional Magnecord broadcast equipment.

Three-motor unit accepts reels up to 10½" (267 mm) with NAB type A or type B hubs, and fits standard 19" equipment racks. 3000 Series transport and RP85 record/play preamplifiers and accessories may be ordered as separate items or as a complete package. One and two channel systems are available and include transport, amplifiers, cables, rack-mount adaptor.

- Two-speed transport is available for 3¾ - 7½ ips (9.5 - 19 cm/s) or 7½ - 15 ips (19 - 38 cm/s) operation. A hysteresis synchronous drive motor maintains even tape speed regardless of line voltage fluctuations.
- Transformer isolated CMOS logic controls all tape motion smoothly and positively. Computer-grade push-buttons with adjacent LEDs indicate operating mode.
- Automatic cycling.
- Automatic cue release.
- Interchangeable head blocks.
- RP85 record/reproduce preamplifier offers excellent performance and almost unlimited flexibility.

## Specifications:

Frequency Response Play or Record/Play (Adjustments optimized for 3M 176 tape:

15 ips:

60 to 20,000 Hz ..... + 3 dB

7½ ips:

30 to 18,000 ..... + 3 dB

3¾ ips:

20 to 12,000 Hz ..... 3 dB

Amplifier Only (no tape):

20 to 20,000 Hz ..... ± dB

Wow and Flutter:

0.22% DIN, 0.15% RMS or less at 3¾ ips

0.15% DIN, 0.1% RMS or less at 7½ ips

0.15% DIN, 0.1% RMS or less at 15 ips

Tape Speed: Two speed switches, selectable 3¾ - 7½ ips and 7½ - 15 ips

Equalization: Per NAB open-reel standards (adjustable for most standard or Hi output Lo noise tapes) 3¾ - 7½ ips as supplied, 7½ - 15 ips by adjustment

Reel Size: 10½" (266.7 mm) and 7" (177.8 mm)

Power: 105/125V 60 Hz - 180 W max. (50

Hz special order)

210/250 V 50 Hz - 180 W max. (60

Hz special order)

Switched Outlet: 3A max.

Size,

Transport: 12¼" (311 mm)H  
19" (483 mm)W  
10" (254 mm)D

Weight,

Transport: Shipping 46 lbs.  
(20.9 kg)  
Net 39 Lbs. (17.7 kg)



# REEL-TO-REEL TAPE SYSTEMS

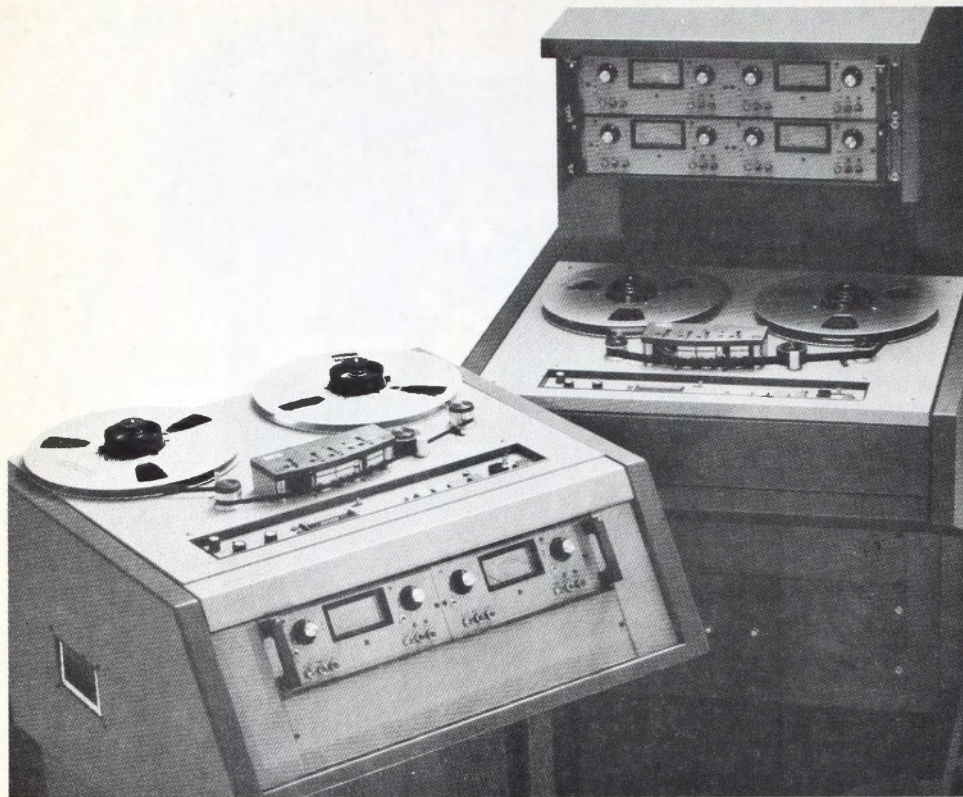

## MCI JH-110B

The choice of many top recording studios, the name MCI means quality without compromise.

- 3 speeds (7 + 1/2, 15, and 30 ips), with an option for 3 + 3/4 vs. 15 ips.
- Available in full or half-track 1/4" or four-channel 1/2".
- Automatic sync/input switching for overdubbing.
- Microprocessor tape timer/memory/search as standard.

The JH-110B has a built-in  $\pm 20\%$  variable speed control, automatic bias and EQ electronic switching for each speed, a microprocessor-based digital time, a "joystick" allowing scans of tape in either direction, excellent editing capabilities: and all that's just for starters.

A 70 db signal-to-noise ratio of 15 ips and a frequency response of 30-24 kHz are further indications of MCI's emphasis on quality.

## Specification:

### Frequency Response

#### Record/Response:

30 ips, AES:

50 Hz . . 28 kHz + .75/-2 dB

15 ips, NAB:

30 Hz . . 24 kHz + .75/-2 dB

7.5 ips, NAB:

30 Hz .20 kHz + .75/-1.5 dB

#### Wow Flutter: (DIN 45507

weighted):

30 ips, .022%

15 ips, .035%

7.5 ips, .055%

#### Long Term Speed Stability

Better than .02%

#### Reel Sizes Available with:

NAB A (3, 5 or 7 inch)

NAB B (10 1/2 or 14 inch)

DIN 1000M (11 1/2 inch)

#### Size,

variable 37" (94 cm)H

profile 25 1/2" (64 cm)W

cabinet: 24 7/8" (63.35 cm)D

Weight: 214 lb (96.3 kg)

#### Size,

high 48 1/4" (122.5 cm)H

profile 27 3/4" (70.5 cm)W

cabinet: 29" (73.6 cm)D

Weight: 197 lb (88.65 kg)



# MICROPHONES AND ACCESSORIES

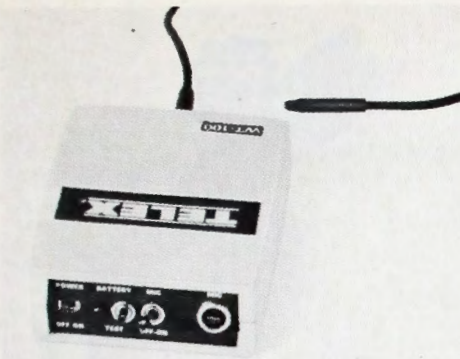

## Telex Wireless Microphone System

The Telex Wireless system is a professional-quality system that transmits a microphone signal via FM radio transmission to a receiving station. The system eliminates hum, noise, sound-mixing problems and the potential shock hazard from poorly grounded microphones. The Telex system achieves superb, consistent performance over line-of-sight to 2000 feet (600 m). Though Telex wireless microphone equipment is FCC type accepted, the user must obtain proper licensing. Transmitter and receiver are single frequency, crystal-controlled units operating in the VHF band between 150 and 174 MHz.



## Sennheiser MD 421

This sleek dynamic cardioid from Sennheiser can handle whispers and yet it won't overload at 175 dB — and it does so over a broad 30 Hz to 17 kHz frequency response range. Because the MD 421 performs with superb fidelity, it is capable of recording or broadcasting any instrument, voice, or sound; its rugged construction, virtual immunity to overload, low handling noise, and freedom from feedback also make it ideal for live performances.

The MD 421 can be worked closely with minimum proximity effect (due to its five-step bass attenuator). It further provides improved definition in upper ranges (5 kHz to 10 kHz) because of an intentionally increased sensitivity.

Alternate versions of the MD 421 are also available.



## Electro-Voice DO 56

The EV DO 56 is a sturdy omnidirectional mic — perfect for hand-held interview and sound reinforcement applications. Its shock-mounted design and shock isolation, extended frequency response 80 Hz to 18 kHz, high density acoustifoam blast filter, and

handsome styling (silver-tone beige finish) make it both functional and attractive.

Several other features of the Do 56 also stand out:

- Its "G-factor" margin makes it less susceptible to bell-like clangs than other shock-mounted mics.
- The slow roll-off below 200 Hz ( $-8\text{db @ }50\text{Hz}$ ) obviates low frequency noise interference.
- A slight emphasis in the 2 kHz to 12 kHz range adds excellent presence.
- Steel and aluminum casing give ideal hand-held balance.
- The Memreflex grill screen bounces back to stay in shape.



## Electro-Voice RE-20

As low as 45 Hz and as high as 18 kHz in frequency response, the RE-20 is an excellent cardioid mic. The unique E-V "Variable-D" design means no proximity effect; the high performance blast filter cuts pops totally; the bass roll-off switch adapts the RE-20 to avoid unwanted low frequency response.

This is a mic ideal for critical recording, broadcasting, or sound reinforcing situations. Its slight elevation from 5 Hz to 15 kHz means refreshing brilliance coupled with fidelity. And it's a rugged mic, the RE-20 — capable of handling sound pressure levels beyond 160 db.

Impedance is 150 ohms (changeable to 50 or 250); output is  $-57\text{ dB}$ . Diaphragm is E-V Acousalloy.

# MICROPHONES AND ACCESSORIES



**Electro-Voice RE 50**  
Reporters — on the go, frequently in less than desirable surroundings, often with vexing sound problems: Electro-Voice had them in mind in designing the RE-50.

This omnidirectional mic is shockproof, impervious to handling noise and damage from mechanical shock, and offers a highly effective pop filter. The low impedance RE-50 "hears" from 80 Hz to 13 kHz. Its output is -55 dB. Because of its light weight (9½ oz.) and exceptional strength (from aluminum), the RE-50 is a go-anywhere, take-any-pressure, never-fail trouper.



**Electro-Voice 635-A**  
The 635-A is almost synonymous with the word "microphone." Few are the deejays, studios, or reporters who've not used one of these durable, dynamic omnidirectional mics. It's also Electro-Voice's toughest performer.

Frequently response ranges from 80-13 kHz, with a gradual roll-off below 200 Hz and a broad rise from 2 k to 12 kHz. That means bright, natural sound and distinctive presence. Pops are no problem either, due to the four stage filter (which also protects from dust and magnetic particles). External shock is minimized by a firm plastic elastomer surround.



## Shure SM-7

Because almost a decade was devoted to its development, the dynamic unidirectional SM-7 incorporates advantages such as a pioneering "air suspension" integral shock mount and a built-in wind/pop filter which lead to freedom from noise, pops, and mechanical interference. Other key features are the four settings for response curves:

- Extremely flat.
- Low frequency roll-off.
- Mid-frequency boost.
- And a combination of roll-off and boost.

Frequency response is 40-16 kHz. Output is -79 dB.



## Shure Sm-53 and SM-54

Both the Sm-53 and 54 mics are cardioid, low impedance mics, with identical 70-16 kHz ranges and minimal proximity effect. They differ only in the fact that the SM-54 has an added pop and wind blast filter that is extraordinarily effective.

On location or in studio, these mics have broad front-working angles and are built to avoid off-axis reflections, reverberations, and background noises. Both the SM-53 and SM-54 are tough (the 53 is so sturdy, in fact, that it can even be dropped on its nose without cartridge damage). Styling (neutral matte metallic finish) makes them excellent for on-camera or on-stage work.

# MICROPHONES AND ACCESSORIES



## Shure SM-50

This is a "hands-on" mic—touch, quiet, true. Shure's omnidirectional dynamic SM 50 is almost immune to pops and wind noise, due to its built-in wind screen. It's natural sounding over its 40-13 kHz range and is thus perfect for voice. The SM-50 weighs just 8 oz. and is as compact as can be—making it ideal for remote broadcasting or interviews.

This dynamic Shure mic comes with a slip-in stand adapter and shock-mounted cartridge.



## Shure SM63

looks and sounds great in front of people and cameras.

This small, rugged omnidirectional dynamic mic has high output; can be hand held or stand-mounted in broadcast/recording studios; on location for interviews and sports broadcasts or on-stage and in television productions. Frequency

response is extremely wide; controlled low-frequency rolloff assures natural sounding voice and music pickup; extended high-frequency response provides clear, crisp sound. Integral wind and pop filter is extremely effective in normal environments; a dual-density, two-layer windscreens is available for adverse/outdoor applications.

Frequency response: 50 to 20,000 Hz

Weight: 2.8 oz (80 g)



## Shure SM82:

hand-held line level unidirectional mic

Self-contained mic has its own line level amplifier, peak limiter and 9.8 volt battery. The SM82 is ideal for applications/live remotes involving long cable runs, even using unshielded cables. Built-in peak limiter prevents overloading of mic line amplifier or remote broadcast amplifier. Rugged construction includes built-in "pop" and wind filter; automatic switchover from simplex to battery power.

Frequency response: 40 to 15,000 Hz

Weight: 14.4 oz (406 g)

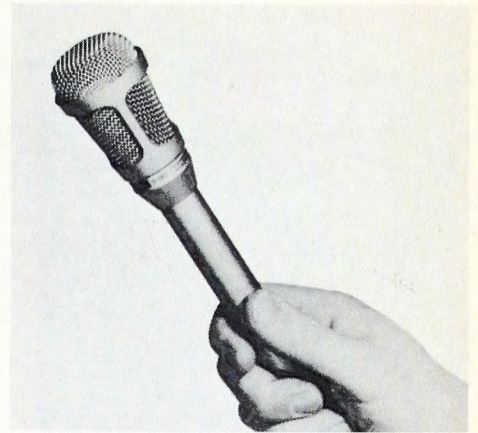

## Shure SM85:

Pro-Tech performance in a hand-held condenser mic

The SM85 sets a new standard for professional reliability. All critical components have been field-tested in live performances and the SHURE quality assurance program. The SM85 is lightweight, yet stands up to tough on-stage use and abuse. It maintains the high quality expected of a studio condenser mic. It's ideal for the most demanding live sound applications as well as for broadcasting and studio recording requirements.

Frequency response: 50 to 15,000 Hz

Weight: 6.3 oz (180 g)

# MICROPHONES AND ACCESSORIES

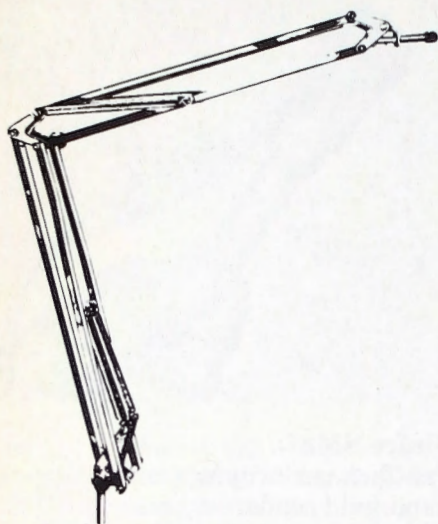

## Luxo Microphone Arms

Luxo arms are perfectly balanced to carry microphones to any desired position and remain there. LM-1 has a 41-inch (104 cm) reach; LM-2 26-inch (66 cm) reach. Mike weights of 198 to 368 (7 to 13 oz) can be accommodated. Heavier mike capacities are available on special order. Order mounting brackets as a separate item. (clamp bracket, wall bracket, horizontal mounting bracket.)

## Sennheiser Accessories

Sennheiser offers three mic stands (the lightweight MZS 142, the taller MZS 144, and the heavy-duty, anti-vibration MZS 210). The latter two extend from 33" to 62" (84 cm-158 cm), while the 142 can be raised from 16" to 54" (40.6-137.1 cm). All three accept the MZS 211 boom arm. For desk or console applications, the MZT 421 stand is ideal.

Heavy duty shielded cable is also offered with standard XLR connectors at both ends. Sennheiser manufactures two wind screen/pop filters: the MZW 421 (made from open cell sponge) and the fiberglass-reinforced polyester MZW 22.

## Atlas Accessories

From Atlas' comprehensive line of mic stands and other accessories, Continental Electronics has selected four top-of-the-line models.



- SB-36 is a professional boom stand with height ranging from 48" to 72" (121.9 cm-157.5 cm). Boom is 62" (157.5 cm). This hefty, 36 lb (16 kg) stand is exceptionally stable—in part because of its integral air suspension system and its accompanying boom counterbalance. It is a handsome unit, with textured charcoal base and chrome cover.

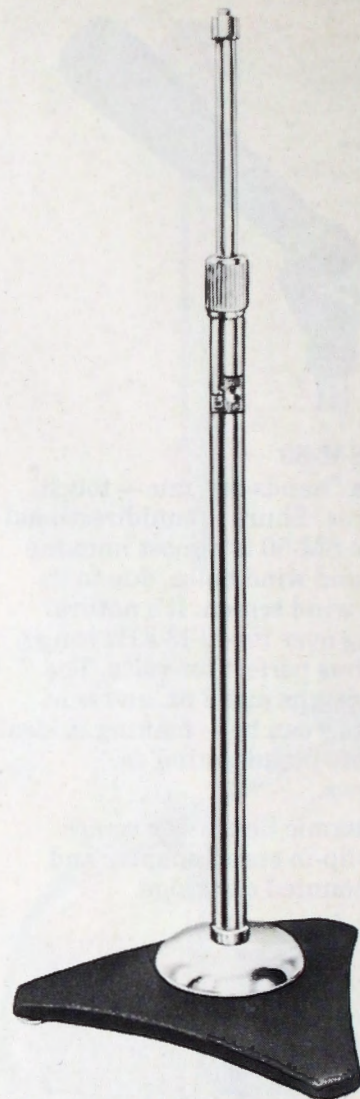

- The MS-25 stage and studio floor stand is a solid 23 lb (10.4 kg) unit, extending from 38" to 67" (96.5cm-170.2 cm). Because of its integrated air suspension system, it offers excellent mic counterbalance. It features oversize 1 1/8" (2.9 cm) diameter tube assembly with a 5/8" (1.6 cm) -27 thread top adapter.

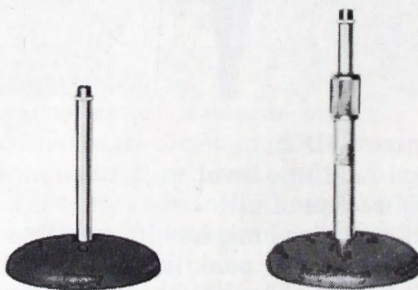

- The DS-5 and DS-7 are desk stands. The 5 is general purpose, non-adjustable, and stands 4" (10 cm) tall from its base. The DS-7 is adjustable from 8" to 13" (20.3 cm-33 cm) from its 6" (15 cm) base. The stands weight 2 and 3 lbs, respectively (0.9-1.3 kg).

## Davis Speakers XEB-50, XEB-40

The Davis shelf-size XEB-50 speaker system utilizes a modified Helmholtz design. Three speakers are used: an 8" (20.3 cm) free-edge cone, full range; a 3" x 5" (7.6 - 12.7 cm) tweeter; and a 6" (15.2 cm) super-tweeter. One watt of power is required for the normal room. Power capacity is 25 watts; response is 37 to 19,000 Hz; impedance is 8 ohms. The cabinet is finished in a walnut grain vinyl.

The XEB-40 is a four speaker system using a 15" (38.1 cm) woofer; an 8" (20.3 cm) mid-range and 3" x 5" (7.6 - 12.7 cm) enclosed tweeter; and a 6" (15.2 cm) super tweeter. Response is 24 Hz to beyond audio range; impedance is 8 ohms; power capacity is 50 watts. Bass response and brilliance controls are mounted on the rear of the cabinet.

Size,  
XEB-50: 12" (30.5 cm)H  
24" (67 cm)W  
10½" (26.7 cm)D

Size,  
XEB-40: 24½" (62.2 cm)H  
30" (76.2 cm)W  
14½" (38.8 cm)D



## Electro-Voice Sentry 100

This compact monitor speaker delivers amazingly accurate sound over a 30 Hz to 20 kHz minimum frequency response range making it ideal for control and production room use. It features a Super-Dome tweeter with a 25-watt input capacity and a 8" direct radiator woofer installed in an optimally vented enclosure with fourth-order Butterworth tuning.

The Sentry 100's crossover network is a 12 db/octave dual section type, with cross-over occurring at 2 kHz. The speaker also has a continuously variable shelf-type high frequency control allowing adjustment for individual listening preferences. (both boost and cut capabilities are included.)

The Sentry 100 can be rack-mounted with an optional kit.

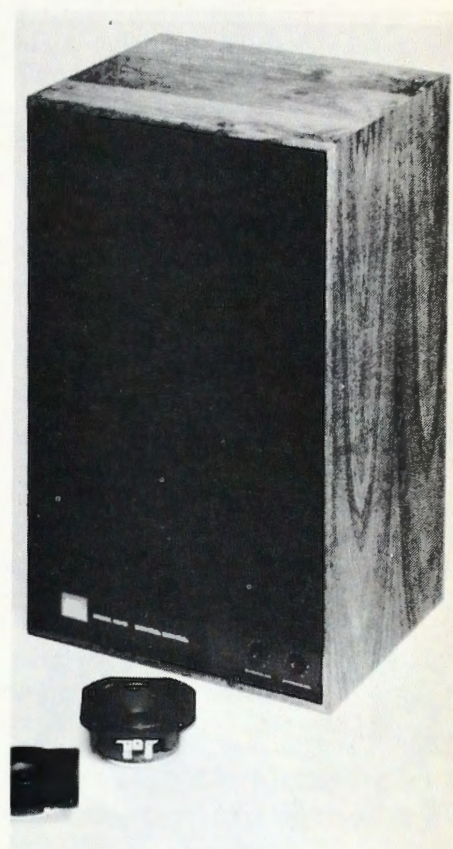

## JBL Speakers

### 4301B Broadcast Monitor, 2-way

JBL's smallest monitor is designed primarily for the broadcast control room and edit booth, and has achieved wide acceptance in home studios, remote recording and quality control areas. Smooth, wide range response and low distortion are obtained from 200 mm (8 in) low frequency and 36 mm (1.4 in) high frequency loudspeakers. A high frequency level control is provided on the front baffle. Available in oiled walnut with dark blue grille.

### 4311B Control Monitor, 3-way

A compact loudspeaker system designed for control rooms and other applications where space is restricted, the 4311B utilizes 300 mm (12 in) low frequency, 130 mm (5 in) midrange and 36 mm (1.4 in) high frequency loudspeakers. Front panel controls, below the grille, permit convenient adjustment of midrange and high frequency levels. Available in textured gray or oiled walnut with black grille.

# HEADPHONES

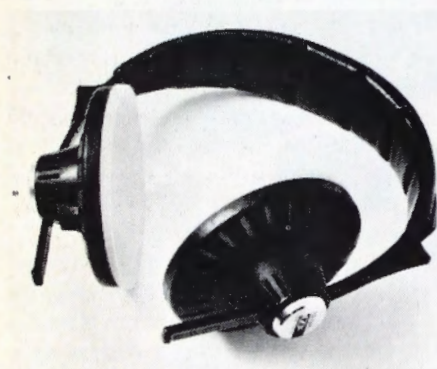

## **Sennheiser HD 414, HD 424**

Acoustical quality and headphone comfort are built into these high fidelity stereo headphones. Model 414 has a frequency response of 20 to 20,000 Hz; Model 424 has a frequency response of 16 to 20,000 Hz. Both models have an impedance of 2000 ohms. The HD 414 weighs 4.7 oz. (135 g); the HD 424 weighs 5.9 oz. (170 g). The cable length on both models is 9.8 ft. (3 m).



## **AKG-140S Studio "Cardan"**

An improved version of the best-selling K-140, the AKG-140S has modified transducers which improve high-frequency performance. The "open-air" design provides superb bass response, free from the "boominess" which often detracts from low-frequency fidelity. The lightweight K-140S also uses the patented principal of "Cardan" earpiece suspension in which each earpad can be independently adjusted. A single input cable is connected to the left earpiece.

### **Specifications**

Cable: 9.8 ft. (3 m) 4-conductor cable, 3-conductor, 1/4-inch (.63 cm) with telephone plug  
Weight: 9 oz. (259 g) with cable and plug.



## **AKG-141 Deluxe "Cardan"**

The AKG-141 is a lightweight high-quality stereo headphone that is so comfortable as to be almost unnoticeable even after hours of wearing. It is a semi-open style that has the resonance-free characteristics usually associated with "open-air" designs, but having greater freedom from low-frequency side effects caused by varying ear shapes and contact pressure. The K-141 provides an extremely broad, flat response almost totally free of coloration: sound which is warm, not boomy; open and present without harshness. A single input cable is connected to the left earpiece.

### **Specifications**

Cable: 9.8 ft. (3 m) 4-conductor cable, 3-conductor, 1/4-inch (.63 cm) telephone plug  
Weight: 9 1/4 oz. (259 g) with cable and plug

# PATCHCORDS AND PANELS

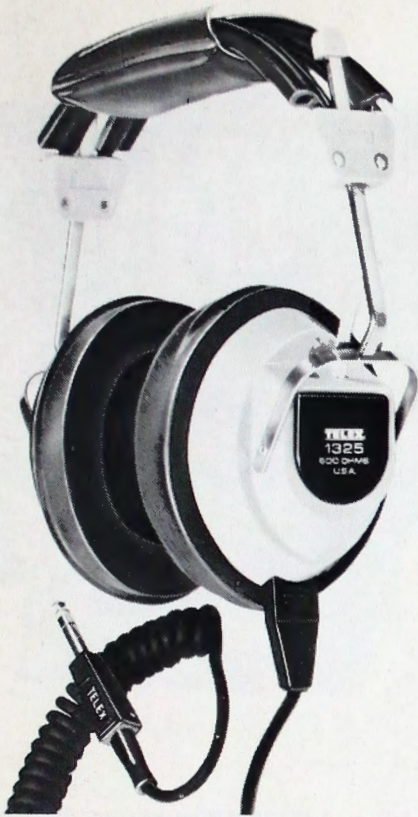

## Telex 1325, CS-61

The Telex 1325 is a 2-channel broadcast monitor headphone incorporating audiometric transducers. Either 600-ohm or 6000-ohm models are available. It is ideally suited to monitor stereo broadcasts or monaural broadcasts where program bus and cue bus are received on separate channels. Muffs and headband are foam-filled



and the 12 ft. (3.66 m) cord is detachable. The Telex 1320 series is designed for a variety of communication requirements. Model CS-61 has dual muffs and dynamic mike; Model CS-75 has single muff and dynamic mike; Model CS-7 has dual muffs; Model CS-11 has single muff. Impedance of all these 1320 models is 600 ohms; usable response is 20 Hz to 20,000 Hz.

## Trimm Patchcords

Most widely used broadcast types. Two live circuits go to tip when used on balanced lines, grounded sleeves of both plugs connected together through shield. Standard color black.

Sizes:           12" (30.5 cm)  
                      2-circuit  
                      24" (61.0 cm)  
                      2-circuit  
                      36" (91.4 cm)  
                      2-circuit

## Trimm Jack Panels

These panels are available in 12-pair, single row and 24-pair double row models to fit any standard 19 inch (48.26 cm) rack and include such features as: solid  $\frac{5}{8}$  inch (1.58 cm) thick Bakelite panel with steel reinforcing; heavy gauge, special spring temper nickel/silver alloy leaves; ground lugs aligned to allow single ground bus to be run full length of strip; large palladium silver contacts; connection lugs fanned out for ease of soldering.

12-pair, single row, Model 96-01  
24-pair, double row, Model 96-02



# CLOCKS AND WARNING LIGHTS



**Telechron 2012 Studio Clock**  
The Telechron "Commerce" clock has a 12" (30.48 cm) dial and rich brown case.  
124-0083-705 Studio Clock

**Quartzmatic 46377 Clock**  
The Quartzmatic Model 46377 battery-operated 12" (30.5 cm) studio clock offers accuracy within 1 minute per year. This clock is ideal for control room and studio applications. The unit has a full sweep second hand and a brown finished case.



**Fidelipac "World-Standard" Studio Warning Lights**  
When lit, brilliant red lettering on jet black background can be seen in even the brightest ambient light conditions. Faceplate is manufactured from unbreakable plexiglas; the light includes lamps and mounting hardware.

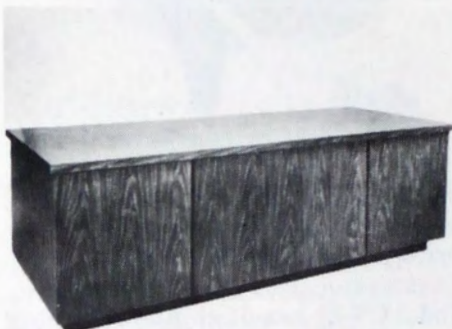
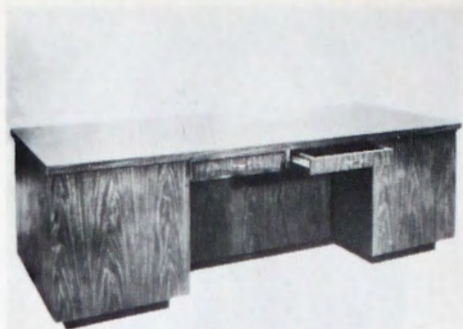

## Grinnan studio furniture

Grinnan studio furniture is available in a variety of styles, to meet virtually any operational requirement. Cabinets are available in a blond (natural fir) or walnut finish. Natural fir is standard finish for all record and tape storage cabinets; standard finish for studio furniture, cartridge cabinets and Lazy Susans is walnut.

Shown are some of the more frequently used modular units.

### Control console desk

Sit-down style, CD-3695-L:

95" (241.30 cm) W

30" (76.20 cm) D

30" (76.20 cm) H

Stand-up style, CD-3965-H:

95" (241.30 cm) W

30" (76.20 cm) D

40" (101.60 cm) H

### Lazy Susan cartridge rack

Model LS-0240 holds 240 cartridges, is available with 4" (10.16 cm) or 12" (30.48 cm) base. Rack is 20" × 20" (50.80 cm × 50.80 cm).

Model LS-0400 holds 400 cartridges, is available with 4"

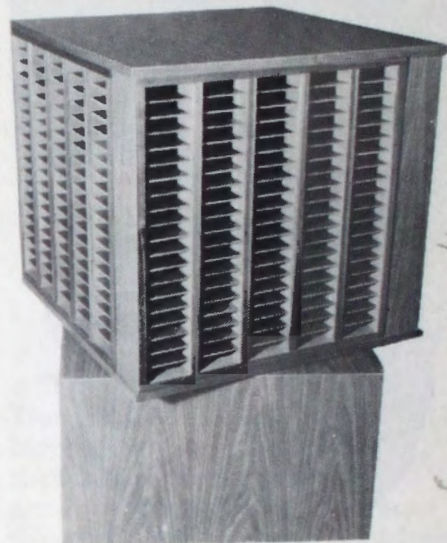

(10.16) or 12" (30.48 cm) base.

Rack is 29<sup>5</sup>/<sub>8</sub>" × 29<sup>5</sup>/<sub>8</sub>" (75.25 cm × 75.25 cm).

Model LS-0800 holds 800 cartridges, comes with 4" (10.16 cm) base. Rack is 24<sup>3</sup>/<sub>4</sub>" × 24<sup>3</sup>/<sub>4</sub>" and 68" high (62.87 cm × 62.87 cm × 172.72 cm).

Model LS-1000 holds 1000 cartridges, comes with 4" (10.16 cm) base. Rack is 29<sup>5</sup>/<sub>8</sub>" × 29<sup>5</sup>/<sub>8</sub>" and 68" high (75.25 cm × 75.25 cm × 172.72 cm).

### 30-minute cartridge cabinet

Model BC-0550 holds 250

30-minute cartridges.

35<sup>3</sup>/<sub>4</sub>" (90.81 cm) W

6<sup>1</sup>/<sub>8</sub>" (15.56 cm) D

67<sup>5</sup>/<sub>8</sub>" (171.77) H

### 7-inch record cabinets:

All cabinets in this series are 7<sup>5</sup>/<sub>8</sub>" (19.37 cm) deep and 84" (213.36 cm) high. Pictured is Model GS-0748.

Model GS-0724 holds 1200 7-inch records, is 24" (60.96 cm) wide.

Model GS-0736 holds 1800 7-inch records, is 36" (91.44 cm) wide.

Model GS-0747 holds 4200 7-inch records, is 48" (121.92 cm) wide.



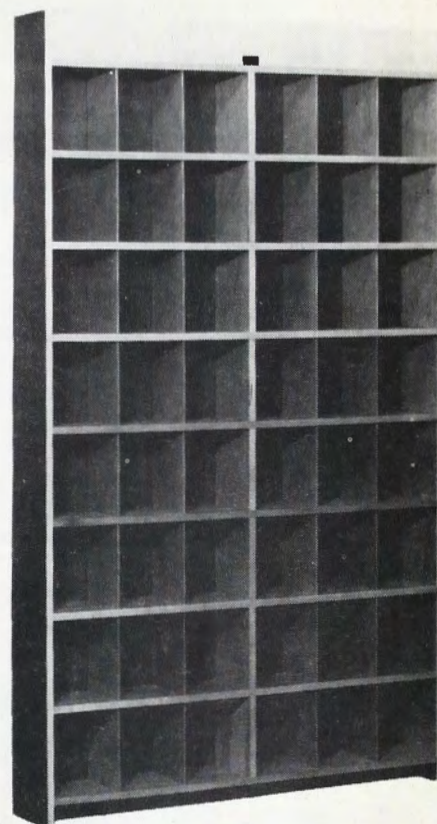
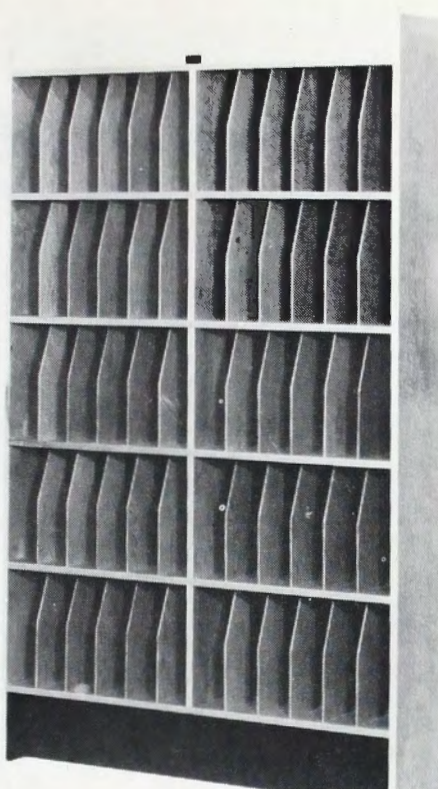

## 12-inch record cabinets:

All cabinets in this series are 12 $\frac{5}{8}$ " (32.07 cm) deep and 84" (213.36 cm) high. Pictured is Model GS-4812.

Model GS-2412 holds 750 12-inch records, is 24" (60.96 cm) wide.

Model GS-3612 holds 1125 12-inch records, is 36" (91.44 cm) wide.

Model GS-4812 holds 1500 12-inch records, is 48" (121.92 cm) wide.

## Tape cabinets:

All cabinets in this series are 84" (213.36 cm) high. Pictured is Model TC-0748.

## For 5-inch tapes:

Model TC-0524 holds 310 tapes, is 5 $\frac{5}{8}$ " (14.29 cm) deep and 24" (60.96 cm) wide.

Model TC-0536 holds 465 tapes, is 5 $\frac{5}{8}$ " (14.29 cm) deep and 36" (91.44 cm) wide.

Model TC-0548 holds 620 tapes, is 5 $\frac{5}{8}$ " (14.29 cm) deep and 48" (121.92 cm) wide.

## For 7-inch tapes:

Model TC-0724 holds 248 tapes, is 7 $\frac{5}{8}$ " (19.37 cm) deep and 24" (60.96 cm) wide.

Model TC-0736 holds 372 tapes, is 7 $\frac{5}{8}$ " (19.37 cm) deep and 36" (91.44 cm) wide.

Model TC-0748 holds 496 tapes, is 7 $\frac{5}{8}$ " (19.37 cm) deep and 48" (121.92 cm) wide.

## For 10 $\frac{1}{2}$ -inch tapes:

Model TC-1124 holds 155 tapes, is 11 $\frac{5}{8}$ " (29.53 cm) deep and 24" (60.96 cm) wide.

Model TC-1136 holds 232 tapes, is 11 $\frac{5}{8}$ " (29.53 cm) deep and 36" (91.44 cm) wide.

Model TC-1148 holds 310 tapes, is 11 $\frac{5}{8}$ " (29.53 cm) deep and 48" (121.92 cm) wide.





# AUDIO PROCESSING EQUIPMENT

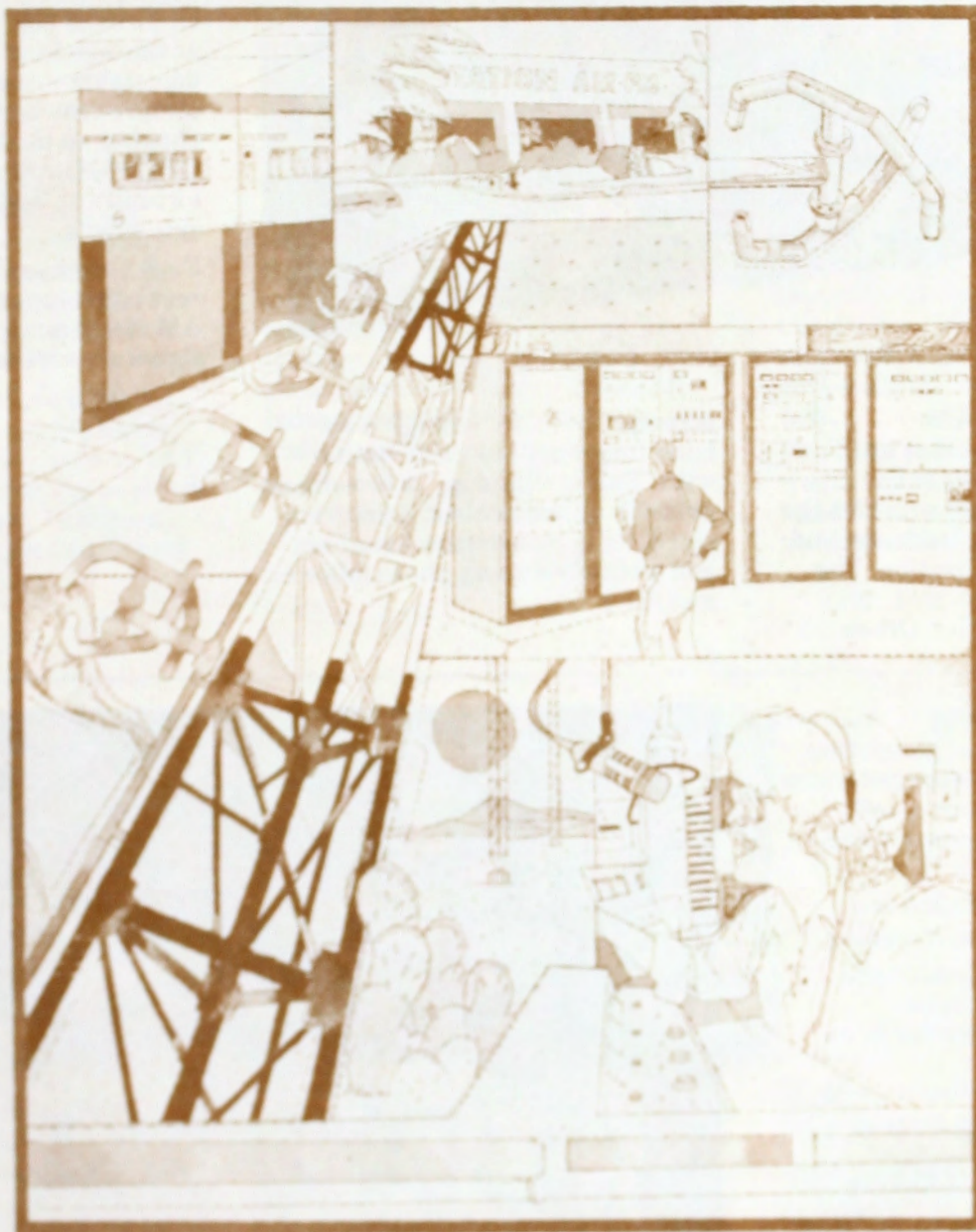

# AUDIO PROCESSING EQUIPMENT



Orban's pledge is to deliver dramatically improved sound and even to expand signal coverage by concentrating energy in the portion of the audio spectrum that cuts through static and interference. OPTIMOD-AM has yet another advantage in that it is totally adjustable — including EQ, compression and limiting, and clipping up to 12 db. And OPTIMOD-AM does all this with virtually no audible processing side effects.

Each Orban unit is equipped with a rear panel connector to accept an AM stereo adapter chassis, should signal conversion be desired.

## Orban OPTIMOD-AM

Orban's OPTIMOD-AM is an advanced electronic signal processing system that provides the best possible quality, loudness, and high frequency equalization. The result? Transmissions that rival the best FM has to offer. Orban

accomplishes this through a six-band frequency-selective limiter with "Smart Clipping," a broadband gain-riding compressor, a program equalizer, a transmitter equalizer, and a totally smooth phase follower and filter.

## Orban OPTIMOD-FM

This is Orban's second generation compressor/limiter/stereo generator — one that offers unsurpassed loudness and brightness without processing side effects.

The OPTIMOD-FM 8100A is a system of components, including:

- a unique wideband/multiband compressor which can be exceptionally transparent or as punchy as you like;
- an innovative peak limiter with total overmodulation control — without overshoot, pumping, clipping distortion, or aliasing;
- a stereo generator — new in design — with flawless performance.

Because the OPTIMOD-FM has accessible controls and clear instructions, you're free to tailor your sound for the effect you find best.

OPTIMOD-FM: self-contained, state-of-the-art; and all you need for the best FM signal possible.



# AUDIO PROCESSING EQUIPMENT

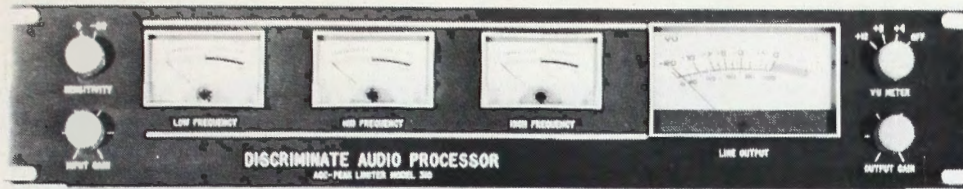

## Dorrough Model 310

In one unit, Dorrough has combined a compressor, a limiter, and an equalizer for the studio transmitter loop. The 310 Discriminate Audio Processor is as modern as can be in its circuits, logic, and all other parts.

The 310 has five quality signal processing systems: an EQ board, three AGC frequency controls, and an output peak limiter. Input is fed to an active three way bandpass filter network with three different

outputs — 20-120 hz, 120-6.5 khz, 6.5-15 khz — all with a subtle 3 db/octave slope assuring a gliding tone from one band to the next. Output from each filter is next fed to the input of an individual processing system — each with a total capacity of from 17 db of expansion to 30 db of compression independent over the entire audio spectrum.

The Discriminate Audio Processor expands through the control voltage nullifying some 17 db of quiescent reduction — thus cutting hiss, rumble, and other unwanted noises. Output from the three discriminate channels is then combined and amplified to produce a composite, single signal, variable from  $\pm 16$ db mW.

The 310's specs include a 30-15 khz frequency response ( $\pm 1$  db), a wide band 60 db signal-to-noise ratio, and distortion of less than 1%.



**CRL Systems 1A and 4A for AM**  
**CRL Systems 1 and 4 for FM**  
 CRL AM and FM audio processing systems have been thoroughly field-tested and offer broadcasters incredible sound control with maximum flexibility and reliability. Modular, building-block concept provides emergency protection: if one stage fails, rest of the system remains in operation.

System can enhance dynamic power of disco bass; maintain natural on-air vocal integrity of studio

announcers; expand transient brilliance of cymbal crashes. Processing is made possible by accurate over-all level controlling; multi-band transient and dynamic conditioning; multi-band limiting/clipping filters. AM filters incorporate original CRL transmitter tilt-overshoot correction designs.

The CRL system offers incredible sound control while maintaining natural sound qualities for AM or FM.

For AM  
 CRL System 1A provides outstanding AM processing capabilities and consists of one App-300A Audio Preparation Processor; one PMC-300A Peak Modulation Controller.

For FM  
 CRL System 1 provides wide-range FM signal processing capabilities and consists of two APP-300A Audio Preparation Processors; one SMC-600 Stereo Modulation Controller; one CC-300 Composite Controller.

# AUDIO PROCESSING EQUIPMENT:

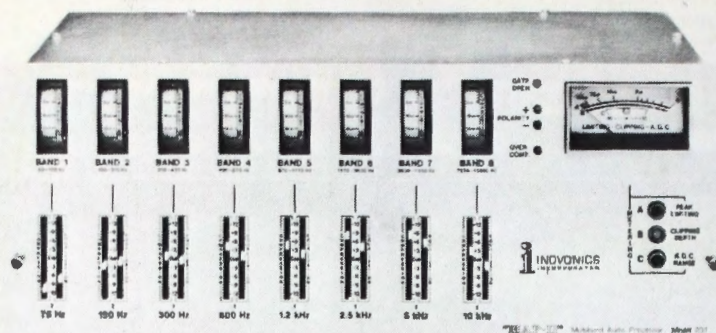

## Inovonics MAP II

Primarily for AM transmissions—though expandable for FM stereo—Inovonics MAP II is a second generation multiband audio processor which makes transmission full, clean, and as loud as you like.

Its features are as impressive as they are innovative:

- a selectable high-pass filter with three low-end frequency cut-offs (50, 70, and 100hz);

- gated automatic gain control effectively erasing long-term input level variations and establishing constant RMS input values for subsequent processing stages;
- a multiband compressor which guards against "swishing" or "phasing" effects;
- an inaudible phase-follower maintaining optimum asymmetrical modulation without "clicks" or "pops"

Still other advantages include a new integrated peak controller, selectable low pass filter, built-in pink noise source, portability, ease of installation, frequency response of 50-15 khz, better than 65 db signal-to-noise, and thd of 0.3% above 200 hz. All this in a 16 lb., 7" x 19" x 19" package.

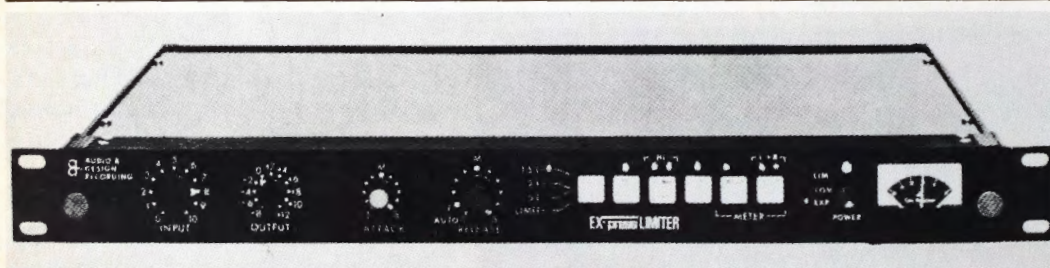

## FM Stereo Ex-press Limiter Audio & Design Recording

The FM Ex-press Limiter is a superb, compact compressor-limiter-expander, designed to provide high quality, high level F.M. signals in 1 3/4" of rack space.

Function mode is controlled by digital logic momentary switches with no audio path contact to wear out. A memory system retains 'last use' settings when switched off, with a series of led indicators to show the status of functions when the unit is powered.

The Ex-press has stereo *input/output* attenuators, variable *attack* and *release* times and an *auto* release network. Ratios provided are 1.5:1, 2:1, 5:1, and limit (20:1) turning into a limit slope after 10dB of compression to ensure smooth overload protection. The softer ratios combine minimum dynamic change with subtle compression ideal for "beautiful music" and "M.O.R.", while the tighter slopes, with fast release, give extremely high modulation levels for maximum loudness and punch, i.e. rock formats etc.

No worries about transients, the C.C.C. (clever clipper circuit) takes care of those.

# AUDIO PROCESSING EQUIPMENT:

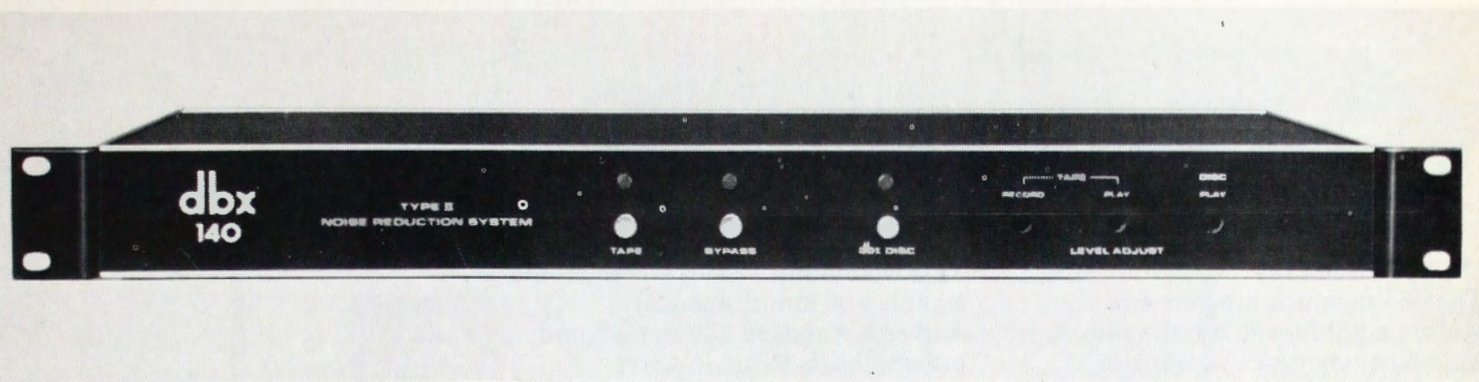

## dbx Model 142

The dbx 142 will permit recording of spots, newsreports, interviews, music, or anything else with no tape hiss whatsoever — whether the tape be cartridge or open-reel. Employing proprietary circuitry, the 142 provides a minimum of 30 db broadband audio noise reduction with a 10% increase in system headroom. This stereo unit features

“encode” (compressing input signal by a 2:1 ratio over a 100 db range), “decode” (expanding in precisely the same manner), and “by-pass” function select switches. There is no audible pumping, breathing, or other bothersome coloration of sound.

The 142 does not eliminate hiss existing in previously recorded tapes. It does, however, let carts

sound “live” so that program continuity is maintained and a smooth sound is broadcast.

Thd is 0.1% typical, frequency response ranges from 30-20 KHz, equivalent input noise is -90 db typical. The 142 weighs a slight 8 lbs.



## dbx Model 165

The 165 is considered by many to be the most advanced compressor/limiter in the world. It is monk-like in its silence, without ever being heard, whether in compression or limiting mode.

dbx engineers have incorporated the unique “Over Easy” compression that — unlike

competitive models — introduces nothing unwanted in programming. A balanced high impedance differential input stage and an unbalanced out, terminating in a barrier strip, are used. This mono instrument is strappable for stereo operation (a master/slave switch is situated on the front panel). Automatic or manual attack and

release rates are built into the 165, along with a special input to the level detector to allow creation of special effects.

20-20 khz frequency response, second harmonic distortion of 0.05%, variable output gain of -20 db to +20 db, and a 25 watt power consumption also distinguish the 165.





# AUDIO PROCESSING EQUIPMENT:



## **Dolby Model 334**

The 334 means an increase in station signal level, a reduction in high frequency compressing or limiting—or both. It even improves the signal-to-noise ratio of other existing Dolby-B type noise reduction circuits.

This Dolby unit erodes stereophonic signals and simultaneously converts standard 75 microsecond pre-emphasis to an effective pre-emphasis of 25 microseconds, as approved by the FCC.

The 334's frequency range is 30-15 khz, with an overall noise level of better than 80 db.

## **Gregg Laboratories 2560 AM Audio**

### **Broadcast Processor**

The 2560 audio processor provides AM broadcasters a remarkably clean, loud, high fidelity signal.

Gregg Laboratories has developed an all new AM audio processing system which will solve bandwidth reduction problems, as well as loudness and audio quality problems faced by broadcasters. The Gregg Laboratories 2560 AM Audio Broadcast Processor is offered to the broadcaster as a complete AM broadcast audio processing system available in one complete package. The 2560 includes a broad-band gain control, band-limiting filters, specialized equalization, a symmetry synthesizer, a five-band compressor, a five-band clipper, low-pass filters, a transmitter phase/amplitude corrector, and two line amplifiers. The system may be divided in two using the optional main-frame to house the broad-band gain control in the event an STL is utilized.

The Gregg Laboratories 2560 is designed to be fed flat, high quality unprocessed material. No pre-processing is necessary or recommended, except for the occasional touch-up of poor audio quality material.

The system begins with a very slow gated and weighted broad-band gain control amplifier with a 24dB control range. The primary purpose of this amplifier is to decrease noticeable operator level errors and/or STL protection. (Two isolated outputs are provided for the optional broad-band gain control main frame.) The control circuitry has audio controlled attack and release times and weights low frequency components to eliminate severe gain changes on low frequency transients, which cause the traditional pumping effects. The overall release time is switch selectable between two fairly slow release times.

All processing status is displayed by means of LED bar graphs. Inputs and outputs are balanced or unbalanced, and RFI suppressed. Instrumentation circuitry is utilized throughout. Gain control is accomplished with voltage controlled amplifiers for accurate consistency and tracking. All filters have been computer generated for extreme accuracy. Stereo adaptation is made possible by replacing mono circuitry cards with stereo circuitry cards. Multi-band processing is in the L + R, L - R format to insure maximum modulation of the L + R on mono receivers at all times. All main frames are stereo; the necessary matrix, L - R

band-limiting filtering and L + R delay network are included. An optional 5 kHz filter is available.

### **Audio performance**

Frequency response: 40 to 12,000 Hz  $\pm 0.5$  dB with equalization OFF, all VCAs, band-limiting and crossover filters IN.

Distortion: Less than 0.1 THD and IMD below broad-band and multi-band gain reduction threshold and in disable.

Signal-to-noise: Better than -75 dB below 100% modulation at threshold of broad-band and multi-band gain reduction.

Power: 115/230 v ac  $\pm 20\%$ , 50/60 Hz, 80 w

Size: 19"W  $\times$  7"H  $\times$  15"D (48.26 cm W  $\times$  17.78 cm H  $\times$  38.10 cm D)

# REMOTE PICKUP EQUIPMENT

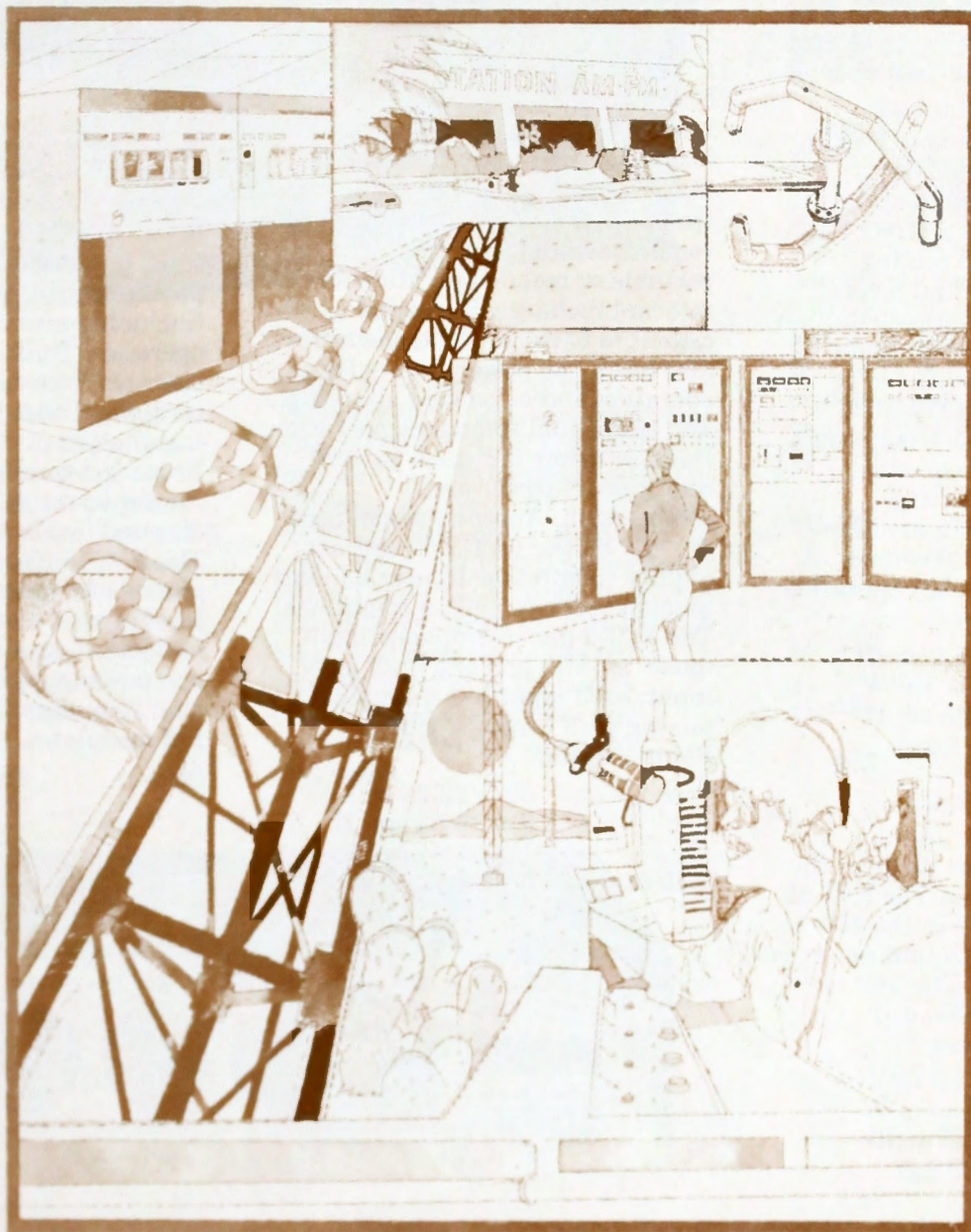

# REMOTE PICK UP EQUIPMENT

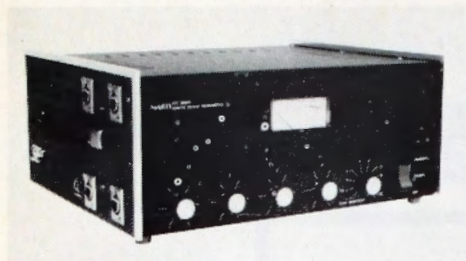

## Marti RPT-40 Transmitter

The Marti RPT-40 Remote Pickup Transmitter is designed for continuous duty. Its solid-state construction features a direct FM modulator, four audio mixing channels with individual level controls, built-in compressor/limiter for modulation control and taut band circuit meter. Designed to operate in the 150- to 172-MHz range, the RPT-40 has a maximum output of 40 watts, frequency stability of  $\pm 0.0005\%$ , and capability to operate from either 115/230 volts ac or 13.6 volts dc. A selectable dual frequency operation is an optional feature.

Size: 6 $\frac{1}{4}$ " (15.9 cm)H  
 15" (38.1 cm)W  
 12" (30.5 cm)D  
 Weight: 20 lb. (9 kg)

## Marti RPT-25 Transmitter

The RPT-25 is similar in appearance to and has many of the features of the RPT-40. The RPT-25 is designed to operate in the 450- to 470-MHz spectrum. Output power is 25 watts, maximum. The unit is compatible with unattended automatic relay devices.

Size: 6 $\frac{1}{4}$ " (15.9 cm)H  
 15" (38.1 cm)W  
 12" (30.5 cm)D  
 Weight: 20 lb. (9 kg)



## Marti RPT-2

### 2.5 watt Continuous-duty Remote Pickup Transmitter

Marti's hand-carried RPT-2 transmitter is a broadcast-quality remote pickup transmitter for portable or mobile operation on internal rechargeable nickel-cadmium battery. The transmitter also has an ac power supply for ac operation and/or battery charging, and offers dual frequency operation. Built-in meter indicates battery condition, rf power and compression. Antenna is mounted directly on the RPT-2. Broadcast-quality compressor/limiter handles toughest remote pickup conditions. The RPT-2 has microphone input (push-to-talk) and one high level input; each input has individual mixing gain controls. Direct FM modulator.

Size: 8 $\frac{3}{4}$ " (22.23 cm) W  
 3 $\frac{3}{4}$ " (9.53 cm) H  
 11" (27.94 cm) D  
 Weight: 5.25 lb (2.4 kg)



## Marti RPT-15

### 15 watt Continuous-duty Remote Pickup Transmitter

Marti's RPT-15 transmitter is a 15 watt, broadcast-quality remote pickup transmitter for mobile (including aircraft) or portable operation. Built-in ac power supply operates from detachable power cord. Small size permits easy installation in most vehicles. Broadcast-quality compressor-limiter operates over a wide range of sound levels without distortion. The RPT-15 has mixing gain controls for microphone and high level inputs; a built-in meter to indicate rf power, audio compression and power supply voltage; offers dual frequency operation, direct FM modulator.

Size: 8 $\frac{3}{4}$ " (22.3 cm) W  
 3 $\frac{3}{4}$ " (9.53 cm) H  
 12 $\frac{1}{2}$ " (31.75 cm) D  
 Weight: 9.25 lb (4.4 kg)

## REMOTE PICK UP EQUIPMENT

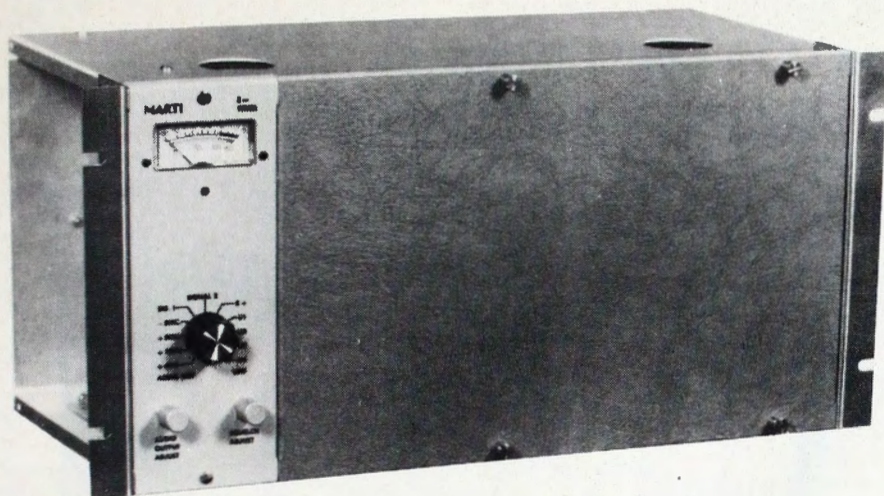

### Marti R-30/150 Receiver

This rack-mounted receiver mates with Marti's RPT-40 Transmitter, for operation in the range of 150 to 172 MHz. A crystal filter provides maximum selectivity: 6 dB at  $\pm 17.5$  kHz with a 10.7/F30 filter module (other filters are available). Audio output is 600 ohms at + 10 dB mW level. The receiver comes with provisions for dual frequency operation; second crystal and switching assembly are extra cost items.

### Marti R-50/450 Receiver

This rack-mounted receiver mates with Marti's RPT-25 Transmitter, for operation in the range of 450 to 470 MHz. A crystal filter provides maximum selectivity: 6 dB at  $\pm 17.5$  kHz with a 10.7/F30 filter module (other filters are available). Audio output is 600 ohms at + 10 dB mW level. The receiver comes with provisions for dual frequency operation; second crystal and switching assembly are extra cost items.

### Marti PA-1 Portable Antenna

The PA-1 is a single ring, portable antenna operating in the 150- to 170-MHz range. It is horizontally polarized and has unity gain. The PA-1 will mount directly on a  $\frac{5}{8}$  inch (1.6 cm) mike stand. As a mobile antenna (type MA-1), it can be mounted on a vehicle bumper.

### Marti YC Antennas

The YC series of antennas is ideal for mobile, portable or base installations. Capable of handling 100 watts input power, the antennas have an average gain of 9 dB, rear signal rejection of 25 dB, and may be either horizontally or vertically polarized. Six different models are available (depending on frequency range selected).

YC-153	Antenna (152.80 – 153.40 MHz)
YC-161	Antenna (161.40 – 162.00 MHz)
YC-166	Antenna (165.95 – 166.55 MHz)
YC-170	Antenna (169.85 – 170.45 MHz)
YC-450	Antenna (450.05 – 450.95 MHz)
YC-455	Antenna (455.05 – 455.95 MHz)

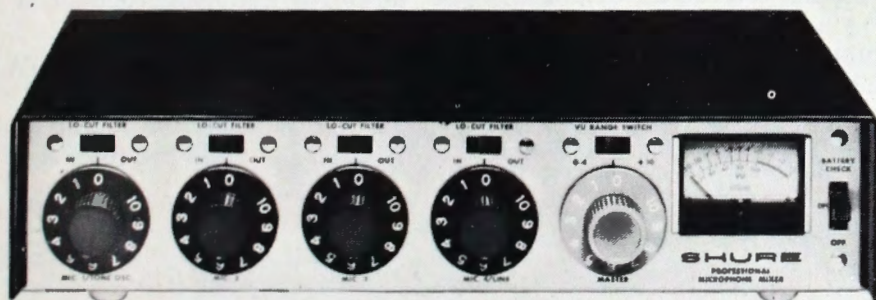

### Shure M67 Mixer

Compact and lightweight, the Shure M67 Microphone Mixer is ideal for both studio and remote applications where several mikes are to be used. The unit accepts four low-level mikes, with one input convertible to line input. It has both 600-ohm lines output and

low-impedance mike output. There is noiseless switchover to battery operation (battery pack is an option) in case of ac line failure.

Size:  $2\frac{3}{4}$ " (7 cm)H  
 $11\frac{3}{8}$ " (28.9 cm)W  
 $7\frac{5}{16}$ " (18.6 cm)D

Weight: 4.8 lb. (2.2 kg)

## REMOTE PICK UP EQUIPMENT

### **Marti ASOR-177 Antenna**

Designed for rooftop mounting and operating in the 130- to 174-MHz range, the ASOR-177 is vertically polarized and has 3-dB gain. The unit includes a sealed, tamper-proof transformer, cable and connector.

SPR-177 NPN Antenna,  
Rooftop Mount

### **Marti ASPC-660 Antenna**

The ASPC-660 is a whip, mobile rooftop antenna for any frequency in the 450- to 470-MHz range. The unit has a 4-dB gain.

SPC-660 NPN Antenna, Whip,  
Rooftop Mount



### **Micro-Trak System D Audio Control Center**

The Micro-Trak System D Compact Audio Control Center is the ideal unit for DJ on the go or the producer who wants the flexibility of operating at different locations. For remotes or discotheque the D Compact can be readily handled by two people; you can move in and have your remote or disco running in minutes. With legs that easily fold, the unit can be broken down into a package measuring only 144.6 cm (55<sup>3</sup>/<sub>4</sub>" W) × 63.5 cm

(25" D) × 40.64 cm (16" H). The standard D Compact comes with a model 6440DT console, two model 740 turntables, two model 303 tonearms and a formica covered high strength plywood cabinet. Stanton model 500-AL magnetic cartridges are installed in the model 303 pickup arms, a close talking dynamic microphone is supplied with the unit.

Size: 55<sup>3</sup>/<sub>4</sub>" (141.6 cm)W  
25" (63.5 cm)D  
38" (96.5 cm)H

Weight: 138 lbs. (63.5 kg)

# STL EQUIPMENT

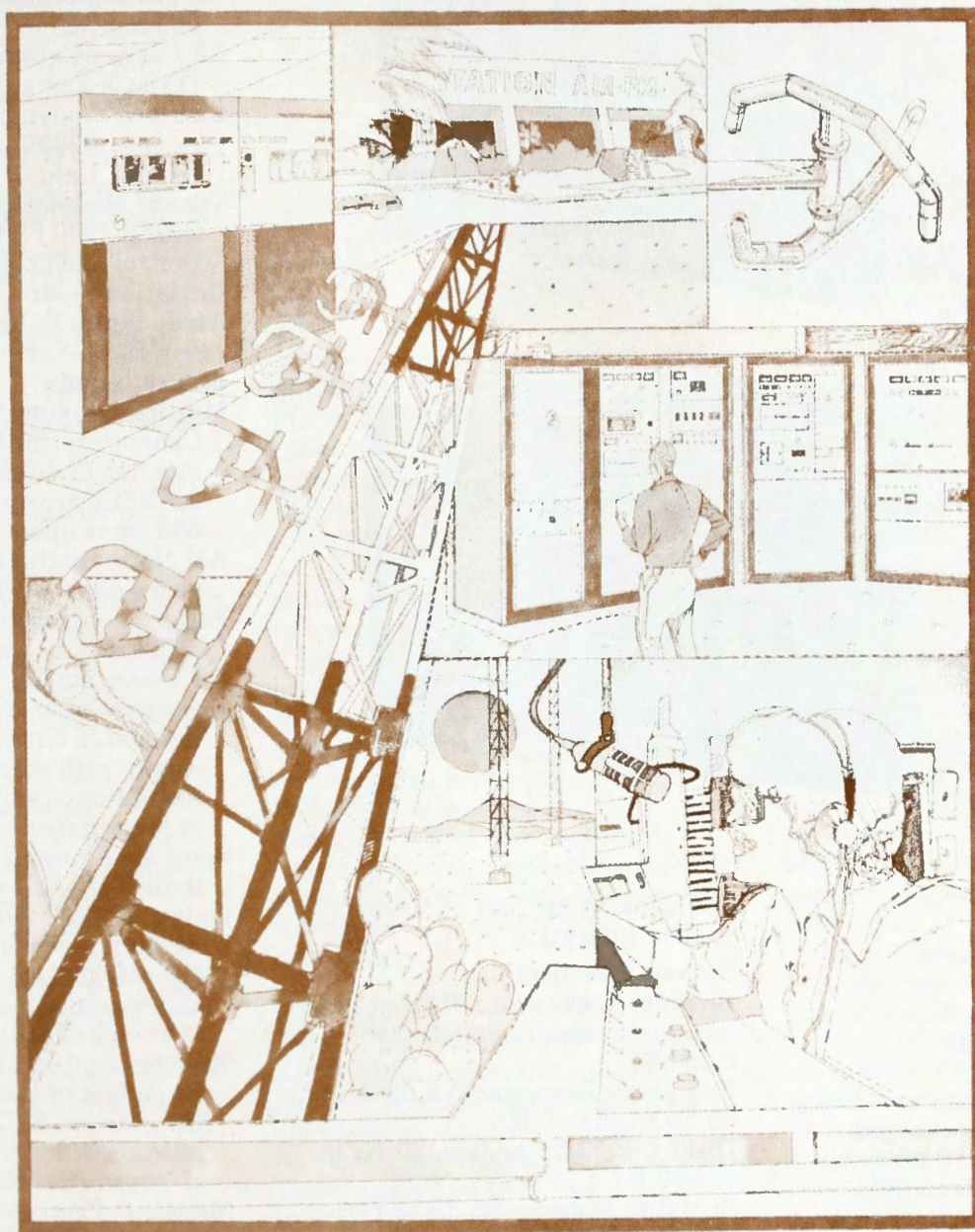

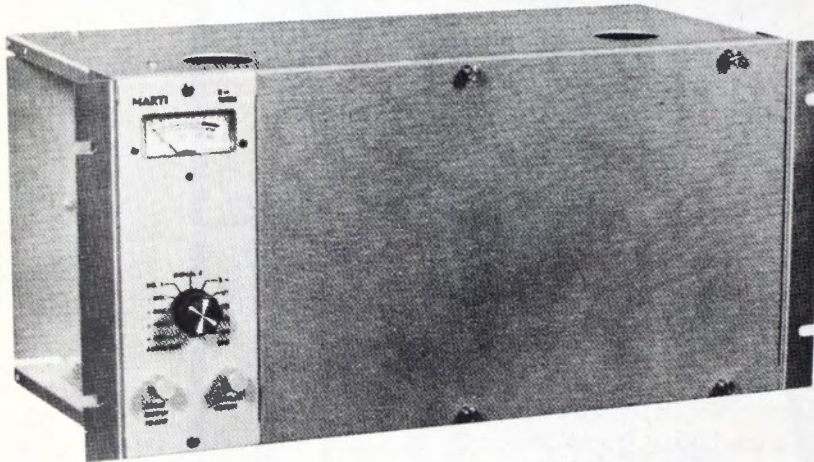
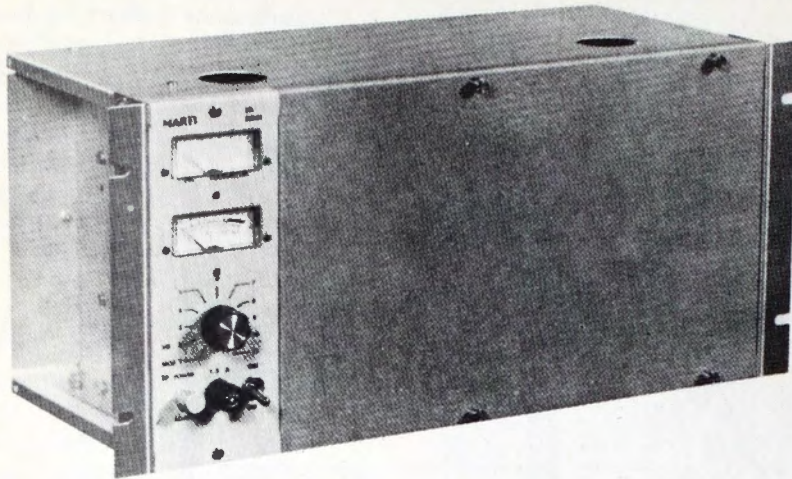

## Marti Solid-State Aural Studio-Transmitter Link

Designed for AM, FM, Mono, Stereo, Inter-City Relay applications. Marti's STL System eliminates lost air time caused by cut, wet or electrically charged telephone lines. Sound quality is better than a 15 kHz equalized line. A typical Marti STL system will pay for itself in saved line charges.

### System Features

- Direct FM modulator
- All solid-state
- Field-proven varactor final
- Current limiting in regulated power supply
- Plug-in modular construction
- Solid-state ovens and hi-accuracy crystals

- RF sensing for "out of status" alarm indication

### System Specifications

Channel Separation: 65dB or better (channel response matched to 0.25 dB)  
 Frequency Response: 0.5 dB from 30 Hz to 15,000 Hz  
 Distortion: 0.5% or less, 40 Hz to 15,000 Hz  
 Signal to Noise: -66 dB or better (400 Hz @ 100% modulation)  
 Carrier Frequency Stability  $\pm .005\%$   
 Temperature Range: --20°C to +60°C

### STL-8F Solid state transmitter specifications

Application: Studio Transmitter Link (FM) (AM) (Inter-City Relay)

Carrier Frequency Range: 942-960 MHz.  
 RF Power Output: Maximum Licensed power 8 watts, nominal 6 watts. Set at factory  
 Output Impedance: Nominal 50 ohms  
 RF Carrier Connector: UG-58A/U (Type N Female)  
 Carrier Frequency Stability: + or - .0005% -30°C +60°C (+25°C Ref.)  
 Type of Modulation: Direct FM 200F3. (200 F9 with remote control and/or Sub Carrier)  
 Deviation: + or - 52.5 KHz.  
 Audio Input: Balanced 600 ohms, +10BM (+ or - 2DB) for 100% modulation.  
 Multiplex Inputs: Two BNC Connectors, for Remote Control and Sub Carrier inputs. .5V, RMS for 20% Carrier Deviation. 50 to 600 ohms unbalanced.  
 AM Noise: Better than -55DB below carrier reference.  
 Power Requirements: 115/230 Volts 50/60 Hz. 110 watts.  
 AC Power Supply: Precision electronically regulated integrated circuit power supply with current limiting. Regulator circuitry contained in plug-in module.  
 Spurious Emissions: More than 60DB below carrier.  
 Output Failure Alarm: Adjustable RF output sensing provides fail-safe contact closure for alarm or automatic switching as standard equipment.  
 Remote Location: Terminals provide for simple remote off-on control of transmitter. Built in RF sensing relay provides remote indication of transmitter status.  
 Metering: Precision taut-band meters for RF power and circuit testing.  
 Cooling: Advanced thermal design provides conduction, convection and forced air cooling from high quality fan.  
 Dimensions: 8 $\frac{3}{4}$ " High x 19" Wide x 8 $\frac{1}{4}$ " Deep. (22.2 cm x 48.5 cm x 20.9 cm).  
 Weight: Net 20 lbs. (9 kg.) Domestic packed 26 lbs. (12 kg.)

## R-200/950F Solid state receiver specifications

Application: Crystal controlled, double conversion FM receiver for STL. Companion to STL-8F Transmitter.

Frequency Range: 942-960 MHz  
Sensitivity: 2uv for 20 db S/N ratio  
10uv for 50 db 32uv for 60 db  
(-106 DBW)

RF Input Impedance: 50 ohms  
UG-58A/U (Type N Female)  
Frequency Stability: .0005% -30°C  
+60°C (+25°C Ref.) Solid state  
proportional temperature  
controlled ovens.

Selectivity: 220 KHz. at 3.0 db 560  
KHz. at 60 db

Spurious Response: -70 db  
Audio Output: Balanced 600 ohms.  
+18 DBM Maximum level

Multiplex Output: Two type BNC  
connectors for sub-carrier and/or  
remote control

Squelch/Fail Safe/Alarm:  
Adjustable squelch provides N/O  
and N/C relay contacts for audio  
muting, fail safe shut-down and  
alarm circuits as required.

Power Requirements: 115/230 volts  
50/60 Hz. 30 watts

AC Power Supply: Precision  
electronically regulated  
integrated circuit power supply  
with current limiting protection.

Metering: Precision taut-band  
meter with front panel test  
selector switch

Dimensions: 8<sup>3</sup>/<sub>4</sub>" High x 19" Wide  
x 8<sup>1</sup>/<sub>4</sub>" Deep. (22.2 cm x 48.5 cm  
x 20.9 cm).

Weight: Net 14 lbs. (6.25 kg.)  
Domestic packed 19 lbs. (8.5 kg.).

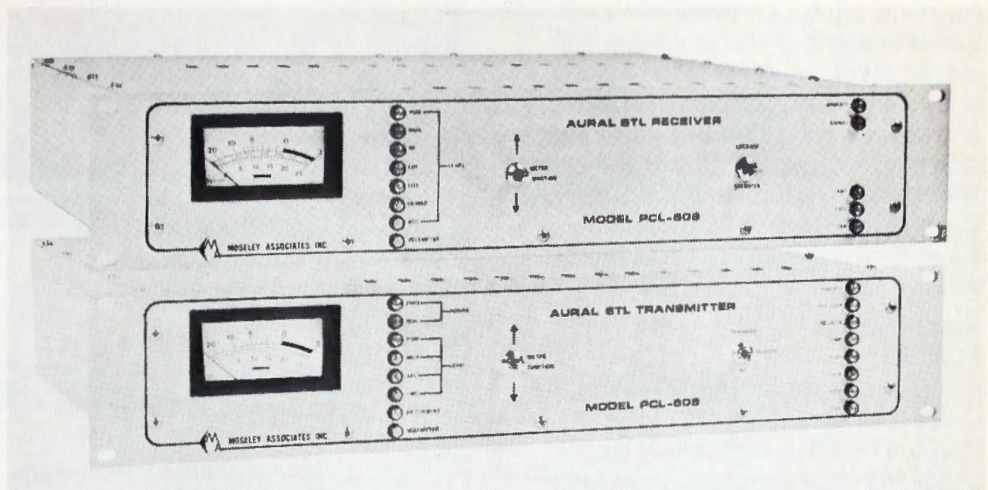

## Models PCL-606 and PCL-606/C

The Models PCL-606 and PCL-606/C Studio-Transmitter Links provide broadcasters and industrial users alike with the highest quality program interconnect currently available in equipment of this type. By the use of the latest technology available in today's market, significantly improved specifications and performance are achieved, even in overly congested areas or high density RF environments. Designed for monaural audio service, the PCL-606 can be used in a dual configuration for stereo service. The PCL-606/C, composite stereo version, conveys composite stereo waveform with virtually no degradation.

### System

This all new, and greatly improved, STL system design continues the Moseley tradition of conservative engineering concepts and field serviceability. Both the STL Transmitter and Receiver incorporate diagnostic metering capabilities to facilitate system performance checks without the need for external test equipment. By the use of brass enclosed module construction, not only is the possibility of RFI greatly reduced, but servicing of each PC board is made considerably easier. Further, all normal service tuning adjustments are easily, yet securely, accessible through the top covers.

### Transmitter

The PCL-606 and PCL-606/C Transmitters employ an entirely new direct FM modulation concept never before used in this type of equipment. By the use of a synthesized AFC, the FMO is frequency and phase locked to a reference oscillator, from which outstanding frequency stability is achieved. Compensated linear baseband response allows maximized monaural and stereo transmission. When abnormal conditions exist such as high VSWR, excessive temperature, or synthesizer loss of lock, a shutdown circuit is automatically enabled, allowing maximum system protection.

### Receiver

The revolutionary design of the receiver incorporates performance and user-controlled features never before seen in point-to-point audio distribution systems of this type. By the use of a Pin Diode Attenuator circuit, overall system dynamic range may be optimized as a function of signal level. At the user's discretion, the IF bandwidth may be changed to optimize the trade off between distortion and selectivity. A broadband, adjustment-free, extended linear digital demodulator enhances system performance by its extremely low distortion and noise characteristics. The front panel, switch selectable, signal metering



## STL EQUIPMENT:

function allows accurate measurement of the incoming RF signal level (in microvolts) over the entire operating range. Built-in transfer circuitry allows automatic changeover to a standby receiver in the event of a detected malfunction. Both PCL-606 and PCL-606/C Receivers incorporate this feature as standard.

### Specifications

#### PCL-606

Frequency Range: 148-174 MHz, 215-240 MHz, 300-330 MHz, 450-470 MHz, 890-960 MHz

Specify exact operating frequency

Frequency Response:  $\pm 0.25$  dB from 30 Hz to 15 kHz

Modulation:  $\pm 40$  kHz

Modulation Capability: One program and two subcarrier channels

Distortion (THD & IMD): 0.25% from 30 Hz to 15 kHz (typically better than 0.1% at 1 kHz)

Sensitivity: Less than 15  $\mu$ V for 60 dB SNR

#### Selectivity:

3 dB I.F. bandwidth  $\pm 90$  kHz

60 dB I.F. bandwidth  $\pm 400$  kHz

80 dB I.F. bandwidth  $\pm 1$  MHz

Signal to Noise Ratio: 72 dB below 100% modulation (typically 75 dB)

Operating Temperature: 0°C to +50°C

#### Dimensions:

Transmitter: 3.5" (8.9 cm) high,

19" (48.3 cm) wide,

15" (38.1 cm) deep

Receiver: 3.5" (8.9 cm) high,

19" (48.3 cm) wide,

15" (38.1 cm) deep

#### Primary Power Source:

Transmitter: 100/120/220/240

VAC  $\pm 10\%$ , 50-60 Hz, 82 watts

Receiver: 100/120/220/240 VAC

$\pm 10\%$ , 50-60 Hz, 19 watts

#### PCL-606/C

Frequency Range: 148-174 MHz, 215-240 MHz, 300-330 MHz, 450-470 MHz, 890-960 MHz

#### Frequency Response:

$\pm 0.1$  dB from 30 Hz to 53 kHz

$\pm 0.3$  dB from 30 Hz to 75 kHz

Modulation:  $\pm 50$  kHz

Modulation Capability: One program and two subcarrier channels

Distortion (THD & IMD): 0.25% from 30 Hz to 53 kHz (typically better than 0.1% at 1 kHz), to meet 50 dB crosstalk (55 dB typical), stereophonic subchannel to main channel and main channel to subchannel, using stereophonic test frequencies from 30 Hz to 15 kHz

Sensitivity: Less than 30  $\mu$ V for 60 dB SNR, de-emphasized (typically 150  $\mu$ V for 60 dB demodulated left or right channel)

#### Selectivity:

3 dB I.F. bandwidth  $\pm 100$  kHz

60 dB I.F. bandwidth  $\pm 450$  kHz

80 dB I.F. bandwidth  $\pm 1$  MHz

Signal to Noise Ratio: 72 dB below 100% modulation, demodulated left or right (typically 75 dB)

Separation: 48 dB from 50 Hz to 15 kHz (50 dB typical)

Operating Temperature: 0°C to +50°C

#### Dimensions:

Transmitter: 3.5" (8.9 cm) high,

19" (48.3 cm) wide,

15" (38.1 cm) deep

Receiver: 3.5" (8.9 cm) high,

19" (48.3 cm) wide,

15" (38.1 cm) deep

#### Primary Power Source:

Transmitter: 100/120/220/240

VAC  $\pm 10\%$ , 50-60 Hz, 82 watts

Receiver: 100/120/220/240 VAC

$\pm 10\%$ , 50-60 Hz, 19 watts

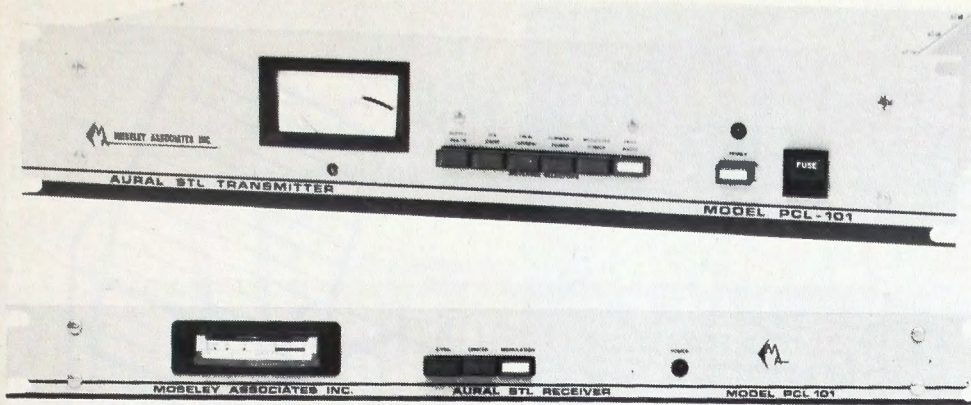

### Moseley PCL-101 System

Consuming only 3½" of height in standard rack space, the PCL-101 STL is self contained (including power supply). Moseley pioneered direct frequency modulation in aural STL, and the 101 series incorporates it, along with FM

subcarrier capability, all solid-state circuits, modular construction, front panel metering and ease of servicing. The companion receiver is dual conversion superheterodyne, with two complete IF amplifier sections.

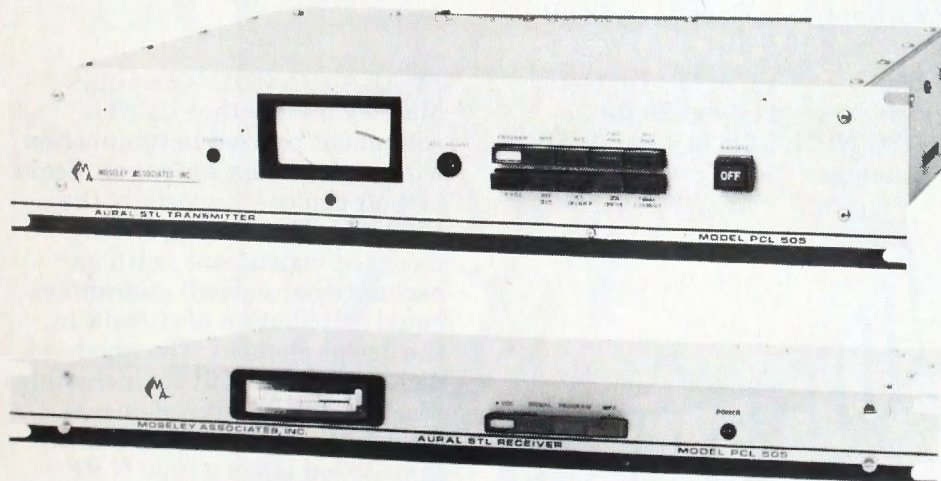

### Moseley PCL-505 and 505A/C Systems

You're talking savings with the PCL-505 and 505A/C STL systems; leased telephone circuits are no more, total control of station facilities is yours and yours alone, adjustments and repairs can be made on-the-spot and at your convenience. All this, with response, distortion, noise and transient characteristics far beyond the best of telephone circuits.

The PCL-505 system links studio to transmitter — or studio to studio or whatever "closed-circuit" network

you need. With its transmitter and receiver you can send and receive signals ranging from 148 mhz to 960 mhz, and do so with better than 70 db noise below carrier (AM).

The PCL-505A/C matches the performance of the standard 505 and goes a step beyond — incorporating specialized electronics to cope with RF problems in the 890-960 mhz band. It does so, in part, through its 70 mhz surface acoustic wave IF filter. It's an essential instrument in today's crowded RF spectrum.

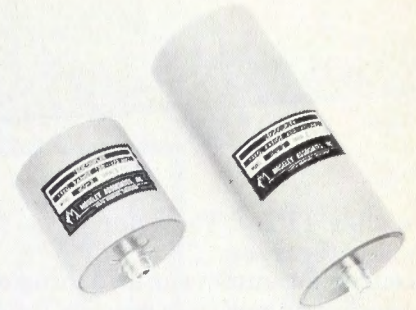

### Moseley ICU-ISOCOUPLER Series

Housed in tough epoxy-fiberglass tubes, these units from Moseley Associates help link remote pickup transmitter or receiver or Aural STL transmitters or receivers to antennas mounted on ungrounded standard AM broadcast towers. The efficiency of these couplers at designed operating frequencies is better than 90%. Using this series, there is no need to employ a quarter wavelength insulated transmission line section when installing remote pickups or STL antennae.

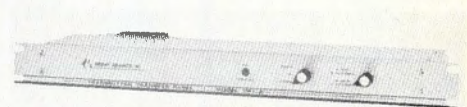

### Moseley STL Automatic Transfer Panel Model TPT-2

Enables automatic transfer from a main to an alternate STL transmitter. TPT-2 senses rf power output, and in the event of carrier failure, it automatically switches output and program input to alternate transmitter. Front-panel selection of "main" or "alternate" status allows alternating operation of two transmitters. Transmitter can be removed from the radiate mode by remote control. When ordering the TPT-2 panel, specify model of Moseley STL transmitters to be used with the panel.



# STL EQUIPMENT:



## Moseley TPR-2 Transfer Panel Receiver

Intended for automatic switching of program and multiple outputs from aural STL receivers, the TPR-2 monitors carrier-operated squelch relays in the main and alternate receivers — switching precisely and promptly should a carrier failure occur. The instrument can accommodate monaural program audio or composite signals. Separate receiving antennae or a power divider must be employed, since both receivers have to be active to use the TPR-2. If not, PD-1 or PD-2 power dividers permit operating from one common antennae.



## Mosely ECP-5 Extension Control Panel

This slim instrument (1¾" high, 19" wide) is designed to interface with Moseley's PCL-505 and PCL-505A/C STL transmitters. What does it do? Provides carrier control and metering of both forward power and AFC voltage. The ECP-5 is interconnected by a five conductor cable to the PCL-505 transmitter. It is powered by 120/240 VAC, 50-60 hz or + 13.5 VDC.

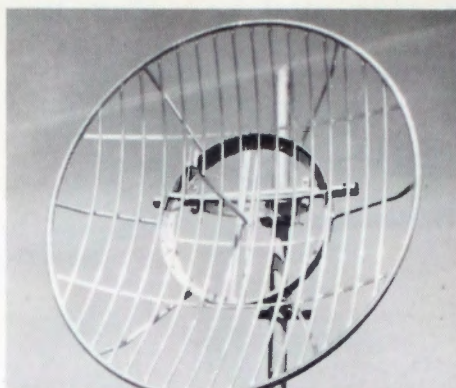

## Mark Products P-948G Parabolic Antenna

The Mark P-948G Parabolic Antenna is of multigrad construction and has extremely high strength and rigidity specifications. It will withstand wind thrusts up to 161 km/h (100 miles per hour). Operating in the 890- to 960-MHz range, the P-948G has a front-to-back ratio of 28 dB and gain of 18.9 dB.

Size: 1.2 m (4') Diameter  
Weight: 11.3 kg (25 lb)  
P-948G NPN: 1.2m (4') Parabolic Antenna

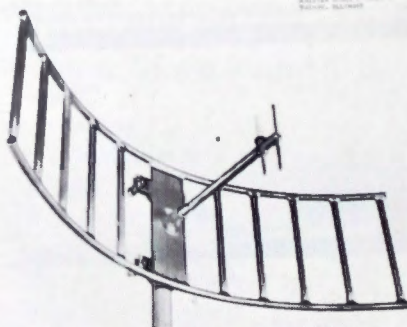

## Mark Products MG-944GN Parabolic Antenna

The Mark Products MG-944GN is a cylindrical parabolic antenna operating in the 940- to 960-MHz range. Gain is 13.5 dB; front-to-back ratio is 20 dB. Strength and rigidity is achieved through welded grid construction.

Size: 29.2 cm (13½")H  
111.8 cm (44")W  
43.2 cm (17")D  
Weight: 3.2 kg (7 lb)  
MG-944GN NPN: Cylindrical Parabolic Antenna



## SCALA PR-450U Antenna

Moseley prefers that its STL equipment be used in conjunction with high quality antennae. Scala is their choice — especially the PR-450U. This strong, swiftly mounted instrument (with an exclusive balun feed) guarantees equal distribution of current in the driver element. The anodized, dichromate PR-450U is incredibly resistive to corrosive elements. Its impedance is 50 to 75 ohms. Connection is via a type N RF female coupler.

# TRC EQUIPMENT

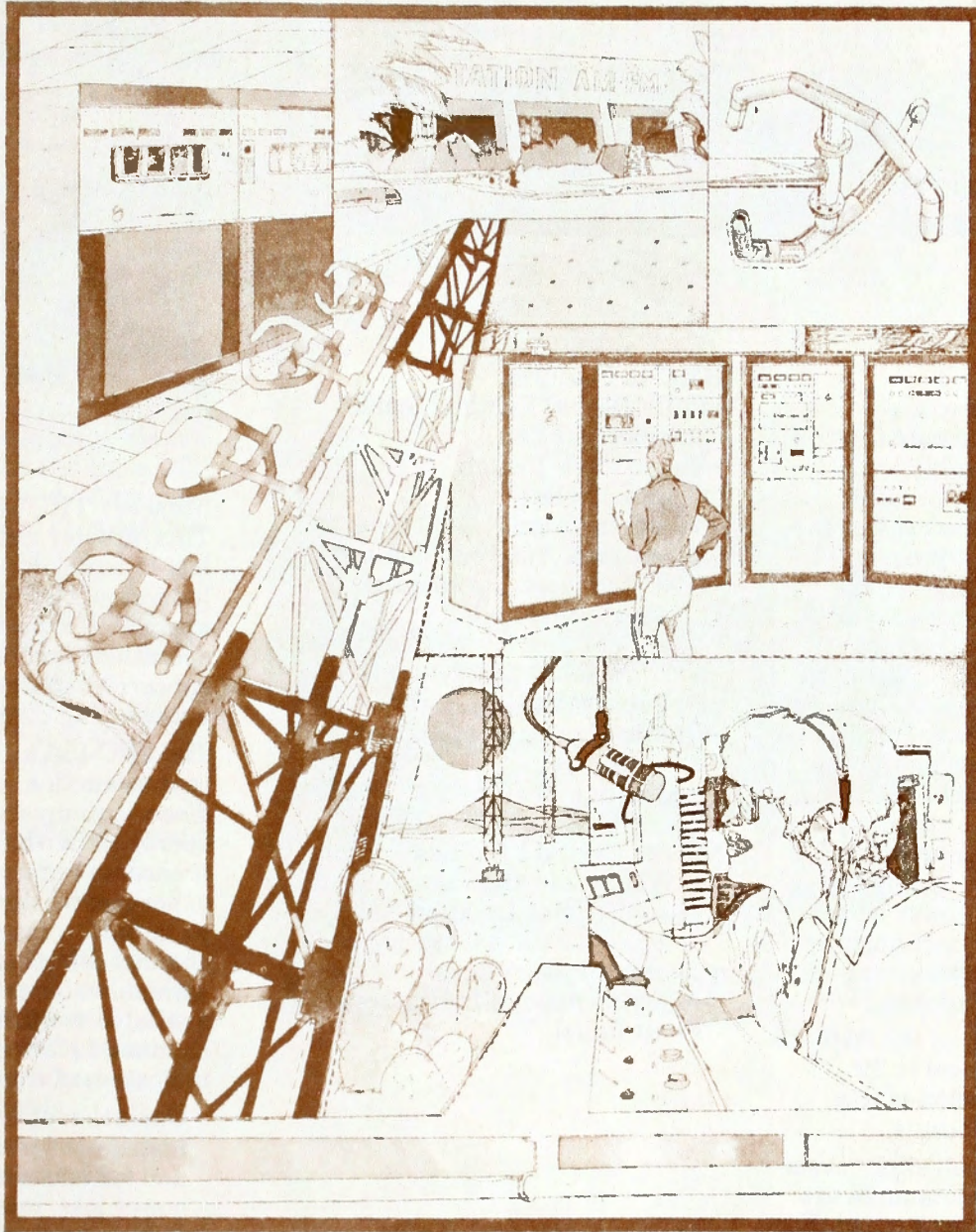

# TRANSMITTER REMOTE CONTROL EQUIPMENT

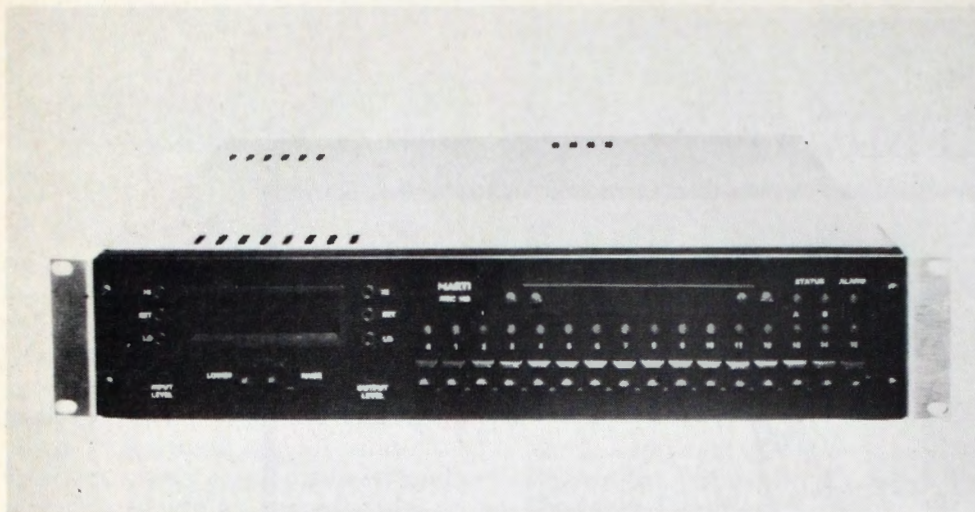

## Marti RMC-15

### Digital Remote Control

The Marti RMC-15 Remote Control System incorporates advanced technical design with operator oriented simplicity to meet the needs of the broadcast industry for an accurate and reliable remote control. The operator may select any metering/control channel by pressing a single button. The data for the selected channel is then read from a large digital panel display. Decimal point position on the RMC-15S readout can be selected by the user for each data channel. Raise and lower commands can be given for the selected channel by pressing the raise or lower button. In addition to these functions, the RMC-15 system has two status monitor channels available.

The channel capacity of the RMC-15 system can be increased to 30 channels by the addition of the RMC-30S and RY-30 units.

Send/receive communication levels at the studio and remote units are adjustable from the front panel. The correct level is set by observing LED indicators which are labeled low-set-high.

### RMC-15 Features

- Fully Digital Command and Telemetry (FSK)
- Single Push-Button Channel Select
- Telemetry Accuracy 0.1% for Directional Antenna Monitoring. RMC-15S Does Not Require Operator Calibration
- Channel Capacity 15 Channels. Expandable to 30 Channels by Optional RMC-30 Units
- Quartz Crystal Synthesized Frequencies
- Radio Link or Wire Line Operation
- Large Digital LED Readout at BOTH Studio and Remote Unit
- Decimal Point Location Can Be Selected for Each Channel
- Communication Level Adjustments and Indicators on Front Panel

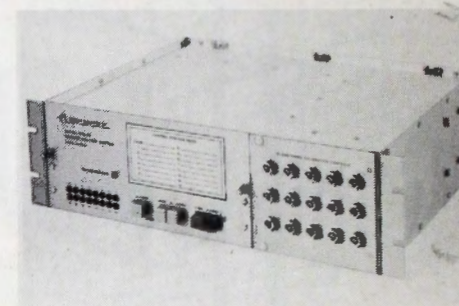
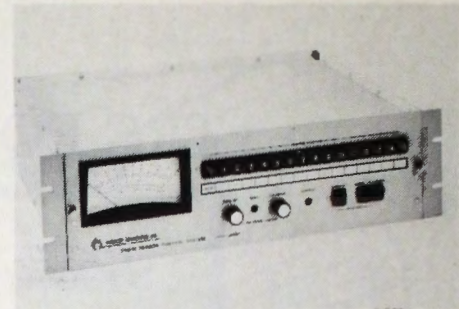

## Moseley TRC-15A

This Moseley remote control system has 15 metering channels and 30 individual control functions. It's applicable to both wire and wireless operations and contains control subcarrier equipment for multiplexing control data.

The TRC-15A's circuitry is modular in construction, using IC's and discrete components. Noiseless in operation (with no stepper relays), it encodes binary numbers generated by the front panel push-button assembly to command channel selection. Additionally, optional external meters are available to display any selected channel. LED's give visual indication of channel select.

Operation of the Moseley instrument is a relief. It is fail-safe and functions even with primary power loss, interconnecting circuit failure, or even equipment malfunction itself. Telemetry is handled through use of an external tone.

# TRANSMITTER REMOTE CONTROL EQUIPMENT

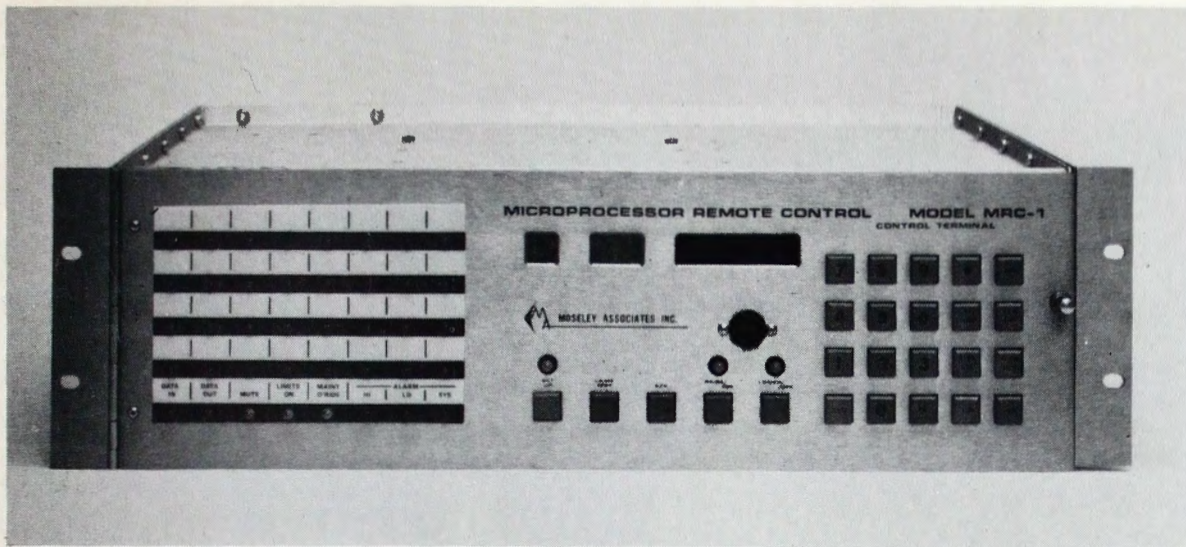

## Moseley MRC-1

This microprocessor-based system incorporates 64 command lines, 32 telemetry channels, and 32 status channels. Its keyboard calculations and automatic logging also distinguish it. And the MRC-1 is a persistent, nosey instrument, checking all operations every four seconds, performing internal calibration procedures to assure long, accurate, stable operation. It is self-alarmed, should malfunction occur.

Among the MRC-1's other advanced features are:

- random assignment of control functions;
- cross-functioning channels to allow indirect power calculations;
- automatic muting for main/alternate or directional patterns
- elimination of potentiometers through programmable display tracking.

This Moseley instrument also has optional long-term memory available.

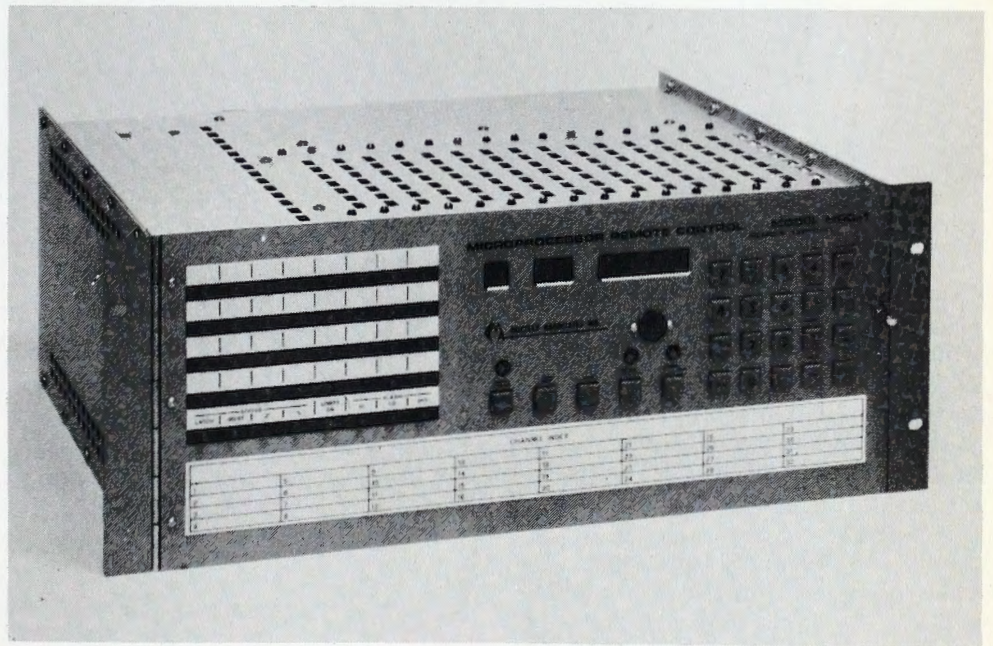

# TRANSMITTER REMOTE CONTROL EQUIPMENT

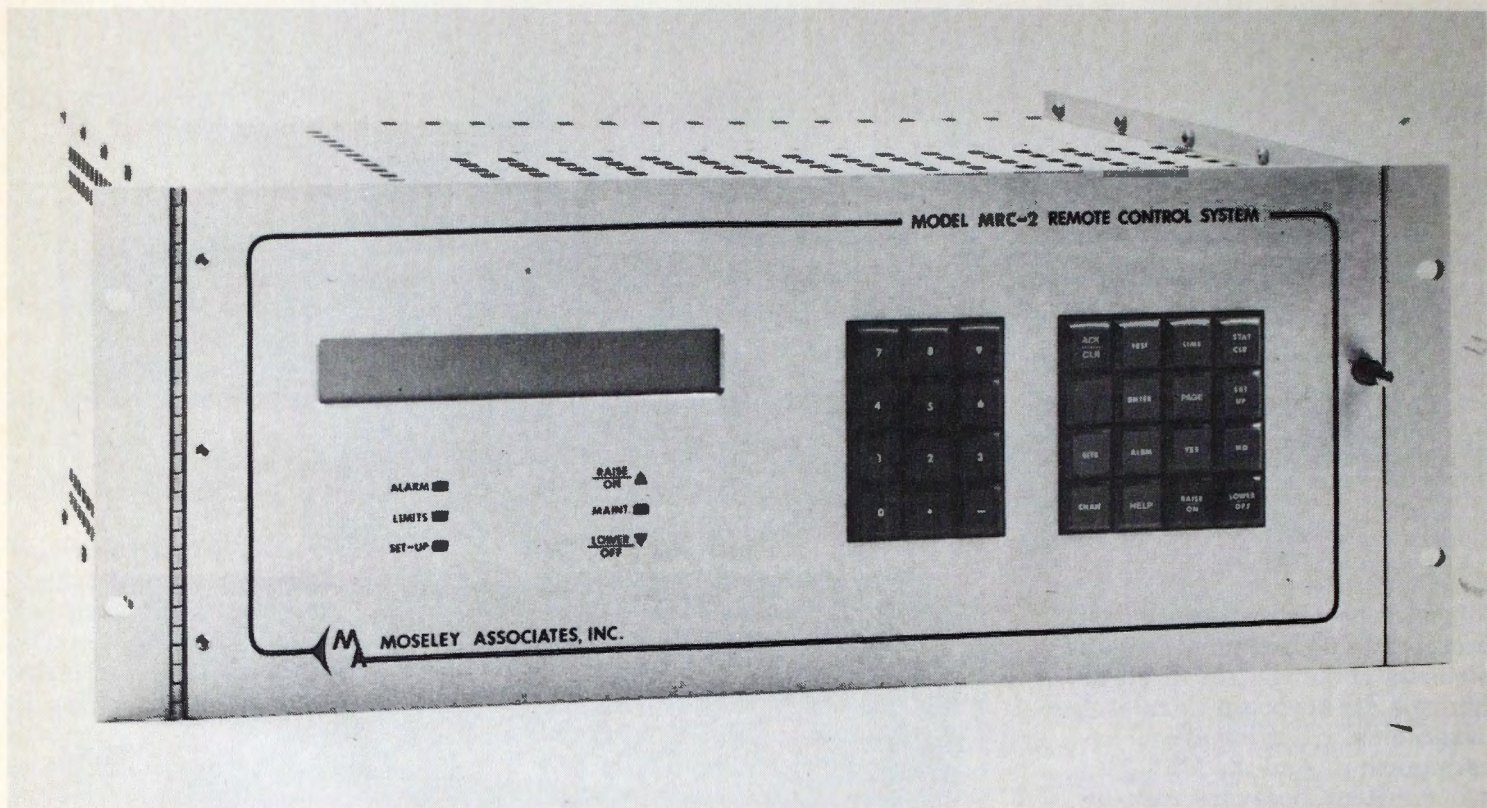

## **Moseley Model MRC-2 Microprocessor Remote Control System**

The MRC-2 System brings a new level of sophistication to remote control, telemetry and status acquisition. Use of the CRT option allows plain-English displays and optional logging of command, status and telemetry functions. The Automatic Control option adds time-oriented and feedback-oriented command capabilities to the system. Moseley's MRC-2 provides the broadcaster with greater control of the transmitter plant thru quick, positive monitoring and control of all desired parameters. Critical operations are monitored constantly. The use of dual limits allows an operator or the system itself to adjust parameters before a critical limit is reached.

Plant security is improved because of the MRC-2 System's ability to continuously monitor transmitter facility for intrusion, fire or equipment failure. The MRC-2 can employ backup communication links to improve system reliability.



# TRANSMITTER REMOTE CONTROL EQUIPMENT

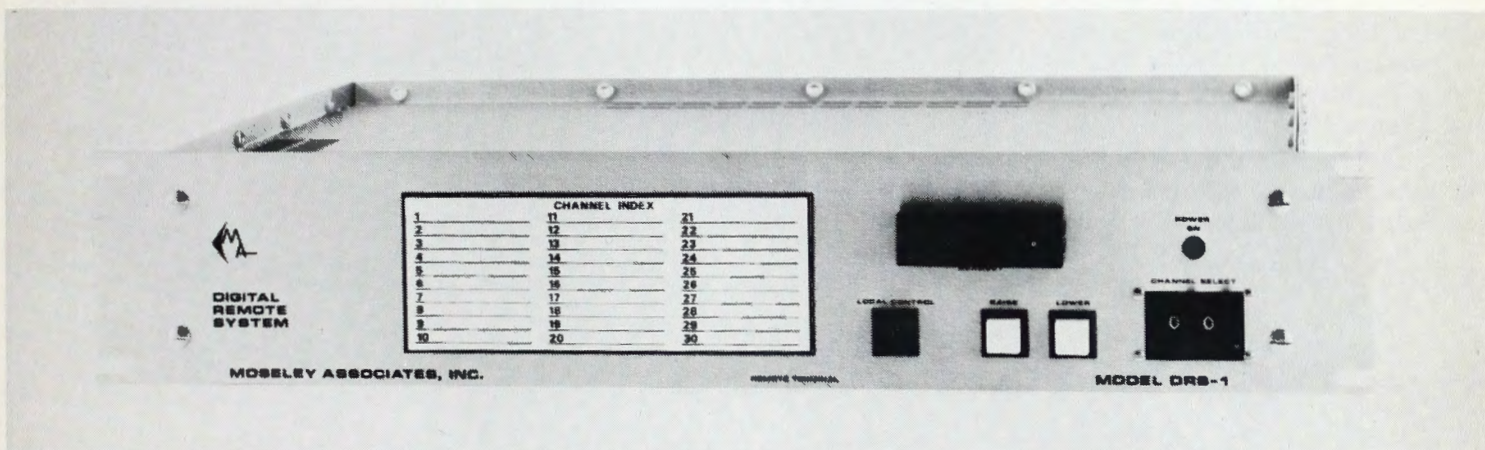
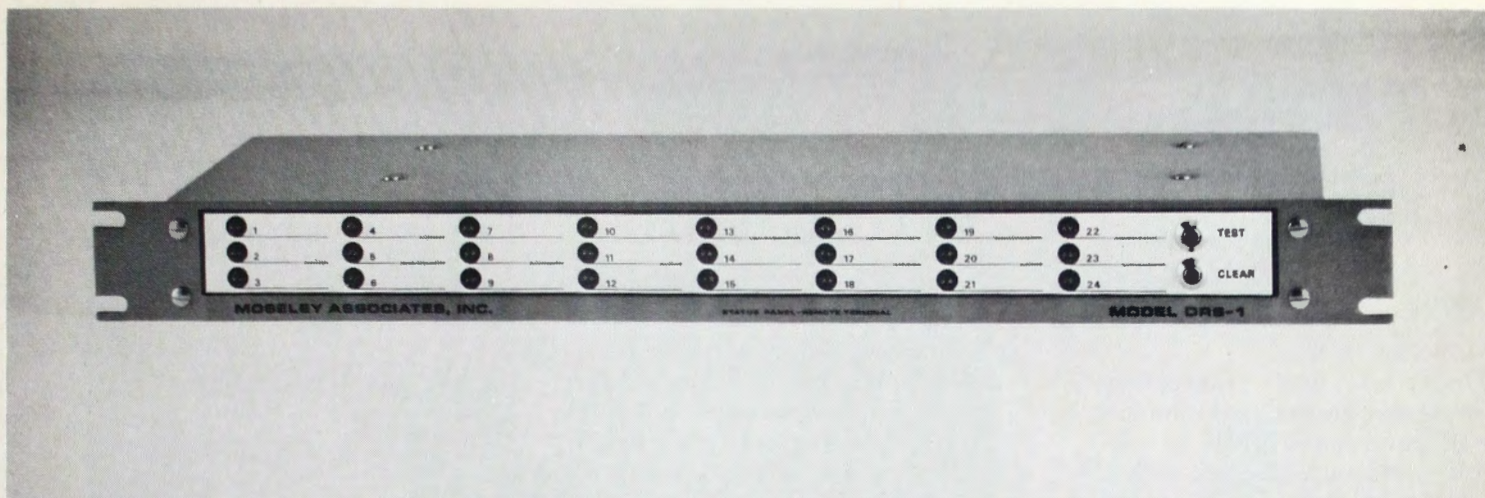

## Moseley DRS-1A Digital Remote Systems

The basic DRS-1A Digital Remote System is divided into three units—Control Terminal, Remote Terminal and Selector Units (s). The Control Terminal is located at the remote control point, normally the studio location in broadcast transmitter remote control. The Remote Terminal and Selector Units are situated at the transmitter site. Each Selector Unit provides 10 telemetry/command channels, which allow for field expansion or tailoring of the DRS-1A to fulfill specific channel requirements. A maximum of 30 channels (3 selector units) may be used.

Each telemetry/command channel provides a single telemetry function and two command functions. These command or control functions are individual Form A, isolated dry

contact closures and are typically identified as Raise and Lower. The Raise and Lower command outputs can switch external loads of up to 50 watts, non-inductive at potentials of 120V AC or DC. Telemetry inputs accept a DC sample voltage representing the desired analog parameter. This DC voltage is typically in the 1 VDC to 10 VDC range.

**DRS-1A DIGITAL REMOTE SYSTEM**—for operation over single voice-grade telephone line or equivalent interconnecting circuits, to provide 10 telemetry/command channels. DRS-1A can be expanded to a total of 20 or 30 telemetry/command channels by the addition of Selector Units.

**DRS-1A DIGITAL REMOTE SYSTEM**—for wireless operation with audible telemetry, to provide 10 telemetry/command channels.

Subaudible telemetry is optionally available. DRS-1A can be expanded to a total of 20 or 30 telemetry channels by the addition of Selector Units. System includes one each of Control Terminal with command subcarrier generator (frequency to be specified), Remote Terminal with command and subcarrier demodulator (frequency to be specified) and Selector Unit.

### Specifications:

Power: 30 channel configuration;  
 Control Terminal 120/240 VAC, 50-60 Hz, 30 W; Remote Terminal 120/240 VAC, 50-60 Hz, 35 W  
 Control Terminal: 8.9 cm H (3½") × 48.4 cm W (19") × 30.5 cm D (12")  
 Remote Terminal: 8.9 cm H (3½") × 48.4 cm W (19") × 25.4 cm D (10")  
 Selector Unit: 4.4 cm H (1¾") × 48.4 cm W (19") × 24.1 cm D (9½")





# TRANSMITTER REMOTE CONTROL EQUIPMENT

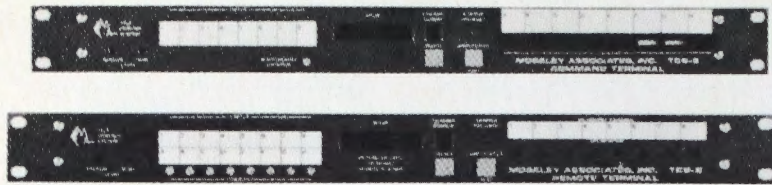

## Moseley TCS-2A

The TCS-2A gives independent command, status, and telemetry control for eight functions — all fully independent, each with technology that is as advanced as can be. It is applicable to broadcast transmitters, ENG systems, earth stations, or industrial sites. The TCS-2A contains both a command and a remote terminal.

Using this sophisticated Moseley device demands no channel select; instead, a simple depression of the

command switch activates the appropriate relay in the remote terminal (momentary or latching is incorporated into each switch). "Status" for the eight independent functions may be pre-programmed to select either a normally open or closed dry contact. Telemetry is via digitally converted analog input from a remote terminal to the command.

Command and status response time is 125 milliseconds nominal; for telemetry, 250 milliseconds.

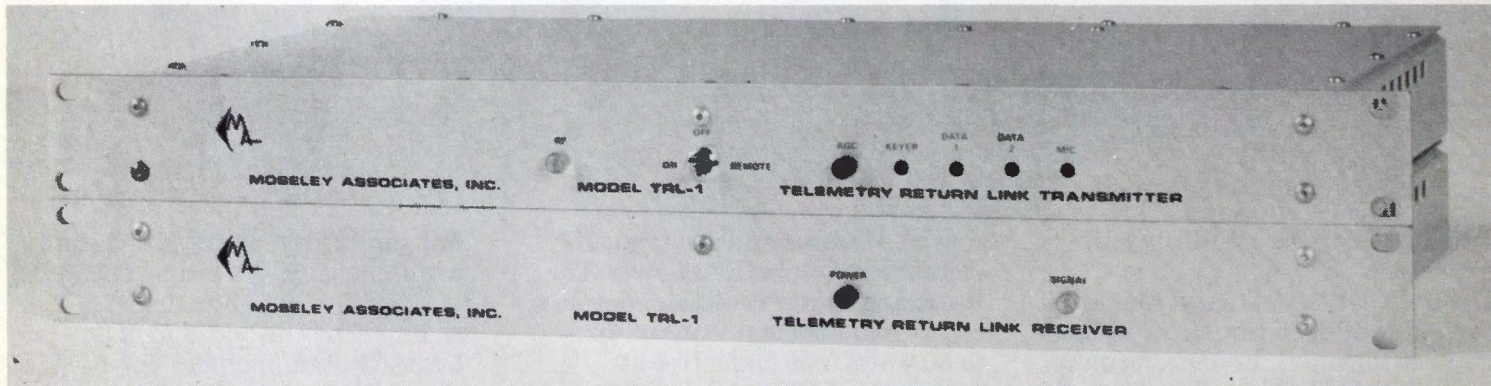

## Moseley TRL-1

Wireless transmission and reception with the TRL-1 is quick, quiet, and efficient. Completely solid-state; "linkable" with aural STL's microprocessor, digital or analog control systems; designed for consistent, continuous, unattended duty — the TRL-1 operates on the 450 mhz band (other frequencies are available on request).

The TRL-1 has two important options;

- A Modulated Continuous Wave (MCW) identifier preprogrammed with alpha/numeric ID.
- A battery back-up which is automatically switched on should AC fail. With it, twenty minutes of power can be provided for stand-by operations.

# TRANSMITTER REMOTE CONTROL EQUIPMENT

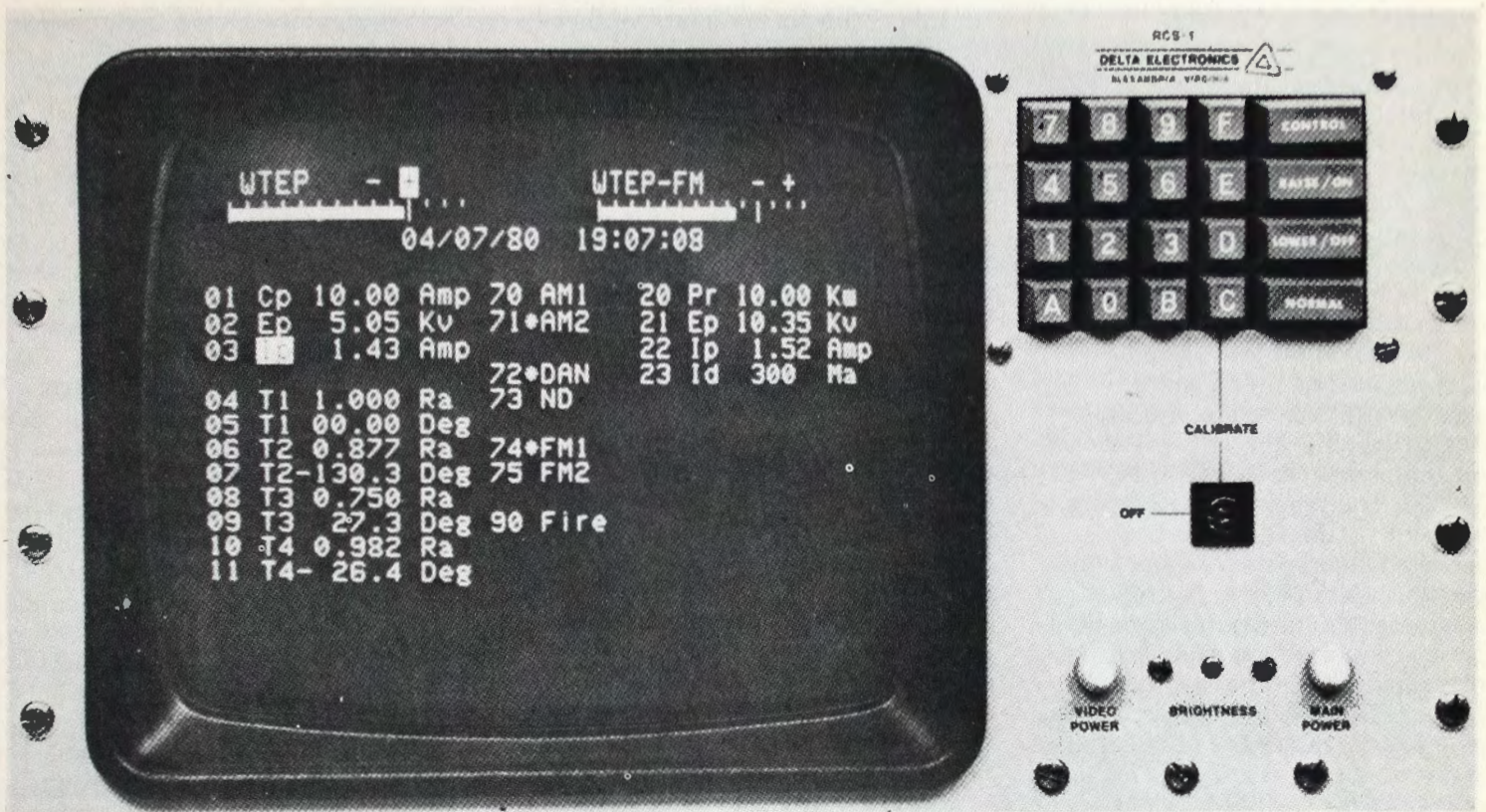

## Delta RCS-1

The RCS-1 from Delta Electronics makes automatic transmission just that — automatic, whether signals be AM, FM, or TV.

Microprocessor-based, the RCS-1 has three basic components:

- a control unit at the control point;
- a control unit at the transmitter location;
- an I/O (Input, Output) unit at the transmitter location.

Delta describes the system's general flow as follows:

- first, there is a "human interface" where the operator gives or receives data to or from the system;
- then a "machine interface" where the system receives data from the station's equipment and controls elements of that equipment;
- and, finally, a microprocessor logic system that converts the data from the station gear to the form most usable to the operator, while also converting the commands of the operator to control the station equipment.

Monitored parameters are in a format programmed by the chief engineer, with predesignated parameters (e.g., antenna base current) continuously and automatically controlled or adjusted as needed.

Two types of the RCS-1 are available — one with its own video display (RCS-IV) and one without (the basic RCS-1, which is linked to an external CRT). Principal among the valuable options offered by Delta are remote modulation displays, auto logging, and telephone access. Key accessories are modems, couplers, and printers.

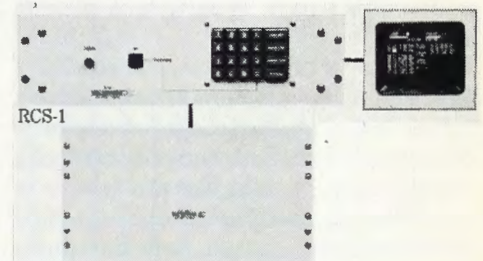

# TRANSMITTER REMOTE CONTROL EQUIPMENT

## **Moseley Model TSK-3A Temperature Sensing Kit**

Providing an accurate means of measuring transmitter building inlet, exhaust, or similar air temperatures, the TSK-3A functions with all current Moseley Associates Remote Control and Automatic Logging Systems. A truly linear indication of temperature is provided — no conversion table or graph is required when read on an appropriate analog meter scale or digital system. The TSK-3A senses air temperatures of  $-20^{\circ}\text{C}$  to  $+60^{\circ}\text{C}$ . The temperature sensing element within the TSK-3A is socketed enabling extension from the unit up to 25 feet. A single-conductor shielded cable with RCA phono connector are used for this extension. When the sensing element is extended, temperatures of  $-40$  to  $+80^{\circ}\text{C}$  may be observed. A power supply is included for operation from a 120/240 VAC 50-60 Hz power source.

## **Moseley Model TLK-2 Tower Light Kit**

Designed to monitor AC currents, this sampling kit can be used for observation of tower light circuits or any other AC current. Inductive sampling by means of a current transformer enables sampling over a wide current range. As a current transformer is used, it is not necessary to make a physical connection to the circuit being sampled.

## **Moseley Model LVK-3 Line Voltage Kit**

The LVK-3 enables operation of AC power mains or other AC power circuits. AC voltages in the range of 120 VAC to 440 VAC may be sampled by the LVK-3.

## **Moseley Model MBB-1 Universal Plate Current Kit**

The MBB-1 can be used to sample either plate current or plate voltage. It is particularly suited to sample a circuit where neither side is at ground potential, or where a positive ground is employed. This unit is designed to operate within

$\pm 15\%$  of the normal plate voltage or current. The MBB-1 will withstand peak voltages of 10,000 VDC above ground potential. External shunt or series resistance required.

## **Moseley Model RFK-1 AM RF Voltage Kit**

This unit is an RF voltage-to-DC converter and is useful for sampling common-point or antenna base currents of standard AM broadcast or HF transmitters. The input coaxial cable functions as one leg of a capacitor voltage-divider network to facilitate sampling a wide range of RF voltages. The output is connected to the Remote Control System and is a DC voltage proportional to the antenna or feedline voltage.

## **Moseley Models RFK-2 and RFK-3 FM RF Voltage Kits**

These kits are designed to sample the power output of FM or TV transmitters in an unpressurized section of transmission line. The RFK-2 is designed for a  $3\frac{1}{8}$ " line, and the RFK-3 is designed for a  $1\frac{5}{8}$ " line. These units are supplied with BNC-type output connectors so that shielded line may be used to minimize stray RF pickup on the sampling line to the telemetry system. Stainless steel, screw-lock straps are provided for attaching the unit to the line.

## **Moseley Models PVK-1A, PVK-1B and PVK-2 Plate Voltage Kits**

Plate voltages from 1kV DC to 20kV DC may be sampled by these kits. These units consist of a well-insulated resistor network. The PVK-1A samples 1-3kV DC; the PVK-1B samples 3-10kV DC; and the PVK-2 samples 10-20kV DC.

## **Moseley Model MMA-1 Modulation Monitor Adaptor**

The MMA-1 provides a DC voltage output proportional to the audio output of any modulation monitor. Functioning as a peak audio detector, response is limited only by the ballistics of the remote analog meter. When used with FM or TV aural monitors, internal strapping provides "repre-emphasis" for

accurate indications of modulation. Input requirements are  $600\Omega$  balanced,  $-20$  to  $+10$  dBm. Power is derived from the Model TRC-15A analog Remote Control System, earlier Moseley analog systems, or an externally regulated supply of  $+$  and  $-10$  VDC at 15 ma.

## **Moseley Model DCA-2 DC Amplifier**

The DCA-2 DC Amplifier enables the sampling of low-level or sensitive DC circuits such as are found in monitoring equipment and RF reflectometers. Having a floating input, the DCA-2 can accept a positive, negative, or isolated-from-ground input.

Two separate outputs are provided by the DCA-2. The first of these is simply a linear application of the input. Gain of the DCA-2 is such that  $10\mu\text{A}$ , applied to the impedance strappable input (1 of  $5\text{k}\Omega$ ), will produce an output of 1.5 VDC, nominal. The second output has been processed by amplitude-squaring circuitry to perform the necessary linearity conversion to enable direct reading of power on digital or linear-scale equipment. Gain and zero (bias or offset) controls are provided.

The operating temperature range of the DCA-2 is  $0^{\circ}\text{C}$  to  $+60^{\circ}\text{C}$ , with power requirements of 120/240 VAC, 50-60 Hz. An optional 19-inch, multiple unit, rack adaptor is also available. Individually, the DCA-2 is small-sized; 23 cm (9 inches)  $\times$  15 cm (6 inches)  $\times$  5 cm (2 inches).

## **Moseley Model RMK-1 Reversible Motor Kit**

The RMK-1 contains a reversible 120 VAC, 1 rpm motor. Coupling can be made directly to a  $\frac{1}{4}$ " shaft or through the 6" flexible shaft which is supplied with the unit. The motor develops 120 inch-ounces of torque and incorporates an adjustable clutch to prevent damage from overtravel. A local-control push button is an integral part of the assembly. The RMK-1 can be supplied for 230 VAC, 50-60 Hz operation on special order.

## Moseley Model CIP-1 Control Interface Panel

The Model CIP-1 Control Interface Panel provides for the use of slave or repeating relays with Moseley Associates Remote Control Systems. Only 5¼" (13.4 cm) of standard 19" (48.3 cm) rack space is required. Seven relay sockets are mounted on the Model CIP-1 Control Interface Panel. These sockets accept plastic-enclosed, plug-in, magnetic latching or momentary relays. Barrier-strip type screw terminals are provided for connection to the relays. Both relay sockets and contacts on all relays are rated to accept loads of up to 10 amperes at 28 VDC or 120 VAC. The silver-cadmium oxide contacts of the relays are rated for continuous operation. Relays are available for operation from 24 VDC and 120 VAC sources.

## Moseley Models DCP-1 and DCP-2 DC Power Supplies

As an accessory to the CIP-1 Control Interface Panel, the DCP-1 and DCP-2 Power Supplies provide 24 VDC for the Type 5480DC and Type 5481DC Relays. The DCP-1 provides an output of 24 VDC at 1 ampere and has seven parallel outputs corresponding to the seven-relay capacity of a single CIP-1 panel. The DCP-1 is rack-mounting requiring only 3½" (8.9 cm) of standard 19" (48.3 cm) rack space. The DCP-2 is identical in size to the DCP-1 but contains two DC power supplies for those applications requiring 2-ampere capacity. Input requirements to either unit are 120/240 VAC, 50/60 Hz.



## Model 760 EBS System

The Model 760 EBS System is designed for broadcasters to meet Parts 73.940, 73.941 and 73.942 of the FCC Rules and Regulations for decoding and encoding the two-tone EBS alert signal. The modular construction of the system provides for maximum versatility and consists of a cabinet assembly, AM or FM receiver, two-tone decoder and two-tone generator. Two or three of these modules can be combined into a cost-effective operational EBS System. FCC type accepted and certified.

- Complete modular design
- Frequency synthesized tunable AM receiver
- Dual channel FM receiver available

## Model 760 Cabinet Assembly

The Model 760 Cabinet Assembly is designed to accept up to three of the EBS modules described below. Standalone units may be constructed by ordering the Model 760 cabinet and any particular module. A fully loaded cabinet would consist of the Two-Tone Generator on the left, either AM or FM Receiver in the center, and the Two-Tone Decoder on the right. Blank panels are used as fillers where modules are not installed.

## Model 760-02 Dual-Channel FM Receiver

The FM Receiver, Model 760-02, is a high performance dual-channel, fixed frequency FM broadcast receiver. Channel selection is accomplished by a pushbutton switch. Both channels are fixed tuned and the crystals are factory installed. A one-channel version is also available. The CARRIER light will come on only when the desired

station is received. A rear panel terminal is provided for activating external carrier-off alarm circuitry. Specify number of channels and frequency with order.

## Model 760-01 Tunable, Frequency Synthesized Receiver

The AM receiver, Model 760-01, is a continuously tunable AM broadcast receiver using a frequency synthesized local oscillator which is phase locked to a 5-MHz crystal oscillator. The local oscillator is tuned by means of a 3-digit front panel thumbwheel switch in 10-kHz steps. The stability of the receiver is that of the crystal oscillator regardless of which AM channel is being received.

Positive tuning to any desired station is accomplished by dialing the frequency of the selected station and peaking the RF amplifier tuning. The CARRIER light will come on only when the desired station is received. A rear panel terminal is provided for activating external carrier-off alarm circuitry.

In addition to broadcast station use, the AM Receiver provides a low cost monitor for all emergency service agencies, such as police, fire, Civil Defense, hospitals, etc. These services can listen to key EBS participating stations in the local area during any emergency.

# EBS EQUIPMENT

## **Model 760-03 Two-Tone**

### **EBS Decoder**

The TFT Two-Tone Decoder, Model 760-03, decodes the 853-Hz and 960-Hz EBS signaling tones from the demodulated output of a receiver. It may be used in conjunction with TFT's Model 760-01 AM Receiver, Model 760-02 FM Receiver, or any audio source which has the EBS Two-Tone signal at 100 mV rms or greater. Stable piezoelectric tuning fork filters are used to achieve  $\pm 5$ -Hz bandwidth from the center frequency of each tone. The timing circuit for the 10-second delay is a signal averaging integrator which eliminates false turn-on by noise. An amplifier and loudspeaker are built-in for audio monitoring. Volume control is internally preset.

## **Model 760-05**

### **Dual-Purpose Decoder**

The Model 760-05 Dual-Purpose Decoder can be used with either AM or FM receivers to respond to the present carrier break and 1000-Hz tone signaling scheme or, by removing a component, decode the new EBS 853- and 960-Hz dual-signaling tones. The circuit design and electrical characteristics are similar to the Model 760-03 module.

## **Model 760-04**

### **Two-Tone Generator**

The Two-Tone EBS Generator, Model 760-04, generates the 853-Hz tones simultaneously with an accuracy of  $\pm 0.25$  Hz. The frequency and stability of the tones are accomplished by synthesizing the tones from a single crystal oscillator.

Model 760-04 should be installed in the program audio line before the audio limiter. A single channel of audio can be routed through the generator. When the generator is activated, program audio is automatically interrupted, the EBS tones inserted, and The Emergency Program Audio is connected to the output. Program audio is restored by the RESET switch.

The generator is activated by two front panel COMMAND switches which need to be simultaneously operated to prevent accidental activation. COMMAND and RESET functions can be remotely controlled through rear panel wiring. The amplitude of each tone can be checked and adjusted individually.

Model 760 Emergency Broadcast System; Time and Frequency Technology, Inc.

System size:      3.5" (8.9 cm) H  
                         19" (48.3 cm) W  
                         12" (30.5 cm) D

System weight:    10 lb (4.5 kg)

# MONITOR & TEST EQUIPMENT



# MONITORING EQUIPMENT

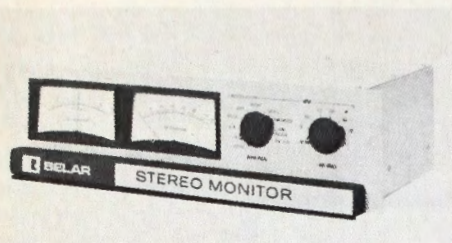

## Belar FMM-1 FM Frequency and Modulation Monitor

This wideband, all solid-state monitor fulfills requirements of monaural FM monitoring and provides a pure demodulated signal to drive a stereo and an SCA monitor in multiplex operations. The peak flasher operates independently of modulation polarity in that it samples both positive and negative peaks simultaneously and automatically selects and registers the greater amplitude if preset level is exceeded. The unit is type approved for remote monitoring.

Size: 5¼" (13.3 cm)H  
19" (48.2 cm)W  
10½" (26.7 cm)D

Weight: 14 lb (6.3 kg)



## Belar SCM-1 SCA Frequency and Modulation Monitor

The SCM-1, added to the FMM-1 Monitor, provides complete monitoring and test functions for SCA storecasting and remote telemetering applications. Up to four crystal switch positions allow four channels to be operated and tested. Interchangeable channel crystals permit unlimited SCA frequency selection.

Size: 5¼" (13.3 cm)H  
19" (48.2 cm)W  
10½" (26.7 cm)D

Weight: 14 lb (6.3 kg)

## Belar RFA-1 FM RF Amplifier

This unit is a solid-state FM RF amplifier for use in remote FM monitoring. It has 100 dB gain with a 70-dB dynamic range and 1-watt output. The 600-kHz phase linear bandwidth will not degrade a stereo multiplex transmission. The zero axis limiters and good selectivity characteristics (50 dB down at 800 kHz) ensure that adjacent channel interferences are suppressed. Output impedance is 50 ohms.

Size: 3" (7.6 cm)H  
19" (48.2 cm)W  
11⅞" (30.2 cm)D

Weight: 7 lb (3.2 kg)

## Belar RFA-2 AM RF Amplifier

Companion to the AMM-1 Monitor, The RFA-2 allows remote monitoring of carrier frequency deviation and modulation characteristics. Built-in automatic gain control eliminates problems associated with changes in transmitter power level, antenna patterns, and signal fading. Automatic gain control provides a range of more than 30 dB. The RF sensitivity is 100 µV across 50 ohms.

Size: 3½" (8.9 cm)H  
19" (48.2 cm)W  
11½" (29.2 cm)D

Weight: 8 lb (3.6 kg).



## Belar AS-1 Audio Sentry

The AS-1 alarm aurally and visually alerts station personnel of any modulation or carrier absence. The audio sentry reacts instantly on loss of carrier. In modulation loss, the AS-1 can be programmed to sound-off between 3 and 60 seconds. The AS-1 has an input sensitivity adjustable from 140 microvolts to 20 volts, an input impedance of 1000 ohms, and a frequency range to 30 to 15,000 Hz. Power requirements are 115/230 volts, 50/60 Hz.

Size: 3½" (8.9 cm)H  
19" (48.26 cm)W  
4¾" (12 cm)D

Weight: 6 lb (2.7 kg)

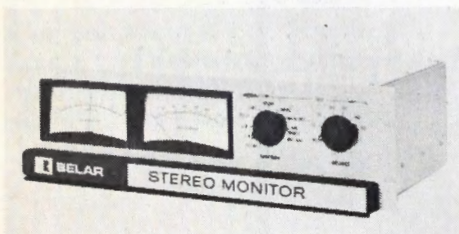

## Belar FMS-1 FM Stereo Frequency/Modulation Monitor

When added to the FMM-1 FM Monitor, the FMS-1 provides complete monitoring and test functions for daily operations and provides additional facilities for weekly and monthly tests and maintenance checks. FM noise, AM noise, pilot frequency, separation, crosstalk, pilot amplitude, and subcarrier suppression all are read on the front panel. It may be used as an intermodulation analyzer to directly measure stereo distortion.

Size: 5¼" (13.3 cm)H  
19" (48.2 cm)W  
10½" (26.7 cm)D

Weight: 12 lb (5.4 kg)



# MONITORING EQUIPMENT

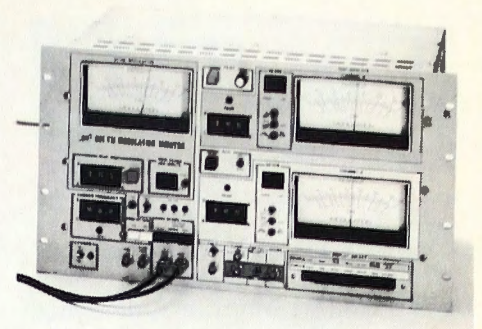
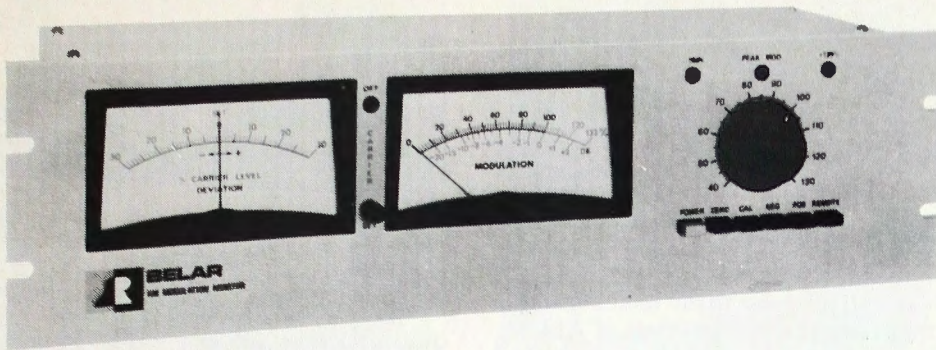

## QEI Model 691 Tuneable Stereo Modulation Monitor and FM Test Set

Designed as a complete FM test system, the QEI 691 simplifies proof of performance measurements with auto ranging meters for separation, crosstalk, noise and phase calibration. Individual components of the FM transmission system can be measured separately, including stereo generator, composite STL receivers and FM excitors. A front panel BNC connector is provided for direct off-air measurement of Pilot and SCA frequencies. A plug-in SCA monitor module is available; order 691/01. NOTE: 691 is Type Approved for SCA use only with subcarriers in the range of 59 kHz to 75 kHz with injection of 10% or less.

### Specifications

Size: 10½" (26.67 cm)H  
19" (48.26 cm)W  
12" (30.48)D

### Shipping

weight: 32 Lbs. (14.4 kg)

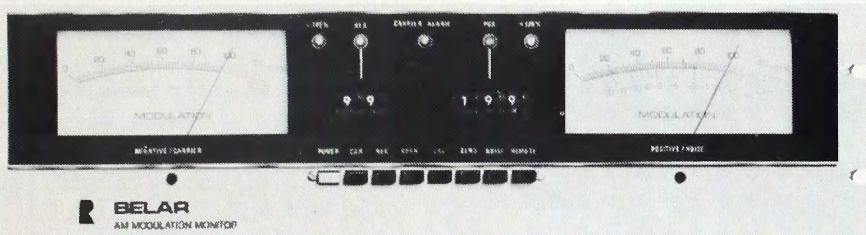

## Belar AMM-2/3 AM Modulation Monitor

Both the AMM-2 and AMM-3 modulation monitors incorporate true ratio-type peak indicators and a unique modulation cancellation scheme to recover unmodulated carrier with which to reference the modulation peaks. The AMM-2, with one modulation meter, and the AMM-3, with two modulation meters, respond accurately to the shortest duration program peaks. The AMM-2 has a single adjustable peak modulation indicator: 40 to 130 percent in less than 1-percent increments. Model AMM-3 has two adjustable peak modulation indicators: positive 1 to 199 percent;

negative 1 to 99 percent. Both indicators are independent of carrier level. Both models are equipped with separate negative and positive indicator lamps (AMM-2) or LED; (AMM-3). Model AMM-3 has outputs for listening as well as test functions.

### Size:

AMM-2 5¼" H (13.3 cm)  
19"W (48.26 cm)  
6"D (15.24 cm)

### Weight:

8 lb (3.62 kg)

### Size:

AMM-3 5¼"H (13.3 cm)  
19"W (48.26 cm)  
8½"D (21.59 cm)

### Weight:

8 lb (5.44 kg)



# MONITORING EQUIPMENT

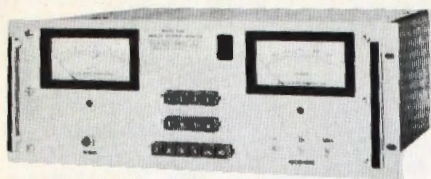

## Delta Model AAM-1 Analog Antenna Monitor

Delta's AAM-1 Monitor is designed to measure the parameters of AM broadcast directional antenna systems. The monitor measures relative current in each tower; the ratio of current in each tower to that of a reference tower; the phase of current in each tower relative to that of the reference tower. The AAM-1 can be equipped for up to 8 input samples without external switching. Two reference towers can be selected for DA-2 applications. Two front panel mirror scale meters flow simultaneous reading of phase and current ratio or phase and relative amplitude of the selected radiator.

### Specifications

Size: 7" (17.78 cm)H  
19" (48.26 cm)W  
15" (38.10 cm)D

Shipping weight: 35 lbs. (15.75 kg)

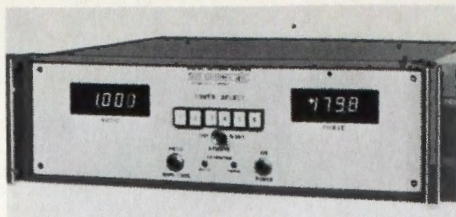

## Delta Model DAM-1 Digital Antenna Monitor

Delta's DAM-1 Monitor is designed to measure the parameters of AM broadcast directional antenna systems. Digital data is obtained thru use of sophisticated digital techniques and TTL components. Data are displayed on front panel 7-segment digital readouts to minimize reading error. A simplified selection system makes operation of the DAM-1 very straightforward. Performance and accuracy of the DFAM-1 are as good or better than other "Precision Monitors".

### Specifications

Size: 5 1/4" (13.34 cm)H  
19" (48.26 cm)W  
17" (43.18 cm)D

Shipping weight: 35 Lbs. (15.75 kg)



## Revox B760 Stereo FM Tuner

Frequency synthesizer provides quartz crystal accuracy. The Revox B760 is designed to receive all internationally-assigned FM channels, from 87.00 to 107.975 MHz. While spacing between FM stations in the United States is currently a rather wide 200 kHz, many other countries often have spacing of only 100 kHz or less. The normal B760 tuning increments of 50 kHz will handle almost any situation, including some frequencies that cannot be received by many digitally-controlled tuners. To assure worldwide usability under the most congested FM channel allocations, a button on the B760 tuner permits tuning increments of 25 kHz.

The B760 has an oscilloscope connection and offers Dolby decoding as an extra-cost option.

Size: 17.8" (452 mm)W  
6" (151 mm)H  
13.7" (348 mm)D

Weight: 26.5 lb (12 kg)





**Potomac Instruments FIM-21  
Field Intensity Meter**

Lightweight and highly stable, the FIM-21 provides precise electromagnetic field measurements in the 535 to 1605 kHz range. Field intensities between 10 microvolts/m and 10 volts/m are directly indicated on the front panel meter. The printed circuit loop antenna is an integral part of the cover and is coupled to the instrument when the cover is opened.

Size: 8<sup>3</sup>/<sub>4</sub>" (22.2 cm)H  
11<sup>1</sup>/<sub>2</sub>" (29.2 cm)W  
5<sup>1</sup>/<sub>8</sub>" (13 cm)D  
(cover closed)

Weight: 11.5 lb (5.2 kg)



**Potomac Instruments FIM-41  
Field Intensity Meter**

This unit is physically similar to the FIM-21 except that it operates in the frequency range of 540 kHz to 5 MHz.

Size: 8<sup>3</sup>/<sub>4</sub>" (22.2 cm)H  
11<sup>1</sup>/<sub>2</sub>" (29.2 cm)W  
5<sup>1</sup>/<sub>8</sub>" (13 cm)D

Weight: 11.5 lb (5.2 kg)

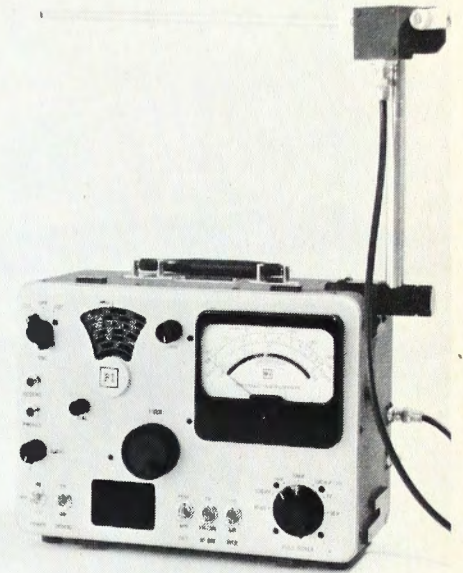

**Potomac Instruments FIM-71  
Field Strength Meter**

The FIM-71, a portable test instrument of laboratory quality, accurately measures commercial TV and FM broadcast signals and harmonics. The unit, with a 47 MHz to 225 MHz frequency range, contains an accurate internal calibration oscillator and may be used as a tuned voltmeter. When used with the associated antenna assembly, it is a highly accurate field strength meter. A front panel speaker and phone jack are provided for signal identification. The FIM-71 has a highly selective and sensitive RF tuner that provides a high degree of immunity to the effects of undesired signals and measures radiated transmitter harmonics without the use of additional fundamental-frequency filtering.

Size: 9" (22.8 cm)H  
12" (30.4 cm)W  
(excluding antenna)  
7" (17.7 cm)D



## Potomac AT51 Audio Test System

The AT51 is an innovative test system which facilitates the measurement of critical parameters in monophonic and stereophonic audio equipment. Designed primarily for commercial broadcast proof-of-performance measurements and equipment maintenance, the AT51 provides automatic testing and analysis of virtually all major recording or broadcasting equipment. The AT51 System consists of two units: the AG51 Audio Generator, and the AA51 Audio Analyzer. The two separate units permit remote measurements requiring physical separation of signal source and signal analyzer.

The AG51 creates every signal needed for analysis, including a low distortion 20 — 200 kHz sine wave; an SMPTE standard intermodulation signal; a fixed frequency sine wave at 3.15 kHz

for wow and flutter; separate left and right outputs; balanced or unbalanced outputs of 150 and 600 ohms; signals for dynamic range and other determinations.

The AA51 measures THD; intermodulation distortion; volts; decibels; signal + noise/noise ratio; wow and flutter; stereo phasing; differential gain in stereo channels. The AA51 has transformerless stereo outputs that are switch-selectable balanced or unbalanced; automatic signal leveling; automatic "set level" and "balance" circuits.

AG51  
Size: 5¼" (13.34 cm)H  
15¼" (38.74 cm)W  
10⅞" (25.75 cm)D  
Weight: 12 lbs (5.44 kg)

AA51  
Size: 5¼" (13.34 cm)H  
15¼" (38.74 cm)W  
10⅞" (25.75 cm)D  
Weight: 12 lbs (5.44 kg)



## Delta OIB-1 Operating Impedance Bridge

Delta's OIB-1 is used to measure impedance of networks, radiators, etc., operating at full power. VSWR can be analyzed, along with complex impedances of up to  $400 \pm j300$  ohms.

Size: 5¼" (13.3 cm)H  
9½" (24 cm)W  
12½" (31.7 cm)D  
Weight: 10 lb (4.54 kg)



## Delta CPB-1 Common Point Impedance Bridge

This permanently installed instrument permits continuous monitoring of the common point, thereby facilitating network adjustments. It is also available with one of Delta's TCA ammeters mounted in the front panel.

Size: (without panel) 7" (17.8 cm)H  
9" (22.8 cm)W  
9¼" (23.5 cm)D  
(panel size) 7" (17.8 cm)H  
19" (48.2 cm)W  
Weight: 12 lb (5.4 kg)

# ENGINEERING DATA

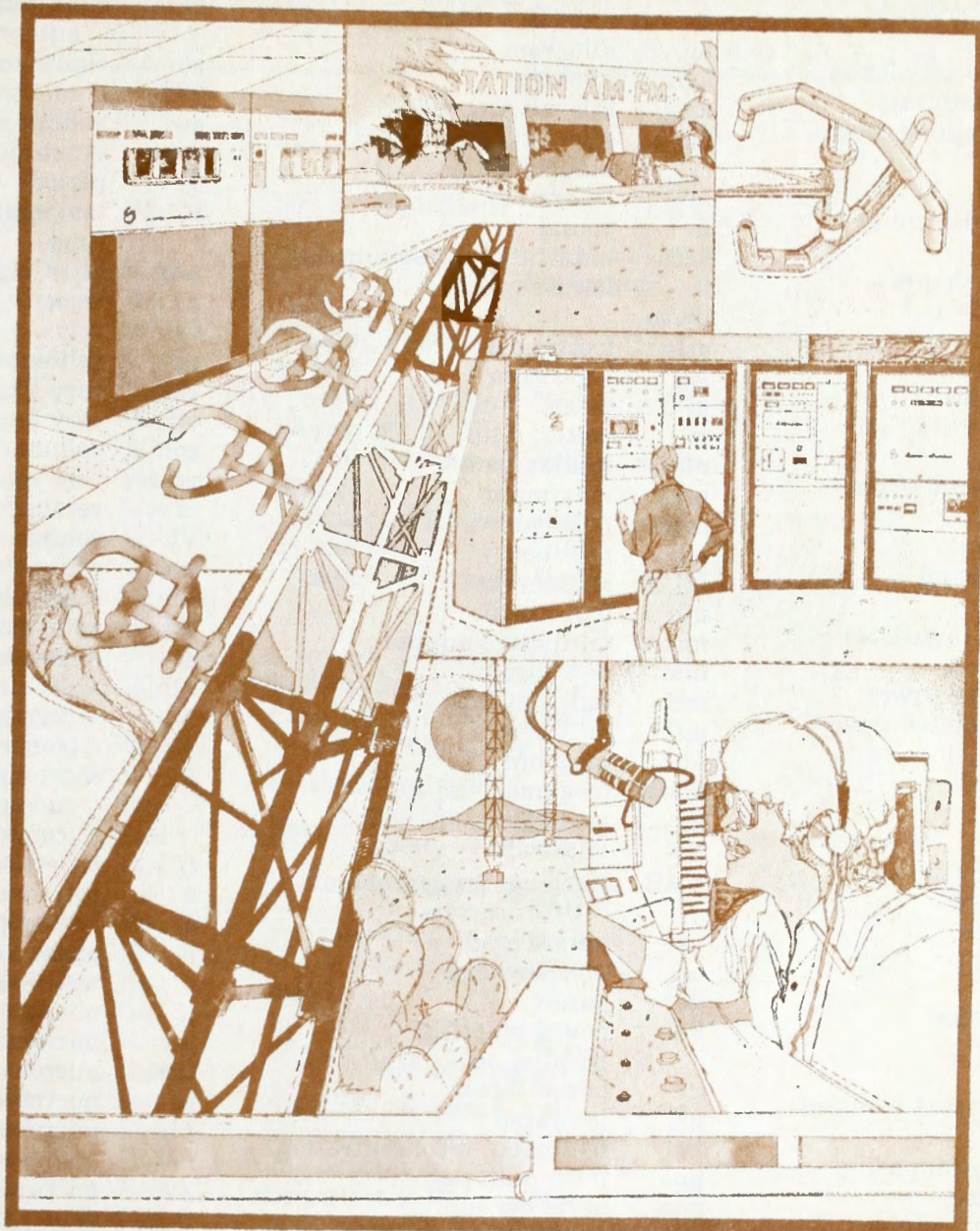

# ENGINEERING DATA

A	ampere	ips	inches per second	rms	root-mean-square
ac	alternating current	IRE	Institute of Radio Engineers	rpm	revolutions per minute
af	audio frequency	ISO	International Standards Organization	s	series as $L_s$
afc	automatic frequency control			s	second
AM	amplitude modulation	$j$	$\sqrt{-1}$	S	siemens
ASA	American Standards Association	k	kilo ( $10^3$ )	SCA	subsidiary carrier authorization
ASTM	American Society for Testing Materials	kg	kilogram	s/n	signal to noise
AVC	automatic volume control	kHz	kilohertz	STL	studio transmitter link
avg	average	kva	kilovolt ampere	swr	voltage standing wave ratio
B	susceptance	kw	kilowatt	sync	synchronous, synchronizing
BCD	binary-coded decimal	$L$	inductance	$T$	period
C	capacitance	lab	laboratory	t	temperature
C	Centigrade, degrees Centigrade	lb	pound	t	time
cm	centimeter	LC	inductance-capacitance	uhf	ultra-high frequency
COD	cash on delivery	lf	low frequency	v	velocity
CW	continuous wave	lm/sq		v	volt
DF	dissipation factor	ft	footcandle	va	voltampere
db	decibel	log	logarithm	vhf	very high frequency
dbm	decibel referred to one milliwatt	$m$	mass	vlf	very low frequency
dc	direct current	m	meter; milli ( $10^{-3}$ )	vol	volume
DSB	double sideband	ma	milliampere	vrms	volt, root, mean, square
E	voltage	max	maximum	vs	versus
EIA	Electronics Industries Association	mbar	millibar	VU	volume unit
emf	electromotive power	mh	millihenry	w	watt
ERP	effective radiated power	MHz	megahertz	X	reactance
F	Fahrenheit, degrees Fahrenheit	mil	0.001 inch	Y	admittance
F	farad	min	minimum; minute	Z	impedance
f	frequency	mm	millimeter	$\alpha$	short-circuit forward current-transfer ratio (common base)
FM	frequency modulation	mS	millisiemens	$\beta$	short-circuit forward current-transfer ratio (common emitter)
f.o.b.	free on board	m $\Omega$	milliohm	L	reflection coefficient
G	conductance	M $\Omega$	megohm	$\Delta$	increment
g	gravitation constant	MM $\Omega$	megamegohm	$\delta$	loss angle
GHz	gigahertz	mv	millivolt	$\theta$	phase angle
G <sub>m</sub>	transconductance	mw	milliwatt	$\lambda$	wavelength
h	henry	NAB	National Association of Broadcasters	$\mu$	micro- ( $10^{-6}$ )
H <sub>z</sub>	hertz	ns	nanosecond	$\mu a$	microampere
$h_f$	forward current-transfer ratio	nS	nanosiemens	$\mu bar$	microbar
$h_i$	Short-circuit input impedance	oz	ounce	$\mu f$	microfarad
$h_o$	open-circuit output admittance	PA	power amplifier	$\mu h$	microhenry
$h_r$	reverse voltage-transfer ratio	$\rho$	parallel, as $L_p$	$\mu s$	microsecond
I	current	PF	power factor	$\mu v$	microvolt
IEC	International Electrotechnical Commission	pF	picofarad	$\Omega$	ohm
IEEE	Institute of Electrical and Electronics Engineers	PH	hydrogen in concentration	U	mho
IF	intermediate frequency	pp	push-pull; pages	w	angular velocity. ( $2\pi f$ )
in.	inch	ppm	parts per million		
		p-p	peak-to-peak		
		prf	pulse repetition frequency		
		Q	quality factor		
		R	resistance		
		®	registered trademark		
		RC	resistance-capacitance		
		re	referred to		
		rf	radio frequency		
		RH	relative humidity		
		RIAA	Recording Industry Association of America		



Orders of magnitude from  $10^{12}$  to  $10^{-18}$  are designated by the following prefixes:

Order	Prefix	Symbol
$10^{12}$	tera	T
$10^9$	giga	G
$10^6$	mega	M

$10^3$	kilo	k
$10^2$	hecto	h
$10^1$	deka	da
$10^{-1}$	deci	d
$10^{-2}$	centi	c
$10^{-3}$	milli	m

$10^{-6}$	micro	$\mu$
$10^{-9}$	nano	n
$10^{-12}$	pico	p
$10^{-15}$	femto	f
$10^{-18}$	atto	a

### Telephone Cable Color Code

Pair No.	Color	White
1	Blue	White
2	Orange	White
3	Green	White
4	Brown	White
5	Slate	White
6	Blue White	White
7	Blue Orange	White
8	Blue Green	White
9	Blue Brown	White
10	Blue Slate	White
11	Orange White	White
12	Orange Green	White
13	Orange Brown	White
14	Orange Slate	White
15	Green White	White
16	Green Brown	White
17	Green Slate	White
18	Brown White	White
19	Brown Slate	White
20	Slate White	White
21	Blue	Red
22	Orange	Red
23	Green	Red
24	Brown	Red
25	Slate	Red
26	Blue White	Red
27	Blue Orange	Red
28	Blue Green	Red
29	Blue Brown	Red
30	Blue Slate	Red
31	Orange White	Red
32	Orange Green	Red
33	Orange Brown	Red
34	Orange Slate	Red
35	Green White	Red
36	Green Brown	Red
37	Green Slate	Red
38	Brown White	Red
39	Brown Slate	Red
40	Slate White	Red
41	Blue	Black
42	Orange	Black
43	Green	Black
44	Brown	Black
45	Slate	Black
46	Blue White	Black

47	Blue Orange	Black
48	Blue Green	Black
49	Blue Brown	Black
50	Blue Slate	Black

Note—The last pair in all cables is a Red with White mate, viz.

6-pair cable	6th pair	Red	White
11-pair cable	11th pair	Red	White
16-pair cable	16th pair	Red	White
26-pair cable	26th pair	Red	White
51-pair cable	51st pair	Red	White

### Convert Electrical Degrees to Feet, or Vice Versa When Frequency and Either Feet or Degrees in Known

From the expression

$$\text{Feet} = \frac{\text{degrees}}{360^\circ} \times \frac{300}{f(\text{MHz})} \times 3.281$$

$$= \text{degrees} \times \frac{2.734}{f(\text{MHz})}$$

The following ratio may be set up on the slide rule using C and D scales:

$$\frac{2.734}{f(\text{MHz})} = \frac{\text{feet}}{\text{degrees}}$$

Set 2.734 on scale C over frequency in megahertz on scale D; read feet and degrees on scales C and D, respectively. In some instances it may be convenient to use the folded scales CD and DF.

### Metric Conversion

To convert pounds to kilograms, multiply by .4536  
 To convert inches to centimeters, multiply by 2.54



# ENGINEERING DATA

## Frequencies Used for Standard Broadcast Stations

The band 535-1605 kHz is used for standard broadcasting. It is divided into 107 channels of 10 kHz

each. Following is a list of standard broadcast channels and the conditions under which each may be used in the United States. For

further reference and additional information, see FCC Rules, and the 1950 North American Regional Broadcast Agreement.

Channel	Classification	NARBA Class I Priority	Use Under FCC Rules
540	Clear	Canada (I-A) Mexico (I-A)	II
550	Regional	Cuba (I-C)	III-A, III-B
560	Regional		III-A, III-B
570	Regional	Cuba (I-D)	III-A, III-B
580	Regional		III-A, III-B
590	Regional	Cuba (I-D)	III-A, III-B
600	Regional		III-A, III-B
610	Regional		III-A, III-B
620	Regional	Dominican Republic (I-C)	III-A, III-B
630	Regional	Cuba (I-D)	III-A, III-B
640	Clear	USA (I-A) Canada (I-C) Cuba (I-C)	I, II
650	Clear	USA (I-A)	I, II
660	Clear	USA (I-A)	I, II
670	Clear	USA (I-A)	I, II
680	Clear	USA (I-B)	I, II
690	Clear	Canada (I-A) Cuba (I-C) Mexico (I-B)	II
700	Clear	USA (I-A)	I, II
710	Clear	USA (I-B)	I, II
720	Clear	USA (I-A)	I, II
730	Clear	Mexico (I-A)	II
740	Clear	Canada (I-A) Cuba (I-D)	II
750	Clear	USA (I-A)	I, II
760	Clear	USA (I-A)	I, II
770	Clear	USA (I-A)	I, II
780	Clear	USA (I-A)	I, II
790	Regional		III-A, III-B
800	Clear	Mexico (I-A)	II
810	Clear	USA (I-B)	I, II
820	Clear	USA (I-A)	I, II
830	Clear	USA (I-A)	I, II
840	Clear	USA (I-A)	I, II
850	Clear	USA (I-B) Mexico (I-B)	I, II
860	Clear	Canada (I-A) Cuba (I-C)	II
870	Clear	USA (I-A)	I, II
880	Clear	USA (I-A)	I, II
890	Clear	USA (I-A)	I, II
900	Clear	Mexico (I-A)	II
910	Regional		III-A, III-B
920	Regional	Cuba (I-D)	III-A, III-B
930	Regional		III-A, III-B
940	Clear	Canada & Mexico (I-B)	I, II
950	Regional	Cuba (I-D)	III-A, III-B
960	Regional		III-A, III-B
970	Regional		III-A, III-B
980	Regional	Cuba (I-D)	III-A, III-B
990	Clear	Canada (I-A)	II
1000	Clear	Mexico & USA (I-B)	I, II
1010	Clear	Canada (I-A) Cuba (I-B)	II
1020	Clear	USA (I-A)	I, II
1030	Clear	USA (I-A)	I, II



# ENGINEERING DATA

Channel	Classification	NARBA Class I Priority	Use Under FCC Rules
1040	Clear	USA (I-A)	I, II
1050	Clear	Mexico (I-A)	II
1060	Clear	Mexico & USA (I-B)	I, II
1070	Clear	Canada & USA (I-B)	I, II
1080	Clear	USA (I-B)	I, II
1090	Clear	Mexico & USA (I-B)	I, II
1100	Clear	USA (I-A)	I, II
1110	Clear	USA (I-B)	I, II
1120	Clear	USA (I-A)	I, II
1130	Clear	Canada & USA (I-B)	I, II
1140	Clear	Mexico & USA (I-B)	I, II
1150	Regional		III-A, III-B
1160	Clear	USA (I-A)	I, II
1170	Clear	USA (I-B)	I, II
1180	Clear	USA (I-A)	I, II
1190	Clear	Mexico & USA (I-B)	I, II
1200	Clear	USA (I-A)	I, II
1210	Clear	USA (I-A)	I, II
1220	Clear	Mexico (I-A)	II
1230	Local		IV
1240	Local		IV
1250	Regional		III-A, III-B
1260	Regional		III-A, III-B
1270	Regional		III-A, III-B
1280	Regional		III-A, III-B
1290	Regional		III-A, III-B
1300	Regional		III-A, III-B
1310	Regional		III-A, III-B
1320	Regional		III-A, III-B
1330	Regional		III-A, III-B
1340	Local		IV
1350	Regional		III-A, III-B
1360	Regional		III-A, III-B
1370	Regional		III-A, III-B
1380	Regional		III-A, III-B
1390	Regional		III-A, III-B
1400	Local		IV
1410	Regional		III-A, III-B
1420	Regional		III-A, III-B
1430	Regional		III-A, III-B
1440	Regional		III-A, III-B
1450	Local		IV
1460	Regional		III-A, III-B
1470	Regional		III-A, III-B
1480	Regional		III-A, III-B
1490	Local		IV
1500	Clear	USA (I-B)	I, II
1510	Clear	USA (I-B)	I, II
1520	Clear	USA (I-B)	I, II
1530	Clear	USA (I-B)	I, II
1540	Clear	Bahamas (I-A) USA (I-B)	II
1550	Clear	Canada & Mexico (I-B)	I, II
1560	Clear	USA & Cuba (I-B)	I, II
1570	Clear	Mexico (I-A)	II
1580	Clear	Canada (I-A)	II
1590	Regional		III-A, III-B
1600	Regional		III-A, III-B



# ENGINEERING DATA

Frequency Designation of FM Broadcast Channels		90.9..... 215		100.9 ..... 265		94.5..... 233		104.5 ..... 283			
Freq. (MHz)	Channel No.	Freq. (MHz)	Channel No.	Freq. (MHz)	Channel No.	Freq. (MHz)	Channel No.	Freq. (MHz)	Channel No.		
88.1	201	98.1	251	91.1	216	101.1	266	94.7	234	104.7	284
88.3	202	98.3	252	91.3	217	101.3	267	94.9	235	104.9	285
88.5	203	98.5	253	91.5	218	101.5	268	95.1	236	105.1	286
88.7	204	98.7	254	91.7	219	101.7	269	95.3	237	105.3	287
88.9	205	98.9	255	91.9	220	101.9	270	95.5	238	105.5	288
89.1	206	99.1	256	92.1	221	102.1	271	95.7	239	105.7	289
89.3	207	99.3	257	92.3	222	102.3	272	95.9	240	105.9	290
89.5	208	99.5	258	92.5	223	102.5	273	96.1	241	106.1	291
89.7	209	99.7	259	92.7	224	102.7	274	96.3	242	106.3	292
89.9	210	99.9	260	92.9	225	102.9	275	96.5	243	106.5	293
90.1	211	100.1	261	93.1	226	103.1	276	96.7	244	106.7	294
90.3	212	100.3	262	93.3	227	103.3	277	96.9	245	106.9	295
90.5	213	100.5	263	93.5	228	103.5	278	97.1	246	107.1	296
90.7	214	100.7	264	93.7	229	103.7	279	97.3	247	107.3	297
				93.9	230	103.9	280	97.5	248	107.5	298
				94.1	231	104.1	281	97.7	249	107.7	299
				94.3	232	104.3	282	97.9	250	107.9	300

## Decibels Vs Ratio

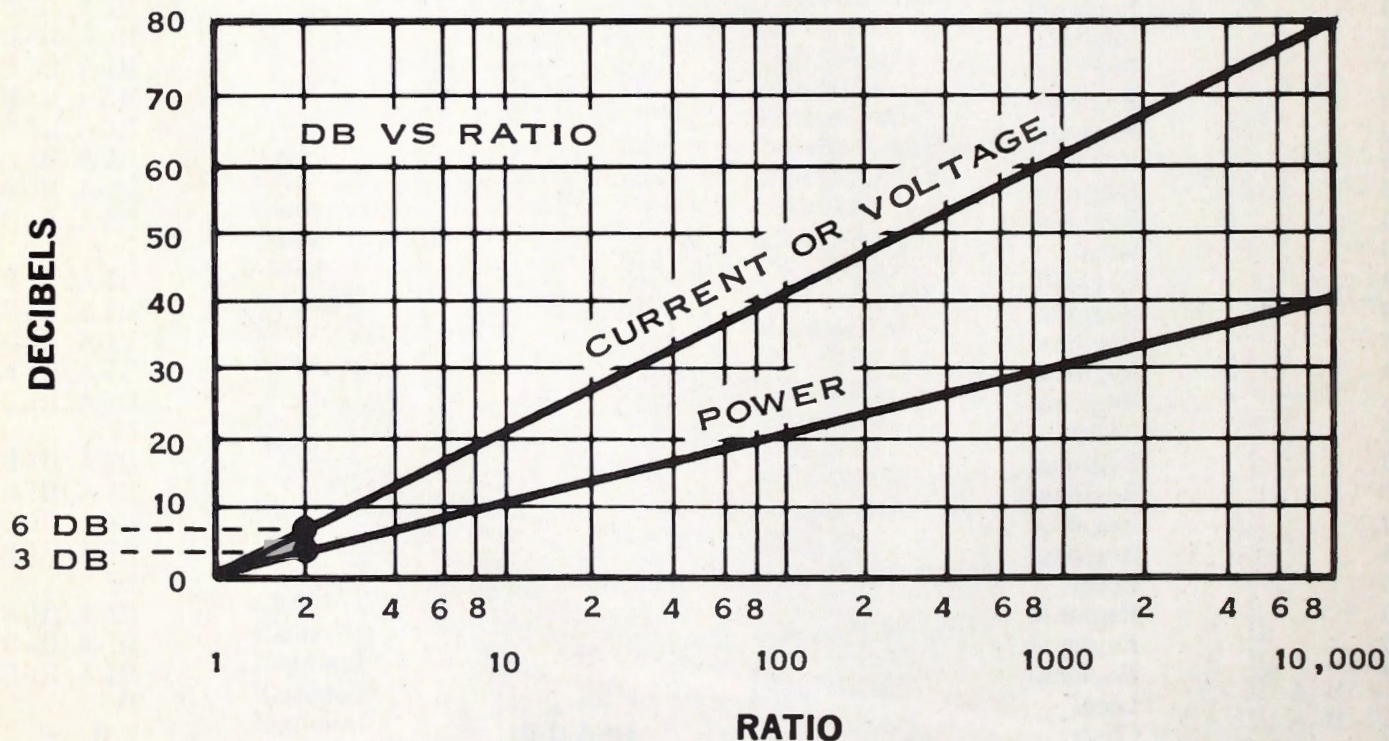

## Footage Table for Broadcast Tower Heights

550 KHZ TO 1070 KHZ					1080 KHZ TO 1600 KHZ				
KHZ	METERS	1 WAVE	½ WAVE	¼ WAVE	KHZ	METERS	1 WAVE	½ WAVE	¼ WAVE
550	545	1787.6	893.8	446.8	1080	277.8	911.1	455.5	227.7
560	536	1758.0	879.0	439.5	1090	275.2	902.6	451.3	225.6
570	526	1725.3	862.6	431.3					
580	517	1695.7	847.8	423.9	1100	272.7	894.4	447.2	223.6
590	509	1669.5	834.7	417.3	1110	270.3	886.5	443.2	221.6
					1120	267.9	879.0	439.5	219.7
600	500	1640.0	820.0	410.0	1130	265.5	870.8	435.4	217.7
610	492	1612.7	806.3	403.1	1140	263.2	862.6	431.3	215.6
620	484	1587.5	799.7	396.8	1150	260.9	855.7	427.8	213.9
630	476	1561.2	780.6	390.3	1160	258.6	847.8	423.9	211.9
640	469	1546.3	773.1	386.5	1170	256.4	840.9	420.4	210.2
650	462	1515.3	757.6	378.8	1180	254.2	834.7	417.3	208.6
660	455	1492.4	746.2	373.1	1190	252.1	826.8	413.4	206.7
670	448	1469.4	734.7	367.3					
680	441	1446.4	723.2	361.1	1200	250.0	820.0	410.0	205.0
690	435	1426.4	713.2	361.2	1210	247.9	813.1	406.5	203.2
					1220	245.9	806.3	403.1	201.5
700	429	1407.1	703.5	351.2	1230	243.9	799.1	399.5	199.7
710	423	1387.4	693.7	346.8	1240	241.9	793.7	396.8	198.4
720	417	1367.7	683.8	341.9	1250	240.0	787.2	393.6	196.8
730	411	1348.0	674.0	337.0	1260	238.1	780.9	390.4	195.2
740	405	1328.4	664.2	332.1	1270	236.2	774.7	387.3	193.6
750	400	1312.0	656.0	328.0	1280	234.4	768.8	384.4	192.2
760	395	1295.6	647.8	323.4	1290	232.6	762.9	381.4	190.7
770	390	1279.2	639.6	319.8					
780	385	1262.8	631.4	315.7	1300	230.8	757.0	378.5	189.2
790	380	1246.4	623.2	311.6	1310	229.0	751.1	375.5	187.7
					1320	227.3	746.2	373.1	186.5
800	375	1230.0	615.0	307.5	1330	225.6	739.9	369.9	184.9
810	370	1213.6	606.8	303.4	1340	223.9	734.7	367.3	183.6
820	366	1200.4	600.2	300.1	1350	222.2	728.8	364.4	182.2
830	361	1184.0	592.0	296.0	1360	220.6	723.2	361.1	180.5
840	357	1170.9	585.4	292.7	1370	219.0	718.3	359.1	179.5
850	353	1157.8	578.9	289.4	1380	217.4	713.4	356.2	178.1
860	349	1144.7	572.3	286.1	1390	215.8	707.8	353.1	176.5
870	345	1131.6	565.8	282.9					
880	341	1118.4	559.2	279.6	1400	214.3	703.5	351.2	175.6
890	337	1105.3	552.6	276.3	1410	212.8	696.9	348.4	174.2
					1420	211.3	693.7	346.8	173.4
900	333	1092.2	546.1	273.0	1430	209.8	688.1	344.0	172.0
910	330	1082.4	541.2	270.6	1440	208.3	683.8	341.9	170.9
920	326	1069.2	534.6	267.3	1450	206.9	678.6	339.3	169.6
930	323	1059.4	529.7	264.8	1460	205.5	674.0	337.0	168.5
940	319	1046.3	523.1	261.5	1470	204.1	669.4	334.7	167.3
950	316	1036.4	518.2	259.1	1480	202.7	664.2	332.1	166.5
960	313	1026.6	513.3	256.6	1490	201.3	660.2	330.1	165.0
970	309	1013.5	506.7	253.3					
980	306	1003.6	501.8	250.9	1500	200.0	656.0	328.0	164.0
990	303	993.8	496.9	248.4	1510	198.7	651.7	325.8	162.9
					1520	197.4	647.8	323.4	161.7
1000	300	984.0	492.0	246.0	1530	196.1	643.2	321.6	160.8
1010	297	974.1	487.5	243.7	1540	194.8	639.6	319.8	159.9
1020	294.1	964.6	482.3	241.1	1550	193.5	634.6	317.3	158.6
1030	291.3	955.3	477.6	238.8	1560	192.3	631.4	315.7	157.8
1040	288.5	946.2	473.1	236.5	1570	191.1	628.8	313.4	156.7
1050	285.7	937.1	468.5	234.2	1580	189.9	623.2	311.6	155.8
1060	283.0	928.2	464.1	232.0	1590	188.7	618.9	309.4	154.7
1070	280.4	919.7	459.8	229.9					
					1600	187.5	615.0	307.5	153.7

# ENGINEERING DATA

## Estimated Ground Conductivity

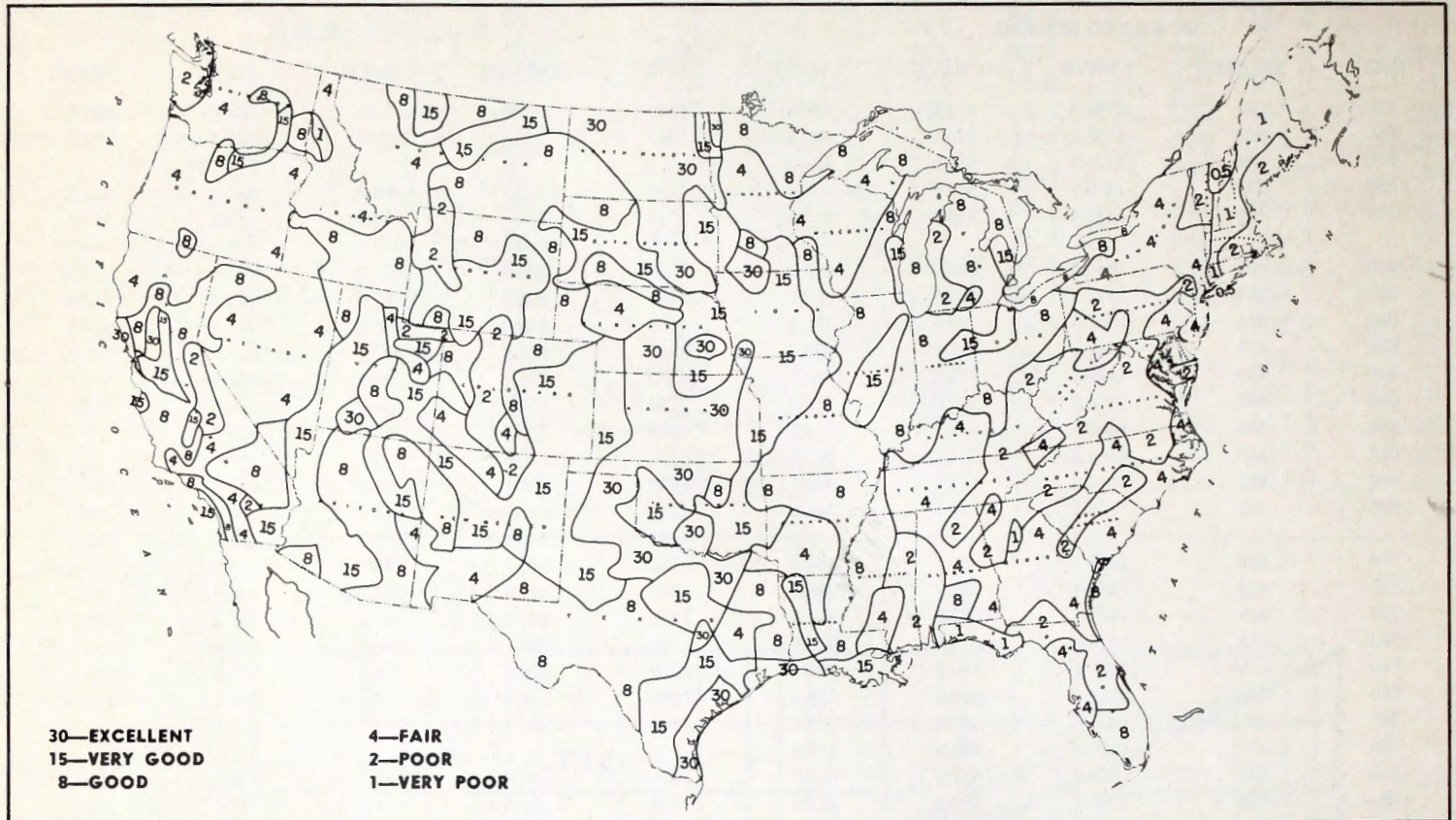

### Conversion Table

MULTIPLY NUMBER OF BY TO OBTAIN NUMBER OF	ANGSTROMS	MICRONS	MILS	INCHES	FEET	MILES	MILLIMETERS	CENTIMETERS	KILOMETERS
ANGSTROMS	1	$10^4$	$2.540 \times 10^5$	$2.540 \times 10^8$	$3.048 \times 10^9$	$1.609 \times 10^{13}$	$10^7$	$10^8$	$10^{13}$
MICRONS	$10^{-4}$	1	$2.540 \times 10$	$2.540 \times 10^4$	$3.048 \times 10^5$	$1.609 \times 10^9$	$10^3$	$10^4$	$10^9$
MILS	$3.937 \times 10^{-6}$	$3.937 \times 10^{-2}$	1	$10^3$	$1.2 \times 10^4$	$6.336 \times 10^7$	$3.937 \times 10$	$3.937 \times 10^2$	$3.937 \times 10^7$
INCHES	$3.937 \times 10^{-9}$	$3.937 \times 10^{-5}$	$10^{-3}$	1	12	$6.336 \times 10^4$	$3.937 \times 10^{-2}$	$3.937 \times 10^{-1}$	$3.937 \times 10^4$
FEET	$3.281 \times 10^{-10}$	$3.281 \times 10^{-6}$	$8.333 \times 10^{-5}$	$8.333 \times 10^{-2}$	1	$5.280 \times 10^3$	$3.281 \times 10^{-3}$	$3.281 \times 10^{-2}$	$3.281 \times 10^3$
MILES	$6.214 \times 10^{-14}$	$6.214 \times 10^{-10}$	$1.578 \times 10^{-8}$	$1.578 \times 10^{-5}$	$1.894 \times 10^{-4}$	1	$6.214 \times 10^{-7}$	$6.214 \times 10^{-6}$	$6.214 \times 10^{-1}$
MILLIMETERS	$10^{-7}$	$10^{-3}$	$2.540 \times 10^{-2}$	$2.540 \times 10$	$3.048 \times 10^2$	$1.609 \times 10^6$	1	10	$10^6$
CENTIMETERS	$10^{-8}$	$10^{-4}$	$2.540 \times 10^{-3}$	2.540	$3.048 \times 10$	$1.609 \times 10^5$	0.1	1	$10^5$
KILOMETERS	$10^{-13}$	$10^{-9}$	$2.540 \times 10^{-8}$	$2.540 \times 10^{-5}$	$3.048 \times 10^{-4}$	1.609	$10^{-6}$	$10^{-5}$	1

° CENTIGRADE  
 ° FAHRENHEIT

$$C = 5/9 (F - 32)$$

$$F = 9/5 C + 32$$

## Decibels above and below reference level 1mw into 600 ohms

Voltage applies to 600 ohm circuits only. Power applies to any impedance.

dB DOWN		LEVEL	dB UP	
VOLTS	MILLIWATTS	dB mW	VOLTS	MILLIWATTS
0.774 6	1.000	0+	0.774 6	1.000
0.690 5	0.794 3	1	0.869 1	1.259
0.616 7	0.631 0	2	0.975 2	1.585
0.548 4	0.501 2	3	1.094	1.995
0.488 7	0.398 1	4	1.228	2.512
0.435 6	0.316 2	5	1.377	3.162
0.388 2	0.251 2	6	1.546	3.981
0.346 0	0.199 5	7	1.734	5.012
0.308 4	0.158 5	8	1.946	6.310
0.274 8	0.125 9	9	2.183	7.943
0.244 9	0.100 0	10	2.449	10.000
0.218 3	0.079 43	11	2.748	12.59
0.194 6	0.063 10	12	3.084	15.85
0.173 4	0.050 12	13	3.460	19.95
0.154 6	0.039 81	14	3.882	25.12
0.137 7	0.031 62	15	4.356	31.62
0.122 8	0.025 12	16	4.887	39.81
0.109 4	0.019 95	17	5.484	50.12
0.097 52	0.015 85	18	6.153	63.10
0.086 91	0.012 59	19	6.905	79.43
0.077 46	0.010 00	20	7.746	100.00
0.043 56	0.003 16	25	13.77	316.2
0.024 49	0.001 00	30	24.49	1.000 Watts
0.013 77	0.000 316	35	43.56	3.162 Watts
0.007 746	0.000 100	40	77.46	10.00 Watts
0.004 356	$3.16 \times 10^{-5}$	45	137.7	31.62 Watts
0.002 449	$1.00 \times 10^{-5}$	50	244.9	100 Watts
0.001 377	$3.16 \times 10^{-6}$	55	435.6	316.2 Watts
0.000 774 6	$1.00 \times 10^{-6}$	60	774.6	1 000 Watts
0.000 435 6	$3.16 \times 10^{-7}$	65	1 377	3 162 Watts
0.000 244 9	$1.00 \times 10^{-7}$	70	2 449	10 000 Watts
0.000 137 7	$3.16 \times 10^{-8}$	75	4 356	31 620 Watts
0.111 077 46	$1.00 \times 10^{-8}$	80+	7 746	100 000 Watts

### USE OF TABLE

Table is tabulated in 1-dB steps from 0 dB mW to  $\pm 20$  dB mW; thereafter in 5-dB steps to  $\pm 80$  dB mW. However, the table may be used in 1-dB steps to  $\pm 80$  dB mW by noting that, except for decimal locations, the power levels repeat themselves every  $\pm 10$  dB and the voltage levels repeat every  $\pm 20$  dB.

**Example 1.** What is the voltage produced by a level of  $-56$  dB mW on 600 ohms? Subtract 40 from 56,

giving 16. Enter table at 16 dB mW, read volts column on left as 0.1228 volt. Now enter table at 55 and 60 dB mW;  $-56$  dB mW is between these two levels, so table shows correct answer as 0.001228 volt.

**Example 2.** What is the voltage produced by a level of  $-68$  dB mW on 600 ohms? Subtract 60 from 68, giving 8. Enter table at 7 dB mW, read volts column on left as 0.3084 volt. Now enter table at 65 and 70 dB mW;  $-68$  dB mW is between

these two levels, so the table shows the correct answer as 0.0003084 volt.

**Example 3.** What is the voltage produced by a level of  $+33$  dB mW on 600 ohms? Subtract 20 from 33, giving 13. Enter the table at 13 dB mW, read volts column at right as 3.460 volts. Now enter table at 30 and 35 dB mW;  $+33$  dB mW is between these two levels, so the table shows the correct answer as 34.6 volts.

# ENGINEERING DATA

## Forward VS Reflected Power

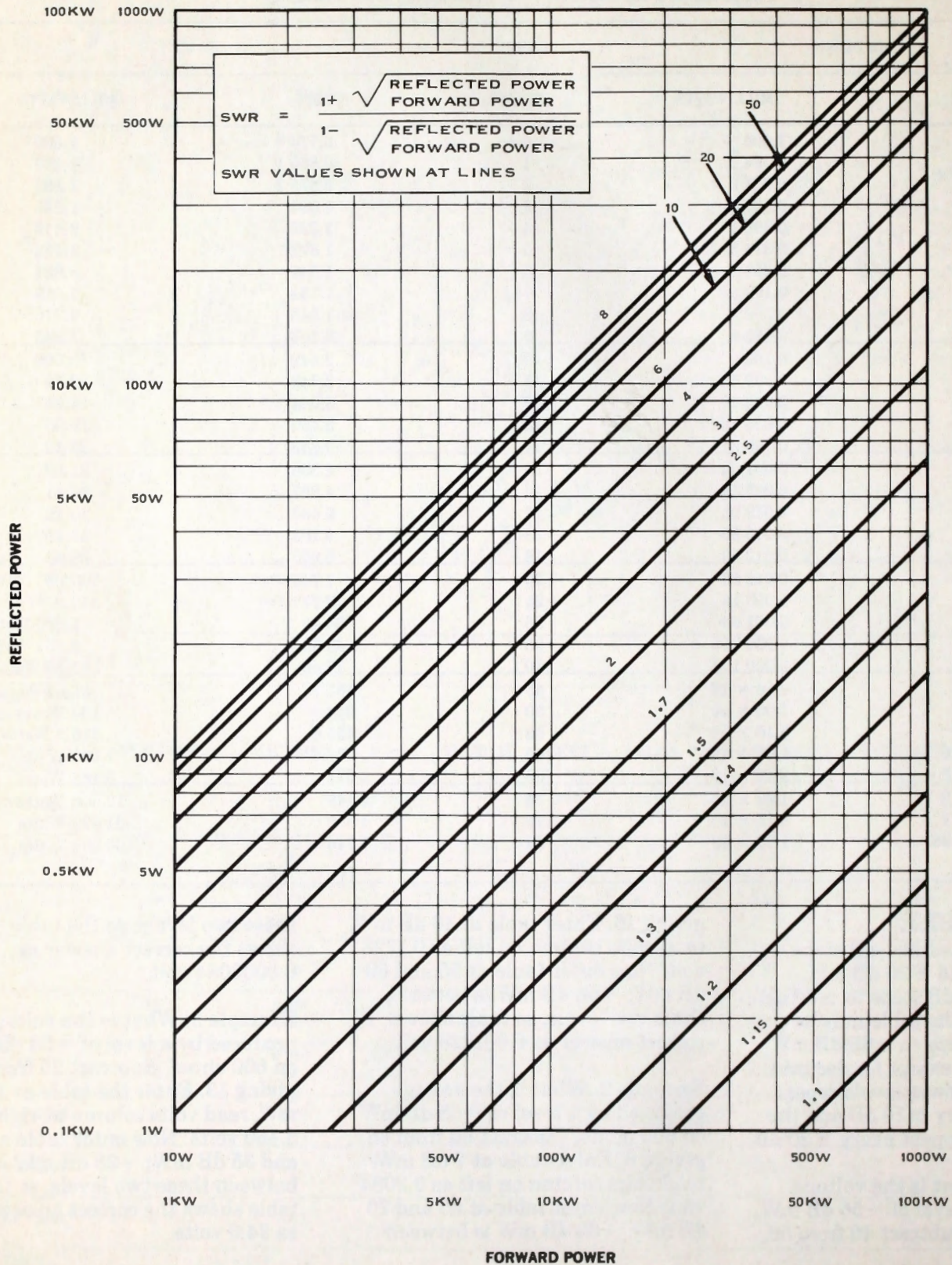

## Attenuator Network

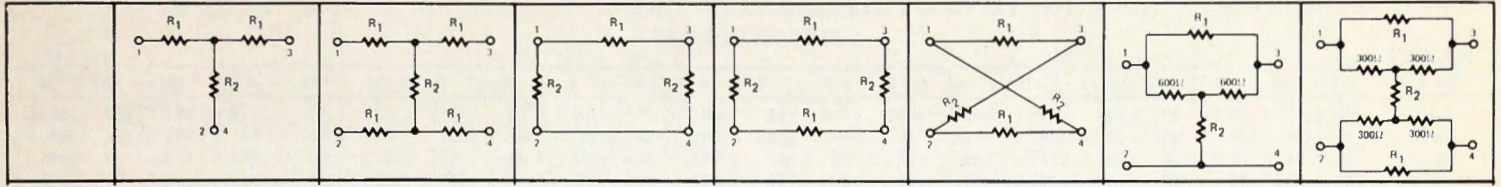

Impedance	600 Ohms		600 Ohms		600 Ohms		600 Ohms		600 Ohms		600 Ohms		600 Ohms	
Loss, dB	R <sub>1</sub> Ohms	R <sub>2</sub> Ohms	R <sub>1</sub> Ohms	R <sub>2</sub> Ohms	R <sub>1</sub> Ohms	R <sub>2</sub> Ohms	R <sub>1</sub> Ohms	R <sub>2</sub> Ohms	R <sub>1</sub> Ohms	R <sub>2</sub> Ohms	R <sub>1</sub> Ohms	R <sub>2</sub> Ohms	R <sub>1</sub> Ohms	R <sub>2</sub> Ohms
0	0	∞	0	∞	0	∞	0	∞	0	∞	0	∞	0	∞
0.1	3.58	50204	1.79	50204	7.20	100500	3.60	100500	3.58	100500	7.2	50000	3.6	50000
0.2	6.82	26280	3.41	26280	13.70	57380	6.85	57380	6.82	57380	13.8	26086	6.9	26086
0.3	10.32	17460	5.16	17460	20.55	34900	10.28	34900	10.32	34900	21.0	17143	10.5	17143
0.4	13.79	13068	6.90	13068	27.50	26100	13.80	26100	13.79	26100	28.2	12766	14.1	12766
0.5	17.20	10464	8.60	10464	34.40	20920	17.20	20920	17.20	20920	35.4	10169	17.7	10169
0.6	20.9	8640	10.45	8640	41.7	17230	20.85	17230	20.9	17230	43.2	8333	21.6	8333
0.7	24.2	7428	12.1	7428	48.5	14880	24.25	14880	24.2	14880	50.4	7143	25.2	7143
0.8	27.5	6540	13.75	6540	55.05	13100	27.53	13100	27.5	13100	57.6	6250	28.8	6250
0.9	31.02	5787	15.51	5787	62.3	11600	31.2	11600	31.02	11000	65.4	5504	32.7	5504
1.0	34.5	5208	17.25	5208	68.6	10440	34.3	10440	34.5	10440	73.2	4918	36.6	4918
1.5	51.8	3452	25.9	3452	104.3	6950	52.1	6950	51.8	6950	113.4	3174	56.7	3174
2.0	68.8	2582	34.4	2582	139.4	5232	69.7	5232	68.8	5232	155.4	2310	77.7	2316
2.5	85.9	2053	42.9	2053	175.4	4195	87.7	4195	85.9	4195	200.4	1796	100.2	1796
3.0	102.7	1703	51.3	1703	212.5	3505	106.2	3505	102.7	3505	247.8	1452	123.0	1452
3.5	119.2	1448	59.6	1448	258.0	3021	120.0	3021	119.2	3021	297.6	1209	148.8	1209
4.0	135.8	1249	67.9	1249	287.5	2651	143.8	2651	135.8	2651	351.0	1025	175.5	1025
4.5	152.2	1109	76.1	1109	324.6	2365	162.3	2365	152.2	2365	407.8	883.7	203.7	883.7
5.0	168.1	987.6	84.1	987.6	364.5	2141	182.3	2141	168.1	2141	466.8	771.2	233.4	771.2
5.5	184.0	886.8	92.0	886.8	405.9	1956	203.0	1956	184.0	1956	530.4	678.7	265.2	678.7
6.0	199.3	803.4	99.7	803.4	447.5	1807	223.8	1807	199.3	1807	597.0	693.0	298.6	603.0
6.5	214.6	730.8	107.3	730.8	492.6	1679	246.3	1679	214.6	1679	667.8	539.8	333.0	539.8
7.0	229.7	685.2	114.8	685.2	537.0	1569	268.5	1569	229.7	1569	743.4	484.3	371.7	484.3
7.5	244.2	615.6	122.1	615.6	584.7	1475	292.4	1475	244.2	1475	822.0	437.0	411.3	437.6
8.0	258.4	567.6	129.2	567.6	634.2	1393	317.1	1393	258.4	1393	907.2	396.8	453.6	396.8
8.5	272.3	525.0	136.1	525.0	685.5	1322	342.8	1322	272.3	1322	996.6	361.2	498.3	361.2
9.0	285.8	487.2	142.9	487.2	738.9	1260	369.4	1260	285.8	1260	1091	329.9	545.5	329.9
9.5	298.9	453.0	149.5	453.0	794.4	1204	397.2	1204	298.9	1204	1191	302.2	595.5	302.2
10.0	312.0	421.6	156.0	421.6	854.1	1154	427.0	1154	312.0	1154	1297	277.5	618.5	277.5
11.0	336.1	367.4	168.1	367.4	979.8	1071	489.9	1071	336.1	1071	1529	235.5	704.5	235.5
12.0	359.1	321.7	179.5	321.7	1119	1002	550.5	1002	359.1	1002	1788	201.3	804	201.3
13.0	380.5	282.8	190.3	282.8	1273	946.1	636.3	946.1	380.5	946.1	2080	173.1	1040s	173.1
14.0	400.4	249.4	200.2	249.4	1443	899.1	721.5	899.1	400.4	899.1	2407	149.6	1204	149.6
15.0	418.8	220.4	209.4	220.4	1632	859.6	816.0	859.6	418.8	859.6	2773	129.8	1387	129.8
16.0	435.8	195.1	217.9	195.1	1847	826.0	923.2	826.0	435.8	826.0	3186	113.0	1598	113.0
17.0	451.5	172.9	225.7	172.9	2083	797.3	1042	797.3	451.5	797.3	3648	98.68	1824	98.68
18.0	465.8	152.5	232.9	152.5	2344	772.8	1172	772.8	465.8	772.8	4166	86.4	2083	86.4
19.0	479.0	136.4	239.5	136.4	2670	751.7	1335	751.7	479.0	751.7	4748	75.8	2374	75.8
20.0	490.4	121.2	245.2	121.2	2970	733.3	1485	733.3	490.4	733.3	5400	66.66	2700	66.66
22.0	511.7	95.9	255.9	95.9	3753	703.6	1877	703.6	511.7	703.6	6954	51.72	3477	51.72
24.0	528.8	76.0	264.4	76.0	4737	680.8	2369	680.8	528.8	680.8	8910	40.4	4455	40.4
26.0	542.7	60.3	271.4	60.3	5985	663.4	2992	663.4	542.7	663.4	11370	34.66	5685	31.66
28.0	554.1	47.8	277.0	47.8	7550	649.7	3775	649.7	554.1	649.7	14472	24.87	7236	24.87
30.0	563.0	37.99	281.0	37.99	9500	639.2	4750	639.2	563.0	639.2	18372	19.58	9186	19.58
32.0	570.6	30.16	285.3	30.16	11930	630.9	5967	630.9	570.6	630.9	23286	15.46	11643	15.46
34.0	576.5	23.95	288.3	23.95	15000	624.4	7500	624.4	576.5	624.4	29472	12.21	14736	12.21
36.0	581.1	18.98	290.6	18.98	18960	619.3	9480	619.3	581.1	619.3	37200	9.66	18630	9.66
38.0	585.1	15.11	292.5	15.11	23820	615.3	11910	615.3	585.1	615.3	47058	7.65	23529	7.05
40.0	588.1	12.00	294.1	12.00	30000	612.1	15000	612.1	588.1	612.1	59400	6.06	29700	6.06

## Volume Level to Power and Voltage Conversion

REFERENCE LEVEL: 0 DBM = 1 MW, 600 OHMS

MILLIWATTS	VOLTS	DBM	WATTS	VOLTS	DBM
0.000001	0.0007746	-60	0.001000	0.7746	0
0.000010	0.002449	-50	0.002512	1.228	+4
0.000100	0.007746	-40	0.006310	1.946	+8
0.001	0.02449	-30	0.01000	2.449	+10
0.010	0.07746	-20	0.1000	7.746	+20
0.100	0.2449	-10	1.000	24.49	+30
1.000	0.7746	0	10.00	77.46	+40

# ENGINEERING DATA

## Distance in Miles From an FM Transmitter to Its 54 dbu (0.5 mv/m) Contour for Various Heights and Powers

### POWER IN DBK

AHAAT IN FT	-20	-18	-16	-14	-12	-10	-8	-6	-4	-2	0	2	4	6	8	10	12	14	16	18	20
3400	20	23	26.5	30	34	38	42	47.5	51.5	55	60	65	69.5	73	78	82	87	91.5	95	100	113.5
3200	19	22	25	29	32.5	37	40.5	45	50	53.5	58.5	63	67	71	75	80	85	90	93	97	100.5
3000	18.5	21.5	24.5	28	31.5	35	40	43	48	52	56.5	60.5	65	69.5	73	77.5	82	86.5	91.5	95	98.5
2800	18	20.5	23	27	30	33.5	38	42	45.5	50	54.5	58.5	63	67	71	75	80	84	89	93	96
2600	17.5	20	22	25.5	29	32	36	40	44.5	48.5	52	56	60	65	69	73	77	81.5	85.5	90	94
2400	17	19	21.5	24.5	28	31	35	38.5	42	46	50.5	54.5	58.5	62	67	70.5	75	78.7	83	88	92
2200	16	18.2	20	23	26.5	29	32.5	36.5	40	44.5	48	52	55.5	60	65	68	72	76.5	80	85	90
2000	15	17.4	19	22	25	28	31	35	38	42	45.5	50	53	57	61.5	65	69.5	73.7	78	82	86
1900	15	17	18.5	21.5	24.5	27	30	33.5	37.5	40.5	45	48.5	52	55.5	60	64	68	72	76	80	85
1800	14	16	18	20.5	23	26.5	29	32.5	36	40	43	47.5	51	55	58.5	62.5	66	70	75	79	83
1700	13.5	15.5	17.5	20	22.5	25	28	31.5	35	38	42	45.5	50	53	57	60.5	65	69	71.5	77	81
1600	13	15	17	19	21.5	24.5	27	30	33	36.5	40.5	44	48	52	55.5	60	63	67	71	75	80
1500	12.5	14.6	16.5	18.5	21	23.5	26.5	29.5	32	35.5	39.5	43	46.5	50	54.5	58	61.5	65	69.5	73	78
1400	12	14	16	18	20	22	25	28	30.5	34.5	38	41.5	45	48.5	52.5	56	60	63	67	71.5	75
1300	11.5	13.4	15.5	17	19	21.5	23.5	27	30	32.5	36	40	43	47	50.5	55	58	61.5	65	70	73.5
1200	11	13	14.5	16.5	18.5	20.5	23	25.5	28	31	35	38	41.7	45	48.5	52.5	56	60	63	67	71.5
1100	10	12	13.5	15.5	17.5	19.5	21.5	24.5	26.5	30	33	36.5	40	43	47	50.5	54.5	58	61.5	65	70
1000	9.1	11.5	13	15	17	18.5	20.5	23	25.5	28	31.2	34.5	38	41	45	48	52	56	58.5	63	68
900	8.7	10.5	12	14	16	18	19.5	21.5	24.5	27	29.6	32.5	35.5	38.5	42.5	46	50	54	57	60.5	65
800	8.2	9.2	11.5	13	15	16.5	18	20	22	25	28	30.5	33.5	37	40	43	47.5	52	55	58.5	63.5
700	7.7	8.7	10.5	12	13.5	15.5	17	18.5	21	23	26	28.5	32	35	38	41	45	49	53	56.5	63
600	7.2	8	9	11	12	14	15.5	17.5	19	21.5	24	26.5	28.7	32	35	38	42	45.5	50	55	60
500	6.5	7.3	8.2	9	11	12.5	14	16	17.5	19	22	24	27	29	32.5	35.5	38.5	43	47	52	57
400	5.8	6.6	7.3	8.3	8.5	11	12.5	14	16	17.5	19	22	24.5	27	29.5	32	35.5	40	43.5	49.5	55
300	5	5.7	6.5	7.2	8	8.7	10.5	12	13.5	15	17	18.5	21	23.5	26.5	28.5	32	35.5	40	45.4	52
200	4	4.6	5.2	5.7	6.5	7.3	8.2	9	11	12	13.7	15.5	17.5	19	22	24.5	28	31.5	35	42	48
100	2.8	3.2	3.7	4.1	4.6	5.2	5.8	6.6	7.4	8.2	9	10.7	12.5	14	16	18.2	21.5	25	30	35.5	45

## Distance in Miles From an FM Transmitter to Its 60 dbu (1 mv/m) Contour for Various Heights and Powers

### POWER IN DBK

AHAAT IN FT	-20	-18	-16	-14	-12	-10	-8	-6	-4	-2	0	2	4	6	8	10	12	14	16	18	20
3400	11	13	15	17.5	20	22.5	27	30	34	37	40.5	45	49	52	57	60	64	65	65	65	65
3200	11	12.2	14.5	16.5	19.5	22	25	28.5	32	39	42.5	47	50.5	55	59	62	64	65	65	65	65
3000	10.5	12	14	16	19	21.5	24.5	28	31	34	38	41	45	49.5	53	57	60	64	65	65	65
2800	10	11.8	13.5	15.7	18	20.5	24	26.5	30	33	36	40	44	48	51	55	59	62	64	65	65
2600	9.7	11.5	13	15	17	20	22.5	25.5	29	32	35	39	42	46	49.5	53	58	60	63	64	65
2400	9.4	11	12.8	14	16	19	21.5	24.5	28	30.5	34	37	40	44	47.5	51	55	59	61	64	65
2200	9.2	10.8	12	13.5	15.5	18	20.5	23.5	26	29	32	35	39	42	45.5	49	52	56.5	59.5	62	65
2000	9	10.2	11.7	13.1	15	17	20	22	25	28	30	33.5	37	40	44	46.5	50.5	54	57.5	60.5	65
1900	8.7	10	11.2	12.7	14.5	16.5	19	21.5	24.5	27	29.5	33	35.5	39	43.5	45.5	49.5	52.5	55.5	59.5	62
1800	8.5	9.7	11	12.6	14	16	18	20.5	23.5	25.5	29	31.5	35	38.5	43	44.5	48.5	51.5	55	59	61
1700	8.3	9.2	10.5	11.6	13.8	15.5	17.3	20	22.5	25	28	30	33	37	40	43	46.5	50	53	57.5	60
1600	8.1	9	10.3	11.5	13.2	15	17.1	19.2	21.5	24	26.5	29.5	32.5	35.5	39	42	45	49	51.5	55	58
1500	8	9	10	11.4	13	14.9	16.9	18.6	21	23	26	28.5	31.5	35	38	40.5	44	47	50.1	54	57
1400	7.5	8.6	9.7	11.2	12.5	14	16.2	18	20	22	25	27.5	30	33	36	40	43	46	48.5	52	55
1300	7.3	8.2	9.3	10.5	12	13.8	15.5	17.5	19	21.5	24	26.5	29	32.5	35	39	41.5	45	47.5	51	54
1200	7	7.8	9	10	11.5	13	15	17	18	21	23	25.5	28	31	34	37.5	40	44	46	49	52
1100	6.8	7.6	8.5	9.5	11	12.5	14.5	16	17.1	20	22	24.5	26.5	29.5	32	35	38	41	44.5	47	50
1000	6.4	7.2	8	9	10.2	12	14	15.6	17	19	21	23	25.5	28	31	34	36.5	40	43	46.5	49
900	6.2	6.8	7.8	8.8	9.7	11.2	13	14.5	16.4	18	20	21	24.5	26	29	32	35	38	40.5	44	47
800	5.8	6.6	7.3	8.2	9.2	10.3	12	13.5	15.2	17	18.5	20.5	23	25	27.5	30	33	36	39	41.5	45
700	5.4	6.2	7	7.8	8.6	9.7	10.5	13	14	16	18	19.2	21	24	26	28.5	31	33	36	39	42
600	5	5.7	6.5	7.1	8	9	9.8	11.8	12.3	14.5	16	18	19.7	21.5	24	26	29	32	35	36.5	40
500	4.6	5	5.8	6.6	7.3	8.2	9	10	12	13.2	14.5	16.1	17.9	20	22	24.5	27	29.5	31.5	35	37
450	4.2	4.8	5.5	6.2	7.0	7.8	8.6	9.6	10.5	12.5	14.0	15.2	17.0	19.0	20.5	23.0	25.4	28	30	33	36
400	4	4.6	5.1	5.9	6.6	7.4	8.2	9	10	11.8	12.5	14.5	16	17.8	19.8	21.5	24.5	26.5	29	31.5	35
350	3.8	4.2	4.8	5.3	6.1	7.0	7.8	8.6	9.5	10.3	11.0	14.0	15	16.8	18.5	20.2	23	25	27.5	30	33
300	3.6	4	4.5	5	5.7	6.3	7.2	8	8.8	10	10.5	12.6	14	15.6	17	19	21	23	25.5	28	30
250	3.2	3.7	4.0	4.6	5.1	5.9	6.7	7.3	8.0	8.9	9.9	10.6	12.5	14.0	15.8	17.8	19	21.5	24	26	28
200	2.9	3.3	3.7	4.1	4.7	5.1	5.9	6.6	7.4	8.1	9	10	11.3	12.5	14	15.5	17.5	19.5	21.5	24	26
150	2.5	2.8	3.2	3.6	4.0	4.5	5.0	5.7	6.4	7.1	7.9	8.8	9.7	10.8	12	14.0	15.2	17.0	19	21	24
100	2	2.3	2.7	2.9	3.2	3.8	4.1	4.7	5.2	5.9	6.5	7.4	8.3	9	10	11.3	12.9	14.5	16.2	18.1	20



## Distance in Miles From an FM Transmitter to Its 80-dbu (10 mv/m) Contour for Various Heights and Powers

AHAAT IN FT	POWER IN DBK																				
	-20	-18	-16	-14	-12	-10	-8	-6	-4	-2	0	2	4	6	8	10	12	14	16	18	20
3400	1.3	1.8	2.1	2.6	3.2	4.0	4.8	6.0	7.3	9	12.5	15	18	20	23	26.5	30	34	38	42	46.5
3200	1.3	1.8	2.1	2.6	3.2	4.0	4.8	6.0	7.3	8.8	12	15	17	19	22	25	29	32.5	36.5	40.5	45
3000	1.3	1.8	2.1	2.6	3.2	4.0	4.8	6.0	7.1	8.5	11.5	14.5	17	18.5	21.5	24.5	28	31.5	35	40	43
2800	1.3	1.8	2.1	2.5	3.2	4.0	4.8	5.9	7.1	8.4	11.3	14	16	18	20	23	26.5	30	34	38	41.5
2600	1.3	1.8	2.1	2.5	3.2	4.0	4.7	5.8	7.0	8.1	11	13	15.5	17.5	19.6	22	25.5	29	32	35.5	40
2400	1.3	1.8	2.1	2.5	3.2	3.9	4.7	5.7	7.0	8.1	10.5	12.5	15	17	19	21.5	24.5	27.5	30.5	35	38.5
2200	1.3	1.8	2.1	2.5	3.2	3.8	4.7	5.6	6.8	8	10	12	14.5	16.5	18	20	23	26.5	29.5	32.5	36.5
2000	1.3	1.8	2.0	2.5	3.1	3.8	4.6	5.4	6.7	7.8	9	11.5	13.5	15	17.5	19.5	21.5	25	28	31	35
1900	1.3	1.8	2.0	2.5	3.0	3.7	4.6	5.3	6.6	7.7	9	11	13	14.8	17	19	21	24.5	27	30	34
1800	1.3	1.8	2.0	2.5	3.0	3.7	4.5	5.3	6.3	7.6	8.7	10.5	12.5	14.5	16.5	18.5	20.5	23	26	29	32.5
1700	1.3	1.8	2.0	2.4	2.9	3.6	4.4	5.2	6.1	7.3	8.4	10	12	14	15.5	18	20	22	25	28	31
1600	1.2	1.7	2.0	2.3	2.9	3.6	4.3	5.1	6	7.0	8.1	9.2	11.8	13.5	15	17.5	19	21.5	24.5	27	30
1500	1.2	1.7	2.0	2.3	2.8	3.6	4.2	5.0	5.9	7.0	8.0	9.0	11	13	14.5	17	18.5	20.5	23	26	29
1400	1.2	1.7	1.9	2.3	2.8	3.5	4.2	5.0	5.7	6.7	7.7	8.7	10.5	12	14	16	18	20	22	25	28
1300	1.2	1.7	1.9	2.2	2.7	3.4	4.1	4.8	5.6	6.4	7.4	8.3	10	11.5	13	15	17	19	21.5	24	26.5
1200	1.2	1.7	1.8	2.2	2.7	3.3	4.0	4.7	5.4	6.2	7.1	8	9.2	11	12.5	14.5	16.5	18	20.5	23	25.5
1100	1.2	1.7	1.8	2.2	2.7	3.2	3.9	4.6	5.2	6	6.8	7.8	8.7	10.2	11.5	14	15.5	17.5	19.5	22	24.5
1000	1.2	1.6	1.8	2.2	2.6	3.1	3.8	4.4	5	5.8	6.4	7.2	8.2	9.2	11	13	15	17	18.5	20.5	23
900	1.2	1.6	1.7	2.1	2.6	3	3.7	4.2	4.8	5.6	6.2	7.0	7.8	8.8	10.5	12	14	16	18	19	22
800	1.2	1.5	1.7	2.1	2.5	2.9	3.4	3.9	4.6	5.1	6.0	6.7	7.4	8.3	9.3	11.5	13	15	16.5	18	20
700	1.2	1.5	1.7	2.0	2.4	2.8	3.2	3.7	4.2	4.8	5.5	6.3	7.0	7.8	8.8	10	12	13.5	15.5	17	18.5
600	1.2	1.4	1.7	1.9	2.3	2.7	3.0	3.4	3.8	4.5	5.0	5.8	6.5	7.2	8	9.0	10.5	12.5	14	15.5	17.5
500	1.1	1.4	1.6	1.8	2.1	2.5	2.8	3.2	3.6	4	4.6	5.2	6	6.7	7.5	8.2	9.2	11	12.5	14.5	15.5
400	1.0	1.3	1.5	1.7	2.0	2.2	2.6	2.8	3.2	3.7	4.1	4.7	5.2	6.0	6.7	7.5	8.2	9.1	11	12.5	14.5
300	0.9	1.2	1.3	1.5	1.8	1.9	2.2	2.6	2.8	3.2	3.6	4	4.5	5.0	5.8	6.2	7.2	7.8	8.9	10.5	12
200	0.8	1.0	1.2	1.3	1.5	1.7	1.8	2	2.3	2.6	3.0	3.3	3.8	4.2	4.7	5.2	6.0	6.7	7.5	8.2	9.0
100	0.5	0.6	0.8	0.9	1.0	1.2	1.3	1.5	1.7	1.9	2.0	2.3	2.7	3.0	3.3	3.7	4.2	4.7	5.2	6.0	6.8





# SALES & SERVICE

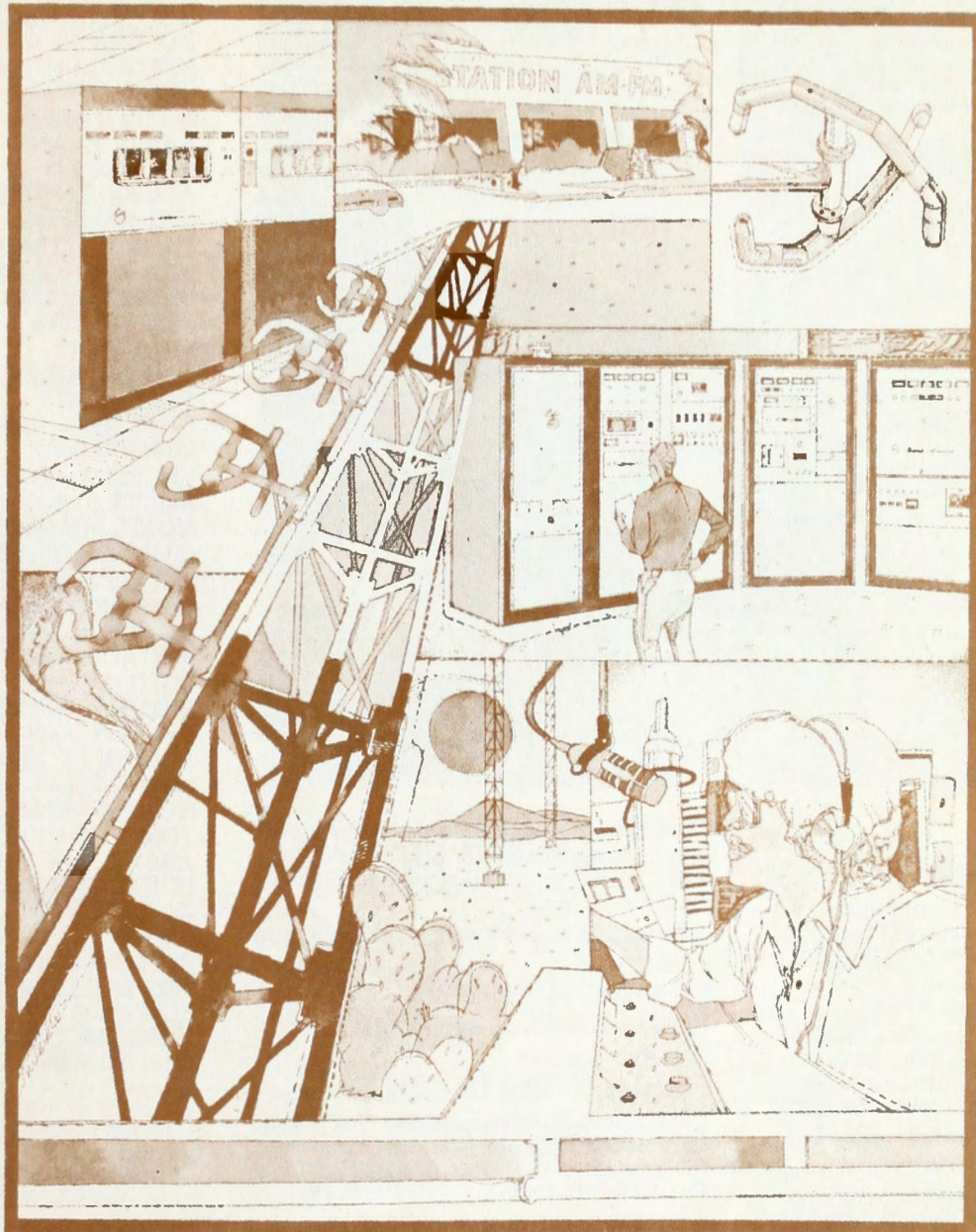

# SALES & SERVICE

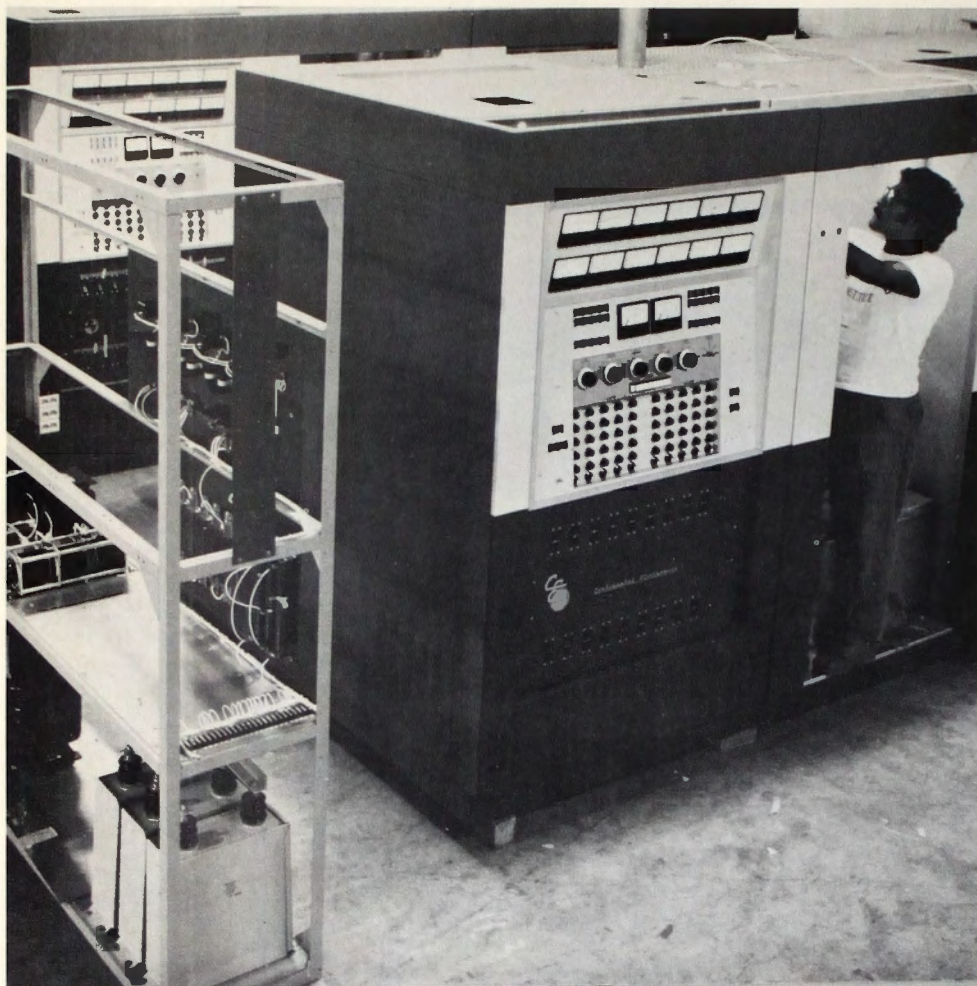

## Sales and Service for Continental Electronics Broadcast Transmitters

Continental broadcast equipment and existing Collins radio transmitters are serviced by a world-wide Continental field support and marketing group headquartered in Dallas, Texas.

All products and prices in this catalog are subject to change without notice.

For price or delivery information, contact your Continental representative.

10 District Managers handle sales for stations in the United States.

Sales to stations in Canada, Arizona, New Mexico, Utah, Hawaii and Puerto Rico are handled from the home office in Dallas, Texas.

International sales are handled thru local sales representatives.

A. V. Collins, Vice President/  
Domestic Broadcast Marketing

E.L. King, Jr., Vice President/  
International Broadcast Marketing

R.L. Floyd, Manager/  
Domestic Broadcast Sales

Continental Electronics offers parts and engineering service for all Continental and Collins radio broadcast equipment 24-hours a day.

You can phone our service numbers day or night.

**(214) 327-4532 parts**

**(214) 327-4533 service**

**Telex: 73398**

**Cable: CONTRONICS**

Continental Electronics Mfg. Co.  
4212 South Buckner Boulevard  
PO Box 270879; Dallas, Texas 75227  
Ph: (214) 381-7161

## Domestic District Managers

### NORTHEAST

MARK F. HUTCHINS  
P.O. BOX 13  
GREENLAND, NH 03840  
(603) 436-4059

KEITH A. LEACH  
P.O. BOX 16  
NEWTON, NJ 07860  
(201) 383-8797

### SOUTHEAST

RAY C. EVANS  
P.O. BOX 143  
ALCOA, TN 37701  
(615) 970-2572

DAVE HULTSMAN  
2280 ROCKCREEK TRAIL  
BIRMINGHAM, AL 35226  
(205) 822-1078

### MIDWEST

JOHN D. ABDNOUR  
P.O. BOX 575  
STREATOR, IL 61364  
(815) 672-8585

LLOYD W. COLLINS  
ROUTE 3, BOX 106  
HOLTS SUMMIT, MO 65043  
(314) 896-5791-5365

JIM LITTLEJOHN  
670 NORTH BRANCH RD.  
MAPLE PLAIN, MN 55359  
(612) 479-2633

### SOUTHWEST

STEVE H. SCHOTT  
P.O. BOX 2008  
PLANO, TX 75075  
(214) 423-3644

### NORTHWEST

TOM T. CAUTHERS  
1215 SE 73rd AVE.  
PORTLAND, OR 97215  
(503) 254-2818

### WEST

STEVE KEATING  
7225 HOLLYWOOD BLVD.  
SUITE 105  
HOLLYWOOD, CA 90046  
(213) 851-6380



## International Sales Representatives

### ABU DHABI, U.A.E.

International Trading Circle Box 592;  
Sh. Ahmed Bin Hamed Bldg. Hamden  
Rd. Telex: 23826 DHRETO EM

### ARGENTINA, S.A.

CIA Standard Electric Argentina  
S.A.I.C. Corrientes 311 - 9th Floor  
Buenos Aires 1043 Telex: 21151 KOBEO  
AR & 26070 Ph: 311-3300/8388  
32-4041/4042/4043/7146

### AUSTRALIA

Rank Electronics Pty Ltd.  
60 Rosebank Ave.; Clayton South  
Victoria 3169; Telex: 31904 AA  
Ph: (03) 541-8444  
16 Suakin St.; Box 2073; Pymble,  
N.S.W. 2073 Telex: 71289 AA  
Ph: (02) 449-5666

### BANGLADESH

Shell Co.; Akbari House; 9H, Motijheel  
Commercial Area Dacca-2 Telex: 667  
VIKING DAC Cable: PARSHELL  
Ph: 255464

### BRAZIL

Larex Electronica, Ltda Av. N.S.  
Copacabana, 195, Grupo 1301; Rio de  
Janeiro 22020 Telex: 2121616 LREX BR  
Ph: 542-4343

### CHILE

Raylex Representaciones y  
Servicios S.A.  
Box 13373; Santiago  
Telex: 40406 RYLEX CL Ph: 749835

### TAIWAN 104, ROC

Heighten Corp.; Box 46-65; Taipei  
Telex: 21472 HEIGHTEN; Cable:  
HEIGHTEN Ph: 551-9916

### COLOMBIA, S.A.

Auditron, Ltda.; Avenida 9<sup>a</sup> No. 118-71  
Oficina 201; Bogota 2 Ph: 2131002,  
2131170, 2143191; Telex: 43415 HEGAS  
CO

### EGYPT ARE

Electrical & Telecommunications  
Engineering; 5, Kasr El Nil St.; Cairo  
Telex: 93915 ETSAS; Ph: 750755 &  
750683

### ENGLAND

Lee Engineering, Ltd; Napier House  
Bridge St.; Walton-on-Thames; Surrey  
KT12 1AP; Telex: 928475 LEETEK G  
Ph: 44-9322 + 43124, 5, 6

### BELGIUM

Eurotech Marketing (Overseas) Ltd.  
Avenue De La Tanche 2; B-1160  
Brussels Telex: 25387 Ph: 660 49 78

### HONG KONG

Eastern Union (H.K.) Ltd.; Rm. 1725A;  
Prince Bldg.; Des Voeux Rd., Central  
Cable: MARENORP (via RCA)  
Ph: 5-236322, 5-244465

### ICELAND

G. Helgason & Melsted, Ltd.; Box 528  
Raudararstig 1, Reykjavik; Telex: 2145  
Cable: MELSTED REYKJAVIK  
Ph: 11644

### INDIA

The National Radio & Electronics Co.,  
Ltd. "Unity House"; 8, Mama  
Parmanang Marg; Bombay. Telex:  
011-3902 NELBOM Cable: NELCOFF  
Ph: 336441

### INDONESIA

Elektronika Nusantara P.T.; Box  
234/JKT Jakarta, Telex: 44337  
ELNUSA Ph: 596411/592023

### ISRAEL

Rapac Electronics Ltd.; Box 18053  
Tel Aviv 61 180. Telex: 33528  
Ph: 454 246 & 477 155

### ITALY

Elco, s.r.l.; Via Del Sansovino, 6 Rome.  
Ph: 396-6344 & 396-6398 Telex: 613471

### JORDAN

W.R. Abdul-Hadi & Co.; Box 855  
Amman. Telex: 1266 MEKANO JO  
Cable: MEKANO Ph: 22561

### MEXICO

Servicios En Comunicaciones  
Electricas y Electronica, S.A.; Sta.  
Eduwiges 2819 Primer Piso;  
Guadalajara, Jalisco  
Telex: 0684043 Ph: 164415 & 166600

### MEXICO, CENTRAL AMERICA & COLOMBIA

National Products Co., Inc; 8809  
Grenore; Dallas, Texas 75218  
Ph: 214-327-6677

### MOROCCO

Etablissements Hubert Dolbeau & Fils;  
Boite Postale 133; Casablanca  
Telex: 23051 M; Cable: MATERIO  
Ph: 30-41-82/30-68-38

### NETHERLANDS ANTILLES

Industrial Electronics (Antilles) N.V.  
Centro Comerical Antilia 1; Curacao  
Telex: 1125 INDELNA;  
Cable: INDELECA  
Ph: 37201 & 37202

### NEW ZEALAND

Pacific Communications Systems, Ltd.  
CNR. Fleet & Macaulay St.; Box 460  
Auckland. Telex: 791-21057 (NO  
ANSWERBACK)  
Ph: 771-501 or 775-118  
1 Southern Cross Crescent; Box 227  
Wellington. Telex: 3353 ANSERWN NZ  
Ph: 724-702 & 837-129

### NIGERIA

RMP Telecommunications;  
Royal London;  
22/25 Finsbury Sq.; London, EC2P  
England. Telex: 888240 "STEEL" Cable:  
MINPLAN LONDON EC2 Ph:  
01-606-7000

### PAKISTAN

The Modern Trading Co.; Box 7103,  
Mahboob Chambers; Karachi 3. Cable:  
MODERTRACO; Telex: 95224603  
LINTA PU Ph: 51 08 05

### REPUBLIC OF PANAMA

Tropelco. S.A.; Apartado 8465;  
Panama 7  
Telex: 3318 TROPELCO PG;  
Cable: TROPELCO  
Ph: 23-1285 & 23-6157

### PERU

Fernando Ezeta B. s.r.l.; Casilla 3061  
Lima. Telex: 25811 PE SULCOSA  
Cable: FEPERU Ph: 45-2335

### PORTUGAL

Soc. Com. Crocker, Delaforce & Co.  
Box 2738; 1118 Lisboa Codex; Lisbon.  
Telex: 12 328 CRODEL P  
Ph: 680141, 2, 3, 4

### QATAR

Al Nasr Trading Organization; Box 28  
Doha. Telex: 4242 ALNASR DH;  
Ph: 22230 Cable: ALNASR DOHA

### SINGAPORE & BRUNEI

Anrite Aviation Co., Pty. Ltd.; 508 West  
Camp, Seletar Airport; Box 53; Jalan  
Kayu Post Office; Singapore 28. Cable:  
ANRITE Telex: 24353 AVION RS  
Ph: 481377778/79

### SOUTH AFRICA

Communications Technology (Pty.) Ltd.  
Box 1030; Kempton Park 1620.  
Telex: 8-6401 Ph: (011) 970-3416

### SPAIN

Busling, S.A.; Orense 24; Madrid-20.  
Ph: 42435; Cable: BUSLING SA  
Ph: 455 0228 + 455 1231

### SUDAN

FOM Trading Co.; Box 1876; Khartoum  
Telex: 626 FOM KM; Ph: 73654 &  
73882

### THAILAND

Siam Teltech Co. Ltd.; Box 2718;  
29/3 Saladaeng S011 Rd.; Bangkok.  
Telex: TH2631; Cable: SITECO  
BANGKOK Ph: 235-0515

### TRINIDAD & TOBAGO

Edgar H. Borde Ltd.; Box 897;  
Port-of-Spain. Telex: 3481 BORAD  
Cable: BORAD, Trinidad Ph: 662-3652  
4000, 4773

### URUGUAY

Farell & Boix Ltda.; Coronel Alegre  
1222 Montevideo. Telex: 822 DEAMSAL  
UY Ph: 78 72 46

### VENEZUELA

Corporacion Electronica, S.A.; Apartado  
Correos 60.856; Caracas. Cable:  
CORELSA Telex: 27876 CPBTH VE  
ATTN: CORELSA Ph: 02-322765,  
02-313479 & 02-723893

### ZAMBIA

International Aeradio (Zambia) Ltd.  
Box 31253; Lusaka. Telex: ZA 43260  
Cable: INTAERIO; Ph: 212083 &  
217020

# SALES & SERVICE

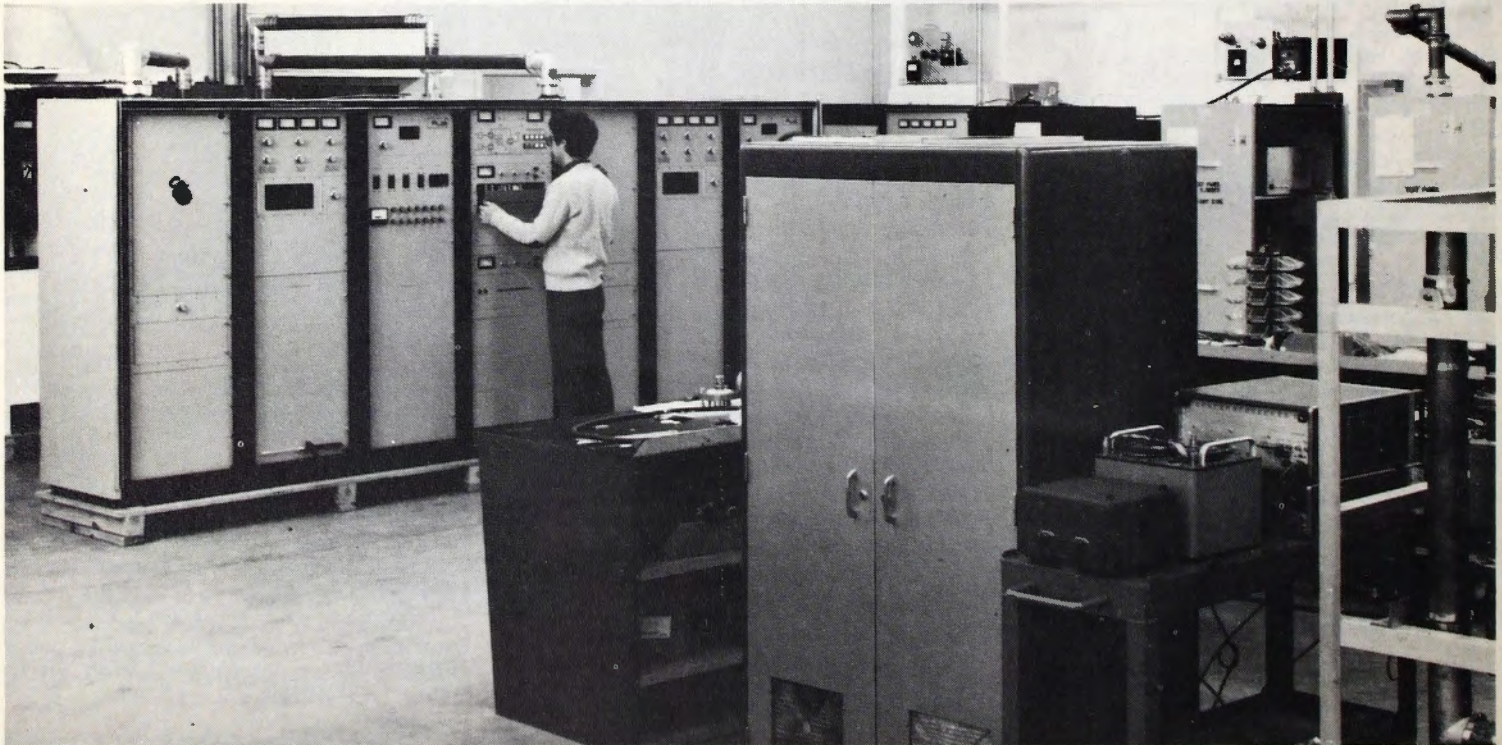
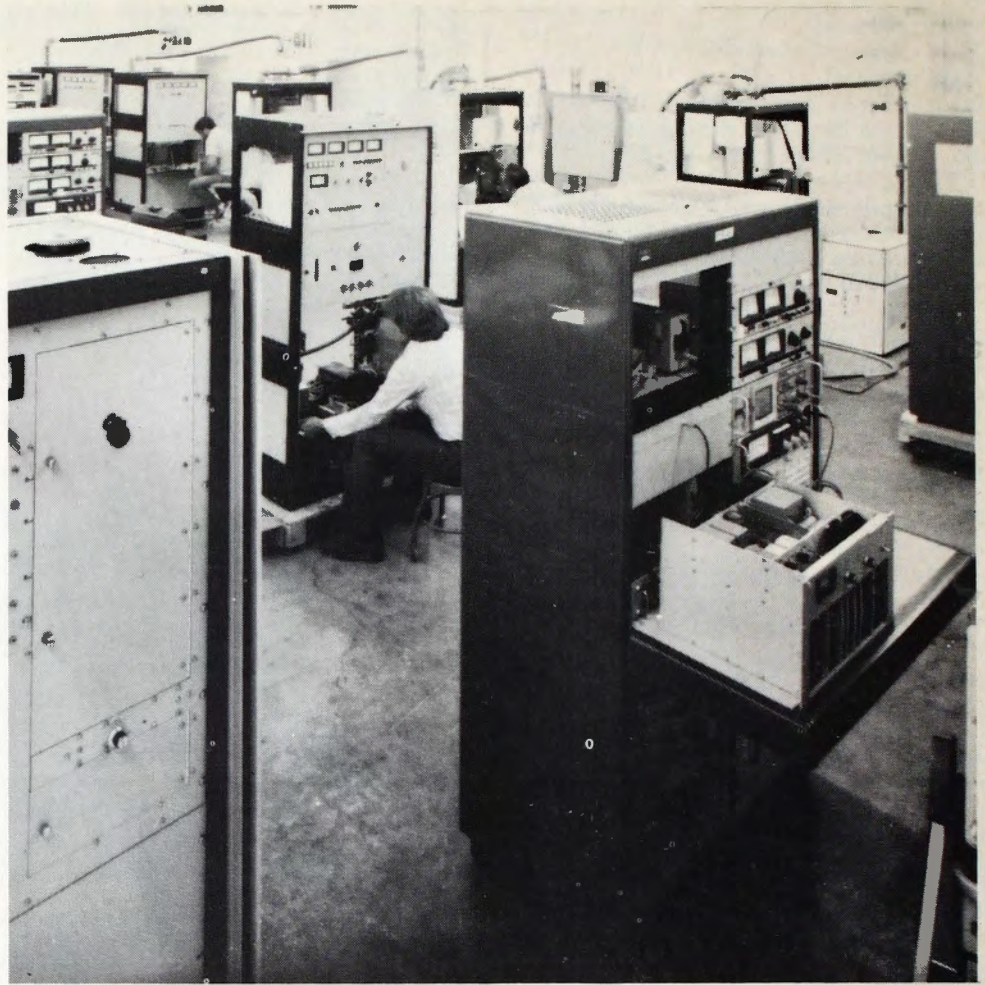

*Continental Electronics*   
Continental Electronics Mfg. Co. Box 270879 Dallas, Texas 75227 (214) 381-7161