

**QUALITY DESIGN  
PUTS CONTINENTAL FIRST**

Continental Electronics was first to use silicon solid-state high voltage power supplies in broadcast transmitters; the result of a pioneering effort that has kept Continental transmitters at the forefront of advanced design concepts since the 40's.

Continental's Type 315/316F 5,000/10,000 watt AM transmitter utilizes state-of-the-art concepts combined with solid-state devices to give broadcasters consistent quality and performance with high reliability. Transistors with conservative safety margins assure long-term reliability and contribute to excellent audio frequency response and low distortion and noise characteristics.

With only two tubes, a blower for cooling and a minimum of relay contacts, the 315/316F is easy to maintain and gives outstanding performance. Customer letters cite examples of 30,000 hours and more of transmitter operation without a moment of unscheduled down time.

**QUALITY MODULATION**

The Type 315/316F transmitter has two sections: a completely transistorized exciter and a two-tube high-efficiency amplifier. The exciter uses 24 NPN transistors; (11) 2N697 transistors are used in low level stages and (13) DTS-423 are used in the power stages.

Modulation takes place in the 40 watt output stage of the exciter. This "collector-modulation" technique eliminates critical tuning adjustments and is almost identical to plate modulation except that no transformers or chokes are used. Audio output is applied simultaneously to the RF driver and output transistors. This dual-level modulation technique gives the 315/316F the capability of providing the maximum positive modulation peaks allowed by the FCC (125%) with very low distortion and ample reserve without increasing carrier power.

**5,000 OR 10,000 WATTS**

The Type 315F is a 5,000 watt AM broadcast transmitter; the Type 316F is a 10,000 watt AM broadcast transmitter. The transmitters are virtually identical, the primary difference being the PA tubes.

**QUALITY SOUND  
WITH SIMPLE CIRCUITRY**

Continental's Type 315/316F uses a high-efficiency linear amplifier for simplicity and reliability. The 315F 5,000 watt transmitter uses two 4CX10000D tubes in the amplifier while the 316F 10,000 watt transmitter uses two 4CX15000A tubes in its amplifier. This conservative application assures long tube life.

The two-tube high-efficiency amplifier is used because of its relative simplicity as compared to other complex systems using variable width rectangular pulses or dual channel phase variable waveforms.

The Type 315/316F transmitter tunes easily in a straightforward manner. Modulated output from the 40-watt solid-state exciter drives the high-efficiency amplifier. Since the amplifier tubes are not driven into grid current, a stable resistance load is used to dissipate output from the exciter. This allows grid and transistor output circuits to be fixed-tuned with predetermined coil-tap settings; without variations from tube to tube. Drive level is adjusted by meter indication, and the plate circuit is adjusted by minimizing the PA plate current with the plate tuning capacitor.



**SPECIFICATIONS**

**Carrier Power, Type 315F:**

Rated 5 kW  
Capability 5.5 kW

**Carrier Power, Type 316F:**

Rated 10 kW  
Capability 10.6 kW

**Modulation:**

Collector modulation of rf driver stage

**Emission:**

A3

**Frequency Range:**

Any single frequency 535-1620 kHz

**Frequency Stability:**

±5 Hz

**Audio Input:**

150/600 ohms, +10 dbm, ±2 db for 100% modulation

**Audio Response:**

20-15,000 Hz ±1.5 db

**Audio Distortion:**

30-10,000 Hz, less than 3%

**Carrier Shift:**

3% or less at 100% modulation

**Modulation Capability:**

100% continuous at any frequency 30-10,000 Hz  
125% positive peak with asymmetrical input

**Noise:**

-60 db below 100% modulation

**Spurious & Harmonic Emissions:**

-80 db

**Output Impedance:**

50 to 250 ohms, unbalanced

**Power Source:**

208/230V, 3 phase, 50/60 Hz

**Permissible Combined Voltage Variation:**

±5%

**Power Factor, Type 315F:**

94%

**Power Factor, Type 316F:**

92%

**Power Consumption, Type 315F:**

11.2 kW @ 0% modulation  
11.5 kW @ 30% modulation  
12.2 kW @ 75% modulation  
14.2 kW @ 100% modulation

**Power Consumption, Type 316F:**

23.6 kW @ 0% modulation  
24.1 kW @ 30% modulation  
26.5 kW @ 75% modulation  
28.4 kW @ 100% modulation

**Altitude:**

7,500 feet (2286 meters) higher by special order

**Ambient Temperature:**

-10°C to +45°C

**Cooling:**

Forced air

**Size, Type 315F or 316F:**

66 1/8" wide, 25 1/2" deep, 77 1/8" high (168 CM wide, 65 CM deep, 196 CM high)

**Net Weight:**

Type 315F: 1,500 lbs. (680 kilos)  
Type 316F: 1,650 lbs. (748 kilos)

**Export Shipping:**

Gross weight 2480 lbs. (1124.9 kilos);  
173.1 cubic feet (4.9 cubic meters)



**Continental Electronics**

CONTINENTAL ELECTRONICS MFG. CO. New Mailing Address:  
P. O. Box 270879  
Dallas, Texas 75227

(214) 381-7161



Printed in USA 2M375K





**QUALITY TALKS**

- Loud Sound**  
 125% positive peak handling capability of asymmetrical audio processing.
- Quality Sound**  
 No transformer in audio system. Transparent – faithfully reproduces program content.
- Excellent Performance**  
 Exceeds all FCC, DOC and CCIR specifications.
- Efficient Operation**  
 On-the-air five seconds from cold start. Low power consumption. Designed for unattended operation.
- High Reliability**  
 Quality workmanship, conservative design. Customers report, "We have passed 30,000 hours without unscheduled down time."
- State-Of-The-Art Design**  
 All solid-state exciter. Only two tubes, one tube type. 24 transistors, 2 types.
- Simplicity – No Complex Circuitry**  
 Easy to install, operate and maintain.
- Magniphase**  
 Provides transmission line, antenna and tuning equipment protection.
- Small Size and Weight**  
 Economical to ship and install.

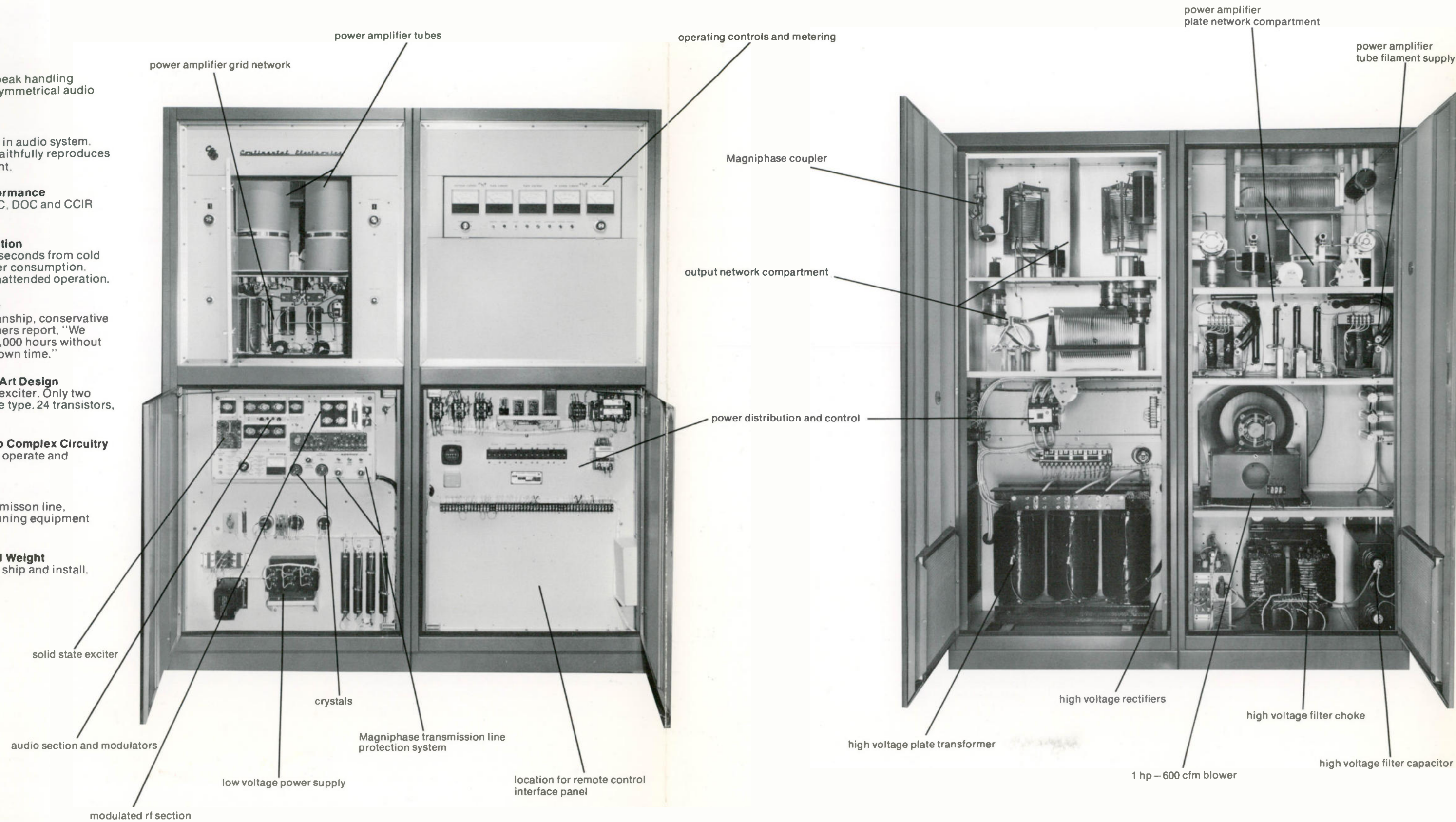

**CONTINENTAL ELECTRONICS  
TYPE 315/316F 5,000/10,000 WATT  
AM BROADCAST TRANSMITTER**

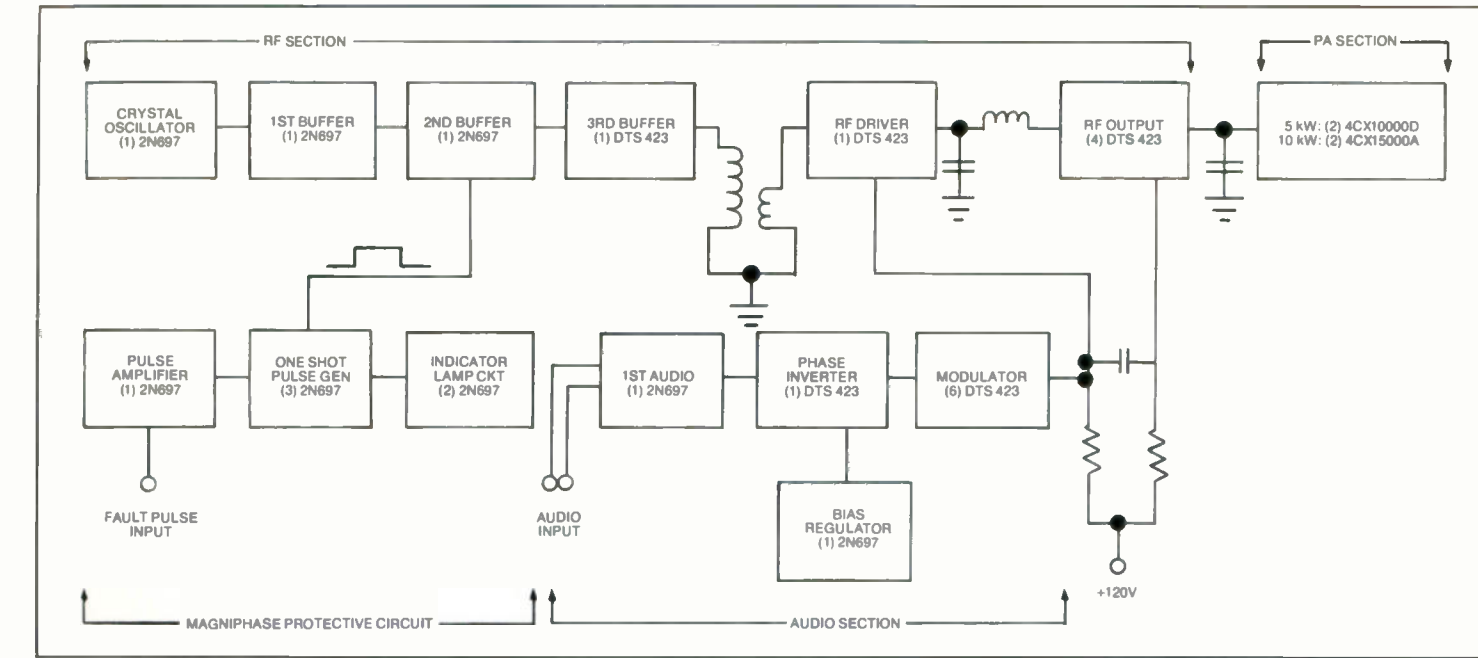

**SIMPLIFIED BLOCK DIAGRAM**

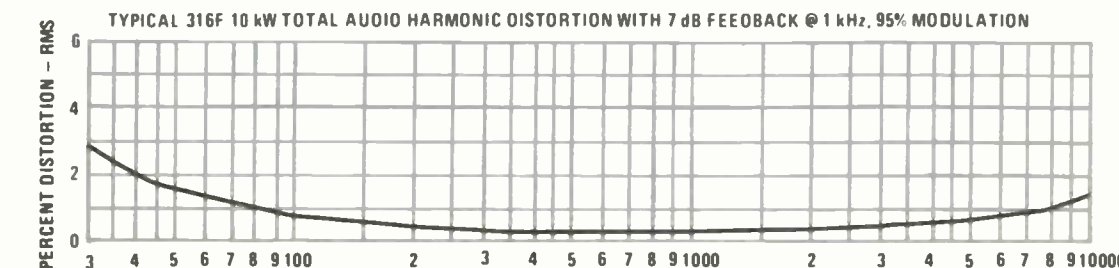
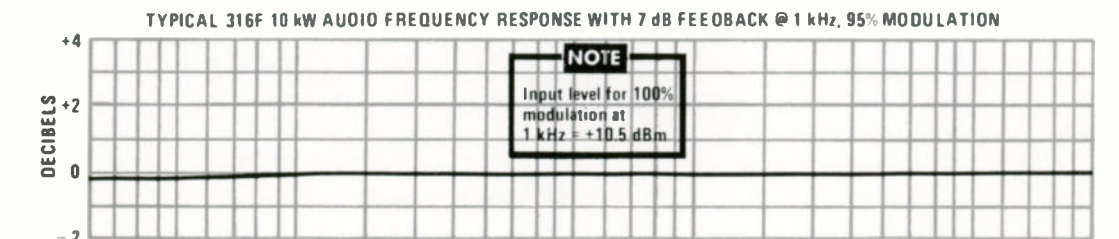
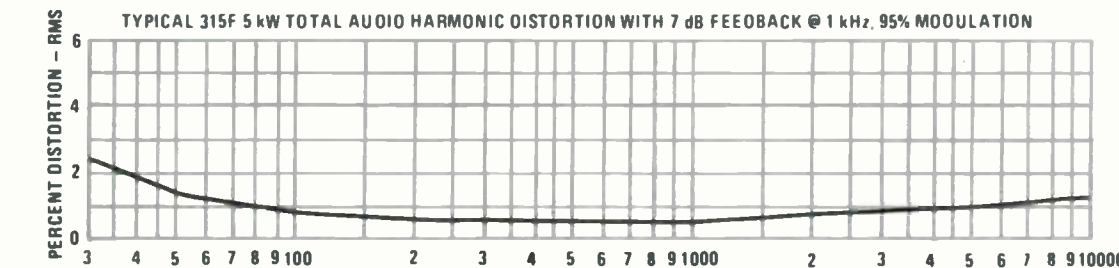
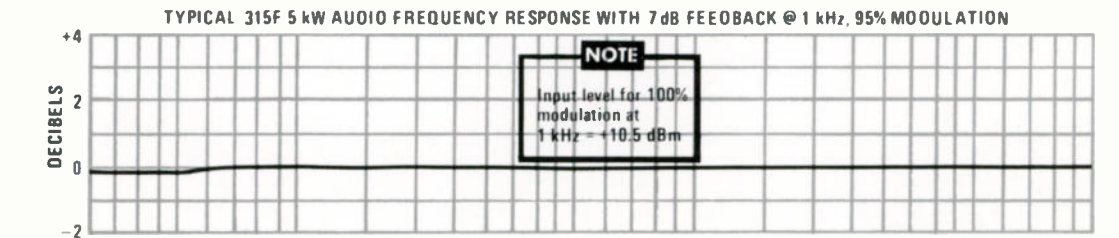

ALL FREQUENCIES IN Hz



**Continental Type 315R-1 5 kW AM transmitter offers broadcasters a new standard of performance. It's also available as the Type 314R-2 (828D-1) 2.5 kW AM transmitter**

- High efficiency SwitchMod pulse modulation
- Overall efficiency exceeding 57% at 5000 watts 95% sine wave modulation.
- Harmonic distortion less than 2.0% from 20 to 10000 Hz.
- Low intermodulation distortion per standard 4:1 SMPTE
- Feedback taken from modulated DC, not from RF envelope for reduced sensitivity to load conditions.
- Bandpass "Q-Taper" output network for flatter response across the audio passband and improved adjacent signal rejection.
- Lower peak voltages as a result of operation of the PA anode at DC ground.
- Local and remote metering directly at ground reference.
- No plate blocking capacitor or DC feed choke required.
- Automatic modulation control keeps modulation sensitivity constant at all power levels and with a  $\pm 10\%$  line voltage variation, standard.
- Built-in Instantaneous Peak Limiter.
- + 125% modulation capability.
- Built-in Forward/Reflected Power meter.
- Low power setting continuously adjustable over entire power range of the transmitter.
- Use of triodes eliminates need for screen grid supply.
- Overload recycle interrupts pulse train to remove high voltage in microseconds. After third overload, high voltage power supply is shut down.
- Improved phase linearity in "Q-Taper" network for AM stereo.

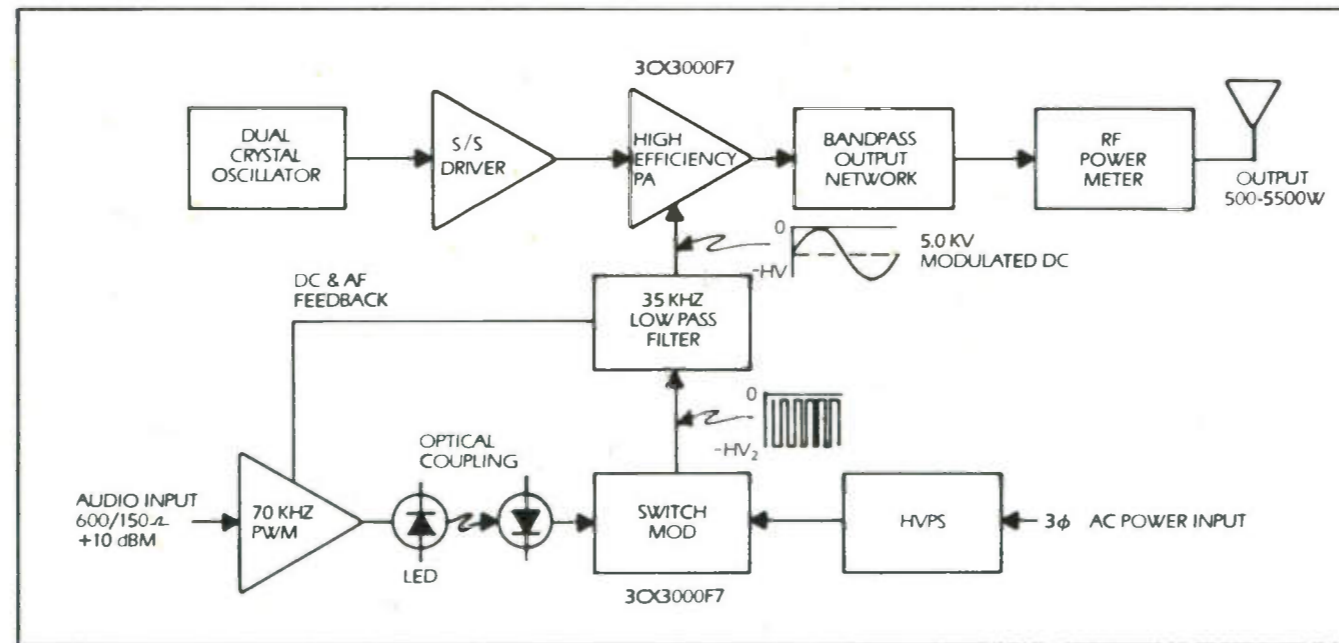
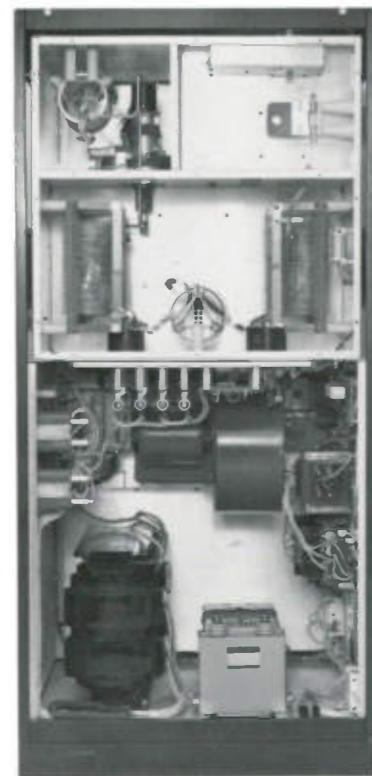
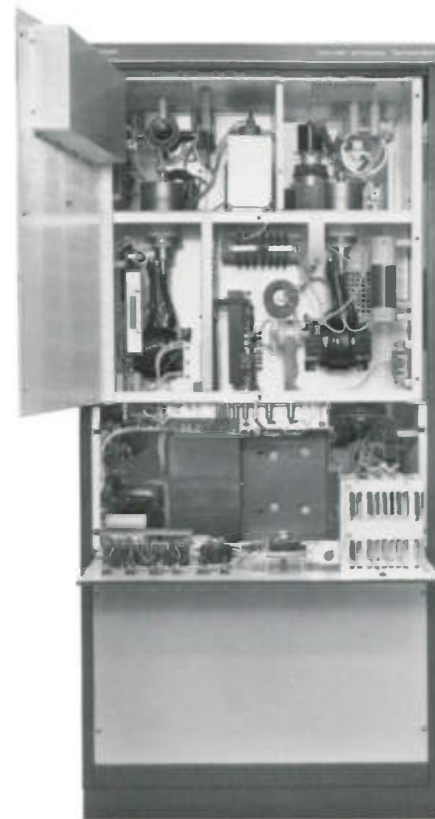

## SPECIFICATIONS

### ELECTRICAL

**Frequency Range**  
540-1600 KHz.

**RF Output Power**  
500-5500 w. 315R-1  
(250-2750 W) 314R-2

**Output Impedance**  
50 Ohm nominal (others  
available on special order)

**Output Fitting**  
1-5/8" EIA male flange standard  
7/8" EIA flange or stud output  
also available.

**Harmonic and Spurious**  
Complies with FCC and CCIR  
regulations.

**Carrier Amplitude Reg.**  
2% max. adjustable to 0

**Frequency Stability**  
 $\pm 5$  Hz. over ambient temp.  
range (below)

**Power Requirements**  
200-250 VAC 3  $\phi$  3 or 4 wire,  
wye or closed delta, 50/60 Hz  
385-435 VAC available on  
special order

**Power Consumption**  
13.0 KVA @ 95% PF for 5000  
Watts, 95% sine wave  
modulation

**Overall Efficiency**  
Better than 57% at 5000 Watts,  
95% sine wave modulation.

**Frequency Response**  
 $\pm 1$  dB, 20-10000 Hz. @ 95%  
modulation, 5000 Watts output

**Total Harmonic Distortion**  
less than 2% 20-10000 Hz @  
95% mod, 5000 Watts output

**Noise**  
better than -60dB reference 400  
Hz., for 100% modulation @  
5000 Watts output

**Audio Input**  
+ 10 dBm  $\pm 2$  db 600/150  
ohms for 100% modulation

**Modulation Capability**  
- 100%, + 125% standard

### GENERAL

**Size**  
88 cm. (34-3/4") W. x 85 cm.  
(33-3/8") D. x 176 cm. (69") H.  
0.75 sq. meters (7.9 sq. ft.) floor  
space

**Weight**  
476 Kg (1050 lbs)

**Tubes**  
3CX3000F7 (2)

**Air Flow Requirement**  
500 CFM

**Humidity**  
95%, max

**Ambient Temp. Range**  
To 0°C to +50°C. (meets FCC  
requirements to -20°C)

**Altitude**  
2280. M (7,500 ft.) above mean  
sea level

**Continental Electronics**

CONTINENTAL ELECTRONICS MFG. CO. BOX 270879 DALLAS, TEXAS 75227 (214) 381-7161



CONTINENTAL TYPE 315R-1  
5 KW AM  
BROADCAST TRANSMITTER

**AM**





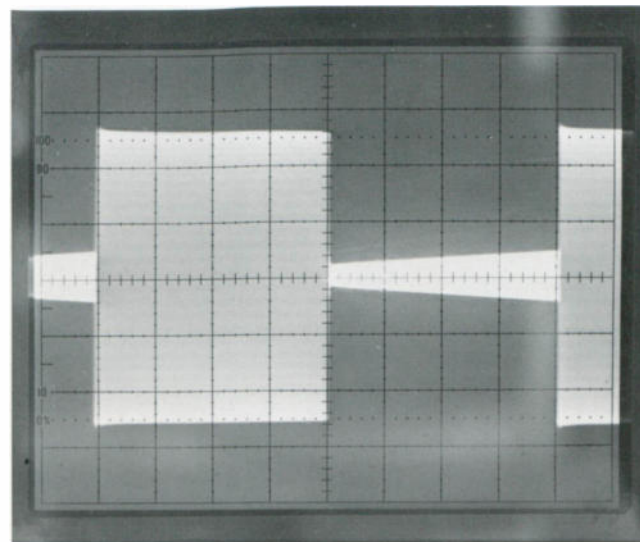

Oscilloscope photo shows excellent dynamic response of Continental's 5 kW AM transmitter at 20 Hz modulation.

Test/monitor equipment photos show modulation (top), total harmonic distortion (middle) and intermodulation distortion (bottom) at 95% modulation at 100 Hz. Intermodulation test was made in accordance with standard 4:1 SMPTE method.

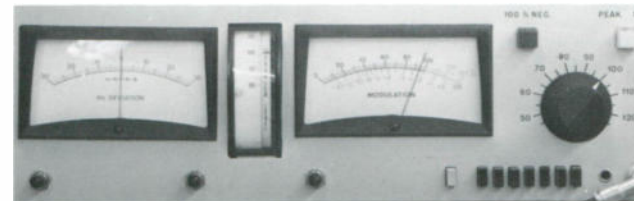

modulation.

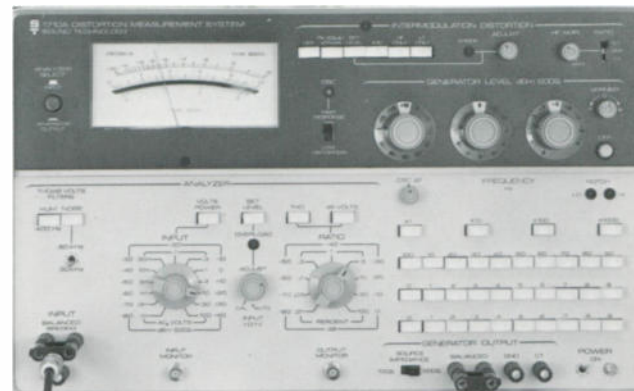

harmonic

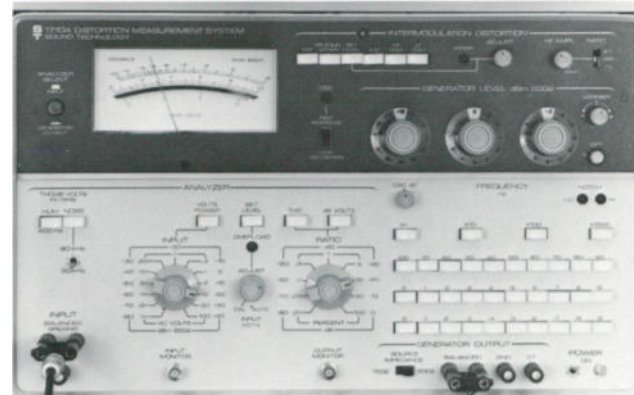

intermodulation

**Continental Type 315R-1 5 kW AM transmitters are designed for state-of-the-art performance, cost-effective operation and easy maintainability.**

**AM Stereo**

A Signal Access Card provides rear panel access to both audio and RF drive for use in either parallel operation of two 315R-1 transmitters or for future use in AM stereo. These terminals will make possible the connection of an external stereo generator to the RF drive line and to the audio chain.

**Q-Taper Network**

A Q-Taper network provides flatter response across the audio pass band and very steep skirts above and below the pass band. Unlike conventional "Pi" networks, the skirts of the Q-Taper network are nearly symmetrical with second harmonic suppression at 80 dB below carrier. The 3 dB bandwidth is approximately 10% of the operating frequency, 100 kHz average. The 4 node network achieves low circulating currents by the use of low nodal Q's, on the order of 2-6. Overall system Q-Product is approximately 250. These lower circulating currents allow the use of smaller components neither sacrificing performance or conservative component rating. The Q-Taper network also has improved phase linearity over conventional networks, an important consideration for AM stereo.

**SwitchMod System**

The dc coupled series switching modulator with the stability of the proven 12 phase power supply, the built-in Instantaneous Peak Limiter (IPL) and the automatic modulation controller circuits to achieve dramatically improved AM audio performance in the areas of low frequency response, IM distortion

and overall modulation density. IPL front panel adjustments set both positive and negative limits of modulation. Working in conjunction with the automatic modulation control, the maximum level of modulation is maintained at all power levels even with 10% power line variations. Overmodulation due to powerline variations or audio peaks is effectively prevented.

**High Efficiency P.A.**

Continental's 315R-1 transmitters achieve a final PA efficiency approaching 90% using the third harmonic injection technique of the proven Tyler-type. Combined with the high efficiency SwitchMod technique, overall efficiency exceeds 55%.

**Grounded Anode**

The anode of the final amplifier operates at dc ground, reducing peak RF voltages with respect to the chassis to about half the conventional configuration. Metering is accomplished at ground reference for both local and remote operation. There is no need for a blocking capacitor or feed choke. This technique is made practical by using fiber-optics to couple audio input to the audio driver. High audio performance is maintained by using dc coupling throughout the audio chain.

**12-Phase Power Supply**

The 12-phase power supply uses an extended Delta power transformer, for additional harmonic suppression, and two three-phase, full wave rectifiers to develop high voltage dc with a 720 Hertz ripple frequency. Because of the high ripple frequency, the absence of filter inductors and large capacitors helps reduce transmitter size; eliminates several expensive, failure-prone components. Inductors, which cause resonances, are eliminated. Power supply sag and bounce are not a problem.

**Maintainability**

Continental's Type 315R-1 transmitters offer excellent accessibility. Modular circuit boards with extender cards and LED status indicators on major circuits and relays help to simplify maintenance. One tube type is used for both final PA and switch-tube applications. The bottom line is a smooth, easily maintained day-to-day operation.

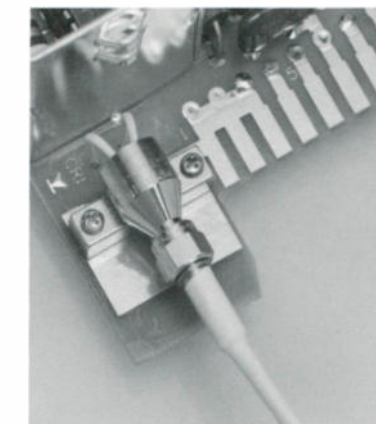
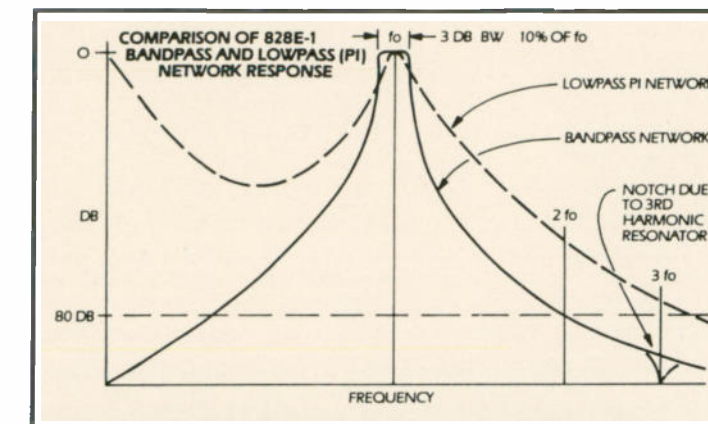
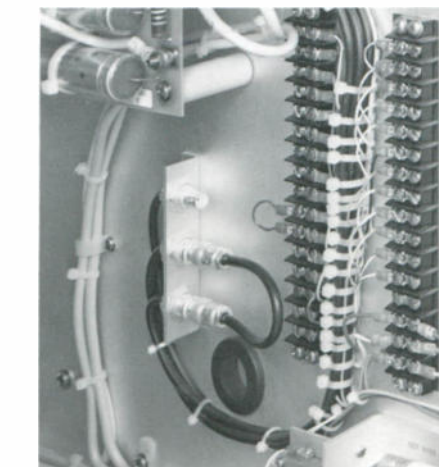
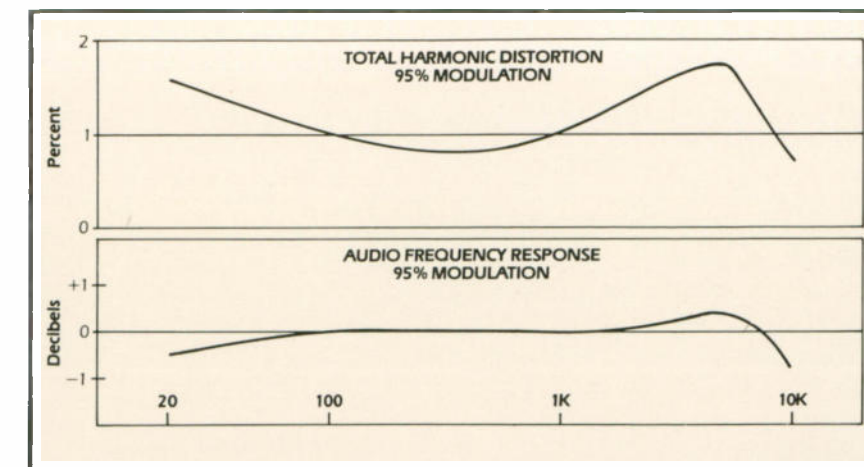

Q-Taper network circuit

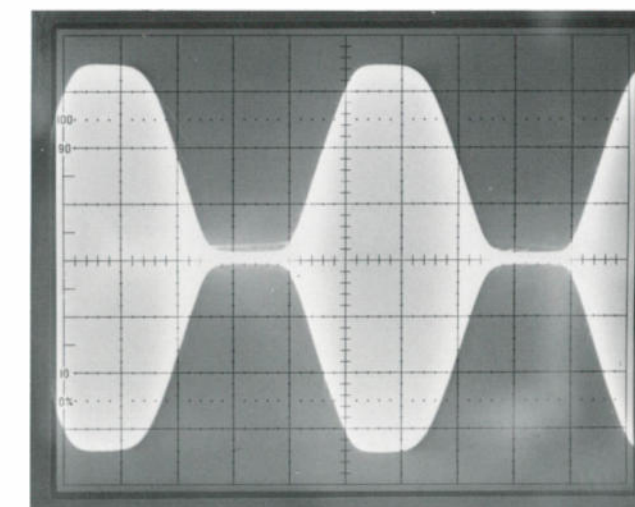
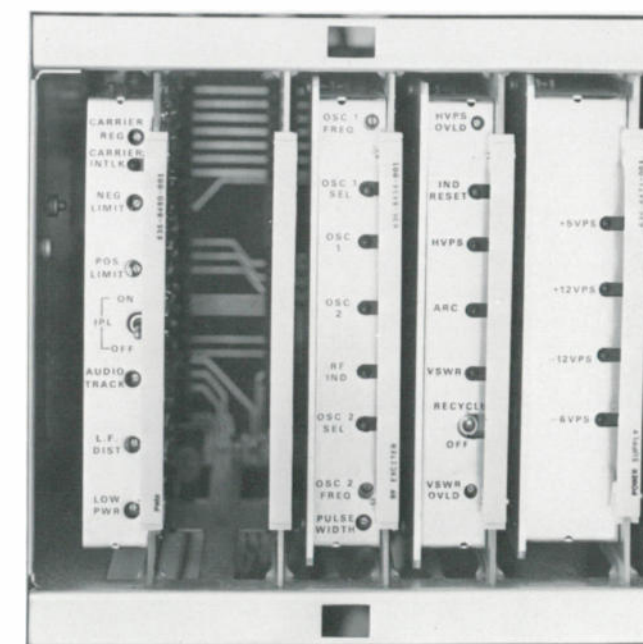
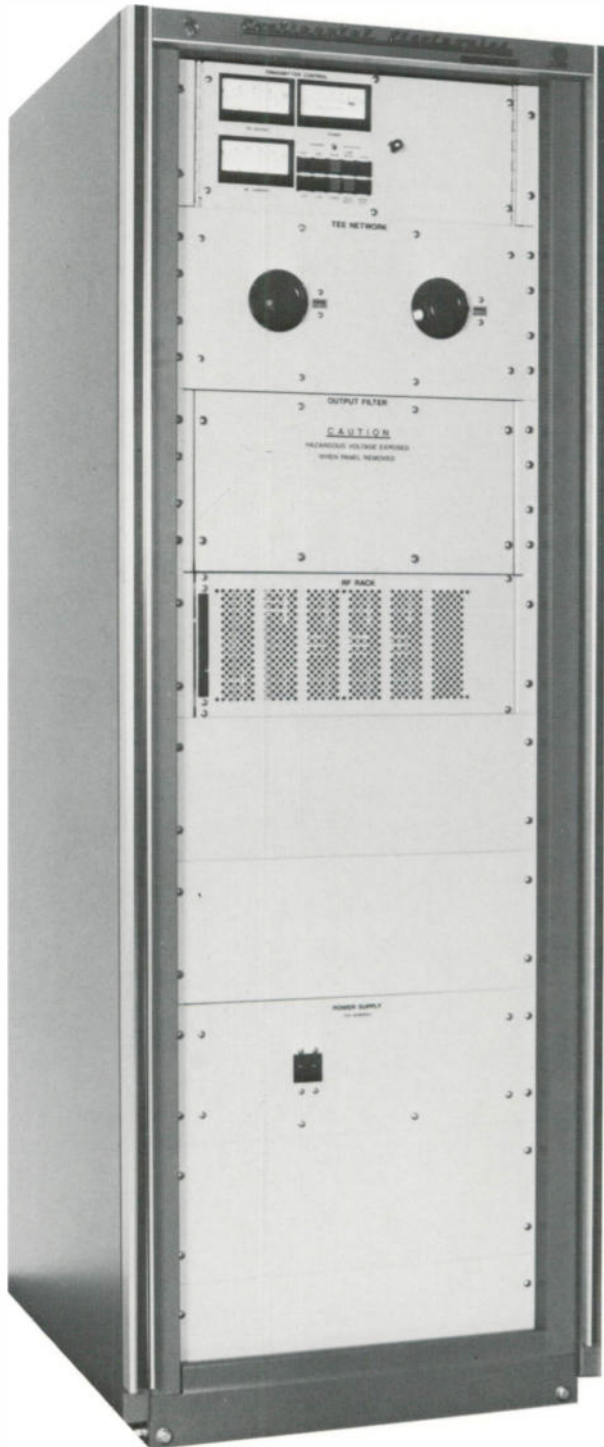

Photo of modulation wave form shows effect of Instantaneous Peak Limiter (IPL).

Top right: rear panel connections for Signal Access Card; middle right: Fiber Optics Assembly; bottom right: IPL settings on PWM Card.







Type 314F, 1 kW AM Transmitter

**New!**  
**Solid-state 1 kW**  
**AM Transmitter**

#### Overview

- All Solid-state
- Plug-in Modules
- VSWR Protection Circuit
- High Quality Audio Performance
- Stereo Interface
- Designed For Unattended Operation
- Easy Maintenance

#### General Description

Continental's Type 314F offers broadcasters top audio performance in a modular, compact and reliable package.

All important circuits, including the exciter, transmitter control and power amplifiers, are mounted on plug-in circuits for ease of handling and maintenance.

Each MOSFET module employs on-board protection to prevent device failure from high temperature, overvoltage or overcurrent conditions.

In addition to the on-board power amplifier protection, an overall VSWR sensing circuit protects external circuits such as phasors and ATU's.

The use of broadband and bandpass circuits combined with state-of-the-art integrated circuit technology enable the 314F to handle sophisticated audio processing.

Advanced circuit design allows an easy stereo interface.

Modular design simplifies transmitter spares requirements while making it easy to handle routine maintenance.



## PRELIMINARY DATA FOR TYPE 314F

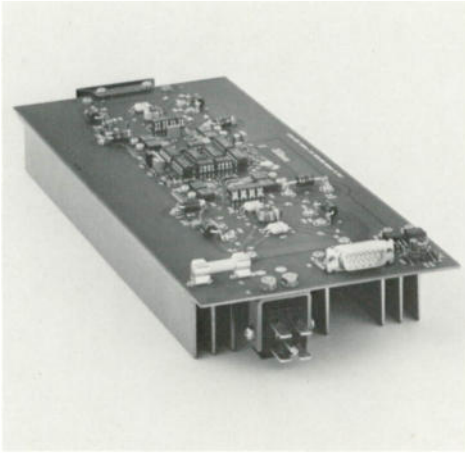

MOSFET PA Module

### SPECIFICATIONS

#### GENERAL

##### RF Power Output:

1 kW, nom.;  
1.1 kW, max.

##### Power Consumption:

2.6 kW at 1 kW, 100% modulation

##### RF Power Reduction:

3 power levels standard; lowest  
available level is 10 watts

##### RF Frequency Range:

535 kHz to 1705 kHz

##### PA Configuration:

Modular

##### PA Active Device:

IRF140 MOSFET

##### Internal PA Protection:

Withstands short circuits at any point  
in output or antenna circuits

##### Carrier Stability:

$\pm 5$  Hz

##### Stereo Interface:

Standard

##### Output Impedance:

50 ohms, unbalanced

##### VSWR:

1.2:1, max., full modulation;  
1.5:1, max., full power at carrier

##### Output Connector:

L/C or Protected Terminal or Type "N"

##### Carrier Shift:

2% max., (0.5% typical), at 100%  
modulation

##### Harmonics:

Meets CCIR & FCC regulations

##### Spurious Emissions:

Meets CCIR & FCC regulations

##### Audio Frequency Response:

$\pm 1$  dB; 20 Hz to 12 kHz or better  
at 95% modulation, 1000 Hz reference

##### Audio Frequency Harmonic Distortion:

Less than 1.5% at 95% modulation,  
1 kW, 20 Hz to 12 kHz

##### Noise Below 100% Modulation:

Better than -60 dB, unweighted

##### Positive Peak Capability:

125% at 1100 W output

##### Incidental Phase Modulation:

Less than 0.035 Radians average;  
95% modulation at 1 kHz

##### Audio Input:

-10 dBm to +10 dBm active, balanced,  
150/600 ohms

##### Cooling:

Low velocity air

### ELECTRICAL

##### Power Source:

180 to 250 volts ac; 50/60 Hz,  
single phase; 3.8 KVA at 1 kW,  
100% modulation

##### AC Source Tolerance:

-10% to +20% voltage,  $\pm 5\%$  frequency

### OPERATING ENVIRONMENT

##### Altitude Range:

0 to 13,000 ft. (0 to 3,965 m)

##### Ambient Temperature Range:

0° C to 50° C (32° F to 122° F);  
2° C / 305 m (35.6° F/1000 ft.) derating

##### Ambient Humidity Range:

0 to 95%

### MECHANICAL

##### Size:

69" (175.26 cm) H x 22" (55.88 cm) W x  
26" (66.04 cm) D

##### Weight:

350 lb (157.5 kg) net

##### Remote Control Interface:

Standard

##### Computer Control:

Optional; signal conditioning and  
interface provided

##### Front Panel Meters:

3 Analog

All specifications are subject to change without notice.  
© 1987 Continental Electronics / 8361  
Printed in USA 1M387



Continental Electronics



© a Division of Varian Associates, Inc.

PO Box 270879

Dallas, Texas 75227

Ph: (214) 381-7161

Telex: 73-398

varian



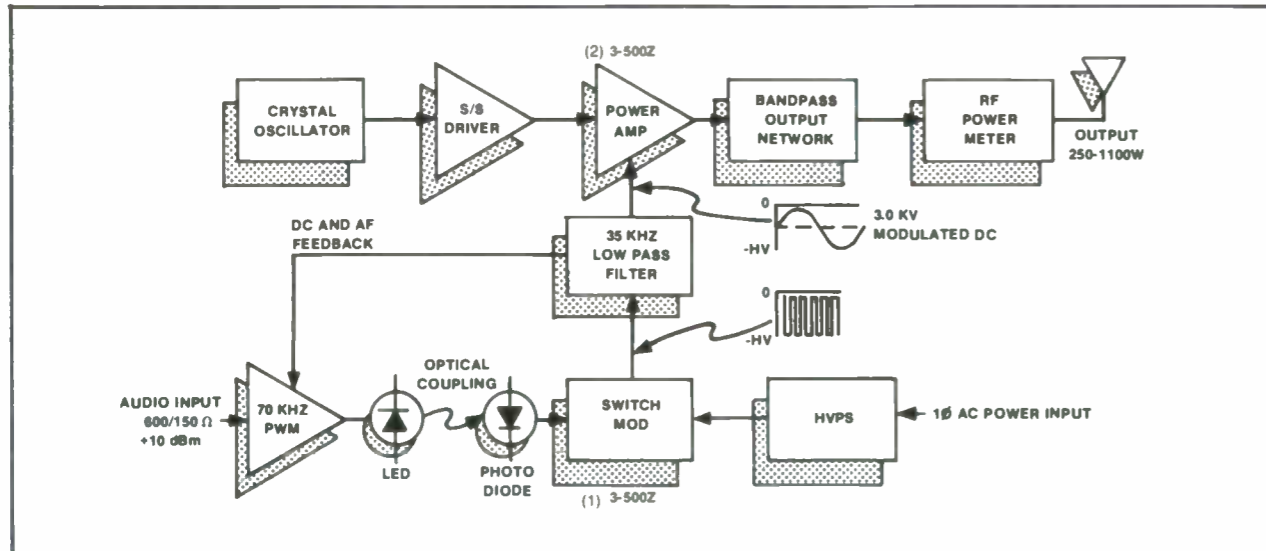

### Specification

**Frequency Range**

540 to 1600 kHz

**RF Power Output**

250W to 1100W max.

**RF Output Impedance**

50 ohm, Unbalanced, Nominal

**RF Output Fitting**

Coax. Type LC (Optional Stud)

**Harmonic and Spurious**

-73.4 dB meets FCC and CCIR

**Carrier Regulation**

2% max (400 Hz, 95% mod.)

**Frequency Stability**

±5 Hz (0 to 50° C)

±20 Hz (-20° C to +50° C)

**Audio Response**

±1 dB, 20-10 kHz,

1 KW, -95% Modulation

**Audio Distortion**

Less than 2%, 20-10 kHz

1 KW, 95% Modulation

**Noise**

-55 dB (400 Hz, 95% mod.)

**Audio Input**

+ 10 dBm ± 2 dB,

600/150 ohms, Balanced

**Modulation Capability**

- 100% + 125% (1100 W, 1 kHz)

**Power Requirements**

1 φ, 200/250V, 50/60 Hz

**Power Consumption**

3500W at 1 KW, 95% mod.

**Ambient Temperature**

- 20° C to +50° C

**Humidity**

95% Max.

**Altitude**

7500 Ft.

**Size**

32 1/16" (81.4cm) W × 25 1/16"

(63.6cm)D × 69" (175.3cm)H

**Weight**

760 Lbs. (345 Kg)

**Tubes**

3-500Z (3) (1 mod. 2rf)

**Remote Control**

Direct—No Interface Required

**Features**

IPL, Auto Power Control,

Auto mod. Control

**Optional Equipment**

60 Hz Filament Regulator

50 Hz Filament Regulator

Extended Control and Meter Panel

Extended Meter Panel

RF Output Stud Connection

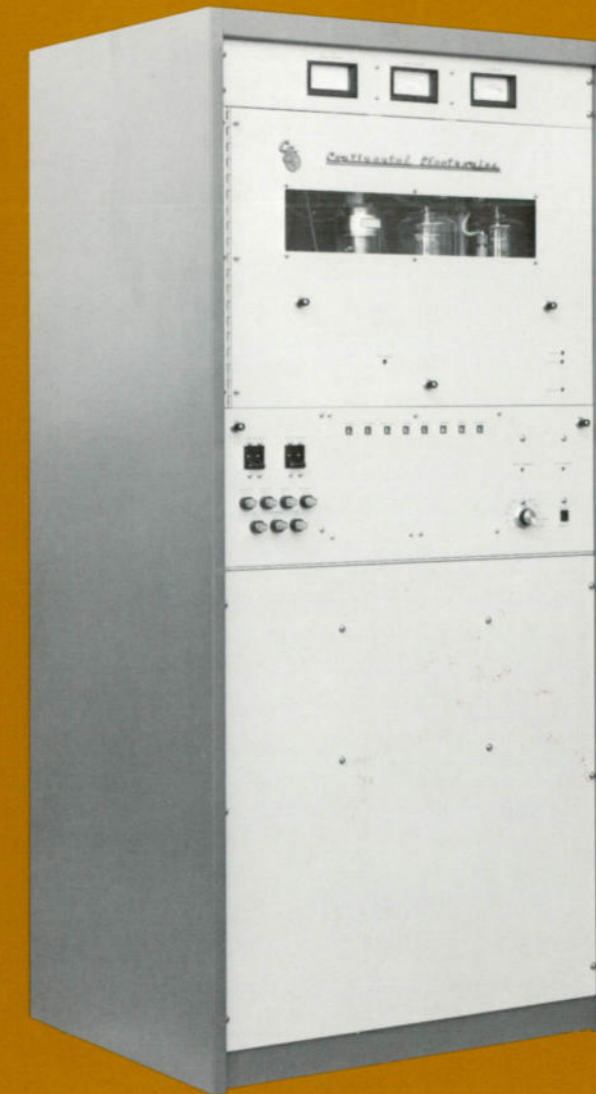

Printed in USA 4841M/5628





### A New 1kW Standard!

Continental now offers the performance and technology of pulse width modulation in an efficient 1kW package. The 314R-1 offers AM broadcasters the efficiency and reliability of a tube-powered final and the clear, crisp sound of full, transformerless modulation.

### Transformerless Audio

The SwitchMod System is a total concept that efficiently combines the interplay of all aspects of the transmitter system—from the audio input to the audio modulated rf output—from the main power supply to the rf output network. The 314R-1 1kW AM transmitter provides the combination of a built-in Instantaneous Peak Limiter (IPL), an Automatic Power Control (APC), and an Automatic Modulation Control. These features provide correct output power and maximum modulation even with input line voltage variations of  $\pm 5\%$ . The IPL adjustment allows independent setting of both negative and positive limits.

The inefficient modulator using a modulation transformer is eliminated as is the conventional transformer input to the audio chain. A DC coupled OP-AMP minimizes overshoot and ringing. The 314R-1 will reproduce a 20 Hz square wave at 100% modulation.

### AM Stereo

The 314R-1 is designed to convert to stereo operation. The left channel is initially wired as part of the main audio chain with provisions for future addition of the right channel and audio matrix by PC board component additions. Both mono and future stereo versions of the plug-in RF Exciter Cards will be interchangeable.

### Q-Taper Network

A Q-Taper output network provides steep skirts and an exceptional flat response across the audio pass band. Unlike conventional "Pi" networks, the skirts of the Q-Taper are nearly symmetrical with second harmonic suppression exceeding FCC requirements without the use of additional traps. The 3 dB bandwidth is approximately 10% of the operating frequency, about 100 kHz average. In addition an

improved phase linearity is realized over conventional configurations.

### Grounded Anode and Fiber Optics Coupling

A unique design feature of the final amplifier is a grounded anode which reduces peak voltages, with respect to the chassis, to about half the values encountered in conventional designs. This permits required metering of the final plate current and voltage to be done directly at ground reference, either locally or remotely. Problem areas such as the dc feed choke and blocking capacitor are eliminated. Audio dc coupling is maintained throughout the audio chain by the use of advanced fiber optics to couple to the modulator driver for superior audio performance.

### No-Bounce Power Supply

Power supply bounce and overshoot have been eliminated in the 314R-1 through a capacitive input filter design which eliminates the choke. Low frequency resonances are avoided and an outstanding frequency response is maintained.

### Designed For The User

For day-to-day operation and routine maintenance the 314R-1 is designed with the broadcast engineer in mind. The transmitter has excellent accessibility, and utilizes modular circuit boards.

LED status indicators are provided on major circuits. By broadbanding the driver only the PA need be tuned. Control and overload circuits, the exciter, driver module and the SwitchMod module are all plug-in units. The use of a 3-500Z triode for both switching modulator and final amplifier simplifies maintenance.

Built-in forward and reflected power metering with VSWR protection is easily read from the front of the cabinet as are all meters. Remote control and monitoring are made directly with no interfacing required.

For high/low power requirements, the power can be adjusted to the correct value and thereafter changes from either power levels are accomplished by a push button

control which can be readily removed. The 314R-1 has the capability to come up to full power from a cold start in a matter of seconds at the push of a button.

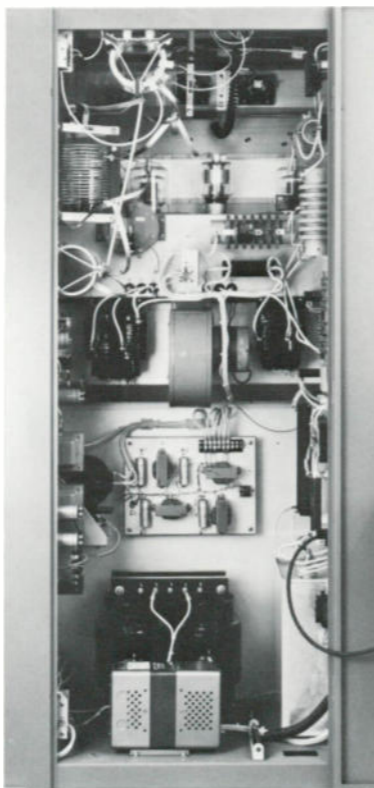
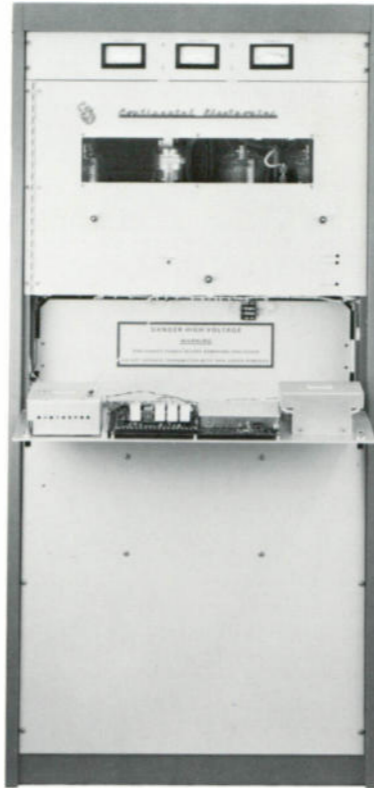

### FEATURES

- High efficiency SwitchMod pulse modulation technique.
- Overall efficiency: 43% at 95% modulation, 1100 watts carrier.
- Harmonic distortion less than 2.0% from 20 to 10000 Hz.
- Low intermodulation distortion per standard 4:1 SMPTE.
- Feedback taken from modulated dc, not from rf envelope for reduced sensitivity to load conditions.
- Bandpass "Q-Taper" output network for flatter response across the audio passband and improved adjacent signal rejection.
- Lower peak voltages as a result of operation of the PA anode at dc ground.
- Local and remote metering directly at ground reference.
- No plate blocking capacitor or dc feed choke required.
- Automatic modulation control keeps modulation sensitivity constant at all power levels with a  $\pm 5\%$  line voltage variation, standard.
- Built-in Instantaneous Peak Limiter.
- + 125% modulation capability.
- Built-in Forward/Reflected Power metering.
- Low power setting continuously adjustable over entire power range of the transmitter.

- Built-in troubleshooting aids.
- Use of triodes eliminates need for screen grid supply.
- Overload recycle interrupts pulse train to remove high voltage in microseconds. After third overload, high voltage power supply is shut down.
- Improved phase linearity in "Q-Taper" network for AM stereo.

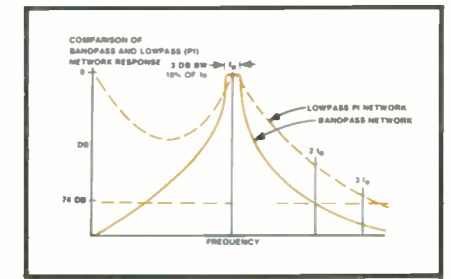

Q-Taper network

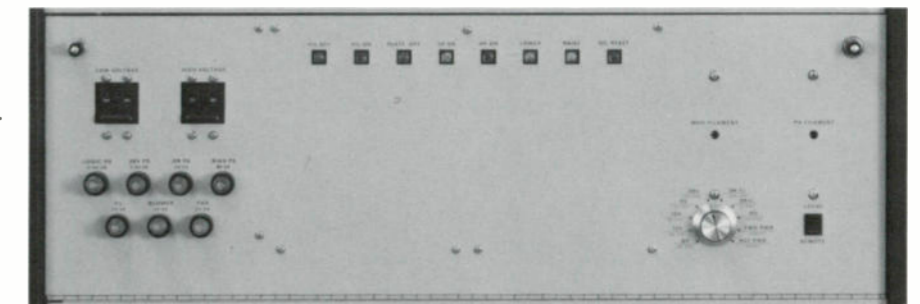
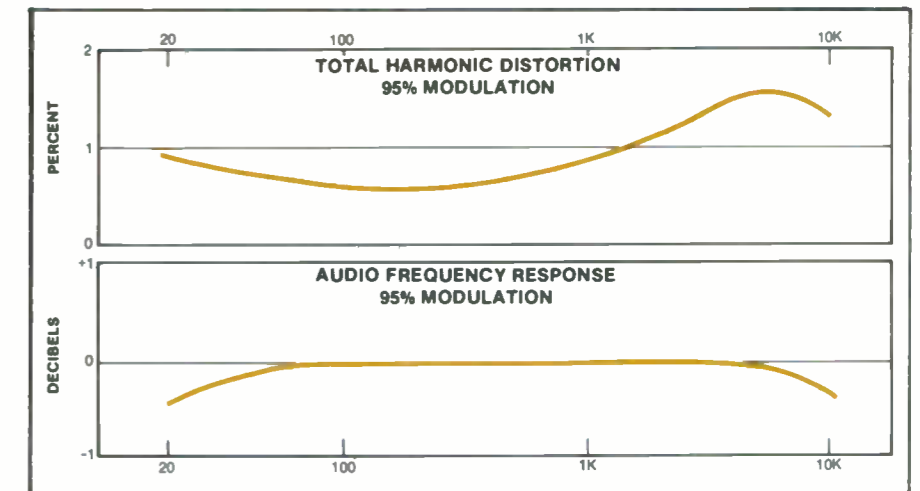

Convenient switches and LED status indicators simplify troubleshooting and maintenance

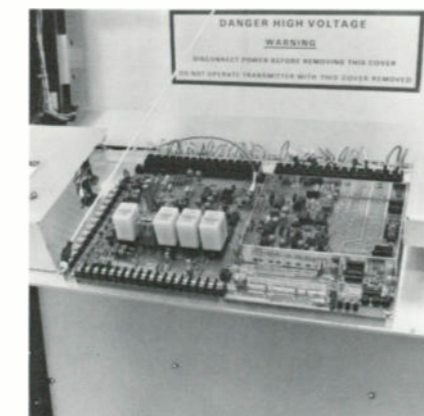

One solid-state board controls the transmitter and pulse width modulation



Advanced fiber optic coupling to modulation tube



## Continental's XL-310, 10 kW Solid-State Broadcast Transmitter

AM

### Features

- Solid State Modulator Design
- RFPWM (PWM at the Carrier Frequency)
- AM Stereo Compatible
- Operation from 100 W to 11 kW with Excellent Audio Response
- Relative Insensitivity to Load Fluctuations
- On-Board Fault Protection
- Easy to Maintain
- Datatrax Computer Control and Monitoring

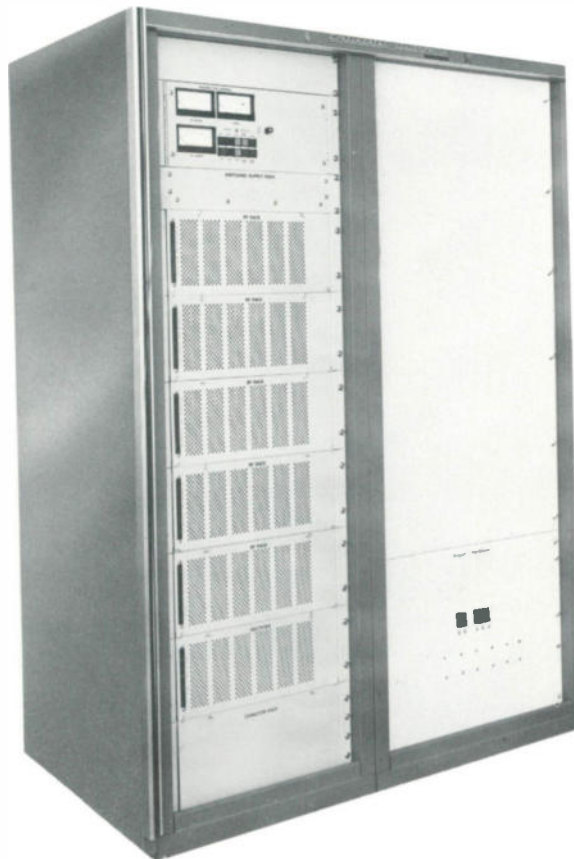

### Top Performer

Continental's XL-310, 10 kW AM solid state transmitter offers broadcasters excellent, reliable performance in a modular, compact package, with improved efficiency.

The exciter, transmitter control and power amplifiers, are mounted on plug-in modules for ease of handling and maintenance.

Each MOSFET module employs on-board protection to prevent device failure from high temperature, overvoltage or overcurrent conditions.

In addition to the on-board power amplifier protection there is an overall VSWR sensing circuit.

The use of broadband and bandpass circuits combined with state-of-the-art integrated circuit technology enables the XL-310 to handle advanced audio processing.

### Solid State Design

The XL-310 uses today's solid-state workhorse, the power FET transistor. The power FET is now the device of preference where high power, fast switching and rugged performance is required.

### Load Fluctuations:

Deviations in load are corrected by front panel tuning and loading controls. Load matching required by conventional PWM transmitters is not sensitive within the XL-310.

Load fluctuations only slightly vary switching efficiency. Correction of the filter mismatch enables the XL-310 to operate at continuous full output power with no effects on the audio frequency response.



## PRELIMINARY SPECIFICATIONS

### GENERAL

**RF Power Output:**  
10 kW nominal

**Calculated Power Consumption:**  
17 kW at 10 kW 100% modulation

**Typical Efficiency:**  
75% or better

**RF Power Reduction:**  
Three power levels standard:  
lowest available level is 100 watts

**RF Frequency Range:**  
535 kHz to 1705 kHz

**PA Active Device:**  
MOSFET

**Internal PA Protection:**  
Withstands short circuits at any point in output

**Carrier Stability:**  
 $\pm 5$  Hz

**Stereo Interface:**  
Standard

**Output Impedance:**  
50 Ohms, unbalanced

**VSWR:**  
1.2:1, maximum, full modulation;  
1.5:1, maximum, full power at carrier

**Output Connector:**  
1-5/8 EIA Flange

**Carrier Shift:**  
2% maximum, (0.5% typical),  
at 100% modulation

**Harmonics:**  
Meets CCIR & FCC regulations

**Spurious Emissions:**  
Meets CCIR & FCC regulations

**Audio Frequency Response:**  
 $\pm 1$  dB; 20 Hz to 12 kHz or better  
at 95% modulation, 1,000 Hz reference

**Audio Frequency Harmonic Distortion:**  
Less than 1.5% at 95% modulation.  
10 kW, 20 Hz to 12 kHz

**Noise Below 100% Modulation:**  
Better than -60 dB, unweighted

**Positive Peak Capability:**  
125% at 10 kW output

**Incidental Phase Modulation:**  
Less than 0.035 radians average:  
95% modulation at 1 kHz

**Audio Input:**  
-10 dBm to +10 dBm active,  
balanced, 150/600 ohms

**Cooling:**  
Low velocity air

### ELECTRICAL

**Power Source**  
180 to 250 VAC: 50/60 Hz, 3 Phase

**AC Source Tolerance:**  
-10% to +10% voltage for 70 VDC  
at 10 kW,  $\pm 5\%$  frequency

### OPERATING ENVIRONMENT

**Altitude:**  
13,000 ft. (3,963 m)

**Ambient Temperature Range:**  
0°C to 50°C (32°F to 122°F)  
2°C/305m (3.56°F/1,000 ft.) derating

**Relative Humidity:**  
0 to 95%

### MECHANICAL

**Transmitter:**  
69" (175 cm) H  
46" (117 cm) W  
26" (66 cm) D

**Export Shipping Volume:**  
48 Cubic Feet

**Weight:**  
500 lbs (227 kg)

**Export Shipping Weight:**  
700 lbs (318 kg)

**Remote Control Interface:**  
Standard

**Datatrax Computer Control:**  
Optional: Signal conditioning and  
interface provided

**Front Panel Meters:**  
Three Analog

All specifications are subject to change  
without notice.

Printed in USA IM588

© 1988 Varian, Continental Electronics Division

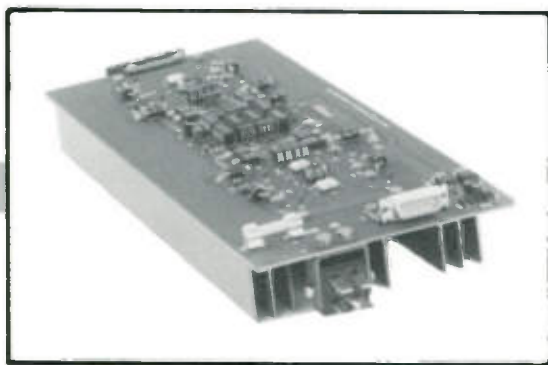

MOSFET PA module

Continental's customer service is  
the industry's best!

Call anytime, day or night!  
Main offices: (214) 381-7161  
Engineering service: (214) 327-4533  
Parts: (214) 327-4532

**varian** 

*continental electronics division*

P. O. Box 270879 Dallas, Texas 75227

Telephone: 214-381-7161 Fax: 214-381-4949





### 317C-3 Typical Performance

#### Audio Phase Characteristics (Input, Lower Trace; Output, Envelope)

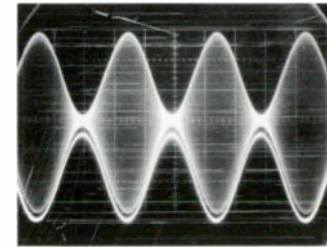

90% modulation at 20 Hz

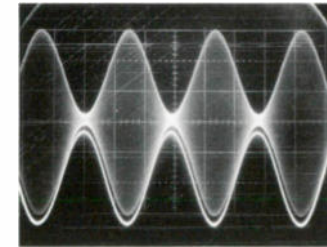

90% modulation at 1,000 Hz

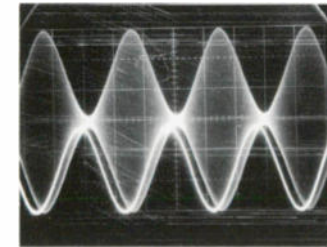

90% modulation at 7,500 Hz

#### Square Wave Response

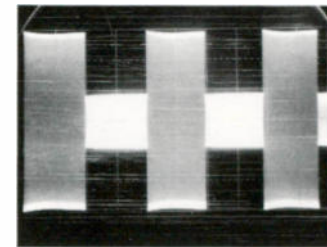

60% modulation at 50 Hz

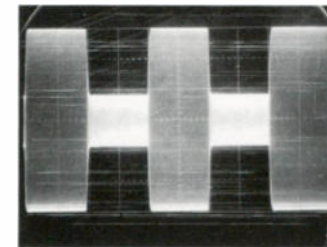

60% modulation at 1,000 Hz

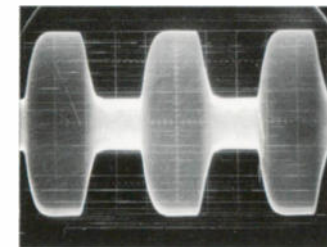

60% modulation at 7,500 Hz

#### Frequency and Phase Response At 90% Modulation

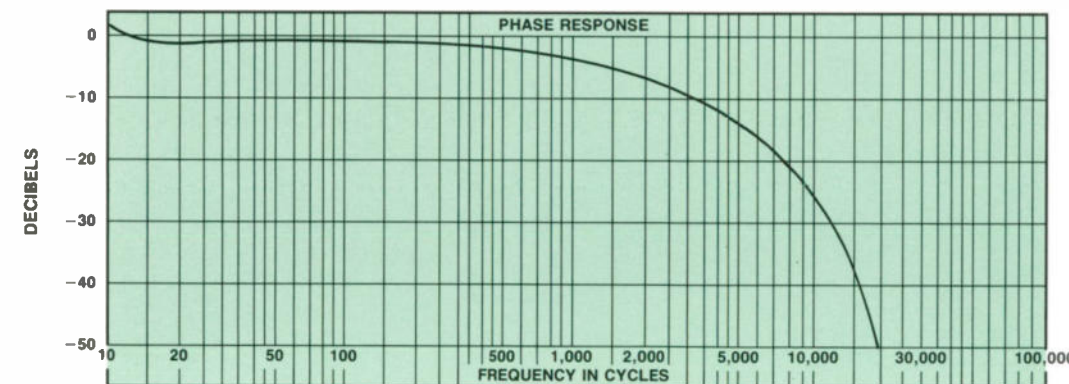
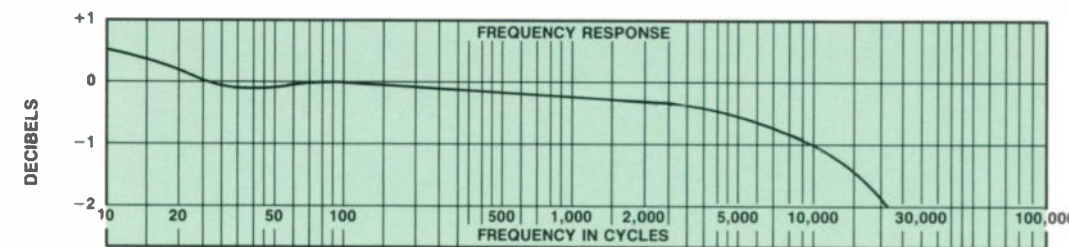

### SPECIFICATIONS

#### GENERAL

##### Carrier Power:

Rated 50 kW  
Capability 60 kW  
Power reduction 25 kW or 10 kW

##### Modulation:

High-level screen-grid/impedance modulation

##### Emission:

A3

##### Frequency Range:

Any single frequency 535-1,620 kHz

##### Frequency Stability:

±5 Hz

##### Audio Input:

±10 dBm ±2.0 dB at 100% modulation

##### Audio Response:

±0.5 dB, 10 Hz to 7,500 Hz; -1.5 dB, 15,000 Hz reference to 1,000 Hz; at 70% modulation

##### Phase Response:

±2° from 10 to 1,000 Hz, and phase linear to 30 kHz with output lagging 45° at 15 kHz

##### Audio Distortion:

Less than 2.5%, 20 to 10,000 Hz at 95% modulation

##### Intermodulation Distortion:

3.5% at 90% total modulation by SMPTE test method using 60 and 7,000 Hz in 4:1 ratio

##### Carrier Shift:

2% or less at 100% modulation

##### Tilt and Overshoot:

**Clipped Sinewave:**  
3% variation in modulation percentage using 6 dB symmetrical clipping, 30 to 10,000 Hz at 90% modulation

##### Squarewave:

5% variation in modulation percentage, squarewave frequencies from 30 to 7,500 Hz at 60% modulation

##### Modulation Capability:

100% continuous at any frequency 20-10,000 Hz +125% positive peak with asymmetrical input

##### Noise Unweighted:

-60 dB below 100% modulation

##### Spurious & Harmonic Emission:

-80 dB

##### Output Impedance:

40 to 300 ohms as specified by customer

#### ELECTRICAL

##### Power Source:

460V, three-phase, 50/60 Hz, other available on request

##### Permissible Combined Voltage Variation:

±5% voltage  
±2.5% frequency

##### Power Factor:

Approximately .95

##### Overall Efficiency:

Better than 60% at any depth of modulation

#### OPERATING ENVIRONMENT

##### Altitude:

7,500 feet (2,286 meters)  
Higher by special order

##### Ambient Temperature:

-4° to 122°F (-20° to 50°C)

##### Cooling:

Transmitter is air cooled

#### MECHANICAL

##### Transmitter:

78" (198 cm) H  
144" (366 cm) W  
54" (137 cm) D  
62 sq. ft. (5.8 sq. m.)

##### Weight:

4,891 lbs. (2,219 kg)

##### Plate Transformer:

72" (183 cm) H  
24" (61 cm) W  
46" (117 cm) D

##### Weight:

1,990 lbs. (903 kg)

##### Export Shipping:

Gross weight 9,700 lbs. (4,400 kilos);  
800 cubic feet (22.65 cubic meters)

All specifications are subject to change without notice.  
Printed in USA 1M388  
© 1988 Varian, Continental Electronics Division

Continental's 317C-3, 50 kW  
Broadcast Transmitter

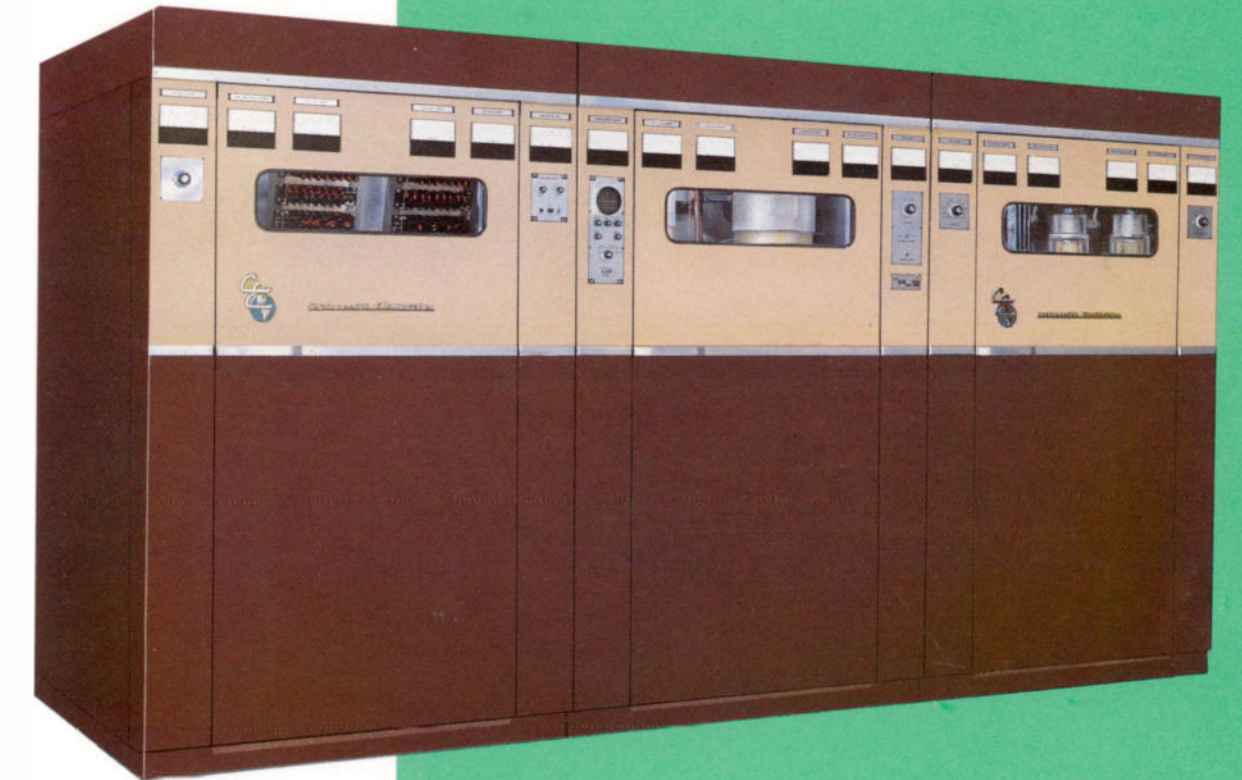

Continental's customer service is  
the industry's best!

Call anytime, day or night.  
Main offices: (214) 381-7161  
Engineering service: (214) 327-4533  
Parts: (214) 327-4532

varian®

continental electronics division

P.O. Box 270879 Dallas, Texas 75227  
Telephone: 214-381-7161 Fax: 214-381-4949





Continental's 317C-3 is a 50 kW AM broadcast transmitter that meets today's programming demands. Its field-proven, cost effective design offers excellent performance with high overall efficiency, increased reliability and easy maintainability.

The 317C-3 replaces its predecessor, the 317C-2, and delivers superb audio quality and faithfully reproduces the most sophisticated audio processing. The solid-state driver, which replaces the 4-400C driver tube, further improves Continental's transmitter quality.

Continental's first 317C transmitter installation was a result of extensive research and analysis of transmitter circuit and modulation techniques.

Our early investigations included plate out-phasing (Ampliphase), screen grid, control grid, series anode, Cathanode and Doherty modulation systems. Later on, pulse width and pulse duration modulation were studied.

Out of this research came Continental's patented\* screen-impedance modulation technique. Our application of this technology to the final amplifier tubes in the Doherty system achieved high performance combined with high efficiency.

Continental's design has been thoroughly tested and enthusiastically accepted by broadcasters around the world for transmitter requirements from 50 to 2,000 kW.

Today, our 317C-3 offers customers the highest level of performance from a proven, unmatched heritage.

### 317C-3 Standards of Performance

#### Superior Audio Frequency Response

±0.5 dB amplitude variation from 10 to 10,000 Hz and less than 5° phase variation from 10 Hz to midband and essentially phase linear to 30 kHz.

#### Flat Top Response

Less than 5% tilt or overshoot on trapezoidal waveforms generated by clipping a sinewave 6 dB below peak amplitude from 30 to 10 kHz at 90% modulation.

### Extra Power for High Peaks

Ruggedized 12-phase plate supply eliminates filter reactor, provides extra power for high positive peak demands of low frequency programming and minimizes audio phase shift. Improved regulation virtually eliminates carrier shift.

### High Positive Modulation

12-phase plate supply transformer rating and output voltage are increased to provide +125% modulation with plenty of headroom, and 100% sinewave modulation capability down to 10 Hz.

### Program Peak Limiter

Automatic program peak controller with adjustable positive and negative thresholds will maintain peaks at limits set by station engineer. LED flashers indicate limiting.

### AM Stereo Compatibility

With its new solid-state RF driver and 12-phase plate supply, Continental guarantees compatibility with any AM stereo transmission system established by the FCC. The 317C-3 is built to receive a stereo exciter.

### Solid-State Driver

A broadband, untuned circuit that eliminates two tuning controls improves performance in the angle modulated stereo operation and reduces incidental phase modulation. The solid-state module plugs into the 4-400C socket and uses available air for cooling.

### Long Tube Life

Conservative operation of the power amplifier leads to extended tube life.

### High Efficiency

Overall efficiency is better than 60% at any level of modulation.

### Magniphase® Line Protection System

Protects transmission line, antenna and tuning equipment. Reduces power automatically; shuts down transmitter if permanent antenna fault occurs.

### Easy to Operate

Motor driven tuning and power adjustments; designed for unattended operation by remote control. Complete instrumentation and maximum personnel protection.

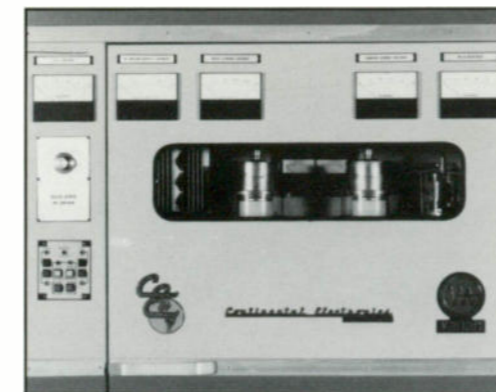
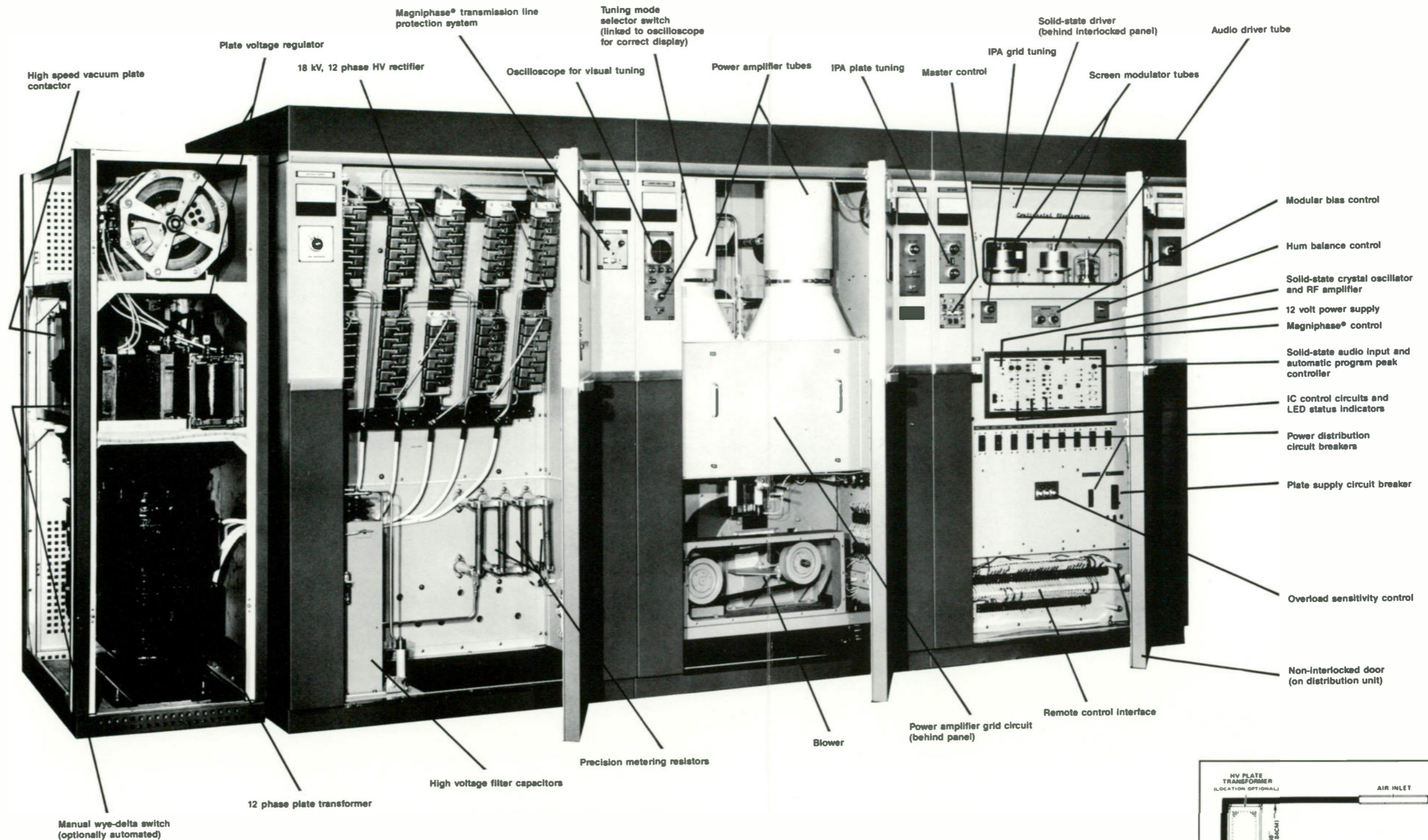

RF driver module

### Floor Plan

Continental's 317C-3 is self-contained except for the plate transformer which is in a separate enclosure. A single blower housed inside the transmitter cabinet provides cooling. Wide doors give easy access to all cabinets, with walk-in access to the driver and power distribution cabinet.

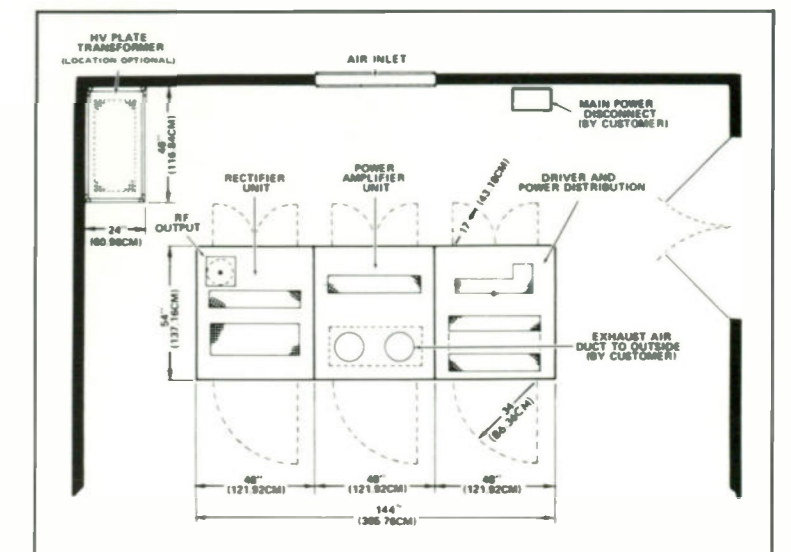

\*Continental Electronics holds the following patents for the high efficiency screen modulated amplifier: Canada 784,805; France 1,432,543; UK 1,044,479; USA 3,314,024



**Continental Type 315R-1 5 kW AM transmitter offers broadcast-ers a new standard of performance. It's also available as the Type 314R-2 (828D-1) 2.5 kW AM transmitter**

- High efficiency SwitchMod pulse modulation
- Overall efficiency exceeding 57% at 5000 watts 95% sine wave modulation.
- Harmonic distortion less than 2.0% from 20 to 10000 Hz.
- Low intermodulation distortion per standard 4:1 SMPTE
- Feedback taken from modulated DC, not from RF envelope for reduced sensitivity to load conditions.
- Bandpass "Q-Taper" output network for flatter response across the audio passband and improved adjacent signal rejection.
- Lower peak voltages as a result of operation of the PA anode at DC ground.
- Local and remote metering directly at ground reference.

- No plate blocking capacitor or DC feed choke required.
- Automatic modulation control keeps modulation sensitivity constant at all power levels and with a  $\pm 10\%$  line voltage variation, standard.
- Built-in Instantaneous Peak Limiter.
- + 125% modulation capability.
- Built-in Forward/Reflected Power meter.
- Low power setting continuously adjustable over entire power range of the transmitter.
- Use of triodes eliminates need for screen grid supply.
- Overload recycle interrupts pulse train to remove high voltage in microseconds. After third overload, high voltage power supply is shut down.
- Improved phase linearity in "Q-Taper" network for AM stereo.

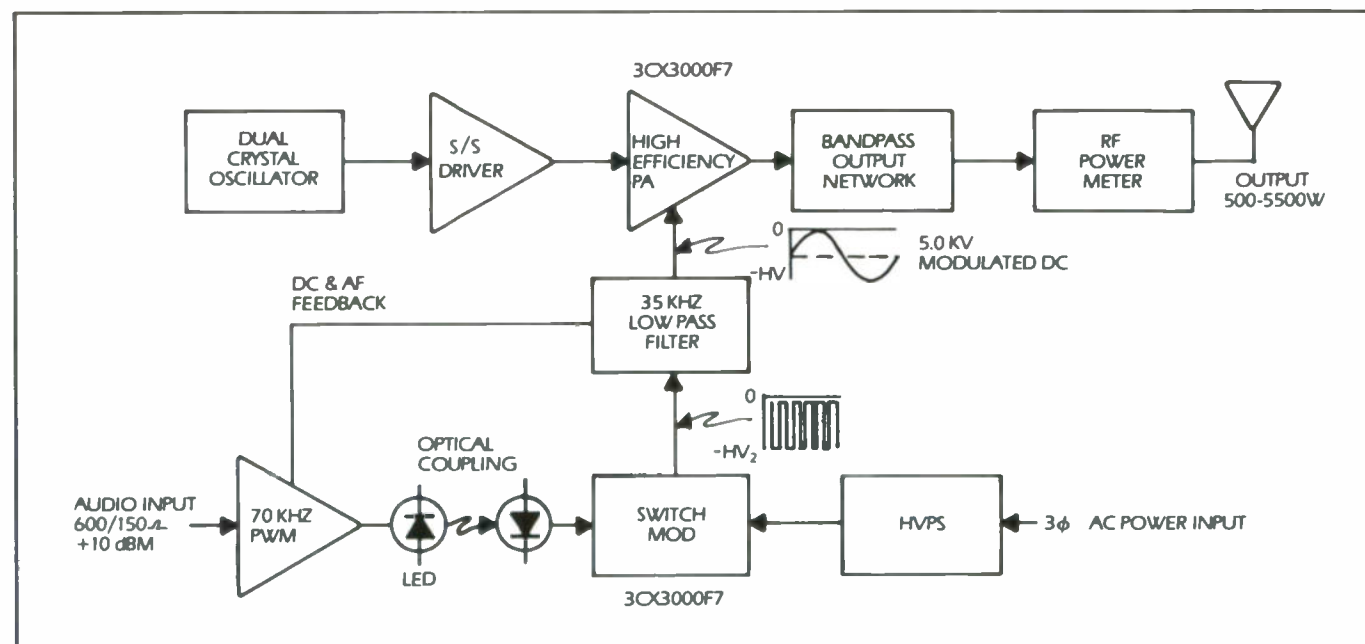
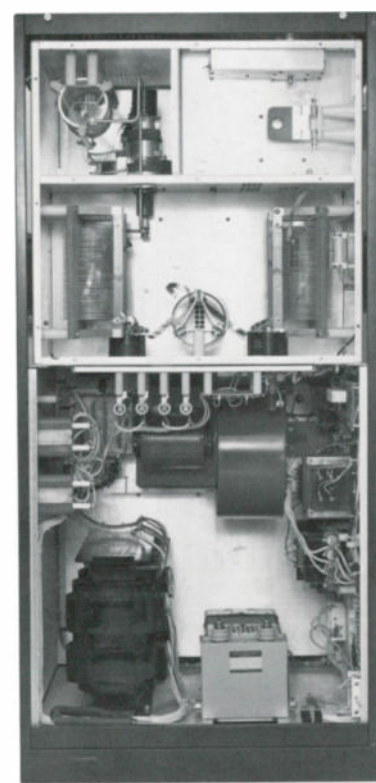
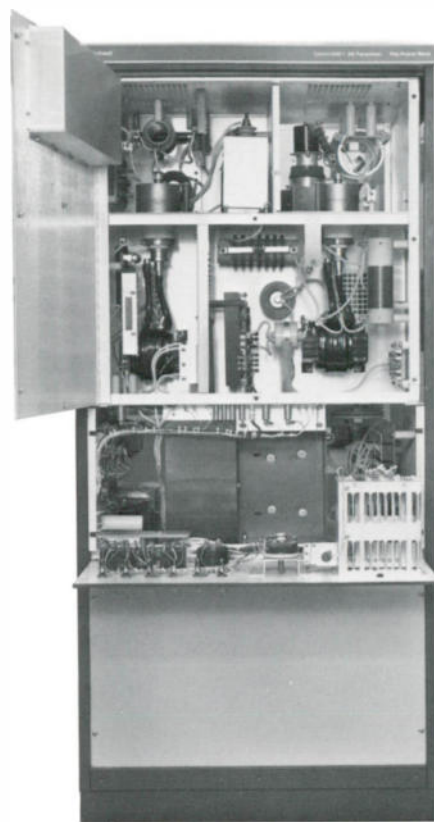

**SPECIFICATIONS**

**ELECTRICAL**

- Frequency Range**  
540-1600 KHz.
- RF Output Power**  
500-5500 w. 315R-1  
(250-2750 W) 314R-2
- Output Impedance**  
50 Ohm nominal (others available on special order)
- Output Fitting**  
1-5/8" EIA male flange standard  
7/8" EIA flange or stud output also available.
- Harmonic and Spurious**  
Complies with FCC and CCIR regulations.
- Carrier Amplitude Reg.**  
2% max. adjustable to 0
- Frequency Stability**  
 $\pm 5$  Hz. over ambient temp. range (below)
- Power Requirements**  
200-250 VAC 3  $\phi$  3 or 4 wire, wye or closed delta, 50/60 Hz  
385-435 VAC available on special order

**Power Consumption**

13.0 KVA @ 95% PF for 5000 Watts, 95% sine wave modulation

**Overall Efficiency**  
Better than 57% at 5000 Watts, 95% sine wave modulation.

**Frequency Response**  
 $\pm 1$  dB, 20-10000 Hz. @ 95% modulation, 5000 Watts output

**Total Harmonic Distortion**  
less than 2% 20-10000 Hz @ 95% mod, 5000 Watts output

**Noise**  
better than -60dB reference 400 Hz., for 100% modulation @ 5000 Watts output

**Audio Input**  
+ 10 dBm  $\pm 2$  db 600/150 ohms for 100% modulation

**Modulation Capability**  
- 100%, + 125% standard

**GENERAL**

- Size**  
88 cm. (34-3/4") W. x 85 cm. (33-3/8") D. x 176 cm. (69") H.  
0.75 sq. meters (7.9 sq. ft.) floor space
- Weight**  
476 Kg (1050 lbs)
- Tubes**  
3CX3000F7 (2)
- Air Flow Requirement**  
500 CFM
- Humidity**  
95%, max
- Ambient Temp. Range**  
To 0°C to +50°C. (meets FCC requirements to -20°C)
- Altitude**  
2280. M (7,500 ft.) above mean sea level

**Continental Electronics**  
CONTINENTAL ELECTRONICS MFG. CO. BOX 270879 DALLAS, TEXAS 75227 (214) 381-7161



CONTINENTAL TYPE 315R-1  
5 KW AM  
BROADCAST TRANSMITTER

**AM**

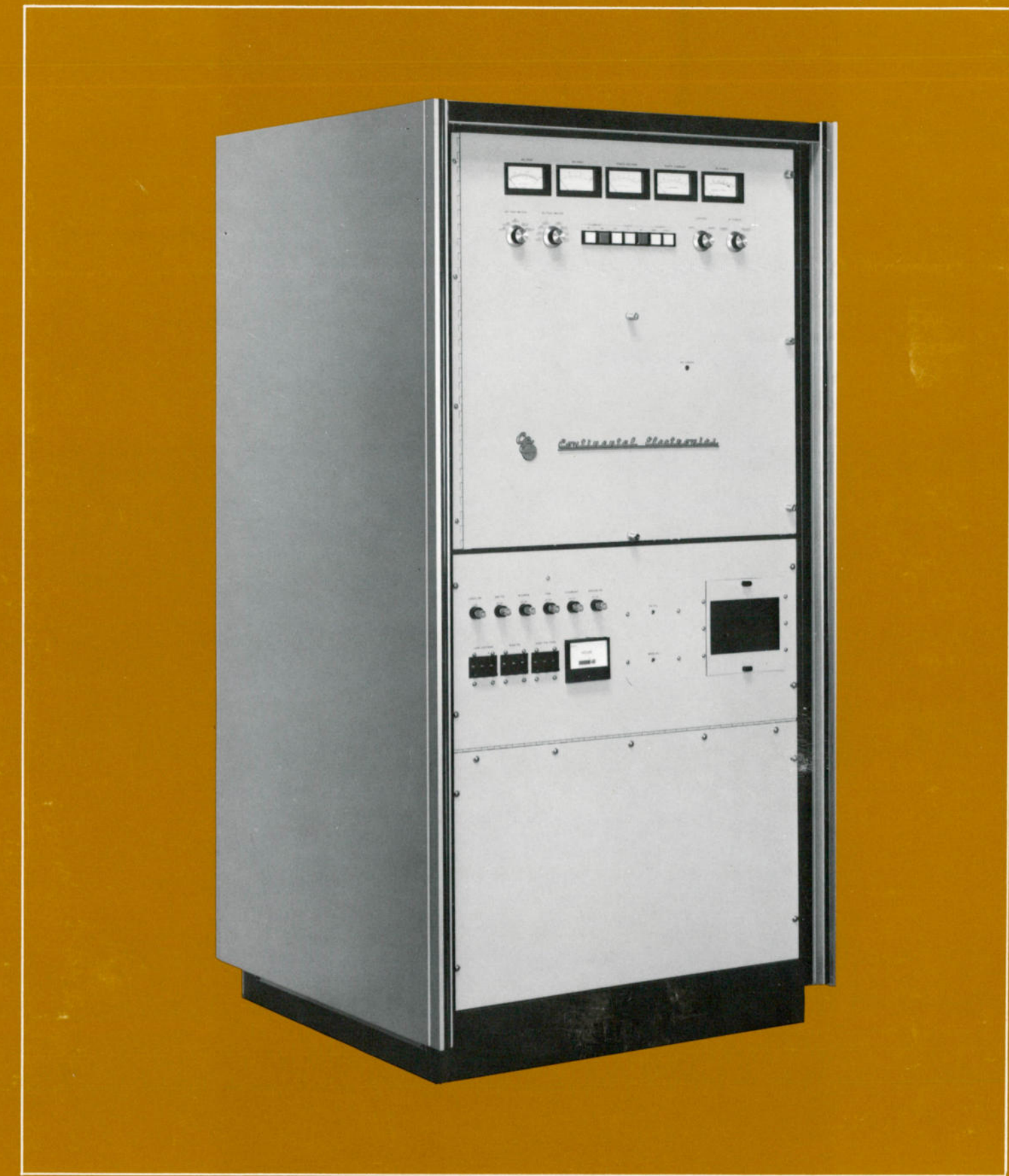

Printed in USA 3M382/4868

© 1982 Continental Electronics Mfg. Co.

Continental Electronics





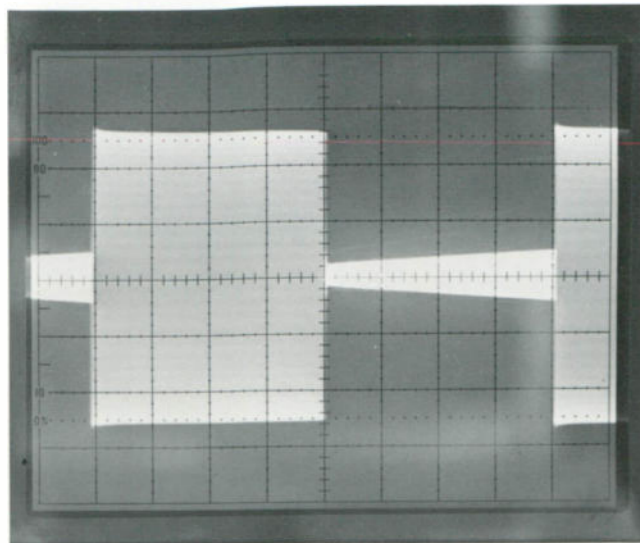

Oscilloscope photo shows excellent dynamic response of Continental's 5 kW AM transmitter at 20 Hz modulation.

Test/monitor equipment photos show modulation (top), total harmonic distortion (middle) and intermodulation distortion (bottom) at 95% modulation at 100 Hz. Intermodulation test was made in accordance with standard 4:1 SMPTE method.

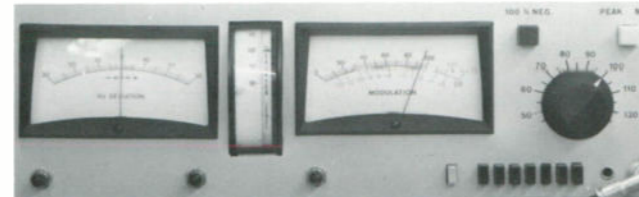

modulation.

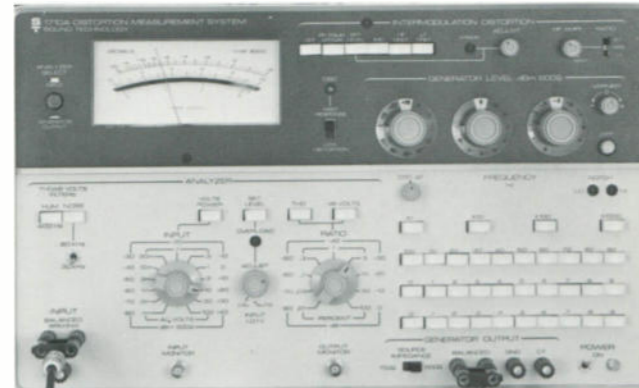

harmonic

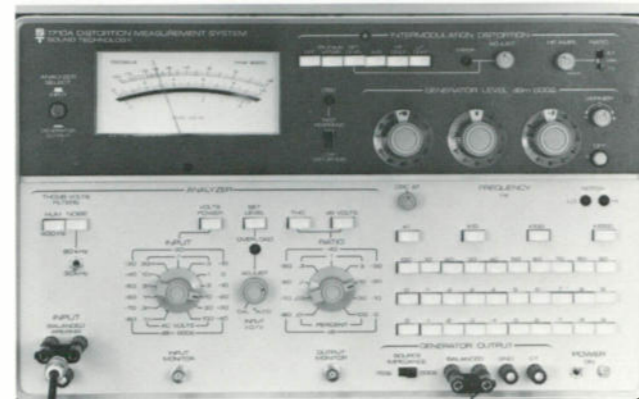

intermodulation

**Continental Type 315R-1 5 kW AM transmitters are designed for state-of-the-art performance, cost-effective operation and easy maintainability.**

#### AM Stereo

A Signal Access Card provides rear panel access to both audio and RF drive for use in either parallel operation of two 315R-1 transmitters or for future use in AM stereo. These terminals will make possible the connection of an external stereo generator to the RF drive line and to the audio chain.

#### Q-Taper Network

A Q-Taper network provides flatter response across the audio pass band and very steep skirts above and below the pass band. Unlike conventional "Pi" networks, the skirts of the Q-Taper network are nearly symmetrical with second harmonic suppression at 80 dB below carrier. The 3 dB bandwidth is approximately 10% of the operating frequency, 100 kHz average. The 4 node network achieves low circulating currents by the use of low nodal Q's, on the order of 2-6. Overall system Q-Product is approximately 250. These lower circulating currents allow the use of smaller components neither sacrificing performance or conservative component rating. The Q-Taper network also has improved phase linearity over conventional networks, an important consideration for AM stereo.

#### SwitchMod System

The dc coupled series switching modulator with the stability of the proven 12 phase power supply, the built-in Instantaneous Peak Limiter (IPL) and the automatic modulation controller circuits to achieve dramatically improved AM audio performance in the areas of low frequency response, IM distortion

and overall modulation density. IPL front panel adjustments set both positive and negative limits of modulation. Working in conjunction with the automatic modulation control, the maximum level of modulation is maintained at all power levels even with 10% power line variations. Overmodulation due to powerline variations or audio peaks is effectively prevented.

#### High Efficiency P.A.

Continental's 315R-1 transmitters achieve a final PA efficiency approaching 90% using the third harmonic injection technique of the proven Tyler-type. Combined with the high efficiency SwitchMod technique, overall efficiency exceeds 55%.

#### Grounded Anode

The anode of the final amplifier operates at dc ground, reducing peak RF voltages with respect to the chassis to about half the conventional configuration. Metering is accomplished at ground reference for both local and remote operation. There is no need for a blocking capacitor or feed choke. This technique is made practical by using fiber-optics to couple audio input to the audio driver. High audio performance is maintained by using dc coupling throughout the audio chain.

#### 12-Phase Power Supply

The 12-phase power supply uses an extended Delta power transformer, for additional harmonic suppression, and two three-phase, full wave rectifiers to develop high voltage dc with a 720 Hertz ripple frequency. Because of the high ripple frequency, the absence of filter inductors and large capacitors helps reduce transmitter size; eliminates several expensive, failure-prone components. Inductors, which cause resonances, are eliminated, Power supply sag and bounce are not a problem.

#### Maintainability

Continental's Type 315R-1 transmitters offer excellent accessibility. Modular circuit boards with extender cards and LED status indicators on major circuits and relays help to simplify maintenance. One tube type is used for both final PA and switch-tube applications. The bottom line is a smooth, easily maintained day-to-day operation.

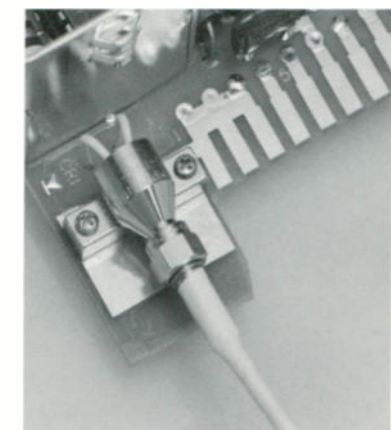
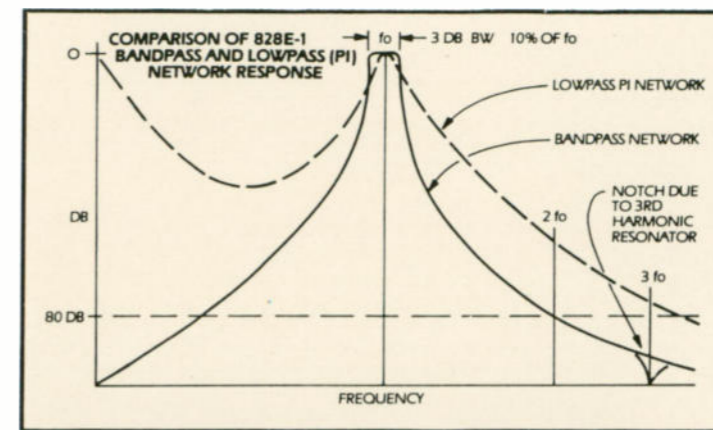
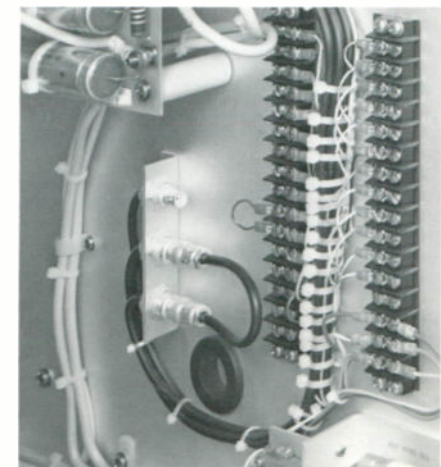
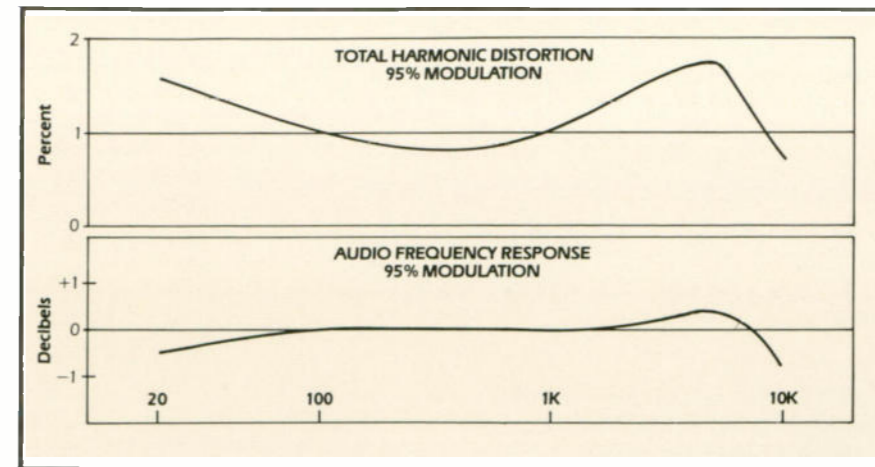

Q-Taper network circuit

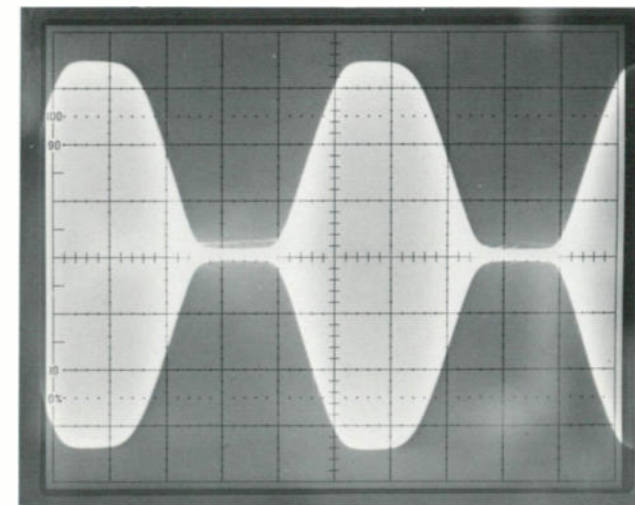
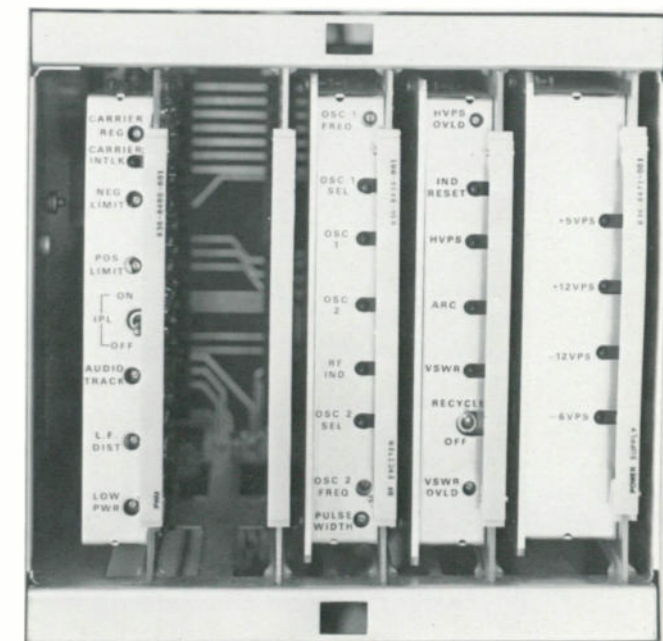

Photo of modulation wave form shows effect of Instantaneous Peak Limiter (IPL).

Top right: rear panel connections for Signal Access Card; middle right: Fiber Optics Assembly; bottom right: IPL settings on PWM Card.





### 316F OFFERS BROADCASTERS UNMATCHED PERFORMANCE

**Superior audio frequency response**  
± 1 dB amplitude variation from 10 to 10,000 Hz; less than 5° phase variation from 10 Hz to midband; essentially phase linear to 30 kHz.

**High positive modulation**  
Transformer rating and output voltage provide + 125% modulation with plenty of headroom, and 100% sinewave modulation capability to 10 Hz.

**Program peak limiter**  
Automatic program peak controller has adjustable positive and negative thresholds; will maintain peaks at limits set by station engineer. LED flashers indicate limiting.

**AM stereo compatibility**  
Continental guarantees compatibility with any AM stereo transmission established by the FCC. The 316F is built to receive a stereo exciter.

**Long tube life**  
Two 4CX15000A tubes are used in the final amplifier. This conservative application assures long tube life.

**Proven "on-air" reliability**  
All components, output networks and power supply are rated conservatively; this provides an extra operating margin with extended component life and performance.

**Magniphase® line protection system**  
Protects transmission line, antenna and tuning equipment.

**Easy to operate**  
Designed for unattended operation by remote control; complete instrumentation; maximum personnel protection.

### TRANSPARENCY WITH ON-AIR RELIABILITY

The 316F delivers superb audio quality and faithfully reproduces the most sophisticated audio processing.

All components, output networks and power supply are rated conservatively to provide an extra operating margin.

With only two tubes, a blower for cooling and a minimum of relay contacts, the 316F is easy to maintain. Many broadcasters have passed 30,000 hours of operation without unscheduled downtime.

"Collector modulation" technique eliminates critical tuning adjustments and is almost identical to plate modulation except that no transformers or chokes are used.

The transmitter tunes easily in a straightforward manner and uses a high-efficiency linear amplifier for simplicity and reliability.

The 316F is rated at 10,000 watts; a similar model, the Type 315F, operates at 5,000 watts and is identical to the 316F except for tubes and power supplies.



Automatic program peak limiter.

### SPECIFICATIONS

**Carrier power**  
Type 316F: 10.6 kW  
Type 315F: 5.5 kW  
**Modulation**  
Collector modulation of rf driver stage  
**Emission**  
A3  
**Frequency range**  
Any single frequency, 535 to 1620 kHz  
**Frequency stability**  
± 5 Hz  
**Audio input**  
150/600 ohms, + 10 dBm ± 2 dB for 100% modulation  
**Audio response**  
50 to 7,500 Hz, ± 1 dB; 30 to 15,000 Hz, ± 1.5 dB  
**Audio distortion**  
30 to 10,000 Hz, less than 3%  
**Carrier shift**  
2% or less at 100% modulation

**Modulation capability**  
100% continuous at any frequency, 30 to 10,000 Hz; 125% positive peak with asymmetrical program input  
**Noise**  
- 60 dB below 100% modulation  
**Spurious and harmonic emissions**  
- 80 dB or better  
**Output impedance**  
50 to 250 ohms, unbalanced  
**Power source**  
208/230 v ac, 3-phase; 50/60 Hz  
**Permissible combined voltage variation**  
± 5%  
**Power factor**  
93%  
**Power consumption, 316F**  
23.6% kW @ 0% modulation  
24.1% kW @ 30% modulation  
28.4% kW @ 100% modulation  
**Power consumption, 315F**  
11.2 kW @ 0% modulation  
11.5 kW @ 30% modulation  
14.2 kW @ 100% modulation

**Operating altitude**  
Up to 7,500 feet (2286 m); higher by special order  
**Ambient temperature**  
- 10°C to + 45°C  
**Cooling**  
Forced air  
**Size, 316F or 315F**  
77 1/8" (196 cm) H  
66 1/8" (168 cm) W  
25 1/2" (65 cm) D  
**Net weight**  
316F: 1,650 lb (748 k)  
315F: 1,500 lb (680 k)  
**Export shipping, 316F or 315F**  
Size: 173.1 cu-ft (4.9 cu-m)  
Gross weight: 2,480 lb (1124.9 k)

Performance data taken from Type Acceptance data on file with the FCC. 316F @ 10,600 w. 315F @ 5,500 w.  
Specifications are subject to change without notice.

**Continental Electronics**  
CONTINENTAL ELECTRONICS MFG. CO. BOX 270879 DALLAS, TEXAS 75227 (214) 381-7161

CONTINENTAL TYPE 316F/315F  
10 & 5 KW AM  
BROADCAST TRANSMITTER

**AM**



Printed in USA 11/28/83/5004

© 1982 Continental Electronics Mfg. Co.

Continental Electronics



**TYPE 316F TYPICAL PERFORMANCE**

Audio phase characteristics (Input: lower trace; Output: envelope)

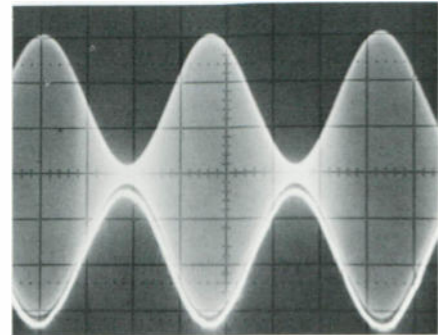

90% modulation at 50 Hertz

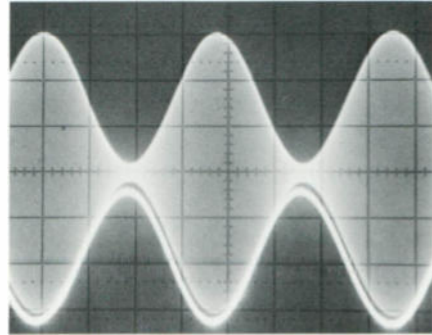

90% modulation at 1,000 Hertz

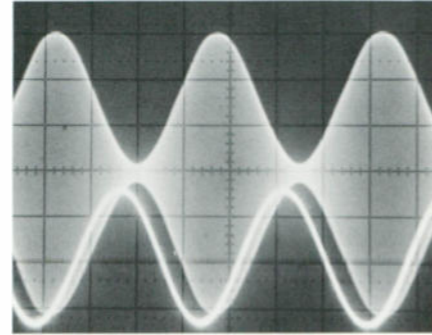

90% modulation at 7,500 Hertz

Square wave response

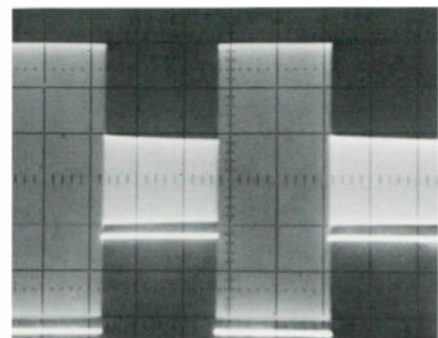

60% modulation at 50 Hertz

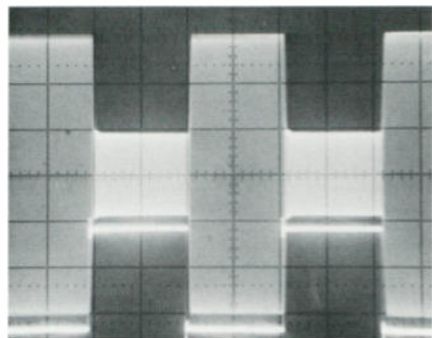

60% modulation at 1,000 Hertz

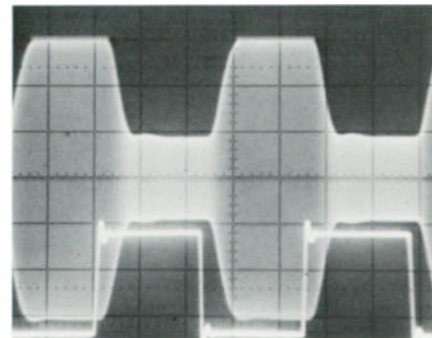

60% modulation at 7,500 Hertz

Frequency and phase response at 90% modulation

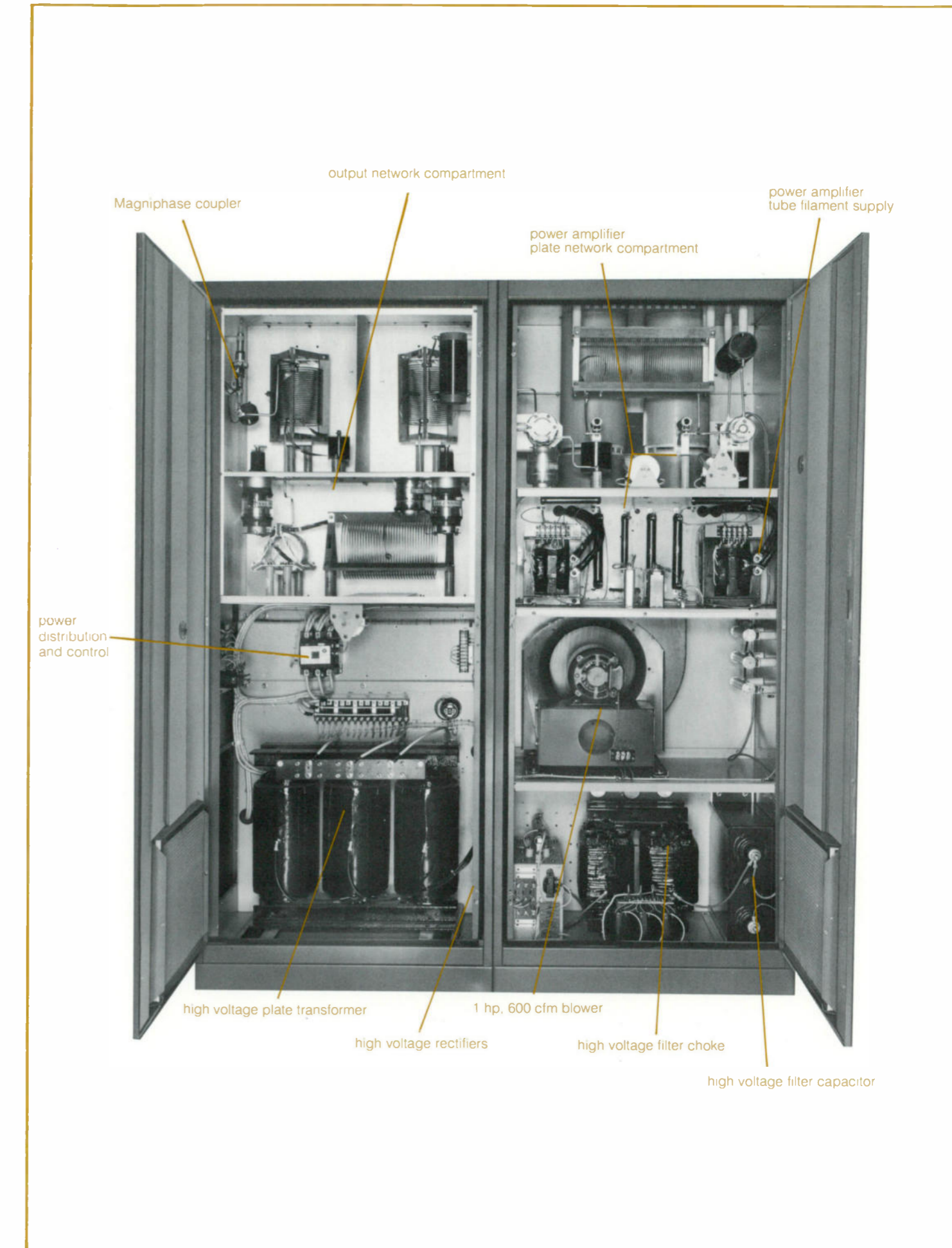
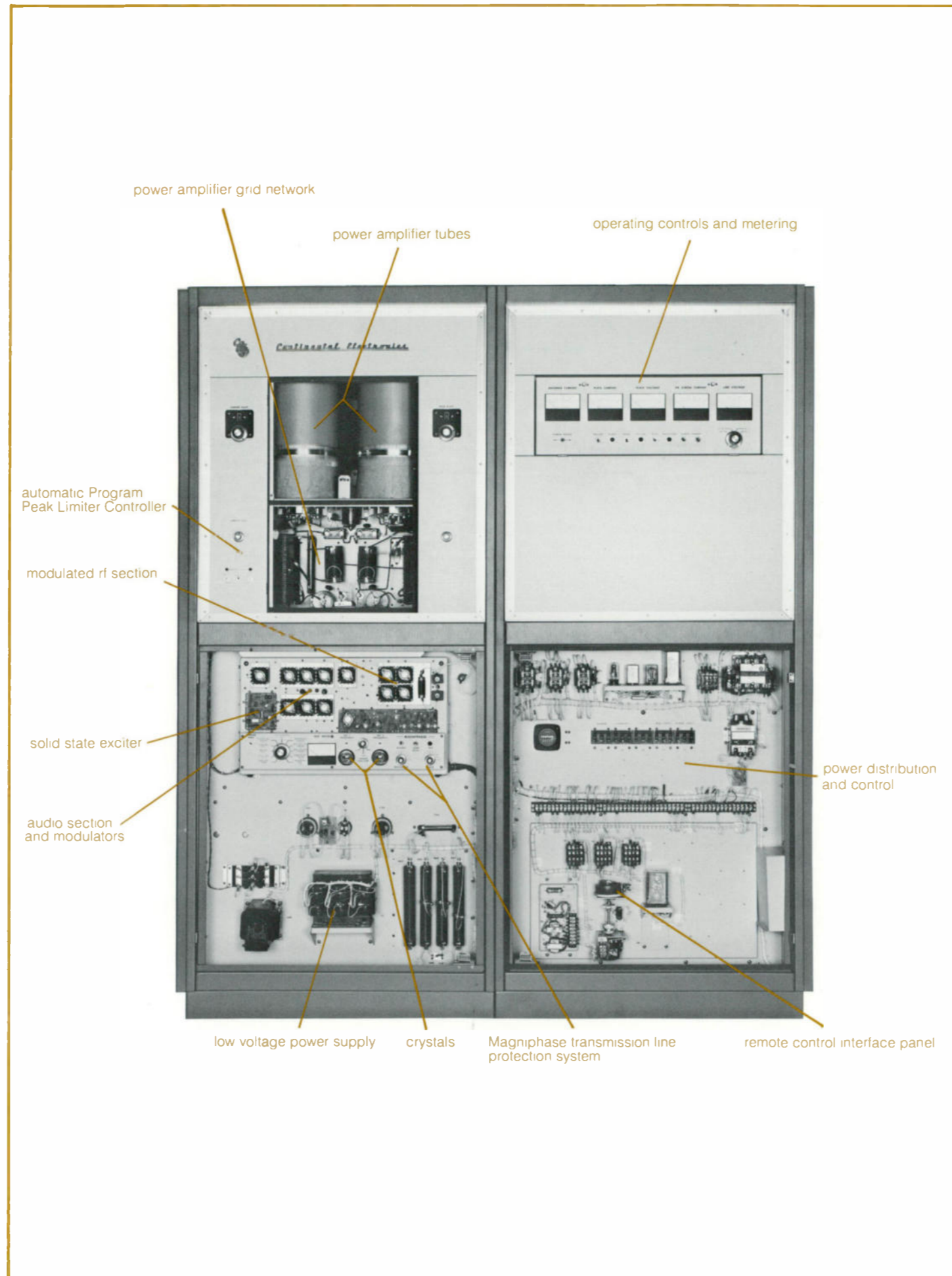
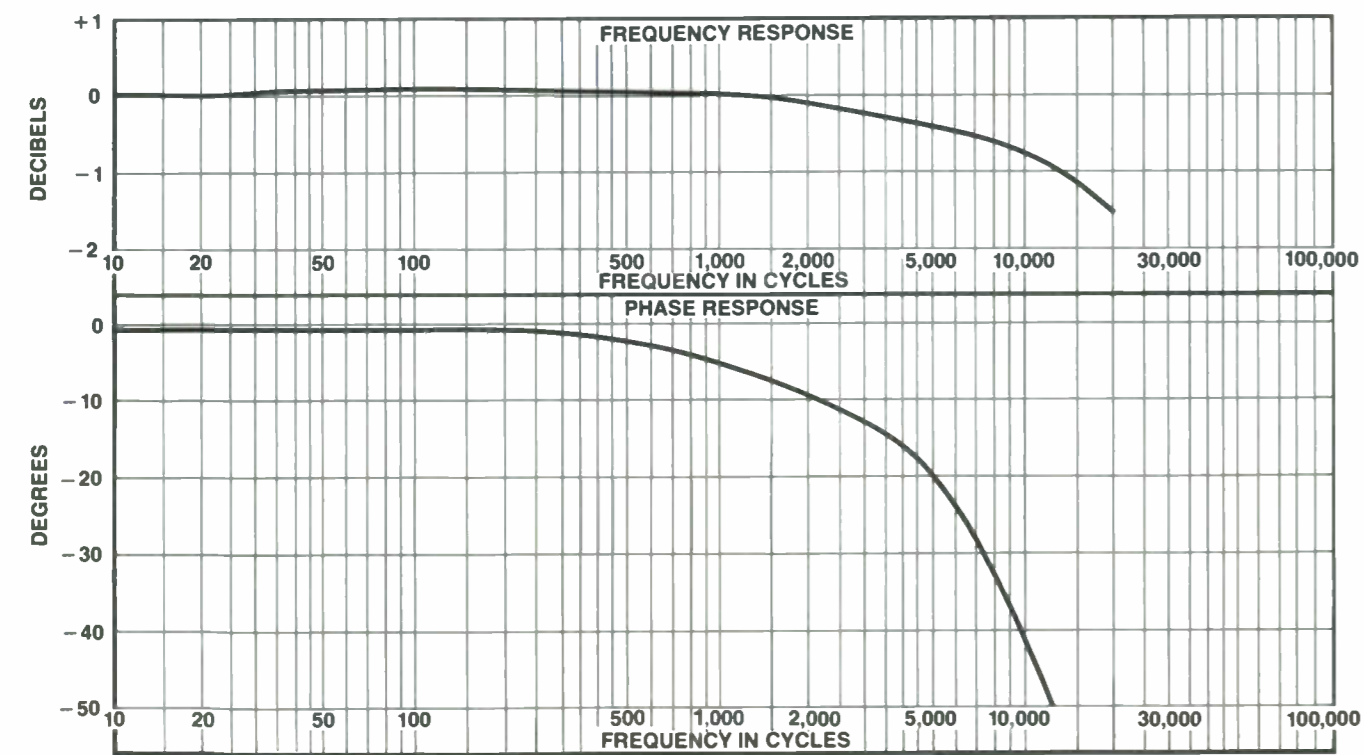



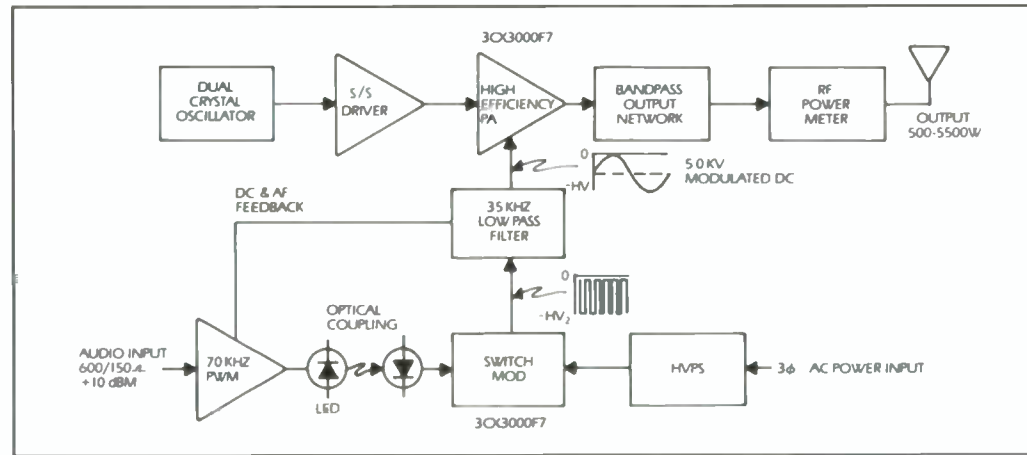

**Continental's 315R-1, 5 kW Broadcast Transmitter**

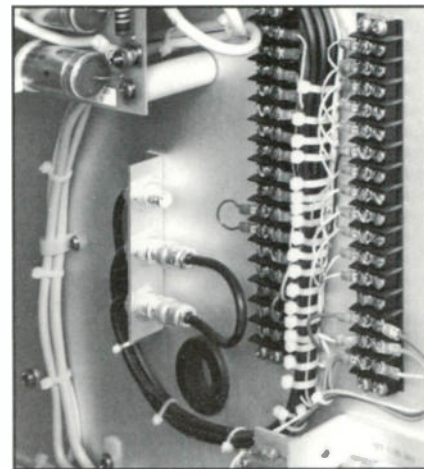

Rear panel connections for signal access card.

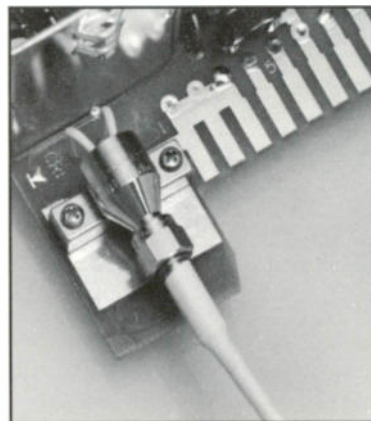

Fiber optics assembly.

**SPECIFICATIONS**

**ELECTRICAL**

- Frequency Range:**  
540-1,600 kHz
- RF Output Power:**  
500-5,500 W
- Output Impedance:**  
50 ohms nominal  
(others available on request)
- Output Fitting:**  
1-5/8" EIA male flange standard 7/8" EIA flange or stud output also available
- Harmonic and Spurious:**  
Complies with FCC and CCIR regulations
- Carrier Amplitude Regulation:**  
2% maximum, adjustable to 0
- Frequency Stability:**  
±5 Hz (0 to 50°C); ±20 Hz (-20°C to 50°C)
- Power Requirements:**  
200-250 VAC three-phase 3 or 4 wire, wye or closed delta. 50 Hz, 385-435 VAC available on request
- Power Consumption:**  
13.0 KVA at 95% PF for 5,000 watts, 95% sine wave modulation
- Overall Efficiency:**  
Better than 57% at 5,000 watts, 95% sine wave modulation
- Frequency Response:**  
±1 dB, 20-10,000 Hz at 95% modulation, 5,000 watts output
- Total Harmonic Distortion:**  
Less than 2% 20-10,000 Hz at 95% modulation, 5,000 watts output
- Noise:**  
Better than -60 dB reference 400 Hz, for 100% modulation at 5,000 watts output

- Audio Input:**  
+10 dBm ± 2 dB 600/150 ohms for 100% modulation
- Modulation Capability:**  
-100%, +125% standard

**GENERAL**

- Transmitter:**  
69" (176 cm) H  
34 3/4" (88 cm) W  
33 3/8" (85 cm) D  
7.9 sq. ft (.75 sq. m)
- Weight:**  
1,050 lbs (476 kg)
- Tubes:**  
3CX3000F7 (2)
- Air Flow Requirement:**  
500 CFM
- Relative Humidity:**  
0 to 95%
- Ambient Temperature Range:**  
To 0°C to +50°C (meets FCC requirements to -20°C)
- Altitude:**  
7,500 ft (2,280 m)

All specifications are subject to change without notice.  
Printed in USA 1M 989  
© 1989 Varian, Continental Electronics Division

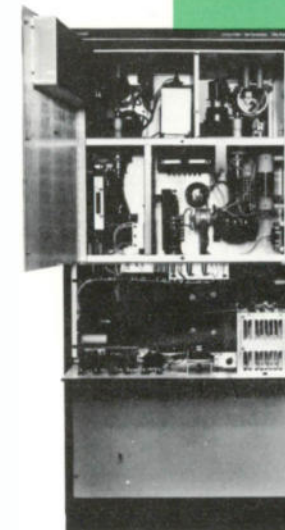
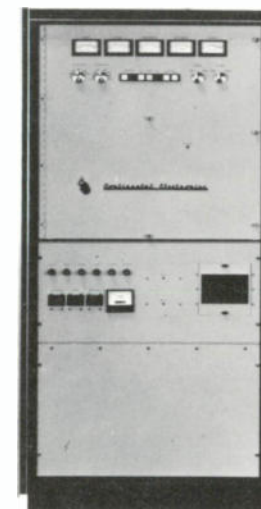

**Continental Electronics Corporation**

P.O. BOX 270879 DALLAS, TEXAS 75227-0879 214-381-7161 TELEX: 73-398 FAX: 214-381-4949

Continental's customer service is the industry's best!

Call anytime, day or night. Main offices: (214) 381-7161 Engineering service: (214) 388-5800 Parts: (214) 388-3737



### The 315R-1 is a Proven Performer

Continental's 315R-1 5 kW AM transmitter is designed for state-of-the-art performance, cost-effective operation and easy maintainability.

#### Q-Taper Network

A Q-Taper network provides flatter response across the audio pass band and very steep skirts above and below the pass band.

Unlike conventional "Pi" networks, the skirts of the Q-Taper network are nearly symmetrical with second harmonic suppression at 80 dB below carrier. The 3 dB bandwidth is approximately 10% of the operating frequency, 100 kHz average.

The four-node network achieves low circulating currents by using low nodal Q's, on the order of 2-6. Overall system Q-product is approximately 250.

Lower circulating currents allow the use of smaller components without sacrificing performance or conservative component rating. The Q-Taper network also has improved phase linearity over conventional networks, an important consideration for AM stereo.

#### SwitchMod System

The dc coupled series switching modulator has the stability of the proven 12-phase power supply, the built-in Instantaneous Peak Limiter (IPL) and the automatic modulation controller circuits. It achieves dramatically improved AM audio performance in the areas of low frequency response, IM distortion and overall modulation density.

IPL front panel adjustments set both positive and negative limits of modulation. Overmodulation due to powerline variations or audio peaks is effectively prevented.

### High Efficiency P.A.

Continental's 315R-1 transmitters achieve a final PA efficiency approaching 90% using the third harmonic injection technique of the proven Tyler-type. Combined with the high efficiency SwitchMod technique, overall efficiency exceeds 55%.

#### Grounded Anode

The final amplifier anode operates at dc ground, reducing peak RF voltages with respect to the chassis to about half the conventional configuration.

Metering is accomplished at ground reference for both local and remote operation. There is no need for a blocking capacitor or feed choke.

High audio performance is maintained by using dc coupling throughout the audio chain. This technique is made practical by using fiber-optics to couple audio input to the audio driver.

#### 12-Phase Power Supply

The 12-phase power supply uses an extended delta power transformer for additional harmonic suppression and two three-phase, full wave rectifiers to develop high voltage dc with a 720 Hz ripple frequency.

Because of the high ripple frequency, the absence of filter inductors and large capacitors helps reduce transmitter size and eliminates several expensive, failure-prone components. Inductors, which cause resonances, are eliminated and power supply sag and bounce are not a problem.

#### Maintainability

Continental's 315R-1 offers excellent accessibility. Modular circuit boards with extender cards and LED status indicators on major circuits and relays help to simplify maintenance. One tube type is used for both final PA and switch-tube applications. The bottom line is a smooth day-to-day operation that is easy to maintain.

### Features

- High efficiency SwitchMod pulse modulation
- Overall efficiency exceeding 57% at 5,000 watts, 95% sine wave modulation
- Harmonic distortion less than 2.0% from 20 to 10,000 Hz
- Low intermodulation distortion per standard 4:1 SMPTE
- Feedback taken from modulated dc, not from RF envelope, for reduced sensitivity to load conditions
- Bandpass "Q-Taper" output network for flatter response across the audio passband and improved adjacent signal rejection
- Lower peak voltages as a result of operation of the PA anode at dc ground.
- Local and remote metering directly at ground reference

- No plate blocking capacitor or dc feed choke required
- Automatic modulation control keeps modulation sensitivity constant at all power levels and with a  $\pm 10\%$  line voltage variation, standard
- Built-in IPL
- +125% modulation capability
- Built-in forward/reflected power meter
- Low power setting continuously adjustable over entire power range of the transmitter
- Use of triodes eliminates need for screen grid supply
- Overload recycle interrupts pulse train to remove high voltage in microseconds. After third overload, high voltage power supply is shut down.
- Improved phase linearity in "Q-Taper" network for AM stereo

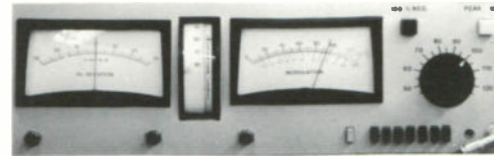

Modulation



Harmonic



Intermodulation

Test/monitor equipment photos show modulation (top), total harmonic distortion (middle) and intermodulation distortion (bottom) at 95% modulation at 100 Hz. Intermodulation test was made in accordance with standard 4:1 SMPTE method.

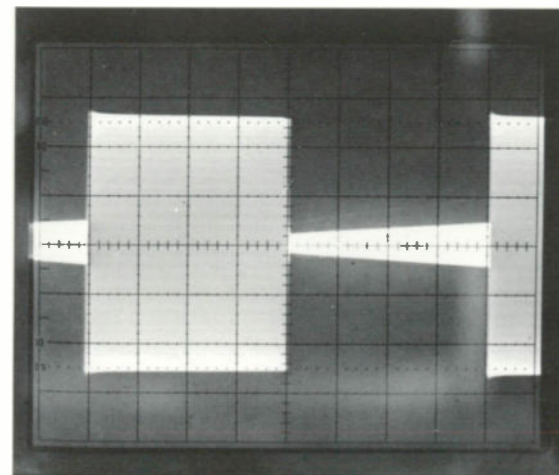

Oscilloscope photo shows excellent dynamic response of Continental's 5 kW AM transmitter at 20 Hz modulation.

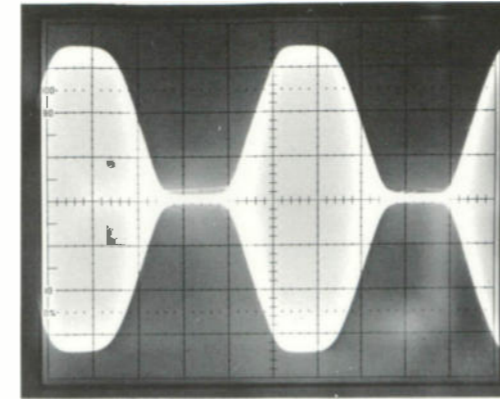
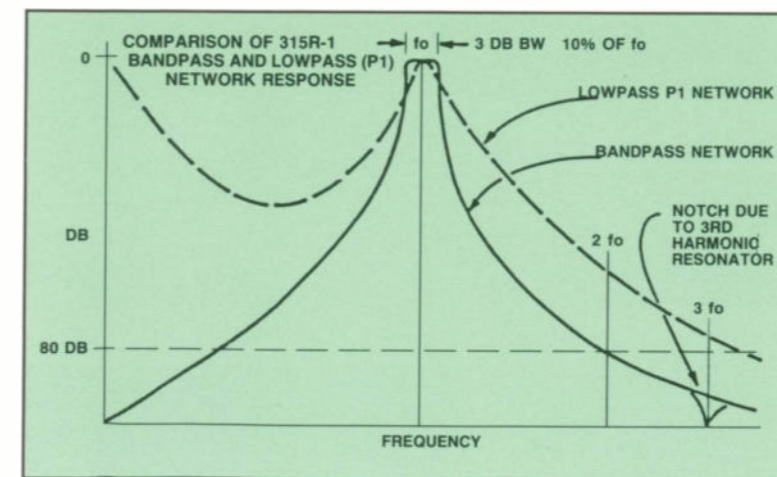
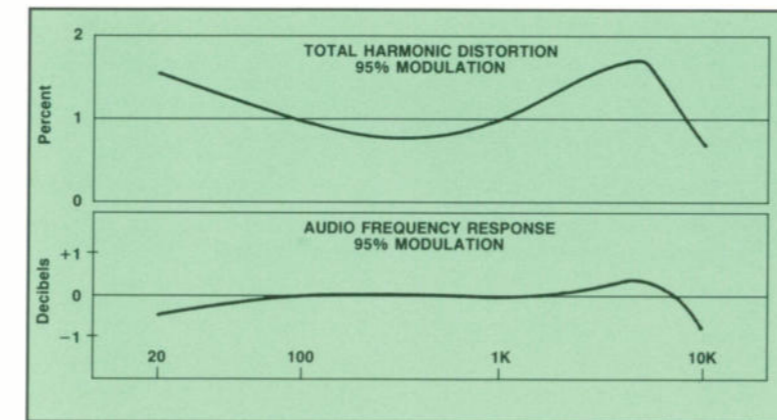
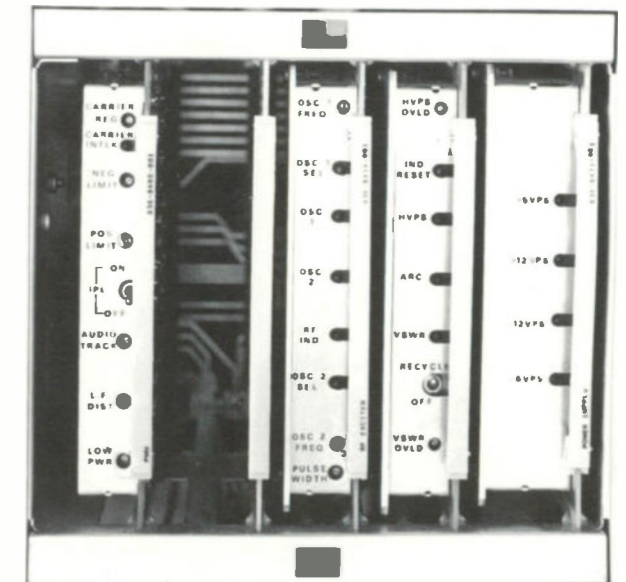

Photo of modulation wave form shows effect of Instantaneous Peak Limiter (IPL).



Q-Taper network circuit



IPL settings on PWM card.





# Continental Electronics Corporation

P. O. BOX 270879 DALLAS, TEXAS 75227-0879 (214) 381-7161 FAX (214) 381-4949 TELEX 73-398

## SPECIFICATIONS

### ELECTRICAL

**Rated Power Output:**  
50 kW

**Reduced Power:**  
In 4 Steps to 10 kW

**Frequency Range:**  
530 to 1705 kHz

**Frequency Stability:**  
± 5 Hz

**Load Impedance:**  
50 ohms with 1.2:1  
Maximum VSWR

### INPUT POWER

3ø, 380-600 V, 50/60 Hz

**Voltage Variation:**  
±5 Percent

**Frequency Variation:**  
±5 Percent

**Consumption:**  
Unmodulated 62.5kW  
100% Modulation 94.0 kW

**Power Factor:**  
0.09 Minimum

**Efficiency at 50 kW, Unmodulated:**  
80% Minimum  
(75% from 162f to 1705kHz)

### AUDIO PERFORMANCE

**Audio Input:**  
+10 dBm, ±2 dB at 100% Modulation

**Frequency Response:**  
±0.5 dB, 30 Hz to 10 kHz  
Referenced to 1 kHz

**Harmonic Distortion:**  
1% THD or less at 95% Modulation, 30  
Hz to 10 kHz, between 10 and 50 kW

**Intermodulation Distortion:**  
1% or less at 90% Modulation using  
SMPTE test method of 60 Hz/7kHz in a  
4:1 ratio at 50 kW Output Power

**Carrier Shift Modulation:**  
1% or less at 100% Modulation

**Incidental Phase Modulation:**  
35 dB below 95% Phase Modulation

**Square Wave Overshoot:**  
2% less at 1kHz, 80% Modulation

**Square Wave Tilt:**  
2% or less at 40 Hz

**Modulation Capability:**  
100% Continuous at any frequency  
30 to 10 kHz, +125% Positive Peak  
with Asymmetrical Input

**Hum and Noise:**  
65 dB below 100% Modulation (Unweighted)

### RF EMISSIONS

**Spurious:**  
Meets or Exceeds FCC, DOC and  
CCIR Requirements

**Harmonics:**  
Meets or exceeds FCC, DOC and  
CCIR Requirements

### ENVIRONMENTAL CONDITIONS

**Altitude:**  
13,000 ft. (3,963 m)  
Maximum

**Temperature:**  
- 10°C to 50°C (4°F to 122°F) Maximum  
Altitude and Temperature not occurring  
at same time

**Humidity:**  
0 to 95 Percent, Non-Condensation

### MECHANICAL

**Size:**  
78" (198.1 cm) High  
165" (419.1 cm) Wide  
33" (83.8 cm) Deep

**Weight:**  
5,000 lbs (2,269.6 kg) Maximum

All specifications are subject to change without notice.  
Printed in USA 2M 394  
©1994 Continental Electronics Corporation

## CONTINENTAL'S 317D 50kW BROADCAST TRANSMITTER

# am

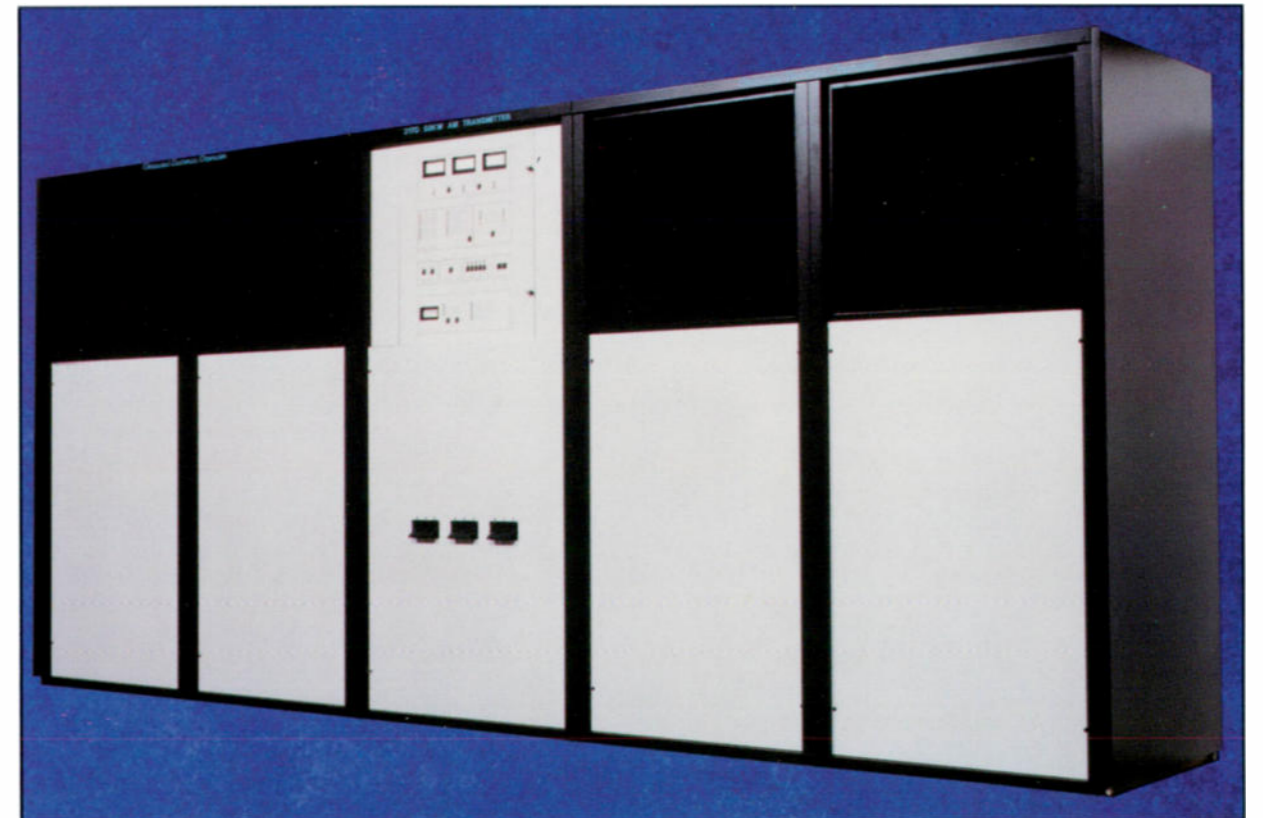



# Continental Electronics Corporation

## THE HIGH POWER AM TRANSMITTER

### FEATURES

- Totally Solid-State
- High Efficiency
- Automatic Power Level Control
- Front Panel Metering
- Totally Self Contained
- Component Accessibility
- Modular Design
- Module Redundancy
- Internal AM Stereo

Continental's 50 kW transmitter provides the broadcaster with low power consumption and superb audio performance. The transmitter is made up of two identical 25 kW sections combined for a single output capable of 50 kW. Each 25 kW section consist of 16 power blocks and it's own power supply.

**The Power Blocks** consist of 5 RF amplifier assemblies and 5 PWM modulator assemblies. Each RF amplifier assembly is capable of providing 350 watts.

**The Solid-State Amplifiers** Are identical and broadband. There are **no frequency determining parts in the amplifiers** making them interchangeable. Each RF amplifier bridge is on an individual printed circuit board and employs 8 field effect transistors forming a bridge with two parallel connected devices per branch.

**The PWM Modulator** uses two parallel connected FETs as switching devices mounted on one printed circuit board which is connected to each RF amplifier.

**Power Supplies** are identical for each 25 kW section. Transformers and rectifiers are located beneath the power amplifier blocks allowing ample space and accessibility.

**The Output Filter** Adds in phase the outputs of the two 25 kW sections and permits the operation of a single 25 kW transmitter. The filter also presents a high impedance at harmonic frequencies and blocks any DC component that may be introduced in the antenna by lightning strikes.

**The Combining Unit** contains the RF networks necessary for the combining of two transmitters. This unit also allows the operation of one transmitter into the antenna while the other transmitter is de-energized for maintenance or operation into a customer furnished test load.

**Control and Monitoring** for each 25 kW section is centralized to permit the simultaneous operation of all of the power blocks. Metering of the combined system, low level electronics and output filtering are also part of the center cabinet.

**AM Stereo Operation** is provided for with the addition of an internal stereo generator.

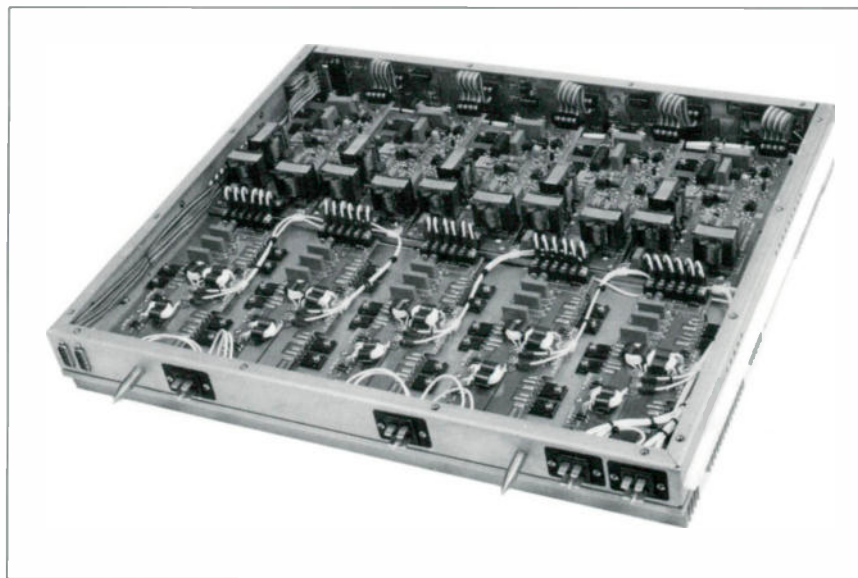

Power Block

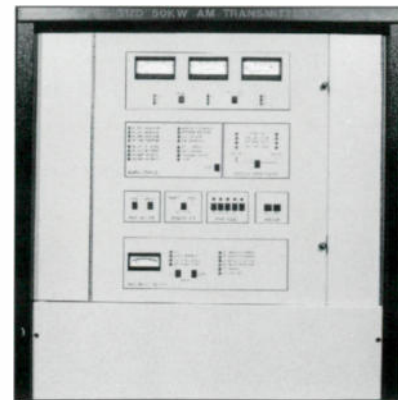

Control Panel

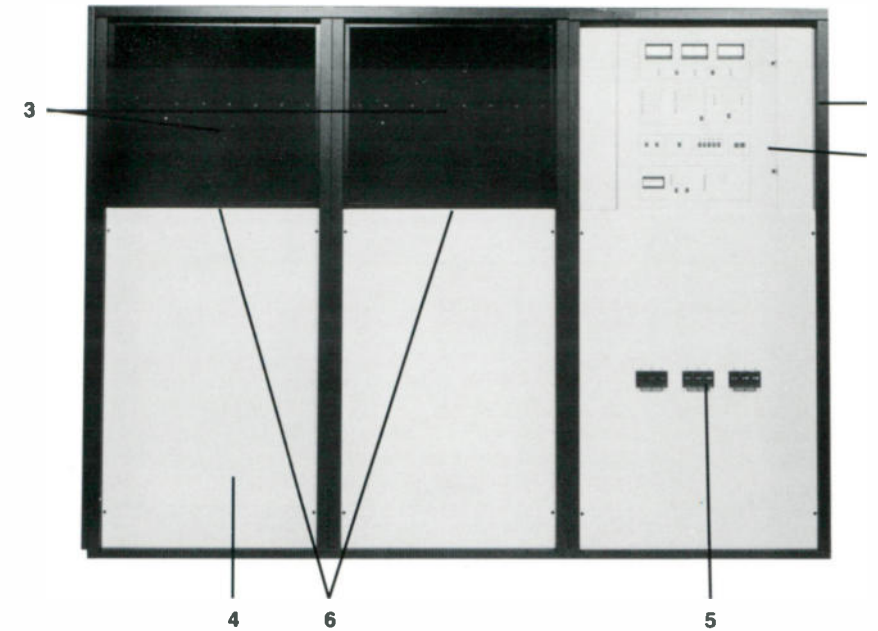

### THE INSIDE STORY

1. Single 25 kW transmitter.
2. Metering, control, combining and filtering section.
3. Amplifier power blocks.
4. Power Supplies.
5. Circuit breakers and AC mains.
6. Cooling fans.

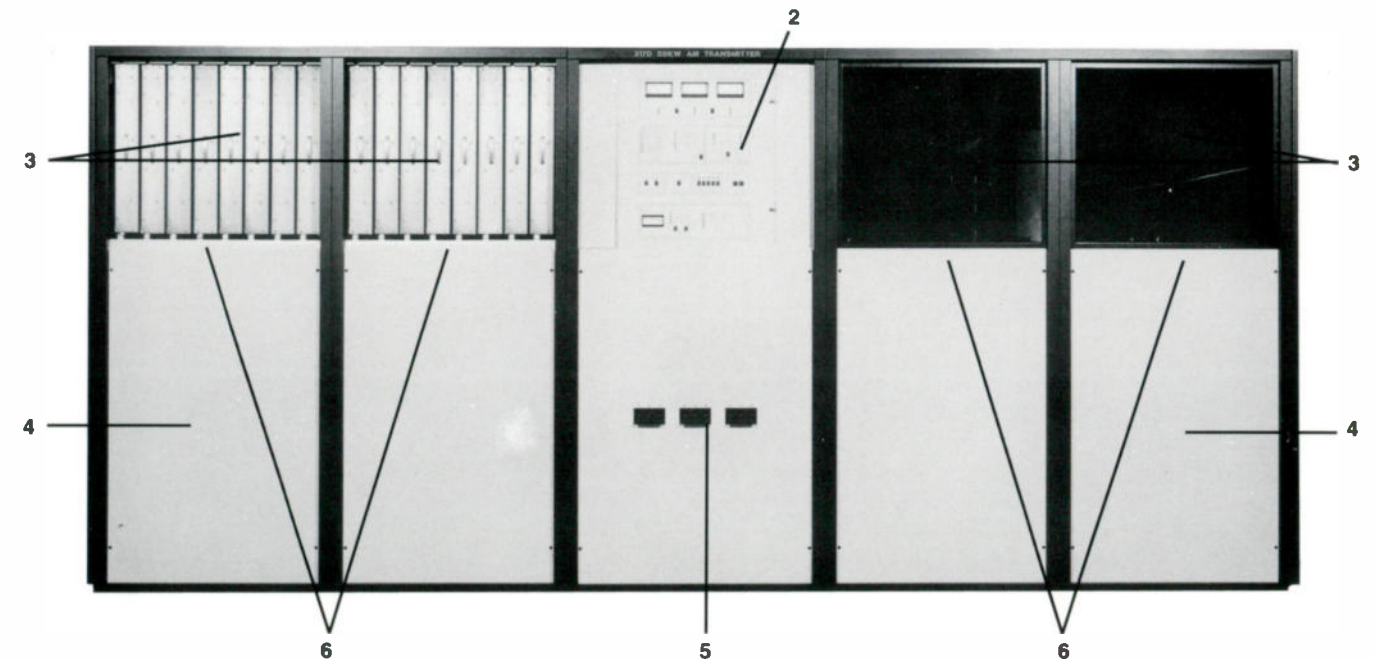



## SPECIFICATIONS

### GENERAL

**RF Power Output:**

1 kW, nominal;  
1.1 kW, maximum

**Power Consumption:**

2.6 kW at 1 kW, 100% modulation

**RF Power Reduction:**

Three power levels standard; lowest available level is 10 watts

**RF Frequency Range:**

535 kHz to 1,705 kHz

**PA Active Device:**

MOSFET

**Internal PA Protection:**

Withstands short circuits at any point in output

**Carrier Stability:**

±5 Hz

**Stereo Interface:**

Standard

**Output Impedance:**

50 ohms, unbalanced

**VSWR:**

1.2:1, maximum, full modulation;

1.5:1, maximum, full power at carrier

**Output Connector:**

L/C or protected terminal or type "N"

**Carrier Shift:**

2% maximum, (0.5% typical), at 100% modulation

**Harmonics:**

Meets CCIR & FCC regulations

**Spurious Emissions:**

Meets CCIR & FCC regulations

**Audio Frequency Response:**

±1 dB; 20 Hz to 12 kHz or better at 95% modulation, 1,000 Hz reference

**Audio Frequency Harmonic Distortion:**

Less than 1.5% at 95% modulation, 1 kW, 20 Hz to 12 kHz

**Noise Below 100% Modulation:**

Better than -60 dB, unweighted

**Positive Peak Capability:**

125% at 1,100 W output

**Incidental Phase Modulation:**

Less than 0.035 radians average; 95% modulation at 1 kHz

**Audio Input:**

-10 dBm to +10 dBm active, balanced, 150/600 ohms

**Cooling:**

Low velocity air

### ELECTRICAL

**Power Source:**

180 to 250 VAC; 50/60 Hz, single phase; 3.8 KVA at 1 kW, 100% modulation

**AC Source Tolerance:**

-10% to +10% voltage for 70 VDC at 1 kW, ±5% frequency

### OPERATING ENVIRONMENT

**Altitude:**

13,000 ft. (3,963 m)

**Ambient Temperature Range:**

0°C to 50°C (32°F to 122°F);

2°C/305 m (35.6°F/1,000 ft.) derating

**Relative Humidity:**

0 to 95%

### MECHANICAL

**Transmitter:**

69" (175 cm) H

22" (56 cm) W

26" (66 cm) D

**Weight:**

550 lbs. (250 kg) 560 lbs. (254kg)

**Remote Control Interface:**

Standard

**Dataflex Computer Control:**

Optional; signal conditioning and interface provided

**Front Panel Meters:**

Three Analog

All specifications are subject to change without notice.

Printed in USA 2M388

© 1988 Varian, Continental Electronics Division

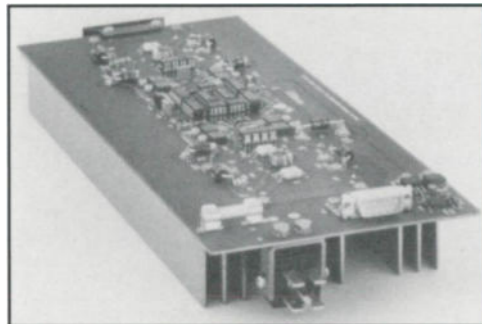

MOSFET PA module

## Continental's XL-301, 1 kW Solid-State Broadcast Transmitter



**varian**®

*continental electronics division*



Continental's customer service is  
the industry's best!

Call anytime, day or night.

Main offices: (214) 381-7161

Engineering service: (214) 327-4533

Parts: (214) 327-4532

P.O. Box 270879 Dallas, Texas 75227

Telephone: 214-381-7161 Fax: 214-381-4949



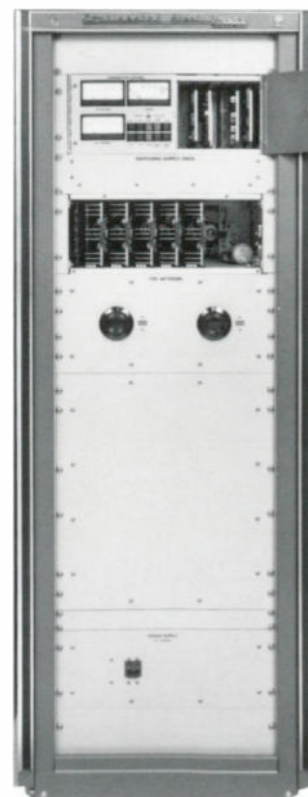

Front view

### Features

- Solid State Modular Design
- RFPWM (PWM at the carrier frequency)
- AM Stereo Compatible
- Operation from 10 to 1,100 W with Excellent Audio Response
- Relative Insensitivity to Load Fluctuations
- On-Board Fault Protection
- Easy to Maintain
- Dataflex Computer Control and Monitoring (optional)

### Top Performer with Proven Design

Continental's XL-301 1 kW AM solid-state transmitter offers broadcasters excellent, reliable audio performance in a modular, compact package. It is a result of our dedication to improve the performance and efficiency of AM transmitters.

The exciter, transmitter control and power amplifiers, are mounted on plug-in modules for ease of handling and maintenance.

Each MOSFET module employs on-board protection to prevent device failure from high temperature, overvoltage or overcurrent conditions.

In addition to the on-board power amplifier protection there is an overall VSWR sensing circuit.

The use of broadband and bandpass circuits combined with state-of-the-art integrated circuit technology enables the XL-301 to handle sophisticated audio processing.

Advanced circuit design allows simplified stereo interface.

Modular design simplifies transmitter spares requirements while making it easy to handle routine maintenance.

### Solid State Design

The XL-301 departs from Continental's successful line of tube type transmitters by using today's solid-state workhorse, the power FET transistor. The power FET is now the device of preference where high power, fast switching and rugged performance is required.

### RFPWM

The modulation system used is RFPWM, that is pulse width modulation at the carrier frequency. This ensures the highest amount of sampling possible, resulting in audio response independent of the modulating frequency.

### AM Stereo

Low phase noise due to RFPWM and elimination of conventional PWM filters that distort phase response are features of the XL-301 which yield superior AM stereo separation. The phase noise of RFPWM is quite low at .035 radians average at 95% modulation.

### Operation from 10 to 1,100 W

The XL-301 transmitter contains five identical power amplifier modules. The input to these modules is TTL and thus no input drive tuning is required or necessary.

This design allows operation at positive and negative load angles. Since no PWM filter is required, the PA modules can operate at a wide variation in load impedance that does not lead to over-dissipation of the FETs.

For these reasons, only the number of PA modules required for a given output power are used to produce power. This conserves dynamic range of the RFPWM pulsewidth.

### Relative Insensitivity to Load Fluctuations

The XL-301 transmitter is not sensitive to the load matching required by a PWM filter. Distortion is related to non-linear changes in switching efficiency during a modulation cycle. Load fluctuations only slightly vary switching efficiency so long as the power amplifier modules are not operated beyond their dissipation limits.

Conventional PWM solid-state transmitters have very large changes in switching efficiency between positive and negative load angles. Operation with negative load angles results in PWM filter mismatch which alters the ability to make power and affects audio response.

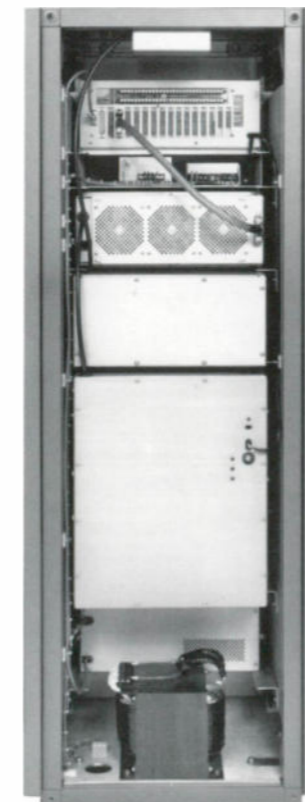

Rear view

### Modular Design

Continental's XL-301 uses five PA modules for 1.1 kW of rated output. On-board protection of PA modules allows 'isolation' of faulted modules by clamping the RF switching drive. This graceful degradation is a valuable feature as the transmitter remains on the air in case of PA failure.

### On-Board Fault Protection

The XL-301 has protection features that make it stand out.

Each power amplifier has on-board overcurrent fault protection that operates within one RF cycle to swiftly prevent over-dissipation of the RF switching transistors, throwing the amplifier into a low loss clamp condition that passes RF energy. Thus transients due to lightning and static discharge are safely controlled.

On-board temperature protection protects the power amplifier modules in the event of cooling failure, causing the hottest module to be clamped, reducing the output power and the temperature of the other PA modules.

Fuse failure is detected on-board causing the module to be clamped.

A final level of protection is provided by a crowbar across the dc supply. This operates in case of overvoltage on the module due to extreme power line disturbance or if the fuse should open. This protects from further damage and provides graceful degradation ensuring continued air time until repairs are convenient.

Conventional VSWR type protection at the transmitter output is also used to protect from stressful operation that can cause long term damage to the power amplifiers.

### Ease of Maintenance

Ease of maintenance and speed of repair to conserve valuable air time is ensured by the modular design of the transmitter.

Control and modulation circuits are all PC board mounted for quick replacement in rack mounts accessible from the front. In case of failure, a replacement card can be installed and the transmitter returned on the air in under 60 seconds.

Power amplifier modules are all PC board mounted for quick replacement in rack mounts accessible from the front. They may not be removed 'hot', but in case of failure, a replacement card can be installed and the transmitter returned on the air in under three minutes.

All ICs are socketed for fast and easy troubleshooting by experienced personnel. Circuit design uses commonly available TTL and CMOS ICs.

Rack mounting of all components allows easy removal of any rack so that work can be done on a bench if required.

### Dataflex Computer Control and Monitoring

The XL-301 has been designed with interfaces to allow computer control and fault reporting.

Computer control is not necessary for operation of the basic transmitter, but brings added features such as:

- Annual power level control for PSA/PSSA/Day/Night requirements.
- Fault reporting allowing the isolation of faults such as loss of power from intermittent cooling or atmospheric disturbances.
- Automatic re-arm of faults.
- Periodic output power correction due to load variations.
- Automatic recording of operating parameters for a daily log.



Specifications\*

**GENERAL**

**RF Power Output:**  
Rated @ 10.0 kW; 10.6 kW capability

**Power Consumption:**  
23.6 kW @ 0% modulation  
24.1 kW @ 30% modulation  
28.4 kW @ 100% modulation

**Frequency Range:**  
Any single frequency, 535 to 1620 kHz

**Frequency Stability:**  
±5 Hz (0°C to 45°C)

**Emission:**  
A3

**Modulation:**  
Collector modulation of RF driver stage

**Modulation Capability:**  
100% continuous at any frequency 30 to 10,000 Hz; 125% positive peak with asymmetrical program input

**RF Output Impedance:**  
50 to 250 ohms, unbalanced

**Audio Response:**  
50 to 7500 Hz ± 1 dB; 30 to 15,000 Hz ± 1.5 dB

**Audio Distortion:**  
30 to 10,000 Hz less than 3%

**Noise:**  
60 dB below 100% modulation @ 5,000 watts

**Harmonic and Spurious:**  
-80 dB or better, exceeds FCC regulations and CCIR recommendations

**Carrier Regulation (shift):**  
2% max. or less @ 100% modulation

**Audio Input:**  
+10 dBm ± 2 dB, 600/150 ohms, for 100% modulation

**Tubes:**  
Two Type 4CX15000A

**ELECTRICAL**

**Power Source:**  
208 to 230 volts AC, 50/60 Hz, three phase 50/60 Hz

**Permissible Combined Line Voltage Variation:**  
± 5%

**Power Factor:**  
93%

**COOLING**

**Air Flow Requirement:**  
Forced air, by self-contained blower

**OPERATING ENVIRONMENT**

**Altitude Range:**  
0 to 7,500 ft (0 to 2286 m)  
(higher on special order)

**Ambient Temperature Range:**  
-10°C to +45°C (-14°F to +113°F)

**Relative Humidity:**  
0 to 95%

**MECHANICAL**

**Transmitter Size as Shown:**  
78" (198 cm) H x 67" (170 cm) W  
x 26" (748 cm) D;  
Weight: 1650 lb (748kg) nominal

**Export Shipping Information:**  
2480 lb (1124.9); 173.1 ft<sup>3</sup> (4.9 m<sup>3</sup>)

\*Taken from Type Acceptance data on file with FCC. Transmitters will meet or exceed all requirements of FCC for Broadcast Service.

All specifications are subject to change without notice  
© 1986 Continental Electronics/6195 Printed in USA 1M486





**CONTINENTAL'S TYPE 316F-1 OFFERS BROADCASTERS UNMATCHED PERFORMANCE**

**Superior audio frequency response**

± 1 dB amplitude variation from 10 to 10,000 Hz; less than 5° phase variation from 10 Hz to midband; essentially phase linear to 30 kHz.

**High positive modulation**

Transformer rating and output voltage provide + 125% modulation with plenty of headroom, and 100% sinewave modulation capability to 10 Hz.

**Program peak limiter**

Automatic program peak controller has adjustable positive and negative thresholds; will maintain peaks at limits set by station engineer. LED flashers indicate limiting.

**AM stereo compatibility**

Continental guarantees compatibility with any AM stereo transmission established by the FCC. The 316F is built to receive a stereo exciter.

**Long tube life**

Two 4CX15000A tubes are used in the final amplifier. This conservative application assures long tube life.

**Proven "on-air" reliability**

All components, output networks and power supply are rated conservatively; this provides an extra operating margin with extended component life and performance.

**Magniphase® line protection system**

Protects transmission line, antenna and tuning equipment.

**Easy to operate**

Designed for unattended operation with remote control interface and power cutback; complete instrumentation; maximum personnel protection.

Frequency and phase response at 90% modulation

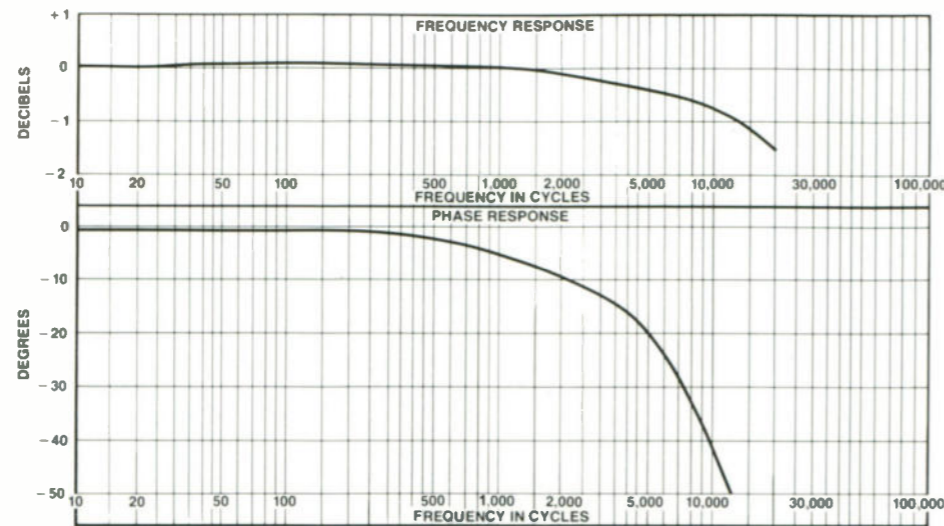

**TYPE 316F-1 TYPICAL PERFORMANCE**

Audio phase characteristics (Input: lower trace; Output: envelope)

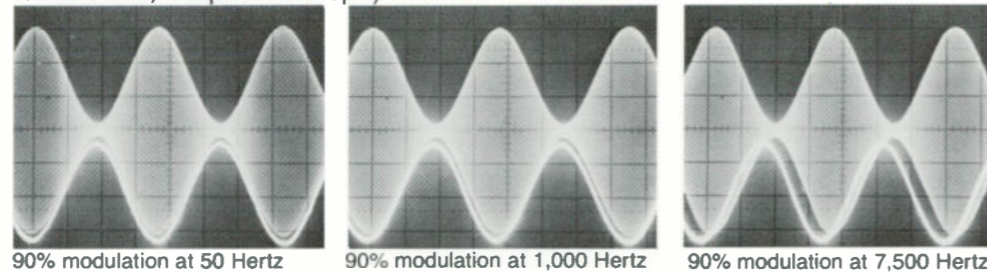

Square wave response

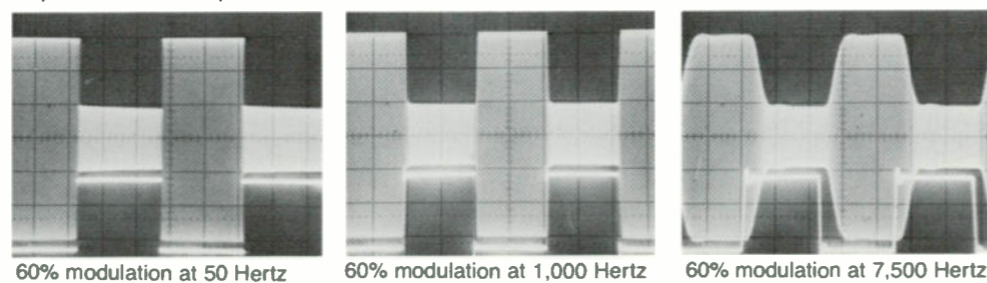

**TRANSPARENCY WITH ON-AIR RELIABILITY**

The 316F delivers superb audio quality and faithfully reproduces the most sophisticated audio processing. All components, output networks and power supply are rated conservatively to provide an extra operating margin.

With only two tubes, a blower for cooling and a minimum of relay contacts, the 316F is easy to maintain. Many broadcasters have passed 30,000 hours of operation without unscheduled downtime.

"Collector modulation" technique eliminates critical tuning adjustments and is almost identical to plate modulation except that no transformers or chokes are used. The transmitter tunes easily in a straightforward manner and uses a high-efficiency linear amplifier for simplicity and reliability. The 316F is rated at 10,000 watts.

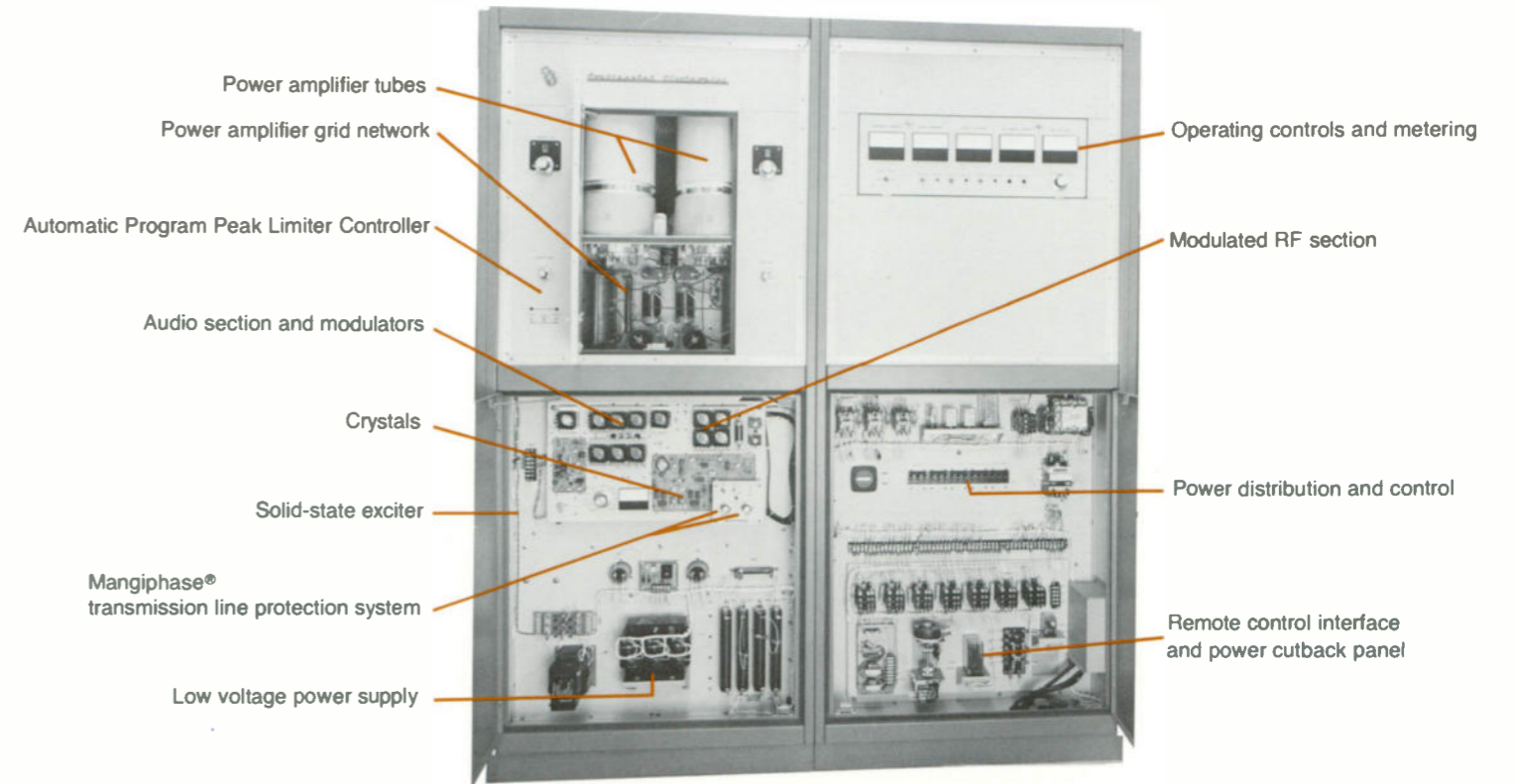

Front View, Type 316F-1 10 kW AM Transmitter

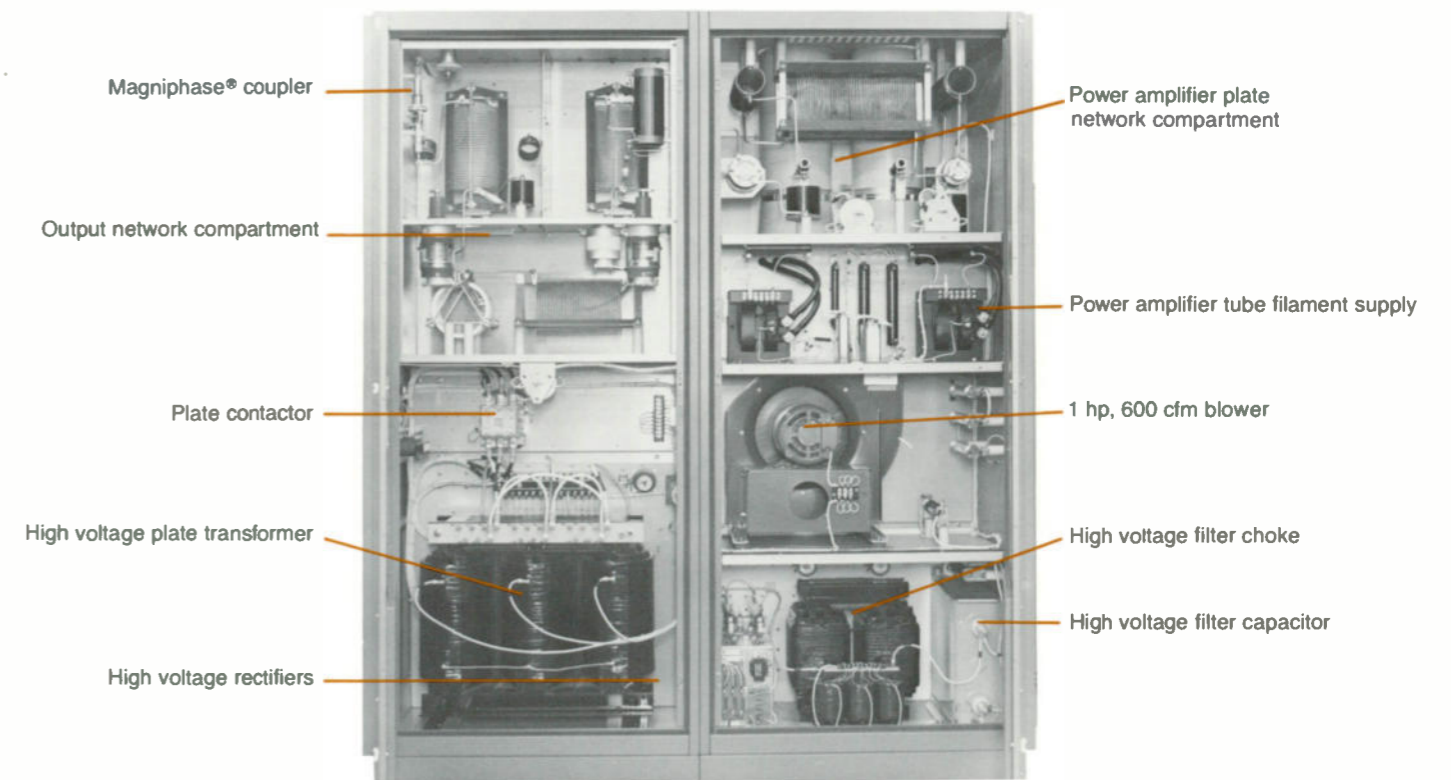

Rear View, Type 316F-1 10 kW AM Transmitter



Specifications\*

**GENERAL**

**RF Power Output:**  
Rated @ 10.0 kW; 10.6 kW capability

**Power Consumption:**  
23.6 kW @ 0% modulation  
24.1 kW @ 30% modulation  
28.4 kW @ 100% modulation

**Frequency Range:**  
Any single frequency, 535 to 1620 kHz

**Frequency Stability:**  
±5 Hz (0°C to 45°C)

**Emission:**  
A3

**Modulation:**  
Collector modulation of RF driver stage

**Modulation Capability:**  
100% continuous at any frequency 30 to 10,000 Hz; 125% positive peak with asymmetrical program input

**RF Output Impedance:**  
50 to 250 ohms, unbalanced

**Audio Response:**  
50 to 7500 Hz ± 1 dB; 30 to 15,000 Hz ± 1.5 dB

**Audio Distortion:**  
30 to 10,000 Hz less than 3%

**Noise:**  
60 dB below 100% modulation @ 5,000 watts

**Harmonic and Spurious:**  
-80 dB or better, exceeds FCC regulations and CCIR recommendations

**Carrier Regulation (shift):**  
2% max. or less @ 100% modulation

**Audio Input:**  
+10 dBm ± 2 dB, 600/150 ohms, for 100% modulation

**Tubes:**  
Two Type 4CX15000A

**ELECTRICAL**

**Power Source:**  
208 to 230 volts AC, 50/60 Hz, three phase 50/60 Hz

**Permissible Combined Line Voltage Variation:**  
± 5%

**Power Factor:**  
93%

**COOLING**

**Air Flow Requirement:**  
Forced air, by self-contained blower

**OPERATING ENVIRONMENT**

**Altitude Range:**  
0 to 7,500 ft (0 to 2286 m)  
(higher on special order)

**Ambient Temperature Range:**  
-10°C to +45°C (-14°F to +113°F)

**Relative Humidity:**  
0 to 95%

**MECHANICAL**

**Transmitter Size as Shown:**  
78" (198 cm) H x 67" (170 cm) W  
x 26" (748 cm) D;  
Weight: 1650 lb (748kg) nominal

**Export Shipping Information:**  
2480 lb (1124.9); 173.1 ft<sup>3</sup> (4.9 m<sup>3</sup>)

\*Taken from Type Acceptance data on file with FCC. Transmitters will meet or exceed all requirements of FCC for Broadcast Service.

All specifications are subject to change without notice  
© 1986 Continental Electronics/6195 Printed in USA 1M486





**CONTINENTAL'S TYPE 316F-1 OFFERS BROADCASTERS UNMATCHED PERFORMANCE**

**Superior audio frequency response**

± 1 dB amplitude variation from 10 to 10,000 Hz; less than 5° phase variation from 10 Hz to midband; essentially phase linear to 30 kHz.

**High positive modulation**

Transformer rating and output voltage provide +125% modulation with plenty of headroom, and 100% sinewave modulation capability to 10 Hz.

**Program peak limiter**

Automatic program peak controller has adjustable positive and negative thresholds; will maintain peaks at limits set by station engineer. LED flashers indicate limiting.

**AM stereo compatibility**

Continental guarantees compatibility with any AM stereo transmission established by the FCC. The 316F is built to receive a stereo exciter.

**Long tube life**

Two 4CX15000A tubes are used in the final amplifier. This conservative application assures long tube life.

**Proven "on-air" reliability**

All components, output networks and power supply are rated conservatively; this provides an extra operating margin with extended component life and performance.

**Magniphase®**

**line protection system**

Protects transmission line, antenna and tuning equipment.

**Easy to operate**

Designed for unattended operation with remote control interface and power cutback; complete instrumentation; maximum personnel protection.

Frequency and phase response at 90% modulation

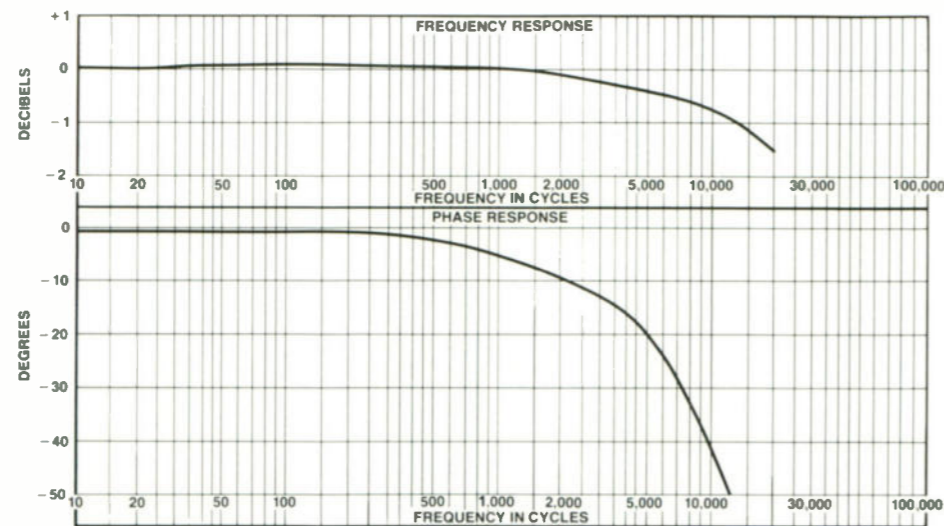

**TYPE 316F-1 TYPICAL PERFORMANCE**

Audio phase characteristics (Input: lower trace; Output: envelope)

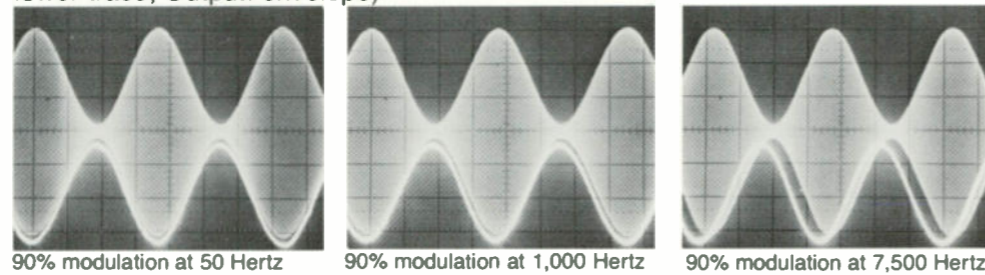

**Square wave response**

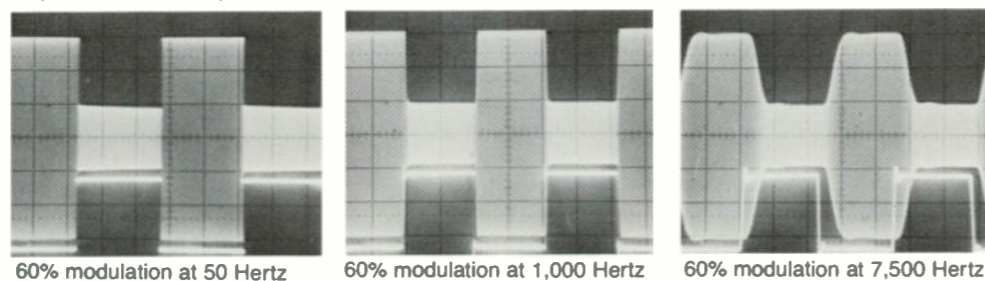

**TRANSPARENCY WITH ON-AIR RELIABILITY**

The 316F delivers superb audio quality and faithfully reproduces the most sophisticated audio processing. All components, output networks and power supply are rated conservatively to provide an extra operating margin.

With only two tubes, a blower for cooling and a minimum of relay contacts, the 316F is easy to maintain. Many broadcasters have passed 30,000 hours of operation without unscheduled downtime.

"Collector modulation" technique eliminates critical tuning adjustments and is almost identical to plate modulation except that no transformers or chokes are used. The transmitter tunes easily in a straightforward manner and uses a high-efficiency linear amplifier for simplicity and reliability. The 316F is rated at 10,000 watts.

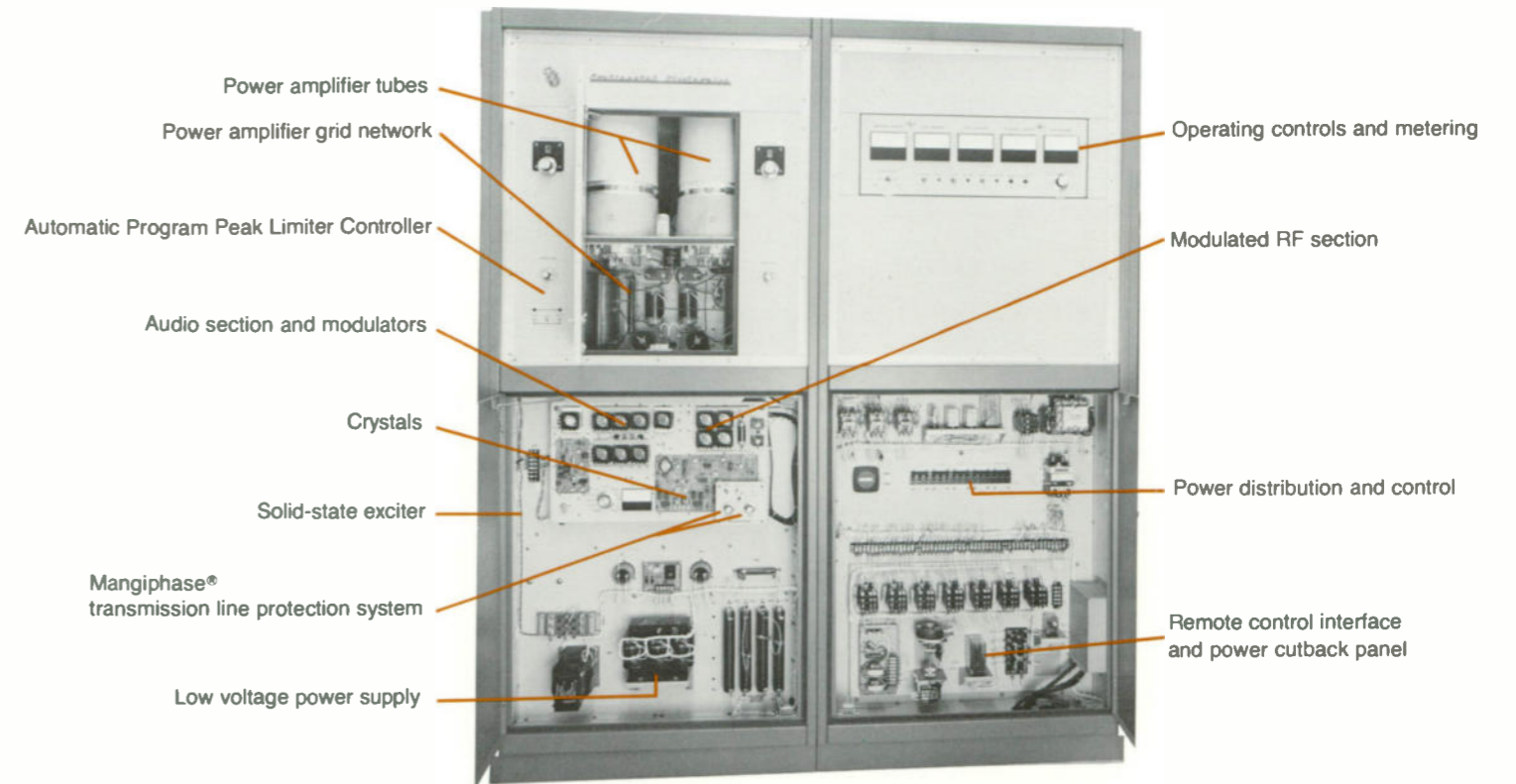

Front View, Type 316F-1 10 kW AM Transmitter

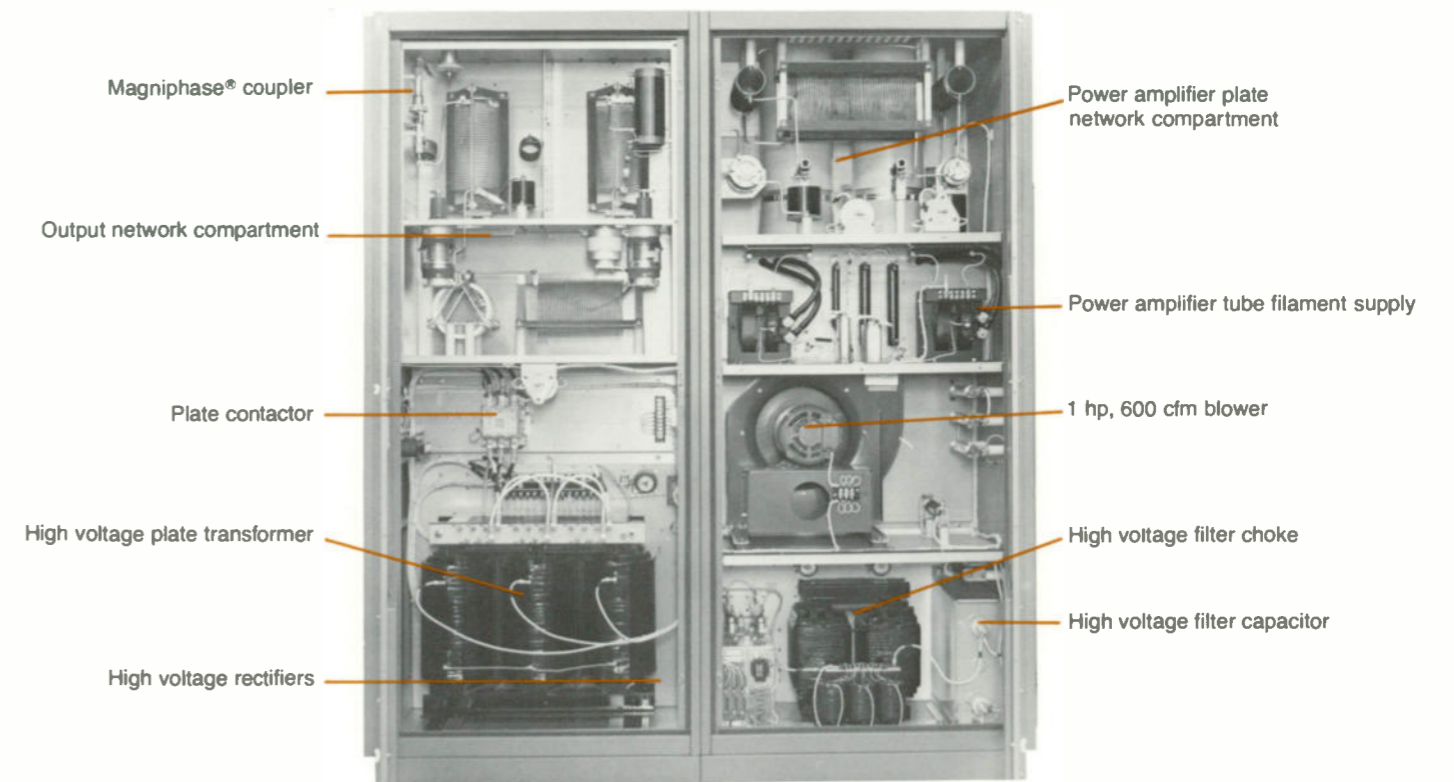

Rear View, Type 316F-1 10 kW AM Transmitter



### 317C-2 SETS NEW STANDARD OF PERFORMANCE

**Superior audio frequency response**  
± 0.5 dB amplitude variation from 10 to 10,000 Hz and less than 5° phase variation from 10 Hz to midband and essentially phase linear to 30 kHz.

#### Flat top response

Less than 5% tilt or overshoot on trapezoidal waveforms generated by clipping a sine wave 6 dB below peak amplitude from 30 to 10 kHz at 90% modulation.

#### Extra power for high peaks

Husky 12 phase plate supply eliminates filter reactor, provides extra power for high positive peak demands of low frequency programming, and minimizes audio phase shift. Improved regulation virtually eliminates carrier shift.

#### High positive modulation

12 phase plate supply transformer rating and output voltage are increased to provide +125% modulation with plenty of headroom, and 100% sine wave modulation capability down to 10 Hz.

#### Program peak limiter

Automatic program peak controller with adjustable positive and negative thresholds will maintain peaks at limits set by station engineer. LED flashers indicate limiting.

#### AM stereo compatibility

Continental guarantees compatibility with any AM stereo transmission system established by the FCC. The 317C-2 is built to receive a stereo exciter.

#### Long tube life

Conservative operation of the power amplifier leads to extended tube life.

#### High efficiency

Overall efficiency is better than 60% at any level of modulation.

#### Magniphase® line protection system

Protects transmission line, antenna and tuning equipment. Reduces power automatically; shuts down transmitter if permanent antenna fault occurs.

#### Easy to operate

Motor driven tuning and power adjustments; designed for unattended operation by remote control; complete instrumentation; maximum personnel protection.

### TRANSPARENCY AND HIGH EFFICIENCY

Continental's 317C-2 is a 50 kW AM broadcast transmitter built for today's programming demands.

It delivers superb audio quality and faithfully reproduces the most sophisticated audio processing. Yet, it can be operated very cost-effectively.

The 317C-2 comes from a field-proven design and offers you excellent performance with high overall efficiency, increased reliability, greater simplicity and easy maintainability.

### WHY THE 317C-2 IS A GOOD INVESTMENT

Continental installed the first 317C transmitter in 1968. Its introduction followed an extensive review and analysis of transmitter circuit and modulation techniques.

Early investigations included plate, out-phasing or Ampliphase, screen grid, control grid, series anode, Cathanode and Doherty modulation systems.

Later investigations included pulse width and pulse duration modulation.

Out of this research came Continental's unique and patented\* screen-impedance modulation technique. The 317C-2 applies this system, with its current refinements, to the final amplifier tubes in the Doherty system to achieve high performance with high efficiency.

The design concept has been thoroughly tested and enthusiastically accepted by broadcasters around the world, for transmitter requirements ranging from 50,000 to 2,000,000 watts.

Today, Continental's 317C-2 gives you new performance from a proven, unmatched heritage.

### TYPE 317C-2 SPECIFICATIONS

#### Carrier power:

Rated 50 kW  
Capability 60 kW  
Power reduction 25 kW or 10 kW

#### Modulation:

High-level screen-grid/impedance modulation

#### Emission:

A3

#### Frequency range:

Any single frequency 535-1620 kHz

#### Frequency stability:

± 5 Hz

#### Audio input:

± 10 dBm ± 2.0 dB at 100% modulation

#### Audio response:

± 0.5 dB, 10 Hz to 7500 Hz;  
- 1.5dB, 15,000 Hz; ref. to 1000 Hz;  
at 70% modulation

#### Phase response:

± 2° from 10 to 1,000 Hz, and phase linear to 30 kHz with output lagging 45° at 15 kHz

#### Audio distortion:

less than 2.5%, 20 to 10,000 Hz at 95% modulation

#### Intermodulation distortion:

3.5% at 90% total modulation by SMPTE test method using 60 and 7,000 Hz in 4:1 ratio

#### Carrier shift:

2% or less at 100% modulation

#### Tilt and overshoot:

##### Clipped sine wave:

3% variation in modulation percentage using 6 dB symmetrical clipping, 30 to 10,000 Hz at 90% modulation

##### Square wave:

5% variation in modulation percentage, square wave frequencies from 30 to 7,500 Hz at 60% modulation

#### Modulation capability:

100% continuous at any frequency 20-10,000 Hz + 125% positive peak with asymmetrical input

#### Noise unweighted:

-60dB below 100% modulation

#### Spurious & harmonic emission:

-80dB

#### Output impedance:

40 to 300 ohms as specified by customer

#### Power source:

460V, 3 phase, 50/60 Hz, other available by special order

#### Permissible combined voltage variation:

± 5% voltage  
± 2.5% frequency

#### Power factor:

approximately .95

#### Overall efficiency:

better than 60% at any depth of modulation

#### Altitude:

7,500 feet (2286 meters) higher by special order

#### Ambient temperature:

-4° to 122°F (-20° to 50°C)

#### Cooling:

transmitter is air cooled

#### Size:

transmitter is 144" wide, 54" deep, 78" high (365.76 CM wide, 137.16 CM deep, 198.1 CM high); plate transformer enclosure is 24" wide, 46" deep, 72" high (60.96 CM wide, 116.84 CM deep, 183.2 CM high)

#### Total floor space:

62 sq. ft. (5.8 sq. meters)

#### Net weight:

transmitter (all cabinets) weighs 4,891 lbs. (2,273 kilos); plate transformer enclosure weighs 1,990 lbs. (903 kilos)

#### Export shipping:

gross weight 9,700 lbs. (4,400 kilos); 800 cubic feet (22.65 cubic meters)

All specifications are subject to change without notice.  
© 1987 Continental Electronics 6353  
Printed in U.S.A. 5C387

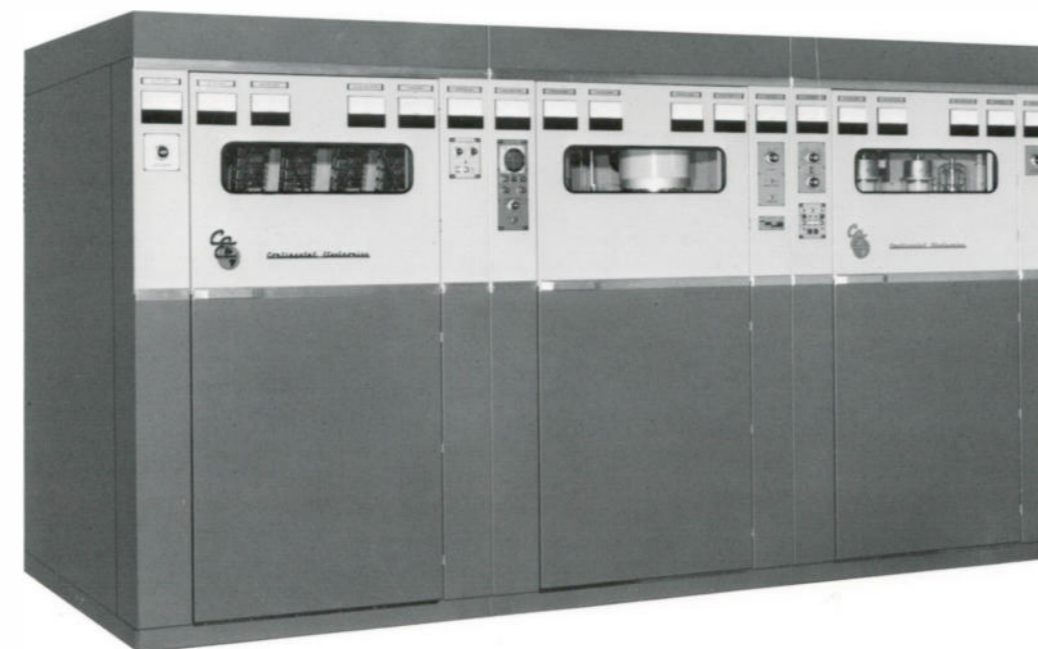

# 317C-2

\*Continental Electronics holds the following patents for the high efficiency screen modulated amplifier: Canada 764,805; France 1,432,543; UK 1,044,479; USA 3,314,024



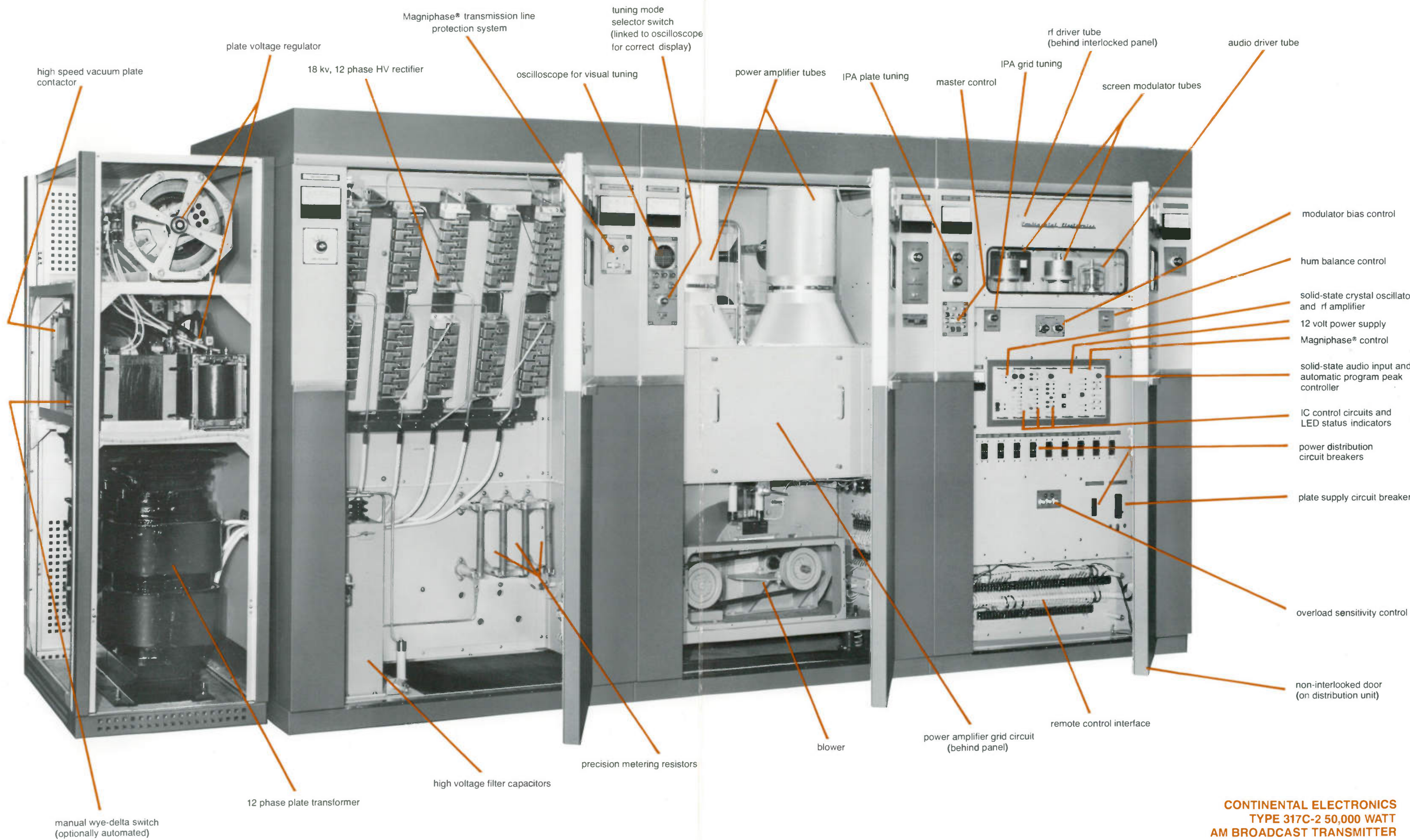

**CONTINENTAL ELECTRONICS  
TYPE 317C-2 50,000 WATT  
AM BROADCAST TRANSMITTER**

**TYPE 317C-2 TYPICAL PERFORMANCE**

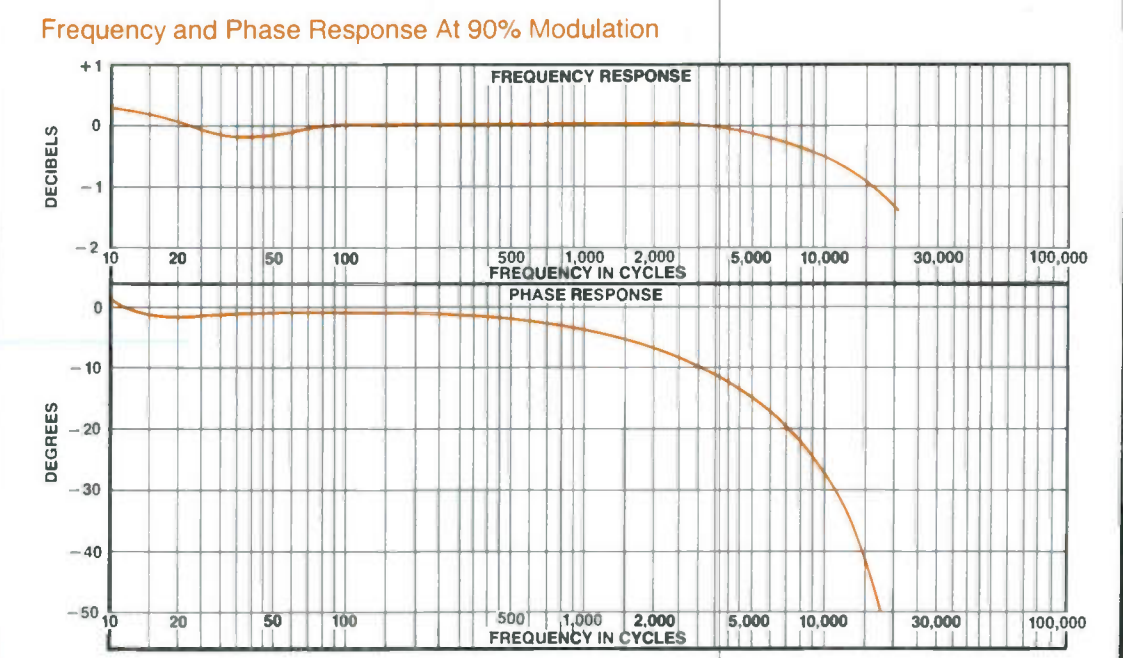
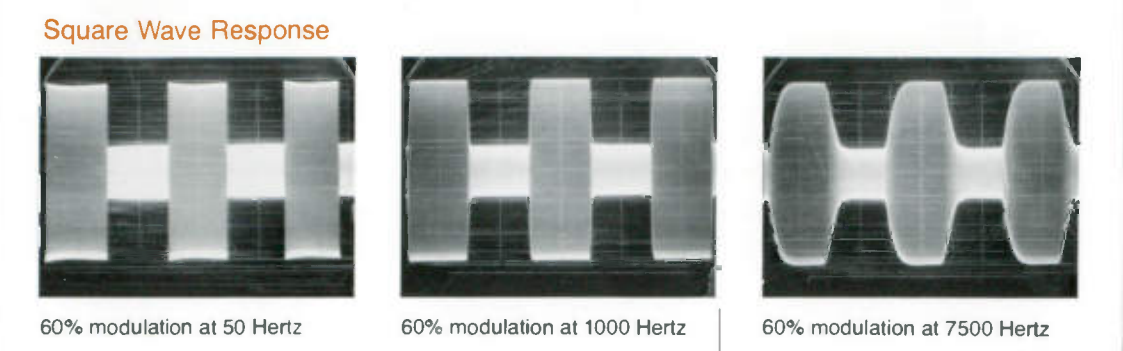
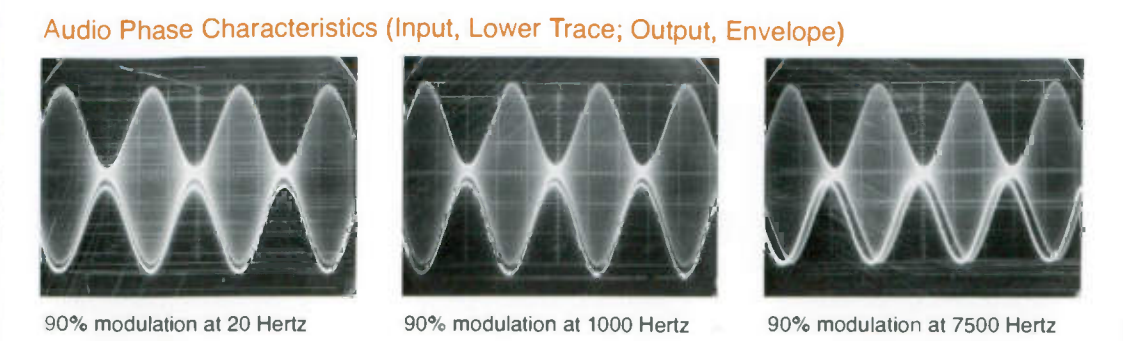

**FLOOR PLAN**

Continental's Type 317C-2 is all self-contained except for the plate transformer which is in a separate enclosure. A single blower housed inside the transmitter cabinet provides cooling. Wide doors give easy access to all cabinets, with walk-in access to the driver and power distribution cabinet.

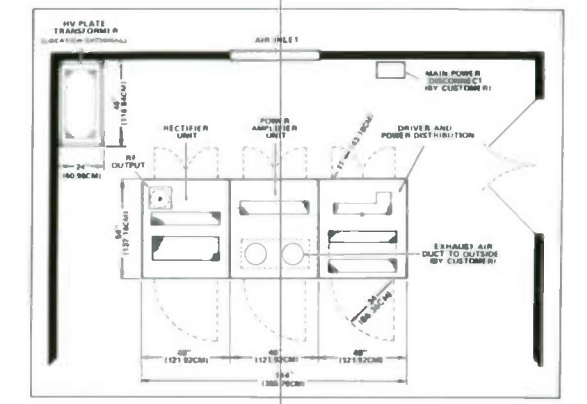



### 317C-2 SETS NEW STANDARD OF PERFORMANCE

**Superior audio frequency response**  
± 0.5 dB amplitude variation from 10 to 10,000 Hz and less than 5° phase variation from 10 Hz to midband and essentially phase linear to 30 kHz.

#### Flat top response

Less than 5% tilt or overshoot on trapezoidal waveforms generated by clipping a sinewave 6 dB below peak amplitude from 30 to 10 kHz at 90% modulation.

#### Extra power for high peaks

Husky 12 phase plate supply eliminates filter reactor, provides extra power for high positive peak demands of low frequency programming, and minimizes audio phase shift. Improved regulation virtually eliminates carrier shift.

#### High positive modulation

12 phase plate supply transformer rating and output voltage are increased to provide +125% modulation with plenty of headroom, and 100% sinewave modulation capability down to 10 Hz.

#### Program peak limiter

Automatic program peak controller with adjustable positive and negative thresholds will maintain peaks at limits set by station engineer. LED flashers indicate limiting.

#### AM stereo compatibility

Continental guarantees compatibility with any AM stereo transmission system established by the FCC. The 317C-2 is built to receive a stereo exciter.

#### Long tube life

Conservative operation of the power amplifier leads to extended tube life.

#### High efficiency

Overall efficiency is better than 60% at any level of modulation.

#### Magniphase® line protection system

Protects transmission line, antenna and tuning equipment. Reduces power automatically; shuts down transmitter if permanent antenna fault occurs.

#### Easy to operate

Motor driven tuning and power adjustments; designed for unattended operation by remote control; complete instrumentation; maximum personnel protection.

### TRANSPARENCY AND HIGH EFFICIENCY

Continental's 317C-2 is a 50 kW AM broadcast transmitter built for today's programming demands.

It delivers superb audio quality and faithfully reproduces the most sophisticated audio processing. Yet, it can be operated very cost-effectively.

The 317C-2 comes from a field-proven design and offers you excellent performance with high overall efficiency, increased reliability, greater simplicity and easy maintainability.

### WHY THE 317C-2 IS A GOOD INVESTMENT

Continental installed the first 317C transmitter in 1968. Its introduction followed an extensive review and analysis of transmitter circuit and modulation techniques.

Early investigations included plate, out-phasing or Ampliphase, screen grid, control grid, series anode, Cathanode and Doherty modulation systems.

Later investigations included pulse width and pulse duration modulation.

Out of this research came Continental's unique and patented\* screen-impedance modulation technique. The 317C-2 applies this system, with its current refinements, to the final amplifier tubes in the Doherty system to achieve high performance with high efficiency.

The design concept has been thoroughly tested and enthusiastically accepted by broadcasters around the world, for transmitter requirements ranging from 50,000 to 2,000,000 watts.

Today, Continental's 317C-2 gives you new performance from a proven, unmatched heritage.

### TYPE 317C-2 SPECIFICATIONS

#### Carrier power:

Rated 50 kW  
Capability 60 kW  
Power reduction 25 kW or 10 kW

#### Modulation:

High-level screen-grid/impedance modulation

#### Emission:

A3

#### Frequency range:

Any single frequency 535-1620 kHz

#### Frequency stability:

± 5 Hz

#### Audio input:

± 10 dBm ± 2.0 dB at 100% modulation

#### Audio response:

± 0.5 dB, 10 Hz to 7500 Hz;  
- 1.5dB, 15,000 Hz; ref. to 1000 Hz;  
at 70% modulation

#### Phase response:

± 2° from 10 to 1,000 Hz, and phase linear to 30 kHz with output lagging 45° at 15 kHz

#### Audio distortion:

less than 2.5%, 20 to 10,000 Hz at 95% modulation

#### Intermodulation distortion:

3.5% at 90% total modulation by SMPTE test method using 60 and 7,000 Hz in 4:1 ratio

#### Carrier shift:

2% or less at 100% modulation

#### Tilt and overshoot:

**Clipped sinewave:**  
3% variation in modulation percentage using 6 dB symmetrical clipping, 30 to 10,000 Hz at 90% modulation

#### Squarewave:

5% variation in modulation percentage, squarewave frequencies from 30 to 7,500 Hz at 60% modulation

#### Modulation capability:

100% continuous at any frequency 20-10,000 Hz + 125% positive peak with asymmetrical input

#### Noise unweighted:

- 60dB below 100% modulation

#### Spurious & harmonic emission:

- 80dB

#### Output impedance:

40 to 300 ohms as specified by customer

#### Power source:

460V, 3 phase, 50/60 Hz, other available by special order

#### Permissible combined voltage variation:

± 5% voltage  
± 2.5% frequency

#### Power factor:

approximately .95

#### Overall efficiency:

better than 60% at any depth of modulation

#### Altitude:

7,500 feet (2286 meters) higher by special order

#### Ambient temperature:

- 4° to 122°F (- 20° to 50°C)

#### Cooling:

transmitter is air cooled

#### Size:

transmitter is 144" wide, 54" deep, 78" high (365.76 CM wide, 137.16 CM deep, 198.1 CM high); plate transformer enclosure is 24" wide, 46" deep, 72" high (60.96 CM wide, 116.84 CM deep, 183.2 CM high)

#### Total floor space:

62 sq. ft. (5.8 sq. meters)

#### Net weight:

transmitter (all cabinets) weighs 4,891 lbs. (2,273 kilos); plate transformer enclosure weighs 1,990 lbs. (903 kilos)

#### Export shipping:

gross weight 9,700 lbs. (4,400 kilos); 800 cubic feet (22.65 cubic meters)

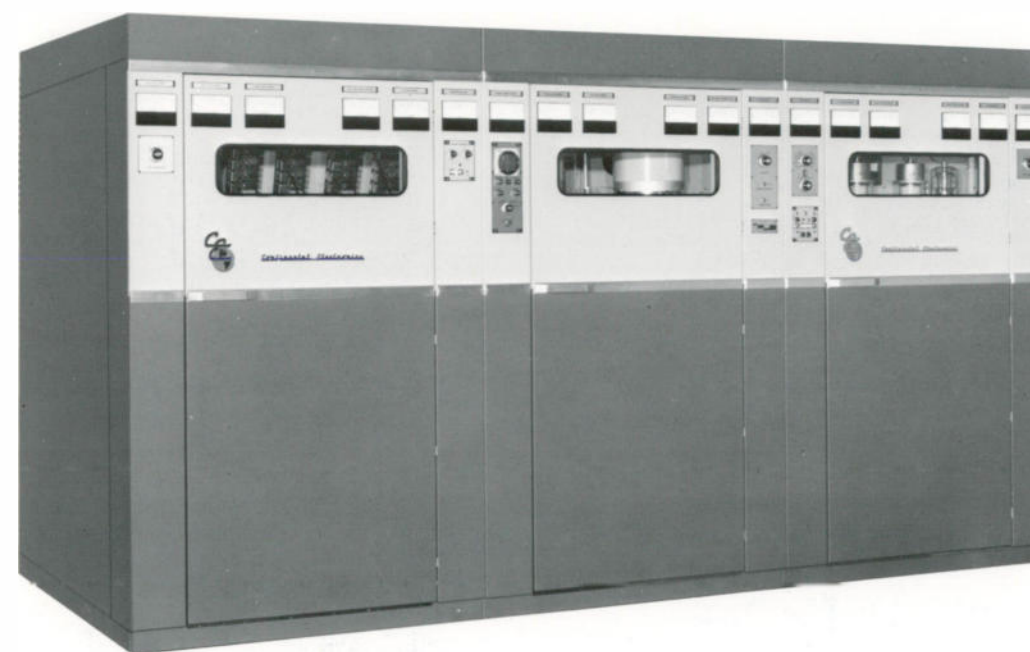

Continental Electronics

CONTINENTAL ELECTRONICS MFG. CO. BOX 270879 DALLAS, TEXAS 75227 (214) 381-7161



Printed in USA 1M 382

## CONTINENTAL 50,000 WATT AM BROADCAST TRANSMITTER

# 317C-2

\* Continental Electronics Mfg. Co. holds the following patents for the high efficiency screen modulated amplifier: Canada 764,605; France 1,432,543; UK 1,044,479; USA 3,314,024



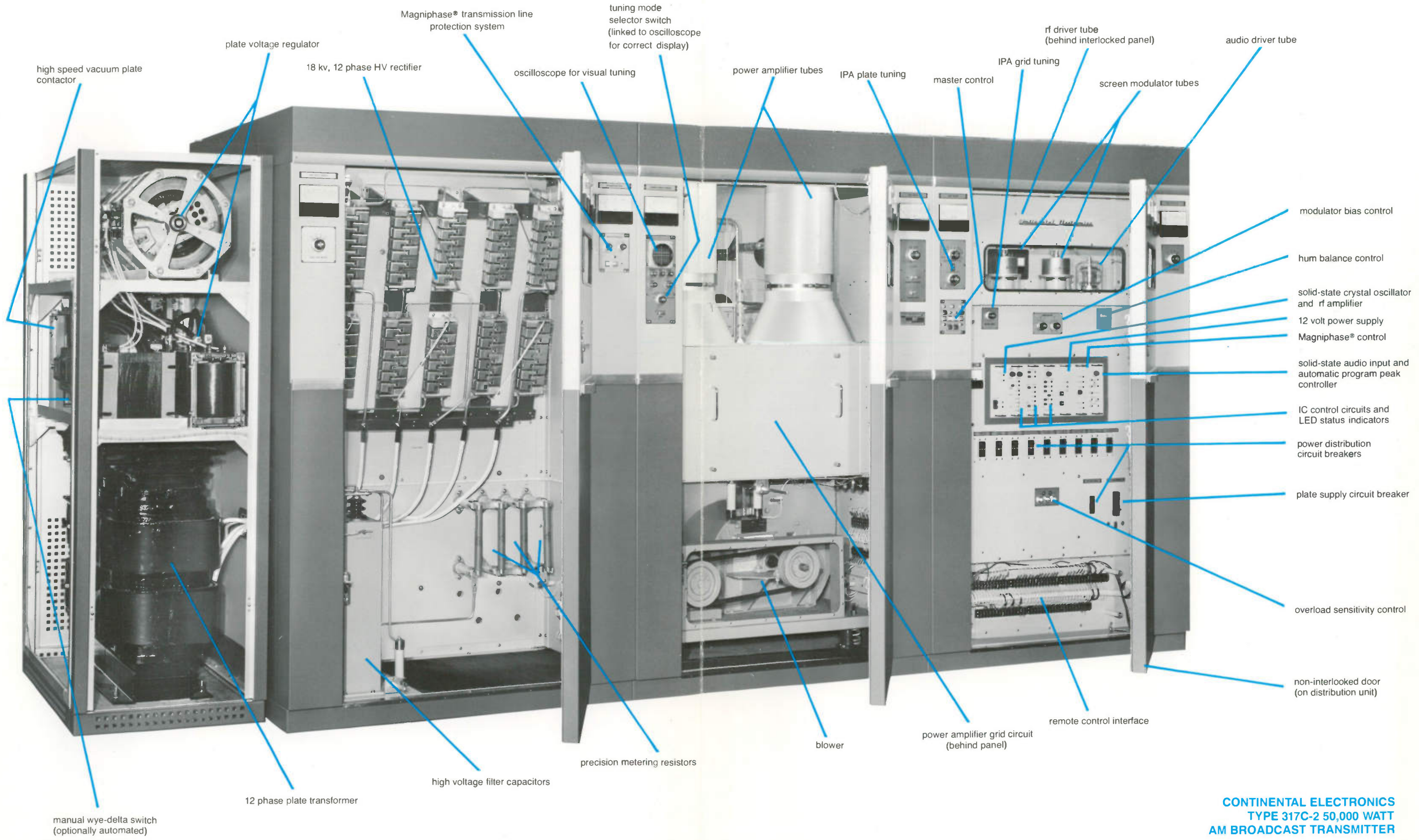

**CONTINENTAL ELECTRONICS  
TYPE 317C-2 50,000 WATT  
AM BROADCAST TRANSMITTER**

**TYPE 317C-2 TYPICAL PERFORMANCE**

Audio Phase Characteristics (Input, Lower Trace; Output, Envelope)

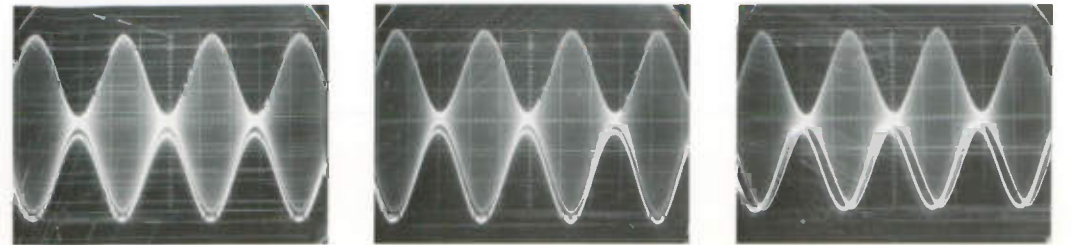

90% modulation at 20 Hertz      90% modulation at 1000 Hertz      90% modulation at 7500 Hertz

Square Wave Response

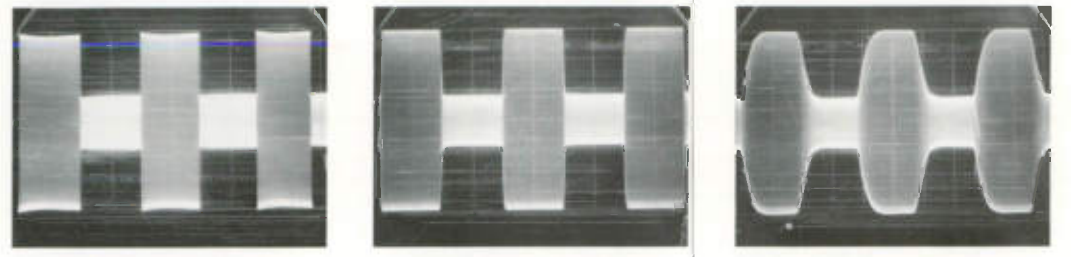

60% modulation at 50 Hertz      60% modulation at 1000 Hertz      60% modulation at 7500 Hertz

Frequency and Phase Response At 90% Modulation

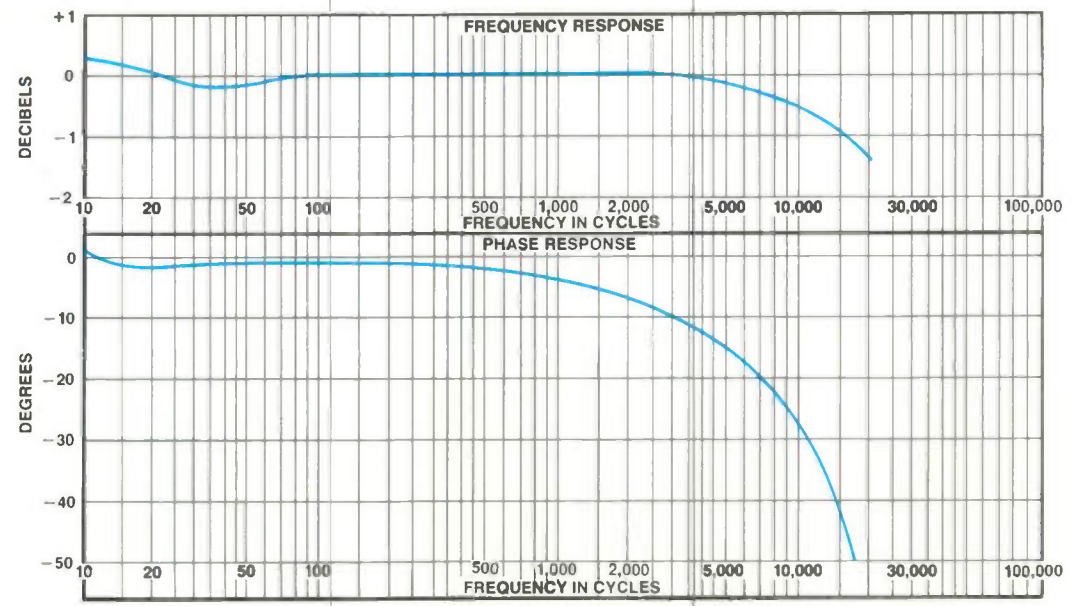

**FLOOR PLAN**

Continental's Type 317C-2 is all self-contained except for the plate transformer which is in a separate enclosure. A single blower housed inside the transmitter cabinet provides cooling. Wide doors give easy access to all cabinets, with walk-in access to the driver and power distribution cabinet.

