

Continental Electronics Corporation

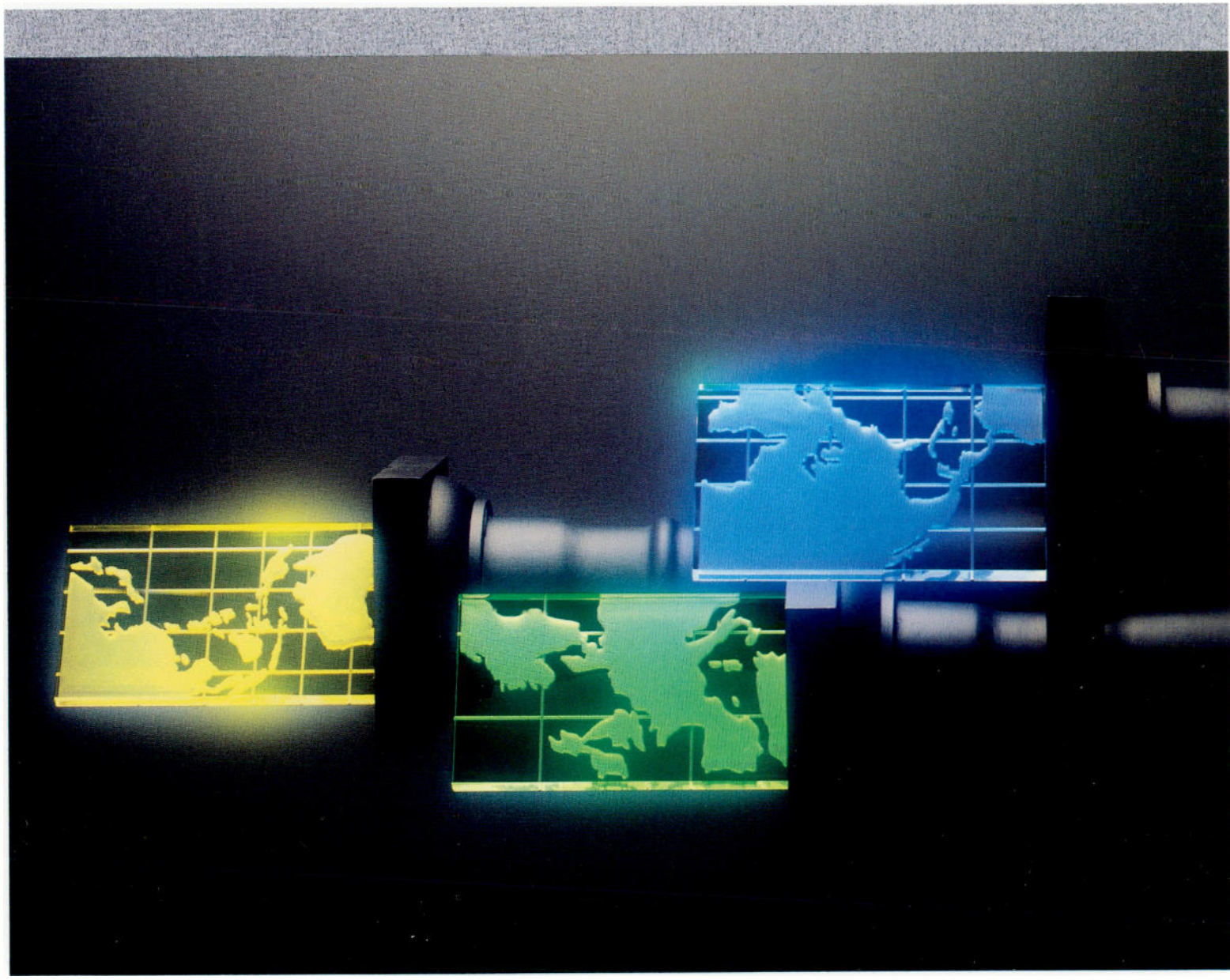

Continental Electronics Corporation

*Continental Electronics Corporation
has the best product warranty and the best 24-hour
technical service in the broadcast industry.*

—
Main Office 214-381-7161

Fax 214-381-4949

Telex 73-398

—
EMERGENCY PHONE NUMBERS

24-Hour Telephone Technical Service

214-388-5800

24-Hour Emergency Parts Service

214-388-3737

—
P.O. Box 270879

Dallas, Texas 75227-0879

Continental Electronics Corporation

Leading the Way...

Continental Electronics Corporation, a Tech-Sym Company, is an engineering oriented corporation specializing in the design and manufacture of low, medium and high power radio frequency transmitters for radio broadcast, communications, radar and scientific research applications.

Established in 1946, the company's sole purpose was to create an extensive and unique capability in RF product design.

Since its establishment, Continental has an unmatched record of achievement in the RF energy industry. Most of the company's innovative engineering designs have been at the forefront of technology and have paved the way for product development.

Continental is committed to excellence. This is reflected in the quality workmanship in our products and in the operational performance of all CEC radio/electronic equipment. Continental products bridge the frequency spectrum from ELF to UHF, S-band and beyond with power levels ranging from watts to megawatts.

Commercial and governmental broadcasting facilities around the world use Continental transmitters for local, regional and international broadcasting. In addition to the AM and FM products, Continental is also the leader in high power shortwave transmitters. These installations sometimes require special teaming or joint ventures with other companies in this specialized field. Complete facilities commissioning can be accomplished to the customer's specification.

This catalog is a brief representation of the variety of products and companies Continental can provide in a package quotation. Additional products may be available. For performance data, specifications, pricing and delivery information, contact your Continental District Sales Manager, manufacturer's representative or the main office in Dallas, Texas.

Product Warranty

Product specifications and prices are subject to change at any time without notice. All products are subject to prior sale; no guarantee as to product availability or performance is given or implied. Some products in this catalog are not manufactured by Continental Electronics but are included to give our customers a representation of products available from Continental. No endorsement or preferential treatment is given or implied for these products; any warranty or guarantee is the sole responsibility of the manufacturer of that product and not of Continental Electronics Corporation, Dallas, Texas.

Table of Contents

Continental Electronics RF Products	1-13
Transmitter Accessories	14-40
STL/TSL/Remote Control Products	41-49
Studio, Audio, Monitoring and Test Equipment	50-95

802B FM Exciter

- Offers broadcasters outstanding performance of digital quality, superb reliability and modular construction • With a variable output from 5W to 50W and the internal harmonic filter, may be used as a low power transmitter • Totally self-contained • All subassemblies are modular and accessible from top of unit • Entire exciter can be slide mounted for ease of service and installation • For bench testing, exciter can be completely removed • All components exceed rated requirements for their application • Will accept composite baseband signal from any stereo generator and STL system or monaural audio and SCA program input • Newly designed power transformer produces very low external field with no measurable S/N ratio degradation

Frequency Selection

The operating frequency of the 802B is generated with a digitally programmed, dual speed, phase-locked synthesized system. Internal switches provide selection of any of the 2200 channels in increments of 10kHz, from 87MHz to 109MHz. A stable, temperature-compensated master oscillator operating at 10MHz provides carrier frequency stability and accuracy of $\pm 250\text{Hz}$ over the temperature range 0° to 55°C .

Broadband Amplifier

The 802B is completely broadband. No adjustments are required other than digital selection of operating frequency. Power output is conservatively rated at 50W into a 50 ohm load at all frequencies in the FM band.

Automatic Power Control

The output power level control maintains output power at a preset level from 5W to 50W. A strip line directional coupler is incorporated into the power amplifier subassembly. Both forward and reflected power are measured on the front panel digital meter. Special circuits protect the amplifier from any mismatched load, including open or short circuits.

Overtemperature and Muting

In the event an overtemperature occurs within the 802B, power can be reduced to a user defined level, down to 0 if desired. An external muting input allows the exciter to be muted for test or other purposes.

Metering and Front Panel Indicators

Meter selection is derived from all electronic circuitry, eliminating all mechanical assemblies. Multiple colored LEDs provide easy viewing of all operating parameters under high ambient lights.

Functional Styling

Status lamps indicate system performance while allowing an uncluttered front panel for easy visual monitoring. Forward and reflected RF power output is viewed on a digital meter, along with amplifier current and operating voltages of the exciter. Modulation is indicated on a bargraph display. Individual status indicators indicate conditions of VCO lock, VSWR, cooling status, muting and overmodulation. A BNC connector located on the front panel provides a sample point of the modulating signal at a level suitable for signal analysis.

Linearity

Measurement of modulation distortion and noise indicates performance that approaches that of the most sophisticated digital audio.

Remote Control and Metering

Connections on the rear panel of the 802B exciter allow remote power level control and muting. Muting is accomplished by either a closure to ground or by applying a control voltage; this feature is user selectable. All metering functions that are on the front panel may also be metered remotely. These metering connections are located on the rear panel of the exciter.

Specifications

General

Power Output: 5W to 50W continuously adjustable; **RF Output Impedance:** 50 ohms, VSWR $< 2:1$ for full output, protected for open and short circuit; BNC connector; **RF Harmonic and Spurious:** 60dB or more below rated output; **Frequency Range:** 87MHz to 109MHz in 10kHz steps; **Frequency Control:** phase locked loop frequency synthesis from highly stable master oscillator; **Frequency Stability:** $\pm 250\text{Hz}$; **Modulation Type:** direct carrier frequency modulation; **Modulation**



802B

Capability: $\pm 200\text{kHz}$ deviation; **Modulation Indication:** bargraph: 5% increments; digital meter: 0.1% resolution; **Stereo Separation:** 50dB minimum; 50Hz to 15kHz (60dB or better, 400Hz to 7.5kHz typical)

Composite Operation

Composite Inputs: balanced, unbalanced and test; **Composite Input Impedance:** 5000 ohms, nominal; **Composite Input Level:** 1.25VRMS (3.5V p-p for $\pm 75\text{kHz}$ deviation); **Composite Amplitude Response:** $\pm 0.1\text{dB}$, 20Hz to 100kHz; **Composite Phase Response:** $\pm 0.5^\circ$, 20Hz to 75kHz; **Composite Group Delay Variation:** $\pm 25\text{ns}$, 20Hz to 75kHz; **Composite Total Harmonic Distortion:** 0.005%; **Composite Intermodulation Distortion:** 0.005%, 60Hz/7kHz, 4:1; **Composite FM S/N Radio (FM Noise):** 90dB at 400Hz, 75 μs de-emphasis; **3 SCA Inputs:** balanced or unbalanced; **SCA Input Impedance:** 15,000 ohms, nominal; **SCA Input Level:** 1.25VRMS for 10% injection; **SCA Amplitude Response:** $\pm 0.3\text{dB}$, 40kHz to 100kHz. Harmonic distortion and FM S/N ratio measured using "A" weighted filter

Electrical

Input Power: 115V or 230V, user selectable, $\pm 10\%$, 50/60Hz $\pm 5\%$, single phase, 200W maximum

Operating Environment

Temperature Range: -4°F to 131°F ; **Altitude Range:** 0' to 15,100'; **Relative Humidity Range:** 0% to 95%

Mechanical

Mounting: equipped with rackmounting sides; **Size:** 5.25" H x 17.5" W centered in a 19" W rackmounting panel 22" D; **Weight:** Approximately 31.5 lbs.

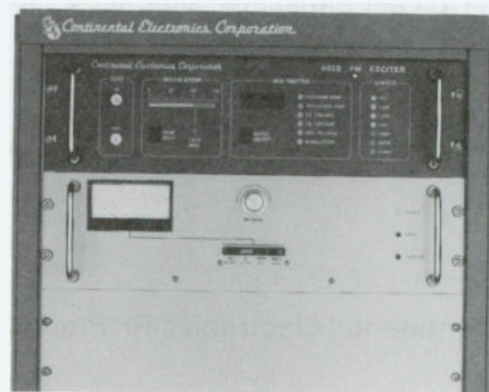

811B

811B 100W FM Transmitter

- Overtemperature and muting • Broadband amplifier • Automatic power control • Front panel indicators and metering • Total modular construction

The totally solid-state 811B is a compact, high performance transmitter designed to be used as a low power or emergency transmitter. Easily tunable throughout the entire FM band, the 811B can be operational within a few minutes. The RF chain consists of the 802B exciter, a broadband 150W amplifier and a power supply.

814H 1000W FM Transmitter

General

• **Rated Power Output:** 1000W • **Power Consumption:** 2500W nominal (at 1kW) • **Frequency Range:** 88MHz-108MHz, in 10kHz steps • **Frequency Control:** Phase-locked loop frequency synthesis from high stability master oscillator • **Frequency Stability:** $\pm 250\text{Hz}$ • **Output Impedance:** 50 ohms • **Output Connector:** Type "N" female • **VSWR:** 2:1, max. • **Modulation Type:** Direct carrier frequency modulation • **Modulation Capability:** $\pm 200\text{kHz}$ deviation • **Modulation Indication:** Digital LED display shows true peak level of modulated signal in 5% increments with accuracy better than $\pm 2\%$ • **Exciter:** Solid-state unit with variable output of 5W-50W; has self-contained harmonic filter • **RF Harmonic Attenuation:** -80dB, min. • **Power Supply Rectifiers:** Silicon

Monaural Operation

• **Audio Input Impedance:** 600 ohms, balanced • **Audio Input Return Loss:** 30dB or better • **Audio Input Level:** +10dBm (6.93V p-p) at 600 ohms for $\pm 75\text{kHz}$ deviation • **Audio Frequency Response:** $\pm 0.5\text{dB}$; flat, 25, 50 or 75 μs pre-emphasis, 20Hz-15kHz • **Total Harmonic Distortion:** 0.08% max.; 20Hz-15kHz (measured with spectrum analyzer) • **Intermodulation Distortion:** 0.08% or less, 60Hz/7kHz, 4:1 ratio • **FM S/N Ratio (FM Noise):** 75dB min. below $\pm 75\text{kHz}$ deviation at 400Hz, measured within a 20Hz-15kHz bandwidth with 75 μs de-emphasis • **Asynchronous AM S/N Ratio (AM Noise):** 62dB RMS below carrier; reference: 100% AM modulation, full power at 400Hz with 75 μs de-emphasis, no FM modulation • **Synchronous AM S/N Ratio (Incidental AM Noise):** 60dB below carrier; reference: 100% AM modulation, full power at 400Hz with 75 μs de-emphasis, FM modulation $\pm 75\text{kHz}$ at 400Hz

Wideband Operation

• **Composite Inputs:** Balanced, unbalanced and test • **Composite Input Impedance:** 5000 ohms, nominal • **Composite Input Level:** 1.25VRMS (3.54V p-p) for $\pm 75\text{kHz}$ deviation • **Composite Amplitude Response:** $\pm 0.1\text{dB}$, 20Hz-100kHz • **Composite Total Harmonic Distortion:** 0.08% maximum • **Composite Intermodulation Distortion:** 0.08% or less, 60Hz/7kHz, 4:1 ratio • **3 SCA Inputs:** Balanced or unbalanced • **SCA Input Impedance:** 15,000 ohms, nominal • **SCA Input Level:** 1.25VRMS for $\pm 7.5\text{kHz}$ deviation • **SCA Amplitude Response:** $\pm 0.3\text{dB}$, 40kHz-100kHz

Stereo Operation

Most stereo performance parameters are determined primarily by the stereo generator used. The following specifications are influenced by the RF System and assume a state-of-the-art stereo generator is used.

• **Stereo Separation:** 50dB min.; 50Hz-15kHz (60dB or better, 400Hz-7.5kHz typical) • **Total Harmonic Distortion:** 0.08% max.; 50Hz-15kHz (measured with spectrum analyzer) • **Intermodulation Distortion:** 0.08% max.;

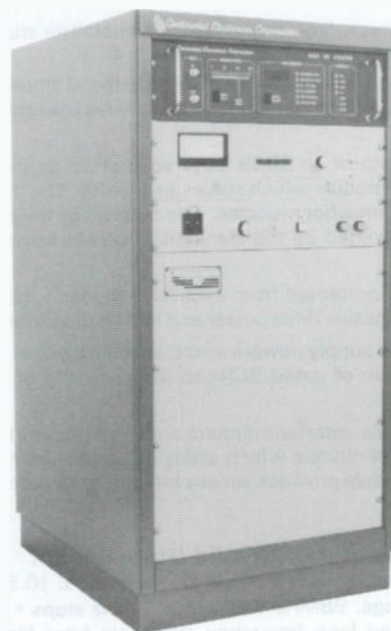

814H

60Hz/7kHz, 4:1 ratio • **FM Noise:** -72dB referenced to 400Hz, 75kHz deviation. Measured with 75 μs de-emphasis within a 20Hz-15kHz bandwidth • **Linear Crosstalk:** -55dB

Electrical

• **Power Source:** 188VAC-272VAC, 60Hz, single phase; available voltage taps are 188, 200, 210, 218, 230, 242, 250, 260, 272 (50Hz available on request)

Operating Environment

• **Altitude Range:** 0'-10,000' • **Ambient Temperature Range:** -4°F to +122°F • **Relative Humidity:** 0%-95%

Mechanical

• **Size, as shown:** 42" H x 21" W x 25" D • **Weight:** 448 lbs.

SCA Operation

Most SCA performance parameters are determined primarily by the SCA generator used. The following specifications are influenced by the RF System and assume a state-of-the-art SCA generator is used.

Crosstalk, SCA to Main and Stereo (67kHz and/or 92kHz): -60dB, SCA deviation 5kHz, Main 75 μs de-emphasis

Crosstalk, Main and Stereo to SCA (67kHz and/or 92kHz): -50dB, Main and Stereo 75kHz deviation; SCA reference deviation, 5kHz and 200Hz modulation; SCA de-emphasis, 150 μs

Crosstalk SCA to SCA (67kHz and/or 92kHz): -50dB, SCA reference deviation 5kHz and 200Hz modulation frequency; de-emphasis, 150 μs

814J 3.8kW Solid-State Broadcast Transmitter

- Broadband modular design • Transparent audio performance • No tuning • 100% solid-state • Single-phase power supply • VSWR protection circuit • 100% self-protected solid-state amplifier modules • Designed for low maintenance and long life • Built-in redundancy for reliable performance

The 814J is a compact, high performance transmitter that uses the 802B exciter to deliver a crisp, clean signal.

The transmitter design is based on a 700W broadband amplifier module and utilizes a splitter/combiner technique to achieve the rated output of 3800W.

The RF chain consists of an 802B 50W solid-state exciter driving a solid-state amplifier module which serves as the IPA. The IPA output is split to drive the PA amplifier modules. The outputs of the PA modules are combined and treated as the transmitter's final power amplifier stage.

All modules are self-protected from excessive power supply voltage, VSWR overload, excessive drive power and high temperature.

A single-phase power supply powers all the power modules. The power supply is fed by a pair of gated SCRs to allow control of the supply output voltage.

All transmitter controls, interface circuits and metering are housed in a self-contained control module which slides out on tracks for easy access. The control module provides access for local or remote operation.

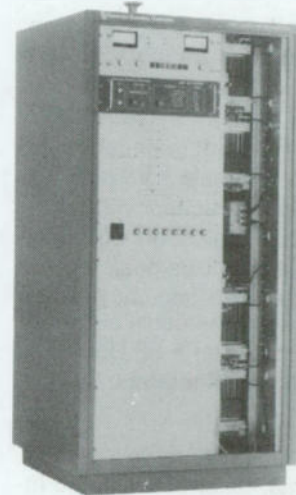

814J

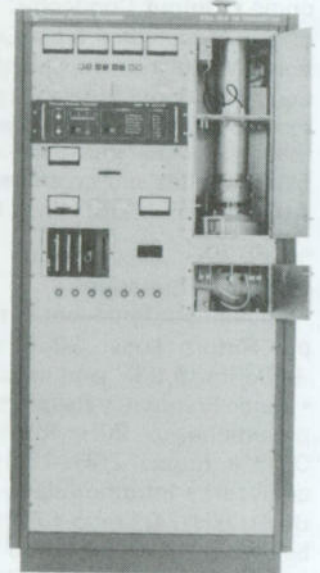

815B

815B 5kW Single Tube Broadcast Transmitter

- Single tube • SCR power control • Automatic power output control • Automatic VSWR protection • Automatic SWR output power fold-back • Remote control interface • Filament voltage regulator • True RMS filament voltage metering • AC power failure recycle • 2/4-shot automatic overload recycle • Internal diagnostics • Modular subassemblies easily reached from front of exciter • 802B will accept composite baseband signal from stereo generator, STL system of monaural audio and SCA programming • 802B exciter is completely solid-state and needs no tuning adjustments other than selection of operating frequency • Exciter generates operating frequency with a digitally programmed, dual speed, phase-locked frequency synthesis system

The 815B is a high performance, state-of-the-art transmitter that uses the 802B exciter to deliver a crisp, clean signal.

With an output power of 5000W, it has an adequate power reserve for Class A FM operation using a 2-bay antenna system.

The RF chain consists of an 802B 50W exciter and a solid-state IPA driving a 4CX3500A tetrode tube in the final amplifier.

The harmonic filter is internally mounted, providing a 1 5/8" EIA flange for direct mounting to the transmission line

IC logic is used for all control functions. A computer-like memory, powered by battery backup, restarts the transmitter after a power failure.

Specifications Using 802B Solid-State Exciter

Specifications are similar to 814J except:

- **Rated Power Output:** 5kW • **Power Consumption:** 9.8kW nominal
- **VSWR:** 2:1 maximum • **RF Harmonic Attenuation:** -80dB minimum

Wideband Operation

- **Composite Total Harmonic Distortion:** 0.1% maximum

Stereo Operation

- **Intermodulation Distortion:** 0.15% maximum; 60Hz/7kHz, 4:1 ratio
- **FM Noise:** -70dB

Mechanical

- **Weight:** 1020 lbs.

Specifications Using 802B Solid-State Exciter

- **Rated Power Output:** 3.8kW • **Power Consumption:** 10.5kW, nominal
- **Frequency Range:** 88MHz-108MHz in 10kHz steps • **Frequency Control:** Phase-locked loop frequency synthesis from high stability master oscillator • **Frequency Stability:** ± 250Hz • **Output Impedance:** 50 ohms • **Output Connector:** 1 5/8" EIA flange • **VSWR:** 1.2:1 maximum
- **Modulation Type:** Direct carrier • **Modulation Capability:** ± 200kHz deviation • **Modulation Indication:** Digital LED display shows true peak level of modulated signal in 5% increments with accuracy better than ± 2%
- **Exciter:** Solid-state unit with variable output of 5W-50W; has self-contained harmonic filter • **RF Harmonic Attenuation:** 78.8dB, minimum • **Power Supply Rectifiers:** Silicon

Wideband Operation

- **Composite Inputs:** Balanced, unbalanced and test • **Composite Input Impedance:** 5000 ohms, nominal • **Composite Input Level:** 1.25VRMS (3.54V p-p) for ± 75kHz deviation • **Composite Amplitude Response:** ± 0.1dB, 20Hz-100kHz • **Composite Total Harmonic Distortion:** 0.08% maximum • **Composite Intermodulation Distortion:** 0.08% or less, 60Hz/7kHz, 4:1 ratio
- **3 SCA Inputs:** Balanced or unbalanced • **SCA Input Impedance:** 15,000 ohms, nominal • **SCA Input Level:** 1.25VRMS for ± 7.5kHz deviation • **SCA Amplitude Response:** ± 0.3dB, 40kHz-100kHz

Stereo Operation

Most stereo performance parameters are determined primarily by the stereo generator used. The following specifications are influenced by the RF system and assume that a state-of-the-art stereo generator is used.

- **Stereo Separation:** 50dB minimum; 50Hz-15kHz (60dB or better, 400Hz-7.5kHz typical) • **Total Harmonic Distortion:** 0.08% maximum; 50Hz-15kHz (measured with spectrum analyzer) • **Intermodulation Distortion:** 0.08% maximum; 60Hz/7kHz, 4:1 ratio • **FM Noise:** -72dB referenced to 400Hz, 75kHz deviation. Measured with 75µs de-emphasis within a 20Hz-15kHz bandwidth • **Linear Crosstalk:** -55dB

Electrical

- **Power Source:** 200 to 250VAC; 60Hz, single-phase; available transformer taps are 200, 210, 220, 230, 240, 250VAC; 50Hz available on request • **Permissible Line Voltage Variation:** ± 5%

Operating Environment

- **Altitude:** 7500' standard • **Ambient Temperature Range:** -4°F to 113°F • **Relative Humidity:** 0%-95%

Mechanical

- **Transmitter:** 69" H x 34 3/4" W x 33 3/8" D • **Weight:** 1100 lbs. nominal

816B 11kW FM Transmitter

- Compact • Easy installation • 23 circuits protect transmitter • "Soft-Start™" circuit limits current surges • 2 independent VSWR protection circuits automatically reduce transmitter power to safe operating level • Transmitter output adjusts between 0% and 100%

The 816B 11kW FM transmitter combines the features of higher power FM transmitters and low power FM transmitters to provide you with the best in efficiency and sound. Low power consumption, low distortion and excellent stereo separation are a few of the standard features.

Transmitter output may be adjusted to any level between 0% and 100% with minimal retuning. If momentary power outages or overloads occur, special circuits protect the transmitter and automatically restore it to the previous operational status.

2 independent VSWR protection circuits automatically reduce transmitter power to a safe operating level whenever abnormal antenna mismatches occur. 1 circuit handles severe mismatches such as lightning strikes by interrupting the RF when reflected power reaches 10%. The other circuit holds reflected power to a preset level during severe icing conditions, allowing output power to be maintained at the highest "safe" level.

The "Soft-Start" circuit limits current surges at turn-on, reducing down time and minimizing power supply component replacement.

23 different circuits are used to protect the transmitter. All control circuits are conventional 28VDC design. Meters and controls are placed at or near eye level for easy reading and accurate adjustments. If a problem should occur, 15 status indicators, 16 indicating fuse holders and 4 front panel circuit breakers assist in trouble-shooting.

Wide bandwidth provided by the plate circuit quarter-wave cavity design optimizes transmitter performance, while the 816B control options offer maximum operating flexibility. Compact size and ease of installation will get you on the air with minimal time and cost.

Featured in this transmitter is a 700W solid-state driver which provides superb reliability and decreases maintenance cost. This configuration also offers greater bandwidth and self-protecting RF modules. The solid-state driver unit is mounted on slides for easy access.

Specifications

Rated Power Output: 11kW (11.5kW maximum) • **Power Consumption:** 17.8kW, nominal (at 10kW) • **Frequency Range:** 88MHz-108MHz • **Frequency Control:** phase-locked-loop frequency synthesis from highly stable master oscillator • **Frequency Stability:** ± 250 Hz • **Output Impedance:** 50 ohms • **Output Connector:** 3 $\frac{1}{8}$ " EIA flange • **VSWR:** 2:1 maximum • **Modulation Type:** direct carrier frequency modulation • **Modulation Capability:** ± 200 kHz deviation • **Modulation Indication:** bargraph: 5% increments; digital meter: 0.1% resolution • **Exciter:** solid-state unit with variable output of 5W-50W; has self-contained harmonic filter • **RF Harmonic Attenuation:** -80dB minimum • **Power Supply Rectifiers:** silicon

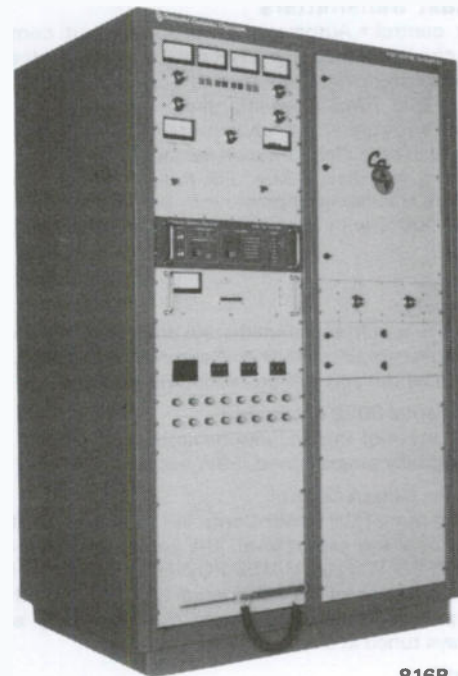

816B

Composite Operation

- **Composite Inputs:** balanced, unbalanced and test • **Composite Input Impedance:** 5000 ohms, nominal • **Composite Input Level:** 1.25VRMS (3.5V p-p) for ± 75 kHz deviation • **Composite Amplitude Response:** ± 0.1 dB, 20Hz-100kHz • **Composite Intermodulation Distortion:** 0.05%, SMPTE method • **Composite Total Harmonic Distortion:** 0.05%, 50Hz-15kHz • **3 SCA Inputs:** balanced or unbalanced • **SCA Input Impedance:** 15,000 ohms, nominal • **SCA Input Level:** 1.25VRMS for 10% injection • **SCA Amplitude Response:** ± 0.3 dB, 40kHz-100kHz

Stereo Operation

Most stereo performance parameters are determined by the stereo generator used. The following parameters are influenced by the RF system. These specifications assume a state-of-the-art stereo generator is used.

- **Stereo Separation:** 50dB minimum, 50Hz-15kHz (60dB or better, 400Hz-7.5kHz typical) • **FM Noise:** -72dB referenced to 400Hz, 75kHz deviation

Electrical

- **Power Source:** 200-250VAC, 60Hz, 3-phase; available transformer taps are 200, 210, 220, 230, 240, 250VAC; 50Hz available upon request • **Permissible Line Voltage Variation:** $\pm 5\%$ • **Filament Regulator:** $\pm 1\%$ of optimum

Operating Environment

- **Altitude Range:** 0'-7500' standard; optional to 10,000' with modification kit • **Ambient Temperature Range:** -20°C to +50°C (-4°F to +122°F) • **Relative Humidity:** 0%-95%

Mechanical

- **Size, as shown:** 69" H x 45" W x 34" D • **Weight:** 1658 lbs.

816R Series 21.5/25/27.5/35kW

FM Broadcast Transmitters

• SCR power control • Automatic RF power output control • Automatic VSWR circuit protection • SWR output power foldback • 802B solid-state FM exciter offers unmatched performance • Remote control interface • True RMS filament power regulation/metering • AC power failure recycle • 2/4 shot automatic overload recycle • Grounded screen amplifier • Internal diagnostics • Harmonic filter internally mounted, providing a 3 1/8" EIA flange for direct mounting of transmission line • Transmitter power may be adjusted to any level between 0% and 100% with minimal retuning by using front panel controls

Solid-State Driver

Featured in this transmitter is a solid-state driver which increases reliability and decreases maintenance and complexity. This driver also offers greater bandwidth and self-protecting RF modules.

Includes Continental 802B FM Exciter

The 802B is a state-of-the-art, low noise, low distortion, frequency synthesized, digitally programmed, 50W exciter.

Automatic Power Output Control

Uses an all solid-state SCR Power Controller to automatically maintain the power output at any preset level. The power can also be manually adjusted from ZERO TO FULL RATED POWER with a single front panel control. A unique feature of the Continental transmitters is the ability to control both plate and screen voltages simultaneously so that the transmitter stays tuned at all power levels.

SCR Soft-Start™

Gently applies primary voltage to the plate and screen power supplies when the plate control is turned on. The SCRs are conservatively rated at 350A in a 40A to 75A circuit.

Completely Self-Contained

(27.5kW transmitter and lower) in a single cabinet including the high voltage power supply, harmonic filter, filament voltage regulator, etc. The 35kW transmitter is completely contained within 2 cabinets.

Broadband Quarter Wave Cavity

Uses the highly reliable, long life 4CX15000A tube in all power levels from 21.5kW through 27.5kW. The 816R-5C uses the 9019/YC-130 tetrode that was designed especially for Continental to meet stringent FM service requirements at 35kW.

Two Independent VSWR Protection Circuits

Prevent the reflected power from exceeding safe levels. One circuit handles severe instantaneous mismatches, such as lightning strikes, by momentarily interrupting the plate and screen voltage when the reflected power reaches a preset level. The second circuit limits the reflected power to a preset level by controlling the plate and screen voltage during icing conditions. This allows the transmitter to operate at the highest safe user selected power level during severe antenna icing.

Automatic Filament Voltage Regulation

Keeps a constant filament voltage on the PA tube to help EXTEND TUBE LIFE.

Positive Pressure Cabinet

Keeps dust from collecting on critical components. The 816R air intake and exhaust are located on the top of the cabinet for easy ductwork installation.

Screen Neutralization

Is used in the PA in a highly stable GROUNDED SCREEN GRID circuit.

Automatic Power Interrupt Recycle

"Remembers" and restores the transmitter to its previous operating status after a momentary power interruption.

Specifications Using 802B Solid-State Exciter

• **Rated Power Output:** 816R-2C 21.5kW, 816R-3C 25kW, 816R-4C 27.5kW, 816R-5C 35kW • **Power Consumption:** 816R-2C 33kW nominal, 816R-3C 40kW nominal, 816R-4C 42kW nominal, 816R-5C 54kW nominal • **Frequency Range:** 88MHz to 108MHz, in 10kHz steps • **Frequency Control:** Phase-locked loop frequency synthesis

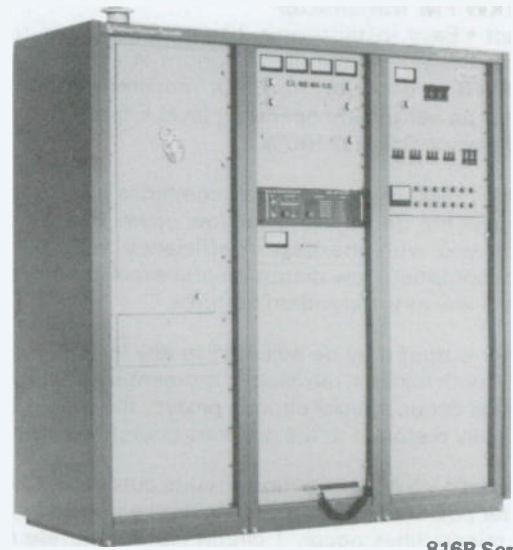

816R Series

from high stability master oscillator • **Frequency Stability:** $\pm 250\text{Hz}$ • **Output Impedance:** 50 ohms • **Output Connector:** 3 1/8" EIA flange • **VSWR:** 2:1, maximum • **Modulation Type:** Direct carrier frequency modulation • **Modulation Capability:** $\pm 200\text{kHz}$ deviation • **Modulation Indication:** Digital LED display shows true peak level of modulated signal in 5% increments with accuracy better than $\pm 2\%$ • **Exciter:** Solid-state unit with variable output of 5W to 50W; self-contained harmonic filter • **RF Harmonic Attenuation:** -80dB, minimum

Wideband Operation

• **Composite Inputs:** Balanced, unbalanced and test • **Composite Input Impedance:** 5,000 ohms, nominal • **Composite Input Level:** 1.25VRMS (3.54V p-p) for $\pm 75\text{kHz}$ deviation • **Composite Amplitude Response:** $\pm 0.1\text{dB}$, 20Hz-100kHz • **Composite Total Harmonic Distortion:** 0.08% maximum • **Composite Intermodulation Distortion:** 0.08% maximum; 60Hz/7kHz, 4:1 ratio • **3 SCA Inputs:** Balanced or unbalanced • **SCA Input Impedance:** 15,000 ohms, nominal • **SCA Input Level:** 1.25VRMS for $\pm 7.5\text{kHz}$ deviation • **SCA Amplitude Response:** $\pm 0.3\text{dB}$, 40kHz to 100kHz

Stereo Operation

Most stereo performance parameters are determined primarily by the stereo generator used. The following parameters are influenced by the RF system. These specifications assume that a state-of-the-art stereo generator is used.

• **Stereo Separation:** 50dB minimum; 50Hz to 15kHz (60dB or better, 400Hz to 7.5kHz typical) • **Total Harmonic Distortion:** 0.08% maximum; 50Hz to 15kHz (measured with spectrum analyzer) • **Intermodulation Distortion:** 0.08% maximum; 60Hz/7kHz, 4:1 ratio • **FM Noise:** -72dB referenced to 400Hz, 75kHz deviation. Measured with 75 μs de-emphasis within a 20Hz to 15kHz bandwidth • **Linear Crosstalk:** -55dB

Electrical

• **Power Source:** 200 to 250VAC; 60Hz, 3-phase; available transformer taps are 200, 210, 220, 230, 240, 250VAC; 50Hz available on request • **Permissible Line Voltage Variation:** $\pm 5\%$ (each phase voltage variation within 5% of the average of all 3 phases) • **Filament Regulation:** $\pm 1\%$ of optimum

Operating Environment

• **Operating Altitude:** 7,500' standard; optional to 10,000' with modification kit • **Ambient Temperature Range:** -4°F to +122°F

Mechanical

• **Transmitter:** 69" H x 72" W x 28" D • **Weight:** 1,962 lbs. nominal

35kW Mechanical

• **External Plate Transformer:** 46" H x 35" W x 24" D • **Weight:** 901 lbs. nominal

816R Series 40/50/55/70kW Broadcast Transmitters

- Each model consists of 2 transmitters whose inputs are combined in a 90° hybrid • Low power consumption • Good stereo separation and excellent frequency stability • Transmitter power may be adjusted to any level between 0% and 100%, using front controls • Special circuits protect transmitter and automatically restore it to operational status • 2 independent circuits automatically reduce power to safe operating level whenever abnormal mismatches occur • Soft start circuit • 23 different circuits or indicators protect the transmitter • Control circuits are 28VDC • Simple installation

Solid-State Driver

Featured in this transmitter is a solid-state driver which increases reliability and decreases maintenance and complexity. This driver also offers greater bandwidth and self-protecting RF modules.

Includes Continental 802B FM Exciter

The 802B is a state-of-the-art, low noise, low distortion, frequency synthesized, digitally programmed, 50W exciter.

Automatic Power Output Control

Uses an all solid-state SCR Power Controller to automatically maintain the power output at any preset level. The power can also be manually adjusted from ZERO TO FULL RATED POWER with a single front panel control. A unique feature of the Continental transmitters is the ability to control both plate and screen voltages simultaneously so that the transmitter stays tuned at all power levels.

SCR Soft-Start™

Gently applies primary voltage to the plate and screen power supplies when the plate control is turned on. The SCRs are conservatively rated at 350A in a 40A to 75A circuit.

Completely Self-Contained

(27.5kW transmitter and lower) in a single cabinet including the high voltage power supply, harmonic filter, filament voltage regulator, etc. The 35kW transmitter is completely contained within 2 cabinets.

Broadband Quarter Wave Cavity

Uses the highly reliable, long life 4CX15000A tube in all power levels from 21.5kW through 27.5kW. The 816R-5C uses the 9019/YC-130 tetrode that was designed especially for Continental to meet stringent FM service requirements at 35kW.

Two Independent VSWR Protection Circuits

Prevent the reflected power from exceeding safe levels. One circuit handles severe instantaneous mismatches, such as lightning strikes, by momentarily interrupting the plate and screen voltage when the reflected power reaches a preset level. The second circuit limits the reflected power to a preset level by controlling the plate and screen voltage during icing conditions. This allows the transmitter to operate at the highest safe user selected power level during severe antenna icing.

Automatic Filament Voltage Regulation

Keeps a constant filament voltage on the PA tube to help EXTEND TUBE LIFE.

Optional Automatic Exciter Control

Continental's 377C-1A automatic exciter control unit provides monitoring and control for two 802B or similar exciters. If one exciter fails, the standby exciter is automatically put on-line. Indicator lamps show which exciter is operating.

The 377C-1A is designed to fit in the control cabinet furnished with the 40kW, 50kW and 55kW transmitters.

Optional Automatic Combiner Control

Continental's 377D-1 combiner control provides automatic or manual control of 2 parallel FM transmitters and automatically assures maximum available power to the antenna at all times.

In the event of a transmitter failure, the remaining transmitter output is automatically switched through the combiner into the antenna. The transmitter that failed is automatically switched to the test load for troubleshooting.

The combiner control provides all interlock and sequencing functions; it is designed to fit in the control cabinet furnished with the D816R-2C 40kW, D816R-3C 50kW, D816R-4C 55kW or D816R-5C 70kW transmitters.

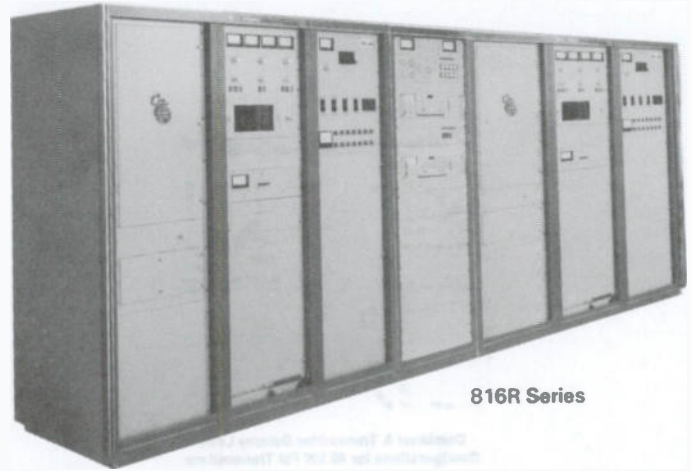

816R Series

Specifications Using 802B Solid-State Exciter

- **Rated Power Output:** D816R-2C 40kW, D816R-3C 50kW, D816R-4C 55kW, D816R-5C 70kW • **Power Consumption:** D816R-2C 62kW nominal, D816R-3C 80kW nominal, D816R-4C 84kW nominal • **Frequency Range:** 88MHz-108MHz in 10kHz steps • **Frequency Control:** Phase-locked loop frequency synthesis from high stability master oscillator • **Frequency Stability:** $\pm 250\text{Hz}$ • **Output Impedance:** 50 ohms • **Output Connector:** 6 $\frac{1}{8}$ " EIA flange • **VSWR:** 2:1 maximum • **Modulation Type:** Direct carrier frequency modulation • **Modulation Capability:** $\pm 200\text{kHz}$ deviation • **Modulation Indication:** Digital LED display shows true peak level of modulated signal in 5% increments with accuracy better than $\pm 2\%$ • **Exciter:** Solid-state unit with variable output of 5W-50W; self-contained harmonic filter • **RF Harmonic Attenuation:** -80dB minimum • **Power Supply Rectifiers:** Silicon

Wideband Operation

- **Composite Inputs:** Balanced, unbalanced and test • **Composite Input Impedance:** 5000 ohms, nominal • **Composite Input Level:** 1.25VRMS (3.54V p-p) for $\pm 75\text{kHz}$ deviation • **Composite Amplitude Response:** $\pm 0.1\text{dB}$, 20Hz-100kHz • **Composite Total Harmonic Distortion:** 0.08% maximum • **Composite Intermodulation Distortion:** 0.08% maximum; 60Hz/7kHz, 4:1 ratio • **3 SCA Inputs:** Balanced or unbalanced • **SCA Input Impedance:** 15,000 ohms, nominal • **SCA Input Level:** 1.25VRMS for $\pm 7.5\text{kHz}$ deviation • **SCA Amplitude Response:** $\pm 0.3\text{dB}$, 40kHz-100kHz

Stereo Operation

Most stereo performance parameters are determined primarily by the stereo generator used. The following parameters are influenced by the RF system. These specifications assume a state-of-the-art stereo generator is used.

- **Stereo Separation:** 50dB minimum, 50Hz-15kHz (60dB or better, 400Hz-7.5kHz typical) • **Total Harmonic Distortion:** 0.08% maximum, 50Hz-15kHz (measured with spectrum analyzer) • **Intermodulation Distortion:** 0.08% maximum, 60Hz/7kHz, 4:1 ratio • **FM Noise:** -72dB referenced to 400Hz, 75kHz deviation. Measured with 75 μs de-emphasis within a 20Hz-15kHz bandwidth • **Linear Crosstalk:** -55dB

Electrical

- **Power Source:** 200VAC-250VAC, 60Hz, 3-phase; available transformer taps are 200, 210, 220, 230, 240, 250VAC; 50Hz available on request • **Permissible Line Voltage Variation:** 5% (each phase voltage variation within 5% of the average of all 3 phases) • **Filament Regulator:** 1% of optimum

Operating Environment

- **Altitude:** 7500' standard; optional to 10,000' with modification kit • **Ambient Temperature Range:** -4°F to +122°F

Mechanical

- **Transmitter:** 69" H x 159.8" W x 28" D; Weight: 4074 lbs. nominal
- **Combiner, 40kW:** 60" H x 48" W x 30" D; Weight: 790 lbs. nominal
- **Combiner, 50/55kW:** 73" H x 68 $\frac{1}{2}$ " W x 31" D; Weight: 1130 lbs. nominal

Typical Setup: 40kW FM Transmitters

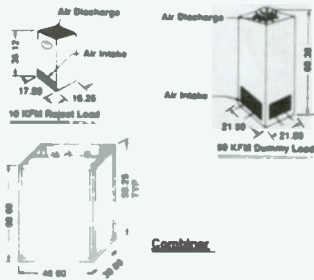

Combiner & Transmitter Dummy Load Configurations for 40 kW FM Transmitters

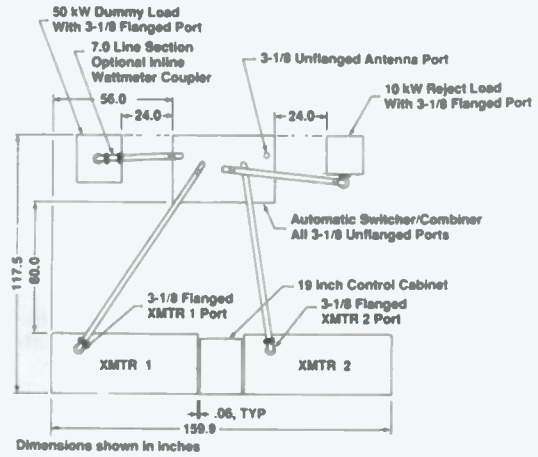

Typical Plan View, 40 kW FM Transmitters

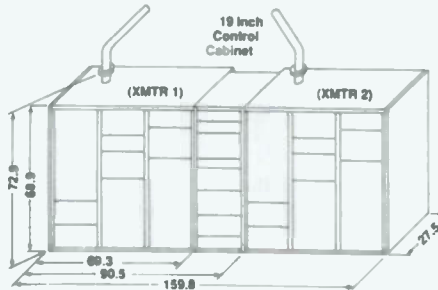
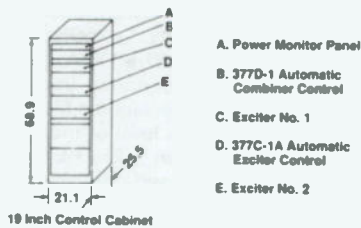

Typical Setup: 50kW, 55kW FM Transmitters

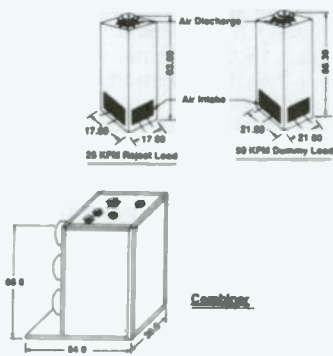

Combiner & Transmitter Dummy Load Configurations for 50,55 kW FM Transmitters

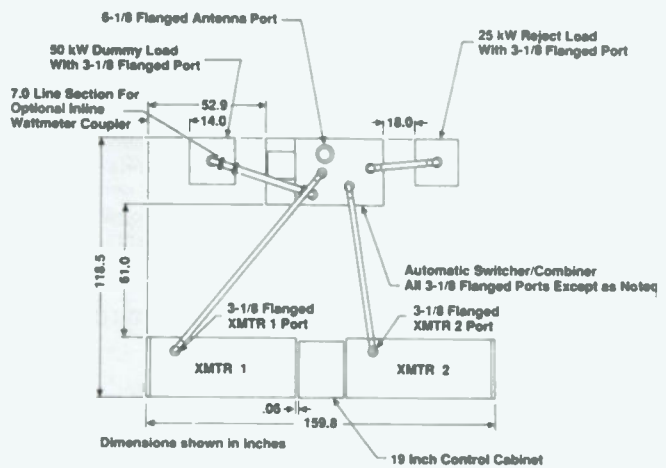

Typical Plan View, 50 & 55 kW FM Transmitters

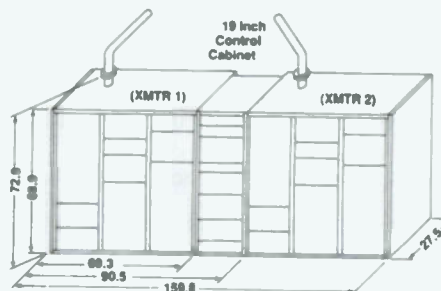
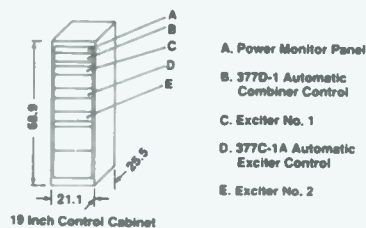

TranStat™ RF Accessories

- Programmable digital transmitter monitoring
- Wyse 85 video terminal and built-in 2400 baud modem
- Programmable digital control functions
- Real time clock and calendar
- Automatic logging into memory or on printer
- Long-term trends presented on graphics screen
- Provides valuable diagnostic information
- Complete remote control and telemetry

The Screens



MAIN SCREEN

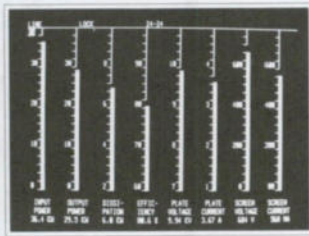

GRAPHICS SCREEN

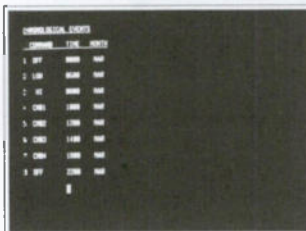

TIMER CONTROL SCREEN



HELP SCREEN

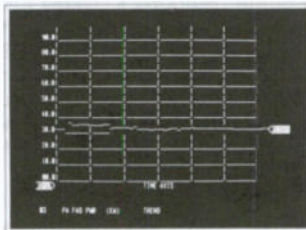

TREND SCREEN

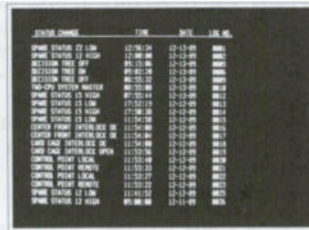

STATUS CHANGE SCREEN



Type 377C-1A

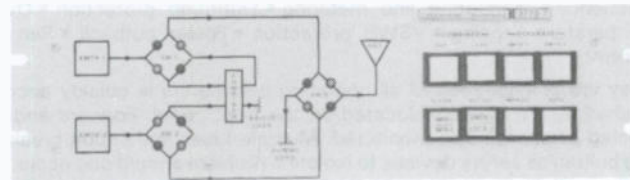

Type 377D-1

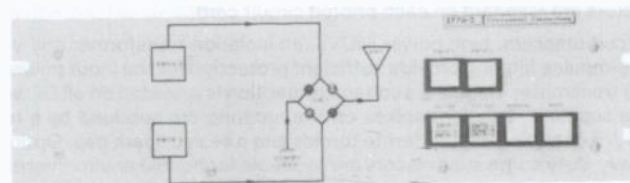

Type 377D-2

Type 377C-1A Exciter Control

- Monitors the status and controls 2 exciters
- During typical operation, the 377C-1A switches 1 exciter to the transmitter to be driven
- The second exciter is operated into a 100W load provided with the unit
- If the primary exciter fails, the standby exciter is switched on line in less than 100ms
- If used with 802B FM exciters, the standby exciter is held at 5% of normal power by a bias voltage from the 377C-1A until full power is needed
- Front panel controls include operate/standby and pushbuttons for both exciters and a normal/test switch for station monitors
- Occupies 3 1/2" of rack space and uses BNC connectors for RF connections, a barrier strip for control connections

Type 377D-1 Combiner Control

- Provides control commands and monitoring for a pair of parallel transmitters and their associated motor-driven coax switches
- By monitoring predetermined parameters, the 377D-1 can switch 1 transmitter directly into the antenna system and thereby avoid the normal power loss of 6dB that takes place in a hybrid combiner
- If 1 PA fails, the down unit is automatically switched to a dummy load for service
- System status is shown by a series of 12 LEDs and a flow chart gives a quick visual reference from a distance
- 8 illuminated pushbuttons program the 377D-1
- Operating modes include: combined power to load; combined power to antenna; transmitter 1 or 2 to antenna; transmitter 1 or 2 plate on or plate off; and manual or automatic operation

The 377D-1 uses IC logic to give status and command functions, and has its own NiCad power supply across the DC lines to hold memory during a power failure. After a primary power failure, transmitter operation will automatically resume in its last mode. The unit occupies 5 1/4" of rack space, has standard BNC connectors on the back for RF connections, and uses barrier strips for control connections.

Type 377D-2 Transmitter Control

- Similar in operation to the 377D-1 except controls 2 transmitters in an alternate/main or "hot standby" condition
- NiCad power supply across the DC lines holds memory during a power failure
- Front panel controls include transmitter 1, transmitter 2, plate on, plate off, manual, automatic
- LED flow chart shows RF routing to an antenna system and dummy load
- Occupies 5 1/4" of rack space, has standard BNC connectors on the back for RF connectors, and uses barrier strips for control connections

Type 377D-2A Option

- Same as the 377D-2 except has a sensing device to monitor transmitter audio level
- If the audio drops below a preset level, the unit automatically switches the down unit into a dummy load and puts the alternate/hot standby transmitter on the air

"T" Line AM Transmitters

- Provide broadcasters with an economical/efficient means to upgrade or build new
- Solid-state modules
- Low power consumption
- Modules are interchangeable
- No tuning
- Offer simple frequency changes
- Harmonic filter can be quickly interchanged to match new frequency
- Monitoring and metering
- Lightning protection
- Over-temperature sensing
- VSWR protection
- Power cutback
- Remote control

Easy visual inspection of all operating parameters is quickly accomplished by a multimeter located on the front panel. Forward and reflected power are also monitored. Multiple fuses and circuit breakers are built-in as safety devices to isolate a problem should one occur. All of the modules contain a series of diagnostic LEDs to visually obtain the operational status of each module. Voltage regulators and surge protectors are standard on each printed circuit card.

Circuit breakers, high power MOVs, an isolation transformer and voltage impulse filtering provide sufficient protection for the input power to the transmitter. Regulated voltage protection is provided on all DC voltage supplies. Transient spikes on the antenna are subdued by a high VSWR detection circuit, ferrite toroids and a sealed spark gap. Optional heavy-duty surge suppressors are available for hostile environments.

Each of the power amplifier modules incorporates over-temperature sensors that will remove a module from operation should a problem occur. After an over-temperature condition has corrected itself, the module returns to full output power.

Cabinet cooling is established with the use of low velocity fans. Normal operation of the transmitter will remain unaffected even with the loss of a fan due to the reserve capacity of each fan.

A dual directional coupler and detection circuit protect the transmitter from heavily mismatched loads. Performance and efficiency may be minimally affected by a mismatched load.

User defined power reduction requirements are available in 5 steps. Once reduced powers are selected, a switch located on the front panel provides easy access to power reduction. Power changes may also be accomplished through the remote interface.

Monitoring of all operational parameters, control of on/off functions and transmitter output power may be conveniently accessed through the remote interface.

Additional Options

Audio processing may be incorporated with the use of internal plug-in cards or with an outboard processor. AM stereo operation is possible with the use of an external stereo exciter and monitor.

312T 300W AM Broadcast Transmitter

- Solid-state reliability
- Modular design
- Ruggedized and light-weight
- World-common parts
- Frequency synthesizer
- 125% peak modulation
- Power cutback
- High efficiency

The 312T is the 300W member of the Continental "T" line of competitively priced, highly efficient, ruggedized AM broadcast transmitters. This series of transmitters complies with all FCC standards and meets the specifications of various international broadcasting authorities. The 312T transmitter is solid-state, using efficient pulse duration modulation (PDM) techniques. The use of state-of-the-art integrated circuits and MOSFETs in the design provides better reliability than that experienced with bipolar transistors or vacuum tubes. The use of a modular concept in the 312T design provides ease of maintenance. Front panel status indicators and meters facilitate diagnostics and operation. All components are mounted on plug-in modules for ease of maintenance, minimizing down time. The highly reliable and excellent AC to RF conversion efficiency translates into a very short payback period. The optional AP1 integrated audio processor is a high quality NRSC audio processor on a plug-in card. Other options include a spare parts kits.

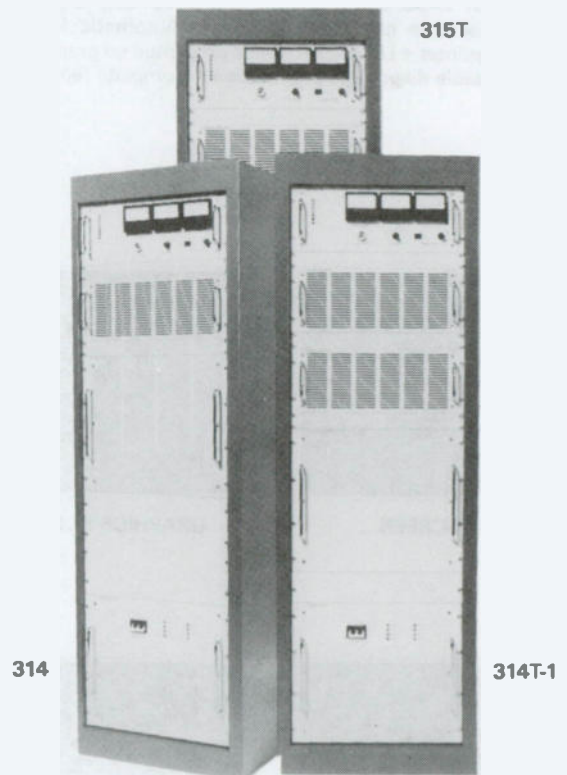

314T 1000W

Electrical

Power Output: 1000W into 50 ohms (1100W max.) • **Frequency Range:** 535kHz-1710kHz • **Exciter:** synthesized across the band in 9kHz or 10kHz steps • **Frequency Stability:** ± 5 ppm (± 8 Hz max.) • **Power Input:** 20VAC $\pm 15\%$ single phase, 50/60Hz • **Overall Efficiency:** $> 65\%$ • **Modulation:** up to 125% positive peak • **Carrier Shift:** $< 2\%$ at 1kW, 95% modulation • **Frequency Response:** ± 0.5 dB, 20Hz-10kHz • **Audio Distortion:** $< 2\%$ 20Hz-10kHz (Bessel filter out) • **Spurious and Harmonic Energy:** meets FCC spec through factory set filters • **Remote Control:** transmitter on/off, power cutback, metering • **RF Output:** unbalanced type N • **Power Cutback:** 5 field-selectable settings

Other Specifications

• **Temperature:** 0°C-50°C, derate 2°C per 300m (1000') • **Altitude:** 10,000' • **Dimensions:** 68.5"H x 22.4"W x 29.0"D • **Cooling:** low velocity air • **Weight:** 325 lbs.

314T-1 2500W

Same as 314T except: • **Power Output:** 2500W into 50 ohms (2750W max.) • **Carrier Shift:** $< 2\%$ at 2.5kW, 95% modulation • **Frequency Response:** +0.3dB, -1.5dB, 20Hz-10kHz • **RF Output:** unbalanced, 50 ohm coax cable output • **Weight:** 425 lbs.

315T 5000W

Same as 314T except: • **Power Output:** 5000W into 50 ohms (5500W max.) • **Power Input:** 220VAC $\pm 15\%$, 50/60Hz, 3-phase (single-phase optional) • **Overall Efficiency:** 75% • **Carrier Shift:** $< 2\%$ at 5kW, 95% modulation • **RF Output:** unbalanced, 50 ohm coax cable output • **Height:** 77.2" • **Weight:** 750 lbs.

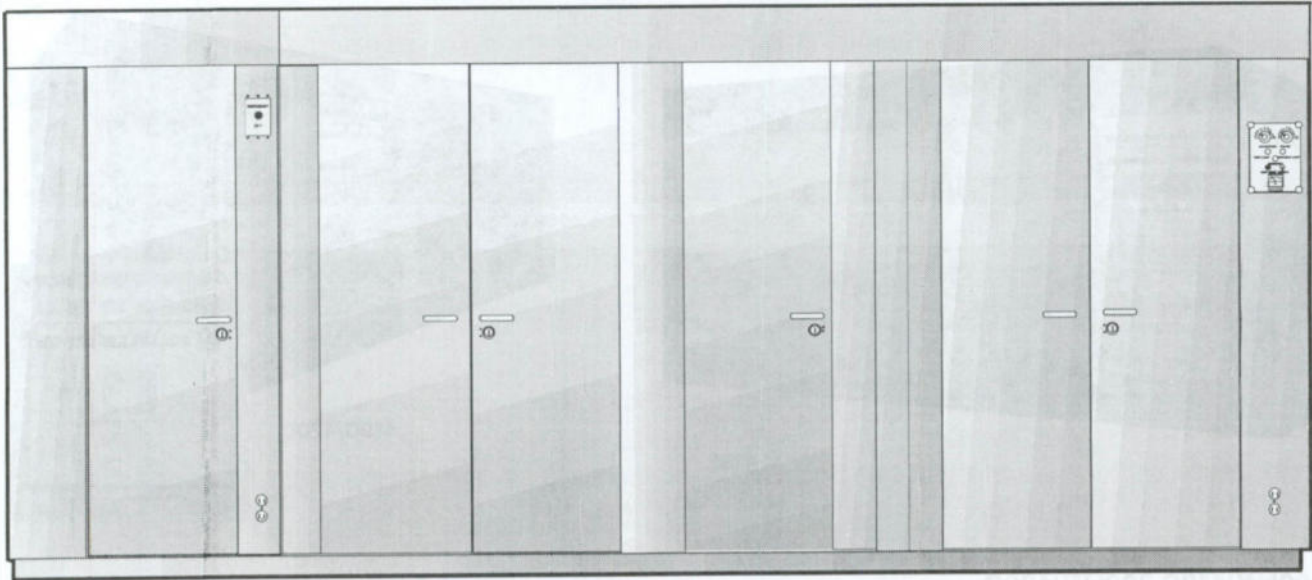

100-1000kW Mediumwave Broadcast Transmitters

The international marketplace requires much more power, creating a demand for higher power mediumwave broadcast transmitters. These transmitters range in power from 100kW to 1000kW carrier power output. Higher power levels can be achieved with the use of combiners for transmitter power outputs to 2000kW. Continental has designed and built many high power mediumwave facilities throughout the world.

The Continental mediumwave transmitters are all of the same general physical configuration and utilize a highly efficient patented solid-state modulator. Overall transmitter efficiencies typically range from a minimum of 78% to over 82% for the higher power levels. Input power requirements range from 360V/480V, 3-phase for the 100kW to 11,000V, 3-phase for the higher power transmitters.

All of the mediumwave transmitters contain circuitry to provide controlled carrier level modulation or CCM. This energy saving feature reduces the carrier level to a preset level when there are pauses in the modulation.

Since most broadcasting facilities have their own unique layout and design, all Continental high power mediumwave transmitters are customized to the customer's specific requirements.

With the exception of electrical supply voltages and system efficiencies, all of the Continental high power transmitters exhibit the same typical performance characteristics.

Specifications

Frequency Range:	525 to 1620kHz
Frequency Stability:	± 1Hz/day
RF Output	
Impedance:	50 ohms unbalanced or other customer specified impedance
Spurious Radiation:	< 50mW
Type of Emission:	Amplitude modulation
Carrier Shift:	± 3% maximum
Modulation System:	High level anode modulation using solid-state modulator
Audio Frequency	
Response:	100 to 5000Hz, ± 0.5dB; 50 to 8000Hz, + 0.5/-1.5dB
Audio Frequency	
Harmonic Distortion:	50 to 8000Hz, 3% maximum

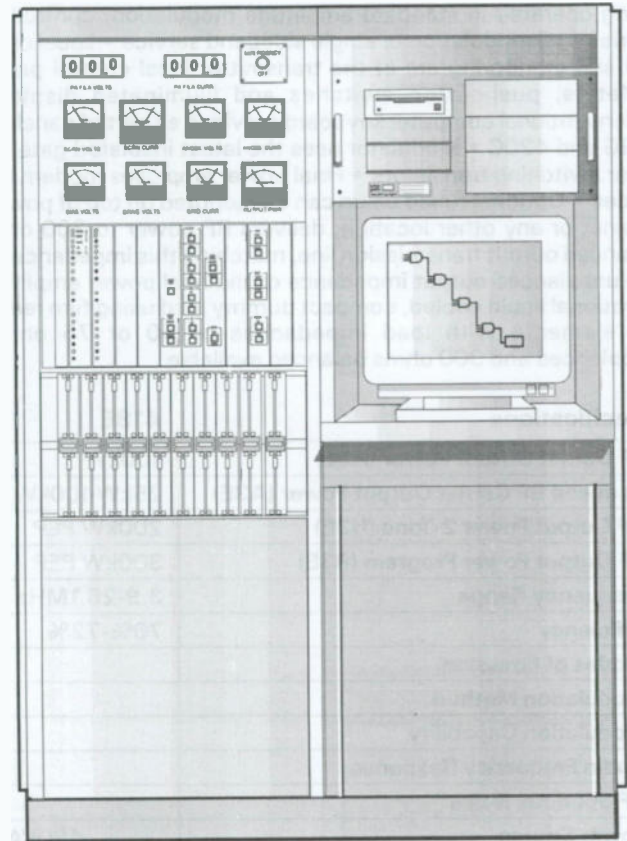

Unweighted Noise Level:	At least 55dB below 100% modulation in a bandwidth of 10Hz to 10kHz
Audio Input Impedance:	600 ohm balanced, or balanced bridging

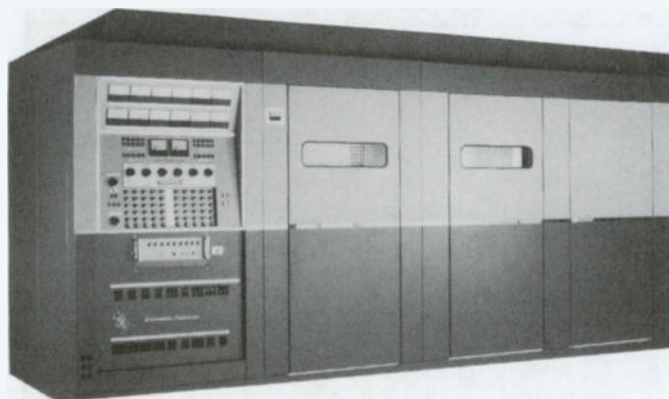

418E

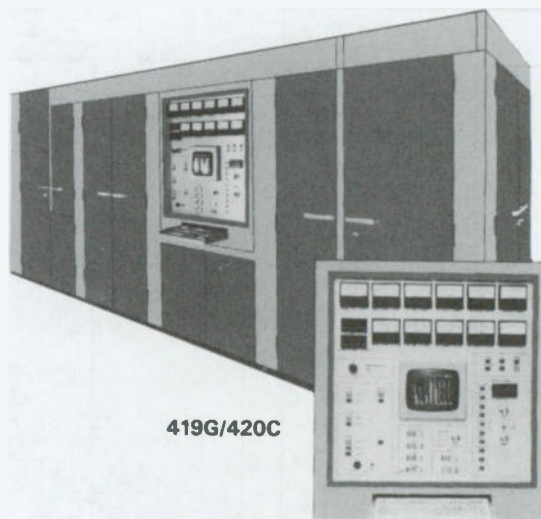

419G/420C

**418E 100kW/419G 300kW/420C
500kW Shortwave Broadcast
Transmitters**

- Versatile • State-of-the-art • High efficiency • Capable of being operated in standard amplitude modulation, controlled carrier level modulation or single sideband service • Local control and monitoring are at the transmitter local control panel
- Meters, pushbutton switches and illuminated displays
- Conventional computer keyboard provided as part of panel on 419G and 420C • Modulator uses the latest insulated gate bipolar switching transistors • Final power amp uses modern tetrodes • Optional tuned balun can be mounted on top of power cabinet or any other location; delivers RF power to 300 ohm balanced output transmission line, matching this impedance to the unbalanced output impedance of the final power amplifier
- Optional liquid cooled, compact dummy load using film resistor elements with load impedances of 50 or 75 ohms unbalanced and 300 ohms balanced available

The 419G and 420C are essentially the same transmitter. The principal differences are in the type of final output tube, rating of some vacuum capacitors, power rating of the high voltage transformers and input power switch gear. From a central master control panel or from a remote computer control and monitoring station, either of these transmitters may be set up and either pretuned or automatically tuned to deliver full carrier power at any frequency between 3.9MHz and 26.1MHz. They may be manually tuned using controls and indicators located on the central master control panel.

All critical major components of the RF amplifier such as vacuum tubes and vacuum capacitors are either water or water-vapor cooled. Dual loop liquid cooling systems can be provided when required by freezing conditions.

Both transmitters include all required switchgear, power supplies, protective circuits, amplifiers, controls, as well as cooling and peripheral equipment.

Specifications

	418E	419G	420C
RF Carrier Output Power (A3E)	100kW	300kW	500kW
Reduced RF Carrier Output Power (A3E)	25kW-100kW	30kW-300kW	50kW-500kW
RF Output Power 2-Tone (H3E)	200kW PEP	600kW PEP	1000kW PEP
RF Output Power Program (R3E)	300kW PEP	800kW PEP	1500kW PEP
Frequency Range	3.9-26.1MHz	3.9-26.1MHz	3.9-26.1MHz
Efficiency	70%-72%	71%-73%	71%-73%
Modes of Emission	A3E and R3E		
Modulation Method	High level solid-state step modulator		
Modulation Capability	70% continuous, 100% up to 10 minutes		
Audio Frequency Response	± 1dB 50Hz-10,000Hz		
RF Spurious Noise	< 50mW, complies with CCIR 328-5		
Power Source	480VAC, 4160VAC or 11,000VAC standard — other voltages on request		
Ambient Temperature	+ 5°C to + 45°C indoors, -10°C to + 45°C outdoors		
Altitude	2000M AMSL		
Relative Humidity	0%-95%		
Cooling	Air, water, water vapor		

SSM Series High Efficiency Solid-State Modulators
For 100kW, 300kW, 500kW, 600kW, 1000kW Broadcast Transmitters

- Serve as both the RF amplifier anode power supply and the high level audio power source
- Audio quality sets new standards of performance for high power broadcasting
- Installation flexibility
- Ease of maintenance
- Cooling system simplicity
- Along with the conventional AM (A3E) mode of operation, the modulators also provide operation in the Controlled Carrier-Level Modulation (CCM) mode and the H3E and R3E Single Sideband (SSB) modes
- Provide high level anode modulation of the associated RF amplifier

The modulator consists of 48 series connected modules which are switched on or off to provide the high voltage DC and the superimposed high level audio voltage. The switching is accomplished with Insulated Gate Bipolar Transistors (IGBT), and takes place at frequencies significantly higher than the highest audio modulation frequencies. A low pass filter follows the series connected modules, which removes the switching signals and allows the DC and audio signals to pass to the RF amplifier. Because each of the modules is either in full conduction with very low loss or turned off, again with very low loss, the overall modulator efficiency is in excess of 97%.

Control of each module is accomplished from an assembly of printed circuit cards that are contained in a control module located within the RF amplifier cabinet. Interconnection between the control module and each of the 48 series connected modules is through fiber optic cables that ensure positive control while totally eliminating the possibility of conducted RF interference. Patented circuits using simple discrete logic are employed to ensure that each module contributes equally to the overall output, and in the unlikely event of a module failure, to effectively remove the module from contributing to the overall output voltage.

Each of the modulators is capable of producing a maximum of 16,000VDC average for the carrier condition, and 32,000V peak at the positive crest of the modulating signal. Each IGBT has a collector-emitter rating of 1200VDC, which gives an ample safety factor for the 700VDC each module can produce. The actual voltage for each module is somewhat less than 700VDC and is dependent on the desired anode voltage desired for the particular RF amplifier tube. Normally this unmodulated voltage is in range of 14kV to 15kV.

The current rating of the IGBT switch elements is considerably higher than necessary for the peak current demands. 50A devices are used for the 100kW modulator, 150A devices for the 500/600kW modulator, and 300A devices for the 1000kW modulator.

Controlled Carrier-Level Modulation

Controlled carrier-level modulation (CCM), a standard feature of the solid-state modulator, maintains the carrier at a sufficient level to be 100% modulated by the incoming audio. In operation, the input audio level is set so that 100% modulation is achieved on program peaks with the transmitter carrier output at the full level. With this audio level setting and CCM systems enabled, the carrier level will fall to a preset level in the absence of modulation, and rise to a level compatible with the instantaneous peak level of the program audio. The level to which the carrier will be reduced is adjustable at the front panel of the transmitter in 1dB steps from 0-6dB.

Activation or deactivation of CCM is also selectable at the transmitter front panel by a single switch, and may be accomplished at any time without interruption of programming. Continental Electronics Corporation can also provide the Dynamic Radiation Compression System, advocated by the British Broadcasting Corporation (BBC). This BBC form of CCM is essentially the inverse of the system described above, in that full carrier is provided when no modulation is present, and the carrier level reduced as the modulating signal level is increased. The primary reason to employ CCM is to effect an input power saving, and this should be accomplished without reducing listener satisfaction. Our tests and reports indicate that the use of the CCM is virtually undetectable to the audience. In practice, actual power saving over non-CCM usage is highly affected by program content, with talk programs giving more power saving than most music programming. Power consumption tests using processed music programming and a transmitter with 70% efficiency consistently produced an 18% power saving when CCM with a 6dB carrier level drop was used; talk programs produced power savings in excess of 22%.

Single Sideband

The SSB modes of H3E and R3E are available as an optional feature when the solid-state modulator is used with the CEC supplied frequency synthesizer. The SSB system is the Envelope Elimination and Restoration technique which employs phase modulation of the frequency synthesizer in conjunction with amplitude modulation of the RF amplifier with an analog of the SSB

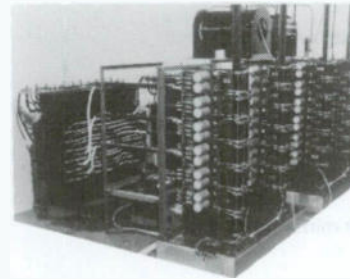
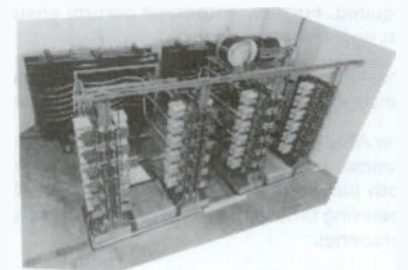
100kW Modulator

**300kW/500kW/600kW
Solid-State Modulator**

signal. With this system, the high efficiency of the Class C RF amplifier is retained and tuning of the RF amplifier is the same for both AM and SSB. In the SSB modes, all CCIR recommendations are met or exceeded.

Power Supply

Each of the modulator power transformers have primary taps for extended delta connections so the phase relationship of each transformer winding is shifted $\pm 15^\circ$ from the power line phase. With this arrangement, 1 transformer is connected for $+15^\circ$ shift, and the other transformer shifted -15° . (In the 1000kW modulator, 2 transformers are at $+15^\circ$ and 2 are at -15° .) This phase shifting produces the effect of 12-pulse rectification and greatly improves power line utilization. An additional benefit is that rectification harmonics conducted back to the power source are attenuated significantly below that which would be produced by the conventional 6-pulse rectification. Power transformers can be provided to operate from any of the normal 3-phase line voltages, for either 50Hz or 60Hz operation, and are sized for the required transmitter power output.

Specifications

Maximum Peak-to-Peak Output Voltage: 32kV • **Maximum Average Output Current, Carrier Condition:** SSM 100—8.5ADC, SSM 300—25.0ADC, SSM 500/600—50.0ADC, SSM 1000—83.5ADC • **Maximum Peak Output Current, Modulation Crest:** SSM 100—17A, SSM 300—50A, SSM 500/600—100A, SSM 1000—167A • **Audio Response (A3E)*:** ± 1 dB 50Hz-7500Hz • **Audio Response (H3E/R3E)*:** ± 1 dB 100Hz-4500Hz • **Audio Harmonic* Distortion (A3E):** < 3% at 90% modulation at full power output 50Hz-7500Hz • **Intermodulation Distortion* (H3E/R3E):** At least -35dB relative to either tone of a 2-tone test signal at full PEP output • **Carrier Reduction (H3E/R3E)*:** -6dB to -24dB relative to 2 audio tone PEP output, adjustable in 3dB steps • **Noise (A3E)*:** -56dB referenced to 100% modulation with a 1000Hz tone, 10Hz-10kHz bandwidth • **Audio Input Requirement:** Adjustable from -8dBm to +10dBm for full output • **Audio Input Impedance:** 600 ohm or 10,000 ohm, balanced • **Power Source:** 3-phase, 50/60Hz, SSM 100kW—360V-480V, SSM 300kW/500kW/600kW/1000kW—4160V or 11,000V. Other voltages may be accommodated on special order. Total power input requirements dependent on associated RF amplifier • **Ambient Temperature:** $+5^\circ\text{C}$ to $+45^\circ\text{C}$, $+55^\circ\text{C}$ on special order • **Altitude:** Up to 2000 meters above sea level. Higher altitudes may be accommodated on special order • **Relative Humidity:** 0%-95% non-condensing • **Cooling:** air cooled, air ducting or liquid cooling may be accommodated if desired

* Characteristics of modulator in conjunction with appropriate RF amplifier.

APS-3A/APS-3MI Control Panels

- UL listed (CSA optional)
- Microprocessor control for simplicity and reliability
- Variety of sensors available
- Multiple sensor capability
- Adjustable heater hold-on time ensures complete snow/ice melting
- Status indicators
- Manual heater cycle capability
- 30A contactor rating
- Optimized for constant wattage or mineral insulated heaters
- Fail-safe capability

When used with sensors of the appropriate type and number, the APS-3A and APS-3MI control panels automatically control snow/ice melting heaters. This minimizes power costs since heaters operate only when required. Further, automatic control ensures reliable ice melting without operator attention.

The APS-3A and APS-3MI operate in conjunction with up to 8 standard sensors including the CIT-1 and CIT-2 sensors.

The APS-3MI keeps mineral insulated heater insulation dry during the summer months by operating heaters for 15 minutes every 40 hours. Both panels offer a user enabled fail-safe feature. This limits heater operating time in the event of a sensor failure or tampering by operating personnel.

The calibrated hold-on timer continues heater operation after snow stops to complete snow melting. An off position defeats the timer function in gutter ice melting and rain detection applications. The timer adjustment range of up to 5 hours ensures snow melting completion. Pushing the heater cycle switch operates heaters for the hold-on time setting in the absence of snow or ice. Status indicators display the presence of power, icing conditions and relay operation.

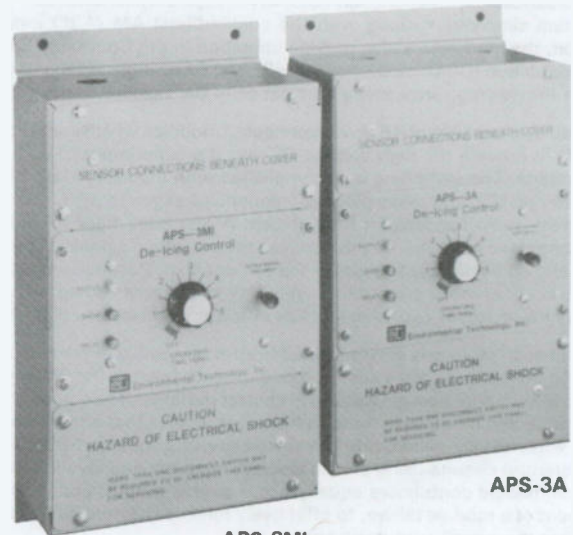

APS-3MI

APS-3A

Sensors operate from low voltage supplied by the control panel. Depending upon the extension wire size, sensors can be located up to 2000' away from the control panel.

Control panels operate from 120V, 50/60Hz power. The NEMA 1 panel enclosure requires a location protected from rain and snow. The internal contactor controls loads up to 30A at 240V. The operating temperature range is -40°F to 140°F. The storage temperature range is -50°F to 180°F. The humidity range is 0%-100%.

CIT-1TV/CIT-2TV Ice Sensors

- No ice accumulation required for heater operation
- Optional lock-out to prevent energy waste at low temperatures
- Adjustable heater hold-on timer completes ice melting after precipitation stops
- Lightning and RFI suppression
- Low cost
- Simple installation

An antenna ice melting control employs either a CIT-1TV or CIT-2TV ice sensor located adjacent to the transmitting antenna. Normally located in the transmitter shelter and within 2000' of the sensor, the APS-3 control panel interfaces the sensor with the heater contactor. Sensors and the control panel employ special filters and circuit design techniques to minimize susceptibility to RFI and lightning damage.

When using the CIT-1TV sensor, heaters operate at temperatures below 38°F during precipitation and for the hold-on timer interval thereafter. The CIT-2TV sensor prevents heater operation at temperatures below 20°F to save electrical energy and to prevent partial ice melting. Heaters operate for the hold-on time as the temperature increases through 20°F if precipitation occurred during lock-out.

The APS-3 control panel interfaces the sensor with the power control contactor. In addition to supplying 24VAC for sensor operation, it provides status indicators, an adjustable heater hold-on timer and a bypass switch.

Applications

- Automatic control of transmitting antenna ice melting heaters: UHF television, VHF television, FM broadcast

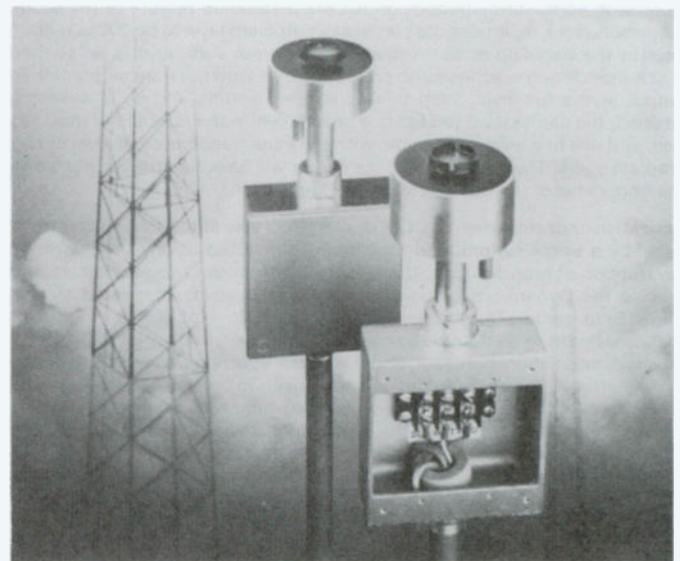

CIT-1TV/CIT-2TV

	CIT-1TV	CIT-2TV
Operating Temp. Setting	38°F ± 1°F	38°F ± 1°F
Lock-out Temp. Setting		20°F ± 2°F
Operating Temp. Range	-40°F to 140°F	-40°F to 140°F
Storage Temp. Range	-50°F to 180°F	-50°F to 180°F

IP Series Transient Voltage Suppression Hardwire Panel Protector Units

- Protect against lightning induced transients
- Reduce equipment downtime
- Extend equipment service life
- Reduce computer logic loss and data errors
- Reduce heat, vibration and carbon buildup in motors
- Reduce breakdown of motor insulation
- Improve overall efficiency of electrical system

IP Series High Energy Protector panel units protect AC service panels up to 2000A. IP panel units are a passive parallel installation and mount directly to the service panel. Hardwire panel units will protect all the equipment supplied by the panel from harmful surges and spikes. The Protector's advanced engineered design combines technologies from both electronic and chemical science. A multi-staged solid-state suppression network is encapsulated in a solid chemical compound with high energy dissipation properties. This complex compound is electronically bridged to the suppression network. Any overvoltage entering the panel is sensed by electronic triggers which cause the unit to drop its resistance. This provides the damaging overvoltage a path of least resistance into the Protector, where it is absorbed and dissipated internally by the chemical compound through a thermal conversion process. By absorbing and dissipating transient induced heat away from the electronic network components, the Protector achieves an unmatched performance and service life, even when subjected to constant transient activity. IP Series Protectors are recommended for electrical service entrance panels up to 2000A, branch circuit panels between 600 and 2000A, and broadcast transmitter and facility service panels.

Specifications

Peak Current Surge:	130,000 to 320,000A
Response Time:	< 1 ns
Response Clamping Voltage:	135VRMS (IP1S)
Clamping Voltage Drift:	None
Deterioration:	None (5000 impulses IEEE Category B Biwave C62.41)
Protection Modes:	All modes—normal and common
Input Power Frequency:	0-4000Hz
Operating Temp. Range:	-40°F to +185°F
Storage Temp. Range:	-60°F to +200°F
Operating Relative Humidity Range:	0-100%
Operating Altitude:	Unlimited
Deionization Time:	None
Operational Indicator Lamp:	Neon replaceable type K1A5
High Energy Dissipation Chemical:	Proprietary solid-state non-toxic
Circuit Design:	Thermal stress reducing, parallel design
Electronic Suppression Network:	Multi-stage hybrid electronic
Safety Features:	UL approved Nema 12 enclosure; Industrial #10 THNN wire; Suppression network totally encapsulated; Green safety ground wire; Test standards met: ANSI/IEEE C62.41, formerly IEEE 587-1980, category A and B, biwave, UL 1449; UL 1449 listed E75634—CSA listed
Life Expectancy:	In excess of 100 years
Warranty:	10 years



IP Series

IP-1S	For 120/240V—single-phase, 3-wire; clamping voltage: 135VRMS; energy dissipation: 3120 joules; peak surge current: 240,000A; frequency attenuation: -3dB to -32dB (CMNR); -4 to -37dB (NMNR); frequency range: 500kHz to 30MHz (CMNR), 300kHz to 30MHz (NMNR)
IP-3D	For 120/240V—3-phase delta system—4-wire; clamping voltage: 135VRMS (120 leg); 255VRMS (240 leg); energy dissipation: 7840 joules; peak surge current: 320,000A
IP-3Y	For 120/208V—3-phase Wye system, 4-wire; clamping voltage: 135VRMS; energy dissipation: 4160 joules; peak surge current: 320,000A; frequency attenuation: -3dB to -32dB (CMNR); -4dB to -37dB (NMNR); frequency range: 500kHz to 30MHz (CMNR), 300kHz to 30MHz (NMNR)
IP-240NN	For 240V—no neutral 3-phase, 3-wire; clamping voltage: 255VRMS; energy dissipation: 8540 joules; peak surge current: 240,000A
IP-480NN	For 480V—no neutral 3-phase, 3-wire; clamping voltage: 510VRMS; energy dissipation: 18,000 joules; peak surge current: 240,000A; frequency attenuation: -3.5dB to -37dB (CMNR); -3dB to -40dB (NMNR); frequency range: 1MHz to 30MHz (CMNR) and (NMNR)
IP-277/480	For 277-480V—3-phase, 4-wire; clamping voltage: 320VRMS, 510VRMS; energy dissipation 3680 joules; peak surge current: 240,000A; frequency attenuation: -3dB to 35dB (CMNR) and (NMNR); frequency range: 1MHz to 30MHz (CMNR) and (NMNR)
IP-1SA	For 120V—single-phase, 2-wire; clamping voltage: 135VRMS; energy dissipation: 2080 joules; peak surge current: 160,000A

SE Series Voltage Suppressors

Utilizes an in-line Series Control Element to intercept and control incoming surges. Single and split phase models available 30A to 300A per phase and 3-phase models 30A to 4000A per phase. SE Series provides common mode (L-G), normal mode (L-N, L-L) protection and up to 40dB of EMI/RFI noise attenuation.

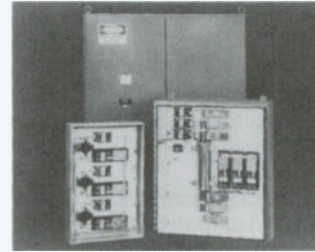

Panel Rating (Amps)	30	60	100	150	200	300	400	600	1000	1500	2000	3000	4000
Model Number by Voltage and Number of Poles -1,-2,-3													
SE-120-()-1	X	X	X	X	X	X							
SE-120/240-()-2	X	X	X	X	X	X							
SE-208-()-1 or 2	X	X	X	X	X	X							
SE-220-()-1 or 2	X	X	X	X	X	X							
SE-230 to 250-()-1 or 2	X	X	X	X	X	X							
SE-120/208-()-3Y	X	X	X	X	X	X	X	X	X		X	X	X
SE-220/380-()-3Y	X	X	X	X	X	X	X	X	X	X	X	X	
SE-240/415-()-3Y	X	X	X	X	X	X	X	X					
SE-277/480-()-3Y	X	X	X	X	X	X	X	X	X	X	X	X	X
SE-347/600-()-3Y	X	X	X	X	X	X	X	X					
SE-220-()-3D	X	X	X	X	X	X	X	X					
SE-230-()-3D	X	X	X	X	X	X	X	X	X	X	X	X	X
SE-240-()-3D	X	X	X	X	X	X	X	X					
SE-380-()-3D	X	X	X	X	X	X	X	X					
SE-480-()-3D	X	X	X	X	X	X	X	X	X	X	X	X	
SE-600-()-3D	X	X	X	X	X	X	X	X					

NOTES: 1. Select 1 of the Panel Amps and insert in the Model Number. Formula example: SE-120/208-300-3Y.
 2. UL listed models are available in other voltage ranges and panel amp sizes.
 Please verify the voltage configuration before ordering a Wye or Delta suppressor.

Options	Availability	Specify ¹
Redundant Status Indicators	Standard	N/A
Status Alarm Monitor	Option	SAM
Surge Counter ²	Option	SCO
Audible Alarm ²	Option	AAO
Remote Status Monitor ²	Option	RSM
1 N.O.-1 N.C. Dry Contact	Option	DCO

1. Add as suffix to model number. 2. Status Alarm Monitor (SAM) required.

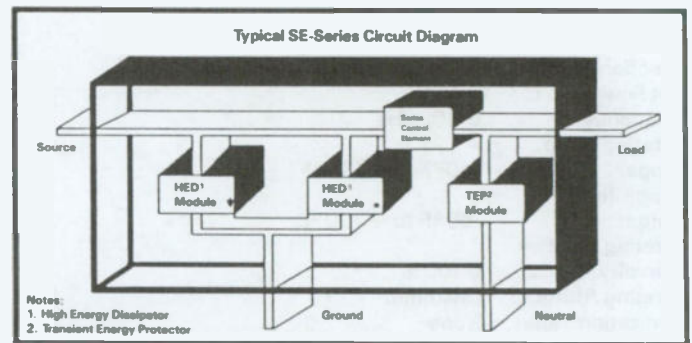

SE-SERIES SPECIFICATION TRANSIENT VOLTAGE SURGE SUPPRESSION

- All units are UL listed and tested to UL 1449 and ANSI/IEEE C62.41 and C62.45
- Maximum Surge Current per Phase (8 x 200µs)
 - 30A thru 600A Ratings 75,000A/Phase
 - 800A thru 4000A Ratings 125,000A/Phase
- Maximum EMI/RFI NOISE ATTENUATION 20kHz-400MHz¹ Up to 40dB
- Guaranteed to survive 1000 Sequential Category C Bi-wave Impulses
- Warranty 5 Years

¹ MIL-STD 220A ohm insertion loss test method.



ALTRONIC RESEARCH INC.

RF COAXIAL LOAD RESISTORS

OMEGALINE RF COAXIAL LOAD RESISTORS

5700 Series

• Low cost • Lightweight • RF power is dissipated in a proven, ceramic rugged film-type cylindrical resistor • Resistors can easily be replaced • No field adjustments needed • Non-contaminating water circuit • Ordinary tap or distilled water in open or closed systems • Rugged, brass and aluminum construction • Bright nickel plate finish • Any operating position

The 5700 Series consists of direct water-cooled terminations for 50 ohm coaxial transmission line systems. Transmitters, microwave components, power tube manufacturers and transmitting stations can be assured of ideal dummy load conditions during designing, testing, adjusting and aligning of transmitters or components.

- 5705N 5kW, Series N-Female Connector
- 5705SC 5kW, Series SC-Female Connector
- 5705LC 5kW, Series LC-Female Connector
- 5705HN 5kW, Series HN-Female Connector
- 5705E1 5kW, 1 1/8" EIA Flange
- 5705E3 5kW, 3 1/8" EIA Flange
- 5715E1 15kW, 1 1/8" EIA Flange
- 5715F1 15kW, 1 1/8" Unflanged/Flush
- 5715R1 15kW, 1 1/8" Unflanged/Recess
- 5715E3 15kW, 3 1/8" EIA Flange
- 5715F3 15kW, 3 1/8" Unflanged/Flush
- 5715R3 15kW, 3 1/8" Unflanged/Recess
- 9725E3 (9725E3) 25kW, 3 1/8" EIA Flange
- 9725F3 (9725F3) 25kW, 3 1/8" Unflanged/Flush
- 9725R3 (9725R3) 25kW, 3 1/8" Unflanged/Recess
- 9725E6 (9725E6) 25kW, 6 1/8" EIA Flange
- 9750E3 (9750E3) 50kW, 3 1/8" EIA Flange
- 9750F3 (9750F3) 50kW, 3 1/8" Unflanged/Flush
- 9750R3 (9750R3) 50kW, 3 1/8" Unflanged/Recess
- 9750E6 (9750E6) 50kW, 6 1/8" EIA Flange
- 9750R6 (9750R6) 50kW, 6 1/8" Unflanged/Recess
- 5780BE3 80kW, 3 1/8" EIA Flange (1 Resistor)
- 5780BR3 80kW, 3 1/8" Unflanged/Recess (1 Resistor)
- 5780BE6 80kW, 6 1/8" EIA Flange (1 Resistor)
- 5780BR6 80kW, 6 1/8" Unflanged/Recess (1 Resistor)
- 57100BE3 100kW, 3 1/8" EIA Flange (1 Resistor)
- 57100BR3 100kW, 3 1/8" Unflanged/Recess (1 Resistor)
- 57100BE6 100kW, 6 1/8" EIA Flange (1 Resistor)
- 57125BE3 (822BE3) 125kW, 3 1/8" EIA Flange (1 Resistor)
- 57125BR3 (822BR3) 125kW, 3 1/8" Unflanged/Recess (1 Resistor)
- 57125BE6 (822BE6) 125kW, 6 1/8" EIA Flange (1 Resistor)
- 57200BE6 (219BE6) 200kW, 6 1/8" EIA Flange (1 Resistor)
- 57200BR6 (219BR6) 200kW, 6 1/8" Unflanged/Recess (1 Resistor)
- 57300BE9 300kW, 9 3/16" EIA Flange (1 Resistor)
- 7580BE6 80kW, 6 1/8" EIA Flange — 75 ohm (1 Resistor)
- 157100SB (2103SB) 100kW, Stub Connector — 150 ohm (1 Resistor)
- 157200SB (2150SB) 200kW, Stub Connector — 150 ohm (1 Resistor)

5800 Series

• For use where suitable water is not readily available • Self-contained cooling system/heat exchanger • Quiet • Compact • Portable • Economical • Easy air ducting • Calorimetry available

- 5810E3-115* 10kW, 3 1/8" EIA Flange
- 5810F3-115* 10kW, 3 1/8" Unflanged/Flush
- 5810R3-115* 10kW, 3 1/8" Unflanged/Recess
- 5825E3-115* 25kW, 3 1/8" EIA Flange
- 5825F3-115* 25kW, 3 1/8" Unflanged/Flush
- 5825R3-115* 25kW, 3 1/8" Unflanged/Recess
- 5850E3-230* 50kW, 3 1/8" EIA Flange
- 5850F3-230* 50kW, 3 1/8" Unflanged/Flush
- 5850R3-230* 50kW, 3 1/8" Unflanged/Recess
- 5850E6-230* 50kW, 6 1/8" EIA Flange
- 5850R6-230* 80kW, 6 1/8" EIA Flange

* Indicates voltage, 60Hz single phase.
50Hz operation available (please specify)

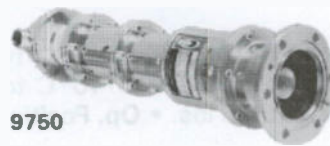

9750



5800



6735

6700 Series Air-Cooled RF Coaxial Load Resistor

• Rugged, precision designed • All components carefully selected for reliability and ease of replacement • Preventive maintenance is limited to annual blower cleaning and lubrication • Easy component replacement • Thermal sensor detects application of RF power and automatically activates air flow system • Exceptionally quiet, pressurized airflow system

The 6700 Series are extraordinary air-cooled terminations for 50 ohm coaxial transmission line systems. Manufacturers of transmitters, microwave components and power tubes as well as transmitting stations can be assured of ideal dummy load conditions during designing, testing, adjusting and aligning of transmitters or components.

- 6705N 5kW, Series N-Female Connector
- 6705SC 5kW, Series SC-Female Connector
- 6705LC 5kW, Series LC-Female Connector
- 6705HN 5kW, Series HN-Female Connector
- 6705E1 5kW, 1 1/8" EIA Flange
- 6710E1 10kW, 1 1/8" EIA Flange
- 6710E3 10kW, 3 1/8" EIA Flange
- 6710F3 10kW, 3 1/8" Unflanged/Flush
- 6710R3 10kW, 3 1/8" Unflanged/Recess
- 6715E1 15kW, 1 1/8" Flange
- 6715E3 15kW, 3 1/8" EIA Flange
- 6715F3 15kW, 3 1/8" Unflanged/Flush
- 6715R3 15kW, 3 1/8" Unflanged/Recess
- 6725E3 25kW, 3 1/8" EIA Flange
- 6725F3 25kW, 3 1/8" Unflanged/Flush
- 6725R3 25kW, 3 1/8" Unflanged/Recess
- 6735E3 35kW, 3 1/8" EIA Flange
- 6735F3 35kW, 3 1/8" Unflanged/Flush
- 6735R3 35kW, 3 1/8" Unflanged/Recess
- 6750E3 50kW, 3 1/8" EIA Flange
- 6750F3 50kW, 3 1/8" Unflanged/Flush
- 6750R3 50kW, 3 1/8" Unflanged/Recess
- 6750E6 50kW, 6 1/8" EIA Flange
- 6750R6 50kW, 6 1/8" Unflanged/Recess

Note: Standby operation is a standard feature on all air cooled models. The above prices apply to loads which are designed for AC requirements of 115VAC/60Hz, operating to 110MHz.

Air cooled dummy loads available up to 1.5MW.

Options

AC power requirements:

230VAC

50Hz

Operation above 110MHz (to channel 13) for:

6705, 6710, 6715

6725, 6735, 6750



RF COAXIAL LOADS

CPTN-1500 Oil Dielectric

• Frequency: DC—1000MHz • VSWR: 1.15 max., 1.1 typical • Power: 1500W continuous, 2000W intermittent • Ambient: -40°C to +45°C • Input: Std. LC, available N, 7/8, 1 5/8 • Weight: 35 lbs. • Op. Position: Horizontal only

CPTN-3000 2500-3000W Oil Dielectric

• Frequency: DC—1000MHz • VSWR: 1.15 max., 1.1 typical • Power: 2500W continuous, 3000W intermittent • Ambient: -40°C to +45°C • Input: Std. LC, available 7/8, 1 5/8 • Weight: 35 lbs. • Op. Position: Horizontal only

CPTC-5K 5000W Oil Dielectric/Forced Air

• Frequency: DC—1000MHz • VSWR: 1.15 max., 1.1 typical • Power: 5000W max. • Ambient: -40°C to +45°C • Input: Std. LC, available 7/8, 1 5/8 • Weight: 57 lbs. • Op. Position: Horizontal only • AC Power: 115VAC, 60Hz (220VAC/50Hz available as option)

DACT 5KFM/DACT 7.5 KFM Dry, Convection Cooled

• Frequency: DC—110MHz • VSWR: 1.1:1 max. • Power: 5000W continuous, 7500W intermittent (7500W continuous average power limited to 30 minutes on, 30 minutes off) • Ambient: -40°C to +52°C • Input: Std. 1 5/8, available 3 1/8 • Weight: 65 lbs. • Op. Position: Upright only • Overtemp interlock available

DACT-14 Dry, Convection Cooled

• Frequency: DC—30MHz • VSWR: 1.15:1 max. • Power: 10,000W continuous, 12,000W intermittent • Ambient: -40°C to +52°C • Input: Std. 1 5/8 • Weight: 65 lbs. • Op. Position: Upright only • Outdoor version DACT-14A available

DACT-153/DPTU-153 Dry, Convection Cooled, No Line Power Needed

• Frequency: (AM) DC—1750kHz (DPTU-153), DC—30MHz (DACT-153) • VSWR: 1.1:1 max. • Power: 15kW continuous • Ambient: -40°C to +52°C • Input: Std. 1 5/8, available 3 1/8 • Weight: 90 lbs. • Op. Position: Upright • Interlock: Thermostat included • Ideal for 10kW AM transmitter

DPTC-50KFM 55kW Dry, Forced Air Cooled

• Frequency: DC—110MHz • VSWR: 1.15:1 • Power: 55kW continuous • Ambient: -40°C to +45°C • Input: 3 1/8 std. • Weight: 143 lbs. • Op. Position: Upright • Air Flow: 1600 CFM interlocked for line power, air flow and over-temperature • AC Power: 220VAC, 7A, 60Hz (50Hz available as option), Reject Load option available

CPTC-50K 50kW Calorimeter Version CPM-50,000 Water Load With Integral Heat Exchanger

• Frequency/VSWR: DC—1GHz 1.1:1, 1.05:1 available • Power: 50kW continuous • Ambient: 0°C to +35°C • Input: 3 1/8 EIA • Weight: 500 lbs. • Air Flow: 4500 CFM • Op. Position: Upright • AC Power: 220VAC, 15A, 60Hz, 3Ø (50Hz available as option) • Fully Interlocked: Load resistor is field replaceable

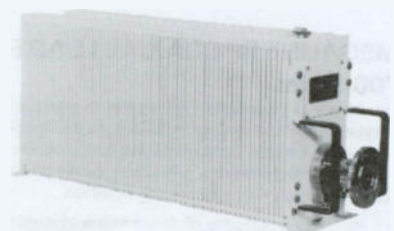

CPTN-3000

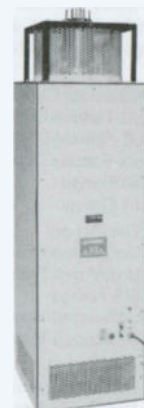

DPTC-50KFM



DACT-14

RF COAXIAL LOADS

Model	Avg. Power (Watts)
CPTN-500	500/750
CPTN-1000	1000
CPTN-1500	1500/2000
CPTN-1500, 1 5/8	1500/2000
CPTN-3000	2500/3000
CPTN-3000, 1 5/8	2500/3000
CPTC-5K	5000
CPTC-5K, 1 5/8	5000
DACT-5KFM	5000/7500
DACT-7.5KFM	7500
** DACT-14	10,000/12,000
+ + DPTC-10KFM	10,000/12,000
** DPTU-153	15,000
** DACT-153	15,000
*** CPTC-15K	15,000
+ + DPTC-25KFM	25,000
** DACT-253	30,000
*** CPTC-25K	Use CPTC-30K
*** CPTC-30K	30,000
** DPTU-50K	Use DPTC-50KFM
** DPTC-50KFM	55,000
*** CPTC-50K	50,000
DPTC-65KFM	Use DPTC-75KFM
DPTC-75KFM	75,000
*** CPTC-80K	80,000
** DPTU-75K	80,000

Larger Loads Available

- † Also accepts changeable connectors by other manufacturers.
- ** Voltage divider type power meter optional
- *** Detail Frequency/VSWR specs of loads may change slightly.
- + + Reject Load Option (Controls Fan) Field Kit Unflanged Connectors

HELIAX[®] Coaxial Cables

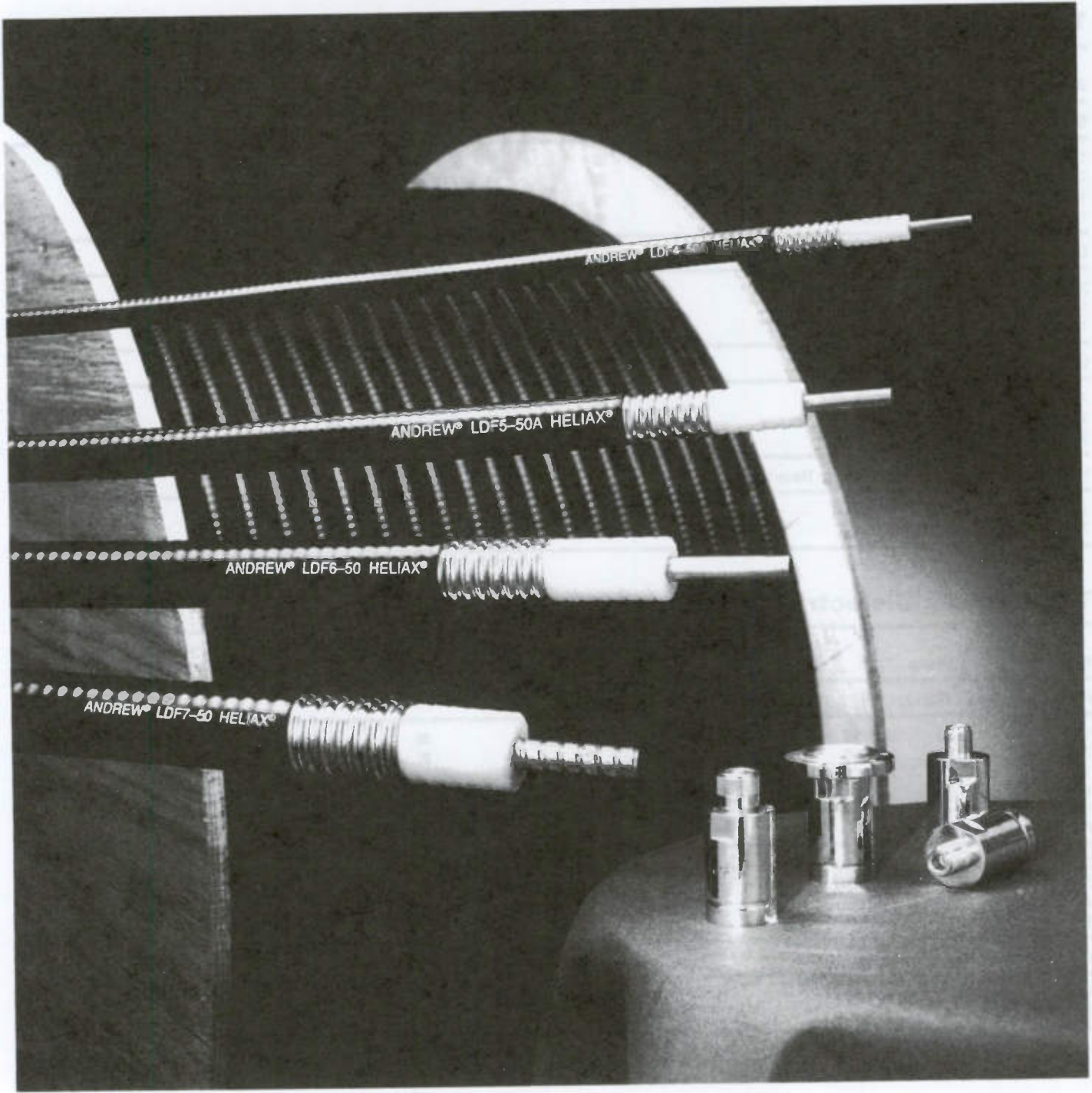



Cable Selection by Optional Features

Tables A and B list the standard versions of HELIAX® coaxial cable and the optional features.

Table A - Foam-Dielectric Cables

Size	Ohms	Type	Fire-Retardant, Non-Halogenated Jacket	Low VSWR	Cellular Band	Phase Stabilized/ Phase Measured	MIL C-28830
Superflexible Series							
1/4"	50	FSJ1-50A	■	■		■	
1/4"	75	FSJ1-75	■				
1/2"	50	FSJ4-50B	■	■	■	■	
1/2"	75	FSJ4-75A	■				
LDF Series - 1/2" and Smaller							
3/8"	50	LDF2-50	■	■		■	
1/2"	50	LDF4-50A	■	■	■	■	■
1/2"	75	LDF4-75A	■				
LDF Series - 7/8" and Larger							
7/8"	50	LDF5-50A	■	■	■	■	■
1-1/4"	50	LDF6-50	■	■	■		
1-5/8"	50	LDF7-50A	■	■	■		■
High Temperature Series - Plenum Rated							
1/2"	50	FT4-50					
7/8"	50	FT5-50					

Table B - Air-Dielectric Cables

Size	Ohms	Type	Fire-Retardant, Non-Halogenated Jacket	Low VSWR	Cellular Band	Phase Stabilized/ Phase Measured
HJ Series - Small Diameter						
1/2"	50	HJ4-50	■	■		■
7/8"	50	HJ5-50	■	■		■
7/8"	75	HJ5-75	■		■	
1-5/8"	50	HJ7-50A	■	■	■	
HJ Series - Large Diameter						
2-1/4"	50	HJ12-50	■	■	■	
3"	50	HJ8-50B		■	■	
4"	50	HJ11-50		■		
5"	50	HJ9-50		■		
High Temperature Series						
1/2"	50	HT4-50				
7/8"	50	HT5-50				

1/2" and 7/8" Flexwell Low Loss Foam FLC

Cablewave Systems Low Loss Foam Flexwell coaxial cables are designed to exhibit lower attenuation than prior foam cables. The proprietary design features a closed cell foam dielectric with low density and high velocity specifications. These cables provide low loss performance characteristics that are almost as low as air dielectric cables but with none of the pressurization requirements associated with air cable. The outer conductor is annularly corrugated for flexibility, crush resistance, and prevention of moisture migration. The cable center conductor is copper clad aluminum for 1/2 inch cable, and copper tube for the 7/8 inch cable size. Cables are supplied with a black polyethylene jacket for improved handling and for use in direct burial applications.

Low Loss Foam Flexwell offers optimum performance for many applications throughout the Land Mobile, Microwave, Broadcast and Radar bands.

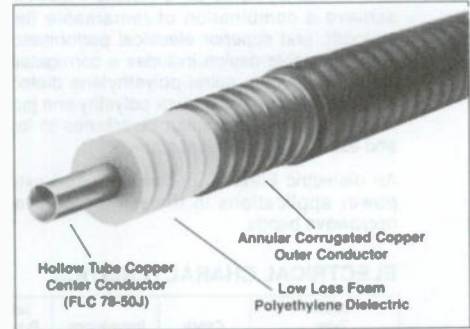

ELECTRICAL CHARACTERISTICS

Cable Type (part no.)	Cable Size	Impedance Ohms	Velocity of Propagation percent	Max. Freq. 90% fco GHz	Attenuation dB/100 ft. (dB/100m)			Average Power, kW @ 40° Ambient		
					30 MHz	400 MHz	1000 MHz	30 MHz	400 MHz	1000 MHz
FLC 12-50J (810918-001) M28830/3B-II FLC 12-50JFR* 810918-007	1/2"	50	88	8.0	0.37 (1.21)	1.40 (4.59)	2.30 (7.54)	5.0	1.3	.80
FLC 78-50J (810921-001) M28830/4B-II FLC 78-50JFR* 810921-007	7/8"	50	88	5.0	0.20 (0.65)	0.80 (2.62)	1.37 (4.49)	10.5	2.8	1.7

75 ohm versions of these cables available upon request

MECHANICAL CHARACTERISTICS

Cable TYPE (part no.)	Center Conductor O.D., in. (mm)	Outer Conductor O.D., in. (mm)	Jacket O.D., in. (mm)	Minimum Bending Radius, in. (mm)	Cable Weight lbs./ft. (kg/m)
FLC 12-50J (810918-001) M28830/3B-II FLC 12-50JFR* 810918-007	.189 (4.80)	.547 (13.9)	.640 (16.30)	5.0 (127.00)	.165 (.251)
FLC 78-50J (810921-001) M28830/4B-II FLC 78-50JFR* 810921-007	.357 (9.07)	.990 (25.14)	1.124 (28.55)	10.0 (254.0)	.40 (.595)

Connectors for 1/2" and 7/8" Low Loss Foam Flexwell

	<table border="1"> <thead> <tr> <th colspan="4">N Male</th> </tr> <tr> <th>Cable</th> <th>Ohms</th> <th>Part No.</th> <th></th> </tr> </thead> <tbody> <tr> <td>1/2"</td> <td>50</td> <td>738802</td> <td></td> </tr> <tr> <td>7/8"</td> <td>50</td> <td>738841</td> <td></td> </tr> </tbody> </table>	N Male				Cable	Ohms	Part No.		1/2"	50	738802		7/8"	50	738841			<table border="1"> <thead> <tr> <th colspan="4">UHF Female</th> </tr> <tr> <th>Cable</th> <th>Ohms</th> <th>Part No.</th> <th></th> </tr> </thead> <tbody> <tr> <td>1/2"</td> <td>50</td> <td>738803</td> <td></td> </tr> <tr> <td>7/8"</td> <td>50</td> <td>738844</td> <td></td> </tr> </tbody> </table>	UHF Female				Cable	Ohms	Part No.		1/2"	50	738803		7/8"	50	738844	
N Male																																			
Cable	Ohms	Part No.																																	
1/2"	50	738802																																	
7/8"	50	738841																																	
UHF Female																																			
Cable	Ohms	Part No.																																	
1/2"	50	738803																																	
7/8"	50	738844																																	
	<table border="1"> <thead> <tr> <th colspan="4">N Female</th> </tr> <tr> <th>Cable</th> <th>Ohms</th> <th>Part No.</th> <th></th> </tr> </thead> <tbody> <tr> <td>1/2"</td> <td>50</td> <td>738801</td> <td></td> </tr> <tr> <td>7/8"</td> <td>50</td> <td>738842</td> <td></td> </tr> </tbody> </table>	N Female				Cable	Ohms	Part No.		1/2"	50	738801		7/8"	50	738842			<table border="1"> <thead> <tr> <th colspan="4">7/8" EIA (GP)</th> </tr> <tr> <th>Cable</th> <th>Ohms</th> <th>Part No.</th> <th></th> </tr> </thead> <tbody> <tr> <td>1/2"</td> <td>50</td> <td>738807</td> <td></td> </tr> <tr> <td>7/8"</td> <td>50</td> <td>738845</td> <td></td> </tr> </tbody> </table>	7/8" EIA (GP)				Cable	Ohms	Part No.		1/2"	50	738807		7/8"	50	738845	
N Female																																			
Cable	Ohms	Part No.																																	
1/2"	50	738801																																	
7/8"	50	738842																																	
7/8" EIA (GP)																																			
Cable	Ohms	Part No.																																	
1/2"	50	738807																																	
7/8"	50	738845																																	
	<table border="1"> <thead> <tr> <th colspan="4">N Male</th> </tr> <tr> <th>Cable</th> <th>Ohms</th> <th>Part No.</th> <th></th> </tr> </thead> <tbody> <tr> <td>1/2"</td> <td>50</td> <td>734736</td> <td>low profile, low VSWR</td> </tr> </tbody> </table>	N Male				Cable	Ohms	Part No.		1/2"	50	734736	low profile, low VSWR	<table border="1"> <thead> <tr> <th colspan="4">IEC 7/16" Male</th> </tr> <tr> <th>Cable</th> <th>Ohms</th> <th>Part No.</th> <th></th> </tr> </thead> <tbody> <tr> <td>7/8"</td> <td>50</td> <td>734737</td> <td></td> </tr> </tbody> </table>		IEC 7/16" Male				Cable	Ohms	Part No.		7/8"	50	734737									
N Male																																			
Cable	Ohms	Part No.																																	
1/2"	50	734736	low profile, low VSWR																																
IEC 7/16" Male																																			
Cable	Ohms	Part No.																																	
7/8"	50	734737																																	
	<table border="1"> <thead> <tr> <th colspan="4">N Female</th> </tr> <tr> <th>Cable</th> <th>Ohms</th> <th>Part No.</th> <th></th> </tr> </thead> <tbody> <tr> <td>1/2"</td> <td>50</td> <td>734747</td> <td>low profile, low VSWR</td> </tr> </tbody> </table>	N Female				Cable	Ohms	Part No.		1/2"	50	734747	low profile, low VSWR	<table border="1"> <thead> <tr> <th colspan="2">7/8" EIA 90° Miter Elbow</th> <th>Part No.</th> </tr> </thead> <tbody> <tr> <td></td> <td></td> <td>920225</td> </tr> </tbody> </table>		7/8" EIA 90° Miter Elbow		Part No.			920225														
N Female																																			
Cable	Ohms	Part No.																																	
1/2"	50	734747	low profile, low VSWR																																
7/8" EIA 90° Miter Elbow		Part No.																																	
		920225																																	
	<table border="1"> <thead> <tr> <th colspan="4">UHF Male</th> </tr> <tr> <th>Cable</th> <th>Ohms</th> <th>Part No.</th> <th></th> </tr> </thead> <tbody> <tr> <td>1/2"</td> <td>50</td> <td>738804</td> <td></td> </tr> <tr> <td>7/8"</td> <td>50</td> <td>738843</td> <td></td> </tr> </tbody> </table>	UHF Male				Cable	Ohms	Part No.		1/2"	50	738804		7/8"	50	738843			<table border="1"> <thead> <tr> <th colspan="4">End Terminal</th> </tr> <tr> <th>Cable</th> <th>Ohms</th> <th>Part No.</th> <th></th> </tr> </thead> <tbody> <tr> <td>1/2"</td> <td>50</td> <td>738805</td> <td></td> </tr> <tr> <td>7/8"</td> <td>50</td> <td>738847</td> <td></td> </tr> </tbody> </table>	End Terminal				Cable	Ohms	Part No.		1/2"	50	738805		7/8"	50	738847	
UHF Male																																			
Cable	Ohms	Part No.																																	
1/2"	50	738804																																	
7/8"	50	738843																																	
End Terminal																																			
Cable	Ohms	Part No.																																	
1/2"	50	738805																																	
7/8"	50	738847																																	
	<table border="1"> <thead> <tr> <th colspan="4">Splice</th> </tr> <tr> <th>Cable</th> <th>Ohms</th> <th>Part No.</th> <th></th> </tr> </thead> <tbody> <tr> <td>1/2"</td> <td>50</td> <td>738806</td> <td></td> </tr> <tr> <td>7/8"</td> <td>50</td> <td>738846</td> <td></td> </tr> </tbody> </table>	Splice				Cable	Ohms	Part No.		1/2"	50	738806		7/8"	50	738846																			
Splice																																			
Cable	Ohms	Part No.																																	
1/2"	50	738806																																	
7/8"	50	738846																																	



1 5/8", 3" and 3 1/2" Air Dielectric Flexwell HCC

Cablewave Systems air dielectric Flexwell coaxial cables achieve a combination of remarkable flexibility, rugged strength, and superior electrical performance. The 1 5/8", 3" and 3 1/2" cable design includes a corrugated tubular copper center conductor, spiral polyethylene dielectric, corrugated outer conductor, and a black polyethylene jacket. The special helix insulator construction contributes to low dielectric loss and excellent mechanical stability.

Air dielectric Flexwell cables are used extensively in high power applications in the HF through lower frequency microwave bands.

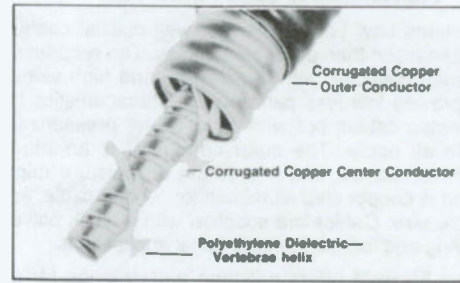

ELECTRICAL CHARACTERISTICS

Cable Type (part no.)	Cable Size	Impedance Ohms	Velocity of Propagation Percent	Max. Freq. 90% fco GHz	Attenuation dB/100 ft. (db/100m)			Average Power kW 40° Ambient		
					30 MHz	400 MHz	1000MHz	30 MHz	400 MHz	1000 MHz
HCC 158-50J (810903-001)	1 5/8"	50	95	2.74	.110 (.36)	.417 (1.36)	.699 (2.29)	29.0	7.8	4.9
HCC 300-50J (810905-001)	3"	50	96	1.63	.075 (.24)	.270 (.89)	.454 (1.43)	70.0	17.0	9.15
HCC 312-50J (810915-001)	3 1/2"	50	96	1.43	.058 (.19)	.229 (.751)	.384 (1.26)	93	25	15

MECHANICAL CHARACTERISTICS

Cable Type (part no.)	Center Conductor O.D., in. (mm)	Outer Conductor O.D., in. (mm)	Jacket O.D., in. (mm)	Minimum Bending Radius, in. (mm)	Cable Weight lbs./ft. (kg/m)
HCC 158-50J (810903-001)	.732 (18.6)	1.830 (46.4)	1.996 (51)	20 (508)	.864 (1.286)
HCC 300-50J (810905-001)	1.150 (29.2)	2.850 (72.3)	2.990 (75.94)	30 (762)	1.423 (2.118)
HCC 312-50J (810915-001)	1.370 (34.8)	3.36 (85.34)	3.502 (88.95)	30 (762)	1.985 (2.954)

Connectors for 1 5/8", 3" and 3 1/2" Air Flexwell

<p>1 5/8" EIA (Gas Pass) Cable Ohms Part No. 1 5/8" 50 738314* (Inner Connector P/N 612874)</p>	<p>7/8" EIA (GP/Low VSWR Tunable) Cable Ohms Part No. 1 5/8" 50 738308</p>	<p>7/8" EIA (GB/Low VSWR Tunable) Cable Ohms Part No. 1 5/8" 50 738310</p>
<p>1 5/8" EIA (Gas Barrier) Cable Ohms Part No. 1 5/8" 50 738303* (Inner Connector P/N 612874)</p>	<p>7/8" EIA Reducer Connectors Connector Cable Ohms Part No. 7/8" EIA (GB) 1 5/8" 50 738304 7/8" EIA (GP) 1 5/8" 50 738311</p>	
<p>3 1/8" EIA (GP) Cable Ohms Part No. 3" 50 738355* 3 1/2" 50 734579*</p>	<p>*Inner connector supplied loose</p> <p>End Terminal Cable Ohms Part No. 1 5/8" 50 738306</p>	
<p>3 1/8" EIA (GB) Cable Ohms Part No. 3" 50 738350* 3 1/2" 50 734578*</p>	<p>Splice Cable Ohms Part No. 1 5/8" 50 738305 3" 50 738352 3 1/2" 50 734574</p>	
<p>3 1/8" EIA Anchor Inner Connector Ohms Part No. 50 622720</p>	<p>LC Female Cable Ohms Part No. 1 5/8" 50 738302</p>	
<p>N Female Cable Ohms Part No. 1 5/8" 50 738301</p>	<p>3 1/8" EIA Anchor Inner Connector 622720 1 5/8" EIA 90° Miter Elbow 920226 3 1/8" EIA 90° Miter Elbow 920227 3 1/8" EIA End Terminal 920254</p>	

Description and Model Numbers — 20' Sections

Size	Impedance Ohms	20 Foot section, flanges both ends		20 Foot section, flange one end		20 Foot section, no flanges	
		Model No.	Part No.	Model No.	Part No.	Model No.	Part No.
7/8"	50	1-78-50	920213	2-78-50	920217	3-78-50	920221
1 1/8"	50	1-158-50	920214	2-158-50	920218	3-158-50	920222
3 1/8"	50	1-318-50	920215	2-318-50	920219	3-318-50	920223
4 1/8"	50	1-416-50	926201	2-416-50	926202	3-416-50	926203
6 1/8"	50	1-618-50	920216	2-618-50	920220	3-618-50	920224
6 1/2"	75	1-618-75	914647	2-618-75	914784	3-618-75	926011
9 1/8"	50	1-936-50	926241	2-936-50	926242	3-936-50	926243
9 1/2"	75	1-936-75	926271	2-936-75	926272	3-936-75	926273

Description and Model Numbers — Special Lengths

Size	Impedance Ohms	Special length, flanges both ends*		Special length, flange one end*		Special length, no flanges*	
		Model No.	Part No.	Model No.	Part No.	Model No.	Part No.
7/8"	50	1S-78-50	914677	2S-78-50	926008	3S-78-50	914685
1 1/8"	50	1S-158-50	914678	2S-158-50	914682	3S-158-50	914686
3 1/8"	50	1S-318-50	914679	2S-318-50	914683	3S-318-50	914687
4 1/8"	50	1S-416-50	926204	2S-416-50	926205	3S-416-50	926206
6 1/8"	50	1S-618-50	914680	2S-618-50	926009	3S-618-50	926010
6 1/2"	75	1S-618-75	926012	2S-618-75	926013	3S-618-75	926014
9 1/8"	50	1S-936-50	926244	2S-936-50	926245	3S-936-50	926246
9 1/2"	75	1S-936-75	926274	2S-936-75	926275	3S-936-75	926276

* Prefix designations "1S", "2S" and "3S" refer to special lengths of rigid line in which the exact length in inches is added as a suffix after the impedance, ie: 1S-318-50 (24) for a 24 inch length of 3 1/8" 50 ohm line with EIA flanges on each end. When ordering, part numbers should also be used.

Electrical Characteristics

Size	Impedance Ohms	Maximum Frequency MHz	Velocity Percent	Peak Power kW
7/8"	50	6,000	99.8	78
1 1/8"	50	3,000	99.8	294
3 1/8"	50	1,550	99.8	1,149
4 1/8"	50	1,200	99.8	1,937
6 1/8"	50	800	99.8	4,464
6 1/2"	75	900	99.8	2,918
9 1/8"	50	530	99.7	10,090
9 1/2"	75	600	99.7	6,592

Mechanical Characteristics and Shipping Information

Size	Impedance Ohms	Outer Conductor O.D. x I.D. Inches (mm)	Inner Conductor O.D. x I.D. Inches (mm)	Shipping Carton Inches (mm)	Net Weight Per Length Lbs. (Kg)	Number of Line Sections Per Carton	Shipping Weight Per Carton Lbs. (Kg)
7/8"	50	.875 x .785 (22.2 x 20.0)	.341 x .291 (8.7 x 7.4)	13 x 13 x 245 (330 x 330 x 6,223)	12 (5.5)	16	250 (114)
1 1/8"	50	1.625 x 1.527 (41.3 x 38.8)	.664 x .588 (16.9 x 14.9)	13 x 13 x 245 (330 x 330 x 6,223)	27 (12.3)	9	303 (138)
3 1/8"	50	3.125 x 3.027 (79.4 x 76.9)	1.315 x 1.231 (33.4 x 31.3)	13 x 13 x 245 (330 x 330 x 6,223)	44 (19.9)	4	268 (122)
4 1/8"	50	4.062 x 3.935 (103.2 x 99.9)	1.711 x 1.661 (43.4 x 42.2)	—	110 (49.9)	—	—
6 1/8"	50	6.125 x 5.981 (155.6 x 151.9)	2.600 x 2.520 (66.0 x 64.0)	12 x 24 x 245 (305 x 610 x 6,223)	135 (61.4)	2	370 (168)
6 1/2"	75	6.125 x 5.981 (155.6 x 151.9)	1.711 x 1.666 (43.4 x 42.2)	—	130 (59.1)	1	—
9 1/8"	50	9.188 x 9.000 (232.8 x 228.6)	3.910 x 3.812 (99.3 x 96.8)	—	229 (103.9)	1	—
9 1/2"	75	9.188 x 9.000 (232.8 x 228.6)	2.580 x 2.516 (65.5 x 63.9)	—	229 (103.9)	1	—

Series APD-20 .2 SCFM Automatic Dehydrators

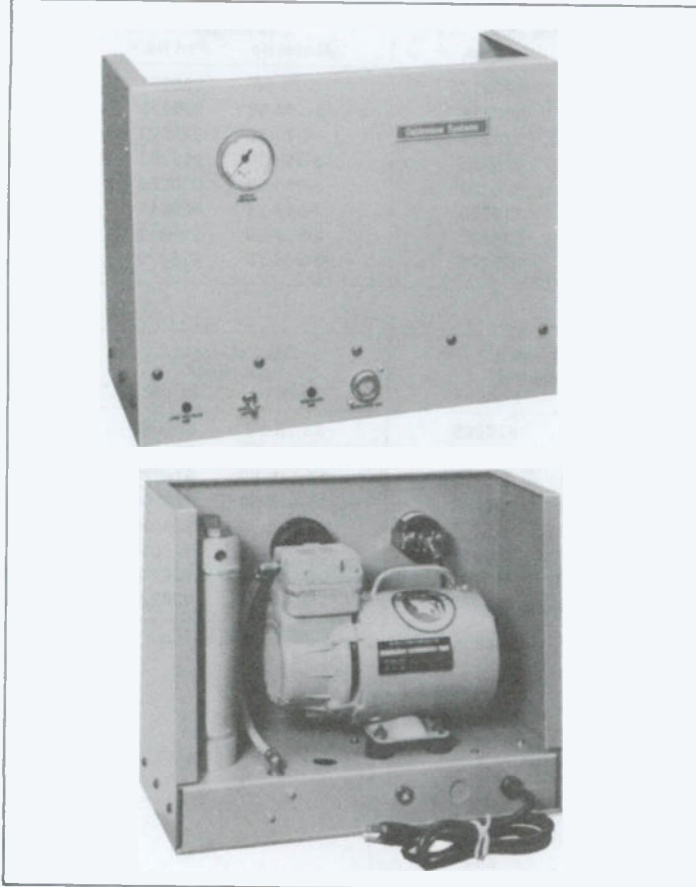

The APD-20 Automatic Pressurization Dehydrator is designed for reliable pressurization of elliptical waveguide, coaxial cable, and rigid line systems. The dehydrator utilizes the pressure swing absorption drying system with completely automatic operation eliminating the need for replacement or manual reactivation of the desiccant. The APD-20 is rated at .2 SCFM (.09 liter/sec.) and -40°F (-40°C) dry air dew point output at 95°F (35°C) 95% relative humidity input. From normal room environments, the output air has typical dew points of -55°F (-46°C). The dryer operates over an ambient temperature range of -20°F to 120°F (-28.9° to 49°C). Output pressure is factory adjusted to 2 psig (13.8 kPa) "on" and 5 psig (34.5 kPa) "off", but may be re-adjusted in the field to operate anywhere between 2 and 15 psig (13.8 and 103.4 kPa). A check valve prevents loss of pressure back through the dehydrator and a standard low pressure alarm switch, factory set for 1 psig (6.9 kPa), offers SPST contacts for remote monitoring.

Standard features include a power switch, 0-15 psig pressure gauge, indicating power fuse, and visual moisture alarm monitor which turns dark blue when dry and pink when wet. The units may be shelf mounted or placed in 14" of an EIA 19" relay rack. The dehydrator color is light grey and an optional black expanded metal rear cover, catalog number 933639, may be ordered as an accessory.

CHARACTERISTICS

Power Source		
APD-20 P/N 920635	115 V	50/60 Hz
APD-22 P/N 920637	230 V	50/60 Hz
Output Ratings		
60 Hz	0.2 scfm (.09 liters/sec.)	-40°F (-40°C) dew point @ 95°F (35°C) 95% RH input
50 Hz	0.14 scfm (.08 liters/sec.)	-40°F (-40°C) dew point @ 95°F (35°C) 95% RH input
Ambient Temperature	33°-120°F (1°C to 49°C)	
Output Pressure On/Off		
Factory set	2-5 psig (13.8-34.5 kPa)	
Field adjustable	2-15 psig (13.8-103.4 kPa) @ 2 psig (13.8 kPa) differential	
Standard Low Pressure Alarm	factory set 1 psig (6.9 kPa) @ 1 psig (0.7 kPa) differential	
P/N 920467		
Output	3/8" plastic tube fitting	
Dimensions,		
HxWxD inches	14 x 17 11/16 x 8	
(mm)	(355 x 450 x 203)	
Compressor Rating, hp	1/12	
Power Consumption,		
watts: pumping	350	
idle	10	
Net Weight, lbs. (kg)	36 (16)	
Shipping Weight, lbs. (kg)	44 (20)	
Standard Items Supplied	20 ft. (6m) 3/8" plastic tubing 1/8" MPT fitting 6 ft. 3 conductor grounded power cord	
Optional Accessories		
P/N 933639	Accessory Back Cover Kit	
P/N 920641	Maintenance Parts Kit for APD-20, or 22	
P/N 914710	Floor Stand	
P/N 913907	Relay Rack Mtg. Brkt. Kit	
P/N 920184	High pressure alarm	
P/N 920187	Regulator reservoir tank	
P/N 940008	Wall Shelf	
P/N 920717-001	Pressure and Humidity Monitor Kit for APD-20	
P/N 920717-003	Pressure and Humidity Monitor Kit for APD-22	

APD-20 DEHYDRATOR CAPACITY RATINGS

for 60 Hz operation*

Transmission Line		Approx. Length	
		feet	(meters)
7/8"	Rigid Line	15,000	(4,600)
1 1/8"	"	4,000	(1,200)
3/4"	"	1,200	(370)
4 1/16"	"	900	(270)
6 1/8"	"	200	(60)
9 1/16"	"	80	(25)
6 to 12 GHz	Waveguide	3,000	(900)
4 to 5 GHz	"	1,000	(300)

* Capacity ratings are based on a 20% duty cycle and 8 psig system pressure.

For 50 Hz operation, multiply capacity ratings by 5/6 (a reduction of 17%).

210 1⁵/₈" Ohm Rigid Coaxial Lines and Components

Electrical Characteristics

• Impedance: 50 ohms • Upper Frequency Limit: 1355MHz • Velocity: 99.7% free space • Test Voltage: 11kVDC • VSWR: 1.03:1

Mechanical Characteristics

• Outer Conductor: High conductivity hard drawn copper (Type 201) or aluminum (Type 211) tubing, 1.625" outside diameter, 1.527" inside diameter • Inner Conductor: High conductivity copper tubing, 0.664" outside diameter, 0.588" inside diameter • Insulator Supports: Locked virgin VTFE Teflon cross pins, spaced according to frequency. Locked pin design ensures concentricity, eliminates sagging

- 201-001* Line assembly, 20', flanged both ends
- 201-002* Line assembly of customer specified length, flanged both ends
- 201-004 Line assembly of customer specified length, unflanged, no connector or hardware
- 201-006 Line assembly, 20', 1 end flanged
- 201-008 Fixed flange, brass, with silver solder ring insert, for silver brazing
- 201-009 Swivel flange, brass, with silver solder ring insert, for silver brazing

301 3¹/₈" 50 Ohm Rigid Coaxial Transmission Line and Components

Electrical Characteristics

• Impedance: 50 ohms • Upper Frequency Limit: 1550MHz • Velocity: 99.89% free space • Test Voltage: 19kVDC • VSWR: 1.03:1

Mechanical Characteristics

• Outer Conductor: High conductivity hard drawn copper (Type 301) or aluminum (Type 311) tubing, 3.125" outside diameter, 3.027" inner diameter • Inner Conductor: High conductivity copper tubing, 1.315" outside diameter, 1.231" inner diameter • Insulator Supports: Locked virgin VTFE

Teflon cross pins, spaced according to frequency. Locked pin design ensures concentricity, eliminates sagging

- 301-004 Line assembly, 20', unflanged, no connector or hardware
- 301-006 Line assembly, 20', 1 end flanged
- 301-007** Line assembly, 20', flanged, expansion inner conductor/connector
- 301-008 Fixed flange, brass, with silver solder ring insert, for silver brazing
- 301-009 Swivel flange, brass, with silver solder ring insert, for silver brazing

401 4¹/₁₆" 50 Ohm Rigid Coaxial Transmission Line and Components

Electrical Characteristics

• Impedance: 50 ohms • Upper Frequency Limit: 1200MHz • Velocity: 99.89% free space • Test Voltage: 12kVDC • VSWR: 1.03:1

Mechanical Characteristics

• Outer Conductor: High conductivity hard drawn copper tubing, 4.062" outside diameter, 3.935" inside diameter • Inner Conductor: High conductivity copper tubing, 1.711" outside diameter x 1.631" inside diameter • Insulator Supports: Locked virgin VTFE Teflon cross pins, spaced according to frequency. Locked pin design ensures concentricity, eliminates sagging

- 401-004 Line assembly, 20', unflanged, no connector or hardware
- 401-006** Line assembly, 20', flanged 1 end
- 401-007** Line assembly, 20', flanged, with expansion inner conductor, factory installed type connector
- 401-008 Fixed flange, brass, with silver solder ring insert, for silver brazing
- 401-009 Swivel flange, brass, with silver ring insert, for silver brazing

*Includes anchor insulator connectors, "O" ring, hardware
 **Includes anchor insulator connector with anti-splitting device, "O" ring, hardware

50 Ohm — EIA Standard Connector RS-225

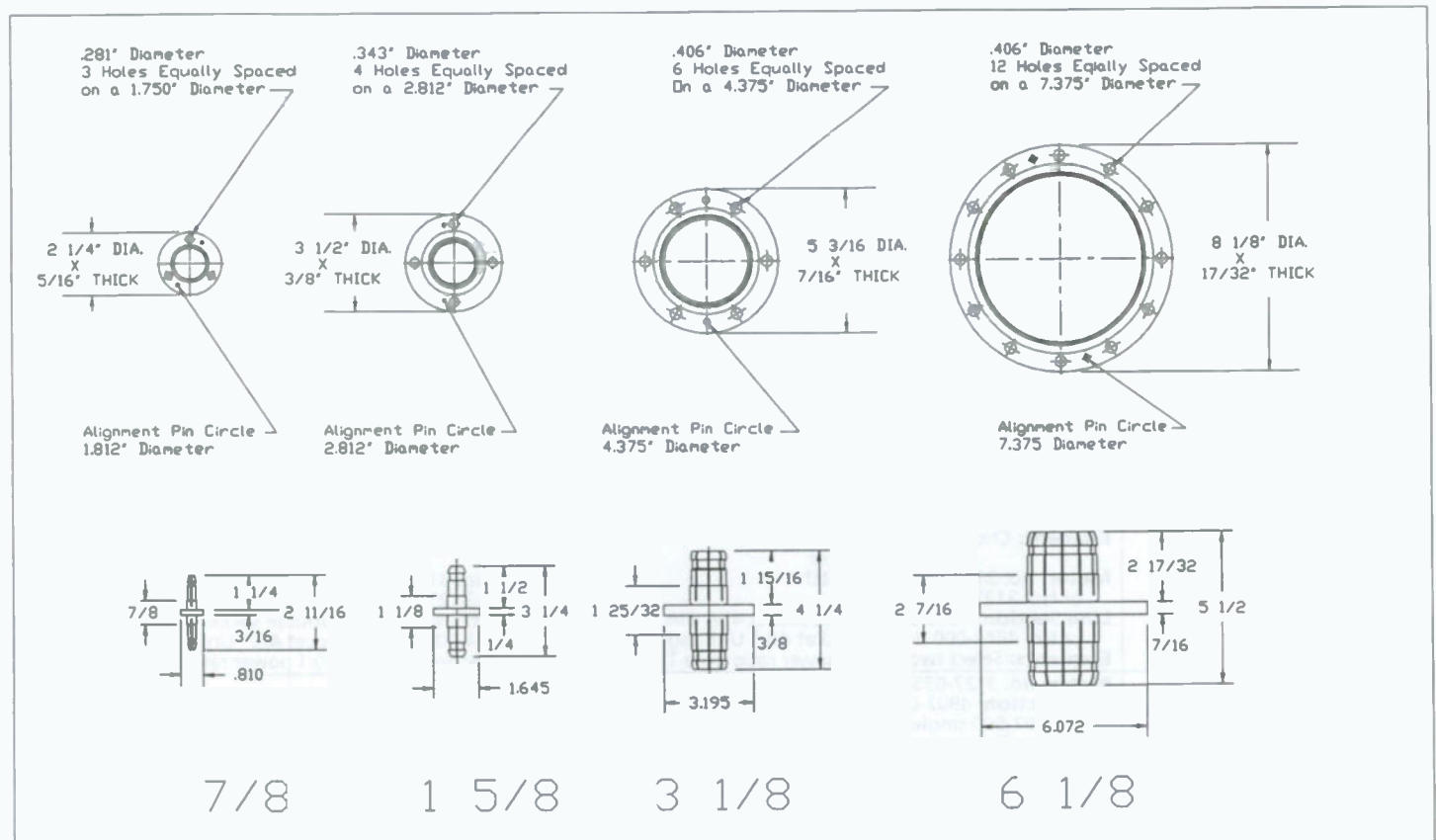

THRULINE® RF DIRECTIONAL WATTMETERS 4521/4522/4526/4527 Panel-Mounted Wattmeters

The 4521 (single-socket) and 4522 (double-socket) are designed for power measurement in CW and FM systems with cable or 7/8" EIA transmission lines. For forward or reflected power indication, the single plug-in element is rotated to the proper direction with 4521, while a switch selects either of 2 elements with 4522. This double-socket wattmeter permits the use of a more sensitive element (up to 1:10 ratio for reflected power measurement). The 4526 has 2 meters and no switch for simultaneous display of power indication in both directions.

The 4527 is tailored for 2-way mobile applications from 2MHz to 512MHz and has an RF sampling output (female BNC) for frequency counting and analysis.

Specifications

Power Range: 100mW-10kW using Bird plug-in elements. Accuracy not guaranteed with components not supplied by Bird

Frequency Range: 0.45MHz-2300MHz (4527: 2MHz-512MHz)

Insertion VSWR: With N connector 1.05 max. to 1000MHz

Accuracy: ± 5% of full scale

RF Sample Output: (4527 only) fixed at -53dB from 512MHz-10MHz decreasing to -70dB at 2MHz, from BNC (female) port

Connectors: QC type (female N normally supplied)

Finish: Light navy gray baked enamel (MIL-E-15090)

Nominal Size: 19" x 57/32" x 1 11/16" 3 RU

Weight: 3 1/2 lbs.

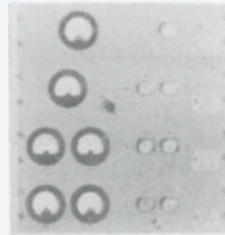

4521/4522/4526/4527

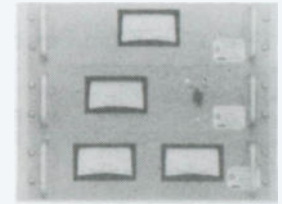

3127 Series

Rackmounted Wattmeters

(To assemble, use selection guide below)

Specifications

Assembled Rackmounted Wattmeters

Finish: Line sections—silver plated; panel—light navy gray baked enamel (MIL-E-15090)

Nominal Size and Weight:

Panels 19" x 57/32" x 43/8" RU; 3 lbs.

RF Sampler Elements

For RF signal observation, spectrum analysis or frequency counting and control, use the 4274-025 wide range RF sampler element. This non-directional coupler delivers an unrectified signal at about -50dB ± 2dB from 25MHz to 1000MHz tapering to -66dB at 2MHz. The 4274-050 delivers an unrectified signal variable from -35 to -48dB (± 1dB) between 100MHz and 400MHz. Main line power should not exceed 500W.



Variable RF Sampler Element

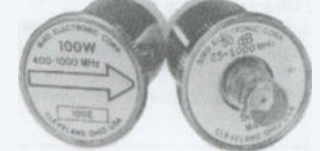

Standard Element

RF Sampler Element

Selection Guide

	5/10/25 scale-division meters	15/30/60 scale-division meters
for 1 1/2" Systems	Meter: No. 3127-035 Line Section: 4712-000 single socket 1 1/2" EIA Flg or 4720-000 single socket 1 1/2" Unflanged Element: Choose one from Table 1 1/2 A or Meter: No. 3127-055 with switch or No. 3127-040 double meters Line Section: 4715-000 double socket 1 1/2" EIA Flg or 4723-000 double socket 1 1/2" Unflanged Elements: Select two in 10:1 power ratio from Table 1 1/2 A	Meter: No. 3127-070 Line Section: 4712-000 single socket 1 1/2" EIA Flg or 4720-000 single socket 1 1/2" Unflanged Element: Choose one from Table 1 1/2 B or Meter: No. 3127-080 with switch or No. 3127-075 double meters Line Section: 4715-000 double socket 1 1/2" EIA Flg or 4723-000 double socket 1 1/2" Unflanged Elements: Select two in 10:1 power ratio from Table 1 1/2 B
for 3 1/2" Systems	Meter: No. 3127-035 Line Section: 4600-000 single socket 3 1/2" EIA Flg or 4805-000 single socket 3 1/2" Unflanged Element: Choose one from Table 3 1/2 A or Meter: No. 3127-055 with switch or No. 3127-040 double meters Line Section: 4610-000 double socket 3 1/2" EIA Flg or No. 4802-000 double socket 3 1/2" Unflanged Elements: Select two in 10:1 power ratio from Table 3 1/2 A	Meter: No. 3127-070 Line Section: 4600-000 single socket 3 1/2" EIA Flg or 4805-000 single socket 3 1/2" Unflanged Element: Choose one from Table 3 1/2 B or Meter: No. 3127-080 with switch or No. 3127-075 double meters Line Section: 4610-000 double socket 3 1/2" EIA Flg or 4802-000 double socket 3 1/2" Unflanged Elements: Select two in 10:1 power ratio from Table 3 1/2 B
for 4 1/2" Systems	Meter: No. 3127-035 Line Section: 4641-000 single socket 4 1/2" EIA Flg or 4843-000 single socket 4 1/2" Unflanged Element: Choose one from Table 4 1/2 A or Meter: No. 3127-055 with switch or No. 3127-040 double meters Line Section: 4643-000 double socket 4 1/2" EIA Flg or No. 4844-000 double socket 4 1/2" Unflanged Elements: Select two in 10:1 power ratio from Table 4 1/2 A	Meter: No. 3127-070 Line Section: 4641-000 single socket 4 1/2" EIA Flg or 4843-000 single socket 4 1/2" Unflanged Element: Choose one from Table 4 1/2 B or Meter: No. 3127-080 with switch or No. 3127-075 double meters Line Section: 4643-000 double socket 4 1/2" EIA Flg or 4844-000 double socket 4 1/2" Unflanged Elements: Select two in 10:1 power ratio from Table 4 1/2 B
for 6 1/2" Systems	Meter: No. 3127-035 Line Section: 4902-000 single socket 6 1/2" EIA Flg or 4907-000 single socket 6 1/2" Unflanged Element: Choose one from Table 6 1/2 A or Meter: No. 3127-055 with switch or No. 3127-040 double meters Line Section: 4905-000 double socket 6 1/2" EIA Flg or No. 4909-000 double socket 6 1/2" Unflanged Elements: Select two in 10:1 power ratio from Table 6 1/2 A	Meter: No. 3127-070 Line Section: 4902-000 single socket 6 1/2" EIA Flg or 4907-000 single socket 6 1/2" Unflanged Element: Choose one from Table 6 1/2 B or Meter: No. 3127-080 with switch or No. 3127-075 double meters Line Section: 4905-000 double socket 6 1/2" EIA Flg or 4909-000 double socket 6 1/2" Unflanged Elements: Select two in 10:1 power ratio from Table 6 1/2 B

High Power Rigid Line ThruLine® Wattmeters

Each RF directional wattmeter is comprised of a line section and a direct reading 3-scale meter housed in a convenient carrying case. Measuring element(s) are ordered separately.

Line Section: A precise 50 ohm 1⁵/₈" , 3¹/₈" , 4¹/₁₆" or 6¹/₈" coaxial air line is designed for insertion into your transmission line between transmitter and antenna or load. Each line section is equipped with 1 or 2 sockets into which plug-in element(s) with the desired power and frequency range are inserted. Double-socket line sections are for simultaneous measurement of forward and reflected power.

Indicating Meter: A sensitive micro-ampere meter with 3 expanded scales of 5/10/25 (or 15/30/60) unit calibration to permit full scale direct power reading from 250W to 250kW. Sockets for storing extra elements are provided on the side of the rugged cast aluminum case. A 10' shielded cable for connecting meter to line section is standard. Other cable lengths are available on request. A special meter for 8/80kW is also available.

Wattmeters with 2 separate element sockets (1 for forward and 1 for reflected power measurement) are equipped with a dual DC input meter case and 2 shielded cables. A switch mounted on the meter face selects the desired reading.

Wattmeters ordered by model number are supplied with the appropriate line section, connecting cable(s) and portable meter. If panel-mounted meter(s) for 19" equipment racks are preferred, line section and meter panels should be ordered individually. In case of doubt, select a model and ask for a quote on replacing the portable meter by a meter panel.

Plug-In Elements: These elements read both forward and reflected power as indicated by the direction in which the arrow is pointing.

Frequency range and full-scale power are marked on each element. Since elements are not interchangeable between different ThruLine models, be sure to specify wattmeter model number (or line section part number) for which elements are intended. For periodic verification convenience, order elements in identical pairs for each socket.

Finish: Line sections are bright silver plated; meter housing and panels are finished in light navy gray baked enamel (MIL-E-15090).

Series 4700A/4600A/4800A/4900A Specifications

Accuracy:	± 5% of full scale
Insertion VSWR:	1.05 max.
Finish:	Line section—silver plated, meter housing—light navy gray baked enamel (MIL-E-15090)
Nominal Size:	Meter housing 5 ⁹ / ₁₆ " x 6 ¹ / ₂ " x 3 ³ / ₈ "
Weight:	Meter 3 lbs.

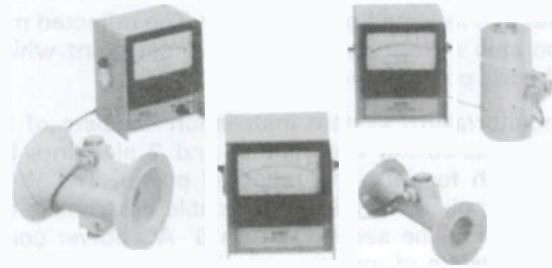

High Power Rigid Line Series

Model No.	Freq. Range MHz	Power Range kW	Flg/Unflg	No. of Sockets	Scale Divisions	Element Table	Overall Length	Weight (Line Only)
1½" LINE 50 ohms nominal								
4712A	2-1000	0.1-25	EIA Flg	Single	5/10/25	1½A	6¾" (171mm)	3 lbs (1¼kg)
4715-200A	2-1000	0.1-25	EIA Flg	Double	5/10/25	1½A	6¾" (171mm)	3½ lbs (1.4kg)
4720A	2-1000	0.1-25	Unflg	Single	5/10/25	1½A	6¾" (162mm)	1½ lbs (0.6kg)
4723-200A	2-1000	0.1-25	Unflg	Double	5/10/25	1½A	6¾" (162mm)	1½ lbs (0.7kg)
4712-037A	2-250	0.3-15	EIA Flg	Single	15/30/60	1½B	6¾" (171mm)	3 lbs (1¼kg)
4715-300A	2-250	0.3-15	EIA Flg	Double	15/30/60	1½B	6¾" (171mm)	3½ lbs (1.4kg)
3¾" LINE 50 ohms nominal								
460A	2-1000	1-100	EIA Flg	Single	5/10/25	3¾A	7½" (179mm)	7 lbs (3kg)
4610-200A	2-1000	1-100	EIA Flg	Double	5/10/25	3¾A	7½" (179mm)	7½ lbs (3.1kg)
4805A	2-1000	1-100	Unflg	Single	5/10/25	3¾A	6¾" (165mm)	4 lbs (2kg)
4802-200A	2-1000	1-100	Unflg	Double	5/10/25	3¾A	6¾" (165mm)	4½ lbs (2.1kg)
4600-037A	50-1000	1.5-30	EIA Flg	Single	15/30/60	3¾B	7½" (179mm)	7 lbs (3kg)
4610-300A	50-1000	1.5-30	EIA Flg	Double	15/30/60	3¾B	7½" (179mm)	7½ lbs (3.1kg)
4805-037A	50-1000	1.5-30	Unflg	Single	15/30/60	3¾B	6¾" (165mm)	4 lbs (2kg)
4802-300A	50-1000	1.5-30	Unflg	Double	15/30/60	3¾B	6¾" (165mm)	4½ lbs (2.1kg)
4¾" LINE 50 ohms nominal								
4641A	50-250	2.5-50	EIA Flg	Single	5/10/25	4¾A	8¾" (213mm)	8 lbs 10 oz (3.9kg)
4642-200A	50-250	2.5-50	EIA Flg	Double	5/10/25	4¾A	8¾" (213mm)	8 lbs 14 oz (4.0kg)
4843A	50-250	2.5-50	Unflg	Single	5/10/25	4¾A	7¾" (191mm)	2 lbs 10 oz (1.2kg)
4844-200A	50-250	2.5-50	Unflg	Double	5/10/25	4¾A	7¾" (191mm)	2 lbs 14 oz (1.3kg)
4641-037A	50-750	3-60*	EIA Flg	Single	15/30/60	4¾B	8¾" (213mm)	8 lbs 10 oz (3.9kg)
4642-300A	50-750	3-60*	EIA Flg	Double	15/30/60	4¾B	8¾" (213mm)	8 lbs 14 oz (4.0kg)
4843-037A	50-750	3-60*	Unflg	Single	15/30/60	4¾B	7¾" (191mm)	2 lbs 10 oz (1.2kg)
4844-300A	50-750	3-60*	Unflg	Double	15/30/60	4¾B	7¾" (191mm)	2 lbs 14 oz (1.3kg)
4641-080A	50-250	8-80	EIA Flg	Single	8/80	4¾C	8¾" (213mm)	8 lbs 10 oz (3.9kg)
4843-080A	50-250	8-80	Unflg	Single	8/80	4¾C	7¾" (191mm)	2 lbs 10 oz (1.2kg)
6¾" LINE 50 ohms nominal								
4902A	2-1000	2.5-250	EIA Flg	Single	5/10/25	6¾A	10½" (260mm)	16½ lbs (7½kg)
4905-200A	2-1000	2.5-250	EIA Flg	Double	5/10/25	6¾A	10½" (260mm)	17 lbs (7¾kg)
4907A	2-1000	2.5-250	Unflg	Single	5/10/25	6¾A	9¾" (245mm)	12½ lbs (5½kg)
4909-200A	2-1000	2.5-250	Unflg	Double	5/10/25	6¾A	9¾" (245mm)	12½ lbs (5½kg)
4902-037A	50-750	3-60	EIA Flg	Single	15/30/60	6¾B	10½" (260mm)	16½ lbs (7½kg)
4905-300A	50-750	3-60	EIA Flg	Double	15/30/60	6¾B	10½" (260mm)	17 lbs (7¾kg)
4902-080A	50-750	8-80	EIA Flg	Single	8/80	6¾C	10½" (260mm)	16½ lbs (7½kg)
4907-080A	50-750	8-80	Unflg	Single	8/80	6¾C	9¾" (245mm)	12½ lbs (5½kg)

81070/81071 WATTCHMAN

RF Station Monitor/Alarm

- Protects your transmitter system • Continuous power display forward and reflected • Audible and visual alarms
- Fast fault response (15ms) • Remote reset provision

The WATTCHMAN rackmounted wattmeter measures forward/reflected RF power simultaneously in 50 ohm coaxial cables and transmission lines. It accepts plug-in elements that range from 100mW to 100,000W full scale and from 0.45MHz to 2300MHz. Note: Schedule 1 frequency range from 2MHz to 1300MHz.

The 81070 is a rackmounted RF wattmeter complete with power supply and 2 panel-mounted 4 1/2" meters for forward power and reflected power display. The reflected meter incorporates a front panel adjustable set point which controls the trip point on the meter alarm.

Station monitor/alarm system installation consists of an 81070, a double-socket line section and 2 elements for monitoring both forward and reflected power. The WATTCHMAN is supplied with 2 25' DC cable assemblies for connection to the line section, and a 6' AC power cord. Installation consists of inserting the line section into the transmission line, connecting proper terminals of the transmitter interlock system(s) to the proper terminals on the WATTCHMAN and providing AC power.

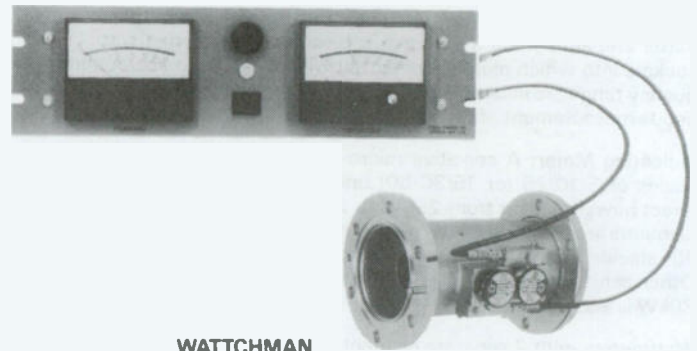

WATTCHMAN

Abnormal load conditions quickly cause transmitter shutdown within less than 15ms (including control relay). An audible single tone alarm will indicate system/transmitter malfunction. Relay contacts are provided for remote alarm and reset switching. Fail-Safe or Non-Fail-Safe mode is selected by a switch located on the rear of the instrument.

The 81071 has the addition of a front panel meter contact control on the forward power meter to alarm on a low incident power level. This will help meet FCC requirements.

81000-A/81001-A RF Directional Wattmeters

- Shock mounted "taut band" meter • 4 1/2" mirrored scale • Quick match connectors • Internal line section • Hi Con plated plug-in elements • 2-year limited warranty

The 81000-A can measure RF power in 50 ohm coaxial cable and transmission lines, and accept plug-in elements in the range of 0.1 to 10,000W full scale and from 0.45 to 2300MHz.

Complete with a built-in line section, "Quick Match" RF connectors for 50 ohm cables and transmission lines offer the speed and reliability you expect from Coaxial Dynamics.

The 81000-A is easy to use. Simply connect the wattmeter between the power source and antenna or "dummy" load, plug in the appropriate measuring element and select forward or reflected direction. The RF power is visually identified directly on the 4 1/2" 3-scale display.

Versatile and strong, the 81000-A can be used with accessory cables up to 200' from the meter and is protected by a rugged, virtually indestructible shock-proof housing. For added convenience, 2 sockets for storage of additional elements are located on the back of the unit.

81000-A

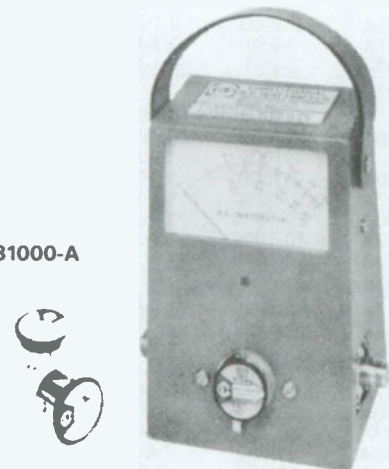

The 81001-A RF Wattmeter, identical to the 81000-A, has the added feature of an auxiliary DC input, providing the option of single-meter measurement of several power sources. Line sections (P/N 88525) are permanently installed at these measurement points, with the 81001-A connected to each as needed. The DC signal is coupled from the line section to the auxiliary DC input to provide the same measuring capabilities as the basic 81000-A.

81000-A/81001-A (Cont'd)

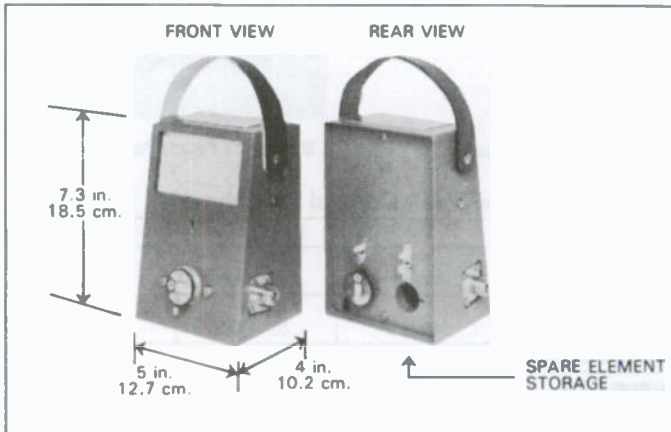

Specifications:

MODEL 81000-A & 81001-A

Power Range 100 mW- 10 kW
 Frequency Range 0.45-2300 MHz
 VSWR 1.05:1 max., with N connectors
 Accuracy ±5% of full scale
 Impedance 50 ohms
 RF Connectors Type N(F) Standard
*Other "Quick Match" Connectors are available.
 See 88000 Series Below*
 Weight 3.6 lbs. (1.6 kg.)
 Element Weight 1.25 oz. (.035 kg.)

SCHEDULE (1)

STANDARD ELEMENTS (CATALOG NUMBERS)

Power Range	Frequency (MHz)						
	2-30	25-60	50-125	100-250	200-500	400-1000	950-1300
5 watts		82012	82020	82028	82036	82045	82068
10 watts		82013	82021	82029	82037	82046	82069
25 watts		82014	82022	82030	82038	82047	82070
50 watts	82004	82015	82023	82031	82039	82048	82071
100 watts	82005	82016	82024	82032	82041	82049	82072
250 watts	82006	82017	82025	82033	82042	82050	82073
500 watts	82007	82018	82026	82034	82043	82051	
1000 watts	82008	82019	82027	82035	82044	82052	
2500 watts	82009						
5000 watts	82010						

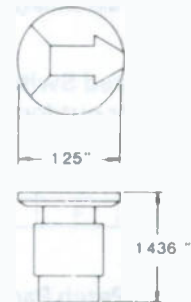

SCHEDULE (2)

MILLIWATT ELEMENTS

100 mW	Cat. No.	250 mW	Cat. No.	500 mW	Cat. No.
20-23 MHz	820A022	70-80 MHz	820B075	25-30 MHz	820C028
44-50 MHz	820A047	72-76 MHz	820B074	65-90 MHz	820C078
62-70 MHz	820A066	105-120 MHz	820B113	72-76 MHz	820C074
74-76 MHz	820A075	310-350 MHz	820B330	105-120 MHz	820C113
105-120 MHz	820A113	416-436 MHz	820B426	130-170 MHz	820C150
135-165 MHz	820A150	800-900 MHz	820B850	300-350 MHz	820C325
190-205 MHz	820A198	900-950 MHz	820B925	800-900 MHz	820C850
310-350 MHz	820A330			900-950 MHz	820C925
416-436 MHz	820A426				
740-760 MHz	820A750				
800-900 MHz	820A850				

SCHEDULE (3)

LOW POWER ELEMENTS

1 watt	Cat. No.	2.5 watts	Cat. No.
28-44 MHz	820D036	60-80 MHz	820E070
40-50 MHz	820D045	80-140 MHz	820E110
44-70 MHz	820D057	95-150 MHz	820E123
70-120 MHz	820D095	150-250 MHz	820E200
108-118 MHz	820D113	200-300 MHz	820E250
108-181 MHz	820D145	225-400 MHz	820E313
150-250 MHz	820D200	275-450 MHz	820E363
200-300 MHz	820D250	340-560 MHz	820E450
275-450 MHz	820D363	800-900 MHz	820E850
310-350 MHz	820D330		
327-543 MHz	820D435		
425-850 MHz	820D638		
800-950 MHz	820D875		

NOTE: Special elements other than those listed can be custom designed. Please inquire.

88000 Series RF Quick Match 50 ohm Connectors

88000	N Female	88010	7/8" Swivel Flanged
88001	N Male	88011	TNC Female
88002	BNC Female	88012	TNC Male
88003	BNC Male	88013	HN Female
88004	UHF Female	88014	HN Male
88005	UHF Male	88020	SMA Female
88006	LC Female	88021	SMA Male
88007	LC Male	88026	Miniature UHF Female
88008	C Female	88027	SC Female
88009	C Male	88028	SC Male

Coaxial Switches A 50000 Series

Line Size (inches)	Impedance (ohms)	Number of Ports	Motor Drive Voltage	Control Relay Coil Voltage	Catalog Number
3 1/8	50	4	115VAC	12VDC	A 50000-300
3 1/8	50	4	115VAC	24VDC	A 50000-301
3 1/8	50	4	115VAC	115VAC	A 50000-303
3 1/8	50	4	230VAC	12VDC	A 50000-305
3 1/8	50	4	230VAC	24VDC	A 50000-306
3 1/8	50	4	230VAC	115VAC	A 50000-308
3 1/8	50	4	230VAC	230VAC	A 50000-309
3 1/8	50	3	115VAC	12VDC	A 50000-310
3 1/8	50	3	115VAC	24VDC	A 50000-311
3 1/8	50	3	115VAC	115VAC	A 50000-313
3 1/8	50	3	230VAC	12VDC	A 50000-315
3 1/8	50	3	230VAC	24VDC	A 50000-316
3 1/8	50	3	230VAC	115VAC	A 50000-318
3 1/8	50	3	230VAC	230VAC	A 50000-319

3 1/8" Manual Coaxial Switches 80 Series

Line Size (inches)	Number of Ports	Number of U-Links	Impedance (ohms)	Catalog Number	
				Without Interlocks	With Interlocks
3 1/8	3	N/A	50	N/A	DC 385-534
3 1/8	4	N/A	50	N/A	DC 385-544

All ports are terminated with EIA flanges.

3 1/8" Pressurized Switch 80 Series (with heater for outdoor use)

Line Size (inches)	Impedance (ohms)	Number of Ports	Motor Drive Voltage	Control Relay Coil Voltage	Catalog Number
3 1/8	50	4	115VAC	115VAC	D 27035-501

3 1/8" Coaxial Patch Panels 80 Series

Line Size (inches)	Number of Ports	Number of U-Links	Impedance (ohms)	Catalog Number	
				Without Interlocks	With Interlocks
3 1/8	3	1	50	DC 385-430	DC 385-431
3 1/8	4	2	50	DC 385-440	DC 385-441
3 1/8	7	3	50	DC 385-470	DC 385-471



A 50000 Series

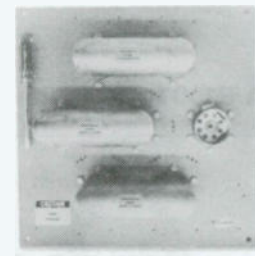

80 Series Patch Panels

Specifications for 3 1/8" Coaxial Switches

	A 50000	Patch Panels	Manual
Frequency Range	DC-900MHz	DC-900MHz	DC-900MHz
Characteristic Impedance	50 ohms	50 ohms	50 ohms
Insertion Loss	0.1dB	0.1dB	0.1dB
Maximum VSWR	1.05:1	1.05:1	1.05:1
at Peak Power at 30MHz	500kW	500kW	500kW
Ratings at 300MHz	90kW	90kW	90kW
at 900MHz	30kW	30kW	30kW
Ports Available	3 or 4	3, 4 or 7	3 or 4
Switching Time	2 sec.	N/A	N/A
Minimum Isolation	60dB	60dB	60dB
RF Connectors	EIA Unflanged*	EIA Unflanged	EIA Unflanged*
Aux. Switch Contact Rating	0.3A at 125VDC 10A at 250VAC	0.3A at 125VDC 10A at 250VAC	0.3A at 125VDC 10A at 250VAC
Approx. Net Weight	54 lbs.	3-Port 65 lbs. 4-Port 100 lbs. 7-Port 185 lbs.	47 lbs.
Drive 115VAC Motor 50/60Hz Current 220VAC 50/60Hz	3.5A Start 0.5A Run 1.5A Start 0.3A Run	N/A	N/A
Control Relay Coil Voltage	1.2W DC 2.7VA AC	N/A	N/A
Finish	Lt. Blue Hamertone	Lt. Blue Hamertone	Lt. Blue Hamertone

*With optional adaptors



MICRO COMMUNICATIONS, INC.

FMC-03 FM Panel Antenna

• Band 11 panel • Broadband 87.5MHz-108MHz • 4.5dB gain • Circular polarization • Directional pattern • Suitable as a component in various arrays on square towers • Stainless steel dipoles

Electrical Data

• Frequency Range: 87.5MHz-108MHz • Impedance: 50 ohms • Connectors: 4 x 7/8" EIA • Max. Power: 20kW (5kW for each input) • VSWR: ≤ 1.1 (in circular polarization) • Polarization: Circular • Gain (referred to half wave dipole): 4.5dB circular polarization, 7.5dB linear polarization • Half Power Beamwidth: ± 30° horizontal component, ± 32° vertical component • Lightning Protection: All metal parts DC grounded

Mechanical Data

• Dimensions: 2200mm x 2200mm x 1056mm • Weight: 96kg • Wind Surface: 0.965m² • Max. Wind Velocity: 220km/h. Safety factor: 2 • Wind Load: 188kg (wind speed at 150km/h) • Materials: Reflector (hot dip galvanized steel), radiating dipoles (stainless steel), internal parts (silver plated brass), radome (fiberglass) • Icing Protection: Feed point radome • Radome Colors: Orange (standard) • Mounting: Directly on supporting mast

Radiation Pattern (Mid Band)

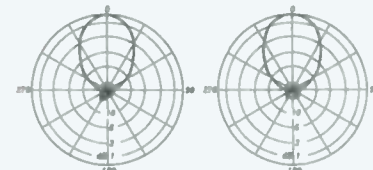

Horizontal Component

Vertical Component

VSWR

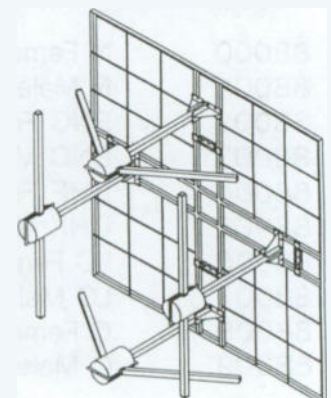
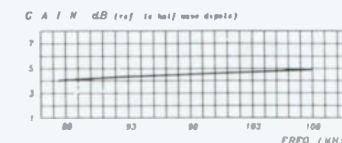
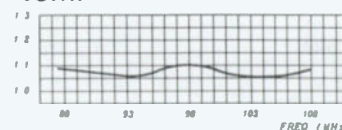

G5CPS/G5CPM Series FM Antennas

- Low VSWR • Internal feed • Fully pressurized • Series fed radiating elements • Circular polarization • Welded feed connections • Superior VSWR bandwidth • High input power capacity • Custom modifications available • Corrosion resistant construction • Modular construction facilitates easy installation and repair • Minimal weather related VSWR problems • Beam tilt and/or null fill available • Half-wave spacing between elements available • Rugged brass construction—TIG welding • Stainless steel support brackets and hardware • Radomes or deicing heaters not normally required for radial ice less than 1/2" • Teflon coating, radomes or deicing heaters available • Custom designed antenna supports; poles or Lambda sections also available

ERI's original and distinctive design combines the exceptional engineering features of an internally fed, fully pressurized system with superior fabrication characterized by totally welded feed connections, rugged brass material and TIG welding.

The G5 Series antenna's unique design consists of 2 series fed, bent dipole elements which form a space phased, circularly polarized radiator. The antenna's configuration and the large diameter of the radiation elements contribute to the excellent bandwidth of the antenna system and also inhibit corona discharge.

The horizontally polarized horizontal plane azimuthal pattern of the G5CPS series antenna is omnidirectional within ± 2dB when the antenna is pole or Lambda mounted atop a tower. Side mounting the antenna on a typical tower structure will affect the azimuthal pattern. ERI offers a pattern measurement service to assist in determining the effect of the mounting structure on the antenna's pattern. Using ERI's pattern optimization service, the pattern's circularity may be improved through the addition of parasitically excited elements.

NOTE: VSWR specifications apply over a frequency ± 200kHz from the tuning point of the antenna. Where radomes or deicing heaters are not used, this tuning point is customarily set 200kHz above the station operating frequency to provide improved performance under icing conditions. Parasitic elements tend to reduce the VSWR bandwidth of the antenna.

G5CPS Series FM Antenna Weight and Windload Information

Type	Antenna Weight (lbs.)				Antenna Windload (lbs.)			
	Antenna Only	With 1/2" Radial Ice	With Radome	w/Radome and 1/2" Radial Ice	Antenna Only	With 1/2" Radial Ice	With Radome	w/Radome and 1/2" Radial Ice
"A" MODEL, 3 1/8" Interbay Line, 3 1/8" Element Stem								
G5CPS-1AE	114	194.63	185	340.79	137	244.87	354	485.15
G5CPS-2AE	225	383.65	376	684.98	304	499.81	742	980.37
G5CPS-2AC	250	417.07	385	702.40	319	521.77	749	1002.33
G5CPS-2AC6	301	482.37	436	767.69	421	580.18	851	1060.70
G5CPS-3AE	336	572.67	568	1030.16	470	754.75	1130	1475.59
G5CPS-4AE	447	761.70	759	1374.35	637	1009.68	1518	1970.81
G5CPS-4AC	472	795.11	768	1391.77	652	1027.78	1525	1988.90
G5CPS-4AC6	523	860.41	819	1457.06	758	1086.14	1631	2047.26
G5CPS-5AE	558	950.72	951	1719.53	804	1264.62	1905	2466.03
G5CPS-6AE	669	1139.74	1142	2063.72	971	1519.56	2294	2961.24
G5CPS-6AC	694	1173.16	1151	2081.13	986	1533.78	2300	2975.47
G5CPS-6AC6	745	1238.45	1202	2146.43	1096	1592.15	2410	3033.83
G5CPS-7AE	780	1328.76	1334	2408.90	1138	1774.50	2682	3456.46
G5CPS-8AE	891	1517.78	1525	2753.08	1305	2029.44	3070	3951.68
G5CPS-8AC	916	1551.20	1534	2770.50	1320	2039.79	3076	3962.04
G5CPS-8AC6	967	1616.50	1585	2835.80	1433	2098.16	3190	4020.40
G5CPS-10AC	1138	1929.24	1917	3459.87	1653	2545.80	3852	4948.61
G5CPS-10AC6	1189	1994.54	1968	3525.17	1770	2604.16	3970	5006.97
G5CPS-12AC	1360	2307.29	2300	4149.24	1987	3051.81	4628	5935.18
G5CPS-12AC6	1411	2372.58	2351	4214.54	2108	3110.17	4750	5993.54

G5CPM Series FM Antenna Weight and Windload Information

Type	Antenna Weight (lbs.)				Antenna Windload (lbs.)			
	Antenna Only	With 1/2" Radial Ice	With Radome	w/Radome and 1/2" Radial Ice	Antenna Only	With 1/2" Radial Ice	With Radome	w/Radome and 1/2" Radial Ice
G5CPM-1E	57	97	83	153	91	152	192	267
G5CPM-2E	114	194	166	307	188	313	390	543
G5CPM-2C	152	245	199	353	230	362	432	592
G5CPM-3E	170	291	248	460	285	474	588	819
G5CPM-3C	207	340	282	507	327	523	630	868
G5CPM-4E	227	388	331	614	382	635	786	1095
G5CPM-4C	260	437	364	659	424	684	828	1144
G5CPM-5E	283	485	413	767	479	796	984	1371
G5CPM-5C	317	531	447	813	521	848	1026	1421
G5CPM-6E	340	582	496	921	576	957	1182	1647
G5CPM-6C	373	628	529	966	618	1007	1224	1697
G5CPM-7E	396	679	578	1073	673	1118	1380	1923
G5CPM-7C	430	725	612	1120	715	1168	1422	1973
G5CPM-8E	453	776	661	1227	770	1279	1578	2200
G5CPM-8C	486	821	694	1273	812	1329	1620	2249
G5CPM-9C	543	919	777	1427	909	1490	1819	2525
G5CPM-10C	599	1015	859	1580	1006	1651	2017	2801
G5CPM-11C	656	1113	942	1733	1103	1812	2215	3077
G5CPM-12C	712	1209	1024	1886	1200	1973	2413	3353

Windload based on 50/33psf, EIA/RS-222 C Standard

Specifications

- Frequency Range: 88MHz to 108MHz • Polarization: Circular (clockwise) • Input: 1 5/8" or 3 1/8" EIA flange
- Azimuthal Pattern: ± 2dB in free space • Axial Ratio: < 3dB in free space • VSWR at Input: 1.07:1 or less (with field matching); 1.25:1 or less, top pole or Lambda section mounting; 1.5:1 or less side mount (without field matching)

Type	Power Gain		Female 50 ohm Input	Input Power Rating kW	Approx. Length ft
	Horiz	db			
G5CPM-1E	0.4611	-3.3623	1 5/8"	9	--
G5CPM-2E	0.9971	-0.0128	1 5/8"	9	10
G5CPM-2C	0.9971	-0.0128	3 1/8"	12	10
G5CPM-3E	1.5588	1.9278	1 5/8"	9	20
G5CPM-3C	1.5589	1.9278	3 1/8"	12	20
G5CPM-4E	2.1322	3.2903	1 5/8"	9	30
G5CPM-4C	2.1322	3.2903	3 1/8"	12	30
G5CPM-5E	2.7154	4.3384	1 5/8"	9	40
G5CPM-5C	2.7154	4.3384	3 1/8"	12	40
G5CPM-6E	3.3028	5.1888	1 5/8"	9	50
G5CPM-6C	3.3028	5.1888	3 1/8"	12	50
G5CPM-7E	3.8935	5.9034	1 5/8"	9	60
G5CPM-7C	3.8935	5.9034	3 1/8"	12	60
G5CPM-8E	4.4872	6.5197	1 5/8"	9	70
G5CPM-8C	4.4872	6.5197	3 1/8"	12	70
G5CPM-9C	5.0826	7.0608	3 1/8"	12	80
G5CPM-10C	5.6800	7.5435	3 1/8"	12	90
G5CPM-11C	6.2783	7.9785	3 1/8"	12	100
G5CPM-12C	6.8781	8.3747	3 1/8"	12	110

Type	Power Gain		Female 50 ohm Input	Input Power Rating kW
	Horiz	db		
G5CPS-1AE	0.4611	-3.3623	3 1/8"	32
G5CPS-2AE	0.9971	-0.0128	3 1/8"	32
G5CPS-2AC	0.9971	-0.0128	3 1/8"	39
G5CPS-2AC6	0.9971	0.0128	6 1/8"	64
G5CPS-3AE	1.5588	1.9278	3 1/8"	32
G5CPS-4AE	2.1322	3.2903	3 1/8"	32
G5CPS-4AC	2.1322	3.2903	3 1/8"	39
G5CPS-4AC6	2.1322	3.2903	6 1/8"	64
G5CPS-5AE	2.7154	4.3384	3 1/8"	32
G5CPS-6AE	3.3028	5.1888	3 1/8"	32
G5CPS-6AC	3.3028	5.1888	3 1/8"	39
G5CPS-6AC6	3.3028	5.1888	6 1/8"	64
G5CPS-7AE	3.8935	5.9034	3 1/8"	32
G5CPS-8AE	4.4872	6.5197	3 1/8"	39
G5CPS-8AC	4.4872	6.5197	3 1/8"	32
G5CPS-8AC6	4.4872	6.5197	6 1/8"	64
G5CPS-10AC	5.6800	7.5435	3 1/8"	39
G5CPS-10AC6	5.6800	7.5435	6 1/8"	64
G5CPS-12AC	6.8781	8.3747	3 1/8"	39
G5CPS-12AC6	6.8781	8.3747	6 1/8"	64

"B" Model, 4 1/8" Interbay Line, 4 1/8" Element Stem

G5CPS-18E	0.4611	-3.3623	6 1/8"	40
G5CPS-28E	0.9971	-0.0128	6 1/8"	58
G5CPS-28C	0.9971	-0.0128	6 1/8"	80
G5CPS-38E	1.5888	1.9278	6 1/8"	58
G5CPS-48E	2.1332	3.2903	6 1/8"	58
G5CPS-48C	2.1332	3.2903	6 1/8"	112
G5CPS-58E	2.7154	4.3384	6 1/8"	58
G5CPS-68E	3.3028	5.1888	6 1/8"	58
G5CPS-68C	3.3028	5.1888	6 1/8"	112
G5CPS-78E	3.8935	5.9034	6 1/8"	58
G5CPS-88E	4.4872	6.5197	6 1/8"	58
G5CPS-88C	4.4872	6.5197	6 1/8"	112
G5CPS-108C	5.6800	7.5435	6 1/8"	112
G5CPS-128C	6.8781	8.3747	6 1/8"	112

"C" Model, 6 1/8" Interbay Line, 4 1/8" Element Stem

G5CPS-1CE	0.4611	-3.3623	6 1/8"	40
G5CPS-2CE	0.9971	-0.0128	6 1/8"	80
G5CPS-4CE	2.1332	3.2903	6 1/8"	120
G5CPS-6CE	3.3028	5.1888	6 1/8"	120

DCR-G Series Tri-Pole FM Broadcast Antennas

• Circularly polarized • Adjustable polarization ratio • Integral de-icers optional • Arrays to 16 sections • Pole or tower-leg mount • VSWR field adjustable under pressure

The DCR-G Series of antennas consists of circularly polarized elements with a power rating of 6kW per section. They are available in stacked arrays up to 16 sections with an input rating to 40kW. The DCR-G antenna is a 3-pole system with factory-adjustable elements that allow control of the ratio between vertical and horizontal polarization. The elements of the antenna section may be adjusted to provide maximum ERP in the horizontal plane and less in the vertical plane. This is most useful where available transmitter power is less than necessary for maximum ERP in both planes.

Pattern Circularity ± 1dB

The arrays described here offer radiation circularity within 1dB in free space. In side-mount situations, tower metal and guy wires affect the circularity to varying degrees. We recommend that side-mounted arrays be above the highest guy wire. When this is impractical, the guy wires can be insulated from the tower and at 3.5' intervals for a distance of 14' from the point where the guy wires touches the tower.

General Specifications

Polarization: Circular; **Horizontal Pattern Circularity in Free Space:** ± 1dB; **Vertical Pattern Circularity in Free Space:** ± 1dB; **VSWR at Input, Top Mounted, Without Field Trim:** 1.2: 1 maximum; **VSWR at Input, Side Mounted, Without Field Trim:** 1.5: 1 maximum; **VSWR at Input, Top or Side Mounted, With Field Trim (200kHz):** 1.1: 1; **Input Connection Diameter (50 ohm, EIA Flange):** 3 1/8"; **De-Icer Power (nominal, per section):** 750W; **Section Dimensions:** 20" H x 25" diameter; **Feedpoint Locations (approximate):** 7 sections and fewer (below lowest section): 10.5'; 8 sections and more (below array center): 13'

Electrical Data

Antenna Type	Power Gain ¹			Field Intensity	Power Rating ²	
	Power	dB	Field		kW	dBk
DCR-G1	0.46	-3.37	0.678	130.6	6	7.78
DCR-G2	1.0	0	1.00	193.9	12	10.79
DCR-G3	1.5	1.76	1.23	237.9	18	12.55
DCR-G4	2.1	3.22	1.45	281.9	24	13.80
DCR-G5	2.7	4.31	1.64	319.0	30	14.77
DCR-G6	3.2	5.05	1.79	347.9	36	15.56
DCR-G7	3.8	5.80	1.95	379.5	40 ²	16.02
DCR-G8	4.3	6.34	2.07	402.9	40 ²	16.02
DCR-G10	5.5	7.40	2.35	458.5	40 ²	16.02
DCR-G12	6.6	8.20	2.57	499.1	40 ²	16.02
DCR-G14	7.8	8.92	2.79	543.1	40 ²	16.02
DCR-G16	8.9	9.49	2.98	580.3	40 ²	16.02

¹ Horizontal and vertical gain combined. Horizontally polarized gain may be specified at any level between 50 and 75 percent of total gain listed. Vertical power gain is then equal to the combined gain less the horizontal gain. For each polarization, the field gain is equal to the square root of the power gain. The effective field intensity at one mile (1.604 km) for 1 kW input is equal to 137.5 times the field gain.

² Power Rating based on a 40° C ambient. Multiply values listed by 0.8 for 50° C ambient. G-7 and larger antennas with greater power ratings are available on special order.

Antenna is DC grounded and does not require shorting stubs.

Mechanical Data

Antenna Type	Freq. MHz	Dimensions						Wind load ¹ 50/30 lbs/ft (244/146kg/m)					
		Hc Top		Hc Side		H Top		H Side		Less De-Icers		With De-Icers	
		Feet	Meters	Feet	Meters	Feet	Meters	Feet	Meters	Lbs.	Kg.	Lbs.	Kg.
DCR-G1	88	5.0	1.52	0.8	0.24	8.0	2.44	1.7	0.52	178	81	198	90
	98	5.0	1.52	0.8	0.24	8.0	2.44	1.7	0.52	178	81	198	90
	108	5.0	1.52	0.8	0.24	8.0	2.44	1.7	0.52	178	81	198	90
DCR-G2	88	10.6	3.23	6.4	1.95	19.2	5.85	12.8	3.90	337	153	377	171
	98	10.0	3.05	5.8	1.77	19.0	5.79	11.7	3.57	327	148	367	167
	108	9.5	2.90	5.4	1.65	18.0	5.49	10.8	3.29	319	145	359	163
DCR-G3	88	16.2	4.93	11.9	3.63	30.4	9.27	23.9	7.28	495	225	555	252
	98	15.0	4.57	10.9	3.32	28.9	8.81	21.8	6.64	475	215	535	243
	108	14.1	4.30	9.9	3.02	27.5	8.38	19.9	6.07	459	208	519	235
DCR-G4	88	21.7	6.61	17.6	5.36	41.5	12.65	35.2	10.73	653	296	723	328
	98	20.0	6.10	15.9	4.85	38.4	11.70	31.8	9.69	623	283	703	319
	108	18.6	5.87	14.5	4.42	36.8	11.22	29.0	8.84	599	272	679	308
DCR-G5	88	27.3	8.32	23.2	7.07	52.7	16.08	46.4	14.14	810	367	911	413
	98	25.0	7.62	20.9	6.37	49.4	15.06	41.8	12.74	791	359	871	395
	108	23.2	7.07	19.0	5.79	46.1	14.05	38.1	11.61	763	346	839	381
DCR-G6	88	32.9	10.28	28.8	8.78	63.9	19.48	57.6	17.56	970	440	1090	494
	98	30.0	9.14	25.4	7.74	59.3	18.07	51.9	15.51	920	417	1040	472
	108	27.7	8.44	23.6	7.19	54.9	16.73	47.2	14.39	882	400	1000	454
DCR-G7	88	38.5	11.73	34.3	10.45	75.0	22.86	68.7	20.94	1128	512	1268	575
	98	35.1	10.70	30.9	9.42	68.7	20.94	61.9	18.87	1068	484	1208	548
	108	32.3	9.85	28.1	8.56	64.2	19.57	56.3	17.16	1020	463	1160	526
DCR-G8	88	44.0	13.41	40.0	12.19	86.2	26.27	80.0	24.38	1308	593	1468	666
	98	40.1	12.22	35.9	10.94	78.9	24.05	71.9	21.92	1238	562	1398	634
	108	36.8	11.22	32.7	9.97	73.2	22.31	69.4	21.15	1182	536	1342	609
DCR-G10	88	55.2	16.82	51.1	15.58	108.6	33.10	102.2	31.15	1625	737	1875	851
	98	50.1	15.27	46.0	14.02	96.6	30.05	92.0	28.04	1535	692	1735	787
	108	45.9	13.99	41.8	12.74	91.2	27.80	83.7	25.51	1483	673	1663	754
DCR-G12	88	66.4	20.24	62.3	18.99	131.0	39.92	124.7	38.01	1942	881	2182	1013
	98	60.1	18.32	56.0	17.07	119.8	36.52	112.1	34.17	1832	831	2072	954
	108	55.0	16.76	51.0	15.54	109.6	33.41	101.9	31.06	1744	791	1984	900
DCR-G14	88	POLE MOUNT		73.5	22.40	POLE MOUNT		147.0	44.81	2258	1024	2538	1151
	98	NOT RECOMMENDED		66.1	20.15	NOT RECOMMENDED		132.2	40.29	2128	965	2408	1092
	108	RECOMMENDED		60.0	18.29	RECOMMENDED		120.1	36.61	2008	947	2304	1045
DCR-G16	88	POLE MOUNT		84.7	25.82	POLE MOUNT		169.4	51.63	2575	1166	2895	1313
	98	NOT RECOMMENDED		78.1	23.20	NOT RECOMMENDED		152.3	46.42	2425	1100	2745	1245
	108	RECOMMENDED		69.1	21.06	RECOMMENDED		138.3	42.15	2205	1000	2625	1191

¹Interpolate dimensions and wind load for antennas of intermediate frequency.



DCR-G Series

Weight in Pounds (kg)¹:

	Less De-Icers	With De-Icers
1 Section:	111 (50)	200 (91)
2 Sections:	177 (80)	328 (149)
3 Sections:	243 (110)	483 (219)
4 Sections:	309 (140)	611 (277)
5 Sections:	375 (170)	766 (347)
6 Sections:	441 (200)	894 (406)
7 Sections:	507 (300)	1049 (476)
8 Sections:	598 (271)	1202 (545)
10 Sections:	730 (331)	1485 (674)
12 Sections:	862 (391)	1768 (802)
14 Sections:	994 (451)	2051 (930)
16 Sections:	1126 (511)	2334 (1059)

¹Weight includes feed system to antenna input and 13" to 18" (330mm to 457mm) extension brackets for mounting.

DCP-B Series Medium Power FM Panel Antennas

- Low cost
- Low wind load
- High power capability
- Single or multichannel input
- Broad band
- High strength materials
- Adjustable mounts

The DCP-B panel antenna is designed for side mounting on standard broadcast towers or top mounting on a special tower section. The antenna provides omnidirectional coverage in a 3-around configuration and by varying the quantity of panels per face, power division and phasing can meet highly directional pattern requirements. The 4-dipole design provides a higher gain per layer than is possible with a 2-dipole design. Each dipole is individually fed, which provides optimum control of phase and power division for tailoring beam tilt and null fill.

The panel and dipole elements are fabricated from stainless steel tubing, providing optimum strength with minimum dead weight. The dipoles have a pressurized feed point and do not require radomes, however, radomes are available for areas with severe icing conditions. Each panel is capable of handling up to 10kW of input power. Higher power ratings are available in custom designs.

The antenna feed system is fabricated from Dielectric's standard components and feedlines. Each feed system is custom designed to meet the specific performance requirements. Pattern optimization can be verified with optional quarter scale range testing or optional full scale 3-layer testing.

Wind Load of Panel Antenna (Broadband)

	1	2	3
1	714	1320	1572
2	1429	2641	3144
3	2144	3961	4716
4	2857	5281	6288
5	3572	6602	7860
6	4286	7922	9432
7	5000	9242	11004
8	5714	10562	12576
9	6429	11883	14148
10	7143	13203	15720
11	7857	14523	17292
12	8571	15844	18864

* 50/33 lbs. (flats/rounds)

The above wind loads are the worst case (i.e., no shielding of components) for a generic panel system. The actual load will increase with increased line sizes for higher power levels and is also a function of panel orientation. Upon complete design of the system, shielding can be attributed to some components due to proximity of tower structure. This shielding will tend to reduce loads.

Actual deadweight figured for each system due to custom design.

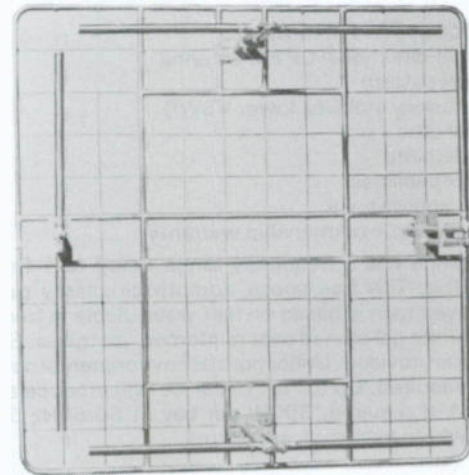

DCP-B Mounted — 10' Center to Center

Elevation

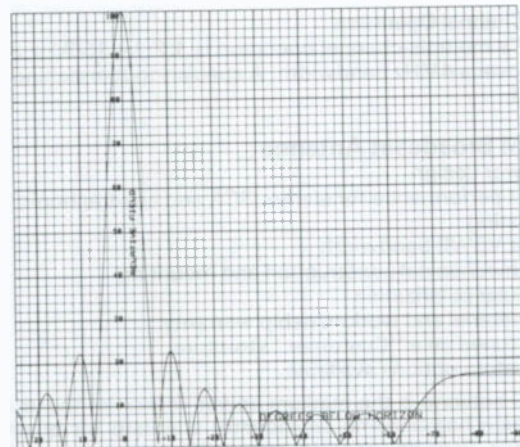

Special patterns per your requirements can be computer synthesized and tested on our quarter-scale range. Approximate Aperture for DCP-B Antenna: 10 (X-1) + 7.21 in feet; 120 (X-1) + 86.5 in inches; X = Number of Levels in System

Electrical Specifications

VSWR: 1.20:1 across 20MHz of FM band

Typical Patterns

Azimuth

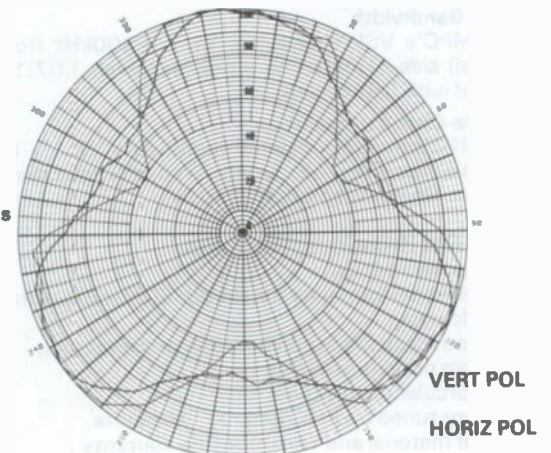



JBBP Broadcast FM Antenna

- Balanced omni-directional CP FM antenna
- 1 symmetrical pattern
- Superior frequency stability, lower VSWR
- Superior axial ratio
- Broadband element
- High power capabilities
- Multi-station applications
- 2-year material and workmanship warranty

The JBBP antenna has a frequency range tuned to 1 frequency from 88-108MHz. The free space azimuth circularity pattern is ± 2 dB. The power gain is based on half wave dipole in free space. Radomes are white gel coated over reinforced fiberglass. Stainless steel hardware is provided. Under normal environmental conditions deicing is not required. Up to $\frac{1}{2}$ " radial ice will produce a typical VSWR of 1.5:1. If required, 500W per bay at 50/60Hz 500. Radome is used where extreme icing occurs.

Power Rating

The JBBP has a power rating of 40kW per element.

VSWR Bandwidth Capability

The JBBP's VSWR rating is $1.1:1 \pm 200$ kHz from factory (per channel) side-mounted on a pole or tower, $1.07:1 \pm 200$ kHz per channel with field tuning.

Multiple-Channel Operation

The JBBP's multiple-channel operation is $1.2:1 \pm 150$ kHz at given channels over a 4MHz bandwidth. A special input matching device is required.

JMPC FM Broadcast Antenna

- High power design
- Excellent performance for stereo, SCA and quadraphonic broadcasting
- Excellent VSWR bandwidth
- Rugged mechanical construction and mounting
- True circular polarization
- 2-year material and workmanship warranty
- Factory-tuned on a "Customer" structure
- Many custom options available

The JMPC antenna is the medium power version of the JHPC antenna, which has become an industry standard for quality and performance. Each bay consists of a JHPC style radiating element with a $1\frac{5}{8}$ " shunt feed line supported by a galvanized steel mounting bracket; standard round leg mounting brackets for a uniform face tower are included with each antenna. Silver plated inner conductor connectors are used throughout for maximum contact life and minimum power loss.

Power Rating

The JMPC antenna has 10kW input power.

VSWR Bandwidth

The JMPC's VSWR rating is $1.1:1 \pm 200$ kHz from factory (per channel) side-mounted on a pole or tower, $1.07:1 \pm 200$ kHz per channel with field tuning.

Multiple-Channel Operation

The JMPC's multiple-channel operation is $1.2:1 \pm 150$ kHz at given channels over 4MHz bandwidth. A special input matching device is required. Contact factory for details.

JHPC FM Broadcast Antenna

- High power design
- Excellent performance for stereo, SCA and quadraphonic broadcasting
- Rugged mechanical construction and mounting
- Custom options available
- True circular polarization
- Factory-tuned on a "Customer" structure
- 2-year material and workmanship warranty

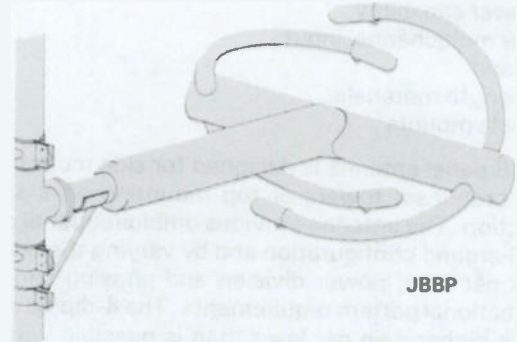

JBBP

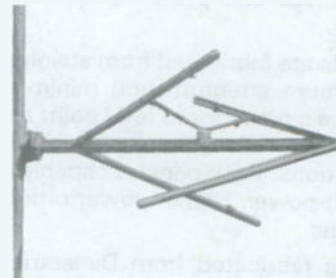

JMPC



JHPC

The JHPC antenna is an improved version of a circularly polarized FM broadcast antenna that has become the industry standard. Each bay consists of a radiating element with associated $1\frac{5}{8}$ " flange, and both element and line are bolted to the mounting bracket for that bay. The interbay feed lines are joined by $3\frac{1}{8}$ " flanges, using inner conductor connectors for maximum contact life and minimum power loss.

The patented radiating element consists of 4 quarterwave arms attached to a support boom, which also contains the element feed. A tuning cap, incorporating a large-radius tip, is supplied on each arm, which eliminates corona while facilitating field tuning.

The antenna system is fabricated of heavy gauge marine brass and copper throughout. The interbay line and element boom are pressurized up to the feed point by the transmission line pressurization system, with a pressure relief valve at the top of the antenna.

Power Rating

The JHPC has a power rating of 15kW per element.

VSWR Bandwidth Capability

The JHPC's VSWR rating is $1.1:1 \pm 200$ kHz from factory (per channel) side-mounted on a pole or tower, $1.07:1 \pm 200$ kHz per channel with field tuning.

Multiple-Channel Operation

The JHPC's multiple-channel operation is $1.2:1 \pm 150$ kHz at given channels over 4MHz bandwidth. A special input matching device is required. Contact factory for details.

6014PB Broadband High Power Circularly Polarized Antenna

Stations over the entire FM band can be combined into the 6014PB. Frequency changes or station additions involve no changes to the antenna.

The natural characteristics of a panel-style antenna can yield excellent circularity for wide area metropolitan coverage or a wide variety of directional patterns.

The power handling of the 6014PB is conservatively rated at 15kW average, 100kW peak, per panel; therefore an 8-level, 3-around configuration would have an average power rating of 360kW, far higher than conventional rigid coax sizes could deliver.

The 6014PB has an excellent strength-to-windload ratio. The panels are approximately 8' square. Panels and radiators are constructed entirely of stainless steel for durability, no maintenance and high strength. VSWR—1.1:1 or better across entire FM band.

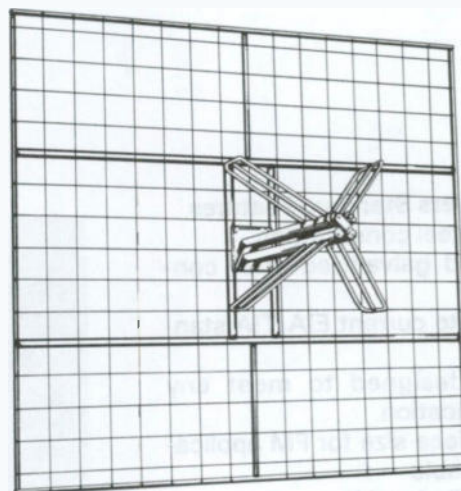

6014PB

6810 High Power Circularly Polarized Antenna

The 6810 has a 10kW power rating per bay and is an excellent choice for most class C stations. Maximum input for an array of 4 or more bays is 40kW due to its feedline rating. The broad bandwidth of the 6810 assures stereo and SCA performance. It also allows 2 stations, with a frequency separation of up to 2.4MHz, to diplex into a common antenna.

The 6810 is also unusually capable of being accurately directionalized and so is used for formal directional antenna requirements. With hundreds in service worldwide, the 6810 provides the high power FM broadcaster with a well proven, reliable antenna. VSWR—1.08:1 ± 100kHz for single station operation.

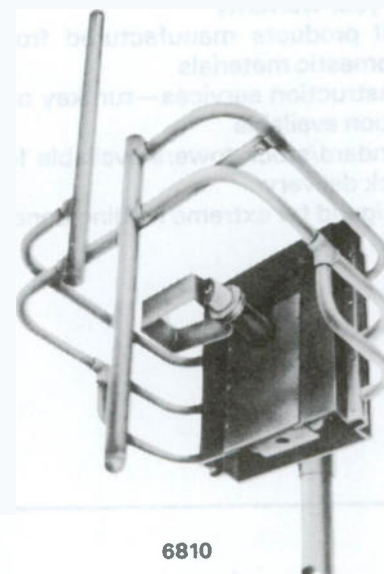

6810

6813 Medium Power Circularly Polarized Antenna

The 6813 has a 3kW per bay power rating and is competitively priced to offer an exceptional value to the medium power FM broadcaster. This antenna has proven to be the primary choice of the Class A broadcaster. The 6813 has extremely low windloading; its windload with radomes compares favorably to that of other similar antennas without radome protection.

This model also has a broad bandwidth, assuring excellent stereo and SCA performance. In fact, in certain close-spaced situations, the bandwidth has allowed 2 stations to be diplexed into this model without degradation of stereo or SCA performance on either station. If the high power (3 1/8") input is used, a maximum power input of 20kW is possible (12 or more bays). Hundreds of these antennas are now in service around the world. VSWR—1.08:1 ± 100kHz

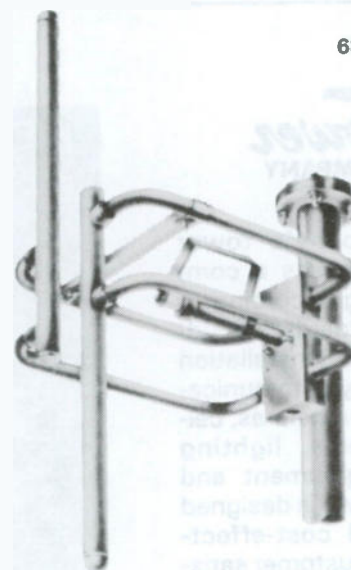

6813



CENTRAL TOWER, INC.

TOWERS

Central Towers Standard Features

- All-solid steel construction
- Hot-dipped galvanized after construction
- Designed to current EIA/TIA standards
- Custom designed to meet any wind application
- Reduced face size for FM applications available
- Fully certified welders
- 5-year warranty
- All products manufactured from domestic materials

Construction services—turnkey operation available

Standard/stock towers available for quick delivery

Designed for extreme loading conditions

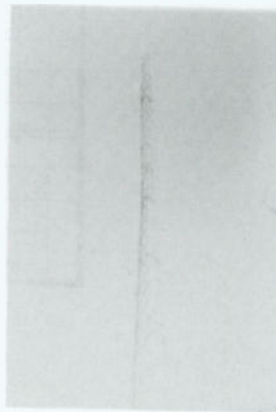

Series SS/SRX

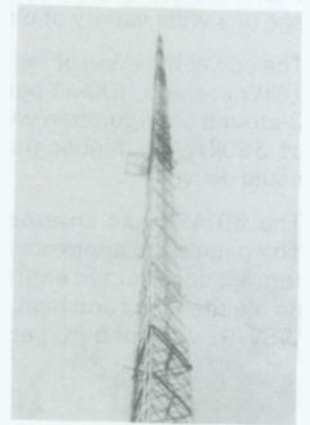

Series 6024

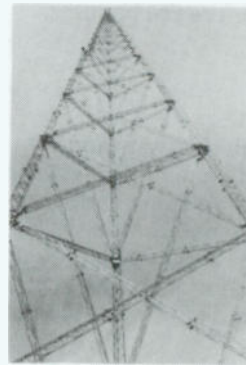





Series SS/STX

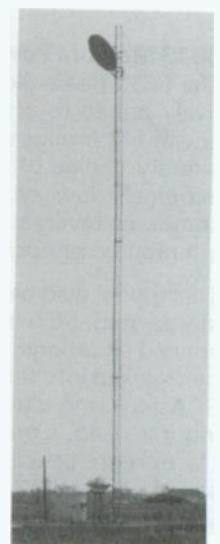
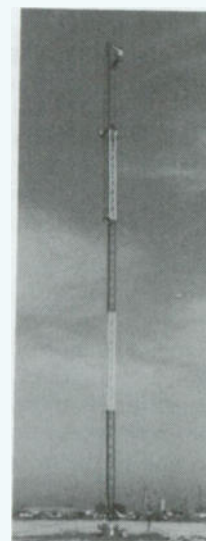
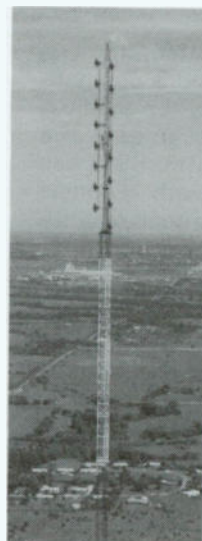
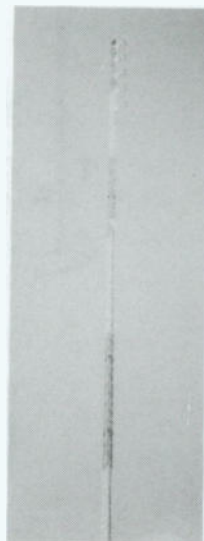

Utility Tower Company's tower product line encompasses a complete product offering according to current industry standards, including the manufacture and installation of AM, FM, TV, 2-way communication, microwave relay, antennas, cellular, ground systems, lighting systems, lighting equipment and coaxial lines. Each tower is designed with an eye toward cost-effectiveness and a goal of customer satisfaction.

Call for Custom Quotations

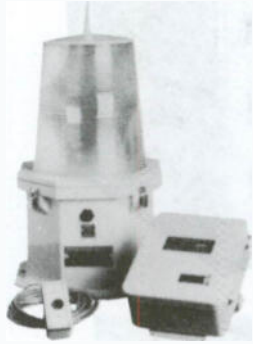

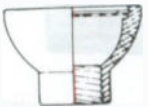
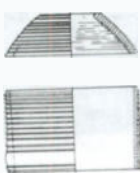
	300mm BEACON & ACCESSORIES (FAA L-864)	
	Part No.	Description
	KG114 300mm Type R	300mm Beacon With Red Lens
	KG114 300mm Type F	300mm Beacon With Clear Lens and Red Filter
	KG114 300mm Type G	300mm Beacon With Clear Lens and Green Filter
	Shipping Weight: 75 lbs.	
	MEDIUM INTENSITY STROBE (FAA L-865)	
	Part No.	Description
	KG225 Type W	Medium Intensity Strobe FAA Type L865
	C6A1004AA2	Flash Tube Replacement
	LH620120GE	GE 620W 120V Beacon Lamp
	LH62010SYL	Sylvania 620W 120V Beacon Lamp
	LH620120HDT	Durotest 620W 120V Beacon Lamp
	LH620130GE	GE 620W 130V Beacon Lamp
	LH620125HDT	Durotest 620W 125/130V Beacon Lamp
	LH700120HDT	Durotest 700W 120V Beacon Lamp
LH700125HDT	Durotest 700W 125/130V Beacon Lamp	
	FC02A300B	Filter Red Color Beacon
	FC04A300B	Filter Yellow Color Beacon
	FC08A300B	Filter Green Color Beacon
	B6A0301AB	Beacon Breather Assy 1/2"
	B6A0301AD	Beacon Breather Assy 3/4"
	B6A0301AE	Beacon Breather Assy 1"
	BEACON REPLACEMENT PARTS	
	GL2034R	Dome Lens Red
	GL2035R	Upper Lens Red
	GL2036R	Lower Lens Red (2 required)
	GL2034F	Dome Lens Clear
	GL2035F	Upper Lens Clear
	GL2036F	Lower Lens Clear (2 required)
	BA7125	Beacon Gaskets Kit (9 gaskets)
	WC2029	Internal Wire Kit
	XL2025	Beacon Lamp Recerptical
LRB58L7510M	Lightning Rod & Base	

KTL Antenna Phasing Systems

High quality components are used throughout the KTL phasing systems. All fixed and variable inductors are manufactured in-house based on designs that have proven to yield long life in the field. Depending on the RF amperage rating, the coil windings either consist of edgewound silver-plated copper ribbon or silver-plated copper tubing terminated at each end with silver-soldered end terminals. The interconnecting RF buses are made of silver-plated $\frac{3}{8}$ " O.D. copper tubing and the coil adjustment straps are made of .032" thick x $\frac{5}{8}$ " wide silver-plated copper ribbon. Insulators are steatite type. Mica capacitors manufactured by Sangamo and vacuum capacitors manufactured by Jennings are used as specified in the design. Variable components in the phase and power dividing networks have counter dials to insure accurate resetability. All variable components are preset to design values prior to shipment.

The phasor may be configured in either a cabinet or on open panel(s) in accordance with the transmitter building layout as specified by the customer. The input connections from the transmitters and dummy load will be provided at the top of the cabinet/panel, unless otherwise specified. Transmission line connections may be provided at either the top or bottom of the cabinet/panel. Cable terminating clamps will be incorporated for input and output connections to the phasing and power dividing networks as well as the line terminating units (LTU's) unless other connectors are specified. J-plugs will be provided at each end of each transmission line, as well as at the output of each LTU, in order to facilitate the use of an operating impedance bridge. Also to aid the field engineer in the phasor tune-up, a detachable shelf that mounts on the rear of each bay of the phasor cabinet is provided to support RF bridge equipment.

The LTU's are fabricated in weatherproof housings or on aluminum panels depending on the design specifications. In the LTU weatherproof housing the transmission line is typically brought in at the bottom left and the antenna feed is coupled through a bowl insulator mounted on the upper right side of the box. A solid stud bowl insulator is provided with each open panel LTU to allow for coupling of the antenna feed through the doghouse wall. Horn gaps are available upon request to provide added lightning protection. A double J-plug is incorporated in the output leg of each LTU to allow the RF thermocoupler ammeter to be plugged into the line only when base current measurements are desired. This avoids the possibility of the meter being damaged by lightning. Delta sampling transformers and/or base current meters can also be installed in each of the LTU's upon request.

The switching of the day and night operation or directional and non-directional operation is accomplished by means of an indicating type pushbutton switch on the front panel. When the pushbutton is actuated the system automatically removes the plate voltage or carrier drive of the transmitter before switching and restores it when the interlock switching is completed. The fully interlocked doors on the phasing and power dividing cabinet serve to remove the transmitter plate voltage when they are opened. The control system is equipped with a tally light system which indicates the position of each RF contactor. When switching from day and night or directional and non-directional operation the tally lights indicate if all contactors switched or which one failed to complete the switching mode. Relays are also provided to allow for 24VDC remote control operation via one of the currently available remote control systems.

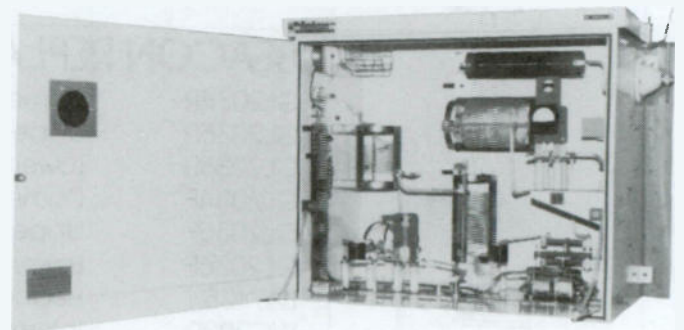
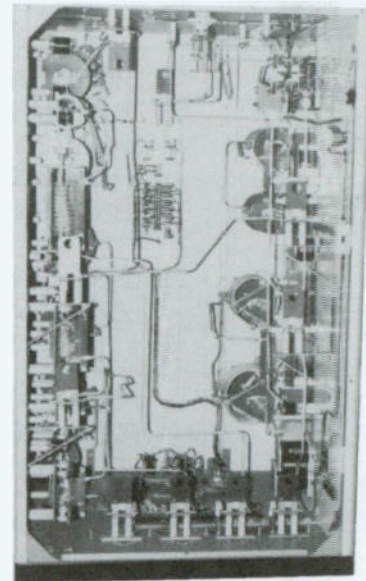
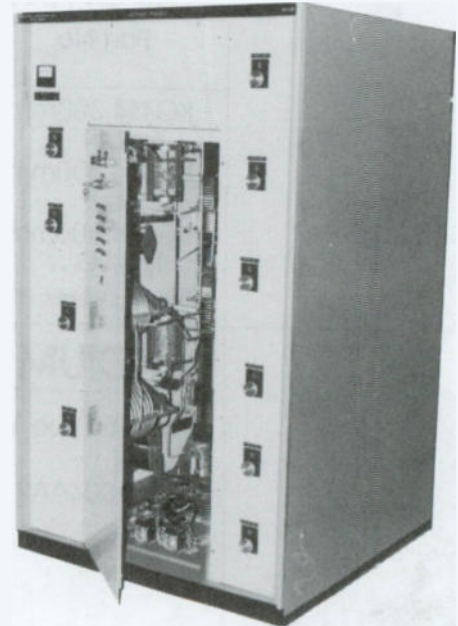



Diesel Fueled Electric Generating Sets

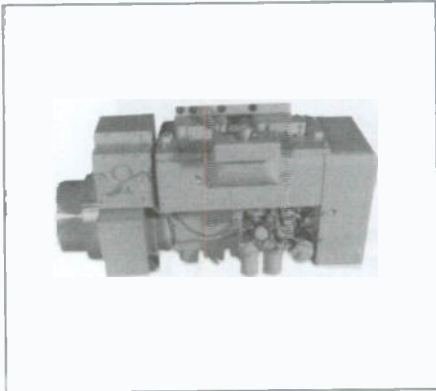

12kW

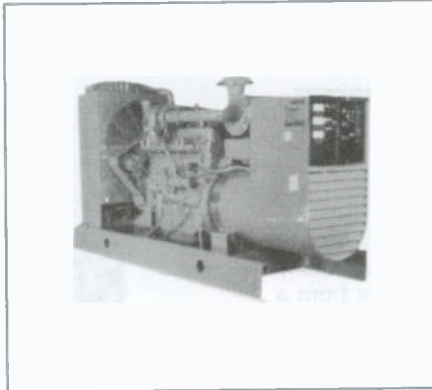

150kW



750kW

Thoroughly tested, Onan diesel generating sets are complete and ready for installation and a long-running life. The revolving field, broad range, 4-pole, 12-lead reconnectable brushless alternator is engineered for minimum reactance, low distortion of the voltage waveform and

maximum efficiency. The unique solid-state voltage regulation system automatically matches the torque of the engine to that of the alternator, preventing engine stall on surge and momentary overloads.

Optional Accessories

- Weather-protective housing • Trailers • Water jacket heaters • Additional meters • Factory mounted line circuit breakers

Standard Voltages	
50Hz	60Hz
110/190, 115/200, 115/230, 220/380, 230/400	120/208, 127/220, 120/240, 139/240, 240/416, 254/440, 277/480, 347/600
Additional Voltages Available	

Diesel Genset Representative Models*

kW Rating 60Hz	Length (in.)	Width (in.)	Height (in.)	Weight (lbs.)	kW Rating 60Hz	Length (in.)	Width (in.)	Height (in.)	Weight (lbs.)
3.0	30.3	19.7	26.2	348	150.00	100.7	33.0	50.7	3300
6.0	33.4	18.4	26.1	485	175.00	121.5	44.0	69.5	6120
12.0	46.8	19.5	26.1	710	200.00	115.5	44.0	71.5	5930
15.0	56.6	27.0	40.1	940	250.00	115.5	44.0	71.5	6320
20.0	63.4	31.5	39.4	1125	300.00	120.0	55.0	71.5	7837
25.0	63.8	26.5	41.8	1500	350.00	120.0	55.0	71.5	8220
30.0	64.7	33.0	45.6	1780	400.00	138.2	68.6	88.8	10910
45.0	76.7	31.0	52.5	2095	450.00	138.2	68.6	88.8	11220
50.0	80.2	33.0	46.5	2800	500.00	138.2	68.6	88.8	11675
60.0	81.8	33.0	46.5	2800	600.00	154.0	68.6	97.1	15500
75.0	82.8	33.0	46.5	2800	750.00	154.0	68.6	97.1	16500
100.00	94.5	33.0	50.7	2800	1000.00	178.0	77.0	93.5	20000
125.00	98.7	33.0	50.7	3000					

*Approximate dimensions. Available in 50Hz.

Phasemaster® T-Series Rotary Phase Converter
Operates 3-phase broadcast transmitters from a single-phase source. Regulates stinger leg of Open-Delta Service.

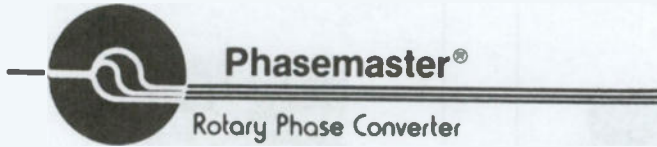

Phasemaster

Description and Application

The Phasemaster T-Series Rotary Phase Converter is a single to 3-phase transformer and phase generator which is specifically engineered to operate 3-phase broadcast transmitters from a single-phase supply. It is very economical in areas not served by utility 3-phase lines. The Phasemaster converter is built in a range of sizes for all AM, FM and TV transmitters. Standard converter ratings range from 1-50kW and can be operated in parallel to produce any desired power output.

The Phasemaster converter will power any transmitter without any reduction in performance. It is extremely efficient and requires minimal maintenance. The converter has been used extensively on broadcast transmitters for over 25 years and has a very successful field service record.

The Phasemaster converter is particularly cost effective as compared to the total cost of bringing in new utility lines and offers the following benefits:

- Immediate availability of 3-phase power
- Elimination of utility installation and demand charges
- Reduced utility line transients
- Stabilization of open-delta systems

Performance Features

- Phasemaster produces true 3-phase output which is virtually identical to utility 3-phase
- The converter output voltage is balanced within a range of 2-5% of the incoming single-phase line
- Built-in voltage control minimizes AM noise
- The Phasemaster buffers voltage spikes and other power line transients
- Integral lightning protection
- The converter can operate continuously 24 hours per day indefinitely with or without load
- Phasemaster converters require very little maintenance
- Optional automatic controller package allows remote on/off

Dimensions (inches)

Model Number	Length L	Width W	Height H	Ship Wt. (lbs.)
T-1300	14.81	15.09	17.00	145
T-2000	15.17	16.72	20.06	190
T-2500	16.67	16.72	22.06	227
T-4000	19.68	19.00	25.88	365
T-5000	20.56	22.06	27.88	430
T-7500	22.06	22.06	27.88	497
T-8000	22.32	23.66	29.69	640
T-10000	23.32	23.66	29.69	788
T-12000	24.68	25.81	33.50	905
T-14000	26.18	26.96	33.50	950

Information Required for Sizing

Each Phasemaster converter application is sized to the specific characteristics of the transmitter. The following data is essential to assure proper operation:

- Transmitter type, AM, FM, TV
- Manufacturer's model number and kW rating
- Total input power consumption (kW) at rated output power on FM or 100% modulation on AM
- Incoming line voltage and type of service
- Hours of operation
- Site elevation

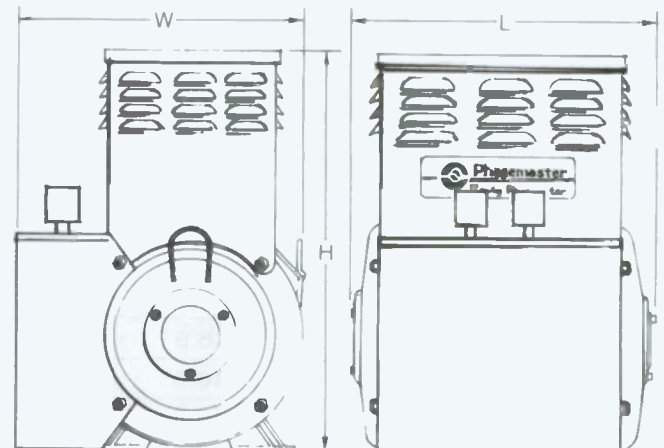

TC-8 Remote Control System

- Full-time control • Simplified operation for non-technical operators
- Easy-to-read dot-matrix display • Fast, simple installation • Built-in sub-carrier generators at no extra cost • Optional antenna monitor interface allows monitoring of up to 6 towers using only 2 channels—1 each for phase and ratio • Optional computer interface • Ideal for AM or FM facilities with 1 or 2 transmitters • 8 analog metering channels • 8 status channels • 16 control outputs (8 raise, 8 lower) • Failsafe output also provided which may be used to ensure positive control • Pushbutton calibration • Calibrations are retained in non-volatile memory (EEPROM) • Includes 1 studio unit, 1 transmitter unit and 1 set of modems to connect by telco, STL, SCA or TRL
- Specify method of interconnection and include desired subcarrier frequencies for STL or SCA links • SCA links also require an SCA receiver to recover telemetry

SSI Studio Status Indicator—Installs in studio unit and provides open collector outputs to drive lamps, buzzers or other user-supplied indicators from the 8 status channels. Not compatible with CI-8 option.

CI-8 Computer Interface—Installs in studio unit and connects the TC-8 system to any PC-compatible computer. Provides auto-logging, full access to all control functions and full screen display of metering and status. Includes software. Requires IBM compatible computer with monitor, 256K RAM, 1 floppy disk drive and serial port. Printer optional.

ARC-16 2-Unit Remote Control System

- Full-time studio control, dial-up control, or both • Studio controller displays clear text prompts for non-technical operators • Dial-up speech unit features digitally-recorded human voice • Built-in subcarrier generators at no extra charge • Built-in alarms • Optional computer interface • Control multiple sites with a single unit • 16 analog metering channels, 16 status channels and 32 control outputs (16 raise, 16 lower) • Transmitter unit with a 32-character display for easy calibration and local operation • Includes 1 studio unit, 1 transmitter unit and 1 set of modems to connect by telco, STL, SCA or TRL • Specify types of modems and include desired subcarrier frequencies for STL or SCA links • SCA links also require an SCA receiver to recover telemetry

ARC-16SA Stand Alone System—Includes transmitter unit with front panel display and calibration, plus DSU (Digital Speech Unit). Provides complete call-in remote control, metering and status information, as well as call-out reporting of user-defined alarm and metering limits conditions.

ARC-16CI Single Unit With Computer Interface—Similar to ARC-16SA with CI-16 installed instead of DSU. Provides complete control through RS-232 interface when used with any PC-compatible computer.

ARC-16SA/CI Single Unit for Speech and Computer—Similar to ARC-16SA with CI-16. Provides both speech and computer access.

DSU Digital Speech Unit—Installs in any studio or transmitter unit for call-in access of all metering, status or supervisory control functions, or as backup. User defined alarms and limit conditions initiate call-out of up to 9 telephone numbers. Password protected at 2 levels for security.
Note: The DSU is included in the ARC-16SA.

CI-16 Computer Interface—Installs in any studio or transmitter unit and connects the ARC-16 to any PC-compatible computer. Provides auto-logging, full access to all control functions and full screen display of metering and status. Color or monochrome monitors supported. Includes software. Requires IBM compatible computer with monitor, 256K RAM, 1 floppy disk drive and serial port. Printer optional.

DSU/CI-16 Combination Speech/Computer Unit—Combines the DSU and the CI-16 options on a single card for installation in either a studio or transmitter unit.

SSI-1 Studio Status Indicator—Add to studio unit to drive an external set of user-supplied alarms, buzzers or indicators. Provides 16 independent open collector outputs driven by the first transmitter site status channels.

SSI-2 Studio Status Indicator—Same as SSI-1 except monitors the second transmitter site.

Note: An SIO may also be configured to serve as an SSI. Up to 2 SIOs or SSIs in any combination may be installed in 1 unit.



TC-8

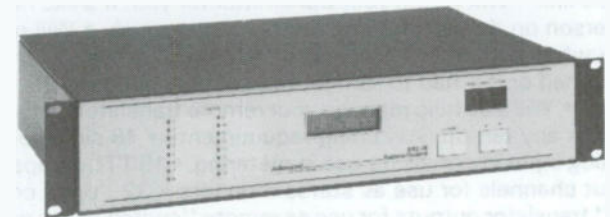

ARC-16

Accessories for Both TC-8 and ARC-16

AMI Antenna Monitor Interface—Allows phase and ratio metering of up to 8 towers. Compatible with most analog antenna monitors including Potomac, Gorman/Redlich and Delta. Required for 4 or more towers.

IP-8 Interface Panel—Provides barrier strip connections for 8 metering inputs, 8 status inputs and 8 each raise and lower outputs, plus fail-safe. All outputs are isolated with 10A, Form C (NC, NO) contacts. 1 panel is required for every 8 channels. Mounts on rear rack rails for easy access.

Note: Some transmitters will accept the open collector outputs directly from the remote control. You may still choose to use the IP-8 Interface Panel for the convenience of the barrier strip connections and to provide total isolation.

FMA Front Mount Adaptor—A set of black finish sheetmetal brackets with 10-32 hardware for mounting an IP-8 where rear rack rails are not available.

SCA-1 Subcarrier Receiver—Required when telemetry return is via an SCA channel on an FM carrier. Specify main carrier frequency and subcarrier frequency when ordering. External antenna is required.

Multi-Site Options

ARC-16S Additional Studio Unit—Includes control terminal with display and modem to connect to existing transmitter or studio unit. Please specify type of modem and include desired subcarrier frequencies for STL or SCA links. Requires additional modem and 2-port adaptor, described below, for existing unit. SCA links also require an SCA receiver to recover telemetry.

ARC-16T Additional Transmitter Unit—Includes 16 channels of analog inputs, 16 channels of status and 32 control outputs (16 raise, 16 lower). Also includes modem to connect to existing transmitter or existing studio unit. Specify type of modem and include desired subcarrier frequencies for STL or SCA links. Requires additional modem and 2-port adaptor, described below, for existing unit. SCA links also require an SCA receiver to recover telemetry.

TPA 2-Port Adaptor—Required to add an additional site to the system. 1 unit in the system must connect to both of the other units. In addition to the 2-port adaptor, a modem must be specified.

SIO Studio Input/Output Option—Provides 16 control outputs (8 raise, 8 lower), 8 analog metering channels and 8 status inputs for controlling and monitoring equipment at the studio site. 2 SIOs may be installed for a total of 16 channels.

LX-1 6-Input Stereo Selector

- Select air program from studio, automation, satellite or tape • Control from front panel, studio or remote control • Start automation or tape with machine-follow outputs • Eliminate patching for alternate air program sources • Mix sources for 2-studio dialogue • Match IHF or PRO inputs • 6 inputs • Frequency response 20Hz-20kHz • Maximum level + 28dBm with nominal + 4dBm • Soft-switch time 3.5ms

VRC-2000 Remote Control Unit

- For controlling your broadcast transmitter from anywhere a telephone line, radio link, data link or bi-directional audio link is available
- Access from any Touch Tone® telephone to communicate with the synthesized voice. It will provide full-time data and automatic logging capabilities on a terminal or IBM® or compatible personal computer. If there are no telephone lines to your transmitter, you can use a radio link or any bi-directional audio link
- Will watch your transmitter for you. It's like having a person on duty at the transmitter continuously
- Will notify you when something goes out of tolerance, when security is breached or if it had to turn on the standby because the main failed
- Will also help manage your remote translator site or will handle any remote switching requirements
- 16 single-ended analog input channels for use in metering
- 16 TTL compatible input channels for use as status monitors
- 32 "open collector" transistor outputs for use as remote "switches" to generate control commands
- 32 outputs are configured as 16 separate "Command Channels" with 2 outputs per channel—an "A" output and a "B" output



VRC-2000

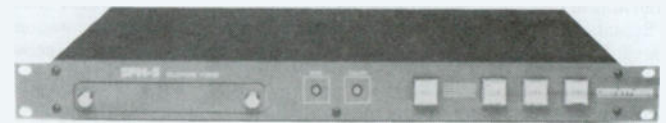

SPH-5

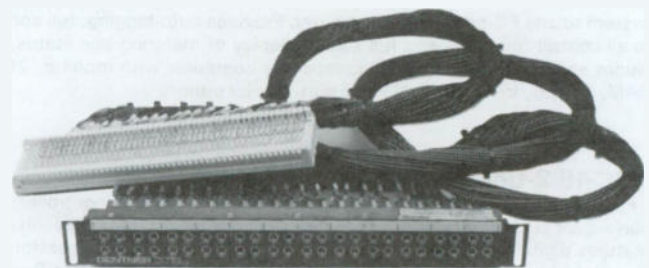

Pre-Wired Patch Panels

SPH-5 Analog Telephone Hybrid

- Provides both excellent hybrid null and high sonic quality
- With the push of a button, the SPH-5 can send a call to your tape recorder, automatically starting and stopping the machine
- Cue button allows you to talk to callers on-air and off-air. When depressed, the cue button allows you to speak with callers off-air, press the button again to place calls on-air
- Full duplex for boardroom or meeting facility. The cue button acts as a privacy switch, preventing mixer audio from going down the line
- Caller control reduces caller audio level when your talent or moderator speaks. The level of caller reduction can be set from no reduction to almost full cutoff
- Quiet connection
- Fully remotable, rear panel DB connectors

Pre-Wired Audio Patch Panels

- High-quality components (Switchcraft, ADC or equivalent)
- 22-gauge shielded pair stranded wire for flex strength (Belden 8451 or equivalent)
- Numbers at both ends of each cable, protected with clear heatshrink
- Combined wire bundle for neat appearance and easy handling
- Extensive testing prior to shipment

Bay Types:

24SR: 24 tip-ring-sleeve jacks (single row); 1 3/4" x 19" (1 rack unit); Gentner designation system; offset jack spacing; ADC PJ393 or Switchcraft 1334B

26SR: 26 tip-ring-sleeve jacks (single row); 1 3/4" x 19" (1 rack unit); Single designation system; offset jack spacing; ADC PJ396 or Switchcraft 1534B

48DR: 48 tip-ring-sleeve jacks (double rows of 24); 2 1/8" x 19" (non-standard rack space); Gentner designation system; offset jack spacing; ADC PJ391 or Switchcraft 2534B

52DR: 52 tip-ring-sleeve jacks (double rows of 26); 1 3/4" x 19" (1 rack unit); single designation strips for each row; even jack spacing; ADC PJ390 or Switchcraft 2734B

78MR: 78 tip-ring-sleeve jacks (3 rows of 26); 2 5/8" x 19" (non-standard rack space); third (monitor) row provides non-interruptive monitoring; single designation strips; even jack spacing; ADC PJ397

96BA: 96 tip-ring-sleeve Bantam jacks (double rows of 48); 1 3/4" x 19" (1 rack unit); single designation strips for each row; offset jack spacing; ADC PJ739 or Switchcraft 1634B

Versapatch chassis enclosed patch panel with Flexiblock or "66" block termination on the rear panel. The ideal solution for last minute patch panel needs. Standard 1/4".

Jack Types:

T-R-S Tip-ring-sleeve jack

T-R Tip-ring jack (sometimes referred to as tip-sleeve jack)

Wiring Of Normals

BO Normals brought out to termination

AB Normals wired at the bay using a short jumper

TRB Normals are bridged so top row may be used for non-interruptive monitoring

Patch Panel Terminations

FB-100 Gentner Flexiblock Accepts stranded or solid wire, 2 x 50 terminals, 2 connection slots per terminal insulation displacement (punch) connection

ET/FB-1 Easy/Term/Flexiblock Rackmount termination, 320 terminals, 2 connection slots per terminal, accepts stranded or solid wire, entire panel swings out for equipment access, locks down with thumbscrew

PU Punch Block Siemens 66B3-75 (66B3-50 also available)

3 x 50 terminals (2 x 50 for 66B3-50), insulation displacement connection

XT Christmas tree 6 x 26 terminals, solder connection

BB Barrier block 24 terminals, crimp connection

NT No termination stub ends, numbered cables

STL-10 Aural Broadcast

Studio-Transmitter Links Intercity Relay

• Unexcelled stereo separation, noise and distortion specs • High interference rejection receivers • Backup reliability of SCPC stereo • Full 10W output power • Ga As FET low noise amplifier • Available for narrow channels • Matched phase and amplitude • Provision for automatic switching • 12V battery operation • Selectable 0, 25, 50 or 75µs emphasis • FCC Approved under Parts 74 and 94, FCC ID: BEN9EZSTL-10/950 • Up to 4 subcarriers per stereo system • Accurate watt meters for forward and reflected power

STL-10 Transmitter Specifications

Frequency Range: 600-960, 400-480, 280-340, 200-260, 140-180MHz

RF Power Output: 15W 200-480, 10W 600-960MHz 50 ohms

Carrier Frequency Stability: ± .00025%, 0°C to +50°C

Type of Modulation: Direct FM

Audio Input: Balanced 600 ohms + 8dBm, barrier strip. BNC connector for unbalanced input

Subcarrier Inputs: 2 BNC connectors for remote control and subcarrier inputs, 50 to 600 ohms unbalanced

Power Requirements: 120/220VAC, 50/60Hz. 80W. 13.5VDC 2.6A, 24-28VDC 2.6A

AC Power Supply: Precision, electronically regulated with current limiting

Spurious Emission: More than 60dB below carrier

Automatic Changeover: Provision for Automatic Changeover

Accessory Connector: 15-pin connector on rear panel provides filtered outputs for remote control, automatic changeover, remote power metering and external DC power

Metering: Calibrated RF wattmeter reads forward and reflected power. Test meter reads main channel peak modulation, subcarrier level, supply voltage, PA current, RF Drive 1 and RF Drive 2

Dimensions: 3 1/2" H x 19" W x 14" D

Weight: Net 11 lbs.

RF Connector: UG-58



STL-10 Transmitter



R-10 Receiver

R-10 Receiver Specifications

Frequency Range: 600-960, 400-480, 280-340, 200-260, 140-180MHz

Input Impedance: 50 ohms

Frequency Stability: ± .00025%, 0°C to +50°C

Spurious Response: -90dB 200-480MHz, -70dB 600-960MHz

Audio Output: Balanced 600 ohms, + 10dBm, barrier strip. BNC connector for unbalanced output

Subcarrier Outputs: 2 BNC connectors for remote control and/or subcarrier outputs

Front Panel Controls: 10dB attenuation switch, program level adjust, meter switch, squelch adjust

Power Requirements: 120/220VAC, 50/60Hz. 10W

AC Power Supply: Precision, electronically regulated with current limiting

Metering: RF signal level, audio output level, subcarrier output level, + 13VDC supply, LO level, mixer level. LED indicators for power and open squelch

Dimensions: 3 1/2" H x 19" W x 12" D

Weight: Net 10 lbs.

RF Connector: UG-58

51 Stereo STL System

2 STL-10/950 transmitters, 2 R-10/950 receivers for STL, 1 HRC-10 transmitter combiner, 1 MTS-10 receiver combiner

50 Mono System

1 STL-10/950 transmitter, 1 R-10/950 receiver for STL

STL-10/R-10 Radio Link Application and System Specifications

SYSTEM NO	APPLICATION	FREQ RANGE MHz	CHAN BW KHz	SCPC STEREO OFFSET FROM C.F. ± KHz	FCC EMISSION DESIGNATOR	FCC PART	OPTIONAL SUBCARRIERS (NUMBER) KHz	TX PWR. WATT	TX FM DEV. ± KHz	REQUIRED RECEIVER SIGNAL (UV) FOR QUIETING			SYSTEM			CHANNEL SEPARATION DB	EQUIPMENT PACKAGE
										50 DB	60 DB	ULT	MAIN CHANNEL RESPONSE	T.H.D. < %	ULT. NOISE -DB		
1	FM Stereo STL	945-952	500	125	180KF8E (2) each	74	(2) 39.67.92	10	50	3 0	10	80	±0.25 DB 20Hz-15KHz	0.25	-80	-80	51
2	FM Stereo STL	945-952	300	62.5	80KF8E (2) each	74	(1) 39	10	20	8 0	25	130	±0.25 DB 20Hz-15KHz	0.3	-72	72	51
3	AM Stereo STL	945-952	200	50.0	80KF8E (2) each	74	(1) 26	10	15	8 0	25	130	±0.3 DB 20Hz-15KHz	0.3	-72	-72	51
9	Audio Data 1-4 Channels*	200-480	100 200	each each	export export	-- --	(1) 39 (2) 39.67	15 15	15 15	8 0 10	25 30	120 130	±0.3 DB 20Hz-15KHz	0.3	-72	-72	53- 55

*For 2 or more channels on export frequencies, use separate TX Yagi antennas spaced 60dB.

RPT-30 Remote Pickup Broadcast Transmitter

- Frequency range and maximum power output: 140-180MHz — 45W; 200-260MHz — 40W; 280-340MHz — 35W; 400-480MHz — 30W
- Frequency switch selects both frequency and deviation, preventing operator error and interference
- Subaudible encoder activates repeaters or other equipment simply by a single switch (standard equipment on all Marti RPUs)
- Illuminated meter displays compressor gain reduction, relative power output or power supply voltage
- Flashing LEDs indicate antenna VSWR problems and over-temperature condition
- Automatic modulation control by built-in FM compressor-limiter
- 4 balanced microphone mixing inputs, 1 switchable to balanced line level
- Continuous duty, broadcast quality
- FCC type accepted
- Compatible with Marti mobile repeater, fixed automatic repeater and base station

RPT-30 Single frequency
RPT-30-2 Dual frequency

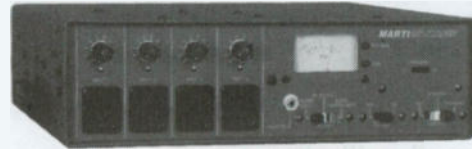

RPT-30

RPT-15 Portable Mobile/Airborne Transmitter

- 400-480, 280-340, 200-260 and 140-180MHz
- Type accepted on all VHF-UHF RPU channels
- 15W continuous output
- Dual frequency capability
- Subaudible encoder
- Built-in metering
- Built-in AC supply
- FM compressor-limiter
- Mic and line mixing inputs
- MCS-800 companding option available

RPT-15 is a compact 15W transmitter designed for portable and mobile remote broadcast service. It delivers the maximum power allowed by the FCC for airborne remotes such as traffic reports. The RPT-15 has a built-in power supply for operation on 115VAC. It will also operate on an external 12-14VDC supply. The subaudible encoder enables use with Marti mobile repeaters and automatic repeaters.

RPT-15 Single frequency
RPT-15-2 Dual frequency

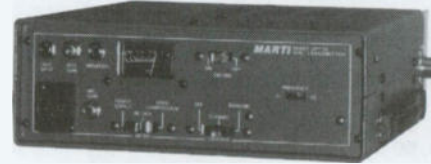

RPT-15

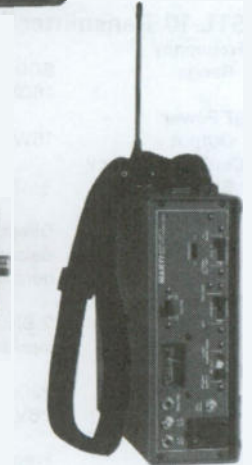

RPT-2

RPT-2 Hand-Carried Transmitter

- Type accepted on all VHF-UHF RPU channels
- 2.5W continuous output
- Dual frequency provision
- Subaudible encoder
- Built-in metering
- 3-way power option
- Internal NiCad battery
- Internal charger and AC supply
- FM compressor-limiter
- Mixing mic and line mixing inputs

The RPT-2 is a hand-carried, broadcast quality, continuous duty transmitter. It will operate from its internal NiCad battery, from 115VAC power, or from external 12VDC power. A special subaudible encoder enables the RPT-2 to access Marti mobile repeaters for coverage of indoor events. 2.5W is the maximum power allowed by FCC Rule 74.431 (C) (1).

RPT-2 Single frequency without internal battery
RPT-2-2 Dual frequency without internal battery
RPT-2 Single frequency with internal battery
RPT-2-2 Dual frequency with internal battery

CR-10 Remote Pickup Receiver

- Rackmounted VHF or UHF base station receiver
- Dual frequency capability built-in
- 90dB spurious rejection
- GaAs Fet low noise RF amplifier 200-480MHz
- Double balanced mixer
- 4 IF bandwidths
- Companding option available
- 6-function illuminated test meter
- Built-in tone decoder and relay
- Monitor speaker and control
- All modular construction

CR-10-D Single frequency with decoder board
CR-10/2-D Dual frequency with decoder board

AR-10 Mobile Relay Receiver

- Potable or mobile repeater receiver
- Built-in AC power supply
- Will operate from an external source of 12-15VDC
- Built-in subaudible tone decoder meets FCC Rule 74.431, allowing this receiver to automatically turn on a mobile transmitter upon receiving an encoded signal from a hand-carried portable transmitter, thus automatically relaying a broadcast to the base station receiver over a greater distance
- Operates on all remote pickup frequencies and bandwidths
- Built-in dual frequency capabilities, monitor speaker and terminals for feeding telephone lines in portable operations
- Special noise reduction circuit provides an improvement of 6dB in S/N ratio for weak signals
- 5 1/2 lbs.

AR-10 Single frequency
AR-10-2 Dual frequency

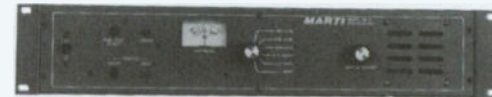

CR-10

RPU Accessories

Crystal	High-accuracy for RPU transmitters and receivers
APS-28/18	Airborne power supply 28-18VDC for RPT-15
040-001-1	Internal battery for RPT-2 transmitter
040-009	Portable battery for RPT-15 transmitter with belt strap, case and charger
580-116	AC power cord for RPT-2, RPT-15, RPT-30, AR-10 and CR-10
585-069	DC power cord for RPT-2 transmitter with connectors
585-070	DC power cord for RPT-15 transmitter with connectors
585-074	DC power cord for RPT-30 transmitter with fuse and cable
700-251	Mobile mounting kit for RPT-30, 4 mounting fasteners with DC power plug, fuse and cable
700-252	Mobile mounting kit for RPT-15 or AR-10
700-253	Rackmounting kit for RPT-30 transmitter
800-278	Audio companding boards for RPT-2, RPT-15 or RPT-30 transmitters ONLY (2 boards) and AR-10, 8R-10, CR-10 or DR-10 receivers ONLY (1 board). NOT FOR OTHER MODELS
633-6	Duplexer with cables to connect AR-10/450 receiver and RPT-30 transmitter to common antenna. MOBILE USE ONLY
WP-678	Duplexer with cables to join CR-10 and RPT-15 or RPT-30 to common line and antenna. USED WITH FIXED AUTO RELAY. UHF ONLY
RMH-3	Rack shelf for mounting RPT-2 transmitter
RMH-38	Rack shelf with fan for mounting RPT-15
TR-2	Coaxial switching unit required in RPT-15 if used for base station or mobile 2-way communications
TR-3	Antenna relay for RPT-30 for 2-way operation

TSL-10 Telemetry Systems for Part 94, 928-960MHz

- 4 continuous data/voice channels on single carrier
- Multiple receive sites possible
- 25kHz, 50kHz, 100kHz, 200kHz bandwidths available
- Transmitter FCC authorized for Part 94 service. FCC ID: BEN9EZSTL-10/950
- Battery backup available with the UPS-12

If you are serious about data/voice transmission (TSL, ICR, TRL, etc.), you should look at Part 94 "Private Operational-Fixed Microwave Service" in the 928-960MHz band. Bandwidths of 25, 50, 100 and 200kHz are available to broadcasters for many uses except the final link of an STL. These frequencies are professionally data base coordinated interference-free channels for reliable communications. Marti has been providing FCC authorized equipment for this service over the past years. Bandwidths are licensed based upon demonstrated need: the wider channels reserved for wideband FM, high data rate or multichannel uses. Marti multichannel systems are not time-shared, which means that data flows continuously on each channel. License application is on Form 402.

Package 94-1 Single Channel

1 STL-10 Transmitter, 1 R-10 Receiver

Package 94-2 2 Channels

1 STL-10 Transmitter, 1 R-10 Receiver, 1 Subchannel

Package 94-3 3 Channels

1 STL-10 Transmitter, 1 R-10 Receiver, 2 Subchannels

Package 94-4 4 Channels

1 STL-10 Transmitter, 1 R-10 Receiver, 3 Subchannels



STL-10



CR-10



R-10

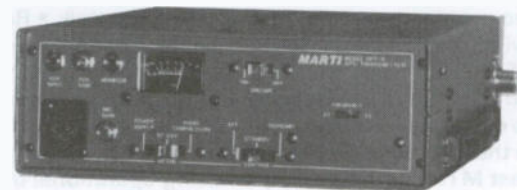

RPT-15

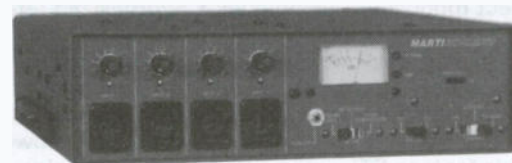

RPT-30

TSL-15/TSL-30 Telemetry Systems for Part 74, 450-456MHz

- Choice of transmitter power 15 or 30W continuous duty
- Transmitters are FCC type accepted
- Super selective receiver with 90dB spurious rejection
- Test meter built into both transmitter and receiver
- Receiver has adjustable squelch and carrier operated relay
- Built-in modulation control
- Internal AC supply in transmitter and receiver with provision for external DC operation
- Optional automatic station identifier
- Analog or digital telemetry or voice modulation in 50Hz-2800Hz band
- Mic and line level inputs with mixing controls
- Built-in 27Hz status channel with relay contacts

The TSL-15 and TSL-30 telemetry links provide reliable telemetry circuits for AM, FM and television stations. Expensive and unreliable Telco lines can now be replaced with cost effective Marti TSL systems. These links are simple to install, easy to operate and maintain. Marti has assembled complete equipment packages consisting of transmitter, receiver, yagi antennas, identifier and optional items. Package prices do not include cost of 2 "N" female and 2 "N" male connectors and 1/2" transmission line.

Specifications

Frequency: (Group P) 450.01, 450.02, 450.98, 450.99, 455.01, 455.02, 455.98, 455.99MHz, FCC 74.402 (a) (7)

Modulation: 10F3 (± 1.5 kHz deviation)

Frequency Response: 50Hz-2800Hz ± 2.0 dB

Distortion: 2% THD

S/N Ratio: 45dB

TSL-30 Package (30W)

1 RPT-30/450 Transmitter, 1 CR-10/450 Receiver, 1 1300 Station Identifier, 1 700-253 Rackmounting Kit

TSL-15 Package (15W)

1 RPT-30/450 Transmitter, 1 CR-10/450 Receiver, 1 1300 Station Identifier, 1 RMH-3B Rack Shelf

Part 74 TSL Antenna Package

2 YC 450 Yagi Gain Antennas, 1 PG-2A Jumper Cable, 1 PG-2B Jumper Cable, 1 K-1 Weatherproofing Kit

DSP 6000 Digital Transmission System

- CD-quality digital STL • Features internationally-accepted digital connectivity, multichannel capability and harmonious coexistence with analog radios • Constant SNR • 80dB crosstalk • No background chatter • No phase distortion • Multiple hops • Direct digital I/O • 90dB dynamic range • 140MHz-1900MHz frequency range • Built-in V.35/RS-422 interface • 4 audio and 2 data channels • System consists of the DSP 6000E encoder, the DSP 6000D decoder and a digital-ready STL transmitter and receiver

DSP 6000E • AES/EBU stereo 16-bit linear PCM data input for direct digital interface

DSP 6000D Comprehensive bit-error rate monitoring • AES/EBU output for direct digital interface

MRC-1620 Microprocessor Remote Control System

- Consists of a remote terminal that allows an optional control terminal or IBM PC with Taskmaster 20 software to monitor and control a remote facility from both dedicated and/or dial-up control points • Built-in internal 1200 baud modem to communicate over dedicated circuits • 2 special system test channels • System setup and calibration are done at the remote terminal with 8 color-coded buttons • Equipped with 32 relay-isolated command outputs, 16 TTL status inputs and 16 analog metering inputs with the required terminal connectors • Programmable from 1 to 9999 minutes

PCL 6000 Series Studio Transmitter Links

- Monaural or composite operation • 2 PCL 6000 systems can be used in a dual discrete configuration to transmit right and left stereo programs with no measurable crosstalk • Receiver IF bandwidth can be factory or field set for channel spacing of 100kHz-500kHz • Both the PCL 6010 transmitter and PCL 6020 and 6030 receivers employ a synthesized reference oscillator to eliminate fixed-frequency crystals • Physical module count on the PCL 6000 Series has been kept to a minimum for the highest MTBF without compromising operational or maintenance ease • All oscillators, up converters and discriminator audio sections can be individually isolated by appropriate jumpers for alignment or repair

PCL 6010 Transmitter

- Uses direct modulation techniques • Synthesized reference oscillator used for FM generation • Conversion of the transmitter FM-modulated oscillator frequency to the final output is done via an up converter mixer technique • Optional extended baseband available for users conveying 67kHz and 92kHz FM SCA through baseband • Optional 15W transmitter power output available for long STL paths • IF repeater technology available for STL paths requiring a midpoint

PCL 6020 Receiver

- Dual conversion PCL 6020 receiver uses an FM quadrature detector to provide maximum fidelity • Excellent selectivity characteristics ignore adjacent channels in your area • Receiver IF bandwidth can be set for channel spacing of 100kHz-500kHz, depending on RF congestion and channel availability • Built-in transfer circuitry allows automatic changeover to a standby receiver in the event of a detected malfunction • Front-panel meter indicates true RF input level in microvolts, program output level, subcarrier level, oscillator levels and supply voltages • When used in conjunction with the optional composite stereo generator and built-in stereo decoder, the PCL 6020 is an excellent choice for AM stereo



6000E



6000D

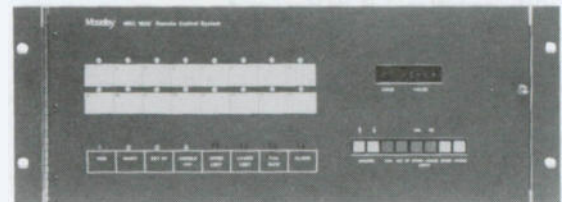

MRC-1620

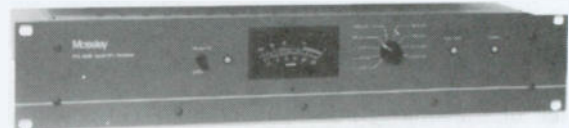

PCL 6020



PCL 6010/6030

PCL 6030 Receiver

- Triple conversion PCL 6030 receiver uses a digital pulse counting discriminator to provide extremely low distortion and low noise characteristics • Excellent selectivity characteristics ignore adjacent channels 20dB stronger than your received signal • Front-panel meter allows the monitoring of several parameters, including RF input in microvolts, audio and subcarrier outputs, power supply and oscillator levels • Built-in automatic changeover circuitry included for hot standby operation • Receiver IF bandwidth can be set for channel spacing of 100kHz or 500kHz, depending on RF congestion and channel availability

**8300 Series Broadcast Quality Composite
950MHz Aural Studio Transmitter
Link and Intercity Relay System**

• Improved S/N ratio • Better stereo separation • Reliable operation in dense RF signal environments • Unique IF repeater capability • Automatic hot-standby switchover (optional) • Tested to customer specified operating frequency

8300 Series Transmitter

• Direct locked RF carrier • IF modulation between 60 and 80MHz • Fully protected against short and open circuits and high VSWR • Wide baseband bandwidth • RF power output 4W minimum, 14W maximum • ± 50 kHz deviation for 100% modulation • Frequency stability better than 0.0001% 0°C to 50°C

8300 Series Receiver

• Surface acoustic wave filter is used to eliminate phase distortion and provide superior selectivity • Pulse-counting discriminator provides ultra-linear FM demodulation • Selectable IF bandwidth • Selectable high or low gain RF amplifier

8300 5116-8300 composite transmitter

83018 5116-83018 narrow/wideband (250kHz)

composite receiver

7100-3780 (Option 1) spare parts kit for 8300 series

7100-3710 (Option 15) stereo decoder module

7100-3790 (Option 16) extended baseband response, permits STL to convey 92kHz SCA channel

7100-4071 (Option 22A) IF repeater option for 8300

7100-4070 (Option 22B) IF repeater option for 83018

9100 Composite Aural STL Transmitter

• Frequency synthesized—provides accurate and stable carrier frequency; operating frequency is field programmable • IF modulation—0.02% THD, 85dB SNR and 55dB stereo separation. USA patent No. 4,710,970 • Composite baseband—accommodates full stereo baseband, including 2 additional SCAs and/or MUXs. Allows processing equipment to be located at the studio for ease of operations and maximum modulation • Provision for optional plug-in SCA generator • Provision for hot standby operation—interface to optional auto changeover unit for full STL transmitter redundancy • Provision for DC operation—+12V optional • IF interface STL option—provides interface so standard FM exciter specifications can be used at the studio as the only modulator in the system for superior performance in TFT reciter applications • Built-in audio processor/stereo generator option—provides L, R input to complement L, R output in AM stereo and other applications • FCC type-notified—950MHz board meets all FCC requirements. FCC Notification No. BIO9100

9100 5116-9100 Frequency synthesized composite transmitter, including self-contained power supply and tested to customer specified operating frequency (944-952MHz standard in 12.5kHz steps)

9100S 5116-9100S Model 9100 with built-in stereo generator and audio processor

9107 5116-9107 Frequency synthesized composite receiver, including self-contained power supply and automatic receiver changeover unit and tested to customer specified operating frequency (944-952MHz standard in 12.5kHz steps)

7100-4204 (Option 01) spare parts kit for 9100 series

7100-3710 (Option 15) stereo decoder module

7100-3790 (Option 16) extended baseband response, permits STL to convey 92kHz SCA channel

7100-3572 (Option 24) plug-in SCA decoder board, specify audio or sub-carrier output frequency

7100-4227 (Option 25) plug-in SCA generator board, specify audio or subcarrier input frequency

9200/9205 Series Monaural Studio-to-Transmitter Link

• Frequency synthesized transmitter and receiver • Optimized for stereo or dual mono with redundancy • 0.2% THD, 70dB SNR, 80dB channel separation • Internal phase and gain matching for excellent stereo performance • Designed for channel allocations as little as 75kHz and 150kHz • Spurious free, on-channel power amplification • Economical built-in subcarrier generator and demodulator (optional) • Interface to transmitter automatic changeover • Built-in automatic changeover in receiver

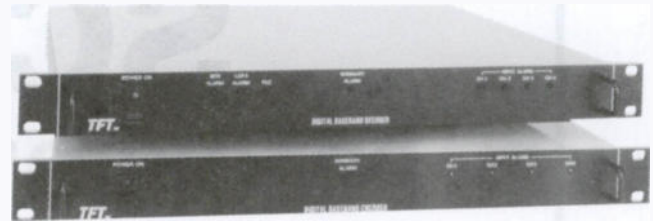

DMM-92

9200	5116-9200	Frequency synthesized monaural transmitter including self-contained power supply and tested to customer specified operating frequency (944-952MHz standard in 12.5kHz steps)
9205	5116-9205	Frequency synthesized monaural receiver including self-contained power supply, automatic receiver changeover unit and tested to customer specified operating frequency, 200kHz channel spacing (944-952MHz standard in 12.5kHz steps)
9205N	5116-9205N	100kHz narrow channel version of Model 9205, 100kHz channel spacing
7100-4224	(Option 01)	spare parts kit for 9200 series
7100-3572	(Option 24)	plug-in SCA decoder board, specify audio or sub-carrier output
7100-4227	(Option 25)	plug-in SCA generator board, specify audio or subcarrier input

8900 Reciter™

• Phase, frequency and modulation level synchronization between main and booster transmitters (8900) • STL receiver and FM exciter in 1 to improve sound quality • 0.02% THD, 85dB SNR and 55dB stereo separation • Directly synthesized from STL frequencies to FM broadcast frequencies (88-108MHz) • Maintains ± 2 PPM exciter frequency stability • Adjustable RF power output from 5 to 50W

8900 5116-8900 Reciter with booster synchronization module

8910 5116-8910 Reciter, IF interface STL receiver and FM exciter (88-108MHz)

Option 01 Booster synchronization option (casing to be exchanged)

8920 5116-8920 digital delay line

8921 5116-8921 19kHz time base generator

7100-4225 (Option 02) IF repeater option for Reciter

8888 RPU System

• RPU transmitter and receiver are frequency synthesized for maximum versatility in the N1, N2 and S frequency bands • 2 operating frequencies are programmed by internal DIP switches and are front panel selectable • Allows you to select ± 5 kHz, ± 10 kHz or ± 25 kHz frequency deviation depending on frequency band or occasion • Selection of receiver bandwidths is possible via front panel switch or DTMF signal • Full audio frequency response • Versatile DTMF control is provided for receiver activation, bandwidth and deviation selection, and security • Enables you to change the RF power output via rear panel switch to suit your needs • Switching power supply for lightweight, cool operation

8888 5116-8888 25W transmitter (specify frequency)

8889 5116-8889 receiver (specify frequency)

7100-4189 (Option 01) DC option for 8889

2001-2937 (Option 02) 19" rack shelf for 8888

7100-4188 (Option 03) 27Hz tone generator for 8888

DMM-92 Spectrally Efficient Digital STL Modem

• Provides transparent delivery of audio and data signals from studio to transmitter in less than 200kHz of occupied bandwidth • Digital audio transmission via analog radios—requires only 75kHz of composite baseband for use on existing STL systems without modification • 4 digital channels—256K bytes/sec., 2 x 64K bytes/sec., 0-9600 bytes/sec. provide left, right and 2 SCAs plus transmitter remote control • Adaptive signal equalization • Forward error correction • Comprehensive status alarms • Provision for multiple clock rates—internal and/or external • Compatible with existing analog STLs

SCALA

PRECISION ANTENNAS

- VHF AND UHF TELEVISION MONITORING
 - LOW POWER TELEVISION SYSTEMS (TO 1kW)
 - TV AND FM TRANSLATOR SYSTEMS
 - AURAL STL AND RELAY SYSTEMS
 - RPU AND TELEMETRY LINKS
 - RADIO COMMUNICATIONS (40-1000MHz)
 - CATV SYSTEMS

FOR MORE THAN 25 YEARS SCALA HAS DESIGNED AND MANUFACTURED HIGH-PERFORMANCE RUGGEDIZED ANTENNAS AND ARRAYS FOR THE BROADCAST, CATV AND COMMUNICATIONS INDUSTRIES THROUGHOUT THE WORLD. THE MECHANICAL AND ELECTRICAL DESIGN OF EVERY SCALA ANTENNA PRODUCT ASSURES YOU OF MAXIMUM VALUE, PERFORMANCE AND RELIABILITY. YOU ARE WELCOME TO CONTACT CONTINENTAL FOR TECHNICAL INFORMATION AND PRICING ON OUR FULL LINE OF QUALITY ANTENNA PRODUCTS.

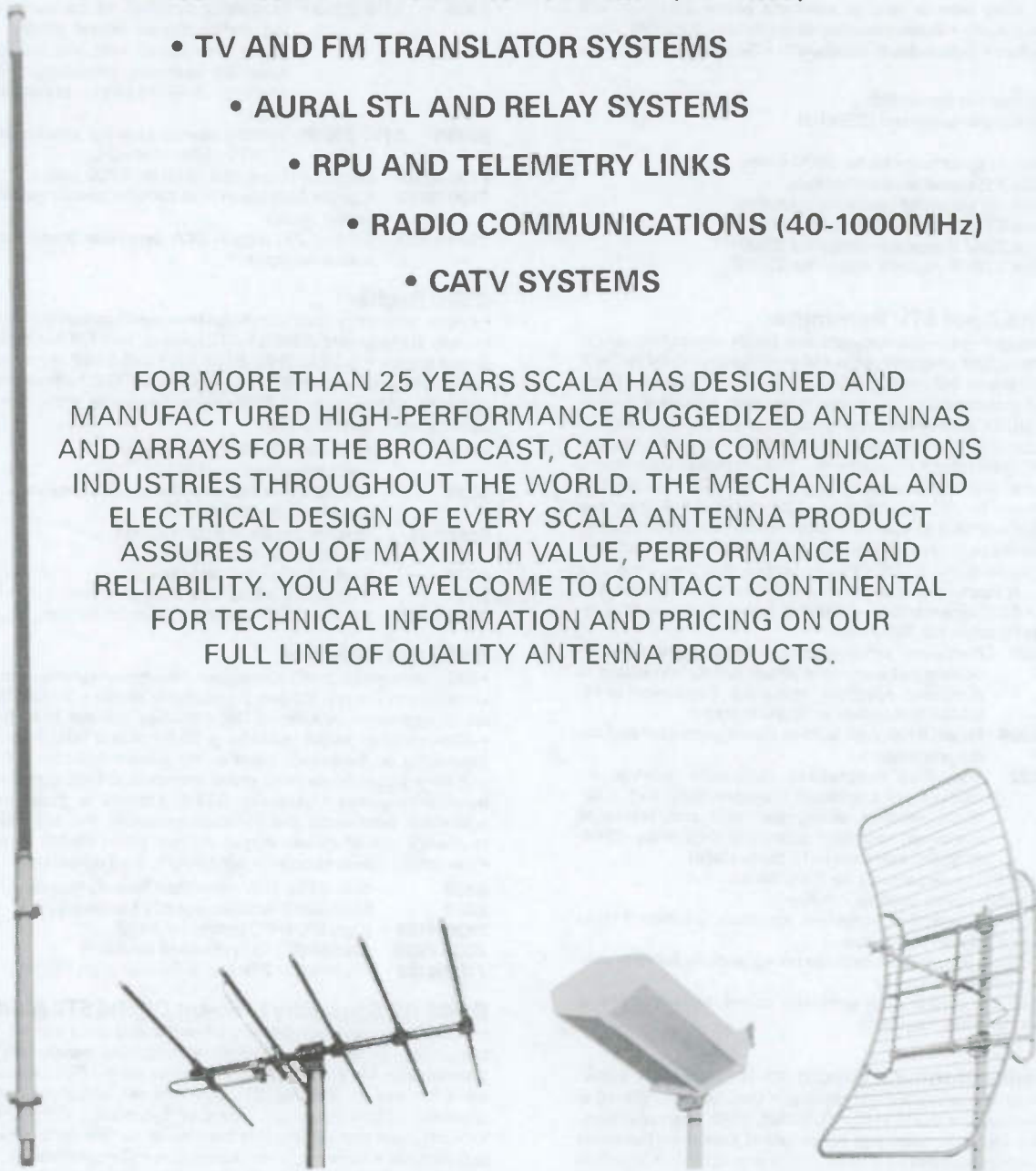

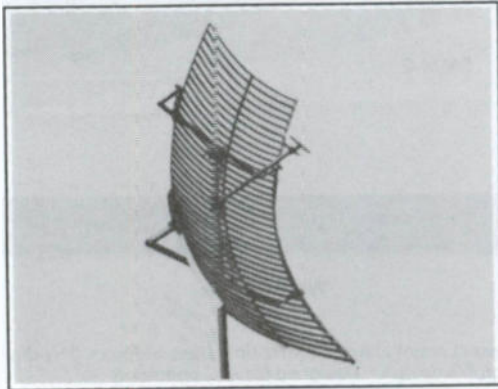

UPS Shippable Super Short Haul

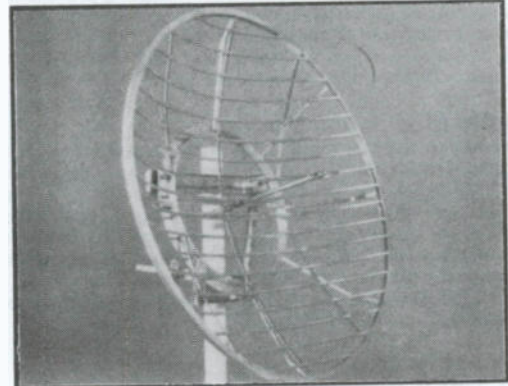

900MHz

940-960MHz

Diameter FT. (M)	Model Number	Part 74 FCC CAT.	Gain/DBi			B/W DEG	F/B RATIO	VSWR	CROSS POL.
			Low	Mid	High				
Grid Antennas									
4 (1.2)	P-9A48G	B	19.1	19.2	19.3	19.25	22	1.30	25
6 (1.8)	P-9A72G	A	22.0	22.1	22.2	12.5	24	1.30	25
8 (2.4)	P-9A96G	A	24.4	24.5	24.6	8.7	24	1.30	26
10 (3.0)	P-9A120G	A	26.9	27.0	27.1	6.6	27	1.30	26
12 (3.7)	P-9A144G	A	27.7	27.8	28.9	5.8	26	1.30	26
15 (4.6)	P-9A180G	A	30.5	30.6	30.7	4.7	32	1.30	26
Short Haul Antenna									
6 (1.8)	SH-9A72G	B	19.4	19.5	19.6	20.0	20	1.30	19
Super Short Haul Antenna (UPS Shippable)									
6 (1.8)	SSH-9A72G	(V)A (H)B	19.9	20.0	20.1	10.0 19.0	29 24	1.10 1.30	21 28
Solid Antennas									
3.5 (1.1)	P-9A42	-	17.2	17.2	17.3	20.5	28	1.30	25
4 (1.2)	P-9A48	B	19.0	19.1	19.2	19.25	27	1.30	26
6 (1.8)	P-9A72	A	22.0	22.1	22.2	12.5	26	1.30	20
8 (2.4)	P-9A96	A	24.9	25.0	25.1	9.3	29	1.30	24
10 (3.0)	P-9A120	A	26.7	26.8	26.9	7.6	31	1.30	25
12 (3.7)	P-9A144	A	27.9	28.0	28.1	6.0	35	1.30	30

Feed Input Flange: N Female or 7/8" EIA Available



AMM-2B AM Modulation Monitor

- Measures total modulation characteristics of AM broadcast transmitters
- Input circuitry is non-frequency discriminating • Suitable for measuring shortwave and VHF transmitter modulation • Metering provisions allow direct measurement of carrier level deviation and modulation • Adjustable peak modulation flasher provided along with fixed 125% peak positive and 99% peak negative indicators • Modulation calibrator and carrier level alarm provided • Direct replacement for the AMM-2A

AMM-3 AM Modulation Monitor

- Measures AM transmitter modulation characteristics over a frequency range of 200kHz to 160MHz • Utilizing true ratio-type peak indicators and unique modulation cancellation circuitry, modulation peaks are referenced to unmodulated carrier for extremely accurate program peak indication • 2 meters provide for simultaneous positive and negative modulation, along with individual thumbwheel programmable peak flashers • Fixed 125% peak positive and 100% peak negative indicators also provided • Metering of carrier level and AM noise provided, as well as built-in modulation calibrator and remote outputs for all indicators

AMM-4 AM Frequency Monitor

- 10kHz to 50MHz frequency range • LED readout displays a range ± 1999 Hz deviation from the assigned channel • Front panel indicators warn of low RF level, loss of carrier and ± 10 Hz/ ± 20 Hz off-frequency conditions • Logic outputs duplicate all front panel indicators, optional relay circuit assembly available for ease of interface for ATS and alarm requirements

Option 01 3-alarm relay card

RFA-2 AM RF Amplifier

- Provides the required signal level for Belar AM Modulation and Frequency Monitors when the monitors are located remotely from the transmitter site
- Requires whip or loop antenna (Belar LP-1 Loop Antenna recommended)
- AGC range — more than 30dB — allows proper operation of monitors when transmitter power or antenna patterns are changed

AM Equipment

- MP-6B Remote meter panel for AMM-2B
- MP-7 Remote meter panel for AMM-3
- LP-1 Shielded loop antenna
- LP-1A Shielded loop antenna, built-in preamplifier for RFA-2
- OPTION 01 power supply for LP-1A
- AS-1 Audio sentry

FMM-2 FM Modulation Monitor

- Ultra-linear digital discriminator • Digitally selectable peak indicator, adjustable in 1% increments from 1% to 199%, independent of modulation polarity • Built-in voltmeter for AM and FM noise measurements • Carrier alarm with front panel indicator • 2 wideband outputs • True peak or semi-peak metering • Separate fixed 100% modulation indicator • High visibility rear-illuminated meter measures modulation characteristics of monaural as well as multiplexed FM transmitters • Low distortion and low noise FM demodulator drive companion stereo and SCA monitors • Provides audio outputs for aural monitoring and proof-of-performance measurements

Option 01 Peak weighting module, 5 time constants plus FCC mode

FMS-2 FM Stereo Modulation Monitor

- 2 independent semi-peak modulation meters for simultaneous monitoring of left and right channels • Front panel switchable deemphasis for noise measurements • Pilot alarm with front panel indicator • Outputs for audio proof-of-performance measurements • 2 auto-ranging voltmeters with LED displays for 0dB to -80dB range measurements • Stereo separation measurement capability of over 70dB at 15kHz • High visibility rear-illuminated meters • Operates in conjunction with FMM-2 baseband modulation monitor • Used for test functions in conjunction with FMM-2 to ensure proper performance of FM stereo transmitters • 2 independent auto-ranging voltmeters, allowing automatic measurement of channel separation and crosstalk along with subcarrier suppression and noise • Front panel hold button can be used to lock autorange to displayed range

FMM-4A FM Digital Frequency Monitor

- RF/LO input • IF input (when LO is used) • ± 1 kHz off-frequency alarm
- ± 2 kHz off-frequency alarm • Low level alarm • RF/LO selector switch
- Average counts selector switch • ± 500 Hz off-frequency alarm • Low

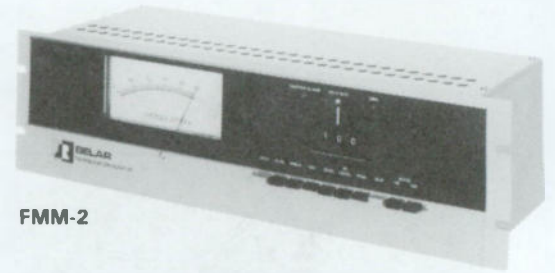

FMM-2



WIZARD

- level alarm • Invalid count alarm • 6MHz time base output • 3 1/2-digit LED display • Low profile design • Designed for ATS operation
- Option 01 8-alarm relay card
- Option 02 Module for interfacing alarms with the WIZARD

SCM-2 SCA Modulation Monitor

- When added to the FMM-2 the system provides complete monitoring and test functions for SCA storecasting, data transmission and remote telemetering applications • Up to 4 crystal switch positions allow 4 channels to be operated and tested

RFA-1A FM RF Amplifier

- Sensitive, high gain, all solid-state preamplifier • Designed for off-air monitoring of both monaural and multiplexed FM transmitters • Amplifies signal to a level suitable for input requirements of Belar FM modulation monitors
- 650kHz IF output • 10.7MHz and LO outputs for use with FMM-4A FM Digital Frequency Monitor • S/N 85dB (500 μ V input) • Harmonic distortion <0.03% at 1kHz, 75kHz deviation • Third adjacent channel selectivity 46dB • AGC • 1 rack unit high

RFA-4 Frequency Agile FM RF Amplifier

- Performance of the RFA-1A, but frequency agile • 10 memory presets • 12-character alphanumeric display shows preset, channel frequency and user-programmed call letters • Enter any frequency directly, or scan up and down
- Option 01 Module for interfacing RFA-4 with WIZARD. Allows remote access to the RFA-4 with the WIZARD and WIZARD software. Displays channel frequency and call letters on the PC. Change presets, enter and frequency from the PC

FMMA-1 WIZARD™ FM Digital Modulation Analyzer

- Menu-driven 16-character alphanumeric display • Deviation in percent — 0.1% or 1% increments • Deviation in kHz — 0.1kHz or 1kHz • Up to 0.1% accuracy — function of demodulator calibration • Self-calibration to external calibrating signal • Pre-set peak modulation — adjustable in 0.5% increments • Pre-set ppm — adjustable from 0 to 100 ppm • Variable peak hold time • Peak weighting mode • Real time mode or past time mode • Provision for pilot injection measurement and pilot modulation measurement from FMS-2 • Provision for SCA injection measurement from SCM-2 • Silent sentry alarm adjustable in time and threshold • Will accept external alarms • Alarms read on menu • Modulation adjust on 2 ports, adjustable in 0.5% increments • RS-232 port provides computer graphs and remote operation • 3-level password protection • Either infinite window histogram or sliding window histogram • 1 rack height panel space, including precision demodulator
- Option 01 Precision FM demodulator with calibrator (IF input)
- Option 02 Down converter and AM noise detector (specify frequency)

FM Accessories

- MP-8 Combined remote meter panel for FMM-2 and FMS-2
- MP-9 Remote meter panel for FMM-2
- MP-10 Remote meter panel for SCM-2
- PWM-1 Peak weighting module (5 time constants plus FCC mode)
- AS-1 Audio sentry (loss of program alarm)



***C-QUAM® AM STEREO SYSTEM**

ASE-1 AM Stereo Exciter

ASM-1 AM Stereo Modulation Monitor

The C-QUAM Stereo Exciter and Stereo Modulation Monitor produce an AM stereo quadrature modulated signal having superior separation and low distortion throughout the audio spectrum. The ASE-1 Exciter and ASM-1 Monitor C-QUAM System is completely compatible with existing monaural receivers and multimode decoder receivers.

The C-QUAM stereo transmission system is a full spectrum system providing separation from 50Hz to over 10kHz. Its signal can be demodulated by simple envelope detectors to produce a low distortion monophonic audio signal while stereo receivers demodulate the same signal to full stereo.

The ASE-1 C-QUAM Exciter produces the signals needed for stereo operation of an AM broadcast transmitter. From stereo audio input, the Exciter generates an audio drive signal for the transmitter's modulator and stable RF signal to replace the transmitter's internal crystal oscillator output.

ASE-1 Exciter circuitry includes all required processing features. Limiters are provided to prevent excessive positive and negative modulation. A blend processor makes high single-channel modulation possible by blending a little of each channel with the other. Additional processing is not necessary. Unlike FM stereo, C-QUAM AM modulation does not require pre-emphasis.

Meters and convenient controls simplify use of the ASE-1. Large lighted meters display either left and right audio levels or L+R and L-R audio levels, in dB and percentage modulation. The mode switch selects stereo or mono operation. The pilot switch controls the 25Hz tone, allowing the tone to be turned off as required in testing. The switch labeled Day/Night selects 1 of 2 audio equalization circuits, adjusted to match separate, alternate transmitters. The equalization circuits also can be remotely selected through contacts on the rear panel.

The ASM-1 Stereo Modulation Monitor houses a high performance C-QUAM decoder which demodulates the RF sample. The ASM-1 provides all the demodulated signals necessary for annual proof of performance when used with standard AM proof equipment.

The demodulated signals available on the rear panel of the monitor include L+R, L-R, envelope detector output and Left and Right audio, both balanced and unbalanced. The 25Hz pilot tone used in the C-QUAM system also is available on a rear panel connector.

Front panel meters display the pushbutton selected parameters: positive and negative L+R, L-R, L and R modulation levels. Peak flashers indicate -100%, +125%, L-R limit and negative limit modulation conditions. 2 additional thumbwheel controlled peak flashers can be set to flash at any desired level of modulation. The modulation meters and the thumbwheel controlled peak flashers are accessible through rear panel connectors for remote indication.

Specifications

The following is typical closed loop performance of the Exciter operating into the monitor.

- Stereo Separation:** At 70% single-channel: 35dB minimum 100Hz to 5kHz. At 50% single-channel: 40dB minimum 50Hz to 5kHz, 30dB minimum 5kHz+ to 10kHz, 25dB minimum 10kHz+ to 15kHz
- Frequency Response:** 50Hz to 10kHz ± 0.5dB any modulation; 10kHz + to 15kHz ± 1dB any modulation

EXCITER

Audio Input: Right 0dBm to 10dBm balanced 600 ohms; left 0dBm to 10dBm balanced 600 ohms. Both inputs adjustable with factory installed pad per customer requirements

*Registered Trademark, Motorola, Inc.

*Mfg. under License from Motorola, Inc.

ASE-1

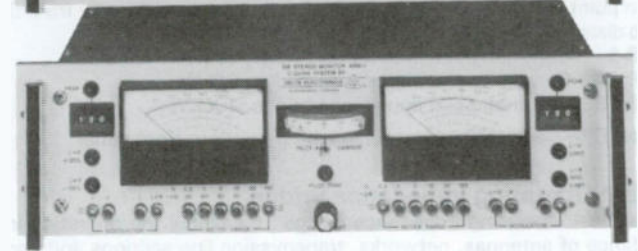
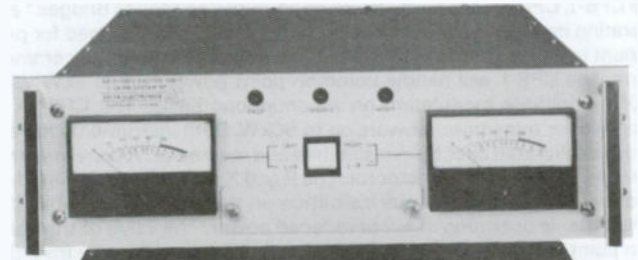

ASM-1

- Meter Range:** -20dB to +3dB, 0dB= 100% modulation
- RF Outputs:** Dual square wave to 38V p-p into 50 ohms, dual TTL level outputs
- (L+R):** Dual output, adjustable under cover on front panel via 10-turn potentiometer up to 16dBm, 600 ohms balanced
- Phase Equalization:** Internally adjustable phase equalization is provided to compensate for phase variations in the transmitter chain. 2 paths are available for day/night or main/aux modes
- Stereo/Monaural:** Switched under cover on front panel. Switches L=R for monaural. Stereo or monaural mode is indicated by LED on front panel. May also be remotely switched via rear panel terminals
- MONITOR**
- RF Input:** Frequency crystal controlled, input level 1V to 10VRMS, impedance 50 ohms
- Modulation Meters:** Meter range 0 to 140% -20dB to +2dB, attenuator range 0dB to -50dB in -10dB steps, accuracy at 100% modulation 400Hz ± 2%, meters switchable to + or - L, R, (L+R), (L-R)
- Peak Modulation Indicators**
- (L+R) Group:** -100% indicator internally set to flash when modulation exceeds -99%, +125% indicator internally set to flash when modulation exceeds +124%, peak indicator adjustable via thumbwheel switches from 30% to 150%. Modulation selectable via pushbutton switches + or -
- (L-R) Group:** Negative limit set internally to flash at 1.46 radians or 83.67°, (L-R) limit set internally to flash when modulation exceeds 99%, peak flasher adjustable via thumbwheel switches for 30% to 125%
- Output BNC Connectors on Rear:** Remote flashers (L+R), (L-R)
Remote meters (L+R), (L-R)
Left audio 600 ohms balanced and unbalanced, Right audio 600 ohms balanced and unbalanced (L+R), (L-R) and 25Hz pilot tone



CPB-1/CPB-1A/CPB-1B Common Point Impedance Bridges

The CPB-1, CPB-1A and CPB-1B Common Point Impedance Bridges* are operating impedance bridges similar to the OIB-1, but designed for permanent installation in your phasing equipment at the antenna common point. The CPB-1 will handle common point powers up to 5kW with 100% amplitude modulation on a continuous basis. The CPB-1A is designed for transmitter powers up to 50kW. Both instruments have 2 4" dials calibrated directly in resistance and reactance. A panel meter is provided for use as a null detector. The R and X dials are manipulated as a normal bridge to give a null indication on the panel meter while the transmitter is operating at full or reduced power. The value of the common point resistance and reactance can then be read directly from the two dials. 500kHz to 1.65MHz.

- CPB-1 Common point impedance bridge, 5kW
- CPB-1A Common point impedance bridge, 50kW
- CPB-1B Common point impedance bridge, 100kW

Note: CPB-1 and CPB-1A available with or without front panel

OIB-1 Operating Impedance Bridge

The OIB-1 Operating Impedance Bridge* measures the operating impedance of antennas, networks, transmission line sections and common point of directional antenna systems while they are functioning under normal power. This "operating impedance" cannot be measured by usual impedance bridge methods because the systems' characteristics are disrupted when the bridge is inserted in the circuit. The OIB-1 thus satisfies a critical requirement long felt by consulting and broadcast station engineers. In addition it has many applications in other fields that cannot be duplicated by any other instrument. 500kHz to 5MHz.

- OIB-1 Operating impedance bridge (specify lead length 12" or 18")
- Permits reading resistance to 1000 ohms.
- Reactance to 900 ohms. Includes calibration.

*U.S. Patent No. 3,249,863

OIB-3 Operating Impedance Bridge

The OIB-3 is an advanced version of the industry standard OIB-1 operating impedance bridge. It has all of the OIB-1 features plus an extended resistance and reactance range and an improved meter amplifier. It is built in a heavy drawn aluminum case and no additional carrying case is required. 500kHz to 5MHz.

- OIB-3 Operating impedance bridge (specify 12" or 18" leads)
- Bridge Leads 12" replacement leads for OIB-1 or OIB-3 (2 each)
- Bridge Leads 18" replacement leads for OIB-1 or OIB-3 (2 each) (changing lead length requires recalibration)
- Calibration Services available

Accessories for Impedance Bridges

- Large UHF/BNC female adaptor
- BNC female/N male adaptor
- BNC male/N female adaptor
- Large UHF/N female adaptor
- N male/large UHF female
- MJ50 meter jack
- BP50 bridge plug

ASE-2 AM Stereo Exciter

The ASE-2 AM Stereo Exciter converts a broadcast transmitter operating in the medium wave band (530kHz to 1700kHz) from monophonic to stereo operation using the C-QUAM® standard. Balanced audio inputs from the audio processing equipment connect to the Left

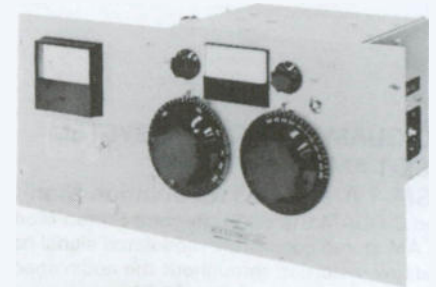

CPB-1/1A

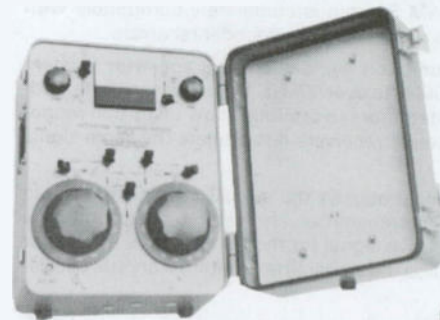

OIB-3

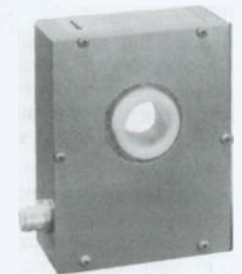

TCT-1

Audio Input and the Right Audio Input connectors. The Audio Output connector provides a balanced audio signal for the transmitter's modulator. This is the main channel audio (left channel plus right channel or L + R) which amplitude modulates the carrier inside the transmitter just as in monophonic operation. The front panel SEP control sets the level of this audio for best stereo separation. The ASE-2 generates an RF signal to replace the transmitter's crystal oscillator. This RF signal is phase modulated and contains the stereo subchannel (left channel minus right channel or L-R) information. The RF signal is available in 2 forms, a TTL level square wave from the TTL OUT connector or an optional, adjustable high level square wave from the High Level Output connector. The RF output employed is determined by the transmitter's requirements. Equalization filters and delay circuits control the properties of the phase modulated RF signal to compensate for transmitter characteristics. When these controls are correctly adjusted, the transmitter produces accurate C-QUAM AM stereo modulation. All switches and controls are adjustable from the front panel. 600 ohms audio input and output.

TCT-1/TCT-2/TCT-3 Toroidal Current Transformers

The TCT-1, TCT-2 and TCT-3 are precision toroidal current transformers designed primarily for obtaining sampling voltages for phase and magnitude measurements on broadcast arrays. The units are housed in rectangular aluminum shield enclosures with a 1 1/4" teflon lined pass hole through which the current carrying conductor is passed.

The TCT-1 and TCT-2 may both be used in the same system since they have identical tracking characteristics. The TCT-3 has somewhat different characteristics and preferably should not be mixed with the other two types.

- TCT-1 Toroidal current transformer 0.5V/A High voltage (HV) model
- TCT-2 Toroidal current transformer 0.25V/A High voltage (HV) model
- TCT-3 Toroidal current transformer 1.00V/A High voltage (HV) model

GORMAN— REDLICH

BROADCAST EQUIPMENT

CM Antenna Monitor

- True ratio reading. Non-Reference and Reference amplitudes are separately measured and divided electronically to give an accurate digital reading (and an equally accurate DC voltage for remote readings) that will not vary with carrier level, and is exceptionally stable under conditions of deep, asymmetric modulation
- Stable, accurate phase reading with automatic phase sign
- Amplitude or true ratio may be selected for measurement with a front panel switch. Optional common point terminal for measuring common point amplitude
- Designed for reliability and maintainability. Mil. Spec. PC boards with plated through holes. Gold plated switch and relay contacts. Relays have been tested to 10⁷ operations without failing. All ICs and relays are socketed. Each unit is burned in for at least 1 week to expose early IC failure
- Dual surge protection. Gas discharge tubes across sample line terminations, plus a relay that drops out when the monitor is not being interrogated and disconnects the sample lines from the electronics, protect against lightning induced sample line surges
- Level meter simplifies installation
- Accurate. Typically exceeds FCC specs by substantial margins
- Narrow phase-sign ambiguity (typically $\pm 0.2^\circ$) gives accurate phase readings near zero or 180°

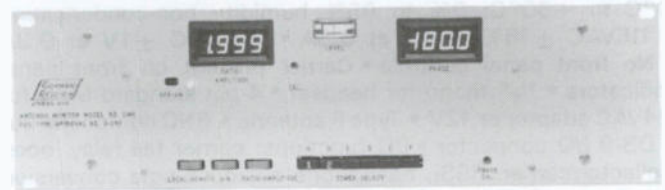

CMR

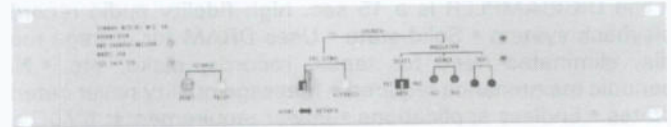

CEB

CMR Antenna Monitor

- Same as CM monitor except remote controllable with any manufacturer's remote equipment

CMR-1 Remote Indicator

- May be used for hardwire remote control and remote reading of CMR antenna monitor
- The 2 units are connected by a multiconductor cable up to 1500' long
- Because the readings of the CMR-1 will exactly duplicate those of the CMR, weekly remote metering calibration is not necessary
- Local/Remote switch on the CMR front panel transfers control to the CMR-1 when it is set to Remote; when it is set to Local, control reverts to the CMR



CRW

EBS Equipment — CEB Encoder/Decoder

- The CE or the encoder portion of the CEB generates the 853Hz and 960Hz tones that make up the attention signal of the EBS system
- A "loop through" relay substitutes the attention signal tones for program audio when the encoder is activated
- Activation is for a period of 20 to 25 seconds, and can be initiated either by a front panel switch or remotely
- The CD or the decoder section of the CEB works in conjunction with a radio receiver tuned to the station being monitored
- Any stable receiver will work satisfactorily, and connection of the CEB or CD is very simple
- When an EBS attention signal is received, the receiver will be demuted and will remain demuted until a reset button is pushed
- Auxiliary alarm terminals provided

CRW Weather Radio

- 0.28 μ V sensitivity for clear, reliable reception
- Crystal and ceramic IF filters, dual gate MOSFET front end for excellent interference rejection
- Rackmounting, remotable. Attractive black anodized panel
- Relay closure by 1050Hz "alert" tone for automated recording of emergency messages
- Relay closure by 1650Hz, tone signal for automated recording of updated forecasts
- 1050Hz "alert" tone demutes receiver, gates audio to rear terminals and energizes a flashing LED for local and/or remote alarm
- Built-in whip antenna, plus jack for 50 ohm outdoor antenna and terminals for 300 ohm antenna
- False alarms and missed alerts eliminated by high Q, individually tuned active filters, and a circuit that requires at least 4 seconds of continuous tone signal to trigger
- Mil. Spec. PC board, socketed ICs, conservative component ratings for long maintenance-free performance

Hallikainen & Friends

DRC-190 Digital Remote Control

- Can be operated manually or with the standard computer peripherals will monitor, display and print all relevant readings including phase, relative amplitude, calculated ratios and deviations
- Can be programmed to print parameters out of limits, make the adjustments, then print the corrected reading along with a notation of the adjustment
- With the addition of a modulation controller, can be programmed to meet FCC requirements for full ATS and, with distortion analysis equipment, test and log proof of performance data automatically
- Interchangeable studio and transmitter units
- 10 analog metering inputs
- 10 raise outputs
- 10 channel selected outputs each expandable to 100 channels

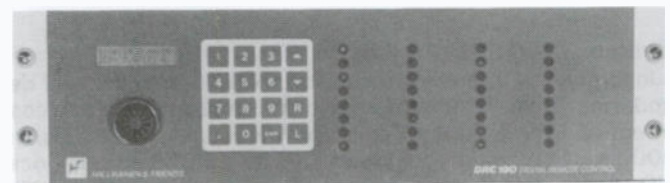

DRC-190

2070 FM Composite Receiver

- Single rack space 1.7" H x 19" W x 10" D • Environment: 0°C to +50°C; 0% to 95% humidity non-condensating
- 115VAC ± 15%, 60Hz at 0.5A • 13.0VDC ± 1V at 0.3A
- No front panel controls • Carrier present on front panel indicators • 1/4" mono for headset • 4-pin standard MTS for 24VAC adaptor or 12V • Type F antenna • BNC composite out
- DB-9 I/O connector • I/O functions: carrier fail relay, open collector/carrier, RSSI, headphone audio • Single conversion receiver • 10.7MHz IF frequency • Crystal controlled LO
- Low side injection • 73dB ultimate S/N • Maximum RF input -10dBm • 3dB bandwidth 75kHz



2070

2071-001 DIGISAMPLER Module

- The DIGISAMPLER is a 15 sec. high fidelity audio record/playback system • Solid-state • Uses DRAM for storage media, eliminates need for tapes, records, disks, etc. • No periodic maintenance required • Message quality never deteriorates • Endless applications • Power requirements: 5VDC at 10mA • Input and output audio levels: 0dBm • Input type: single ended 10K ohm • Output type: single-ended 900 ohm • 15 sec. max. time • Variable length • Dimensions: 1.5" x 3.0" x 0.6" • Control inputs: record, play, pause, stop • Accessories include switch panel, power supply card, speaker driver card



System 1000

NOAA National Weather Service Receiver

- Single rack space 1.7" H x 19" W x 10" D • Environment: 0°C to +50°C; 0% to 95% humidity non-condensating
- Power requirements: 117VAC ± 15%, 60Hz at 0.5A; 13.0VDC ± 1.0VDC at 0.3A • Alarm reset • Momentary pushbutton • Latching pushbutton • Carrier and alarm front panel indicators • Front panel speaker: 1.5", 0.2W, 8 ohm • 4-pin standard MTS for 115VAC or 12VDC • 600 ohm balanced audio level adjustable -20dBm to +4dBm • Dual conversion receiver • 10.7MHz, 455kHz IF • Crystal controlled LO
- 65dB ultimate S/N • Frequency 1050Hz



System 3000

System 1000 EBS Monitor

- Integrated EBS monitor • Incorporates EBS encoder, decoder and receiver in 1 single rack space enclosure • Continuous automatic self test • Full program audio loopthrough • Stereo outputs • Independent encoder output • Alarm relay • Hi-Z RX monitor port • Encode duration 22.5 sec. • Tone levels internally independent and adjustable from -25dBm to +8dBm • Output impedance 600 ohms balanced • Decode time 8.5 sec. • Decoder bandwidth + 5Hz • FM receiver sensitivity 5uV for 26dB siand • FM receiver bandwidth 7kHz • AM receiver sensitivity is greater than 15µV for 10dB S/N • AM receiver bandwidth 5kHz • Dimensions: 1.75" H x 19" W x 13" D



2016

System 3000 EBS Monitor

- Incorporates 3 monitor/receivers, the EBS encoder and decoder into 1 unit • Ultimate answer for simple, reliable and cost effective EBS service • Same specifications as the System 1000 • Can monitor your area's CPCS1, CPCS2 and the local NOAA Weather Service or can monitor your CPCS1, CPCS2 and an adjacent area CPCS1 • With 2 or more systems you can monitor EBS and NOAA services over a large area • Continuous self test keeps you informed of system status • National Weather Receiver optional

1008/2016 Distribution Amplifiers

- Detachable terminal block • Easy access to channel trim pots • Socketed ICs • Super small single rack space unit only 3" deep • Frequency response 20Hz to 20kHz ± 0.2dB
- -75dB referenced to 0dBm • +18dBm max. input level
- 93dB dynamic range • 0.02% intermodulation distortion
- 0.03% at 1kHz 0dBm harmonic distortion • 2016 has 2-input, 16-output distribution amplifier • 1008 has 1-input, 8-output distribution amplifier • Dimensions: 1.75" H x 19" W x 3" D



"C-Quam" AM Stereo

The name "C-Quam" is derived from the phrase Compatible Quadrature Modulation. This means that the system has the advantages of quadrature modulation for stereo transmission, and is compatible with the hundreds of millions of existing monaural AM radios. In fact, the C-Quam system simply takes the sum of left and right stereo channels (L + R) and directly amplitude modulates the broadcast signal. This is the precise signal that monaural radios were designed to receive.

To provide stereophonic information, angle modulation results from straightforward Quadrature Modulation followed by limiting. That is, the monophonic (L + R) provides in-phase modulation while (L-R) provides quadrature phase modulation. The limiter assures constant level exciter drive to the transmitter.

A separate signal, 25Hz pilot tone, is added to the quadrature difference (L-R) signal for indicating the presence of a received stereophonic C-Quam broadcast.

Existing AM broadcast transmitters may be adapted to C-Quam with relatively simple and inexpensive modifications.

Specifications:

The following performance is typical closed loop performance of the exciter operating into the monitor.

Stereo Separation: 35dB minimum from 20Hz to 7.5kHz

Frequency Response: L, R 20Hz to 15kHz \pm 1.5dB

*Distortion,

Harmonic: L=R Monaural 0.25% max. at 85% mod. L=R pure stereo 0.5% max. at 85% mod. **L, R single channel 1.0% max. at 70% mod.

Exciter

RF Output: Adjustable internally up to 5W into 50 ohms (L + R);
Adjustable under cover on front panel via 10 turn potentiometer up to + 16dBm, 600 ohms balanced

Stereo-Monaural: Switched under cover on front panel. Switches L=R for monaural. Stereo, Monaural indicated by LED on front panel

Audio Input: Right 0dBm to + 15dBm balanced 600 ohms, left 0dBm to + 10dBm balanced 600 ohms, both inputs adjustable with factory installed pad per customer requirement

Meter Functions: (L+R)₀ (L-R)₀ Range -20dB to + 3dB, 0dB = 100% modulation. Right, Left: Meter functions switched at front panel between meters.

Phase Equalization: Internally adjustable phase equalization is provided to compensate for phase variations in the transmitter chain.

Sample Transmitter Output:

A sample transmitter output is provided on the rear. This contains all of the modulation aspects (L+R)₀, (L+R)₁, (L-R)₀. This is provided for diagnostics and comparison of transmitter characteristics vs. exciter characteristics. Sample transmitter output 2V p-p into 50 ohms.

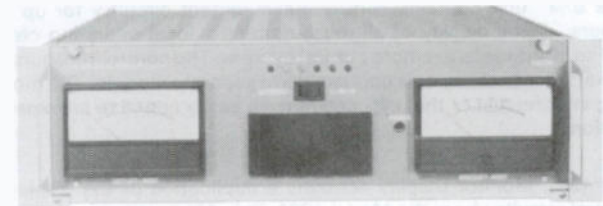
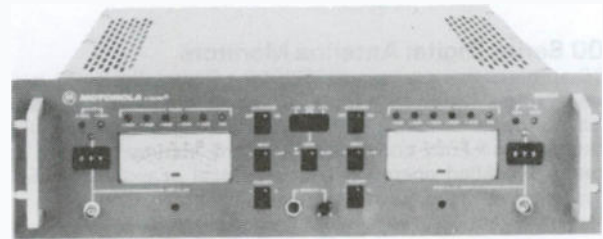

"C-Quam"

Monitor

RF Input: Frequency crystal controlled, Input level = 1V to 10V RMS, Impedance = 50 ohms.

Modulation Meters: Meter range 0 to 140% (-20dB to +3dB), Attenuator range 0 to -50dB in -10dB steps, accuracy at 100% modulation 400Hz \pm 2%, meters switchable to \pm left or (L+R), \pm right or (L-R).

Peak Modulation Indicators:

(L+R) group: -100% indicator internally set to flash when modulation exceeds -99%, + 125% indicator internally set to flash when modulation exceeds + 124%, peak indicator adjustable via thumb wheel switches from 30% to 150%. Modulation selectable via pushbutton switches + or -. (L-R) group: Negative limit set internally to flash at 1.46 radians or 83.67°. (L-R) limit set internally to flash when modulation exceeds 99%. Peak flasher adjustable via thumb wheel switches for 30% to 125%

Output BNC Connectors on Rear:

Remote flashers (L+R), (L-R). Remote meters (L+R), (L-R). Left audio 600 ohms balanced and unbalanced, Right audio 600 ohms balanced and unbalanced, (L+R), (L-R), 25Hz pilot tone.

1400 Exciter (includes day/night card)
1410 Modulation monitor

SIMPLIFIED SYSTEM BLOCK DIAGRAM

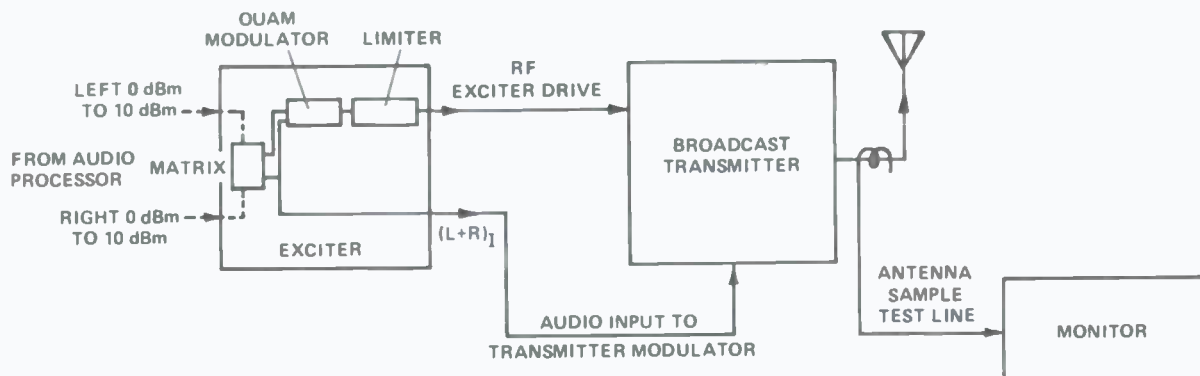

* Actual measurements of stereo separation, frequency response and distortion are supplied with each exciter monitor pair.

** This is equivalent of 150% modulation, 75% envelope modulation, simultaneous with 75% stereo information.

1900 Series Digital Antenna Monitors

- FCC authorization number: IJ3PI1900
- Digital display of ratio and phase of up to 12 towers
- Modular design simplifies expansion, reduces downtime
- Provides continuous analog outputs of all tower measurements
- Fully compatible with any standard remote control system
- Simplified operating controls, local or external
- Measurements for up to 12 towers in 5 1/4" rack height

There are 3 different units in the 1900 Series. The basic unit is the 1901. This 5 1/4" unit contains control/measurement circuitry for up to 12 towers, digital display of all measurements, local operating controls and an interface to a remote control system. The control/measurement circuitry for each tower is contained in a separate module. The modules plug into the rear of the unit, and may be easily added to an expanding station.

The 1902 Monitor Display contains a duplication of the display and control circuitry from the Model 1901. This 1 3/4" unit provides remote control and monitoring of a 1901 or 1903.

The 1903 is equivalent to a 1901, but does not contain any front panel control or display circuitry. This function may be performed with a 1902 or any standard remote control system.

Simplified Operation

The operating controls are identical for the 1901 and 1902 models. The monitoring system is controlled with 4 pushbuttons; 3 are located to the left of the display and 1 to the right. The first pushbutton is used to select 1 of 3 different modes. The ratio mode displays the true ratio of the selected tower sample as compared to the reference sample. The amplitude mode displays the relative amplitude of the selected tower sample. The test mode is used to check the calibration of the instrument. Separate LED indicators display the selected mode.

The next 2 pushbuttons are labeled down and up. These buttons are used to select the tower to be monitored and displayed on the front panel LED displays. The selected tower number is shown to the right of these pushbuttons.

2 separate 4-digit displays are used to indicate the amplitude or ratio and the phase of the selected tower. The pushbutton to the right of the digital display is used to select the pattern. Separate LEDs indicate day, night or a third pattern. LEDs in the display also indicate if the monitor is under local or external control.

Performance Features

The 1900 Series indicates sample ratio directly with virtually no modulation effect; independent of the power level.

The 1900 Series utilizes a separate control/measurement module for each tower. The modules plug into the rear of the 1901 and 1903 units. This feature provides a continuous readout of the ratio and phase of each tower, simplifying the interface to a remote control device and eliminating input switching within the monitor. The modular design also simplifies expansion when another tower is added and eliminates extended downtime if a spare module is available on-site. The 1900 Series can accommodate up to 12 towers.

System Interfacing

The 1901 and 1903 units provide a direct interface to a remote control device. Each of the control/measurement modules (1 for each tower in the system) provides continuous analog outputs relative to the ratio and phase for each tower. These outputs may be connected to the telemetering inputs of the remote control device. The outputs may also be connected to an array of meters to provide a continuous and simultaneous display of each tower in the system.

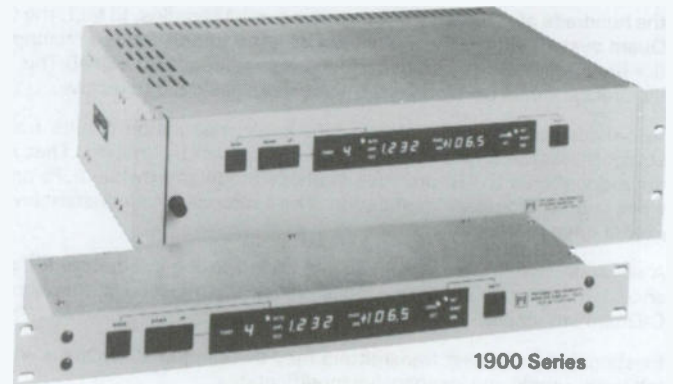

1900 Series

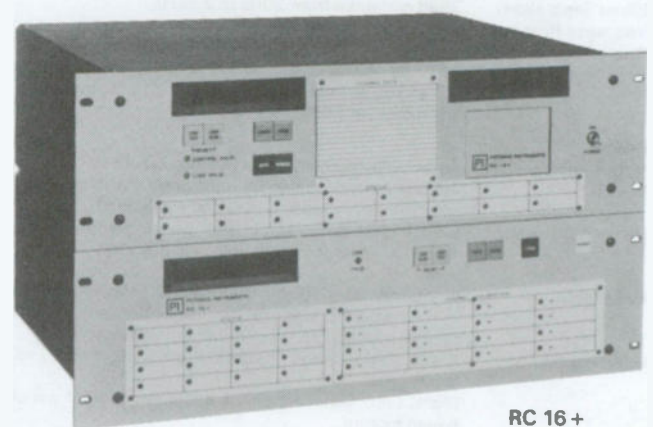

RC 16+

External control inputs to the 1901 and 1903 units, in the form of contact closure to ground, can switch the units to the correct pattern and can also select the amplitude and test modes.

RC 16+ Automatic Remote Control System

Includes SU-16 Studio Unit (16 channels). This unit contains the master controller and time clock. It sends commands to the transmitter unit and receives data from it. It is pre-programmed for each station according to user specifications. It provides manual or automatic surveillance and control at the option of the operator. Front panel indicators provide channel number, telemetry data, time and status indications.

Includes TU-16 Transmitter Unit (16 channels). This unit accepts analog telemetry and status inputs and provides relay closure control outputs. It receives its instructions from the studio unit and operates the relays to control each function. Individual telemetry adjustments are provided for 1-person calibration under local control

Options

- XTU/XSU channel expansion units
- ALU automatic logging unit
- VDU video display unit
- Telephone interface option
- Subcarrier modem option
- SAU status alarm option

AA-51 Audio Analyzer

The AA-51 is an automatic multi-purpose test instrument designed to accurately measure total harmonic distortion, intermodulation distortion, wow and flutter, frequency response, signal-to-noise ratio, RMS voltage level, stereo phasing, and a differential gain (ratio) of signals in the audio frequency spectrum. There are no "Set Level" or "Balance" controls. Input signals between 0.1VRMS and 50VRMS are automatically leveled to the proper reference for distortion measurements. Out-of-range lights are provided for indicating that input levels are within the usable 40dB range.

For THD measurements, automatic nulling is accomplished via internal feedback circuitry. The operator coarse-tunes the input frequency, switches the function switch to THD and reads the meter. Accurate harmonic distortion measurements at various discrete frequencies and different power levels can be made faster than with conventional distortion analyzers.

Intermodulation distortion measurements are performed with equal simplicity. Utilizing the SMPTE standard modulation signal provided by the AG-51 generator, the AA-51 displays percent IM for input levels between 0.1VRMS and 50VRMS. Again, measurements are automatic—no level or balance adjustments are required. With the function switch in the IM position, variations in intermodulation distortion may be observed over a wide dynamic range—automatically. This feature makes the AA-51 a very useful test instrument for troubleshooting audio systems.

Signal + Noise/Noise ratio measurements are made with the function switch in the "Noise" position. In this mode, the voltmeter bandwidth is restricted to 20kHz. S+N/N measurements are accomplished by reading the difference in audio output level between reference signal corresponding to 100% modulation and the residual noise of an unmodulated signal.

Accurate frequency response measurements are facilitated by a wideband voltmeter which exhibits a flat response (± 0.1 dB) from 20Hz to 200kHz. Input level range is from 1mV to 100V full scale. The average responding meter is calibrated to the RMS value of a sine wave.

Incidental frequency modulation termed "Wow and Flutter" is usually associated with record and playback equipment such as tape decks, cart machines and turntables. The AA-51 measures weighted peak flutter as specified by IEEE standard 193. Wow and flutter measurements are automatic. Test signals may be derived from a prerecorded standard test tape or record or from the 3.15kHz signal provided by the AG-51.

Stereo signals and mono signals derived from a stereo source are often degraded by phase errors and differential gain variation between Left and Right channels of a given audio system. The AA-51 contains both Phase and Ratio measuring circuitry which enables the operator to evaluate these characteristics quickly and accurately throughout the complete audio spectrum and over a wide dynamic range. Phase angle is displayed with a zero center scale indication and full scale sensitivity of either $\pm 54^\circ$ or $\pm 180^\circ$ as determined by a front panel switch. The ratio meter is also a zero center scale device with ± 6 dB full scale deflection.

The Phase and Ratio measurement features of the AA-51 are particularly useful for line equalization measurements, azimuth alignment of stereo tape heads, and troubleshooting of audio consoles, amplifiers and networks.

AA-51

RFI shielded, stereo inputs, 117VAC (230VAC optional)
 THD Meter: 0.1% to 100%, 20Hz to 20kHz, automatic set level and balance
 Intermodulation Distortion Meter: 0.1% to 100% 60Hz and 7kHz composite (other frequencies optional), automatic set level
 AC Voltmeter: 5Hz to 500kHz, 1mV to 100V
 S + N/N Meter: 20Hz to 20kHz
 Phase Meter: $\pm 180^\circ$, 20Hz, to 20kHz
 Wow and Flutter Meter: 0.01% to 1% peak weighted, automatic set level
 Ratio Meter: ± 6 dB, 20Hz to 20kHz

AG-51 Audio Generator

The AG-51 contains a low distortion 20Hz to 200kHz sine wave generator, a SMPTE standard intermodulation signal generator and a fixed frequency sine wave generator at 3.15kHz for wow and flutter tests. Signal outputs are simultaneously available at levels of up to +1dBm (equivalent sine wave power for complex signals) at separate Left and Right output connectors. Outputs may be switch-selected for Left only, Right only, Left and Right in phase (L + R), and Left and Right in phase opposition (L - R). Front panel switches enable the operator to select fully balanced or unbalanced outputs at impedance levels of 150 ohms or 600 ohms. A dynamic range of 99.9dB

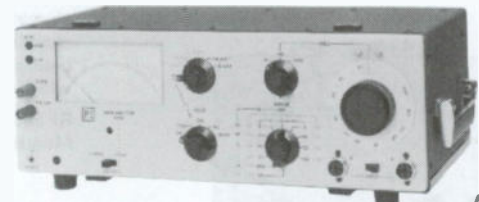

AA-51



AG-51

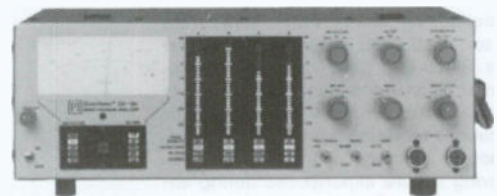

QA-100

in 0.1dB steps utilizing a combination of 10dB, 1.0dB and 0.1dB precision attenuators is provided. Attenuator dials display output level directly in dBm in the 150 ohm source impedance configuration. Automatic output leveling circuitry with a built-in self-test feature provides a constant output level, thereby eliminating the need for output metering.

Audio Generator: RFI shielded, transformerless stereo outputs, balanced and unbalanced, 600 ohms and 150 ohms, automatic signal leveling with self test feature. 117VAC (230VAC option)
 Stereo Matrix Switch: L, R, L + R, L - R
 Precision Attenuators: 10dB, 1.0dB, 0.1dB steps
 Low Distortion Sine Wave Generator: 20Hz to 200kHz
 Composite Intermodulation Test Generator: 60Hz and 7kHz at 4:1 (other frequencies optional)
 3.15kHz SMPTE Wow and Flutter Frequency Standard

Audio Test System: Includes AA-51 Analyzer and AG-51 Generator at single purchase price

Audio Test Accessories

TC-51 Fiberglass Reinforced Transport Case, houses both AA-51 and AG-51, dimensions 21" x 19" x 14"
 DX-51 Low Distortion AM Detector
 IX-51 Balanced to Unbalanced Audio Transformer with switch selectable line termination of 600 ohms, 150 ohms or open circuit
 RK-51 19" Rackmounting Kit for AA-51 or AG-51 (2 kits required for complete AT-51 system)

QA-100 QuantAural Audio Program Analyzer

• Measures audio processing • Evaluates station sound • Analyzes competitive stations

Designed for professional broadcast programmers and engineers to assist in program sound analysis.

Take audio from any source: receiver, tape recorder, modulation monitor, production studio output, audio processing equipment; and measure: Maximum peak level (FCC limits this value), Overall audio processing effectiveness (average level), Tightness of sound, processing control (peak density), Tonal balance and consistency (4-band real time analyzer), Stereo image width (L - R to L + R ratio), Preemphasis (4-band real time analyzer), "Punch" (special "aural intensity" measurement).

This device is a must for any highly competitive radio station. It provides important technical information about any audio signal which can suggest adjustments in equipment, operations and audio processing for that special sound you want to achieve.



SD-31

SD-31 Synthesizer/Detector

- Designed for antenna impedance measurements with RF bridges in the presence of strong interference • High-level oscillator compatible with general radio 1606 series, 916 series, and Delta OIB-1 impedance bridges • Frequency crystal controlled, variable in 500Hz steps from 100.0kHz to 1999.5kHz • Versatile—can be used as an RF signal generator for troubleshooting antenna systems; as a variable frequency oscillator for antenna site survey; or other applications requiring a precise frequency source • Special coherent detector circuit rejects interfering signals experienced during antenna measurements • Receiver for detector can be external or optional built-in RX-31 receiver • Powered by rechargeable batteries • Self-contained portable package

The SD-31 Synthesizer-Detector is a high-output signal generator of precisely known frequency combined with a sensitive, selective detector for RF bridge measurements of AM antenna impedance. Packaged in a single lightweight battery-powered unit, the SD-31 complements bridges such as the General Radio 1606, 916, and the Delta OIB-1.

A frequency synthesizer determines the generator frequency, which can be adjusted in 0.5kHz steps by means of a front-panel switch from 100.0kHz to 1999.5kHz. Frequency accuracy is the same as that of the internal crystal reference oscillator. A front panel fine-frequency control varies the frequency up to $\pm 0.1\%$. The generator can drive a wide range of load impedance at levels up to 20VRMS. It also has a variable low-level output suitable for driving a counter or for receiver frequency calibration.

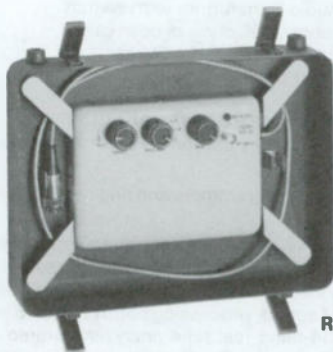

RX-31

RX-31 Receiver Option

The RX-31 is designed specifically as an RF interface between an impedance bridge and the SD-31 Coherent Detector. Conveniently mounted in the protective cover of the SD-31, the RX-31 is a single conversion super heterodyne receiver which derives its local oscillator signal and

power supply voltage from the SD-31. Receiver circuitry is packaged in an aperture-free, drawn aluminum enclosure which provides excellent RF shielding. IF selectivity is provided by active bandpass filter which can limit receiver bandwidth to 100Hz.

RF Filter

Manually tuned in 3 bands: 0.1-0.3MHz
0.3-0.8MHz
0.8-2.0MHz

Accessories

HS-11 Headset

GR

Adaptor Adapts general radio type 874 connector to BNC jack

FL-31

2-Pole Tuneable Band Pass Filter 0.5MHz to 1.7MHz (provides attenuation for strong adjacent channel signals resulting from RF Bridge feed through)

Test

Cable

RG223 Double Shielded Coaxial Cable; 5' length with UG88 (BNC male) connectors on each end

MCC-31

Deluxe wood carrying case

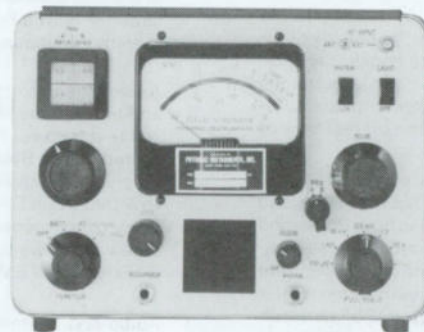

FIM-21

Field Strength Meters

FIM-21, FIM-22, FIM-41

- 6-position (20dB per step) attenuator • High Q double-tuned RF input for maximum image rejection • Multi-pole hybrid IF filter with shape factor (6dB to 60dB) of 2.2:1 • Fully temperature compensated circuitry plus voltage regulation for long term stability • 4", mirrored scale, taut-band meter with internal lighting • Front panel speaker with weather-treated cone or headphone output • RF coaxial input for measuring terminal voltage between 10 μ V and 10V • Mechanical "vernier" is integral part of receiver tuning control • Differential comparison circuit for balancing oscillator and receiver output for precise calibration • Capable of signal ratio measurements (including harmonics) to -80dB

FIM-21, FIM-22 and FIM-41 represent a new generation of precision instruments for direct measurement of electromagnetic fields in the 200kHz to 5.0MHz frequency spectrum. These units are intended for portable field use and include a laboratory quality receiver, integral shielded loop antenna, precision attenuator, internal calibration source, and voltage regulated battery power supply.

FIM-21 Covers AM broadcast spectrum only (535, to 1605kHz). Utilizes 6 "D" batteries (not included)

FIM-22 Covers 200 to 550kHz frequency spectrum. Utilizes 6 "D" batteries (not included)

FIM-41 Covers 540kHz to 5MHz frequency spectrum in 2 bands. Utilizes 6 "D" batteries (not included)

FIM-71

- Accurate, direct reading, volts or dB • 45MHz to 225MHz continuous tuning • Peak or averaging detector (switch selectable) • Wide or narrow IF bandwidth (switch selectable) • 20dB or 60dB meter range (switch selectable) • AM or FM demodulator (switch selectable) • Calibrated dipole antenna, mounted on case for near-ground measurements or removable for TASO measurements • 140dB measurement range (1 μ V to 10V) • 4 1/2", mirrored scale, taut-band meter • Front panel speaker • Recorder output • Rugged, portable package • Calibrated signal generator, 45MHz to 225MHz • Battery or external power • Use as signal source/selective voltmeter for insertion loss measurements of filters, etc. • Measures FM harmonics to -80dB

FIM-71 Utilizes 10 "D" batteries (not included)



FIM-71

FIM-72

- Same as 71 but 470MHz to 960MHz continuous tuning • Calibrated generator 470MHz to 960MHz

FIM-72 Utilizes 10 "D" batteries

Accessories

HS-11 Headset for all models

MCC-21 Deluxe wood carrying case for FIM-21, FIM-22, FIM-41

MCC-71 Deluxe wood carrying case for FIM-71

Unipod Telescoping stand for FIM-21, FIM-22, FIM-41

ANT-71 Antenna elements and balun (spare) for FIM-71

AC72 117VAC adaptor for FIM-71, FIM-72

RO-71 Phone plug with internal potentiometer for adjustable record output

BK-71 Rechargeable battery kit includes BP-71 and BC-71 for FIM-71, FIM-72

844A/884 FM Stereo Modulation Monitors

- 3 major subsystems in 1 package: Frequency-Agile RF Pre-Selector, Baseband Demodulator, Stereo Demodulator • Complete stereo measurements: L + R, L - R, Pilot, 38kHz, L, R, SNR, Phase, AM Noise, Multipath • Built-in frequency-synthesized type modulation calibrator, 1% modulation accuracy without performing Bessel null calibration
- Exclusive peak modulation duration differentiator and counter (P.M.D.D.), separate transients from true peak modulation • Carrier and pilot frequency measurement via front panel connector • Fully synthesized high and low level inputs

844A (5116-844A) FM baseband/stereo modulation monitor. Includes absence of modulation/carrier fail alarm (75 μ s de-emphasis supplied standard)

Option 02 (7100-4184) Spare parts kit
804 (5116-0804) Remote meter and peak flasher panel for 844A

884 (5116-0884) FM baseband/stereo modulation monitor (75 μ s de-emphasis supplied standard)

Option 01 (7100-4185) Spare parts kit

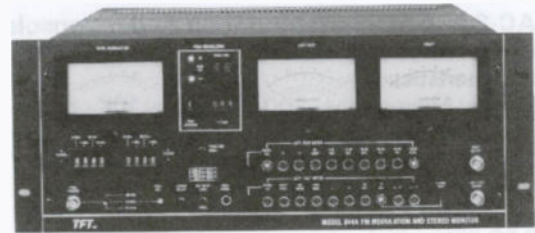

844A

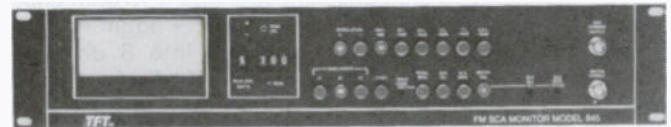

845

845 FM SCA Modulation Monitor

- Up to 3 customer-specified frequencies are selectable from the front panel • Accommodates today's multi-channel operations • Complete, accurate measurements of injection level, modulation, S/N ratio, crosstalk and THD (using an external analyzer) • Measurement modes are selected by front panel pushbuttons • For true proof-of-performance measurements (at the transmitter), a wideband input is provided • Accuracy is ensured by upconverting the baseband signal to an IF frequency and extracting the SCA sub-channel through precision filters
- Pushbutton selection of either ± 4 kHz or ± 6 kHz as the frequency deviation to represent 100 percent modulation is standard • Remote metering outputs are available at the rear panel for use with a TFT Remote Panel accessory

845 (5116-0845) 3-channel SCA modulation monitor, 67kHz supplied standard

Option 01 (7100-3880) RF module-preselector (specify frequency)

Option 02 (7100-3900) SCA channel (41kHz)

Option 03 (7100-3910) SCA channel (92kHz)

Option 04 (7100-3920) Spare parts kit

805 (5116-0805) Remote meter and peak flasher panel for 845

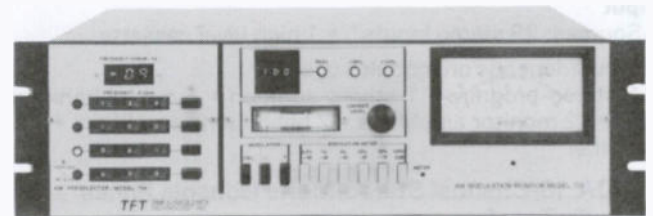

753/755A

- bandwidth of ± 5 Hz from each tone frequency • The receiver squelch is controlled by a programmable delay circuit in 2, 4 or 8 seconds after receipt of the 2-tone attention signal • Separate 2-digit LED displays on the front panels, showing the number of days, up to 12, since EBS test transmissions were last received and/or sent. On the 12th day, the displays start flashing • Bargraphs are provided on the front panel for both audio level and RF signal strength observations • A front panel loudspeaker is standard in each receiver for audio monitoring, with its volume control located on the rear panel • The integral 2-tone EBS generator, using crystal oscillators, produces the 853Hz and 960Hz tones simultaneously, with an accuracy of ± 0.25 Hz • The duration of the 2-tone signal is also programmable by internal DIP switches in 6, 12 or 24 second intervals • Tone amplitudes may be observed and adjusted individually • Test and on-air transmission switches are provided on the front panels of each receiver • Stereo and composite signal loopthrough are provided on the rear panel • Remote activation and reset are available via opto-isolators

886 AM Receiver

- Tunable across the AM broadcast band, using a frequency synthesized local oscillator • Tuning is accomplished with a 3-digit, front-panel pushbutton switch in 10kHz increments • The stability of the receiver is that of the crystal oscillator, ± 500 Hz per year

886 (5116-0886) Tunable AM receiver/encoder/decoder, includes AM loop antenna
Option 01 (7100-4213) AM loop antenna and cable assembly (when ordered separately)

887 FM Receiver

- Digitally tunable receiver, using a 4-digit front-panel pushbutton switch in 100kHz increments • Ideally suited to FM intercity relay networks, key links in the EBS alerting procedure, allowing pickup and rebroadcast of emergency programming without degradation of signal quality

887 (5116-0887) Tunable FM receiver/encoder/decoder

753 AM Modulation Monitor

- Makes extremely accurate proof-of-performance measurements
- Allows you to monitor your transmitter so precisely that you can modulate it to the maximum legal limits in absolute confidence

753 (5116-0753) AM modulation monitor

Option 02 (7100-2440) Carrier power alarm

Option 03 (7100-2410) 10kHz whistle filter

Option 04 (7100-2420) 30Hz telemetry lowpass filter

Option 05 (7100-2430) Absence of modulation alarm

Option 06 (7100-2460)* 230VAC

Option 07 (7100-2560) Spare parts kit

755A (5116-0755A)* AM RF preselector (tunable in 1kHz increments)

Option 01 (7100-2470) Narrow band filter

Option 04 (7100-2500) Spare parts kit

704E (5116-704E) Remote meter and peak flasher panel for 753

886 (AM)/887 (FM) EBS Receivers

Common Features

- Designed for broadcasters to meet parts 73.940, 73.941 and 73.942 of the FCC rules and regulations • Built-in 2-tone decoders for the 853Hz and 960Hz EBS signaling tones from demodulated audio outputs • Stable piezoelectric tuning fork filters are used to achieve a

*Not field installable

IC-10, AC-8 and AC-6 Stereo/Mono Audio Consoles
Common Features

Input Characteristics:

- Impedances: Microphone, 200. High level 10K ohm bridge or 600 ohm terminate • External monitor 10K ohm • Levels: Microphone: -65 to -50dBm. High level: -10dBm to +10dBm • External monitor: -10dBm to +10dBm • Noise: Program/audition: 120dBm • Monitor: 110dBm • Power source: 117 or 230VAC 50-60Hz single phase

Output Characteristics:

- Impedances: Program/audition 600 ohm balanced or unbalanced • Monitor 4-16 ohm unbalanced • Cue 4-16 ohm unbalanced • Levels: Program/audition or mono: +8dBm nominal: +24dBm maximum • Monitor: 15WRMS into 8 ohm load • Cue and headset: 1W into 8 ohm load • Frequency Response • Program/audition ± 1 dB 30 to 15kHz. Monitor ± 1.5 dB 30 to 15kHz • Distortion: Program/audition less than 0.5% THD • Monitors less than 1.5% THD • Tabletop with bottom or back entry cable • 10" H x 44" W x 20" D

IC-10 10-Channel Stereo/Mono Audio Console

Input

- Sources: 28 stereo inputs* • 1 high level cassette

Output (depends on modules used)

- 1 stereo program • 1 stereo audition • 1 monophonic program • 2 monitor amplifiers • 2 headphone amplifiers • 1 cue amplifier

IC-10A 10-Channel Stereo/Mono Console Prices

No Audio Transformers

Electronically Balanced In and Out

IC-10B 10-Channel Stereo/Mono Console Prices

Transformers In and Out

Modules

LA-3 Line amplifier
 MA-1 Monitor amplifier
 CA-1 Cue amplifier
 HA-1 Headset amplifier
 MPA-2A Mic amplifier
 PS-1 Power supply/regulator
 IA-1 Input amplifier
 MXA-2 Mixing amplifier
 XL-1 Microphone connector
 OJ-1 Output jumper module

AC-8 8-Channel Stereo/Mono Console

Input

- Sources: 26 stereo inputs* • 1 high level cassette

Output (depends on modules used)

- 1 stereo program • 1 stereo audition • 1 monophonic program • 2 monitor amplifiers • 2 headphone amplifiers • 1 cue amplifier

Mini-Mix 8 Professional Audio Console

- Aluminum case—oak endbells • 2 stereo output buses—mono output • 8 slide plug-in pots • 2 dedicated mic slide pots • 12 stereo inputs • 6 unbalanced stereo—CD/cassette/tape/etc. • 6 high level balanced—pro-stereo inputs • All VCA operated • Cue amplifier/speaker built-in • Lightweight • 19" x 14" x 4" (approximate) • Made in USA

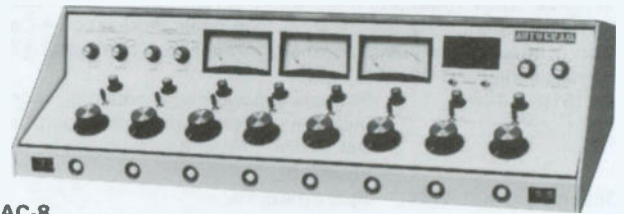

AC-8

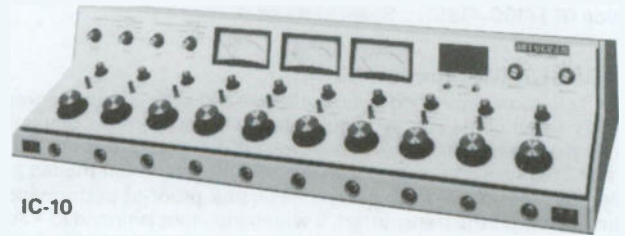

IC-10

AC-8A 8-Channel Stereo/Mono Console Prices

No Audio Transformers

Electronically Balanced In and Out

AC-8B 8-Channel Stereo/Mono Console Prices

Transformers In and Out

AC-6 6-Channel Stereo/Mono Audio Console

Input

- Sources: 23 stereo inputs* • 1 high level cassette

Output (depends on modules used)

- 1 stereo program • 1 stereo audition • 2 monitor amplifiers • 2 headphone amplifiers • 1 cue amplifier

*Customer's option as to use by plug-in modules.

AC-6A 6-Channel Stereo/Mono Console Prices

No Audio Transformers

Electronically Balanced In and Out

AC-6B 6-Channel Stereo/Mono Console Prices

Transformers In and Out



Mini-Mix 8

R/TV-12 and R/TV-20 Stereo Audio Console

Common Features:

- VCA level control • Electronic switching • No audio transformers
- Penny & Giles linear conductive plastic pots • Schadow selector switches • Engraved front panel • Pluggable miniature terminal strips
- Up to 8 patchable microphone preamplifiers • Each channel remotely controllable • Easy input level selection • Optional interface card for logging to printer plus interfacing to Live Assist or Computer • Optional autoclock or autocount

Specifications

Input Characteristics

Sources: 24 stereo inputs, 4 or 8 microphone inputs (R/TV-12), 34 stereo inputs, 4 or 8 microphone inputs (R/TV-20); Impedances: Microphone, 150 ohm, High level, 20K ohm bridge or 600 ohm terminate, External monitor, 20K or 600 ohm; Levels: Microphone, -65 to -50dBm, High level, -10 to +10dBm, External monitor, -10 to +10dBm; SNR: Programs/Monitor, better than -90dB at +18dBm out, Headphone/Cue, better than -80dB at 2W; Power Source: 117 or 230VAC, 50/60Hz; Mounting/Dimensions: Tabletop with bottom or back cable entry, Height: 10", Depth: 21.75", 37.5" (R/TV-12), Width: 44" (R/TV-20)

Output Characteristics

Outputs: 1 stereo program, 1 stereo audition, 2 mix minus, 1 mono, 2 line monitor, 2 headphones, 1 cue; Impedances: Programs/Monitor, 600 ohm balanced or unbalanced; Phone/Cue, 2W at 8 ohms; Levels: Programs/Monitor, +8dBm nominal +24dBm maximum; Headphone/Cue, 2W at 8 ohms; Frequency Response: Programs/Monitor, ± 0.1 dB 20-20kHz; Headphone/Cue, ± 0.5 dB 20-20kHz; Distortion: Programs/Monitor, less than 0.05% THD and IMD; Headphone/Cue, less than 0.05% THD and IMD

R/TV-12 12 slide pots—typical stereo/mono—2 stereo programs; 1 mono program; 2 mix minus; 1 cue, 2 headphones; 2 line monitors out; 8 single inputs; 4 multi-line inputs (4 inputs each); 1 mic preamp card (4 mic preamps); balanced line outputs; Penny & Giles slide attenuators; VCA controlled

R/TV-20 20 slide pots—typical stereo/mono—2 stereo programs; 1 mono program; 2 mix minus; 1 cue; 2 headphones; 2 line monitors out; 18 single inputs; 2 multi-line inputs (8 inputs each); 1 mic preamp card (4 mic preamps); balanced line outputs; Penny & Giles slide attenuators, VCA controlled

Clocks

AutoClock Time, stop watch, date and temperature (high and low of the day and time each occurred). Model 100C, console-mounted; model 100D, stand-alone

AutoCount Count-up and stop watch. Model 200C, console mounted; model 200D, stand-alone model

Live Assist Package for R/TV Series Radio and TV Stereo Consoles

The Live Assist Package consists of:

- Microprocessor board • Control panel • Interface board with cable
- Allows automatic operation of 1 bus while live work is being done on the other bus. Also enables the operator to program up to 32 sequential steps per program on each of 4 programs: a total of 128 steps.

The system offers complete and random selection of all console channels. It also allows remote control of each channel on the console using a small 8-wire cable.

The Live Assist Package is an option for use with the R/TV series stereo radio and TV audio consoles: the R/TV-12 offers 24 stereo inputs; the R/TV-20 offers 34 stereo inputs.

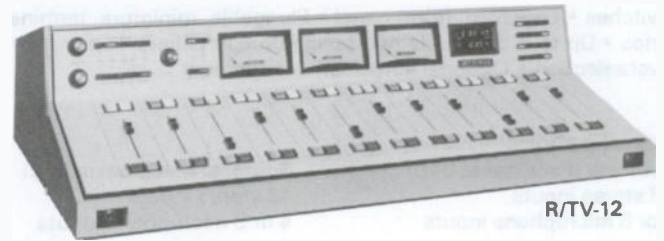

R/TV-12

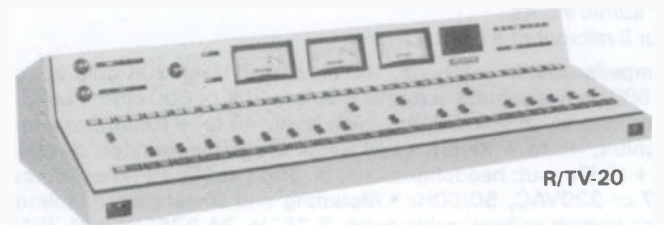

R/TV-20

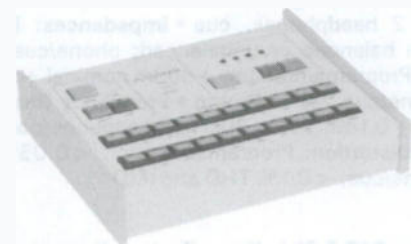

R/TV Live Assist

The Live Assist Panel plugs into the R/TV series console and offers full remote control plus 4 live assist programs. Each program contains up to 32 steps.

With Live Assist, the operator can:

- Start, stop and select audio bus for each console channel via remote control
- Pre-program the start time and program sequence with bus selection for each channel
- Activate and set silence sense timing for program and audition buses
- Observe live assist status at all times
- Monitor sources to transfer on EOM or silence-sense
- Use multiple live assist panels for tandem remote control
- Override live assist at any time
- Obtain limited real-time updates for program format control
- Repeat or chain live assist programs for longer walk-away time

The Microprocessor Board plugs into the console's card cage. It decodes logging from tapes encoded by the Autogram Production Center and collects and dumps channel usage data to an external printer.

The microprocessor board has:

- Parallel printer port
- RS-232C port for communicating to either an external printer or a computer for optional computer control

Note: The external printer or computer and related interconnect cables are not included in the Live Assist package.

Pacemaker Series Consoles

Common Features

- Machine control for all inputs
- Legend strip for each input
- VCA level control
- Electronic switching
- No audio transformers
- Penny & Giles linear conductive plastic pots
- Shadow selector switches
- Engraved front panel
- Pluggable miniature terminal strips
- Up to 8 patchable microphone preamplifiers
- Easy input level selection
- Optional autoclock or autcount

Specifications

Sources: (Pacemaker 648)

48 stereo inputs

4 or 8 microphone inputs

Sources: (Pacemaker 828)

28 stereo inputs

4 or 8 microphone inputs

Sources: (Pacemaker 1032)

32 stereo inputs

4 or 8 microphone inputs

Sources: (Pacemaker 618)

18 stereo inputs

4 or 8 microphone inputs

Sources: (Pacemaker 1644)

44 stereo inputs

4 or 8 microphone inputs

- **Impedances:** Microphone, 150 ohm, high level, 20K ohm bridge or 600 ohm terminate, external monitor, 20K or 600 ohm
- **Levels:** Microphone, -65 to -50dBm, high level, -10 to +10dBm, external monitor, -10 to +10dBm
- **S/N Ratio:** Programs/monitor, > -90dB at +18dBm out; headphone/cue, > -80dB at 2W
- **Power Source:** 117 or 230VAC, 50/60Hz
- **Mounting and Dimensions:** Tabletop with bottom or back cable entry. 9.25"H, 34.375"W x 21.75"D
- **Outputs:** Stereo program, stereo audition, mix minus, mono, 2 line monitor, 2 headphones, cue
- **Impedances:** Programs/monitor, 600 ohm balanced or unbalanced; phone/cue, 2W at 8 ohms
- **Levels:** Programs/monitor, +8dBm nominal +24dBm maximum; Headphone/cue 2W at 8 ohm
- **Frequency Response:** Programs/monitor, ± 0.1 dB, 20 to 20kHz; headphone/cue, ± 0.5 dB, 20 to 20kHz
- **Distortion:** Programs/monitor, < 0.05% THD and IMD; headphone/cue, < 0.1% THD and IMD

Pacemaker 648 6 Slide Pots—Typical: 2 stereo programs, 1 mono program; 1 mix minus, 1 cue; 2 headphones; 2 line monitors out; 6 multiline inputs (8 inputs each—48 stereo inputs, each with machine start control); 1 mic card (4 mic preamps). Self-contained power supply; balanced line outputs; Penny & Giles slide attenuators; VCA level control

Pacemaker 828 8 Slide Pots—Typical: 2 stereo programs, 1 mono program; 1 mix minus, 1 cue; 2 headphones; 2 line monitors out; 8 dual line inputs (2 inputs each); 2 multiline inputs (8 inputs each with machine start controls), 1 mic card (4 mic preamps); self-contained power supply; balanced line outputs; Penny & Giles slide attenuators; VCA level control

Pacemaker 1032 10 Slide Pots—Typical: 2 stereo programs, 1 mono program; 1 mix minus, 1 cue; 2 headphones; 2 line monitors out; 10 dual line inputs (2 inputs each); 2 multiline inputs (8 inputs each with machine control); 1 mic card (4 mic preamps); self-contained power supply; balanced line outputs; Penny & Giles slide attenuators; VCA level control

Pacemaker 618 6 Slide Pots—Typical: 2 stereo programs, 1 mono program; 1 mix minus; 1 cue; 2 headphones; 2 line monitors out; 5 dual line inputs (2 inputs each); 1 multiline input (8 inputs each with machine control); 1 mic card (4 mic preamps); self-contained power supply; balanced line outputs; Penny & Giles slide attenuators; VCA level control

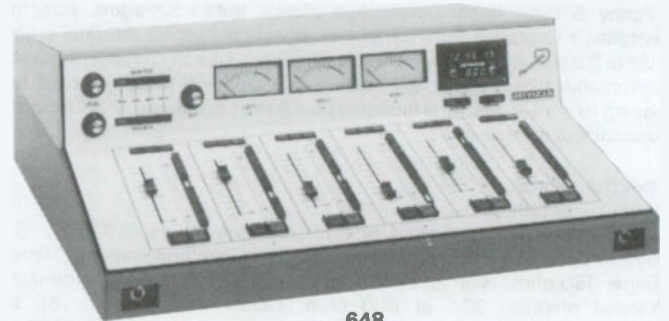

648

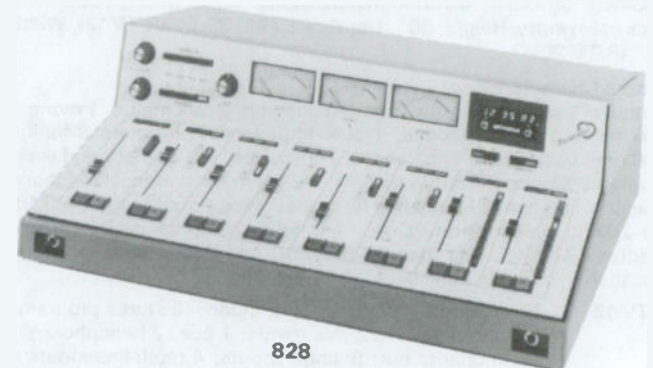

828

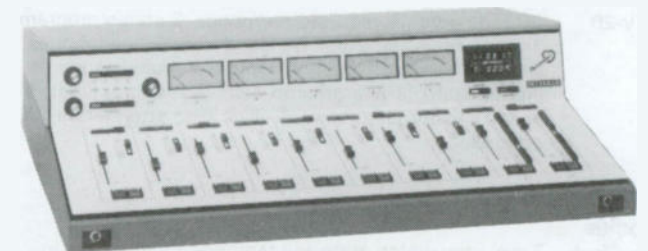

1032

Pacemaker 1644 16 Slide Pots—Typical: 2 stereo programs; 1 mono program; 1 mix minus; 1 cue; 2 headphones; 2 line monitors out; 14 dual line inputs (2 inputs each); 2 multiline inputs (8 inputs each with machine control); 1 mic card (4 mic preamps); self-contained power supply; balanced line outputs; Penny & Giles slide attenuators; VCA level control

Clocks

100C/100D Autoclock—Time, stop watch, date and temperature (high and low of the day and time each occurred).

100C Console-mounted

100D Stand-alone

200C/200D Autocount—Count-up and stop watch.

200C Console mounted

200D Stand-alone

Signature III Audio Consoles

• Models include 6-, 8-, 10- and 12-mixer duals, both mono and stereo. All are identical functioning full duals, i.e., the only difference between any 2 stereo (or mono) consoles is the number of mixers (and associated inputs) • State-of-the-art semiconductors. A headphone amplifier has been added with jacks on both sides of the front panel • On stereo models, all mixers may operate in mono or stereo with the status of each indicated on panel LEDs • Remote start pushbuttons standard • 3 inputs per mixer, rotary Shallco step or optional Penny & Giles stepless faders, plug-in modules, LED peak indicators, switchable mic gain, all transformer inputs and outputs and RFI immunity • Mixers 1 through 4 accept either microphone or high level plug-ins (option available for more); others are fixed high level • Monitor speaker muting and tally provided for mixers 1 through 3 • Every fader has a cue position and consoles include an internal cue amplifier and 5" cue speaker as well as 12W/channel monitor amplifiers

S-11	6-mixer dual mono	S-21	10-mixer dual mono
S-10	6-mixer dual stereo	S-20	10-mixer dual stereo
S-15	8-mixer dual mono	S-24	12-mixer dual stereo
S-13	8-mixer dual stereo		

Accessories

PMM	Mono mixdown (for stereo consoles only)
PMINUS	Mix-minus plug-in (for stereo consoles only)
PMOUNT	Mix-minus mounting kit (for mono or older Signature consoles)
P220	Operation on 220V 50/60Hz
PMP	Microphone preamplifier plug-in (spare)



Signature III S-15



Signature III S-24

PIT	High level input transformer plug-in (spare)
PLA	Line output amplifier plug-in (spare)
PPA	Power amplifier (monitor or cue) plug-in (spare)
PQH	Headphone amplifier plug-in (spare)
PVA	Voltage regulator plug-in (spare)
PSK	Semiconductor spares kit

marantz.

PMD 430 Portable Stereo Cassette Recorder/Player

• Dolby B noise reduction • dbx noise reduction • 3-head design • Bias fine adjustment • Memory rewind • 3-position tape selector (metal, CR0₂, normal) • Limiter • 3-digit tape counter • 4-way power supply: 120VAC, 4.5VDC, 3 D cells, optional rechargeable RB430 battery pack • Built-in speaker • Headphone output jack • Pitch control • Auto shutoff • Auto replay • 3-position microphone attenuator (0dB, -15dB, -30dB) • Illuminated VU meters • Impact resistant case • Dimensions: 2" H x 8 7/8" W x 6 1/2" D • 2.9 lbs.

PMD 430



PMD 222 Portable Cassette Recorder/Player

• 3-head design • 2-speed (1 7/8 and 1 5/16 ips) • Balanced input and XLR connector • Telephone line input • 1/2 speed recording and playback • Line input and output • 3-position microphone attenuator (0dB, -10dB, -20dB) • Selectable high-pass and band-pass filters • LED peak level and low-battery indicators • Built-in limiter • Automatic or manual record level control • Separate input and output level controls • Analog VU meter • Tone control • Playback pitch/speed control • Headphone jack • Replay memory • Auto replay • Audible cue and review • External speaker connection • Built-in condenser microphone • Input and off-tape monitoring • AC adaptor/battery charger • 117VAC • 3 D cells • RB430 optional rechargeable NiCad battery pack • Dimensions: 2" H x 8 7/8" W x 6 1/2" D • 2.9 lbs.

PMD 222



PMD 221



PMD 221 Portable Cassette Recorder/Player

• 3-head design • 2-speed (1 7/8 and 1 5/16 ips) • Full auto shutoff • 3-way power with low battery indication • VU level indication • Switchable limiter • 3-position microphone attenuation (0dB, -10dB, -20dB) • Built-in monitor speaker • 3-digit tape counter • Direct telephone connective jack • Telephone pickup jack • Line input and output jacks • External speaker jack • Anti-roll transport • Playback pitch/speed control • 3-position tape selector (normal, CR0₂, metal) • Automatic or manual record level • Built-in electret condenser microphone • Audible cue and review • Volume and tone control • 3-position automatic noise cancel switch • External microphone jack • Headphone jack • Dimensions: 2" H x 8 7/8" W x 6 1/2" D • 2.9 lbs.

PMD 201 Portable Cassette Recorder/Player

• 2-head design • 2-speed (1 7/8 and 1 5/16 ips) • Full auto shutoff • 3-way power with low battery indication • VU level indication • Switchable limiter • 3-position microphone attenuation (0dB, -10dB, -20dB) • Built-in monitor speaker • 3-digit tape counter • Direct telephone connective jack • Telephone pickup jack • Line input and output jacks • External speaker jack • Anti-roll transport • Playback pitch/speed control • 3-position tape selector (normal, CR0₂, metal) • Automatic or manual record level • Built-in electret condenser microphone • Audible cue and review • Volume and tone control • 3-position automatic noise cancel switch • External microphone jack • Headphone jack • Dimensions: 2" H x 8 7/8" W x 6 1/2" D • 2.9 lbs.



R-30 Radio On-Air Console

- Designed for maximum performance
- Available in 2 mainframe sizes, 12 or 18 input channels
- 2 stereo outputs, mono sum and mix-minus
- Can be expanded to include optional accessory modules, multiphone input, machine control panels, intercom and studio monitor modules, multiple line select module
- Modular construction, fully regulated rackmount power supply, logic follow, full machine control and an all-gold module-to-console interface system
- Input channels available in mono mic and stereo line versions (each with A/B source select)
- Program/audition bus assign, plus cue switches on line modules
- Program and audition VU meters
- Digital timer and clock
- Built-in cue speaker
- Monitor module for control room and headphone functions

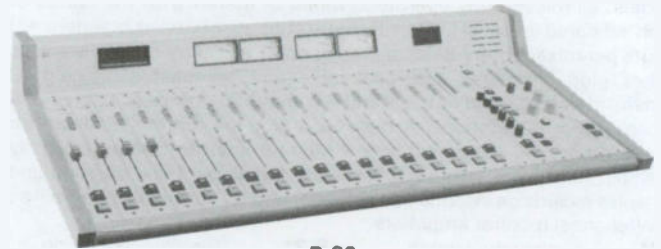

R-30



DL Series

- Replay lock-out and reminder prevents accidental replay errors
- Manual or automatic muting of output audio
- Status indicator lamps show at a glance cue tone presence, both SEC and primary
- Latched lamps verify both have been sensed
- Mute lamp indicates audio on/off status
- Automatic motor turn-off, if selected, conserves power and heat
- +8dBm output ability with 12dB of headroom
- Cart holding system (over top for stereo) for positive location of cartridge
- Slide back cover design allows for quick, easy access for cleaning
- Complete remote control connections, plugs are furnished
- Full view meters for accurate level monitoring
- Bias and tone presence indicators
- Automatic meter switching from record to replay
- Recording shut-off with end of SEC tone option provided
- Front access tone editing and line level controls in mini-drawer
- Optional digital recording timer available for accurate timing
- 100% solid-state design with high noise immunity CMOS logic
- Modular design with plug-in circuit cards
- Selectable 600/150 ohm balanced transformer outputs
- Bridging 5K ohm recorder input
- Dual adjustable equalizers play and record

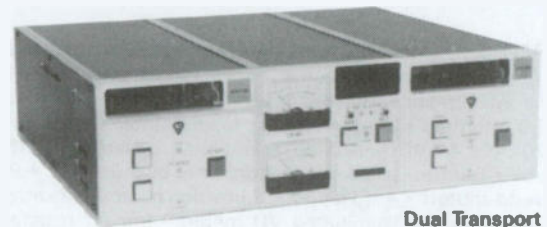

Dual Transport Record-Play

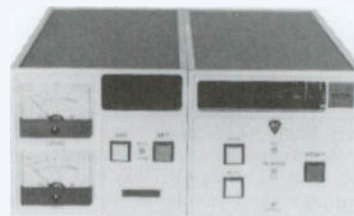

Record-Play



Play

- DL-PM Playback, mono
- DL-PS Playback, stereo
- DL-RM Record-play, mono
- DL-RS Record-play, stereo
- DL-DM Dual transport record-play, mono
- DL-DS Dual transport record-play, stereo

Dominator™ II Precision Multi-Band Peak Limiter

- 104dB dynamic range • Servo-balanced transformerless inputs and outputs • Relay, bypass, remote controllable • Detented potentiometers • Freedom from pumping • Freedom from spectral gain intermodulation • Automatic Limit Threshold (ALT) • Peak ceiling trimmable in 0.2dB steps over a 34dB range • Adjustable density (relative crest height) • Switchable crossover frequencies

720 Designed for applications in which the frequency response is flat — recording, mixing, mastering, sampling, sound reinforcement and certain broadcast applications

723 Designed for applications in which the frequency response must follow a pre-emphasis curve (either 50 or 75µs) — broadcasting, satellite and STL uplink

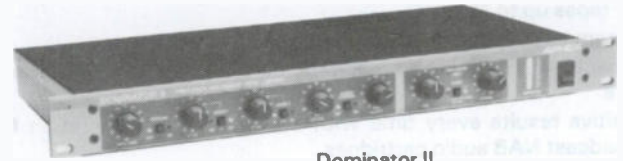

Dominator II

320 Compellor — Dual Channel/Stereo

- Dual mono operation • Individual silence gates • Simple metering select (1 touch for input, output or gain reduction) • 2 stereo modes: leveling link, compression and leveling link • Reference level (-10, +4, +8) switchable (from rear panel) • Leveling speed (fast/slow) switchable from front panel • Peak limiter defeat switch on front panel • Bypass relays, remote controllable • Improved I/O circuit



320 Compellor

DENON

DN-970FA CD Cart Player™

- Variable speed • Quick search • Stores up to 3 cue points • RAM buffer memory starts audio within 30ms of pushing play button • 2 audio channels • Digital audio outputs in AES/EBU professional format • External synchronization • Full remote control capability • Standby/cue functions • Track search • Index search • 18-bit D/A converters • Optional 8cm CD adaptor available • 20Hz-20kHz frequency response • 90dB or more dynamic range • Optional pickup cleaner available



DN-970FA

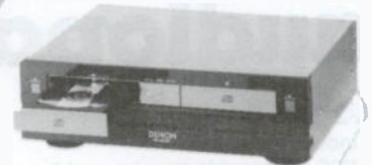

DN-4000F



DN-4000F Dual Transport CD Player

- Rackmount or tabletop • Wired remote controller with large function buttons, illuminated monitor meters and oversized shuttle knob • Manual control of music playback • Full mixing control with 3 ways to do beat mixing • Pitch control ± 10% • Instant start • 18-bit D/A converters • 8X oversampling high-resolution filters • 20Hz-20kHz frequency response • Included accessories: connecting wire (3m), pin cord (4 pcs.), rackmount bracket (6 screws)

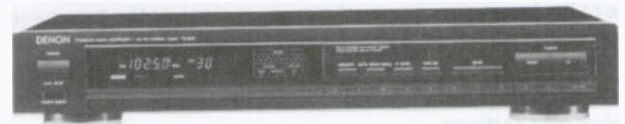

TU-660

DN-951FA CD Cart™ Player

- Proprietary auto track select system reads bar-coded labels placed on the CD cart to enable the player to lock-out play of a specific track, lock-in play of a specific track only, or auto-cue to a specific track while still allowing manual selection of other tracks • 2 audio channels • Selectable fixed speed increase of up to +3% over normal, with steps of 0.2% • 3 units can be rackmounted side-by-side • End monitor • Full remote control capability • Dual 18-bit DACs • 8X oversampling • 20-bit digital filter • 20Hz-20kHz frequency response

TU-660 AM/FM Stereo Tuner

- High sensitivity • High S/N ratio • 2-step IF bandwidth selection • 30-station random preset memory • Remote control • MPX-NR switch • NRSC standard • Digital synthesizer • 500 ohm impedance output • Auto-scan tuning • Quick manual tuning • Manual step tuning • Last-channel memory • Large FL display

TU-280 AM/FM Stereo Tuner

- Very affordable tuner that rivals upper-class models • High sensitivity • High S/N ratio • 30-station random preset memory • Remote control • 500 ohm impedance output • Auto-scan tuning • Quick manual tuning • Manual step tuning • Last-channel memory • Large FL display • Beat cut filter • High-speed FM station search • Large insulator feet • Large, low-impedance AM loop antenna

DN-961FA Drawer-Loading CD Player

- Ideal for stations that do not use the CD cart format • Same specifications as the DN-951FA • Also provides eject lock during play • Single track or continuous play modes

TD-1B Tape Degausser

- Erases audio, video, computer, data tape, magnetic films, cartridges and cassettes
- For tapes up to 3/4"
- Accommodates up to 10 1/2" NAB reels
- Provides a wide focused magnetic field to assure complete erasure
- Positive results every time with a simple 2-pass operation for broadcast NAB audio cartridges
- Transient protection to prevent permanent tape damage
- Thermostatically protected
- 115V/220V, 50/60Hz models available

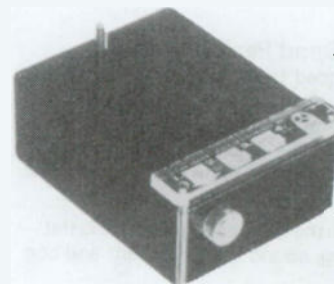

TD-1B



TD-4A



TD-5

TD-4A Tape Degausser

- Erases audio, video, data tapes, U-Matic cassettes up to 750 oersteds and reels up to 16" in diameter
- Provides a 2550 effective gauss field
- Built-in timer has adjustable "on" cycle and automatic shut-off
- Automatic cooling fan operation
- Overheat light with automatic thermal protection prevents exceeding duty cycle on "HI" position. Thermal protection resets to normal operation automatically
- HI-LO operation allows continuous duty erasing on "LO" position for most tapes
- Standard 5/16" center post with 3" NAB hub supplied
- Conservative design assures long, reliable performance

TD-5 Tape Degausser

Includes same features as TD-4A plus:

- Erases metal tape
- Erases up to 1100 oersteds
- Provides a 3700 effective gauss field

audiopak®

A-2 Tape Cartridge

- Industry standard
- 605 ferric oxide tape is used for wide frequency response at the NAB recommended operating level of 160nWb/m
- Low friction heavy-duty binder remains stable and clean running even in climatic extremes
- Graphite backcoat reduces wow and flutter to extremely low levels
- Adhesive properties prevent dropouts or high-frequency losses due to backcoat deposits on the oxide surface or the tape heads



A-2



AA-3



AA-4

AA-3 Tape Cartridge

- 613 tape assures compatibility with all broadcast recorders and typical bias settings
- Supports elevated recording level of 250nWb/m
- Neutral casing design allows the cart machine to guide the tape, maintaining phase stability for the life of the recording
- Warping, stress relief or molding tolerances do not interfere
- Tape cueing accuracy, holdback tension and surface wiping are all provided by the side pressure pad

AA-4 Tape Cartridge

- Also features neutral casing
- To capture the extended frequency response of digital source material, AA-4 uses 614 tape, a premium oxide formulation
- The low friction binder reduces running tension and extends head life
- Extended response can be achieved without changing record level and bias settings used with 613 tape

Technical Specifications

	A-2	AA-3	AA-4
Tape Type:	605	613	614
Base Film:	Balanced Polyester		
Base Thickness (mils):	0.75	0.88	0.88
Magnetic Coating Thickness (mils):	0.30	0.39	0.36
Backcoat Lube Thickness (mils):	0.05	0.05	0.05
Overall Thickness (mils):	1.10	1.32	1.29
Width (inches):	0.248 (+0, -0.002)		
Coercivity, H_c (Oersteds):	295	315	360
Flux/1/4", Ø_n (Maxwells):	0.50	0.80	0.80
Retentivity, B_r (Gauss):	1050	1300	1400
Squareness Ratio, B_r/B_m:	0.81	0.85	0.91
Max. Output Level (MOL), 1kHz at 3% THD (dB):	0	+3.5	+4.5
Saturation Output Level (SOL), 10kHz (dB):	0	+2.0	+5.0
Sensitivity at 50Hz (dB):	0	+0.5	+1.0
Sensitivity at 1kHz (dB):	0	+0.5	+1.0
Sensitivity at 10kHz (dB):	0	+2.0	+4.5
Sensitivity at 16kHz (dB):	0	+2.0	+5.5
Bias Noise (A weighted) (dB):	0	-4.0	-5.0

The above recording properties were tested using a tape speed of 7.5 ips in a commercial broadcast cartridge recorder, biased at 2dB over peak at 10kHz. The reference recording level was 250nWb/m; reference tape was Audiopak 605 in an A-2 cartridge.



FIDELIPAC®
BROADCAST TAPE PRODUCTS

CARTRIDGE MACHINES/ ERASER/SPLICE DETECTOR

Dynamax® CTR90 Series Cartridge Machines

- Superior audio quality • Dolby HX Pro™ headroom extension (recorder only) • DNR® dynamic noise reduction • 3 cue tones • FSK compatibility • Fast forward • Fast forward cue detection • Extended scale VU/PPM metering (recorder only) • Active balanced differential inputs and outputs (transformers optionally available) • Balanced XLR type and "D" input/output connectors • NAB or IEC equalization • Bridging selectable outputs for parallel unit operation • 110/120/220/240VAC, 50/60Hz mains • Cool running—rugged construction • DC/PLL capstan servo drive • Real time minutes and seconds timer with auto-freeze capability • High stability non-interactive head bridge • Constant current solenoid • Self-aligning long life pinch roller • Status indicators • Cleaning mode • Full-function remote interconnects • Advanced programmable internal logic network • PC cards removable from rear of machine • 19" rackmountable, 3 across

- CTR91** A size mono reproducer
CTR92 A size stereo reproducer
CTR93 A size mono recorder/reproducer
CTR94 A size stereo recorder/reproducer
CTR92MX A size stereo reproducer with Maxtrax® head format
CTR94MX A size stereo recorder/reproducer with Maxtrax head format
- Options:** Output transformer, per channel (1 per CTR91 or CTR93, 2 per CTR92 or CTR94)
 Input transformer, per channel (1 per CTR93, 2 per CTR94)
 220VAC, 50Hz, IEC equalization, 3.75 or 15 ips

Dynamax CTR100 Series Cartridge Machines

Operational

- Cartscan System—automatic activation of Elevated Level, Aux, Mono* and Maxtrax* modes • All front panel switches are illuminated • Fast forward • Vary speed—motor speed continuously variable from 1.875 to 30 ips from external reference • Cue tone tracking within ± 30% of preselected speed • Front panel diagnostics • On-board test oscillator

Mechanical

- Playback units—1/3 rack width • Record/Play units—1/2 rack width • 1/2" anodized tool plate deck • Brushless variable speed 3-phase DC servo motor with electrolyzed nonmagnetic stainless steel shaft and permanently lubricated ball bearings, strappable for 3.75, 7.5 and 15 ips • Micro adjustable tape guides

Electrical

- Crystal controlled reference for all internal functions • 144kHz bias oscillator • Audio transformerless circuitry • All power supplies regulated • 110/220V, 50Hz operation

*Stereo machines only

- CTR111** A size mono play
CTR112 A size stereo play
CTR123 A size mono record/play
CTR124 A size stereo record/play
CTR112MX A size stereo reproducer with Maxtrax head package
CTR124MX A size stereo recorder/reproducer with Maxtrax head package

Accessories

- RM-1S** 19" Rackmount shelf for CTR100, CTR100, or ESD Series
FP-2 Filler panel, 1/2 rack width (for use with RM-1S)
FP-3 Filler panel, 1/3 rack width (for use with RM-1S)
FP-6 Filler panel, 1/6 rack width (for use with RM-1S)
HG-1 Head height/zenith gauge
PC-1 Play cable, "D" to female
RC-1 Record cable, "D" to male
TE-1 PC board test extender
TE-90 PC test extender for CTR Series



CTR90

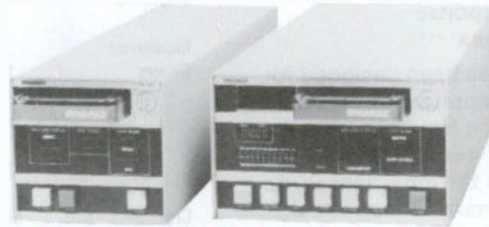

CTR100 Series

Options

Options are field selectable, but will be provided on shipment at no charge if specified at time of order. 220V, 50Hz; IEC equalization; 15 ips or 3.75 ips; RM-1S (with purchase of machines and cover exchange).

Dynamax CTR10 Series Cartridge Machines

Operational

- Versatile, switch-selectable audio/test metering • Bar graph LED VU meters • Fast forward • Selectable high speed recue • 150Hz control of audio muting • Audio switcher and mixer • Strappable repeat play disable • All front panel switches illuminated • Front panel 1kHz defeat with dedicated indicator

Mechanical

- Compact size—1/3 rack width • 1/2" anodized aluminum deck plate • Micro-adjustable tape guides • Removable head nest with precision reference surfaces • Low voltage air damped solenoid • Premium-quality switches

Electrical

- Transformerless audio inputs/outputs • Fully regulated DC power supplies • Complete remote control • Active bias/signal mixing

- CTR11** A size mono play
CTR12 A size stereo play
CTR13 A size mono record/play
CTR14 A size stereo record/play
CTR12MX A size stereo reproducer with Maxtrax head package
CTR14MX A size stereo recorder/reproducer with Maxtrax head package

Options

Options are field selectable, but will be provided on shipment at no charge if specified at time of order. 220V; IEC equalization; RM-1S (with purchase of 2 or more machines and cover exchange).

- 50Hz**
S-CTR11 CTR11 semiconductor/1C kit
S-CTR123 CTR123 semiconductor/1C kit

Dynamax ESD 10 Eraser/Splice Detector

- Provides clean erasures with machine precision—erasure depth of 75dB or more • Improved S/N ratio and on-air sound • Uses dual, high-quality heads • Desktop or rackmountable • Duplicates reel-to-reel recorder technology

Options

Options are field selectable, but will be provided on shipment at no charge if specified at time of order. 220V, 50Hz.



"DX" Series Speaker Systems

- Designed for listening
- Faithful reproduction
- Recommended for foreground and background uses
- Both music and voice applications
- Bass reflex — port tuned for low-frequency response
- Broad coverage area

The "DX" series has been designed for general purpose applications. While special consideration has been given to the reproduction of music, the even frequency response in the important 90Hz to 3000Hz range makes these speaker systems equally suitable for speech projection.

Model	DX-50	DX-80
Power Handling	50WRMS 110W peak	70WRMS 130W peak
Frequency Response ± 4dB	49Hz-15kHz	40Hz-15kHz
Sensitivity 1W/1 Meter	93dB	93dB
Directivity	180° x 170° at 1kHz 110° x 110° at 10kHz	180° x 170° at 1kHz 110° x 110° at 10kHz
Impedance Drivers	8 ohms 10" Woofer (34 oz.) 5" Midrange (16 oz.) 3" Tweeter (5.5 oz.)	8 ohms 12" Woofer (34 oz.) 5" Midrange (16 oz.) 3" Tweeter (5.5 oz.)
Crossovers — 6dB	650Hz, 2kHz	650Hz, 2kHz
Dimensions	23" H x 13 1/2" W x 11 9/16" D	26" H x 19" W x 14 1/2" D

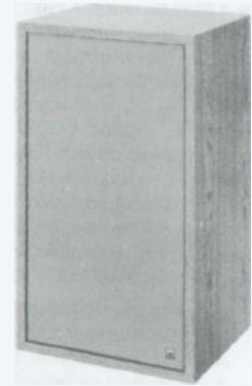

DX-50/DX-80

Loudspeakers

Only the highest grade of materials are used in Davis loudspeakers. Consistency is maintained by extensive TEF® testing before the speakers are accepted into our warehouse. You can rest assured you will receive the same quality every time you order a Davis speaker.



DS-805



DS-810DC



DS-505

Model Number	Diameter	Impedance (ohms)	Power Rating (watts)	Frequency Rating (Hz)	Resonant Frequency	Magnet Weight (oz.)	Voice Coil (in.)	Sensitivity (1W/1m)	Speaker Depth (in.)	Recommended Use and Special Features
DS-805	8"	8	10	70-14,500	85	5.3	1	95dB	2 5/8	General purpose, full range Use with SBA System
DSWP-805	8"	8	12	50-8,000	125	5.5	3/4	90dB	2 3/4	Waterproof, general purpose, sealed voice coil
DS-810	8"	8	20	70-13,000	69	10	1	95dB	3	Greater power, full range general purpose
DS-810DC	8"	8	12	60-12,000	75	10	1	92dB	2 7/8	Twin voice coils for simultaneous music and paging or stereo
DS-805/45	8"	45	10	80-15,000	90	5.3	1	95dB	2 5/8	45 ohm, general purpose
Q830C	8"	8	20	70-10,500	90	10	1	93dB	3 1/4	Coaxial, general purpose
DS-505	5"	8	10	70-16,000	130	10	1	90dB	2 1/4	General purpose, full range, no whizzer
DS-505/16	5"	16	10	70-16,000	130	10	1	89dB	2 1/4	16 ohm, no whizzer, full range, general purpose
DS-510	5"	8	20	150-16,500	110	10	1	91dB	2 1/8	Greater power, full range, no whizzer
FC104	5"	8	10	60-14,000	110	10	1	90dB	2 1/4	No whizzer, wide range, smooth response
DS-545	5"	45	5	120-8,500	150	3	3/4	92dB	2 5/16	45 ohm, voice only, no whizzer
12W8	12"	8	16	50-13,000	73	10	1	95dB	4 1/2	General purpose

"S" Series Modular Production Studio, On-Air Consoles and Turntable Pedestals

Console Table

• Top: Full 1 1/2" thick up to 32" x 96" (other sizes available) • Panel base: 4 panels 24" x 29"H become a sturdy console table when assembled

Single Pedestal

• 29"H x 22" x 24" • 21" front rack space • Standard EIA tapped rails • Liftoff back panels • Levelers

Double Pedestal

• 29"H x 24" x 42" • Two 21" front rack spaces • Standard EIA tapped rails • Liftoff back panels • Levelers

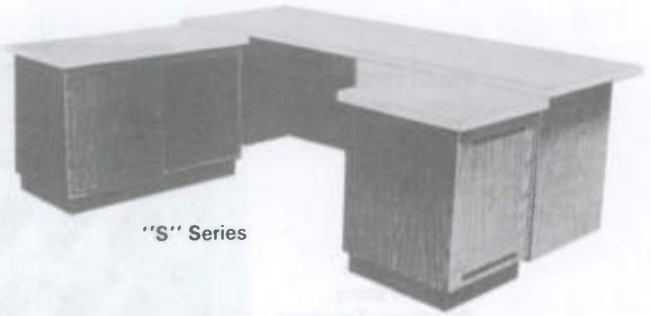

"S" Series

Overbridge System

Available in 4 depths: 11", 12 3/4", 16 1/8" and 18 1/2" (actual dimensions). Made up of 4 parts: a finished top, a finished bottom and 2 finished side panels in lengths required for rack space with rackmount rails applied. The 4 parts are held together by rods and dowel locaters. When assembled, has 19" standard rack space. To increase rack space for additional equipment, just add new side panels with longer rods and rack rails. The system can be mounted on any flat desk surface; RL liftoff back panels can be added as options. 2 sizes of risers are available: small center type and wide type for larger sized overbridges. An access hole for cables is cut inside the riser and 4 bolts to hold unit in place are all that is necessary at installation. If space is available next to overbridge, RL System 23 cart racks can be placed next to both sides of overbridge.



Overbridge System

System 23 Modular Card Racks

System 23 is made up of 6 basic units holding either 18, 36, 54, 72, 90 or 108 cartridges. These units do not have dust collecting shelves, which can interfere with cart use. The individual units can be bolted together to become freestanding, rotating, 4-sided cart racks which hold up to 1296 cartridges. Other configurations are designed to sit on tabletops or be wall mounted. 2 different rackmountable units can fit into any standard 19" rack with EIA rackmount rails. They can be stacked and intermixed to fill available rack space. There are 2 units designed for that seldom used front space in pedestal bases.



System 23 Wall or Table Mount



System 23 Floor
Type Lazy Susan Rack

Modular Record and Tape Storage Systems

Made up of 6 basic units with bases and finished tops. Modules can be used on tabletops, shelves or with our stock 6" high floor bases. Stack them from floor to ceiling, convert into corner units or mix and match. When stacked 3 units high with a finished top, they are ideal as an island unit either singly or back to back. With modified bases they can be used under tables or console tables.

They can be mixed with 7", 12" or Ruslang's cart rack storage system. With the modular system and 24", 36" or 48" lengths many various configurations can be achieved. If the units have to be moved, the records and tapes do not have to be removed from the modules. And unlike a 1-piece unit, they can be carried separately.

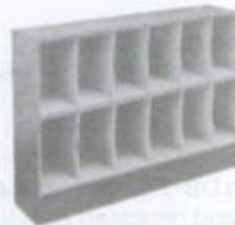

Modular Record and Tape Storage

RL500 Tape Transport Console

Accepts tape transport 19" x up to 15 3/4" H (17 5/8" H on special order). Transport tilts down in front for ease of operation; lifts up for service. Front directly under transport lifts off after loosening 4 mounting screws. Casters are included. The overbridge can accommodate any size required from 3 1/2" H x 11" D to 36" H x 19" D.



RL500

Electronic Equipment Racks

Accept standard 19" wide electronic equipment. These racks come in 14 different heights in 3 1/2" increments, ranging from 21" to 70". But if you need something larger, Ruslang will design to your exact specifications. Constructed of high quality materials, including high pressure laminates and steel mounts, all racks come fully assembled. Available in a variety of solid colors, as well as a lustrous wood grain finish.

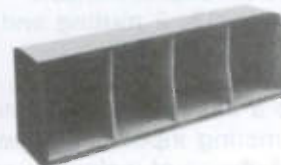

Model 1202A
Compressor/Limiter/
De-esser

Model 4200B
Stereo 4-Band
Parametric Equalizer

Model 2700B
1/3 Octave Graphic
Equalizer

Model 1500C
Notch Filter System

Model SDA-82A
Stereo 8-Channel
Distribution Amp

Model 822A
Stereo Selector

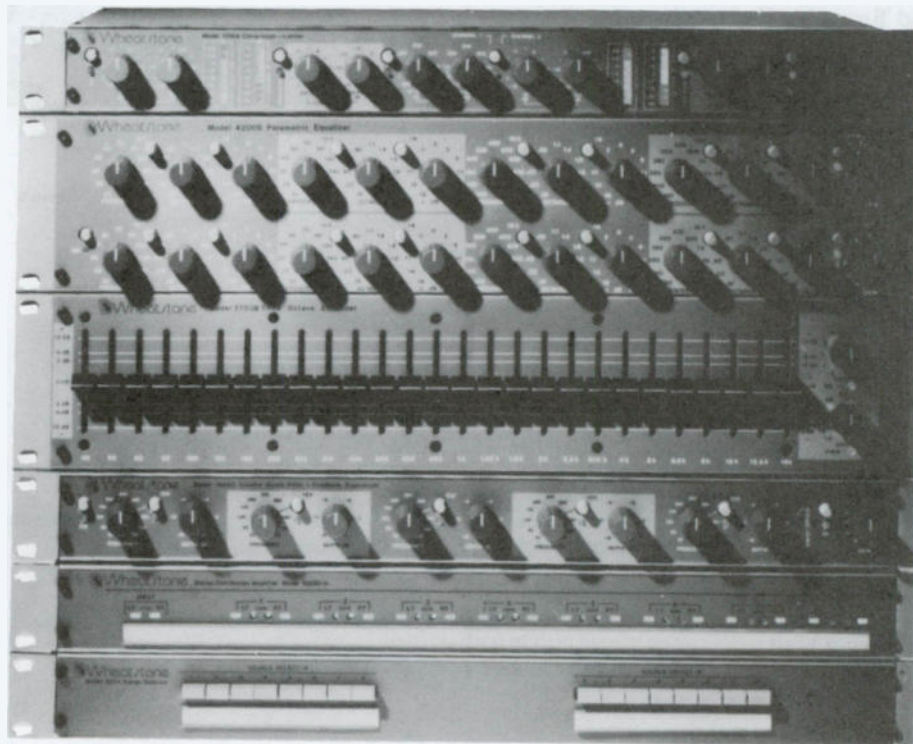

Wheatstone Rackmount Signal Processing Equipment

What are the most important factors in choosing audio gear? Reliability and sonic performance. Consider the extra measures Wheatstone takes to ensure reliability: fully burned-in ICs, hand soldering to avoid thermal shock and wave solder contaminants, varistor over-voltage protected secondaries, electrostatically shielded power transformers, computer assisted performance

analysis and (of course) a thorough listening test. Sonic performance depends on careful attention to circuit topology, a thorough understanding of internal gain structure, meticulous component selection and screening, precision circuit board mapping and proper shielding design—all these add up to smooth, artifact-free performance.



FIDELIPAC®

BAC-0806 System 8-VI Stereo Broadcast Console

Includes 6 mixers, expandable to 8. 3 relays and 11 open collectors for mute/control.

All Series VI consoles include a heavy-duty, regulated power supply, blank panels, mating DB-25 input connectors, choice of walnut or oak trim and recessed or table-top mounting.

BAC-1204 System 12-IV Stereo Broadcast Console

Includes 8 mixers, expandable to 12. 2 muting and 8 control relays.

All Series IV consoles include a heavy-duty, regulated power supply, blank panels, mating input connectors with MOLEX crimping tool and choice of walnut or oak trim.



Series VI



DA 10000 Modular Distribution Amplifier Systems

- Ten 1 x 6 DA modules in 5 1/4" • Dual redundant plug-in power supplies • 5 interchangeable types of DA modules
- Active balanced or transformer outputs • Metering and compressor options • Safe, attractive closed front design
- Barrier block or mass termination connectors • State-of-the-art, high slew rate design

DA 100 Basic 1 In, 6 Out Distribution Amplifier

- Single power stage drives 6 active balanced outputs at +22dBm each • Split and bypassed build-out resistors give protection against shorts and RF • Balanced bridging input
- Single panel level control sets all outputs • Headphone monitor jack

MDA 100 Metered 1 x 6 Distribution Amplifier

- Adds an LED bargraph VU meter to the basic amplifier described above • Measures -21 to +6 VU with 0 VU adjustable for outputs from 0 to +18dBm • Signal alarm indicator and output warns of dead channel

IDA 100-1 Independent 6 Output Distribution Amplifier

- 6 transformer balanced outputs at +22dBm • Individual trimmers provided for each output along with a master level control • Headphone output

PS 100 Power Supply

- A bi-polar unregulated 18VDC supply drives the system power bus through fused isolation diodes • Operates singly or as a redundant pair in the right hand positions of each rack frame • Front panel LEDs indicate low voltage and blown fuses • Power failure alarm relay contacts close for any power loss and can activate external alarm • Dual power transformers in each module run cooler and generate minimal hum field. 115 and 230VAC operation

RM 100 Rack Frame Assembly

- Mounts up to 10 amplifier modules and up to 2 power modules in a 5 1/4" high by 19" wide Eurocard specification enclosure 14 1/2" deep • All modules plug in from the front, are secured with captive hardware and present an attractive and safe closed front panel • Aluminum extrusion construction makes a strong and rugged enclosure and allows free convection for vertical air flow • The basic frame includes power bussing for all positions • Individual modules include mating connector assemblies which mount on the rear of the card frame and plug into the power bus • Connector assemblies provide barrier block connections with fanout strips for studio wiring. Consult factory for alternate insulation displacement. Mass termination connector systems allow simple plug-on audio connections

DA 1000 1 x 8 and DA 2008 1 x 4 Mass Feed Distribution Amplifiers

- +24dBm active balanced outputs • 70dB output isolation and full short circuit protection • Signal present LED (DA 1000 only) • Output clipping LEDs • Front headphone or metering jack • 30K ohm balanced input bridges +24dBm • 26dB loaded gain, front panel adjustment • Flat response, ±0.25dB, 20-20,000Hz • Low distortion 0.2% max THD, 20-20,000Hz • Quiet, -70dBm maximum output noise

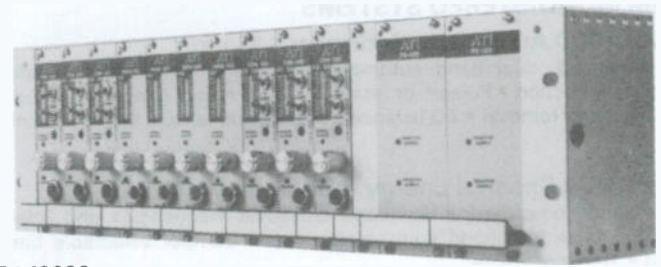

DA 10000

DA 2008-1



DA 1000



MA 1000

- DA 1000-1 1 input to 8 balanced outputs
- DA 2008-1 Dual sections, each 1 by 4
- P/N 20021-501 Single unit, centered mount
- P/N 20024-501 Double, side-by-side mount

MA 1000 Stereo Power Amplifier

- 10W per channel—Stereo • 25W—mono bridged • Balanced bridging inputs • Front level control and headphone jack rear speaker terminals • Electronic output protection instantaneously limits output voltages and current to safe levels • Mode control switches both inputs and outputs for mono bridged operation • Ideal headphone booster or monitor amplifier for low output consoles • Balanced differential inputs allow internal console connection without causing ground loops



AUDIO PROCESSING EQUIPMENT

AM MONO/STEREO SYSTEMS

AGC-400 Audio Gain Controller — Mono

- Linearized, dual band automatic gain control • Gating • Dynafex noise reduction • Pulsed or static USASI noise generator • Audio asymmetry removal • EQ balance • Attack and release time constants

SEC-400 Spectral Energy Compressor — Mono

- 4-band compressor • Multiband crossover frequencies and filters • Selectable multiband compression ratio • Jumper selectable bass EQ • Time constants

PMC-450 Tri-Band Peak Modulation Controller — Mono

- Input gain control • Tilt correct • NRSC standard pre-emphasis and low pass filtering • Resonant low pass clipping filter • Jumper selectable bass EQ • Powerful input compressor followed by a tri-band limiter section and low pass filter • Can be used as a stand-alone processor or with various AGCs and pre-processors

SMP-950 AM Stereo Tri-Band Matrix Processor

- Stereo enhancement • Input gain control • Modified matrix limiting • Tilt correction • NRSC standard pre-emphasis and low pass filtering • Jumper selectable bass EQ • Monaural output • Tri-band limiter

SGC-800 Stereo Gain Controller

- Audio asymmetry removal • Linearized, dual band automatic gain control • Gating • Attack and release time constants • EQ balance • Dynafex® noise reduction • Pulsed or static USASI noise generator

SEC-800 Stereo Spectral Energy Controller

- Musically designed 4-band compressor/limiter • Multiband crossover frequencies and filters • Jumper selectable bass EQ

AM MONO

AM-2M System

- AGC-400 Audio gain controller
- PMC-450 AM peak modulation limiter tri-band

AM-4M System

- AGC-400 Audio gain controller
- SEC-400 Spectral energy controller
- PMC-450 AM peak modulation limiter tri-band

AM STEREO

AM-2S System

- SMP-950 AM stereo matrix limiter tri-band
- SGC-800 Stereo gain controller (AGC)

AM-4S System

- SMP-950 AM stereo matrix limiter tri-band
- SGC-800 Stereo gain controller (AGC)
- SEC-800 Spectral energy compressor

FM STEREO PROCESSING SYSTEMS

SGC-800 Stereo Gain Controller

- Audio asymmetry removal • Linearized, dual band automatic gain control • Gating • Attack and release time constants • EQ balance • Dynafex noise reduction • Pulsed or static USASI noise generator

SEC-800 Spectral Energy Controller

- Stereo • Musically designed 4-band compressor/limiter • Multiband crossover frequencies and filters • Jumper selectable bass EQ



AM-2M System

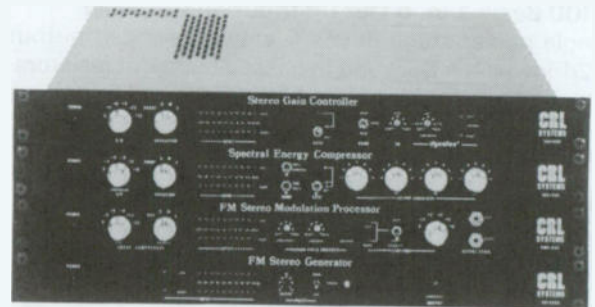

FM-2G+ System

SMP-850 FM Stereo Processor/Dual-Band Limiter

- Stand-alone input AGC/compressor • Time constants • Sound field enhancement • Limit or clip priority • Variable transfer pre-emphasis limiting • Final output limiter • High protection low pass filter

SG-800A Digital FM Stereo Generator

- Digitally synthesized carrier • Pulse amplitude modulator • 2 input SCA ports for multiple SCA use • High current output

Audio Signature 4-Band AGC/Compressor

- Separate wideband/multiband crossover filters • Real time analysis monitoring of equalization • 4 simple memory recall sound settings • IBM PC and modem remote control capability • 8-position diagnostic meter • Built-in USASI test generator

Modulation Signature FM Limiter/Stereo Generator

- Stereophone sound field enhancement • Low-frequency bass enhancement • Adjustable limiting/clipping loudness control • Superior stereo baseband filtering • Digitally synthesized stereo generator • Separate multiplex and audio limiter outputs

FM-1G System

- SMP-850 Stereo modulation processor (limiter)
- SG-800A Stereo generator with filter
Without filter

FM-2G System

- SGC-800 Stereo gain controller (AGC)
- SMP-850 Stereo modulation processor (limiter)
- SG-800A Stereo generator with filter
Without filter

FM-2G+ System

- SGC-800 Stereo gain controller (AGC)
- SEC-800 Spectral energy compressor
- SMP-850 Stereo modulation processor (limiter)
- SG-800A Stereo generator with filter
Without filter

FM-3 System

- SGC-800 Stereo gain controller (AGC)
- SEC-800 Spectral energy compressor



AUDIO PROCESSING EQUIPMENT

Amigo FM AGC, Limiter/Stereo Generator

- Easy to install and operate • Complete AGC, limiter and stereo generator system • Dual band AGC with more than 25dB range • Built-in stereo sound field enhancement circuitry • Advanced digitally synthesized multiplex generator with more than 50dB of separation • Separate multiplex and audio outputs

MBL-100 AM Modulation and Bandwidth Limiter

- Designed specifically for news/talk/sports formats • Maximum loudness and density capability • 7.5kHz audio bandwidth exceeds NRSC-1 standards • Improves intelligibility of speech in receivers • Dual band AGC/compressor circuit freezes action at 20dB below G/R threshold to prevent amplification of noise floor • 2 equalizer sections: (1) 55Hz-145Hz; (2) high frequency boost (for pre-emphasis) • Tri-band limiter and final wideband limiter • Stop band attenuation is greater than 50dB • Transmitter correction • Bypass/test mode controls • Remote control operation • Multi-section EMI/RFI filtering



MBL-100



DX-2

FM/TV AND SCA MONO

BAP-2000 FM/TV Monaural Audio Processor

- Complete stand-alone audio processor for any mono FM or TV application • Advanced 2-band AGC and variable transfer function pre-emphasis limiter • Linearized AGC action provides over 30dB of AGC range • Integral Fh filter for television applications • dynafex® single ended noise reduction system included • Dual 10-segment LED display for easy setup of gain reduction and relative output • Rugged 1³/₄" rackmount chassis with integral RFI protection

SCA-300B Subcarrier Limiter/Generator and SCA-2 System

- Digitally synthesized, frequency locked subcarrier generation • Integral 2-band audio limiter increases intelligibility of voice or music • User can program different subcarrier frequencies and deviation levels • Full remote control capability • Superior crosstalk protection • Direct modulator inputs via RS-232 or BNC connectors • Rugged 1³/₄" rackmount chassis with integral RFI protection

SCA-300B Subcarrier limiter/generator

AGC-400 Audio gain controller

SCA-2 1 AGC-400 and 1 SCA-300B

AM/FM/TV/STUDIO

DX-1 Noise Reduction System—Mono

- Single ended—no encoding or decoding • Simple, trouble-free operation • 30dB of noise reduction • Useful on any audio signal • Filter bandwidth control • Extended threshold range • Gain control • Adjustable release time • Brilliance control

DX-2 Noise Reduction System—Stereo

- Single ended—no encoding or decoding • Simple, trouble-free operation • 30dB of noise reduction • Brilliance control • Useful on any audio signal

IPP-100 Microphone Processor

- Selectable microphone or line level inputs. Microphone pre-amplifier standard • Phase processor • 2-band parametric equalizer, constant Q • 2-band compressor with gain reduction gating • User adjustable compressor band split frequency • User adjustable release time • Send and return ports for connection of external signal processing (reverb, etc.) • Anti-pop filtering

Control features

- 18 memories for all user adjustable controls • Parallel or serial remote control connector allows choice of: contact closure, computer terminal or serial remote control of IPP presets • Optional remote control box • Easy-to-use "analog" controls • Quick acquisition of preset information • Security lock prevents alteration of presets • Fast switching from 1 preset to another • Remote control muting of output • Automatic bypass if power lost

The IPP-100 incorporates features that are specifically designed to address the problems of voice processing in the broadcast environment. Powerful equalization and compression circuitry are combined with an advanced microcontroller to give a wide range of programmable preset characteristics

IPP-100R Digital IPP-100 remote control box

IPPcable 25' serial digital remote cable

Real Time Event Sequencer

- Sequences up to 200 events • Controls up to 8 contact closures • Full microprocessor control • 32K byte 8 EPROM for operating software and a special real time clock chip • Ultra stable time base • Simple keypad operation • Built-in long-life lithium battery for uninterrupted operation during power failures

NRSC UPGRADES

MDF-400/800 De-emphasis/Filter

- NRSC de-emphasis characteristic • HQ notch filter • 9.5kHz or 11kHz steep lowpass filter • Functions can be selected individually or in any multiple combination • Post detection—interfaces to any AM modulation monitor or monitor/receiver • Active-balanced or unbalanced audio inputs and outputs • Rugged 1³/₄" rackmount chassis with integral RFI protection

MDF-400 Monaural

MDF-800 Stereo

SLR Slide rackmount kit

SC-03 3-unit plexiglas cover

Loudness Meter Model 40-A

- Model 40-A simultaneously displays both peak and average of the audio signal
- For audio gain riding and the control of loudness
- Other sizes available, including the Model 380, a 2-channel stereo meter which fits into most consoles

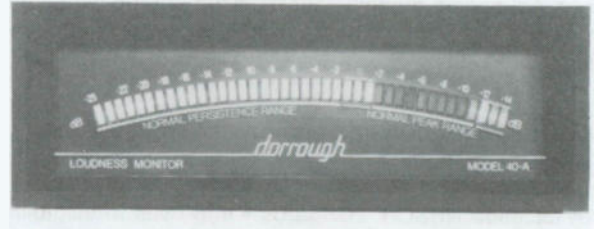

40-A

Discriminate Audio Processor Model 610-A

- Model 610-A is a tri-band audio broadcast limiter
- It delivers a truly uncompressed, open and loud sound
- Broadcast coverage is increased with this system
- Units available for AM, FM, TV and HF
- FM stereo generator included with the FM system

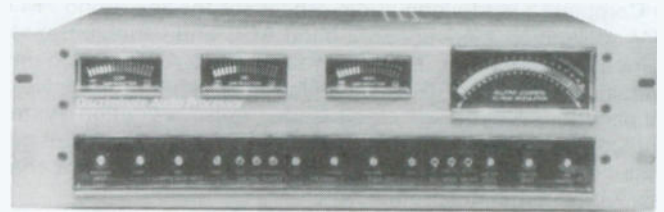

610-A

Stereo Signal Test Set Model 1200

- Model 1200 is a simple and easy-to-operate gain set
- It allows stereo measurements of level, balance, crosstalk and signal-to-noise over the entire dynamic range of your system from noise floor to clipping
- L/R polarity and phase compatibility testing in either mono or stereo also featured
- The solution to balanced stereo lines



1200

Spectrum Systems

Lazer Digital Limiter/Stereo Generator

- 100% digital processing provides crystal clear audio
- Less distortion, cleaner signal
- Loudness achieved without clipping
- 23 processing parameters
- Ultra precise baseband stereo signal generation
- Simple setup and operation
- 8 preset processing programs, user adjustable
- A/B processing program comparison
- Remotely accessible via RS-232
- Upgradeable through future software programs

Lazer's 5-button control panel and LCD screen can be learned in minutes. You can also access Lazer from any personal computer, allowing you to make changes from anywhere, any time.

Monitoring parameters is easy on Lazer. Left, right and composite signals are monitored constantly on the left 3 meters. All other parameters can be selected for viewing on the right 3 meters. You'll be able to visually determine how Lazer is processing your signal so that you can adjust it to do exactly what you want, without guesswork.

Lazer comes with a companion unit, the Optical Encoder. The Optical Encoder converts your stereo signal into a digital data stream and then, via a fiber optic link, sends the signal to Lazer. If you're using the complete Spectrum System, the digital signal is first routed to the digital Prizm and then to Lazer.

You can also receive excellent results by using a pair of analog Prizm II FM units as your preprocessor, feeding high quality audio into the Optical Encoder, then to Lazer.

Lazer has an analog composite output to connect to your existing FM exciter. In anticipation of digital exciters in the future, a digital exciter output is also provided. In addition, Lazer has an input for a feed from a digital SCA generator.

Lazer's RS-232 serial data port allows PC connection either directly or through a modem. All front panel functions of the Lazer can be controlled via the RS-232.

Lazer has 4 main menus: Metering, Program Selection, Program Parameters and System Parameters.

Lazer Metering Menu

Lazer gives you 10 different metering choices. To change the selectable A-B-C meters just press the Mode button, use the Up/Down keys to select your new choice, and then press Enter. This feature can be accessed at any time and is convenient when you're making a parameter adjustment.

Lazer Program Selection Menu

Lazer has 8 factory preset processing programs in its memory. Each of these programs can be altered to meet your specific processing needs. Alteration occurs in the Program Parameters menu. Once you've set up your programs, use the Program Selection menu to select a program for on-air use. You can change to any of the 8 programs at any time and as often as you want. Lazer's unique A/B comparison capability allows you to detect subtle differences between programs. When connected to a PC, you can have an almost unlimited number of processing program choices which can be changed automatically.

Program Parameters Menu

This menu allows you to alter the 8 preset processing programs. Over 20 different parameters can be changed. You can even change the name of each program. Analog processors do not allow you to change as many parameters because the parameters are implemented in hardware. However, when digital processors are used, all such parameters are available for alteration. This new technology gives you the freedom to adjust the sound of your station to your precise requirements.

System Parameters Menu

Parameters such as passcode, pilot injection adjustment and RS-232 baud rate are included in this menu. Diagnostic signal generation, including Bessel tones, is also provided.

Optical Encoder



Lazer



Prism II

Prism II FM Digitally Controlled Audio Processor

- Digital control of the processing yields high apparent loudness without excessive listener fatigue
- Multiband processing allows heavy processing in 1 band without "punching holes" in the rest of the audio spectrum
- A safety buffer protects the processing from overloads caused by excessive levels from the on-air console
- Front panel LEDs show the status of each processing band as well as the degree of expansion or compression taking place
- Individual "mix level" controls for each band allow band equalization without a separate program equalizer
- A "density" control adjusts the amount of processing action in the Prism II FM. Low settings provide intelligent and gentle processing for classical music or TV audio. Higher levels provide the aggressive processing necessary for heavy rockers
- Adjustable gating provides "single ended" noise reduction
- Built-in phase rotator produces symmetrical audio peaks for more consistent loudness. Phase rotator can be disabled if desired
- The optional RCF-1 Card maximizes the processing power of the Prism II FM and the Optimod 8100A

Conventional audio processing constantly compresses or expands. This creates a busy, intense sound which can be tiresome and irritating to listeners. The digitally-controlled processing in the Prism II FM compresses when necessary, expands when required and simply does nothing when no action is needed. The result is maximum modulation without the irritation associated with over-processed audio. You receive the competitive loudness while your listeners enjoy clean, bright audio.

Since the Prism II FM is a multi-band processor, heavy processing in 1 audio band does not "punch holes" in the whole audio spectrum. The 4-band architecture of the Prism II FM enhances its ability to produce a loud but clear sound. Since the level of each band is individually adjustable, the Prism II FM can be adjusted to tailor your station's sound to be unique in your market.

RCF-2 Replacement Card Five for Optimod 8100A

A popular FM processing combination is a pair of Prism II FMs used with an Orban Optimod 8100A. The RCF-2 is a plug-in replacement for Card #5 in the 8100A. The addition of the RCF-2 delivers more loudness and control over low frequency response. The result is increased bass response and greater modulation density without sounding overprocessed. Addition of the RCF-2 requires no circuit modification to your Optimod. The RCF-2 also comes with a new access panel to accommodate the additional RCF-2 controls.

222 NRSC Audio Processor

- Specifically intended for AM broadcasting • Incorporates an "adaptive" preemphasis characteristic to enhance signal intelligibility and "presence" • Built-in peak limiter can enhance or replace existing peak controllers • Feedforward pulse width modulation • Active multipole lowpass filtering exceeds requirements for adjacent-channel protection

222-00 AM broadcast preemphasis/lowpass processor, for U.S. "NRSC" specification, 10kHz cutoff

222-01 AM broadcast processor for European medium-wave service, 9kHz cutoff

222-02 AM shortwave broadcast processor for U.S.-based shortwave broadcasters, 6.4kHz cutoff

222-03 AM shortwave broadcast processor for international shortwave broadcasting, 5kHz cutoff



222-00

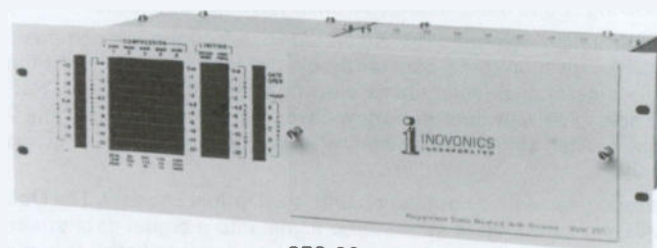

250-00

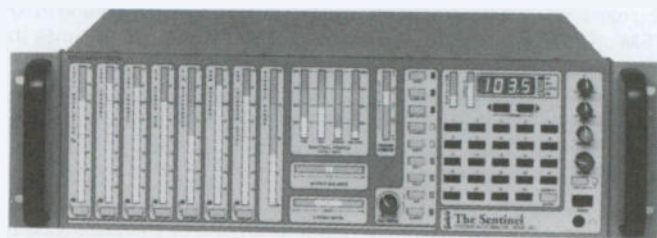

550

250 Programmable Stereo Broadcast Audio Processor

- Digital programmability enables the user to adapt processing parameters to alternative program sources or to suit changing station formats and listener profiles over the course of the broadcast day • Performs all the signal conditioning required between broadcast console and transmitter • Accomplishes the multiple functions of slow, gain-riding AGC, multiband compression and program equalization and final peak control conforming to FM/TV preemphasis characteristics or with fully matrixed processing for AM stereo • Feedforward pulse width modulation • Unique soft knee compression yields smooth "program adaptive" transfer ratios

250-00 Programmable multiband stereo processor for FM and stereo-TV

250-01 Programmable multiband stereo matrix processor for AM stereo

250-02 Programmable multiband processor for monaural AM broadcasting (field-convertible to stereo)

255 Triband Stereo Broadcast Processor

- Multifunction device incorporating slow "gain riding" AGC with 3-band compressor/limiter • Gain control utilizes implementation of pulse width modulation (PWM) in a feedforward, soft-knee circuit configuration • Gated AGC has peak-weighted response • Gated 3-band compressor/limiter includes a variable platform release characteristic and program-adaptive clipping function • Split-spectrum peak control may be set for 75 or 50ms transmission pre-emphasis protection • Feedforward PWM gain reduction yields smooth, colorless operation with any degree of processing • User controls are calibrated in terms for convenient setup and easy return to previous presets

260 Stereo Broadcast Processor

- Ideal for the more basic broadcasting situations which require ample and consistent transmitter modulation • User adjustments have been reduced to only those which are essential to operation • Easy to install and use • Gated AGC and compression • Level alarm warns of "dead air" and out-of-limits operation • Feedforward PWM gain control for smooth, colorless operation

705 FM Stereo Generator

- Full-featured stand-alone incorporating all necessary lowpass filtering and transmission preemphasis functions • Subcarrier and pilot signals generated by digital circuitry to assure optimum performance and drift-free operation • FMX™ coverage-extension system available as plug-in option • Digital synthesis of pilot(s) and subcarrier(s) give maximum stereo separation • Internal phase-compensated lowpass input filtering • Built-in peak overmodulation protection and proprietary filter overshoot control circuits • Adjustable composite equalization • Interface with a variety of audio processing systems

706 FM/FMX Stereo Generator

- Second generation FM stereo generator • Makes extensive use of digital techniques in generating the composite multiplex output • Incorporates the FMX coverage extension transmission system as a field-installable plug-in option • Digital synthesis of composite signal • Patented filter overshoot compensation • Internal combining circuitry for up to 3 SCA or RDS channels • Built-in composite processor • Fully compatible with most audio processing systems

715 David Integrated FM Stereo Processor/Generator

- Stereo audio processing includes slow-AGC, dynamic compression and peak limiting. Single knob control adjusts program density • Digital synthesis of pilot and subcarrier for best separation and freedom from drift and routine adjustment • Built-in combining for SCA or RDS subcarriers with separate TTL pilot sync output • Easy to set up, easy to use. "Generic" components used throughout for ease in servicing anywhere in the world

550 Sentinel Monitor/Receiver

- All-mode monitor/receiver with powerful, built-in audio quality diagnostics • Our staff can quickly and easily monitor, evaluate and compare key quality parameters of any station in their market • Optional computer interface automates and provides hard copy • Total modulation is shown directly in percent • Metering conforms to the true "CBS Loudness Meter" specification • Dynamic range metering helps define the "listener fatigue" factor • 4-band real time spectral display shows contribution of each "acoustic perception" band • Stereo image and stereo balance visually depict "stereo stage" width and center-channel location • Program symmetry monitor helps maintain "absolute phase" • All-mode reception: expanded-band AM-mono and C-Quam® stereo; FM/FMX stereo and all analog and digital SCA/RDS subcarriers

modulation sciences, inc.

AUDIO PROCESSING EQUIPMENT

CP-803 Composite Audio Processor for FM Stereo

- Reduces amount of audio processing required
- No variable gain element, gives you more loudness without audible distortion
- Upgrade the quality of your signal, a brighter, more "open" sound
- Automatically reduces filter overshoot present in every stereo generator or composite STL
- Allows transmitter to be modulated with lower peak to average ratio
- Restores "lost" modulation capability and loudness
- 95 to 130VAC, 10W maximum (190 to 260VAC option available)
- Temperature range 0°C to 50°C
- All inputs and outputs RF suppressed, power supply RF suppressed and shielded from main circuitry
- Frequency response $\pm 0.03\text{dB}$ referenced to 1kHz

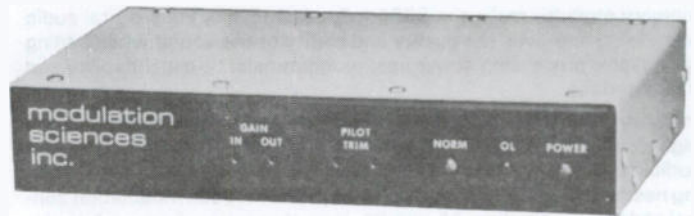

CP-803

DSCA-188 Data Sidekick

- 4800bps data rate
- Operates synchronous or asynchronous (data rate in synchronous mode is about 600 characters per second; in asynchronous mode about 480 characters per second)
- AC coupled code can be decoded inexpensively using conventional SCA receiver technology and additional equipment
- Low data error rate is measured at better than 1 in 10E7
- Built-in error test generator allows for exact evaluation of entire transmission
- Symmetrical modulation and program-like power spectrum
- Bi-polar code minimizes crosstalk into stereo and provides maximum resistance to the effects of multipath
- Crystal controlled subcarrier synthesizer
- Error checking of data before transmission
- All data regenerated before transmission
- Built-in peak deviation meter
- Transmitter tuning aid for synchronous AM
- Excellent RF shielding
- Stable over a wide temperature range
- Controlled baseband spectrum for minimum bandwidth
- Standard RS-232/RS-422 data input



SCA-186

SCA-186 Sidekick SCA Generator/Audio Processor

- Excellent RF and EMI shielding
- Built-in transmitter tuning aid
- Stable over a wide temperature range
- Compatible with compander, data or telemetry systems
- Peak holding deviation meter can eliminate need for a modulation monitor
- Quartz crystal controlled synthesizer can be programmed to any SCA frequency
- Built-in audio processor, gain reduction metering and a device to help minimize crosstalk-causing incidental AM modulation
- Specify SCA operating frequency: 92kHz or 67kHz

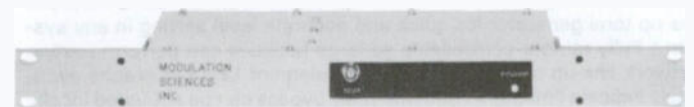

CLD-2504

CLD-2504 Composite Distribution Amp

- Allows connection of multiple transmitters and alternate stereo generator/processor setups without interaction
- Highly immune to RFI from FM, AM or TV transmitters
- Supports more than 60dB of stereo separation
- 4 low impedance outputs drive long cable lengths
- Provides test signals without disrupting the air chain
- More than 40dB isolation: no interaction among loads
- Broadband S/N ratio of greater than 80dB
- Group delay under 40ns, 50Hz to 53kHz
- Frequency response flat to 1MHz (-1dB point)
- Easily drives 50 to 75 ohm loads
- Optional terminator/attenuator controls signal level without raising output impedance
- All connectors are BNC for easy hookup

ModMinder Modulation Monitor With DeMod Board

- Increases modulation by 1dB to 4dB
- Uses less processing
- Measurement technique complies with FCC rulings
- Digital technology improves measurement accuracy by over 500%
- Updates any conventional modulation monitor
- Operation



ModMinder

from remote control or PC

- Internal card turns ModMinder into a self-contained peak modulation analyzer
- Calibration is factory-locked and certified NIST- (NBS-) traceable for 2 full years
- No need to calibrate before each measurement
- Measures peak deviation on any RF level from 10mW to 1W without any user adjustments and locks itself out automatically if RF level is outside of its operating range
- All functions remote-compatible
- Provides graphic modulation analysis with easy-to-use ModMinder Remote and Advanced Remote PC software
- ModMinder Remote (free with every ModMinder) runs on any PC-compatible computer. It allows remote access to all of ModMinder's front panel controls via modem and dial-up telco line, while providing modulation analysis of your station
- Optional Advanced Remote software requires PC-AT equivalent with EGA or VGA graphics. The advanced package adds 2-D and 3-D graphic presentations of modulation information
- No crystals required
- DeMod employs software programmed frequency synthesizer for total accuracy and stability
- External tuner permits off-the-air monitoring and modulation analysis of local stations



AUDIO PROCESSING EQUIPMENT

8200 Optimod®-FM Digital Audio Processor

Provides complete audio processing and transmitter protection for FM broadcast. Interfaces with all commonly found transmitters and studio-to-transmitter links. Digital signal processing cards and program memory modules make the 8200 fully expandable. Fully-digital audio processing improves the quality and clarity of the sound while adding changeable processing structures, programmability, expandability and a PC interface.

Integrates the stereo encoder with the audio processor to achieve the highest average and peak modulation levels with the least amount of audible compression and peak limiting. Fulfills all of a station's processing needs: automatic gain control, compression, peak modulation control and stereo encoding. All circuitry is on plug-in boards or modules for easy troubleshooting and maintenance. Programmable processing structures allow the 8200 to change its sound with the push of a button. Automation preset switching allows stations broadcasting different formats to optimize the processing throughout the day. 120V/230V, 30Hz-53Hz. Switchable 50 μ s or 75 μ s. Includes protection, 2-band purist and 2-band processing structures.

- 8200/U2S** Includes 2 DSP cards
8200/U3S Includes 3 DSP cards and multi-band structure



8200



9100B

4000 Transmission Limiter

- Ideal for transparently protecting transmission links from overload
- Can be operated in stereo or as 2 independent units
- Accurately and transparently limits levels without producing audible artifacts
- Has very low static and dynamic distortion
- Includes pre-emphasis limiting for 5 different pre-emphasis curves: 25 μ s, 50 μ s, 75 μ s, 150 μ s, and CCITT J.17
- Rigorously limits its output bandwidth to 15kHz
- Built-in line-up tone generator for quick and accurate level setting in any system
- Fully remote-controllable so large facilities can perform routine network line-up checks centrally
- 10-element LED bar graphs accurately indicate limiting
- Hardwire relay bypass can be activated locally or by remote control, and activates automatically when the 4000 loses main power
- Transformerless, balanced floating 30 ohm output to ensure high transparency and accurate pulse response

- 40002/U75** 2 channel, 120V 75 μ s
40002/UT75 2 channel, 120V OPTx / 75 μ s
40002/UTT75 2 channel, 120V IPTx OPTx 75 μ

9100B1/U10 Optimod-AM Mono Processor

Complete audio processing for AM broadcast. Includes broadband AGC, NRSC-standard and alternative pre-emphasis, 6-band limiter with distortion-canceled clipper, switchable NRSC 10kHz filter, jump-erable 5kHz low-pass filter, transmitter equalizer for 2 transmitters (day/night). One ACC-023 NRSC Monitor rolloff filter supplied. Field convertible to stereo. 115V/230V, 50-60Hz.

9100B2/U10 Optimod-AM Stereo Processor

For C-QUAM or Kahn. As 9100B1/U10 above, equipped for stereo operation. Uses sum and difference control of processing to assure maximum loudness on mono receivers. Switchable features include L and R 75% negative peak limiter as recommended by Motorola for C-QUAM, adjustable stereo enhancer that increases L-R, 200Hz high-pass filter for telemetry or LF SCA. Two ACC-023 NRSC Monitor rolloff filters supplied. 115V/230V, 50-60Hz.

Optimod-AM Accessories

MRF023 NRSC Monitor Rolloff Filter (one per channel)

Approximates typical receiver rolloff when monitoring from modulation monitors and wideband receivers. Includes rolloff to the NRSC standard 75 μ s de-emphasis. Included in all 9100B1/U10, 9100B2/U10 and several stereo upgrade kits.



8100A1

8100AXT2

8100A1 Optimod-FM Stereo Processor

Dual-band stereo compressor, high frequency limiter, smart clippers, stereo generator. 115/230V, 50-60Hz. 75 μ s standard; order OPT-11 for 50 μ s installed (no charge).

8100AST/U Studio Chassis

Separates 8100A and 8100A/1 audio processing into 2 chassis to locate compressors at studio. Controls average levels into STL or phone lines, and optimizes signal-to-noise ratio. 115V/230V, 50-60Hz.

8100AXT2 Six-Band Limiter

Accessory to 8100A1. Provides aggressive multiband processing where bright, loud, "highly-processed" audio is desired that jumps out of auto and table radios. Especially suited for CHR formats.

Optimod-FM Accessories

8100AFC

For enhanced SCA protection. Used to provide 25dB more protection to 67kHz SCA than provided by standard 8100A1. Will also increase average modulation capability by about 0.5dB. Installs in 8100A or 8100A1. Usable with XT Six-Band Limiter.

Note: For Continental 510R-1, Collins 310Z-2 and 310Z-1 exciters, obtain interface from Continental. Most other direct-FM exciters with broadband inputs do not require special interface.

222A/U Stereo Spatial Enhancer

- Designed to be inserted in the program line at the studio prior to processing
- Proprietary, patent-pending technique detects and enhances psychoacoustic directional cues which are present in all stereo program material
- Increases brightness, impact, and definition of music
- Front-panel enhancement and width limit controls allow tailoring of processing to user requirements
- No increase in FM multipath distortion, no unnatural exaggeration of reverberation, and no increase in sensitivity to vertical tracing distortion in disc playback
- Full mono compatibility
- Complements any broadcast audio processor without changing the station's "sound"
- LED bargraph displays indicate status and degree of enhancement

- Stereo inputs and outputs

222A/U 115VAC \pm 10%
222A/E 230VAC \pm 10%



222A/U

245F/U Stereo Synthesizer

- Creates a pseudo-stereo effect from mono original
- Left and right channels sum back to original mono for total compatibility in disc cutting and FM stereo broadcast
- Doesn't affect the frequency balance of the mono original
- Easy to use; only 3 operating controls
- Unbalanced line level input and outputs

245F/U 115VAC \pm 10%
245F/UT With output transformers
245F/E 230VAC \pm 10%
245F/ET With output transformers



245F/U

275A/U Automatic Stereo Synthesizer

- 19" rackmount package
- 2 modes of stereo synthesis (wide and narrow)
- Automatic mono and single-channel recognition
- Automatic polarity correction
- Single-ended noise reduction

275A/U 115VAC \pm 10%
275ARC Remote control
275A/E 230VAC \pm 10%



275A/U

290RX/U 2-Channel Adaptive Enhancement Processor

- 2 independent channels, each providing harmonic restoration, spectral restoration and single-ended noise reduction
- Noise is removed by 2 separately adjustable interactive processes: downward expansion and bandwidth control
- Each channel has 3 separate LED displays
- 2 channels can be operated independently or as a stereo-coupled pair

290RX/U 115VAC \pm 10%
290RX/E 230VAC \pm 10%



290RX/U

412A/U, 414A/U Compressor/Limiters

- Wide-range attack time, release time and ratio controls
- Threshold control with 20dB range
- Ideal for sound reinforcement applications
- Front panel output attenuator control with output clip LED to indicate line amplifier clipping
- Illuminated, true peak-reading gain reduction meter
- Gain reduction overload lamp warns of control circuit overload
- Mono unit (412A/U) requires only 1 rack space

412A/U Mono
412A/E 230VAC \pm 10%
414A/U Dual channel/stereo version of 412A/U
414A/E Dual channel/stereo version of 412A/E

422A/U, 424A/U Gated Compressor/Limiter/De-essers

- "The Studio Optimod"
- Production AGC device which achieves high average loudness without undesirable artifacts
- Separate compressor/limiter and de-esser control loops, with program-controlled parameters
- Defeatable gate with adjustable threshold freeze gain
- Adjustable attack time, release time and compression ratio
- Independent de-esser similar to the 526A de-esser
- Low distortion operation. 25dB gain reduction. > 25dB de-ess gain reduction in addition to 25dB compressor/limiter gain reduction
- True peak-reading output level meter and gain reduction meter
- Selectable linear or exponential release time characteristics
- 19" rackmount package
- Extensive RFI suppression
- Balanced input and output and 115/230V, 50/60Hz power supply standard

422A/U Mono
422A/E 230VAC \pm 10%
424A/U Dual channel/stereo version of 422A/U
424A/E Dual channel/stereo version of 422A/E

464A/U "Co-operator" Gated Stereo Leveler/Compressor/HF Limiter/Peak Clipper

- 4-stage level control selectable on front panel
- Defeatable silence gate
- 6 switchable HF limiter curves (25 to 150 μ s) match the HF limiting to the medium or device being protected and optimize control of excessive sibilance
- Defeatable clipper follows the HF limiter, so the unit can be used for absolute peak protection
- Switch-selectable gain compression recovery rate
- Faster "compression" function can be switched-in
- Switchable for stereo-tracking or independent 2-channel operation
- 2 LED bargraphs per channel simultaneously display gain reduction and peak output level
- Output level meter can be calibrated to match the overload point of the device being driven
- Balanced, floating inputs and outputs are EMI-suppressed
- 25dB gain reduction range is achieved with a low-distortion, Class-A VCA
- 1 $\frac{3}{4}$ " H rackmount package
- Hardwired bypass switch included

464A/U 115VAC \pm 10%
464A/E 230VAC \pm 10%

4000 Transmission Limiter

- Ideal for transparently protecting transmission links (such as digital PCM, NICAM, analog microwave, and telephone/post lines) from overload
- Can be operated in stereo or as 2 independent units
- Accurately and transparently limits levels without producing audible artifacts
- Has very low static and dynamic distortion, thus producing extremely transparent, natural audio quality, both below and above threshold
- Includes pre-emphasis limiting for 5 different pre-emphasis curves: 25 μ s, 50 μ s, 75 μ s, 150 μ s, and CCITT J.17
- Rigorously limits its output bandwidth to 15kHz
- Contains a built-in line-up tone generator for quick and accurate level setting in any system
- Fully remote-controllable so large facilities can perform routine network line-up checks centrally
- 10-element LED bar graphs accurately indicate limiting
- Equipped with a hardware relay bypass that can be activated locally or by remote control, and which activates automatically when the 4000 loses main power
- Transformerless, balanced floating 30 ohm output to ensure high transparency and accurate pulse response

40002/U75 2 channel, 120V 75 μ s
40002/UT75 2 channel, 120V OPTx 75 μ s
40002/UTT75 2 channel, 120V IPTx OPTx 75 μ s

425 Stereo Compressor/Limiter

- Independent downward expander, compressor, limiter
- Individual LED meters for each processing section
- Stereo or dual-mono operation
- Balanced/unbalanced XLR
- Balanced/unbalanced 1/4" connectors
- Soft-knee compression curve

501 Peak-RMS Compressor/Limiter

- Separate processors for both compression and peak limiting
- Balanced in/out XLR
- Unbalanced in/out 1/4"
- Sidechain in/out 1/4"
- Stereo connect 1/4"

501 Option 01—Transformer coupled output

511A Noise Reduction System

- No encoding required
- Dynamic filter and downward expander
- Subsonic filter
- Up to 30dB S/N improvement
- Stereo/2-channel switch
- Balanced in/out XLR
- Unbalanced in/out 1/4"

524E Multi-Mode Crossover

- Mono 2-3-4 or stereo 2-way operation
- User interchangeable cards
- Phase alignment between bands
- Individual band limiting
- Individual band muting

528 Voice Processor

- Mic to line level
- Preamp, de-esser, downward expander, compressor/limiter, parametric EQ/notch filter, +4B phantom power, switchable metering
- Single rack space
- Mic input XLR
- Unbalanced in/out on 1/4"
- Line level in/out on #6 barrier

564E Quad Expander/Gate

- Hipass/lowpass controls for frequency conscious gating
- XLR balanced inputs and outputs plus control loop/key input
- 6 LED gain reduction meter per channel
- Balanced inputs/outputs XLR
- Control loop/key input in/out TRS 1/4"

571 SPL Computer™

- Senses ambient noise, automatically adjusts levels
- Music input, paging controller
- Semi-automatic calibration
- Sensing mic inputs XLR
- Page mic XLR
- Balanced/unbalanced in/out connections on #6 barrier

571S SPL computer slave

572 SPL Computer

- Senses ambient noise, automatically adjusts levels
- Uses the system's loudspeakers as input transducers for ambient noise sensing
- Page mic XLR
- Balanced/unbalanced in/out connections on #6 barrier

A-220 Stereo Amplifier

- 20W/channel, 50W bridged
- Mono, 2-channel or true stereo
- 0.05% THD
- Balanced/unbalanced inputs, XLR 1/4"
- Speaker outputs on barrier strip
- SC-1 Security cover

SX201 Parametric EQ Preamplifier

- Studio quality
- +15dB boost, -30dB cut
- High headroom
- Unbalanced in TS 1/4"
- Balanced in/out TRS 1/4"

SX202 Dual Microphone Preamplifier

- Variable gain with 15dB pad
- Polarity switch on 1 channel
- +48V phantom power
- Mic inputs XLR
- Outputs TRS 1/4"

SX203 Telephone Interface

- Fast hookup
- High quality audio transfer
- Desk set, phone line RJ-11 modular jack
- Balanced/unbalanced in/out TRS 1/4"



511A



524E



528



SX201

SX204 Headphone Amplifier

- 4 channels
- Stereo operation
- All headphone impedances
- Balanced/unbalanced in TRS 1/4"
- Outputs TS 1/4"

SX206 Multi Dynamics Processor

- Versatile multi-mode operation
- Exceptional sonic performance
- Selectable mode at power-up
- Master or slave designation
- Balanced/unbalanced input TRS 1/4"
- Unbalanced out TS 1/4"
- Balanced out TRS 1/4"
- Stereo link TRS 1/4"
- Control loop TRS 1/4" (return), TS 1/4" (send)

SX208 Stereo Compressor/Limiter

- Exceptionally low noise and distortion
- Simple, straightforward operating controls
- LED indicators for input level, compression and clipping
- Balanced or unbalanced signal connection
- UL approved power supply

TI-101 Single-Line Telephone Interface

- Level compatibility. Back-panel gain switches permit the TI-101 to operate with virtually any professional mixer or console
- Bandpass filtering
- Caller mute: A user provided remote contact closure mutes the caller instantly without clicks or pops
- LED clip indicators are provided
- Conference linking
- Caller equalization
- 2-band equalizer with 8dB of boost and cut at 400Hz and 2.5kHz brightens up the caller and enhances intelligibility
- Send limiter
- Receiver compressor/expander

421 AGC-Leveler

- Smart gated release true AGC-Leveler with peak limiting, speech filtering and intelligent downward expansion
- For use in PA, post, duplication, studio and broadcast environments
- Perfect for gain riding microphones used for on-air talent



STEREO HEADPHONES

K-500 Professional Dynamic Circumaural Headphone

Highly accurate, enhanced sensitivity large diaphragm transducer with very open design to eliminate resonance coloration. Response from 15 to 27,000Hz, 120 ohm impedance, neodymium magnet structure. Oxygen-free copper cable, with 1/4" and mini-stereo gold-plated phone plugs. Black with gray leather headband and gray fabric-covered washable ear cushions. Weighs 7.8 oz.

K-400 Professional Dynamic Circumaural Headphone

Highly accurate, large diaphragm open design similar to the K-500. Response from 20 to 26,000Hz, 120 ohm impedance, neodymium magnet. Oxygen-free copper cable with 1/4" and mini-stereo gold-plated phone plugs. Newly designed plastic self-adjusting headband. Black with black ear cushions and gray headband. Weighs 7.8 oz.

K-340 Electrostatic/Dynamic Headphone

2-way stereo headphone. Offers unsurpassed frequency and transient response, plus accurate spatial reproduction. Patented design combines electrostatic high-frequency transducers, dynamic mid/low frequency transducers, crossovers and 10 passive diaphragms in circumaural earcups. Matches 4-400 ohm outputs. With 10' coiled cable and standard stereo phone plug. Weighs 14 oz.

K-280 Parabolic Headphone

Dual transducer design in each circumaural earcup focuses the sound toward the center of the ear. Twice the radiating area of conventional stereo headphones. Low impedance electrical circuit produces distortion free, clear, crisp and full bodied sound at higher than usual levels. Matches 4-75 ohm outputs. With 9.8' cable, standard stereo phone plug. Weighs 8.8 oz. 20-20,000Hz.

K-270S Playback Headphone

The K-270S is a sealed version of the K-280 that uses 2 optimized transducers per channel for excellent high end response combined with efficient isolation. The dual spring wire suspended self-adjusting headband ensures wearing comfort and features auto on/off switch. 20-20,000Hz, sensitivity 92dB.

K-270 Without automatic on/off switch

K-240DF Studio Monitor Headphone

The K-240DF meets the IRT criteria, an acoustically diffuse field equalized design. Each set of the K-240DF is individually measured, and uses hand selected and matched components to maintain very close tolerances. Self-adjusting headband, single-sided cable. Dynamic circumaural, 20-20,000Hz, sensitivity 88dB, single cord 8', 1/4" stereo jack plug. Weighs 8.5 oz.

K-240M Monitor Headphone

Preferential use in many professional recording and broadcast studios, as well as the home. An accurate performer with precise bass and distortion-free high frequency capability. Weight distribution over the head is uniform. Its cardan-pivoted earpieces are comfortable and self-adjusting. Dynamic moving coil, 20-20,000Hz. Single cord 8' 4" 1/4" stereo phone plug. Weighs 8.5 oz. without cable.

K-141/2 Monitor Headphone

An accepted standard of the professional recording community, high sensitivity design has self-adjusting headband, single-sided cable. Small coupling volume of enclosure gives accurate, punchy sound quality. Dynamic supra-aural, 20-20,000Hz, sensitivity 97.5dB, single cord 9' 8", 1/4" stereo jack plug. Weighs 8 oz.



K-340



K-280



K-270S



K-240DF



K-240M



K-141/2

V6HP Headphone Amplifier

6-channel headphone amplifier, 20V. Professional headphone amplifier that delivers clean, high output levels for up to 6 stereo headphones, arranged in 3 pairs. For stereo or dual mono mixes. Each headphone pair has its own front panel mix selector switch to select among 5 possible combinations of the 2 inputs. Rugged aluminum and steel case is threaded for stand mount.

Accessories

- RTS4 Connector, RTS Communications Systems, 4-pin mono male XLR
- RTS5 Connector, RTS Communications Systems, 5-pin mono male XLR
- CC4 Connector, Clear-Corn Communications Systems, 4-pin mono female XLR
- CC6 Connector, Clear-Corn Communications Systems, 6-pin mono female XLR
- H 45 Cable clothing clip



DYNAMIC MICROPHONES

C-414B/ULS Microphone

- Its dual classic 1" gold-sputtered large diaphragms and variety of switchable polar patterns, pre-attenuation settings and roll-off curves make the C-414 a very flexible recording or reinforcement tool • Surpasses the demands of digital recording • Extremely low self-noise coupled with exceptionally high overload points guarantee dynamic range specs of over 126dB, achieved with all output loads • Special care at the design stage was spent achieving very flat on-axis and exceptionally smooth off-axis frequency response curves, with no variance in sensitivity • Complete with the SA 18/3 stand adaptor and W-414 windscreen

Specifications

Frequency Range: 20-20,000Hz **Polar Pattern:** Cardioid, hypercardioid, omnidirectional and figure 8 **Sensitivity:** 12.5mV/Pa (all patterns) **Impedance:** 180 ohms

D58E Noise Cancelling Microphone

- Designed for communications, paging and talkback applications
- Extremely small and lightweight • Integral XLR connector provided for mounting to any standard 3-pin female XLR connector, whether on a gooseneck or a mic cable • Matte-nickel finish • Matte-black finish available

Specifications

Frequency Range: 70-10,000Hz **Polar Pattern:** Hypercardioid **Sensitivity:** 0.72mV/Pa **Impedance:** 240 ohm

D109 Lavalier Microphone

- Lightweight lavalier microphone with sliding necklace clamp • May be worn on lapel, around the neck or handheld for reporting • Includes 29.5" non-detachable cable with stripped and tinned leads at the free end, nylon neck cord, tie clasp, cable spool and case • Matte-nickel finish

Specifications

Frequency Range: 50-15,000Hz **Polar Pattern:** Omnidirectional **Sensitivity:** 1.1mV/Pa **Impedance:** 240 ohms

D112 Large Diaphragm Low-Frequency Microphone

- Similar to large-cone loudspeakers, large-diaphragm microphones reproduce bass frequencies with greater definition • Built to handle SPL levels up to 168dB • Ideal for kick drum, bass guitar cabinets, trombone and other low-frequency sources • Low bass is clean and powerful, plus mid and high frequency tailoring keep the instrument clearly distinguishable in the mix • Built-in windscreens and SA 40 stand adaptor included

Specifications

Frequency Range: 20-17,000Hz **Polar Pattern:** Cardioid **Sensitivity:** 1.8mV/Pa **Impedance:** 210 ohms

D130E/D130NR Omnidirectional Microphone

- Exceptionally rugged microphone for field broadcast use • Designed for newsfilm and ENG applications where durability is of utmost importance • Picks up sound evenly from all sides • Insensitive to pop and handling noise and has no proximity effect • Includes SA 40 stand adaptor and case

Specifications

Frequency Range: 50-14,000Hz **Polar Pattern:** Omnidirectional **Sensitivity:** 1.7mV/Pa **Impedance:** 220 ohms

D130NR Steel wire mesh grille, finished in a non-reflective dark gray

D190E/D190ES Cardioid Microphone

- Cardioid dynamic microphone with sintered bronze windscreens/pop filter. Cardioid pattern reduces feedback • Excellent speech or music microphone for performing and recording • Includes SA 40 stand adaptor and case

Specifications

Frequency Range: 30-16,000Hz **Polar Pattern:** Cardioid **Sensitivity:** 1.6mV/Pa **Impedance:** 280 ohms

D190ES Same as D190E with integral on/off switch



C-414B/ULS



D58E



D109



D112



D130E



D190E



D510B

D510B Gooseneck Microphone

- Omnidirectional microphone mounted on 10" flexible gooseneck shaft • Provides neutral sound quality for speech applications • Total length 12.5" • Includes 3'4" attached cable and mounting hardware • Matte-nickel finish

Specifications

Frequency Range: 140-15,000Hz **Polar Pattern:** Omnidirectional **Sensitivity:** 1.1mV/Pa **Impedance:** 230 ohms

D541/D541E Gooseneck Microphone

- Dynamic cardioid mic mounted on 12" flexible gooseneck • D541 provides for the needs of public address and sound reinforcement systems • Includes 5'4" cable and mounting hardware • Total length 13.25" • Matte-black finish

Specifications

Frequency Range: 140-17,000Hz **Polar Pattern:** Cardioid **Sensitivity:** 2.3mV/Pa **Impedance:** 700 ohms

D541E Includes integral XLR connector at end of gooseneck

D558B Gooseneck Microphone

- Differential noise-cancelling dynamic microphone for use wherever high ambient noise levels or environmental acoustics are a problem • Compact and unobtrusive • Mounted on 10" flexible gooseneck shaft • Total length 12.5" • Includes 3'4" attached cable and mounting hardware • Matte-nickel finish

Specifications

Frequency Range: 300-12,000Hz **Polar Pattern:** Hypercardioid **Sensitivity:** 0.72mV/Pa **Impedance:** 230 ohms

D590 Gooseneck Microphone

- Designed for indoor or outdoor speech applications where conditions create potential background noise or acoustic feedback • Shock mount suspended capsule reduces rumble and transmitted noises to a minimum • Includes sintered bronze cap (wind and pop screen) • Mounted on 10" gooseneck • Total length 13.5" • Includes 3'4" attached cable and mounting hardware • Matte-nickel finish

Specifications

Frequency Range: 250-17,000Hz **Polar Pattern:** Cardioid **Sensitivity:** 1.3mV/Pa **Impedance:** 230 ohms

SM7 Unidirectional Dynamic Microphone

- Excellent for use with either instruments or voice in multi-track recording situations • Designed for boom or stand-mounting
- Frequency response: 40-16,000Hz • Graphic response-tailoring switches to permit 4 different microphone response curves



SM7

SM57 Unidirectional Dynamic Microphone

- Provides wide range reproduction of music and voice • Exceptionally uniform and effective unidirectional pickup pattern • Cartridge shock-mounted for quiet operation • Frequency response of 40-15,000Hz

SM57-CN With 25' cable

SM57-LC Without cable



SM57

SM58 Unidirectional Dynamic Microphone

- Professional stage microphone, with a self-contained spherical filter to control explosive breath sounds and wind noise • Uniform cardioid pickup pattern minimizes off-axis coloration and rejects background noise • Effective presence rise in mid-frequencies and a fixed low-frequency rolloff to minimize boominess • Frequency response of 50-15,000Hz

SM58-CN With 25' cable

SM58-LC Without cable

SM58S Without cable, includes on/off switch



SM58



SM87

SM85 Unidirectional Condenser Microphone

- Lightweight microphone designed for handheld live vocal applications as well as broadcasting and studio recording requirements
- Lightweight, extremely tough aluminum case and Teflon-coated all-steel grille • Elastomer "spaceframe" isolates the condenser element from virtually all mechanical vibration • Frequency response of 50-15,000Hz

SM85 Without cable

SM87 Supercardioid Condenser Microphone

- Similar in appearance and construction to the SM85, the SM87 features a supercardioid, rather than cardioid, pickup pattern • Flat response means less equalization is needed, for fewer potentially troublesome response peaks • Tight pickup pattern results in greater gain-before-feedback and less microphone "bleed" (unwanted pickup of other voices, instruments or room noise) • Especially useful in multiple-miking situations or single-miking in a noisy or reverberant environment • Frequency response of 50-18,000Hz

SM87 Without cable

FP410 Portable Automatic Mixer

- Designed for use in video production, corporate television, A/V rental applications and meeting room applications • Minimizes the number of open microphones with its patented Shure Intellimix circuitry, thereby improving overall audio quality • Automatic or manual operation • 4 transformer balanced mic/line inputs • 2 isolated transformer balanced outputs • 48V phantom power • Peak or VU metering • 1kHz tone • Linkable for a maximum of 100 inputs • Powered by 2 9V batteries or 120/240VAC • 50/60Hz with detachable AC power cord • Includes rack ears



FP410

M267 Professional Mixer With Limiter

- For recording or broadcast use • 4 low-impedance balanced inputs switchable to mic or line level • Phantom power on each input • Fast-acting limiter • Built-in battery supply • Headphone level control • Illuminated VU meter with LED peak level indicator • Low-cut filters and tone oscillator • Battery check switch • Mix bus jack • Mic and line level outputs • 120/240VAC, 50/60Hz, 9.5W; battery power • 2³/₄" H x 11³/₈" W x 7¹/₂" D



M267

FP31 Microphone Mixer

- Designed for electronic news gathering (ENG), electronic field production (EFP), television and remote broadcast applications • Measures just 6⁵/₁₆" x 5⁵/₁₆" x 1⁷/₈" • 3 XLR transformer balanced mic/line inputs and 2 outputs • VU meter • Peak LED overload/limiter indicator • Adjustable limiter • Tone oscillator • Phantom and A-B (T) power • Built-in slate tone and microphone • Powered by 2 9V batteries (3 required for A-B power) • Case included

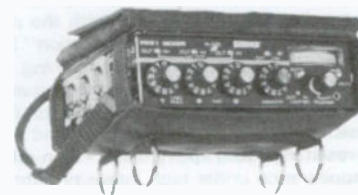

FP31

FP32 Stereo Microphone Mixer

- Stereo version of the FP31 • Center detented pan pots on input channels • Concentric clutched stereo master gain control • Includes all FP31 features, plus a monitor input for the headphone circuit

FP42 Stereo Microphone Mixer

- Handles remote mixing jobs with its 2 outputs (1 for each stereo channel) and 4 balanced inputs, each switchable for line or mic level operation • Each input channel also has a low-frequency rolloff switch and a center-detented stereo pan pot for convenient stereo mixing • Concentric clutched stereo master level control • Pull-pot cueing permits cueing or checking each input via headphones • Can be battery or AC operated • Mini and 1/4" stereo headphone jacks with level control included



AT4033 Cardioid Capacitor Microphone

- Transformerless studio microphone • Utilizes a gold-plated, "aged-diaphragm" condenser element with an internal baffle plate to increase S/N ratio • Dynamic range is 123dB without built-in attenuator • Accepts up to 140dB SPL without capsule or electronic system distortion above 1% THD • Floating-construction element provides isolation from noise and vibration • Switchable 10dB pad is built-in, increasing the SPL capabilities to 150dB SPL • Integral 80Hz hi-pass filter provides easy switching from a flat frequency response to a low-end rolloff • Hi-pass position reduces microphone's sensitivity to wind noise "popping" in close vocal use and handling noise • Internal open-cell foam windscreens permanently installed inside case assembly between grille and element for pop protection

AT4033



ATLAS / SOUNDOLIER

DIVISION OF AMERICAN TRADING AND PRODUCTION CORPORATION

Microphone Floor Stands

MS-10C • 5/8" -27 standard microphone threads • Grip-action clutch • 10" diameter circular base, charcoal finish • 35"-63" high, 10 lbs.

PS-C/PS-C3 Porta-Series • Functional and foldable • Designed for the touring performer • Spring-lock tripod base reduces to 32" H minimum for transport and storage • PS-C3 with 3-section tube for miking at low height • PS-C: 35"-65" height, 4.5 lbs. PS-C3: 26"-66" height, 4 lbs.

MS-11S/MS-12S • Automatic sleeve action clutch for instantaneous height adjustment • Low silhouette, circular base • MS-11S with decorative chrome base-cover • 39"-62" height • MS-11S: 13 lbs. • MS-12S: 12 lbs.

MS-11C/MS-12C • General purpose floor stands feature grip-action clutch, low profile 10" diameter base with added weight for stability • MS-11C: chrome finish base • MS-12C: texture charcoal base • 34"-62" height, 12 lbs.

MS-4/MS-20 • Professional stands with grip-action clutch • Low contour circular base provides heavy-duty stability required for stage, or use with boom attachment • MS-4: 3-section, 25"-65" height, 11 lbs., low height option • MS-20: 37"-66" height, 14 lbs.

MS-25 • Professional studio stand • Air suspension system for microphone protection • Over-size 1 1/8" diameter tube assembly and extra heavy 17" triangular base with chrome cover for maximum stability • 38"-67" height, 23 lbs.

MSX-100CE Space Saver Microphone Stand

- Optimum stability of a solid cast circular base with the portability and storage advantage of a tripod stand • Patented "1-motion" base positioning from horizontal to vertical • Eliminates time consuming "set up" and "breakdown" of microphone stands • Minimum space requirement during transportation • Adjustable, variable height extends to 61" • Recommended for touring musicians and entertainers, studio and stage use, theaters and clubs • Wear-resistant baked epoxy finish • Non-reflective ebony color for unobtrusive appearance under high intensity lighting • Extends from 34"-61" height, 11.4 lbs. • 38" height, 10" diameter round base for storage/transportation

Ebony Stands and Booms

- Contemporary professional microphone stands and boom attachments with non-reflective surfaces specifically designed to eliminate the specular visual effects of high intensity lighting • Recommended for use by performers whenever appearance is a major consideration

SB-36/SB-36W Studio Booms

- Professional stands with grip-action clutch, integral air suspension system for counterbalance • Boom length 62", tapered counterweight • Vertical adjustments from 48"-72" height, triangular base 17" • Includes microphone swivel, cable guide clips, chrome shell on base • 36 lbs. • SB-36W mobile model, same as SB-36 with noiseless rubber casters, 40 lbs.

DMS-10E Instrument Miking Stand and DMB-10XE Boom

- Professional drum miking accessory for accurate sound pickup in live concert miking situations and recording studio applications • Adjustable in

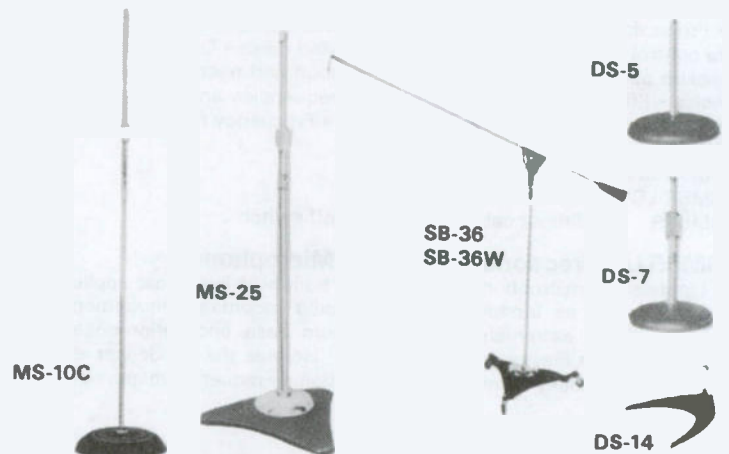

MS-10C

MS-25

SB-36
SB-36W

DS-5

DS-7

DS-14

- horizontal and vertical planes • Low profile to allow "close-in" miking of entire drum kit • Cast base isolates microphone from drum vibration • Finished in non-reflective ebony color
- DMS-10E Stand** • 14 1/2" to 26" height • 5.5 lbs.
- DMB-10XE Boom** • 15 1/2" to 22" long • 2.0 lbs.

Desk Stands

DS-5 General Purpose Desk Stand • Charcoal finish base • 4" H • Chrome tube • 2 lbs.

DS-7 • Adjustable height desk stand • Grip-action clutch • 6" dia. • Charcoal base • 8" to 13" H • 3 lbs.

DS-14 • Contemporary styled professional stand • Textured base • 3" H • Chrome tube • 2 lbs.

Accessories

GN • Flexible goosenecks to extend any standard 5/8"-27 thread stand • Choice of 6" GN-6 • 13" GN-13; • 19" GN-19 • 0.338" I.D.

CO-1B • Versatile connect-on attachment allowing use of a second microphone at any height of a standard 5/8" or 7/8" tube dia. floor stand • Use with gooseneck for close instrument miking • Charcoal finish

SO-1B/LO-2B • Snap-on/lock-on accessories for instantaneous fastening or disconnect of microphone holder or boom attachment • Use with standard 5/8"-27 thread stand

TM-1 • Twin-mount • For horizontal extension and installation of 2 or 3 microphones on any standard 5/8"-27 thread floor stand or podium top • 8 3/4" W, chrome finish

Typical Adaptors

AD-5B • 5/8"-27 female to 5/8"-27 female coupling

AD-11B • Flange, 5/8"-27 female • Base diameter 1 3/4"

AD-12B • Flange 5/8"-27 male • Base holes on 1 1/4" mounting centers

AD-18B • Heavy-duty triangular flange 5/8"-27 female

PB-K • Designer-styled microphone boom attachment swivel for use with 5/8" dia. tubing

ATLAS / SOUNDOLIER

DIVISION OF AMERICAN TRADING AND PRODUCTION CORPORATION

Select Series heavy-duty modular enclosures include 19", 24" and 30" wide vertical cabinets, 19" slope front consoles, turrets and wedge sections. These attractive enclosures are welded 16 ga. CRS and conform to EIA standards. Furnished with basic frame, gusseted base, removable top panel and rear door with lock and louvers, horizontal trim, 11 ga. CRS mounting rails and choice of finish. Options include insert panel, vertical trim, side panels, front doors and UL listed versions.

Standard Series 19" racks and equipment cabinets are available in various width, height and depth configurations with welded, knocked down and UL listed models to meet most specification requirements. Unless otherwise listed, 16 ga. CRS units include adjustable 11 ga. CRS mounting rails on EIA spacing, louvered side panels, wiring access, necessary hardware and choice of 17 standard colors.

A complete selection of convenience and electronic accessories is available for both series as well as custom manufacturing to meet individual needs.



*1044/1044LS Select Series consoles include listed features plus bottom front panel and writing surface (1044LS is without writing surface). Units are 54 1/8" H x 23 3/8" W x 25 1/2" D with 19 3/8" (top) and 24 5/8" (bottom) vertical panel space.

*1047 Select Series console includes listed features plus bottom front panel. Unit is 54 1/8" H x 23 3/8" W x 25 1/2" D with 19 3/8" (top) and 28 1/8" (bottom) vertical panel space.

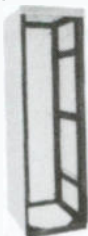

*2000/2400/3000 Select Series cabinets are 23 3/8" W, 28 3/8" W and 34 3/8" W respectively and include listed features. All models

are 25 1/2" D (30" depths available) with 5 sizes from 36 7/8" - 77 1/8" vertical panel space.



*700 Select Series desk turrets include frame, base, horizontal trim and removable top and back panels. 700-14 is 17 5/8" H x 23 3/8" W x 18" D with 14 1/8" vertical panel space. 700-19 is 22 1/2" H x 23 3/8" W x 20" D with 19 3/8" vertical panel space.



2000-45 Select Series floor wedge joins the 2000, 2400 and 3000 Series cabinets. 45° unit includes frame, removable top panel and rear door with lock.

*1044-45 Select Series 45° wedge joins all consoles. Furnished with frame, base, removable top panel and louvered rear door with lock.

*700-45 Series are 45° wedge units which join 700 Series desk turrets. Units include frame, removable top and back panels.



100/*WA100 Standard Series cabinets with fixed mounting rails are 22 3/8" W x 18 1/2" D with 5 vertical panel sizes from 36 7/8" to 77 1/8". 100 Series is knocked down. WA 100 Series is welded.

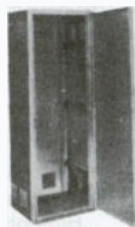

200/*WA200 Standard Series cabinets with adjustable mounting rails and locking front door are 22 3/8" W x 18 1/2" D with 5 verti-

cal panel sizes from 36 7/8" to 77 1/8". 200 Series is knocked down. WA200 Series is welded. 200LD and WA200LD Series are without front door.

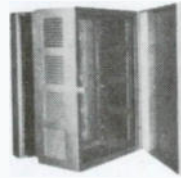

300/320 Standard Series welded sectional wall cabinets with locking front door are 17 1/2" D and 21 1/2" D respectively with 6 vertical panel sizes from 17 1/2" to 61 1/4". Available without front door, order 300LD or 320LD.

400 Standard Series cabinets are welded desktop assemblies with solid rear door. Units are 22 1/4" W x 15 3/8" D with 4 vertical panel sizes from 12 3/8" to 31 5/8".



*500/*502 Standard Series multitracks are 18" D and 25 1/2" D respectively. Models include open side frame, wiring access and louvered rear door with lock. Both series are 22 3/8" W with 61 3/8", 70 1/8" or 77 1/8" vertical panel space.



*600-12 Standard wall mount cabinet is a welded, surface mounting assembly with full back and keyhole slots. Unit is 15 1/4" H x 22 3/8" W x 15 3/8" D with 12 3/8" vertical panel space.

Rack Units (see chart)

Easy-to-use measuring system for electronic equipment uses 1 3/4" as a standard EIA rack unit. This industry-recognized system allows simple calculation of cabinet space requirements. To assure proper fit, all Atlas/Soundolier cabinets include 1/8" panel space clearance.

CABINETS



AWR Series amplifier wall cabinets include 14 ga. CRS frame with flush, tilt out locking door and attached 16 ga. CRS back-box. Recessed models have 3 1/2" panel space. Surface models have 3 1/2" and 5 1/4" panel space.



800 Standard Series open relay racks include frame, base and 11 ga. CRS mounting rails. 5 vertical panel sizes available from 36 7/8" to 77 1/8". Racks are shipped knocked down with mounting hardware.

RACK UNITS
(1-3/4" ea.)

PANEL SPACE
(Inches)

44	77
43	75-1/4"
42	73-1/2"
41	71-3/4"
40	70"
39	68-1/4"
38	66-1/2"
37	64-3/4"
36	63"
35	61-1/4"
34	59-1/2"
33	57-3/4"
32	56"
31	54-1/4"
30	52-1/2"
29	50-3/4"
28	49"
27	47-1/4"
26	45-1/2"
25	43-3/4"
24	42"
23	40-1/4"
22	38-1/2"
21	36-3/4"
20	35"
19	33-1/4"
18	31-1/2"
17	29-3/4"
16	28"
15	26-1/4"
14	24-1/2"
13	22-3/4"
12	21"
11	19-1/4"
10	17-1/2"
9	15-3/4"
8	14"
7	12-1/4"
6	10-1/2"
5	8-3/4"
4	7"
3	5-1/4"
2	3-1/2"
1	1-3/4"

/// = 1/16" CLEARANCE
TOP AND BOTTOM



STICK-ON SERIES — Power Supplies Included

STM-1 Preamplifier

- Hi or Lo-Z input mic preamplifier • 12VDC to 40VDC • Balanced or unbalanced output • Optional phantom supply input • Balanced microphone input accepts impedances from 150 to 600 ohms • Frequency response: 50Hz to 30kHz \pm 1dB • Fixed gain: 50dB nominal • Total harmonic distortion: <0.05%

STM-2 Preamplifier

- Same features as STM-1 except: • Variable gain up to 65dB • 2 balanced or unbalanced outputs • Frequency response: 50Hz to 25kHz \pm 1dB • 12VDC to 40VDC

STM-3 High Gain Mic Preamplifier

- Low noise mic preamplifier • Adjustable gain to 75dB • Hi or Lo-Z mic inputs • 2 balanced or unbalanced outputs

ST-PH1 Stereo Phono Preamplifier

- Stereo or mono phono preamplifier • Balanced or unbalanced output • Hi or Lo-Z output • Accurate, low noise preamplification • Left and right output levels adjustable

ST-ACR Audio Controlled Relay

- Control switching from audio signal • Switching from mic or line signals • Precise threshold adjustment • DPDT switching contacts • Open-collector "Slave" output

Release Delay ST-ACR1: Multiturn adjustable 0.5-5 secs. nom.

Release Delay ST-ACR2: Multiturn adjustable 5-50 secs. nom.

ST-ACR1M Mic Audio Controlled Relay

- Control switching from mic level audio • Precise threshold adjustment • Adjustable release time from 0.5 to 5.0 seconds • DPDT switching contacts

ST-VOX1 Voice-Activated Relay

- Triggered by unbalanced line level input or unbalanced mic level input • DPDT relay contacts • Open-collector "slave" output • Adjustable threshold and release delay • Fast time constants optimized for any voice-triggered application

ST-SSR1 Solid-State Relay

- Line-level audio switching without relay contacts • All solid-state, noiseless switching • Use to select between 2 inputs, or turn single input on/off • Line-level inputs and output are unity gain • Studio-quality audio performance

ST-LCR1 Logic Controlled Relay

- More contacts by adding a "slave" relay • Activation from logic circuits • DPDT switching relay • Open collector switching • Control from switch, button or logic circuits

ST-LCR2 Logic Controlled Relay

- Alternate-action switching • Activation from logic circuits • DPDT switching relay • Open collector switching • Control from switch, button or logic circuits



ST-PH1



ST-LCR1



ST-MPA2

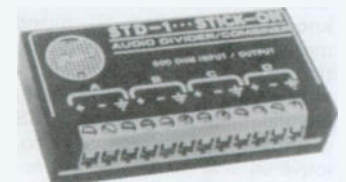

STD-1

ST-MPA2 Mic Phantom Adaptor

- Adds phantom powered mics to standard inputs • 2 phantom adaptors in 1 module • Phantom conversion with full frequency response • Fully trimpot adjustable phantom voltage • Highly filtered phantom power

ST-AMC3 Active Mic Combiner

- 3 mic inputs to a single mic output • Combines mics of same or different types • Input trimmers permit combining different level mic signals • Combines mics with isolation to feed single mic input

STD-1 Divider/Combiner

- 4-channel • Combines audio signals to a single output • Filters RF from an audio line • Combines stereo signals • Feeds a mono signal to stereo inputs • Combines multiple mics to a single amp input • Available in 150 ohm and 600 ohm models

STP-1 Attenuator

- 2-channel • Reduces audio level • Feeds audio into equipment • Presets audio levels • Precisely matches audio levels • Prevents input overload • Increases audio input headroom

STR-19 Rackmount Assembly

- Mounts multiple Stick-ons in a rack • Convenient access to Stick-on adjustments • Holds 12 Stick-ons

STR-19 19" rack kit, snaps included

STR-12 Rack kit snaps (additional 12-pack)

Accessories

RR-6 Rack rail, 6" (use with STR-12)

RR-12 Rack rail, 12" (use with STR-12)

ACB-1 Headphone jack box

ACB-2 Dual RCA jack box

PS-24A 24V power supply



ACM-2 FM/AM Noise Monitor

- Accurate metering of significant synchronous AM noise • 20-LED bright-string metering with 4 operating ranges • Programmable "ACM" wideband, 75 μ s and high-pass filtering • Programmable alarm with remote status output • Continuous-reading remote DC output for AM noise level • Remote DC output representing transmitter power output



ACM-2

STICK-ON SERIES — Power Supplies Included

STA-1 Electronic Transformer

- Dual channel • Up to 20dB gain in an audio line • Conversion from balanced to unbalanced or unbalanced to balanced • Conversion from high to low impedance or low to high impedance • Frequency response: DC to 25kHz \pm 0.25dB • Total harmonic distortion: 0.003% to 0.009%; 0.005% nominal



STA-1

STA-1M Audio Line Amplifier

- A single channel audio line amplifier • Balanced or unbalanced inputs and outputs • Bridges a line to avoid loading • Hi/Lo or Lo/Hi impedance conversion • Instrumentation input to isolate ground "loops" • Precisely matches audio levels



ST-SH1

ST-PA6 Power Amplifier

- Up to 6WRMS into 8 ohms • 2 balanced or unbalanced inputs • Full output from small input signals • Frequency response: 30Hz to 40kHz



ST-MX3

ST-SH1 Stereo Headphone Amplifier

- Allows bridging any audio line, adjusting the gain and driving any impedance headset • The circuit design allows the input to accept either balanced or unbalanced signals, of either high or low impedance



ST-VCA1

ST-PA2 2W Utility Amplifier

- 2WRMS output • Drives 8 or 600 ohms • Low noise and distortion • Adjustable gain

ST-DA3 Distribution Amplifier

- Audio distribution with up to 3 outputs • Balanced or unbalanced input and outputs • Total harmonic distortion (10Hz to 30kHz): <0.03% Hi-Z load, <0.015% 600 ohm load • Frequency response: \pm 0.25dB 10Hz to 30kHz, \pm 0.50dB 10Hz to 45kHz

STM-DA3 Mic Level Distribution Amplifier

- Feeds 1 mic to 3 inputs • Electrical isolation • Audio isolation • Low-noise performance • Ultra-low distortion • Unparalleled phase response • Versatility of "Stick-On" compactness

ST-MX3 Line Level Mixer/ST-MMX3 Mic Level

Mixer/ST-MLX3 Mic/Line Level Mixer

- Mix mic or line level signals • Individually adjustable inputs • Expandable systems (multiple modules may be combined for larger mixing systems) • All mixers are line-level output
- ST-MX3 Line level mixer, 3 line inputs
- ST-MMX3 Mic level mixer, 3 mic inputs
- ST-MLX3 Mic/line level mixer, 1 mic input, 2 line inputs

ST-EQ3 3-Band Equalizer

- Low-noise line level graphic equalizer • Separate adjustments for bass, midrange and high frequencies • Each adjustment provides for boost or cut • Balanced input and output

ST-CL1 Compressor/Limiter

- Multi-stage incremental gain reduction • Select average/peak or peak only control • Positive audio level protection • Smooth inaudible gain reduction • Very low noise compressor

ST-GCA 1 Gain Control Amplifier

- Automatic gain control • Wide dynamic range • Slow "inaudible" gain reduction • Low noise and distortion AGC

ST-GCA2 Gain Control Amplifier

- Fast automatic gain control • Gain reduction/expansion • Tight dynamic control • Positive, fast gain reduction • Low noise and distortion AGC

ST-VCA1 Voltage Controlled Amplifier

- Controls audio level with DC voltage • Remotely controls audio
- Single-pair DC control of audio • Mic or line input VCA • Mic or line output VCA • Built-in mic preamp

ST-VP1 Voice-Over Paging Module

- Studio quality for preset voice-over or "click free" paging • Module selects, fades and mixes 2 line level sources • 2 independent control inputs: fade and hard-cut • Fade-down sequence ramps down music, activates voice input • Fade-up sequence deactivates voice input and ramps music up • Fade rate and depth are user adjustable • Line level inputs and outputs are unity gain

Series One Amplifiers

- High-performance, full-complementary circuit
- Independent DC and sub-audio speaker protection on each channel
- Delayed turn-on, instant turn-off with pop filter
- Dual power supplies
- Calibrated gain controls
- Active balanced inputs
- Octal input sockets for active or passive input modules such as crossovers, limiters or transformers
- Gold plated octal socket programming switches
- Mono-bridging switch
- 1/4" RTS, XLR and barrier input connectors
- 5-way binding post output connectors arranged for mono-bridging
- Patented Output Averaging™ short-circuit protection
- Clipping indicators
- Large passive heatsinks for ample cooling
- Direct mounted power transistors
- Sculptured aluminum front panel
- Premium components throughout:
 - High-speed, low-noise, low distortion 5532 op-amp front end.
 - Large SOA (Safe Operating Area) high-speed, triple-diffused MESA output devices.
 - High-density, low ESR filter capacitors.
- UL listed, CSA approved

Series One is designed for users who demand superior audio performance but don't require front-removable channel modules, de-tented gain controls or true dual-monaural configuration.

- 1100** Stereo; 50W at 8 ohms, 65W at 4 ohms; passive cooling; 1 rack space tall
- 1200** Stereo; 100W at 8 ohms, 150W at 4 ohms; passive cooling; 3 rack spaces tall
- 1400** Stereo; 200W at 8 ohms, 300W at 4 ohms; 2-speed fan cooling; 3 rack spaces tall
- 1700** Stereo; 325W at 8 ohms, 500W at 4 ohms; 2-speed fan cooling; 4 rack spaces tall



1100

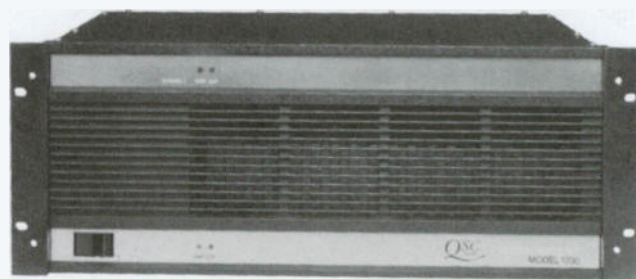

1700

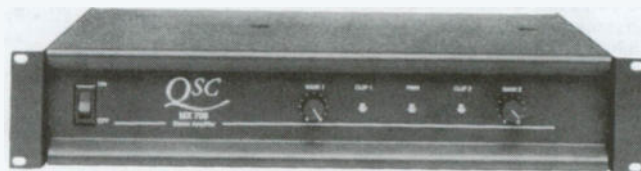

MX 700



EX 4000

MX Series Amplifiers

- Low profile (2 rack spaces)
- Fan cooled
- Direct mounted power transistors
- Recessed front panel controls
- 1/4" RTS and barrier strip input connectors
- Full complementary outputs; active balanced inputs

- MX 700** Stereo; 150W at 8 ohms, 225W at 4 ohms, 350W at 2 ohms; fan cooling
- MX 1000a** Stereo, 250W at 8 ohms, 350W at 4 ohms; fan cooling
- MX 1500a** Stereo; 350W at 8 ohms, 500W at 4 ohms; fan cooling
- MX 2000a** Dual mono; 450W at 8 ohms, 650W at 4 ohms, 1000W at 2 ohms; fan cooling

- EX 1600** Output power per channel:
8 ohms, 20Hz to 20kHz, 0.1% THD 400W
4 ohms, 20Hz to 20kHz, 0.1% THD 600W
19" x 17.9" x 3.5" (2 rack space) 44 lb
- EX 2500** Output power per channel:
8 ohms, 20Hz to 20kHz, 0.1% THD 500W
4 ohms, 20Hz to 20kHz, 0.1% THD 750W
19" x 17.9" x 5.25" (3 rack space) 53 lb
- EX 4000** Output power per channel:
8 ohms, 20Hz to 10kHz, 0.1% THD 720W
4 ohms, 20Hz to 10kHz, 0.1% THD 1100W
19" x 17.9" x 5.25" (3 rack space) 64 lb

Accessories

- UF-1** Universal filter, hi pass, low pass and CD horn equalization
- AT-1** Precision attenuator and input transformer
- PL-1** Power limiter — adjustable rate, attack/release and threshold
- T-1** Input balancing/isolation transformer
- XH-1** 2-way 24dB/octave electronic crossover, selectable above 500Hz
- XL-1** 2-way 24dB/octave electronic crossover, selectable below 500Hz
- OT-300** 300W, 70V output autoformer — mounts to back of 1200 and 1400

EX Series Amplifiers

EX Series products are designed to meet the demands of touring, installed sound and recording studios. EX amplifiers feature variable speed fans, Speakon output connectors and Open Input Architecture™.

- EX 800** Output power per channel:
8 ohms, 20Hz to 20kHz, 0.1% THD 175W
4 ohms, 20Hz to 20kHz, 0.1% THD 275W
19" x 17.9" x 3.5" (2 rack space) 40 lb
- EX 1250** Output power per channel:
8 ohms, 20Hz to 20kHz, 0.1% THD 275W
4 ohms, 20Hz to 20kHz, 0.1% THD 400W
19" x 17.9" x 3.5" (2 rack space) 42 lb



Digi-Corder Digital Audio System

- Easy-to-use analog/digital/analog audio record/playback system
- Ideal replacement for any station wishing to replace outdated cart machines in the production and control rooms
- Replace audio sources in any automation system such as carousels, insta-carts and other audio equipment used to play commercials, psa's, jingles, liners, etc.
- Computerized, tapeless system designed by broadcasters
- Fully stereo or mono compatible record/playback unit
- Will hold any combination and length from 100 minutes in full stereo at 15kHz or 5 hours in mono at 10kHz
- Can be pre-programmed to schedule all stop sets and play them manually or automatically
- Plays anything instantly and back-to-back without pre-programming
- Data files can be played directly from the directory of files
- Hard disk storage 100 to 1200M bytes
- 3.5" 1.44M floppy drive accessible from the front and behind key lock door on rackmount unit and 1 or more hard disk drives
- Includes main processor unit, 14" super VGA color monitor and 101 key enhanced keyboard
- Frequency response: 2000 to 20,000Hz
- Auto record level
- Printer can be connected to the parallel port provided
- Main display screen divided into 3 operations: vertical directory of files, log schedule of pre-selected files to be played including the time for each stop set, and the current portion of the log schedule from the center screen
- Logs for days or weeks in advance may be stored
- Central processor unit is 80386SX operating at 25MHz in a mini-tower
- Video, communications, digital processing and data acquisition components designed internally in CPU cabinet
- 120/240VAC at 50/60 cycles
- Standard 19" rackmount cabinet with front filter and dual cooling systems is available
- Optional accessories include: additional super VGA 14" color monitor and keyboard, additional hard drives installed in matching expansion 19" rackmount cabinet, file transfer cable and relay card



Digi-Corder



The Phantom

The Phantom® Desktop Digitally Automated Radio Station

- Provides everything needed to record, store and play back commercials, liners, jingles, IDs and other promotional material on the hard disk of a PC computer
- Provides the necessary information to operate satellite programming systems automatically
- Complements the RDS™ Traffic and Billing System and the RDS Digi-Corder
- True CD quality for all audio, eliminating the problems caused by carts, cassettes and other tape products
- No more troubles with wow, flutter and jumped cues
- Choice of mono or stereo
- Frequency response up to 20,000Hz plus
- Every audio source is ready to play instantly
- Analog/digital/analog audio signal processing
- All audio switching is computer controlled in an easy-to-use menu driven format using broadcast language
- Flexibility to operate with complete control of all satellite functions automatically
- Software design allows for virtually unlimited control of multiple satellite or network inputs and unlimited voice inputs from each source
- Voices can be overlapped with satellite or network sources
- Logs may be scheduled as far ahead as desired with no limit and can be quickly generated
- Logs may be directly imported from your existing traffic system
- Verifies back to the traffic system the exact date and time of each spot for billing
- Instant on-screen editing is possible
- Every break automatically filled by the traffic system is timed right to the second
- Automatic generic audio source files with varied lengths may be stored and used by the system for unplanned audio discrepancies
- Automatically records pre-timed source from any satellite or network
- Storage space limited

- only by the size of the hard disk (the smallest model holds 100 minutes in stereo at 15MHz)
- Uses original recorded time, selected time stored or any other variation needed to time exact break stop sets within percentages prescribed
- CPU is 80486 operating at 33MHz
- Standard 19" rackmount cabinet with front filter and dual cooling
- 3.5" 1.44M byte floppy disk and hard disk drive provided
- Rack size 19" x 7" x 9"
- Solid-state switching provided in matching companion RDS audio matrix switcher
- 8 600 ohm balanced stereo inputs and 4 600 ohm balanced stereo outputs
- Audio connections provided on 60 terminals barrier strip
- Multi-pair cable and plug assembly connector provided
- Super VGA 14" color monitor and 101-key enhanced keyboard is provided
- Optional accessories: Additional 14" monitor, keyboard with data acquisition switch and accessory cabling for remote operation

System Seven Single or Multi User Complete Traffic, Billing and Accounting System

- Easy-to-use interfaced microcomputer
- Combines sales, traffic, billing and accounts receivable with accounts payable, payroll and general ledger all in one package
- 255 lines of scheduling information available on each order
- 200 sales people per station with 999 clients and orders per station
- 26 billing cycles
- 576 commercial breaks per day per station
- Stores unlimited number of log formats
- 73 months of client history
- 400 general ledger accounts
- 999 invoices per month per station and 999 A/P vendors per station
- 1999 A/P vouchers per station and 1999 unpaid invoice per station
- 99 active employees per station
- Unlimited miscellaneous pay entries per employee and misc deduction entries per employee
- Provides upgrade path

Superelay Utility Control Interface

- 6 double-pole relays for low voltage and audio switching
- Solid-state synchronous relay controls 300W of on-the-air lights without buzz, pops or arcing (1000W version available)
- Built-in flasher, can be defeated for constant-on mode
- Can be controlled by switch, relay, CMOS and TTL compatible
- Can be connected to telco line for ring control switching
- Built-in power supply, 24VDC available for utility use

DigiStor Digital Message Storage System

- Ideally suited for radio and TV station information lines, e.g., concert information, ski report, sports scores, etc.
- Stores up to 4 minutes of audio for automatic playback via a regular telephone line
- Message stored in digital memory with battery backup
- Can be programmed to play the message only once or continuously until the caller hangs up
- There is no recall time; the caller always hears the message from the beginning
- Can also be used as a stand-alone digital record/playback unit (not connected to a phone line) for utility applications, e.g., message repeater, sound effects, etc.

SynchroStart Turntable-Recorder Synchronizer

- Start-muting for 2 turntables, individual delay adjustments
- Compatible with any cartridge or reel-to-reel recorder
- Either or both turntables can auto-start recorder
- Recorder will auto-start only if in record mode
- Audio inputs/outputs electronically balanced, direct coupled
- Timer output will start external timer when recorder starts

Fast Trac Dubbing System

- Self-contained automatic dubbing system allows almost anyone to make flawless dubs without the need for a studio
- Fast Trac has 2 important functions: to dub from 1 machine to another, and to automate the dubbing process
- Fast Trac is essentially a 4 input mini-board
- Operates just like a console, but with only 1 pot
- Accepts 4 input sources, which are pushbutton selectable. User can "ride again" so that all dubs are at a consistent level
- Stereo balance can be adjusted to correct for off-center material
- Recordings can be in stereo or mono, and multiple copies can be made simultaneously
- Fast Trac automates the dubbing process with 1-button simplicity
- All dubs are tight and consistent

Net Commander Network Cueing Interface

- Essentially a "mini automation system" that allows you to pre-program the stop-set breaks you'll be using each hour
- Break/Bypass switch for each stop-set in the format-hour
- Select either Break or Bypass according to your spot load, load up the cart machines and walk away
- When Net Commander comes to a break, it will mute network audio and start commercial spots playing
- At the end of the spots, it will put network audio back on the air
- When Net Commander comes to a bypass break, it simply ignores that stop-set and network audio remains on the air
- If you run news at the top of the hour, Net Commander also has facilities to mute the network during news and return to the network at the end of the news feed

Retro Fit Modules

MA-10 Differential Microphone Preamp

- High performance design achieves excellent sonic characteristics with exceptionally low noise and extended headroom
- Input is transformerless and bridging so microphone is not loaded, resulting in improved bass response
- Gain continuously adjustable from 20dB to 65dB. EIN is -130dBm; with the gain set to 50dB, the noise level is 80dB down
- DC blocking provided for compatibility with powered condenser microphones



DigiStor



SynchroStart



Fast Trac

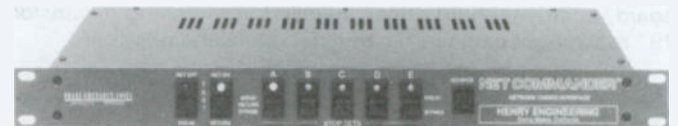

Net Commander

LA-1 Differential Line Input Amplifier

- Active balanced-input buffer amplifier that replaces all line-input transformers in console
- Provides a balanced bridging input for line level sources, e.g., cart machines, CD players and cassette recorders
- Gain adjustable; any audio level from -20dBm to +8dBm can be fed directly into the console without pads, booster amplifiers or matching transformers
- Ideal interface between console and source equipment achieved with no ringing, loading or headroom/noise compromise

SA-10 Servo-Coupled Summing Amplifier

- Ultra low-noise summing amplifier that uses servo-coupled circuitry to eliminate all coupling capacitors in this critical stage
- Unlike traditional designs that use distortion-producing electrolytics, the SA-10's audio path is DC coupled to yield low frequency response below 3Hz and 0.01% distortion regardless of frequency

OA-10 Program/VU Meter Output Amplifier

- Differential output amplifier that produces a balanced output without a transformer
- Will drive a 600 ohm load to +26dBm; because circuitry produces a purely resistive source, performance is unaffected by load conditions
- Even capacitive loads, such as long runs of shielded cable, have no adverse effects
- Also provides an isolated, buffered output to drive VU meters, eliminating all meter-induced distortion

HENRY ENGINEERING

STUDIO/RADIO CONTROL ROOM EQUIPMENT

The Matchbox Interface Amplifier

- Gain adjustable to +20dB • +26dBm maximum output level
- 0.008% distortion, 90dB S/N • All active direct coupled circuitry
- Does not load or ground studio lines • Self-contained regulated power supply • Provides extra AC outlet for convenience

Universal Turntable Controller

- Works with most console remote control facilities, or use "outboard" switches • Tally lamp outputs accommodate illuminated pushbuttons
- No contact bounce or false operation • CMOS circuitry is RF immune—no relays • Self-contained regulated power supply • 1 UTC controls 2 turntables

LogiConverter Studio Equipment Control Interface

- All inputs are opto-isolated • All outputs are relay-isolated • User programmable logic translation • Compatible with TTL/CMOS/Open-collector logic • Inputs/outputs can be momentary or maintained
- Start-only or start-stop from single input signal

MixMinus Plus Differential Summing Amplifier

- Designed to add a "MixMinus" output to a broadcast console • Output typically used to feed the Send input of a telephone hybrid device
- 2 inputs and 1 output. 1 input is fed with the Program output of the console (+4 or +8dBm nominal). The second input is fed with hybrid receive (caller) audio, tapped just after the "phone" channel fader on the console • Accepts caller levels from -50dBm to -10dBm
- Subtracts the hybrid receive signal from the Program output to generate a Program mix minus the Receiver (Caller) audio • Null adjustment provides 40dB caller audio rejection (30Hz-3kHz) • Overall gain is unity; the output drives a 600 ohm load to +26dBm

U.S.D.A. Utility Summing and Distribution Amplifier

- Stereo-mono mode switching for each output channel • All inputs are bridging, can be balanced or unbalanced • Up to 20dB gain, matches -10dB unbalanced to +4dB balanced • Gain adjustment for each output channel • Combines and splits audio signals for distribution • 2 inputs and 4 outputs

MicroMixer™ 4-Input, 2-Output Stereo Utility Mixer

- Accepts up to 4 line-level inputs (balanced or unbalanced) and will mix them to a stereo output • Level control for each input provides adjustment from "off" to +10dB of gain • "Micro-Assign" switching permits each input to be assigned to the left, right or both outputs in any combination • All circuitry active and direct coupled for exceptional sonic accuracy • Each output drives a 600 ohm load to +25dBm • Noise 80dB below nominal output level; distortion below 0.01%

TwinMatch™ Dual Stereo Level and Impedance Converter

- Designed to interface unbalanced (-10dBV) equipment outputs with professional (+4dBm) studio inputs • 4 channels of amplification provided • Ideal for use with pair of stereo CD players • Each channel accepts unbalanced input at -10dBV and amplifies it to balanced, low impedance output at +4dBm • Gain adjustment provided for each channel • All circuitry active and direct coupled for exceptional sonic accuracy • Each output drives a 600 ohm load to +25dBm • Noise 85dB below nominal output level; distortion below 0.01%

Telecart II Multi Telecontroller

- Interfaces with virtually any cart machine to automatically answer a phone line and play a recorded message to the caller • All machine control circuits are relay and opto-isolated • "Failsafe" design prevents line from being answered unless message cart is cued and ready to play • Can also be used for "listen lines" and similar uses where a phone line is automatically answered and audio is fed to the caller, or caller audio is recorded and put on the air • Dual-range digital call counter registers up to 9999 calls received • CPC sensing included for line-release when caller hangs up • Optional dial-tone/busy signal decoder available for areas without CPD



The Matchbox

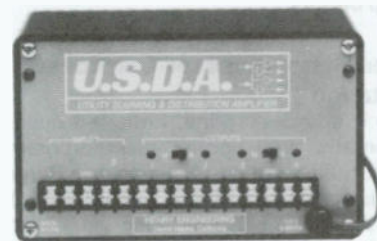

U.S.D.A.



MicroMixer

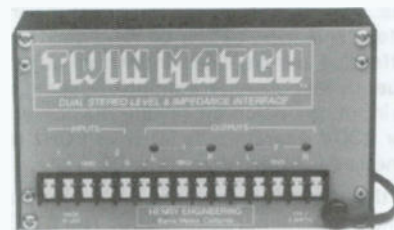

TwinMatch

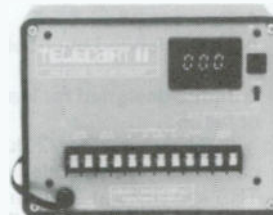

Telecart II

RFC-1/B Remote Facilities Controller

The RFC-1/B has the capability to automatically monitor up to 6 designated telemetry channels and call 2 user-programmed telephone numbers when telemetry falls outside a pre-set range. When the RFC-1/B makes a call, it reports its security code (for site identification) and the channel number responsible for the alarm.

The security code, number of rings before answering, telephone alarm status, telephone numbers to be called for alarm, and the channels designated for automatic monitoring (up to 6) are all user-programmable. All but the security code can be programmed from either the local (transmitter) telephone or a remote telephone. The security code can be programmed from the local telephone only. User-programming is stored in non-volatile memory and does not require a backup battery.

News Director Microprocessor-Controlled Audio Workstation

- Controls up to 16 sources (15 line, 1 mic) • 2 buses (1 program, 1 monitor) • Automatic level control (user programmable, digital control) • 4-digit multifunction LED display • Bargraph VU meter • Internal speaker and headphone amplifiers • 12-hour clock, switchable to 24 hours • Event timer, smart timer • 12 time-activated functions • Software flexible • Automatic dub function • Front panel input jack to accommodate external gear (cassette) • 2-way radio and telephone push-to-talk (PTT) • Standard 12-key telephone style keypad (only moving parts) • No scratchy pots, unreliable audio selector switches or relays

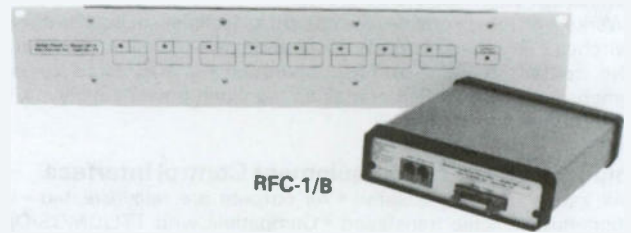

RFC-1/B



News Director



310B Professional Phono Preamplifier/Equalizer

The 310B is designed to correctly interface magnetic phonograph cartridges for optimum playback of disk records and calibration of audio systems. The 310B features universal mounting by special brackets, instant selection of flat or NAB postemphasis curves, switchable effective rumble filter, individual adjustment of gains and high frequency responses, trimming of the capacitive cartridge loading at the input, provision for setting the power transformer for either 117V or 230V operation at 50Hz or 60Hz and immunity to external magnetic AC fields.

In addition to the above features, the 310B offers active balanced output resulting in additional gain of 6dB. The 310B can be used in balanced as well as in unbalanced modes and as in phase and out of phase mix of L and R channels for monophonic reproduction of older records.

Specifications

Output (Per Channel): +26dBm maximum
Gain (Per Channel): Adjustable 36dB-66dB
Output Type: Active balanced or unbalanced
Output Source Impedance: 0 ohms, designed for loads 150 ohms or higher
Frequency Response: ±0.5dB from 20Hz-20kHz in flat or NAB positions of mode selector
Distortion: THD < 0.05% at 20dBm
Rumble Filter: 3dB knee at 28Hz, -35dB at 5Hz
Max. Input Level at 1kHz: 120mV



310B

Noise (Input Terminated in Cartridge):

-70dB below 10mV input at 1kHz NAB curve, 44dB voltage gain -74dB or lower with rumble filter in

Input Resistance:

47K ohms

Input Capacitance:

15pF, switchable in 50pF steps to 350pF maximum

Channel Separation:

60dB minimum (20Hz-15kHz)

Input Connectors:

RCA phono jacks

Output Connector:

5-terminal barrier strip

Power Requirements:

Can be set for 100-125VAC or 200-240VAC, 50-60Hz, 5W maximum

Indicators:

LED pilot light

Dimensions:

2 1/4" x 5" x 7 1/4"

Calibration Standard Series (With "Longhair" Brush)

Model	Stylus Model	Tracking Force
881 MK IIs	D81 IIs	3/4 to 1 1/2 grams
890AL** †*	D89AL	2 to 7 grams
681EEE MK IIs	D6800EEE IIs	3/4 to 1 1/2 grams
681SE†	D6800SE	2 to 4 grams
681A†	D6807A	1 1/2 to 3 grams

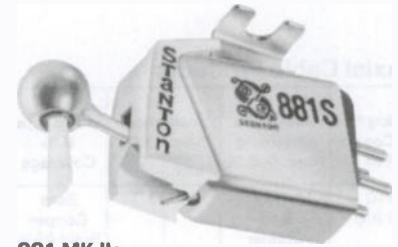
881 MK IIs
680 Stereo Standard Series (With "Longhair" Brush)

680SL†	D6800SL	2 to 5 grams
680EE	D680	3/4 to 1 1/2 grams
680EL*††	D6800EL	2 to 5 grams
680EL-MP†*	D6800EL-MP	2 to 5 grams
(Matched Pair)		
680AL*††	D6800AL	2 to 5 grams

681EEE MK IIs
Stereo Standard Plug-In Series (Pre-Mounted With 1/2" Adaptors)

L747S	D74S	3/4 to 1 1/2 grams
L727E	D72E	3/4 to 1 1/2 grams
L725E	D71-2E	3/4 to 1 1/2 grams
L720EE	D71EE	3/4 to 1 1/2 grams
L680EL*†	D6800EL	3 1/2 to 4 grams
L500AL†	D57PAL	3 1/2 to 4 grams

680EL
Broadcast Standard Series

500AL-MP (Matched Pair)†	D5107AL-MP	2 to 5 grams
500AL-DP*†	D5107AL	2 to 5 grams
500AL†	D5107AL	2 to 5 grams
500EL†	D5107EL	2 to 5 grams

500AL
Broadcast Series—Mark II

500EE MK II	D50EE MK II	3/4 to 1 1/2 grams
500E MK II	D50E MK II	1 to 2 grams
500A MK II	D50A MK II	1 to 2 grams

* Does not include brush.

† Includes extra stylus.

** Non-calibrated

† For backcuing

Coaxial Cable Products

Catalog No. and Coaxial Type	AWG Size Stranding Nom. D.C.R.	Insulation Nom. O.D.		Shield Type & % Coverage	Jacket Type Nom. Cable O.D.		Nominal Capacitance		Nom Vel. of Prop	Nom Imp. Ohm	Nom Attenuation		
		inch	mm		inch	mm	pf/ft	pf/m			MHz	dB/100 ft.	db/100m
		810 RG 8/U	11 (7x20) Bare Copper 1.15 ohm/M		.280	7.11	Bare Copper Braid 95%	.405			10.29	26	85
Foam Polyethylene				PVC Black							100	1.8	5.9
											200	2.6	8.5
											300	3.4	11.2
											400	3.9	12.8

810

Catalog No. and Coaxial Type	AWG Size Stranding Nom. D.C.R.	Insulation Nom. O.D.		Shield Type & % Coverage	Jacket Type Nom. Cable O.D.		Nominal Capacitance		Nom Vel. of Prop	Nom Imp. Ohm	Nom Attenuation		
		inch	mm		inch	mm	pf/ft	pf/m			MHz	dB/100 ft.	db/100m
		812 RG 58A/U	20 (19x32) Tinned Copper 8.8 ohm/M		.116	2.95	Tinned Copper Braid 95%	.195			4.95	25	82
Foam Polyethylene				PVC Black							100	4.8	15.7
											200	6.9	22.6
											400	10.1	33.1
											500	11.3	37.1
											900	15.5	50.8

812

Catalog No. and Coaxial Type	AWG Size Stranding Nom. D.C.R.	Insulation Nom. O.D.		Shield Type & % Coverage	Jacket Type Nom. Cable O.D.		Nominal Capacitance		Nom Vel. of Prop	Nom Imp. Ohm	Nom Attenuation		
		inch	mm		inch	mm	pf/ft	pf/m			MHz	dB/100 ft.	db/100m
		813 RG 58/U	20 Solid Tinned Copper 10.1 ohm/M		.116	2.95	Tinned Copper Braid 95%	.195			4.95	26	85
Foam Polyethylene				PVC Black							100	4.1	13.4
											200	6.2	20.3
											400	9.5	31.2
											500	10.4	34.1
											900	14.5	47.6

813
Twisted Pair Overall Shield

Catalog No.	No. of Cond	AWG Size & Stranding	Nominal Insulation Thickness		Nominal Jacket Thickness		Nominal O.D.		Nominal Capacitance			
			inch	mm	inch	mm	inch	mm	pf/ft*	pf/m*	pf/ft**	pf/m**
291	2	22 (7 x 30)	.010	.25	.020	.51	.141	3.58	55	180	99	325
294	2	16 (19 x 29)	.010	.25	.020	.51	.192	4.88	80	262	144	472

291/294

Standard Spool Size: 1000'.

Color Code: black, red

Special Jacket Colors: 291 is available (from our North Carolina plant only) in the following colors: white, brown, yellow, gray, violet, red, black, green, blue and orange

*Capacitance between conductors.

**Capacitance between 1 conductor and the others connected to the shield.

Standard Jacketed Microphone Cable

Catalog No. and Coaxial Type	AWG Size Stranding Nom. D.C.R.	Insulation Nom. O.D.		Shield Type & % Coverage	Jacket Type Nom. Cable O.D.		Nominal Capacitance*		Standard Spool Size: 1000' Color Code: black, clear Jacket: gray *Capacitance between conductors.
		inch	mm		inch	mm	pf/ft	pf/m	
535 2 Cond.	20 (7x28) Bare Copper 10.5 ohm/M	.015	.38	Bare Copper 95%	.245	6.22	23	41	
		Polyethylene			PVC				

WEEKLY TRANSMITTER READINGS

CALL LETTERS:

CITY OF LICENSE:

DATE:									
TIME:									
PA PLATE VOLTAGE KV									
PA PLATE CURRENT A									
E x I x PA EFF FACTOR KW									
FORWARD POWER %									
REFLECTED POWER %									
28 VDC P.S. V									
SCREEN CURRENT mA									
SCREEN VOLTAGE V									
PA GRID CURRENT mA									
PA BIAS VOLTAGE V									
FILAMENT VOLTAGE V									
LINE VOLTAGE A-B VAC									
LINE VOLTAGE B-C VAC									
LINE VOLTAGE C-A VAC									
FILAMENT HOURS Hrs									
IPA Ec V									
IPA Ic A									
IPA FWD POWER W									
IPA REF POWER W									
EXCITER FWD POWER W									
EXCITER REF POWER W									
EXCITER AMPLIFIER V V									
EXCITER AMPLIFIER I A									
EXCITER +22 V P.S. V									
EXCITER -22 V P.S. V									
EXCITER +5 V P.S. V									
EXCITER AFC VOLTAGE V									
AIR TEMP - EXHAUST °F									
AIR TEMP - INTAKE °F									
TEMPERATURE RISE °F									
STEREO INJ %									
SCA SUBCARRIER INJ %									
OVERLOADS?									
LINE/TANK PRESSURE psi	/	/	/	/	/	/	/	/	/
INITIALS									



MANUFACTURER INDEX

AKG Acoustics, Inc.	.81, 82
Altronic Research, Inc.	.17
Andrew Corp.	.19, 20
Aphex Systems Ltd.	.65
Atlas/Soundolier	.84, 85
Audi-Cord Corp.	.64
Audioarts Engineering.	.64
Audiolab Electronics, Inc.	.66
Audiopak, Inc.	.66
Audio Technica US, Inc.	.84
Audio Technologies, Inc.	.71
Autogram Corp.	.60-62
Belar Electronics Laboratory, Inc.	.50
Bird Electronic Corp.	.26, 27
Burk Technology.	.41
Central Tower, Inc.	.36
Circuit Research Labs	.72, 73
Coaxial Dynamics, Inc.	.28, 29
Continental Electronics Corp.	.2-13, 95
J. W. Davis	.68
Delta Electronics, Inc.	.51, 52
Denon America, Inc.	.65
Dielectric Communications	.30, 32, 33
Dorrrough Electronics	.74
Electro Impulse Laboratory, Inc.	.18
Electronics Research, Inc.	.31

Energy Control Systems	.15
Environmental Technology, Inc.	.14
Fidelipac Corp.	.67, 70
Gentner Electronics Corp.	.42, 75
Gorman-Redlich Mfg. Co.	.53
Hallikainen & Friends, Inc.	.53
Henry Engineering	.90, 91
Hughey & Phillips	.37
Inovonics, Inc.	.76
IT Protector/Energy Control Systems	.15
Jampro Antennas, Inc.	.34
Key Industries, Inc.	.40
KinTronic Labs, Inc.	.38
L.E.A. Dynatech, Inc.	.16
LPB, Inc.	.63
Marantz Professional Products	.63
Mark Antenna Products, Inc.	.49
Marti Electronics, Inc.	.43-45
Micro Communications, Inc.	.30
Modulation Sciences, Inc.	.77
Moseley Associates, Inc.	.46

Motorola Inc./AM Stereo	.55
MTS/Multi-Technical Services	.54
Myat, Inc.	.25
Onan Corp.	.39
Orban Associates, Inc.	.78, 79
Potomac Instruments, Inc.	.56-58
QSC Audio Products, Inc.	.88
Radio Design Labs	.86, 87
Radio Frequency Systems, Inc.	.21-24
Register Data Systems	.89
Ruslang Corp.	.69
Scala Electronic Corp.	.48
Shively Labs, Inc.	.35
Shure Brothers, Inc.	.83
Sine Systems, Inc.	.92
Stanton Magnetics, Inc.	.92, 93
Symetrix, Inc.	.80
TFT, Inc.	.47, 59
Utility Tower Co.	.36
West Penn Wire Corp.	.94
Wheatstone Corp.	.70

PRODUCT INDEX

Accounting System	.89
AGC Leveler	.80
AM Stereo Systems	.51, 55
Amplifiers, Audio	.71, 80, 87, 88, 90
Amplifiers, Summing	.90
Analyzer, Audio Program	.57
Antenna Monitors	.53, 56
Antenna Phasing Systems	.38
Antennas, FM	.30-35, 48
Antennas, Microwave	.44, 49
Attenuators	.86
Audio Cassette Recorders/Players	.63
Beacon Lights	.37
Cabinetry, Studio	.69
Cabinets, Consoles, Racks and Accessories	.69, 85
Cartridge Machines	.64, 67
Cartridges, Audio Tape	.66
Combiner, Microphone	.86
Compact Disc Cartridge Players	.65
Compressor/Limiters	.70, 79, 80, 87
Connectors, Coaxial	.21, 22, 25
Consoles, Audio	.60-64, 70
Crossovers	.80
Cueing Interface	.90
De-icing Controls/Sensors	.14
Degaussers/Erasers	.66
Desktop Automated Radio Station System	.89
Digital Audio Recorders	.89
Distribution Amplifiers, Audio	.54, 70 .71, 77, 87, 91
Divider/Combiner	.86
EBS Systems and Equipment	.53, 54, 59
Equalizers, Audio	.70, 87

Eraser/Splice Detector	.67
Exciters, AM Stereo	.51, 52, 55
Exciters, FM	.2
Gain Controllers	.72
Generators, Electric	.39
Generators, Stereo	.65, 70, 72-80
Headphones	.81
Impedance Bridges	.52
Lighting, Tower/Obstruction	.37
Meters, Field Strength	.58
Microphone Booms, Stands and Accessories	.84
Microphones	.82-84
Mixers	.83, 87
Modulation Monitors, AM/FM	.50, 51, 55, 59
Modulators, AM	.13
Noise Reduction Systems, Audio	.73, 76, 80
Paging Module, Voice-Over	.87
Patching Systems	.42
Phase Converters	.40
Phono Cartridges	.93
Preamplifier/Equalizer, Phono	.92
Preamplifiers, Audio	.80, 86, 90
Pressurization Equipment	.24
Processors, Audio	.65, 70, 72-80, 87
Receivers, AM/FM	.54, 59
Relays, Audio Controlled	.86
Remote Pickup Equipment	.44, 47
RF Coaxial Loads	.17, 18

SCA Equipment	.59, 73, 77
SPL Computers	.80
Speaker Systems	.68
Storage Systems, Record/Tape	.69
Strobe Lights	.37
Studio Furniture	.69
Studio Transmitter Links	.43, 46, 47
Switches, Coaxial	.30
Synchronizer, Turntable-Recorder	.90
Synthesizers, Stereo	.79
Telemetry Links	.45
Telephone Hybrids	.42
Telephone Interfaces	.80
Test and Measurement Equipment	.57 .58, 74
Tower Lighting	.37
Towers	.36
Transformers, Audio	.87
Transformers, Toroidal	.52
Transmission Lines, Coaxial	.19-23, 25
Transmitter Log	.95
Transmitter Remote Controls	.9, 41, 42 .46, 53, 56, 92
Transmitters, AM	.10
Transmitters and Accessories, FM	.2-8
Transmitters, MW	.11
Transmitters, Shortwave	.12
Tuners, AM/FM Stereo	.65
Voltage Suppressors	.15, 16
Wattmeters	.26-29
Weather Radio	.53, 54
Wire and Cable	.94
Workstation, Audio	.92

Continental Electronics Corporation

*Continental Electronics Corporation
has the best product warranty and the best 24-hour
technical service in the broadcast industry.*

—
Main Office 214-381-7161

Fax 214-381-4949

Telex 73-398
—

EMERGENCY PHONE NUMBERS

24-Hour Telephone Technical Service

214-388-5800

24-Hour Emergency Parts Service

214-388-3737
—

P.O. Box 270879

Dallas, Texas 75227-0879

Continental Electronics Corporation

A Sound Investment In Your Broadcasting Future



Continental Electronics Corporation

P.O. Box 270879 Dallas, Texas 75227