

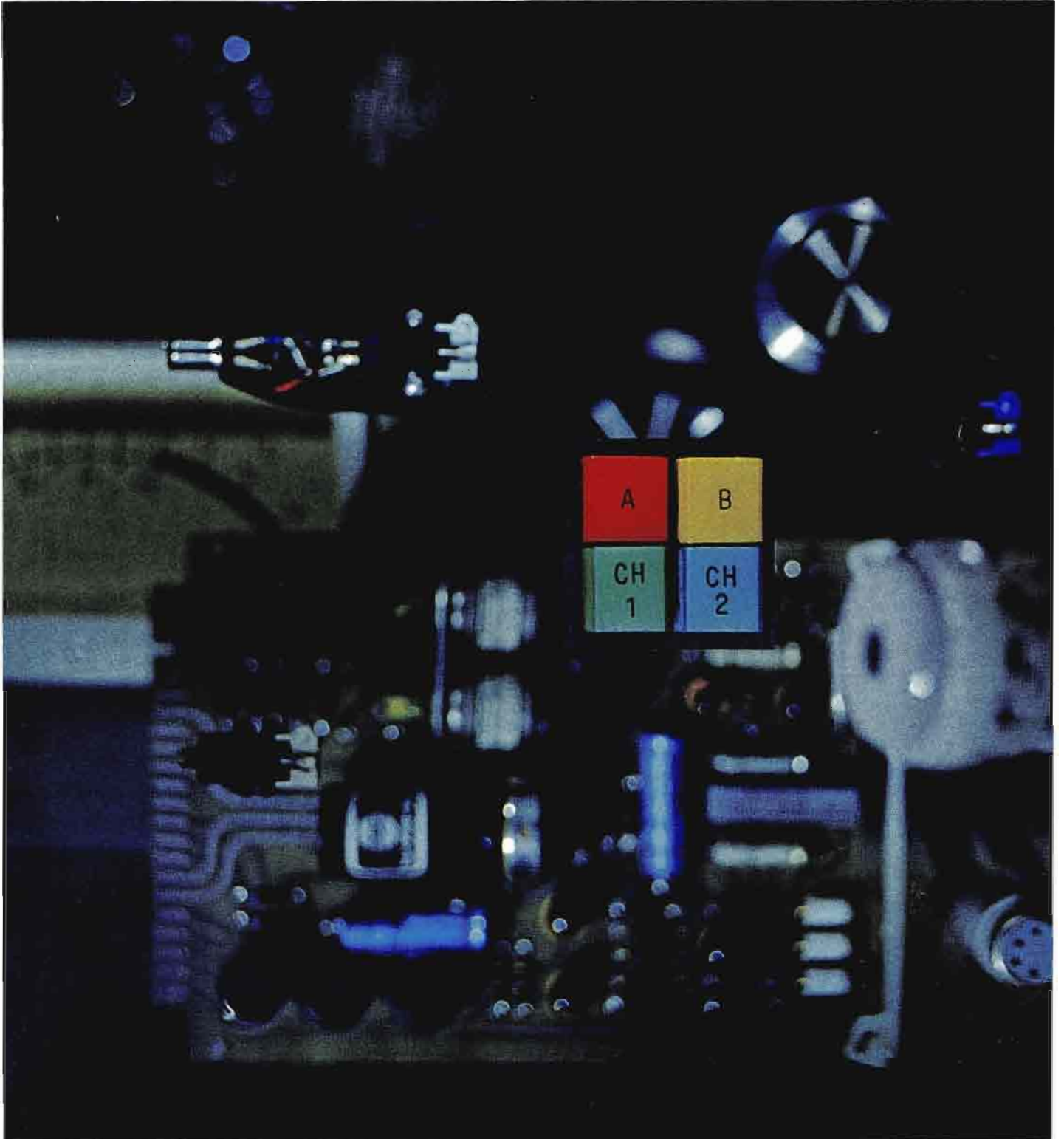

Broadcast Equipment





Collins Broadcast Equipment Catalog No. 45

TABLE OF CONTENTS

Collins Radio Company.....	2
AM Transmitters	5
FM Transmitters	13
FM Antennas	30
Audio Equipment	36
Audio Accessories	62
Remote Equipment	71
Measuring-Monitoring-Remote Control	75
Tables-Charts-Graphs	83
Index by Description.....	104
Index by Type Number.....	105
Sales Policy	107

Equipment descriptions in this catalog are condensed so that the complete line of broadcast units supplied by Collins Radio Company can be shown. For more information on any of these units, you are invited to contact your Collins Broadcast Sales Engineer or Collins Radio Company, Broadcast Marketing, Dallas, Texas.

Customers in countries other than the United States are invited to contact the nearest International Sales Office or Collins International Division, Dallas, Texas.

All specifications contained within are subject to change without notice.

Collins Radio Company

Collins Radio Company is an international electronics corporation combining communication, computation and control equipment into total systems which acquire, transfer, store, extract, process and condense information for man's use.

Collins produces more than 1000 products at manufacturing facilities in Dallas, Texas; Cedar Rapids, Iowa; Newport Beach, California; and Toronto, Ontario. Sales and service facilities are maintained at key points throughout the world.

Company activities include research, development, manufacture and product support in the areas of avionics, space tracking and communication, broadcasting, microwave, scatter, high frequency long-range equipment, antennas, components, and computer and data transmission systems.



Administration Building and Corporate Offices, Dallas, Texas

To meet worldwide requirements of business, industry and government, Collins produces communication, computation and control systems in the following areas:

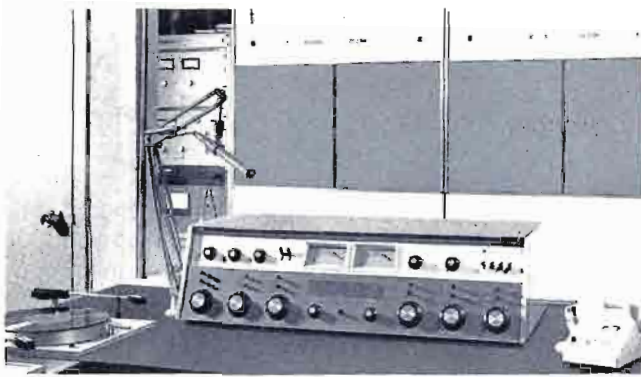

BROADCAST

Collins offers a wide range of AM and FM broadcast equipment, including 250 to 250,000 watt transmitters for government organizations. The Collins broadcast product line includes all equipment needed to go on the air — from microphones to antennas.

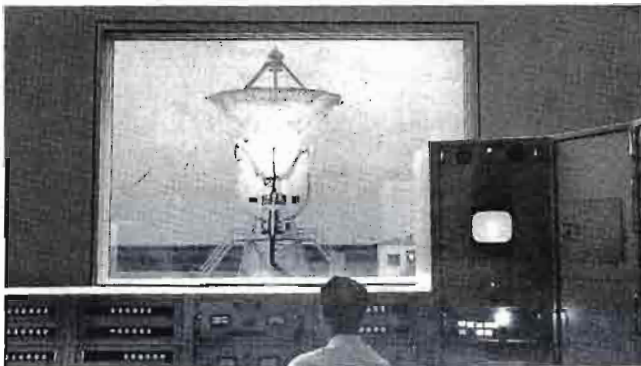

SPACE TRACKING & COMMUNICATION

Collins contributions to the U. S. space efforts include communication and tracking equipment aboard spacecraft and at ground tracking and range installations.

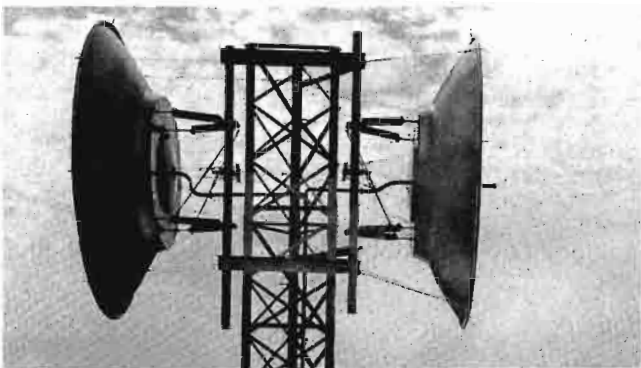

TELECOMMUNICATION

Collins is one of the largest world suppliers for telecommunication, including microwave and tropospheric scatter systems. Collins total systems engineering capability provides construction of buildings, roads, bridges, towers and antennas, power plants, and other facilities required for the operation of a complete telecommunication system.



AVIONICS

Collins supplies the most complete line of avionics equipment and systems available to the aviation industry. More than 75 percent of all aircraft operated by the world's major airlines carry Collins avionics systems.

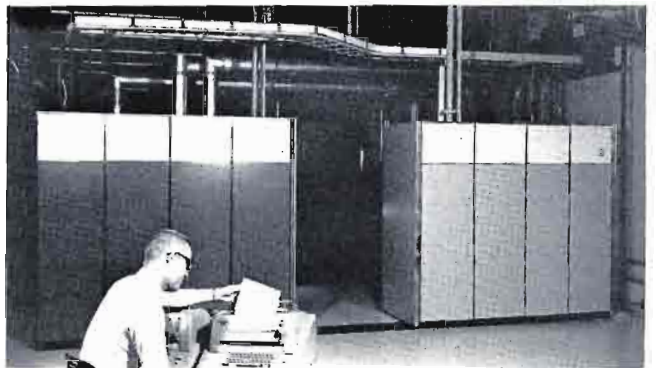

HF LONG RANGE SYSTEMS

Collins offers a line of completely integrated, automatic fixed station and transportable single sideband systems for worldwide communication. Both fixed station and transportable single sideband units made by Collins are in use today by free-world industries operating in remote areas.



DATA SYSTEMS

An important segment of the company's activity includes the design, development and manufacture of data communication and processing equipment and systems for industry. Collins computerized message processing centers are in daily operation around the clock handling message traffic for airlines and railroads in the United States, Canada and Europe.

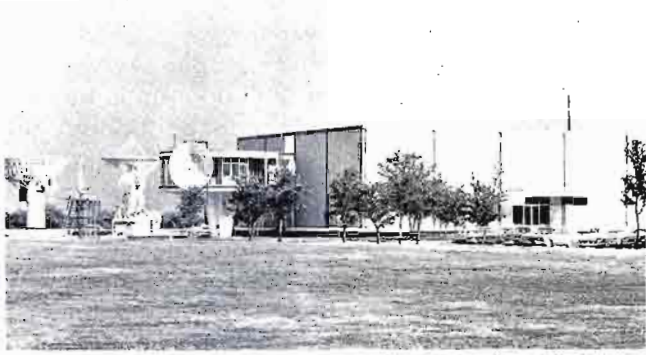

ANTENNAS

Housed in a specially designed laboratory at the company's Dallas, Texas, site to ensure year-round research capability, Collins engineers have developed a complete line of ground, fixed station and transportable, airborne, and space antennas.

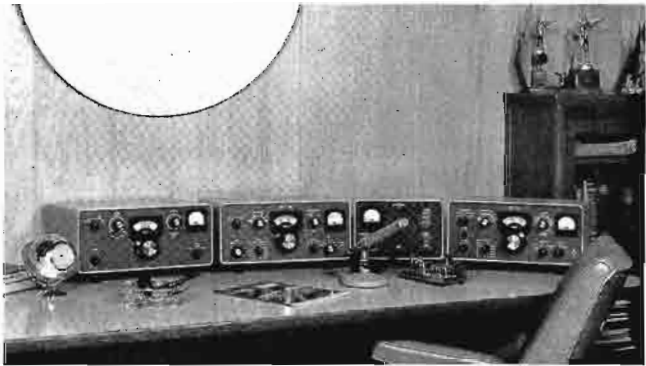

AMATEUR

Collins continues to offer to the world-wide fraternity of amateur radio operators the best equipment available. Many governmental agencies, including civil defense organizations, specify Collins high quality amateur radio equipment for use in their official operations.

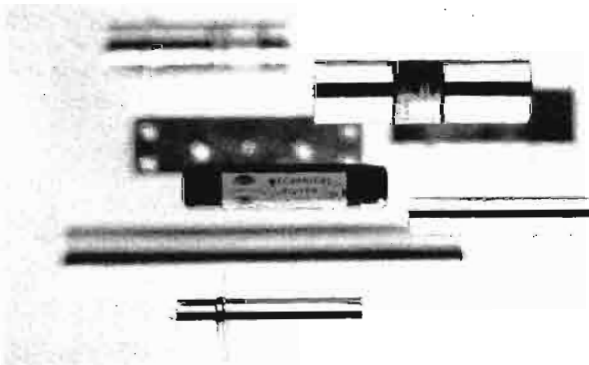

COMPONENTS

Collins manufactures high quality mechanical filters, crystal filters, and magnetic products.

Collins efforts in all phases of communication have resulted in significant contributions toward advanced and reliable systems. The design and performance of these systems are a direct result of Collins depth of experience and broad diversification in the field of communication.

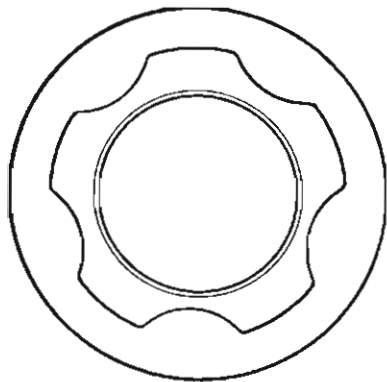

AM
Transmitters

COLLINS 820D-1 1-KW AM TRANSMITTER

The Collins 820D-1 1-kw AM transmitter is designed for reliable high fidelity broadcasting at any specified frequency from 540 to 1600 kHz.

The new 820D-1 has many features that make it one of the most advanced transmitters on the market. Many proven techniques, together with maximum use of silicon semiconductors in the power supplies and low level rf and audio stages, result in a high degree of reliability and a reduction in size, weight, and power consumption.

Frequency source for the 820D-1 is the type 310W-1 Exciter. The rf driver is solid state and consists of a single transistor. The stage is operated class C in a common-emitter configuration for high-gain capability and reasonable input impedance. The power amplifier is designed to deliver 1100 watts at the output terminal. The plates are modulated conventionally by a transformer-coupled modulator in conjunction with a modulation reactor. Power cut-back to either 500 or 250 watts is possible by reduction of plate voltage. The PA uses two 5-500A tubes.

The output network design consists basically of a 3-node filter, with inductive coupling between nodes. The proper bandpass response is attained by the selection of node Q distribution and provides for essential flat response of the modulated transmitter output signal.

Two push-pull driver stages amplify audio signals to drive the modulator. Both stages are common emitter for good gain and high input impedance. Feedback from the plates of the modulator tubes is applied to the input of the first driver stage. Two Eimac 5-500A pentodes are employed in class AB, push-pull operation to supply modulating voltage to the power amplifier.

Maintenance meters are provided for measuring power amplifier plate voltage and power amplifier plate current.

Power supplies are of conventional design and all are silicon solid state.

Control circuits have been simplified as much as possible consistent with safety and reliability. Provisions are made for both direct digital control and optional remote control.

Direct digital control is accomplished with five push-button switches. These are Filament Off, Filament On, Plate Off, High Power On, and Low Power On. Operation of the High or Low Power On switch to apply full or reduced power, respectively, will energize the transmitter completely, including application of rf signal. A separate Filament On function is provided to allow independent filament operation. No time delays are used. Power change between full power (1000 watts) and reduced power (500 watts or 250 watts as customer specifies) is accomplished by depressing the proper control pushbutton. Interlocking is provided to eliminate the necessity of separately deenergizing the transmitter before changing power. The Filament

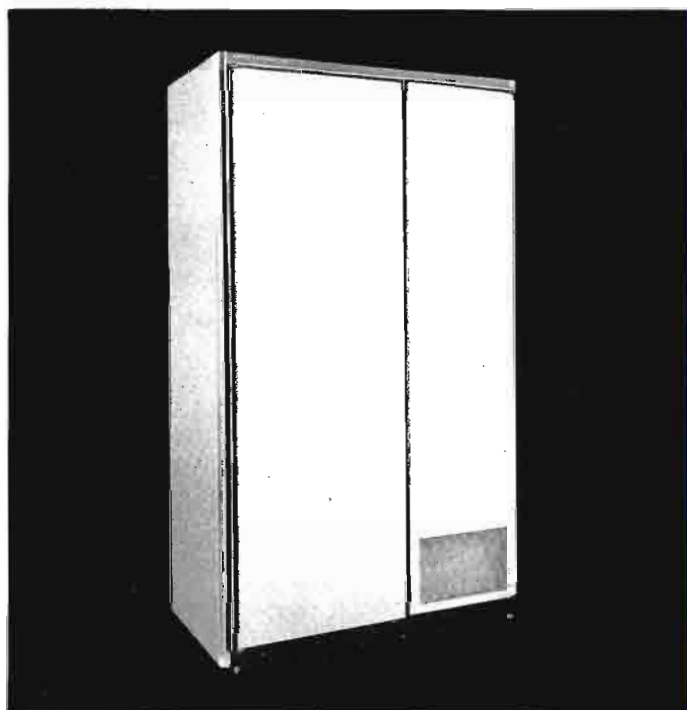

CONTROL PANEL

Off switch, when depressed, deenergizes the transmitter completely, including removal of filament voltage and cooling air. No postoperative tube cooling is necessary. A 50-foot cable is supplied with the control panel, allowing the control panel to be located in a control console or supervisory control room away from the transmitter.

Remote control can perform the following functions: Filament Off, Filament On, Plate Off, High Power On, Power Increase/Decrease, and Remote Control Fail-Safe.

Also provided are samples of plate voltage and current, which are brought out to a terminal board to be used for remote metering.

Options for the 820D-1 include a remote control unit, automatic output-power control, and filament regulation control.

RF Input: 50 ohms unbalanced, 2 watts, 24 volts peak-to-peak, nonsinusoidal from type 310W-1 Exciter

RF Output: Power output capability is 1.1 kw into a 50-ohm unbalanced load. Facilities for reduced power operation are provided at either 550 or 275 watts. Other unbalanced output impedances can be supplied on special order.

Emission: Amplitude modulation (A3)

Harmonics: 73 db below carrier

Frequency Range: 540 to 1600 kHz

Frequency Stability: Determined by type 310W-1 Exciter, ± 10 Hz, -10° to $+45^{\circ}\text{C}$

Audio Input: $+10$ dbm ± 2 db

Response: ± 1 db from 100 to 7500 Hz, ± 2 db from 50 to 10,000 Hz

Distortion: Less than 3% from 50 to 7500 Hz for 95% modulation

Carrier Shift: Less than 3% from 0 to 100% modulation

Hum and Noise: 60 db below 100% modulation

Type of Service: Continuous duty, attended or unattended, local or remote control

Ambient Temperature Range: -25° to $+45^{\circ}\text{C}$

Ambient Humidity: Up to 95% relative humidity

Altitude: Up to 7500 feet

Power Requirements: 208/230/240 volts $\pm 5\%$, 50/60 Hz, single phase

Filaments: 0.4 kw, 90% PF

Carrier: 2.2 kw, 90% PF

30% Modulation: 2.5 kw, 90% PF

100% Modulation: 3.4 kw, 90% PF

Size: 69 in. H by 41 in. W by $23\frac{3}{8}$ in. D (175 cm H by 104 cm W by 59 cm D)

Weight: Approx 1100 lb (500 kg)

Part No. 522 3391 (820D-1)
 Part No. 771 9085 001 (Automatic Power Control)
 Part No. 771 9009 001 (Remote Control Module)
 Part No. 771 9008 001 (Filament Voltage Regulator)

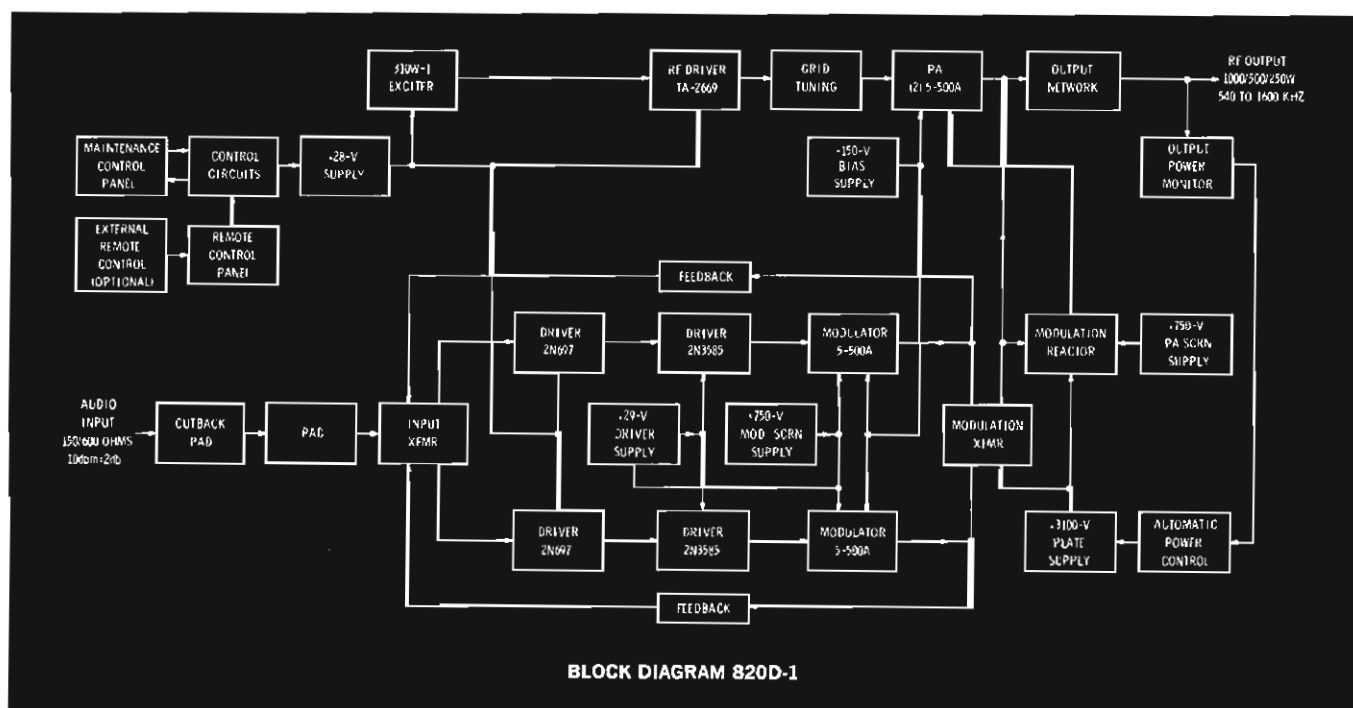

COLLINS 820E/F-1 5/10 KW AM TRANSMITTER

The Collins 820E/F-1 is the most extensively transistorized transmitter in the 5/10 kw power range. It features solid-state devices in the low-level audio and driver, the power supply circuits and the rf exciter.

This new exciter has a highly stable ovenless crystal operating in the 2.1- to 4.3-MHz range, with division to standard broadcast frequency by thin-film components.

The 10-kw model, shown below, uses six tetrode vacuum tubes in the rf driver, power amplifier, and modulator circuits, but requires only two tube types. The 5-kw model uses one less tube in the final rf amplifier.

Tuning of Collins new 820E/F-1 is automatic. A phase-comparator circuit in the power amplifier stage automatically controls the PA tuning as loading is adjusted. Since the tuning capacitor is at a higher network impedance point and since it requires less padding capacitance than the loading capacitor, tuning correction is fast enough to take place well within the time required for loading changes.

Collins designed this new transmitter for easy, space-saving installation, as well as extended reliability. It measures just 69 in. H by 67-7/16 in. W and 32 in. D. All power supply components are completely self-contained.

For attended operation such as a combination station, all metering and control of the transmitter is accomplished from a separate extended control panel, which requires no remote control authorization. All meters, controls, and status indicators necessary for monitoring performance of the transmitter are housed at the extended control panel. When operating rules permit completely unattended operation without transmitter log, the 820E/F-1 will be immediately adaptable to that concept without rebuilding or

modification. It is truly the transmitter for both the present and the future.

EXTENDED CONTROL PANEL

The transmitter is suitable for installation at an unattended site and may be remotely controlled from a distant studio location in the conventional manner. As a convenience for attended operation and maintenance, all meters, operating controls, and status indications are grouped on a 12¼ by 19 inches extended control panel supplied with 50 feet of multiconductor shielded cable for connection to the transmitter. All controls necessary for normal operation of the transmitter can be made from the extended control panel.

RF EXCITER

An all solid-state unit, the type 310W-1 exciter offers increased frequency stability through operation of the oscillator at two or four times the output frequency. Division to standard broadcast frequencies is obtained by digital circuitry employing thin-film components. The exciter is normally located externally to the transmitter and supplies drive through a coaxial cable. Fifty feet of interconnecting cable is furnished with the exciter, but the unit may be located up to 250 feet from the transmitter if desired.

RF DRIVER

The rf driver uses two 6146B tubes in parallel, operating Class C. Tuned-grid, tuned-plate circuits are used, with the frequency monitor sample derived from the plate tank coil. Driver modulation is not employed except for the partial modulation that occurs because of changes in the PA grid impedance over the audio cycle.

OUTPUT NETWORK

Conventional low-pass L-sections transform the 50-ohm nominal output impedance to 1000 ohms plate impedance

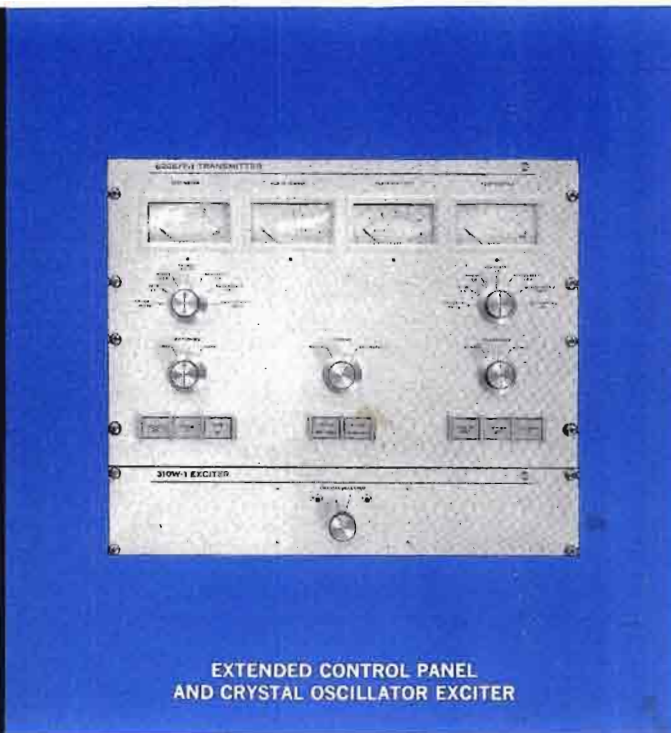
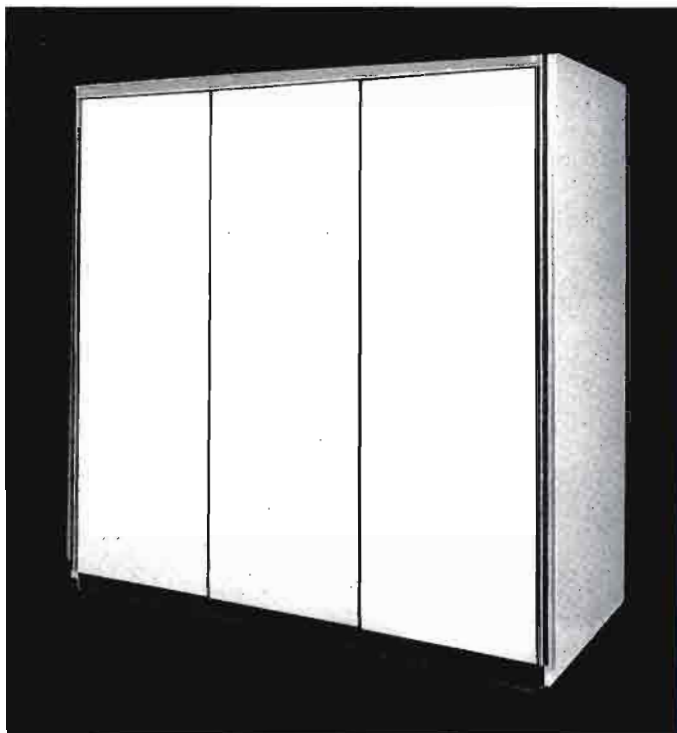

EXTENDED CONTROL PANEL
AND CRYSTAL OSCILLATOR EXCITER

for the 10-kw transmitter, and to 2000 ohms for the 5-kw version.

The combined network consists of three series inductances and three shunt capacitances, plus a second harmonic shunt trap to ground. Overall phase shift through the networks is -360° , giving a favorable plate impedance characteristic when operating into loads within the EIA limit for "normal" loads.

Motor-driven variable vacuum capacitors are provided in the PA tuning and loading positions—controllable from switches on the extended control panel. PA loading is used to adjust transmitter power output and is normally extended to the remote point in remotely controlled installations.

A phase-comparator circuit is used in the PA stage to automatically control the PA tuning motor as loading is adjusted. Because the tuning capacitor is at a higher network impedance point and requires less padding capacitance than does the loading capacitor, tuning correction will occur at a more rapid rate, and within the time required for loading changes. The tuning function is not normally extended to the remote control point, and to assure fail-safe operation, the automatic tuning adjustment is disabled until loading changes take place. A Manual/Automatic Tuning switch is provided on the extended control panel to disable the automatic mode during maintenance checks.

Frequency Range: 540 to 1600 kHz

Power Output: 820E-1 5500 watts (1100 watts reduced power) 820F-1 10,600 watts (5500 watts reduced power)

Frequency Stability:

± 5 Hz, 0° to $+35^\circ\text{C}$

± 10 Hz, -10° to $+45^\circ\text{C}$

± 20 Hz, -25° to $+45^\circ\text{C}$

Output Impedance: 50 ohms, unbalanced

Audio Input Impedance: 150/600 ohms, balanced

Audio Input Level: $+10$ dbm ± 2 db

Audio Frequency Response:

± 1 db, 100 to 7500 Hz

± 2 db, 50 to 10,000 Hz

Audio Harmonic Distortion: Less than 3%, 50 to 7500 Hz

Carrier Shift: Less than 3%, 0 to 100% modulation

Residual Noise Level: 60 db below 100% modulation

Modulation Type: High-level plate

Ambient Temperature Range: -25° to $+45^\circ\text{C}$

Ambient Humidity Range: Up to 95%

Altitude Range: Up to 7500 feet

Power Source: 208/240 volts, 3-phase, 50/60 Hz

Combined Voltage Variation and Regulation Tolerance: $\pm 5\%$

Power Requirement at 5500 Watts, 100% Modulation: 18.5 kw, 0.98 power factor

Power Requirement at 10,600 Watts, 100% Modulation: 32 kw, 0.97 power factor

Size: 69 in. H by 67-7/16 in. W by 32 in. D (175 cm by 171 cm by 81 cm)

Total Weight Including Transformers: 820E-1, 2000 lb (910 kg); 820F-1, 2450 lb (1115 kg)

Part No. 522 3291 000 (Type 820E-1)

Includes one set of tubes, one crystal and one instruction book

No Part Number

Complete set of spare tubes for 820E-1

No Part Number

FCC set of spare tubes for 820E-1

Part No. 522 3292 000 (Type 820F-1)

Includes one set of tubes, one crystal and one instruction book

No Part Number

Complete set of spare tubes for 820F-1

No Part Number

FCC set of spare tubes for 820F

No Part Number

Spare crystal for 820E/F-1

Part No. 522 1410 004 (Type 172G-1)

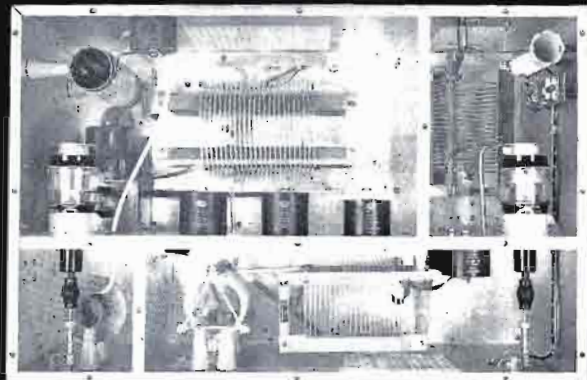

OUTPUT NETWORK COMPARTMENT

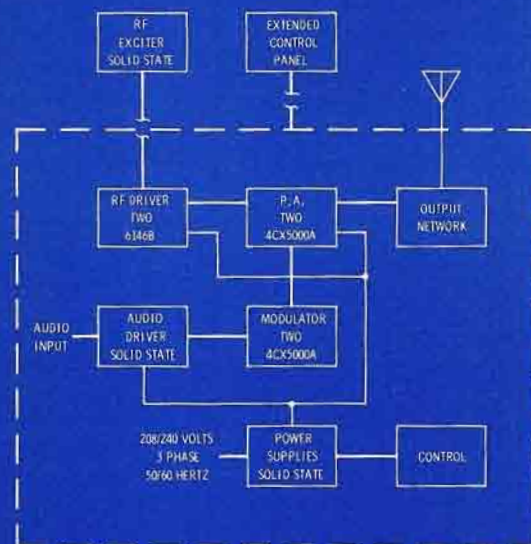

BLOCK DIAGRAM 820F-1

COLLINS 81M PHASOR

Collins Radio Company maintains a research and development staff that devotes its full efforts to custom design and manufacture of phasing and tuning equipment that will meet critical operating parameters with a minimum of maintenance and adjustment. By instituting its own design and construction, Collins can offer fastest possible delivery, maintain its famous standard of quality and sell at the lowest possible cost.

Engineered into each installation are easily-adjusted networks, highest stability, adequate voltage and current safety factors and maximum economy. A customer's requirements, as specified by his consulting engineer, are strictly adhered to and designs are submitted for approval before construction is started.

After the consulting engineer has made channel studies for an available frequency, he will design an array to fit the location, frequency and other requirements. He will determine the pattern shape and size in both the vertical and horizontal planes, the maximum expected operating values of fields in both the nulls (minimum signal areas) and the lobes (maximum signal areas), the proper size, shape, height, spacing, and orientation of the antenna towers, and the phase relationships and amplitude ratios of the radiation fields of the individual antennas. This information is then submitted to the FCC with the application for a construction permit.

A Collins 81M directional antenna phasing and branching system consists of: a branching circuit in which the power is divided in precisely the amounts of power necessary to give the proper ratio of fields from the individual antennas; an impedance matching circuit to match the power divider input impedance to the common point impedance at which the power input is measured; phase-shifting networks in series with each of the transmission lines going to the individual antenna towers; the transmission lines

themselves; and the impedance-matching network between each of the transmission lines and its associated antenna tower.

The power divider in Collins 81M equipment is usually a resonant tank circuit consisting of a large fixed coil tapped with smaller variable coils for power adjustment. An alternate design uses a group of variable coils, each one feeding a tower; this group then becomes the tank coil of the circuit.

For 1 kw or lower, the capacitive arm of the tank circuit is a capacitor and variable coil connected in series. The variable coil provides tuning adjustment by varying the overall negative reactance in this branch of the tank. In higher powers, the tank capacitance is usually a variable vacuum capacitor in parallel with one or more fixed capacitors.

Phase shifting networks are "T" designed, with variable coils mechanically connected in tandem for the series arms and a coil and capacitor in series for a shunt arm. Wherever possible, 90° networks capable of being adjusted $\pm 30^\circ$ from the design value are supplied.

Wherever a phase shift network is not required, a series variable coil and capacitor are used to supply variation of $\pm 20^\circ$ around a 0° setting. They are used for trimming phase shift of current in the towers in which they are used.

"T" networks are also used for impedance matching at the tower base. The network has sufficient latitude of adjustment to match the transmission line impedance to any expected base operating impedance and still permit adjustment of phase shift.

Switching of circuits for day and night operation or directional and nondirectional operation is accomplished by impulse-type, toggle-operated rf relays, energized by pushbutton switches on the front panel. The pushbutton automatically removes the plate voltage of the transmitter before pattern switching and restores it when switching

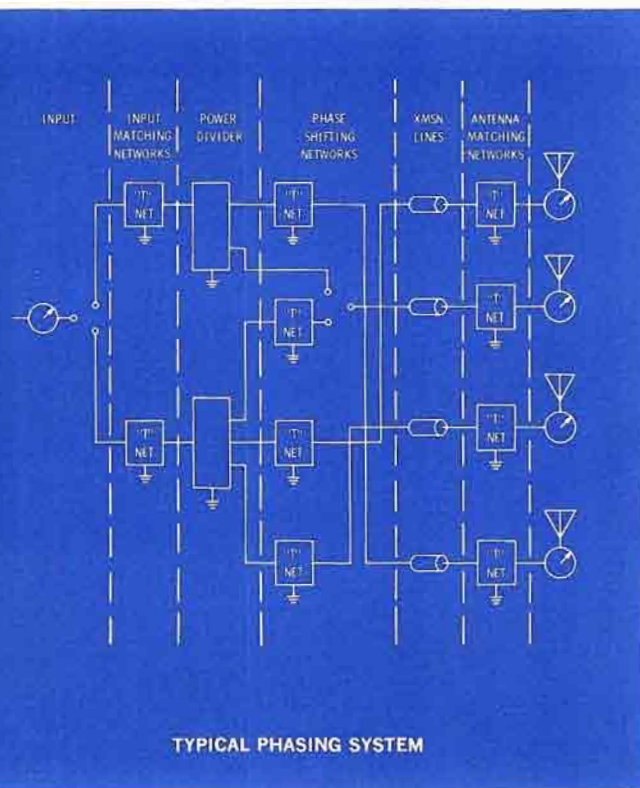
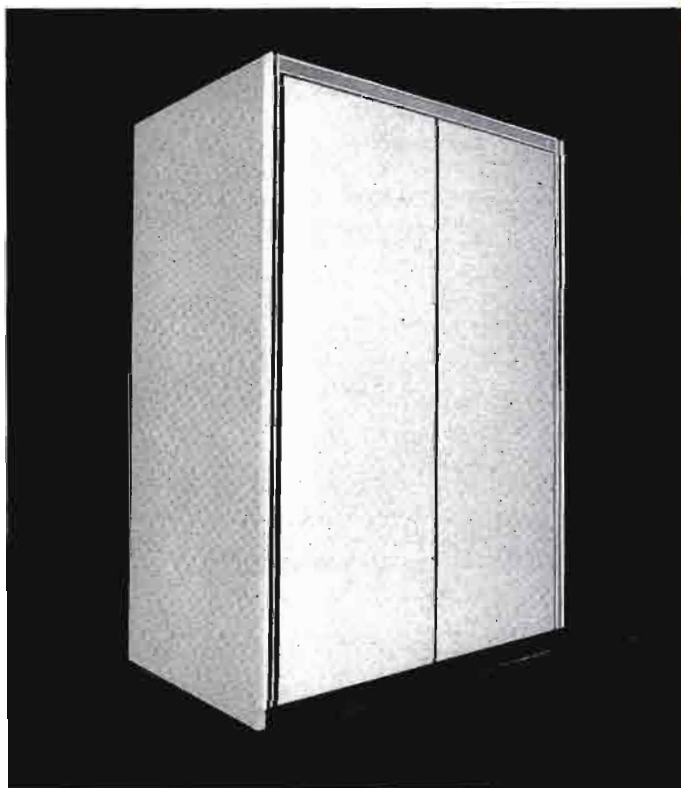

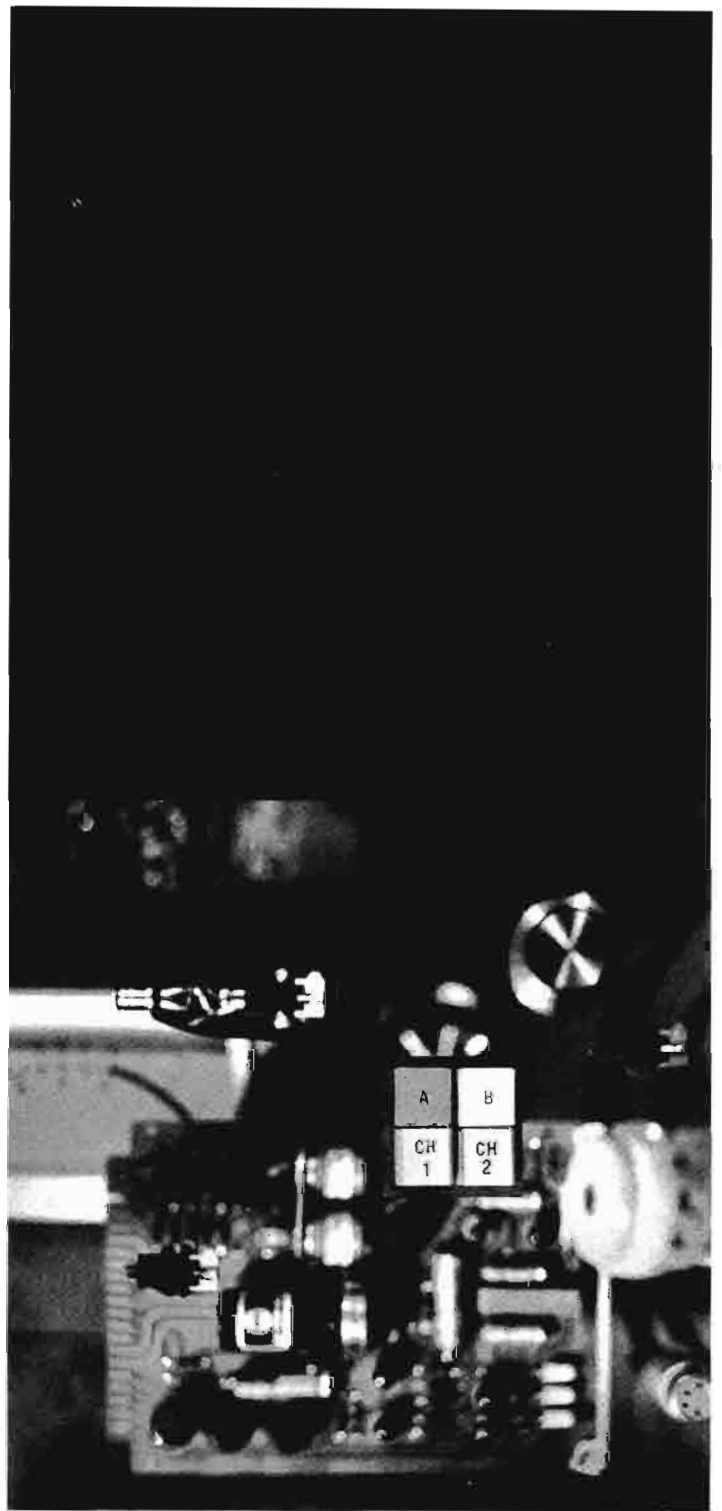

Broadcast Equipment

PRICE LIST / CATALOG NO. 45 / APRIL 1, 1968



A large, stylized graphic of the text "1st". The "1" is a solid black block letter. The "st" is rendered in a white, outlined font with a 3D effect, appearing to be attached to the right side of the "1".

Collins broadcast firsts include: *First* production consoles using photocell switching and gain control . . . *First* solid-state remote amplifiers . . . *First* Broadcast tape cartridge system . . . *First* AM transmitters using automatic tuning . . . *First* digital readout frequency monitors . . . *First* Broadcast transmitters using ovenless crystals.



COMMUNICATION / COMPUTATION / CONTROL

TABLE OF CONTENTS

AM Transmitters	4
AM Transmitter Accessories	5
81M Phasing Equipment	6
FM Transmitters	7
FM Antennas	8
Towers and Accessories	12
Audio Equipment	12
Audio Accessories	17
Remote Equipment	19
Measuring, Monitoring, Remote Control	20
Domestic Sales Offices	21
International Sales Offices	22
Conditions of Sale	23

©Collins Radio Company 1968. 523-0560560-001430
April 1968. Printed in U.S.A.

AM TRANSMITTERS

Catalog Page	Type No.	Part Number	Description	Price
6	820D-1	522 3391	1-KW AM Transmitter	\$ 6,300.00
6	820D-1	771 9009 001	A-2 Remote Control	99.00
6	820D-1	771 9275 001	A-6 Power Control Servo Amplifier	134.00
6	820D-1	771 9085 001	A-8 Power Control Sensor	108.00
6	820D-1	771 9008 001	Sola Filament Regulator	107.00
6	820D-1	NPN	Tubes 100% Set	234.00
6	820D-1	NPN	Semiconductors, 100% Set	296.95
6	820D-1	NPN	Semiconductors, 100% Set including Servo Amplifier	325.86
6	820D-1	NPN	Tubes, Recommended Set	117.00
6	820D-1	NPN	Semiconductors, Recommended Set	185.40
6	820D-1	NPN	Semiconductors, Recommended Set including Servo Amplifier	203.80
6	820D-1	NPN	Spare Crystal	90.00
8	820E-1	522 3291 000	5-KW AM Transmitter, One Set of Tubes, One Crystal and One Instruction Book	19,150.00
8	820E-1	NPN	Tubes, 100% Set	1,495.40
8	820E-1	NPN	Semiconductors, 100% Set	609.60
8	820E-1	NPN	Tubes, Recommended Set	500.20
8	820E-1	NPN	Semiconductors, Recommended Set	299.80
8	820E-1	NPN	Spare Crystal	90.00
8	820F-1	522 3292	10-KW AM Transmitter, One Set of Tubes, One Crystal, and One Instruction Book	21,550.00
8	820F-1	NPN	Tubes, 100% Set	1,990.40
8	820F-1	NPN	Semiconductors, 100% Set	609.60
8	820F-1	NPN	Tubes, Recommended Set	500.20
8	820F-1	NPN	Semiconductors, Recommended Set	299.80
8	820F-1	NPN	Spare Crystal	90.00

AM TRANSMITTER ACCESSORIES

Catalog Page	Type No.	Part Number	Description	Price
11	Tower Light- ing Filter Chokes	543 3927 000	Unhoused, 2-wire, 2000 Watts	150.00
11	Tower Light- ing Filter Chokes	543 3926 000	Unhoused, 3-wire, 2000 Watts	170.00
11	42E-7	522 1028 000	Antenna Coupling Unit	550.00
11	42E-8A	522 1029 000	Antenna Coupling Unit	850.00
11	42E-8B	522 1029 000	Antenna Coupling Unit	1,005.00
12	172G-1	522 1410 004	Dummy Antenna, 1 KW, 50 Ohm, Air Cooled	70.00
12	WG-50	124 0061 794	Dummy Antenna, 7.5 KW, 50 Ohm, Air Cooled	250.00
12	338-32J	124 0061 801	Dummy Antenna, 15 KW, 50 Ohm, Air Cooled	459.00
12	144A-1	522 1520 001	Isolation Coil Form	63.00
12	Antenna Cur- rent Trans- former	543 3917 003	Antenna Current Transformer	48.00
12	135-15-1	097 1501 000	One Bowl and Fittings	17.50
12	135-15-3	097 6673 000	Two Bowls and Fittings	31.95
12	135-15-4	099 1170 000	Two Bowls and Fittings	41.00
12	135-15-7	097 5646 000	Two Bowls and Fittings	32.50
12	145-101-13	410 0209 00	Johnson SPDT Relay	113.00
12	145-102-13	410 0210 00	Johnson DPDT Relay	123.50
12	145-201-13	410 0211 00	Johnson SPDT Relay	130.00
12	145-202-13	410 0212 00	Johnson DPDT Relay	145.00

81M PHASING EQUIPMENT

Page 10 The prices listed below are based on the use of standard components and the use of mica condensers except where current and voltage conditions dictate the use of vacuum condensers. Request quotations where special conditions or vacuum condensers are required. Normal delivery cycle is 60 days after receipt of approval of our design from the consultant engineer.

Power	Pattern	2-Tower	3-Tower	4-Tower	5-Tower
1 KW	DA-1	\$2,825.00	\$4,370.00	\$5,545.00	\$6,720.00
5 KW	DA-1	3,405.00	5,265.00	6,795.00	8,455.00
10 KW	DA-1	4,095.00	6,040.00	7,875.00	9,935.00
1-1 KW	DA-N	3,350.00	5,195.00	6,585.00	8,025.00
5-5 KW	DA-N	4,305.00	6,275.00	8,190.00	10,500.00
10-10 KW	DA-N	4,620.00	6,710.00	8,820.00	11,340.00
1-1 KW	DA-2	4,190.00	6,420.00	8,285.00	10,135.00
5-5 KW	DA-2	5,565.00	7,875.00	10,710.00	13,125.00
10-10 KW	DA-2	5,985.00	8,610.00	11,445.00	14,175.00

NOTE:

DA-1 Directional Day and Night, same pattern

DA-N Directional Night time only

DA-2 Different Pattern Day and Night

Prices are based on the use of weatherproof tuning units.

Deduct \$75.00 per tower if panel mounted tuning units are used.

Six or more towers, prices on request.

Catalog Page	Type No.	Part Number	Description	Price
-	601-48	NPN	Electronics Research Adjustable Phase Sampling Loop, Size 48 by 12 Inches	120.00
--	601-96	NPN	Electronics Research Adjustable Phase Sampling Loop, Size 96 by 12 Inches	145.00
-	13555	097 6124 000	Andrew, Hanger Adapter for Angle Leg Tower (2 required per loop)	5.00 ea.
-	13550	097 6745 000	Andrew, Hanger Adapter for Round Leg Up to 3 Inch Diameter (2 required per loop)	5.00 ea.
-	14063	NPN	Andrew, Insulator (4 per loop)	7.00 ea.
-	42W	NPN	Andrew, Plug (type "N" Male) for 3/8-Inch Sampling Line	5.50 ea.

FM TRANSMITTERS

Catalog Page	Type No.	Part Number	Description	Price
14	310Z-1	522 4687	FM Exciter	2,550.00
14	310Z-1	NPN	Semiconductors, 100% Set	186.90
14	310Z-1	NPN	Semiconductors, Recommended Set	139.35
15	786V-1	772 5336 001	Stereo FM Generator	825.00
15	786V-1	NPN	Semiconductors, 100% Set	43.90
15	786V-1	NPN	Semiconductors, Recommended Set	22.80
15	786W-1	772 5338 001	SCA Generator	495.00
15	786W-1	NPN	Semiconductors, 100% Set	19.45
15	786W-1	NPN	Semiconductors, Recommended Set	14.75
16	786M-1	522 2914 000	FM Stereo Multiplex Generator	1,575.00
18	830B-1B	777 1783	250-Watt FM Transmitter	5,200.00
18	830B-1B	NPN	Tubes, 100% Set	38.40
18	830B-1B	NPN	Semiconductors, 100% Set	268.50
18	830B-1B	NPN	Semiconductors, Recommended Set	182.35
20	830D-1B	777 1784	1-KW FM Transmitter	6,900.00
20	830D-1B	NPN	Tubes, 100% Set	181.00
20	830D-1B	NPN	Semiconductors, 100% Set	437.90
20	830D-1B	NPN	Semiconductors, Recommended Set	172.85
22	831D-1	522 4682	2-KW FM Transmitter	9,200.00
22	831D-1	NPN	Tubes, 100% Set	247.80
22	831D-1	NPN	Semiconductors, 100% Set	435.10
22	831D-1	NPN	Semiconductors, Recommended Set	233.85
24	830E-1B	777 1785	5-KW FM Transmitter	13,775.00
24	830E-1B	NPN	Tubes, 100% Set	592.90
24	830E-1B	NPN	Semiconductors, 100% Set	233.00
24	830E-1B	NPN	Semiconductors, Recommended Set	199.45
26	830F-1B	777 1786	10-KW FM Transmitter	18,847.00
26	830F-1B	NPN	Tubes, 100% Set	530.60
26	830F-1B	NPN	Semiconductors, 100% Set (does not include full set silicon plate rectifiers)	233.00
26	830F-1B	NPN	Semiconductors, Recommended Set	199.45
26	830F-2B	777 1787	10-KW FM Transmitter	21,525.00
26	830F-2B	NPN	Tubes, 100% Set	676.00
26	830F-2B	NPN	Semiconductors, 100% Set, (does not include full set silicon plate rectifiers)	402.50
26	830F-2B	NPN	Semiconductors, Recommended Set	299.35
28	830H-1B	777 1788	20-KW FM Transmitter	28,717.00
28	830H-1B	NPN	Tubes, 100% Set	1,171.00
28	830H-1B	NPN	Semiconductors, 100% Set (does not include full set silicon plate rectifiers)	662.90
28	830H-1B	NPN	Tubes, Recommended Set	676.00
28	830H-1B	NPN	Semiconductors, Recommended Set	299.35
29	830N-1B	522 3592	FM Transmitter	28,350.00
29	830N-1B	NPN	Tubes, 100% Set	1,171.00
29	830N-1B	NPN	Semiconductors, 100% Set (does not include full set silicon plate rectifiers)	662.90
29	830N-1B	NPN	Tubes, Recommended Set	676.00
29	830N-1B	NPN	Semiconductors, Recommended Set	299.35
29	NTN	554 6850 001	FM Transmitter Extended Control Panel	400.00
29	830	NPN	Spac Crystal for 830 Series	90.00
29	CLW-10K	124 0061 831	10-KW Water Cooled Load	1,200.00

FM ANTENNAS

Catalog Page	Type No.	Part Number	Description	Price
31	37M-1	013 0020 000	Single-Ring FM Antenna, 1 5/8-Inch Line	585.00
			Single-Ring FM Antenna, 3 1/8-Inch Line	635.00
31	37M-2	013 0030 000	2-Ring FM Antenna, 1 5/8-Inch Line	1,025.00
			2-Ring FM Antenna, 3 1/8-Inch Line	1,090.00
31	37M-3	013 0040 000	3-Ring FM Antenna, 1 5/8-Inch Line	1,537.00
			3-Ring FM Antenna, 3 1/8-Inch Line	1,635.00
31	37M-4	013 0050 000	4-Ring FM Antenna, 1 5/8-Inch Line	2,050.00
			4-Ring FM Antenna, 3 1/8-Inch Line	2,180.00
31	37M-5	013 0060 000	5-Ring FM Antenna, 1 5/8-Inch Line	2,562.00
			5-Ring FM Antenna, 3 1/8-Inch Line	2,725.00
31	37M-6	013 0070 000	6-Ring FM Antenna, 1 5/8-Inch Line	3,075.00
			6-Ring FM Antenna, 3 1/8-Inch Line	3,270.00
31	37M-7	013 0080 000	7-Ring FM Antenna, 1 5/8-Inch Line	3,587.00
			7-Ring FM Antenna, 3 1/8-Inch Line	3,815.00
31	37M-8	013 0090 000	8-Ring FM Antenna, 1 5/8-Inch Line	4,100.00
			8-Ring FM Antenna, 3 1/8-Inch Line	4,360.00
31	37M-9	124 0061 836	9-Ring FM Antenna, 1 5/8-Inch Line	4,612.00
31	37M-9	124 0061 837	9-Ring FM Antenna, 3 1/8-Inch Line	4,905.00
31	37M-10	124 0061 838	10-Ring FM Antenna, 1 5/8-Inch Line	5,125.00
31	37M-10	124 0061 839	10-Ring FM Antenna, 3 1/8-Inch Line	5,450.00
31	37M-11	124 0061 840	11-Ring FM Antenna, 1 5/8-Inch Line	5,637.00
31	37M-11	124 0061 841	11-Ring FM Antenna, 3 1/8-Inch Line	5,995.00
31	37M-12	124 0061 842	12-Ring FM Antenna, 1 5/8-Inch Line	6,150.00
31	37M-12	124 0061 843	12-Ring FM Antenna, 3 1/8-Inch Line	6,540.00
31	37M-13	124 0061 844	13-Ring FM Antenna, 1 5/8-Inch Line	6,662.00
31	37M-13	124 0061 845	13-Ring FM Antenna, 3 1/8-Inch Line	7,080.00
31	37M-14	124 0061 846	14-Ring FM Antenna, 1 5/8-Inch Line	7,175.00
31	37M-14	124 0061 847	14-Ring FM Antenna, 3 1/8-Inch Line	7,625.00
31	37M-15	124 0061 848	15-Ring FM Antenna, 1 5/8-Inch Line	7,687.00
31	37M-15	124 0061 849	15-Ring FM Antenna, 3 1/8-Inch Line	8,170.00
31	37M-16	124 0061 850	16-Ring FM Antenna, 1 5/8-Inch Line	8,200.00
31	37M-16	124 0061 851	16-Ring FM Antenna, 3 1/8-Inch Line	8,715.00
31	37M	NPN	Horizontal FM Antenna for Inputs over 20 KW	On Request
31	37M	124 0061 713	Deicers, Factory Installed, 300 Watt, 115 Volt, With Interbay Wiring	135.00/Bay
31	37M	124 0061 672	Replacement Heating Elements, 115 Volt, 150 Watt (2 required per bay)	30.00 ea.
31	37M/300C	124 0061 557	Fixed Antenna Power Divider for 37M/300C, 3 1/8-Inch Input and Output	525.00
33	300C-1	099 2571 000	Single-Bay Vertically Polarized FM Antenna, 1 5/8-Inch Line	585.00
33	300C-1	099 2572 000	Single-Bay Vertically Polarized FM Antenna, 3 1/8-Inch Line	635.00

33	300C-2	099 2573 000	2-Bay Vertically Polarized FM Antenna, 1 5/8-Inch Line	1,025.00
33	300C-2	099 2574 000	2-Bay Vertically Polarized FM Antenna, 3 1/8-Inch Line	1,090.00
33	300C-3	099 2575 000	3-Bay Vertically Polarized FM Antenna, 1 5/8-Inch Line	1,537.00
33	300C-3	099 2576 000	3-Bay Vertically Polarized FM Antenna, 3 1/8-Inch Line	1,635.00
33	300C-4	099 2577 000	4-Bay Vertically Polarized FM Antenna, 1 5/8-Inch Line	2,050.00
33	300C-4	099 2578 000	4-Bay Vertically Polarized FM Antenna, 3 1/8-Inch Line	2,180.00
33	300C-5	099 2579 000	5-Bay Vertically Polarized FM Antenna, 1 5/8-Inch Line	2,562.00
33	300C-5	099 2580 000	5-Bay Vertically Polarized FM Antenna, 3 1/8-Inch Line	2,725.00
33	300C-6	099 2581 000	6-Bay Vertically Polarized FM Antenna, 1 5/8-Inch Line	3,075.00
33	300C-6	099 2582 000	6-Bay Vertically Polarized FM Antenna, 3 1/8-Inch Line	3,270.00
33	300C-7	099 2583 000	7-Bay Vertically Polarized FM Antenna, 1 5/8-Inch Line	3,587.00
33	300C-7	099 2584 000	7-Bay Vertically Polarized FM Antenna, 3 1/8-Inch Line	3,815.00
33	300C-8	099 2585 000	8-Bay Vertically Polarized FM Antenna, 1 5/8-Inch Line	4,100.00
33	300C-8	099 2586 000	8-Bay Vertically Polarized FM Antenna, 3 1/8-Inch Line	4,360.00
33	300C-9	124 0061 852	9-Bay Vertically Polarized FM Antenna, 1 5/8-Inch Line	4,612.00
33	300C-9	124 0061 853	9-Bay Vertically Polarized FM Antenna, 3 1/8-Inch Line	4,905.00
33	300C-10	099 2587 000	10-Bay Vertically Polarized FM Antenna, 1 5/8-Inch Line	5,125.00
33	300C-10	099 2588 000	10-Bay Vertically Polarized FM Antenna, 3 1/8-Inch Line	5,450.00
33	300C-11	124 0061 854	11-Bay Vertically Polarized FM Antenna, 1 5/8-Inch Line	5,637.00
33	300C-11	124 0061 855	11-Bay Vertically Polarized FM Antenna, 3 1/8-Inch Line	5,995.00
33	300C-12	099 2589 000	12-Bay Vertically Polarized FM Antenna, 1 5/8-Inch Line	6,150.00
33	300C-12	099 2590 000	12-Bay Vertically Polarized FM Antenna, 3 1/8-Inch Line	6,540.00
33	300C-13	124 0061 856	13-Bay Vertically Polarized FM Antenna, 1 5/8-Inch Line	6,662.00
33	300C-13	124 0061 857	13-Bay Vertically Polarized FM Antenna, 3 1/8-Inch Line	7,085.00
33	300C-14	124 0061 858	14-Bay Vertically Polarized FM Antenna, 1 5/8-Inch Line	7,175.00

33	300C-14	124 0061 859	14-Bay Vertically Polarized FM Antenna, 3 1/8-Inch Line	7,630.00
33	300C-15	124 0061 860	15-Bay Vertically Polarized FM Antenna, 1 5/8-Inch Line	7,687.00
33	300C-15	124 0061 861	15-Bay Vertically Polarized FM Antenna, 3 1/8-Inch Line	8,175.00
33	300C-16	124 0061 862	16-Bay Vertically Polarized FM Antenna, 1 5/8-Inch Line	8,200.00
33	300C-16	124 0061 863	16-Bay Vertically Polarized FM Antenna, 3 1/8-Inch Line	8,720.00
33	300C/37M	124 0061 557	Fixed Antenna Power Divider for 300C/37M, 3 1/8-Inch Input and Output	525.00
34	37CP-1	124 0061 383	Single-Bay Circularly Polarized FM Antenna, 3 1/8-Inch Line	825.00
34	37CP-2	124 0061 385	2-Bay Circularly Polarized FM Antenna, 3 1/8-Inch Line	1,550.00
34	37CP-3	124 0061 387	3-Bay Circularly Polarized FM Antenna, 3 1/8-Inch Line	2,250.00
34	37CP-4	124 0061 389	4-Bay Circularly Polarized FM Antenna, 3 1/8-Inch Line	3,000.00
34	37CP-5	124 0061 391	5-Bay Circularly Polarized FM Antenna, 3 1/8-Inch Line	3,750.00
34	37CP-6	124 0061 393	6-Bay Circularly Polarized FM Antenna, 3 1/8-Inch Line	4,500.00
34	37CP-7	124 0061 395	7-Bay Circularly Polarized FM Antenna, 3 1/8-Inch Line	5,250.00
34	37CP-8	124 0061 397	8-Bay Circularly Polarized FM Antenna, 3 1/8-Inch Line	6,000.00
34	37CP-9	124 0061 864	9-Bay Circularly Polarized FM Antenna, 3 1/8-Inch Line	6,750.00
34	37CP-10	124 0061 399	10-Bay Circularly Polarized FM Antenna, 3 1/8-Inch Line	7,500.00
34	37CP-11	124 0061 865	11-Bay Circularly Polarized FM Antenna, 3 1/8-Inch Line	8,250.00
34	37CP-12	124 0061 401	12-Bay Circularly Polarized FM Antenna, 3 1/8-Inch Line	9,100.00

34	37CP-13	124 0061 866	13-Bay Circularly Polarized FM Antenna, 3 1/8-Inch Line	9,850.00
34	37CP-14	124 0061 403	14-Bay Circularly Polarized FM Antenna, 3 1/8-Inch Line	10,500.00
34	37CP-15	124 0061 867	15-Bay Circularly Polarized FM Antenna, 3 1/8-Inch Line	11,250.00
34	37CP-16	124 0061 405	16-Bay Circularly Polarized FM Antenna, 3 1/8-Inch Line	12,000.00
34	37CP	124 0061 469	Deicers, Factory Installed, 300 Watt, 115 Volt, With Interbay Wiring	190.00/Bay
34	37CP	124 0061 676	Replacement Heater Element, 150 Watt, 115 Volt, (2 required per bay)	60.00 ea.
34	37CP	NPN	Deicers, Factory Installed, 500 Watt, 115 Volt, With Interbay Wiring	200.00/Bay
34	37CP	124 0061 868	Replacement Heater Element, 250 Watt, 115 Volt, (2 required per bay)	65.00 ea.
-	C22B	124 0032 415	Temperature Control, 15 A, 115 Volts	62.00
-	NTN	NPN	36-Inch Antenna Extenders (purchased with antenna)	10.00/Bay
-	NTN	NPN	36-Inch Antenna Extenders (purchased separately)	25.00/Bay
-	37M/300C	NPN	Intermix 1 to 2 Horizontal and Vertical Bays	300.00
-	37M/300C	NPN	Intermix 3 to 6 Horizontal and Vertical Bays	450.00
-	37M/300C	NPN	Intermix 7 to 16 Horizontal and Vertical Bays	750.00
-	37M	NPN	Charge for First Null Fill	425.00
-	37M	NPN	Charge for Beam Tilt	860.00
-	300C	NPN	Charge for First Null Fill 2 to 12 Bays	550.00
-	300C	NPN	Charge for First Null Fill 13 to 16 Bays	600.00
-	300C	NPN	Charge for Beam Tilt 2 to 12 Bays	190.00
-	300C	NPN	Charge for Beam Tilt 13 to 16 Bays	205.00
-	37CP	NPN	Charge for First Null Fill	450.00
-	37CP	NPN	Charge for Beam Tilt	300.00
-	402	124 0032 465	Electronics Research AM/FM Isolation Unit, 10- KW FM, 3-KV AM, 1 5/8-Inch Line	885.00
-	402	124 0061 016	Electronics Research AM/FM Isolation Unit, 10- KW FM, 3-KV AM, 3 1/8-Inch Line	1,080.00
-	425	124 0061 613	Electronics Research AM/FM Isolation Unit, 25- KW FM, 3-KV AM	2,550.00

TOWERS AND ACCESSORIES

Catalog Page	Type No.	Part Number	Description	Price
35	NTN	NPN	Antenna Towers	On Request
35	NTN	421 1010 000	No. 10, Copper Ground Wire (31.8 ft/lb)	On Request
35	NTN	097 1445 00	2-Inch by 0.032-Inch Copper Ground Strap (4.02 ft/lb)	On Request
35	NTN	099 2689 00	3-Inch by 0.032-Inch Copper Ground Strap (3.01 ft/lb)	On Request
35	NTN	097 0811 00	4-Inch Copper Ground Strap (2.01 ft/lb)	On Request
11	NTN	522 3927 000	2-Wire, 2000-Watt Tower Lighting Choke	150.00
11	NTN	522 3926 000	3-Wire, 2000-Watt Tower Lighting Choke	170.00
35	TI-2017	097 6920 00	Hughes & Phillips Ring Transformer, 1750 Watts	320.00
35	TI-2035	099 0365 00	Hughes & Phillips Ring Transformer, 3500 Watts	375.00
35	NTN	013 0107 00	Truscon Mesh Ground Screen 8 Feet by 24 Feet	On Request
35	63305-DB	124 0032 559	Fisher-Pierce Beacon Light Control	40.50
35	NTN	782 0009 001	1 5/8-Inch Transmission Line Kit	794.00
35	NTN	782 0008 001	3 1/8-Inch Transmission Line Kit	1,513.00

AUDIO EQUIPMENT

Catalog Page	Type No.	Part Number	Description	Price
37	212S-1	522 3880 001	Stereo Speech Input Console	4,230.00
37	212S-1	522 3880 710	Dual-Channel Speech Input Console	3,950.00
38	260S-1	522 3882 001	Mixer Add-on Unit	910.00
39	212M-1	522 3879 001	Speech Input Console	2,640.00
40	356T-1	522 3885 001	Preamplifier	94.50
40	356V-1	522 3887 001	High-Level Input Preamplifier	97.00
41	356P-1	522 3884 001	Program Amplifier	110.00
41	356M-1	522 3883 001	Monitor Amplifier	122.00
42	356R-1	758 5486 001	Microphone-Phonograph Preamplifier	125.00
42	356U-1	772 5273 001	Broadcast Audio Preamplifier	130.00
43	384D-1	522 3888 001	Switch Matrix	90.00
43	409Z-1	522 3886 001	Power Supply	415.00
44	212T-1	772 5108	Audio Control Console	9,950.00
44	212T-2	772 5109	Audio Control Console	9,950.00
46	212J-1	777 1428 001	Broadcast Audio Console	950.00
46	212J-1	221 0036 020	12-Volt Battery	63.00
48	26U-1	522 0966 00	Limiting Amplifier	550.00
48	26U-1	NPN	Tubes, 100% Set	15.00
49	26U-2	522 3237 00	Stereo Limiting Amplifier	997.00
49	26U-2	NPN	Tubes, 100% Set	30.00

50	TT-900	124 0032 011	12-Inch Turntable	185.00
50	TT-400	097 3736 00	16-Inch, 4-Pole Motor Turntable	199.50
50	TT-400S	097 3737 00	16-Inch, Synchronous Motor Turntable	235.00
50	TT-450S	097 6286 00	16-Inch, Synchronous Motor, 50-Hz Turntable	275.00
50	TT-200	097 3971 00	12-Inch, 4-Pole Motor Turntable	130.00
50	TT-200S	097 3811 00	12-Inch, Synchronous Motor Turntable	152.50
50	TT-250S	097 6285 00	12-Inch, Synchronous Motor, 50 Hz Turntable	165.00
50	NTN	097 8123 00	Rubber Pad to Fill Turntable Indentation for TT-400/200 Series	3.50
50	NTN	097 7235 00	220-Volt to 115-Volt Stepdown Transformer, 150 Watts	8.80
50	TCW-9Q	124 0032 228	TT-900 Turntable Cabinet	110.00
50	TCW-2Q	124 0032 230	TT-200 Turntable Cabinet	110.00
50	TCW-4Q	124 0032 229	TT-400 Turntable Cabinet	110.00
51	356H-1	522 2468 000	Phono Preamplifier	121.00
51	208-S	099 0387 000	16-Inch Gray Playback Arm	67.00
51	208-SG	099 0164 000	16-Inch Gray Playback Arm	67.00
51	8-SG	099 0837 000	Slide Mount for 208-SG Playback Arm	4.55
52	206-S	124 0061 222	12-Inch Gray Playback Arm	67.00
52	206-SG	124 0061 223	12-Inch Gray Playback Arm	67.00
52	303	124 0061 741	12-Inch Gray Playback Arm	72.50
52	306	124 0061 775	16-Inch Gray Playback Arm	82.50
53	M44-7	099 3018 000	Shure Phonograph Cartridge with 0.0007-Inch Needle	19.95
53	M44-7	124 0032 301	Shure Phonograph Cartridge With 0.001-Inch Needle	19.95
53	N44-7	124 0032 302	Shure 0.0007-Inch Needle Assembly	9.75
53	N44-1	124 0032 303	Shure 0.001-Inch Needle Assembly	9.75
53	M44-5	NPN	Shure Phonograph Cartridge With 0.0005-Inch Needle	27.50
54	M232	097 8118 00	12-Inch Shure Playback Arm	29.95
54	M236	097 8122 00	16-Inch Shure Playback Arm	31.95
54	S-260	099 0242 000	16-Inch Rek-O-Kut Playback Arm (less balance weight)	39.95
54	S-320	099 0241 000	12-Inch Rek-O-Kut Playback Arm (with balance weight)	34.95
54	S-260	124 0032 094	Balanec Weight for S-260	2.50
54	PS20-L	124 0032 549	Cartridge Shell	4.95
54	642E-1	777 1427 001	Monaural Twintape Playback Unit	1,450.00
54	642E-2	777 1423 001	Stereo Twintape Playback Unit	1,650.00
54	642E	774 7330 001	Cue Detector	100.00
54	642E	770 5625 001	Rack Adapter	20.00
55	216D-1	758 5726 001	Monaural Record Amplifier	440.00
55	216D-2	777 1391 001	Stereo Record Amplifier	650.00
55	216D	774 7528 001	Cue Oscillator	125.00

55	216D	770 5593 001	Rack Adapter	12.00
56	TCR-1Q	124 0032 300	Tape Cartridge Rack	52.50
56	NTN	097 7559 00	ABCO Lazy Susan Cartridge Rack	267.00
56	NTN	097 7560 00	ABCO Wire Cartridge Rack	23.00
56	MM-151	099 2629 000	Automatic Programming Bulk Recording Tapc, 1700 Feet	7.07
56	300 Series	124 0032 057	40-Second Cartridge, Box 6	12.96
56	300 Series	124 0032 058	70-Second Cartridge, Box 6	13.68
56	300 Series	124 0032 059	90-Second Cartridge, Box 6	14.16
56	300 Series	124 0032 060	100-Second Cartridge, Box 6	14.40
56	300 Series	124 0032 061	2 1/2-Minute Cartridge, Box 6	15.24
56	300 Series	124 0032 062	3-Minute Cartridge, Box 6	15.84
56	300 Series	124 0032 063	3 1/2-Minute Cartridge, Box 6	16.44
56	300 Series	124 0032 064	5-Minute Cartridge, Box 6	18.12
56	300 Series	124 0032 090	5 1/2-Minute Cartridge, Box 6	18.84
56	300 Series	124 0032 065	7 1/2-Minute Cartridge, Box 6	21.12
56	300 Series	124 0032 066	10-Minute Cartridge, Box 6	23.76
56	300 Series	124 0032 067	10 1/2-Minute Cartridge, Box 6	24.72
56	600 Series	124 0032 068	11-Minute Cartridge, Box 2	11.32
56	600 Series	124 0032 069	13 1/2-Minute Cartridge, Box 2	12.40
56	600 Series	124 0032 070	15-Minute Cartridge, Box 2	13.10
56	600 Series	124 0032 071	16-Minute Cartridge, Box 2	13.52
56	1200 Series	124 0032 072	31-Minute Cartridge, Box 2	23.80
57	300 Series	124 0032 073	Blank Cartridge, Box 6	10.20
57	600 Series	124 0032 074	Blank Cartridge, Box 2	5.64
57	1200 Series	124 0032 075	Blank Cartridge, Box 2	8.48
57	NTN	097 6076 00	Test Tape (for 642A-1/2 only)	6.00
57	111A-12	272 1407 00	Tape, 1200 Feet on 7-Inch Reel	2.34
57	150-18	097 7112 00	Tape, 1800 Feet, Mylar, 7-Inch Reel	4.13
57	190-181	099 0040 00	Tape, 1800 Feet, Plastic, 7-Inch Reel	3.67
57	ST-500	124 0032 544	Robins Bulk Splicing Tape	1.35
57	TS-8D	124 0032 178	Robins Splicer-Cutter	8.60
57	NTN	554 2632 002	Head Alignment Gauge (penetration gauge for 642A-1/2 only)	10.00
57	NTN	554 2635 002	Head Alignment Gauge (height gauge for 642A-1/2 only)	5.00
57	NTN	094 2546 00	Replacement Pressure Pads, Box 50	7.50
57	200C	097 5172 00	Magneraser Tape Eraser	18.00
57	HD-11M	099 0371 00	Microtran Tape Eraser	18.95
57	HD-11-AD	124 0032 839	Microtran Tape Eraser (10 1/2-Inch Reel Adapter)	3.10
58	280	NPN	Scully Recorder/Reproducer, Full Track, 1/4-Inch, Rack Mtg.	1,975.00
58	280-1	NPN	Scully Recorder/Reproducer, 1/2-Track, 1/4-Inch, Rack Mtg.	1,975.00
58	280-2	124 0032 473	Scully Stereo Record/Reproducer, 1/4-Inch, 2- Channel, Rack Mtg.	2,465.00

58	280	124 0061 884	Scully Console, 1 and 2 Track	280.00
58	280	124 0061 883	Scully Remote Control, 30-Foot Cable	80.00
58	SX811	NPN	Crown Monaural, Full Track, Recorder/Reproducer	1,395.00
58	SX822	NPN	Crown Two-Track, Stereo, Recorder/Reproducer	1,495.00
59	1021X	124 0032 185	Magnecord Recorder/Reproducer 3 3/4 - 7 1/2 ips, Catalog 91E6190-1	708.00
59	1021X	124 0061 159	Magnecord Recorder/Reproducer 7 1/2 - 15 ips, Catalog 91E6190-33	743.00
59	1028-2X	099 3013 000	Magnecord Recorder/Reproducer Stereo, 7 1/2 - 15 ips, Catalog A91A9808-2	1,095.00
59	1022X	124 0032 375	Magnecord Recorder/Reproducer Stereo, 7 1/2 - 15 ips, Catalog 91E6190-2	788.00
-	1021/1022/ 1024	124 0032 723	Transport Carrying Case, Catalog A81D128-2	40.00
-	1021/1022/ 1024	124 0032 724	Amplifier Carrying Case, Catalog A81D129-2	40.00
60	AG-440-1	NPN	Record/Reproducer, 7 1/2 - 15 ips, Full Track, 60 Hz, Rack Mtg., No. 4010071-01	1,970.00
60	AG-440-1	NPN	Record/Reproducer, 7 1/2 - 15 ips, Full Track, 50 Hz, Rack Mtg., No. 4010071-02	1,970.00
60	AG-440-1	NPN	Record/Reproducer, 7 1/2 - 15 ips, Full Track, 60 Hz, Console, No. 4010071-03	2,350.00
60	AG-440-1	NPN	Record/Reproducer, 7 1/2 - 15 ips, Full Track, 50 Hz, Console, No. 4010071-04	2,350.00
60	AG-440-1	124 0061 687	Record/Reproducer, 7 1/2 - 15 ips, Full Track, 60 Hz, Portable, No. 4010071-05	2,110.00
60	AG-440-1	NPN	Record/Reproducer, 7 1/2 - 15 ips, Full Track, 50 Hz, Portable, No. 4010071-06	2,110.00
60	AG-440-2	NPN	Record/Reproducer, 7 1/2 - 15 ips, Two Track, 60 Hz, Rack Mtg., No. 4010072-01	2,640.00
60	AG-440-2	NPN	Record/Reproducer, 7 1/2 - 15 ips, Two Track, 50 Hz, Rack Mtg., No. 4010072-02	2,640.00
60	AG-440-2	NPN	Record/Reproducer, 7 1/2 - 15 ips, Two Track, 60 Hz, Console, No. 4010072-03	3,020.00
60	AG-440-2	NPN	Record/Reproducer, 7 1/2 - 15 ips, Two Track, 50 Hz, Console, No. 4010072-04	3,020.00
60	AG-440-2	NPN	Record/Reproducer, 7 1/2 - 15 ips, Two Track, 60 Hz, Portable, No. 4010072-05	2,780.00
60	AG-440-2	NPN	Record/Reproducer, 7 1/2 - 15 ips, Two Track, 50 Hz, Portable, No. 4010072-06	2,780.00
60	AG-440	NPN	Other Models	On Request
60	AA-620	124 0061 817	20-Watt, Amplifier/Speaker, Portable, 50/60 Hz, No. 4010070-01	239.00
60	AA-620	NPN	20-Watt, Amplifier/Speaker, Rack Mtg. 50/60 Hz, No. 4010070-02	209.00
61	AG-600-1	124 0061 807	Record/Reproducer, 3 3/4 - 7 1/2 ips, Full Track, 60 Hz, Unmounted, No. 4010063-01	660.00

61	AG-600-1	NPN	Record/Reproducer, 3 3/4 - 7 1/2 ips, Full Track, 50 Hz, Unmounted, No. 4010063-05	660.00
61	AG-600-1	124 0061 808	Record/Reproducer, 3 3/4 - 7 1/2 ips, Full Track, 60 Hz, Portable, No. 4010063-02	720.00
61	AG-600-1	NPN	Record/Reproducer, 3 3/4 - 7 1/2 ips, Full Track, 50 Hz, Portable, No. 4010063-06	720.00
61	AG-600-2	124 0061 809	Record/Reproducer, 3 3/4 - 7 1/2 ips, Two Track, 60 Hz, Unmounted, No. 4010064-01	915.00
61	AG-600-2	NPN	Record/Reproducer, 3 3/4 - 7 1/2 ips, Two Track, 50 Hz, Unmounted, No. 4010064-05	915.00
61	AG-600-2	124 0061 812	Record/Reproducer, 3 3/4 - 7 1/2 ips, Two Track, 60 Hz, Portable, No. 4010064-02	1,010.00
61	AG-600-2	NPN	Record/Reproducer, 3 3/4 - 7 1/2 ips, Two Track, 50 Hz, Portable, No. 4010064-06	1,010.00
61	AG-600-1	124 0061 815	Rack-Mount Adapters, No. 4010078-01	21.00
61	AG-600-2	124 0061 816	Rack Mount Adapters, No. 4010079-01	29.00
61	AG-600	124 0061 824	Plug-in Microphone Preamplifier, No. 4010066-01	55.00
61	AG-600	124 0061 825	Phono Preamplifier (RIAA) Magnetic, No. 4010097-01	50.00
61	AG-600	124 0061 826	Balanced Bridge Line Input Transformer, No. 4580200-01	20.00
61	AG-600	124 0061 827	Line Matching Input Transformer, No. 4580200-02	20.00
61	AG-600	NPN	Other Models	On Request
61	AG-500-1	NPN	Record/Reproducer, 7 1/2 - 15 ips, Full Track, 60 Hz, No. 4010048-02, Unmounted	1,202.00
61	AG-500-1	NPN	Record/Reproducer, 7 1/2 - 15 ips, Full Track, CCIR, Equalization, 50 Hz, No. 4010048-18 Unmounted	1,259.00
61	AG-500-1	NPN	Record/Reproducer, 7 1/2 - 15 ips, Two Track, 60 Hz, Portable, No. 4010048-1	1,294.00
61	AG-500-2	NPN	Record/Reproducer, 7 1/2 - 15 ips, Two Track, 60 Hz, Unmounted, No. 4010049-02	1,432.00
61	AG-500-2	NPN	Record/Reproducer, 7 1/2 - 15 ips, Two Track, 50 Hz, Unmounted, No. 4010049-26	1,489.00
61	AG-500-4	NPN	Record/Reproducer, 3 3/4 - 7 1/2 ips, 4 Track, 60 Hz, Unmounted, No. 4010049-08	1,432.00
61	AG-500-4	NPN	Record/Reproducer, 3 3/4 - 7 1/2 ips, 4 Track, 50 Hz, Unmounted, No. 4010049-20	1,489.00
61	AG-500	NPN	Portable Case, Single Channel, No. 4150161-06	100.00
61	AG-500	NPN	Portable Case, Two Channel, No. 4150231-01	105.00
61	AG-500	NPN	Other Models	On Request

AUDIO ACCESSORIES

Catalog Page	Type No.	Part Number	Description	Price
63	M-20	097 5464 00	Microphone	36.00
63	NTN	097 6627 00	Replacement Lavalier Clip for M-20	0.50
63	NTN	097 5826 00	Desk Stand for M-20	3.50
63	NTN	097 0870 00	Replacement Cord and Clip	3.00
63	M-40	097 5463 00	Microphone	72.50
63	M-70	099 2402 000	Microphone	57.50
64	SM5A	124 0032 551	Shure Microphone	225.00
64	SM5B	124 0032 552	Shure Microphone	225.00
64	SM33	124 0032 533	Shure Microphone	129.00
64	SM50	124 0032 554	Shure Microphone	75.00
65	SM300	124 0032 555	Shure Microphone	90.00
65	M-20	097 5826 00	M-20 Microphone Desk Stand	3.50
65	DS-7	097 1119 00	Atlas Microphone Desk Stand	3.53
66	BS-36	097 1500 000	Atlas Boom Stand	45.00
66	BS-36W	097 1790 000	Atlas Boom Stand	51.00
66	BB-1	097 0984 00	Atlas Microphone Boom	5.55
66	MS-11C	097 1511 00	Atlas Floor Stand	9.15
66	MS-10C	097 5729 00	Atlas Floor Stand	6.90
66	MS-25	097 1510 00	Atlas Floor Stand	18.60
66	FM-1	097 1499 00	Flexo Mikester	17.50
67	CS-12	124 0032 017	Loudspeakers	19.80
-	LS12A	124 0061 907	Electro-Voice, 12-Inch, 20-Watt, 8-Ohm Loudspeaker	19.80
67	A-3818	099 2686 000	Stancor A-3818 Speaker Transformer, 500/1000/1500-Ohm Prim. 4/8/15-Ohm Sec, 25 Watts	4.75
67	NTN	NPN	Frazier Manhattan Loudspeakers	On Request
67	P12-T	097 2119 00	Jensen Speaker	7.08
67	ST-276	124 0032 123	Jensen Level Controls	2.95
67	NTN	097 3192 000	Miratel Air Alert	169.95
68	SCB-8D	099 2374 00	Argos Baffle (walnut finish)	8.60
68	SCB-8D	099 2375 00	Argos Baffle (blonde finish)	8.60
68	SCB-12D	099 2376 00	Argos Baffle (walnut finish)	12.05
68	SCB-12D	099 2377 00	Argos Baffle (blonde finish)	12.05
68	WB-8D	124 0032 295	Argos Baffle (walnut finish)	4.40
68	WB-8D	124 0032 296	Argos Baffle (blonde finish)	4.40
68	WB-12D	124 0032 297	Argos Baffle (walnut finish)	6.05
68	WB-12D	124 0032 298	Argos Baffle (blonde finish)	6.05
68	156	273 0003 00	Trimm Headphones, 600 Ohms	15.75
68	157	273 0004 00	Trimm Headphones, 17,000 Ohms	15.75
68	BA-206	099 0495 00	Brush Headphones, 50 K	30.90
68	BA-200-1	099 2488 000	Brush Headphones (45,000 ohm with plug)	17.25
68	BA-200-2	099 2489 000	Brush Headphones (45,000 ohm with eyelet terminals)	17.25
68	NTN	361 0010 00	6-Inch Patch Cord	7.85
68	NTN	361 0011 00	12-Inch Patch Cord	7.95
68	NTN	361 0012 00	24-Inch Patch Cord	8.25
68	NTN	361 0013 00	36-Inch Patch Cord	8.50
68	NTN	361 0014 00	48-Inch Patch Cord	8.75
68	NTN	361 0015 00	60-Inch Patch Cord	9.00
68	NTN	361 0016 00	120-Inch Patch Cord	10.25
68	NTN	097 3561 00	Trimm Jack Panel (12 pair, single row)	27.00

68	NTN	097 4200 00	Trimm Jack Panel (24 pair, double row)	50.00
69	8451	124 0032 961	Shielded Wire, 2 Conductor No. 22	4.05/100 Ft 16.50/500 Ft
69	8738	097 6029 00	Shielded Wire, 2 Conductor No. 22	0.04/Ft
69	8422	097 1142 00	Microphone Cable (in lengths of less than 100 feet)	0.08/Ft
			More Than 100 Feet	0.07/Ft
69	8412	425 0250 00	Microphone Cable (in lengths of less than 100 feet)	0.11/Ft
			More Than 100 Feet	0.10/Ft
-	NTN	425 0061 000	Shielded Pair Wire, No. 16	0.10/Ft
-	NTN	425 0151 000	Shielded Pair Wire, No. 12	0.14/Ft
69	427-6	097 6282 00	Trimm Terminal Board	9.50
69	CR-1773-B	099 2474 000	Bud Rack Cabinets (22 inches W, 76 inches H, 17 1/8 inches D)	125.00
69	CR-1772	124 0032 949	Bud Rack Cabinet (22 inches W, 69 inches H, 17 1/8 inches D) for use with 820E/F transmitter	150.00
69	NTN	502 8389 123	Rack Cabinet Blank Panels (1 3/4 inches, 4.45 cm)	5.50
69	NTN	502 8393 113	Rack Cabinet Blank Panels (3 1/2 inches, 8.89 cm)	6.50
69	NTN	502 8397 123	Rack Cabinet Blank Panels (5 1/4 inches, 13.34 cm)	7.50
69	NTN	502 8401 113	Rack Cabinet Blank Panels (7 inches, 17.78 cm)	8.50
69	NTN	502 8405 113	Rack Cabinet Blank Panels (8 3/4 inches, 22.23 cm)	9.50
69	NTN	502 8409 123	Rack Cabinet Blank Panels (10 1/2 inches, 26.67 cm)	11.00
69	NTN	502 8413 113	Rack Cabinet Blank Panels (12 1/4 inches, 31.12 cm)	12.50
69	NTN	502 8417 113	Rack Cabinet Blank Panels (14 inches, 35.56 cm)	14.00
69	1H1612	097 1735 00	Telechron Studio Clock	13.95
70	P3-CG-11S	370 2180 00	Cannon Female Cable Plug	7.85
70	P3-CG-12S	370 2190 00	Cannon Male Cable Plug	7.20
70	P3-13	370 2060 00	Cannon Female Panel Receptacle	5.75
70	P3-14	370 2090 00	Cannon Male Panel Receptacle	4.75
70	P3-35	370 2150 00	Cannon Single Female Wall Receptacle	9.60
70	P3-35-2G	370 2170 00	Cannon 2-Gang Female Wall Receptacle	Discontinued
70	XLR-3-11C	097 5372 00	Cannon Female Cable Plug	1.45
70	XLR-3-11SC	097 5371 00	Cannon Female Cable Plug With Latch-lock Cable Clamp	4.55
70	XLR-3-12C	097 5370 00	Cannon Male Cable Plug	1.25
70	XLR-3-12SC	097 5369 00	Cannon Male Cable Plug With Latch-lock Cable Clamp	3.50
70	XLR-3-13	097 5368 00	Cannon Female Panel Receptacle, Flush Mount	2.05
70	XLR-3-13N	097 5367 00	Cannon Female Panel Receptacle With Lock Nut	2.80
70	XLR-3-14	097 5366 00	Cannon Male Panel Receptacle, Flush Mount	0.95
70	XLR-3-14N	097 5365 00	Cannon Male Panel Receptacle With Lock Nut	2.25
70	XLR-3-35	097 5364 00	Cannon Single-Gang Female Wall Receptacle	5.25
70	XLR-3-35-2G	097 5363 00	Cannon 2-Gang Female Wall Receptacle	9.65
70	XLR-3-36	097 5362 00	Cannon Single-Gang Male Wall Receptacle	3.90
70	XLR-3-36-2G	097 5361 00	Cannon 2-Gang Male Wall Receptacle	8.35

REMOTE EQUIPMENT

Catalog Page	Type No.	Part Number	Description	Price
72	212H-1	522 2419 00	Remote Amplifier (includes batteries)	375.00
73	M-30-B	099 1571 000	Marti 30-Watt Transmitter With 117-VAC Power Supply	575.00
73	M-30-B/TPS	099 1572 000	Marti 30-Watt Transmitter With 12.6-VDC and 117-VAC Power Supply	625.00
73	M-25C	099 2699 000	Marti 25-Watt Base Station Transmitter, Communication Quality, 117-VAC Operation	425.00
74	M-25C/MR30/150/170	NPN	Broadcast Quality Receiver, 117-VAC Operation	650.00
74	Pigtail	099 0849 000	4 Feet R8/UW PL 259 Connectors Attached	2.95
			Each Additional Foot of Cable	0.60/Ft
74	XT-1	099 2383	Spare Crystal for M-30-B and M-3-60C Transmitter	8.50
74	DFT	099 0555 008	Dual Frequency Kit for M-30-B Transmitter, Less Crystal	25.00
74	MR-30/150-170	099 2638 000	152 to 172 MCS Marti Rack Mounting Receiver	375.00
74	MR-50/150-450	NPN	12.6-VDC Mobile Receiver Communication Quality	250.00
74	XR-1	099 2384	Spare Crystal for 11RS-2R, RA-150, & MR-30/150-170 Receivers	14.00
74	DFR	NPN	Dual Frequency Kit for MR-30/150-170 & MR-25/150-170C Less Crystal	25.00
74	TPS-1	097 6653 000	Power Supply	89.50
74	TPS-TC	099 0541 000	Mobile Assemblage	35.00
74	RMC-1C	099 0542 000	Marti Remote Control Console	172.50
74	PA-1	097 6952 000	Portable Single-Ring Antenna	19.95
74	MA-1	097 6953	Mobile Single-Ring Antenna	19.95
74	RA-2	099 0543	Two-Ring Antenna	60.00
74	RA-4	097 6950 000	Four-Ring Antenna	131.75
74	P-1	099 0588 000	Marti Bridging Pad	4.00
74	MA-100	099 1884 000	Marti FM Final Amplifier 100 Watts for 88 to 108 MHz (specify frequency)	675.00
74	YC-153	097 8135	Five-Element Yagi Antenna 152.80-153.40	29.95
74	YC-161	099 0179	Five-Element Yagi Antenna 161.30-161.90	29.95
74	YC-166	099 0758	Five-Element Yagi Antenna 159.95-166.55	29.95
74	YC-170	099 0177	Five-Element Yagi Antenna 169.85-170.45	29.95
74	ASP-143	097 6880 000	Antenna Bumper Mount	7.95
74	2YC	099 0190	Coaxial Stacking Harness for Two YC Antennas	11.25
74	SC-155	124 0032 885	Vertically Polarized Antenna	114.50
74	SC-155-B	099 0544	Kreko Vertically Polarized Antenna, Same as Above but Brass	154.00
74	ASP-177	099 0545	Vertical Rooftop Antenna, ASPR-177	25.90
74	NTN	099 0146 00	100 Feet RG 8/U With Connectors	13.00
74	NTN	099 0137	100 Feet RG 17/U With Connectors	60.00
74	NTN	099 0546 000	83-JSP Connector	0.75
74	NTN	099 0547 000	83-I J-Adapter	1.20
74	NTN	099 0548 000	GR 6355 Adapter	9.50

MEASURING, MONITORING, REMOTE CONTROL

Catalog

Page	Type No.	Part Number	Description	Price
76	900C-3	758 5812 001	FM Stereo Modulation Monitor	2,500.00
77	54Z-1	758 5605 003	AM Frequency Monitor	1,300.00
78	54N-1	758 5742 004	FM Frequency Monitor	1,410.00
79	506B-1	124 0061 032	Metron Amplitude Modulation Monitor	550.00
-	-	124 0032 294	Remote Meter for 506B-1	67.00
80	F1M-135	124 0032 914	Nems-Clarke Field Intensity Meter	950.00
80	112	NPN	Nems-Clarke Phase Monitor, 2 Tower	1,395.00
-	112	NPN	Meter for Additional Tower	50.00
81	RC-2400D	124 0061 694	Rust Pushbutton DC Remote Control System	2,290.00
-	RC-2400F	NPN	Rust Microwave/Voice Line Remote Control System	2,290.00
81	RC-1000DC	NPN	Rust Remote Control	890.00
-	3B	124 0061 597	Rust Antenna Current Unit	85.00
-	4B	097 2482 000	Rust 2S-A Latching Relay DPNO	35.00
-	5A-1	124 0061 597	Rust Tower Lighting Unit	85.00
-	6A	124 0061 601	Rust AC Potential Unit 115/230V	65.00
-	7A	NPN	Rust 5 to 60-A AC Current Unit	40.00
-	8A-1	NPN	Rust 0 to 2500 VDC Metering Unit	40.00
-	8B-1	124 0061 346	Rust 2500 to 5000 VDC Range Extension Unit	40.00
-	8C-1	124 0061 347	Rust 1-MA Meter Sampling Resistor Unit	10.00
-	9A-1	097 2016 000	Rust 300-MA DC Current Unit	20.00
-	9B-1	097 2017 000	Rust 600-MA DC Current Unit	20.00
-	9C-1	097 2018 000	Rust 1200-MA DC Current Unit	35.00
-	9D-1	097 2019 000	Rust 2400-MA DC Current Unit	35.00
-	10B	124 0061 700	Rust Rotary Tuning Motor	110.00
-	13B	124 0061 598	Rust, Marion Auxiliary Two-Meter Panel "Modulation" and "Frequency"	95.00
-	14C-3	NPN	Rust AM Monitor Preamplifier	540.00
-	15C-3	124 0061 763	Rust FM Monitor Preamplifier	540.00
-	31B	124 0061 600	Rust Temperature Indicator	45.00
82	PBR-21	NPN	Moseley Transmitter Remote Control System	1,865.00
82	WRC-10T	124 0061 026	Moseley Transmitter Remote Control System	910.00
-	RMK-1	NPN	Moseley Tuning Motor	82.50
-	TLK-1	124 0061 290	Moseley Tower Light Sampling Kit	30.00
-	LVK-1	124 0061 364	Moseley Line Voltage Sampling Kit 120 VAC and 240 VAC	30.00
-	PVK-1*	NPN	Moseley Plate Voltage Sampling Kit	30.00
-	MBB-1*	124 0061 635	Moseley Universal Plate Circuit (I_p or E_{bb}) Sampling Kit	90.00
-	RFK-1	124 0061 654	Moseley AM RF Transmission Line Voltage Sampling Kit	38.00
-	RFK-2	124 0061 303	Moseley FM RF Transmission Line Voltage Sampling Kit for 3 1/8-Inch Line	38.00
-	RFK-3	124 0061 340	Moseley FM RF Transmission Line Voltage Sampling Kit for 1 5/8-Inch Line	38.00
-	TSK-1	124 0061 365	Moseley Temperature Sensing Kit	30.00
-	1077-2	124 0061 205	Moseley Frequency and Modulation Remote Meter Panel	90.00

*Specify normal voltage, current, or frequency when ordering.

DOMESTIC SALES OFFICES

Collins Radio Company
Broadcast Marketing
Dallas, Texas 75207
Telephone: Area Code 214 235-9511

K. A. Blake
Collins Radio Company
13601 East Whittier Blvd., #210
Whittier, California 90605
Telephone: 213-693-5412



Arizona, Hawaii, California (South of San Jose and Highway 50), Nevada (South of Highway 50), Utah (Southern Half)

T. S. Butler
Collins Radio Company
Route 1, Box 124-I
Broken Arrow, Oklahoma 74012
Telephone: 918-251-8894



Colorado, Wyoming, Nebraska, Oklahoma, Kansas, Kansas City, Mo.

R. C. Evans
P. O. Box 8026
Jackson, Mississippi 39204
Telephone: 601-939-4220



Alabama, Arkansas, Louisiana, Mississippi, Florida (West of Highway 231), Memphis, Tennessee (Shelby County)

J. L. Littlejohn
12708 Myrtle Circle
Hopkins, Minnesota 55343
Telephone: 612-935-7011



Michigan (North and West of Lake Michigan), Minnesota, Wisconsin, North Dakota, South Dakota, Iowa (North of Highway 20)

R. O. Looper
Collins Radio Company
423 First National Bank Building
Peoria, Illinois 61602
Telephone: 309-673-7325



Illinois, Iowa (South of Highway 20), Indiana (West and South of a line bounded by Highway 49 South to 30, East to 31, South to 40 and East to Ohio including Indianapolis and Richmond), Missouri (except Kansas City), Kentucky (West of Highway 75)

J. D. Miller
103 Rose Place
Neptune Beach, Florida 32050
Telephone: 904-246-1041



Georgia, Florida (East of Highway 231 excluding Panama City)

R. J. Henry
Route 2
Grabill, Indiana 46741
Telephone: 219-627-5111



Ohio, Michigan (South and East of Lake Michigan), Indiana (East and North of a line bounded by Highway 49 South to 30, East to 31, South to 40 and East to Ohio)

J. L. Humphreys
11623 Vantage Hill Road, Unit 12C
Reston, Virginia 22070
Telephone: 703-471-7449



Delaware, District of Columbia, Maryland, Pennsylvania, West Virginia (East and North of Highway 77/64), Virginia (North and East of a line from Princeton, West Virginia to Danville, Virginia)

L. H. Leggett
Collins Radio Company
245 Park Avenue
New York, New York 10017
Telephone: 212-661-6530



Maine, New Hampshire, Massachusetts, Rhode Island, Connecticut, New Jersey, New York, Vermont

W. J. Monroe
Collins Radio Company
4933 Papaya Dr.
Fair Oaks, California 95628
Telephone: 916-961-1142



Alaska, Idaho, Montana, Oregon; Washington, California (North of San Jose and Highway 50), Nevada (North of Highway 50), Utah (North of Highway 50, 189 to 40 and 40 East to Wyoming)

J. H. Speck
Collins Radio Company
Dallas, Texas 75207
New Mexico, Texas



J. F. Stanbery
P. O. Box 748
Gallinburg, Tennessee 37738
Telephone: 615-436-5497



North Carolina, South Carolina, Kentucky (East of Interstate Highway 75), Virginia (West and South of a line from Princeton, West Virginia to, but excluding Danville, Virginia), West Virginia (West and South of Highway 77 from Princeton to Charleston and South of 44 from Charleston to Huntington but excluding Charleston and Princeton), Tennessee (Memphis)

SPECIAL CONSULTANT
A. P. Walker
Collins Radio Company
Rosslyn Plaza
1611 North Kent Street
Arlington, Virginia 22209
Telephone: 703-524-9503



INTERNATIONAL SALES OFFICES

Collins Radio Company
International Region
Dallas, Texas 75207
AREA CODE: 214 PHONE: 235-9511
CABLE: COLINRAD DALLAS
TELEX: 073307

Collins Radio International, Inc.
Latin America Sales
Dallas, Texas 75207
AREA CODE: 214 PHONE: 235-9511
CABLE: COLINRAD DALLAS
TELEX: 073307

Collins Radio International, Inc.
Latin America Sales
P. O. Box 927
Miami, Florida 33148
AREA CODE: 305 PHONE: 887-4393
CABLE: COLINRAD MIAMI, FLORIDA
TELEX: 051514

Collins Radio Company of Canada, Ltd.
150 Bartley Drive
Toronto 16, Ontario, Canada
AREA CODE: 416 PHONE: 757-1101
CABLE: COLINRAD TORONTO
TELEX: 022-130

Collins Radio International, Inc.
Heathrow House, Bath Road
Cranford, Hounslow
Middlesex, England
PHONE: SKYPORT 9911
CABLE: COLINRAD HOUNSLOW
TELEX: 25463

Collins Radio Company of England, Ltd.
Heathrow House, Bath Road
Cranford, Hounslow
Middlesex, England
PHONE: SKYPORT 9911
CABLE: COLINRAD HOUNSLOW
TELEX: 25463

Collins Radio Company G.M.B.H.
P. O. Box 130
605 Offenbach/Main
Frankfurter Strasse 47
Germany
PHONE: 885041 (FRANKFURT)
CABLE: COLINRAD FRANKFURT
TELEX: 4-152757

Collins Radio France, S.A.
80, Route de Saint-Cloud
92-Rueil Malmaison
France
PHONE: 967-7560
TELEX: COLINRAD 25925F

Collins Italiana, S.P.A.
Viale Liegi 41
Int. 12
00198 Rome, Italy
PHONE: 8-862415
CABLE: COLINRAD ROME
TELEX: 61410

Collins Radio International, Inc.
P. O. Box 2309
Beirut, Lebanon
PHONE: 255044 & 253755
CABLE: COLINRAD BEIRUT
TELEX: BEIRUT 627

Collins Radio International, Inc.
Scandinavian Sales Office
Kastruplundgade 21
Kastrup, Denmark
PHONE: (01) 514337
CABLE: CRCKH
TELEX: 2382

W. K. Thompson, Representative
Collins Radio International, Inc.
P. O. Box 6585
Johannesburg,
Republic of South Africa
PHONE: 220-157

C. K. Harrison, Representative
Collins Radio International, Inc.
P. O. Box 30646
Nairobi, Kenya
CABLE: COLINRAD NAIROBI

Collins Radio de Mexico, S.A.
Apartado 5-423
Leibnitz 34 — 3rd Floor
Mexico 5, D. F.
PHONE: 25-11-92-56
25-14-01-47
25-28-97-48
CABLE: COLINRAD MEXICO CITY
TELEX: 0017-7385

Charles R. Shipp
c/o Electrobras Comercio e Industria, S.A.
Caixa Postal 324
Rio de Janeiro, GB - Brazil
PHONE: 42,5905
CABLE: ELECTROBRAS—RIO DE JANEIRO
TELEX: C. R. SHIPP—RADIOBRAS 352
RIO DE JANEIRO, BRAZIL (VIA RCA)

Collins Radio Company (A'Asia) Pty. Ltd.
Hooker House — Fifth Floor
327 Collins Street
Melbourne, Victoria, 3000 Australia
PHONE: 61-2626
CABLE: COLINRAD MELBOURNE
TELEX: AA30450

Collins Radio Company (A'Asia) Pty. Ltd.
Room 404, A.I.A. Building
Jalan Ampang
Kuala Lumpur, Malaysia
PHONE: 27283 or 27284
CABLE: COLINRAD KUALA LUMPUR
TELEX: KLTX 375

Collins Radio Company (A'Asia) Pty. Ltd.
P. O. Box 9434, Courtenay Place
Motor Trade House, Kent Terrace
Wellington C.I., New Zealand
PHONE: 54343
CABLE: COLINRAD WELLINGTON

Collins Radio Company (Far East) Ltd.
P. O. Box 1930
Thai Farmers Bank Ltd.
142 Silom Road — 6th Floor
Bangkok, Thailand
PHONE: 36768 or 30842
CABLE: COLINRAD BANGKOK
TELEX: BK2217

GENERAL CONDITIONS OF SALE

1. **PRICES.** Buyer agrees to pay Collins Radio Company, (hereinafter called Collins), at its office in Dallas, Texas, for the articles described herein, the prices as specified on the face hereof, provided, however, that if articles are included herein that are manufactured by others than Collins, Collins reserves the right to increase the price thereof to Collins list price for such articles in effect at time of delivery. If all articles are not delivered at one time, Buyer agrees to pay on the terms stated the unit prices applicable to the articles so delivered.

2. **TAXES.** Except as otherwise specified, the prices stated herein do not include any state, federal, or local sales, use or excise taxes applicable to the sale, delivery, or use of said equipment, and the Buyer expressly agrees to pay to Collins, in addition to the prices herein specified, the amount of any such taxes that may be imposed upon or payable by Collins. Any such tax imposed by a taxing authority in a state in which Collins is not registered will be received and remitted by Collins as agent for Buyer.

3. **TERMS.** Notwithstanding any statement of terms or time of payment appearing on the face of this order, Collins reserves the right to require payment in advance of shipment or to ship COD. It is agreed that title to any articles not fully paid for at time of delivery to Buyer shall be retained by and remain in Collins until said purchase price is fully paid and if the purchase price is to be paid on an installment basis, Buyer will at time of delivery execute a note for such purchase price and a conditional sale contract or chattel mortgage as Collins shall specify, all upon forms customarily used by Collins in similar transactions in the state of the Buyer.

4. **DELIVERY.** Unless otherwise specified, delivery will be made for the place of location of Collins factory from which Collins elects to make shipment, according to the delivery schedule specified herein, which is approximate and subject to delays due to causes beyond Collins control including, but not limited to, inability to obtain material, labor, or manufacturing facilities, acts of God, or of the public enemy, any preference, priority, or allocation order issued by the Government or any other act of Government, fires, floods, epidemic quarantine restrictions, strikes, freight embargoes, or delays of Collins suppliers. In the event of such delay, delivery dates shall be extended accordingly for a period equal to the time lost by reason of such delay. In no event shall Collins be liable for consequential damages. Buyer agrees that Collins may unconditionally appropriate to this order, equipment of the description set out on the face of this order by packing same for shipment to Buyer and notifying Buyer that same has been done; thereupon the sale shall be deemed complete subject to Collins right to possession of and a lien upon said equipment (or to Collins reserved title in ease property is to be covered by conditional sales contract) for the unpaid purchase price.

5. **SHIPMENT.** In the absence of specific instructions Collins will select the carrier to whom delivery will be made for shipment to Buyer. Except for its obligations under the sections hereof entitled "Guarantee" and "Patents" all responsibility of Collins for said equipment ceases upon delivery to carrier.

6. GUARANTEE.

(a) Except as set forth in paragraph (b) of this section, Collins agrees with Buyer to repair or replace, without charge, any properly maintained equipment, parts, or accessories that are defective as to design, materials or workmanship and that are returned in accordance with Collins instructions by Buyer to Collins factory, transportation prepaid, provided:

- (1) Notice of a claimed defect in the design, materials, or workmanship of the equipment manufactured by Collins is given by Buyer to Collins within five (5) years from date of delivery, with exception of rotating machinery such as blowers, motors, and fans whereby notice must be given by Buyer to Collins within two (2) years from date of delivery.
- (2) Notice of a claimed defect in the design, materials or workmanship of the following described Collins manufactured equipment is given by Buyer to Collins within two (2) years from the date of delivery:

20V-3	81M	216C-2	642A-2	830D-1
26J-1	144A-1	313T-1	786M-1	830E-1
26U-1	172G-1	313T-3	820E-1	830F-1
26U-2	172G-2	313T-4	820F-1	830F-2A
42E-7	212H-1	356H-1	A 830-2	830H-1A
42E-8	212Z-1	564A-1	830B-1	830N-1A

(b) The above guarantee does not extend to other equipment, accessories, tubes, lamps, fuses, and tape heads manufactured by others, which are subject to only adjustment as Collins may obtain from the supplier thereof.

(c) Collins further guarantees that any radio transmitter described herein will deliver full radio frequency power output at the antenna lead when connected to a suitable load, but such guarantee shall not be construed as a guarantee of any definite coverage or range of said apparatus.

(d) The guarantee of this section is void if:

- (1) The equipment malfunctions as a result of alterations or repairs by others than Collins or its authorized service center
- (2) The equipment is exposed to environmental conditions more severe than specified by Collins in equipment manuals.

(e) NO OTHER WARRANTIES, EXPRESSED OR IMPLIED, INCLUDING WARRANTIES OF MERCHANTABILITY OR FITNESS FOR INTENDED PURPOSE, SHALL BE APPLICABLE TO ANY EQUIPMENT SOLD HEREUNDER.

(f) THE FOREGOING SHALL CONSTITUTE THE BUYER'S SOLE RIGHT AND REMEDY UNDER THE AGREEMENTS IN THIS SECTION. IN NO EVENT SHALL COLLINS HAVE ANY LIABILITY FOR CONSEQUENTIAL DAMAGES, OR FOR LOSS, DAMAGE, OR EXPENSE DIRECTLY OR INDIRECTLY ARISING FROM THE USE OF THE PRODUCTS, OR ANY INABILITY TO USE THEM EITHER SEPARATELY OR IN COMBINATION WITH OTHER EQUIPMENT OR MATERIALS, OR FROM ANY OTHER CAUSE.

(g) The guarantees of this section and limitations thereon will also accrue to the benefit of any purchaser of Buyer's FCC license, provided:

- (1) Notice of the sale of the FCC license is given by Buyer to Collins in writing within thirty (30) days after the consummation of said sale
- (2) No greater rights are granted to the purchaser of Buyer's FCC license than are granted herein to Buyer.

7. **PATENTS.** Collins agrees that it will defend, at its own expense, all suits against Buyer for infringement of any United States patent or patents covering, or alleged to cover, either said apparatus itself in the form sold by Collins, or the normal operation thereof, where the only issue in such infringement suits involves the Buyer's use of said apparatus, as so sold, for the purpose and in the manner contemplated by this agreement, and Collins agrees that it will pay all sums that, by final judgment or decrees in any such suits, may be assessed against the Buyer on account of such infringement, provided Collins shall be given (i) immediate written notice of all claims of any such infringement and of any suits brought or threatened against Buyer, and (ii) authority to assume the sole defense thereof through its own counsel and to compromise or settle any suits so far as this may be done without prejudice to the right of the Buyer to continue the use, as contemplated, of the apparatus so purchased. If in any such suit so defended the apparatus is held to constitute an infringement and its use is enjoined, or if in the light of any claim of infringement Collins deems it advisable to do so, Collins may either procure the right to continue the use of the same for the Buyer, or replace the same with noninfringing apparatus, or modify said equipment so as to be noninfringing, or take back the infringing apparatus and refund the purchase price less a reasonable allowance for use, damage, or obsolescence. The complete liability of Collins for any such infringement, or claim of infringement, shall be limited to its agreements herein contained. It is understood that Buyer acquires no license rights from Collins under the patents covering inventions of Edwin H. Armstrong relating to the transmitting or receiving of sound, visual images, or graphic matter from frequency modulated radio waves; that nothing contained herein shall be deemed to apply or relate to suits or claims based upon any of the said Armstrong patents; and that insofar as a Buyer needs a license under said Armstrong patents, it will procure such license itself.

8. **SUBSTITUTIONS AND MODIFICATIONS.** Collins reserves the right to modify the design and specifications of equipment designed by Collins provided that the modification does not adversely affect the performance.

9. **ENTIRE CONTRACT.** The terms and provisions stated hereon, together with those appearing on the face hereof, and on all continuation sheets, if any, comprise all the terms, conditions, and agreements of the parties respecting the sale of said articles, and supersede any provisions on the face and reverse side of the Buyer's Order or any prior general agreement inconsistent with the provisions hereof. No modification hereof shall be valid unless in writing and duly signed by an officer of Collins.

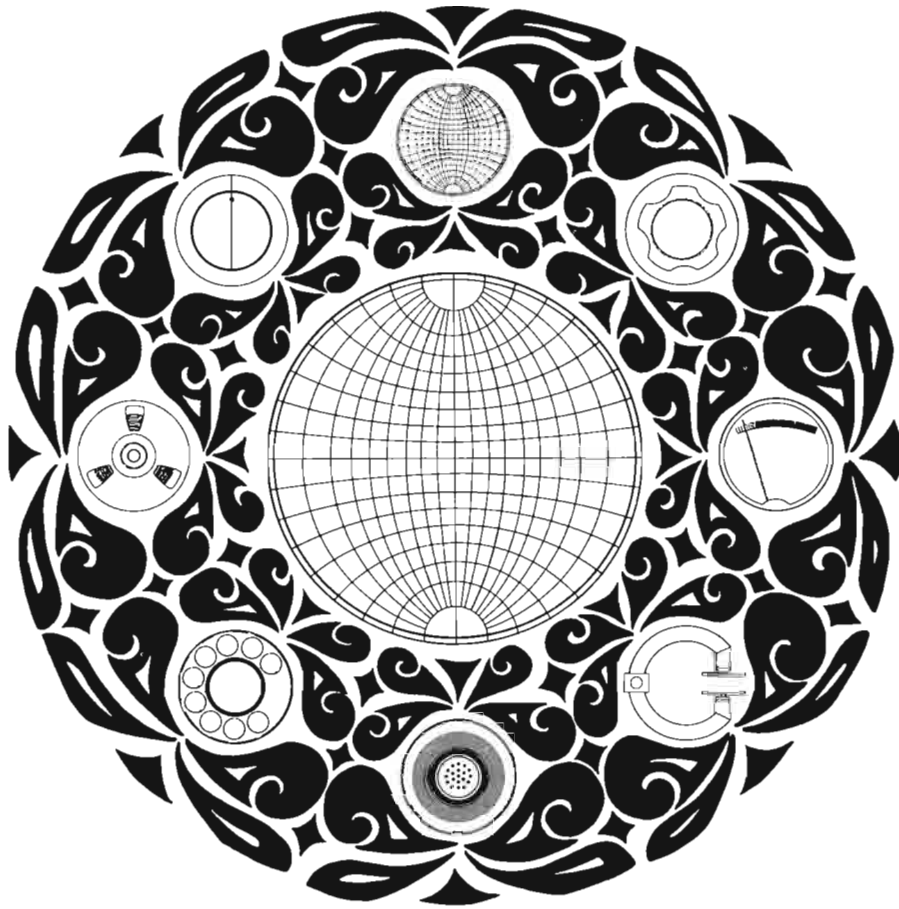

A World of Experience in Broadcast

Collins maintains the leadership in design and production of the world's finest Broadcast equipment. Your station may be in Karachi or Chicago, it may require 250 watts or 250,000 watts—Collins experience will serve you best. An extensive product line of studio equipment, transmitters, and antennas offers total installation capability to complement every Broadcaster requirement.



is completed. Interlocks on the cabinet doors also remove the plate voltage when doors are opened.

Amplitude and phase controls have counters to assure accurate resetability. In complex arrays requiring additional controls, the controls and counters are behind the tilt-out panel in the lower half of the cabinet.

Power-dividing circuits and phase-shift networks utilize heavy edge-wound copper ribbon inductors and ceramic cased mica capacitors. Vacuum capacitors are used where made necessary by high circulating currents.

Plated 5/16-inch copper tubing is used for all rf busses and insulation is steatite or Mycalex.

Input and output connections are provided at the top of the phasing cabinet unless otherwise specified. Special terminations are provided for solid dielectric cables in both the phasing cabinet and antenna coupling units.

An input common point rf ammeter is supplied along with line current meter jacks. Antenna current meters have make-before-break switches, which can be operated without opening the cabinet door on the weatherproof coupling units.

Power: 1, 5, and 10 kw in 2-, 3-, 4-, 5-, and 6-tower arrays.

Patterns: Directional day and night, same pattern; directional nighttime only; or different pattern day and night. The 820D/E/F style cabinets are available in three sizes to fit the complexity of the system.

25-7/16 in. W, 69 in. H, 32 in. D (65 cm W, 175 cm H, 81 cm D)

47-7/16 in. W, 69 in. H, 32 in. D (119 cm W, 175 cm H, 81 cm D)

67-7/16 in. W, 69 in. H, 32 in. D (171 cm W, 175 cm H, 81 cm D)

COLLINS TOWER LIGHTING FILTER CHOKES

These solenoid wound 2- and 3-wire chokes provide high impedance throughout the broadcast band for isolation of the ac power lines from the antenna. Coils are wound of #10 wire and are rated at 2000 watts, 120 vac, single phase. Provided with mounting brackets and standoff insulators for mounting in 42E-7/8 antenna coupling units.

Part No. 543 3927
Unhoused, 2-wire, 2000 watts

Part No. 543 3926
Unhoused, 3-wire, 2000 watts

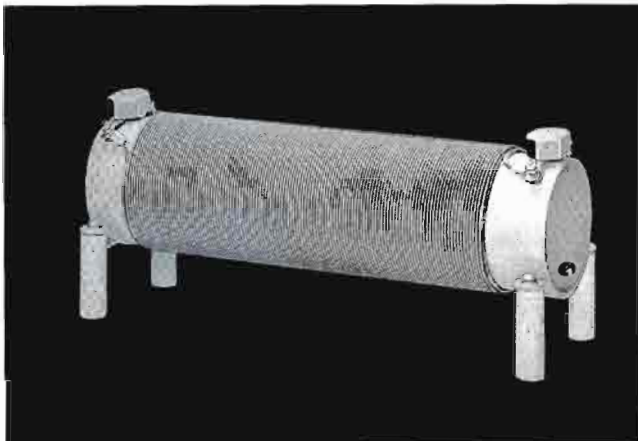

COLLINS 42E ANTENNA COUPLING UNITS

These specially constructed units match a series-fed vertical radiator to an unbalanced transmission line. Intended for continuous, unattended duty in conjunction with transmitters having emission type A0, A1, A2 or A3, the 42E-7 operates with transmitters of carrier power output of 250 to 1000 watts. The 42E-8A operates with transmitters of 5000 watts and the 42E-8B operates with transmitters of 10,000 watts.

The electrical circuit of the 42E Antenna Coupling Units is a low-pass "T" network with good harmonic attenuating properties. A 3-wire or 2-wire tower lighting filter choke and remote antenna current sampling transformer may be mounted in the cabinet, and an antenna current meter and line current meter jack are provided.

A horn gap furnishes lightning protection. The antenna connection is made by an insulated feed-through bushing on the side of the cabinet and the bushing has a hollow stud for the lightning circuit. The transmission line comes through the base of the cabinet. The unit is contained in a gray weatherproof aluminum housing. Remote antenna current metering kit and antenna current transformer for remote reading of antenna current up to 25 A available for all Collins AM transmitters.

Size: 42E-7, 29 in. W, 28 in. H, 18 in. D (74 cm W, 71 cm H, 46 cm D)

Weight: 64 lb (29.03 kg)

Size: 42E-8A/B, 36 in. W, 28 in. H, 22 in. D (91 cm W, 71 cm H, 56 cm D)

Weight: 124 lb, (56 kg)

Part No. 522 1028 (Type 42E-7)

Part No. 522 1029 (Type 42E-8A)

Part No. 522 1029 (Type 42E-8B)

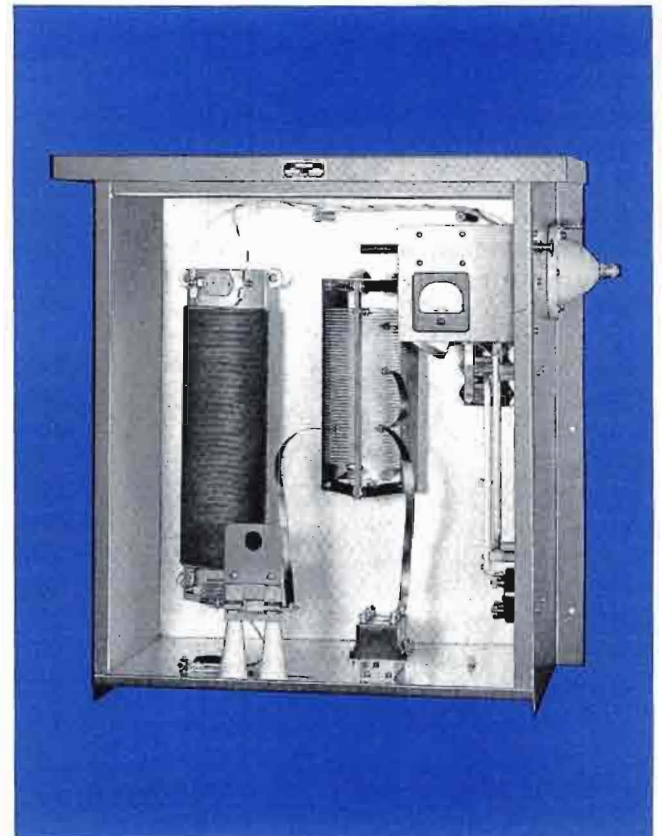

COLLINS 172G-1 DUMMY ANTENNA

This air-cooled unit provides a load to dissipate transmitter output for off-the-air testing. Consisting of eight ferrule type, non-inductive resistors, with insulated end brackets and clips, it may be mounted on the transmitter or adjacent wall. The 172G-1 has an impedance of 52 ohms.

Power Rating: 1 kw

Size: Approx. 6 in. W, 9 in. H, 12½ in. D (15.24 cm W, 22.86 cm H, 31.75 cm D)

Weight: 5 lb (2.27 kg)

Part No. 522 1410 004

STATES WG-50 DUMMY ANTENNA

An air-cooled 50-ohm rf load that will dissipate the output of the Collins 820E/F AM transmitters.

Part No. 124 0061 794 (WG-50) 7.5 kw

Part No. 124 0061 801 (Catalog No. 338-32J) 15 kw

COLLINS 144A-1 ISOLATION COIL

Coil provides isolation for the sampling line in directional arrays, presenting a high impedance for the line across the base insulator. Unit consists of a phenolic coil form which will accommodate 37 turns (approx. 105 ft) of RG8/U or similar solid dielectric sampling line. May be mounted on wall of tuning shack or in housing similar to that pictured.

Inductance: Approx. 180 microhenrys

Size: 10 in. diameter, 18 in. L (25.4 cm diameter, 46 cm L)

Weight: 6 lb (2.7 kg)

Part No. 522 1520 001

COLLINS ANTENNA CURRENT TRANSFORMER

The antenna current transformer is used with remote thermocouple and meter for remote monitoring of antenna current. For currents up to 25 amperes. Thermocouple is not included.

Part No. 543 3917 001

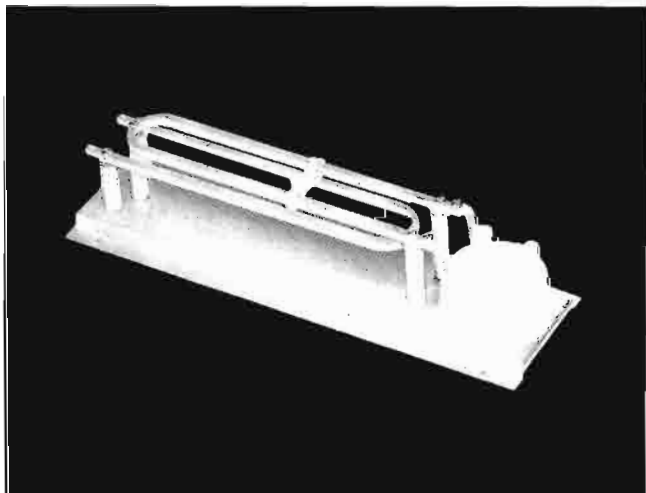

JOHNSON FEED-THROUGH BOWL INSULATORS

Designed to carry rf transmission line through a wall. Assembly includes glass bowls, cork gasket, steel mounting with six 3/16 in. mounting holes. Bowl is 6-15/16 in. max. diameter and 4¾ in. high. Mounting flange: 7¾ in. diameter. Fittings include spun aluminum corona shield, ½ in.-13 threaded stud except 135-15-4 which has ⅝ in.-18 threaded stud (hollow), washers, and nuts.

Part No. 097 1501 000 (Type 135-15-1)
One bowl and fittings, 10¼ in. stud.

Part No. 097 6673 000 (Type 135-15-3)
Two bowls and fittings, 16 in. stud. for walls up to 4 in. thick

Part No. 099 1170 000 (Type 135-15-4)
Two bowls and fittings, 24 in. hollow stud I.D. 7/16 in. for walls up to 12 in. thick

Part No. 097 5646 000 (Type 135-15-7)
Two bowls and fittings, 24 in. stud for walls up to 12 in. thick

JOHNSON RF CONTACTORS

The 145-100 and 145-200 contactors are especially designed for high voltage radio frequency switching and dc voltage switching in high voltage rectifier circuits. They require no holding power and will operate with a momentary application of voltage.

Standard contactors are supplied with four auxiliary switches: two normally-closed for control of solenoid voltage and two normally-open for operation of signal lamps or other related functions. Solenoids are wired for 220 v, 50-60 Hz, or can be strapped for 110 v.

	Max. Current	Max. Contact Rating (at 2 MHz)
Part No. 410 0209 00	4 A	17 kv, 25 A
Part No. 410 0210 00	4 A	17 kv, 25 A
Part No. 410 0211 00	8 A	22 kv, 25 A
Part No. 410 0212 00	8 A	22 kv, 25 A

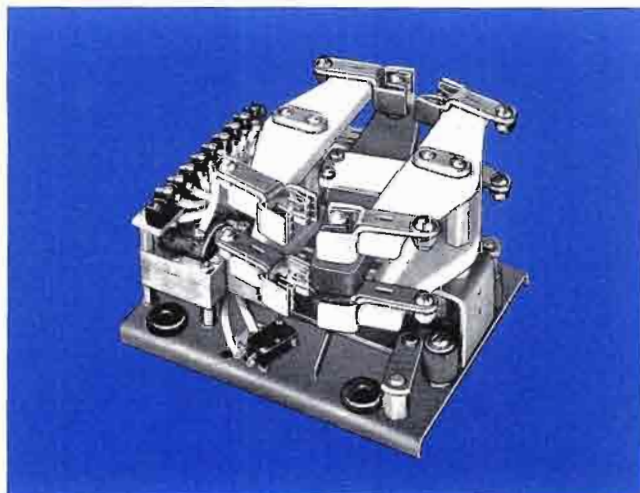

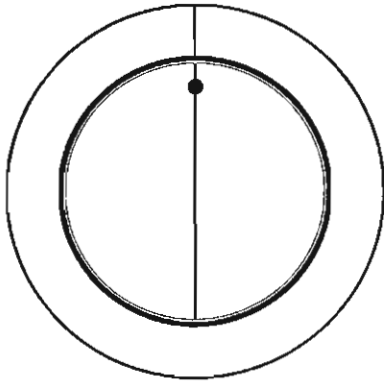

FM
Transmitters

COLLINS 310Z-1 FM EXCITER

The 310Z-1 FM Exciter features the newest concepts in FM broadcast exciter design. The exciter, completely solid state, provides a frequency-modulated 88- to 108-MHz signal suitable for further amplification or direct transmission.

Monophonic, stereophonic, and SCA audio inputs are processed and frequency modulate the carrier with the resultant. It is designed to match a 50-ohm load and will accept frequencies up to 75 kHz. Plug-in circuit card construction makes the exciter compact and easily maintained. The circuit cards may be extended or removed from the transmitter front panel for test and maintenance.

Output power may be manually adjusted between 10 and 20 watts. Accessibility and maintainability are greatly improved through total modular construction, and all circuitry and adequate test points are accessible from the front of the exciter.

A stereo generator and SCA generator are inherent companion modules of the 310Z-1. With the addition of those modules, this unit performs all the functions required of an FM stereo broadcast exciter.

During monaural operation, audio is applied directly to the baseband amplifier through the monaural audio filters. For stereo multiplex or SCA operation, the 786V-1 stereo generator and 786W-1 SCA generator must be employed.

There are two basic methods of FM signal generation, direct FM and phase modulation. The 310Z-1 uses the direct method.

The complete stereo signal (and SCA signal if used) is fed through a baseband amplifier to a frequency-modulated oscillator. The discriminator completes an audio feedback loop that suppresses FM oscillator distortion, incidental FM noise, transient carrier offset, and gain/phase variation in the baseband amplifier and modulator. Automatic frequency control (afc) circuitry is provided to maintain good frequency stability. The output of the modulator is a 14-MHz FM signal with ± 75 -kHz peak deviation. The output frequency is obtained by translating this signal with a stable vhf oscillator. The use of the direct FM system removes the requirement for double modulators, phase delay lines, and baseband amplifiers with a response that changes with frequency.

Power Source: 117 vac $\pm 10\%$, 50 to 60 Hz, single phase
Carrier Frequency Stability: Less than ± 1000 Hz, 117 vac $\pm 15\%$

FM Noise Level: 65 db below 100% modulation (± 75 kHz)

AM Noise Level: 55 db below 100% AM level

Exciter Inputs: Stereophonic, monophonic, and SCA, all 600 ohms, balanced

RF Output: 10 to 20 watts, variable

Output Impedance: 50 to 70 ohms, unbalanced

Frequency Range: 88 to 108 MHz

Modulation: Direct FM

Monaural

Preemphasis: 75 us

Distortion: 0.5%, 50 Hz to 15 kHz; 1.0%, 15 kHz to 75 kHz

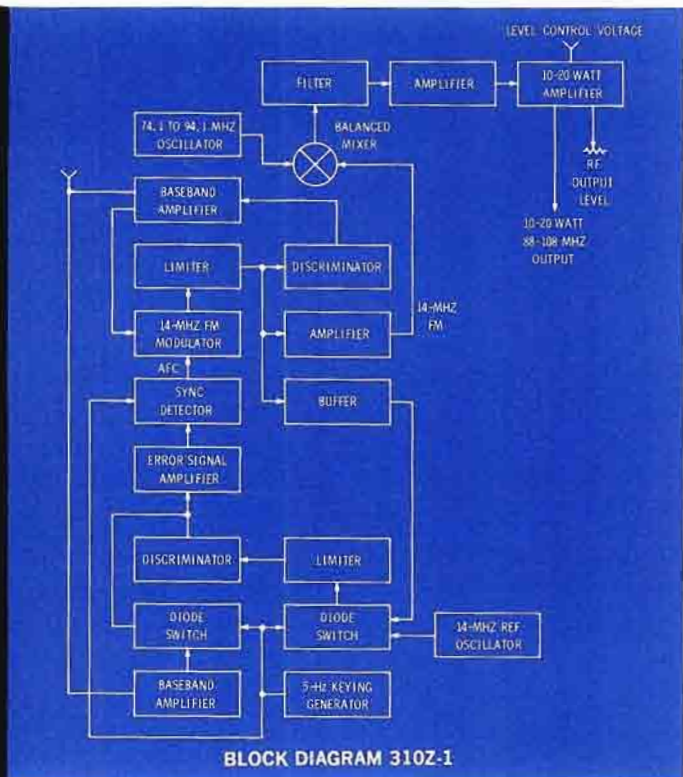

Frequency Response: Standard 75-microsecond preemphasis for left channel. Deviation from the standard preemphasis curve shall not be more than ± 2.0 db from 50 to 10,000 Hz and ± 2.5 db from 10 to 15 kHz

Stereo — Electrical Characteristics with 786V-1 Stereo FM Generator

Inputs (Left or Right Audio Channel): 600 ohms balanced. Input for 100% modulation is 10 ± 2 dbm. Frequency range is 50 Hz to 15 kHz

Subcarrier Suppression (38-kHz): The stereophonic subcarrier and its 2nd harmonic in the output are at least 40 db and 60 db respectively below 90% modulation

Stereo Channel Separation: Greater than 35 db, 50 to 15,000 Hz

Type of Emission:

Frequency modulated with:

Main Channel: 50 Hz to 15 kHz

Sub-Channel: 23 kHz to 53 kHz

Pilot Carrier: 19 kHz ± 2 Hz

Pilot Carrier Level: Adjustable from 0 to 15% modulation of main carrier

Crosstalk: When inputs of 10 dbm are applied to both left and right stereophonic channels with the phase relationships $L = R$, output in the stereophonic subchannel, due to crosstalk, is at least 40 db below 90% modulation. When inputs of 10 dbm are applied to both left and right stereophonic channels with the phase relationship $L = -R$, output in the main channel, due to crosstalk, is at least 40 db below 90% modulation.

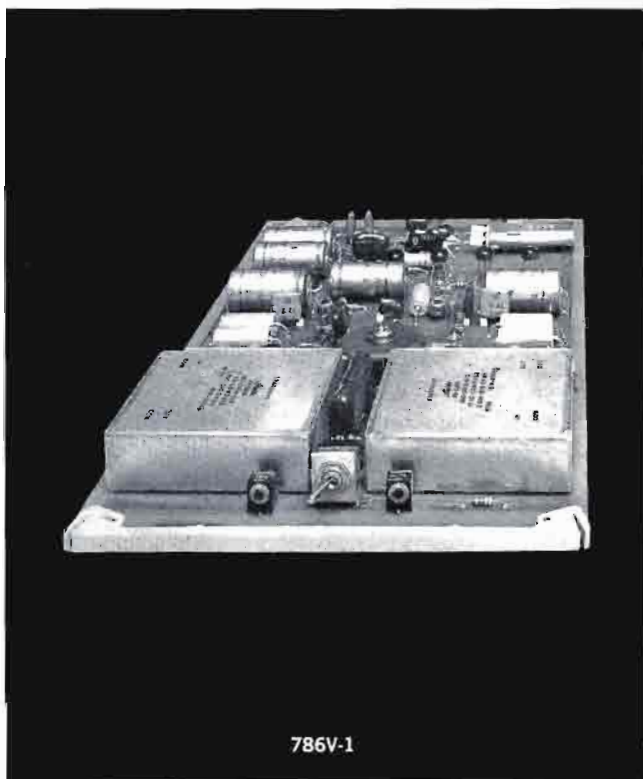

786V-1

Electrical Characteristics with 786W-1 SCA Generator

Input: 600 ohms, balanced input. 6 to 15 dbm for 7.5-kHz deviation of 67-kHz, SCA subcarrier

Frequency Range: 50 Hz to 15,000 Hz

NOTE: Sideband amplitudes are functions of the modulating frequency and carrier frequency deviation. Even though the 310Z-1 can accommodate 15 kHz, a frequency less than 15 kHz must be used to meet FCC regulations for stereo operation. Recommended maximum modulating frequency and 67-kHz subcarrier frequency deviation are 5.0 kHz and 3.5 kHz respectively.

Subcarrier Frequency Deviation: ± 7.5 kHz maximum

SCA Subcarrier Frequency: 67 kHz

SCA Subcarrier Frequency Stability: $\pm 0.2\%$

Preemphasis: 75 microseconds

Frequency Response: Standard 75-microsecond preemphasis for both left and right channels. Deviation from the standard preemphasis curve shall not be more than ± 2.0 db from 50 to 10,000 Hz and ± 2.5 db from 10 kHz to 15 kHz.

Distortion: 0.5%, 50 Hz to 15 kHz audio modulation

Size: 10½ in. H by 19 in. W by 15 in. D (27 cm H by 48 cm W by 38 cm D)

Weight: 38 lb (17 kg)

Part No. 522 4687

310Z-1

Part No. 772 5336 001

786V-1

Part No. 772 5338 001

786W-1

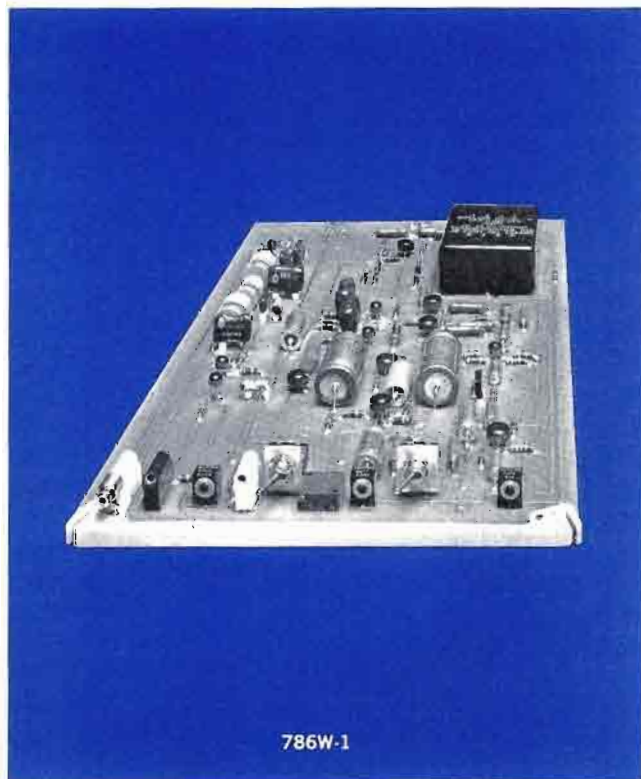

786W-1

786M-1 FM STEREO MULTIPLEX GENERATOR

A stable and reliable method of stereophonic FM broadcasting is now available through the new time division system where both stereo channels are integrated into a composite signal that is fed to a wide-band exciter (Collins A830-2) on a single line.

The Collins 786M-1 FM Stereo Multiplex Generator does away with the inherent instability of the conventional dual channel method of stereo injection.

Instead, the Collins 786M-1 feeds monaural audio and the subchannel, required for stereo operation, to the exciter on a single, composite signal. The time division system eliminates the costly and unstable dual channels that require matrix networks. L + R and L - R outputs of the

matrix networks must be compensated to make up time differences in the two channels. Also, accurate amplitude balance between the two channels must be maintained. In the Collins system, this problem is eliminated by using a wide-band direct FM exciter. With a system of this type, any gain changes or time delays will affect the main and subchannels equally.

The Collins time division system is nothing more than a sampling at a 38-kHz rate of the left and right audio inputs. After transmission, a corresponding component in the FM receiver demodulates the composite signal in synchronism with the sampling, converting it to left and right audio through the respective speakers.

The composite stereo signal (L + R and L - R) is achieved by filtering out unwanted harmonics created in the function of the 4-diode time division switching circuit.

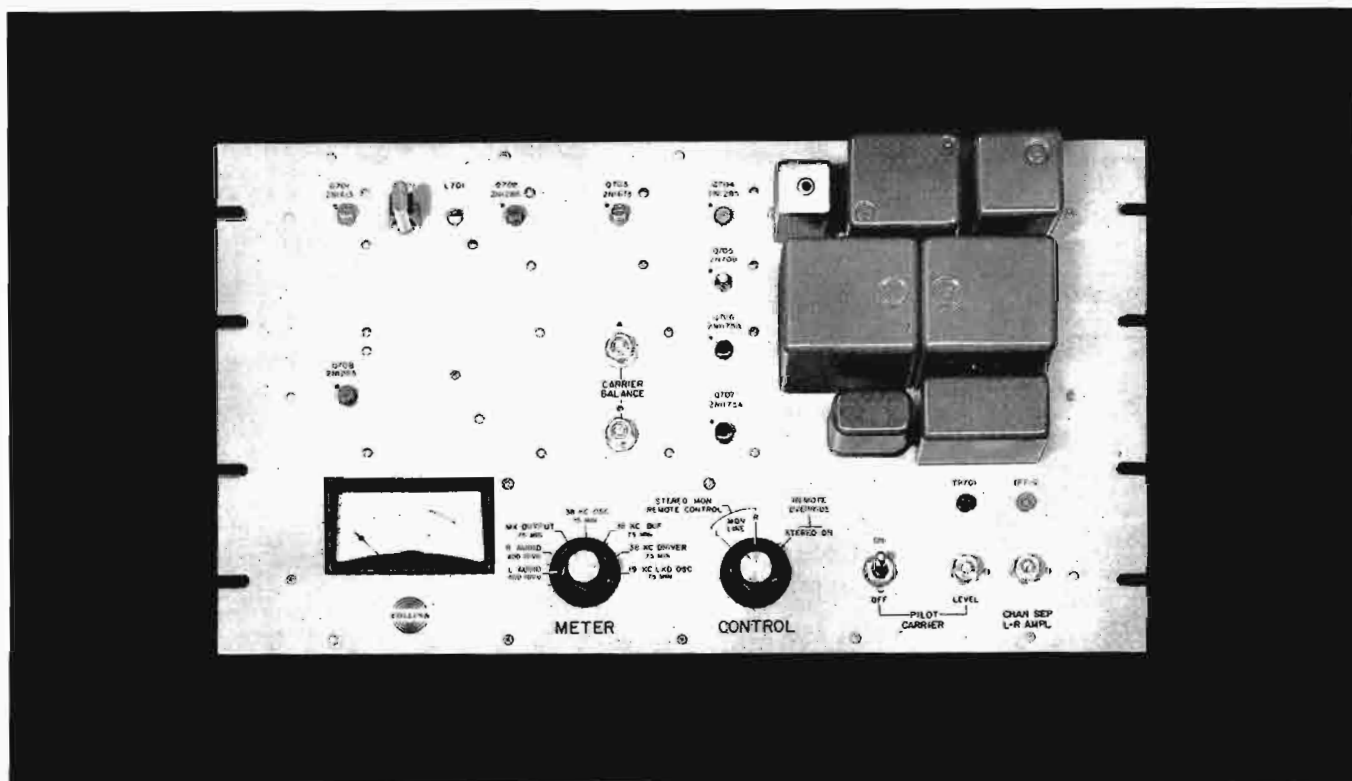

The resulting spectrum shows only the main channel (L + R), which is the monaural signal; a 10 percent 19-kHz pilot carrier; the subchannel (L - R), which is the stereo signal on a 38-kHz carrier. An SCA channel may be placed on a 67-kHz carrier by addition of an auxiliary SCA generator.

Features of the 786M-1 are:

SIMPLE CIRCUITS — The single line, time division system eliminates matrixing components, greatly simplifying circuitry.

STABLE — All components are temperature-compensated to provide long-term stability. The unit is completely transistorized.

SELF-METERED — An audio VU meter monitors both audio inputs and interior circuit points for rapid maintenance.

EASILY INSTALLED — The Collins 786M-1 may be installed in the 830B-1A, 830D-1A or 830E-1A FM, 830F-1A, 830F-2A, 830H-1A, 830N-1A.

Preemphasis networks are plug-in type; can be replaced with a 20-db flat pad for testing. Hi-pass filter and 600-ohm/600-ohm transformers prevent interference with exciter afc circuits by any 5-Hz components in input. Transformers convert from balanced to unbalanced inputs. 15-kHz low-pass filters limit bandwidth to 15 kHz preventing cross-talk between main and subchannels. Filters provide over 60 db of attenuation for frequencies above 19 kHz. Emitter followers provide isolation between left and right audio inputs and stereo switch. A 38-kHz oscillator, buffer, and driver provide the 38-kHz drive signal to the stereo switch. When the 38-kHz carrier goes positive, upper pair of diodes in switch conduct and connect left channel to output; when carrier goes negative, lower pair of diodes connect right channel to output. L + R correction is obtained by feeding left and right signals around switch through two resistors. The 53-kHz low-pass linear phase filter removes high frequency switching components that would fall outside the assigned bandwidth. The filter meets the requirement of constant time delay for all frequencies up to 53 kHz. Main channel audio and subchannel DSB crossings thus occur simultaneously. The filter also has flat frequency response to 53 kHz. These two factors are held to tolerances that provide over 35 db of channel

separation for 50- to 15,000-Hz audio input frequencies rising to 38 db at 5 kHz. The emitter follower and 19-kHz locked oscillator provide a 19-kHz pilot carrier in phase with the 38-kHz subcarrier at the output of the linear phase filter.

Distortion (either channel): Less than 1%, 50 to 15,000 Hz
Channel Separation: 35 db or greater, rising to 38 db at approx. 5 kHz

Pilot Carrier Stability: ± 2 Hz at 19,000 Hz

Output Impedance: 600 ohms unbalanced

Size: 19 in. W, 8 $\frac{3}{4}$ in. H, 3 $\frac{1}{8}$ in. D (48 cm W, 22 cm H, 8 cm D)

Weight: 14 lb (6 kg)

Part No. 522 2914 00

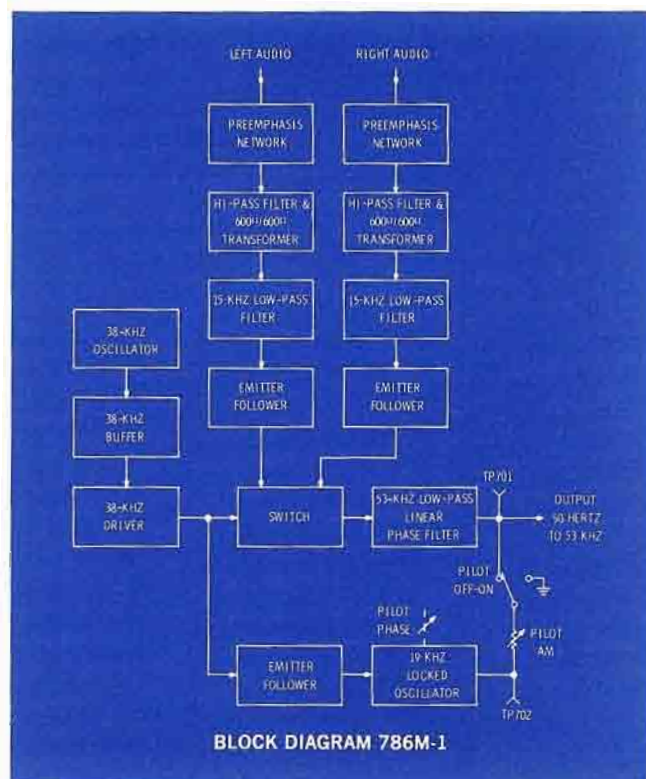

COLLINS 830B-1B FM TRANSMITTER

Designed for top reliability and superior quality sound, the Collins 830B-1B 250-Watt FM Transmitter not only affords the broadcaster an economical, self-contained unit, but also is readily adaptable to a variety of uses, including stereophonic FM and increased station power.

Clean, sharp lines plus "humanized" engineering for both operation and maintenance make the Collins 830B-1B an attractive, integrated unit in the most modern broadcast station.

Other quality features of the Collins 830B-1B that underscore its superior performance include:

SELF-CONTAINED — Transformers for all solid state power supply as well as the harmonic filter are housed inside the cabinet. Self-contained multiplexing equipment, including the Collins 786V-1 Stereo Generator also may be installed inside. This unit is used as a driver for the 830E-1B 5000-watt and 830F-1B and 10,000-watt Transmitters.

SIMPLE OPERATION — The 830B-1B is pushbutton operated, featuring a step-start system in which starting sequences are fully automatic. All rf circuits are tuned from the front panel. Adequate metering is provided for rapid operation analysis. All adjustments can be made while the transmitter is on the air.

DEPENDABLE — The compact transmitter uses space-saving silicon rectifiers, which generate a minimum of heat. Spurious radiation is minimized and the unit has a high degree of stability.

MAINTENANCE EASE — Vertical panel construction eliminates hidden components and allows rapid inspection and maintenance. Cabinet interlocks minimize danger during circuitry inspection and maintenance. A grounded shorting stick is readily accessible to discharge capacitors before transmitter servicing.

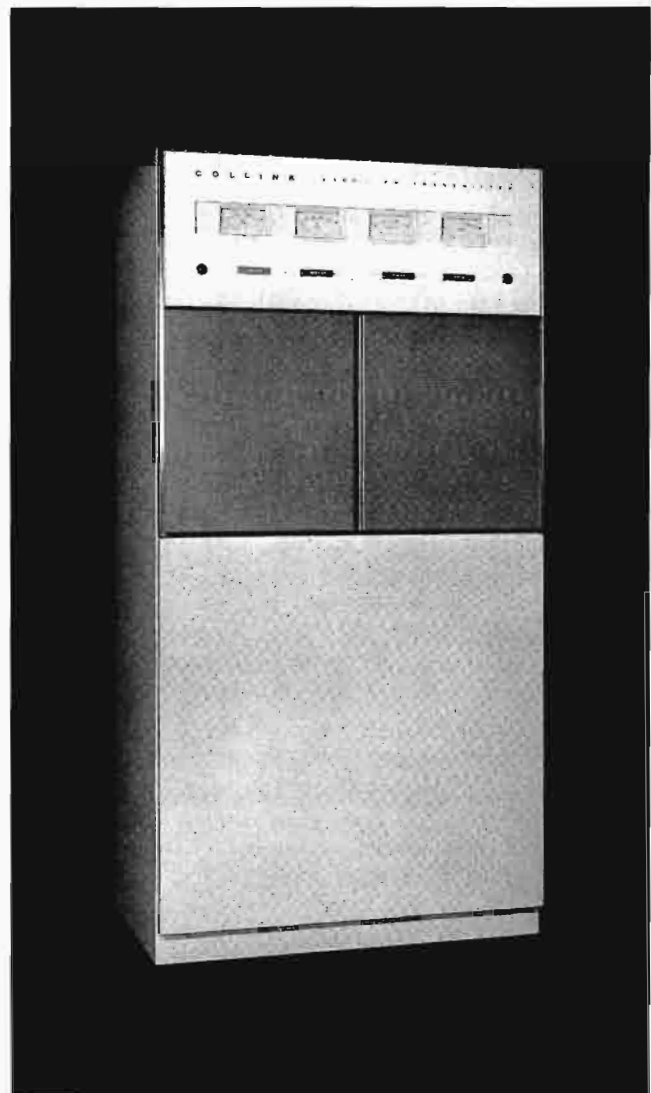

failure. Driver power supply uses silicon rectifiers which take little space and generate a minimum of heat. Efficient blowers force air directly on the 4CX250B and 4CX500A power amplifier tubes. Power supply is all solid state with the exception of the final amplifier plate voltage supply which uses mercury vapor rectifiers.

MAINTENANCE EASE — Vertical panel construction eliminates hidden components and allows rapid inspection and maintenance. Cabinet interlocks minimize danger during circuitry inspection and maintenance. A grounded shorting stick is readily accessible to discharge capacitors before transmitter servicing.

RIGID TESTING — In keeping with rigid Collins standards, the 830E-1B is tested on the broadcaster's channel under proper load conditions before the unit is shipped.

While the transmitter nominally operates on 60-Hz power, only the two blower motors need be changed to convert to 50-Hz operation.

Frequency Range: 88 to 108 MHz

Power Output: 5000 watts

Carrier Frequency Stability: ± 1000 Hz

Audio Frequency Response: ± 1 db, 50 to 15,000 Hz

Distortion: Less than 0.5%, 50 to 15,000 Hz

FM Noise Level: 65 db below ± 75 Hz

AM Noise Level: -55 db rms

Harmonic Attenuation: -80 db

Modulation Capability: ± 100 kHz

RF Output Impedance: 50 ohms; swr not to exceed 2:1

Audio Input Level: +10 dbm, ± 2 db

Power Source: 230 vac, 60 Hz, 3 phase (tapped for 200 to 250 v in 10-v steps)

Input Power Requirement: 11 kw, 90% power factor

Power Line Regulation: 3%

Variations: Slow line, $\pm 5\%$; rapid line, $\pm 3\%$

Tube Complement: One 4CX250B, *six 872A, one 4CX-500A

Temperature Range: 15° to 45°C

Humidity: 0% to 95%

Altitude: 7500 ft

Size: 76 in. W, 76 in. H, 27 in. D (193 cm W, 193 cm H, 69 cm D)

Weight: 1800 lb (816 kg)

*Not used if silicon diode rectifiers are employed.

Part No. 777 1785

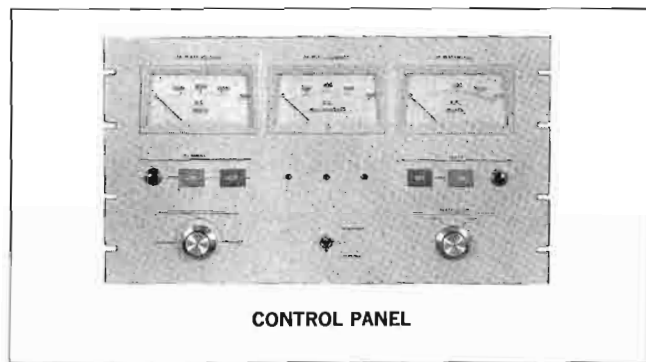

CONTROL PANEL

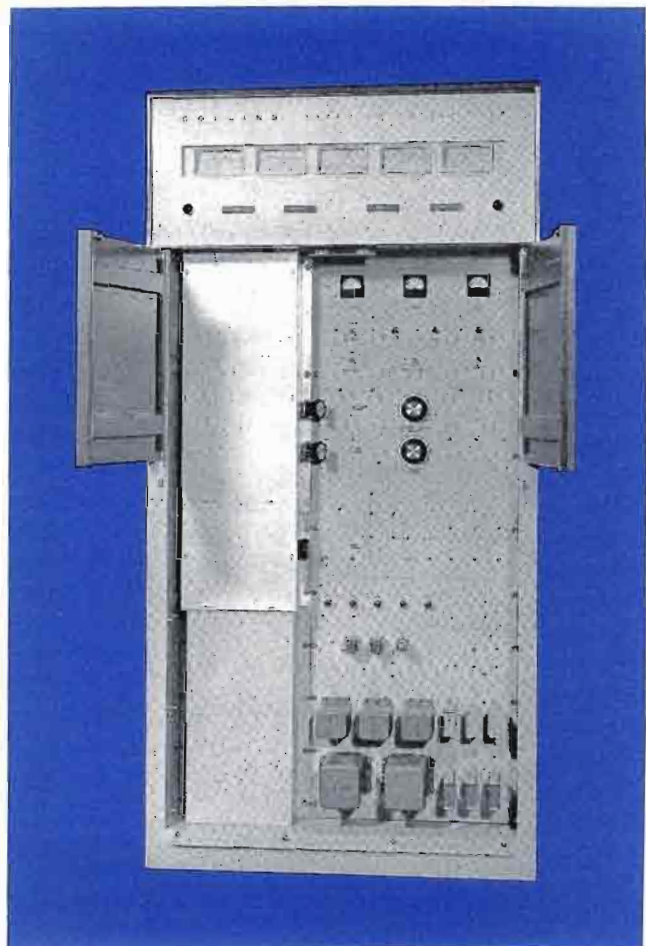

COLLINS 830F-1B 10-KW FM TRANSMITTER

The Collins 830F-1B 10-KW FM Transmitter assures the broadcaster the clean, strong signal he needs to make his programming outstanding in a highly competitive market area and the extended coverage required to build and maintain an audience.

Like all Collins FM transmitters, the 2-cabinet 10,000-watt model is carefully engineered and manufactured to a quality level that is a hallmark at Collins.

SELF-CONTAINED — Every component is housed within the two cabinets, including power transformers, harmonic

filters and directional coupler. An optional feature is the Collins 786V-1 Stereo Generator, which plugs into the 310Z-1 exciter.

EASE OF OPERATION — Pushbutton operated, the transmitter starting sequences are fully automatic by the step-start system. Rf circuits are tuned and metered at the front panel. All adjustments can be made while the transmitter is on the air. No tuning or trimming of the harmonic filter is required. The PA stage is easily neutralized and is non-critical in adjustment.

DEPENDABLE — Grounded screen eliminates the bypass capacitors, doing away with a common source of failure.

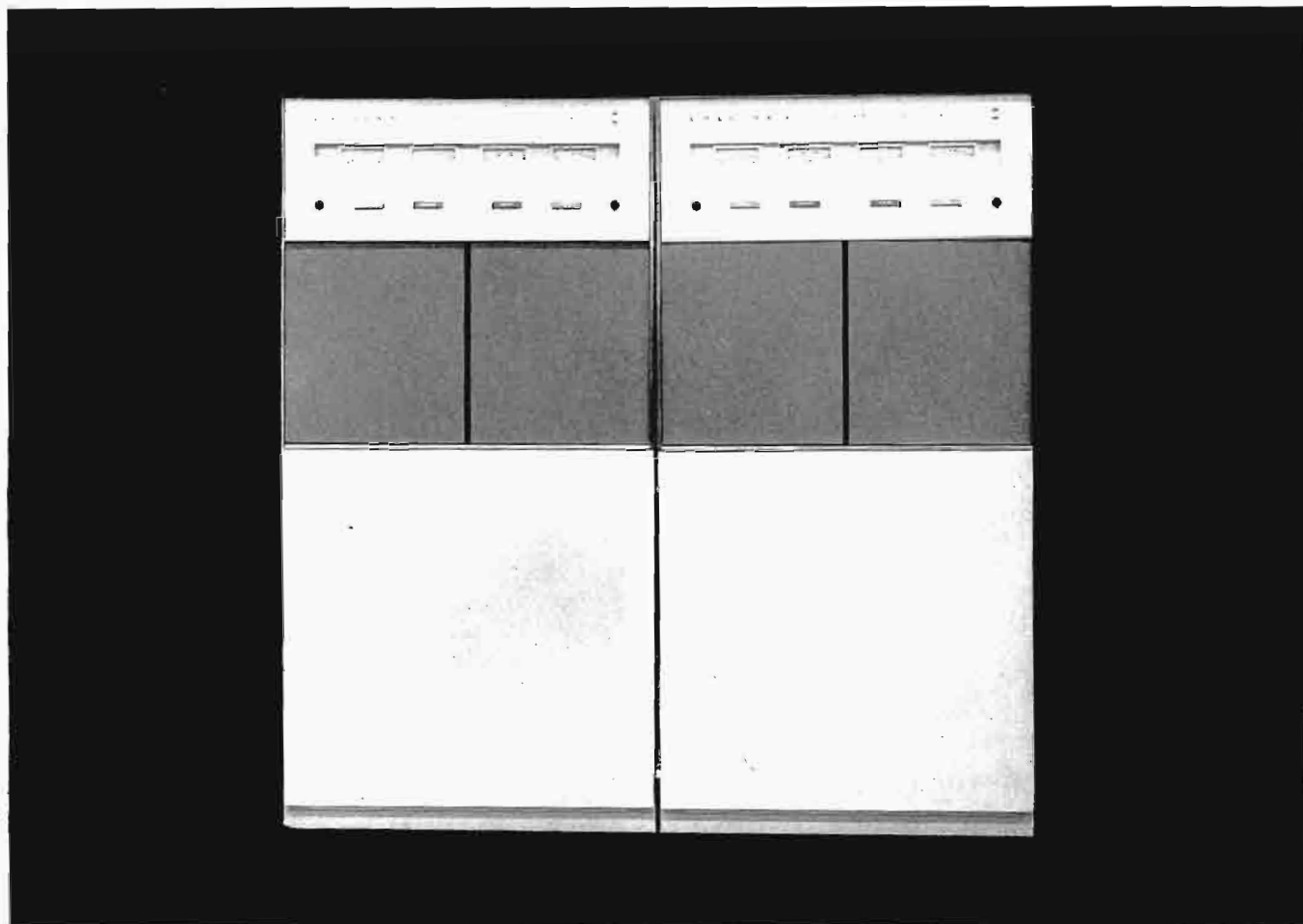

The driver power supply uses solid-state silicon rectifiers that generate little heat and require a minimum of space. The final amplifier plate voltage supply uses silicon diode rectifiers. Efficient blowers force cooling air directly on the power tubes.

MAINTENANCE EASE — All components are easily accessible and may be rapidly inspected through the use of vertical panels. All panels are interlocked for safety; a grounded shorting stick is provided.

RIGID TESTING — In keeping with rigid Collins standards, the transmitter is tested under actual load conditions on the broadcaster's channel before the unit is shipped.

While the transmitter is designed for 60-Hz operation, only the blower motors and plate contactors need be changed for 50-Hz use.

Collins also manufactures the 830F-2B transmitter. This unit uses an 830D-1B 1000-watt driver, required when the additional PA is installed for 20,000-watt operation. If an eventual increase to 20 kw is planned, the 830F-2B should be installed initially.

Frequency Range: 88 to 108 MHz

Power Output: 3000 to 10,000 watts nominal

Carrier Frequency Stability: ± 1000 Hz

Audio Frequency Response: ± 1 db, 50 to 15,000 Hz

Distortion: Less than 0.5%, 50 to 15,000 Hz

FM Noise Level: 65 db below ± 75 kHz

AM Noise Level: -55 db rms

Harmonic Attenuation: -80 db

Modulation Capability: ± 100 kHz

RF Output Impedance: 50 ohms; swr not to exceed 2:1

Audio Input Level: +10 dbm, ± 2 db

Power Source: 230 vac, 60 Hz (50 Hz optional), 3 phase
(tapped for 200 to 250 v in 10-v steps)

Input Power Requirement: 20 kw, 90% power factor

Power Line Regulation: 3%

Variations: Slow line, $\pm 5\%$; rapid line, $\pm 3\%$

Tube Complement: One 4CX250B, one 4CX500A

Temperature Range: 10° to 45°C

Humidity: 0% to 95%

Altitude: 7500 ft

Size: 76 in. W, 76 in. H, 27 in. D (193 cm W, 193 cm H,
69 cm D)

Weight: 1900 lb (861.8 kg)

Part No. 777 1786 (Type 830F-1B)

Part No. 777 1787 (Type 830F-2B)

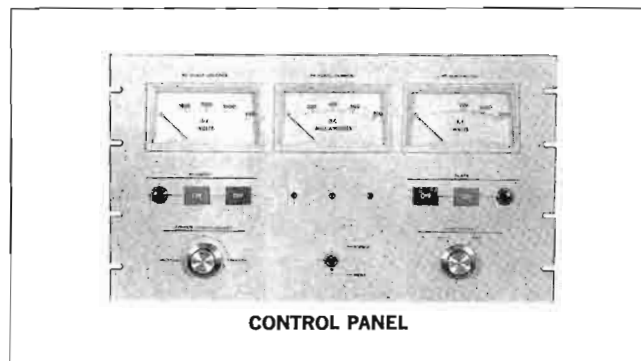

CONTROL PANEL

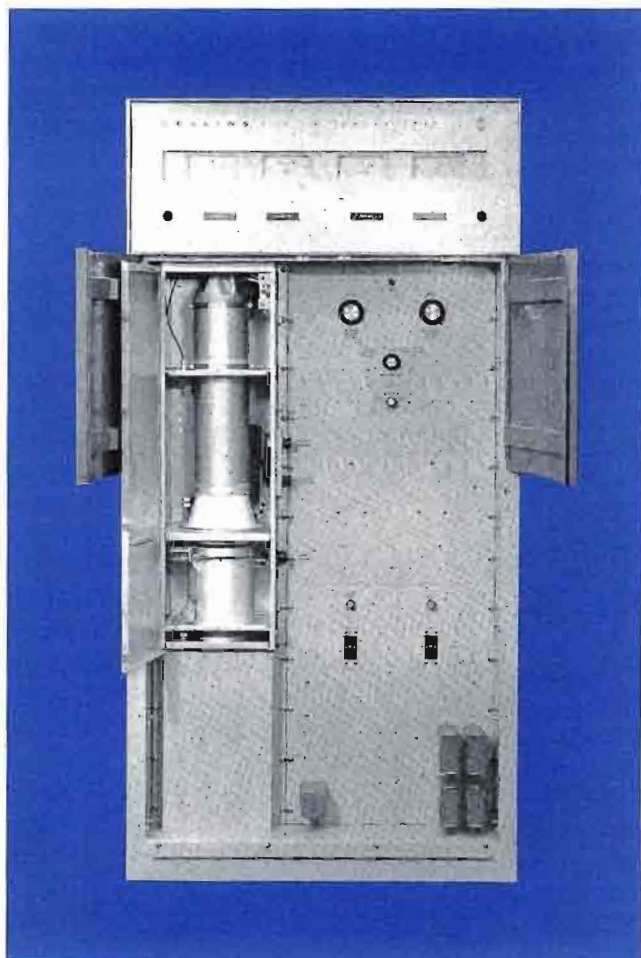

COLLINS 830H-1B/20-KW FM TRANSMITTER

For the broadcaster requiring extended coverage in major markets, Collins offers the 830H-1B, a 20,000-watt FM transmitter contained in only three cabinets. Use of a diplexing system assures continuous duty even though one of the two power amplifiers is removed from service for routine maintenance or repair.

Careful engineering, use of conservatively rated components and precision manufacturing techniques assure the broadcaster of quality upon which he can depend.

Outstanding benefits of the 830H-1B are:

SELF-CONTAINED — Every component, including power transformers, harmonic filters and directional couplers, is housed within the three cabinets. Only the diplexer assembly is mounted on the exterior. This assembly may be located anywhere convenient to the broadcaster. An optional accessory is the 786V-1 Stereo Generator, which plugs into the 310Z-1 exciter.

SIMPLE OPERATION — A pushbutton-operated step-start system assures automatic starting sequencing. Rf circuits, tuned and metered at the front panel, may be adjusted while the transmitter is on the air. The harmonic filter re-

quires no tuning or trimming. The PA stage is neutralized easily and is noncritical in adjustment.

DEPENDABLE — In event of a PA outage, the transmitter remains on the air at 6 db lower output until the antenna is patched to one amplifier to permit half-power (-3 db) operation while the disabled PA is being restored to service. The transmitter is not off the air during this operation. A grounded screen eliminates the bypass capacitors, common trouble points. Independent driver power supply is solid state, requiring little space and generating little heat. The PA power supply consists of a solid-state supply. Efficient, quiet blowers force air directly on the 4CX1000A and two 4CX5000A power amplifier tubes.

MAINTENANCE EASE — All components are easily accessible for inspection and maintenance through vertical panel construction. All cabinet panels are interlocked for safety; a grounded shorting stick is installed in each cabinet to discharge capacitors before servicing.

RIGID TESTING — The 830H-1B, like all Collins transmitters, is tested on the broadcaster's channel under actual load conditions before shipment.

While the transmitter nominally operates on 60 Hz, only the blower motors and plate contactors need be changed for 50-Hz operation.

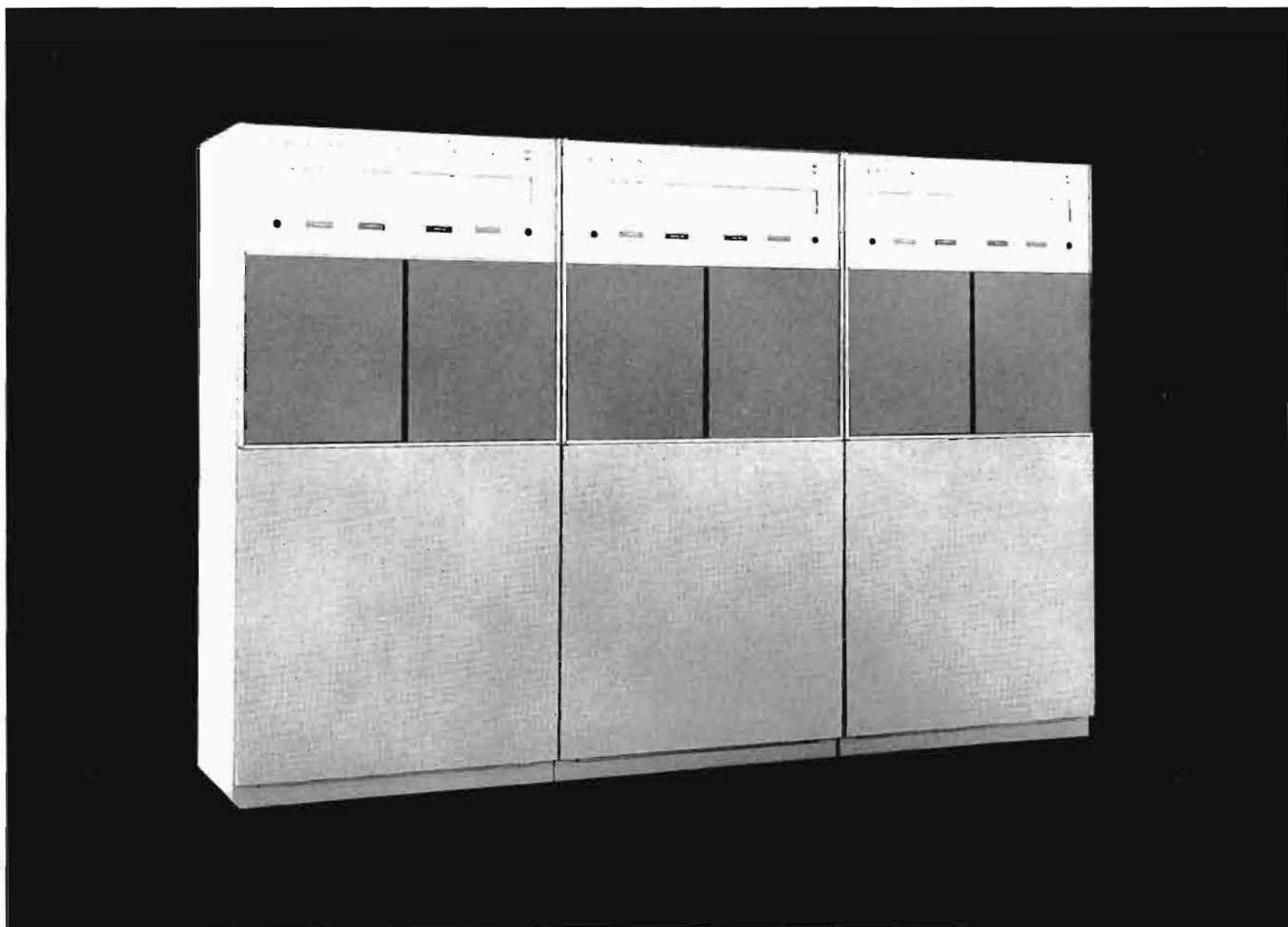

Frequency Range: 88 to 108 MHz
Power Output: 6000 to 20,000 watts nominal
Carrier Frequency Stability: ± 1000 Hz
Audio Frequency Response: ± 1 db, 50 to 15,000 Hz
Distortion: Less than 0.5 %, 50 to 15,000 Hz
FM Noise Level: 65 db below ± 75 kHz
AM Noise Level: -55 db rms
Harmonic Attenuation: -80 db
Modulation Capability: ± 100 kHz
RF Output Impedance: 50 ohms; swr not to exceed 2:1
Audio Input Level: +10 dbm, ± 2 db
Power Source: 230 vac, 60 Hz (50 Hz optional) 3 phase
(tapped for 200 to 250 v in 10-v steps)
Input Power Requirement: 40 kw, 90% power factor
Power Line Regulation: 3%
Variations: Slow line, $\pm 5\%$; rapid line, $\pm 3\%$
Tube Complement: One 4CX1000A, two 4CX5000A
Temperature Range: 10° to 45°C
Humidity: 0% to 95%
Altitude: 7500 ft
Size: 114 in. W, 76 in. H, 27 in. D (290 cm W, 193 cm H,
69 cm D)
Weight: 2900 lb (1315 kg)

Part No. 777 1788

COLLINS 830N-1B FM TRANSMITTER

For the broadcaster whose market includes extensive mobile reception, Collins sells the 830N-1B, a dual 10,000-watt transmitter. This unit transmits 10,000 watts through vertically polarized antennas for automobile receivers and 10,000 watts to the horizontally-polarized antennas for home receivers.

Part No. 522 3592

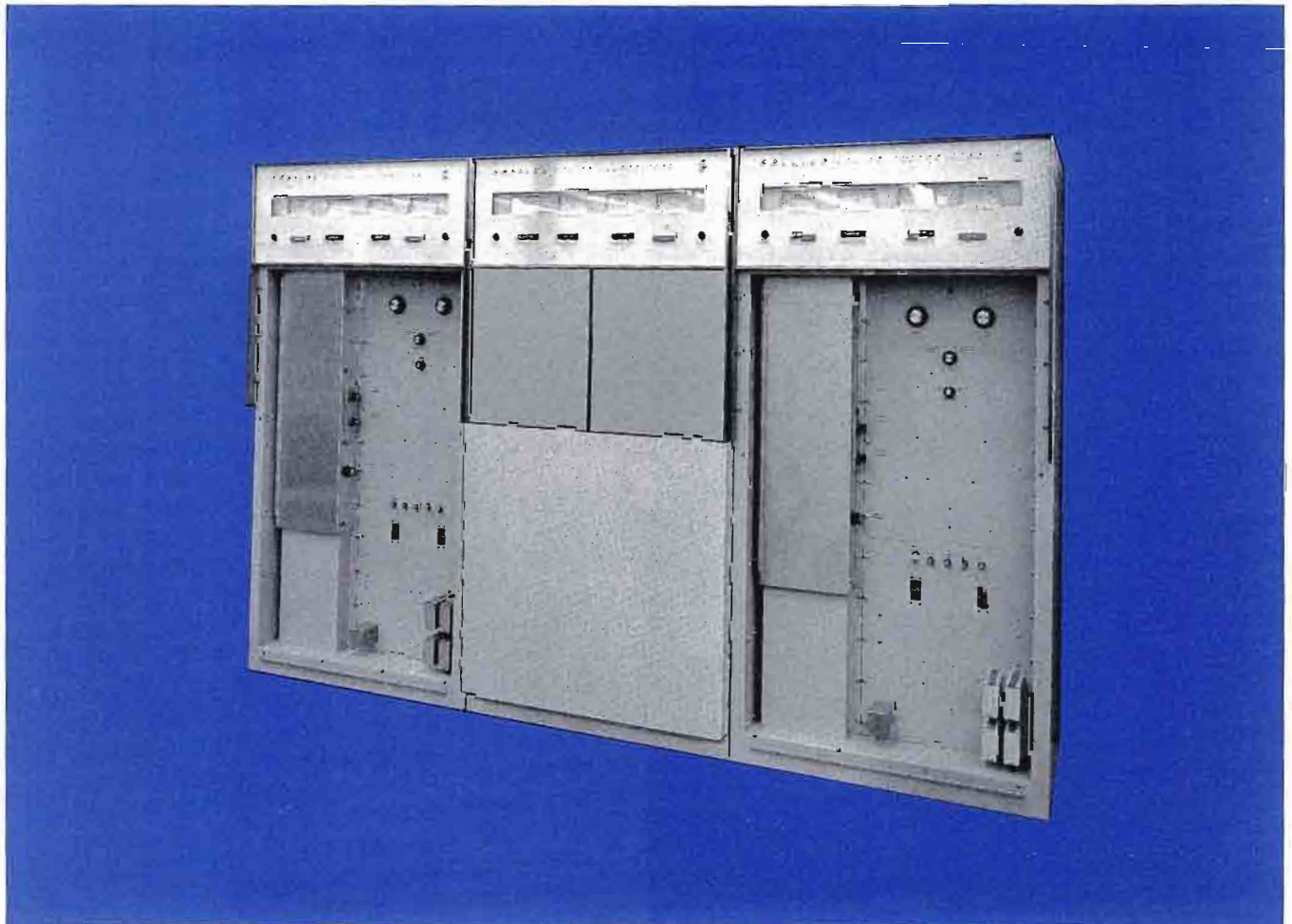

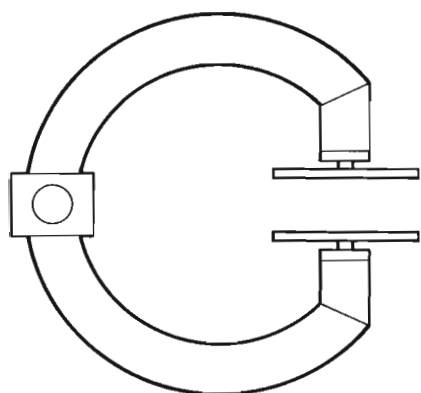

FM
Antennas

COLLINS 37M FM ANTENNA

A proven design that has been imitated but never duplicated in efficiency during the past decade, the Collins 37M Antenna still maintains its position of leadership in FM broadcasting.

The advanced design features of the unit make it an ideal antenna for stereo and multiplex operations. The aerodynamic simplicity and low weight of the 37M provide greater efficiencies and savings in new tower costs, erection time and maintenance expense. These features also eliminate undue oscillating and weaving of the tower and antenna.

The Collins 37M Ring Antenna consists of only two basic parts: the radiating ring and the connecting interring transmission line. Any number of rings, either odd or even, may be used to provide maximum flexibility in high power gain.

Antenna arrays mounted on 1½ or 3½-inches line are available for handling transmitter powers up to 20 kw. Antenna assemblies on a 1½-inch line are rated for power inputs at base of antenna up to 2.5 kw for a single ring array; 10 kw for four or more rings. Antenna assemblies on a 3½-inch line are rated for power inputs up to 2.5 kw per ring at base of antenna with maximum of 20 kw for eight or more rings.

Only one interelement transmission line is required to feed all rings in a multiple element array. The individual radiating rings are identical mechanically and electrically. They are both shunt fed and supported by a single interconnecting feed line, which consists of modified lengths of standard EIA rigid coaxial line insulated with Teflon. The Collins 37M FM Antenna feed system has a stub at the top of the array that is capacitive and adequately removes the inductive reactance created by the shunt feed on the ring. The 37M terminates in a standard EIA 50-ohm flange connection on the bottom element of the array for coupling directly to a 1½ or 3½-inch transmission line.

The horizontal radiation pattern of the Collins 37M FM Antenna is essen-

tially circular for both top-mounting and side-mounting arrays. The extent of deviation from a circular pattern in the side-mounted antenna is dependent on the type and size of tower on which the antenna is mounted. In cases of very large supporting structures and in all cases where guy wires are used, expert recommendations should be requested on spacing of insulators and guy wires and mounting of the antenna. Insulators should be placed where the guys attach to the tower and guys should also be broken with insulators approximately every 3 feet for 15 feet in the immediate area of the antennas.



The voltage standing wave ratio of the Collins 37M Antenna can be maintained at better than 1.15:1 when field tuned because of the inherently high stability of the tuning system. The capacitor plates of the 37M are adjustable for optimum performance and equal power distribution through all rings. These features allow an accurate prediction of the gain from the given number of loops in the array. Adequate bandwidth virtually eliminates detuning effects caused by changes in atmospheric conditions. The bandwidth and linearity of the antenna are more than adequate for multiplexing service.

The compactness and simplicity of the 37M allow maximum efficiency in ice removal. Each ring may be equipped with an internally mounted, 300-watt heating unit consisting of a cartridge type element inside each of

the tuning capacitor plates and an additional flexible heating element extending the full circumference of the inside of the ring. The simplicity of the heating arrangement makes it possible to replace the elements in the field if necessary. The absence of large masses of metal assures efficient and practical deicing of the antenna and capacitor, which are the most critical parts of the antenna when icing occurs.

The 37M Antenna is easy and quick to erect. There are no heavy hoisting problems, so many hours of erection time can be saved. Support brackets are specially fabricated for each installation to match the tower and mounting arrangement, thus minimizing erection problems at the site.

Either guyed or self-supporting towers will in nearly all cases support the side mounting 37M. Towers that support top mounting television antenna arrays increase their usefulness with the addition of a side-mounting 37M Antenna.

Top or pole mounting design is available on special order for installation on towers where no TV antenna is present or planned. This type of mounting provides the maximum in height and coverage. The light weight and windloading of the top mounting series allows erection on most guyed and self-supporting towers without extensive tower modification.

Further information and quotations on the 37M FM Directional Antenna will be supplied upon request.

Part No.	Type and Number of Rings
013 0020	37M-1
013 0030	37M-2
013 0040	37M-3
013 0050	37M-4
013 0060	37M-5
013 0070	37M-6
013 0080	37M-7
013 0090	37M-8
097 1693	37M-10
097 1528	37M-12

For top mounted, with mast rings mounted on 1½-in. Line or 3½-in. Line, Part Number remains the same for the specified number of rings.

No Part Number

37M FM Antennas for power inputs over 20 kw

Part No. 013 0099 000

Deicer per bay installed at the factory

Part No. 124 0061 672

Replacement heating element. Two required per ring — 115v, 150w

Type 37M Antenna — Side Mounted

Collins Type	No. of Rings	Power Gain	Field Gain	db Gain	A** Feet & Inches	On 1 5/8" Line		On 3 1/8" Line	
						B***	Weight (lb)	B***	Weight (lb)
37M-1	1	0.9	.95	— 0.45	2'5"	43	42	81	69
37M-2	2	2.0	1.41	3.01	12'3"	125	91	234	155
37M-3	3	3.0	1.73	4.77	22'1"	206	140	386	241
37M-4	4	4.1	2.02	6.13	31'10"	288	189	538	327
37M-5	5	5.2	2.28	7.16	41'8"	370	238	691	413
37M-6	6	6.3	2.51	7.99	51'5"	451	287	843	499
37M-7	7	7.3	2.70	8.63	61'3"	533	336	996	585
37M-8	8	8.4	2.90	9.24	71'0"	614	385	1148	671
37M-9*	9	9.4	3.07	9.73	80'10"	696	434	1300	757
37M-10*	10	10.5	3.24	10.21	90'7"	778	483	1453	843
37M-12*	12	12.5	3.54	10.97	110'3"	941	581	1758	1015
37M-14*	14	14.5	3.81	11.61	129'10"	1104	679	2062	1187
37M-16*	16	16.5	4.06	12.17	149'5"	1267	777	2367	1359

- * Antennas of over 8 bays are center fed.
- ** Computed for 100 MHz. For other frequencies multiply by 100 divided by frequency in MHz.
- *** Wind loads based on 60 pounds on flat surfaces, 40 pounds per square foot on projected areas of cylindrical surfaces with all sections considered round.

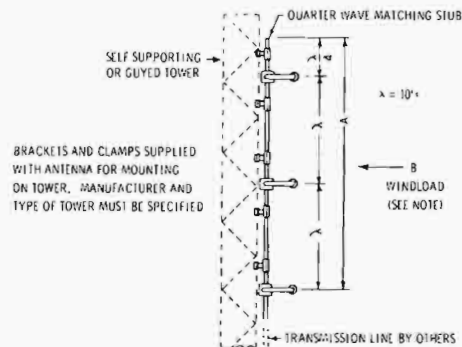

Type 37M Antenna — Top Mounted

Collins Type	No. of Rgs	Pwr Gn	On 1 5/8-in. Line									On 3 1/8-in. Line					
			A Ft	B Ft	C Ft	D Ft	E Dia	F Dia	G Lb	H Ft-Lb	Dead Wt	D Ft	E Dia	F Dia	G Lb	H Ft-Lb	Dead Wt
37M-1	1	0.9	6		3	4-7	3 1/8"	3 1/8"	50	230	223	4-7	3 1/8"	3 1/8"	68	312	250
37M-2	2	2.0	16	10±	4	10	4 1/2"	4 1/2"	239	2,390	305	12-3	4 1/2"	4 1/2"	291	3,565	360
37M-3	3	3.0	26	20±	7	14-5	6 5/8"	6 5/8"	403	5,803	736	14-4	6 5/8"	6 5/8"	486	6,950	825
37M-4	4	4.1	36	30±	10	19	7 5/8"	7 5/8"	564	10,716	1169	18-9	7 5/8"	7 5/8"	678	12,713	1290
37M-5	5	5.2	46	40±	12	23	8 5/8"	7 5/8"	747	17,181	1652	22-8	9 5/8"	9 5/8"	919	20,769	2128
37M-6	6	6.3	56	50±	14	27-2	9 5/8"	8 5/8"	951	25,867	2285	26-7	10 3/4"	9 5/8"	1173	31,260	2770
37M-7	7	7.3	66	60±	15	31	10 3/4"	8 5/8"	1175	36,425	3218	31-3	10 3/4"	8 5/8"	1388	43,375	3485
37M-8*	8	8.4	76	70±	16-6	34-9	11 3/4"	9 5/8"	1417	49,241	4051	34-8	12 3/4"	11 3/4"	1696	58,682	4650

*up to 12 bays on application

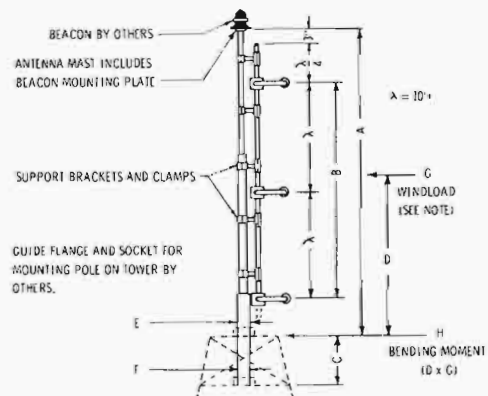

COLLINS 300C VERTICALLY POLARIZED FM ANTENNA

Collins 300C vertically polarized FM antenna can significantly improve your FM coverage. Here's how:

FCC regulations permit simultaneous FM radiation in both horizontal and vertical planes. For example, if your station is authorized for 5-kw ERP horizontal, vertical radiation can be added up to the same power. Stations now operating with greater ERP than specified in new FCC rules for their classification may radiate vertically up to the maximum ERP specified in the rules.

Two methods are commonly used:

(1) A single power amplifier and transmission line to provide power for each antenna.

(2) Two power amplifiers fed from a common exciter-driver and two transmission lines. The antennas are fed separately.

The preferred method will be dictated by your power situation. If min-



imum initial investment is your primary concern, the first method is preferred. If redundancy is important, the second method permits either amplifier to be operated individually or both simultaneously. The recommended ratio of vertical to horizontal ERP is unity.

Collins Type 300C costs no more than your present horizontal bays, can be installed on your present tower, and is compatible with your FM transmitter.

Vertical polarization with Collins 300C:

- Fills in shadow areas
- Reduces null effects
- Improves fringe area reception
- Vastly improves car FM radio reception
- Maintains FM stereo quality
- Improves SCA operation.

Type 300C Antenna — Side Mounted

Type	No. of Dipoles	Power Gain	Field Gain	db Gain	Power Rating		Length
					1 7/8-in. Line	3 1/8-in. Line	
300-1	1	0.950	0.975	-0.002	3	3	3'9"
300-2	2	1.969	1.400	2.942	6	6	13'7"
300-3	3	3.120	1.767	4.942	9	9	23'4"
300-4	4	4.198	2.045	6.230	10	12	33'2"
300-5	5	5.310	2.305	7.251	10	15	42'11"
300-6	6	6.393	2.528	8.057	10	18	57'9"
300-7	7	7.500	2.738	8.751	10	21	62'7"
300-8*	8	8.571	2.926	9.330	20	24	72'4"
300-9*	9	9.755	3.124	9.892	20	27	82'2"
300-10*	10	10.960	3.311	10.398	20	30	91'11"
300-12*	12	13.195	3.633	11.204	20	36	111'7"
300-14*	14	15.290	3.910	11.844	20	42	131'2"
300-16*	16	17.483	4.181	12.426	20	48	150'9"

Type	Weight		Wind Load**		Over Turning Moment***	
	1 7/8-in. Line	3 1/8-in. Line	1 7/8-in. Line	3 1/8-in. Line	1 7/8-in. Line	3 1/8-in. Line
300-1	50	55	104	104	0	0
300-2	111	135	259	307	1,190	1,430
300-3	171	215	414	510	3,900	4,840
300-4	232	292	569	713	8,350	10,200
300-5	292	375	724	916	14,300	17,600
300-6	353	455	879	1119	21,100	27,000
300-7	413	535	1034	1322	29,900	38,400
300-8*	474	615	1189	1525	40,200	51,700
300-9*	534	695	1344	1728	52,100	67,100
300-10*	595	775	1499	1931	65,400	84,400
300-12*	716	935	1809	2337	96,600	125,000
300-14*	837	1095	2119	2743	133,965	173,000
300-16*	958	1255	2429	3149	177,000	230,000

* Antennas of eight bays and over are center fed.

** Wind load in the direction through the mounting toward the tower computed for 60 lb on flat surfaces and 40 lb on projected areas of cylindrical surfaces.

*** For 60-lb wind loading direction through the mounting toward the tower and referred to the centerline of the bottom bay.

COLLINS 37CP CIRCULARLY POLARIZED FM ANTENNA

Collins 37CP series of Circularly Polarized FM Antennas is designed for use in monaural, stereo, and multiplex FM broadcasting. These antennas have a low standing wave ratio over a 200-kHz channel, providing optimum conditions for stereo or multiplex operation.

The 37CP antenna radiates a circularly (clockwise) polarized wave for improved reception in FM automobile radios employing vertical whip antennas and in home receivers employing dipole antennas. In fact, these antennas can be used to advantage in any application that previously required the use of separate vertically and horizontally polarized antennas of equal power gain and equal power input requirements.

Collins 37CP antenna transmits circular polarization as authorized by the FCC rules and regulations. A station's ERP is determined by the signal radiated in the horizontal plane. The ERP is determined by the antenna power gain (see table) in the horizontal plane multiplied by the power fed to the antenna. When using circular polarization instead of horizontal polarization, transmitter power can be doubled without exceeding the licensed horizontal effective radiated power. This is because the additional power radiated is in other planes of polari-

zation. Conversely, for a given transmitter power, the number of antenna bays can be doubled for the same reason. An external power divider or splitter is not required.

Mechanically, the 37CP Antenna is designed for rugged service in all types of weather environment; it will withstand wind velocities of over 100 miles per hour. Any number of antenna elements from 1 to 16 may be used to provide maximum flexibility in selecting gain for any particular installation. The design is flexible and permits ease of installation on the side of an existing tower, or pole mounting on top of towers or buildings.



Mounting brackets are supplied with antennas for standard or conventional installation at no extra cost. Custom brackets can be supplied at extra cost for special or unusual types of installations. The antenna can be supplied with standard poles using either pedestal or socket mounts.

Frequency Range: Factory tuned to one frequency in the 88- to 108-MHz band

Polarization: Circular, clockwise

Power Gain:

Horizontal Polarization: See table.

Vertical Polarization: See table.

Azimuthal Pattern:

Horizontal Polarization:

Circular ± 2.0 db in free space

Vertical Polarization:

Circular ± 2.0 db in free space

VSWR at Input (without field trimming):

Top Mounting: 1.1:1 or better

Side Mounting: 1.5:1 or better

VSWR at Input (with field trimming):

Top or Side Mounting: 1.1:1 or better over ± 110 kHz

Input Connection: 3/8-inch, 50-ohm EIA female flange

Power Input Rating (one bay): 20 kw

Windload: 50 lb/sq ft for flat surfaces;

33 lb/sq ft for cylindrical surfaces

Dimensions: 30 in. high by 45 1/2 in. long

Weight:

Antenna Bay: 41 lb (19 kg)

Interconnecting Feed Line: 27 1/2

lb (12 kg)

Mounting Bracket: 22 lb (10 kg)

Type 37CP Antenna

Type	No. of Elements	Power Gain		Field Gain		DB Gain		Power Rating	Length**	Weight (lb)	Wind Load***
		H	V	H	V	H	V				
37CP-1	1	.438	.438	.662	.662	-3.7	-3.7	20	2' 5"	55	177
37CP-2	2	.947	.947	.973	.973	-.1	-.1	40	12' 3"	120	402
37CP-3	3	1.48	1.48	1.22	1.22	1.7	1.7	40	22' 1"	185	627
37CP-4	4	2.02	2.02	1.42	1.42	3.1	3.1	40	31' 10"	250	851
37CP-5	5	2.58	2.58	1.61	1.61	4.1	4.1	40	41' 8"	315	1076
37CP-6	6	3.13	3.13	1.77	1.77	5	5	40	51' 5"	380	1301
37CP-7	7	3.69	3.69	1.92	1.92	5.7	5.7	40	61' 3"	445	1526
37CP-8	8	4.26	4.26	2.06	2.06	6.3	6.3	40	71' 0"	510	1751
37CP-9	9	4.82	4.82	2.20	2.20	6.8	6.8	40	80' 10"	575	1975
37CP-10*	10	5.40	5.40	2.33	2.33	7.3	7.3	40	90' 7"	640	2247
37CP-12*	12	6.53	6.53	2.56	2.56	8.2	8.2	40	110' 3"	770	2696
37CP-14*	14	7.67	7.67	2.77	2.77	8.9	8.9	40	129' 10"	900	3146
37CP-16*	16	8.81	8.81	2.97	2.97	9.5	9.5	40	149' 5"	1035	3595

* Antennas of 10 bays and over are center fed with even numbers of bays, or at a point 1/2 bay below center with odd number of bays.

** When determining coax line lengths add 6 ft to antenna lengths to allow for matching stub.

*** Wind loading based on 50 psf wind pressure on flat surface, 33 psf on cylindrical surface (110 mph actual wind velocity).

AM AND FM TOWERS

Collins furnishes a wide selection of both self-supporting and guyed antenna towers to meet the requirements of any AM or FM installation.

Towers are normally supplied with a protective coating of rust inhibitive paint prior to shipment, although they can be supplied with a galvanized finish at a slightly higher price. Galvanized is recommended in locations where the tower will be subjected to salt water spray, extreme humidity or other corrosive conditions. The finish coat is normally supplied by the tower erector and is in keeping with FAA requirement.

All hardware, fittings, guy insulators, anchor steel and base insulator (where required) are supplied with each tower. The applicable FCC (FAA) lighting kit and wiring are also provided.

COPPER GROUND WIRE

Bare #10 copper ground wire is used for ground radials. Wire attaches to mesh ground screen.

Weight: 31.8 ft per lb

Part No. 421 1010 000

COPPER GROUND STRAP

This fine quality copper ground strap is available in two sizes: 2 in. by 0.032 in. (4.02 ft per lb.), and 4 in. by 0.032 in. (2.01 ft per lb.).

Part No. 097 1445 00 (2-in. strap)

Part No. 099 2689 00 (3-in. strap)

Part No. 097 0811 00 (4-in. strap)

HUGHEY & PHILLIPS RING TRANSFORMER

For use wherever 60-Hz energy must be transferred across two points with very low capacitance or at very high voltages. Provides a highly reliable, low capacity means of supplying power across base insulator or insulated radio towers employed as radiators. Their relatively large spacing and low capacity between windings make these isolation transformers desirable for use in directional arrays, and especially with radiators that develop very high voltages across the base insulators. No tuning or rf adjustments are necessary. Available in load capacities of 1750 watts (Model TI 2017) and 3500 watts (Model TI 2035) 115/230 volts.

Part No. 097 6920 00 (Type TI 2017)

Part No. 099 0365 00 (Type TI 2035)

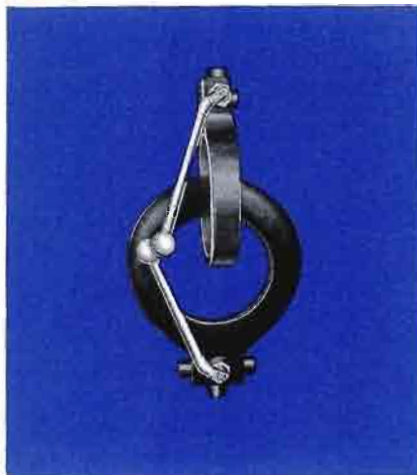

TRUSCON MESH GROUND SCREEN

Expanded copper mesh ground screen is for use beneath base of antenna tower to increase soil conductivity. Available in 8- by 24-ft sheets.

Part No. 013 0107 00

FISHER-PIERCE 63305-DB BEACON LIGHT CONTROL

Designed to mount in a standard commercial meter socket. The 63305-DB will automatically control broadcast tower lights directly or with auxiliary contactors. Adjustable potentiometer allows adjustment for operation from 0 to 50 footcandles.

Power Requirements: 105 to 130 volts, 50/60 Hz

Built-in Load Contactor: Single Pole, Single Throw, Double Break

Load Rating: 3000 watts

Part No. 124 0032 559

COLLINS TRANSMISSION LINE KIT

Collins Transmission Line Kit contains an assortment of couplings, flanges, elbows, fittings, hardware, etc. for installation of FM antennas and coaxial lines. All items are packed in a sturdy case in which the unused items may be returned to Collins for credit.

Part No. 782 0009 001
(1 $\frac{5}{8}$ -inch kit)

Part No. 782 0008 001
(3 $\frac{1}{8}$ -inch kit)

TRANSMISSION LINES AND ACCESSORIES

Information on Andrew or Prodelin transmission lines, fittings, and accessories will be supplied upon request.

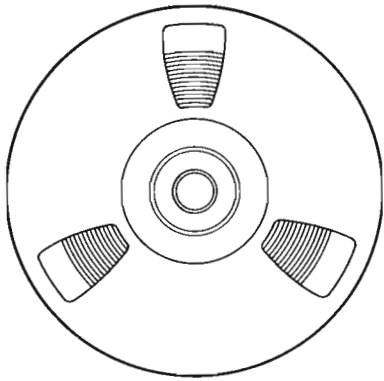

Audio Equipment

COLLINS 212S-1 STEREO SPEECH INPUT CONSOLE

The Collins 212S-1 Speech Input Console features new concepts and techniques to offer broadcasters, recording studios and television studios quality performance with versatility and adaptability.

It's the newest switching technique in speech input consoles. It's noiseless. The switch is made of a photoconductive cell and a lamp in a sealed container. The cell shows a very low resistance when the lamp is on. This makes a switch with no contacts to wear, bounce, or become contaminated.

A similar device for level control of the program material is also used. The photoconductive cell responds to variable voltages from a potentiometer to control attenuation in the signal path. This control eliminates maintenance time normally required for cleaning and relubrication of mixer controls.

The fact that these photoconductive devices can be remotely controlled by dc voltages makes it possible to mount the switching and attenuating components where they are needed rather than on the front panel. This allows complete physical and electrical separation of the two program channels and elimination of all program audio wiring and components from the front panel.

Collins new 212S-1 was designed primarily for stereo, but it can also be used for monaural. It provides monaural output simultaneously on both program channels from a single input, or can handle completely separate monaural material from inputs through two program outputs. One switch controls this function.

Like all other Collins broadcast equipment, the 212S-1 is easy to install and maintain. Simple removal of a protective cover exposes the input/output terminals on the deck. Cable access ports through this deck permit an installation that's free of the "haywire look"! Removal of another protective cover exposes the wiring to the

card box receptacles. And inspection of the cards can be made simply by lifting the hinged card box to the vertical position. An extender card is furnished for troubleshooting at the component level with the cards connected to the rest of the console.

The solid-state amplifiers and the control elements are mounted on the plug-in cards that fit in two card boxes, one box for each program channel. The card box provides space and receptacles for six high-level or low-level pre-amplifiers, one program amplifier, one monitor amplifier and one switch matrix for remote line input switching. Each high-level and low-level card has two balanced inputs selectable from the front panel. Stable, high-quality components and circuits are used throughout the amplifiers to assure reliability and fidelity.

The VU meters may be switched to the channels or to external lines. Switching and terminals are also provided for the connection of the Collins 900C-3 FM Stereo Modulation Monitor outputs to the inputs of monitor amplifiers.

The 212S-1 also includes an intercom amplifier that can be switched to one of four stations or to a selected remote line. The speaker is also used for the intercom microphone. The intercom amplifier can be used as the amplifier for the signals on the cue bus by setting the intercom switch at the cue position. A reverse cue amplifier is also provided so that program material may be sent back to a remote site preceding the start of a remote program.

Switching for warning light and speaker muting is provided by a relay unit with a self-contained 12-volt dc power supply. The power supply is used to power the lamps which illuminate the VU meters. Four relays are included in the unit.

A Dual Channel version of the 212S-1 is available without stereo. It has stereo capability, and if desired later, the stereo configuration can be added by the simple addition of cards.



260S-1 Mixer Add-on Units

You can add input capability to the 212S-1 Speech Input Console with the addition of one or more Collins 260S-1 Mixer Add-on Units. You can add two complete stereo input channels for microphones, turntables or tape recorders. Each input amplifier has two selectable inputs. Level and switching control on the 260S-1 units are performed the same as on the 212S-1. The add-on units accommodate either four preamplifiers or four high-level input cards, or two preamplifiers and two high-level cards — depending upon your needs or sources.

Maximum Number of Channels: Five stereo inputs from local sources plus one of four remote stereo inputs or



one network stereo input. Each local stereo input may have two selectable sources. With each 260S-1 Add-On Unit, two additional local stereo inputs may be used, each having two selectable sources.

Power Source: 115 or 230 vac $\pm 10\%$, 50 to 60 Hz, single phase

Input Impedance: Lower level, 30/150/250/600 ohms balanced or unbalanced; Net/Remote, 600 ohms balanced; Medium level, 600 ohms balanced or unbalanced

Output Impedance: Line, 600 ohms (150 ohms on special order); Monitor, 8 ohms

Input Level: Low, -55 dbm nominal; Medium, -10 dbm; Net/Remote, $+8$ dbm

Gain: Low level to program output at least 100 db

Output Level: Program, $+8$ dbm; Monitor, 10 watts

Frequency Response: ± 1 db, 30 to 15,000 Hz (ref. 1 kHz) on both program and monitor outputs

Harmonic Distortion: Less than 1% at max. program level or max. monitor level

Noise: -120 dbm or less equivalent input noise

Size: 10 $\frac{1}{8}$ in. H by 37- $\frac{3}{16}$ in. W by 18 $\frac{3}{8}$ in. D (26 cm by 95 cm by 47 cm)

Weight: 114 lb (52 kg)

Color: White and dark gray front panel; terra cotta accent strip, light gray cabinet

Part No. 522 3880 001 (212S-1)

Part No. 522 3880 710 (Dual Channel)

Part No. 522 3882 001 (260S-1)

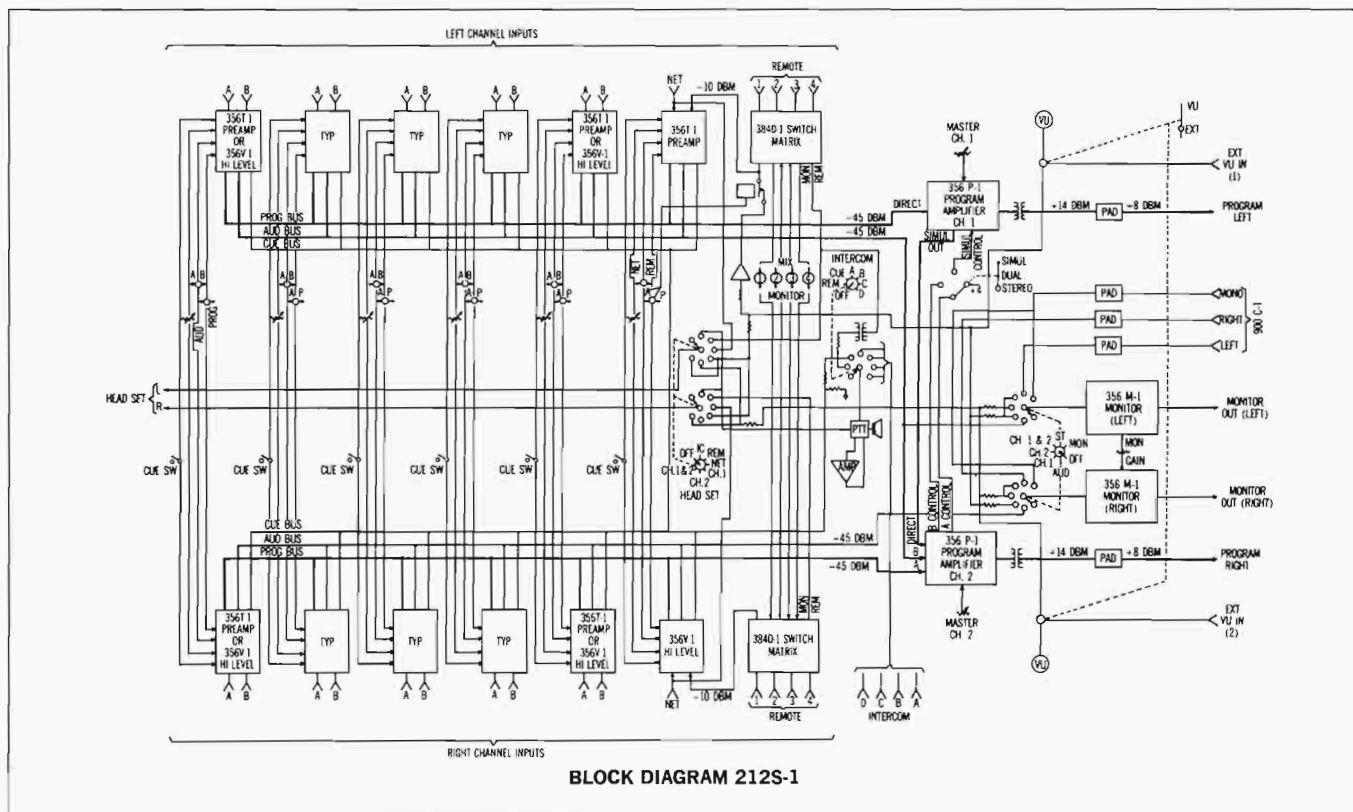

COLLINS 212M-1 SPEECH INPUT CONSOLE

The 212M-1 is the monaural equivalent of the 212S-1 Stereo Console. Utilizing the source modules in a lesser quantity, the broadcaster can realize the same reliability, fidelity and operational features as described above by the 212S-1.

Maximum Number of Channels: Five mono inputs from local sources plus one of four remote inputs or one network input. Each local input may have two selectable sources. With each 260S-1 Add-On Unit, two additional local inputs may be used, each having two selectable sources.

Power Source: 115 or 230 vac $\pm 10\%$, 50 to 60 Hz, single phase

Input Impedance: Low level, 30/150/250/600 ohms balanced or unbalanced; Net/Remote, 600 ohms balanced;

Medium level, 600 ohms balanced or unbalanced
Output Impedance: Line, 600 ohms, (150 ohms on special order); Monitor, 8 ohms
Input Level: Low, -55 dbm nominal, Medium, -10 dbm, Net/Remote, +8 dbm
Gain: Low level to program output at least 100 db
Output Level: Program, + 8 dbm; Monitor, 10 watts
Frequency Response: ± 1 db, 30 to 15,000 Hz (ref. 1 kHz) on both program and monitor outputs
Harmonic Distortion: Less than 1% at max. program level or max. monitor level
Noise: -120 dbm or less equivalent input noise
Size: 10 $\frac{1}{8}$ in. H by 37-3/16 in. W by 18 $\frac{3}{8}$ in. D (26 cm by 95 cm by 47 cm)
Color: White and dark gray front panel; terra cotta accent strip. Light gray cabinet
Weight: 107 lb (49 kg)

Part No. 522 3879 001

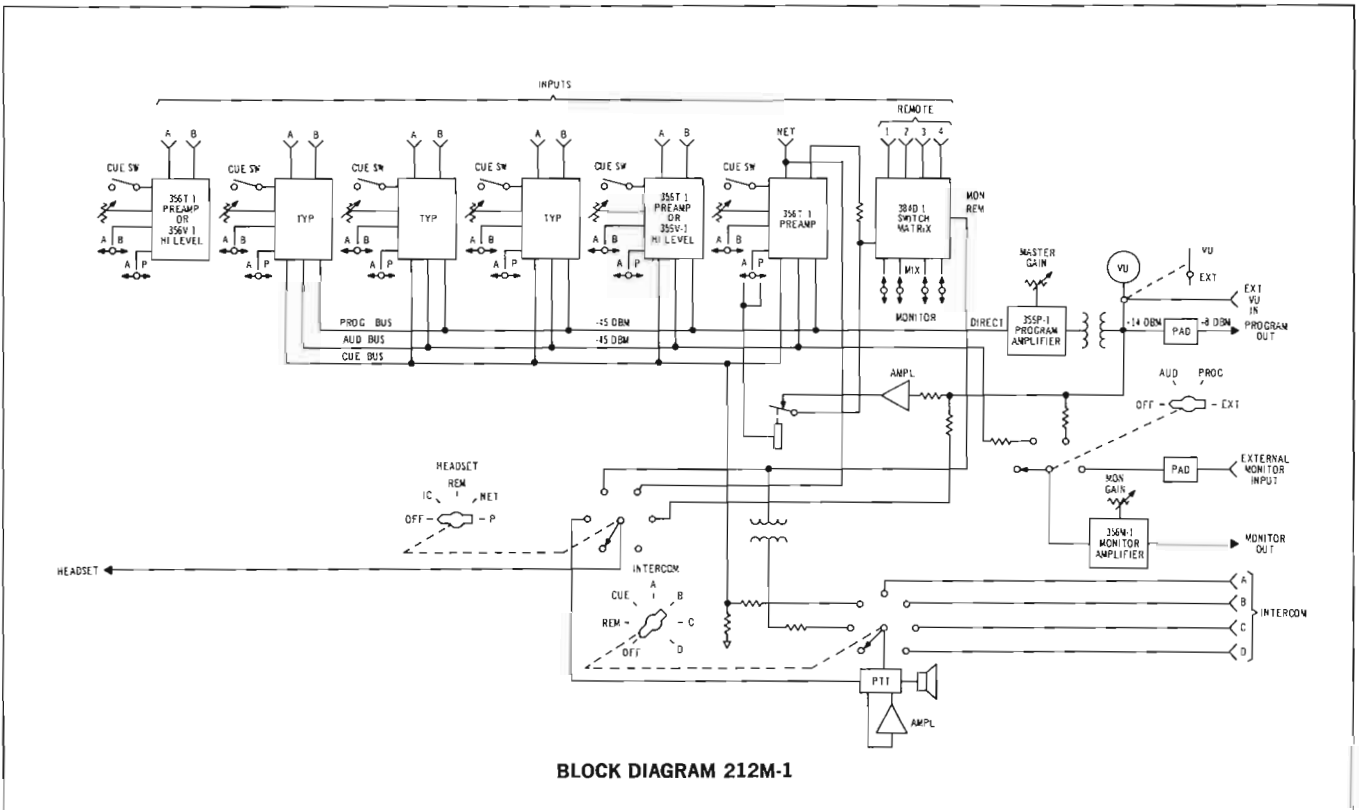

COLLINS 356T-1 PREAMPLIFIER

The 356T-1 is used with the 212S-1 and 212M-1 consoles in input channels where microphones are to be utilized.

Input Impedance: 600/250/150/30 ohms balanced, factory wired for 150 ohms

Gain: Total 50 db voltage gain, -65 dbm from microphone will deliver -45 dbm to input to program amplifier (Includes mixer loss)

Noise: 120 dbm equivalent input noise

Output Impedance: Direct \approx 150 ohms, Program >10 K, 25 db mixing loss

Outputs: Direct, program, audition, and cue

Inputs: MIC 1, Max. input = -30 dbm

MIC 2, Max. input = -30 dbm

Power Requirements: +30 vdc Regulated at 5 ma

Attenuator & Switch Lamps	}	+6 vdc Regulated at 60 ma (1 lamp)
		+4 vdc Regulated at 120 ma (3 lamps)

Frequency Response: ± 0.5 db from 30 Hz to 15 kHz (ref. to 1 kHz)

Harmonic Distortion: 0.5% max. at rated output

Temperature Limits: 0° to 50° C

Size: 4 by 6-inch plug-in card; 1-inch max. component height

Adjustments: Trimpot for tracking attenuators

Attenuator: Photocell lamp unit built into circuit board.

0 vdc to 6 vdc (controlled by external series variable resistor*) attenuates signal over a 55-db range.

Switches: Photocell lamp unit used for all audio circuit switching

*One variable resistor may be used to control attenuation of two preamps. Preamps track within ± 1 db.

Part No. 522 3885 001

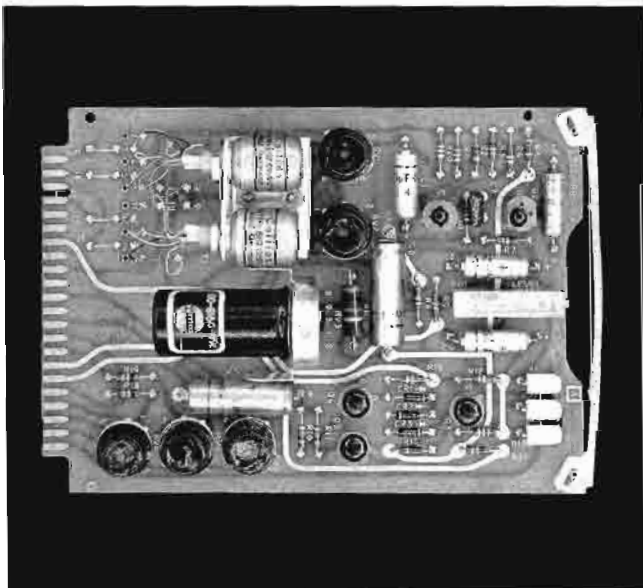

356V-1 HIGH LEVEL INPUT PREAMPLIFIER

The 356V-1 is required for input channels for the 212S-1 and 212M-1 consoles where outputs of the turntable pre-amplifier, tape recorders, and other equipment with audio outputs between -10 dbm and +10 dbm are fed into the console.

Input Impedance: 600 ohms, balanced

Gain: -10 dbm input will deliver -45 dbm to input of program amplifier (Includes mixer loss), 30-db pad on input

Output Impedance: Direct \approx 15 ohms

Program: >10 K, 25-db mixing loss

Outputs: Direct, program, audition, and cue

Inputs: IN 1: Max. input = +10 dbm

Inputs: IN 2: Max. input = +10 dbm

Power Requirements: +30 vdc at 5 ma

Attenuator & Switch Lamps	}	+6 vdc at 60 ma Regulated (1 lamp)
		+4 vdc at 120 ma Regulated (3 lamp)

Frequency Response: ± 0.5 db from 30 Hz to 15 kHz (Ref. to 1 kHz)

Harmonic Distortion: 0.5% maximum at rated output

Temperature Limits: 0° to +50° C

Size: 4 by 6-in. plug-in card; 1-in. maximum component height

Adjustments: Trimpot for tracking attenuators

Attenuator: Photocell lamp unit built into circuit board.

0 vdc to 6 vdc (controlled by external series variable resistor*) attenuates signal over a 55-db range.

Switches: Photocell lamp unit used for all audio circuit switching

*One variable resistor may be used to control attenuation of two hi-level inputs. Tracking is within ± 1 db.

Part No. 522 3887 001

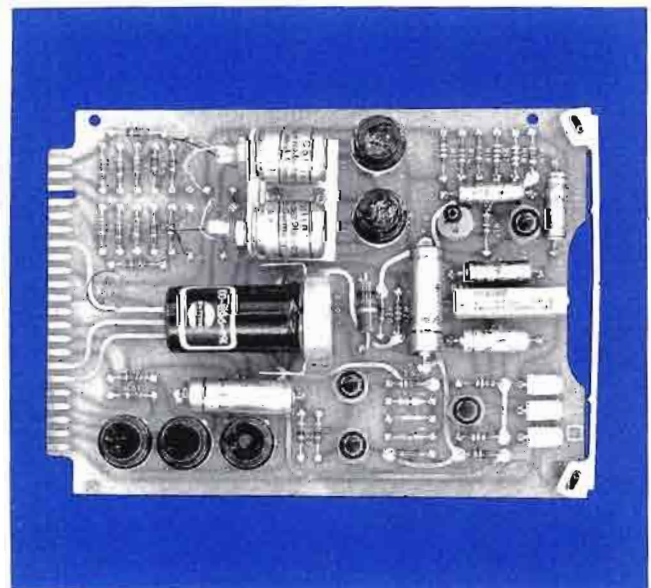

356P-1 PROGRAM AMPLIFIER

The 356P-1 is supplied for use in 212S-1 and 212M-1 consoles as the program output amplifier.

Input Impedance: 600 ohms, balanced or unbalanced

Gain: -45 dbm input will deliver +18 dbm at maximum gain setting; 63-db gain

Output Impedance: 600 ohms (external transformer and capacitor required, not supplied) (direct output impedance less than 30 ohms)

Outputs: Program and Simulcast

Inputs: Switched 1, switched 2, and direct

Power Requirements: +48 vdc at 100 ma (full output)

Attenuator & Switch Lamps $\left\{ \begin{array}{l} +6 \text{ vdc at } 60 \text{ ma regulated} \\ +4 \text{ vdc at } 40 \text{ ma regulated} \end{array} \right.$

Frequency Response: ± 0.5 db from 30 Hz to 15 kHz (ref. to 1 kHz)

Harmonic Distortion: 0.5% maximum at rated output

Temperature Limits: 0° to +50°C

Size: 4 by 6-inch plug-in circuit card; 1-inch maximum component height

Adjustments: Trimpot for Simulcast gain set

Attenuator: Photocell lamp unit built into circuit board.

0 vdc to 6 vdc (controlled by external series variable resistor) attenuates signal over a 50-db range

Simulcast: Simulcast output and photocell switched inputs allow switching for dual, stereo, or Simulcast without level adjustments.

Part No. 522 3884 001

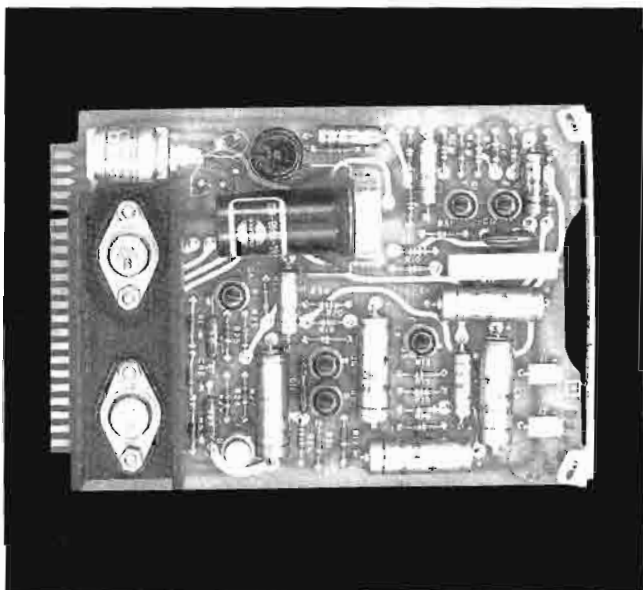

356M-1 MONITOR AMPLIFIER

The 356M-1 is used in 212S-1 and 212M-1 consoles as the monitor amplifier.

Input Impedance: 600 ohms balanced

Gain: 90 db, -50-dbm input will deliver 10 watts to speaker load

Output Impedance: 4, 8, or 16 ohm speakers may be used; 8 ohms optimum (External coupling capacitor required)

Outputs: One to speaker

Inputs: One

Power Requirements: +48 vdc at 750 ma (full output)

Attenuator: +6 vdc at 60 ma regulated

Frequency Response: ± 1 db from 30 Hz to 15 kHz (ref. to 1 kHz)

Harmonic Distortion: Less than 1% at rated output (10 watts rms)

Temperature Limits: 0° to +50° C

Size: 4 by 6-inch plug-in circuit card; 3 $\frac{3}{8}$ -inch thick (heatsink attached)

Adjustments: Trimpot for tracking attenuator

Attenuator: Photocell lamp unit built into circuit board.

0 vdc to 6 vdc (controlled by external series variable resistor*) attenuates signal over a 50-db range

*One variable resistor may be used to control attenuation of two monitor amplifiers, tracking is within ± 1 db.

Part No. 522 3883 001

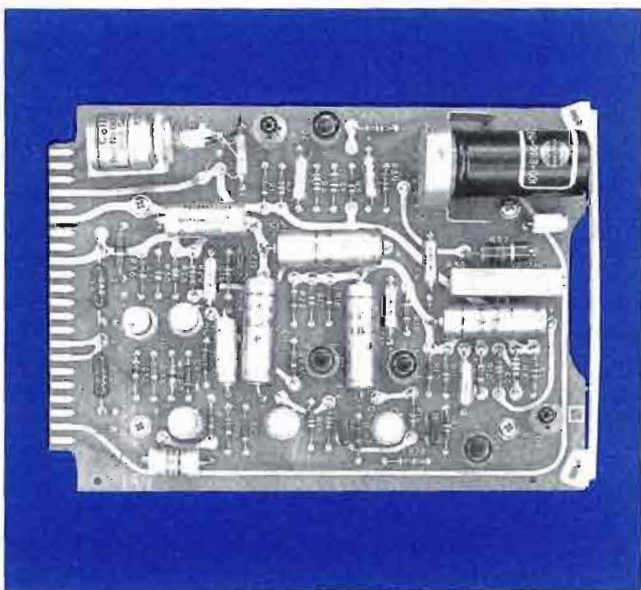

356R-1 MICROPHONE-PHONOGRAPH PREAMPLIFIER

The 356R-1 amplifies and equalizes audio from a magnetic pickup or amplifies audio from a microphone. Two remotely switched inputs, three remotely switched outputs, and one direct output are provided.

Input Impedance:

Microphone: 600/250/150/30 ohms, balanced (wired for 150 ohms)

Phonograph: 50K, nominal at 1 kHz

Output Impedance (Unbalanced): Program and Audition greater than 10K

Direct: 600 ohms, approximately

Cue: 1K, approximately

Input Level:

Microphone: -65 dbm, nom -20 dbm, max

Phonograph: 2 mv rms, nom 100 mv rms, max

Output Level: Program and Audition (600-ohm load) -45 dbm, nom -10 dbm, max

Direct: 5 volts, max (10K load)

Cue: 12 mv, nominal (2600-ohm load)

Frequency Response: 30 to 15,000 Hz ± 1.0 db (referred to 1 kHz)

Total Harmonic Distortion: 0.5% max at rated output

Noise: Equivalent input noise, -120 dbm (microphone input)

S/N Ratio: Greater than 60 db with 6-mv input signal (phonograph input)

Equalization of Phonograph Input: Strapping allows:

RIAA

RIAA with 3 db of high-frequency boost

RIAA with 3 db of high-frequency rolloff

Ambient Service Conditions:

Temperature 0° to 50°C

Relative humidity up to 90%

Altitude up to 10,000 feet

Size: 4 by 6 by 1 inch

Part No. 758 5486 001

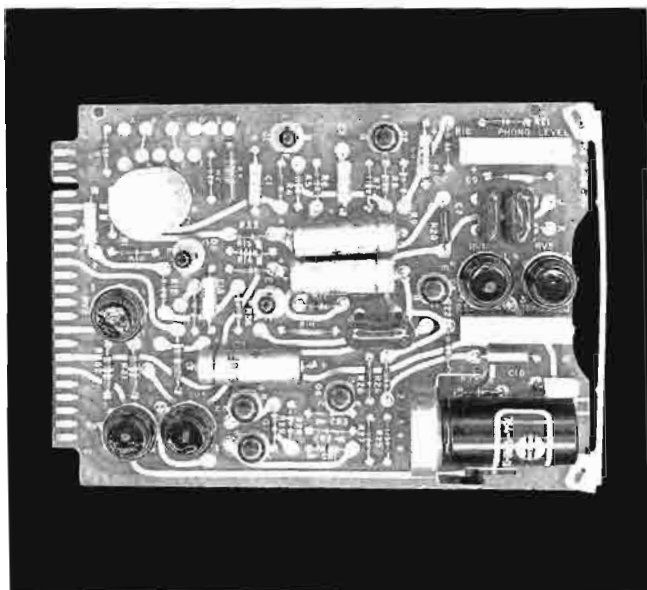

356U-1 BROADCAST AUDIO PREAMPLIFIER

The 356U-1 Broadcast Audio Amplifier amplifies audio signals from two separate high- or low-level inputs. Remotely operated photoconductive devices switch and control audio level of both input and three output channels. One direct output is also available. Four strapping options permit input impedance selection. The card is delivered strapped for 150-ohm inputs.

Microphone Input Impedance: 600, 250, 150, and 30 ohms.

When strapped for high-level input, the input impedance is 600 ohms (terminated) or 100 kilohms (bridging)

Output Impedance:

Unbalanced: Program, Audition, and Cue outputs greater than 10 kilohms

Direct: 600 ohms, unbalanced

Input Level: -65 dbm nominal, -30 dbm maximum; high level, +10 dbm, maximum

Output Level:

Program and Audition (into 600 ohms): -10 dbm, maximum

Cue (into 600 ohms): -40 dbm, -65-dbm microphone input

Direct (into 10 kilohms): 5 volts peak-to-peak, maximum

Frequency Response: ± 1 db, 30 to 15,000 Hz with 1000 Hz as reference level

Total Harmonic Distortion: 0.5% maximum at rated output

Noise:
Equivalent Input Noise: -120 dbm at maximum gain
Signal-to-Noise Ratio (1000-Hz Signal/Wideband Noise Level at Bus Output): Minimum 60 db for -60-dbm input signal

Power Requirements: +30 vdc at 15 ma, 1 mv maximum ripple; +6 vdc at 60 ma, regulated; +4 vdc at 120 ma, regulated

Relative Humidity: Up to 95%

Altitude: Up to 10,000 feet above msl

Type of Service: Continuous

Size: 4-7/16 by 6-3/8 by 1-1/16 inches

Part No. 772 5273 001

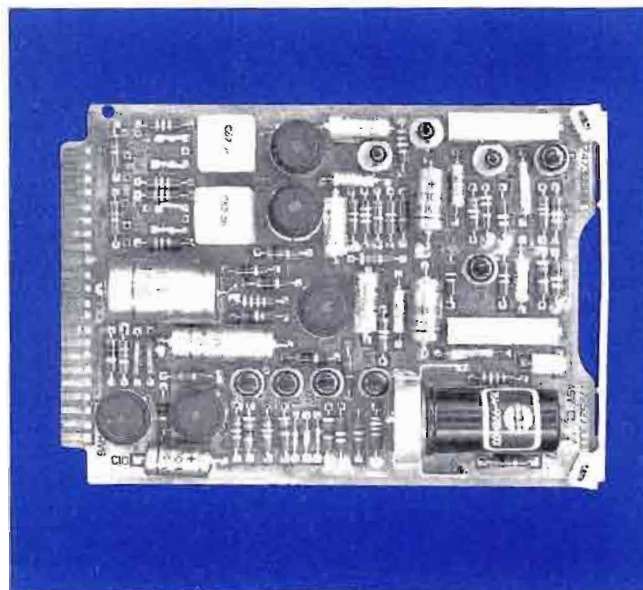

384D-1 SWITCH MATRIX

The 384D-1 is used in the 212S-1 and 212M-1 consoles to switch remote lines coming into the consoles. The 4 x 2 matrix consists of 16 photoconductive switches. Each switch consists of two photocells with 4-volt lamps. The resistance of the photocell is approximately 13 megohms when the lamp is off, and 380 ohms when the lamp is on.

The 384D-1 accepts four balanced inputs with an impedance of 820 ohms.

Outputs: 2 (balanced lines)

Output Impedance: Designed to work into 10K ohms

Power: 4 vdc at 40 ma times number of cells turned on, maximum requirement $16 \times 0.04 = 0.64$ A

Ambient Service Conditions:

Temperature: 0° to 50°C

Relative Humidity: Up to 95%

Altitude: Up to 10,000 feet

Switching Control: Eight switching functions

Temperature Limits: 0 to +50°C

Size: 4- by 6-inch plug-in circuit card, 3/4-inch maximum component height



409Z-1 POWER SUPPLY

The 409Z-1 supplies the necessary voltage for the modules of the 212S-1 and 212M-1 consoles.

Power Requirements: 115/220 $\pm 10\%$ vac at 4/2 A, 50/60 Hz, 230 watts maximum

Output Voltages: 48 volts dc at 1 A series regulated, zener reference, less than 5-mv ripple; 48 vdc at 1 A series regulated, zener reference, less than 5-mv ripple; 30 vdc at 50-ma zener regulated, less than 1-mv ripple; 30 vdc at 50-ma zener regulated, less than 1-mv ripple; +6 vdc at 1.5 A, less than 5-mv ripple, adjustable series regulator, temperature compensated; +4 vdc at 2.5 A, less than 5-mv ripple, adjustable series regulator, temperature compensated

Ambient Service Conditions:

Temperature: 0° to 50°C

Relative Humidity: Up to 95%

Altitude: Up to 10,000 feet

Size: 8½ in. H by 8 in. W by 13 in. D

Weight: 30 lb (14 kg)

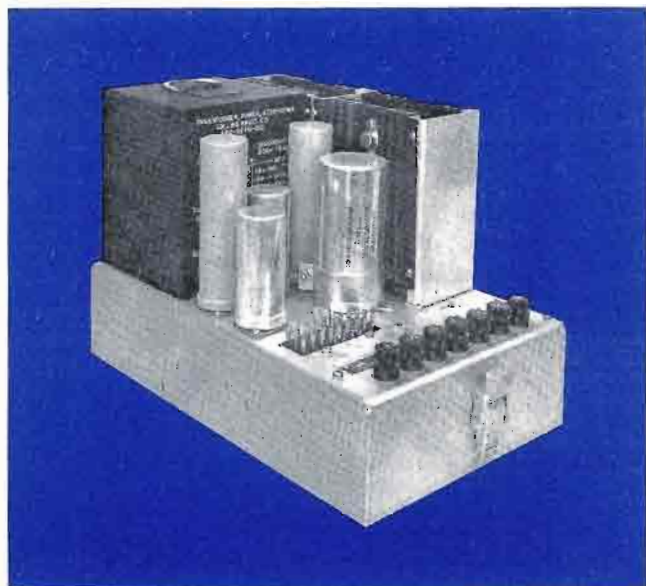

COLLINS 212T-1/2 AUDIO CONTROL CONSOLE

Collins 212T Audio Control Console was designed especially for television, large AM facilities, and recording studios. The 212T-1 and 212T-2 consist of three basic units: a control panel, a rack-mounted assembly containing the amplifiers and input-output terminals, and rack-mounted power supplies. Both systems have many common features; the primary difference is control panel configuration. Two different panel designs provide for a variation in the number of controls available and for flexibility in panel mounting.

All audio and power supply components are common to both the 212T-1 and 212T-2 and are contained in a rack-mounted assembly. This assembly may be located in an area remote from the control room, thus keeping audio leads away from video and sync signal interference present in TV control rooms.

Silicon transistors provide the base for the solid-state 356U-1 Amplifiers. The amplifiers are built on military-grade, etched-epoxy circuit boards. Photocell operation for switching and level control functions are performed within the amplifier cards. A selection of amplifier cards is available to meet all common input levels and impedances.

Program amplifier master gain controls are mounted on the front of the assembly and normally covered to avoid disturbance. Covers for the assembly are hinged and can

be quickly removed for service or adjustment. A test VU meter and selector switch are located on the top of the unit for local audio level monitoring.

Each system has two power supplies. One provides power to control lighting levels for pushbuttons and metering lights, and the other provides power for the audio amplifiers. Both power supply components mount on a 19-inch wide rack shelf and are interconnected to the rack-mounted assembly by plug-in cables.

All rack-mounted assembly wiring is readily accessible. Audio inputs and outputs are connected to terminal strips. Rugged connectors are used to interconnect cables to the front panel. The cable lengths are cut to fit each individual installation.

212T-1 Audio Control

The 212T-1 is a dual-channel console providing 28 inputs to 14 faders, two program output channels, a VU meter for each program output channel, two auxiliary program outputs, two 10-watt monitor outputs, and a built-in cueing speaker.

Each fader is engraved and has illuminated pushbuttons for A and B input selection and channel 1 or 2 selection. These buttons are the push-on, push-off type and are normally preset prior to air time. Two levels of illumination show the status of all switches during operation. The overall level is adjustable by a single control knob on the rack-mounted assembly. This feature is especially useful in dimly lit areas, such as a TV control room.

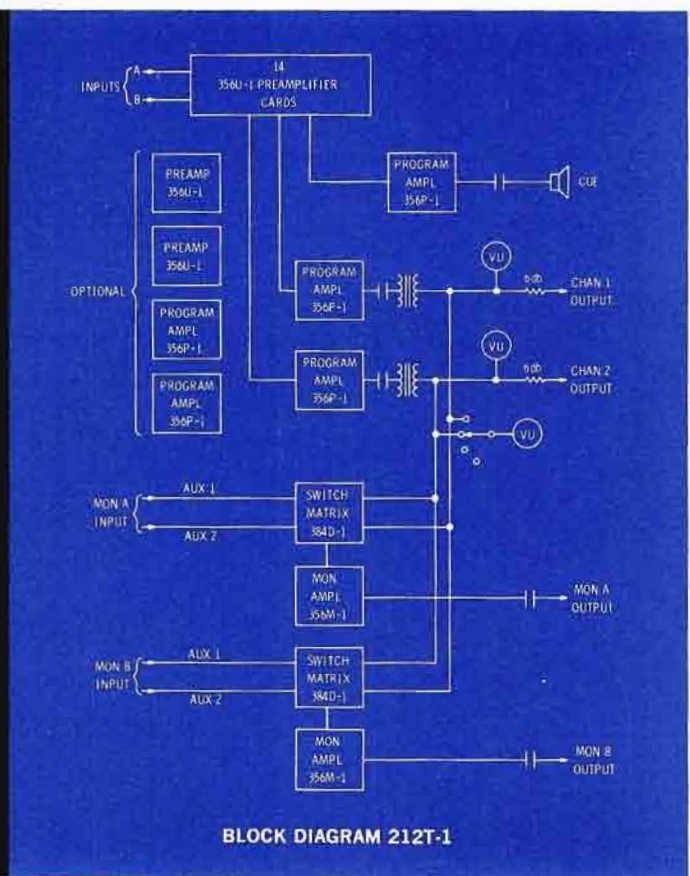
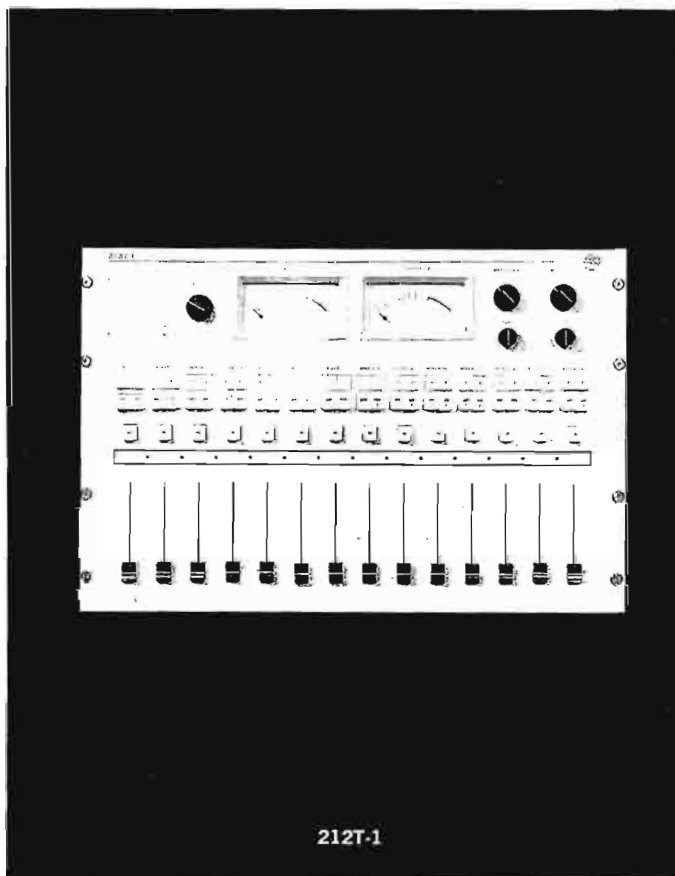

RIGID TESTING — In accordance with rigid Collins standards, the 830B-1B is tested on the broadcaster's channel under proper load conditions prior to shipment.

The 830B-1B can meet a variety of power situations. Only the blower motor need be changed to convert from the nominal 60- to 50-Hz operation.

Frequency Range: 88 to 108 MHz

Power Output: 250 watts

Carrier Frequency Stability: ± 1000 Hz

Audio Frequency Response: ± 1 db, 50 to 15,000 Hz

Distortion: Less than 0.5%, 50 to 15,000 Hz

FM Noise Level: 65 db below ± 75 kHz

AM Noise Level: -55 db rms

Harmonic Attenuation: At least -67 db

Modulation Capability: ± 100 kHz

RF Output Impedance: 50 ohms; SWR not to exceed 2:1

Audio Input Level: +10 dbm, ± 2 db

Power Source: 230 vac nominal, 60 Hz, 1 phase (tapped for 200 to 250 v in 10-v steps)

Input Power Requirement: 860 watts, 90% power factor

Power Line Regulation: 3%

Variations: Slow line, $\pm 5\%$; rapid line, $\pm 3\%$

Tube Complement: One 4CX250B

Temperature Range: 15° to 45°C

Humidity: 0% to 95%

Altitude: 7500 ft

Size: 38 in. W, 76 in. H, 27 in. D (97 cm W, 193 cm H, 69 cm D)

Weight: 638 lb (289 kg)

Part No. 777 1783

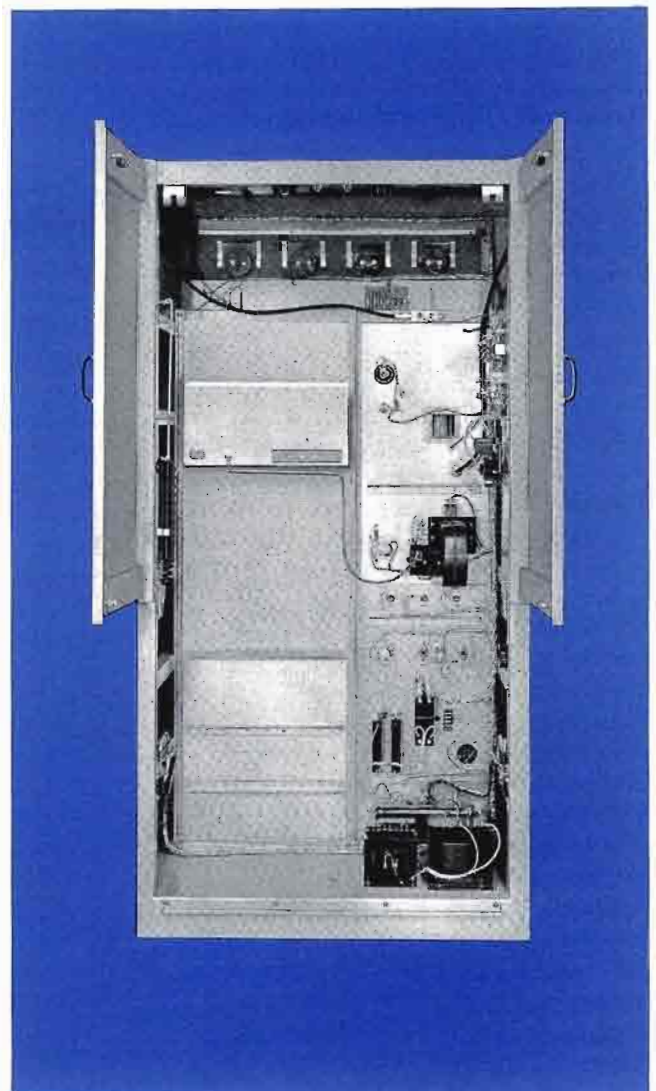

COLLINS 830D-1B FM TRANSMITTER

Carefully engineered design, straight-forward circuitry, and clean-line cabinetry all make the Collins 830D-1B FM Transmitter a powerful and versatile installation in the most modern station.

The self-contained 1000-watt unit achieves a new degree of reliability and operational ease never before obtainable by the FM broadcaster.

The new 310Z-1 Solid-State Exciter is the heart of the 830D-1B. This wide-band direct FM unit accepts a composite stereo signal directly without using auxiliary modulators for either the stereo or SCA channels.

Operation and maintenance of the Collins 830D-1B is simplicity itself. Fewer components and fewer tuned circuits enhance the dependability and operational ease of the transmitter.

Some of its features are:

SELF-CONTAINED — Transformers for the all solid state power supply as well as the harmonic filter are enclosed in the cabinet. Self-contained multiplexing equipment, including the Collins 786V-1 Stereo Generator, also may be mounted inside.

SIMPLE OPERATION — The 830D-1B is pushbutton operated, featuring a step-start system in which starting sequences are fully automatic. All rf circuits are tuned from the front panel. Adequate metering is provided for rapid operational analysis. All adjustments can be made while the transmitter is on the air.

DEPENDABLE — Space-saving silicon rectifiers that generate a minimum of heat are employed. A regulated filament transformer prolongs tube life. Stability is enhanced through the neutralized final power amplifier. Spurious radiation is held to a minimum; the entire unit has a high degree of stability.

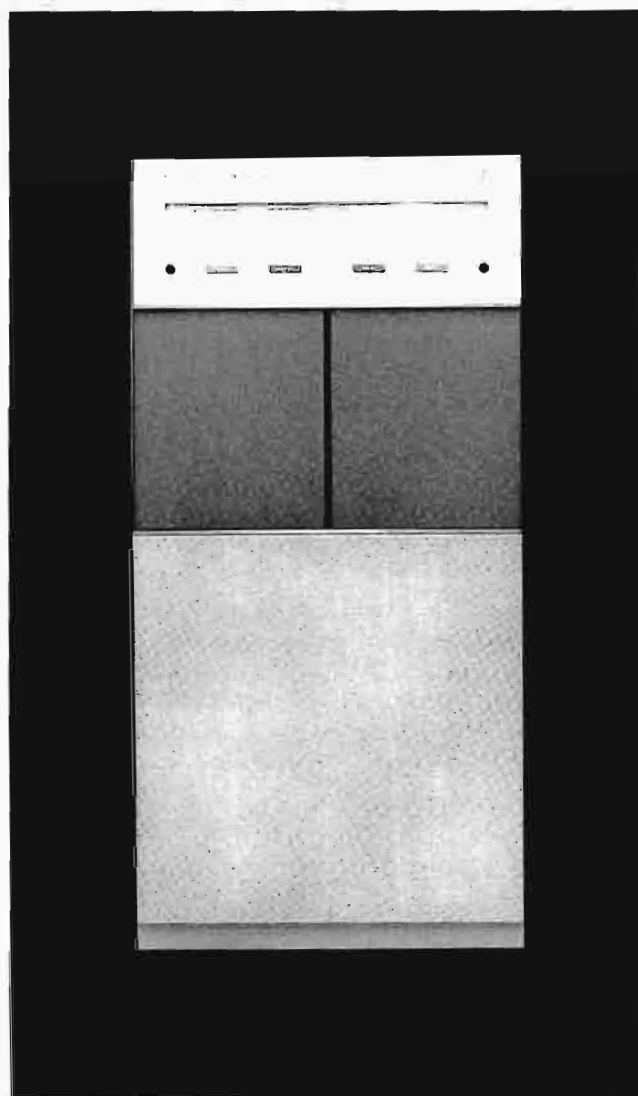

MAINTENANCE EASE — Vertical panel construction eliminates hidden components and allows rapid inspection and maintenance. Cabinet interlocks minimize danger during circuitry inspection and maintenance. A grounded shorting stick is readily accessible to discharge capacitors before transmitter servicing.

RIGID TESTING — In accordance with rigid Collins standards, the 830D-1B is tested on the broadcaster's channel under proper load conditions before shipment is made.

The 830D-1B can meet a variety of power situations. No components need to be changed to operate the transmitter on 60- or 50-Hz power.

Frequency Range: 88 to 108 MHz

Power Output: 1000 watts

Carrier Frequency Stability: ± 1000 Hz

Audio Frequency Response: ± 1 db, 50 to 15,000 Hz

Distortion: Less than 0.5%, 50 to 15,000 Hz

FM Noise Level: 65 db below ± 75 kHz

AM Noise Level: -55 db rms

Harmonic Attenuation: -73 db

Modulation Capability: ± 100 kHz

RF Output Impedance: 50 ohms; swr not to exceed 2:1

Audio Input Level: +10 dbm, ± 2 db

Power Source: 230 vac nominal, 50 to 60 Hz, 1 phase
(tapped for 200-250 v in 10-v steps)

Input Power Requirement: 2300 watts, 90% power factor

Power Line Regulation: 3%

Variations: Slow line, $\pm 5\%$, rapid line, $\pm 3\%$

Tube Complement: One 4CX1000A

Temperature Range: 15° to 45°C

Humidity: 0 to 95%

Altitude: 7500 ft

Size: 38 in. W, 76 in. H, 27 in. D (97 cm W, 193 cm H,
69 cm D)

Weight: 776 lb (352 kg)

Part No. 777 1784

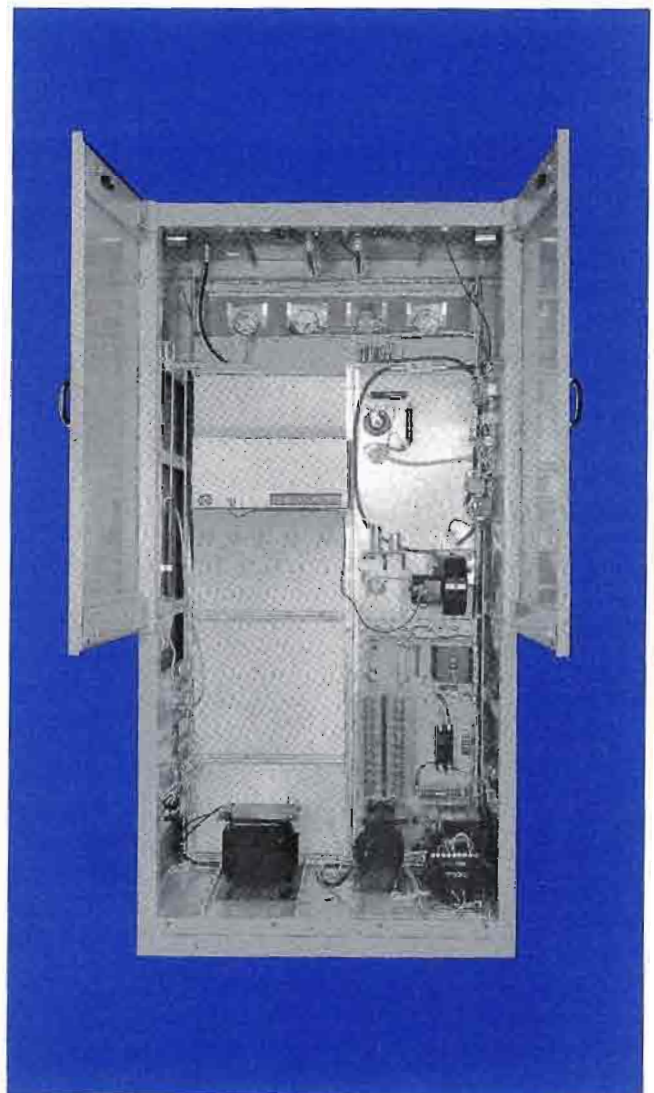

831D-1 2-KW FM TRANSMITTER

The 831D-1, 2-kilowatt frequency-modulated broadcast transmitter is designed to cover the 88- to 108-MHz standard FM broadcast band. A direct FM, all solid-state, 10/20-watt 310Z-1 exciter is used in the transmitter. Optional exciter features include stereo-multiplex and SCA circuits.

This self-monitoring transmitter is provided with automatic power output, fault, overload, and start/stop cycle control and protection circuits. Local and remote control and monitoring is provided by either hard-wire or digital input. Digital control and monitoring circuits of this com-

pletely automatic transmitter make possible a fully automated broadcast station. Through this system, a station processor transmits control commands such as turn-on and turnoff to the transmitter. Monitor information such as fault indications and modulation level is returned to the station processor over the multiplex control system. Thus the station processor can automatically control and monitor the station complex and display the operational status of all station equipment.

SELF-CONTAINED — Every component is housed inside a two-bay cabinet, including the 310Z-1 solid-state exciter, cavity-type power amplifier utilizing a 5CX1500A tube, directional watt-meter, three-node bandpass filter, solid-

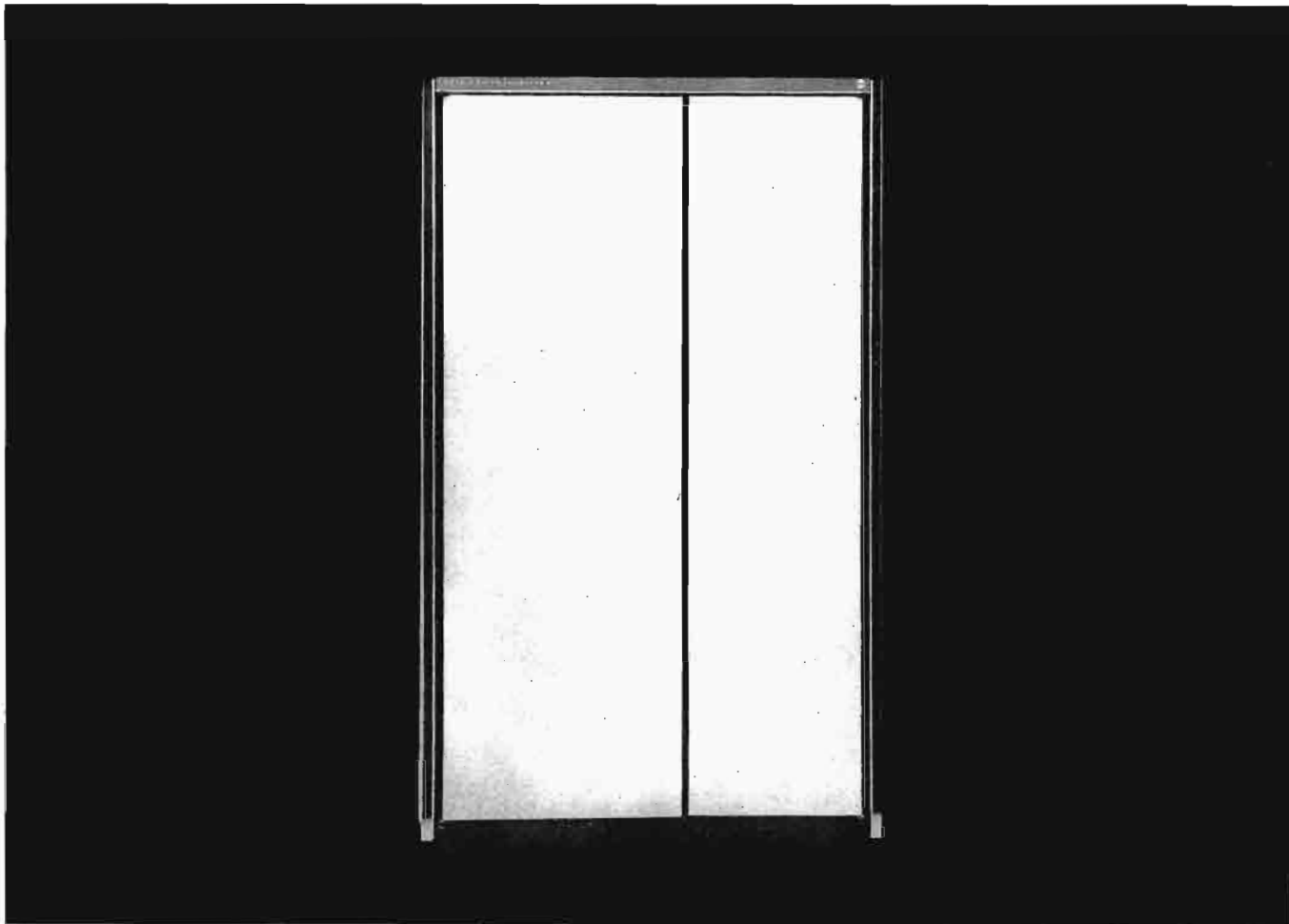

state power supply, and control and monitoring circuits.

DEPENDABLE — Reliability, stability, and dependability are maximized by the all solid-state exciter and power supplies, and by the improved power amplifier cavity. Only one tube is used in the transmitter. Tube replacement costs are, therefore, minimized. The neutralized power amplifier stage improves transmitter stability and minimizes tuning and loading adjustment problems. Component reliability and life are enhanced by the use of filtered cooling air.

MAINTENANCE EASE — Vertical panel construction eliminates hidden components and allows rapid inspection and maintenance. Cabinet interlocks minimize danger during circuitry inspection and maintenance. A grounded shorting stick is readily accessible to discharge capacitors before transmitter servicing.

RIGID TESTING — In keeping with rigid Collins standards, the 830D-1 is tested on the broadcaster's channel under proper load conditions before the unit is shipped.

No components need to be changed to operate the transmitter on 60- or 50-Hz power.

Frequency Range: 88 to 108 MHz

Power Output: 2000 watts

Carrier Frequency Stability: ± 1000 Hz

Audio Frequency Response: ± 1 db, 50 to 15,000 Hz

Distortion: Less than 0.5%, 50 to 15,000 Hz

FM Noise Level: 65 db below ± 75 kHz

AM Noise Level: -55 db rms

Harmonic Attenuation: -76 db

Modulation Capability: ± 100 kHz

RF Output Impedance: 50 ohms; swr not to exceed 2:1

Audio Input Level: Input of +10 dbm ± 2 db required for 100% modulation

Tube Complement: One 5CX1500A

Temperature Range (Operating): +15 to +45°C

Altitude (Operating): 7500 feet at 30°C

Relative Humidity (Operating): 0 to 95%

Size: 69 in. H by 40-13/16 in. W by 22 $\frac{1}{4}$ in. D (175 cm H by 104 cm W by 57 cm D)

Weight: 850 lb (386 kg)

Power Source: 230 vac nominal, 50 to 60 Hz, single-phase (tapped for 200 to 250 volts in 10-volt steps)

Input Power Requirement: 4100 watts (90% power factor)

Power Line Regulation: 5% maximum

Line Voltage Variation: Slow, $\pm 5\%$; rapid, $\pm 3\%$ maximum

Part No. 522 4682

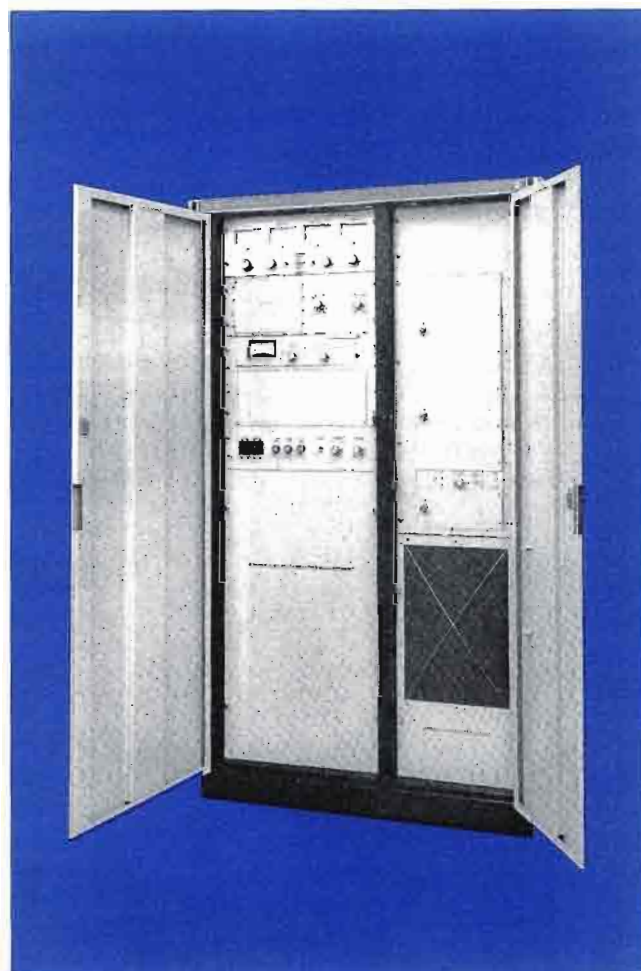
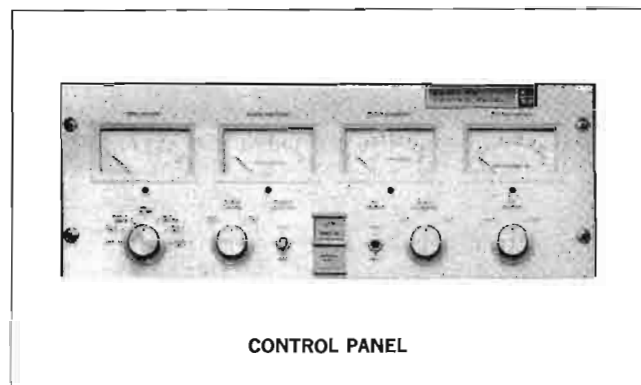

COLLINS 830E-1B 5000-WATT FM TRANSMITTER

Award-winning design and humanized engineering, hallmarks of Collins quality, are reflected in the Collins 830E-1B.

One cabinet houses the 310Z-1 Solid-State Exciter and the 250-watt B830-1 Driver Unit; the other houses the 5000-watt, single-stage amplifier.

Features of the Collins 830E-1B are:

SELF-CONTAINED — Every component is housed inside the two cabinets, including power transformers, harmonic

filter and directional coupler. An accessory, the Collins 786V-1 Stereo Generator, plugs into the 310Z-1 exciter.

SIMPLE OPERATION — The transmitter is pushbutton operated, featuring a step-start system in which starting sequences are fully automatic. Highly stable rf circuits are tuned and metered from the front panel, and all adjustments can be made while the transmitter is on the air. No tuning or trimming of the harmonic filter is required. The PA stage is easily neutralized and is not critical in adjustment.

DEPENDABLE — Grounded screen, eliminating the screen bypass capacitor, does away with a common source of

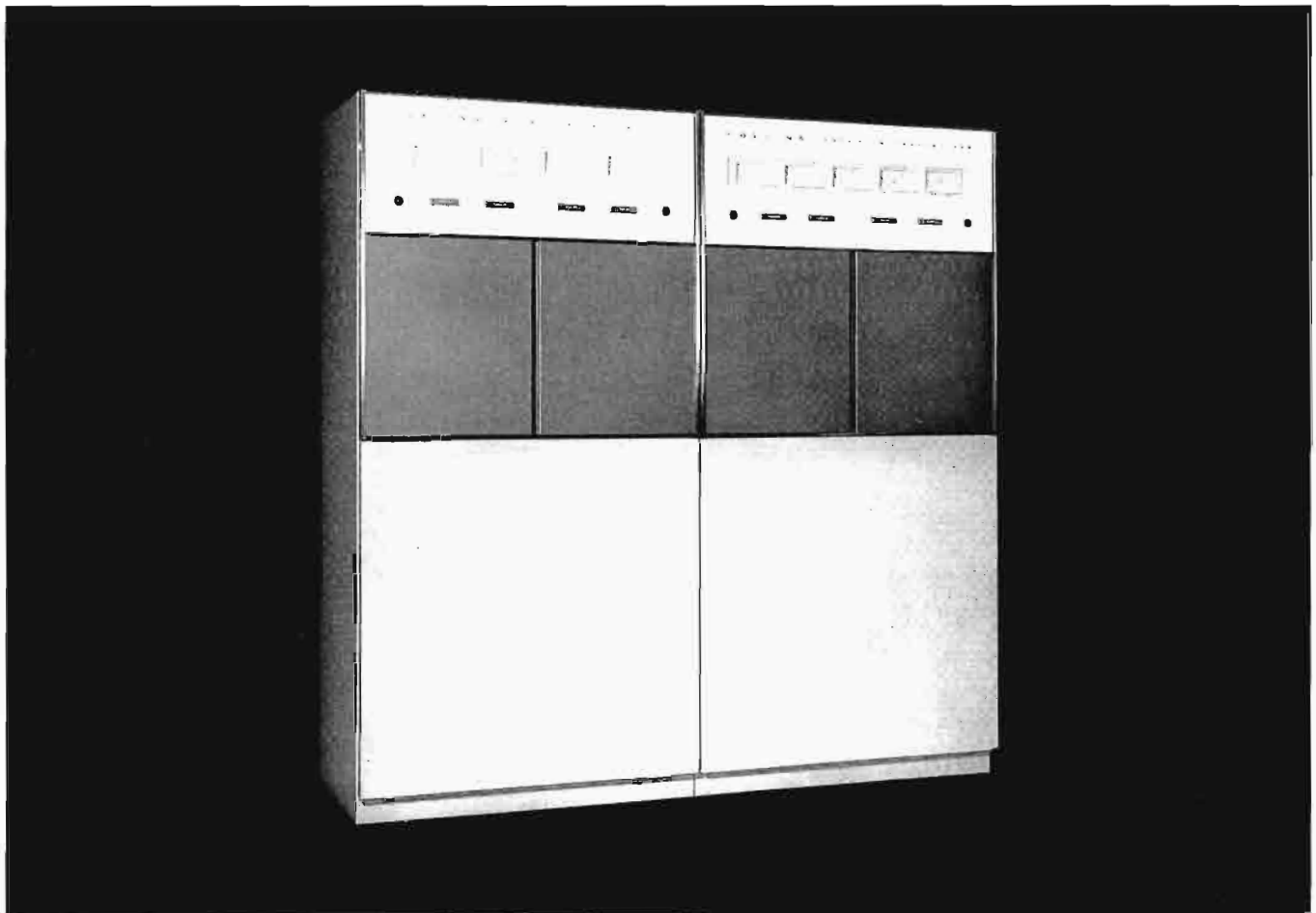

Power Source: 115 vac $\pm 10\%$, 50/60 Hz, single phase, 170 ma, or 12 to 15 vdc 400 ma max

Input Impedance:

Mike: 150/200 ohms (strappable for 600 ohms) balanced

High Level: 600 ohms, balanced

Phonograph: 100,000 ohms nominal at 1 kHz, unbalanced

Input Level:

Mike: -50 dbm

High Level: -10 dbm

Phonograph: 6 mv

Output Impedance:

Line: 600 ohms

Monitor: Use 8-ohm load (monitor output impedance is less than 1 ohm)

Public Address: Use 600-ohm load

Output Level:

Program: +8 dbm

Monitor: ¼ watt

Public Address: 0 dbm

Frequency Response: ± 1.5 db on mike or high level, 50 to 15,000 Hz; RIAA compensation, ± 1.5 db, on phonograph input

Harmonic Distortion: Less than 1% on normal or maximum level

Equivalent Input Noise: -120 dbm or less

Temperature Range: 0° to 50°C

Size: 5.5 in. H by 17 in. W by 14 in. D (14 cm H by 43 cm W by 36 cm D)

Weight: 28 pounds (13 kg)

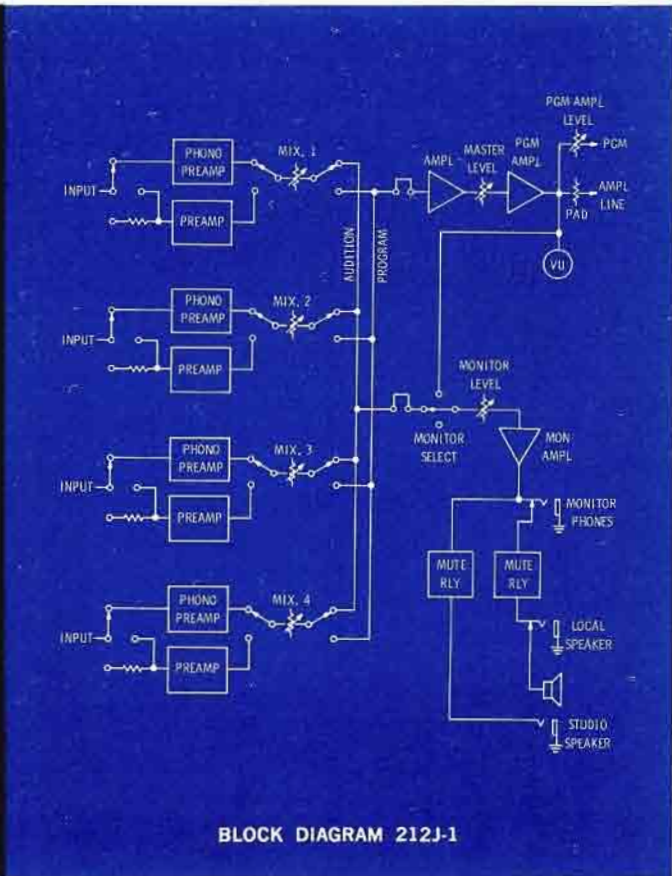
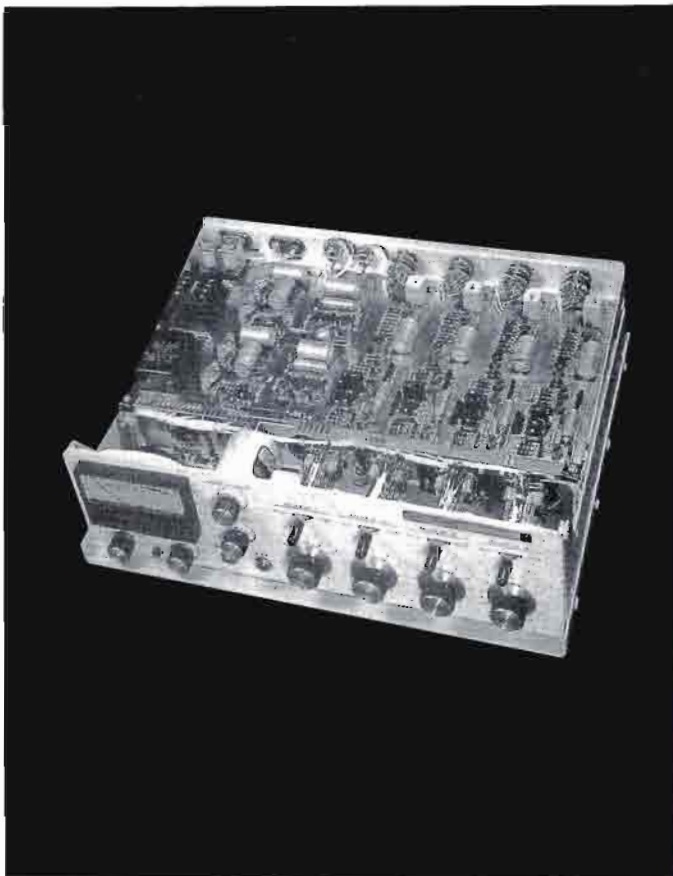

COLLINS 26U-1 LIMITING AMPLIFIER

Designed to achieve maximum modulation with minimum distortion, the Collins 26U-1 Limiting Amplifier provides full tonal range broadcasting with thump-free performance.

The Collins limiting amplifier limits loud audio passages to prevent overmodulation, distortion and adjacent channel interference, while allowing low level passages to be broadcast in their true range.

The transmission range of the station's signal and the overall efficiency of the transmitter are increased through the limiting action, which permits a higher average modulation level.

When used with recording equipment or with a public address system, the 26U-1 prevents overloading, and by allowing a higher average audio level, the limiting amplifier improves the signal-to-noise ratio.

A self-balancing circuit eliminates the need of tube selection or delicate balancing procedures usually associated with peak limiters. The Collins 26U-1 is capable of greater than 30-db compression.

Conventional circuitry, negative feedback, full wave rectification for control voltage and silicon rectifiers in the

power supply are incorporated into this unit.

An illuminated VU meter with a special scale calibrated in VU and db of compression, which measures five functions, is provided in the limiting amplifier. The VU meter attenuator and a rotary switch allow measurement of external gain reduction, db of compression and levels of input, output and external audio circuits. The external meter circuit measures audio levels on other program lines, eliminating the need for an additional VU meter panel.

Silicon diodes and extended life electrolytic capacitors provide an efficient, low heat power supply with a minimum of maintenance. A voltage regulator provides stabilized reference voltages. Input, output and VU meter level controls are Daven step-type.

The 26U-1 consists of a push-pull variable gain input stage, a push-pull interstage voltage amplifier, and a push-pull output stage. A bias rectifier supplies dc bias from the signal output to regulate the gain of the input stage. A self-contained power supply provides the plate and filament voltages.

Designed for rack mounting, the 26U-1 has a minimum number of controls, tubes and tube types. It has a hinged front panel for access to internal wiring and components.

The panel is finished with blue-gray enamel, and the chassis is cadmium plated and chromate dipped.

Frequency Response: ± 1.5 db, 50 to 15,000 Hz

Gain: 32 db minimum

Input Impedance: 600 ohms unbalanced

Input Level: -20 dbm to +20 dbm. Note: 0 dbm equals 1 mw across 600 ohms

Output Impedance: 600 ohms unbalanced adjustable, or 600 ohms balanced fixed level

Output Level: -20 dbm to +20 dbm

Distortion: 1.5% maximum

Output Noise: -50 dbm or less

Compression Ratio: 12:1 first 10 db above threshold

Attack Time: Adjustable, 0.5 to 3.0 milliseconds

Release Time: Adjustable, 0.5 to 3.0 seconds for 63% recovery

Power Source: 115 or 230 vac, 50 to 60 Hz, single phase.

Shipped wired for 115 vac

Size: 19 in. W, 10½ in. H, 9 in. D (48.26 cm W, 26.67 cm H, 22.86 cm D)

Weight: 32½ lbs. (15 kg)

Part No. 522 0966 00

No Part Number

100% set of spare tubes

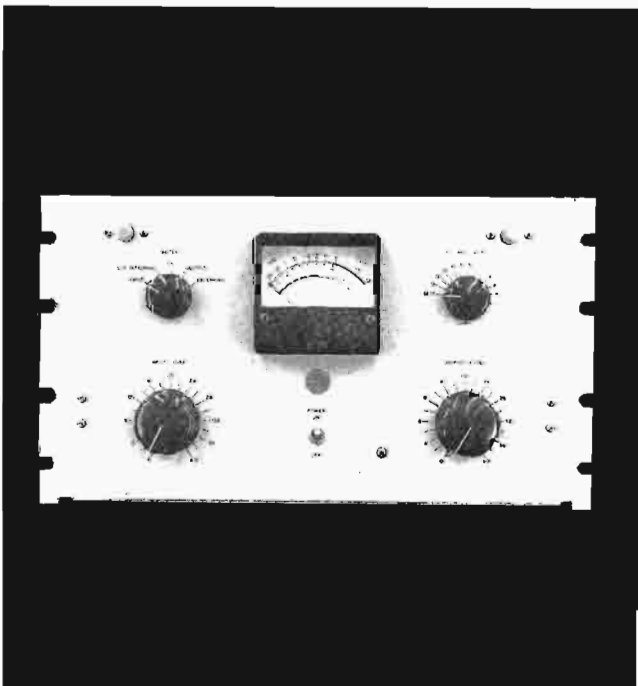

COLLINS 26U-2 STEREO LIMITING AMPLIFIER

Easy to operate and maintain and affording maximum flexibility, the Collins 26U-2 Stereo Limiting Amplifier is designed to permit maximum modulation with minimum distortion. It provides full tonal range broadcasting with thump-free performance.

The 26U-2 limits loud audio passage to prevent over-modulation, distortion and adjacent channel interference, while raising low level passages to be broadcast in their true value.

When used with stereo recording equipment, the Collins stereo limiting amplifier prevents overloading and improves signal-to-noise ratio by allowing a higher average audio level.

Based on the time-proven circuitry of the Collins 26U-1, the stereo limiter has conservatively rated components and long life. Typical mean time between failures: 4 years of continuous service.

The 26U-2 may be used as a single-channel limiter, two monaural channels or for stereo broadcasting. A switch in the subpanel selects either stereo or monaural operation.

The self-balanced circuit eliminates the need for tube selection or delicate balancing procedures usually associated with peak limiters. The Collins 26U-2 is capable of greater than 30 db compression.

Two illuminated VU meters, calibrated in VU and db of compression are incorporated. The meter switch allows measurement of external and internal gain reduction (db of compression), and levels of input, output, and external



audio circuits. The external circuit measures audio levels of other program lines, eliminating the need for an additional VU meter panel.

Silicon diodes provide an efficient, low heat power supply with a minimum of maintenance. A voltage regulator provides stabilized reference voltages. Input and output level controls are continuously variable bridge-T attenuators.

Occupying only 10.5 inches of rack space, the Collins 26U-2 has a minimum number of controls, tubes and tube types. A hinged front panel with magnetic latches provides access to the subpanel controls.

Frequency Range: 50 to 15,000 Hz ± 1.5 db

Input: 600 ohm bridged T (ungrounded), -20 dbm to +20 dbm

Output: 600 ohm bridged T (ungrounded), -20 dbm to +20 dbm

Distortion: 1% maximum

Output Noise: -50 dbm or less

Cross-Talk: 60 db minimum

Compression Ratio: 12:1 first 10 db above threshold

Gain: 40 db

Attack Time: Adjustable, 0.5 to 3.0 milliseconds

Release Time: Adjustable, 0.5 to 3.0 seconds

Controls:

Panel Mounted	Meter Selector Switch
	Meter Multiplier Selector
Subpanel Controls	Input Level (2)
	Output Level (2)
	Gain Reduction Meter Zero (2)
	Gain Reduction Balance (2)
	Stereo-Mono
	Power ON-OFF
Rear Chassis Controls	Attack Time (2)
	Release Time (2)

Protection: Overload fuse in primary circuit

Metering: Two 3½ in. voltmeters that can be switched to measure input level, external gain reduction, gain reduction, output level and external level

Tube and Rectifier Complement:

2	GL-6386	Variable gain input stages
2	12AU7	Interstage voltage amplifiers
4	6V6GTA	Output amplifiers
2	6AL5	Limiter bias rectifiers
2	OA2	Voltage regulators
4	1N3256	Power rectifiers (silicon, commercial)

Power Source: 115 or 230 vac, 50 to 60 Hz, single phase (150 watts at 115 vac)

Size: 19 in. W, 10½ in. H, 10¼ in. total D—9¼ in. behind panel (48 cm W, 27 cm H, 26 cm total D—24 cm behind panel)

Weight: 35 lb (16 kg)

Part No. 522 3237 00

COLLINS TT-900 TURNTABLE

The TT-900 turntable was designed for stereo and meets NAB specifications for stereo operation. The chassis is of heavy cast aluminum. A simple speed shift lever is located in the center of the chassis for choice of 2 speeds, 33 $\frac{1}{3}$ and 45 rpm. In the off position the drive puck is removed from the rim to prevent flattening. An indentation in the platter eliminates the need for a spindle adapter for 45-rpm records.

Motor: Synchronous

Speeds: 33 $\frac{1}{3}$ and 45 rpm

Speed Regulation: .05%

Acceleration: Less than 1/12 rpm for full speed

Wow Limit: 0.2%

Flutter Limit: 0.2%

Wow and Flutter Limit: 0.2%

Vertical Rumble: -36 db

Lateral Rumble: -40 db

Mono Rumble: -36 db

Size: 14.5 in. W by 15.34 in. D

Cut Out Size: 13.5 in. W by 14.34 D

Weight: 35 lb (24 kg)

Part No. 124 0032 011

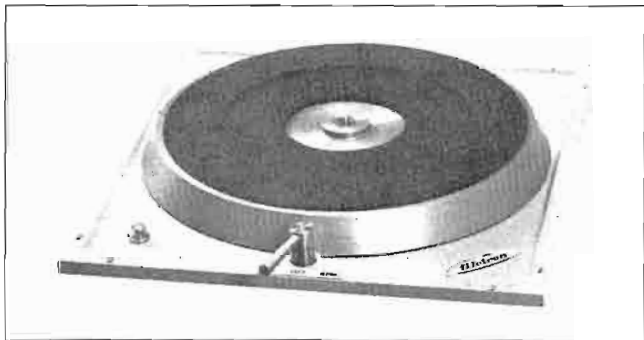

COLLINS TT-400/200 TURNTABLES

Collins turntables feature a simplicity of design that requires only three moving parts in the drive mechanism. There is no complicated linkage system to break down or to add to wow or rumble.

The turntables, constructed of heavy cast aluminum with a blue-gray wrinkle finish, are nonmagnetic. A gear speed shift offers selection of 33, 45 and 78 rpm, with neutral between slots. An indentation in the turntable eliminates the need for a spindle adapter for 45 rpm records.

The tables are rim-driven by a single molded Neoprene idler wheel. The idler wheel serves only to transfer power to the rim. It does not determine the speed of the table. Normal wear and reduction of the idler wheel have no effect on the precision of the platter speed.



	<i>Speed</i>	<i>Noise level*</i>	<i>Speed Acceleration</i>
16 in. TT-400	33 $\frac{1}{3}$	-48 db	1/10 rev.
	45	-47 db	1/8 rev.
	78	-42 db	1/2 rev.
12 in. TT-400	33 $\frac{1}{3}$	-49 db	1/16 rev.
	45	-49 db	1/12 rev.
	78	-46 db	1/3 rev.

*Based on reference level of 7 cm/sec., at 1000 Hz

Size: TT-400 and TT-400S—2 in. (5 cm) above base plate, 6 in. (15 cm) below base plate, overall base 19 $\frac{3}{8}$ in. square (50 cm)

TT-200—1 $\frac{1}{2}$ in. (4 cm) above table, 4 $\frac{1}{4}$ in. (11 cm) below table, base 15 $\frac{3}{8}$ in. W, 14 $\frac{1}{2}$ in. D (39 cm W, 37 cm D)

TT-200S—Same as TT-200, except 6 in. (15 cm) below table

Weight: TT-400—53 lb (24 kg). TT-200—22 lb (10 kg)

Part No. 097 3736 00 (Type TT-400) 16 in., 4-pole motor

Part No. 097 3737 00 (Type TT-400S) 16 in., synchronous motor

Part No. 097 6286 00 (Type TT-450S) 16 in., synchronous motor, 50 Hz

Part No. 097 3971 00 (Type TT-200) 12 in., 4-pole motor

Part No. 097 3811 00 (Type TT-200S) 12 in., synchronous motor

Part No. 097 6285 00 (Type TT-250S) 12 in., synchronous motor, 50 Hz

Part No. 097 8123 00

Rubber pad to fill turntable indentation for TT-400/200 series. Allows playing small hole 33 $\frac{1}{3}$ rpm records.

Part No. 097 7253 00

220 v to 115 v step-down transformer. 150 watts, for use with TT-400/200 turntables.

COLLINS TURNTABLE CABINET

Has front door for accessibility to turntable components. Cutout on top for one Collins TT-900, TT-400 or TT-200 series turntable. Cabinet finished in Regency walnut Formica. Other coverings available on special order. Specify turntable model number.

Size: 24 in. W, 30 in. H, 24 in. D (61 cm W, 76 cm H)

Part No. 124 0032 228 (Type TCW-9Q)

For use with TT-900 series turntables.

Part No. 124 0032 230 (Type TCW-2Q)

For use with TT-200 series turntables.

Part No. 124 0032 229 (Type TCW-4Q)

For use with TT-400 series turntables.



212T-2 Audio Control

The 212T-2 is identical to the 212T-1 except that it provides 32 inputs to 16 faders and has a control panel divided into two separate, functional sections. The top section contains the VU meters and monitoring controls, and the bottom section contains faders and cue switches. Both sections can be rack mounted. The two panels are interconnected by plug-in cable assembly. When desired, the VU meter panel may be mounted at a different angle or location than that of the fader panel.

The pushbuttons are alternate-action types that change color to indicate the position of the switches. The identification letters on each button can be changed at any time to facilitate operator control.

Number of Inputs:

- 212T-1: 28 with 14 faders
- 212T-2: 32 with 16 faders

Input Impedance:

- Low Level: 30/150/250/600 ohms, balanced or unbalanced
- Medium Level: 600 ohms, balanced or unbalanced

Output Impedance:

- Line: 600 ohms (150 ohms on special order)
- Monitor: 8 ohms

Input Level:

- Low: 55 dbm, nominal
- Medium: 10 dbm

Output Level:

- Program: +8 dbm
- Monitor: 10 watts

Frequency Response: ± 1 db, 30 to 15,000 Hz (1-kHz reference) on both program and monitor circuits

Harmonic Distortion: Less than 1% at maximum program level or maximum monitor level

Noise: -65 db below output level (-50-dbm input)

Size:

212T-1 Control Panel: 15 $\frac{3}{4}$ in. H by 24 in. W by 6 in. D (40 cm H by 61 cm W by 15 cm D)

212T-2 Control Panels:

VU Meter and Monitoring Control Panel: 5 $\frac{1}{4}$ in. H by 19 in. W (13 cm H by 48 cm W)

Fader and Cue Switch Panel: 10 $\frac{3}{4}$ in. H by 19 in. W (27 cm H by 48 cm W)

Rack-Mounted Equipment: 21 in. H by 19 in. W by 12 in. D (53 cm H by 48 cm W by 30 cm D)

Power Supply Shelf: 10 $\frac{1}{2}$ in. H by 19 in. W by 14 in. D (27 cm H by 48 cm W by 36 cm D)

Power Source: 115/230 vac $\pm 10\%$, 50/60 Hz

Weight:

- 212T-1/2 Rack: 41 lb (19 kg)
- 212T-1/2 Power Supply: 50 lb (24 kg)
- 212T-1 Control Panel: 32.5 lb (15 kg)
- 212T-2 Control Panel: 19 lb (9 kg)
- 212T-2 Meter Panel: 4.5 lb (2 kg)

Part No. 772 5108 (212T-1)

Part No. 772 5109 (212T-2)

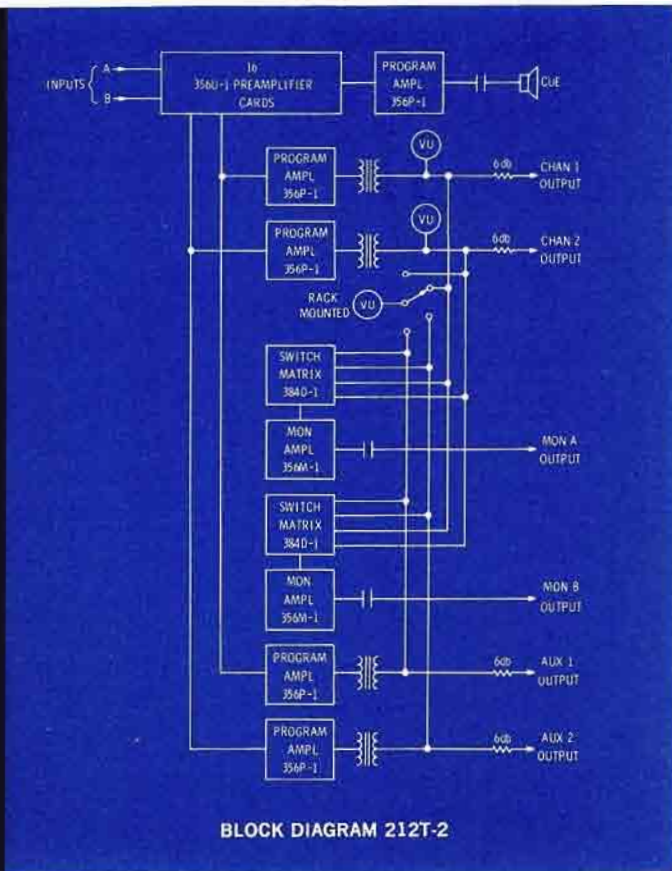
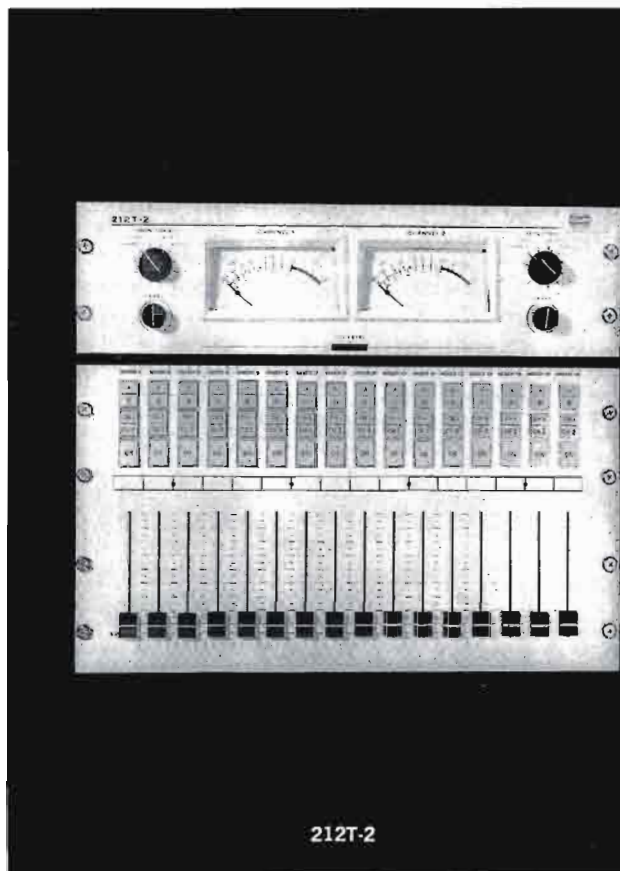

212J-1 BROADCAST AUDIO CONSOLE

Collins 212J-1 Console is a 4-channel monophonic audio mixer for broadcast studios or remote applications. Each of the four mixers controls the gain of a single channel that accepts switched inputs from a microphone, magnetic cartridge, or high-level source. The magnetic cartridge input is RIAA compensated or may be strapped to provide 3 db of treble boost or cut. Console features include 600-ohm public address output, and extremely compact and lightweight design.

Electronics include four mixers and associated amplifiers, a program amplifier, and a monitor amplifier. Mixer outputs may be switched to program or audition bus, or off. The monitor amplifier output switch selects the audition or program bus, or off. Cueing is provided by feeding

the mixer cue output to the monitor amplifier in such a manner as to override the switch selected input. A monitor speaker is contained in the console cabinet and provisions are made for head phone or external speakers. An illuminated VU meter displays the program amplifier output and a front-panel jack allows program or talkback monitoring.

Mechanically the unit consists of one printed circuit board, three subassemblies, and a top, bottom, and front cover. When the covers are removed the majority of the console electronics are accessible. Removal of several screws allows lifting of the rear panel and circuit board, making every space accessible while the unit remains operable.

An optional paralleling unit permits connection of two 212J-1 units. In this configuration all eight channels are available for either of two separate outputs.

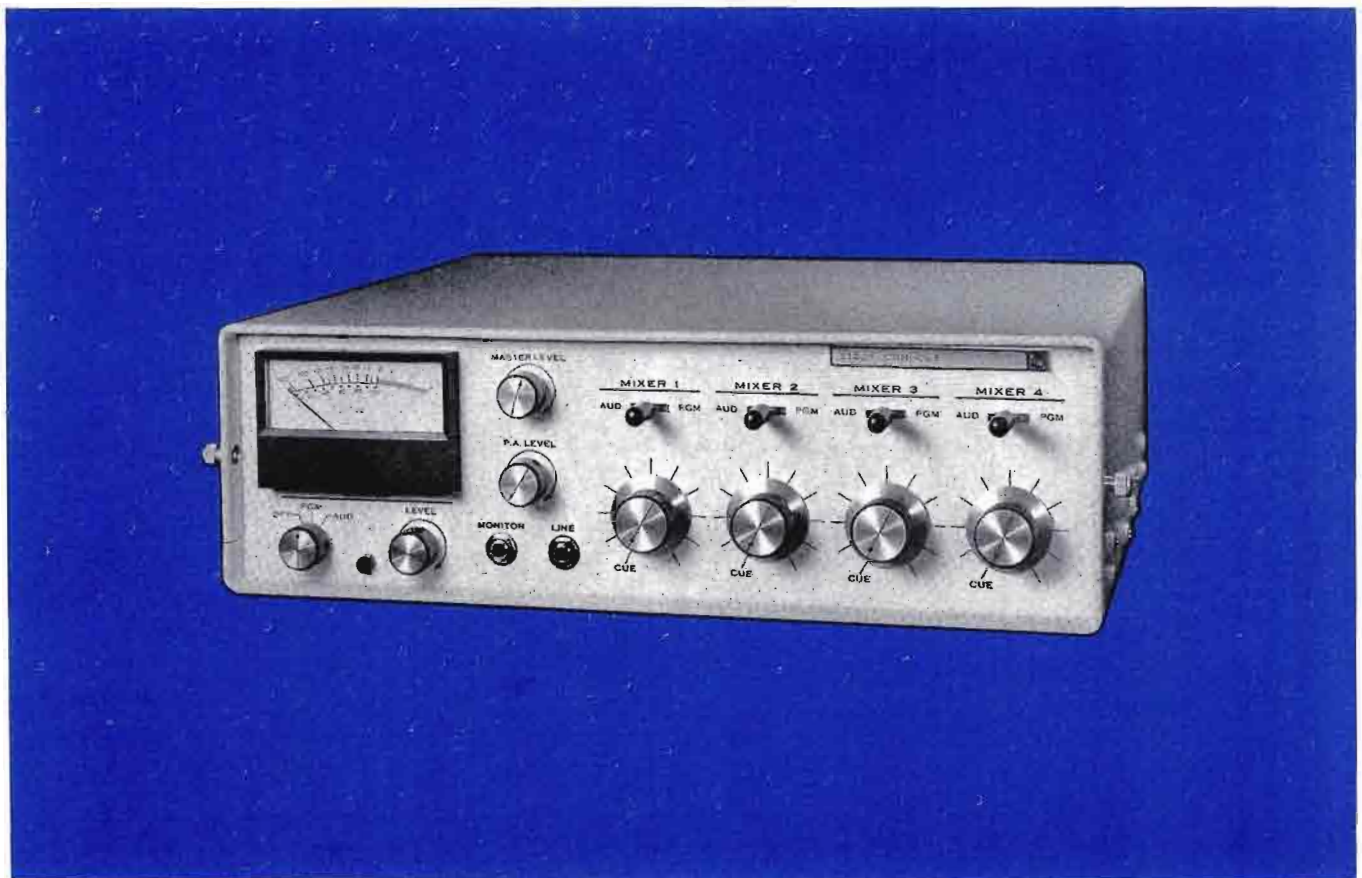

COLLINS 356H-1 PHONOGRAPH EQUALIZER PREAMPLIFIER

An economical unit to equalize and amplify the output signal of a magnetic phono cartridge, this small transistorized unit is used to replace passive equalizers and console or turntable preamplifiers. The housing of the unit is constructed of steel for magnetic shielding.

Control shafts are 3 inches long and may be cut to proper length after mounting the unit in the cabinet. The 356H-1 provides choices between two inputs and between four response curves: (1) Flat, for test purposes, and mike preamp use; (2) Hi-Boost, which has a 4 db rise above normal at 15,000 Hz; (3) Normal, which is the RIAA equalizing curve, and (4) Hi-Cut, which has a 4-db drop below the normal curve at 15,000 Hz.

Frequency Range: 30 to 15,000 Hz (Typical—Flat position ± 1.5 db, 20 to 20,000 Hz)

Frequency Response: ± 1.5 db from RIAA playback equalization response curve

Output Level: -10 dbm, ± 3 db with -50 dbm input at 1000 Hz

Output Impedance: 150/600 ohms, balanced or unbalanced

Input Impedance: High impedance bridging, unbalanced

Distortion: 1.0% maximum, 30 to 15,000 Hz at -10 dbm output

Output Noise: Signal-to-noise ratio, 60 db

Gain: 40 db at 1000 Hz minimum

Power Source: 120/240 vac, $\pm 5\%$, 50/60 Hz

Size: 4 in. W, 2 in. H, $7\frac{3}{4}$ in. D (10 cm W, 5 cm H, 20 cm D)

Weight: 5 lb (2.27 kg)

Part No. 522 2468 00

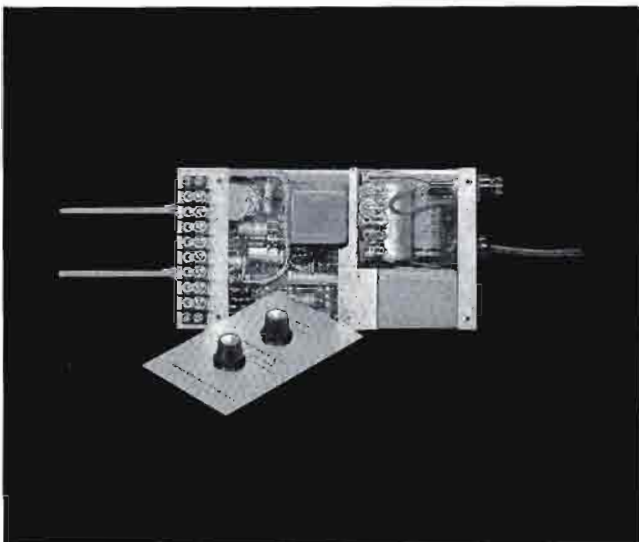

GRAY 208 SERIES PLAYBACK ARMS

The Gray professional stereo tone arm is available in two models that are identical in performance. Model 208-S comes with a slide and modular weights for mounting single play stereo or monophonic cartridges. Model 208-SG has a special slot cut into the front of the tone arm to clear the stem of a GE turnaround cartridge allowing plug-in operation and comes with specific hardware for this application.

Accessory slide kits are available for multiple cartridge operation.

The 8-S accessory slide assembly includes the cartridge slide, modular weights, mounting hardware and impresible spacers for the installation of stereo or monophonic single play cartridges. The 8-S slide assembly with cartridge mounted is usable in either the 208-S or 208-SG interchangeably.

The 8-SG accessory slide assembly is specifically designed to mount the GE turnaround cartridge. With this cartridge installed, it will only fit the 208-SC arm; however, cartridges are interchangeable between arms in this model. Response is ± 1 db from 5 Hz to top end limit imposed by cartridge used.

Part No. 099 0387 000

(Type 208-S)

Part No. 099 0164 000

(Type 208-SG)

Part No. 099 0837 000

(Type 8-SG) Sidemount for 208-SG.

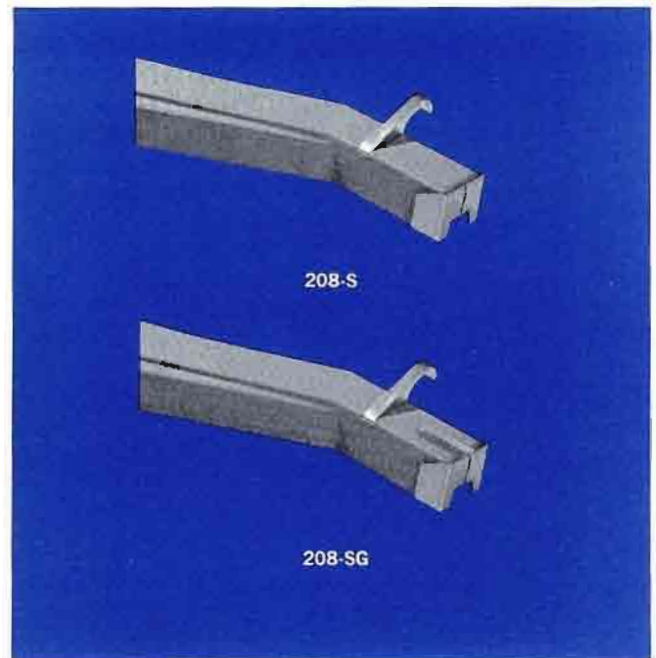

GRAY 206-S PLAYBACK ARM

Gray's goal while developing the 206-S was to minimize, to the vanishing point, the effect of a tone arm on reproduced sound while maximizing the number of distortion-free plays that could be obtained from a disc. No attempt was made to limit these stringent requirements to present-day records. All discs produced during this century ranging from 16 $\frac{2}{3}$ rpm to 85 rpm, including all known groove configurations—microgroove, standard, vertical, lateral, and stereo—were included within the scope of the project.

The 206-S is viscous damped and this damping plays a key role in its performance. Silicone fluids tend to resist motion when they are moved rapidly, but have an insignificant amount of resistance when they are moved slowly. Because of viscous damping, the 206-S stands still when the stylus is moved rapidly but can still spiral freely toward the center of a record.

Additional features include minimal tracking error, micrometer damping adjustment, and automatic lateral and vertical balance adjustments.

Part No. 124 0061 222 (206-S)

Part No. 124 0061 223 (206-SG for GE turnaround)



GRAY 303 PLAYBACK ARM

The Gray 303 arm will provide high compliance for stereo, absolute durability, and is engineered specifically for broadcasting. It has high isolation from resonance, will track distortion-free at micro pressures to 1/10 of a gram, and is free from fragile weights and gadgets.

The 303 arm has been designed to satisfy the need in the industry for micro pressure cartridges and to provide a stereo tone arm suitable to handle the finest distortion-free reproduction.

These arms feature a unique system of clean, modern styling, plug-in memory balance head, and body fabrication from epoxy-impregnated hardwood. Arm mass and resonance are exceptionally low.

All of this engineering effort and careful analysis has enabled Gray to offer the finest tone arm ever to carry the Gray name, and the only tone arm primarily designed for broadcast incorporating these features. Available for 12-inch (303) and 16-inch (306) recordings.

Part No. 124 0061 741 (Gray 303)

Part No. 124 0061 775 (Gray 306)

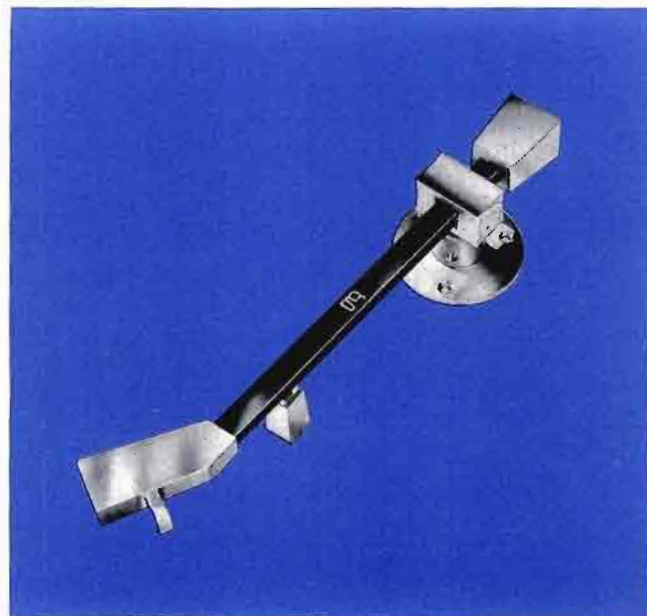

SHURE M44-7 PHONOGRAPH CARTRIDGE

The Model M44-7 Dynetic Phonograph Cartridge has been developed for use in all high fidelity applications. It has been designed to drive magnetic and constant velocity inputs.

Recently, highly technical papers have been published in the leading audio journals to the effect that a hitherto "hidden" source of distortion has finally been identified. It was stated that the difference in the effective angles between the record cutting mechanism's chisel point and the angle of the ball point playback stylus led to an annoying, discernible and measureable distortion. A matching of the vertical tracking angle of the playback stylus to the effective angle at which the record has been cut will eliminate this distortion.

Major recording companies have now begun to use a 15° effective cutting angle and it is the proposed EIA standard (similar in practice and effect to the adoption of the RIAA equalization curve).

The M44 Series of Stereo Dynetic Phono Cartridges has been specifically designed to complement the 15° effective cutting angle now being used on the newest recordings. It also serves to significantly improve the sound obtained from older discs.

The M44-7 is completely compatible. It will play stereo discs stereophonically, monaural discs monaurally, and stereo discs monaurally without excessive wear and distortion.

The Model M44-7 utilizes the Moving Magnet principle and features:

- High needle compliance.
- Low needle talk.
- Low tracking force.
- Wide range frequency response.
- Improved shielding for maximum reduction of hum pickup.
- Exceptional ease in changing stylus assembly.
- No magnetic attraction to steel turntables.

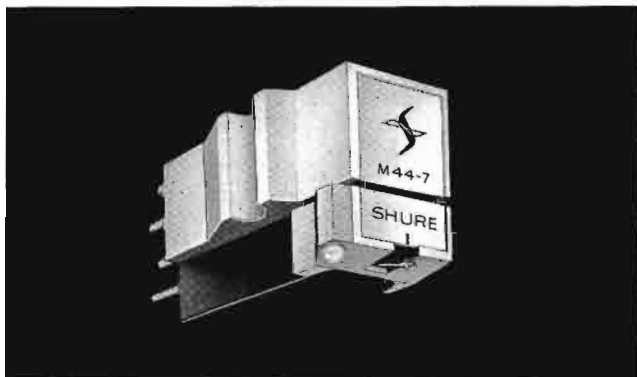

Frequency Response: From 20 to 20,000 Hz
Output Voltage: 9 millivolts per channel at 1000 Hz
Channel Separation: More than 25 db at 1000 Hz
Recommended Load Impedance: 47,000 ohms per channel
Stylus Replacement: Model Number N44-7; Radius, 0.0007 in. (0.018 mm) diamond; stylus grip color, White
Compliance: Vertical-horizontal, 20.0 x 10⁶ cm/dyne
Tracking: 1.5 to 3.0 grams
Stylus: No-scratch retractile feature
Inductance: 680 millihenrys
DC Resistance: 650 ohms
Terminals: 4 terminals
Mounting: Standard ½ in. (12.7 mm) mounting center
Weight: Net Weight: 7 grams
Part No. 099 3018 000 (Type M44-7)
Part No. 124 0032 301 (Type M44-7)
 Special J.O. 198 with .001 needle.
Part No. 124 0032 302 (Type N44-7)
 0.0007 in. needle assembly.
Part No. 124 0032 303 (Type N44-1)
 0.001 in. needle assembly.

SHURE M44-5 PHONOGRAPH CARTRIDGE

Frequency Response: From 20 to 20,000 Hz
Output Voltage: 6 millivolts per channel at 1000 Hz
Channel Separation: More than 25 db at 1000 Hz
Recommended Load Impedance: 47,000 ohms (per channel)
Stylus Replacement: Model Number N44-5, radius, 0.0005 in. 0.013 mm) diamond, stylus grip color, Red
Compliance: Vertical-Horizontal, 25.0 x 10⁶ cm/dyne
Tracking: ¾ gram to 1½ grams
Stylus: No-scratch retractile feature
Inductance: 680 millihenrys
DC Resistance: 650 ohms
Terminals: 4 terminals
Mounting: Standard ½ in. (12.7 mm) mounting center
Weight: 7 grams
 *The N44-3 Stylus may be used in the M44 Dynetic Cartridge to reproduce the standard 78-rpm records. The N44-3 is designed for tracking forces of 1.5 to 3.0 grams.

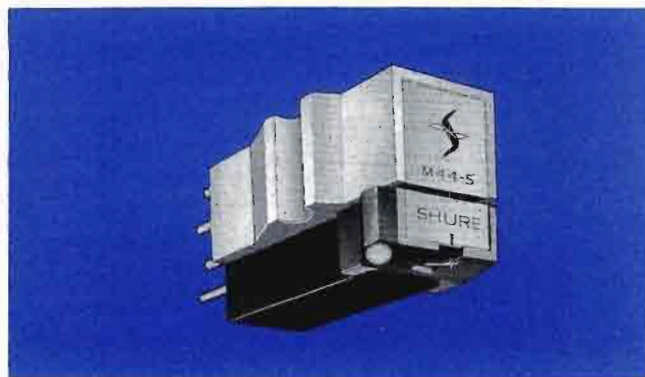

SHURE PLAYBACK ARMS

Accepts stereo and monophonic cartridges. Arm features precision ball bearings at all pivot points, plug-in head with positive alignment lock and variable adjustment. Supplied with arm rest, mounting template, mounting hardware and 4-foot cable assembly.

Size and Weight: 12 in. arm (M232), 12-11/16 in. L, 1 lb (0.45 kg); 16 in. arm (M236), 14½ in. L, 1½ lb (0.48 kg)

Part No. 097 8118 00 (Type M232)
Part No. 097 8122 00 (Type M236)

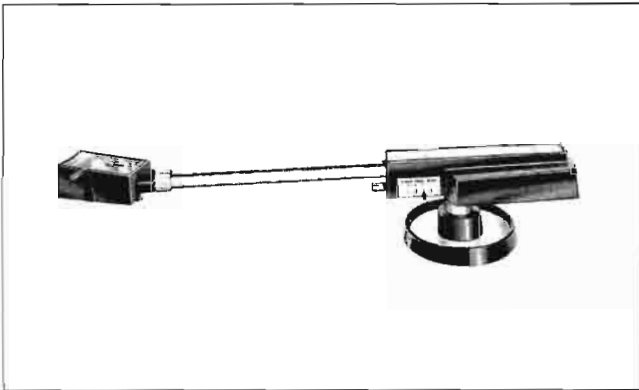

REK-O-KUT PLAYBACK ARMS

Tubular arm body with die cast aluminum cartridge shell. Four-conductor lead accommodates all 3- and 4-wire stereo cartridges. Does not include but uses all standard cartridges. Available for either 16 in. (S-260) or 12 in. (S-320) recordings.

Part No. 099 0242 000 (Type S-260) less balance weight.
Part No. 099 0241 000 (Type S-320) with balance weight.
Part No. 124 0032 094 Balance weight for S-260
Part No. 124 0032 549 (Type PS20-L) cartridge shell.

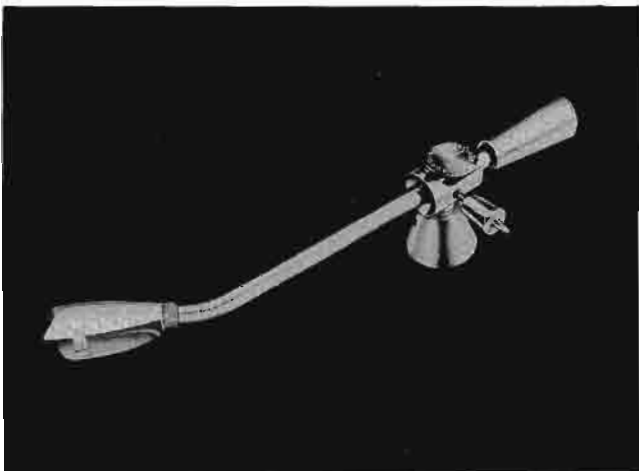

COLLINS 642E-1/2 TWINTAPE PLAYBACK UNITS

The 642E Twintape Playback Unit is the most convenient, flexible, and easy to operate cartridge machine on the market.

Using the 216D Record Amplifier, this twintape system provides simultaneous playback of two cartridges; playback of one cartridge while recording on another; and dubbing from one cartridge to another. The playback unit utilizes two independent tape transports with direct-drive capstan motors. Tape wow and flutter are almost eliminated due to the absence of belts, pulleys, etc. in the transport system.

Modular design concepts are used throughout the twintape system and all circuit cards. Access for service is with utmost ease. Snap-release head-assembly covers permit routine maintenance and head cleaning in seconds.

A highly flexible system, the 642E can be remotely controlled and provides for automatic sequencing of other tape machines, slide projectors, etc.

Other features include separate record and playback heads, heavy-gauge Mu-metal shields over the heads, completely solid-state circuitry all on plug-in military-grade glass-epoxy boards and backplane construction that almost eliminates wiring harnesses.

The 642E-1 alone will perform all the functions of a broadcast cartridge unit except recording. For recording, the 216D Record Amplifier must be used. Monaural operation would require the 642E-1 and the 216D-1. The 642E-2 and the 216D-2 would be required for stereo operation.

Options include 19-inch rack-mounting adapters and cue detector card.



Power Source: 105 to 125 vac, 60 Hz (50-Hz model available on order), single phase

Audio Inputs: Audio to record heads from "mode" switch in 216D-1/2 Record Amplifier

Outputs:

Program Audio:

Unit 1: Nominal 0 dbm into 600 ohms (adjustable)

Unit 2: Nominal 0 dbm into 600 ohms (adjustable)

Cue:

150 Hz: One set of "C" contacts; 0.5 ampere, 115-vac rating

8000 Hz: One set of "C" contacts; 0.5 ampere, 115-vdc rating

Frequency Response Equalized NAB 7-1/2 IPS: ± 2 db, 50 to 12,000 Hz; (1000-Hz reference), ± 4 db, 50 to 15,000 Hz (1000-Hz reference)

Distortion: 2% at 0 VU record level, 400 Hz (record to playback)

Noise: SN ratio -50 db with reproduce amplifier set for 0 dbm, noise level will drop to -50 dbm when signal is removed

Tape Speed: 7-1/2 ips $\pm 0.4\%$ or better

Tape Motion Start and Stop Time: Less than 0.10 second

Wow and Flutter: Less than 0.2% RMS

Size: 7 in. H, 17 $\frac{3}{8}$ in. W, 13 $\frac{1}{8}$ in. D (18 cm H, 44 cm W, 33 cm D); adapter permits 19-inch rack mounting

Weight: 48 lb (22 kg)

Part No. 777 1427 001 (642E-1)

Part No. 777 1423 001 (642E-2)

Part No. 774 7330 001 642E Cue Detector

Part No. 770 5625 001 642E Rack Adapter

Audio Inputs:

Line Input Impedance: 600/160 ohms (will accommodate levels from -20, ± 15 dbm)

Briding Input: 10K impedance

Input is brought from the left 642E-1/2 playback unit to feed the recording amplifier's dubbing mode operation.

Outputs: Left and right channel record amplifier outputs are brought through mode switch and routed to desired record head in playback unit.

Frequency Response:

50 to 12,000 Hz: ± 2 db (1000-Hz reference)

50 to 15,000 Hz: ± 4 db (1000-Hz reference)

Distortion: 2% at 0 VU record level, 400 Hz (record to playback)

Noise: S/n ratio -50 db with reproduce amplifier set for 0 dbm; noise level will drop to -50 dbm when signal is removed.

Tape Speed: 7 $\frac{1}{2}$ ips $\pm 0.4\%$ or better

Tape Motion Start and Stop Time: Less than 0.10 second

Wow and Flutter: Less than 0.2% rms

Size: 3 $\frac{1}{2}$ in. H by 17 $\frac{3}{8}$ in. W by 13 $\frac{1}{8}$ in. D (9 cm H by 44 cm W by 33 cm D) Adapter available for 19-inch rack mounting

Weight:

216D-1: 11 lb (5kg)

216D-2: 12 lb (5.5 kg)

Part No. 758 5726 001 (216D-1)

Part No. 777 1391 001 (216D-2)

Part No. 774 7528 001 216D Cue Oscillator

Part No. 770 5593 001 Rack Adapter

Exceeds NAB standards for tape cartridge equipment.

COLLINS 216D-1/2 TWINTAPE RECORD AMPLIFIERS

Collins 216D Amplifier offers high quality record capability to the twintape system. Using this unit with the 642E playback unit permits recording on either cartridge or dubbing from one cartridge to another.

Cue tone oscillators, VU metering, operational controls, and a record amplifier are contained in the 216D. One cue tone is standard, with option available for three cue tones. Solid-state design is used throughout, with all circuitry on military-grade glass-epoxy plug-in boards. Monaural (216D-1) or stereo (216D-2) models are available. Power for the amplifier is provided by the 642E playback unit through an interconnecting plug-in cable. The amplifier may be stacked compactly with the playback unit or rack-mounted with an optional adapter.

Power Source: All operating power supplied by 542E-1/2 playback unit



COLLINS TAPE CARTRIDGE RACK

Formica covered wood rack holds 120 of the Series 300 cartridges used with Collins automatic programming equipment. Four rubber cushions allow the rack to be set on top of a programming wing. It also may be hung on the wall. Walnut Formica. Other finishes available on request.

Size: 45¾ in. W, 14¾ in. H, 4 in. D (116 cm W, 37 cm H, 10 cm D)

Weight: 25 lb (11 kg)

Part No. 124 0032 300

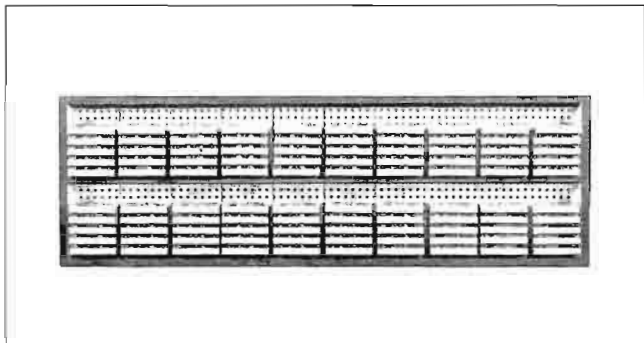

ABCO LAZY SUSAN CARTRIDGE RACK

This sturdy rack holds 500 of the Series 300 Collins automatic programming equipment tape cartridges. Ten chrome-plated racks with 50 slots each make storage and selection of cartridges fast and simple. Revolves easily on roller bearing hub and will not tip regardless of arrangement of cartridges. Cartridges held in wire holders at an angle to prevent slipping out while the rack is being revolved. Shipped knocked down.

Size: Approx. 72 in. H, 36 in. diameter (183 cm H, 91 cm diameter)

Weight: Approx. 50 lb (23 kg)

Part No. 097 7559 00

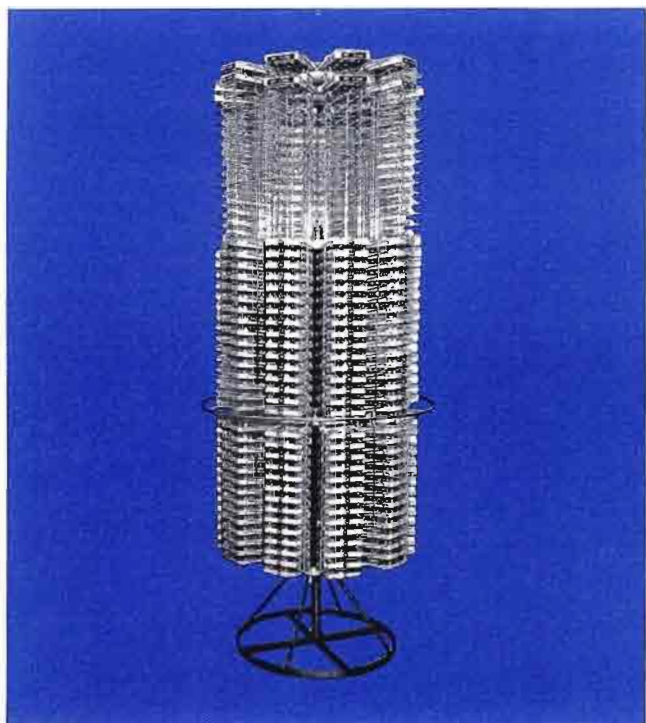

ABCO WIRE CARTRIDGE RACK

Individual wire rack holding 50 Collins automatic programming equipment cartridges. Identical rack to those used in the Lazy Susan. Includes tapped mounting brackets welded to wire rack.

Size: Approx. 5 in. W, 1½ in. H, 7 in. D (12.7 cm W, 3.8 cm H, 8 cm D)

Weight: Approx. 2 lb (0.91 kg)

Part No. 097 7560 00

COLLINS MM-151 AUTOMATIC PROGRAMMING BULK RECORDING TAPE

A fine quality, specially lubricated, Minnesota Mining tape in bulk lengths of 1700 ft on 7-in. reels for use with Collins Automatic Programming blank cartridges.

Part No. 099 2629 000

COLLINS AUTOMATIC PROGRAMMING LOADED CARTRIDGES

Manufactured for Collins automatic programming equipment, these cartridges are loaded with fine quality, specially lubricated tape.

300 Series: Loaded cartridges packed six per box (minimum one box) in following lengths: 40, 70, 90, 100 seconds, 2½, 3, 3½, 5, 5½, 7, 7½, 10, 10½ minutes. Specify length.

Type No.	Part Number	Length
300 Series	124 0032 057	40 Second Tape Cartridges
300 Series	124 0032 058	70 Second
300 Series	124 0032 059	90 Second
300 Series	124 0032 060	100 Second
300 Series	124 0032 061	2½ Minute
300 Series	124 0032 062	3 Minute
300 Series	124 0032 063	3½ minute
300 Series	124 0032 064	5 Minute
300 Series	124 0032 090	5½ Minute
300 Series	124 0032 065	7½ Minute
300 Series	124 0032 066	10 Minute
300 Series	124 0032 067	10½ Minute

600 Series: Loaded cartridges packed two per box (minimum one box) in following lengths: 11, 12½, 15, 16 minutes. Specify length.

600 Series	124 0032 067	11 Minute
600 Series	124 0032 069	13½ Minute
600 Series	124 0032 070	15 Minute
600 Series	124 0032 071	16 Minute

1200 Series: Loaded cartridges packed two per box (minimum one box) in 31 minute lengths.

1200 Series	124 0032 072	31 Minute
-------------	--------------	-----------

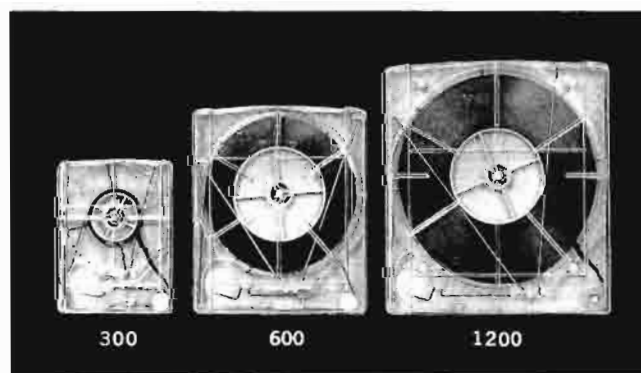

COLLINS AUTOMATIC PROGRAMMING BLANK CARTRIDGES

Identical to above cartridges for custom loading.

300 Series: Blank cartridges packed six per box (minimum one box). Up to 10½ minutes playing time.

Part No. 124 0032 073

600 Series: Blank cartridges packed two per box (minimum one box). From 11 to 16 minutes playing time.

Part No. 124 0032 074

1200 Series: Blank cartridges packed two per box (minimum one box). From 16½ to 31 minutes playing time.

Part No. 124 0032 075

COLLINS AUTOMATIC PROGRAMMING TEST TAPE

Azimuth head alignment test tape for Collins automatic programming playback in 70-second length with 5000-Hz tone on cue track and 10,000-Hz tone on program track.

Part No. 097 6076 00 (for 642A-1/2 only)

AUDIOTAPE AND MM RECORDING TAPES

The following tapes are designed for conventional recorders (see description under Collins Automatic Programming MM-151 Bulk Recording Tape for specially lubricated bulk tape):

111A-12: Minnesota Mining tape, 1200-ft, 7-in. reel.

150-18: Minnesota Mining tape, Mylar, 1800-ft, 7-in. reel.

190-18: Minnesota Mining tape, plastic base, 1800-ft, 7-in. reel.

Part No. 272 1407 00 (Type 111A-12)

Part No. 097 7112 00 (Type 150-18)

Part No. 099 0040 00 (Type 190-181)

ROBINS ST-500 BULK SPLICING TAPE

Robins splicing tape for use with automatic programming equipment and reel to reel recording tape. ½ by 100-inch Mylar tape.

Part No. 124 0032 544

ROBINS TS-8D SPLICER-CUTTER

Used for magnetic recording tape, this unit cuts two rounded indentations in the tape splice, giving the splice a "Gibson Girl" shape and leaving the edges of the tape free of adhesive. The unit can be removed from its base and mounted directly on any tape recorder. It comes complete with a roll of splicing tape and tape feed.

Part No. 124 0032 178



COLLINS HEAD ALIGNMENT GAUGES

Penetration and alignment gauges for aligning heads of Collins tape cartridge units.

Part No. 554 2632 002 Penetration gauge for 642A-1/2 only

Part No. 554 2635 002 Height gauge for 642A-1/2 only

REPLACEMENT PRESSURE PADS

Long lived Polyurethane pad interchangeable with pads in original cartridge in boxes of 50.

Part No. 094 2546 00

MAGNERASER 200C TAPE ERASER

A compact and convenient bulk tape eraser that removes recorded signals from tape up to 35 mm in size and lowers background noise level up to 6 db below that of unused tape. A pushbutton safety switch prevents current from being applied when not in use.

Operating Voltage: 100 to 130 v, 50 to 60 Hz

Size: 2 in. H, 4 in. diameter (5 cm H, 10 cm diameter)

Weight: 2½ lb (1.13 kg)

Part No. 097 5172 00



MICROTRAN HD-11M TAPE ERASER

A bulk tape demagnetizer that develops a high intensity magnetic field to erase signals and noise without rewinding. Spindle mounting of reel permits rapid and thorough coverage.

Reel Size Range: 5 in., 7 in., 10½ in. (spindle removable for use with other size reels).

Adapter Hub: Available for use with 10½ in. reels.

Rating: 117 vac, 5 A

Size: 5 in. W, 3 in. H, 8 in. D (13 cm W, 8 cm H, 20 cm D)

Part No. 099 0371 00 (HD-11M)

Part No. 124 0032 839 (HD-11-AD) 10½-in. Reel adapter



SCULLY 280 RECORDER/REPRODUCER

The Scully 280 professional tape recorder features all heads, reel hubs, relays, and amplifier cards with plug-in design; modular subassembly construction; and MIL-type cables.

Innovations such as automatic tape lifters, scrape filter, and patented disk brakes are standard on the 280. Power transformers are tapped, allowing selection of line voltage for lowest operating temperature, and synchronization for multi-channel over-dub effects is selective.

All control functions are in operations-oriented sequence. Individual reel-size selector switches and edit-control button are Scully design innovations. Calibration and all adjustment controls are accessible from the front of the amplifier control panel. Bias, operating levels, and gain of the amplifiers are totally immune to line voltage variations of up to 20 percent.

Three separate plug-in etched circuit boards contain microphone, record, and playback preamplifiers and erase and bias oscillators. The 280 offers reliable operation in a variety of critical audio applications where exacting performance is essential.

Frequency Response: ± 2 db 30 to 18,000 Hz at 15 ips; ± 2 db 50 to 15,000 Hz at $7\frac{1}{2}$ ips; ± 2 db 50 to 7,500 Hz at $3\frac{3}{4}$ ips

Signal-to-Noise Level: Peak record level to weighted noise (30-Hz to 15-kHz band) $7\frac{1}{2}$ and 15 ips full track . . . 70 db 3 M201 or equivalent

Flutter and Wow: 15 ips, 0.08% rms; $7\frac{1}{2}$ ips, 0.1% rms; $3\frac{3}{4}$ ips, 0.2% rms

Tape Speeds: $3\frac{3}{4}$ to $7\frac{1}{2}$ ips; $7\frac{1}{2}$ to 15 ips; other speeds on special request

Multichannel Configurations: $\frac{1}{4}$ in. — 1 or 2 channels; $\frac{1}{2}$ in. — 3 or 4 channels

Starting Time: Tape reaches full play speed in 0.1 second

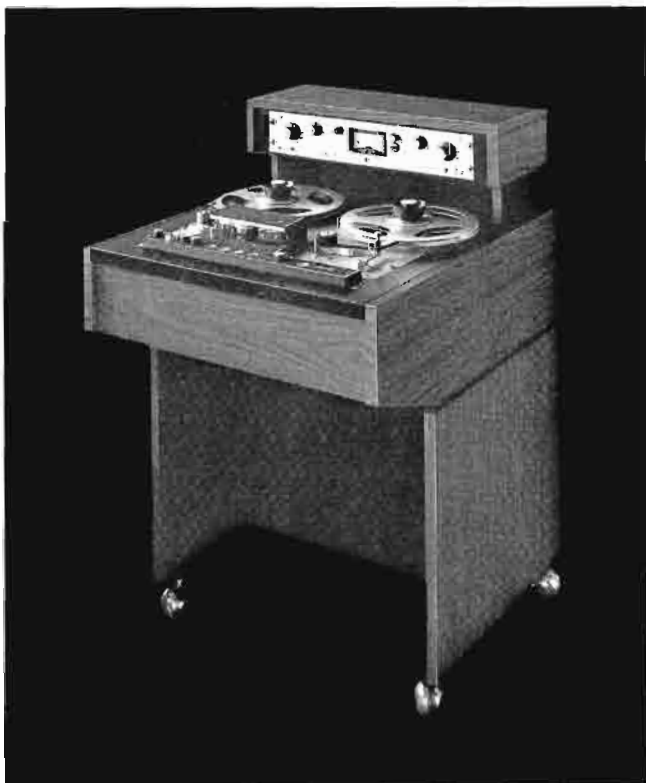

Stopping Time: Tape moves less than $1\frac{1}{2}$ inches after depressing stop (15 ips)

Timing Accuracy: 99.9% ± 1.5 seconds for 30-minute tape

Rewind Time: Approximately 75 seconds for 2400-foot NAB reel

Edit Function: Edit button permits tape to move in play mode without winding on takeup reel

Reel Size: Up to $11\frac{1}{8}$ inches

Playback Amplifier Distortion: Less than 0.5% THD at +18 dbm

Equalization: Transport speed switch controls equalization change. NAB curve

Erase Frequency: 60 kHz

Bias Frequency: 180 kHz

Controls: Power On and Off; Record; individual reel size switches; Rewind; Fast Forward; Stop; Play; Speed Change Switch; Edit; all relays and solenoids 24 vdc, relays are plug-in type

Remote Control: On, Off, Record, Rewind, Fast Forward, Stop, Play

Equalization Adjustment and Calibration Controls:

Accessible from front of electronics panel by removing cover plate

Outputs: +4 or +8 dbm (+18 dbm peak) 600-ohm balanced line

Input: Bridging 600-ohm balanced or unbalanced line level, also microphone

Monitoring: Separate record and playback amplifiers permit tape to be monitored while recording

Power Requirement: 117 vac, 50 to 60 Hz, 275 watts

Mounting: All models available unmounted for rack mounting or in console or portable cases

CROWN SX800 RECORDER/REPRODUCER

The Crown SX800 Recorder has the latest in advanced design concepts including patented magnetic braking, computer logic control, straight line threading, and precision micro-gap heads. Integrated circuits are utilized, with advanced computer logic circuitry for simplicity of operation and complete tape handling safety. The logic control unit performs all operating sequences. Lighted pushbuttons display each mode of operation. All new compact, solid-state electronics provide excellent frequency response and low distortion.

Four separate microphone or line inputs feed a 2-input mixer per channel. Each channel has two separate 600-ohm



unbalanced outputs. In addition, the front panel will accommodate two pairs of 600-ohm stereophones.

The SX800 is available in a variety of configurations ranging from full-track monaural to 4-channel in-line or 4-channel, 8-track stereo.

Frequency Response:

7½ ips: ±2 db 30 to 20,000 Hz, 55-db s/n (Scotch 202)

3¾ ips: ±2 db 30 to 10,000 Hz, 50-db s/n (Scotch 202)

Signal-to-Noise Ratio: Record and playback noise referenced to 400 Hz, 3% HD standard tape. Total harmonic distortion noise less than 1.5% for zero record level at 1 kHz. Crosstalk rejection -55 db minimum.

Flutter and Wow:

7½ ips: 0.09%

3¾ ips: 0.18%

Timing Accuracy: 99.8% or 1.8 seconds in 15 minutes (microadjustable to ±0.05% short term)

Record Input:

Microphone: -66 dbm, 0.4 mv minimum for zero level (10K or above)

Line: -25 dbm, 45 mv minimum for zero level (>10K)

Playback Output: 2.5 v, 600-ohm unbalanced, maximum undistorted output is 14 v.

Reel Size: Standard up to 10½-inch NAB.

Power Requirements: 117 vac, 60 Hz (50 Hz available)

MAGNECORD 1021 RECORDER/REPRODUCER

The Magnecord 1021 features fully transistorized electronics with regulated power supply. Switchable equalization (NAB standard).

Tape Speeds: 3.75 and 7.5 ips

Flutter and Wow: 0.25% at 3.75 ips; 0.2% at 7.5 ips

Timing Accuracy: ±0.2%

Reel Size: 5-, 7- and 8-inch EIA hubs

Rewind Time: 1200 feet in 80 seconds

Frequency Response: ±2 db — 30 to 8,000 Hz at 3.75 ips. 20 to 15,000 Hz at 7.5 ips

Signal-to-Noise Ratio: 53 db, both speeds

Inputs: Lo-Z microphone, balanced bridge, unbalanced bridge, mixing bridge, and auxiliary bridge

Outputs: 150/600-ohm balanced; unbalanced, auxiliary A and auxiliary B (+8 dbm)

Heads: Full-track erase, record, and half-track play

Weight: 47 lb (21 kg)

Dimensions: 19 in. W, 15¾ in. H, 12 in. D (48 cm W, 40 cm H, 30 cm D)

50-Hz model at no extra cost



MAGNECORD 1022 RECORDER/REPRODUCER

The Magnecord 1022 features solid-state electronics with regulated power supply and built-in input and output transformers.

Tape Speeds: 7.5 and 15 ips

Flutter and Wow: 0.17% at 7.5 ips; 0.15% at 15 ips

Timing Accuracy: ±0.2%

Reel Size: 5-, 7- and 8-inch EIA hubs

Rewind Time: 1200 feet in 80 seconds

Frequency Response: ±2 db — 25 to 18,000 Hz at 7.5 ips; 35 to 22,000 Hz at 15 ips

Signal-to-Noise Ratio: 53 db, both speeds

Inputs Per Channel: Lo-Z microphone, balanced bridge, unbalanced bridge, auxiliary bridge

Outputs Per Channel: 150/600-ohm balanced, auxiliary A and auxiliary B unbalanced (+8 dbm)

Heads: Selectable 2-channel erase, 2-channel record, 2-channel play and ¼-track play

Weight: 47 lb (21 kg)

Dimensions: 19 in. W, 15¾ in. H, 12 in. D (48 cm W, 40 cm H, 30 cm D)

Part No. 124 0032 375

MAGNECORD 1028 RECORDER/REPRODUCER

The Magnecord 1028 has advanced circuit design, utilizing latest types, and printed wiring to insure uniform high performance from recorder to recorder.

Tape Speeds: 7.5 and 15 inches per second

Flutter and Wow: 0.15% at 7.5 ips; 0.1% at 15 ips

Timing Accuracy: ±0.2%

Reel Size: 5-, 7- and 10½-inch

Rewind Time: 2400 feet, less than 100 seconds

Frequency Response: ±2 db — 40 to 16,000 Hz at 7.5 ips; 40 to 22,000 Hz at 15 ips

Signal-to-Noise Ratio: 56 db per channel

Inputs: Hi-Z mic and Hi-Z unbalanced bridge; Lo-Z mic and Hi-Z balanced bridge. With input transformer

Input Sensitivity: -90 dbm to -30 dbm

Outputs: Cathode follower, 2.0 volts; 150/600-ohm balanced, +4 dbm. With input transformer

Heads: Select Erase. 2-channel Record and 2-channel Play

Weight: 50 lb (23 kg), 60 lb (27 kg) encased

Dimensions: 17⅞ in. W, 12⅞ in. H, 12 in. D. (17⅞ in. W, 14⅞ in. H, 12 in. D encased)

Part No. 099 3013 000



AMPEX AG-440 RECORDER/REPRODUCER

The AG-440 Recorder is a new generation of professional audio recorders with new tape transport rigidity previously limited to higher cost Ampex mastering recorders and Ampex instrumentation and video recorders. New versatility allows rapid conversion to accommodate either 1/2- or 1/4-inch tape. New flexibility permits buildup to as many as four channels. Head assemblies and new solid-state electronics are all plug-in modules.

One-quarter-inch head assemblies are standard on all 1- and 2-channel recorders. One-half-inch head assemblies are standard on all 3- and 4-channel recorders. The cover bridge modular mount easily accepts four or more 3 1/2-inch electronics panels so that a single-channel machine may be expanded to four channels. The AG-440 contains three motors and is relay-solenoid operated. All machines are dual speed with automatic equalization change.

Frequency Response:

15 ips: ± 2 db 30 to 18,000 Hz

7 1/2 ips: ± 2 db 40 to 10,000 Hz, +2 to 4 db 30 to 15,000 Hz

3 3/4 ips: ± 2 db 50 to 7500 Hz

Signal-to-Noise Ratio:

15 ips: Full track, 68 db; 2 track, 60 db; 3 track, 62 db; 4 track, 60 db

7 1/2 ips: Full track, 68 db; 2 track, 60 db; 3 track, 62 db; 4 track, 60 db.

3 3/4 ips: Full track, 63 db; 2 track, 56 db, 3 track, 57 db; 4 track, 56 db (using low-noise tape).

Flutter/Wow (by ASA Standards):

15 ips: Below 0.08% rms

7 1/2 ips: Below 0.1% rms

3 3/4 ips: Below 0.15% rms

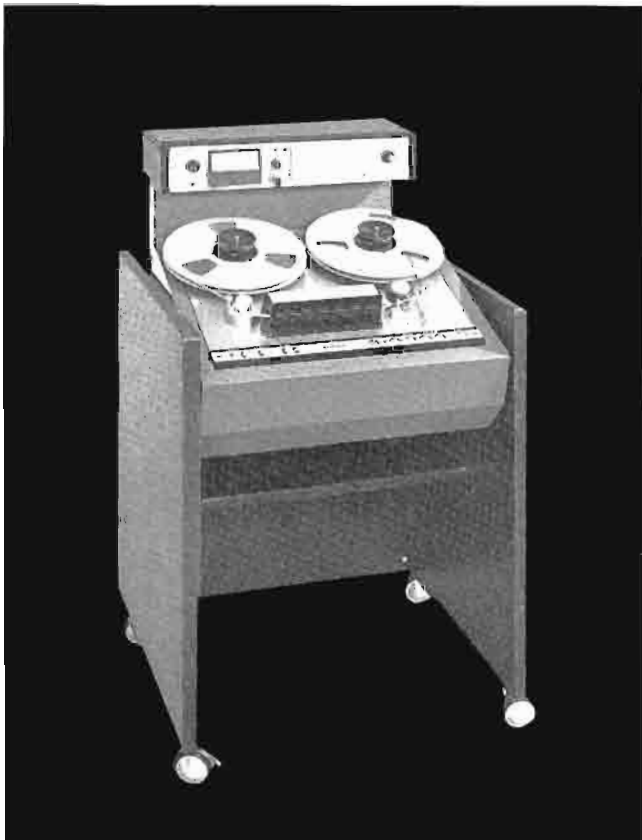

Timing Accuracy: 0.2% (± 3.6 seconds in 30-minute recording time).

Record Input: 100k unbalanced bridging with dummy plug supplied or 20k balanced bridging with plug-in transformer supplied with each electronics unit. (-17 dbm to produce recommended operating level)

Playback Output: +8 dbm into 600 ohm load, balanced or unbalanced

Reel Size: Standard, up to 10 1/2 in., adjustable up to 11 1/2 in.

Power Requirements:

Single Channel Models: 2.0 amperes current

2-Channel: 2.5 amperes, 117 volts, 60 Hz

AMPEX AA-620 SPEAKER/AMPLIFIER

A totally new portable 20-watt amplifier/speaker system for use with the Ampex AG-600 Recorder or any other professional equipment. The new AA-620 offers two speakers, solid-state electronics, increased power output, and separate bass and treble equalization. System-matching provides essentially flat acoustical response (in free air) from 65 Hz to 10 kHz.

Overall Frequency Response (in air): Better than 65 Hz to 10 kHz

Speakers: 10-inch woofer, 3 1/2-inch tweeter

Power Output: 20 watts into an 8-ohm resistive load

Equalization: Two switches on front panel -6, -3, 0, +3, +6 db at 100 Hz and 10 kHz

Signal-to-Noise: Amplifier noise (including hum), 80 db below rated output

Input Impedance: 100,000 ohms unbalanced; 0.9-volt rms for full output

Harmonic Distortion: Less than 1% at full rated output

Power Requirement: 117 volts 50/60 Hz; 0.5 A

Dimension:

Portable: 14 3/4 in. H, 20 1/8 in. L, 9 in. D (37 cm H, 51 cm L, 23 cm D)

Rack Mount: 12 1/2 in. H, 19 in. L, 9 in. D (32 cm H, 48 cm L, 23 cm D)

Weight:

Portable: 24 1/2 lb (11 kg)

Rack Mount: 15 lb (7 kg)



AMPEX AG-600 PORTABLE TAPE RECORDER

Now Ampex offers a smaller, all new version of the 600 series; the world's finest low-cost professional audio recorder. The AG-600 recorder/reproducer is available in single channel (full- or half-track mono) or 2-channel (half- or quarter-track stereo/mono).

The new 2-speed transport uses a rugged die-cast aluminum frame. This means a more rigid top plate that maintains critical alignment of heads and tape guides. There's also an improved clutch assembly and a new cooling system to add to reliability. The AG-600 is available in lightweight carrying case, or can be rack mounted with accessory adapter.

The new solid-state electronics package allows extreme versatility in small space. Each channel has one line and one mike input, providing a built-in mixer capability. The line input may be converted to mike input with an accessory plug-in preamplifier.

Frequency Response: 7½ ips, ±2 db from 60 Hz to 10 kHz, +2 to 4 db from 40 Hz to 15 kHz; 3¾ ips, ±2 db from 50 Hz to 7 kHz, +2 to 4 db from 40 Hz to 8 kHz

Signal-to-Noise: 7½ ips, full track 57 db, half track 55 db; 3¾ ips, full track 52 db, half track 50 db

Crosstalk Rejection: Better than 40 db mid-frequency

Flutter and Wow: (Measured by ASA Standards) 7½ ips less than 0.17%; 3¾ ips less than 0.25%

Timing Accuracy: 7½ ips ±0.2% (±3.6 seconds in a 30-minute recording); 3¾ ips ±0.4% (±7.2 seconds in a 30-minute recording)

Fast Forward or Rewind: 90 for 1200-foot reel

Speeds: Dual speed, 3¾ and 7½ ips

Reel Size: 5 and 7 inches

Inputs: Low impedance mike input; and line input (100K unbalanced)

Outputs: Two outputs for each channel. 1. ±4 dbm into 600 ohm balanced or unbalanced load. 2. Headphone monitor jack (on front panel)

Equalization:

117-vac, 60-Hz Models: 3¾ ips, 120 microseconds; 7½ ips, NAB.

115/230-vac, 50-Hz Models: 3¾ ips, 120 or 200 microseconds; 7½ ips, NAB or CCIR

Power Requirements: For 117-vac operation, 0.5 A; for 230-vac operation, 0.3 A



AMPEX AG-500 PORTABLE TAPE RECORDER

AG-500-1

A new versatile 1-channel recorder with full- or half-track head. This single channel unit has input controls that can mix two incoming line signals. Use of mike pre-amplifier accessory converts line inputs to accept low impedance microphones. Narration over music, music/voice mixing or special sound-on-sound capabilities are possible. Recorder feeds 600-ohm remote phone line.

AG-500-2

The 2-channel version provides complete stereo record and reproduce. A 2-track erase head used with the record/safe selector permits half-track recording of either track, sound-on-sound, cut track, and special effects. Input controls are the same as the AG-500-1.

AG-500-4

Offers all functions of AG-500-2 in quarter track stereo/mono version. Recorder has three one-fourth track stereo heads; erase, record, play . . . (tracks 1 and 3 of 4 tracks). Optional versions are available from factory with extra head and head transfer installed.

Speeds: 7½ and 15 ips, or 3¾ and 7½ ips (AG 500-4: 3¾ to 7½ only)

Overall Frequency Response: 30 to 18,000 Hz ±2 db at 15 ips; 30 to 15,000 Hz ±2 db, -4 db at 7½ ips; 40 to 8,000 Hz +2 db at 3¾ ips

Signal-To-Noise Ratio: (Peak record level to unweighted noise. Includes bias, erase, and playback amplifier noise.)

55 db at 15 and 7½ ips (half track or two track); 60 db at 15 and 7½ ips (full track 60 Hz); 57 db at 15 and 7½ ips (full track 50 Hz); 55 db at 3¾ ips (full track); 50 db at 3¾ (half track and quarter track)

Flutter and Wow: Less than 0.15% rms at 15 ips; 0.18% rms at 7½ ips; 0.25% rms at 3¾ ips

Timing Accuracy: ±0.25% at 15 and 7½ ips; ±0.40% at 3¾ ips

Output: +4 dbm into 600-ohm balanced load

Inputs: Two inputs per channel, 2: balanced or unbalanced bridging (bridging transformers supplied)

Power Required: 117 vac — 60 Hz, 1.50 A; 230 vac — 50 Hz, 0.75 A; 3-wire grounded power cable supplied

Rack Space:

Transport: 8¾ by 19 in. (22.2 by 48.3 cm)

Electronics: 3½ by 19 in. (8.9 by 48.3cm)

Minimum Space Required: 6 in. behind panels (15.2 cm)

Portable Units: Mounted in rugged Samsonite cases.



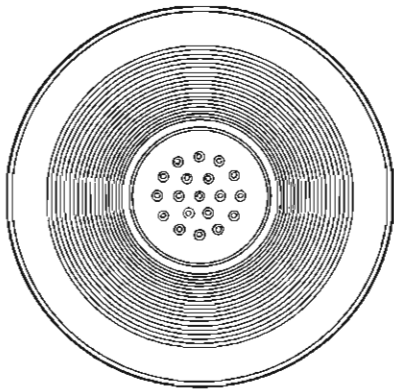

**Audio
Accessories**

COLLINS M-20 MICROPHONE

This small and rugged lavalier microphone frees hands in one-man speaking situations such as weather shows and demonstrations. It is small enough to be hidden behind a necktie or lapel. Supplied with lavalier clip and 25 feet of 3-conductor cable. Essentially omnidirectional polar pattern. Desk stand available on order.

Impedance: 50 ohms or 200 ohms, selectable

Frequency Response: 60 to 18,000 Hz

Output Level: -57 db, with reference to 1 mv/10 dynes/cm²

Size: 4 in. long, 1 in. diameter (10.16 cm L, 2.54 cm diameter)

Weight: 3½ oz (99 gm)

Color: Non-reflecting blue-gray

Part No. 097 5464 00 (M-20)

Part No. 097 6627 00

Replacement lavalier clip for M-20.

Part No. 097 5826 00

Desk stand for M-20.

Part No. 099 0870 00

Replacement cord and clip.

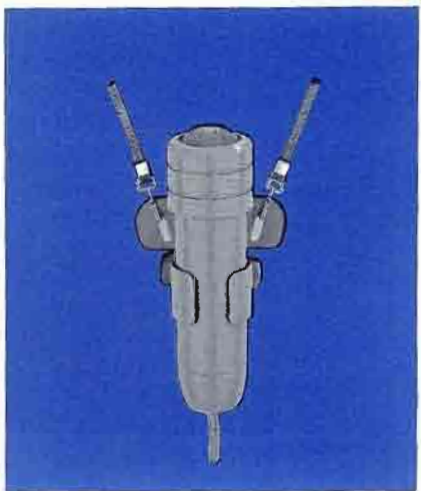

COLLINS M-40 MICROPHONE

Ideal for panel discussions, dinner meetings and interviews. Equipped with desk stand and 20 feet of 3-conductor, plastic jacketed cable. Essentially omnidirectional polar pattern.

Impedance: 50 ohms or 200 ohms, selectable

Frequency Response: 40 to 20,000 Hz
Output Level: -59 db, with reference to 1 mv/10 dynes/cm²

Size: 9⅞ in. long, 1 in. diameter (24.45 cm long, 2.54 cm diameter)

Weight: 11 oz (0.31 kg)

Color: Non-reflecting blue-gray

Part No. 097 5463 00



COLLINS M-70 MICROPHONE

Provides highly directional sound selectivity to double the conventional working distance and to cut out unwanted background sounds. It is especially useful in small booths where reflecting surfaces could be a problem. Comes equipped with desk stand and a 20-foot, 3-conductor shielded cable.

Impedance: 50 ohms or 200 ohms, selectable

Frequency Response: 40 to 15,000 Hz
Output Level: -55 db below 1 mm/10 dynes/cm²

Size: 6 13/16 in. long, 1 17/32 in. diameter (17 cm long, 3.9 cm diameter)

Weight: 12 ounces, (0.34 kg) (without cable)

Color: Non-reflecting blue-gray

Part No. 099 2402 000



SHURE SM5A AND SM5B MICROPHONES

The Shure SM5 dynamic cardioid provides directivity, minimizes sound coloration due to off axis pickup, and wide range frequency response. Integral windscreen, absence of transformers or response correcting inductors prevents pickup of electrical noise. Especially suited for boom application.

Frequency Response: 50 to 15,000 Hz

Polar Pattern: Unidirectional

Impedance: SM5A, 50 ohms; SM5B, 150 ohms

Output Level: 1000-Hz response

SM5A (50 ohm), open circuit voltage: -84.0 db* (0.063 mv)

Power level into 50 ohms: -57.0 db**

Gm sensitivity (EIA microphone rating): -150.0 db***

SM5B (150 ohm) — open circuit voltage: -79.5 db* (0.103 mv)

Power level into 150 ohms: -57.0 db***

Gm sensitivity (EIA microphone rating): -150.0 db***

Connector: Cannon XLR-3-42 receptacle mounted on microphone

Finish: Textured dark gray enamel, light and dark gray plastic foam wind screens

Mounting: 5/8-27 adapter is supplied, desk mount available as accessory

Weight: 1 lb, 15 oz (879 grams)

Hum Level: -120 dbm with field of 1×10^{-3} gauss at 60 Hz

Part No. 124 0032 551 (Type SM5A)

Part No. 124 0032 552 (Type SM5B)

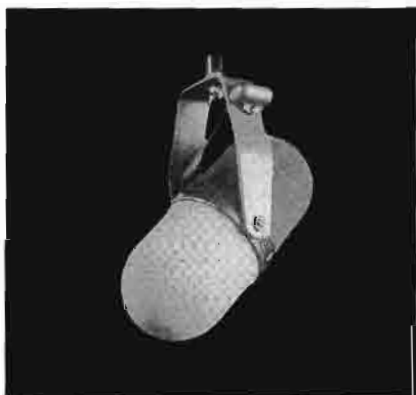

SHURE SM33 MICROPHONE

The model SM33 is a compact and rugged unidirectional ribbon microphone combining wide range response and a super-cardioid directional pattern. This polar pattern is somewhat more directional than the conventional cardioid, providing excellent control of unwanted surrounding noise and reverberation. The performance characteristics are ideal for studio use in broadcasting, recording, and for critical sound reinforcement applications. The SM33 features super-cardioid pickup, wide frequency response, low frequency response adjustable by means of a response selector switch, built in shock mount, and rugged mechanical design.

Type: Ribbon

Frequency Response: 40 to 15,000 Hz

Polar Pattern: Super-cardioid

Impedance: Dual. Choice of 30 to 50 ohms or 150 to 250 ohms (Connected for 150 to 250 ohms)

Output Level: 1000 Hz response

SM33 30 to 50 ohms, open-circuit voltage -87.0 db* (0.049 mv)

Power Level -60.0 db**

Gm sensitivity (EIA microphone rating) -152.5 db***

SM33 150 to 250 ohms, open-circuit voltage -81.0 db* (0.089 mv)

Power Level -58.5 db**

Gm sensitivity (EIA microphone rating): -152.5 db***

Connector: XL-3-12 connector in microphone

Cable: 20 ft, 2-conductor shielded with cannon XLR-3-11-C connector attached (one end)

Finish: Textured light and dark gray enamel

Swivel: Self adjusting lifetime swivel permits tilting the head 45° forward and 70° backward

Shock Mount: Special live rubber vibration isolation unit

Weight: 1 lb 10 oz (736 grams)

Part No. 124 0032 533 (Type SM33)



SHURE SM50 MICROPHONE

The SM50 is a rugged, omnidirectional microphone built to withstand the severest field use. It provides very natural and intelligible voice reproduction and unusual freedom from annoying wind and breath noises. Very comfortable hand-held, or mounted in the slip-in stand adapter, the SM50 is ideally suited to remote interviews, news and sports pickups, and a variety of field and studio applications. The SM50 features natural response from 40 to 15,000 Hz, highly effective built-in wind and breath filter, comfortable size, lightweight, and rugged construction.

Type: Dynamic

Frequency Response: 40 to 15,000 Hz

Polar Pattern: Omnidirectional

Impedance: Dual 30 to 50 ohms and 150 to 250 ohms (connected for 150 to 250 ohms when shipped)

Output Level: 1000-Hz response

SM50 30 to 50 ohms, open-circuit voltage -85.0 db* (0.053 mv)

Power level -58.0 db**

Gm sensitivity (EIA microphone rating) -150 db***

SM50 150 to 250 ohms, open-circuit voltage -79.0 db* (0.111 mv)

Power level -58.0 db**

Gm sensitivity (EIA microphone rating): -150 db***

Connector: Cannon XL-3-12 type in microphone

Cable: 20-ft, 2-conductor shielded with Cannon XLR-3-11C connector (one end)

Finish: Textured dark gray enamel

Swivel Adapter: Positive action 90° swivel to mount microphone to stand on fixture with 5/8-27 thread

Weight: 8 oz (227 gm)

Shipping Weight: 2 lb, 5 oz (1049 gm)

Part No. 124 0032 554 (Type SM50)



SHURE SM300 MICROPHONE

The model 300 is an unusually compact ribbon microphone. The 300 is an excellent choice for broadcast or recording studio and for critical sound reinforcement applications in which its symmetrical front and rear pickup with greatly reduced side pickup is useful. Ideal for applications such as across-the-table interviews or dialogue. The bidirectional pattern provides the same control of overall surrounding noise and reverberation as an equivalent microphone. The model 300 features warm, smooth sound from wide range front and rear response, low frequency characteristic adjustable by means of a response selector switch, bidirectional polar pattern, built-in shock mount, impedance selection, and rugged mechanical design.

Type: Ribbon

Frequency Response: 40 to 15,000 Hz

Polar Pattern: Bidirectional. Equally sensitive at front and rear. Response at sides down 15 to 20 db from front and rear response

Impedance: Choice of three by switch. "L" 30 to 50 ohms, "M" 150 to 250 ohms, "H" high

Output Level: 1000 cps response

Model 300—30 to 50 ohms "L" position

Open circuit voltage -87.5 db* (0.043 mv)

Power level into 50 ohms -60.5 db**

Gm sensitivity (EIA microphone rating): -153.0 db***

Model 300—150 to 250 ohms "M" position

Open circuit voltage -79.5 db* (0.105 mv)

Power level into 50 ohms -59.0 db**

Gm sensitivity (EIA microphone rating): -151.0 db***



Model 300 High Impedance "H" position

Open circuit voltage -57.5 db* (1.32 mv)

Loaded with 100,000 ohms -60.0 db**

Gm (sensitivity) -154.0 db***

Finish: Textured dark gray enamel

Swivel: Self-adjusting lifetime swivel permits tilting the head 45° forward and 90° backward so that the microphone can be aimed at the source of sound.

Shock Mount: Live-rubber vibration-isolation unit

Connector: Cannon type XLR-3-12 in microphone

Cable: 20-ft 2-conductor shielded with cannon XLR-3-11C (one end)

Stand Thread: 5/8-27 thread

Response Selector: Two position switch to adjust low frequency characteristic

Part No. 124 0032 555 (Type 300)

ELECTRO-VOICE AND ALTEC-LANSING MICROPHONES

A complete line of Electro-Voice and Altec-Lansing general purpose and specialized microphones, stands, call letter plates and accessories is sold by your Collins Broadcast Equipment Sales Engineer.

COLLINS M-20 MICROPHONE DESK STAND

A small, non-reflecting blue-gray stand that holds the Collins M-20 microphone. The M-20 is held with a felt padded clamp that allows the microphone to be slipped in and out of the stand easily.

Part No. 097 5826 00



ATLAS DS-7 MICROPHONE DESK STAND

A general purpose, chrome plated adjustable desk stand with a base of cast iron and finished in gun metal shrivel finish. Stable base is equipped with pads to prevent damage to desk. Equipped with standard "velvet action" clutch adjustment. Thread size at microphone end is 5/8-27. Adjustable from 8 to 12 inches (20 cm to 30.5 cm)

Weight: 3 lb (1.4 kg)

Part No. 097 1119 00

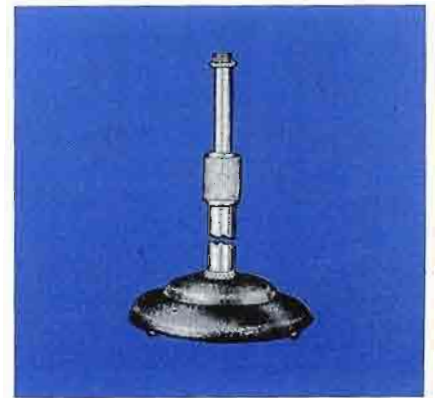

* 0db = 1 volt per microbar

** 0db = 1 milliwatt with 10 microbars

*** 0db = EIA Standard SE-105, August 1949

ATLAS BS-36/36W BOOM STAND

Professional Boom Stand features safety air-lock to prevent slippage, 62-inch boom with gyromatic swivel joint for microphone suspension. Vertical adjustment 48 to 72 inches. BS-36W provides ball bearing swivel casters.

Weight: BS-36 36 lb (16.4 kg). BS-36W 40 lb (18.2 kg)

Part No. 097 1500 000 (Type BS-36)

Part No. 097 1790 000 (Type BS-36W)

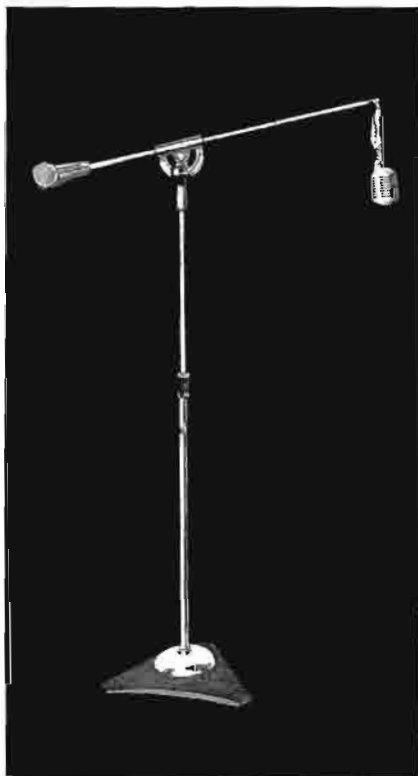

ATLAS BB-1 MICROPHONE BOOM

This 31-inch microphone boom may be attached to any type of floor stand. All swivel parts are precision die castings resulting in smooth operation and secure positioning. Boom is chrome plated and has 5/8-27 thread.

Weight: 3½ lb (1.6 kg)

Part No. 097 0984 00

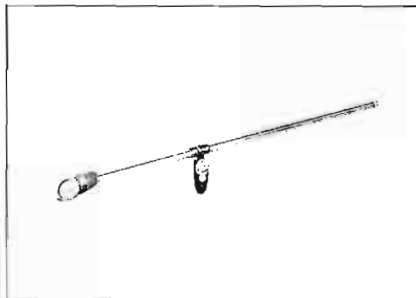

ATLAS MS-11C FLOOR STAND

Features an extended length clutch body, inner lined with a wear-proof locking collet which grips without jamming, slipping or sudden dropping. Includes self-leveling, shock absorbing base pads, plus three additional anti-tip points located between the base pads. Terminates in a 5/8-27 thread.

Finish: Chrome or gray wrinkle (Model MS-10C)

Height Adjust: 35 to 65 in. (89 cm to 165 cm)

Base Diameter: 10 in. (25.4 cm)

Weight: 12 lb (5.5 kg)

Part No. 097 1511 00 (Type MS-11C)

Part No. 097 5729 00 (Type MS-10C)



ATLAS MS-25 FLOOR STAND

Features safety air-lock cushion to prevent slippage of telescoping section. Uses a large diameter, oversize telescoping tube (7/8 in. telescoping tube, 1½ in. base tube). Terminated in 5/8-27 thread.

Finish: Chrome and gray wrinkle

Height Adjust: 37 to 66 in. (94 cm to 167 cm)

Base Diameter: 17 in. (43.18 cm)

Weight: 24 lb (11 kg)

Part No. 097 1510 00



FLEXP MIKESTER FM-1

This arm will handle any mike up to 4 lb. It can be instantly positioned, incorporates a patented enclosed spring-controlled swiveling device, swings out 36 inches in any direction when fully extended. Clamps or screws to any position. Clips hold cable in place.

Weight: 4¾ lb (2.2 kg)

Part No. 097 1499 00



ARGOS BAFFLES

Entire front is inset with plastic grille and cloth covered panel. Constructed of plywood and hardboard for good resonant tone. Extra reinforcing blocks and four bolts installed for mounting speakers. Covering is plastic coated leatherette. Available in blonde or walnut. Slanting corner baffle for 8-inch speaker (SCB-8D) or 12-inch speaker (SCB-12D).

Weight: 6 or 8 lb (2.72 kg or 3.63 kg). Wall baffle for 8 in. speaker (WB-8D) or 12 in. speaker (WB-12D)

Weight: 2½ or 4¼ lb (1.13 kg or 1.93 kg)

- Part No. 099 2374 00** (Type SCB-8D)
Walnut finish.
- Part No. 099 2375 00** (Type SCB-8D)
Blonde finish.
- Part No. 099 2376 00** (Type SCB-12D)
Walnut finish.
- Part No. 099 2377 00** (Type SCB-12D)
Blonde finish.
- Part No. 124 0032 295** (Type WB-8D)
Walnut finish.
- Part No. 124 0032 296** (Type WB-8D)
Blonde finish.
- Part No. 124 0032 297** (Type WB-12D)
Walnut finish.
- Part No. 124 0032 298** (Type WB-12D)
Blonde finish.

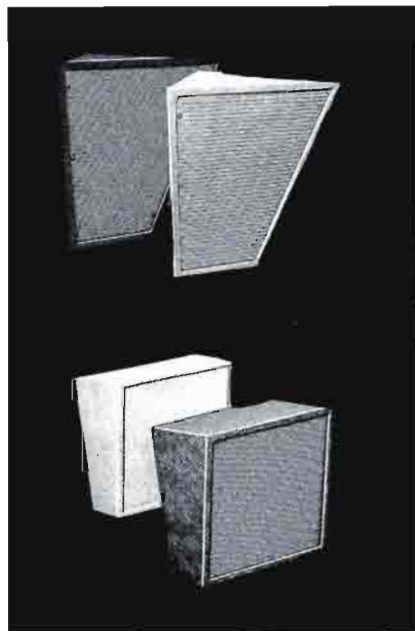

TRIMM HEADPHONES

Lightweight, rugged headphones with black Bakelite shell and cap. Rubber covered headband.

Impedance: 600 ohms (Model 156) or 17,000 ohms (Model 157)

Weight: 5 oz (140 gm)

Part No. 273 0003 00 (Type 156)

Part No. 273 0004 00 (Type 157)

BRUSH BA-200 HEADPHONES

Ideal for general purpose service, the Brush BA-200 headphones have a frequency range from 100 to 5000 Hz. They are especially suitable for general laboratory and studio work as well as for the skilled amateur.

Impedance: 45,000 ohms at 1000 Hz
Weight: 6 oz (170 gm)

Part No. 099 2488 000 (Type BA-200-1)
45000 ohm with plug.

Part No. 099 2489 000 (Type BA-200-2)
45000 ohm with eyelet terminals.



BRUSH BA-206 HEADPHONES

The Brush BA-206 headphones have an exceptionally flat response out to 10,000 Hz and create outstanding fidelity of reception. Impedance at 1 kHz is 50K. Their high impedance and negligible power requirements allow monitoring without any effects on associated equipment. The special "Metalseal" crystal elements provide maximum protection against excessive humidity.

Part No. 099 0495 00



PATCH CORDS

The plugs are of the shielded type, with the sleeves tied together and grounded. The circuit is maintained through connections to the plug tips. The following lengths are available: 6, 12, 24, 36, 48, 60, and 120 inches. Other patch plugs, phone jacks and single circuit jacks available.

Part No. 361 0010 00 (6 in.)

Part No. 361 0011 00 (12 in.)

Part No. 361 0012 00 (24 in.)

Part No. 361 0013 00 (36 in.)

Part No. 361 0014 00 (48 in.)

Part No. 361 0015 00 (60 in.)

Part No. 361 0016 00 (120 in.)

TRIMM JACK PANELS

These panels are available in 12-pair, single row and 24 pair, double row models to fit any standard 19-inch rack and include such features as: solid 5/8-inch thick Bakelite panel with steel reinforcing; heavy gauge, special spring temper nickel/silver alloy leaves; ground lugs aligned to allow single ground bus to be run full length of strip; large palladium silver contacts; connection lugs fanned out for ease of soldering.

Part No. 097 3561 00

12-pair, single row.

Part No. 097 4200 00

24-pair, double row.



COLLINS CS-12 LOUDSPEAKERS

Producing the very finest in high fidelity sound, the Collins CS-12 loudspeaker produces a consistently stable and precise definition. The speaker is designed to operate equally well at full range or as woofers in multiway systems. The CS-12 features Radax construction, which divides the sound between the two cones. A mechanical crossover, when the small cone responds to the higher frequencies, occurs at 1800 Hz.

A slug-type magnet is used for concentrating flux density into the air gap. This type magnet has the lowest possible leakage and greatest structural strength. The high frequency long throw voice coil remains in the air gap even on the longest of excursions to prevent nonlinear operation.

An edge-wound voice coil, which gains an equivalent of five extra watts from most amplifiers over round-wire coils, is wound with precision, flattened ribbon conductor.

Each speaker is carefully tested and inspected before leaving the factory. An individual frequency response curve check is run on each speaker so that it matches the performance of the laboratory standard.

Frequency Response: 30 to 13,000 Hz

EIA Sensitivity Rating: 43 db

Free-Space Cone Resonance: 40 Hz

Power Handling Capacity:

Program Material: 20 watts

Peak: 40 watts

Critical Damping Factor: 15

Impedance: 8 ohms

Mechanical Crossover: 1800 Hz

Voice Coil Diameter: 2 in.

Total Flux: 70,700 maxwells

Power Required for 100 db level: 12 watts

Mounting: Four ¼ in. holes equally spaced on 11½ in. circle

Baffle Opening: 11 in.

Size: 12¼ in diameter, 3½ in. deep (31 cm diameter, 9 cm deep)

Weight: 5½ lb (2.5 kg)

Part No. 124 0032 017 (Type CS-12)

Part No. 099 2686 000

Stancor A-3818 Speaker Transformer

FRAZIER MANHATTAN LOUDSPEAKER

Now a famous loudspeaker, made especially for built-in systems, is available as a handsomely finished cabinet model. Its unique reproduction qualities for bringing to life the whole musical spectrum of the symphonic orchestra, vividly and brilliantly, are well known.

In actuality, the Manhattan enclosure is the well-known Frazier Black Box I that long has been the leading unit used in the finest built-in systems. The enclosure is a modified Helmholtz type using two slit-type tuning tubes, one on each side with a system consisting of a special full range 8-inch loudspeaker unit, one 3½-inch high frequency unit, and one high-pass filter mounted in a special enclosure. The base stand is a separate unit. The Manhattan mounts horizontally, vertically or can be used book shelf style.

Useable Frequency Response: 40 Hz to beyond 15,000 Hz

Efficiency: According to an independent testing laboratory, 4/10 of one watt provides sufficient power for living room listening level

Impedance: 8 ohms

Dimensions: 23¾ in. W, 19 in. H, and 11¾ in. D

Finish: Oil walnut with cane fibre type grille

JENSEN P12-T SPEAKER

This economy speaker is ideal for a high fidelity system to which additional units may be added.

Impedance: 3.2 ohms

Power Rating: 12 watts

Baffle Opening: 10½ in. Jensen transformer (Stancor A-3818 speaker transformer) for P12-T speaker matches to 600 ohms

Part No. 097 2119 00 (Type P12-T)

Part No. 099 2686 00

Stancor A-318 speaker transformer.

JENSEN LEVEL CONTROLS

Designed for use in voice coil or line circuits of similar nominal impedance, Jensen level controls are of the 2-section L-pad type. They provide continuously adjustable level without disturbance of other circuit levels or total impedance. Single hole panel mounting. Complete with lock nut, pointer knob and flat metal escutcheon plate. Model ST-276, 8 ohm, 15 watts, L pad.

Part No. 124 0032 123 (Type ST-276)

STANCOR A-3818 TRANSFORMER

Transformer for Collins CS-12, Jensen P12-T and P8-TS speakers.

Primary Impedance: 500/1000/150 ohms

Secondary Impedance: 15/8/4 ohms

Power Rating: 25 watts

Part No. 099 2686 00

MIRITEL AIR ALERT

Designed to control visible and/or audible alarm circuits on EBS signal from local or sky-wave stations. Frequency tunable from 550 to 1600 kHz. Built-in speaker operates upon alarm. Relay circuit is voltage regulated. External bell or light control terminals and antenna terminals on rear terminal board. Available for rack mounting only.

Part No. 097 3192 000

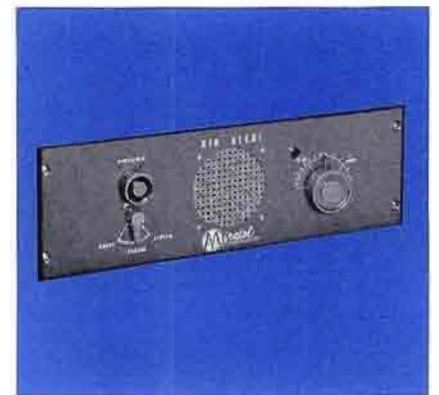

CANNON CONNECTORS

Collins Radio Company is an authorized distributor of the full line of Cannon Connectors. The following is a listing of those connectors most often required in audio applications. All are 3-contact plugs unless otherwise indicated.

P3-CG-11S, Cannon female cable plug.

Part No. 370 2180 00

P3-CG-12S, Cannon male cable plug.

Part No. 370 2190 00

P3-13, Cannon female panel receptacle.

Part No. 370 2060 00

P3-14, Cannon male panel receptacle.

Part No. 370 2090 00

P3-35, Cannon single gang female wall receptacle.

Part No. 370 2150 00

P3-35-2G, Cannon 2 gang female wall receptacle.

Part No. 370 2170 00

XLR-3-11C, Cannon female cable plug.

Part No. 097 5372 00



XLR-3-11SC, Cannon female cable plug with latch-lock cable clamp.

Part No. 097 5371 00

XLR-3-12C, Cannon male cable plug.

Part No. 097 5370 00

XLR-3-12SC, Cannon male cable plug with latch-lock cable clamp.

Part No. 097 5369 00

XLR-3-13, Cannon female panel receptacle, flush mount.

Part No. 097 5368 00

XLR-3-13N, Cannon female panel receptacle with lock nut.

Part No. 097 5367 00

XLR-3-14, Cannon male panel receptacle, flush mount.

Part No. 097 5366 00

XLR-3-14N, Cannon male panel receptacle with lock nut.

Part No. 097 5365 00

XLR-3-35, Cannon single gang female wall receptacle.

Part No. 097 5364 00



XLR-3-35-2G, Cannon 2-gang female wall receptacle.

Part No. 097 5363 00

XLR-3-36, Cannon single gang male wall receptacle.

Part No. 097 5362 00

XLR-3-36-2G, Cannon 2-gang male wall receptacle.

Part No. 097 5361 00

UA-3-11, Cannon female cable plug.

Part No. 370 2082 00

UA-3-12, Cannon male cable plug.

Part No. 370 2081 00

UA-3-13, Cannon female panel receptacle, flush mount.

Part No. 370 2079 00

UA-3-14, Cannon male panel receptacle, flush mount.

Part No. 370 2083 00

UA-3-31, Cannon female wall mount receptacle.

Part No. 099 0463 00

UA-3-32, Cannon male wall mount receptacle.

Part No. 099 0464 00



SHIELDED WIRE AND MICROPHONE CABLE

8451—Belden 2-conductor #22, twisted pair, spiral-wrapped shielding, vinyl insulation overall.

8738—Belden 2-conductor (solid copper) #22 vinyl insulated conductors, all shielded with copper braid.

439-5900-00 — Two-conductor #22 stranded, 7 No. 30 conductors, one red and one black conductor with one #22 ground wire. Shield is single right-hand wrap, #30 AWG maximum diameter of stranding. Nylon jacket, maximum outside diameter is 0.140 in.

8422 Belden, shielded microphone cable, 2-conductor #22, rubber covered.

8412 Belden, shielded microphone cable, 2-conductor #20, Neoprene covered.

423-0219-00 High voltage wire, 15-kv breakdown insulation.

425-0061-00 Shielded pair, #16 stranded cotton insulated, 15 A.

425-0151-00 Shielded pair, #12 stranded cotton insulated, 20 A.

Part No. 124 0032 961 (Type 8451)

Part No. 097 6029 00 (Type 8738)

Part No. 097 1142 00 (Type 8422)

In lengths of less than 100 ft.
More than 100 ft., see below.

Part No. 097 1142 00 (Type 8422)

In lengths of 100 ft. or more
Less than 100 ft., see above.

Part No. 425 0250 00 (Type 8412)

In lengths of less than 100 ft.
More than 100 ft., see below.

Part No. 425 0250 00 (Type 8412)

In lengths of 100 ft. or more
Less than 100 ft., see above.

TRIMM 427-6 TERMINAL BOARD

Contains two groups of terminals, each 13 terminals long and 6 terminals high.

Part No. 097 6282 00

BUD RACK CABINETS

A heavy duty rack cabinet that is custom-made for Collins Radio Company. Finished in light gray, this cabinet is made of sturdy steel with a door on the back and provision at the top for mounting a blower fan. CR-1773-B provides 17 inches of panel space. CR-1772 provides 63 inches of panel space. Both are shipped knocked down.

Part No. 099 2474 000 (Type CR-1773-B)
22 in. W, 76 in. H, 17 $\frac{1}{8}$ in. D.

Part No. 124 0032 949 (Type CR-1772)
22 in. W, 69 in. H, 17 $\frac{1}{8}$ in. D.

For use with 820E/F transmitter.



RACK CABINET BLANK PANELS

These blank panels of 3/16-inch aluminum are finished in light gray to match the BUD CR-1773-A Rack Cabinet.

Size: 19 in. W, (48 cm W) and in heights as listed below.

	Inches	Cm.
Part No. 502 8389 123	(1 $\frac{3}{4}$ in.)	(4.45)
Part No. 502 8393 113	(3 $\frac{1}{2}$ in.)	(8.89)
Part No. 502 8397 123	(5 $\frac{1}{4}$ in.)	(13.34)
Part No. 502 8401 113	(7 in.)	(17.78)
Part No. 502 8405 113	(8 $\frac{3}{4}$ in.)	(22.23)
Part No. 502 8409 123	(10 $\frac{1}{2}$ in.)	(26.67)
Part No. 502 8413 113	(12 $\frac{1}{4}$ in.)	(31.12)
Part No. 502 8417 113	(14 in.)	(35.56)

TELECHRON 1H1612 STUDIO CLOCK

The Telechron "Commerce" clock has a 12-inch dial and rich brown case.

Part No. 097 1735 00



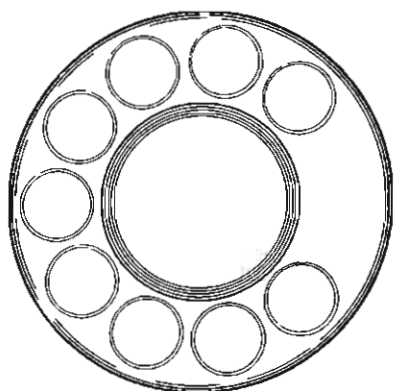

Remote Equipment

COLLINS 212H-1 REMOTE AMPLIFIER

The only one of its kind on the market with so many advanced and deluxe features, the Collins 212H-1 is a 3-channel remote amplifier that provides adequate facilities for most remote applications.

The 212H-1 is transistorized throughout and is built into a highly punishable thermoplastic and vinyl-clad aluminum case. A handle is mounted on the rear chassis to allow quick and easy handling between remote locations. A snap-on cover of durable thermoplastic protects the panel, controls and VU meter.

The unit is completely self-contained and operates from fourteen 1.5-volt flashlight batteries. These batteries supply power to the amplifier for about 200 hours. The supply is interlocked with the headphone jack so that the unit requires headphones to be plugged in before it becomes operational. The VU meter indicates remaining battery voltage.

A built-in phono equalizer on two of three channels provides instantaneous switching between two phonos and a microphone, or between three microphones. A built-in multiple tone generator allows a quick response check of the remote line or provides a standby tone of 100, 1000 or 5000 Hz. Sure-grip thumb wheels indicate volume input control by a diagonally moving white stripe.

Frequency Response: ± 3 db 50 to 15,000 Hz (1000 Hz reference at +8 dbm output)

Gain: 90 db nominal on mike input



Output: Line, Normal, +8 VU (+18 dbm) into 600 ohms; Low, 0 VU (+10 dbm) into 600 ohms; Bridge, -40 dbm into 250 ohms

Power Source: Self-contained batteries. Twelve 1.5-v flashlight batteries for amplifier and two 1.5-v batteries for meter light

Distortion: 2% maximum 50 to 15,000 Hz +18 dbm output

Noise: -115 dbm equivalent input noise or less (-55 dbm input, -60 db noise)

Inputs:

- One:
 - a. Unbalanced mike
 - b. Phono, equalized for magnetic cartridge
- Two:
 - a. Low impedance balanced mike
 - b. Self-contained tone generator
- Three:
 - a. Unbalanced mike
 - b. Phono, equalized for magnetic cartridge

Output Connectors:

- Program line, binding terminal posts;
- Bridge feed, male Cannon connector;
- Program monitor, headphone jack

Ambient Temperature Range: -20°C to +50°C

Ambient Humidity Range: Up to 95%

Size: 10 in. W, 4½ in. H, 12 in. D (25.4 cm W, 11.5 cm H, 30.5 cm D)

Weight: 11 lb (5 kg)

Color: Green, white, and gray

Part No. 522 2419 00
includes batteries

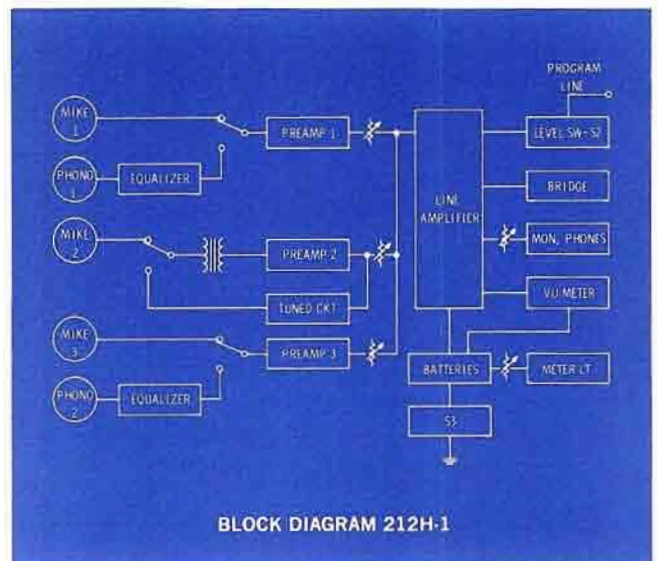

MARTI REMOTE PICK-UP EQUIPMENT

Marti Remote Transmitter and Receiver provide quality transmission of sports, spot news reports and interviews on frequencies assigned for exclusive use by broadcasters. The unit is compact and light enough to be carried into stadiums and press boxes as easily as a multichannel remote amplifier.

The audio quality of the Marti for music or voice transmission is guaranteed to be equal to or better than lines with coverage up to 40 miles radius depending upon the type and location of the transmitting and receiving antennas. The Marti Receiver is equipped with an automatic relay that operates an alarm system in the station to indicate a forthcoming broadcast.

The unit may legally be used instead of lines even where lines are available. Many stations, after installing the Marti system, have standing sponsorship of all their remote programs and have actually paid for the equipment in savings on line charges alone. The equipment also opens new program possibilities that are overlooked because of inconvenience in using other cumbersome and less reliable means.

The Marti Transmitter is operated either by ac or batteries. Designed for continuous duty, the equipment meets the most stringent FCC requirements regarding bandwidth.

It is easily portable and lightweight and does not require frequent tuning. The transmitter and transistorized power supply and associated equipment are easily installed in a car for permanent and immediate use.

MARTI M-30B/TPS MOBILE TRANSMITTER

The M-30B/TPS is a 30-watt base station transmitter for communication with mobile units operating at 152 to 172 MHz. The unit provides frequency stability of $\pm 0.0005\%$ within a temperature range of minus 30 degrees C to plus 60 degrees C. The modulation characteristic is adjusted at the factor for ± 7.5 kHz for 100% modulation at 1000 Hz.

RF Output: 30 watts, continuous

Frequency: 152 to 172 MHz

Crystal Multiplication: 36



Spurious Emission: Spurious radiation attenuated at least 70 db below carrier level, harmonics suppressed at least 60 db

Frequency Stability: $\pm 0.0005\%$

Temperature Range: Minus 30 degrees C to Plus 60 degrees C

Modulation: 30 F3 Maximum (Normally adjusted for Plus or Minus 10 kHz swing)

Audio Inputs: Two (2). Can be adjusted for either 150 or 600 ohms. Use of a 50-, 150-, or 250-ohm microphone will work satisfactorily into the 150-ohm input

Audio Input Level: Minus 70 db

Audio Connectors: Cannon XLR-3-31

Power Requirements: 120 vac or 12.6 vdc

Modulation Control: Push-pull limiter

Noise Level of Transmitter: Better than minus 45 db

Overall Response With Matched Receiver: ± 2 db from 75 to 7500 Hz

Distortion in Transmitter: Less than 3%

Net Weight: 16 lb (7 kg)

Dimensions: 14 in. wide, 10 in. long, and 7 in. high

Part No. 099 1572 000

MARTI MR-30/150-170 RECEIVER

The MR-30/150-170 receiver is used for pickup from a mobile station operating at 150 to 174 MHz. The receiver is sensitive to 0.6 microvolts or less for 20 db quieting, and is selective to -100 db at ± 32 kHz; -6 db or less at ± 15 kHz.

Application: Remote pickup

Frequency Range: 150 to 174 MHz

Spurious Response: All spurious and image responses attenuated at least 100 db

Overall Response: ± 2 db, 60 to 7500 Hz with matching transmitter

Frequency Stability: $\pm 0.0005\%$ with crystal oven

Temperature Range: -40°C to $+70^{\circ}\text{C}$

Audio Output: +8 VU at 600 ohms

Metering: Signal strength and VU brought out to test jacks, visual metering optional

Tube Complement: 6 Nuvistors, 9 tubes

Dimensions: 10½ in. H, 19 in. W, 9 in. D (26 cm H, 48 cm W, 23 cm D) Panel finish, WE hammertone grey

Weight (net): 20 lb (9 kg)

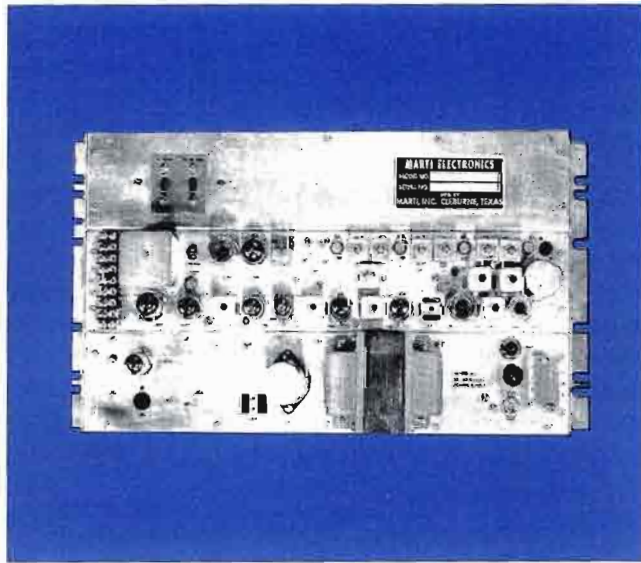

MARTI REMOTE EQUIPMENT ACCESSORIES

MOBILE ASSEMBLAGE—Consists of control unit, all battery and control cables and mounting rack for the M-30B/TPS transmitter (Type TPS-TC).

REMOTE CONTROL CONSOLETTA—For use with M-30B/CD and M250 (Type RMC-1). Constructed of wood cabinet and aluminum anodized front panel, complete with VU meter.

Size: 14 in. W, 9 in. H, 10 in. D (36 cm W, 23 cm H, 25 cm D)

Part No. 099 0542 00

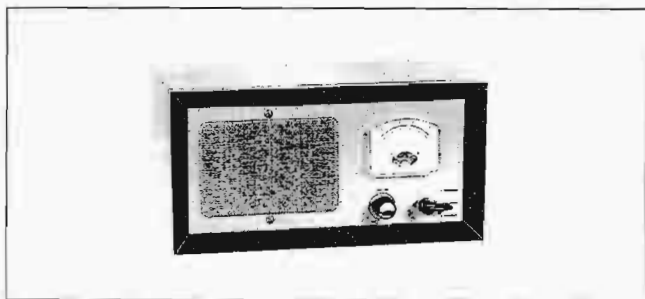

The following antennas are tuned or cut to frequency with a standing wave ratio of less than 1.5:1 and are designed for 50 to 52 ohm transmission lines.

SINGLE RING ANTENNA—Essentially non-directional, horizontally polarized and unity gain.

Specify whether for portable (PA-1) or mobile (MA-1) use.

Part No. 097 6952 (Type PA-1)

Part No. 097 6953 (Type MA-1)

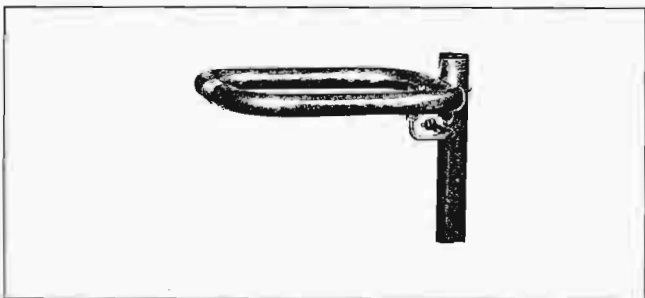

TWO RING ANTENNA—Essentially nondirectional, horizontally polarized. Has a gain of 3 db (Type RA-2).

Part No. 099 0543

ANTENNA BUMPER MOUNT—Chain link bumper mount (Type ASP-143) for use with mobile antenna.

Part No. 097 6880 00

FOUR RING ANTENNA (TYPE RA-4)—Essentially nondirectional, horizontally polarized. Has a gain of 6 db and power gain of 4.

Impedance: 52 ohms

Weight: 11 lb (5 kg)

Part No. 097 6950

FIVE ELEMENT YAGI ANTENNA (TYPE YC)—Unidirectional antenna.

Nominal Impedance: 50 ohms

Average Gain: 9 db

Typical VSWR: Under 1.5

Typical Rear Signal Rejection: 25 db

Power Handling Capacity: 60 watts

Input Connector: Type AN-SO-239 (Amphenol Type 83-1R)

Polarization: Horizontal or vertical

Part No. 099 0177

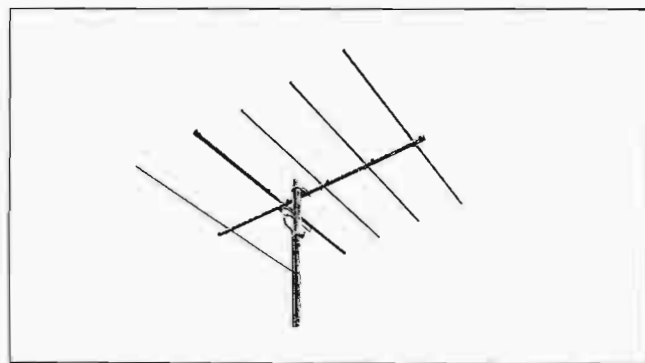

COAXIAL STACKING HARNESS—Required for stacking two, 5-element Yagi antennas. It is made up of two sections of RG-11/U 75-ohm coaxial cable joined at the center by a coaxial T fitting. Each half of the phasing harness is an odd multiple of a quarter wave length and by virtue of its characteristic impedance and length, steps the 50-ohm antenna impedance to 100 ohms. When the two cables are joined at the T connector, the impedance again becomes 50 ohms (Type 2YC).

Part No. 099 0190

KREKO VERTICALLY POLARIZED ANTENNA—This vertically polarized base antenna has a gain of 6 db (Type SC-155-B).

Part No. 099 0544

VEHICLE ROOFTOP ANTENNA—Designed especially for mounting on a vehicle, this antenna has a 3-db gain (Type ASP-177).

Part No. 099 0545

COAXIAL CABLE AND CONNECTORS—The following coaxial cables and connectors may be used with the Marti Remote Pick-Up Equipment:

Part No. 099 0146
RG 8/U coaxial cable, 100 feet

Part No. 099 0137
RG 17/U coaxial cable, 100 feet

Part No. 099 0546 00
RG 8/U connector PL-259 (Type 83-ISP)

Part No. 099 0547 00
RG 8/U straight adapter PL-258 (Type 83-IJ)

Part No. 099 0548 00
RG 17/U to RG 8/U connector (Type GR-6355)

Part No. 097 7023
RG 253/U Spir-O-line cable, 1/2 in., polyethylene jacketed

Part No. 099 0549 00
Spir-O-line RG 253/U to PL-258 connector (Type 87-500)

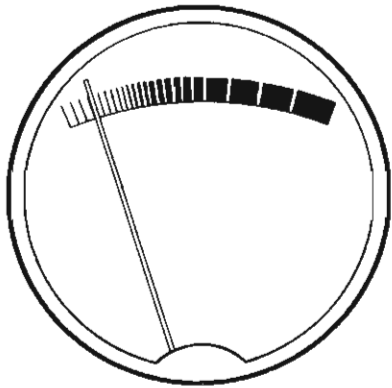

**Measuring
Monitoring
Remote Control**

COLLINS 900C-3 FM STEREO MODULATION MONITOR

Collins new 900C-3 Modulation Monitor assures an FM station of conforming with FCC regulations.

The 900C-3 is completely transistorized and operates in the standard FM frequency band of 88 to 108 MHz. The use of plug-in, glass-epoxy circuit cards aids in fault isolation and keeps maintenance time to a minimum.

This new FM modulation monitor has the phase and frequency response and the demodulation circuits necessary to assure accurate stereo demodulation. Internal crosstalk and noise levels are kept within standards specified by the FCC.

The 900C-3 also provides the demodulating circuitry required to measure total percent modulation of the carrier. It measures percent modulation caused by different bands of modulating frequencies; main channel, stereo subchannel, pilot carrier, and SCA subcarrier. Total peak modulation is monitored continuously and displayed on the peak indicator. A self-contained voltmeter is used for direct measurement of channel separation, crosstalk, signal-to-noise ratio, and stereo subcarrier suppression. Outputs are available for monitoring monaural or stereo operation.

Frequency Range: 88 to 108 MHz

RF Input Impedance: 50 ohms, unbalanced

RF Input Voltage: 5 to 10 vrms

Intermediate Frequency: 900 kHz

Wideband Output: 400 mv peak-to-peak, 1000 ohms unbalanced

MODULATION METER

Meter Scales: 0 to 13.3%, 0 to 30%, and 0 to 133%

Accuracy: Better than 0.5% in modulation percentage on the 0 to 13.3% scale, 1% on the 0 to 30% scale, and 5% on the 0 to 133% scale

Characteristics: Rise time, decay time, and damping factor as prescribed by FCC



PEAK LIGHT INDICATOR

Range: Threshold adjustable from 50 to 120% modulation
Response: Will flash on modulation peaks of 1-ms duration or greater

MONAURAL OPERATION

Outputs:

Monaural Audio: 0 dbm unbalanced (600 ohms deemphasized)

Distortion Meter Output: 10 vrms (10,000 ohms deemphasized)

Frequency Response: Within 1 db of standard 75-us deemphasis curve

Distortion: 0.25% maximum, 50 to 15,000 Hz at 100% modulation

Signal-to-Noise Ratio: 75 db with 75-us deemphasis

STEREO OPERATION

Outputs:

Left and Right Audio: 0 dbm unbalanced (1200 ohms flat or deemphasized)

Distortion Meter Output: 10 vrms (10,000 ohms deemphasized)

Frequency Response: ± 1 db from 50 to 15,000 Hz

Distortion: 0.5% maximum, 50 to 15,000 Hz at 90% modulation

Signal-to-Noise Ratio: 55 db with 75-us deemphasis

Channel Separation Measurement Accuracy: 35 ± 3 db with modulating frequencies from 50 to 15,000 Hz

Crosstalk Measurement Capability: 46 db main channel to stereo subchannel, 46 db stereo subchannel to main channel, 66 db SCA subchannel to main channel, 66 db SCA subchannel to stereo subchannel

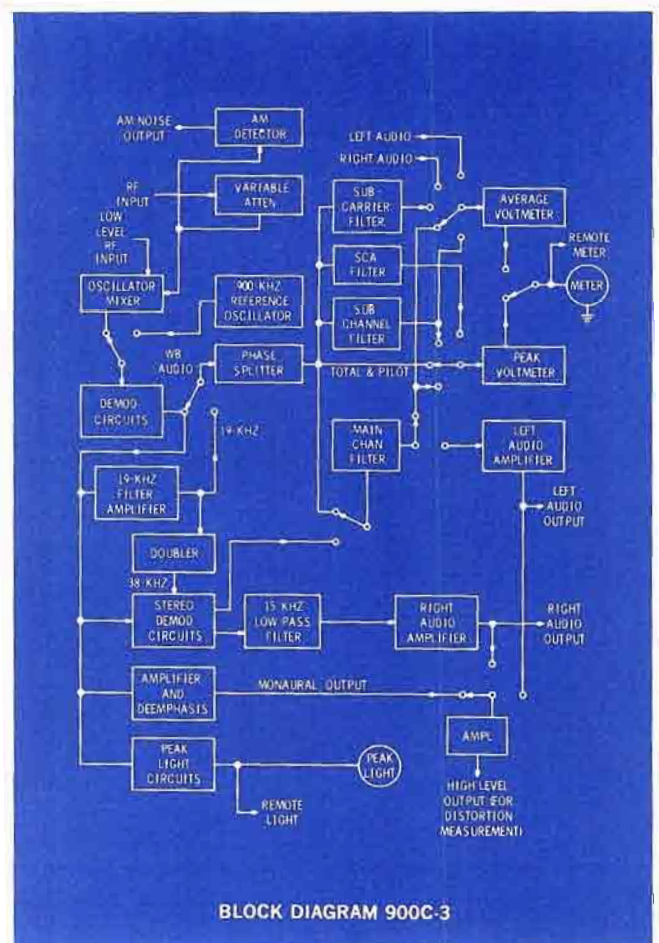

Subcarrier Suppression Measurement Capability: 46 db with modulating frequencies of 5 to 15 kHz
AC Power: 100 to 125 vac or 200 to 240 vac, 50/60 Hz, 50 watts maximum
Size: 19 inches wide by 10-15/32 inches high by 13-25/32 inches deep
Weight: 38½ pounds maximum (17.5 kg)
Part No. 758 5812 001

54Z-1 FREQUENCY MONITOR

Collins 54Z-1 Frequency Monitor is a special purpose digital counter with numeric display for monitoring frequency error of an AM broadcast transmitter. It offers maximum flexibility and ease of operation and maintenance. The 54Z-1 detects and indicates errors in 1-Hz increments from 1 through ± 20 Hz. Visual alarms and contact closures for operation of external interlocks/alarms are provided when frequency error exceeds ± 10 and ± 20 Hz. Error polarity and magnitude are available for remote sensing.

The monitor is completely solid state. Integrated circuits are used in all digital circuits and discrete components are used for the analog functions. The time base signals are derived from a solid-state, temperature-compensated, crystal oscillator that has a temperature stability of 0.5 part per 10^6 over a range from -25° to $+55^\circ\text{C}$.

All components are mounted on military grade, etched, glass-epoxy circuit boards. Convenient test points are provided on the circuit boards for ease of maintenance, if required.

Signals containing up to 90 percent modulation may be applied to the frequency monitor. Both 2-second and 11-second display intervals provide rapid update of information and high accuracy. Frequency error is continuously displayed on the numeric readout. An optional remote output is also available.

The 54Z-1 requires no adjustments or calibration.

AC Power: 117 vac $\pm 10\%$ single phase, 50/60 Hz, 55 watts maximum

Frequency Range: 540 to 1600 kHz

Minimum Channel Spacing: 1 kHz

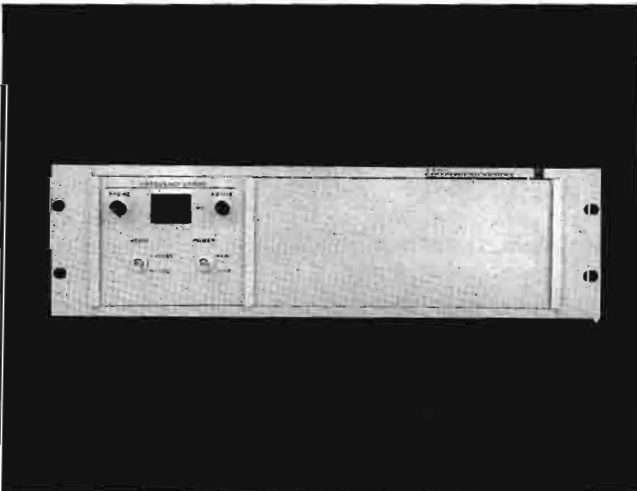

Input Voltage Level:

Unmodulated Carrier: 2.0 to 20 volts peak

Amplitude Modulation: 0 to 90% maximum

Input Impedance: 50 ohms $\pm 10\%$

Frequency Standard:

Stability: 0.5 part per 10^6 from -25° to $+55^\circ\text{C}$

Aging: 1 part per 10^6 per year

Error Display: Numeric display, 0 to 20 Hz and polarity

Alarm Presentation: Visual alarm and contact closure when error exceeds ± 10 and ± 20 Hz. Transient conditions will not cause the ± 20 -Hz alarm or interlock to be activated

Accuracy:

10-Second Count: ± 1 Hz

1-Second Count: ± 2 Hz

Size: 5¼ in. H, 19 in. W, 14 in. D (13 cm H, 48 cm W, 36 cm D)

Weight: 21 pounds (9.5 kg)

Part No. 758 5605 003

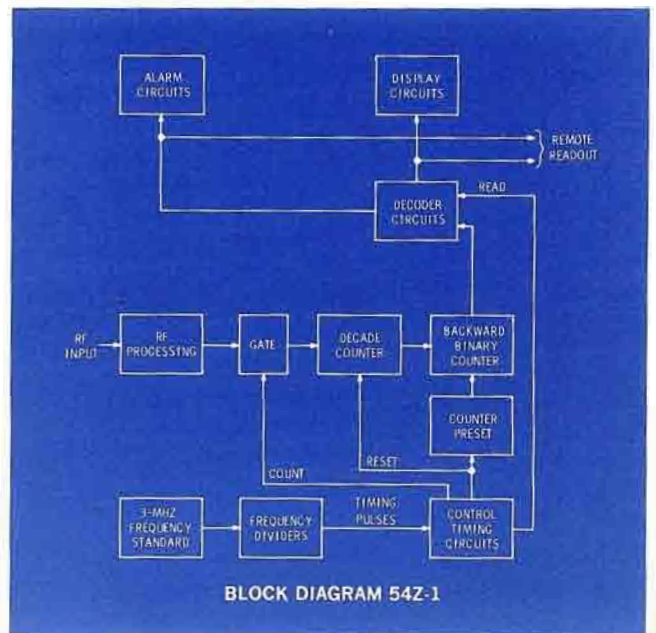

54N-1 FM FREQUENCY MONITOR

The 54N-1 is a special purpose digital counter designed to monitor the carrier frequency of an FM broadcast transmitter. The monitor detects errors in 100-Hz increments, from 0 through ± 2 kHz, and indicates readings on a numeric display.

Visual alarms and contact closures for operation of external interlocks and/or alarms are provided when the frequency error exceeds ± 1 kHz and ± 2 kHz. Error polarity and magnitude are available for remote sensing.

The monitor is completely solid state. Integrated circuits are used in all digital circuits and discrete components are used for the analog functions. The time base signals are derived from a solid-state, temperature-compensated, crystal oscillator that has a temperature stability of 0.5 part per 10^6 over a range from -25° to $+55^\circ\text{C}$.

Provisions have been made in the 54N-1 for measuring the frequency error of the 19-kHz pilot carrier used in stereo multiplex transmission systems. A separate input for the 19-kHz signal is provided. A manually operated switch puts the monitor into this mode of operation. If the error of the 19-kHz signal is greater than ± 1.0 or ± 2.0 Hz, an alarm light lights. Errors from 0 to ± 2.0 Hz will be displayed.

All components are mounted on high-quality, military grade, etched, glass-epoxy boards. Convenient test points offer ease of maintenance.

The 54N-1 requires no adjustments or calibration.

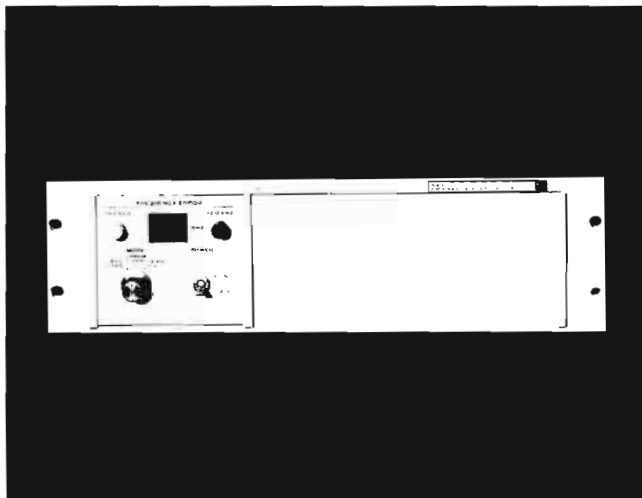

AC Power: 117 $\pm 10\%$ volts single phase ac, 50/60 Hz, 55 watts maximum

Frequency Range:

Carrier: 88 to 108 MHz

Pilot Carrier: 19 kHz

Minimum Channel Spacing: 100 kHz

Input Carrier Signal Specifications:

Voltage Level: 6 ± 3 Vrms

Frequency Modulation: 0 to 100% maximum

Input Impedance: 50 $\pm 10\%$ ohms

19-kHz Input Specifications:

Input Impedance: Greater than 30K ohms

Voltage Level: 0.1 volt to 1.0 volt rms

Frequency Standard:

Stability: 0.5 part per 10^6 from -25° to $+55^\circ\text{C}$

Aging: 1 part per 10^6 per year

Error Display:

Carrier: Numeric display, 0 to ± 2.0 kHz in 100-Hz increments, with accuracy of ± 200 Hz

19 kHz: Numeric display, 0 to ± 2.0 Hz in 0.1-Hz increments, with accuracy of ± 0.1 Hz

Alarm Presentation:

Carrier: Visual alarm and contact closure when error exceeds ± 1 kHz and ± 2.0 kHz. Transient conditions will not cause ± 2.0 -kHz alarm or interlock to be activated.

19 kHz: Visual alarm when error exceeds ± 1.0 or ± 2.0 kHz

Size: 5¼ in. H, 19 in. W, 14 in. D (13 cm H, 48 cm W, 36 cm D)

Weight: 21 pounds (9.5 kg)

Part No. 758 5742 004

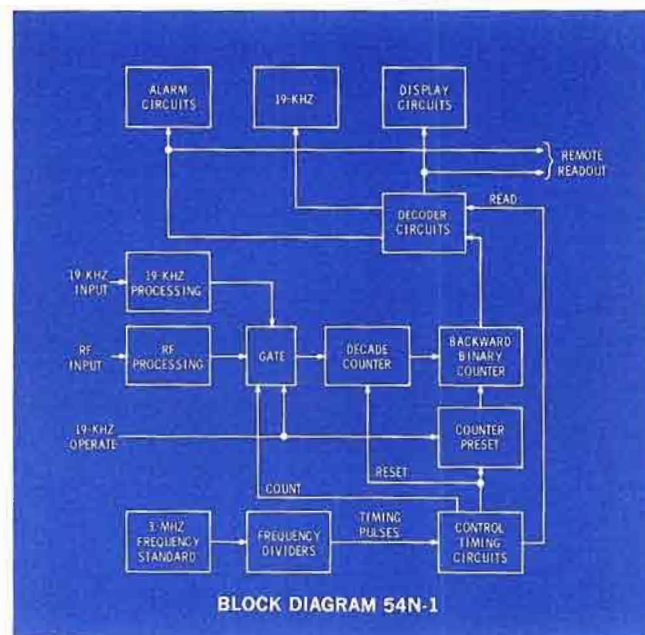

METRON 506B-1 AMPLITUDE MODULATION MONITOR

Occupying only 5¼ inches of rack space, the fully transistorized Metron 506B-1 Amplitude Modulation Monitor continuously measures modulation of the AM rf carrier.

Meeting or exceeding FCC requirements, the 506B-1 mounts in any standard 19-inch rack or cabinet. Frequently used controls are conveniently located on the front panel together with two easy-to-read illuminated meters for monitoring carrier level and percentage modulation.

Modulation peaks are indicated by a flashing lamp. Flashing level is adjustable from 0 to 100 percent modulation. Lamps operate at 60 percent of rated voltage to assure long life.

All external connections are made at the back of the unit. The rf input may be made to either a coaxial receptacle or barrier type terminal strip. A remotely controlled modulation meter and/or remote flasher may be connected to terminals provided and may be switched in or out at will without affecting circuit calibration.

Two auxiliary audio outputs are provided. One of these is a high impedance, high level output for fidelity measurement; the other feeds a 600-ohm audio monitoring circuit.

Input Impedance: 75 ohms

Frequency Range: 0.5 to 1.6 MHz

Rf Power Required: 0.5 watts (6 to 20 vrms)

Power Requirement: 105 to 125 vac, 50 to 60 Hz, 10 watts

Dimensions: 19 in. W, 5¼ in. H, 5 in D (48 cm W, 13 cm H, 12.7 cm D)

Weight: 10 lb (4.5 kg)

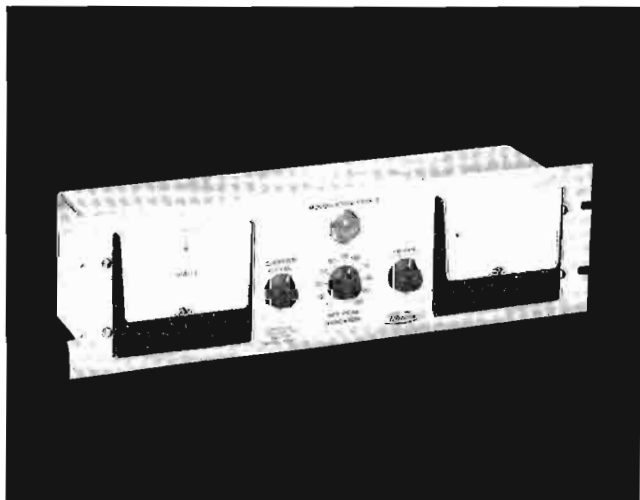

MODULATION PERCENTAGE METER

Accuracy: $\pm 2\%$ of full scale, modulating frequency 1000 Hz

Response: ± 0.3 db, 30 Hz to 100 kHz
 ± 0.1 db, 100 Hz to 30 kHz

MODULATION PEAKS FLASHER

Range: Continuously adjustable, 0% to 100%

Flash Point: Flashes when negative modulation exceeds dial set point by more than 2%

Accuracy: $\pm 2\%$ of full scale, 30 to 15,000 Hz

AUDIO MONITORING OUTPUT

Response: ± 0.5 db, 30 Hz to 100 kHz

Distortion: Less than 0.2%, 600-ohm load

Output Voltage: 0.5 vrms, 100% modulation with 600-ohm load

FIDELITY MEASURING OUTPUT

Response: ± 0.5 db, 30 Hz to 100 kHz

Distortion: Less than 0.1%, 600-ohm load

Hum and Noise Level: At least 80 db below 1.5-vrms signal level

Output Voltage: 3.5 vrms at 100% modulation with load resistance exceeding 100,000 ohms shunted by capacitance of less than 500 pf.

Part No. 124 0061 032

NEMS-CLARKE FIM-135 FIELD INTENSITY METER

The FIM-135 is a lightweight, compact field intensity meter incorporating all the latest innovations for portable test instruments. Dial locks provide a fixed setting at any point across the entire broadcast range from 540 to 1600 kHz. The receiver mode of operation offers a choice between the ease and accuracy of crystal control or the versatility of conventional tuning. A special input jack permits the receiver to be used as a null detector for rf bridge measurements. A taut-band meter movement accurately displays from 10 microvolts per meter to 10 volts per meter, making it equally effective for interference studies at low signal strength and for close-in measurements on high-power directional arrays. A high degree of selectivity is assured by establishing an overall bandwidth of 7 kHz at 1000 kHz for the half voltage response. Accurate measurements are easily obtained by direct reading on all ranges, with a calibration method that compensates for the variations in transistor and battery characteristics.

Frequency Range: 540 to 1600 kHz

Field Intensity Range: 10 uv/m to 10 v/m

Overall Accuracy: $\pm 5\%$

Output Indicator: Taut-band meter, direct reading, with log-arithmetic scale graduated 1 to 10. Phone jack and panel speaker

Antenna: Shielded, unbalanced loop

Power Requirements: Two, 4.2-volt mercury batteries

Battery Life: 175 hours (without audio)

Overall Dimensions, Closed: 6½ in. H, 10⅞ in. W, 6½ in. D (17 cm H, 26 cm W, 17 cm D)

Weight including batteries: 9 lb, 2 oz (4 kg)

Part No. 124 0032 914



NEMS-CLARKE TYPE 112 PHASE MONITOR

This all new solid-state unit offers basically improved indications of the phase relations in directional antenna systems. It also incorporates provisions for indicating the relative amplitudes of the currents in the various antennas. This Phase Monitor can be used with systems containing up to 9 towers.

The phase angle is read out on a panel meter having a continuous 0 to 180° scale. Readings are not affected by modulation and they are presented instantly as each tower is selected, with no adjustment required.

The Model 112 Phase Monitor is simple to operate, easy to read accurately, and incorporates all circuitry necessary to permit future adaptation to remote control.

Absolute Phase Accuracy: ± 1.0 degree

Phase Resolution: 0.5 degree

Input Impedance: 51 to 75 ohms

Number of Inputs: Up to 9

Input Level: 1.5 to 20 vrms

Frequency Range: 540 to 1600 kHz

Phase Angle Voltage Output: Adjustable from 0 to 3.5 volts. (Maximum voltage equals 180°)

Loop Current Voltage Output: Adjustable from 0 to 3.0 volts. (Maximum voltage equals 100%)

Loop Current Meter Accuracy: 2%

Loop Current Meter Resolution: 0.5%

Size: 19 in. W, 7 in. H, 14 in. D (48 cm W, 18 cm H, 36 cm D)

Weight: 20 lb (9 kg)

Power Input: 115/230 v, 50 to 60 Hz, 15 watts

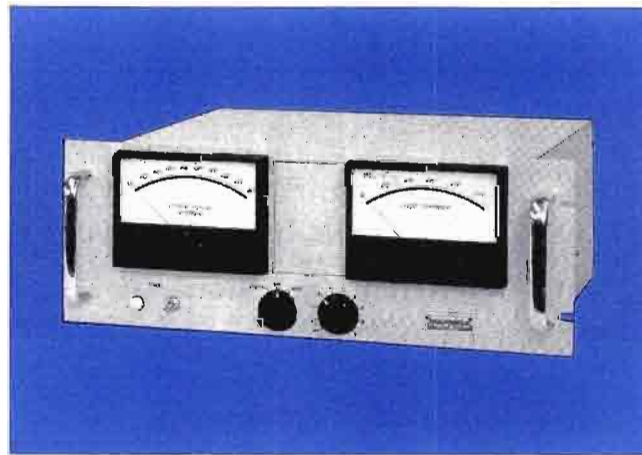

RUST RC-2400D PUSHBUTTON REMOTE CONTROL

The RC-2400D Single DC Pair pushbutton remote control consists of two units — the 2400 (C) studio control and the 2400 (T) transmitter control.

Up to 48 individual functions may be controlled over 24 selected positions. Each position allows selection of two control operations (contact closures). Position selection requires momentary pressure of a pushbutton. Completion of the rapid follow-up is indicated by position light, continually indicating the mode of operation. Control and metering associated with each position are identified at the position selection pushbutton. Discrete signals assure positive synchronization when calibrate is selected.

A most important feature of the RC-2400 is the complete interlocking of control circuitry. This prevents accidental initiated control operation when shifting to a new position and vice-versa.

The RC-2400 offers an exclusive feature, the ability to duplicate all remote control functions and metering at the transmitter site. This is completely independent of studio equipment, and facilitates calibration by one man at the transmitter.

Through the built-in selection system, reading of metering values may be programmed to appear on the desired meter only. If individual parameter meters are desired, external meters can be fed from any of the 24 positions.

Coded pulse width operation, utilizing a simple two-state signal, is a positive means of conveying control information and is neither amplitude nor frequency sensitive. The pulse width signal is converted to FSK (Frequency Shift Keying) for maximum simplicity and excellent noise rejection.

Position Selection: Pushbutton

Control Functions: 48 total (24 Raise or On and 24 Lower or Off)

Control Method: Coded pulse width

Fail-Safe: Meets FCC requirements

Metering: 24 positions plus calibration

Metering Input: 1 v for full-scale reading, 10K impedance

Metering Method: Dc converted to audio voltage whose frequency is controlled by the dc level

Line Requirements: Dc pair 0 to 500 Hz, up to 20-db loss

Power Requirements: 115 vac, 60 Hz, single phase

Dimensions:

Transmitter Unit: 19 by 8¾ inches (48 cm W, 22 cm H)

Control Unit: 19 by 8¾ inches (48 cm wide by 22 cm high)

RC-2400F MICROWAVE/VOICE LINE REMOTE CONTROL

Specifications are the same as the RC-2400D except:

Line Requirements: Voice Line 400-2500 Hz, up to 20 db loss.

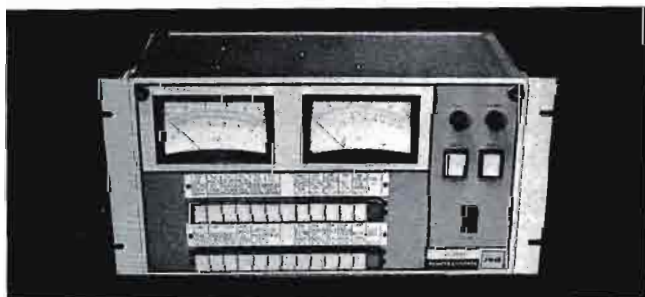

RUST RC-1000 DC REMOTE CONTROL

The Rust RC-1000 Solid-State Single Pair DC Pushbutton Remote Control is designed for operations that require a maximum of 22 control (11 ON/RAISE plus 11 OFF/LOWER) and a maximum of 10 metering positions plus calibrate. The front panel of the 1000C Studio Unit contains a large, 5-inch illuminated bezel mounted, taut band meter with multiple direct reading scales. Provisions are included for external meters such as modulation, frequency, digital readout, etc. A horizontal bank of 11 Interlocked pushbuttons allow easy position selection by the most non-technical personnel. The built-in pushbutton latching feature readily indicates selected position.

The 1000T unit REMOTE/LOCAL switch permits the taking of exclusive control at the transmitter site. When in the LOCAL position, the same switch completes the fail safe circuit. In addition, the transmitter unit contains a POSITION: an ON/RAISE, and an OFF/LOWER pushbutton. These three pushbuttons permit full local control. Provisions for an external meter permit the expansion to a complete one-man calibration system.

The control system utilizes FSK (Frequency Shift Keying) techniques, which result in positive control action. Only a single audio frequency carrier is involved. No narrow band filters are used. The Metering method is a full floating dc phone line system with both sides of the input switched. A built-in dc Isolator isolates the input metering sample from the telephone line so that the telephone line floats from ground. All plug-in solid-state circuit boards are available via the hinged front panel on both units.

Position Selection: 11 Pushbutton Bank

Control Method: Frequency shift carrier

Fail Safe: Meets FCC requirements

Metering: 10 positions plus calibrate position

Metering Input: 1 to 5 volts dc, 10K input pot and 10K load

Metering Method: Floating dc phone line, both sides of input switched

Line Requirements: Single dc pair, 0 to 500 Hz up to 20 db loss, 1-megohm leakage line to line or line to ground

Power Requirement: 115 vac, 60 Hz single phase or 24 vdc

Size: 5¼ in. H by 19 in. W (13 cm H by 48 cm W)

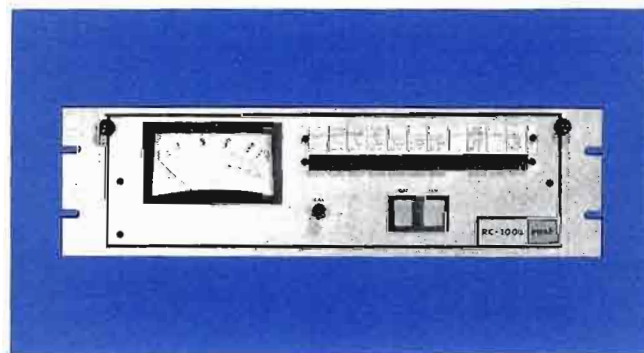

MOSELEY PBR-21 TRANSMITTER REMOTE CONTROL SYSTEM

The PBR-21 represents a new concept in the design of broadcast and television transmitter remote control systems. The path between studio and transmitter is no longer restricted to dc line requirements. A single low cost, voice quality line or STL circuit is all that is necessary. Line attenuation up to 20 db will not adversely affect system operation.

Simple, versatile, and reliable, the PBR-21 features push-button selection of 42 control and 21 metering circuits. The binary logic scheme employs only one silicon transistor type throughout all circuits. Panel lights display Cycle and Read modes. This feature also indicates a malfunction of the return telemetering circuits. A Recycle button allows fast confirmation of each channel selection. The Calibrate position verifies system accuracy at a touch. The binary logic output momentarily interrupts the fail-safe signal to reposition the channel selector switch. The Lower and Raise command tones are 2000 and 2500 Hz. Metering is returned to the studio by a temperature stable oscillator operating between 400 and 750 Hz. Additional control and subcarrier modules adapt the PBR-21 for radio remote control systems.

A complete line of accessories is available to adapt the PBR-21 to any remote control requirement. Various kits will translate voltage, current, and tower light (etc.) indications into appropriate sample voltages for telemetering.



Control Functions: 21 raise, 21 lower commands

Metering: 21 telemetering channels

Fail-Safe: Protected from system failure exceeding 25 s

Line Requirements: 20 db allowable loss from 400 to 3000 Hz

Calibration Reference: Zener diode

Power Requirements: 120/240 vac, 50 to 60 Hz

Finish: Anodized and etched aluminum panels

MOSELEY WRC-10T TRANSMITTER CONTROL UNIT

The new Moseley WRC-10T provides single dc pair remote transmitter control with field-proven operational flexibility through 100-percent silicon transistor circuitry. Positive transmitter control is assured at half the typical monthly operating costs because only one dc signal circuit is required between the studio and transmitter.

Fail-safe provisions meet all FCC requirements; the unit will function even if primary power is lost, the signal line is open or shorted, and the equipment itself malfunctions. Low frequencies (670, 790, and 920 Hz) are used for the fail-safe tone because of the inherently poor frequency response of dc lines. Sequenced interruptions of the fail-safe tone for stepper action are keyed by a telephone dial mechanism.

The new pushbutton channel selector allows rapid selection and immediate identification of the operating channel. Two control functions, Lower and Raise, can be performed on each channel selected. A metered indication of the parameter being controlled can be observed simultaneously. Each sampling voltage can be set to the correct level with individual 10,000-ohm multiturn input calibration controls.

High-Q, temperature-stabilized toroidal inductors and capacitors are used in all oscillator and tone detector circuits to assure drift-free operation. Each side of the dc line circuit is fused to protect against line surges.

Control Functions: 10 Raise, 10 Lower commands

Metering: 10 telemetry channels plus calibration

Line Requirements: Single dc pair, 25,000 ohms maximum loop resistance, dc to 1000-Hz response, 20-db allowable loss at any frequency

Meter Sensitivity and Scales: 100 ma; 0 to 140 linear, 0 to 120% logarithmic

Fail-Safe: Protected from system failure exceeding 20 seconds

Power Requirements: 120/240 vac, 50/60 Hz

Part No. 124 0061 026

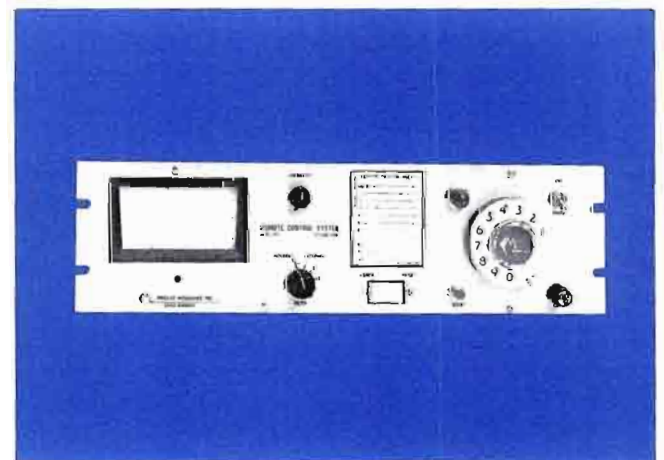

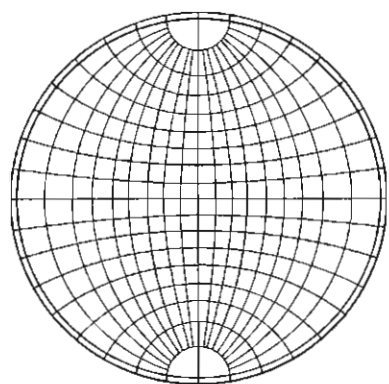

**Tables
Charts
Graphs**

Footage Table for Broadcast Tower Heights

550 KHZ TO 1070 KHZ					1080 KHZ TO 1600 KHZ				
KHZ	METERS	1 WAVE	1/2 WAVE	1/4 WAVE	KHZ	METERS	1 WAVE	1/2 WAVE	1/4 WAVE
550	545	1787.6	893.8	446.8	1080	277.8	911.1	455.5	227.7
560	536	1758.0	879.0	439.5	1090	275.2	902.6	451.3	225.6
570	526	1725.3	862.6	431.3					
580	517	1695.7	847.8	423.9	1100	272.7	894.4	447.2	223.6
590	509	1669.5	834.7	417.3	1110	270.3	886.5	443.2	221.6
					1120	267.9	879.0	439.5	219.7
600	500	1640.0	820.0	410.0	1130	265.5	870.8	435.4	217.7
610	492	1612.7	806.3	403.1	1140	263.2	862.6	431.3	215.6
620	484	1587.5	799.7	396.8	1150	260.9	855.7	427.8	213.9
630	476	1561.2	780.6	390.3	1160	258.6	847.8	423.9	211.9
640	469	1546.3	773.1	386.5	1170	256.4	840.9	420.4	210.2
650	462	1515.3	757.6	378.8	1180	254.2	834.7	417.3	208.6
660	455	1492.4	746.2	373.1	1190	252.1	826.8	413.4	206.7
670	448	1469.4	734.7	367.3					
680	441	1446.4	723.2	361.1	1200	250.0	820.0	410.0	205.0
690	435	1426.8	713.4	356.2	1210	247.9	813.1	406.5	203.2
					1220	245.9	806.3	403.1	201.5
700	429	1407.1	703.5	351.2	1230	243.9	799.1	399.5	199.7
710	423	1387.4	693.7	346.8	1240	241.9	793.7	396.8	198.4
720	417	1367.7	683.8	341.9	1250	240.0	787.2	393.6	196.8
730	411	1348.0	674.0	337.0	1260	238.1	780.9	390.4	195.2
740	405	1328.4	664.2	332.1	1270	236.2	774.7	387.3	193.6
750	400	1312.0	656.0	328.0	1280	234.4	768.8	384.4	192.2
760	395	1295.6	647.8	323.4	1290	232.6	762.9	381.4	190.7
770	390	1279.2	639.6	319.8					
780	385	1262.8	631.4	315.7	1300	230.8	757.0	378.5	189.2
790	380	1246.4	623.2	311.6	1310	229.0	751.1	375.5	187.7
					1320	227.3	746.2	373.1	186.5
800	375	1230.0	615.0	307.5	1330	225.6	739.9	369.9	184.9
810	370	1213.6	606.8	303.4	1340	223.9	734.7	367.3	183.6
820	366	1200.4	600.2	300.1	1350	222.2	728.8	364.4	182.2
830	361	1184.0	592.0	296.0	1360	220.6	723.2	361.1	180.5
840	357	1170.9	585.4	292.7	1370	219.0	718.3	359.1	179.5
850	353	1157.8	578.9	289.4	1380	217.4	713.4	356.2	178.1
860	349	1144.7	572.3	286.1	1390	215.8	707.8	353.1	176.5
870	345	1131.6	565.8	282.9	1400	214.3	703.5	351.2	175.6
880	341	1118.4	559.2	279.6	1410	212.8	696.9	348.4	174.2
890	337	1105.3	552.6	276.3	1420	211.3	693.7	346.8	173.4
					1430	209.8	688.1	344.0	172.0
900	333	1092.2	546.1	273.0	1440	208.3	683.8	341.9	170.9
910	330	1082.4	541.2	270.6	1450	206.9	678.6	339.3	169.6
920	326	1069.2	534.6	267.3	1460	205.5	674.0	337.0	168.5
930	323	1059.4	529.7	264.8	1470	204.1	669.4	334.7	167.3
940	319	1046.3	523.1	261.5	1480	202.7	664.2	332.1	166.5
950	316	1036.4	518.2	259.1	1490	201.3	660.2	330.1	165.0
960	313	1026.6	513.3	256.6					
970	309	1013.5	506.7	253.3	1500	200.0	656.0	328.0	164.0
980	306	1003.6	501.8	250.9	1510	198.7	651.7	325.8	162.9
990	303	993.8	496.9	248.4	1520	197.4	647.8	323.4	161.7
					1530	196.1	643.2	321.6	160.8
1000	300	984.0	492.0	246.0	1540	194.8	639.6	319.8	159.9
1010	297	974.1	487.5	243.7	1550	193.5	634.6	317.3	158.6
1020	294.1	964.6	482.3	241.1	1560	192.3	631.4	315.7	157.8
1030	291.3	955.3	477.6	238.8	1570	191.1	626.8	313.4	156.7
1040	288.5	946.2	473.1	236.5	1580	189.9	623.2	311.6	155.8
1050	285.7	937.1	468.5	234.2	1590	188.7	618.9	309.4	154.7
1060	283.0	928.2	464.1	232.0					
1070	280.4	919.7	459.8	229.9	1600	187.5	615.0	307.5	153.7

**Distance in Miles From an FM Transmitter to
Its 54 dbu (0.5 mv/m) Contour for Various Heights and Powers**

AHAAT IN FT	POWER IN DBK																				
	-20	-18	-16	-14	-12	-10	-8	-6	-4	-2	0	2	4	6	8	10	12	14	16	18	20
3400	20	23	26.5	30	34	38	42	47.5	51.5	56	60	65	69.5	73	78	82	87	91.5	95	100	113.5
3200	19	22	25	29	32.5	37	40.5	45	50	53.5	58.5	63	67	71	75	80	85	90	93	97	100.5
3000	18.5	21.5	24.5	28	31.5	35	40	43	48	52	56.5	60.5	65	69.5	73	77.5	82	86.5	91.5	95	98.5
2800	18	20.5	23	27	30	33.5	38	42	45.5	50	54.5	58.5	63	67	71	75	80	84	89	93	96
2600	17.5	20	22	25.5	29	32	36	40	44.5	48.5	52	56	60	65	69	73	77	81.5	85.5	90	94
2400	17	19	21.5	24.5	28	31	35	38.5	42	46	50.5	54.5	58.5	62	67	70.5	75	78.7	83	88	92
2200	16	18.2	20	23	26.5	29	32.5	36.5	40	44.5	48	52	55.5	60	65	68	72	76.5	80	85	90
2000	15	17.4	19	22	25	28	31	35	38	42	45.5	50	53	57	61.5	65	69.5	73.7	78	82	86
1900	15	17	18.5	21.5	24.5	27	30	33.5	37.5	40.5	45	48.5	52	55.5	60	64	68	72	76	80	85
1800	14	16	18	20.5	23	26.5	29	32.5	36	40	43	47.5	51	55	58.5	62.5	66	70	75	79	83
1700	13.5	15.5	17.5	20	22.5	25	28	31.5	35	38	42	45.5	50	53	57	60.5	65	69	71.5	77	81
1600	13	15	17	19	21.5	24.5	27	30	33	36.5	40.5	44	48	52	55.5	60	63	67	71	75	80
1500	12.5	14.6	16.5	18.5	21	23.5	26.5	28.5	32	35.5	39.5	43	46.5	50	54.5	58	61.5	65	69.5	73	78
1400	12	14	16	18	20	22	25	28	30.5	34.5	38	41.5	45	48.5	52.5	56	60	63	67	71.5	75
1300	11.5	13.4	15.5	17	19	21.5	23.5	27	30	32.5	36	40	43	47	50.5	55	58	61.5	65	70	73.5
1200	11	13	14.5	16.5	18.5	20.5	23	25.5	28	31	35	38	41.7	45	48.5	52.5	56	60	63	67	71.5
1100	10	12	13.5	15.5	17.5	19.5	21.5	24.5	26.5	30	33	36.5	40	43	47	50.5	54.5	58	61.5	65	70
1000	9.1	11.5	13	15	17	18.5	20.5	23	25.5	28	31.2	34.5	38	41	45	48	52	56	58.5	63	68
900	8.7	10.5	12	14	16	18	19.5	21.5	24.5	27	29.6	32.5	35.5	38.5	42.5	46	50	54	57	60.5	65
800	8.2	9.2	11.5	13	15	16.5	18	20	22	25	28	30.5	33.5	37	40	43	47.5	52	55	58.5	63.5
700	7.7	8.7	10.5	12	13.5	15.5	17	18.5	21	23	26	28.5	32	35	38	41	45	49	53	56.5	63
600	7.2	8	9	11	12	14	15.5	17.5	19	21.5	24	26.5	28.7	32	35	38	42	45.5	50	55	60
500	6.5	7.3	8.2	9	11	12.5	14	16	17.5	19	22	24	27	29	32.5	35.5	38.5	43	47	52	57
400	5.8	6.6	7.3	8.3	8.5	11	12.5	14	16	17.5	19	22	24.5	27	29.5	32	35.5	40	43.5	49.5	55
300	5	5.7	6.5	7.2	8	8.7	10.5	12	13.5	15	17	18.5	21	23.5	26.5	28.5	32	35.5	40	45.4	52
200	4	4.6	5.2	5.7	6.5	7.3	8.2	9	11	12	13.7	15.5	17.5	19	22	24.5	28	31.5	35	42	48
100	2.8	3.2	3.7	4.1	4.6	5.2	5.8	6.6	7.4	8.2	9	10.7	12.5	14	16	18.2	21.5	25	30	35.5	45

**Distance in Miles From an FM Transmitter to
Its 60 dbu (1 mv/m) Contour for Various Heights and Powers**

AHAAT IN FT	POWER IN DBK																				
	-20	-18	-16	-14	-12	-10	-8	-6	-4	-2	0	2	4	6	8	10	12	14	16	18	20
3400	11	13	15	17.5	20	22.5	27	30	34	37	40.5	45	49	52	57	60	64	65	65	65	65
3200	11	12.2	14.5	16.5	19.5	22	25	28.5	32	35	39	42.5	47	50.5	55	59	62	64	65	65	65
3000	10.5	12	14	16	19	21.5	24.5	28	31	34	38	41	45	49.5	53	57	60	64	65	65	65
2800	10	11.8	13.5	15.7	18	20.5	24	26.5	30	33	36	40	44	48	51	55	59	62	64	65	65
2600	9.7	11.5	13	15	17	20	22.5	25.5	29	32	35	39	42	46	49.5	53	58	60	63	64	65
2400	9.4	11	12.8	14	16	19	21.5	24.5	28	30.5	34	37	40	44	47.5	51	55	59	61	64	65
2200	9.7	10.8	12	13.5	15.5	18	20.5	23.5	26	29	32	35	39	42	45.5	49	52	56.5	59.5	62	65
2000	9	10.2	11.7	13.1	15	17	20	22	25	28	30	33.5	37	40	44	46.5	50.5	54	57.5	60.5	64
1900	8.7	10	11.2	12.7	14.5	16.5	19	21.5	24.5	27	29.5	33	35.5	39	43.5	45.5	49.5	52.5	55.5	59.5	62
1800	8.5	9.7	11	12.6	14	16	18	20.5	23.5	25.5	29	31.5	35	38.5	43	44.5	48.5	51.5	55	59	61
1700	8.3	9.2	10.5	11.8	13.8	15.5	17.3	20	22.5	25	28	30	33	37	40	43	46.5	50	53	57.5	60
1600	8.1	9	10.3	11.5	13.2	15	17.1	19.2	21.5	24	26.5	29.5	32.5	35.5	39	42	45	49	51.5	55	58
1500	8	9	10	11.4	13	14.9	16.9	18.6	21	23	26	28.5	31.5	35	38	40.5	44	47	50.1	54	57
1400	7.5	8.6	9.7	11.2	12.5	14	16.7	18	20	22	25	27.5	30	33	36	40	43	46	48.5	52	55
1300	7.3	8.2	9.3	10.5	12	13.8	15.5	17.5	19	21.5	24	26.5	29	32.5	35	39	41.5	45	47.5	51	54
1200	7	7.8	9	10	11.5	13	15	17	18	21	23	25.5	28	31	34	37.5	40	44	46	49	52
1100	6.8	7.6	8.5	9.5	11	12.5	14.5	16	17.1	20	22	24.5	26.5	29.5	32	35	38	41	44.5	47	50
1000	6.4	7.2	8	9	10.2	12	14	15.6	17	19	21	23	25.5	28	31	34	36.5	40	43	45.5	49
900	6.2	6.8	7.8	8.8	9.7	11.2	13	14.5	16.4	18	20	21	24.5	26	29	32	35	38	40.5	44	47
800	5.8	6.6	7.3	8.2	9.2	10.3	12	13.5	15.2	17	18.5	20.5	23	25	27.5	30	33	36	39	41.5	45
700	5.4	6.2	7	7.8	8.6	9.7	10.5	13	14	16	17	19.2	21	24	26	28.5	31	33	36	39	42
600	5	5.7	6.5	7.1	8	9	9.8	11.8	12.3	14.5	16	18	19.7	21.5	24	26	29	32	35	36.5	40
500	4.6	5	5.8	6.6	7.3	8.2	9	10	12	13.2	14.5	16.1	17.9	20	22	24.5	27	29.5	31.5	35	37
450	4.2	4.8	5.5	6.2	7.0	7.8	8.6	9.6	10.5	12.5	14.0	15.2	17.0	19.0	20.5	23.0	25.4	28	30	33	36
400	4	4.6	5.1	5.9	6.6	7.4	8.2	9	10	11.8	12.5	14.5	16	17.8	19.8	21.5	24.5	26.5	29	31.5	35
350	3.8	4.2	4.8	5.3	6.1	7.0	7.8	8.6	9.5	10.3	11.0	14.0	15	16.8	18.5	20.2	23	25	27.5	30	33
300	3.6	4	4.5	5	5.7	6.3	7.2	8	8.8	10	10.5	12.6	14	15.6	17	19	21	23	25.5	28	30
250	3.2	3.7	4.0	4.6	5.1	5.9	6.7	7.3	8.0	8.9	9.9	10.6	12.5	14.0	15.8	17.8	19	21.5	24	26	28
200	2.9	3.3	3.7	4.1	4.7	5.1	5.9	6.6	7.4	8.1	9	10	11.3	12.5	14	15.5	17.5	19.5	21.5	24	26
150	2.5	2.8	3.2	3.6	4.0	4.5	5.0	5.7	6.4	7.1	7.9	8.8	9.7	10.8	12	14.0	15.2	17.0	19	21	24
100	2	2.3	2.7	2.9	3.2	3.8	4.1	4.7	5.2	5.9	6.5	7.4	8.3	9	10	11.3	12.9	14.5	16.2	18.1	20

Distance in Miles From an FM Transmitter to Its 80-dbu (10 mv/m) Contour for Various Heights and Powers

AHAAT IN FT	POWER IN DBK																				
	-20	-18	-16	-14	-12	-10	-8	-6	-4	-2	0	2	4	6	8	10	12	14	16	18	20
3400	1.3	1.6	2.1	2.6	3.2	4.0	4.8	6.0	7.3	9	12.5	15	18	20	23	26.5	30	34	38	42	46.5
3200	1.3	1.6	2.1	2.6	3.2	4.0	4.8	6.0	7.3	8.8	12	15	17	19	22	25	29	32.5	36.5	40.5	45
3000	1.3	1.6	2.1	2.6	3.2	4.0	4.8	6.0	7.1	8.5	11.5	14.5	17	18.5	21.5	24.5	28	31.5	35	40	43
2800	1.3	1.6	2.1	2.5	3.2	4.0	4.8	5.9	7.1	8.4	11.2	14	16	18	20	23	26.5	30	34	38	41.5
2600	1.3	1.6	2.1	2.5	3.2	4.0	4.7	5.8	7.0	8.1	11	13	15.5	17.5	19.6	22	25.5	29	32	35.5	40
2400	1.3	1.6	2.1	2.5	3.2	3.9	4.7	5.7	7.0	8.1	10.5	12.5	15	17	19	21.5	24.5	27.5	30.5	35	38.5
2200	1.3	1.6	2.1	2.5	3.2	3.8	4.7	5.6	6.8	8	10	12	14.5	16.5	18	20	23	26.5	29.5	32.5	36.5
2000	1.3	1.6	2.0	2.5	3.1	3.8	4.6	5.4	6.7	7.8	9	11.5	13.5	15	17.5	19.5	21.5	25	28	31	35
1900	1.3	1.6	2.0	2.5	3.0	3.7	4.6	5.3	6.6	7.7	9	11	13	14.8	17	19	21	24.5	27	30	34
1800	1.3	1.6	2.0	2.5	3.0	3.7	4.5	5.1	6.3	7.6	8.7	10.5	12.5	14.5	16.5	18.5	20.5	23	26	29	32.5
1700	1.3	1.6	2.0	2.4	2.9	3.6	4.4	5.2	6.1	7.3	8.4	10	12	14	15.5	18	20	22	25	28	31
1600	1.2	1.7	2.0	2.3	2.9	3.6	4.3	5.1	6	7.0	8.1	9.2	11.8	13.5	15	17.5	19	21.5	24.5	27	30
1500	1.2	1.7	2.0	2.3	2.8	3.6	4.2	5.0	5.9	7.0	8.0	9.0	11	13	14.5	17	18.5	20.5	23	26	29
1400	1.2	1.7	1.9	2.3	2.8	3.5	4.2	5.0	5.7	6.7	7.7	8.7	10.5	12	14	16	18	20	22	25	28
1300	1.2	1.7	1.9	2.2	2.7	3.4	4.1	4.8	5.6	6.4	7.4	8.2	10	11.5	13	15	17	19	21.5	24	26.5
1200	1.2	1.7	1.8	2.2	2.7	3.3	4.0	4.7	5.4	6.2	7.1	8	9.2	11	12.5	14.5	16.5	18	20.5	23	25.5
1100	1.2	1.7	1.8	2.2	2.7	3.2	3.9	4.6	5.2	6	6.8	7.8	8.7	10.2	11.5	14	15.5	17.5	19.5	22	24.5
1000	1.2	1.6	1.8	2.2	2.6	3.1	3.8	4.4	5	5.8	6.4	7.2	8.2	9.2	11	13	15	17	18.5	20.5	23
900	1.2	1.6	1.7	2.1	2.6	3	3.7	4.2	4.8	5.6	6.2	7.0	7.8	8.8	10.5	12	14	16	18	19	22
800	1.2	1.5	1.7	2.1	2.5	2.9	3.4	3.9	4.6	5.1	6.0	6.7	7.4	8.3	9.3	11.5	13	15	16.5	18	20
700	1.2	1.5	1.7	2.0	2.4	2.8	3.2	3.7	4.2	4.8	5.5	6.3	7.0	7.8	8.8	10	12	13.5	15.5	17	18.5
600	1.2	1.4	1.7	1.9	2.3	2.7	3.0	3.4	3.8	4.5	5.0	5.8	6.5	7.2	8	9.0	10.5	12.5	14	15.5	17.5
500	1.1	1.4	1.6	1.8	2.1	2.5	2.8	3.2	3.6	4	4.6	5.2	6	6.7	7.5	8.2	9.2	11	12.5	14.5	15.5
400	1.0	1.3	1.5	1.7	2.0	2.2	2.6	2.8	3.2	3.7	4.1	4.7	5.2	6.0	6.7	7.5	8.2	9.1	11	12.5	14.5
300	0.9	1.2	1.3	1.5	1.8	1.9	2.2	2.6	2.8	3.2	3.6	4	4.5	5.0	5.8	6.2	7.2	7.8	8.9	10.5	12
200	0.8	1.0	1.2	1.3	1.5	1.7	1.8	2	2.3	2.6	3.0	3.3	3.8	4.2	4.7	5.2	6.0	6.7	7.5	8.7	9.0
100	0.5	0.6	0.8	0.9	1.0	1.2	1.3	1.5	1.7	1.9	2.0	2.3	2.7	3.0	3.3	3.7	4.2	4.7	5.2	6.0	6.8

Conversion Table for Units of Length

MULTIPLY NUMBER OF BY TO OBTAIN NUMBER OF	ANGSTROMS	MICRONS	MILS	INCHES	FEET	MILES	MILLIMETERS	CENTIMETERS	KILOMETERS
ANGSTROMS	1	10 ⁴	2.540 × 10 ⁵	2.540 × 10 ⁹	3.048 × 10 ⁹	1.609 × 10 ¹³	10 ⁷	10 ⁸	10 ¹³
MICRONS	10 ⁻⁴	1	2.540 × 10	2.540 × 10 ⁴	3.048 × 10 ⁵	1.609 × 10 ⁹	10 ³	10 ⁴	10 ⁹
MILS	3.937 × 10 ⁻⁶	3.937 × 10 ⁻²	1	10 ³	1.2 × 10 ⁴	6.336 × 10 ⁷	3.937 × 10	3.937 × 10 ²	3.937 × 10 ⁷
INCHES	3.937 × 10 ⁻⁹	3.937 × 10 ⁻⁵	10 ⁻³	1	12	6.336 × 10 ⁴	3.937 × 10 ⁻²	3.937 × 10 ⁻¹	3.937 × 10 ⁴
FEET	3.281 × 10 ⁻¹⁰	3.281 × 10 ⁻⁶	8.333 × 10 ⁻⁵	8.333 × 10 ⁻²	1	5.280 × 10 ³	3.281 × 10 ⁻¹	3.281 × 10 ⁻²	3.281 × 10 ³
MILES	6.214 × 10 ⁻¹⁴	6.214 × 10 ⁻¹⁰	1.578 × 10 ⁻⁸	1.578 × 10 ⁻⁵	1.894 × 10 ⁻⁴	1	6.214 × 10 ⁻⁷	6.214 × 10 ⁻⁶	6.214 × 10 ⁻¹
MILLIMETERS	10 ⁻⁷	10 ⁻³	2.540 × 10 ⁻²	2.540 × 10	3.048 × 10 ²	1.609 × 10 ⁶	1	10	10 ⁶
CENTIMETERS	10 ⁻⁸	10 ⁻⁴	2.540 × 10 ⁻¹	2.540	3.048 × 10	1.609 × 10 ⁵	0.1	1	10 ⁵
KILOMETERS	10 ⁻¹³	10 ⁻⁹	2.540 × 10 ⁻⁸	2.540 × 10 ⁻⁵	3.048 × 10 ⁻⁴	1.609	10 ⁻⁴	10 ⁻⁵	1

Symbols and Prefixes

A	ampere	lab	laboratory	v	velocity
ac	alternating current	lb	pound	v	volt
af	audio frequency	LC	inductance-capacitance	va	voltampere
afe	automatic frequency control	lf	low frequency	vhf	very high frequency
AM	amplitude modulation	lm/sq ft	footcandle	vlf	very low frequency
ASA	American Standards Association	log	logarithm	vol	volume
ASTM	American Society for Testing Materials	m	mass	vrms	volt, root, mean, square
avc	automatic volume control	m	meter; milli (10 ⁻³)	vs	versus
avg	average	ma	milliamper	VU	volume unit
B	susceptance	max	maximum	w	watt
BCD	binary-coded decimal	mbar	millibar	X	reactance
C	capacitance	mh	millihenry	Y	admittance
C	Centigrade, degrees Centigrade	MHz	megahertz	Z	impedance
cm	centimeter	mil	0.001 inch	α	short-circuit forward current-transfer ratio (common base)
COD	cash on delivery	min	minimum; minute	β	short-circuit forward current-transfer ratio (common emitter)
CW	continuous wave	mm	millimeter	L	reflection coefficient
D	dissipation factor	mS	millisiemens	Δ	increment
db	decibel	mΩ	milliohm	δ	loss angle
dbm	decibel referred to one milliwatt	MΩ	megohm	θ	phase angle
dc	direct current	MMΩ	megamegohm	λ	wavelength
DSB	double sideband	mv	millivolt	μ	micro- (10 ⁻⁶)
E	voltage	mw	milliwatt	μa	microampere
EIA	Electronics Industries Association	NAB	National Association of Broadcasters	μbar	microbar
emf	electromotive force	ns	nanosecond	μf	microfarad
ERP	effective radiated power	nS	nanosiemens	μh	microhenry
F	Fahrenheit, degrees Fahrenheit	oz	ounce	μs	microsecond
F	farad	PA	power amplifier	μv	microvolt
f	frequency	p	parallel, as L _p	Ω	ohm
FM	frequency modulation	pf	power factor	∅	mho
f.o.b.	free on board	PH	hydrogen in concentration	ω	angular velocity (2πf)
G	conductance	pp	push-pull; pages		
g	gravitation constant	ppm	parts per million		
GHz	gigahertz	p-p	peak-to-peak		
G _m	transconductance	prf	pulse repetition frequency		
h	henry	Q	quality factor		
Hz	hertz	R	resistance		
h _f	forward current-transfer ratio	®	registered trademark		
h _i	Short-circuit input impedance	RC	resistance-capacitance		
h _o	open-circuit output admittance	re	referred to		
h _r	reverse voltage-transfer ratio	rf	radio frequency		
I	current	RH	relative humidity		
IEC	International Electrotechnical Commission	RIAA	Recording Industry Association of America		
IEEE	Institute of Electrical and Electronics Engineers	rms	root-mean-square		
IF	intermediate frequency	rpm	revolutions per minute		
in.	inch	s	series, as L _s		
ips	inches per second	s	second		
IRE	Institute of Radio Engineers	S	siemens		
ISO	International Standards Organization	SCA	subsidiary carrier authorization		
j	$\sqrt{-1}$	s/n	signal to noise		
k	kilo (10 ³)	STL	studio transmitter link		
kg	kilogram	swr	voltage standing wave ratio		
kHz	kilohertz	sync	synchronous, synchronizing		
kva	kilovolt ampere	T	period		
kw	kilowatt	t	temperature		
L	inductance	t	time		
		uhf	ultra-high frequency		

Orders of magnitude from 10¹² to 10⁻¹⁸ are designated by the following prefixes:

Order	Prefix	Symbol
10 ¹²	tera	T
10 ⁹	giga	G
10 ⁶	mega	M
10 ³	kilo	k
10 ²	hecto	h
10	deka	da
10 ⁻¹	deci	d
10 ⁻²	centi	c
10 ⁻³	milli	m
10 ⁻⁶	micro	μ
10 ⁻⁹	nano	n
10 ⁻¹²	pico	p
10 ⁻¹⁵	femto	f
10 ⁻¹⁸	atto	a

Frequency Designation of FM Broadcast Channels

Freq. (MHz)	Channel No.	Freq. (MHz)	Channel No.	Freq. (MHz)	Channel No.
88.1	201	94.9	235	101.5	268
88.3	202	95.1	236	101.7	269
88.5	203	95.3	237	101.9	270
88.7	204	95.5	238	102.1	271
88.9	205	95.7	239	102.3	272
89.1	206	95.9	240	102.5	273
89.3	207	96.1	241	102.7	274
89.5	208	96.3	242	102.9	275
89.7	209	96.5	243	103.1	276
89.9	210	96.7	244	103.3	277
90.1	211	96.9	245	103.5	278
90.3	212	97.1	246	103.7	279
90.5	213	97.3	247	103.9	280
90.7	214	97.5	248	104.1	281
90.9	215	97.7	249	104.3	282
91.1	216	97.9	250	104.5	283
91.3	217	98.1	251	104.7	284
91.5	218	98.3	252	104.9	285
91.7	219	98.5	253	105.1	286
91.9	220	98.7	254	105.3	287
92.1	221	98.9	255	105.5	288
92.3	222	99.1	256	105.7	289
92.5	223	99.3	257	105.9	290
92.7	224	99.5	258	106.1	291
92.9	225	99.7	259	106.3	292
93.1	226	99.9	260	106.5	293
93.3	227	100.1	261	106.7	294
93.5	228	100.3	262	106.9	295
93.7	229	100.5	263	107.1	296
93.9	230	100.7	264	107.3	297
94.1	231	100.9	265	107.5	298
94.3	232	101.1	266	107.7	299
94.5	233	101.3	267	107.9	300
94.7	234				

Channels Available for Assignment to Noncommercial Educational FM Stations

Freq. (MHz)	Channel No.	Freq. (MHz)	Channel No.	Freq. (MHz)	Channel No.
88.1	201	89.5	208	90.9	215
88.3	202	89.7	209	91.1	216
88.5	203	89.9	210	91.3	217
88.7	204	90.1	211	91.5	218
88.9	205	90.3	212	91.7	219
89.1*	206	90.5	213	91.9	220
89.3	207	90.7	214		

*The frequency 89.1 MHz in the New York City metropolitan area is reserved for the use of the United Nations.

Convert Electrical Degrees to Feet, or Vice Versa When Frequency and Either Feet or Degrees is Known

From the expression

$$\text{Feet} = \frac{\text{degrees}}{360^\circ} \times \frac{300}{f(\text{MHz})} \times 3.281 = \text{degrees} \times \frac{2.734}{f(\text{MHz})}$$

The following ratio may be set up on the slide rule using C and D scales:

$$\frac{2.734}{f(\text{MHz})} = \frac{\text{feet}}{\text{degrees}}$$

Set 2.734 on scale C over frequency in megahertz on scale D; read feet and degrees on scales C and D, respectively. In some instances it may be convenient to use the folded scales CD and DF.

Metric Conversion

To convert pounds to kilograms, multiply by .4536

To convert inches to centimeters, multiply by 2.54

Telephone Cable Color Code

Pair No.	Color	Mate
1	Blue	White
2	Orange	White
3	Green	White
4	Brown	White
5	Slate	White
6	Blue White	White
7	Blue Orange	White
8	Blue Green	White
9	Blue Brown	White
10	Blue Slate	White
11	Orange White	White
12	Orange Green	White
13	Orange Brown	White
14	Orange Slate	White
15	Green White	White
16	Green Brown	White
17	Green Slate	White
18	Brown White	White
19	Brown Slate	White
20	Slate White	White
21	Blue	Red
22	Orange	Red
23	Green	Red
24	Brown	Red
25	Slate	Red
26	Blue White	Red
27	Blue Orange	Red
28	Blue Green	Red
29	Blue Brown	Red
30	Blue Slate	Red
31	Orange White	Red
32	Orange Green	Red
33	Orange Brown	Red
34	Orange Slate	Red
35	Green White	Red
36	Green Brown	Red
37	Green Slate	Red
38	Brown White	Red
39	Brown Slate	Red
40	Slate White	Red
41	Blue	Black
42	Orange	Black
43	Green	Black
44	Brown	Black
45	Slate	Black
46	Blue White	Black
47	Blue Orange	Black
48	Blue Green	Black
49	Blue Brown	Black
50	Blue Slate	Black

NOTE—The last pair in all cables is a Red with White mate, viz.

6-pair cable	6th pair	Red	White
11-pair cable	11th pair	Red	White
16-pair cable	16th pair	Red	White
26-pair cable	26th pair	Red	White
51-pair cable	51st pair	Red	White

Attenuation — Heliax/Air Dielectric Cables

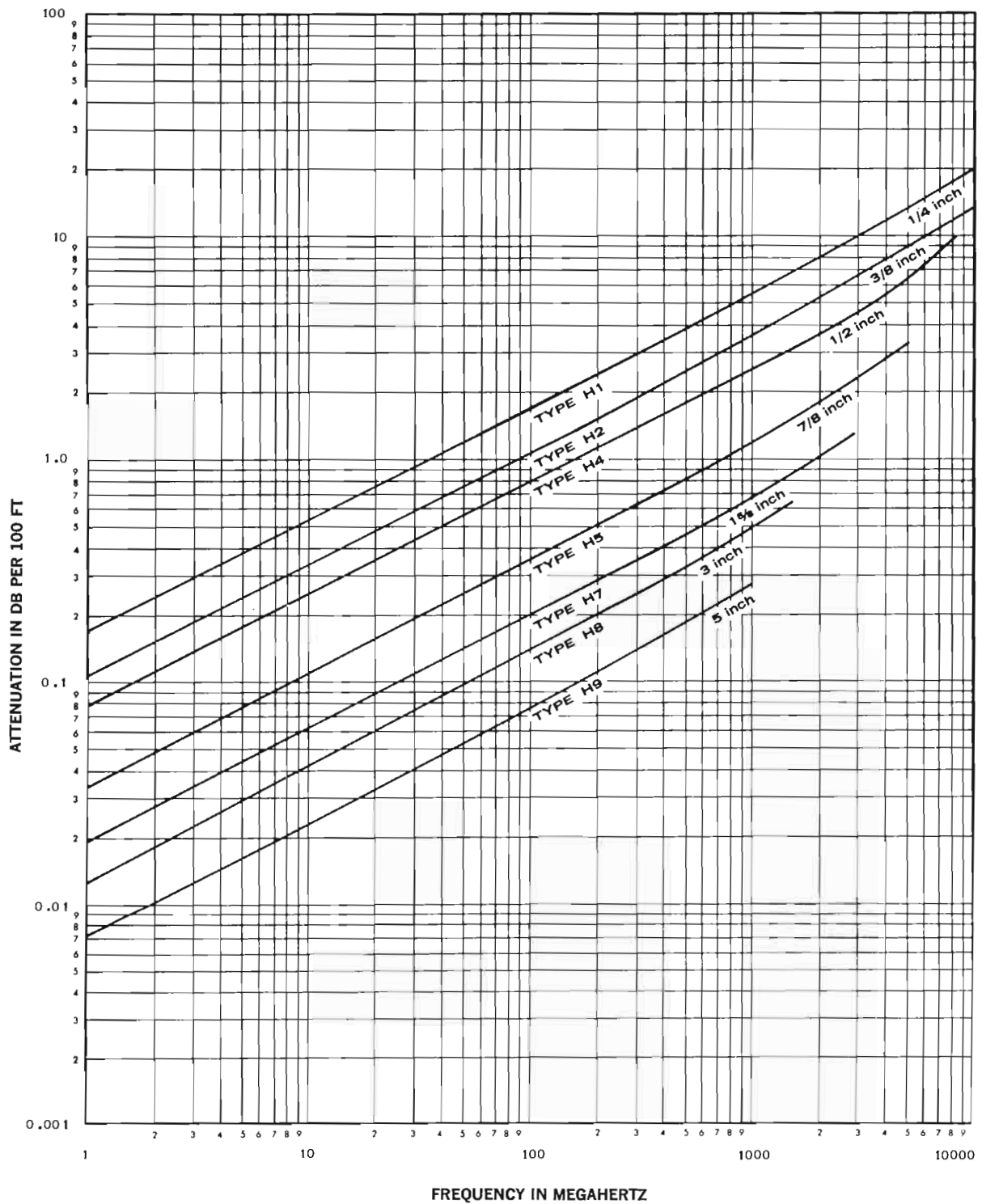

The attenuation curves above are for 50-ohm copper Heliax at unity VSWR. For 75-ohm copper cables the values shown should be reduced 5%. For 50-ohm aluminum (outer conductor) cables the values should be increased 12%.

Power Rating — Helix/Air Dielectric Cables

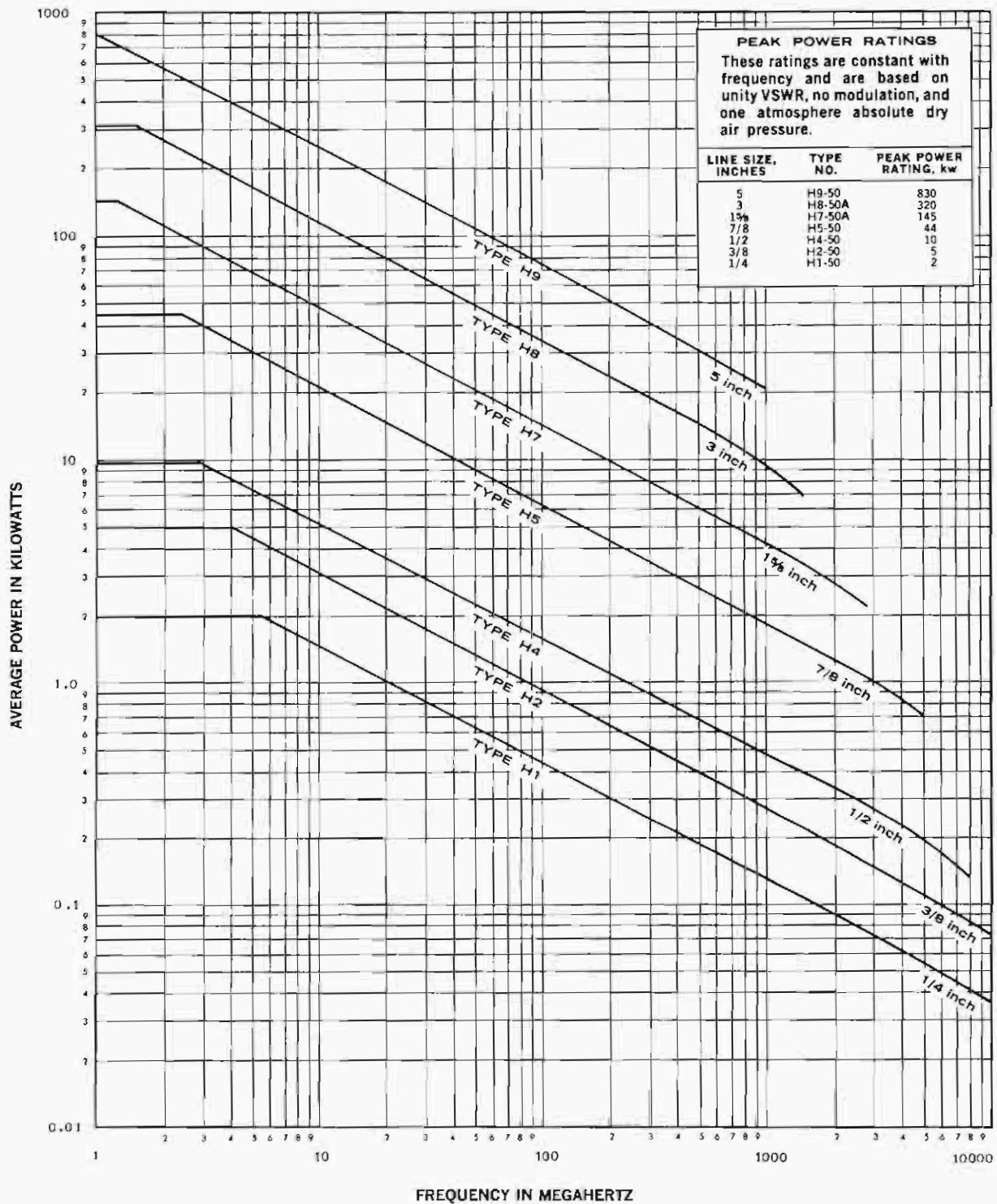

The average power ratings shown above are for 50-ohm copper Helix and are based on unity VSWR and a maximum inner conductor temperature of 212°F at an ambient temperature of 104°F. For 75-ohm copper cables the values shown should be reduced 30%. For 50-ohm aluminum (outer conductor) cables the values should be reduced 10%. For Teflon insulated cables, average power ratings should be increased by 35%.

Attenuation — Heliax/Foam Dielectric Cables

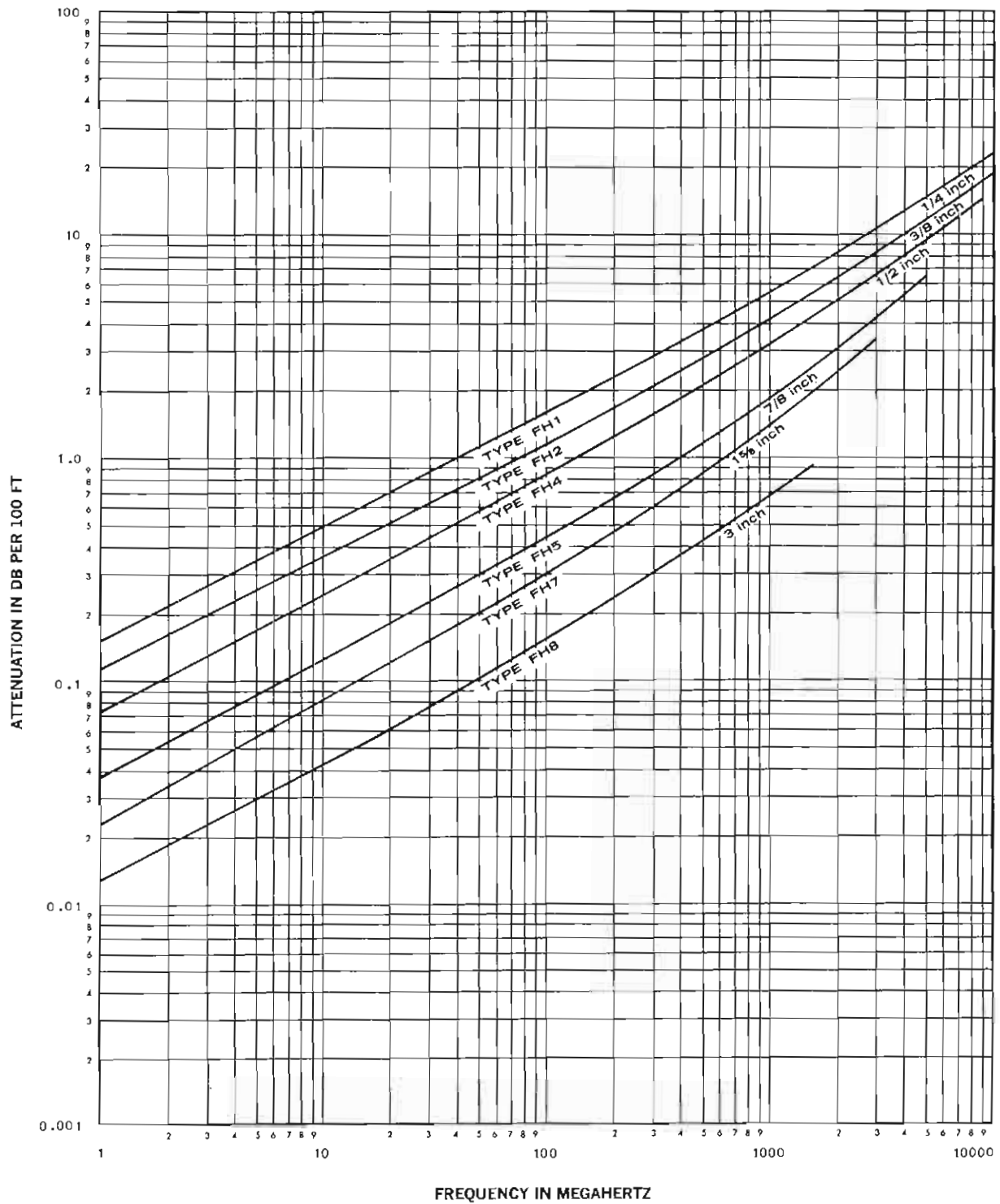

The attenuation curves above are for 50-ohm copper Heliax at unity VSWR. For 75 ohm copper cables the values shown should be reduced 5%. For 50-ohm aluminum (outer conductor) cables the values should be increased 12%.

Power Rating — Helix/Foam Dielectric Cables

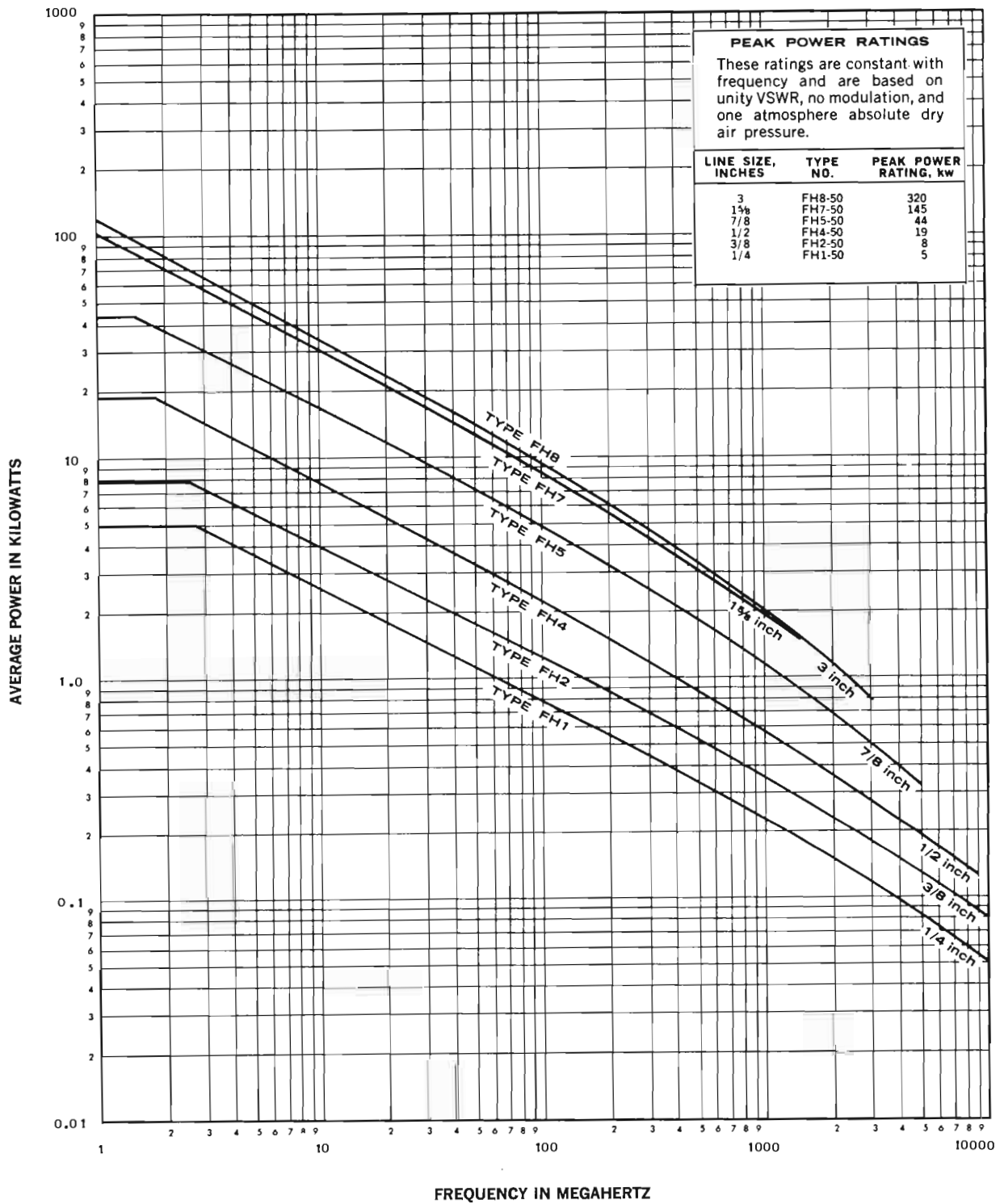

The average power ratings shown above are for 50-ohm copper Helix and are based on unity VSWR and a maximum inner conductor temperature of 175°F at an ambient temperature of 104°F. For 75-ohm copper cables the values shown should be reduced 30%. For 50-ohm aluminum (outer conductor) cables the values should be reduced 10%.

Attenuation — Rigid Transmission Lines

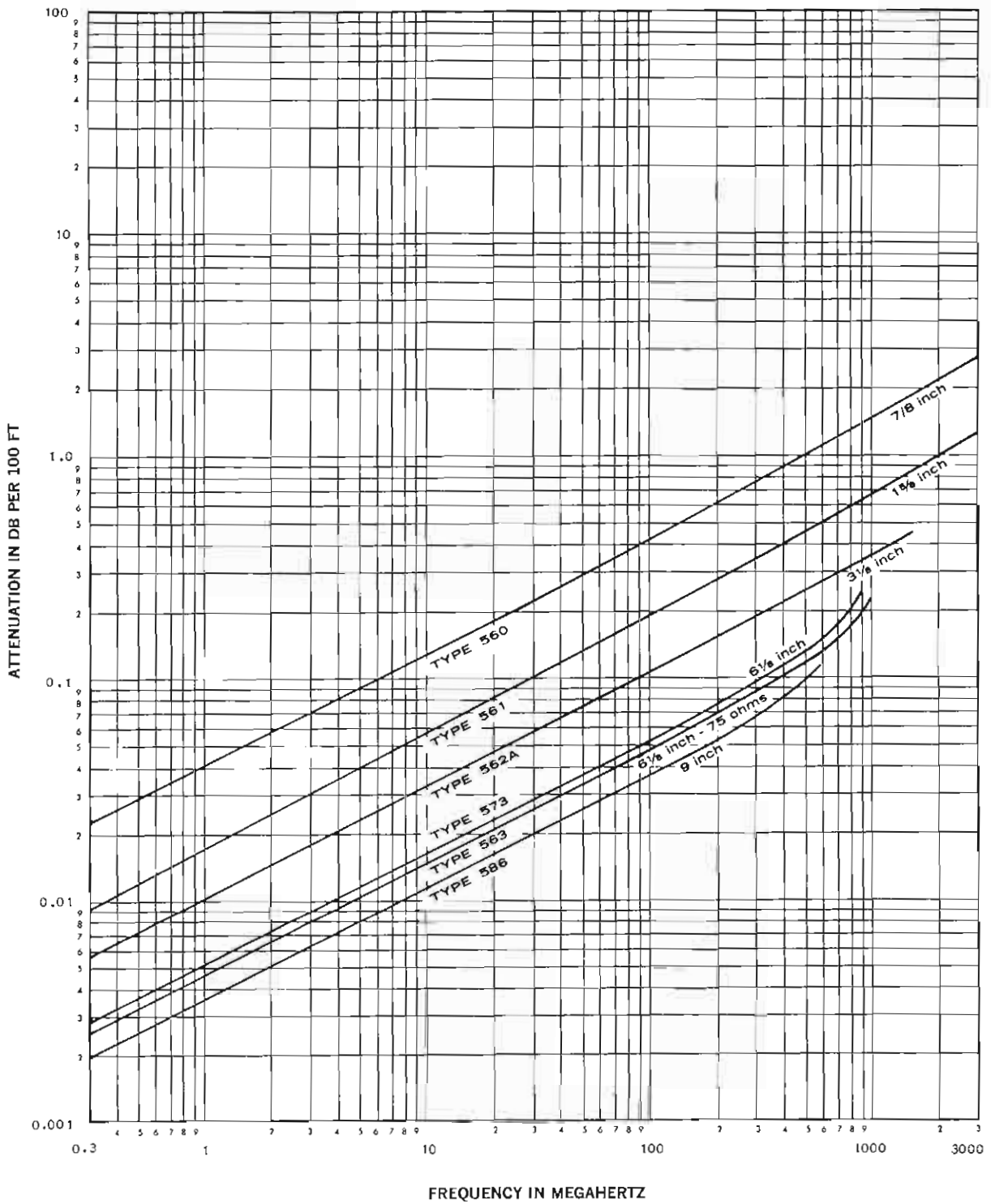

The attenuation curves above are based on unity VSWR.

Power Rating — Rigid Transmission Lines

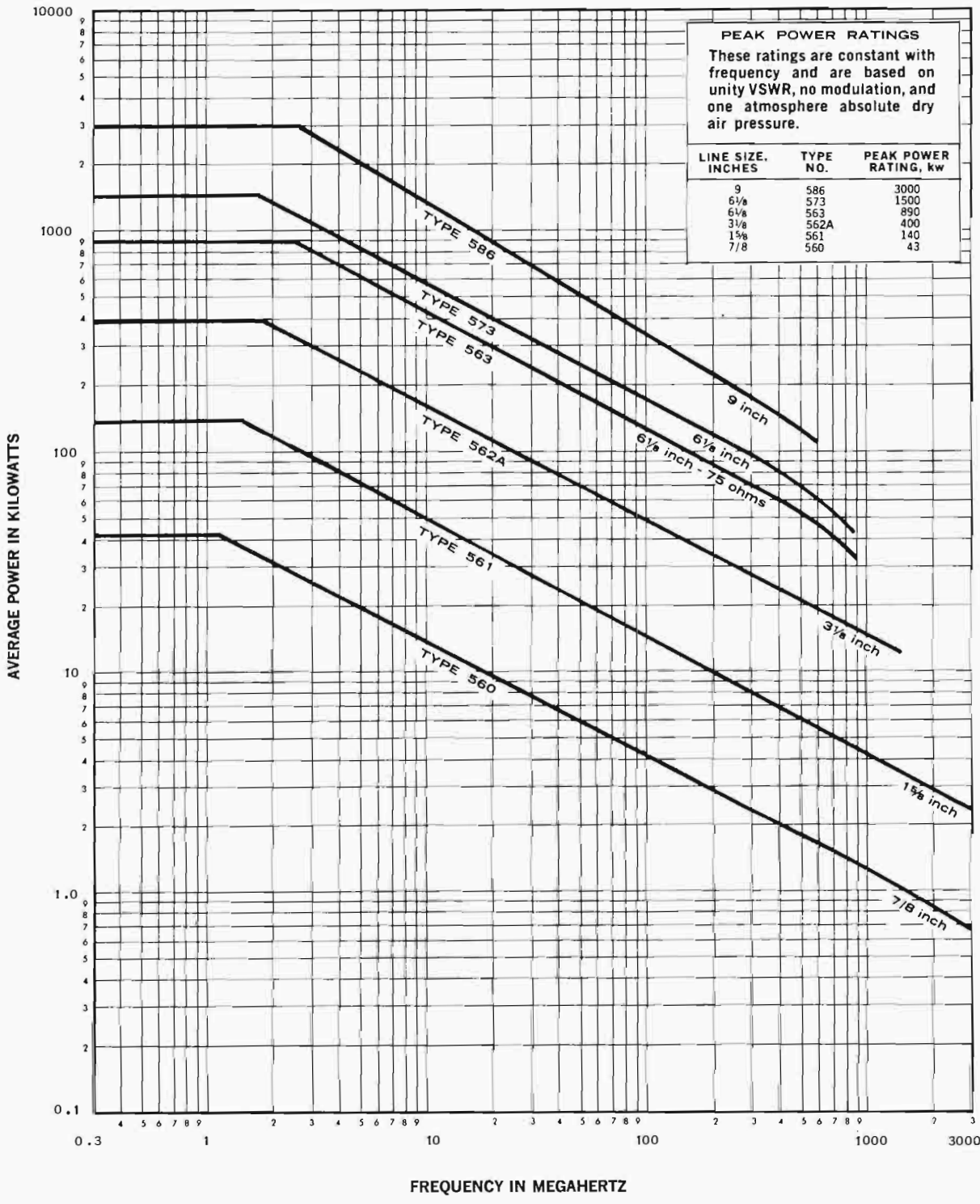

The average power ratings shown above are based on unity VSWR and a maximum inner conductor temperature of 216°F at an ambient temperature of 104°F.

Forward VS Reflected Power

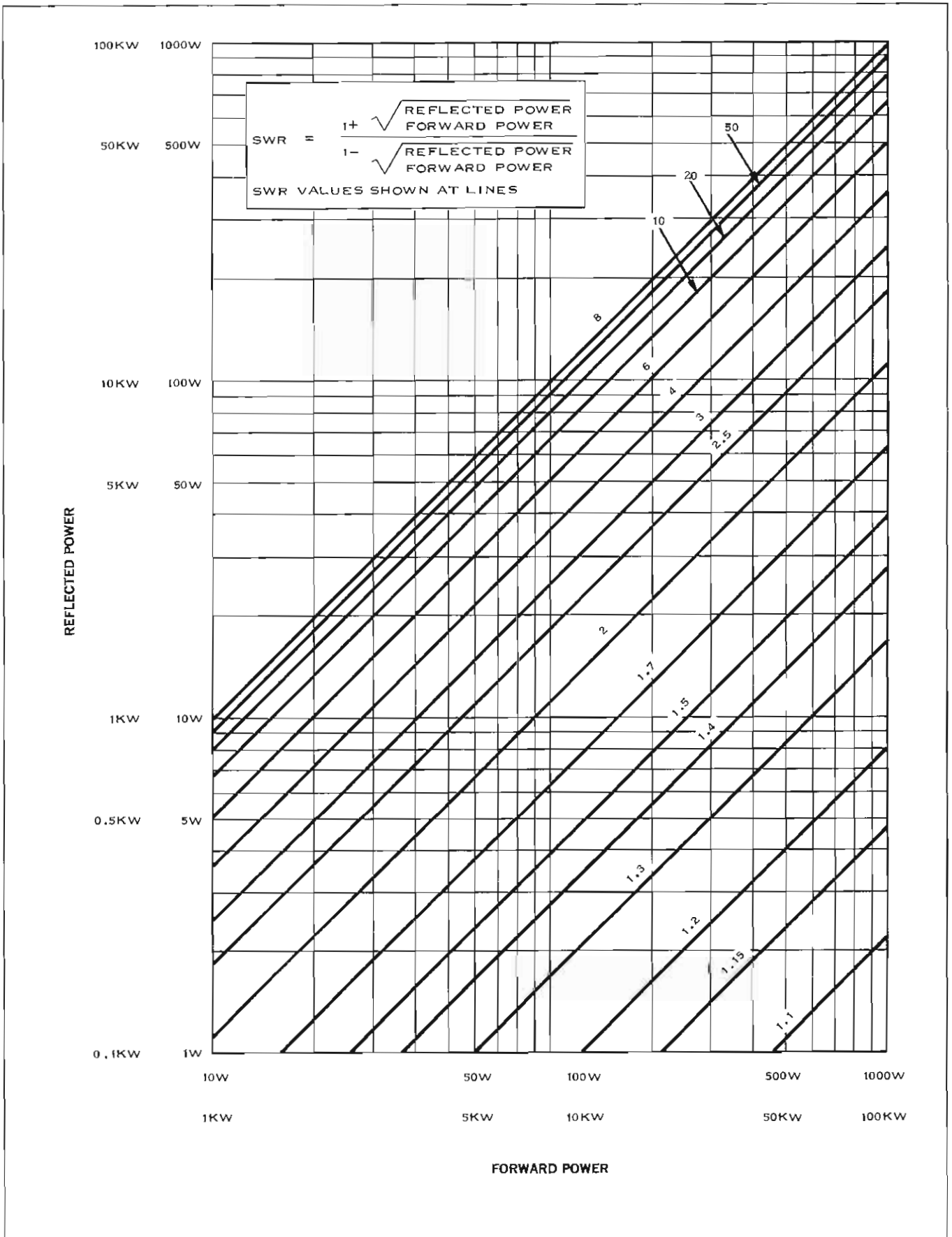

Attenuator Network



DB LOSS	R ₁	R ₂	DB LOSS	R ₁	R ₂	DB LOSS	R ₁	R ₂	DB LOSS	R ₁	R ₂
0.5	17.2	10464	16	435.8	195.1	0.5	8.6	10464	16	217.9	195.1
1	34.5	5208	17	451.5	172.9	1	17.25	5208	17	225.7	172.9
2	68.8	2582	18	465.8	152.5	2	34.4	2582	18	232.9	152.5
3	102.7	1703	19	479.0	136.4	3	51.3	1703	19	239.5	136.4
4	135.8	1249	20	490.4	121.2	4	67.9	1249	20	245.2	121.2
5	168.1	987.6	22	511.7	95.9	5	84.1	987.6	22	255.9	95.9
6	199.3	803.4	24	528.8	76.0	6	99.7	803.4	24	264.4	76.0
7	229.7	685.2	26	542.7	60.3	7	114.8	685.2	26	271.4	60.3
8	258.4	567.6	28	541.1	47.8	8	129.2	567.6	28	277.0	47.8
9	285.8	487.2	30	563.0	38.0	9	142.9	487.2	30	281.6	38.0
10	312.0	421.6	32	570.6	30.2	10	156.0	421.6	32	285.3	30.2
11	336.1	367.4	34	576.5	24.0	11	168.1	367.4	34	288.3	24.0
12	359.1	321.7	36	581.1	19.0	12	179.5	321.7	36	290.6	19.0
13	380.5	282.8	38	585.1	15.1	13	190.3	282.8	38	292.5	15.1
14	400.4	249.4	40	588.1	12.0	14	200.2	249.4	40	294.1	12.0
15	418.8	220.4				15	209.4	220.4			

Estimated Ground Conductivity

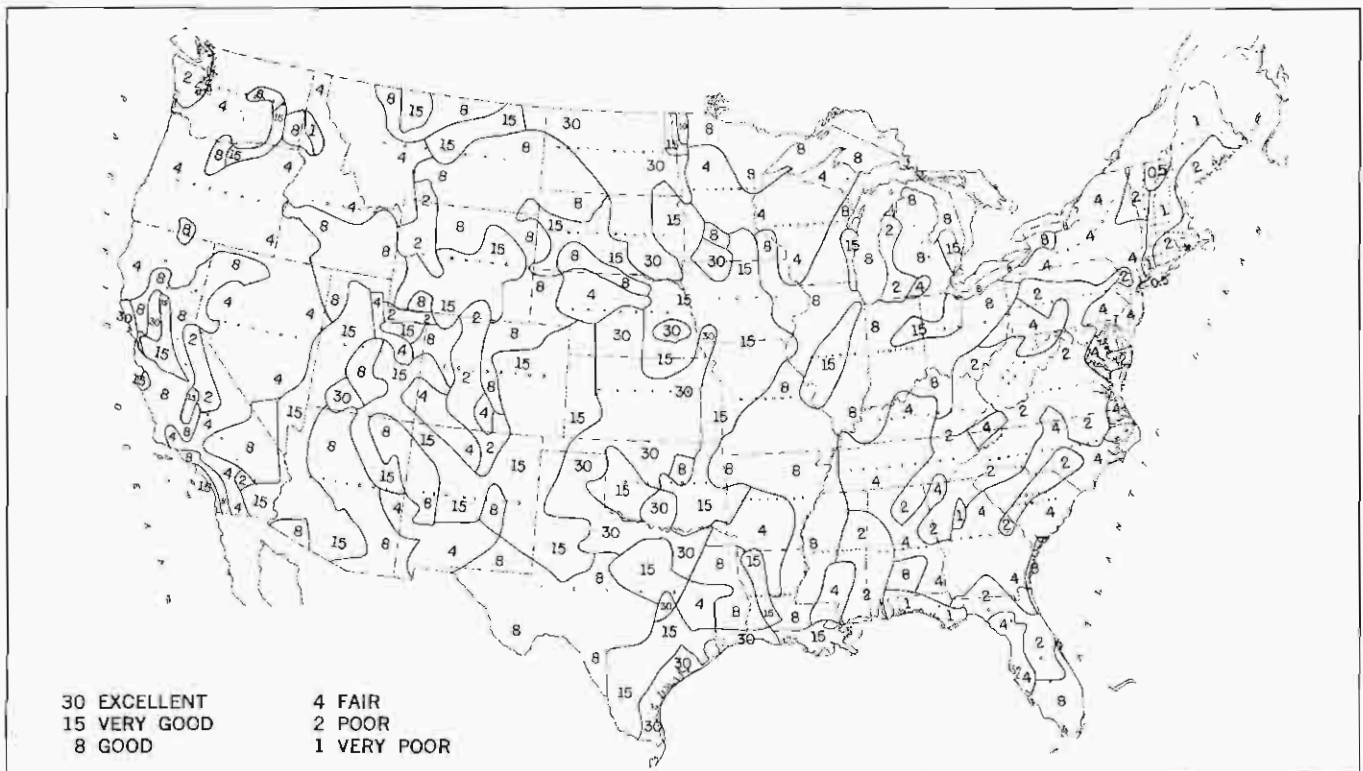

Reactance Chart

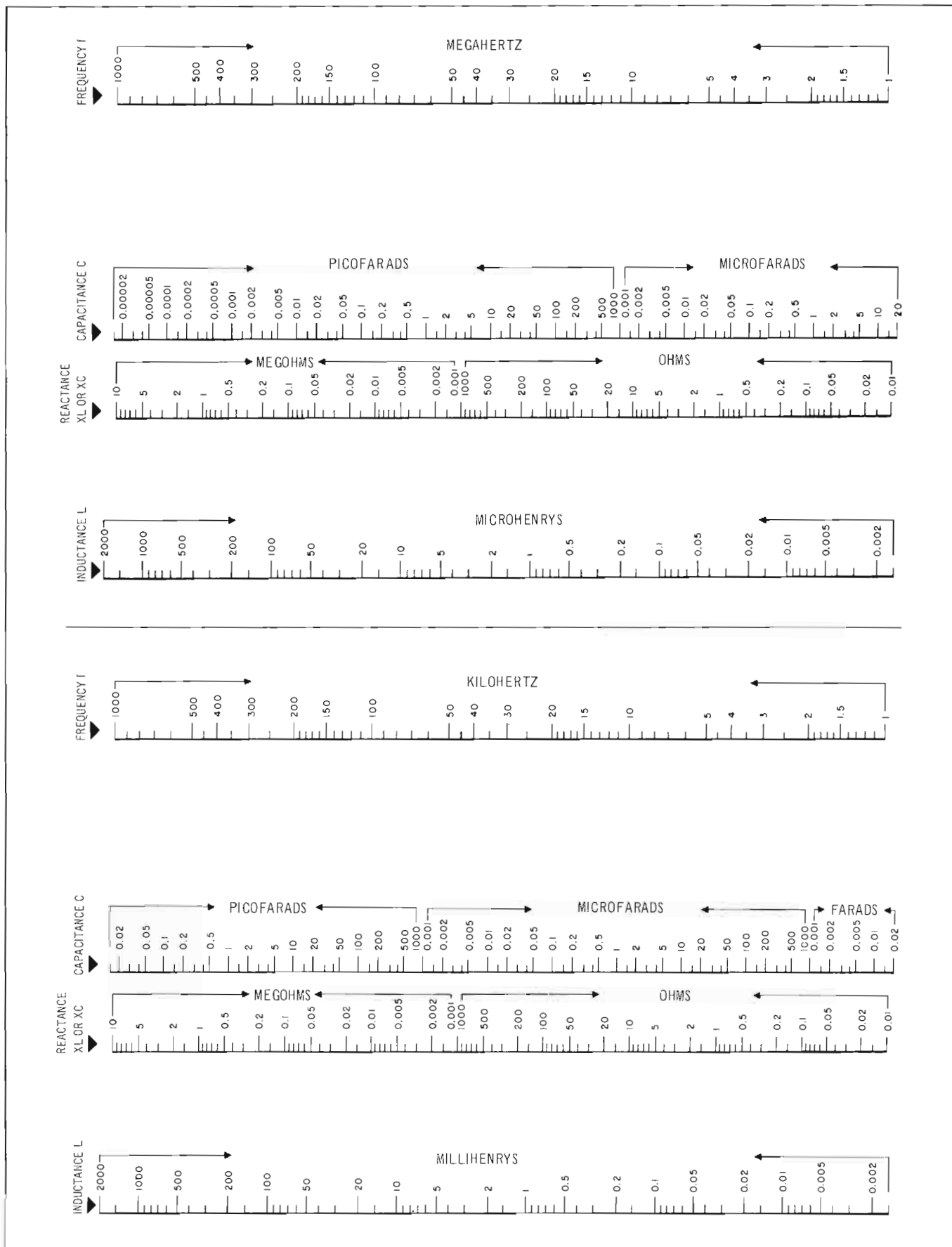

Attenuation Expressed as Efficiency

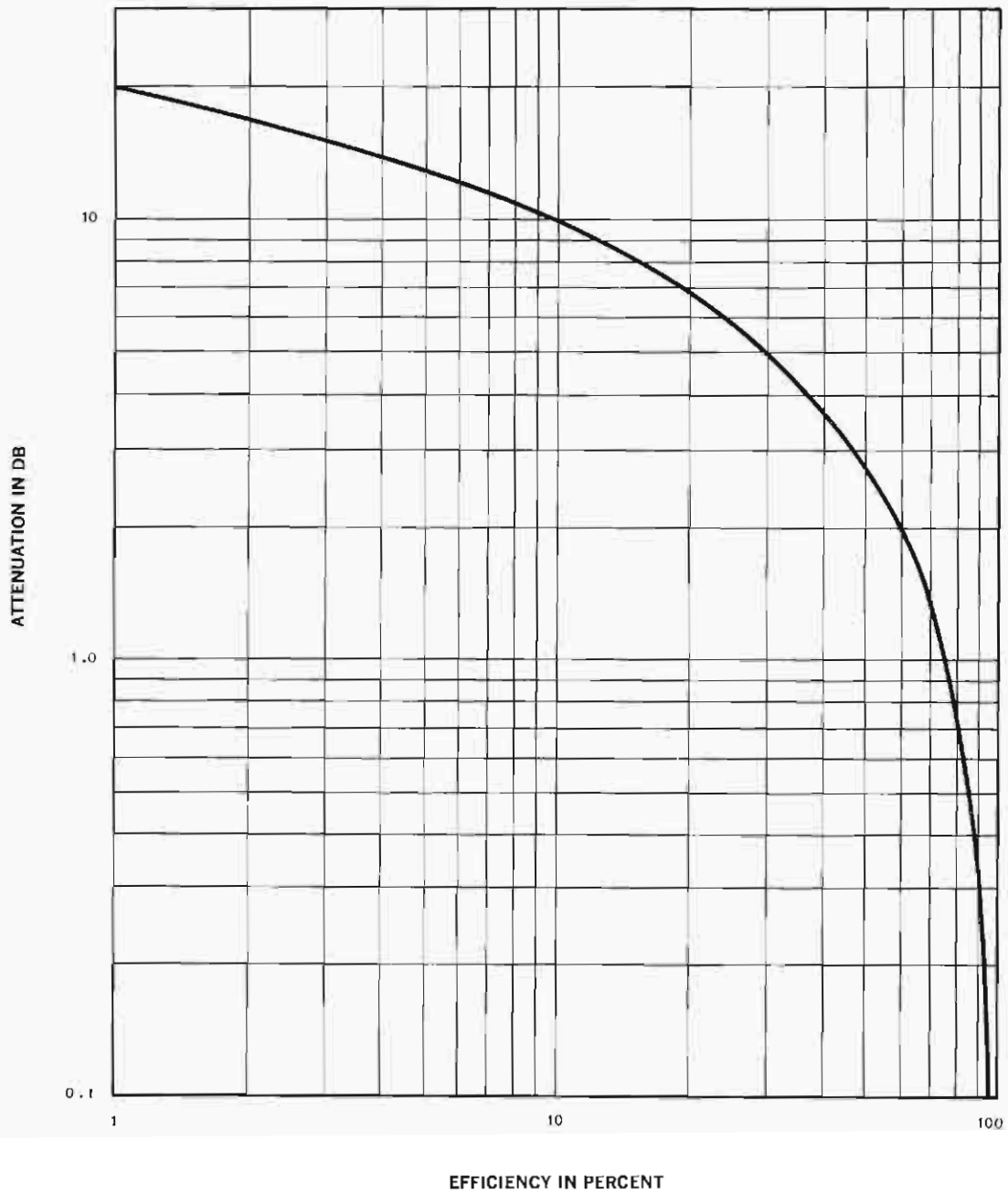

To obtain total loss in a given transmission line, multiply the attenuation in db per 100 ft by the number of 100-foot lengths of line to be used. By referring to the curve on this page, the overall transmission efficiency may be determined.

Station Layouts

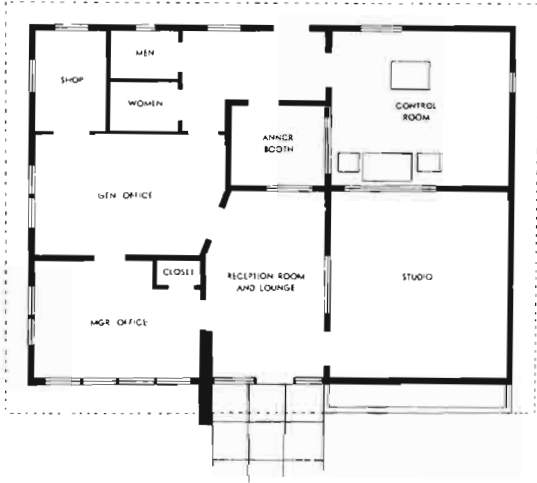
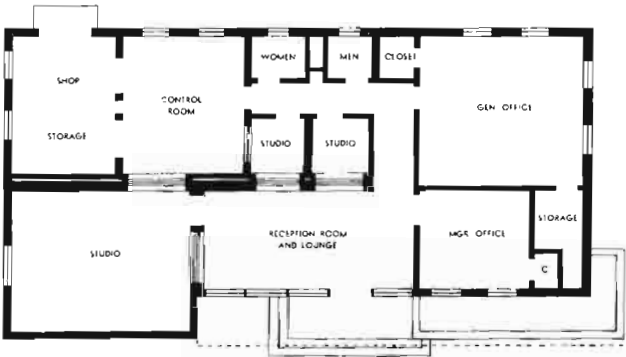
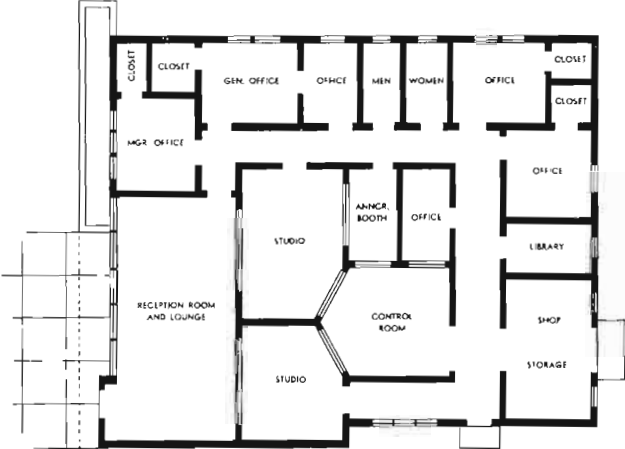
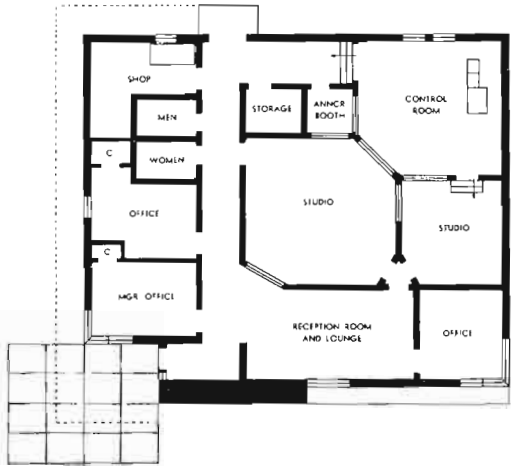

Transformation of Kilowatts to Decibels Above 1 KW

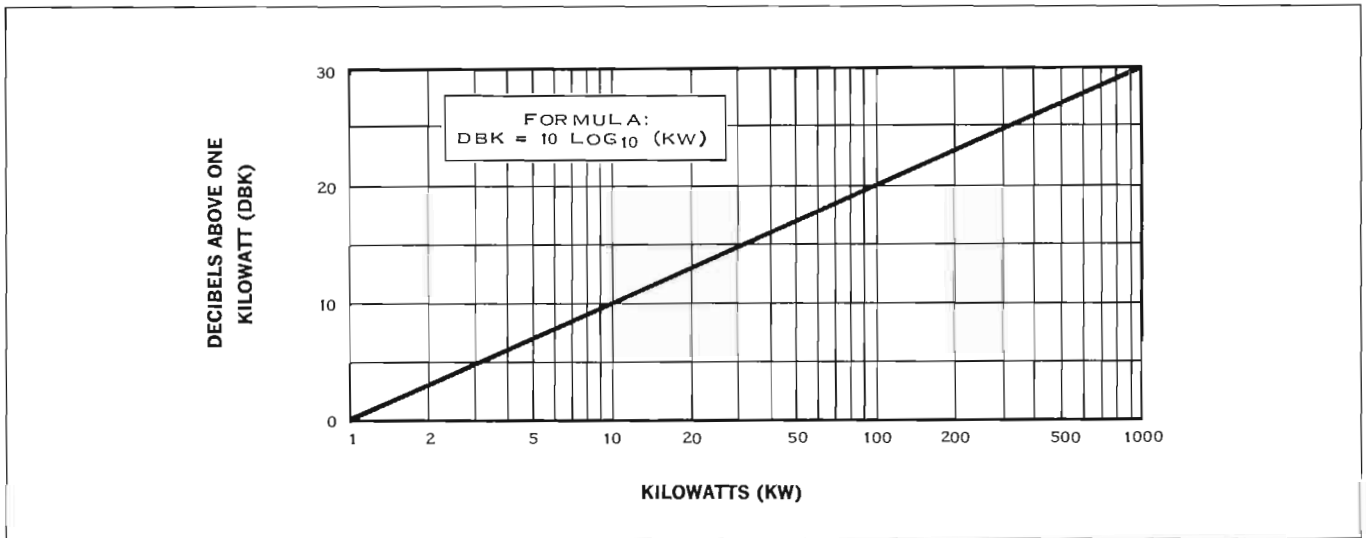

Transformation of Microvolts to Decibels Above 1 μV

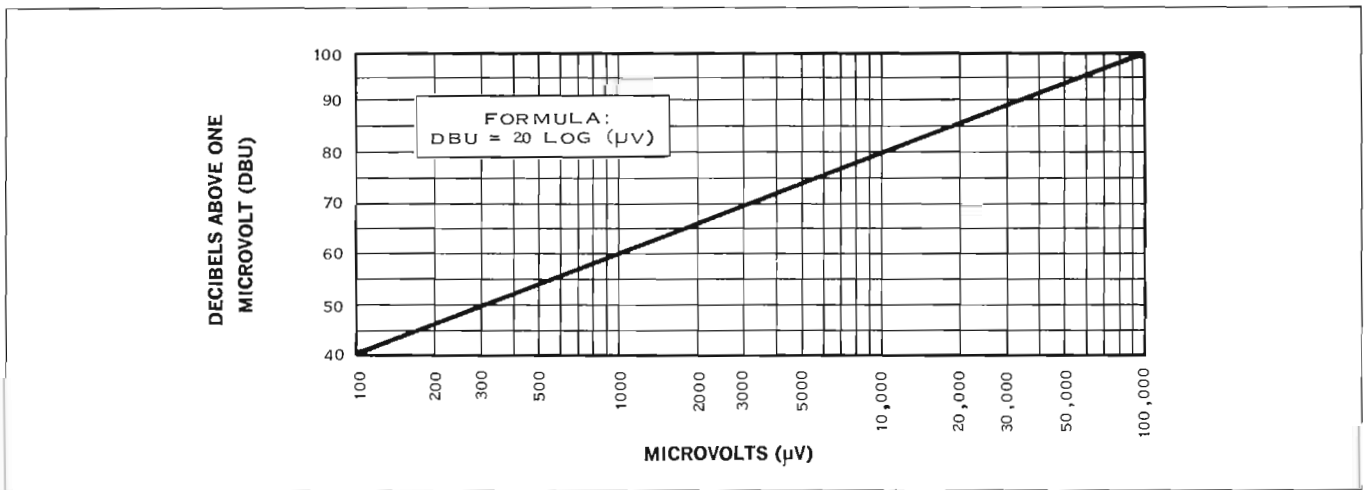

Dbm VS Watts

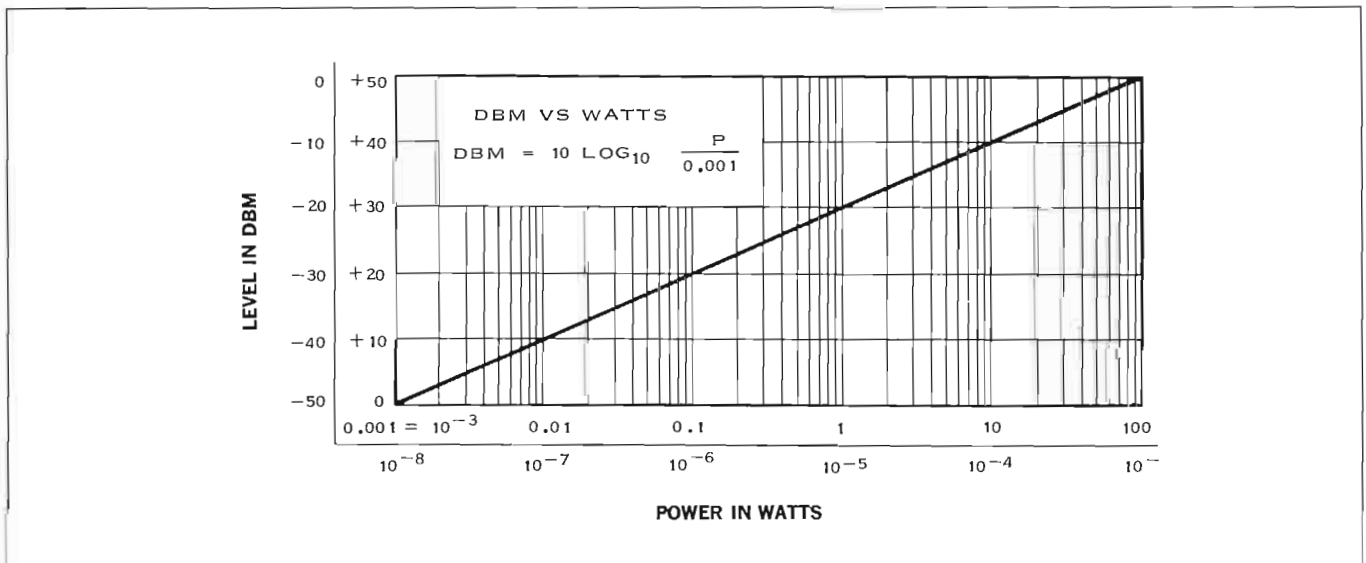

Volume Level to Power and Voltage Conversion

REFERENCE LEVEL: 0 DBM = 1 MW, 600 OHMS					
MILLIWATTS	VOLTS	DBM	WATTS	VOLTS	DBM
0.000001	0.0007746	- 60	0.001000	0.7746	0
0.000010	0.002449	- 50	0.002512	1.228	+ 4
0.000100	0.007746	- 40	0.006310	1.946	+ 8
0.001	0.02449	- 30	0.01000	2.449	+ 10
0.010	0.07746	- 20	0.1000	7.746	+ 20
0.100	0.2449	- 10	1.000	24.49	+ 30
1.000	0.7746	0	10.00	77.46	+ 40

Decibels VS Ratio

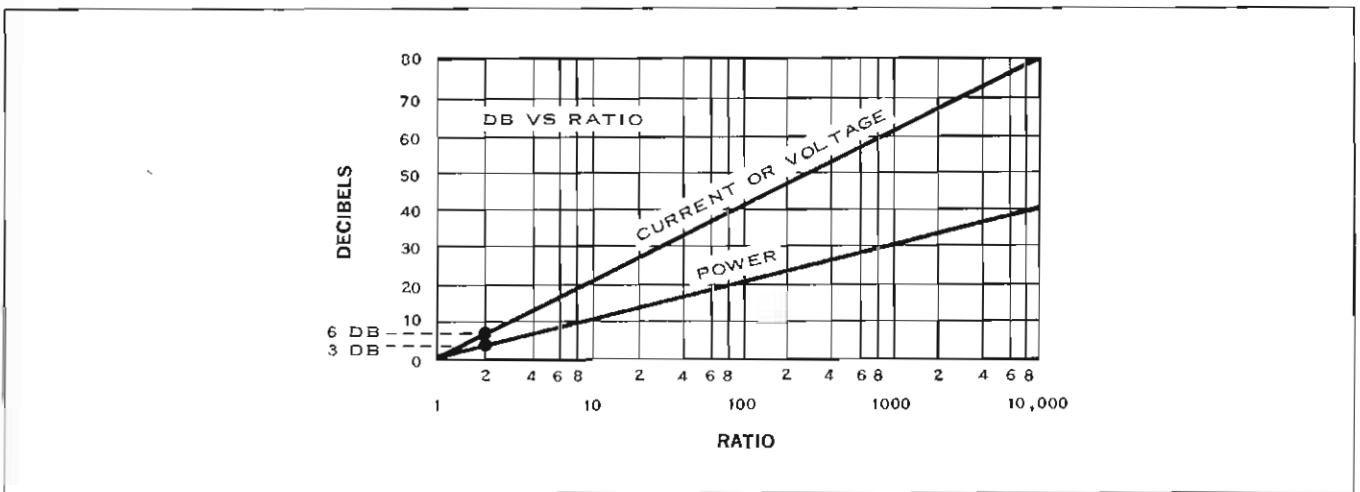

Increase in Attenuation in Line Due to VSWR on Line

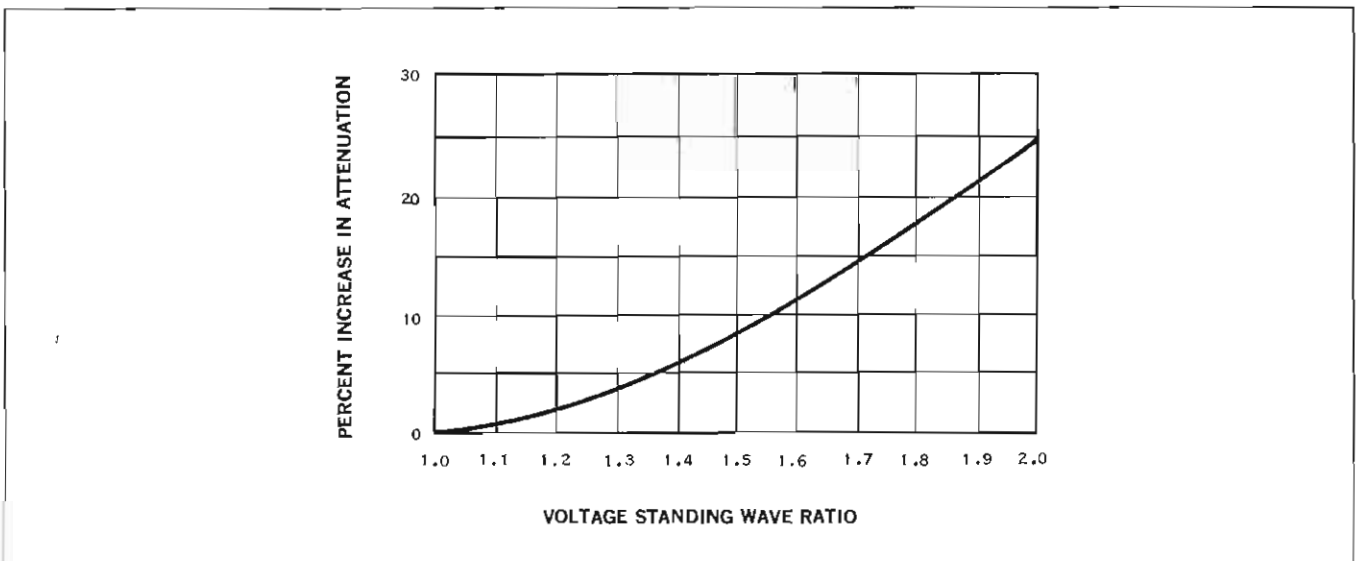

Standard Color Codes — Resistors and Capacitors

INSULATED UNINSULATED COLOR	FIRST RING BODY COLOR FIRST FIGURE	SECOND RING END COLOR SECOND FIGURE	THIRD RING DOT COLOR MULTIPLIER
BLACK	0	0	NONE
BROWN	1	1	0
RED	2	2	.00
ORANGE	3	3	.000
YELLOW	4	4	0.000
GREEN	5	5	00.000
BLUE	6	6	.000.000
VIOLET	7	7	0.000.000
GRAY	8	8	00.000.000
WHITE	9	9	000.000.000

JAN 8,
1948
RMA
CODE

MOLDED MICA TYPE CAPACITORS

CURRENT STANDARD CODE



RMA 3-DOT (OBSOLETE) RATED 500 WVDC ±20% TOL.

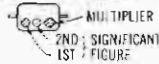

BUTTON SILVER MICA CAPACITOR



RMA (5-DOT OBSOLETE CODE)

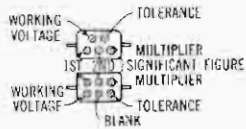
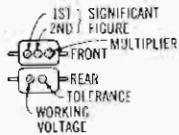

RMA 4-DOT (OBSOLETE)

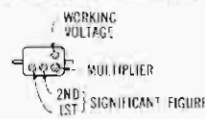

RMA 6-DOT (OBSOLETE)

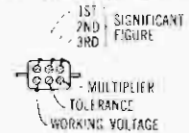

MOLDED PAPER TYPE CAPACITORS

TUBULAR CAPACITOR

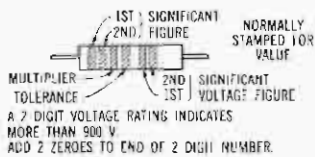

MOLDED FLAT CAPACITOR COMMERCIAL CODE

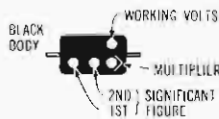

JAN. CODE CAPACITOR

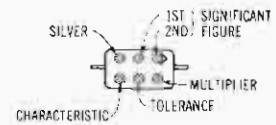

CERAMIC CAPACITORS

5-DOT RADIAL LEAD CERAMIC CAPACITOR



EXTENDED RANGE TC CERAMIC HICAP

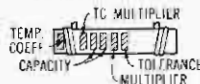

AXIAL LEAD CERAMIC CAPACITOR

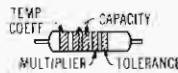

DISC CERAMIC RMA CODE

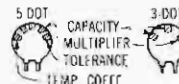

BY-PASS COUPLING CERAMIC CAPACITOR

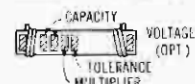

RESISTORS

RADIAL LEAD DOT RESISTOR

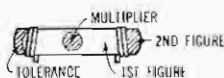

RADIAL LEAD (BAND) RESISTOR



AXIAL LEAD RESISTOR

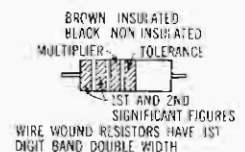

Indexes

INDEX BY DESCRIPTION

Air Alert	67	Mobile Receiver	73
AM Towers	35	Mobile Transmitter	73
AM Transmitters	5	Monitor, Modulation	76, 79
Amplifier, Auto-Level Limiting	48	Pads, Replacement Pressure	57
Amplifier, Console	37-39, 44-47	Patch Cords	68
Amplifier, Stereo Limiting	49	Phase Monitor	80
Antennas	31, 74	Phasing	10
Antenna Coupling Unit	11	Phasor	10
Antenna Current Transformer	12	Phono Equalizer Preamp	51
Auto-Level Limiting Amplifier	48	Phonograph Cartridge	53
Baffles	68	Playback Arms	51, 52
Beacon Light Control	35	Power Supply, Console	43
Cabinet, Turntable	50	Preamplifier	40-42
Cartridges, Automatic Programming	56	Rack Cabinet Panels	69
Cartridges & Styli	53	Recorders, Tape	54, 58-61
Cartridge Racks	56	Recorder Accessories	56, 57
Choke, Tower Lighting	11	Recorder/Reproducer	58-60
Clock, Studio	69	Recording Tapes	56, 57
Connectors	70	Remote Amplifier	72
Console, Speech Input	37-39, 44-47	Remote Control	81, 82
Contactors	12	Remote Control, Tape	58
Deicer, Antenna	31	Remote Equipment	71
Dummy Antenna	12	Remote Equipment Accessories	74
Equalizer	51	Replacement Pressure Pads	57
Exciter, FM	14	Ring Transformer	35
Field Intensity Meter	80	Speakers	67
FM Antenna	30	Speaker/Amplifier, Tape	60
FM Towers	35	Splicing Tape	57
FM Transmitters	13	Stereo Multiplex Generator	15, 16
Frequency Monitor	77, 78	Studio Clock	69
Generator, Stereo Multiplex	15, 16	Styli	53
Ground Screen	35	Switch Matrix	43
Ground Strap	35	Tape, Automatic Programming Test	57
Ground Wire	35	Tape Cartridge Racks	56
Headphones	68	Tape Cartridge System	54, 55
Heating Element, FM Antenna	31	Tape Erasers	57
Insulator, Feed-Through	12	Tape Recorders	54, 58-61
Isolation Coil	12	Tape Splicer, Cutter	57
Jack Panels	68	Terminal Board	69
Lavaliere Microphone Clip	63	Tone Arms	51-54
Level Controls	67	Towers, AM	35
Loudspeakers	67	Towers, FM	35
Meter, Intensity	80	Tower Lighting Choke	11
Microphones	63-65	Transformer, Speaker	67
Microphone Boom	66	Transformer, Turntable	50
Microphone Boom Stand	66	Transmission Lines and Accessories	35
Microphone Cable	69	Turntables	50
Microphone Stands	65	Turntable Cabinet	50
		Wire, Copper	35
		Wire, Shielded	69

INDEX BY PART NUMBER

1H1612 Studio Clock	69	427-6 Terminal Board	69
2YC Stacking Harness	74	500 Recorder	61
26U-1 Amplifier, Limiting Console	48	506B Modulation Monitor	76, 79
26U-2 Amplifier, Stereo Limiting	49	600 Cartridge	56
37CP FM Antenna	34	600 Recorders/Accessories	61
37M FM Antenna	31	620 Speaker/Amplifier	60
42E-7 Antenna Coupling Unit	11	642E Twintape Playback Unit	54
42E-8A Antenna Coupling Unit	11	786M-1 Generator	16
42E-8B Antenna Coupling Unit	11	786V-1 Stereo Generator	15
54N-1 FM Frequency Monitor	78	786W-1 SCA Generator	15
54Z-1 AM Frequency Monitor	77	820D-1 AM Transmitter	6
81M Phasor	10	820E/F-1 AM Transmitter	8
111A-12 Recording Tape	57	830B-1B FM Transmitter	18
112 Phase Monitors	80	830D-1B FM Transmitter	20
135-15 Feed-Through Insulator	12	830E-1B FM Transmitter	24
144A-1 Isolation Coil	12	830F-1B FM Transmitter	26
150-18 Reecording Tape	57	830H-1B FM Transmitter	28
156 Headphones	68	830N-1B FM Transmitter	29
157 Headphones	68	831D-1 FM Transmitter	22
172G-1 Dummy Antenna	12	900C-3 Modulation Monitor	76
172G-2 Dummy Antenna	12	1021 Recorder/Reproducer	59
190-18 Recording Tape	57	1022 Recorder/Reproducer	59
200C Tape Eraser	57	1028 Recorder/Reproducer	59
206 Playback Arms	52	1200 Cartridge	57
208 Playback Arms	51	8412 Microphone Cable	69
216D Twintape Record Amplifier	55	8422 Microphone Cable	69
212J-1 Console	46	8451 Microphone Cable	69
212H-1 Remote Amplifier	72	8738 Microphone Cable	69
212M-1 Console	39	8758 Microphone Cable	69
212S-1 Console	37	63305-DB Beacon Light Control	35
212T-1 Console	44	A-3818 Speaker Transformer	67
212T-2 Console	45	AA-620 Speaker/Amplifier	60
260S-1 Mixer Add-On Unit	38	AG-440 Recorder/Reproducer	61
280 Recorder/Reproducer	58	AG-500 Recorder	60
300 Cartridges	56	AG-600 Recorder	61
300C Antenna	33	ASP 143 Bumper Mount	74
303 Playback Arm	52	ASP-177 Antenna	74
306 Playback Arm	52	BA-200 Headphones	68
310Z-1 FM Exciter	14	BA-206 Headphones	68
356H-1 Phonograph Equalizer Preamplifier	51	BB-1 Microphone Boom	66
356M-1 Monitor Amplifier	41	CR-1772 Rack Cabinet	69
356R-1 Phono Preamplifier	42	CR-1773-B Rack Cabinet	69
356P-1 Program Amplifier	41	CS-12 Loudspeaker	66
356T-1 Preamplifier	40	DS-7 Microphone Desk Stand	65
356U-1 Audio Preamplifier	42	FIM-135 Field Intensity Meter	80
356V-1 Hi-Level Amplifier	40	FM-1 Flexo Mikester	66
384D-1 Switch Matrix	43	GR-6355 Connector	74
409Z-1 Power Supply	43	M-20 Microphone	63
		M-20 Microphone Desk Stand	65
		M-30B/TPS Mobile Transmitter	73

M-40 Microphone	63	SM5A Microphone	64
M44-5 Phonograph Cartridge	53	SM33 Microphone	64
M44-7 Phonograph Cartridge	53	SM50 Microphone	64
M-70 Microphone	63	SM300 Microphone	65
M232 Playback Arm	54	ST-276 Level Control	67
M236 Playback Arm	54	ST500 Splicing Tape	57
MA-1 Antenna	74	SX800 Recorder/Reproducer	58
MM-151 Recording Tape	57	TCW-2Q Turntable Cabinet	50
MR-30/150-170 Remote Receiver	73	TCW-4Q Turntable Cabinet	50
MS-10C Microphone Floor Stand	66	TCW-9Q Turntable Cabinet	50
MS-11C Microphone Floor Stand	66	T1-2017 Ring Transformer	35
MS-25 Microphone Floor Stand	66	T1-2035 Ring Transformer	35
P12-T Speaker	67	TPS-1 Remote Power Supply	74
PA-1 Antenna	74	TPS-TC Mobile Assemblage	74
PBR-21 Meter Panel	82	TS-8D Tape Splicer Cutter	57
PBR-21 Studio Control Unit	82	TT-200 Turntable	50
PBR-21 Transmitter Control Unit	82	TT-200S Turntable	50
RA-2 Antenna	74	TT-250S Turntable	50
RA-4 Antenna	74	TT-400 Turntable	50
RC-2400D Remote Control	81	TT-400S Turntable	50
RC-2400F Remote Control	81	TT-450S Turntable	50
RMC-1 Remote Control	74	TT-900 Turntable	50
S-260 Playback Arm	54	WB-8D Baffle	68
S-320 Playback Arm	54	WB-12D Baffle	68
SC-155-B Antenna	74	WB-52 Dummy Antenna	12
SCB-8D Baffle	68	WRC-10 Transmitter Control Unit	62
SCB-12D Baffle	68	YC Antenna	74



COLLINS BROADCAST SALES POLICY

How to Order

This catalog has been prepared to make it possible for you to order directly from Collins Broadcast Marketing or your Collins Broadcast Sales Engineer with a minimum of effort and maximum assurance that you will receive the best equipment available. Collins type numbers and part numbers are listed so that you may order by mail, if you wish, and receive the same fast, personal service that is available from your Collins Broadcast Sales Engineer.

Prices

Prices in the price book inside the back cover replace all previous prices and are subject to change without notice. Orders are filled at prices in effect at the time of shipment. If prices are reduced, you receive the advantage of the lower price. Collins customers outside the 50 United States should contact Collins Radio Company, International Division, Dallas, Texas, or Collins Radio Company of Canada, Ltd., Toronto 16, Ontario.

Signed Orders

All orders must be signed by an officer of the purchasing corporation, partnership, or company. All orders, down payment agreements and terms are subject to final acceptance at the Collins Broadcast Marketing office in Dallas, Texas.

Substitution and Modification

Collins reserves the right to modify, without notice, the design and specifications of equipment designed by Collins.

Terms of Sale

Terms of payment for all Collins Radio Company broadcast equipment sales fall into the following categories:

1. Cash in advance or COD
2. Net 30 days
3. 30-60-90 days (no interest or carrying charge)
4. Conditional Sales Contract.

Down Payment

On all firm orders applicable to Conditional Sales Contracts, a minimum down payment of 25 percent is required, with the balance spread equally. In the case of contingent orders, a minimum of 3 percent down is required.

Shipment

In the absence of specific instructions, Collins will select

the carrier to whom delivery will be made for shipment to the purchaser.

Damages in Shipping

Usually, shipments from Collins Radio Company or one of its vendors on a drop ship basis are made "Shipping Charges Collect". As such, the equipment automatically becomes the property of the purchaser when picked up by the carrier. Should damage occur during shipment, the request for inspection and claims for damage must be made by the purchaser with reimbursement paid directly to him. Collins will gladly assist the purchaser with any necessary information he may require to successfully negotiate a claim.

Delivery

Unless otherwise specified, delivery will be made fob from one of Collins various shipping points or from the shipping point of a supplier of Collins. Although Collins makes every effort to expedite shipments, the Company cannot guarantee nor be held responsible for delays in shipments caused by a supplier of Collins or by the carrier.

Field Service

Fast field service is assured owners of Collins broadcast equipment by the Collins Service Division. A staff of selected specialists is maintained to provide Collins customers a level of service consistent with high performance equipment. For service on Collins equipment, which is essential to continued on-the-air operations of the station, contact your Collins Broadcast Sales Engineer. For emergency, after-hours service, Call Dallas, Texas, 214 AD 5-9511. Collins field service engineers are stationed at key points throughout the world. Overseas customers contact your nearest International office.

Returning Goods

All returned goods, whether for repair, replacement, or credit, must be authorized by Collins Radio Company. A return material tag and service report will be enclosed with your authorization for the return of the goods. An accurately completed report will assure prompt handling of repairs, necessary parts, replacements, and adjustments of accounts where required. Address material as follows:

Collins Radio Company

Dallas, Texas 75207

Attention: CRG/Re (Sales Order Number)

Contingent on Collins agreement to accept such returned goods, a restocking charge of 15 percent will be made on all items returned due to customer requested changes or deletions from original orders after shipment is made. All returns must be sent prepaid and properly insured by the customer. If warranted, Collins will adjust issue credit for these shipping expenses.

GUARANTEE

- (a) Except as set forth in paragraph (b) of this section, Collins agrees with Buyer to repair or replace, without charge, any properly maintained equipment, parts, or accessories that are defective as to design, materials, or workmanship and that are returned in accordance with Collins instructions by Buyer to Collins factory, transportation prepaid, provided:
- (1) Notice of a claimed defect in the design, materials, or workmanship of the equipment manufactured by Collins is given by Buyer to Collins within five (5) years from date of delivery with exception of rotating machinery such as blowers, motors, and fans whereby notice must be given by Buyer to Collins within two (2) years from date of delivery.
 - (2) Notice of a claimed defect in the design, materials or workmanship of the following described Collins manufactured equipment is given by Buyer to Collins within two (2) years from the date of delivery:

20V-3	81M	216C-2	642A-1	830D-1
26J-1	144A-1	313T-1	786M-1	830E-1
26U-1	172G-1	313T-3	820E-1	830F-1
26U-2	172G-2	313T-4	820F-1	830F-2A
42E-7	212H-1	356H-1	A830-2	830H-1A
42E-8	212Z-1	564A-1	830B-1	830N-1A
- (b) The above guarantee does not extend to other equipment, accessories, tubes, lamps, fuses, and tape heads manufactured by others, which are subject to only adjustment as Collins may obtain from the supplier thereof.
- (c) Collins further guarantees that any radio transmitter described herein will deliver full radio frequency power

output at the antenna lead when connected to a suitable load, but such guarantee shall not be construed as a guarantee of any definite coverage or range of said apparatus.

- (d) The guarantee of this section is void if:
- (1) The equipment malfunctions as a result of alterations or repairs by others than Collins or its authorized service center.
 - (2) The equipment is exposed to environmental conditions more severe than specified by Collins in equipment manuals.
- (e) NO OTHER WARRANTIES, EXPRESSED OR IMPLIED, INCLUDING WARRANTIES OF MERCHANTABILITY OR FITNESS FOR INTENDED PURPOSE, SHALL BE APPLICABLE TO ANY EQUIPMENT SOLD HEREUNDER.
- (f) THE FOREGOING SHALL CONSTITUTE THE BUYER'S SOLE RIGHT AND REMEDY UNDER THE AGREEMENTS IN THIS SECTION. IN NO EVENT SHALL COLLINS HAVE ANY LIABILITY FOR CONSEQUENTIAL DAMAGES; OR FOR LOSS, DAMAGE, OR EXPENSE DIRECTLY OR INDIRECTLY ARISING FROM THE USE OF THE PRODUCTS, OR ANY INABILITY TO USE THEM EITHER SEPARATELY OR IN COMBINATION WITH OTHER EQUIPMENT OR MATERIALS, OR FROM ANY OTHER CAUSE.
- (g) The guarantees of this section and limitations thereon will also accrue to the benefit of any purchaser of Buyer's FCC license, provided:
- (1) Notice of the sale of the FCC license is given by Buyer to Collins in writing within thirty (30) days after the consummation of said sale.
 - (2) No greater rights are granted to the purchaser of Buyer's FCC license than are granted herein to Buyer.

