

TWO FREE GIFTS—Pages 20 & 38

SEPTEMBER 1965

50c

**\$9**

*the citizens band journal*

A TEXAS TORNADO ANTENNA  
CB SPUTNIK  
HOW TO SOLDER  
BUILD A FSM  
SAVED AT SEA BY CB  
CB TUNE-UP GADGET

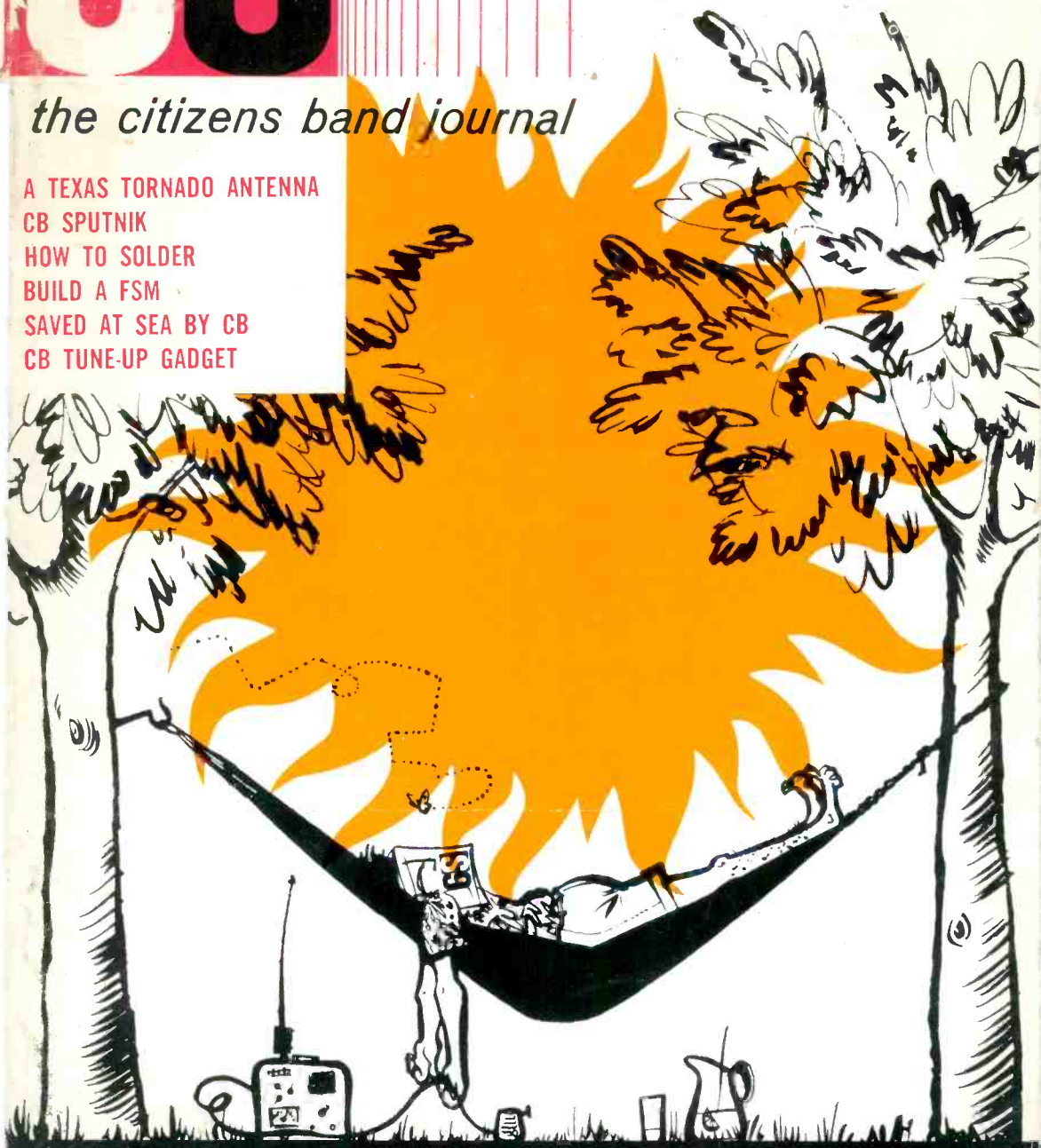

**The OFFICIAL CB RADIO MAGAZINE**

# NEW!

from  
INTERNATIONAL

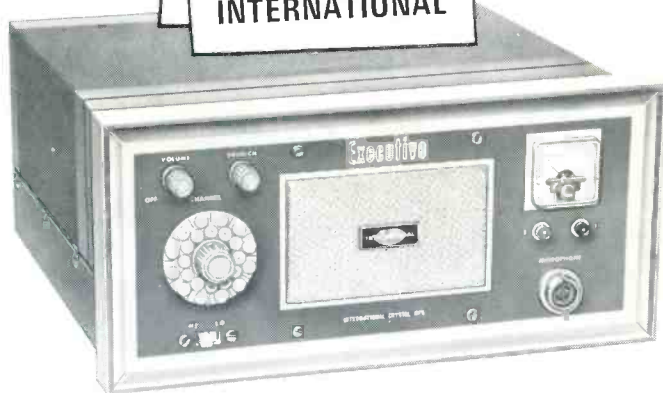

## MODEL 660 CITIZENS

### RADIO TRANSCEIVER

The International Model 660 . . . new in styling . . . new in advanced technical features, combines space-age colors and decor with greater operating convenience.

Designed for base and mobile installations, the Model 660 provides instant push-to-talk operation on all 23 channels. Silicon transistors and tubes are combined in a new hybrid circuit for the highest degree of reliability.

A transistor power supply operates from 6/12 or 115 vac power sources.

See the International Model 660 at your dealer today. It comes complete with crystals, dynamic microphone with coil cord.

- Distinctive New Panel Design
- New Hybrid Circuits
- New Zener Speech Limiter
- Frequency Synthesized Crystal Controlled 23 Channel Operation
- Dual Conversion Receiver
- Illuminated Channel Selector Dial
- Ten Tubes
- Five Silicon Transistors
- Two Power Transistors
- Eleven Silicon Diodes

Write Today For The Name Of Your Nearest International Dealer.

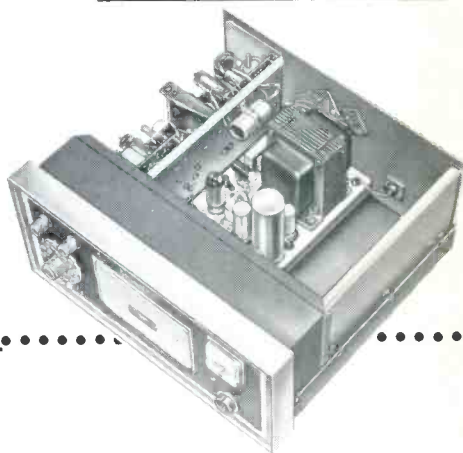

CRYSTAL  
MANUFACTURING CO., INC.  
18 N. Lee - Oklahoma City

FCC Citizens Radio license required. All use must conform with Part 95, FCC Rules and Regulations.

Give your  
mobile

installation this

# PROFESSIONAL "SPRING" TUNE-UP!

Brand new from the Antenna Specialists—  
the *professional touch* to dress up  
and power up your mobile rig!  
Famous high-performance, low-noise  
A/S base-load design . . . "17-7"  
stainless steel whip (bend it in a full circle,  
snaps back to perfect vertical!) . . .  
fine-tuning adapter built-in. *Now—*  
*available with a beautiful, functional stainless*  
*steel shock spring!* Complete with cable  
and connectors, wide choice of base mounts.  
Tool over to your CB dealer today!

M-124

## "SUPER MAGGIE MOBILE" CB ANTENNAS

(Newest "Hot Rod" to match perfectly the great M-117 "Super Magnum" base antenna)



"SPRING" TUNE-UP FOR  
YOUR PRESENT ANTENNA!  
M-126 CONVERSION KIT

Spring, adapter, wrench, all hardware  
for adding Shock Spring  
to M-67, M-73, M-74.

the  
antenna  
specialists co.



TM "Stripes of Quality"



12435 Euclid Ave., Cleveland, Ohio 44106  
Export Div.: 64-14 Woodside Ave., Woodside 77, N. Y.

almost  
forgot...



Send for details on our **ZEUS**  
**AC ELECTRIC GENERATORS**  
Noise-free portable power . . . 12 models.



the citizens band journal 14 Vanderverter Ave., Port Washington, N. Y.

FEATURES

Table listing features such as 'CB Unity', 'Saved at Sea', 'The Texas Tornado', etc., with authors and page numbers.

DEPARTMENTS

Table listing departments such as 'Reader Mail', 'Editorial/Tom Kneitel', 'Kyle's Korner', etc., with page numbers.

EDITORIAL STAFF

Table listing editorial staff roles such as 'editor', 'edit. assistant', 'asst. editor', etc., with names and call signs.

BUSINESS STAFF

Table listing business staff roles such as 'adv. representative', 'circul. mgr.', 'publ. consultant', with names.

S9 (title registered U.S. Post Office) is published monthly by Cowan Publishing Corp. Executive, editorial and advertising offices at 14 Vanderverter Avenue Port Washington, L. I., N. Y. 11050 Telephone: (516) PO 7-9080

Subscription Rates: One year \$5.00, two years \$9.00, three years \$13.00 in United States and Possessions, APO, FPO, and Canada.

Printed in U.S.A. Entire contents copyright 1965 by Cowan Publishing Corp. S9 does not assume responsibility for unsolicited manuscripts.

Controlled Circulation Postage Paid at New York, N. Y. POSTMASTER: SEND FORM 3579 TO: S9, 14 Vanderverter Ave., Port Washington, L. I., N. Y. 11050.



## This is the new Raven CB mobile. We put more into it so you can get more out of it.

Here's the "inside story" on the new Browning Raven mobile. We're putting the units together for you right now. See the Raven for yourself at your franchised Browning Service Center or write to the factory for full details. Here are some of the many Raven features: ■ Transmitter has 100% peak limited plate modulation. ■ Opto-electronic automatic compressor. ■ Receiver has sensitivity 0.2 uv for 10 db of quiet-

ing. ■ Adjacent channel rejection 80 db down. ■ Two Nuvistor cascode front end. ■ All 23-channel crystal control transmit and receive. ■ No synthesized circuits. ■ Twelve tubes (19 functions); two transistors and five diodes. ■ Luxury appearance: Covered with black vinyl in leatherette finish. ■ Truly compact: Only 4" high by 10 $\frac{3}{4}$ " wide by 8" deep.



Write Dept. S9

**browning**  
LABORATORIES, INC.

1269 UNION AVENUE, LACONIA, NEW HAMPSHIRE 03246

# READER MAIL

## ON THE MOVE

Dear Sir:

I enjoy your magazine very much. In fact we own a store that sells magazines. We sell the same amount of S9 as we do Playboy. So when you can top Playboy you know you got it made. Clinton has a population of over 30,000 people.

"73"

Phillip Ohsann, KNJ0105  
Clinton, Iowa

*Maybe we should run photos of CB rigs minus the cabinets?*

## ACHTUNG!

Dear "S9"

In reference to your March issue of S9. I fell in love with the "Achtung" certificate and wondered how you acquired the lingo, so just the other day we had a visitor who is a recent arrival from Germany and is not shy of the fact that her English is broken. So knowing that she does not get offended of making a joke of their nationality I asked if I could hear this "Achtung" in broken English. So she did—

"By Golly" it was a scream and she loved it too so she read it aloud again.

I'm trying to find a way to get this on tape, and I will sure send it to you.

All the best from CB Club "15."

Ben Biro, XM15-065  
Penticton, B. C.

*Yeah Ben, we heard that scream all the way down in New York but I frankly didn't think it was from someone looking at an "Achtung" certificate. For the benefit of those readers who haven't yet received their free certificate, we still have several million of them left so get them before we are gone. All you have to do is write and ask. If you are a subscriber, send us a mailing strip from a recent issue of S9 and we will print your name on this certificate in fancy lettering.*

## WHO'S FISHING

Hi Tom,

Many remarks are made about our "fishing poles" on our cars. Well, to several people that is what it must have appeared last week. While driving across the Eau Gallie Causeway, I heard something hit my 102 inch whip. Looking in my rear view mirror, I noticed coming into view a live shrimp, hook, line, and sinker. As you can guess, a careless fisherman has cast his line from

one of the bridges without waiting for me to pass. Result—I had a true "fishing pole," bait and all on my car.

Just thought I'd pass it along, as it might bring a chuckle or two to our sometime blue CB world.

Kemper Mazzarelli, KKP5223  
Eau Gallie, Florida

*Now let us see how good you can pull in signals.*

## NEGATIVE GROUND PROBLEMS

Gentlemen:

Check the import figures on Volkswagens! All are 6v. Negative ground. Why aren't the transceiver manufacturers all after this 6v business with all-transistor compact sets? We need small sets and low battery drain. Some, are missing a good thing.

N. J. Schweitzer  
Defiance, Ohio

*I have also maintained that Volkswagens are the next step up from windup roller skates, however, I can sympathize with you in your search for a rig to fit an imported car. My own car is 12 volts positive ground, and relatively few pieces of transistorized CB equipment will function in the car.*

## HELP NEEDED!

Dear Tom:

I would like to know if you could help me out, I am a old time CBer, and I have had cards from all over, but in the tornado we had here, I lost everything. I had my CB rig lost and smacked up and lost all of the QSL cards I ever had. I would be glad to send any out to anybody that would send me a card so I can start all over again. I really got hit hard here. I lost 2 homes, a car and my truck stop. I lost the whole works and got to start over. So if you could print a little note in S9, I would sure be glad.

Yours truly,  
Richard Gresso, 18W7230  
% Burger Chef Systems, Inc.  
1350 Stadium Dr.  
Indianapolis, Indiana

*OK Dick, we are running your request, but the next time we go through Indiana you owe us a sack of Burger Chef Hamburgers (rare with everything but hold the onions).*

**S9**



Use it... mobile... base... or portable!



## MESSENGER III

Fairbanks



Cape Horn

### Cape Horn to Fairbanks, Alaska

"Messenger III" goes all the way on Mercury Comet 16,200 mile durability run! Comet drivers report: Over 40 continuous days and nights, through rain, fog, sleet and snow... on washboard roads, some scarcely more than a trail... in tropic heat and frigid Arctic weather—the "Messenger III" never let them down!

## *For unmatched quality and dependability—GO JOHNSON!*

The most popular CB transceiver in the world—the "Messenger III" offers everything you ever wanted in a CB transceiver... compact size, a husky signal, extreme sensitivity, razor-sharp selectivity—and complete flexibility for base station, mobile, public address, or battery powered portable use! Double conversion receiver—set-and-forget "Volume" and "Squelch" controls—11 channel coverage—"Tone Alert" Selective Calling System available as accessory.



**E. F. JOHNSON COMPANY**

7026 10th Ave. S.W. • Waseca, Minnesota 56093

WRITE TODAY for full color brochure, or see your Dealer/Distributor and ask for a demonstration!



**MESSENGER TWO**  
Ten channels and tune-able receiver. Excellent receiver sensitivity and selectivity. Plenty of features. Delivers a penetrating signal with solid punch!



**PERSONAL MESSENGERS**  
100 Milliwatt and 1½ Watt hand-held units: Twice the sensitivity and 40% more range than similar units with conventional circuitry!



**MESSENGER**  
To date—one of the biggest sellers in the Citizens Band field! 5 channels—long on performance, short on cost.

# NOW... Courier 23

WITH

# RANGE BOOST



## 23 CHANNELS

## 24 ~~23~~ FEATURES

**DUAL CONVERSION • TRANSISTOR POWER SUPPLY**

*Still* **\$189.50**

slightly higher west of Rockies

including all crystals, mounting brackets, power cords and noise-cancelling microphone

Send for details . . .

Name .....  
Address .....  
City ..... State .....

  
**EGE electronics communications, inc.**  
dept. S9 56 hamilton ave., white plains, n. y.

World famous manufacturers of quality CB & BB equipment including Courier 1M, Courier 23, Courier 12, Courier 30B, Courier 50 FM, Port-A-Lab, Transistorized Power Supply, Linear Amplifier.



editorial

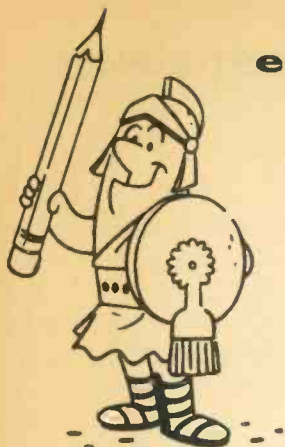

# KBG4303 rides again!

by TOM KNEITEL  
EDITOR, S9

## GETTYSBURG ADDRESS

During a recent excursion to points south, I stopped by the FCC's Gettysburg, Pa., CB application processing office to see how it's all done.

We got a chance to speak to the folks from the Commission and get taken on a tour of their facilities there — and it's really quite an operation. Heading the office is Supervisor Richard C. Zeigler, and buried beneath several tons of CB applications was Chief of the Control Section, Miss Martha Sterner.



Dick Zeigler



Martha Sterner

How they can sift through about 2,500 CB applications a week and still smile is difficult to understand, but they do it. And you CB'ers who have been around for a few years can remember when it took about three months to get an application processed. Now it's less than three weeks!

## CB UNITY?

A few issues back we asked readers to let us know if the wild-eyed radical bunch calling themselves the "American Citizens Band Association" (ACBA) was still on the CB scene. Only a few readers seemed to know, but one was kind enough to send along a copy of the February-March issue of the ACBA newsletter. This was an edition devoted to "CB unity" telling how great it would be if all CB'ers of good will would send the ACBA's membership committee \$3, apparently to finance more of their proposed good work on behalf of CB.

Well, after reading several paragraphs on togetherness and unity we finally arrive at the meat of the whole spiel. They have a hate on for

Lafayette Radio. The ACBA accuses Lafayette of being in some sort of secret pact with "two CB magazines" in the creation of a new CB club, "a commercial venture," to be in competition with ACBA. Members are forewarned about being "taken in" by Lafayette and their club.

The editorial goes on to say that, "We have had several conversations with them (Lafayette) over a long period of time as well as the exchange of letters." However, in the very next paragraph they state, "We made several attempts to talk to the Lafayette people by telephone. They are never in and do not return our calls when requested to do so."

Lafayette Radio is definitely *not* in a secret plot in conjunction with *any* CB magazine. Furthermore, the Lafayette folks have always been easy to contact by phone, by mail, and in person, on any matter concerning the betterment of CB *when the matter is presented in a logical and realistic manner by rational and responsible persons*. There are many thousands of CB'ers and local CB clubs who know this from first hand experience. ACBA has yet to learn that manufacturers have, from time to time, been known to sponsor excellent non-commercial organizations. Hallicrafters sponsorship of REACT is one example.

Then, after all of this fancy linguistic dancing from ACBA, we hit the actual *bone beneath the meat*. To quote the ACBA, "We have attempted to sell them (Lafayette) advertising in the (ACBA) Journal and with the exception of the ad previously mentioned, they haven't supported ACBA. They place several ads in each issue of other magazines while we, without avail, tried to get them to support our national organization."

So the ACBA is still up to their old tricks of trying to blackjack their way into the hearts of CB'ers and CB manufacturers. If you don't advertise with us, we'll give you the full and

*Continued on page 71*

# IF THE RCA MARK VIII C-B TRANSCEIVER IS SO GREAT AT \$114<sup>95</sup>\* ...



- 9 crystal-controlled transmit and receive channels
- Tunable receiver for reception of 23 C-B

channels; dial marked in both channel numbers and frequency

- Exceptionally good voice reproduction
- Highly selective superheterodyne receiver with one rf and two if amplifier stages
- Electronic switching—no relay noise or chatter
- Illuminated “working channel” feature
- Light and compact—only 3½ inches high, weighs only 8 pounds with mike; fits easily under the dashboard of even a compact car
- Improved Automatic Noise Limiter to reduce effects of ignition and similar interference

# ...HOW COME THE NEW MARK NINE IS WORTH \$20<sup>00</sup>\* MORE?

*It has all the Mark VIII features—PLUS these additional features...*

- Combination “S” Meter and Relative RF Output Meter. “S” Meter indicates the relative strength of incoming signal in “S” units. RF Output Meter (EO) indicates relative strength of the signal being transmitted.
- Spotting Switch. Permits precise manual tuning of receiver without use of receiver crystals. Receiver can be tuned (or “spotted”) quickly to any incoming channel for which you have a transmit crystal. This means, when you buy crystals for extra channels, you can (if you wish) omit the RECEIVE crystals and buy only TRANSMIT crystals. This feature alone pays the price difference if you use a number of channels.
- External Speaker Jack. Lets you connect an external speaker to the set, so incoming calls can be heard in remote locations.



GET THE FACTS. Write for free descriptive folder on either the Mark VIII or Mark Nine to: Commercial Engineering, Department 1132R, RCA Electronic Components and Devices, Harrison, N. J.

Available Through Your Authorized RCA C-B Radio Distributor



The Most Trusted Name in Electronics

\*Optional distributor resale price.

Write to our advertisers for special product news

# SAVED AT SEA



## CB RADIO RUNS AFOUL OF CASTRO

by RICHARD APAKIAN

AS TOLD TO EDWARD MAUTNER  
MARKETING MANAGER  
PEARCE-SIMPSON, INC.

The motor vessel "Shrub," a converted Coast Guard Buoy Tender, pitched violently, decks awash and super structure cracking in turbulent seas, seventy-five miles southeast of Camaguey Province off the hostile Cuban coast. The date—February 21, 1963. The ship was en route from Miami to Dominican Republic on a hunt for sharks, lobster and treasure with a nine man crew aboard when it ran into a fierce storm.

"Things really got bad," relates Dick Apakian, 30, the fishing boat's radio operator. "We were taking water fast when suddenly the ship was heaved thirty feet into the air on the crest of a monstrous wave. We pitched there for a few seconds and then slammed down into the sea's angry trough like a piece of balsa wood.

"The anchor was torn from the housing—we tried to turn the ship into the storm but the electrical steering mechanism jammed and tore

the bottom of the boat out. I tried sending May-day signals but the power failed. Minutes later the bow was under water and we were sinking. By some stroke of divine providence, power was momentarily restored and I sent frantic calls for help on both CB and marine channels. Minutes later we were forced to abandon ship and the nine of us, including the captain, took refuge in a twenty-six foot whaling boat. As the storm raged the boat's seams began to split apart and we bailed furiously to keep afloat. Exhausted and almost completely spent, we finally formed teams of three—six resting and three bailing, day and night—and that's the way it was for four days and five nights . . . drifting with no food or water except for three cans of peaches.

"White tip sharks followed the boat constantly. Every time one of us went over the side to try to repair the boat, one of the sharks would

attack and force him back in the boat again—making repairs to the outside hull impossible.

“On the fifth day a lighthouse was sighted. We painstakingly maneuvered a landing of the battered craft and immediately faced thirty or forty guns trained to our heads. We learned later that we had landed at a Russian Sub Base. Here we were imprisoned for a week and then taken to G-2 Security Headquarters in Havana where we were accused of being CIA agents.

“The next 67 days were spent in the Cuban Prisons, including 43 days in solitary confinement. Our cells were 9' x 12'. The food was bad—rice and beans, sometimes macaroni and beans for lunch and dinner. They gave us a rack for a bed, with mattress and pillow but no blanket. We felt lost and forgotten. During those lonely hours we could not have known that my Pearce-Simpson “Companion” CB signal was picked up in Miami, 400 miles away, and the message related to the proper authorities.

“Throughout my long period of confinement, I thought of many things. Most of them concerned my experiences aboard the “Shrub” and the events leading up to that terrible day in February.

“As the ship’s operator I was in contact with other fishing vessels in the Caribbean area trading weather and fishing information. During the day, I operated both marine and CB radios and found that I was using CB almost constantly.

Skip conditions at night allowed me to hear CB’ers in cities all over the United States. As we approached Cuban waters I didn’t realize that I was operating on Russian monitored CB frequencies used by their shore stations along the Cuban coast. The Russians operate on 10 watt CB units compared to the 5 watt legal limit in the United States. CB proved a more valuable channel of communications than regular marine radio because of the crowding.

“The days dragged into months until we were finally herded together in a room one morning and told that the Cuban G-2 had declared us innocent. Some days later we found that Attorney James Donovan had interceded on our behalf. The nine of us were released and sent back to the United States along with the Bay of Pigs prisoners.

“Now that I am back in the United States, it seems as if the whole episode was a bad dream. But the constant stream of refugees is a grim reminder of my shipwreck and confinement . . . and how lucky I am to be home and free.”

Dick Apakian today lives in Philadelphia—he is the sales manager of a company specializing in safety equipment and he is also an executive in a motion picture studio. Perhaps if it had not been for CB, he might still call a Cuban prison his 10-20!

**\$9**

# NEW! NEW!

from PEARCE-SIMPSON

6 CHANNEL TRANSISTORIZED CB

The **SENTRY**

**\$99<sup>90</sup>**



- Car keys show compact size — perfect for easy, under-the-dash installation
- Transistorized receiver and power supply — minimum power drain
- Excellent for use in the new Highway Emergency Locating Plan (H.E.L.P.)

## ALL SOLID STATE CB UNITS

featuring exclusive HetroSync® Circuitry



### The **DIRECTOR**

23 Channel **\$299.90**

23 channel operation — all crystals included.

- *Eyeglasses show compact dimensions of The Director—and Escort II*
- *All solid state—uses less current than a dashboard clock—on the air instantly*



### The **ESCORT II**

11 Channel **\$239.90**

Mono-crystal circuitry — uses only one crystal per channel instead of the usual two — cutting crystal costs in half.

PEARCE-SIMPSON, INC. P.O. Box 800 Biscayne Annex Miami, Florida 33152 Please send full information and model specifications.

Name .....

Address .....

City .....

State .....



**PEARCE-SIMPSON, INC.**

MIAMI, FLORIDA



## ALLIANCE Tenna-Rotor® for Single Bay CB beam antennas



Tenna-Rotor stands up under severe conditions. Tests prove it is the strongest, most durable antenna rotator available for Citizens Band use on all single bay vertically polarized antennas up to six elements.

This latest Alliance Tenna-Rotor will turn heavy antennas and is designed to withstand wind velocities to 90 m.p.h. in accordance with E.I.A. wind loading standards. The patented rigid offset design distributes the load resulting in superior strength to weight ratio for greater ease of installation.

Features anti-windmilling, gearing and brake system to maintain positive positioning and eliminate overtravel. Unit, enclosed in a sturdy, ribbed die-cast zinc housing, is lightweight and simple to set up. If you can lift your antenna and put it on the Tenna-Rotor . . . it will support it, hold it and turn it.

- New Precision Machined Steel Drive Gear
- Greatest Positioning Accuracy Possible

The new Alliance transistorized automatic C-225 features a patented phase-sensing bridge similar to laboratory test equipment and is now available exclusively from Alliance for CB users. Affords automatic, stepless, synchronous pinpoint positioning accuracy throughout 360° of rotation that reduces or eliminates interference.

All this with noiseless control.



The **ALLIANCE** Manufacturing Company, Inc.

(Subsidiary of Consolidated Electronics Industries Incorporated) Alliance, Ohio

CSA approved



# NOW! DUAL CB ANTENNAS

for greater range  
and  
better  
communication  
on  
all channels

**NEW-TRONICS**

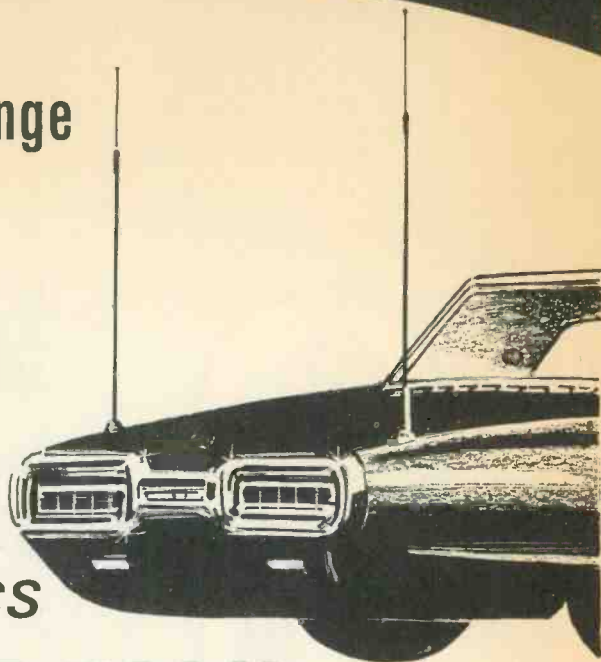

## DOUBLE TALK<sup>TM</sup>

The latest development in mobile CB antennas. Two completely new antennas fed with special coax harness to provide additional power gain on transmit and receive. Double Talk provides more antenna radiating area and better overall performance. Now . . . hear weak signals louder — talk louder longer.

**DT** Double Talk. 2 antennas with one piece mast on 8 ball base. Removable resonator has stainless tip rod for tuning. 216" Y-connected harness with PL-259 connectors. Height is 41 $\frac{1}{4}$ ".....**\$19.95**

**DDT** Deluxe Double Talk. Same as above except with telescoping mast which extends to 52 $\frac{1}{4}$ ", collapses to 38 $\frac{3}{4}$ ".....**\$24.95**

Write for literature describing the famous PRO-27 base station antenna and a complete line of new CB antennas.



See DOUBLE TALK  
at your dealers.

"The Home of Originals"

**NEW-TRONICS Corp.** / 3455 Vega Avenue  
Cleveland, Ohio 44113

# THE TEXAS TORNADO

**GIVE YOURSELF A LEGAL 35 WATT CB SIGNAL!**

by PETER PATTIESON, KBG8911

They do things in a big way in Texas—not necessarily because they want to, but mostly because Texans *have* to. One example is in CB—sometimes the distances between CB stations is so great that it's a long haul for a puny 3½ watts of CB signal. What to do to increase the signal without breaking the law is the problem—and here is one answer. I saw this thing tried during a recent trip through the Lone Star State and decided to see how it worked for normal, non-Texas style, CB'ing. Guess what, this antenna (which I have dubbed the "Texas Tornado") really lays out a whopping signal—gives you more than 10 DB of gain, turning a 3½ watt signal into about 35 watts. It's legal, it's inexpensive, and 35 watts of CB signal does a bang-up job.

It does have a few differences from regular CB-type antennas. For one thing, it's horizontally polarized. This means that the base station(s) you will be working will have to use a similarly polarized antenna for maximum results. Mobile stations will have to be similarly polarized with one of the new horizontally polarized mobile antennas now being introduced to the CB market. Horizontal polarization, by the way, is an extra bonus because it reduces the signal strength of regular vertically polarized CB signals entering your receiver. There are a

number of "horizontally polarized" local CB clubs springing up around the country.

Another difference from regular CB antennas is that it is not only directional, but the direction of the signal can not be rotated. Therefore, good uses for this antenna are from base-to-base, for when your base station is located a considerable distance away from a city or town and you want to speak to your mobile units (or other bases) in the town. In the event, when you hit the band with this one, everyone on the channel will know about it.

## LOCATING THE ANTENNA

Since the antenna is basically a one-direction affair (it has several minor signal lobes in addition to the main one), it will be necessary for you to plan the proper direction for the construction for the antenna. You will need a map of your area, a compass, and (when you find the proper spot) at least 300 feet of space in which to string up the Texas Tornado.

First, locate your base station on the map and place an "X" on the map. Next, locate the general area with which you will communicate, place another "X" there. Now, draw a line between the two "X's" and compute the compass direction. Let's say it's north-north-east. Now, take your compass out in the yard and find this

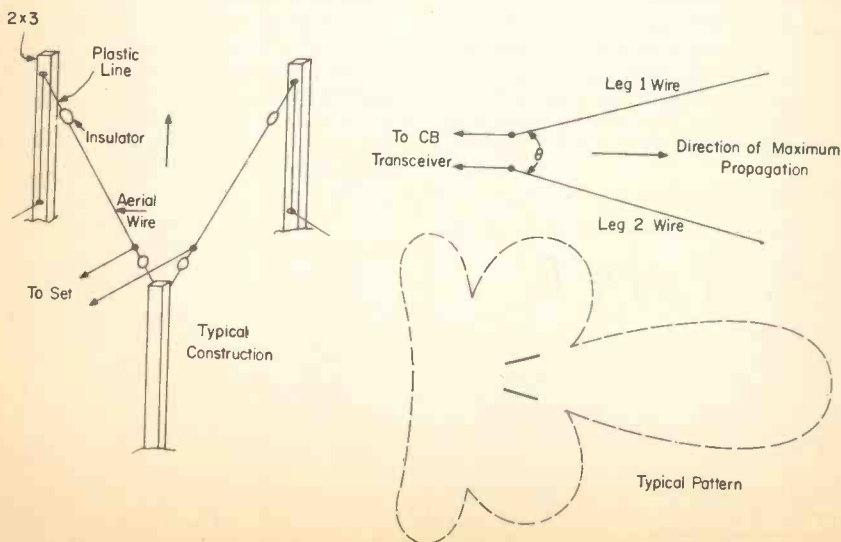

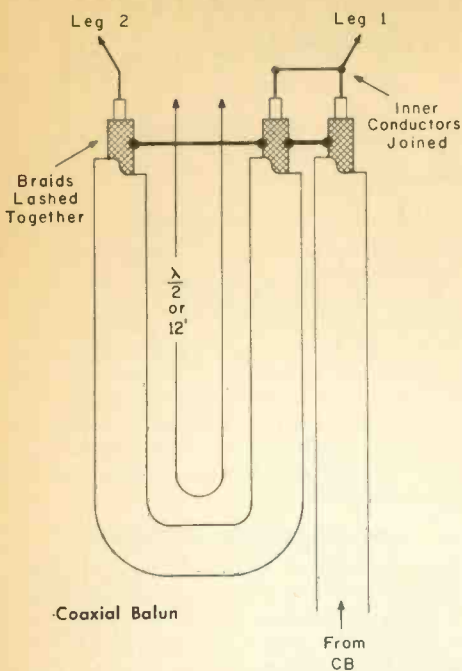

direction, placing a marking rod flat on the ground pointing towards the desired direction.

The Texas Tornado consists of two horizontal long wires which will straddle this marker, they are placed in a "V" shaped configuration, with a 35° angle at the point (the feed point)—this means about 17° on each side of the marker. The proper angle may be easily determined with a draftsman's compass (available at any school supply store for a few cents).

The apex of the "V" (the feed point, that is) may be on the side of the building in which the CB transceiver is located, or you can use a guyed or self-supported 2 x 2 plank as a mast. Whether you use the building or masts for the apex support at the transceiver end of the Texas Tornado,

you will most likely require two additional masts, one for each end of the antenna's legs.

Measure off at least 291 feet for the "far" ends of the antennas two legs—these two ends will be about 175 feet distance from one another if you have measured correctly. Erect your masts here, unless you have conveniently landed within a few feet of another building which can be used as an antenna support.

### CONSTRUCTION

Now that you have established the location of the antenna, the next step is to hang the sky hook. Place screw eye insulators at each of the three antenna termination points. At the feed point, hang two antenna strain insulators from the screw eye insulator, attaching to each exactly 290'9" of copper antenna wire. While the actual antenna length for each leg is 290'5", we have allowed a few inches extra for connections to the insulators at each end.

Run each of these antenna wires out to their respective "far" points and attach to their respective hitching points.

All that's left to do now is to connect the antenna to your rig. It will be necessary to use a matching Balun to get this antenna properly working with your CB rig, and we have therefore provided you with the details of just such a coaxial Balun. Note that the Balun has an input from the CB rig and output connections for each leg of the antenna. This Balun is made from RG-58/U coaxial cable, connected as shown, and with the braids lashed together as indicated. This Balun is located directly at the feed point, any length of RG-58/U may be used to run from the Balun to the rig.

All you have to do now is connect the antenna to the rig, peak up the tuning of the rig and you're on the air.

It occurs to me that all of you may not have all of the footage necessary to try out this antenna so I have computed measurements for smaller versions of the antenna, which, while providing less gain, can be erected in less space. Add a few inches to the lengths indicated to allow for wrapping around insulators.

Leg length (ft.)	Apex Angle in degrees	Gain (DB)
254.1	37	9+
217.8	40	9
181.5	45	8
145.2	50	7
108.5	58	5+
71.8	70	4+
35.4	90	3+

Hope you like the results!

7.11.196

NUSSBAUM'S FOLLY! The printer goofed on our last order and ran off 3 times the amount of our famous wild CB QSL cards than we wanted. We refused to pay for the extras and can now pass these savings on to you. You never saw cards of this quality at 175 for only \$1. All you do is add your name and call signs and they look better than cards costing many times this price. Order; enjoy, enjoy. S. Nussbaum, 1440 50th St., Brooklyn, N. Y.





# NEW Heathkit® All-Transistor 23 Channel 5-Watt CB Transceiver



Kit  
**\$89<sup>95</sup>**  
(LESS AC  
POWER  
SUPPLY  
SHOWN)

Factory Assembled  
**\$124<sup>95</sup>**

## Transceiver Kit & 46 Crystals . . . \$169.90!

- ★ 23 crystal-controlled transmit & receive channels
- ★ 14 transistor, 6 diode circuit for cool, instant operation and low battery drain—.75 A transmit, .12 A receive
- ★ Full 5 watt performance . . . minimum of 3 watts RF output, plus 3 watts audio modulating power
- ★ Front panel "S" meter indicates signal strength & relative power output . . . aids in alignment
- ★ Adjustable squelch control eliminates speaker hiss during standby
- ★ Automatic noise limiter minimizes noise from ignition systems, electric motors, etc.
- ★ ½ uv sensitivity for 10 db signal plus noise to noise ratio
- ★ Built-in PM speaker
- ★ Easy to build with circuit board construction
- ★ Attractive TURNER ceramic PTT microphone
- ★ Handsome die-cast, chrome-plated front panel with rust-resistant aluminum charcoal gray cabinet
- ★ Includes power cables & crystals for 1 channel (Specify) and gimbal mount for versatile installation
- ★ Base mount AC power supply for "fixed" station available soon

Kit GW-14, 8 lbs. . . . . **\$89.95**  
Assembled GWW-14, 9 lbs. . . . . **\$124.95**

FCC license required. Use must comply with Part 95 FCC Regulations.



### Compact "Fit-Anywhere" Size!

Only 2 7/8" H x 7" W x 10 1/2" D . . . ideal for car, boat, jeep, tractor, any mobile installation.

### Complete 23-Channel CB Crystal Pack . . . \$79.95!

Regular \$135.70 value! 46 transmit & receive crystals for complete GW-14 operation. Order GWA-14-2, 1 lb.

### 4 Money-Saving Reasons To Buy Heathkit CB!

1. New Lower Prices On All Units
2. 5% Discount On Any Two 5-Watt Unit Buy
3. New Lowest Cost All-Transistor 5-Watt Transceiver . . . Kit Or Wired!
4. Lowest Crystal Prices . . . \$1.99 Each With Order Of One Or More Transceivers!



## NEW!

### Free 1966 Catalog

108 pages . . . many in full color . . . describe these and over 250 easy-to-build Heathkits. Save up to 50%. Mail coupon for your FREE copy.



Heath Company, Dept. 43-9 Benton Harbor, Michigan 49023  
In Canada: Daystrom, Ltd., Cooksville, Ontario

Enclosed is \$ \_\_\_\_\_, plus postage.  
Please send model(s) \_\_\_\_\_

Please send FREE 1966 Heathkit Catalog

Name \_\_\_\_\_

Address \_\_\_\_\_

City \_\_\_\_\_ State \_\_\_\_\_ Zip \_\_\_\_\_

Prices & Specifications subject to change without notice. GX-142

# THE LOW BANDER

## BEST WAY TO MONITOR 30 TO 50 MC/S

by ROBERT McAIRE, KIC7608

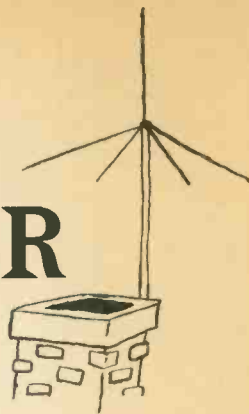

Having tried all manner of homebrew antennas to monitor my state police department, which operates their radio communications network in the 30 to 50 mc/s "low band," I finally decided that perhaps the best approach (considering my limited finances and desire for optimum reception) was *not* via the homebrew route.

Yes, I had tried all manner of long wire lashups, short wire lashups, alligator clips on the window screen deals, TV antennas, CB antennas, and whatever looked like it *might* work. Nothing worked well, since my desired reception area ranged encompassed several hundred square miles. Then it struck me—a ground plane for "low band" is the same thing as a CB ground plane, only a CB GP is larger. If I could find a real inexpensive CB GP,

chop it up and *throw away* a good portion of it, using the remaining pieces for receiving only. I eventually found a GP which sold for \$6.50 and decided that, although it didn't seem as sturdy as the standard brands, it would probably suit my purposes fine (especially since I would be relieving it of a considerable amount of wind resistance when I trimmed it). Subsequently to my purchasing this antenna I noticed that Lafayette Radio sells a CB GP for \$7.90 (stock #42-G-7401WX), which looks pretty sturdy and is made from tubular aluminum.

Anyway, I figured as long as I had to trim it down in bits and pieces, inch by inch, that I would make up a little chart and pass it along to other CB'ers who might want to try this method of emergency service monitoring

### LOW BAND ANTENNA LENGTH

Freq. (mc/s)	Whip	Radials
30 to 31.5	96"	96"
31.5 to 34	90"	96"
34 to 36.5	84½"	84½"
36.5 to 39	79"	84½"
39 to 42	72"	84½"
42 to 44	68"	84½"
44 to 48	62"	84½"
48 to 50	57"	84½"

maybe I could trim it down to the higher frequencies used by the many "low band" stations—because I had later discovered that, in addition to my state police; my local police, fire department and sheriff were also in this band, as well as several other things like my local forestry station, ambulance service, etc.

So out I went to find the *most* inexpensive CB ground plane I could buy. Not having any local fellows who had a spare which they no longer used (never overlook that possibility, by the way), I shopped around and found that some of the local CB shops could let me have a CB GP for a lot less than I had imagined. I found that most GP's ranged from \$12 on up—this was a reasonable price to pay for a CB antenna, but, heck, I was going to

on this band. When you determine the frequency of the "low band" station or network you wish to monitor (see April S9, page 9), then check our chart and start trimming. If your antenna has hollow elements, use a pair of pliers to pinch the tubing at the cut ends of the elements. These antennas are pretty much broadbanded, especially inasmuch as they aren't going to be used for transmitting, so if you cut the thing for, say, 32 mc/s, and you want to hear a station on 45 mc/s, the loss of signal strength because of the antenna size will be relatively low.

Use RG-58/U coaxial cable to feed these antennas.



**\*se-lect-ive** (sĭ lĕk'tĭv) *adj.*

having the function or power of selecting; making selection. *1. Radio.* having good selectivity of being... *2. Elect.* ins... like, by vi



## \*CONTACT! - 23

### AT LAST! SELECTIVITY THAT REALLY SELECTS!

The Contact!-23 has achieved exceptional selectivity through the use of a true Mechanical Bandpass Filter — similar to that found in far more expensive ham equipment.

### AND THERE'S LOTS MORE TO THE CONTACT!-23

You get crystal control on all 23 channels, both Transmit and Receive, via a synthesized circuit — all crystals included.

- Illuminated, angled front panel
- Built-in speech compressor
- Fine tuning
- Illuminated S & RF meter
- Modulation indicator
- Transistorized power supply, 12V and 110V
- Cigar lighter plug-in
- Electronic switching
- Earphone jack
- PA system jack

Complete with: microphone, cords and snap lock mounting brackets.

**USL CONTACT!-23 \$19950**

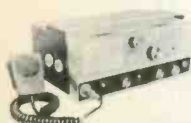

**USL CONTACT!-8 \$14950**

Illuminated, angled front panel. 23-Ch. tunable receiver with illuminated dial. 8-Ch. crystal-controlled transmit & receive. 1-Ch. external crystal socket—transmit & receive. Transistorized power supply. Illuminated S & RF meter. Crystal spotting. Electronic switching. PA system jack. Complete with: microphone, cords, 1 pr. of crystals and snap lock mounting brackets. Cigar lighter plug-in, easy to install. Nuvistor low noise front end.

**USL T 1050 A \$11995**

23-Ch. tunable receiver with illuminated dial. 6-Ch. crystal-controlled transmit & receive. Illuminated S & RF meter. Crystal spotting. Earphone jack. Nuvistor low noise RF front end. 6V or 12V power supply available (optional extra). Unit comes complete with: microphone, AC cord, 1 pr. of crystals and mobile mounting brackets. Squelch & full series noise limiter. TVI trap. Signal-to-noise ratio: better than 10 db at 1 microvolt. Full plate modulation.





**UNITED SCIENTIFIC LABORATORIES, (KKD5719)**  
 Division of Vernitron Corporation  
 475 Union Ave., Westbury, L. I., New York  
 Dealership inquiries invited

# FEAR INDUCER

by DICK TURPIN, KCF2700

## SURE LOOKS IMPRESSIVE ANYWAY!

In the pursuit of saving your mobile CB rig from theft, the next best thing to actually having a burglar alarm in your car is to have something which lets prospective Citizens Bandits *think* that you have a burglar alarm.

Did you ever see those nifty burglar alarm warning signs posted in the windows of trucks? Well I did, and I set about designing one for myself just such a sign for my CB mobile. The results were nice looking, and (so far) nobody has clipped my rig yet (I lost one last year).

Other locals admired the sign, and at their suggestion I am giving you a chance to have one of these signs for your own mobile unit. Here it is. Just cut it from the page and *Scotch* tape it to your window.

**WARNING!**

THIS VEHICLE PROTECTED BY

*Radarmatic*

**ELECTRONIC BURGLAR ALARM**

## IS THAT WHAT'S TROUBLING YOU?

With apologies to Eddie Lawrence, "The Old Philosopher."

Say Cousin!

You say you bet on the Mets,  
And when you told your boss you'd like to go to the game he made you buy his old Edsel,  
And you left the top down and it rained . . .  
All over your new Courier.  
Is that what's troubling you?

Hey Bunky!

You say some local CB'ers as a joke stuck an ad in S9,  
And said you were selling your new Browning base station for \$50,  
And the phone didn't stop ringing for 5 weeks;  
And you received your order of QSL cards, 3000 of them, 4 colors,  
And your call is printed wrong on every one of them;  
And the fellow you promised to swap cards with, but couldn't—  
He just called to say he's coming over to punch you in the nose.  
Is that what ails you?

Hard-Luck Buddy,

You say somebody just tossed a rock through your window . . .  
With a TVI complaint attached!  
And you were joking with a guy about a 250 watt CB rig,  
And he reported you to the FCC,  
And an investigator just walked in to your shack,  
And heard you signing off with a Venezuelan!  
Is that why you're banging your head against the wall?

You again?

You say that the fellow you met at the Jamboree and invited to "drop in" just showed up,  
With his XYL and 9 kids,  
And two mean chow dogs,  
And they're staying for a week!  
And you told him he could be your "unit 2,"  
And he worked 18 stations in Red China,  
And the FCC is calling you a threat to national security,  
And the State Department wants to deport you—to Albania.  
Is that why you're quivering?

Hey Miserable!

You say you sent money to CB Horizons,  
And the next day they stopped publishing,  
So last month you subscribed to a new CB magazine,  
And now you hear *they* may call it quits too?  
So, for a feeling of belonging, you joined the ACBA,\*  
And they said they were sending a representative to the FCC,  
And someone told you it was to burn down the building,  
And one of the FCC Commissioners is your uncle,  
And he never liked you to begin with.  
Is that why you're shaking friend?

Well, lift up your head, face the world, never give up the ship! No! Never! You can make it!  
You'll show them all!

Yes, subscribe to S9! March down to the mailbox, the wind and rain in your face; proudly;  
defiantly; rising above past failures; secure that you've finally chosen a winner!

Then go home, tell your mother-in-law you'd rather do it yourself; buy a new rig and install  
it on your XYL's best table; call your boss and demand a raise . . . THIS is the start  
of a new life for you, at long last!

\* Armenian Corn Bread Addicts



# THE CB SPUTNIK

BUILD YOUR OWN CB SATELLITE—AND IT WORKS

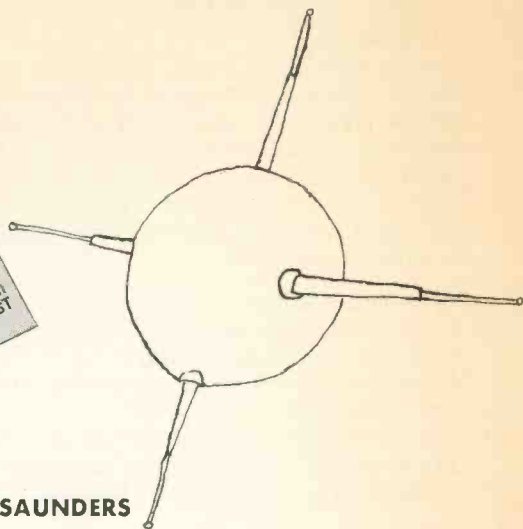
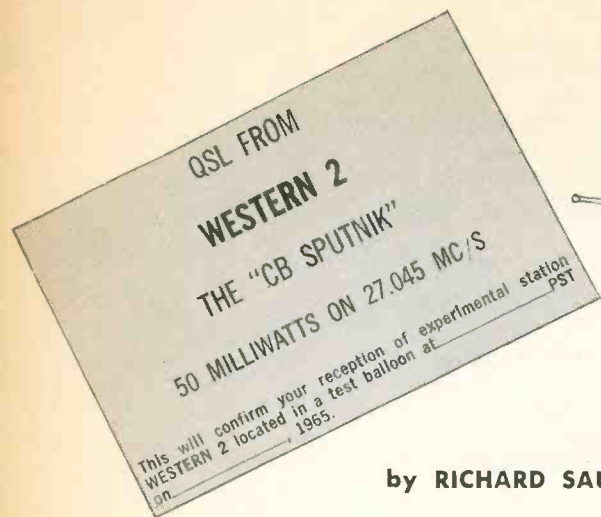

by RICHARD SAUNDERS

I got to thinking one day how the Hams have their own "Oscar" satellite, the TV stations have "Early Bird," and Uncle Sam has scads of satellites. Why not CB'ers? We seem to have gotten the fuzzy end of the lollypop on just about everything else so why shouldn't we at least have a satellite of our own. So I built one.

Admittedly, it didn't get a very elegant launching because when I asked some of the fellows at the local airport if they would let me hang it from any of their private planes they giggled at me. Finally I was reduced to hanging the satellite from one of those big helium filled balloons they sell at kiddie parks. It slowly drifted skyward, sending out its raspy signal on Part 15 Channel B (27.045 mc/s). Without distance measuring equipment it was hard to tell exactly how high it reached before we lost its 50 milliwatt signal, but it was several thousand feet!

A few days later the unit was picked up halfway across the state and returned to me—still in working order!

I'm passing along the design of my unit, you may wish to build one yourself. Even if you never launch it, it makes an interesting desk ornament which can be turned on and off and monitored on your own CB rig. It requires no license inasmuch as it operates under Part 15 low power rules.

## CONSTRUCTION

I built it on a small piece of corrugated cardboard (to keep it as light as possible, but mainly because I don't have any chassis punching tools) which worked out fine and dandy. The layout of the parts isn't critical, but I kept all leads as short as possible.

The circuit was placed inside the "Sputnik," which was a hollowed out clear plastic toy ball (it originally came with a plastic duck floating in some water inside the ball). The ball was pried apart at the seam and the transmitter placed inside. The antenna, a short telescoping whip, was attached to the ball. I used only one whip for my rig, but the use of three additional unconnected whips would have made it *look* somewhat nicer.

After the transmitter was located inside the ball, I packed the ball with foam rubber to keep everything from jogging around, and also as protection during "landing."

## TIPS

Use a miniature wire-lead crystal, soldering directly to the crystal wires. When soldering to the crystal and transistor leads, be sure to use a pair of tweezers or other heat sink to dissipate the heat so as not to damage the components. Be careful with battery polarity. Don't operate this on any of the regular

**CERTIFICATE OF COMPLIANCE WITH  
FEDERAL COMMUNICATIONS COMMISSION  
REGULATIONS, PART 15, PAR. 205**

S9 Magazine certifies that this low power transmitting device can be expected to comply with the requirements of Paragraph 15.205 of the FCC regulations under the following conditions: (A) When this device is assembled according to the diagrams and instructions published by this magazine, using components of the exact specifications described. (B) When in use for the purpose and in the manner indicated in the instructions. (C) When operated on a frequency between 26.97 mc/s and 27.27 mc/s and using an antenna limited to a single element not more than 5 feet long.

*Thomas S. Knatel*

S9 Magazine, Port Washington, N. Y. Dated: Sept. 1, 1965

I hereby certify that I have assembled and adjusted this device in strict accordance with the above.

Owner's signature.

Date:

Class D CB channels. The variable capacitor at the antenna should be rotated for maximum reading on an S meter or field strength meter—this adjusts the loading into the antenna.

To comply with FCC regulations, a certification of compliance with Part 15 *must* be attached to the transmitter. Such a certificate is given here and may be cut out and pasted to the chassis. It's a good idea to also include your address and telephone number if you are really going to send this thing into the wild blue yonder, that is if you ever hope to have it returned to you.

If anyone out there builds one of these, please drop me a line in care of S9, letting me know your experiences with it. How about a picture? I don't have a picture of mine because the last time I sent it aloft it headed toward parts unknown. It was the fifth flight so I didn't feel too bad.

By the way, so many of the locals heard the Sputnik that I decided to issue a special commemorative QSL card. The call sign was a special Part 15 identifier issued to me by the S9 Part 15 registration people. Guess these cards are pretty unusual—the world's only CB Sputnik!

The finishing touch! To comply with FCC regulations it will be necessary for you to sign this tag, cut it from the magazine, and paste it.

**PARTS LIST**

- 3 220K resistors
- 2 15K resistors
- 1 .05 ufd capacitor
- 2 .02 ufd capacitors
- 1 5-20 ufd trimmer capacitor
- 1 crystal for 27.045 mc/s
- 1 1.74 uh choke (Miller RFC 144)
- 2 1 uh chokes
- 2 GE-2 transistors
- 1 2N1225 transistor
- 1 9 volt battery
- 1 SPST switch
- 1 38" whip antenna (Lafayette 99-G4001 or equiv.)

Misc.: chassis, plastic ball, foam rubber, battery clips, hookup wire, launching balloon.

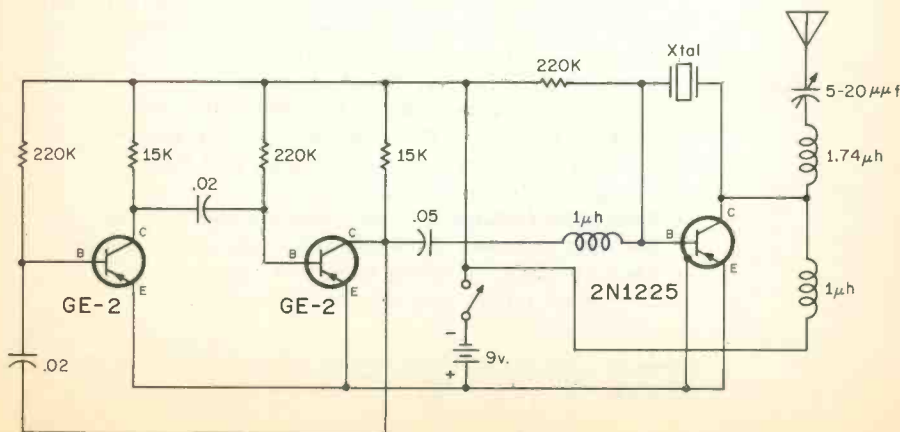

# A Best Buy That's Become A Best Seller!



## SENTINEL 23 by EICO

### 23 CHANNEL DUAL CONVERSION CB

All crystals provided for 23 crystal-controlled transmit & receive channels!

**WIRED ONLY**  
**\$169.95**

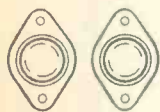

Transistorized  
12 VDC & 117 VAC  
dual power supply  
eliminates vibrator  
hash

Rugged 5-watt CB transceiver with "space-age" 23 channel frequency synthesizer. Gives you bullseye two-way communication in both fixed and mobile locations with equal ease. At your dealer now, the EICO Sentinel 23 (Model 779) is the new CB rig with every wanted and useful feature!

- Super-selective dual conversion superhet requires only  $\frac{1}{4}$   $\mu$ V for 10db S/N.
- Crystal-controlled 6mc IF and three 455kc IF's.
- Effective automatic impulse noise limiter, wide-range AGC.
- Delta tuning for receiving off-frequency transmissions.
- Adjustable squelch and standby switch.
- Illuminated "S" meter/RF output meter.
- Single knob channel selector with illuminated dial.
- Converts to 3.5 watt PA system with remote speaker.
- TURNER 333 noise-cancelling ceramic p-t-t mike.
- Headphones/external speaker jack.
- Scuff-proof textured blue vinyl finished steel cabinet.
- Anodized extruded aluminum panel with polished edges.
- Black anodized, machined aluminum knobs.
- Convenient mobile mounting brackets.

**EICO**

Send for FREE Catalog describing the full EICO line of 250 best buys including Test Instruments, Stereo Hi Fi Components, CB and Ham Gear. EICO, 131-01 39th Ave., Flushing, N.Y. S9-9



# TUNE-UP À LA 1629

## TUNE IN YOUR RECEIVER VIA THE MAGIC EYE METHOD

by PAUL MEYERHOFER, KHH4055

If you didn't like the idea I presented for you last month (The Mod-U-Mon, S9, August, p. 20), here's yet another use for the type 1629 "magic eye" electron tube—this time we use it as sort of an S-meter, or tuning meter. As you tune in a station with your receiver, the eye of the tube begins to close. Maximum closing of the tube indicates that the station is properly tuned in. Often you will find that by properly tuning in a station you'll be able to cut interference and also hear stations further away. At any rate, the pretty green light sure looks nice, even if you don't care much how you tune in a station.

Another use we have found for this gadget is to use it for *quiet* monitoring of Channel 9, the National CB Calling & Monitoring Channel. Luckily, Channel 9 isn't cluttered up with a lot of jibberish and nonsense—when the channel is used, 9 times out of 10 it is a lost or stranded motorist, or else it's someone trying to contact a local who cannot be found on his usual channel. Anyway, I like to monitor 9, but my communications receiver doesn't have a squelch and the background noise is just out of this world and makes it impossible to monitor a dead channel for more than ten minutes at a time without my going batty. Now, since I've installed this 1629 tube, I can flip the set onto 9 and turn down the volume. I just glance over at it from time to time—if the eye is closed that means that someone is on the channel. If I'm not busy, I turn up the volume. Even if I had a squelch I would prefer this system because there is nothing as annoying to me as trying to get a message through on one channel while the standby set is blasting my ear off with one of the other locals calling someone or giving road aid.

Anyway, I'm sure that you will be able to use the 1629 for these and any number of other uses.

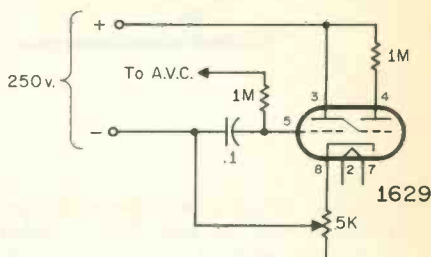

### PARTS LIST

- 1 5 K pot (optional)
- 2 1 Meg. ½ watt resistors
- 1 .1 mfd capacitor
- 1 type 1629 tube
- 1 Amphenol 58-MEA-8 assembly

### CONSTRUCTION

The tube is mounted in an Amphenol type 58-MEA-8 assembly, and the few components in the circuit may be easily attached to (or near) the socket of the assembly. The assembly may be housed in a small *Mini Box* or mounted on the front panel of the receiver with which it is being used.

A pot is included in the circuit as an optional feature, you can use it to vary the amount of closing of the "eye." If you omit this from the circuit it won't diminish the operation of the circuit.

Pin 5 of the 1629 tube, the grid, is connected to the AVC voltage of the receiver, which may be picked from the grid of the DC amplifier, indicated on equipment schematic diagrams, or it can be pointed out to you if you bring your schematic to any CB service shop. The B+ voltage is 250 volts, the filaments receive 12 volts.



# SOLDERING—DO IT RIGHT

by LYNDON DONNELL, KED0422

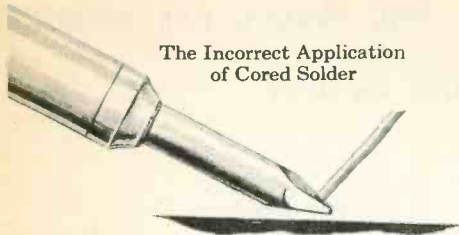

The Incorrect Application of Cored Solder



The Correct Method of Using Cored Solder

Have you ever constructed a piece of electrical equipment only to find that it didn't work? After much work of checking to make sure each component in the circuit is workable, you finally decide that the reason it does not work is because of a "cold" solder joint. These "cold" solder joints, joints which fail to conduct electricity, are difficult to find and this problem could have been avoided by knowing how to correctly use a soldering iron and by using correct soldering techniques.

Before doing any soldering, the tip of the soldering iron or gun should be clean and properly tinned. If on inspection, the tip is discolored or scaly appearing, it is in need of cleaning and re-tinning. Cleaning should be done before the tip is heated. The tip can be cleaned with sand paper, a wire brush, or steel wool. After cleaning, the tip can be tinned by heating the tip and applying solder to the tip as soon as it is hot enough to melt the solder. Care should be taken not to allow the tip to discolor because of over-heating before the solder is applied. After preparing the soldering iron as described, it is ready for soldering.

A good solder joint is one that is bright after cooling as contrasted to a bad joint that is dull gray or frosty in appearance. A bad joint such as this can be caused by not applying enough heat or by moving the joint during cooling. To correct this, should it occur, the joint must be reheated. Reheating of a joint is also necessary when rosin appears to coat one part of the joint. This is an indication that both parts have not been evenly heated.

To be assured of getting a good joint, here are a few "do's" and "don'ts" to follow when soldering.

1. Clean all metals to be soldered so that they are free from dirt, oxides, and grease. This can be done with sandpaper or by scraping the surfaces with a knife blade. Cleaning such as this insures a strong joint.
2. Support the joint mechanically where possible.
3. Large surfaces should be pre-tinned before they are soldered together.
4. Solder should be applied to the joint and not to the tip. The joint should be heated sufficiently enough to cause the solder to flow evenly and freely. Both parts of the joint should be heated evenly.
5. Do not use too much solder. Too much solder not only shows a sign of poor workmanship, but it also can offer too much resistance to current flow and can cause the electrical apparatus to operate poorly or incorrectly.
6. Joints should be soldered as rapidly as possible so as not to overheat the components or burn the insulation.
7. In soldering electrical connections, only rosin-core solder or rosin flux should be used. Acid core solder or acid flux should never be used on copper or brass connections.

By keeping in mind these simple rules and tips, much better joints can be easily obtained. They will not only give a better looking and neater joint but will also help to achieve the best performance from the device.

**S9**



# KYLE'S HORNER

WRITE TO:

JIM KYLE, KEG3382  
% S9 MAGAZINE  
14 VANDERVENTER AVE.  
PT. WASHINGTON, N. Y. 11050

## NEEDS ADDRESS, DATA

Can you help us find the correct address of the Federal Manufacturing and Engineering Corporation? We have what appears to be a very fine RF signal generator made by this firm. It bears the label: "Model LP-5, Serial 598, Type CFD-60006-A, RF Standard Signal Oscillator, Federal Manufacturing and Engineering Corporation." If you can not help us locate the manufacturer, can you offer any assistance in locating a power cord, schematic, or operator's manual for it? Any help you can give us will be greatly appreciated.

—D.E.D., Laytonville Schools,  
Laytonville, Calif.

*It's only a guess—and not a very educated one at that—but this firm may be a division of IT&T. If the guess is right, then the present name is ITT Federal Labs, 3301 Wayne Trace, Fort Wayne, Indiana, and the man to contact there is Mr. W. Hughes. Even if my guess is wrong, Mr. Hughes might know something about the firm. Can any of the rest of the gang help the school out with the data they need?*

## OPERATING IN CANADA

What do I have to do to get a permit to operate in Canada, for how long and what is the charge? I hope to attend some Canadian jamborees this summer and I would like to be able to operate up there.

—L.F.V., Johnstown, N. Y.

*I don't have all the details, but I can at least refer you to the authoritative source. Write to "Department of Transport, 25 St. Clair Ave. East, Toronto 7, Ontario, Canada" and they'll give you the official word. Ask them what the requirements are for the "Tourist Radio Service," which is the name of the special deal letting U.S. CB'ers operate north of the border. I understand that you have to make written application 30 days in advance, to the office of DOT which has jurisdiction over the area where you plan to enter. So far as I know there is no fee nor time limit on operation; you use your U.S. call with the suffix "/XM." But the DOT will give you the official word; what I have is "left over" from last year and may have been changed since then.*

## SOLUTION TO TV NOISE

I would like to know why television manufacturers do not put a squelch (if possible) on TV sets to filter or eliminate unwanted noise?  
—R.B., New York City

*The reasons are numerous. If you're referring to the ordinary squelch, to stop the "hiss" that roars out when you tune to a vacant channel, the main reason is cost. To add this to a TV receiver would cost the manufacturer about a dollar per set. By the time the set gets to you, that would be about a \$50 increase in the price (it just works out this way!). And most people aren't that interested. If you're referring to a noise-limiter to hold down pops and crackles, the circuits for TV would be extra complicated. In the golden days of broadcast radio, some of the bigger sets did have squelch. They called it "QAVC" (quiet AVC) or "interstation muting"; it's from these circuits that many of our CB squelches are adapted. But it died out; nobody felt it was worth what it cost. And it did add another control that could be set wrong, and cause "trouble" in reception.*

## LOOKING FOR CAPACITOR

In the March 1965 issue of S9 you mentioned a 1000-mfd capacitor for noise suppression. I suppose this is the same one that was referred to in the December 1964 issue. It was made by Motorola, Serial No. AK300. What I want to know is how do you get one of these goodies? I have tried for a month and haven't had any luck thru the dealers locally. Would appreciate any help; it is about to bug me. Thanks in advance.

—G.X.B., Richland, Wash.

*Actually, I didn't say how big a capacitor to use, but 1000 mfd sounds fine if you can get one! The Motorola item is news to me; when I need this much capacitance I usually use industrial type electrolytics. For bypassing the coil, electrolytics aren't so good—they puncture too easily with the voltage spikes from the coil. Much better would be non-inductive oil-filled "bathtub" capacitors, such as Sprague's type CPD53. You can get a duel .25-mfd 1000-volt unit for \$2.83 plus postage by ordering catalog no. 15 L 746 from*

# GET ACTION

WITH  PRECISION  
MADE, POPULAR PRICED CB  
UNITS! **CITI-FONE**

**FULL 23 CHANNEL SS**

Triple Tuned RF • Delta Tuned • AC/DC • Illuminated Meter and Channel Selector • "Noise Immune" Squelch • Double Tuned IF's • Compact 8" x 11" x 4 1/4"



**\$169<sup>50</sup>**  
Ready to Operate

**8 CHANNEL OPERATION**

2-Stage Preamp • Electronic Switching • Delayed AVC • Illuminated "SS" Meter • Complete with Crystals for 1 Channel



**\$99<sup>95</sup>**  
Ready to Operate

WRITE,  
WIRE or  
PHONE TODAY FOR  
COMPLETE INFORMATION



**MULTI-ELMAC COMPANY**

21470 COOLIDGE HIGHWAY OAK PARK 37, MICH.

Citi-Fone SS

Citi-Fone 99

Name .....

Address .....

City ..... Zone ..... State .....

Allied Radio, 1000 N. Western, Chicago, Ill. The full description is "Sprague type CPD53 capacitor, part no. B4EG254V, .25-.25 mfd, 1000 volts." Make the leads from terminals to coil and to ground as short as possible, and be prepared to re-time the engine as mentioned before.

## PART 15 TRANSMITTER—ONLY

I already have a good CB set. So do you know of any company that makes a Part 15 radio without a CB set in with it? The reason for my asking is that I am very interested in Part 15. Thanks a lot.

—W.C., Jamestown, Tenn.

So far as I know, nobody makes a transmitter alone for Part 15 use. International Crystal, at 18 N. Lee, Oklahoma City, Okla., has some transistorized transmitter and modulator boards available which could be hooked together to make a P-15 rig, but the cost might be a bit steep since the boards cost around \$5 to \$10 each (depending on model). In the October 1964 issue of S9, on page 19, Hartland Smith described a P-15 transmitter you can build for yourself. It's billed as "Part 15 DeLux" and really is just that; you would have a hard time getting more performance than this rig will give. This issue is available from the circulation department, if you don't have it on hand.

## NEEDS MARINE ANTENNA

I have a Heath GW-11A CB transceiver aboard my Chris-Craft cruiser. I have gotten fair results with it using a 180-inch whip antenna. However I believe I can greatly improve both transmission and reception with the use of some of the improved antennas particularly designed for marine use. Would you suggest, or put me in touch with, manufacturers of good marine CB antennas? I would be most interested in any comparison of such antennas, or further information that will be helpful in selecting the best antenna for marine installations.

—R.N.B., Eatontown, N. J.

Quite a number of the better-known antenna manufacturers include special marine models in their lines. Among them are Hy-Gain Electronics Corporation, The Antenna Specialists Co., B&K/MARK division of Dynascan Corporation, Mosley Electronics, and Francis Industries. All have catalogs of specifications on these, which you can compare. You might also inquire from other CB'ers in your area as to how the various ones stack up against each other. Not having either a cruiser or much water to cruise it on, I'm not in much position to offer practical help here.

## ADDING EXTRA CHANNELS

Do you know of any way to adapt Generals, Johnsons, and other 5-channel CB transmitters to hold more crystals besides the old separate socket on the outside of the set? I've been trying and asking to devise a way to do this in the last few months since the channels are so busy in this

area and since the new rules came out. Thank you.

R.C., Louisiana

Unfortunately, no. The only safe way to do it is to use the crystal sockets the manufacturer put in! The fine print in Part 95 says, among other things, that the only way it's legal for you to even change a crystal in a rig is for the circuit to be so designed that the change cannot possibly put you out of tolerance, and all adjustments must be sealed. When you add an external socket, even, you've in effect "broken the seal" and are thus outside the law! Even such a simple modification can easily put you outside tolerance—and the most common violation the FCC monitors discover is just that, off-frequency operation. The time is very, very ripe for some enterprising manufacturer to come up with a transistorized outboard "frequency box" which could contain either 23 rocks, or a synthesis circuit, and which could just plug into the existing crystal socket. Such a gadget, properly sealed, could be put into any set for all-channel operation—and it wouldn't be too difficult to build, in production quantity, to sell for around \$50 a copy. Any eager manufacturers out there?

### MORE ON THE 6-VOLT INVERTER

In the April issue on page 41 you had a diagram for a 6VDC to 115VAC inverter. I have a Volkswagon in which I would like to put a 12-volt Courier 1M. I would like to know if this inverter would be powerful enough to power a Courier 30B or a rig of about 20 watts output. If your answer to this is "no," I would greatly appreciate details on how I could go about making an inverter which would work with it. Incidentally, I could not locate a 12-volt 10-amp CT filament transformer, a 10-microhenry choke, or a 3-mf 400WVDC capacitor for this circuit. Can you tell me where to purchase them? Thank you very much.

—G. DeM., Brooklyn, N. Y.

Let's take care of parts supply first. For the transformer, try a Stancor No. P-4097, which is Lafayette catalog no. 33 G 8118 at \$7.52. It's not the exact unit specified, but ought to work. The chock can be made from a length of Airdux or B&W Miniductor coil stock, such as Airdux 432 (1/2-inch dia, 32 TPI) with eight turns removed to leave a coil of 56 turns. I can't find a 3-mf capacitor in my catalogs so you'll have to build it up from a 1-mf and a 2-mf in parallel; Lafayette has these, catalog no. 34 G 7752 for the 1-mf and 34 G 7753 for the 2-mf. However, this inverter isn't recommended for an AC load over about 50 to 60 watts, and since publishing the circuit I have been informed by Motorola that they no longer recommend it for construction! You would probably be better off with the two-transformer circuit shown here. It's somewhat experimental, since I haven't had a chance to build it and check it out; try it at your own risk, but if you're careful you shouldn't burn anything up—and it ought to give you at least 100 watts of AC out before the transformers get too warm. All the parts are standard stock items which you should be able to find at industrial supply houses; Lafayette may have them even though they're not all listed in the catalog. To get T2 hooked up correctly, use a 6-volt pilot lamp such as No. 47. Temporarily connect 115 VAC to the primary, and (with power off) connect one lead of secondary winding 1 (S1) to one lead of S2. Connect the other lead of S1 to the pilot lamp and touch the other lead of S2 to the other side of the bulb. If the bulb lights (it'll be bright if it does), reverse the connections to S2. When you find the hookup which doesn't light the bulb, leave the two leads which are connected together, and also connect together the two leads which went through the bulb. Check by seeing if the bulb lights when connected to the two junctions. This time it should have normal brilliance. Connect S3 to S4 by the same procedure. Then connect one lead from a S1-S2 junction to one of the S3-S4 junctions, and test the other pair of junctions.

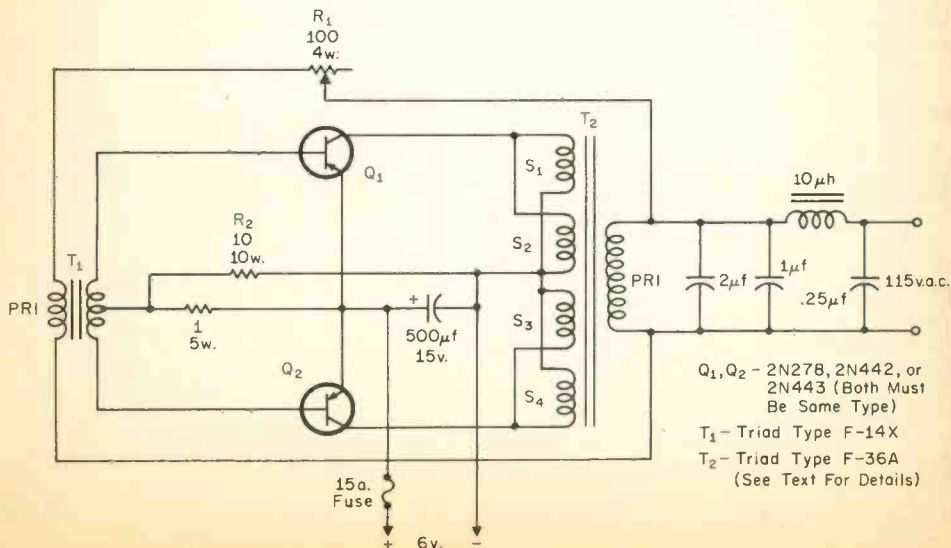

- Q<sub>1</sub>, Q<sub>2</sub> - 2N278, 2N442, or 2N443 (Both Must Be Same Type)
- T<sub>1</sub> - Triad Type F-14X
- T<sub>2</sub> - Triad Type F-36A (See Text For Details)

tions with the bulb. This time, you want the connection which lights the bulb instead of the one which doesn't. When all connections are correct, you'll find 6.3 volts AC across S1-S2, the same voltage across S3-S4, and 12.6 volts from the outside of S1-S2 to the outside of S3-S4. Potentiometer R1 controls the frequency of the AC generated; start with it set at maximum resistance and plug in an electric clock with a sweep-second hand to the output. Adjust R1 until the clock is keeping approximately correct time (one revolution of the second hand every minute) and lock the adjustment with a drop of glue. If R1 is set to less than half its total resistance, cut power and measure the value of R1, then substitute a control with just a little more (next higher standard value) resistance than you're using. The reason for this is that power ratings on potentiometers are based on the maximum resistance; a 100-ohm 4-watt pot that's using only 10 ohms can no longer dissipate 4 watts, but instead will handle only 4/10 of a watt! Don't omit the fuse; if it's not there, not only the transistors but both transformers can be cooked by an overload. The fuse may not protect the transistors, but their cost is less than \$7 compared to more than \$10 for T2. A good heat sink for the transistors will be required—at least 100 square inches. If you're going to build one of these, I would recommend getting a copy of either Motorola's "Power Transistor Handbook" or G-E's "Transistor Manual, 7th Edition" for the details on proper heat-sinking and general care and feeding of power transistors. Either will cost you \$2; the G-E manual can be obtained from any G-E supplier, and the Motorola book from Motorola Semiconductor Products Division Inc., 5005 E. McDowell, Phoenix 8, Arizona. Incidentally, to make this work with 12-volt input, reverse the S1-S2 and S3-S4 connections to those which make the bulb light, and double the value of R2; no other changes are necessary.

## BEAM FOR RECEIVER ONLY?

As transmitter antenna size is limited in Part 15 rigs, would a beam or long-wire such as the Signal Squirter cause a noticeable gain as a receiver antenna? Also, would it be directional?  
—T.H.T., Reno, Nevada

Yes, on both counts. This is one of the best ways to boost Part-15 range, since there's no limitation at all on receiving antennas. If you can afford it, you can put a 6-element beam 100 feet up in the air so long as it's used only for reception (and while you're at it, of course, you can locate the entire transmitter-and-short-antenna assembly right up there with it). Any beam is every bit as directional on receiving as it is on transmitting; in fact, most manufacturers hook the antennas up as receiving ones rather than as transmitting ones, for tests. It's easier to provide a standard signal that way.

## P. A. TROUBLES

I wonder if you might be able to give me some information concerning a project in the article

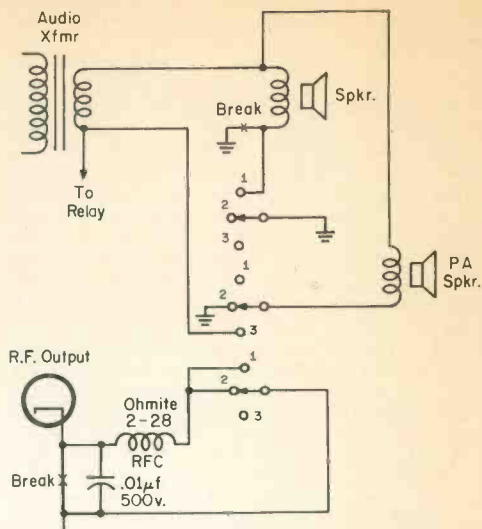

"CB Mobile from A to Z" in the May, 1964, issue of S9. The project I am working on is the P.A. system shown on page 54. It doesn't work. I have a Lafayette HE-90. Everything was built as shown but it doesn't work. There were no specifications for the RF choke. The capacitor shown is a .01 mf disc but is the voltage critical?

—L.P., Belleville, Illinois

Ouch. Looking at the schematic closely, I can see one good reason why it doesn't work on "P.A. only" (switch position No. 3) but if that's what's giving you trouble, it ought to work nicely on position 2. Does it? If it does, the trouble is that the lead from the audio transformer marked "to relay" gets lifted from ground when you push to talk, and naturally nothing can get through. To cure this, rewire the speaker and switch circuit according to the accompanying schematic. This one will work, at least with most rigs. I don't have a diagram for the HE-90, so I can't tell if the PTT switching built into the rig is killing the audio chain somewhere else or not. Chances are, however, that my error is what's wrong. Hope so, anyhow.

Which brings us smack up against the end of the allotted space, even though the basket does still have a lot of unanswered questions in it. We'll get them next month—at least, most of them. Every now and then, you know, one of you stumps me. And when that happens, I'll be the first to admit it.

How about you? Have a question, preferably technical but if not technical, ask it anyway? Then drop me a card, % S9, 14 Vanderventer Avenue, Port Washington, Long Island, New York 11050. By the time you get all that address on the card there won't be much room left for the question, but that will help you keep it fairly short.

Then all you have to do is sit back to enjoy the wait until I'm back again here at the old stand. 10-10 until next time . . .

**S9**

# CB FLICKERS



"You and your lousy 'extra modulation' gadgets!"



"The monitoring truck is coming down the street, you've just got time for one more skip contact!"



"Interesting device you've got here, Dr. Ranjit. What does 'BFEAK-EREAE' mean in your native tongue?"



"Go back and tell THIS to your friends at the FCC!"



"QSL card? You dict, this is the FCC!"



"That dumkopf keeps telling me to clear the REACT channel."

# HANDSOME CALL-LETTER BADGE

Free WITH A SUBSCRIPTION  
TO S9

**\$2.00 VALUE**  
FREE with  
2 year sub or  
3 year sub



Actual Size



Actual Size

**\$1.50 VALUE**  
FREE with  
one year sub

Your choice of many different colors on your personalized badge. Ideal to wear at conventions and jamborees.

## Style #

- 11 Black with White Letters
- 12 White with Black Letters
- 13 Red with White Letters
- 14 Blue with White Letters

## Style #

- 16 Yellow with Black Letters
- 20 White with Red Letters
- 22 Green with White Letters
- 23 White with Blue Letters

S9 Magazine • 14 Vanderventer Ave. • Port Washington, N.Y. 11050

Enter my subscription to S9 for  1 year at \$5.00

To begin with the \_\_\_\_\_ issue.  2 years at \$9.00

Name \_\_\_\_\_  3 years at \$13.00

Address \_\_\_\_\_  NEW

City \_\_\_\_\_ State \_\_\_\_\_ Zip Code \_\_\_\_\_  RENEWAL

Call to be engraved \_\_\_\_\_ Badge Style # \_\_\_\_\_

I have a subscription to S9, please send badge only.

\$1.50 incl.  \$2.00 incl.



From time to time, stories are heard of unfamiliar new tube types reputed to possess magical properties. It is rumored that the mere "plugging in" of one of these new tubes will automatically increase the power output of CB equipment, bring in stronger signals, improve reliability and life, and solve all kinds of difficult electronic problems. Usually, of course, such claims stem from "word-of-mouth" recommendations rather than from published data of qualified sources.

The purpose of this paper is to acquaint

teria, including initial tube cost, circuit complexity, and circuit reliability.

The initial cost of a tube is always a consideration in the choice the designer must make. Because cost is usually directly related to reliability, however, it cannot be considered separately, but must be included as an integral part of component reliability. Certainly, the intended use of a piece of electronic gear will, in large measure, dictate the reliability required from both the component and the over-all system.

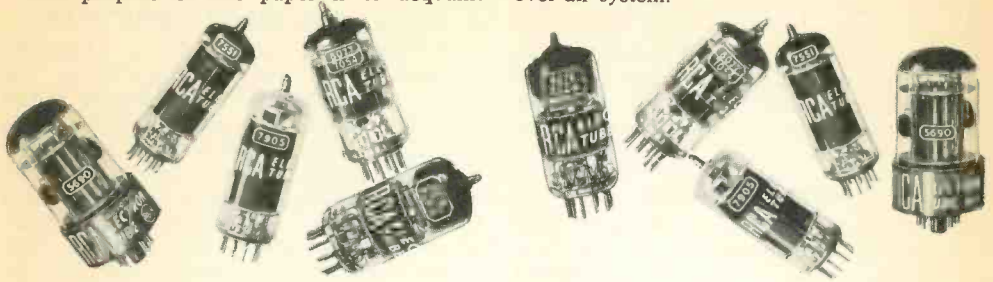

## Those "Special" Tube Types

**SHOULD YOU SPEND THE EXTRA MONEY FOR THEM?**

By **L. W. AURICK, KCD5514**

**RADIO CORPORATION OF AMERICA  
ELECTRONIC COMPONENTS AND DEVICES  
LANCASTER, PA.**

the non-technical reader with some of the relevant facts concerning "special" tube types so that he may reach a more intelligent judgment of extravagant claims and recommendations. Generally, the choice of a tube type for a particular application requires a very carefully considered and reasoned judgment which only an engineer is trained to make. The following discussion will not necessarily enable a non-technical reader to make such a judgment, but it will at least expose some of the problems involved. It may also help to explain why a local radio-parts dealer may not stock, and perhaps may not even have heard of, some of these "special" types of tubes.

### **APPLICATION**

In his initial selection of a tube type for a particular application, an equipment designer first considers where and how the tube is to be employed. Because there are usually several tube types which may be expected to perform the required function in a specific application, the selection is based on several cri-

### **WHAT IS RELIABILITY?**

In addition to the purely technical aspects of tube selection, the equipment designer must consider the required reliability level. In simple terms, reliability is a measure of the capability of a given component to perform a certain function in a particular application for a specified time. Thus, reliability depends on the requirements of the application.

For example, a tube designed for use in a missile might be required to have a functional life of only one minute, but would require an extremely high probability of satisfactory operation because replacement would be impossible and tube failure could destroy the entire mission. In this case, reliability would be the prime consideration, whatever the cost.

On the other hand, tubes of the types used in home-entertainment instruments such as TV, hi-fi, and tape recorders can have a somewhat higher probability of failure because the results are not so serious. These tubes are required to perform their function for a reasonable length of time, but it is equally important

that their initial cost, as well as their replacement cost, also be reasonable. The life of entertainment-type tubes may often be extremely long (there are many instances of tube radios performing for years with the original tubes), but the degree of probability of satisfactory operation need not be as high as that required for many industrial and military applications.

Receiving-type tubes designed primarily for home-entertainment applications are called "commercial" receiving tubes, and those intended for use in communications or other industrial equipment are called "industrial" receiving tubes. The tubes discussed in this paper represent three of the many classifications of industrial receiving tubes: premium tubes, mobile communications tubes, and "special red" tubes.

### "PREMIUM" TUBES

RCA "premium" tubes are designed especially to meet the requirements of a particular military specification or of a critical industrial application. As a result, they are required to pass many special tests, which may include shock, fatigue, vibration, glass strain, microphonics, stability, or high altitude. In applications other than the specific one for which the premium tube is designed, however, there is no guarantee that this "industrial" type will provide better performance than its "commercial" prototype.

For example, many CB rigs utilize one or more of the popular commercial receiving type 12AT7 in mixer, oscillator, or audio stages. Often, it may be tempting to replace these tubes with some of the various industrial types for which the 12AT7 was the prototype, or "take-off point," in the hope of improving CB performance. Unfortunately, there is every probability that such substitutions would result only in disappointment.

Among the "premium" tubes that can replace the 12AT7 are the military types 12AT7WA and 12AT7WB.<sup>1</sup> Each of these types was designed to meet an individual military specification, the details of which are not readily available to non-military customers. Even if the tubes themselves were available, therefore, there is no assurance that they would perform better or last longer, than the prototype 12AT7. In addition, of course, they would cost considerably more than the commercial type.

1. The letter designation W following a type number indicates that the type is tested to a particular military specification (however, not all military types carry this letter designation). A letter designation A, B, or C indicates an improved version of a type that is unilaterally interchangeable with all previous versions (e.g., type 6L6GB could replace type 6L6G, but type 6L6G could not necessarily be used in place of type 6L6GB; similarly, type 6L6GC could replace both type 6L6G and type 6L6GB, but neither of these types would necessarily work in a 6L6GC socket).

Another premium type which evolved from the 12AT7 is the 6201. This type is physically and electrically similar to the 12AT7, but is subjected to special tests to assure dependable performance under shock and vibration and in "on-off" control applications involving long periods of operation under cutoff conditions. Although the 6201 could undoubtedly be used as a replacement for the 12AT7 in most applications, therefore, the substantial increase in cost would buy very little, if anything, in normal CB operation.

### MOBILE-COMMUNICATIONS TYPES

Two of the types in the RCA line of mobile-communications tubes are similar to the 12AT7. The 7898, which has slightly higher maximum-plate-voltage and plate-dissipation ratings, is recommended for use with 6-cell (12-volt) storage-battery systems. The 6679/12AT7 double-branded type<sup>2</sup> is recommended for 3-cell (6-volt) systems. Again, these types are designed specifically for use in the particular application for which they are intended, and their advantages for that type of usage are not necessarily advantages in other types of equipment. For example, the wider heater-voltage range of mobile types (10 to 15 volts for the 12-volt tubes) provides no added capability in CB rigs which operate from a well-regulated line-operated ac power supply.

### "SPECIAL-RED" TUBES

Although the four tube types included in the RCA "special-red" family are not used in CB equipment, some mention of them is worth-while because of the special philosophy they represent. The 5690 is a full-wave rectifier in which each section contains its own heater and cathode; this type is rated for service at altitudes to 60,000 feet. The 5691, 5692, and 5693 are similar to the 6SL7-GT, the 6SN7-GT, and the 6SJ7, respectively. All four are octal-based tubes designed for extreme dependability and exceptional stability. These tubes are subjected to the most stringent tests, and carry a warranty for 10,000-hour life (approximately 2 years). They are also priced accordingly. "Special-red" tubes represent the ultimate in tube design for circuits that require the highest degree of confidence.

### COST DIFFERENTIAL

Although many of the differences between industrial receiving tubes and their commercial prototypes may appear to be minor, the

*Continued on page 71*

2. Double branding indicates that a tube can be used to replace, unilaterally, tubes bearing the individual type numbers; again, the individual types can not necessarily replace the double-branded type.

Live Better Electronically With

# LAFAYETTE RADIO ELECTRONICS



# FREE!

## LAFAYETTE 1966 Catalog 660

Now **BETTER THAN EVER**

Shop At The  
"World's Hi-Fi &  
Electronics Center"  
For Widest Selection,  
Low Prices

Stereo Hi-Fi • Citizens  
Band • Ham Gear •  
Tape Recorders • Test  
Equipment • TV and  
Radio Tubes and Parts •  
Cameras • Auto Acces-  
sories • Musical Instru-  
ments • Tools • Books

**512  
Pages** *Featuring Everything  
in Electronics for*  
• HOME  
• INDUSTRY  
• LABORATORY  
*from the "World's Hi-Fi &  
Electronics Center"*

**SEE LAFAYETTE'S NEW CB UNITS  
LARGEST SELECTION IN THE U.S.A.!**

25 CHANNEL DELUXE 5 WATT  
SOLID STATE CB TRANSCEIVER  
MODEL HB-600



12 CHANNEL CRYSTAL CONTROL  
5 WATT SOLID STATE MOBILE  
CB TRANSCEIVER MODEL HB-555



12 CHANNEL CRYSTAL CONTROL  
5 WATT TRANSISTORIZED CB  
TRANSCEIVER MODEL HE-200



LAFAYETTE "COMSTAT 9"™ KIT  
5 WATT 9 CHANNEL CRYSTAL  
CONTROL CB TRANSCEIVER



Mail the Coupon Today for Your  
**FREE 1966 Lafayette Catalog 660** →  
Use Lafayette's Easy-Pay Budget Plan  
No Money Down... Up to 24 Months to Pay  
Satisfaction Guaranteed or Money Refunded

#### STORE LOCATIONS

**NEW YORK**  
Brooklyn  
Syosset  
Manhattan  
Jamaica  
Scarsdale  
Bronx

**NEW JERSEY**  
Newark  
Paramus  
Plainfield

**MASSACHUSETTS**  
Boston  
Natick  
MARYLAND  
Mt. Rainier  
(Wash. D. C. Area)

LAFAYETTE Radio ELECTRONICS

Dept. S91-5, P.O. Box 10

Syosset, L.I., N.Y. 11791

Send me the Free 1966 Lafayette Catalog 660

Name .....

Address .....

City .....

State .....

Zip .....

(Please Give Your Zip Code No.)

# JOIN the

# ACDA



**(The ASSOCIATION TO CONDEMN  
DETRIMENTAL ASSOCIATIONS)**

Be a free, independent, thinker! Join CB's second largest do-nothing organization!

When you join the ACDA you will have **nobody** telling off the FCC in your name; the ACDA **will not** try to sell you beanie hats and red shirts; we **will not** assess you with a tax; we **will not** announce officers before the election (because we don't have officers); and we **will not** do anything else that you would rather we did not do! Anyone can join!

A membership in the ACDA brings you an outrageous, zany and chintzy membership certificate suitable for wall mounting (mount it **only** if you really are a **true** independent and don't give a hoot what your friends think of you) or for blotting up ginger-ale puddles; you also receive the next 12 issues of CB's **most infuriating**, free-thinking, and helpful monthly publication, **\$9**. Belonging to ACDA gives you **full** rights to condemn any Association which is detrimental to CB. Membership for 1 year is only \$5 (including the \$9 subscription), 2 years \$9, 3 years \$13. Use the form inserted between pages 58 and 61 of this issue, be sure to mark it "ACDA" on the front. If you already subscribe you can still obtain a certificate by sending a self-addressed and stamped envelope to "ACDA" in care of S9, enclosing the address strip with your name from the back cover of a recent issue.

**OFFER LIMITED, SO HURRY!**

## THE HI-LIFE

by WALT MILLER



"I pulled that tube, Harry. Now, what? . . . Harry?"



". . . and now for her second selection, my wife, Ethel, will sing . . ."

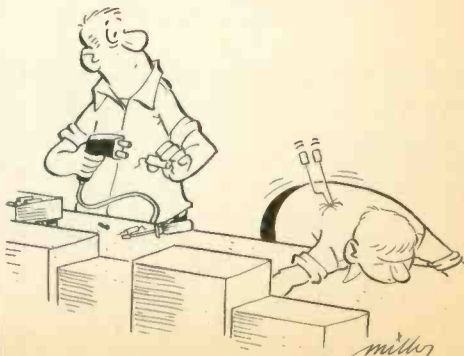

# A NICE \$5 FSM

## HAVEN'T YOU ALWAYS WANTED

## A FIELD STRENGTH METER?

by PETER DENDIN, 17W6366

Really, haven't you ever wondered if your rig was getting out—don't you sometimes think that you're calling into a dead microphone? A field strength meter will cure this—plus several other ailments to boot!

A field strength meter is simply a sort of S-meter which gives a relative reading of your own transmitter's signal strength. It consists of a crystal diode to detect your signal, a tuned circuit to weed out undesired strong signals which could give the meter problems, and (natch) a meter. It is rather insensitive a gadget and will not detect a CB signal from much further than you can throw a monkey wrench. When you press your PTT button the needle on the meter promptly pops up. Since you are able to vary the sensitivity of the meter, the writing on the meter scale is of no particular significance other than as a source of relative signal strength.

### CONSTRUCTION

The FSM isn't too big a project to construct, we built ours in a small plastic box, but just about any handy container will suffice, even a tin can!

The relatively few components can be mounted on a three or four point terminal strip inside the container. The meter movement is a microammeter, I used a 300  $\mu$ a movement in mine, but I would imagine that you could use just about any size down to 0  $\mu$ a—the lower rating should be used if you intend utilizing this FSM with a 100 mw rig. You'll find that meters tend to be somewhat on the expensive side but ours, at \$2.45 (Lafayette 99-G-5028), is about as inexpensive a meter as can be obtained (unless you can scrounge one from a junk box or military surplus shop. The meter is less than an inch square and will allow you to construct your FSM in something like a frozen juice can.

The antenna I used was a short length of bell wire, insulated. The exact length isn't very critical and will depend upon the placement of the FSM in relation to your rig. If

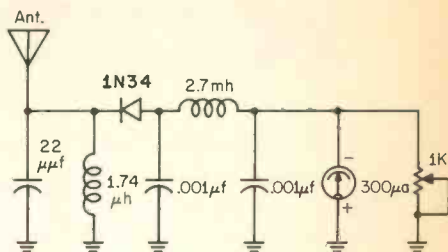

### PARTS LIST

- 1 1N34 diode (Lafayette 19-G-4901)
  - 2 .001 ufd capacitors (Lafayette 32-G-0943C)
  - 1 22 uufd capacitor (Lafayette 32-G-0943C)
  - 1 1000 ohm potentiometer (Lafayette 19-G-6142)
  - 1 1.72 uh choke (Miller RFC-144)
  - 1 2.7 mh choke (Miller 975)
  - 1 Microammeter (any from 50 to 300  $\mu$ a)
- Case, terminal strip, wire

you use the FSM in your mobile unit, place the meter on top of the dashboard and drop the wire antenna out of the way into one of the defroster vents.

### IN OPERATION

With your mike button pressed, and the antenna of the FSM placed so that you get a  $\frac{1}{4}$  meter reading with the sensitivity potentiometer opened about  $\frac{1}{4}$  to  $\frac{1}{2}$ , you have a fine reference spot. Take a crayon and mark the meter cover to indicate this reading, also the position of the sensitivity control. Unless you move your FSM antenna, the meter reading should remain the same each time you go on the air. If it shows any more than a drop of a few degrees, then you may have something out of tune or out of whack in your rig, or possibly in your antenna or transmission line. At least you know that something requires your attention!



**TO ALL VISITORS:**

# **TAKE NOTICE**

**This is a Citizens Band, or "CB," radio station.**

**It is licensed by the Federal Communications Commission.**

**Citizens Band Radio is a method of short distance radio communication used by men and women from all walks of life throughout the United States and Canada.**

**CB'ers require no government exam or test in order to be able to operate. We do not need to understand morse code or to know radio theory. Many CB'ers are licensed "Ham" operators, which is a completely dis-similar radio service.**

**This equipment does not interfere with TV, providing the TV is of good design, filtered, aligned, and operated properly in conjunction with a good antenna.**

**The basic piece of equipment used here is called a "transceiver," it being a combination transmitter and receiver. These sets cost roughly from \$60 to \$300.**

**We are permitted in our operation to use more than 20 specific channels located on a wavelength of 11 meters, a frequency of 27 megacycles. This is not anywhere near the standard radio broadcasting band or TV channels. The power of this station is 5 watts, which is the maximum permitted for CB stations.**

**We cannot communicate with "Ham" radio stations, nor can we hope to establish communications with other CB operators whom you may know, even if they are a few miles from here. For one thing, they may not be listening; for another, government regulations prohibit idle chit-chat between CB stations.**

**Police stations cannot be monitored on CB equipment.**

**Repair of Hi-Fi, TV and table radios should be done only by a repair shop because it requires special skills. It also requires a considerable amount of testing equipment plus a large supply of spare parts. This also holds true for tape recorders.**

**The cards which CB'ers hang on their walls are called "QSL's," and exchanging them with other CB'ers is a pleasant custom.**

**A monthly magazine for CB operators is available for your further information on the subject. A copy of this magazine, called S9/the citizens band journal, is available for your inspection from the operator of this station. License information on CB radio may be obtained from your nearest FCC office or from most stores selling CB equipment.**



*hallicrafters* now brings you  
a new measure of CB transceiver performance—

# Maximum Effective Range

Announcing a major breakthrough in noise reduction... new techniques in talk power... combined to provide more miles per watt than ever before!

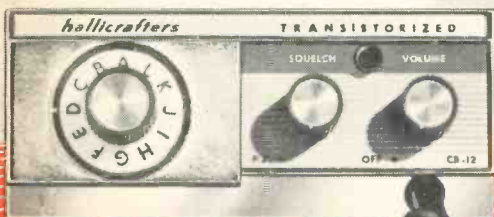

The quiet one... the powerful one... the compact one... the one with 12 channels, a built-in P.A. system and illuminated channel selector... the *all-solid state*

# CB-12

Solid State—12 Channel  
Citizens Band Transceiver

Hallicrafters • 5th & Kostner Aves. • Chicago, Illinois 60624  
Export: Int'l. Div., Hallicrafters • Canada: Gould Sales Co., Montreal, P.Q.

# READERS' BONANZA!

TAKE YOUR PICK OF THESE GIFTS!

For some time now we have been offering all kinds of free goodies with new subscriptions and renewals, we vary them each month. But we always seem to get requests for bonus items which haven't been offered for several months and that sends the Circulation Department into a tailspin. So here it is, a grand round-up of all the various offers, tied in with an exciting offer for you to get several of these things FREE with your subscription or renewal.

BONUS ITEM #1 — Large 3 inch, 3 color, "Monitor Channel 9" decal. Regularly sells for 50¢.

BONUS ITEM #2 — 50 Project Aid cards which you are required to use to notify the FCC whenever you use your CB rig to help a stranded motorist or for any emergency use. These sell for \$1.00.

BONUS ITEM #3 — Membership in the Association to Condemn Detrimental Associations (ACDA), now the world's largest do-nothing CB club. No officers, no program, it was patterned after one of the so-called "national" CB clubs. You get a big red and gold certificate for your wall with this one.

BONUS ITEM #4 — Do-It-Yourself-S9-Editor-Kit — Yes, an official multicolored S9 Press Card which will get you on buses (show it when you pay your fare), also a 10-code card, plus one of our now famous green and white "Wall Certificates."

BONUS ITEM #5 — Jazzy blue-with-white, red-with-white or black-with-white plastic badge engraved with your callsign. Big 1" high by 3" long. Just the thing for a jamboree or use the pin to stab artichoke hearts or your aunt Maud in the clyde. \$1.50 value. Specify color combination.

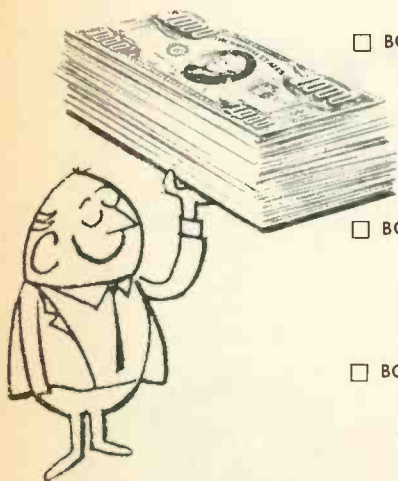

With a 1 year subscription or renewal you get your choice of any one of these items; with a two year subscription or renewal you get your choice of any THREE items, and a three year subscription earns you not only all FIVE items FREE, but we will bow towards your 10-20 once a week (on payday). Just check off the item or items you want, rip out this page and enclose it in the postage-paid envelope (in this issue) when you send in your subscription.

S9 Magazine • 14 Vanderverter Ave. • Port Washington, N.Y. 11050

Enter my subscription to S9 for  1 year at \$5.00

To begin with the \_\_\_\_\_ issue.  2 years at \$9.00

Name \_\_\_\_\_ Callsign \_\_\_\_\_  3 years at \$13.00

Address \_\_\_\_\_  NEW

City \_\_\_\_\_ State \_\_\_\_\_ Zip Code \_\_\_\_\_  RENEWAL





# ON THE COUNTERS

Harry Zipkin, formerly of CB Electronics, Hoboken, N. J., has joined CZ Labs, Co. which has been in business for over a year and a half. CZ specializes in compact parts for CB operators. Write to Harry for free details. The new address is CZ Labs, 82 Lake Ave., Tuckahoe, N. Y.

G & S Sales and Engineering, with offices in Yorktown Heights, N. Y. (a division of CZ Labs) specializes in receiving tubes and special purpose tubes. For more information on their products, contact Nick DeSalvo at CZ Labs.

New-Tronics Corp., 3455 Vega Ave., Cleveland, Ohio 44113, has announced a new line of CB antennas. All of the models feature resonators which may be tuned by means of a stainless steel tip rod. Masts are of chrome plated brass, either one piece or telescoping, or fiberglass. The various models are designated for cowl, fender, or roof-top mounting.

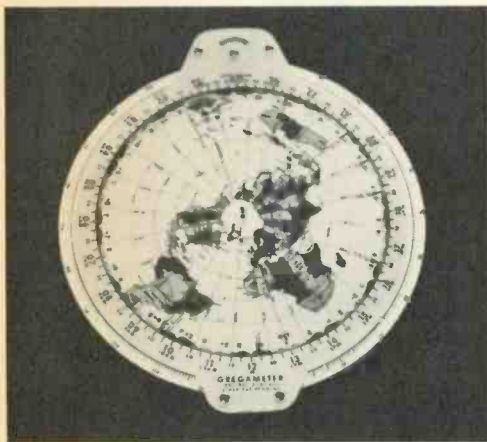

We received information on an interesting new product from Mike Grega of the Gregameter Company, P.O. Box 1014, Alameda, Calif. The Gregameter is a patented celestial-terrestrial slide rule for computing problems relating to time of day at any given hour for all points on earth (Local, GMT), distance and direction of jet flights and missile shots, numerous astronomy uses, celestial navigation and space shots. It's \$12.50.

One good way to protect your mobile unit and its contents from theft is by means of the Wiggins Vehicle Theft Alarm, produced by W. S. Wiggins, P.O. Box 448, Whittier, Calif. 90608. You build the alarm yourself with easily obtainable, standard, parts (assembled units aren't yet available). Highly sensitive, it actuates a signal rhythmically. Stops and re-arms itself when not disturbed. Send \$2 for a nine page brochure of copyrighted circuits and complete instructions.

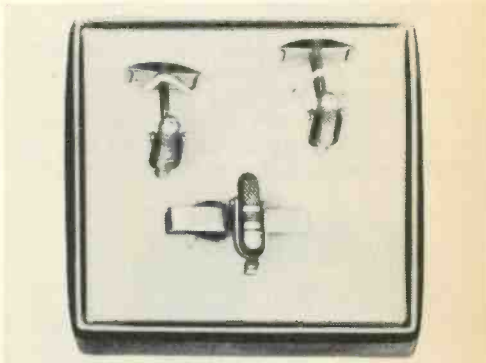

Miniature replica of a CB microphone on a tie bar and cuff links are available in either gold or rhodium finish, gift boxed, at \$4.50, postpaid, from Nordlund Radio Products, 7635 West Irving Park Rd., Chicago, Ill. 06034. The Tie-clasp only is \$2.

J-A Electronics Co., P.O. Box 645, Teaneck, N. J. 07666, has brought out a miniature microphone preamp "for the extra bit of audio." This is a self-contained, battery operated, transistor unit designed to provide up to a gain of 6 (16 DB). Price for the wired and tested is \$10.95.

Lafayette Radio, Dept. S9H5, P.O. Box 50, Syosset, N. Y. has brought forth a whole slew of new CB rigs which we will briefly outline here:

*The HB-600 Deluxe 23 Channel Crystal Controlled CB Transceiver.* 100% solid state, supplied with all crystals; crystal positions left open for HELP and other services which are, or will soon be, operating near CB; range boost in modulator, dual conversion receiver, 1/2 uv sen-



sitivity, effective noise silencer, mechanical filter, delta tuning, socket for selective call unit, PA system self contained when used with external speaker, built in AC/DC (neg. or pos. gnd.) transistorized power supply. Price \$219.95.



*The HB-444 23 Channel Crystal Controlled CB Transceiver.* All crystals supplied, range boost in modulator, Nuistor front end, .3 uv sensitivity, variable ANL and squelch, delta tuning, PA switch on front panel, built-in AC/DC PS, socket for selective call unit. Price is \$179.95.



*The COMSAT 9, 9 Channel CB Transceiver Kit.* This kit has 9 transmit and 9 receive channel capabilities, plus a tunable receiver. Operates from 117 VAC or with optional PS on 12 VDC. Price: \$59.95 in kit form only.



*The COMSAT 23, 23 Channel CB Trans-*

*ceiver.* Equipped for functioning on all 23 channels—no crystals to buy. Dual conversion receiver with .8 uv sensitivity, variable squelch and fine tuning control, selective call switch, TVI trap built-in, AC/DC transistorized PS. Price: \$139.95.



*The HE-20D Transistorized Transceiver.* The famous HE-20 has been introduced for 1966 with transistor circuitry and featuring a mechanical filter. All channel tunable receiver with 12 position transmitter, PA switch, spotting switch, variable squelch and antenna peaking, selective call input socket, built-in AC/DC transistorized PS. Price: \$89.95.

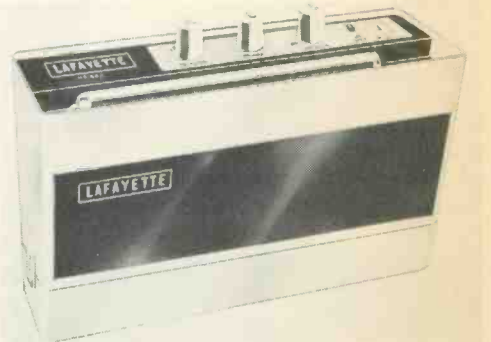

*The HB-555 Solid State Transceiver.* A compact new unit with 12 transmit/receive positions, dual conversion receiver, mechanical filter, automatic noise limiter, PA speaker jack, selective call socket, .6 uv sensitivity, operates from 10-16 VDC, or from 117 VAC when used with optional PS. Channel 9 crystals included. Price \$99.95.

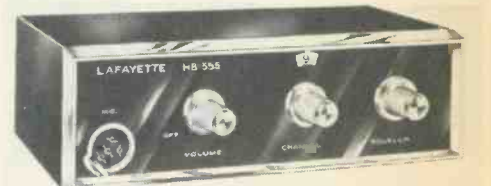

*The HA-450 2½ Watt Transceiver.* This is a super walkie-talkie portable for hand or mobile operation. Fully transistorized and featuring 6 transmit and receive channels, the ANL and squelch are adjustable. A whip antenna is included, as is a jack for an external antenna. Operates from standard "D" size rechargeable nickel cadmium cells. Operates from 10-16 VDC, pos. or neg. ground. Price: \$119.95.



The HE-29D Walkie Talkie. Latest version of the Lafayette workhorse, the HE-29D still needs no license for operation on Channel 10. New improved circuit employs 9 transistors and a diode with a superhet receiver. Price: \$25.95 each or two for \$49.95.

Drop a card to Lafayette for further details on all of these new sets plus some exciting additional CB gear.

Master Mobile Mounts, 4125 West Jefferson Blvd., Los Angeles 16, Calif., has a good idea to keep you from ever having to face the prospect of a dead car battery. This is a 2 battery system which may be controlled from the drivers seat, has a charge rate motor for the second battery, can operate either alternators or generators. There are dozens of advantages to a system of this kind in a CB mobile. Get further details from Master Mobile.



A new all transistor 12 channel rig has been announced by Pace Communications Corp., 520 W. 182nd St., Gardena, Calif. The new unit, the PACE II, features a dual conversion receiver, noise limiter (adjustable), a variable squelch, operates from 12 VDC (pos. or neg. ground). One set of crystals are supplied. Price is \$169.00. Pace says they'll be happy to send you some additional info on the rig if you saw it in S9!

**S9**

The BIG Switch Is To S9

## 15¢ INTRODUCTION

We will send you, prepaid, 1 plastic CB card holder for 20 cards upon your request accompanied by your CB card and 15¢ for postage and packing. One per family only—offer expires Sept. 30. Regularly 3 for \$1, 10 for \$3 at your dealers or prepaid from factory.

**TEPABCO**

Box 198 S, Gallatin, Tenn. 37066

### WE NEED CB DEALERS!!

AS distributors handling all Major brands of CB equipment, antennas, and accessories we can offer local dealerships to aggressive CB dealers and installers. Write at once for information and your costs on the brands you prefer to handle. Dept. 624

**KNOX ELECTRONIC SUPPLY, INC.**

67 N. Cherry St., Galesburg, Illinois.

FOR THE VERY BEST

## QSL CARDS

It's FRANK B. MATHEWS ADVERTISING ART. All of our CB QSL cards are printed in full color, on glossy stock, using the latest in modern designs.

FRANK B. MATHEWS Adv. Art  
1616 Rural St., Rockford, Ill. 61107



WRITE TODAY FOR FREE SAMPLES

## FCC EMERGENCY NOTIFICATION CARDS ONLY 2¢ EACH!

Section 95.85(1) of the CB rules states that if you use your CB gear for any emergency, even for calling for help for a stranded motorist, you must notify (in writing) both the FCC in Washington and your local FCC office. You must do this for each time you use your CB rig for emergencies. These FCC Notification cards were specifically designed to cut to a minimum the paperwork necessary for well meaning clubs and individuals—they contain all of the necessary wording (and are even addressed)—all you do is fill in a few blanks, stamp, and drop into the nearest mailbox. They come with a list of addresses of local FCC offices. Available postpaid in packages of 50 for only \$1. Thousands of these cards are already in circulation. Order now from:

**Project Aid  
S9 Magazine  
14 Vanderventer Avenue  
Port Washington, N. Y. 11050**



Leo I. Meyerson  
KLH 7297

# THIS NEW DELUXE CB TRANSCEIVER PUTS YOU ON THE AIR IN SECONDS!

**COMPLETE  
NO EXTRAS  
TO BUY!**



PRICE INCLUDES:  
Both AC/DC Supply &  
Mounting Bracket.

**\$79<sup>95</sup>**

Made in  
U.S.A.

**\$5.00 Monthly**

## NEW! WRL'S "RUSTLER" CB TRANSCEIVER

Here's a New *Deluxe* American Made CB Transceiver with features you would expect to find only in CB units costing much more. WRL's Rustler CB Transceiver is a complete package with 115 VAC and 12 volt DC power supply, cords, mtg. bracket and PTT mike. It also includes eight crystal-controlled channels and a 23 channel, tunable, superhet receiver. (CRYSTALS FOR CH. 9 SUPPLIED)

Other important features include a positive squelch control, illuminated "S" meter, spotting switch, ANL, 3.4 watts, and a quick-change crystal socket. Beautifully designed for home or auto use! Only WRL offers you the finest for less.

### CB WALKIE-TALKIE Exclusives from WRL

#### 3 TRANSISTOR



**\$9<sup>95</sup>** WIRED  
ea. in pairs

- Ready to operate.
- No license needed — No age limit.
- Operates on single battery.
- Handsome - Compact Weighs 10 oz.

On the move communications. Range ¼ mile and more — ideal conditions.

#### 9 TRANSISTOR



**\$24<sup>95</sup>** WIRED  
ea. in pairs

- Range - 1-3 miles.
- Crystal controlled.
- Noise limiter switch.
- Push-to-talk switch.
- Leather case, earphone.

Ideal For Business, Pleasure & Home Use.

#### ONE WATT



**\$59<sup>95</sup>** WIRED  
ea. in pairs

- Professional Model.
- Range - 1-5 miles.
- FCC License required.
- 13 Transistors.

#### WRL'S CB PRE-AMPLIFIER



**\$1195 each**  
Improves any CB receiver . . .

Guaranteed to improve CB reception. Uses two 6CW4 nuvistors providing up to 20DB gain on receiver signals.  
**READY-TO-INSTALL**

#### WRL

WORLD RADIO LABORATORIES  
3415 West Broadway  
Council Bluffs, Ia. 51504

Please Rush Me

- WRL's Rustler CB Transceiver.  3 Transistor Walkie-Talkie, \$9.95 ea. in pairs.  9 Transistor Walkie-Talkie, \$24.95 ea. in pairs.  1 Watt Walkie-Talkie, \$59.95 ea. in pairs.  WRL's CB Pre-amplifier, \$11.95.  Compression Amplifier, \$14.95.

Name \_\_\_\_\_

Address \_\_\_\_\_

City \_\_\_\_\_ State \_\_\_\_\_ Zip \_\_\_\_\_

#### NEW COMPRESSION AMPLIFIER

Made in  
U.S.A.



**\$1495**

A True Compressor  
Not a Clipper

- CB/HAM/COMMERCIAL USE
- Provides up to 15DB Compression.
- New Low Price
- Quantity Prices Available

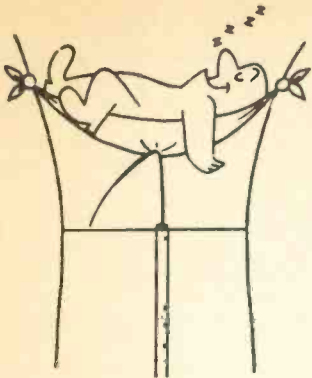

# ANTENNAS

by LEN BUCKWALTER, KBA4480

## LET'S SPEAK JAPANESE

After months, maybe years, of operating on 27 MC, a number of CB'ers get SWL fever. It can bite hard. For short-wave listening can bring in, for example, Dr. Toru Mastumoto and his twice-weekly show from Tokyo, "Let's Speak Japanese." You might learn that *bonzai* doesn't really mean Charge!—like in the old movies—but translates as "10 thousand years." Or if you get lucky on the bands you might hear an aircraft in distress with a stuck-up landing gear or something sensational like the sinking of the Andrea Doria. And if education is your dish, the BBC fills the air with about 500 hours a week with such gems as a West Indian wrestling match.

International shortwave stations (there are now about 3000 on the air) run much power. One big installation at Allouis, France, pours some half-million watts into the shortwave bands. And probably half the lights in the Soviet Union go dim when Radio Moscow fires up its rig and beams signals to North America. But to enjoy shortwave you need a reasonably good antenna. It can make stations around the world sound like locals. Let's take a look at some practical SW antennas.

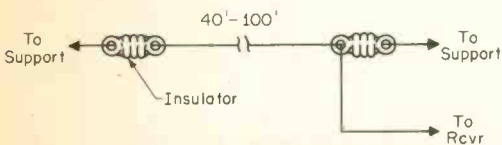

One of the simplest and effective antennas is the inverted-L, shown in Fig. 1. If you've got the room, run it out the full 100 feet. You'll note that there is no transmission line, as in CB antennas—just a long wire. It should run as straight and high as possible. If you want to capture low-angled signals skipping in from overseas with good strength, try to keep the long part of the wire about 30 or more feet above ground. Out at the far end use a pole, garage roof or even a tree for support. If it's a tree, select one with a stout trunk and fasten the wire at that point. Otherwise sway is apt to snap the antenna when the wind kicks up.

The antenna wire itself isn't critical. But over a long run, the heat of summer can cause the

wire to sag due to expansion. Ice loading in winter can also cause sag. A good choice is No. 12 or 14 hard-drawn copper wire, or copper-clad steel. It doesn't matter if the wire has cotton, plastic or enamel insulation; the signal passes through unobstructed. Just be sure to strip it clean where it attaches to the SW receiver. Bring the wire down and into the house with TV-type standoffs to prevent it from touching anything.

Since an antenna of this type does not offer the same degree of lightning protection as one with a coaxial cable, an arrester of some type is advisable. (A direct hit by lightning is not the only kind that causes damage. It's possible for sparking to occur in the receiver during a severe thunderstorm.)

How directional is the inverted-L? This depends on the particular frequency of reception. Since SW stations are strewn out over various bands, the antenna responds differently on different frequencies. If you're having trouble picking up a particular region of the world, try changing the direction of the antenna run, if possible.

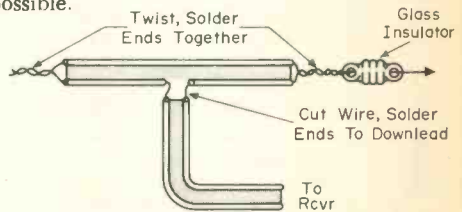

Although the inverted-L has certain advantages, mainly that it is all-band and needs no further tuning, it's not the most efficient type for a particular band. If you're after some choice DX and want to peak up the signal, you might consider a separate antenna system for the desired frequency. A popular arrangement is the folded dipole, shown in Fig. 2. It's quite inexpensive since common 300-ohm TV twinlead is used for construction. The top part of the folded dipole is cut according to the formula: Length in feet = 468 divided by the frequency in megacycles. For example: if you want especially good reception on the 31-meter SW band, which is 9.45 MC, antenna length is 468 divided by 9.45. The answer is approximately 49 feet. The 468 figure, incidentally, remains the same regardless of frequency. It's a constant which permits easy

What is Master Mobile So Excited About! . . .

# 2 NEW REVOLUTIONARY ANTENNAS NEW! DDDR\*

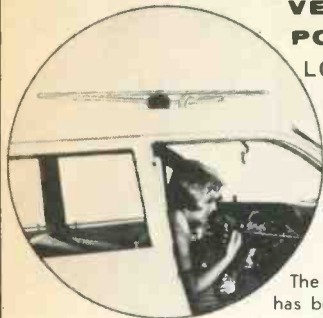

**VERTICALLY  
POLARIZED  
LOW PROFILE  
MOBILE  
ANTENNA**

MODEL CB-42  
CB 11 Meter 27MC

The DDDR Antenna has been designed to incorporate the electromagnetic efficiency of naturally resonant quarter-wave whip antennas with a low profile which can be easily installed on vehicle roof tops and precisely tuned over a wide range of frequencies.

Because of its unique design features, the DDDR Antenna will normally outperform quarter-wave mobile installations, both in transmit and receive modes. CB NET \$29.95.

- VERTICAL POLARIZATION
- OMNI-DIRECTIONAL IN HORIZONTAL PLANE
- LOW PROFILE DESIGN
- EFFECTIVE INCREASE IN RADIATED POWER
- LESS NOISE FROM STATIC CHARGES

Other frequencies available from 27 to 180 mc  
\*Mfg. by Omni-Line Co., Div. of Rad Science, Licensee of Northrop Corp.

## NEW TOROID TENNA

is a super-efficient, compact mobile whip that measures just 42" in length. Toroid-Tenna's quality construction incorporates toroid transformer in base to boost transmit range; all brass and stainless steel; screwdriver adjustment for perfect VSWR (no cutting or trimming needed); weather/waterproof, chrome-plated base. Transformer and capacitor are completely shielded for noise-free operation. 27 Megacycle TOROID-TENNA: \$21.95 NET.

Dept. S9

Dealers Send for Complete Information and "ANTENNA BUYER'S GUIDE"

**Master Mobile Mounts**

4125 W. JEFFERSON BOULEVARD  
LOS ANGELES, CALIFORNIA 90016

AREA 213, 731-2251

DIVISION OF



calculation of a half-wave antenna on any frequency. The folded dipole is definitely directional. It responds best when placed broadside to the signal. Thus if you want signals arriving from east or west, run the antenna north and south, etc.

If your SW receiver is typical, there are two ways to attach the antenna lead-in to the terminals. There are three terminals, marked A, A and G. When the antenna is an unbalanced type, such as the inverted-L, link up the A and G terminal with the small metal strap provided. The A-G combination goes to ground; the antenna wire connects to the free A terminal. For a balanced antenna, such as the folded dipole, connect the two twinlead wires to the two A terminals. The G terminal goes to ground and the metal link not used.

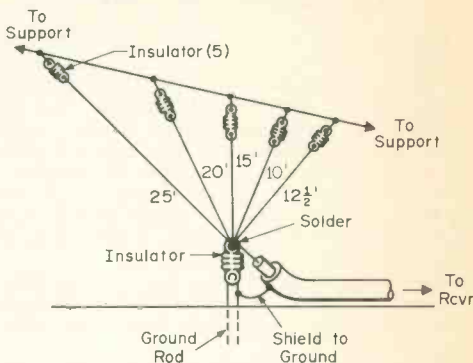

Finally there's the deluxe SW antenna known as the fan dipole. Its claim to fame is that it can tune several bands simultaneously. It's more efficient than the inverted L and covers more frequencies (about 3 to 30 MC) than the folded dipole. But you'll need plenty of room in the yard for installation. The antenna picks up equally well in all directions. As shown in Fig. 3, several wires angle out from an insulated point on the ground. A convenient method is to drive a copper rod (sold for electrical grounding) into the earth and fasten a glass insulator at the top. The various wires are anchored and soldered at this point, as is the coax cable.

**\$9**

## DON'T LOSE YOUR C.B. LICENSE!

At last, a way to protect this valuable document. How? With a Barbett wallet size reproduction, using our Photo Ply process.

**YOUR CHOICE OF:** Wallet size reproduction of your license . . . \$1.00 complete—OR—Wallet size reproduction of your license with miniature QSL or Club Emblem on back . . . \$2.00 complete. All licenses processed the day received and returned by 1st. class mail.

Rush your license and QSL or Club Emblem with check or money order to:

**BARBETT REPRODUCTIONS  
P.O. BOX 1979 / HARTFORD, CONN.**

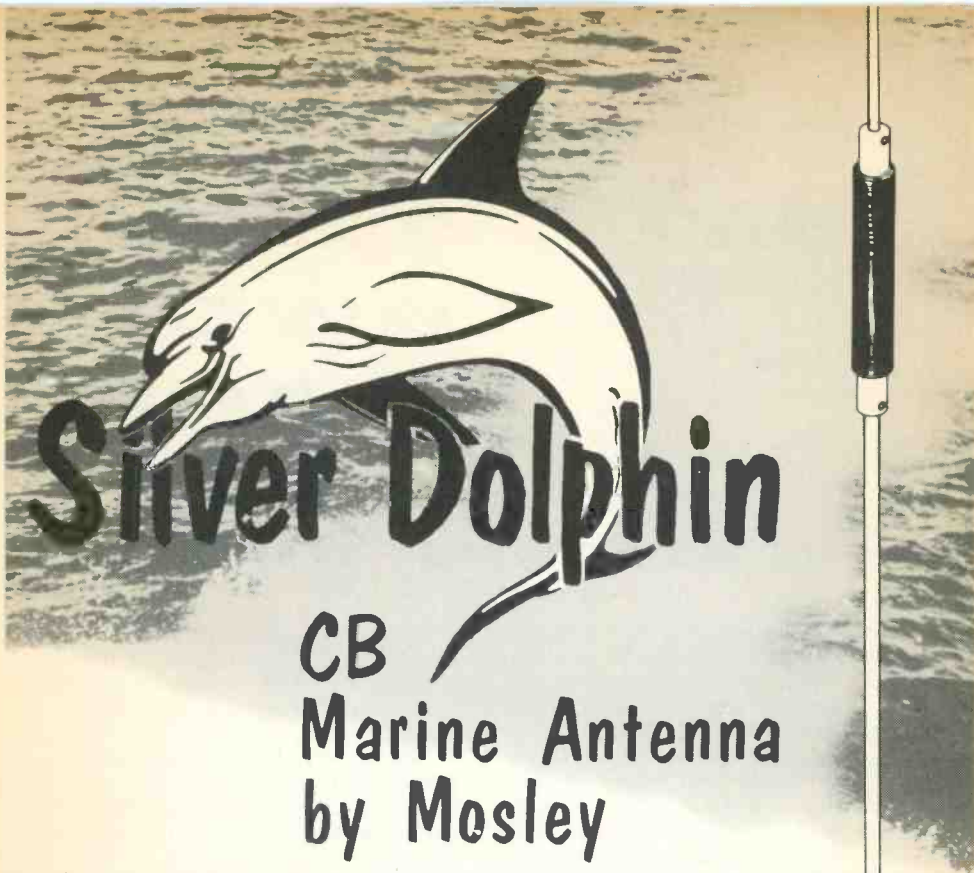

# CB Marine Antenna by Mosley

Here's the amazing Marine antenna you've been looking for - - - an antenna requiring NO GROUND RADIALS OR OTHER GROUNDING SYSTEMS! Yes, it's true! THE NEW MOSLEY SILVER DOLPHIN will operate efficiently even on wood and fiberglass boats.

## Outstanding Features

- Overall height 8 ft. 5 inches.
  - Salt-resistant, Weather-proof, Transformer.
  - Hinge in Base For Folding Antenna Over.
  - Amazing Ship-to-Shore Performance.
- full  
CB NET  
price  
**\$29.50**

Consider this unique Marine antenna guaranteed to perform according to Mosley specifications or your money back.

CLIP OUT COUPON BELOW and send it to  
MOSLEY ELECTRONICS, INCORPORATED  
4610 N. Lindbergh Blvd. Bridgeton, Mo. 63044

For information on the Silver Dolphin Antenna,  For Free CB Antenna Hints brochure,  I AM A DEALER OF  Marine Equipment  
 CB Equipment, I AM ALSO INTERESTED IN  other CB Antennas  
 Amateur Radio Antennas  Business Band Antennas.

Name .....

Address ..... City/State .....



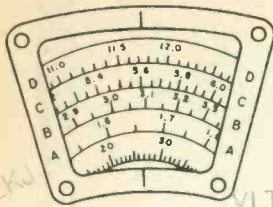

# THE SWL SHACK

## BEST BETS FOR LISTENERS ON THE DX BANDS by RICK SLATTERY

This month we have some listings from a new reporter to the SWL SHACK. It's Steve Jones, KLO0519, of Lawrenceburg, Ky. Steve does amazingly well with no more than a modified Hallicrafters "Ecophone" (used to know a fellow named Hogarth who swore the Ecophone was the best set ever to come out of the second world war). Anyway, Steve has already received QSL's from *Radio Sofia*, *BBC*, *HCJB*, *CBC*, *Switzerland Calling*, *Trans World Radio*, and *Deutsche Welle*.

Steve passes along these loggings for your use: *Radio Sofia*, Bulgaria, 6070 and 9700 kc/s at 1900 EST; *Deutsche Welle*, Cologne, W. Germany, 9605 kc/s at 1620 EST; *Trans World Radio*, Bonaire, Neth. West Indies, 5955 kc/s at 2100 EST; *Switzerland Calling* on 9535 kc/s at 2035 EST; *HCJB*, *The Voice of The Andes*, Quito, Ecuador, 9745, 11915, 15115 kc/s at 2130 EST; *Portuguese National Radio*, Lisbon, on 6185 kc/s at 2330 EST; *Vatican Radio*, Vatican City, 9645, 11740, 15150 kc/s at 2000 EST; *Radio Nederland*, Hilversum, Holland, on 9570 kc/s at 2055 EST; *Radio Australia*, Melbourne, on 9570 kc/s at 0715 EST; *Radio Finland*, Helsinki, 9555 kc/s at 2000 EST; and *Radio Havana*, Cuba, on 15135 kc/s at 0715 EST.

James H. Burton, III, Staunton, Va., passes along the news that *Radio Kiev*, in the USSR, has English beamed to North America from 1930 to 2000 EST on 9810 kc/s. They QSL promptly from: *Radio Kiev*, Radio Center, Kiev, USSR. Jim also reports two utility stations, one of the Bahama Government Telecommunication Department, Nassau, Bahamas, testing on approximately 3400 kc/s at 2245 EST. The other was station AEA, apparently a U.S. Army station, in Thenisens, West Germany. They were heard testing on about 10800 kc/s.

By the way, now is the time to start looking for those weak stations on the standard broadcasting band around sunset. Some real fine DX to be heard in this manner in the coming months!

For the record, so many of you have written to ask about joining a top notch DX club, we will repeat the information on the Newark News Radio Club which we had presented a number of issues back. The NNRC is probably the oldest and largest DX club in the world. Began in 1928, it now numbers members from most of the nations of the world. Each month they send out a super-fantastic BIG DX bulletin covering all aspects of monitoring, including broadcast band, FM-TV, Ham, shortwave broadcast, utility, and even *cardswapping!* Dues are \$5 per year and they will send you a sample of their bulletin for 25¢. Don't forget to mention S9 when writing to them. Address is: Newark News Radio Club, 215 Market Street, Newark 1, N. J.

Rambling on the bands: *Radio Norway*, Oslo, 6130, 11850, 15175, 17825 kc/s at 1600 EST; *V. of Free China*, Taipei, Formosa, on 7130, 11825, 11860, 15345 kc/s at 2217 EST; *RAI*, Rome, Italy, on 9630 and 11905 kc/s at 2005 EST; *Radio Bucharest*, Rumania, on 6150, 6190, 9510, 9590, 11810, 11940 kc/s at 2200 EST (very strong signal in English beamed to North America, usual propaganda rantings however); *Far East Broadcasting Corp.*, Manila, Philippines, 6030, 7230, 9715, 11855, 11920, 11920 kc/s at 1205 EST.

Let us know what you're hearing out there and why not send us a snapshot of your shack?





**Shape up with the  
sharp one!**

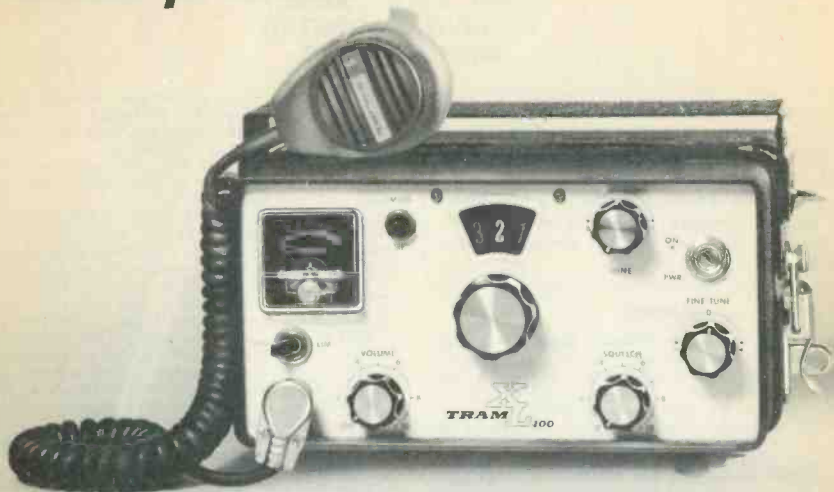

## ***XL-100 C. B. Mobile Brand-new from TRAM***

So sharp, adjacent channel rejection is 95 db or better! TRAM achieves this SUPER-SELECTIVITY with a built-in crystal filter. This, Better-Than-The-Competition excellence, separates TRAM's XL-100 from all others in the field.

Take a fast look at just some of the quality features that make TRAM Number One with pros who know!

23 channel operation via synthesis. • Compact (main unit 4" x 8" x 8"). • Sensitivity second to none. • Selectivity that can't be matched in any standard unit. • Built-in low-pass filter, minimizes "T.V.I.". • Hand wiring. • Teflon covered wire. • Locking switch makes rig tamper-proof. • Set padlocks to dash bracket. • Heavy duty, commercial microphone. • High efficiency transmitter. TRAM delivers 3.5 watts minimum output to the antenna. That's really getting your 5 watts worth of power.

At \$318 TRAM's XL-100 is your best C. B. value . . . your best TRANSCEIVER buy!

Write for FREE ILLUSTRATED BROCHURE  
(name of nearest TRAM dealer)

**XL**  
**TRAM**<sub>100</sub>  
Quality at Your Flinger Tips

**TRAM ELECTRONICS, INC.**

Dept. No. A-9, P.O. Box 187, Lower Bay Rd., Winnisquam, N. H., Phone 603-524-0622

# CB CHIT-CHAT

**INDIVIDUALS AND CLUB MEMBERS!!  
SEND US ITEMS FOR THIS COLUMN!**

Address correspondence to:

**JOHN KREJC, KB18077  
60 DIVISION AVENUE  
GARFIELD, N. J.**

**New appointments this month to the A.P.R.E. program include: Michael A. Zussman, 8078 No. 15th Ave., Phoenix, Arizona; Robert Langermann, KLF0755, Route 2, St. Croix Falls, Wisconsin; Donald R. Shue, KKG-4329, 355 S. George Street, York, Penna.; Fred Lepine, 13 Glen Street, Concord, New Hampshire.**

## ATLANTIC

June 20th the Tidewater Citizens Band Clubs were Host to Robert Rhule, Hy-Gain Antenna representing at the Oceanview Recreation Center. This was most interesting and informative lecture on antenna's and was really enjoyed by everyone that attended.

On Friday, June 25th Terrac held an election of officers. Re-elected President was Fred Bryant, KKK7179. Other officers elected are: Vice-President, Ed Mittle-dorf, KMK0488; Secretary, Joe Mosebaugh, KKK5164; Treasurer, Dick Stilwell, KKK7675 and Communications Officer Dave Meadows, KK3210.

The club welcomes new members Leon Mueller, KMK-2724 and Larry O'Grady, KMK2704.

Please pass your club news to A.P.R.E. Bob Smith, KKK6249.

## WESTERN

In Redding, Calif. the newly organized North Valley CB Club holds its regular meetings on the first Tuesday of each month in the Shasta Savings and Loan Building. We are just getting started and welcome all CB'ers in the area to join us. We have some fine social events planned for the future, and you will be hearing more from this club.

Officers for the first year are President, Ray Maye, KLA4996; Vice-President, Ron Smith, KLA7040; Secretary, Tony DeCoito, KLA6363; and Treasurer, Larry Friar, KNA1909.

New officers of Maricopa County Emergency Communications are: KEJ0269, Barry Lee Pres.; KFA-2889, Mike Zussman Veep; and KKK1900, Mike Campbell, Secretary-Treasurer. Recently M.C.E.C. handled all communications and money pickups for the Annual Arizona Cerebral Palsy Telethon originating in Phoenix. This is the boys fourth year for the Telethon. Assisting them were Superstion REACT of Mesa, Arizona headed by KFA0102 Jim Shaw, and Coconino County Emergency Communications in Flagstaff headed by KFA1473, Bob Lockett.

On the morning of May 29th, 1965, starting at 6:10 A.M., (C.E.M.P.) Citizens Emergency Mobile Patrol KEJ7036, was alerted to participate in an Emergency-Disaster preparedness drill, MERCY V, involving some 17 hospitals in the San Fernando Valley Area of Los Angeles, Cal.

This exercise was coordinated by County and Cities Disaster and Civil Defense Commission. Also the California Disaster Office and U.S. Public Health Service.

C.E.M.P. provided direct communications in and around West Hills Doctors' Hospitals in Canoga Park, and to units positioned at other hospitals, the Police Dept., Fire Station, Radio Station KGIL and other strategic points, where an overflow of "casualties" could be accommodated.

Some 13 Scout Troops, 4 Girl Scout Troops, and 1 Explorer Troop, volunteered to provide the "casualties."

It is to be noted that less than 30 minutes expired from the first alert to the report of all stations manned.

This month members of San Gabriel REACT voted to supply Paul Seaburn, KFB0278, with several pieces of playground equipment for boys from Pacific State Hospital in Pomona, California.

Presently, Paul and his wife care for six boys from the hospital which is for youngsters with mental and physical handicaps.

Bob Bertiaux, KFA7864, Board Chairman along with Vern Broadwell, KKK0419, Lucy Ballew, KFA7864, and Edythe Armstrong, KKK5948, presented Paul with a check to purchase the equipment and have it installed.

At the monthly C.E.M.P. Board of Directors meeting, Tuesday, June 8th, action was taken by the board to appoint two members as Public Relations Officers for C.E.M.P. Mark J. Planovsky (KKY0299) and Phil Seberger (KKX8110), Unit 20 and 9 respectively.

Here's wishing them both much success in their endeavor. CB organizations and clubs are invited to contact either or both at Citizens Emergency Mobile Patrol, Inc. P.O. Box 924, Reseda, Cal. 91336.

On June 17th, 1965 . . . Three CB Units participated in the Local Big day at Pleasant Grove, Utah known as "STRAWBERRY DAY," the participation was over a four day period, being in parades both morning and evening . . . The participants with their mobiles as follows: Mr. Glen Larson, KGC2553, Orem; Mr. Mike Searle, KNE0521, American Fork; Mr. Bill Bird, KLE-2295, Orem and Mr. Harold Sargent, KLE0972, Pleasant Grove, Utah, this was a composite group representing the following organizations: "REACT," Squaw Peak CB Chapter, Civil Air Patrol, Individual Group and the Friendly Five CB Radio Club . . . this representation was full county wise in its participation throughout the whole four days, this is the type of cooperation and participation we like to see on all occasions, also last but not least was the Utah County Sheriff's Posse and their CB units.

The friendly five "REACT" Team for Utah County, Utah has now been sub-divided into six separate units known as groups, Namley, Lehi, Sherman Carlson, KLE1189; American Fork, Lorraine Hayes, KLE0928 Unit 2; Pleasant Grove, Harold Sargent, KLE0972; Orem, Bill Joe Bird, KLE2295; Provo, Clifford Stone, KLE1706; Springville, Irwin (Butch) Curtis, KLE-1656 . . . In addition Mr. David Brown, KLE2804 trying to organize the county of Salt Lake and Mr. Dale Johnson, KLE1442, Heber City, Utah is organizing WA-SATCH, County at the present time . . . Mr. Junius H. Noyes, KLE0928 was the spark in organizing Utah County, Utah and various other parts of the state, plus recruiting many members at large to do the same type of work in their city, county or state. He has since resigned his position as County Head to become a member of the Local City group of American Fork and return to writing for S9 Magazine.

The Emergency Communications Organization, have received their shirts with plaques, yes they are RED SHIRTS. The Club has offered their services to the RED CROSS, in case of an emergency, and when needed, also the Club is planning on going to the Marshall, Texas Jamboree, July 22 to 25th, approximately 40 units from Texarkana will be there, for the Coffee Break, and the Parade Saturday morning, also the Drawing Sunday after a big Bar-B-Que Dinner, Old Radio Red will furnish the sound system, as he did in Dallas for their CB Fair.

Below is a report of recent activities of the Missive Valley CB Club, Inc. of Alamogordo, New Mexico:

On May 1st, 5 members of the club acted as traffic coordinators and assisted the village of Tularosa in making their Annual Rose Festival Parade a success. Members were stationed at strategic points along the parade route with one unit following the parade relaying directives from the Chief of Police to those routing

the traffic along busy U.S. Highways 70 and 54. On the following Saturday, May 8, the Immaculate Conception Catholic Church of Tularosa had their Centennial and a part of the festivities was a street parade along the same route. Club members assisted as in the Rose Parade. Saturday, May 15, an 8 year old child was lost in the mountains near Three Rivers. 8 units of the club responded to the call for help but, fortunately, they were not needed as the boy was found by a member of the Otero County Sheriff's Department approximately 10 minutes prior to the arrival of the first units. On Sunday, May 23, an ice cream social was held in the city park in Alamogordo: this was a family affair and all enjoyed a pleasant afternoon despite a 40 mile an hour wind.

The first annual Citizens band JAMBOREE is scheduled for a one day stand during the month of August, the exact date will be announced as soon as plans are made permanent.

Lorrin Mabus, KGC1915 of Salt Lake City and Bill Holt, KG0797 of Ogden are among those on the committee in charge. This venture is to be a combined effort of CB'ers from Provo, Ogden, Logan and Salt Lake City.

Plans call for demonstrations and displays of various transceivers, antennas and other types of CB equipment from the following manufacturers: Hallicrafters, Mosley, General, Webster, Place Tron Corp., etc. and others . . .

There will be a charge of \$2.00 per person with children being admitted free, there will be drawings for various prizes.

Officers for the current year for the Albuquerque Citizens Radio Association, Albuquerque, New Mexico, are: President, J. R. Jolley, KLE2142; Vice-President, Willard W. Larson, KGC2430; Treasurer, Norman Mathis, KLE2420; and Secretary, Mrs. Sue Kelly, KBG-0800. Members of the Board of Directors include: R. W. Russell, KG0102, John Goff, KGB1029, and Lloyd Starr, KGB1371.

The A.C.R.A. Emergency Net is a separate unit of the club formed to work on a voluntary basis in assisting in search and rescue operations and to give whatever assistance may be needed in the community or surrounding territory. The Net also takes part in the March of Dimes, any and all telethons in the area, and any other fund drives where it may be needed. In addition the Net assists city, county and state law enforcement agencies whenever the need for additional communications arises. The Net Control Officer is Clark Speakman, 15W1793. Assistant Net Control Officers are: Lloyd Starr, KGB1371, John Goff, KGB1029, and Dave Ray, KGB1069.

The Net currently includes 59 mobile units and one permanent base station. The base station is operated by Clarence Juul, KLE0704, who is confined to a wheel chair and is almost totally disabled. Clarence is a real "work-horse" who really enjoys helping others whenever he can, and does a tremendous job in manning the base station during Net operations.

The first A.C.R.A. Net operation in May consisted in the search for a 14 year old girl who was reported missing. She was located with a friend not far from her home. On May 9th, the Net was asked to assist in the search for a seven year old boy who fell into the Rio Grande at Albuquerque and was swept away by the swift current. During the course of the search a C.A.P. major flying an aerial search mission hit a power line and was killed. While the mission to find the boy was unsuccessful, Net members spent an entire weekend at various shopping centers and street intersections soliciting funds for the family of the C.A.P. major. This weekend campaign realized \$2,400 which was turned over to the major's widow.

On May 22nd the Net was again called to assist in the search for the still missing boy. Net members worked side by side with the State Police, City Police, Sheriff's Department and the Civil Air Patrol. The search was continued for 24 hours and again proved unsuccessful. (The body was finally recovered about 25 miles downstream three weeks later.)

This is a story of CB in Action and not as an individual, but as a group of the finest people in the world the CB'ers of the Denver area.

On Wednesday afternoon, June 16, 1965, a tornado hit the Castle Rock and Palmer Lake districts just south of Denver with a deluge of cloudbursts which in turn filled the South Platte River which runs through the City of Denver causing one of the worst disasters ever to hit this city. With about two hours warning

CB'ers went to work. Along with the Police and Fire Dept., Civil Defense, the CB'ers went mobile in patrolling the river and bridges, setting up road blocks, warning people in the area to evacuate the region. When the twenty foot wall of water hit the Denver district, luckily there was only a couple of lives lost. Here the CB'ers did a big job in taking people to other places in their cars and trucks. Several shelter homes and buildings were set up to house these people and feed them. Due to the loss of electrical power and landline communications the CB'ers handled messages to relatives and friends about their loved ones.

For two days these tasks were performed by a possible hundred CB units many without a break all this time and no thought given to their own safety, or costs, or inconveniences at any time.

We had five different base units working with the mobile units which these people stayed on right around the clock. Many of these fine CB'ers missed going to work at their jobs to stay on another job that had to be done.

On June 17th, 1965, portions of Southeastern Colorado, was alerted to expect high winds with flooding. Due to the tornado and heavy rain with hail in the mountains. The Arkansas river was up and still rising, there was dam breakage along the Arkansas river. Also there was flooding from the Fountain river from Colorado Springs, which had a tornado hit with heavy rains with hail. The two rivers come together in the City of Pueblo, Colorado.

The CB'ers of Pueblo, called in all mobile units and set in action REACT, at 3:30 P.M. The crest of the flood reached Pueblo, around 11:00 P.M. on the 17th destroying several homes and making hundreds homeless.

The REACT team quickly went into action warning families of Pueblo, to evacuate and go to the shelters set up for them.

The REACT team quickly set up a chain of communications relaying warnings to the families of Junta, Colorado, and Lamar, Colorado, which is 100 miles from Pueblo, they also set in a link of communications to Fountain, Colorado, where the flood waters were racing from Pueblo, this proved very helpful as we had early warning of the crest to come. The CB'ers also set up a communications station at the Red Cross headquarters giving aid to the needy.

There was CB units stationed at all the bridges in the City as the flooding had caused cracking of the bridges and water was coming up over the bridges, this proved helpful giving instructions to the motorists as to the routes to travel.

There was a call for a boat around 12:00 P.M. to get some children which were cut off by the flood and in seconds the good CB'ers had a boat to the rescue. The City got through this flood without any casualties, thanks to our CB'ers being ready and willing to risk their own safety. The CB'ers worked all through the night of the 17th without fail or tiring, and providing an excellent backup system to the Amateur operators communications already set up.

On the morning of the 18th the Civil Defense Director of Pueblo County called the CB control asking that the CB'ers join them as communications were out and they needed the assistance of the CB'ers. This was done quickly and a communication link was set up with



President, Hank Rail, congratulating the Vice Pres., Al Phelps, on a job well done.

Colorado Springs, 40 miles north of Pueblo, passing on information and inquiries of missing persons

The emergency lasted until late P.M. of the 18th. The good CB'ers worked a full 25 hours without any sleep and without let up.

On the 19th came the clean up, the CB'ers were right there with their never failing assistance, relocating families and helping with the cleaning of homes, also reporting on the damage of the food.

The never failing CB'ers of Pueblo, Colorado, deserve a big hand on the good work done. Thank God for the CB'ers who risk their own safety to save others in a emergency like the Pueblo, Colorado CB'ers did.

#### NORTHERN

The second formal meeting of the proposed North East Council was held in Hillsboro, N. H., June 6, 1965, at 3:00 P.M., in the courthouse building. Representatives of twelve clubs were present, along with interested members that came to hear and be heard.

Don Spear of Newport, N. H., was asked by acting chairman, Ted Millis, to start the meeting and call it to order. He welcomed the people and then said that the nomination of the officers should be held as soon as possible, so that the council could have the necessary officers to start to do council business. The nomination came from the floor, but only the delegates were to vote for the nominees. The council officers are: Don Spear, President, KBD1095, Newport, N. H.; Blanche Vien, Vice President, KMA0504, Pittsfield, N. H.; Tom Gullage, Secretary, KKB1214, Concord, N. H.; Virginia Lyman, Treasurer, KMA0299, Laconia, N. H.

After the slate was voted in and a committee was appointed to draft a constitution, that would be sent to the clerks to have them approve or change, and then return to Council so that the changes could be rewritten into the constitution and then at the next meeting of the council the delegates may then ratify it.

Discussion then turned to dues—and it voted that the dues be \$2.00 per month per club payable quarterly, so the council could have the necessary funds to operate with.

The next regular council meeting will be in Concord,

N. H., September 12, at 3:00 P.M. Exact location will be sent to you later.

**Special Jamboree Report from Roy Shetter, 20W7473, S9, APRE.**

I have attended quite a number of CB Jamborees this year. On April 25th I attended a Trumbull County CB picnic near Champion, Ohio. Crowd was normal and everyone had a good time. Lots of nice prizes.

On May 16th there was a special meeting for all CB'ers at Bradys Run Park, shelter #2. It was to discuss the rules and regulations in Part 95. Many interesting items were discussed. Free coffee and doughnuts were served. I helped to promote this for all interested CB'ers.

On May 29th and 30th I attended the Wayne County REACT Jamboree. Many displays were on hand and many nice prizes were given by the organization. Lots of entertainment on Saturday night including round and square dancing. This was their first annual event, and was well planned and organized. This was held in Wooster, Ohio at the fairgrounds.

I will be taking pictures of all future events, and enclosed is a picture of one of their square dances.

On June 6th I attended the Tri-County CB Radio League of Akron, Ohio Jamboree. This was held at Chippewa Lake Park. The crowd was normal, many nice displays were on hand, and believe it or not, this editor took home their grand prize, a 19-inch portable TV with all the goodies.

Newly installed officers of the Rapid Fire Emergency Net of Nassau County, L. I., include: President, Jerry Gieir, KBG1385; Vice President, KKD0701; 2nd Vice President, Terry Goldstein, KBI2124; Secretary, Ronnie Kalikou, KMD0724; Treasurer, Mike Mais, KMD1341. Interested parties should contact: P.O. Box 372, Levittown, L. I., New York.

With the acquisition of the emergency trailer the Finger Lakes CB Club has now become one of the most versatile disaster and emergency units in the area.

The trailer provides an emergency control center that is mobile and efficient. It can operate from either 110 volts power lines or from its own 12 volts power supply. It carries two transceivers and a control desk for the co-ordinator, and is equipped with two bunk beds and

## CRYSTALS are not all the same!



**INSIST ON  
TEXAS  
CRYSTALS  
BY NAME!**



TEXAS CRYSTALS quality is outstanding as evidenced by use in numerous government space projects where there's no compromise with quality, reliability or accuracy. The same dependable performance is yours for CB operation on all 23 channels at only \$2.95 per crystal.

If your dealer is temporarily out of stock or does not carry Texas Crystals, send us his name along with your order. Minimum order, check or C.O.D. is \$5.00. Add 5¢ per crystal for postage, 10¢ for air mail.



**TEXAS CRYSTALS**

1000 Crystal Drive  
Fort Myers, Florida 33901  
Phone 813 — WE 6-2109



Send for Free Catalog with Circuits

4117 W. Jefferson Blvd.  
Los Angeles, California 90016  
Phone 213 — 731-2258

A Division of Whitehall Electronics Corp.

all necessary equipment for continuous 24-hour service. Twin coordinated antennas permit simultaneous reception and transmission, or transmission on two channels at the same time without interference. In an emergency the club could put 50 mobile units and 12 portables in the field, to work in conjunction with the mobile base in the trailer.

The club is closely affiliated with the Glen Regional CB Club at Watkins Glen and the Phelps Communications Club. William Snyder, past president of the Finger Lakes Club, is in charge of the Emergency Trailer and can be contacted by radio on 20Q3190 on Channel 11 or on land phone—789-2668. A CB antenna was purchased and installed on the roof of the City Hall in Geneva for use in emergencies.

On Thursday afternoon, June 10, about 5:15 P.M. a violent storm thought by some to contain Tornadoic Activity hit the twin cities of Bangor and Brewer, Maine. The duration of which was no more than one half hour, during this time extensive damage was done. Major items were fallen trees, broken power lines and crushed automobiles. Fortunately no serious injuries were counted.

When the sun finally came out again after the storm, REACT came out with it. Searching the city of Bangor for damaged areas with their mobile units locating and sealing off danger areas and reporting these to Police and power company officials, units remained in these areas until the danger was elevated. Re-routing traffic and warning pedestrians away from these places. Power outages were extensive and lasted well into the following day.

KMA1814, Melvin Blackwell operated net control for the REACT Team directed by S/Sgt. Frank Jones, USAF. The Pine Tree Five Watters REACT Team also participated.

The timely action of all individuals involved probably prevented untold injuries which could have resulted from live wires strewn in the street.



Newly elected officers of the South County Rebels CB Radio Club took their oaths of office, at a Dinner Dance held at the Kiate Hills Country Club. Members of the new Executive Board are: President, Ken Spann, KFC1360; Vice Pres., Bob Taylor, KLA5259; Treasurer, Rodger Flick, KLA0699; Sect., Jim Slack, KLA4770; Membership Chairman, Ken Miller, KFC3889; Publicity Chairman, C. R. Comfort, KFD2121; Activities Chairman, John Hansen, KLA0963.

Club meetings are held on the second Sat. of each month at 8:00 P.M., visitors are always welcome to attend.

**EITHER YOU'VE GOT IT OR YOU DON'T!**

I guess I can safely say that I have the smallest mobile in the world.

But let's start at the beginning; I am 20 years old, and I have Muscular Dystrophy. Last year, my father bought me an electric wheel chair from the Everest & Jennings Co. of Los Angeles. Now I could move around without any outside help. It was great, but if anything happened, i.e. a part of one of the two motors broke, I was left helpless and I couldn't do anything. First, I thought of having a walkie-talkie so I could contact my base. But my father had a better idea; he told a friend of ours, Yvon Dumont, an electronics

## Solid-state CB mate

The best way to ring up more 10-2s with the new solid-state transceivers is by using one of the new low-impedance Sonotone Ceramikes®. They are designed specifically for all-transistor transceivers. Transmission is loud and clear, and Ceramikes are built to take abuse. Get the low-impedance "CM-3050" or the "CM-3050M" with Magnetic Mount, today. Also Models "CM-30" and "CM-30M" for tube transceivers. Prices start at \$15.75. Write for Free catalog SAH-7.



Sonotone Corp., Electronic Applications Div., Elmsford, N. Y.

# HALT!

## CB'ers & CLUBS! CH. 9 DECAL ONLY 50¢ ppd.

Get this big, easy-to-see, 3 color Channel 9 Monitoring decal for your car window! Boost better communications on CB by pushing and using Ch. 9 as the National CB Calling and Monitoring Channel. Immediate delivery. Only 50¢ each, bulk orders of 10 or more, 30¢ each. Dealer inquiries invited. Order NOW from:

**Channel 9  
S9 Magazine  
14 Vanderver Avenue  
Port Washington, N. Y. 11050**

# The New

## Devant "Special"

### Tops in CB Performance!

Specify **MOSLEY** ....  
.... For Added Gain.

The New Devant Special features a stainless steel Top Hat of 10 inch radials giving you extra db. gain (4.0 db. gain over Standard Ground Plain: 6.5 db. gain compared to isotropic source). Antenna comes complete and ready to assemble. Guying is unnecessary. The CB Devant Special is guaranteed for . . . Three Years. This superior quality antenna is another of the many outstanding antennas produced by Mosley, the World's Leader in "Quality" Communication Antennas! See this rugged, power-packed antenna at your Dealer's Display Room!

For more detailed information on the Devant Special, Write: Mosley Electronics Inc. Today!

# FREE

Booklet Available!  
"Antenna Hints for CB Communications"

## Mosley Electronics, Inc.

4610 N. LINDBERGH BLVD.,  
BRIDGETON, MISSOURI, 63044.



This is me, XM53463, in my "mobile." This photograph was taken by XM53307, Pierre Dozois. The CB is a Messenger III, and the antenna is an M-130 "Mighty Mite." Best of 73's to all S9 readers.

technician, to get the smallest transistor unit he could find: he got us a Johnson Messenger III, the same unit we have in our car, a '64 T-Bird. He also got me an M-130 "Mighty Mite" antenna, by antenna specialists. That also is very small.

For power, I take 12 volts from my two 6 volt batteries connected in series. In my chair, I can get up to as much as 7 to 8 miles distance. The only thing missing is a good ground plane for better performance, but I never go farther than 3 to 4 miles from home. On base, I use a Courier 1M by e.c.i., and an M-119 "Scanner" by antenna specialists.

So now I think I can safely say that I have the smallest CB mobile in the world! Either you've got the CB bug or not. Do you think I've got it?

### CANADA

The appointment of the Cape Breton Citizens Band Club as headquarters for a newly formed radio emergency citizens team, serving the Cape Breton area on a 24-hour basis, was announced Tuesday by the organization's head office in Chicago.

The Cape Breton club is part of a nation-wide movement called Radio Emergency Associated Citizens Team which is sponsored nationally by the Hallcrafters Radio Company.

Objectives of the movement are to provide a supplementary system of radio communication for local emergency situations and to promote correct and efficient use of radio service.

Co-ordinating the Cape Breton effort will be L. J. MacKeagan of Sydney, president of the Cape Breton Citizens Band Club. He said that a monitor station will be in operation soon at Sydney and Port Hawkesbury for the purpose of relaying emergency messages to proper authorities.

"In many communities, General Radio Service has proved the difference between life and death," Mr. MacKeagan said. "From an accident scene on a remote country road a citizen who is equipped can instantly alert an ambulance, a doctor and hospital staff.

"He could also save previous moments in disaster situations where emergency oxygen or a resuscitator is needed."

Mr. MacKeagan said the recent situation on remote Flint Island where a child, bitten by a dog, had to be removed to hospital is a good example of the effectiveness of General Radio Service and "REACT."

General Radio Service was formed in Canada by the department of transport to satisfy a need for low-cost, two way radio for businessmen. Today, any citizen over 18 years can operate a private general radio service communications system after he receives his radio license.

Mr. MacKeagan said that 132 licenses have been issued in Cape Breton.

### PACIFIC

The Oregon Trail CB Road Patrol over the Memorial Day weekend, was deemed a success after making some 41 assists to motorists in distress.

The Patrols operating out of The Dalles, Wasco and Maupin areas, travelled the highways Friday evening

and Monday afternoon and evening, logging over 2000 miles in these three areas.

The Club would like to express their appreciation for the cooperation and assistance received from The Daily Chronicle, KACI radio, KODL radio and the local and State law enforcement agencies.

Also, a note of thanks to the following members for their extraordinary contributions of vehicles and time to make this Patrol a success:

The Dalles: Mr. and Mrs. James Lee, LeRoy Anderson, Mrs. Arthur Anderson, Mr. and Mrs. Eugene Christenson, Deryl King, Leon Smith, Dale Shuey, Jr., Randy Wink, Jack Dillard, Mr. and Mrs. Charles Hurd and Mr. and Mrs. Paul Dowling.

Wasco area: Mr. and Mrs. Martin Pshigoda, Mr. and Mrs. Jerry Barnett, Mr. and Mrs. Richard Rust and Mr. and Mrs. John Alley, Jr.

Maupin area: Mr. and Mrs. Dolph Baker, Fred Gearhart and Hugh Adams.

To the above named and all other members and non-members alike who participated, we would like to say "Well Done" and give our thanks.

The Oregon Trail CB Club met at the Wasco County Courthouse Annex Building, The Dalles, Oregon, June 8, 1965.

Highlight of the evening was the drawing of the winning numbers of the raffle the club has been conducting. First prize of a Mustang CB radio was won by Mr. Art Means, Sr., The Dalles. Second prize of a M-67 CB antenna was won by Mr. G. A. Nowling, The Dalles.

The members of the club would like to thank all who participated in this raffle, both those who worked so hard to sell the tickets and those who purchased the tickets.

On June 12th the McKenzie C.B.R.A. sponsored a Bowl-a-break at the Firs Bowl in Eugene, Oregon. It was our first "go" at a coffee break and it turned out very well. A delicious buffet dinner was served, after which the pins started to fly. Prizes for high game for men and women were presented to Roger Bishop, KLC-1464 of Albany, Oregon and to Stella Stull (XYL of KLC0885) of Cottage Grove, Oregon. Numerous other prizes were donated by local CB dealers and presented



throughout the evening. There were door prizes galore. The Westerners Lodge #18 took home a nice folding table for having the most members present. "Bud" Stump, KFG1297, the president "gathered it in" for the organization. The E.M.C.O.S. from Klamath Falls collected a thirty cup coffee maker for having traveled the greatest distance. Jessie Barker, KNC0087, its News Editor, took the pot home to roost. We hope the gifts serve everyone well. We wish to thank all the 150 fine people who came to make the evening a terrific success. Our thanks go to Jerry Tynsdale, KFG0730, Don Scott, KLC1171 and all their helpers for the fine job in handling and planning this affair.

Many of our members traveled to Stayton, Oregon over the Memorial Day week-end to camp over-nite and to take in the Santiam River White Water Challenge. Those attending were: the Ora Velkinburgs, KLC1733, the Art Moodies, KFG0582 and KFG0124, the Bill Winns, KLC0691, the Chet Keiths, KFG0784, the Chuck Maesners, KFG1698, and yours truly, Hank Velkinburg, KLC1776. KLC1733 and KLC1776 assisted the Tri-County Transceivers on their emergency communica-

# NOW... You can have your PR's Calibrated .002%



CB operators who have switched to .002% PR CRYSTALS are more than enthusiastic about the advantages of closer tolerance. They agree it is worth many times the extra dollar it costs. If your CB dealer doesn't have them in stock, he can get .002% PR CRYSTALS for you in a hurry. Ask him.

Z-9R — .486" pin spacing; .050" pin diameter; .758" above pins; width .720"; depth .309".  
 Calibrated .005% ..... \$2.95 Net  
 Calibrated .002% ..... \$3.95 Net



Z-13 — New small size, for transistorized and compact equipment. .192" pin spacing; .530" height above pins; width .402"; thickness .150"; .040" diameter pins.  
 .005% ..... \$2.95 Net  
 .002% ..... \$3.95 Net

## PR Crystals

PETERSEN RADIO COMPANY, INC.  
 2800 West Broadway, Council Bluffs, Iowa

# 23'er...



## the finest Citizens Band mobile transceiver...

The 23'er twenty three channel, all transistor Citizens Band transceiver is the choice for any mobile application — car, truck or boat — because only the 23'er has the Squires-Sanders Noise Silencer. This exclusive device virtually eliminates interference due to noisy ignition systems and saves up to \$35.00 in installation expense for ignition noise suppressors. Weak signals are clearly intelligible on the 23'er under electrical noise conditions that would make the ordinary transceiver almost helpless. The 4 watt audio output and the large 3 x 5" front facing speaker are important features for mobile use also, to provide powerful voice reproduction that can be understood over the background of highway tire noise and wind whistle.

The ultra sensitive 23'er receiver (number one in a recent impartial test of the currently available transceivers) is a must for mobile — weak signals can be heard clearly for greater distances.

Compare just some of the other outstanding features of the 23'er and be convinced that it is the only unit for your mobile installation:

**ALL TWENTY THREE CHANNELS** — complete coverage of both unit to unit and station to station communication channels

**ALL SILICON TRANSISTOR** — the least battery drain

**SMALL** — it fits anywhere, even in the compacts

**LIGHT** — weighs only 4 lbs.

**SIMPLE TO OPERATE** — only three controls

**COLOR CODED CHANNEL DIAL** — specially marked for read-at-a-glance identification of channel 9 (H.E.L.P.) and legal station to station channels.

**PUBLIC ADDRESS AND REMOTE SPEAKER** — Provision for converting to Public Address service with a small, inexpensive accessory and provision for plug-in external speaker for either CB or PA service.

**PRICE** — You will save over the cost of less expensive equipment since all crystals are furnished and no ignition suppressors are required. **READY TO OPERATE \$235.** AC Power Supply for base station operation \$24.50.

See your distributor today or write to 23'er Department

## Squires-Sanders, Inc.

Millington, New Jersey 07946



**SPECIAL OFFER:** If you would like an 8 x 10 glossy photo of the 23'er and a shirt pocket size call book to record frequently contacted station call signs, send 25¢ with your request for information.

tions network. The camp grounds were wonderful and many new friends were made eye-balling around the camp fires.

Our REACT team has affiliated itself with the American Red Cross local chapter. A drill is scheduled for June 2, 1965. Progress is being made with a program for cooperating with the Lane County Sheriff's office.

Our next BIG event will be the all-day JAMBOREE, Sunday, September 12th, at the Dan Tracer Farm, KFG-0595, located just outside Lancaster, Oregon. We will have door prizes, games, refreshment stand, pot luck, card exchanges, dealer display booths, kids corner, guide cars, and FUN, FUN, FUN! Plan to visit us if you are in our area that day.

**SPECIAL GUEST STORY BY S9, A.P.R.E.  
MICHAEL J. LA VERSA, SR.**

### "MAN-TRAPPED! !"

"Any base station copy me?"

"Any base station copy me?"

Must be some kid with a walkie-talkie, I thought. This was the chatter at the moment on my Pierce-Simpson Companion I—channel 11.

Being on vacation from my job as an Electrical Tester for G.E. in Pittsfield, Mass., and because we couldn't go away this year, I had been trying to amuse and entertain my family in one way or another. This beautiful Saturday evening in July seemed just perfect for an outdoor movie. A Walt Disney feature; an adventurous trio—two dogs and a Siamese cat, looked very attractive in the ads, so-o-o, three of my boys were all for it. At about 7:45 p.m. we were on our way to a soda and pop-corn evening.

Suddenly, the voice on 11 grew more urgent and insistent—"Does any base station copy me? This is an emergency call! ! ! ! I hesitated only a moment to see if a base station would respond. There was nothing but total silence. Quickly picking up the mike, "This is KKA462, the handle is Mike La Versa, please give your call letters and tell me about your Emergency! ! " This was the ensuing conversation:

"This is Norm, Norm Lissee, KBC4991, you know me, I drive a taxi and I came to 11 to get some help. My base can't copy me from here. I just came up to a wreck with a man trapped inside. Are you base or mobile?"

"Mobile near the Artery Arcade," I answered, "Standby a second, Norm, my base should be on."

"Break, here's base," said my wife.

"Listen to the conversation, Honey, and you will know the story."

"Go ahead, Norm," I continued, "Tell my wife the situation and what she can do to help. I'll standby."

"I'm on State Road," said Norm, "near the old mill and the Community Club—there's a Volkswagen bus with its front end smashed against a tree. The driver is pinned behind the wheel and we can't get him out. We need a Doctor and an ambulance. The guy is bleeding pretty bad! You better call the Police Department, too!"

"Go ahead, Honey, make those calls—Police, ambulance, and Doctor. I'll standby and will be headed out State Road to see if I can help Norm."—"KKA462 will be 10-23," I closed.

"10-4, this unit 10-6"—she promptly responded. Then—Silence settled in like cold death.

The entire conversation had taken place on channel 11. This was the call channel. Not an alien word had been spoken nor had a single call interrupted us during our entire exchange. Everyone had done a 10-23 to give precedence to the emergency. It made me proud of every local CB'er!

"Mike, are you still in there?" came Norm's voice. "Yes, Norm, I'm less than a mile from you. What can I do for you?"

"Stop somewhere and see if you can get a crow-bar. We need it very much! The guy is still stuck in there. Your wife make those calls?"

"I'm near Ken Rice, He should have a bar of some kind at his gas station!" As I spoke the last few words, the fast approaching scream of a siren was deafening—and a Police car went speeding by.

"The Cruiser just went by me, Norm—there's your answer!"

"Yeah, O.K., Mike, I see him coming like h--- now! Wow! —is he traveling! !"

"O.K., Norm, this unit 10-23—" and I turned into



Ken's Gas Station. While my boys kept an ear to the unit for any further calls, I dashed into the station; made my request for a crow-bar, got it, and ran back to the car. Norm called and I reported my success—and was on the way to the scene.

In less than a minute, the entire picture came into view. Several men were crowded near the door of the smashed vehicle whose front end was mashed against a large tree. People from the neighborhood started to arrive—the natural curiosity of the masses—lured by the wailing Police siren.

I parked on the right shoulder of the road and ran across the street toward Norm. We took the crow-bar over to the wreck and some of the men started to probe and pry.

A wounded man about 25 years of age was laying across the seat, conscious and in great pain. His shirt front was soggy with blood from a lower chest wound. He was being held in such a position as to relieve the strain on his trapped foot. One man was in the rear seat, reaching over and supporting the injured man in a partially sitting position. Another man was near the front door on the passenger side supporting the right shoulder and head of the injured man, and bathing his face with a cold towel. They could not remove the man from the car because his left foot was caught between the base of the seat and part of the car body which had been pushed in from the front.

A quick-thinking motorist asked that we hold traffic. He made a quick U-turn and sped back to Ken's Gas Station. In no time at all, he was back—with an acetylene torch and Ken. Now, things really started to look promising. One of the willing helpers, in his efforts to shield the injured man's leg, was severely burned on one hand from the intense heat of the torch.

"Hey, Dad," called one of my sons, "Mom says the doctor can't come unless the Police call him!"

"O.K., Chuck, got the message—Clear the channel!"  
—The message was relayed to Police Headquarters via their own radio.

Again, the loud and eerie sound of a siren engulfed the atmosphere, the ambulance had arrived and a stretcher was being readied for the injured man. An Emergency Fire truck had arrived just moments before—was also standing by.

There were about two hundred people milling around. The accident had happened near an outlying residential district of our city. Despite this, the traffic was kept moving rather briskly by one Policeman and a couple of helpers. Yes, Norm was still there, too, assisting with the traffic problem. The other Police Officers on the scene was instrumental in directing the rescue operation, having assumed responsibility upon his arrival.

When the man was finally freed from his predicament, the ambulance attendants carefully but quickly loaded him on the stretcher and into the ambulance. The man with the burned hand was also seated and the vehicle sped away to the hospital.

Slowly, the crowds of people dispersed, drifting back to their homes—TV's, etc.—to whatever they had been doing. In a matter of minutes, it seemed, the traffic assumed its normal, hectic Saturday evening pace.

Norm had asked repeatedly about the Doctor and it was at this time that I explained why the Doctor had not arrived on the scene. A Doctor had been standing by awaiting verification from the Police Department. The physician did go to the Hospital and handle the case upon its arrival there.

The injured man in this case has never known and still is not aware of the amount of cooperation, endeavor and thoughtfulness it took, and the part so many people played in his unfortunate episode. He doesn't know what CB is and that had assisted him!!

The next edition of the local paper (on Monday afternoon) carried a three line article about an accident, where it happened, and that a man was hospitalized.

That is why, John -----, YOU never knew this part of your accident and about CB'ers and some others that had helped.

In CIVIL DEFENSE and in any Emergency—you can be sure—CB'ers and REACT here in the northwest corner of Massachusetts have been and will continue to be on the ALERT, READY and WILLING to Serve!!!

That's All—FINI!!

#### EXTERIOR

S9, A.P.R.E., Hawaii, KIG0307 reporting.  
On June 12, 1965, members of the District 1, Civil

# The No. 1 CB Antenna on The Market Today

## Devant '1'

CB'ing was never like this! . . . . .  
When the DEVANT "1" Came in the picture, countless CB'ers throughout the nation became aware of a real "Power House" of an antenna.

This remarkable base station antenna features 3.4 DB gain; VSWR of 1.5/1 or better, Feed Point Impedance of 52 Ohms, Assembled Weight, 7.5 lbs. Has extremely low angle radiation. Directs the signal equally well in all directions.

This weather resistant antenna is constructed to last, through high winds (wind load EIA Std. of 41 lbs. at 80 MPH), through extremes in weather! Antenna mounting is simplified, just mount the lightweight antenna on the mast, tighten two screws and lock nuts.

Consider buying the best . . . . .

Net Price \$22.76

## CB Mobile Antenna

### 'Devant "2"

For mobile to base operation the ultimate in a communication antenna is the Devant 2. This slim lined Devant 1 companion is designed for rooftop or trunk installation, has an SWR less than 1.5/1 on all 23 channels, requires no tuning.

Net Price \$14.50

(For further information write)

## Mosley Electronics, Inc.

4610 N. Lindbergh, Bridgeton, Mo., 63044.

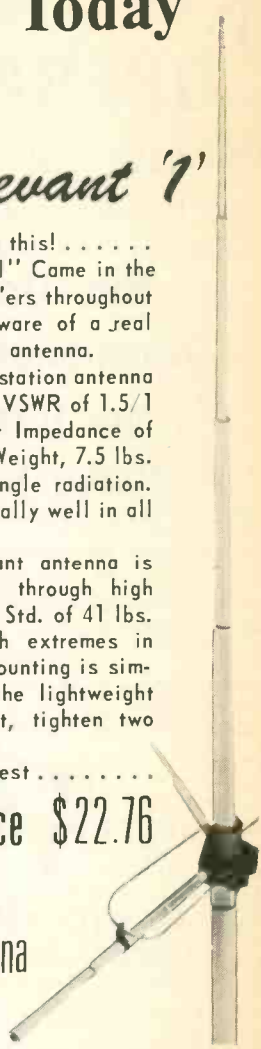

# ATTENTION! CB OPERATORS

SAVE ON CITIZENS  
RADIO EQUIPMENT

Buy Used And  
Discontinued Models  
From International  
Radio Exchange

Select that extra transceiver for mobile or base installation, or equip a new station. Our stock includes International types as well as other makes.

Write Today For A Complete  
List Of Equipment In Stock



**RADIO EXCHANGE**  
18 NORTH LEE, OKLA. CITY, OKLA.  
A Division Of International Crystal Mfg.  
Co. Dealing In Used Citizens  
Radio Equipment



Defense, Honolulu Area Command got together and formed the "ALIMANU RADIO CLUB."

Nomination and election of officers were held and the following members will serve as: President, David Kahi, KLS0123; Vice-President, Bill Kelikolio, KIG-0170; Operation Officer, Frank Machado, KLS0013; Radio Officer, Walter Kaleikini, KNS0037; Recording Secretary, Al Duhaylonso, KNS0008; Corresponding Secretary, Jerry Alidon, KNS0031; and Treasurer, Jimmy Pagan, KLS0049.

Other members attending were: Tommy Bautista; John Manloyo, KNS0020; John Costales, KNS0074; Henry Costales; Henry Rabago, KNS0066; Merl Martin, KLS0141; Bert Kalaikai, KNS0047; and Raymond Romo, KNS0062.

Meeting will be held every second Saturday of the month. The above CB Club "ALIMANU RADIO CLUB" monitor Channel 11 (27.085 mc.).

Plans are considered to open for membership to all CB's and "Ham" Radio Amateur operators residing within the areas boundary from Tripler General Hospital to Ewa Beach. Also considered were plans to start an activity similar to REACT to primarily serve in general communities boundary within the areas.

Do contact Jerry Alidon, KNS0031, 4153 Keake Drive, Honolulu, Hawaii 96818 for further information.

## REACT AND MISSISSIPPI RIVER FLOOD

Things are just beginning to quiet down out this way. I wanted you to come out to Fulton during the height of the flood and tried to get word to you so you could come in and see CB being used.

We were an island city (pop. 4,000) for 3 weeks. I spent 4 weeks inside myself. When the water closed in around the town our Conservation men were inside and carried the bulk of the load.

I never imagined so many problems could arise and that CB could be so useful. All supplies had to be hauled across 5 miles of water, over fields and highways.

There were 5 "Ducks" being used, all CB equipped. We had mobile units at all points of takeoff which changed with water levels, all points being numbered and mobiles working shifts. There was a base station in Flood Headquarters, and I operated from my car using a CB 3A on channel 9, and a Police 39.5. I was operating mikes with both hands for 1 to 14 hours a day. A check had to be made on people coming and going. No one came in unless cleared through mobile units and my car. Many occasions arose which I don't know how we would have handled without CB.

The Meredosa levee, protecting thousands of acres of farm land and homes, was a critical spot. If it failed there would have been 10 feet of water over Hillsdale (pop. 600). It is Rt. 84 below Albany. It was sandbagged 4 feet high and a mile long. My daughter, Karen Bitler, was Post 3 using a CB 3A. Volunteers were called for sandbagging 24 hours a day. One night during the cresting period of the flood she called and said the engineers needed plastic film to protect the sandbag levee. It could be brought across the Gateway Bridge from Clinton, Iowa, if we could bring it down river the rest of the way by boat. While I was asking for information as to the weight and bulk of it, Nitrin Company broke in on channel 9 and said their helicopter would handle it. They came in with several loads the next day, landing in Karen's back-yard.



On another occasion a woman came around to Post 9 wanting sandbags for Johnson Creek levee. Our REACT mobile unit called me. I knew the city of Fulton had extra bags on hand. The mayor was standing by my car and had a city truck load the bags, take them to the army helicopter on the hill, and before the woman got back around to the levee the sandbags were dropped.

### CENTRAL

At a special meeting held recently, the EMERGENCY COMMUNICATIONS TEAM (Cincinnati area), elected Carl Wright, 19Q6324, as Coordinator to assist Lew Prine, KLN1975, who was elected earlier at the regular annual meeting. Craig Ellison, KLC2216, was elected secretary-treasurer to succeed Tim P-ice, KHH-0415, who was elevated to the post of Assistant Coordinator. Besides the monthly meetings held by the Team, special social events are scheduled quarterly. The latest venture of the ECT was a stake-out of a school building which had been vandalized. Most of the community activities of the group are in cooperation with the local area police departments or civic groups. Traffic direction for the annual Forest Park Baseball parade was accomplished at the opening of baseball season. Team members monitor 8, 9, and 14, and the club call (used for club business and emergencies only) is KLM9272.

The Northern Hills CB Club patrolled Interstate 75 leading into Cincinnati during the busy Memorial Day weekend. They were kept busy by motorists stalled along the highway and others stopped for various reasons. The Northern Hills Club has over 200 members and several pieces of motorized equipment. Members are from southwestern Ohio and Northern Kentucky and some come quite long distances to attend the meetings. Northern Hills is a REACT team and monitors channel 9, as "Cincinnati REACT."

The CRYSTAL WIZARDS of Muskegon, Michigan, began their meeting this month with a pot luck supper. On display was a Pearce Simpson 23-Channel owned by Rod Pesch, KDC2221.

Mr. VanDyke, KH12531, from Fruitport (Mich.), was accepted as a member.

July 25 saw a CRYSTAL WIZARDS casavan gathering at the Belt-Line Shopping Plaza. They then traveled south to John Ball Park in Grand Rapids where the meeting took place.

On the 11th and 12th of September, 1965, the Coshocton County REACT Team, Inc., will hold a Regional meeting of REACT teams in Ohio and surrounding states. This meeting will be held for the discussion of various topics such as: Financing, codes, drills, 24-hour monitoring, law enforcement, local team problems, and etc. National REACT headquarters in Chicago will be sending representatives and a speaker. The FCC will be contacted in an effort to supply a speaker. Registration will begin at 10:00 A.M., E.S.T., on the 11th of September with discussions beginning at 1:00 P.M., E.S.T. On Sunday the meeting will begin at 2:00 P.M. with the various speakers addressing the entire body of REACT teams. There will be a registration fee of One Dollar (\$1.00) per person and adm tance only to those persons with official REACT ID cards. Now, here's what you have to do: (1) Determine the number of members that will be attending. At least five (5) members will be needed to attend all seminars. (2) Motel and hotel reservations are limited; state price willing to pay and number in party in your letter. (3) Displays—If your REACT team has any type of emergency equipment for display, state in your reply. The meeting will be held at LAKE PARK One (1) mile NORTH of Coshocton, Ohio, on State Route Number 76. Here is a great opportunity for your REACT team to gain valuable information and know-how. This meeting is for your benefit, so let's support it 100%. For further information and reservations, contact: Coshocton County REACT Team, Inc., P.G. Box No. 22, Coshocton, Ohio—% Steve Dawson, President.

The Missouri Valley Breakers, one of the newer Radio Clubs in K. C. is fast becoming one of the important CB groups in North Central Missouri. Although membership is small they are dedicated to making CB more than just a party line for the latest gossip. Their meetings are held on the second and fourth Thursday of each month in the Raytown Savings and Loan Auditorium. Each member is responsible for a meeting to provide useful and interesting information of vital interest to the other members. On June 27th, the Club sponsored

## KAAR MOVES CB AHEAD 5 YEARS ...OVERNIGHT



# KAAR SKYHAWK

335



- HAND-SPAN COMPACTNESS
- ALL SOLID STATE
- 23 CHANNELS (no limit on channel choice)
- 2 YEAR GUARANTEE

If you've been waiting for the CB transceiver that has everything . . . move up to SKYHAWK!

## YOU GET ALL THESE SKYHAWK FEATURES NOW...No Waiting

- Tantalum capacitors
- Sealed-plug in relay
- Filtered power leads
- Paging
- External speaker jack
- Illuminated signal level meter with dynamic modulation indication
- Glass epoxy circuit board
- Provision for plug-in selective call
- Amplified Zener diode voltage regulator
- Fine tuning (Varactor-technique) on channel selector
- External metering socket
- Inter-station and system channels identified
- Smart chrome and charcoal gray epoxy finish

**199.95**

complete with power cable, mounting bracket, crystal for channel 9 "Help" Channel

\*OPTIONAL

6 pack crystals (for Channels 10-11-12-13-14-23) **19.95**

22 pack crystals — all 23 channel operation

**69.95**

FCC STATION LICENSE REQUIRED. ALL USE MUST CONFORM WITH PART 95, FCC REGULATIONS.

## KAAR ENGINEERING COMPANY

Member: CANADIAN MARCONI COMPANY Group



2250 Charleston Road • Mountain View, California



a swimming and potluck picnic. Another picnic will be held Aug. 1. Anyone interested in joining a family type CB Club should contact KGI7201, Jack Phipps, Treasurer, or 17Q3837, Bob Ahlstrom, Sec.

The Sedalia Citizens Band Radio Club held their annual CB Jamboree, June 20th, at the Mo. State Fair Ground. The outstanding event of the Jamboree this year was the formation of a State CB Group (note Newspaper Clipping) The statewide CB group will be known as the Mo. State Citizens Radio Service. Paul Stewart, St. Joseph, Mo. was elected president, and Hurless King, Chillicothe, Harold Hawkings, Jefferson City, and Norman Burns, Carrollton, as Board Members. The state group already claims 335 members and hopes to provide a statewide emergency and service

group for local communities as well as for visitors to our state.

The Jamboree had an attendance of over 1,000 visitors this year and many manufacturers displayed new CB equipment. Music for the day was provided by the Coments and Templeton bands and several entertaining events were emceed by Nelson Stonner. Walter Boone, 108 S. Prospect, won the five watt CB radio that was given as grand prize. The Sedalia club monitors Ch. 11, so give them a call when in the Sedalia, Mo. area.

The Richards Gabor Air Force Base CB Club has held a coffee break the first Sat. night of each month for the past year. All Area CBers are invited as well as the many CB Clubs in the area. The event is held in the Air Bases Delta Wing Club, and great quantities of coffee and goodies are furnished by the Airmen CB'ers. The coffee breaks are a great success and attendance usually runs into the hundreds. This monthly event has done much to bring harmony to the K. C., CB area.

The Nineteeners Citizens' Radio Service is a non-profit, public service organization of northeastern Ohio. While its members are mainly from the Akron area, some do come from neighboring towns and cities as far away as Cleveland.

The primary purpose of the 19'ers is to provide needed communications for civic events. With the exception of one event, a listing of the club's activities may be found on the back of the enclosed card. The exception is the Fairlawn Fourth-of-July Parade, which is being run for the first time this year.

The club holds meetings on the first Saturday of every month at 8:00 P.M. The meeting place is the Number 1 Fire Station at 1864 W. Market St., Akron. All interested CB'ers, wives, and friends are invited to attend.

The Twin Cities CB Radio Club, The Tri-County CB Club and the Communications CB Club had their Get-Together, Get-Acquainted party recently at the Rendezvous Sisters Lake, Michigan. Highlights for the evening were entertainment, games and prizes, refreshments were served by the host and hostesses. News from Stella Hardin, KHG4644.



## The most important feature of the new Amphenol 510-B



# doesn't appear on its spec sheet.

Many things will impress you about Amphenol's first entry into CB—the Model 510-B. Our literature tells you all about the single-ended transmitter which exceeds 3½ watts. Our spec sheet will describe the latest planar epitaxial silicon transistors used for the first time in a CB unit. Sensitivity of the receiver 0.5 microvolts; 40 db selectivity at 10 kc and dual conversion IF will be also covered.

The literature goes on to tell about a speech clipper which permits full voice power short of over-modulation; and the full range squelch control. Also covered are 8 crystal-controlled channels and a crystal-correlated 23-channel tuner.

You'll soon realize the fully transistorized 510-B is a dependable, no-nonsense transceiver. In a compact housing it can be mounted anywhere for AC or DC operation. Sensibly priced at \$199.95.

So what important feature isn't covered in the spec sheet? *It's the Amphenol name*—your assurance of equipment you can lean on in emergencies, a guarantee of honest specifications, of full compliance with FCC requirements in an American-made device. It's the mark of engineering leadership that combines top performance with reasonable price.

Rounding out the line are two solid-state, 2-channel hand-held transceivers: C-75 1.5 watt model at \$114.50; C-60 100 mw, \$89.50. Selective Call, portable pack and other accessories are available.

See the most advanced CB line at your Amphenol communications distributor.

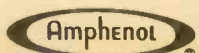

**DISTRIBUTOR DIVISION**  
Amphenol Corporation  
2875 S. 25th Ave., Broadview, Ill. 60155

# COMING EVENT CALENDAR

Second annual High Knob CB Jamboree at Norton, Virginia. Elevation is 4,265 ft. September 3-4-5. Johnson CB grand prize, many other prizes. Ole time fiddlers contest, Ole Mountain Man who is now famous over the U.S., Wagon Train Granny. S9 Reporter at large. Registration fee 50 cents.

**PICNIC-COFFEE BREAK-JAMBOREE**, September 12th at Dan Tracers, KFG0595 place, located at Lancaster—5 miles north of Junction City, Oregon. The event is sponsored by the McKenzie, CBRA.

Second Annual GRS Convention, September 10th, 11th and 12th at the Canadiana Hotel Highway 401 and interchange 59 (Kennedy Road) in Toronto, Ontario, Canada. Contact: Second Annual GRS Convention, Att. Larry Higgins, Box 73, Whitby, Ontario, Canada.

September 4th, 5th and 6th, The 4th Annual Hillbilly CB Jamboree will be held at Maryville, Tenn., Fairgrounds. Grand prize is a CB rig. Contact: G. H. Tarpley, KKM5987, Route 4, Maryville, Tenn.

The Cowan CB's Jamboree, September 26th at Smith Auditorium, Memorial Park, New Castle, Indiana. Event from 9 A.M. to 5 P.M. Contact: O. W. Clawson, Box 38, Cowan, Ind.

The Naugatuck Valley CB Radio Club is holding a state wide Jamboree, October 3rd, Lake Quassapaug Pavilion, Route 6A, Middlebury, Conn. Contact: Ed Duvel, 57 Lounsbury Street, Waterbury, Conn.

October 10th, the Bell City CB Radio Club Jamboree, Lake Compounce, just off Route 72, Bristol, Conn. Contact: Ted Singleton, P.O. Box 753, Bristol, Conn.

September 4th and 5th, the Citizens Radio Ass'n of Crawford County is holding its 2nd Annual Jamboree at Crawford County Fairgrounds, located on Route 77, just outside Meadville, Penna. Contact: C.R.A.C.C., Box 456, Meadville, Penna.

Three Washington State CB Radio Clubs will host the International Camp-Out, September 4th, 5th and 6th, Labor Day week-end. Site: Snoqualmie River Park, Fall City, Washington. Clubs participating are: CB Minutemen of Washington, Inc., The Tacoma CB Radio Club, and the North End CB Radio Club of Washington, Inc. Contact: Jim Bossart, 2411 South 260th, Kent, Washington.

3rd Annual Jamboree, September 4th and 5th the Cape Fear Valley will hold its Jamboree, at White Lake Cosira, White Lake, North Carolina. Contact: James L. Deaver, Box 214, Bladenboro, N. C.

Bergen County Citizens Banders, Inc. will hold their 4th Annual Jamboree, September 12th at Sundance Lodge, Route 46, west of Mountain View Circle, Fairfield, New Jersey. The Lodge is located just off the corners of Route 46 and 23. Jamboree Chairman is Lee Janow. BCCB, P.O. Box 83, Fair Lawn, New Jersey.

September 19th, the Quad County CB Radio Club of Walkerton, Indiana Jamboree at La Porte Fairgrounds, State Road 2 West, La Porte, Indiana. Contact: Kathy Perkins, Box 27, Mill Creek, Ind.

Cross County CB League, Inc. will hold its 3rd Annual Jamboree at Salisbury Park, Sunday, September 5th. 1st prize—Cadrea 510A Radio. Contact: Earl B. Broglin, Jr., Prudential Insurance, Roosevelt Field, Garden City, New York.

Maumee Valley 1965 Round-Up, Sunday, September 19th, Allen County War Memorial Coliseum, Fort Wayne, Indiana. Contact: Mort Knott, KHA4735, 2505 East State Street, Fort Wayne, Indiana.

## CB IN ACTION



By **Les Hench, KHA3272**  
Sales Manager  
Pearce-Simpson, Inc.

"NOISE SUPPRESSION" PART II  
by Guest Author HAROLD PETERSON  
Research Engineer, Pearce-Simpson, Inc.

Last month we discussed how to locate the source of noise problems in CB transceivers. Now that we have traced down the problem—let's discuss how eliminate it.

Most noise suppression methods follow standard procedures—although some are more difficult to locate and correct.

Ignition may be suppressed by one or more of the following: Resistor spark plugs or spark plug suppressors, resistor ignition wires, distributor suppressor, and condenser (preferably coaxial type) at connection of switch lead to the ignition coil.

Filtering noise from voltage regulators can usually be accomplished with capacitors attached to the battery and generator armature terminals at the regulator. Sometimes it will help to connect a small (.002 MFD) capacitor and 3.9 ohm resistor in series from the field terminal to ground.

Generator noise can usually be treated by attaching a capacitor to the armature terminal and grounding the mounting strap directly to the case of the generator. Some stubborn cases can be helped by installing a small tuned trap (commercially available) in series with the generator output. With the engine running, the tuning capacitor in this trap is adjusted so that minimum generator noise is heard in the receiver.

The above measures apply to marine installations as well as to automotive installation.

On an automotive installation, noise is often carried to a point where it can be picked up by the antenna, by way of some metal portion of the auto. Bonding this object or objects to the auto frame will prevent passage. This may require bonding tailpipes, steering shafts, hoods or almost any part of the automobile. Experience is very valuable in tracing down this type of noise transmission.

Wheel static is treated by small springs (available at most supply houses), which are installed inside the hub caps. Tire static can be cured by a powder which is available to put inside the tires.

For very severe noise elimination problems, elaborate systems which not only by-pass but shield the entire ignition system are available. Installation of these kits will be covered by the instructions accompanying the kit. A noise-free rig will improve both the operation of your set and your disposition.

### WIN A COMPANION II

You can win a COMPANION II with your CB in ACTION story. Simply tell us how you helped an individual or your community with CB. Write to Les Hench, National Sales Manager, Pearce-Simpson, Inc., P.O. Box 308, Miami, Florida 33135.



# CARD SWAPPERS UNLIMITED

Swappers Awards are given to those readers who have sufficiently proven that they have reached certain specified levels of achievement in QSL card swapping. There are 19 different and distinctive Swappers Awards, and if you would like a complete set of rules, address your request together with a stamped, self-addressed envelope, to: Swappers Awards, S9 Magazine, 14 Vanderventer Ave., Port Washington, N. Y. 11050. Here are the winners of the black, red and gold certificates for the past month.

- |        |  |   |
|--------|--|---|
| SACA   | 252 J. Mory, KKI2063, Baltimore, Md.<br>253 Hootin' Annie, KKA3340, Poquonnock Bridge, Conn.<br>254 Pop Utah, KKA8441, Poquonnock Bridge, Conn.<br>255 M. Forsyth, KNA1504, El Cerrito, Calif.   | 135 V. Goodnuff, KLM7764, Belleville, Mich.<br>136 H. & B. Handley, KHA0733, Lockport, Ill.<br>137 H. Girard, KBD0747, Woonsocket, R. I.  |
| PX-25  | 493 Pop Utah, KKA8441, Poquonnock Bridge, Conn.<br>494 Hootin' Annie, KKA3340, Poquonnock Bridge, Conn.<br>495 Ed Stefanik, KKD8614, Garfield, N.J.<br>496 T. Twine, KCI5991, Suffolk, Va.<br>497 Sgt. R. Patton, KNM7922, Quantico, Va.<br>498 J. Moriarty, KKA8181, Florence, Mass.<br>499 H. Kuhn, KNJ6045, Alton, Ill.<br>500 P. Barbera, KHD8077, Chicago, Ill.<br>501 W. Hubbs, KEB3600, Little Rock, Ark.<br>502 G. Raybin, KBI0854, Bronx, New York<br>503 J. & C. Markley, KNM9571, Cleveland, Ohio | PX-250 172 E. Inns, 11Q2714, Newport Beach, Calif.<br>PX-300 106 J. Cross, KCF0823, Hagerstown, Md.<br>PX-400 102 B. Ross, KCG1087, Washington, D. C.                                   |
| PX-25  | 422 T. Twine, KCI5991, Suffolk, Va.<br>423 Hootin' Annie, KKA3340, Poquonnock Bridge, Conn.<br>424 D. Bellask, KMD0428, Brooklyn, N. Y.<br>425 Pop Utah, KKA8441, Poquonnock Bridge, Conn.<br>426 P. Barbera, KHD8077, Chicago, Ill.<br>427 W. Hubbs, KEB3600, Little Rock, Ark.<br>428 G. Raybin, KBI0854, Bronx, N. Y.<br>429 J. & C. Markley, KNM9571, Cleveland, Ohio  | MSA 182 H. & B. Handley, KHA0733, Lockport, Ill.<br>183 H. Girard, KBD0747, Woonsocket, R. I.<br>184 E. Inns, 11Q2714, Newport Beach, Calif.<br>185 B. Ross, KCG1087, Washington, D. C. |
| PX-75  | 321 Pop Utah, KKA8441, Poquonnock Bridge, Conn.<br>322 Hootin' Annie, KKA3340, Poquonnock Bridge, Conn.<br>323 H. Huneke, KMD0992, Springfield, N.J.<br>324 B. Cassell, KHI6760, Clendenin, W. Va.<br>325 P. Barbera, KHD8077, Chicago, Ill.<br>326 J. & C. Markley, KNM9571, Cleveland, Ohio<br>327 P. Conant, KBC6229, Florence, Mass.<br>328 R. Frost, KHA4980, Orange, Utah  | SSC-1 197 J. Mory, KKI2063, Baltimore, Md.<br>198 D. Stoneburg, KGI7912, Omaha, Nebr.<br>199 V. & A. Gould, KLP7641, Binghamton, N. Y.  |
| PX-100 | 297 Hootin' Annie, KKA3340, Poquonnock Bridge, Conn.<br>298 M. Forsyth, KNA1504, El Cerrito, Calif.<br>299 Pop Utah, KKA8441, Poquonnock Bridge, Conn.<br>300 P. Barbera, KHD8077, Chicago, Ill.<br>301 A. French, KKA8764, Lynn, Mass.  | SSC-2 154 V. & A. Gould, KLP7641, Binghamton, N. Y.<br>155 D. Theisen, KNM0810, Norwalk, Ohio   |
| PX-125 | 229 Hootin' Annie, KKA3340, Poquonnock Bridge, Conn.<br>230 Pop Utah, KKA8441, Poquonnock Bridge, Conn.  | SSC-3 129 B. Giles, KKI0688, College Pk. Md.  |
| PX-150 | 187 V. Cavicchi, KKD7623, Morristown, N.J.<br>188 Hootin' Annie, KKA3340, Poquonnock Bridge, Conn.<br>189 J. Mory, KKI2063, Baltimore, Md.<br>190 B. Giles, KKI0688, College Park, Md.<br>191 D. Theisen, KNM0810, Norwalk, Ohio   | SSC-4 122 G. Solomon, KKG3692, Hellertown, Pa.<br>123 E. Inns, 11Q2714, Newport Beach, Calif.   |
| PX-175 | 157 D. Banks, KKA4451, Westfield, Mass.<br>158 D. Stoneburg, KGI7912, Omaha, Nebr.<br>159 R. Randall, KLP2986, Hudson Falls, N. Y.   | SSC-5 113 H. & B. Handley, KHA0733, Lockport, Ill.  |
| PX-200 | 134 C. Sylvester, KLK5617, Chicago, Ill.   | SSC-11 106 B. Ross, KCG1087, Washington, D. C.  |

If you would like to be listed as a QSL card swapper in our monthly listing, you must do the following: send us a separate card for each month you would like to be listed (you may send several month's worth of cards at the same time), and enclose 10¢ in cash (no stamps, checks, or money orders) for each month you are to be listed. Try not to write on your cards and don't Scotch Tape your dime to the card. Address the material to: Card Swappers Unlimited, 14 Vanderventer Avenue, Port Washington, N. Y. 11050. Deadline for listing in the November issue is September 12th. Any cards received after this date will be listed in the following issue.

Here are this month's swappers:

- |         |  |
|---------|--|
| 1Q4271  | Henry Sowa, P.O. Box 571, Holyoke, Mass.               |
| 1W6216  | Errol Engraving, 36 Hampden St., Westfield, Mass.      |
| 2Q0152  | Karl Weiss Jr., 245 Ashmore Ave., Trenton, N.J.        |
| 3Q1618  | Everett Lindsey Jr., R.D. #1 Mount Holly, N.J.         |
| 5Q0577  | Fred Harris, Route 3, Gate City, Va.                   |
| 5Q2178  | Elwyn Beam, Route 2, Vale, N.C.                        |
| 6Q0054  | Glenn Poore, 1316 Hixson Pike, Chattanooga, Tenn.      |
| 6W7263  | Bill Orton, 905 Altamaha St., Chattanooga, Tenn.       |
| 6W7515  | Terrell Craven, Route 1 - Box 32, Royston, Ga.         |
| 7W3713  | Chester Sisson, Rt. 1 - Box 1020, Haines City, Fla.    |
| 9Q0472  | Ben Bailey, 4201 Nagel St., Bryan, Texas               |
| 11Q1313 | George Strainline, 1171 W. Miracle Mile, Tucson, Ariz. |
| 11Q2714 | Eileen Inns, 530 Catalina Dr., Newport Beach, Calif.   |
| 18B2648 | Glenn Davis, 6143 North Rockwell St., Chicago, Ill.    |
| 18Q0229 | Barney Ross, 4022 Cameron St., Hammond, Ind.           |
| 18Q3779 | L.A. Morrow, 2210 N. Gayman Ave., Davenport, Iowa      |
| 18Q4913 | Tom Leadbetter, R.R. 4 - Box 40, Muncie, Ind.          |

18Q6800 Dick Markle, Box 75, 11210 Arcola Rd., Arcola, Ind.  
19A8145 Gene Hecht, 26 Sheridan, Pontiac, Michigan  
19Q8152 John Kasten, 5916 Westbrook Drive, Brookpark, Ohio  
19Q9470 Adrian Fallert, 121 N. "C" St., Hamilton, Ohio  
19Q9941 Martin Ripper, 7617 Cavell, Garden City, Mich.  
19QA0442 Art DeFrain, 226 3rd St., Harbor Beach, Mich.  
19W7489 Dick Holman, 1917 Murdoch Ave., Parkersburg, W.Va.  
20Q1360 Ivan Smith, 419 Water St., Danville, Pa.  
20W6677 Frank Rodgers, 1910 Columbia Ave., Tyrone, Pa.  
KAG1649 Al. Young, 350 Van Winkle Ave., Hawthorne, N.J.  
KAG2486 Dave Buda, 717 Centre St., Nutley, N.J.  
KAJ0765 J.L. Kirkland, Route 7, Raleigh, N.C.  
KAR0738 The Card Swapper, P.O. Box 411, Westfield, Mass.  
KBA2894 Charlie Ambush, 31 Pleasant St., Cambridge, Mass.  
KBA5557 Ted Cummings, Bellflower Road, Billerica, Mass.  
KBA7154 Rodney Nelson, Hideaway Lane, Norwalk, Conn.  
KBA8595 Lee Aspinall, 20 Forest Ave., North Haven, Conn.  
KBC3583 John Coons, P.O. Box 33, Plainville, Conn.  
KBC6415 Donald Aspinall, 20 Forest Ave., North Haven, Conn.  
KBC6510 Ralph Bryant, 716 Riverside Drive, Fairfield, Conn.  
KBC6819 Robert Gustina, 68 Dunmoreland St., Springfield, Mass.  
KBC7935 Kathy Connor, 136 Tallman St., New Bedford, Mass.  
KBC8494 Ray Blanchard, 4 Chelsea St., Worcester, Mass.  
KBC9193 Big John Weigel, 119 Shaw St., New London, Conn.  
KBC9285 John Christofaro, 7 New Lane Rd., New Canaan, Conn.  
KBD0747 Herb Girard, 348 Carrington Ave., Woonsocket, R.I.  
KBD0784 Jack Suplicki, 2 Willey Pl., Norwich, Conn.  
KBD1300 Ray Crele, 9 Argyle Circle, Seymour, Conn.  
KBD2925 Ronnie Sauriol, 62 Circuit Ave. N., Worcester, Mass.  
KBG4667 John Krueger, 23 Standpipe Rd., Freehold, N.J.  
KBG6576 Charles Arwine, 725 South Broad St., Trenton, N.J.  
KBG7180 Pat Purcell, 99 Harvard Drive, Hartsdale, N.Y.  
KCG7387 Gerry Schechter, 3535 Kings College Pl., Bronx, N.Y.  
KCG7687 Robert Thatcher, R.R. 1 - Box 59-26, Hudson, N.Y.  
KCG8079 Alvin Allen, 610 Prospect Ave., Spring Lake Hts., N.J.  
KCG8153 Betty Krueger, 23 Standpipe Road, Freehold, N.J.  
KBH0853 Tom Walton, 324 Kenilworth Rd., Louisville, Ky.  
KBH1426 Fred Stearman, R.R. #1 - Box 16, Erie, Ill.  
KBH1571 Morrie Goldman, 8046 South Euclid Ave., Chicago, Ill.  
KBJ0275 Hank Mancura, 64 Meadow Lane, Levittown, L.I., N.Y.  
KBI0854 George Raybin, 1367 Sheridan Ave., Bronx, N.Y.  
KBI2504 Mike Troy, 271 North Ridge St., Port Chester, N.Y.  
KB11349 Jack Hopp, 240-19 144 Ave., Rosedale, N.Y.  
KB12123 Richard Rios, 2897 Ardsley Rd., Wantagh, L.I., N.Y.  
KB12251 Mona French, 19 Essex Lane, Old Bridge, N.J.  
KB14141 Danny Seifert, 163 So. Main St., Phillipsburg, N.J.  
KB14513 Al Leslie, 184 Wales Ave., River Edge, N.J.  
KB15592 George Gross, Waring Rd. M.D. #15, Newburgh, N.Y.  
KB16025 Max Latterman, Box 608, RD #1, Princeton, N.J.  
KB16373 Charles Bennett, 89 Valley Rd., Haworth, N.J.  
KB16480 Art Scheid, 2 Essex Place, Hartsdale, N.Y.  
KB17301 Bob Mihlon, 163 Thomas St., Bloomfield, N.J.  
KB18077 John Krejc, 60 Division Ave., Garfield, N.J.  
KB18797 Jo-Jo Tybush, 20 South St., Albany, N.Y.  
KBJ0499 Herbert Kuehke, 10 E. Grand Ave., Montvale, N.J.  
KBJ1722 George Hunt, 353 Highland Ave., Middletown, N.Y.  
KBJ2055 Harmon Heller, 610 East 20th St., New York, N.Y.  
KCA0102 Frank Askinazy, 1034 Ralph Ave., Brooklyn, N.Y.  
KCC1541 Donald Berle, 228 California Rd., Quakertown, Pa.  
KCC3957 Lee Headley, 309 St. Louis Ave., Pt. Pleasant Beach, N.J.  
KCD1896 Howard Taylor, South DuPont Rd., Penns Grove, N.J.  
KCD2123 Henry Suess, 1812 Eberts Lane, York, Pa.  
KCD3398 Roger Miller, R.D. 2, Kempton, Pa.  
KCD4352 Marge Headley, 309 St. Louis Ave., Pt. Pleasant Bch, N.J.  
KCD5178 Bernie Thomas, R.D. 3, East Stroudsburg, Pa.  
KCD5222 William Wright, R.D. 1, Green Lane, Penna.  
KCD5385 William Wright Jr., R.D. 1, Green Lane, Penna.  
KCD5491 Bernie & Phyllis, 1509 Bondridge Rd., Wilm, Del.  
KCD5966 Al Smith, Penury Priory, Doylestown, Pa.  
KCD6109 Lois Lowell, R.D. 2, Sellersville, Pa.  
KCD6125 Neil O'Connell, 22 Cassatt Ave., Berwyn, Penna.  
KCF0692 David Clouser Sr., Plainfield Dr., Rt. 3, Winchester, Va.  
KCF0823 Jim Cross, 755 S. Potomac St., Hagerstown, Md.  
KCF1224 Harold Channell, P.O. Box 4124, Alexandria, Va.  
KCF2446 Robert Crigger, 411 South Mount St., Baltimore, Md.  
KCF2541 Eddie Lepton, 712 N. Loudoun St., Winchester, Va.  
KCG0706 James Becker, 5606 Franconia Rd., Alexandria, Va.  
KCG1087 Barney Ross, 425 Garden St., Washington, D.C.  
KCG1835 Edsel Peacemaker, Route 2, Winchester, Va.  
KCG2419 Park Bedford, 4903 Asbury Lane, Bethesda, Md.  
KCG2891 Edith Becker, 5606 Franconia Rd., Alexandria, Va.  
KCG3068 Ricky Lowman, 1001 W. Addition St., Martinsburg, W.Va.  
KCG3236 Bob Gallery, 5013 Westport Rd., Chevy Chase, Md.

KCG3569 Charles Berry Jr., Nomreh Rd. Rt. 3, Salisbury, Md.  
KCG3575 Jim Lott, White Post, Va.  
KCG3689 Edward Ross, 1967 Comm. Sqdn. APO, San Francisco, Cal.  
KCG3970 Kenneth Hoyer, R.F.D. 1, Beverly, W. Va.  
KCG4106 Dave Roges, Route 1, Box 133, Finksburg, Md.  
KCG2842 Clarence Moore, Route 4, Box 34, Thomasville, N.C.  
KCI5991 Hillery Twine, 2815 Norfolk Rd., Suffolk, Va.  
KCI2292 Hazel Stubbs, P.O. Box 1076, Rockingham, N.C.  
KCJ2621 Sam Moser, Rt. 7, Box 154, Winston-Salem, N.C.  
KCJ3880 Lee Willick, 3709 Hester Circle, Raleigh, N.C.  
KCJ4079 Jack Kirby, 3601 North Ave., Richmond, Va.  
KCJ4187 Joel Snyre, 747 S. Brady Ave., Newton, N.C.  
KCJ4911 Jearl Bishop, 1801 Chatham Ave., Charlotte, N.C.  
KCJ5002 J.L. Kirkland, Route 7, Raleigh, N.C.  
KCJ5092 Doug Paynter, 1001 East Jefferson, Charlottesville, Va.  
KCJ5244 Joe Tuttle, Route 1, Rural Hall, N.C.  
KCJ6180 Buddy Boy Williamson, 604 Gillespie, Greensboro, N.C.  
KCJ6987 Tommy Pollok, Gladys, Virginia  
KCJ7737 Allison Clarke, 1009 Hamilton Ave., Clifton Forge, Va.  
KCJ8516 The Morrison's, 826 Longview Dr., Woodbridge, Va.  
KCJ9615 James Surrats, Route #2, Box 86, Denton, N.C.  
KCJ9925 Jake Dunlow, R.F.D. 3, Windsor, N.C.  
KDB5453 Isadore Daich, Box 182, Louisville, Ga.  
KDB9372 Claude Hooper, R.F.D. 3, Box 130, Sylva, N.C.  
KDC0390 Jerry Pater, 1195 Dale Road, Hamilton, Ohio  
KDC0443 John Blankenship, P.O. Box 363, Grayson, Ky.  
KDC0614 Clarence Hnanicak, 10809 Prince Ave., Cleveland, Ohio  
KDC0843 Raymond Sheely, Box 95, Petersburg, Ohio  
KDC1255 Ben Hefner, 1804 Lennox Ave., Lima, Ohio  
KDC1358 W.L. McKeever, 408 Lynn Ave., Lakeside, Ohio  
KDC2091 Charlie Kreuger, Route 2, Marion, Ohio  
KDD1234 Michael Ashby, 316 S. Franklin St., Tullahoma, Tenn.  
KDD7853 James Davenport, 316 Reynolds St., Greenwood, S.C.  
KDD7921 Charles Lee, 1455 13th Ave. East, Tuscaloosa, Ala.  
KDD9501 Ray Frisby, Route 5, Marshall, N. C.  
KDE0561 Rodney Wise, P.O. Box 2953, Asheville, N.C.  
KDE1377 George Geriner, 4087 Lewer St., Memphis, Tenn.  
KDE3230 George Payne, 17 Orton Drive, Maryville, Tenn.  
KDI1736 Lew Shacklee, 301 Cortez Rd. East, Bradenton, Fla.  
KDI3211 Donna Wiley, 1601 Cimarron Trail, Wichita Falls, Texas  
KDI3320 Dot Sisson, R.R. 1 - Box 1020, Haines City, Fla.  
KDI3558 Tom Smith, P.O. Box 147, Orlando, Fla.  
KDJ0332 Nick Miller, Box 3006, St. Petersburg, Fla.  
KEB1659 Ed Field, P.O. Box 481, Gautier, Miss.  
KEB4003 Al Mayer, 306 West 8th, North Little Rock, Ark.  
KEE2742 Harry Hoffpowner, 724 Coolidge Rd., Channelview, Tex.  
KEH5846 Kenneth Bales, Box 295, Guymon, Okla.  
KEH7099 Larry Miller, 6907 N.W. 59th St., Bethany, Okla.  
KEJ0071 Melvin Nutting, 932 Western Ave., Colton, Calif.  
KEJ1341 E. H. Rogers, 24950 E. 6th St., San Bernardino, Calif.  
KEJ3938 Bill McCarver, 3712 Mt. Aladin St., San Diego, Calif.  
KEJ5828 John Hamner, 12350 So. Fern Ave., Ontario, Calif.  
KEJ5869 Johnnie France, Box 4146, Riverside, Calif.  
KEJ6681 Bob Osterhout, 3624 Meier St., Los Angeles, Calif.  
KFA2338 Frank Whetzel, 196 Larker Ave., Los Angeles, Calif.  
KFA3830 Dor Schwarm, 445 Park View Ave., Grover City, Calif.  
KFA4167 Mike Daugherty, 2736 E. Fairmont, Phoenix, Ariz.  
KFA4238 Al Froelich, 4128 Casita Way, San Diego, Calif.  
KFA4659 Walt Wise, 613 No. Glenwood Place, Anaheim, Calif.  
KFA6387 George Grock, 4814 W. 131st St., Hawthorne, Calif.  
KFA6882 Les Cannell, 7038 W. 85th St., Los Angeles, Calif.  
KFA9144 Thomas Couch, 9422 Blackley St., Temple City, Calif.  
KFA9923 Helen Morse, P.O. Box 1395, Ontario, Calif.  
KFB0396 Ron Federico, 815 No. Palisade Dr., Santa Maria, Calif.  
KFD1525 Chuck Watrous, 421 W. 12th St., Tracy, Calif.  
KFD2055 Chuck Boehnke, P.O. Box 223, Los Gatos, Calif.  
KFD4870 Bud Fischer, 1525 Blackstone, Fresno, Calif.  
KFD5345 Cecil Long, P.O. Box 367, Ivanhoe, Calif.  
KFD5811 Larry Klueder, P.O. Box 183, Oroville, Calif.  
KFD5994 Howard Daub, 3335 Moon Ave., Stockton, Calif.  
KFD6256 Sparky Pinola, 3335 Mabel St., Sacramento, Calif.  
KFJ12119 Jack Sudduth, 8103 16th S.W., Seattle, Wash.  
KFJ0479 Agnes Sudduth, 8103 16th S.W., Seattle, Wash.  
KGC2576 Gene Godsoe, 1406 Oneida St., Denver, Colo.  
KGF1675 Earl Wertz, 79 Kincheloe St., Kincheloe AFB, Mich.  
KGH2584 Joseph Rose, 1009 Figg, Wichita, Kansas  
KGH3372 Wayne Hutchins, P.O. Box 311, Carthage, Mo.  
KGI6082 W. F. Wilson, 900 South Madison, Plainville, Kans.  
KGI6100 Robert Schminck, 357 No. Waco, Wichita, Kans.  
KGI6857 Kenneth Moore, 3107 Capitol Ave., Sioux City, Iowa  
KGI6979 Don Marshall, 301 Circle Drive, Carrollton, Mo.  
KGI7912 Donn Stoneburg, Box 221 Ames Ave. Station, Omaha, Nebr.  
KGI9206 Bud Ward, 968 Lindeman, Des Peres, Mo.

KHA0733 Harold Handley, 13800 W. 145th Place, Lockport, Ill.  
 KHA3503 Ove LaPlante, 2978 N. Teutonia Ave., Milwaukee, Wis.  
 KHA5150 Virg Mansfield, 600 West 7th, Muncie, Ind.  
 KHA8376 Gordon Velpel, 801 S. Franklin St., Garrett, Ind.  
 KHB1210 Larry Rost, R.R. #2, Muscatine, Iowa  
 KHB3536 John Ernstberger, 3516 S. Hermitage Ave., Chicago, Ill.  
 KHB3971 Larry Parkhurst, 1000 West 11th St., Muncie, Ind.  
 KHC0280 Dick Dill, 505 W. Cherry, McLeansboro, Ill.  
 KHC2912 Helen LaPlante, 2976 N. Teutonia Ave., Milwaukee, Wis.  
 KHC4453 Dick Stout, Maple Springs Farm, Chatham, Ill.  
 KHC5348 Barry Fehlberg, 1801 Summit Ave., Racine, Wis.  
 KHC8347 Jim Taylor, Rosine, Kentucky  
 KHD1288 Charles Couchman, Box 194, North Vernon, Ind.  
 KHD2732 Nick Schmidt, 1719 W. Catalpa, Chicago, Ill.  
 KHD3773 Percy Hunt, 1152 Bigger St., Gary, Ind.  
 KHD4705 George Newberry, 1027 W. Douglas St., Freeport, Ill.  
 KHD5577 Jim Carey, R.R. #1; Sylvan Lake, Rome City, Ind.  
 KHD8077 Peter Barbera, 1834 W. Armitage, Chicago, Ill.  
 KHD9049 Leo Streff, 426 E. Franklin, Paxton, Ill.  
 KHE0968 Mick Newton, 634 Madison Ave., Evansville, Ind.  
 KHG3085 Edwin Chisholm, 1825 Avon St., Saginaw, Mich.  
 KHG3450 Ernie Grubb, 1757 Moonlight Dr., Akron, Ohio  
 KHG4945 C.M. Cooley, 1006 Hooven Ave., Hamilton, Ohio  
 KHG5776 Larry Hensley, 15 N. Dewey Rd., Amherst, Ohio  
 KHG5896 Ron Neufeld, 3090 E. Derbyshire, Cleveland Hts., Ohio  
 KHG5905 Bill Clouse, 569 Carey St., Zanesville, Ohio  
 KHG6176 Herman Werfele, 3121 Jacob St., Wheeling, W. Va.  
 KHG9069 Herb Riggle, Route 5, Zanesville, Ohio  
 KHG9085 Alfred Hogan, 1108 Walker St., Mansfield, Ohio  
 KHH1363 Geo. Radenheimer, 3121 Andrew St., Middletown, Ohio  
 KHH2828 Frank Hall Jr., 711 Water St., Barboursville, W. Va.  
 KHH3134 Flint McCullough, 800 12th St. S.W., Massillon, Ohio  
 KHH3585 John Breeze, 5660 Hipp, Dearborn Hts., Mich.  
 KHH4192 Leon Stone, 8141 Shore Drive Lot 285, Norfolk, Va.  
 KH14973 John Campbell, 216C FTD Box 201, Dow AFB, Bangor, Me.  
 KH17868 Tim Schafer, 1580 S. Clinton St., Defiance, Ohio  
 KH19979 Gene Taylor, 121 N. Adolph Ave., Akron, Ohio  
 KHJ1858 Norm Owings, 505 N. Clairmont, Springfield, Ohio  
 KHJ3477 Donald Belitz, 13474 Enid Blvd., Lake Fenton, Mich.  
 KHJ3482 Robert Albright, R. 3, Alpena, Mich.  
 KHJ4747 Don Senger, 2650 Mandale, Orchard Lake, Mich.  
 KHJ5042 Harold Davis, 9575 Shell Beach Rd., Pinckney, Mich.  
 KHJ6874 Richard Cady, P.O. Box 193, Winchester, Ky.  
 KHJ7033 Max Green, 100 North Main St., No. Baltimore, Ohio  
 KHJ7131 Ken Massie, 115 Woodlawn Dr., Ironton, Ohio  
 KHJ7270 Bob Wilkinson, 500 Magnolia Ave., Cuyahoga Falls, Ohio  
 KHJ7892 Boots Beaudry, Box 252, Trenton, Mich.  
 KHJ7920 Maury Lackey, Route #1, Berea, Kentucky  
 KHJ8472 Doug Thrasher, 1164 Lindsay Ave., Akron, Ohio  
 KHJ9411 Jim Waters, 28 S. Pembroke Ave., So. Zanesville, Ohio  
 KHJ9558 Ed Leonardart, 3518 Smithfield Lane, Cincinnati, Ohio  
 KIA0468 Clarence Kernstock, 1820 Filmore Pl., Essexville, Mich.  
 KIA0762 Leroy Butler, 1808 Lennox, Lima, Ohio  
 KIC1185 Curt Hammond, Rensselaer Falls, N.Y.  
 KIC1207 Arlene Warner, 2273 Mosser Ave., Williamsport, Pa.  
 KIC2881 Mike Ripski, 72 Mooney Rd., Plymouth, Pa.  
 KIC3500 Ruthie Bopp, 350 W. Fifth St., Lewistown, Penna.  
 KIC5642 Dave Klimeck, 218 Ottawa St., Johnstown, Pa.  
 KID0007 Fred Martz, Davis-Lane Speedway, Hustontown, Pa.  
 KID0186 Mike Reshetar Jr., 1021-1/2 Walnut St., Binghamton, N.Y.  
 KID3408 Bruce Sharer, R.D. Box 17, Boalsburg, Pa.  
 KID4563 Pete Gabriell, 751 Parsells Ave., Rochester, N.Y.  
 KID5225 Harry Platt Jr., R.D. 1 - Shaw Rd., Conklin, N.Y.  
 KID5293 George Gould, P.O. Box 42, Hudson Falls, N.Y.  
 KID5869 Robert Kolocok, 844 Taylor St., Hamburg, N.Y.  
 KID6356 Roscoe Harrington, 5 Schuyler St., Hudson Falls, N.Y.  
 KID6623 George Kline, 508 Monroe St., Jamestown, N.Y.  
 KID7260 Stan Breitkopf, 271 Stanton Lane, Rochester, N.Y.  
 KID8232 Roy McGregor, R.D. 2, Central Square, N.Y.  
 KIE0628 Al Gullyer, R.D. 3 - Box 392, Coraopolis, Pa.  
 KJ0223 J.C. McCalla, 273-G Dyea Ave., Ft. Richardson, Alaska  
 KJH0032 Jere Caricofe, 2301 Norfolk St., Hopewell, Va.  
 KJH0080 Robert Grubbs, Route 3, Winston-Salem, N.C.  
 KJ10614 Joe Hamilton, R.D., New Millport, Pa.  
 KJ10777 John White, 311 Owen Ave., Elmira Heights, N.Y.  
 KJ11072 Len Siedinski, 18 Ames Ave., Tonawanda, N.Y.  
 KJ12342 Fenton's, 125 A-W Lake Rd., Penn Yan, N.Y.  
 KJ12893 Isabel Ripski, 72 Mooney Rd., Plymouth, Pa.  
 KJ3461 John Garzel, Box 286, Austin, Pa.  
 KKA0488 Cyril Wilson, 6 Collins Terrace, Lynn, Mass.  
 KKA0658 Jerry Cote, 105 Old Walpole Rd., Keene, N.H.  
 KKA0880 Don Benois, Lambs Grove, Spencer, Mass.

KKA3088 John Myott, 16 Washington St., Westfield, Mass.  
 KKA3340 Hootin Annie, 11 Fort Hill Rd., Poquonnock Br., Conn.  
 KKA4210 Dick Clogston, Starks, Maine  
 KKA4451 Duke Banks, 131 Springdale Rd., Westfield, Mass.  
 KKA5174 George Brown, 101 Truman St., New London, Conn.  
 KKA5308 John Mildner, Roberts St. RD 1, Pascoag, R.I.  
 KKA6885 William Lafond, Eagle Peak Rd., Pascoag, R.I.  
 KKA7269 Phil Newcomb, 59 Center St., Ballardvale, Mass.  
 KKA7402 John Flynt Jr., Royal Coach Motel, Weirs Bch., N.H.  
 KKA7816 Anthony Silva, 9 Holway Ave., Provincetown, Mass.  
 KKA8101 John Moriarty, 86 Beacon St., Florence, Mass.  
 KKA8218 Charlie Judd, 700 Marlboro St., Keene, N.H.  
 KKA8456 Joe Cambo, 31 Woodbury Ave., Norwalk, Conn.  
 KKA8964 C.B. Card Exchange, 3209 Main St., Stratford, Conn.  
 KKA9690 Peter Flynn, 212 Allen St., Springfield, Mass.  
 KKA9788 Steve Kaplan, 91 Valentines St., New Bedford, Mass.  
 KKA9926 Brian Benkosky, 343 Washington St., Keene, N.H.  
 KKB0087 James Lacey, 46 Oread St., Worcester, Mass.  
 KKB0188 Robert Grip, 60 Sexton St., New Britain, Conn.  
 KKB0242 Paul Ferland, 32 Arland Drive, Pawtucket, R.I.  
 KKB0399 Stan Holland, South Rumford, Rumford, Maine  
 KKB0748 Tom Talpa, 31 Stony Hill Rd., Indian Orchard, Mass.  
 KKB1170 George Hensel, 37 Fairview Ave., Thompsonville, Conn.  
 KKB3387 Tom Wilmarth, 466 Main St., Cromwell, Conn.  
 KKB3485 Russell Ferland, 32 Arland Dr., Pawtucket, R.I.  
 KKB3586 Ralph Gauthier, 227 Walnut St., Manchester, N.H.  
 KKB3702 Ron Corda, 525 Nichols Ave., Stratford, Conn.  
 KKB3740 Donald Cone, RFD 1, Box 54, White River Junction, Vt.  
 KKB3757 Harrison Cunningham, 71 Water St., Hallowell, Maine  
 KKB4015 George Wiles, 7 Meadow St., Williamstown, Mass.  
 KKB4058 Phil Gomez, Lebanon, N.H.  
 KKD0349 Jack Golden, 5025 Broadway, New York City, N.Y.  
 KKD0491 Mike Kaplan, 37 Fairview Terrace, Maplewood, N.J.  
 KKD1013 Rich Werner, Box 234, Port Ewen, N.Y.  
 KKD1177 Christopher Ordal, 5 Shelley Rd., Short Hills, N.J.  
 KKD11553 Norm Schweitzer, 99 Feathered Lane, Bronx, N.Y.  
 KKD1640 Al Stanley, 1056 President St., Brooklyn, N.Y.  
 KKD1699 Lou Gangevi, 12 Shelley Ave., Hartsdale, N.Y.  
 KKD1746 Ivan Samuels, 179 Glenview Rd., South Orange, N.J.  
 KKD1946 Al Neely, 90-26 215 Place, Queens Village, N.Y.  
 KKD2292 Henry Meyer, 50 Knickerbocker Rd., Plainview, N.Y.  
 KKD2495 Jay Duhner, 1072 Ruth Place, North Bellmore, L.I., N.Y.  
 KKD2805 Gary Gargia, 164 Lenox Ave., Dumont, N.J.  
 KKD4696 Ed. Ruthberg, 26 Jackson Ave., Middletown, N.Y.  
 KKD5247 Edward Dart, Bay View Road, Southold, L.I., N.Y.  
 KKD6074 Dennis Spata, 283 Hope Ave., Passaic, N.J.  
 KKD6389 Jean DuBois, R.F.D. 4-Chestnut Hills, Middletown, N.Y.  
 KKD6953 Peter Mozzone, 382 Horton Hwy., Mineola, L.I., N.Y.  
 KKD7398 Vera Leitans, 246 Second St., Albany, N.Y.  
 KKD7499 N. Bernstein, 90 Redwood Lane, Massapequa Pk., N.Y.  
 KKD7623 Vinny Cavicchi, Lake Valley Rd., Morristown, N.J.  
 KKD7750 Joel Fishman, 1810-80th St., Brooklyn, N.Y.  
 KKD7898 Vinnie Henry, 221-02 133 Ave., Laurelton, N.Y.  
 KKD7950 Joseph Krzanik, Box 171, New Baltimore, N.Y.  
 KKD7997 Robert Bernsten, 85 Cupsaw Dr., Ringwood, N.J.  
 KKD8372 Mike Mazonne, 439 Livingston Ave., Albany, N.Y.  
 KKD8383 Bob Peterson, 61 Crosshill Ave., Yonkers, N.Y.  
 KKD8808 Louis Femine, 355 Eighth Ave., New York, N.Y.  
 KKD8859 Charles McNally, 36 Marble Hill Ave., New York, N.Y.  
 KKD9510 Ray Dams, 38 Vliet St., Cohoes, N.Y.  
 KKE0035 Louis Malkin, 86-35 Queens Blvd., Elmhurst, N.Y.  
 KKE0171 Al Siebold, 110 Jefferson Ave., River Edge, N.J.  
 KKE0438 Manny Fleischer, 510 Ocean Parkway, Brooklyn, N.Y.  
 KKE0449 Al Farber, 2554 E. 29th St., Brooklyn, N.Y.  
 KKE0663 Brian Zeky, Box 131, Crarryville, N.Y.  
 KKG0371 Ken Yost, Sunset Lake Rd., Newark, R.D. 1, Del.  
 KKG1280 Clarence Diehl, 800 Mohican St., Bethlehem, Pa.  
 KKG1958 Martha Suess, 1812 Eberts Lane, York, Pa.  
 KKG2712 Claude Dye, R.D. 3, Pottstown, Pa.  
 KKG3074 Harold Peer Jr., 617 Hilliard Ave., Beachwood, N.J.  
 KKG3229 Don Schmitt, Box #19, Gettysburg, Pa.  
 KKG3290 Rudy Freimann, 47 Barto Rd., Bally, Pa.  
 KKG3987 John LeMay, 28 E. Water St., Gettysburg, Pa.  
 KKG4281 Charles Lubebaugh, 916 Baltimore St., Hanover, Pa.  
 KKG4472 David Beckab, 109 East Main St., Schuylkill Haven, Pa.  
 KKG4482 Lee Petrucci, 316 W. Van Buren Ave., New Castle, Del.  
 KKG4967 Tom Worley, R.D. #1, Womelsdorf, Pa.  
 KKI0233 Houston Mullins, 321 Yorkshire Lane, Manassas, Va.  
 KKI2000 Tom Termini, 4611 Langdrum Lane, Chevy Chase, Md.  
 KKI2063 Jack Mory, 2501 Washington Blvd., Balto., Md.  
 KKI2997 Don Breitweiser, 947 Maryland Ave., Hagerstown, Md.  
 KKI3040 Kay Bowen, 831 W. Matthews Ave., Baltimore, Md.  
 KKI3355 Donald Vaughn, 318 Mulhenny St., Woodstock, Va.



KKK0471 J.L. Kirkland, Route 7, Raleigh, N.C.  
 KKK0745 Jim Chocklett, 504 Denby St., Wilson, N.C.  
 KKK0927 Tommy Gay, 1146 Rodgers St., Chesapeake, Va.  
 KKK2366 Jack Barbour Jr., 1659 Old Buckroe Rd., Hampton, Va.  
 KKK2869 Kelly Howard II, 415 Broad St., Oxford, N.C.  
 KKK4410 Smylie Grantham, P.O. Box 364, Raeford, N.C.  
 KKK4489 Tommy Spain, 1927 N. Junaluska Dr., Richmond, Va.  
 KKK6182 Gordon Gailahan, 211 Butler Rd., Fredericksburg, Va.  
 KK K6606 Rob Dalton, Bland, Virginia  
 KKK7550 Black Jack, P.O. Box 261, Colonial Heights, Va.  
 KKK8262 Patricia Harris, P.O. Box 6, Bethel, N.C.  
 KKM0735 Ebbie Odum, 140 Dupree St., Chester, S.C.  
 KKM0911 Grady Hill, 205 Walnut St., Union, S.C.  
 KKM1253 Buford Richey, 225 Davis Ave., Florence, Ala.  
 KKM2052 Linton Slapay, P.O. Box 52, Plains, Ga.  
 KKM2213 Lee Harvey, 2478 Sharrondale Dr. N.E., Atlanta, Ga.  
 KKM4156 Fred Monday, 77 Brownwood Ave., Asheville, N.C.  
 KKM5032 W.L. Hudson, 309 Elm, South Pittsburg, Tenn.  
 KKM6607 Neal Alexander, 3790 Wieuca Terrace, Atlanta, Ga.  
 KKM7129 Carl Stapleton, Route 1 - Box 179-N, Helena, Ala.  
 KKM7376 Donald Wilson, 1529 Bush Blvd., Birmingham, Ala.  
 KKM7482 Charles Cromer, Route 1 - Box 282A, Newberry, S.C.  
 KKM7788 Claude Witt, 814 S. Webb Ave., Crossville, Tenn.  
 KKM8374 Oswald Gibson, 206 E. Baruch, Denmark, S.C.  
 KKM9441 Frank Pool, 2007 McBrien Rd., Chattanooga, Tenn.  
 KKN9702 James Wolfe, 1707 Merrycrest Dr., Memphis, Tenn.  
 KKN0258 Bill Powers, P.O. Box 104, Bowling Green, S.C.  
 KKN0300 Steve Masten, P.O. Box 4, Boone, N.C.  
 KKN0793 G.W. Page, Box 398, Lake View, S.C.  
 KKN2631 Warren Stevens, 770 Longleaf Drive N.E., Atlanta, Ga.  
 KKN2632 L.C. Crawford, 407 Chestnut St., Lake City, Tenn.  
 KKN2690 Carroll Rogers III, Box 178, Middletown, Conn.  
 KKN2985 Charles Martin, Rt. 6 - Harrison Pk., Cleveland, Tenn.  
 KKN3229 T.J. Gibson, Box 564, Bennettsville, S.C.  
 KKP0163 Jim Usry, 1206 Tennessee Ave., Lynn Haven, Fla.  
 KKP1645 Henry McLeod, P.O. Box 126, Perry, Fla.  
 KKP2232 John Sanders, 3209 Cherokee Ave., Tampa, Fla.  
 KKP2242 Frank Wolfgang, 4729 Bay Vista Ave., Tampa, Fla.  
 KKP4124 Gene Pairgin, 5111 68th St. North, St. Petersburg, Fla.  
 KKP4175 Jack Thompson, P.O. Box 1091, Ocala, Fla.  
 KKP4260 Clark Dickinson, Rt. 2 - Box 50, Perry, Fla.  
 KKR5223 Charles Keathley, 3005 Loma Dr., Little Rock, Ark.  
 KKR6231 Mike Anderson, P.O. Box 2626, Laurel, Miss.  
 KKT3680 Le Winder, 4204 Oaklawn St., Bryan, Texas  
 KKT3774 Bill Freeman, 4000 Nagle, Bryan, Texas  
 KKT4113 James Bowman, Box 703, Fresno, Texas  
 KKV3836 Clarence Norton, 512 W. Broadway, Longview, Texas  
 KKV4589 Paul Drennon, 2402 Anderson, Irving, Texas  
 KKV6543 Skipper Goulet, 3411 Sentinel Ave., Midland, Texas  
 KXX2898 Jerry Pennell, 4845 Lotus St., San Diego, Calif.  
 KXX5201 Dale Fletcher, 54728 El Prado Trail, Yucca Valley, Calif.  
 KXX6641 Harvey Ingersoll, 531 Edith St., Walla Walla, Wash.  
 KXX7083 James Fuller, 405 Fillmore St., Taft, Calif.  
 KXX7642 Walter Koziel, P.O. Box 2212, Bell Gardens, Calif.  
 KXX8239 Ronny Baxter, 2234 Palm Ave., Imperial Beach, Calif.  
 KKY0194 Skeeter Perkins, 24515 Vermont Ave., Harbor City, Calif.  
 KLA1014 Bo Balanco, 2183 Altamont Rd., San Leandro, Calif.  
 KLA2524 John Brown, P.O. Box 502, San Pablo, Calif.  
 KLA3291 Paul Linehan, 2 Estabueno Dr., Orinda, Calif.  
 KLA3573 Stephen Ward, 1756 Hallmark Ln., San Jose, Calif.  
 KLA3648 Jim Cox, 1865 Michigan, Stockton, Calif.  
 KLA5173 Chuck Hopper, 480 Sonoma Blvd., Vallejo, Calif.  
 KLA5339 Larry Horton, 2369 Mammoth Dr., San Jose, Calif.  
 KLA5519 Cliff Anfinsen, 1830 - 32nd Ave., San Francisco, Calif.  
 KLA5629 Carroll Hatchell, 2222 Sacramento St., Vallejo, Calif.  
 KLA5788 Tom Saunders, 782 Hutchings Drive, San Leandro, Calif.  
 KLA5847 Ray Broten, 40 Buena Vista, Vallejo, Calif.  
 KLA6402 Bruce Farley, 3679 Bryant St., Palo Alto, Calif.  
 KLA6569 Bob Wright, 1243 Sierra Mar Dr., San Jose, Calif.  
 KLA7360 Larry Coxson, 1439 Terilyn Ave., San Jose, Calif.  
 KLA7428 Jack Evans, P.O. Box 108, Ivanhoe, Calif.  
 KLA7441 Jim Lovell, 1781 Industry Rd., Geyserville, Calif.  
 KLC1071 Ed Lyons, P.O. Box 2, Florence, Oregon  
 KLC1392 David Schwartz, 691 Montgomery, Empire, Oregon  
 KLD0511 Tex Warner, 506 Edith St., Walla Walla, Wash.  
 KLD0953 Keith Howe, 9001 - 16th Ave. S.W., Seattle, Wash.  
 KLD1817 Don Fletcher, 3432 So. 180 Pl., Seattle, Wash.  
 KLD2362 Richard Spengler, Rt. 1 - Box 48, Grangeville, Idaho  
 KLE2219 Art Paulk, 3262 W. 3800 So., Salt Lake City, Utah  
 KLF1653 John McGuire, Box 12, Camp Douglas, Wis.  
 KLF2842 William White, 1215 Weeks Ave., Superior, Wisc.  
 KLF2980 Steve Butler, 822 North Glendale Ave., Tomah, Wis.  
 KLB3541 J.B. Walker, 2803 Lewis St., Biloxi, Miss.

KLB4994 Jack Doggett, 8060 Dema Drive, Des Moines, Iowa  
 KLB6583 William Royal Jr., Syracuse, Nebr.  
 KLB7398 Bob Carr, 1507 Jefferson, Great Bend, Kansas  
 KLB7531 Max Meisel, 1328 Westview, Derby, Kansas  
 KLB8133 Norman Royal, Syracuse, Nebraska  
 KLB8375 Michael Anthes, 7800 Bloom Drive, St. Louis, Mo.  
 KLB8600 Leon Priest, Box 3260F Star Rt. B., Anchorage, Alaska  
 KLI10919 Bob McGuire, 927 N. Madison, Topeka, Kansas  
 KLI1335 Phil Holcomb, 712 Dubuque St., Sioux City, Iowa  
 KLI1434 W.H. Stalons Jr., 3903 Garfield, Lincoln, Nebraska  
 KLI0255 Bob Pierce, 182nd St. - Box 382, Lansing, Ill.  
 KLI0440 Don Thielsen, 2803 Iroquois Trail, McHenry, Ill.  
 KLI1650 Dan Wright, 1336 Blaine Ave., Janesville, Wis.  
 KLI2946 Harold Bjorkquist, 8878 South 84th St., Franklin, Wis.  
 KLI3382 Earl Gordon, 419 W. Grand Ave., Decatur, Ill.  
 KLI3945 William Turner, 1728 Ford Ave., Owensboro, Ky.  
 KLI4142 Jon Kramer, R.1. Box 45J, 606 Highland Dr., Trevor, WI  
 KLI4663 Bev Chappell, 3644 E. Minnie St., Decatur, Ill.  
 KLI6057 Bill Hittle, 1601 So. 4th St., Richmond, Ind.  
 KLI6167 Ron Kman, 7848 So. Austin, Oklawm, Ill.  
 KLI6791 Lou Rubenstein, 9901 Calhoun Ave., Chicago, Ill.  
 KLI8259 Jack Jackson, Morocco, Indiana  
 KLI1408 Leon Adams, 509 May St., Sumner, Ill.  
 KLI1975 W.H. Willett, Lewisport, Ky.  
 KLI2079 Russell Smith, 107 So. State St., Louisville, Ky.  
 KLI2328 John Wigginton, R.R. #1, Lincoln, Ill.  
 KLI2458 Lincoln Ide, 7842 So. McVicker, Oak Lawn, Ill.  
 KLI2881 Buzz Colburn, 902 Oak Lane, Russellville, Ky.  
 KLI3372 Don Minnerick, R.R. #6, Connersville, Ind.  
 KLI3438 L.C. Webber, Ludlow, Ill.  
 KLI3619 Matt Loeffler, 2169 South 64th St., West Allis, Wis.  
 KLI3653 Art Prior, Route 1, Box 2, Trevor, Wisc.  
 KLI3588 Charles Copples, 1749 W. Ravina Park Rd., Decatur, Ill.  
 KLI4830 Francis Wagner, Elizabethtown, Indiana  
 KLI4886 Charlotte Stearman, P.O. Box 326, Albany, Ill.  
 KLI4958 Jesse Wade, 224 W. Elm St., Chillicothe, Ill.  
 KLI5002 Dave Karr, 320 Maplewood Dr., Antioch, Ill.  
 KLI5617 Dick Crider, 3033 Ute Ln., Lafayette, Ind.  
 KLI5810 Chuck Sylvester, 1629 East 86th Pl., Chicago, Ill.  
 KLI6181 Irving Felzer, 2131 So. 15th Place, Milwaukee, Wis.  
 KLI8300 Jim Lostien, c/o Artist Corp. Wis. Hotel, Milwaukee, Wis.  
 KLI8405 Marilyn Kempf, Rt. #1 - Box 298, Cambridge, Wis.  
 KLI8819 Bob Duncan, 208 N. Main St., Dunkirk, Ind.  
 KLI9355 Dick Hadley, 607 Wesley St., Huntington, Ind.  
 KLI9616 Mike Geiger, Box 83, Culver, Ind.  
 KLI9761 Todd Schumann, 8025 S. Euclid Ave., Chicago, Ill.  
 KLL0146 David Greer, 708 Peveler Dr., Russellville, Ky.  
 KLL0681 Dick Stichter, 851 E. Pleasant St., Freeport, Ill.  
 KLL0809 Fritz Stearman, Albany, Ill.  
 KLL0995 Jim Mazurek, 1444 S. Clinton Ave., Berwyn, Ill.  
 KLL1090 Reid Kenley, P.O. Box 427, Maywood, Ill.  
 KLL1281 Tom Wilson, 1603 Ruth Ann Dr., Centralia, Ill.  
 KLL1451 Richard Lee, 823 Elmwood Ave., Kewanee, Ill.  
 KLM1447 Lee Collins, 4814 Sundale, Drayton Plains, Mich.  
 KLM3971 Ray Gould, 1806 Kim Ave., Kalamazoo, Mich.  
 KLM4219 Eddie Welch, 177 Broadway Ave., Masury, Ohio  
 KLM4519 N.J. Schweitzer, P.O. Box 232, Defiance, Ohio  
 KLM4842 Bessie Hazen, 231 North Mead St., Zanesville, Ohio  
 KLM5051 Jim Swartz, 62 Stadium Drive, Tallmadge, Ohio  
 KLM5256 Jerry Copeland, R.R. 1, Sawyer, Mich.  
 KLM6265 Terry Wright, 525 South Downing St., Piqua, Ohio  
 KLM7450 Bill Piper, R.F. D. #5 - Box 414, Swanton, Ohio  
 KLM7763 Jim Warner, 836 Pensacola, Pontiac, Mich.  
 KLM7788 Charles Holland, 942 Lingle Ave., Owosso, Mich.  
 KLM8033 Bob Sizemore, 7807 Hope Ave., Cleveland, Ohio  
 KLM9314 Leonard Baudry, 32821 River Rd., E. Rockwood, Mich.  
 KLN1209 Ollie Ramey, 2922 Cypress St., Portsmouth, Ohio  
 KLN1732 Art Lucas, 1011 W. Cherry Creek Rd., Mio, Mich.  
 KLN2082 Bob Browning, 1217 North Ave. NE., Massillon, Ohio  
 KLN3497 Ed Newton, 2120 Irving Dr., Benton Harbor, Mich.  
 KLN3731 Norm Sieggreen, 1532 N. Bond, Saginaw, Mich.  
 KLN4091 Clare Wilson, 94 E. Colgate, Pontiac, Mich.  
 KLN5598 Rawlings Funeral Home, London, Kentucky  
 KLN5649 Roy Wallington, Route 1 - Box 19, Augres, Mich.  
 KLN6235 Fritz Caccia, 3749 Longfield, Ravenna, Ohio  
 KLN7344 John Arnold, 8 E. Main St., Trenton, Ohio  
 KLN8016 Don Gold, 116 Stewart Ave., Sidney, Ohio  
 KLN8105 Gabby Blackie, 10078 E. Coldwater Rd., Davison, Mich.  
 KLN9345 Jim Stephens Jr., 132 Llewellyn Ave., Springfield, Ohio  
 KLN9961 Orville Bluhm, 1483 F. Bellum, Muskegon, Mich.  
 KLO0175 Paul Manville, 1736 Lombardy, East Highland, Mich.  
 KLO0366 Pete Snyder, 4321-10th Ave., Parkersburg, W. Va.  
 KLO0519 Don Jones, R.R. #2, Lawrenceburg, Kentucky

KLO0598 William Lechner, 4441 Parnell, Pontiac, Mich.  
 KLO0638 Dick Seperic, 3324 Karen St., Lansing, Mich.  
 KLO1270 Bob McClellan, Box 51, 203 Furnace Ave., Elberta, Mich.  
 KLO1862 Chuck Cerny Jr., 2522 Belvoir Blvd., Cleveland, Ohio  
 KLO2476 Barbara Race, R.R. 3 - Box 135, Vicksburg, Mich.  
 KLP0319 Pete Hons, 614 Main St., Portage, Pa.  
 KLP2846 Harold Greba, 610 Henry Lane, Irwin, Pa.  
 KLP5005 Bud Fowkes, 1031 5th Ave., Duncansville, Pa.  
 KLP5033 Tom Zawrotny, Rathbone, N.Y.  
 KLP5280 The Bailey's, 1110 Ford St., Ogdensburg, N.Y.  
 KLP5686 Charles Johnson, 332 Huron Ave., Renovo, Pa.  
 KLP5750 William Wood Sr., Box 526, Star Lake, N.Y.  
 KLP6039 Harlan McKenna, 1354 Davis St., Elmira, N.Y.  
 KLP6639 Don Berman, 121 W. Ross St., Wilkes Barre, Pa.  
 KLP6705 John Fox, P.O. Box 92, New York Mills, N.Y.  
 KLP7094 Del Arthur, R. #3, Lowville, N.Y.  
 KLP7250 Chuck Miller, 75 Hamilton Homes, Oswego, N.Y.  
 KLP7516 Guy Widmeyer Jr., Box 99-A, Hopwood, Penna.  
 KLP7578 David Moss, P.O. Box 61, Endicott, N.Y.  
 KLP7749 Ray Bronder, 416 9th St., Monessen, Pa.  
 KLP7848 Bryan May, 147 Old River Rd., Wilkes-Barre, Pa.  
 KLP7879 Clarence Peet, Box 73, Port Crane, N.Y.  
 KLP8083 Howard Davidson, 26 Knight St., Glens Falls, N.Y.  
 KLP8282 Delevan Arthur Jr., R. #3, Lowville, N.Y.  
 KLP8509 Leonard Dotys, Monessen, Pa.  
 KLP8791 Jim Smith, R.D. 3, Fort Plain, N.Y.  
 KLP8809 Don Shumaker, 147 Greenbrier Dr., Carnegie, Pa.  
 KLP9464 Fred Sherman, Beech Creek, Pa.  
 KLP9534 Steve Delorm, 258 Spencer Rd., Rochester, N.Y.  
 KLP9557 George Booth, 971 Sweeney St., North Tonawanda, N.Y.  
 KLP9618 Bill Lohnes, Box 176, Round Lake, N.Y.  
 KLP9656 Irvin Kimmel, P.O. Box 14, Tire Hill, Pa.  
 KLP9789 Ed Kindervater, Box 404, Hopwood, Pa.  
 KLOQ114 R. Hamm, 1447 Union Center-Maine Hwy., Endicott, N.Y.  
 KLOQ123 Paul Blewett, 615 Valley St., Lewistown, Pa.  
 KLOQ423 Roy Clinch, 3558 Gifford Rd., Vernon Center, N.Y.  
 KLOQ457 Charles Goughour, 207 Coldren St., Johnstown, Pa.  
 KLOQ888 Steve Pfaff, 204 S. Fairview St., Lock Haven, Pa.  
 KLOQ906 Pete Guy, Box 55, Middle Grove, N.Y.  
 KLOQ1059 William Nagurney, 727 Marion St., Scranton, Pa.  
 KLOQ1173 Lester Finnegan, 8171 Main St., Williamsville, N.Y.  
 KLO1560 Jud Kurlancheek, 242 East Dorrance St., Kingston, Pa.  
 KLO2217 Don Anderson, 528 Ridge Ave., Cannonsburg, Pa.  
 KLO2302 Bill Caccia Sr., Box 67 - R.D. #4, Greensburg, Pa.  
 KLO2774 Carl Jaegers, R.D. 2, Sunbury, Pa.  
 KLU0148 D.A. Miller, Land of the Midnight Sun Broadcasters  
 KMA0500 Sandy DeRoche, 9 Hazel St., Bangor, Maine  
 KMA0517 Eric Holbrook, 29 Maynard St., Attleboro, Mass.  
 KMA0875 Jim Lyman, Nursery St., Norwalk, Conn.  
 KMA1395 Ray Martel, 143 Parker St., New Bedford, Mass.  
 KMA1685 Henry Fratus, 384 Adelaide Ave., Providence, R.I.  
 KMA2028 Edwin Keller, 10 South St., Plymouth, Mass.  
 KMA2105 Anthony Viera Jr., 9 Holway Ave., Provincetown, Mass.  
 KMA2378 E.L. Bradshaw, 114 Walter St., Bangor, Maine  
 KMA2393 Paul Bond, W. Lebanon, New Hampshire  
 KMA2418 Irving McKlirryher, 421/2 Freeman Ave., Rutland, Vt.  
 KMA2531 Mike Palmieri, 1 Brigham St., Waterville, Maine  
 KMA2585 Walter Palacc, 56 Ames Ave., Chicopee, Mass.  
 KMA2625 Leo Paradis, 540 Mt. Pleasant St., New Bedford, Mass.  
 KMA3939 Johnny McGann, 50 Coombs St., Southbridge, Mass.  
 KMA4164 John McDonalds, Warren, New Hampshire  
 KMA5273 James Stuart, 45 South Main St., Baldwinville, Mass.  
 KMD0023 Gregg Manish, 435 North Second St., E. Newark, N.J.  
 KMD0428 David Bellask, 1159 E. 42 St., Brooklyn, N.Y.  
 KMD0490 Fred Decter, 339 Leslie St., Newark, N.J.  
 KMD0992 Howard Huneke, 518 Mountain Ave., Springfield, N.J.  
 KMD1113 Richard Harvey, 133 Morris Ave., Summit, N.J.  
 KMD1314 John Humphries, 102 Lincoln Ave., East Paterson, N.J.  
 KMD2436 John Erwin, 38 Gouverneur St., New York, N.Y.  
 KMD2632 Donald Heide, 2732 Batchelder St., Brooklyn, N.Y.  
 KMD3059 Bruce McPherson, 231 Wales Ave., River Edge, N.J.  
 KMD3327 W. Mitchell, 31 Fowler Ave., Newburgh, N.Y.  
 KMD3684 Dom & May, 450 Rhodes Lane, West Hempstead, N.Y.  
 KMD3719 Dale Schmallings, 239 Seymour Rd., Port Chester, N.Y.  
 KMG0201 Gerry Hunsicker, 311 9th Ave., Collegeville, Pa.  
 KMG0285 Charles Bell, 407 Pomeroy St., Ridley Park, Pa.  
 KMG0471 Charlie Stauffer, R.D. #1, Holtwood, Pa.  
 KMG0524 Gary Nicholson, 801 North Pitt St., Carlisle, Pa.  
 KMG0791 Gregory Pace, 910 Redwood Dr., Carlisle, Pa.  
 KMG1618 Jim Worrell, R.D. 1, Box 188, Linwood, N.J.  
 KMI0759 Whit Strunk, 52 Broadway, Hagerstown, Md.  
 KMI0928 Jim Shaffer, 109 South Front St., Georgetown, Del.  
 KMI0962 Wm. McDowell, 8 Jones St., Piedmont, W. Va.

KMK0568 Jack Pridgen, 408 W. 19th St., Lumberton, N.C.  
 KMK0600 R.C. Shanks, P.O. Box 252, Moutross, Va.  
 KMK0678 Edith Grantham, P.O. Box 364, Raeford, N.C.  
 KMK0562 Charles Quinley Jr., 507 West 3rd St., S. Pittsburg, Tenn.  
 KMM1177 Ted Booth, 231 Illinois St., Travis A.F.B., Calif.  
 KMM1595 B.C. Murray, Maysville Rd., Commerce, Ga.  
 KMP0707 Jimmy Roberts, 2304 Palmdale St., Jacksonville, Fla.  
 KMR0014 Mark Stevens, Route 6, Box 321, El Dorado, Ark.  
 KMR0848 Scott Allen, 1090 Meadow Heights, Jackson, Miss.  
 KMR1149 Linda Loftins, Rt. 1 - Box 429, Deridder, La.  
 KMR1383 John Funk, Route 4, Paragoud, Ark.  
 KMR1510 James Scroggins, Scroggins Hardware, Belzoni, Miss.  
 KMT1506 Arthur Cates, 1310 North Dakota, Baytown, Texas  
 KMV0649 Harold Maynard, Box 361, Vinita, Okla.  
 KMV3634 Frank White, Rt. #3 - Box 109, Bartlesville, Okla.  
 KMX0073 Jim Stewart, 9335 Carmel Rd., Atascadero, Calif.  
 KMX0440 Warner Mayden, 385 Venus Ct., Rt. 1, Nipomo, Calif.  
 KMX0684 Lois Fletcher, P.O. Box 924, Yucca Valley, Calif.  
 KMX2394 Ed Hoover, 144 Corregidor, Fort Ord, Calif.  
 KMX2815 Chuck Emerson, 7448 E. Holly, Scottsdale, Ariz.  
 KMX3215 Jim Hughes, P.O. Box 1253, Atascadero, Calif.  
 KMX3234 Ron Murphy, 12993 Herrick St., Sylmar, Calif.  
 KMX3515 Red Osgood, 3805 Winona Ave., San Diego, Calif.  
 KMX4118 Pat Sullivan, 726 Oneonta St., Imperial Beach, Calif.  
 KNA1504 Mike Forsyth, 789 Colusa Ave., El Cerrito, Calif.  
 KND0168 Barry Simpson, 4819 So Fife, Tacoma, Wash.  
 KNE0678 Rick Miller, 1608 Huron St., St. Paul, Minn.  
 KNF0919 Don Ebbeson, 509 West Mission Rd., Minneapolis, Minn.  
 KNH0542 Larry Huggins, 614 N. Chestnut St., Olathe, Kans.  
 KNH0786 Bill Howard, 2700 Grandview Ave., Des Moines, Iowa  
 KNH2587 Frank Mauler, R.F.D. 1. Olmitz, Kansas  
 KNH3016 Lee Glone, 101 Fannie, Lemay, Mo.  
 KNH3738 Red Shaw, 9010 Sycamore, Kansas City, Mo.  
 KNH3742 James Stell, 5734 Chestnut St., Kansas City, Mo.  
 KNJ0550 Bill Busse, 100 So. Louis St., Mt. Prospect, Ill.  
 KNJ0959 Bill Berends, 188 Third St., Kalona, Iowa  
 KNJ1478 Jim Heafer, 5103 E. Taylor St., Bloomington, Ill.  
 KNJ1768 Weldon Coldren, 10 East St., Wabash, Ind.  
 KNJ2128 Jim Siddons, 604 20th Ave. Ct., East Moline, Ill.  
 KNJ3100 Steve Sallac, R.R. 4 - Box 10, Valparaiso, Ind.  
 KNJ4063 Charlie Ulshofer, 270 Ross Ave., Wabash, Ind.  
 KNJ4325 William Eager, 629 Ohio, Quincy, Ill.  
 KNJ4360 Andy Croxton, 4241 Main St., Downers Grove, Ill.  
 KNJ4430 David Conder, 1319 South Cherry, Centralia, Ill.  
 KNJ5446 Steve Schneider, 9105 Austin Ave., Morton Grove, Ill.  
 KNJ6056 Jude Littell, R. 6, Lake Edgewood, Martinsville, Ind.  
 KNJ7169 Robert Eburick, R.R. 2 - Box 20-B, Noblesville, Ind.  
 KNJ7698 Steinar Loken, 2825 West McLean Ave., Chicago, Ill.  
 KNJ7768 Fred Smith, 1639 E. 77th St., Indianapolis, Ind.  
 KNJ7979 Bob Born, 1355 N. Poole, Decatur, Ill.  
 KNK0240 Don Field, P.O. Box 65, Park Forest, Ill.  
 KNM0810 Don Theisen, 53 Norwood Ave., Norwalk, Ohio  
 KNM1400 Gerald Koehler, Route 7, New Martinsville, W. Va.  
 KNM1533 Glen Wright, Rt. 1 - Box 122 A-1, Hurricane, W. Va.  
 KNM2078 Bob Factor, 18 Hickory St., So. Zanesville, Ohio  
 KNM2171 Bob Deaton, 2814 Evergreen Dr., Springfield, Ohio  
 KNM2322 Gary Maturen, 1003 Court, Saginaw, Mich.  
 KNM2398 Chuck Sisler, 144 Montgomery Lane, Mingo Junction, Ohio  
 KNM2598 Ky Swegert, 2162 Pleasant Ave., Hamilton, Ohio  
 KNM2551 Richard Kingery, Route 2 - Box 374, Gallipolis, Ohio  
 KNM2986 Jeff Chern, 7404 Devon Lane, Chesterland, Ohio  
 KNM3839 Skye Wittig, 603 Spruce St., Manistee, Mich.  
 KNM4813 Jim Waters, 28 S. Pembroke Ave., So. Zanesville, Ohio  
 KNM5016 Bill Brooks, 117 W. Stewart Ave., Flint, Mich.  
 KNM6195 Larry Reed, Box 2075, Williamson, W. Va.  
 KNM7922 Raymond Patton, 222 Kontner St., Nelsonville, Ohio  
 KNP0126 Earl Sprague, Port Henry, N.Y.  
 KNP0224 Dava Latina, 458 Harvest Dr., Rochester, N.Y.  
 KNP0344 Elmer Hoose, 3053 Butler Ave., Horseheads, N.Y.  
 KNP0457 Jeff Ohlsson, 86 Bowen St., Jamestown, N.Y.  
 KNP0567 Bob Ivanoff, 726 Ellsworth Ave., Jeannette, Pa.  
 KNP1042 Don Lewis, 33 South Morningside Dr., Binghamton, N.Y.  
 KNP1200 Chuck Krotovichs, 111 Cort St., Jeannette, Pa.  
 KNP1444 Paul Clark, 863 Monaca Rd., Monaca, Pa.  
 KNP1445 Earl Roehl, 861 Monaca Rd., Monaca, Pa.  
 KNP1806 John Rose, 431 Jackson St., Summerhill, Pa.  
 KNP2225 Robert Madison, 1515 Edgar Ave., Chambersburg, Pa.  
 KNP2429 Bob Bialecki, 17 Roser St., Rochester, N.Y.  
 KNP2730 Dick Newell, 395 Fairmount, Jamestown, N.Y.  
 KNP2915 John Bryant, Route #4, Brookville, Pa.  
 KNP4176 Ron Taylor, Chapel Hill Rd., East Randolph, N.Y.  
 KNP5138 Bob Isele, P.O. Box 214, Gasport, N.Y.

Continued on page 71

Watch for next month's big issue

HEY GANG!

БУДУ

HOY!

הנהגה NOW!

ACHTUNG!

AHORA

Whoopie!

FINALLY!

UNBELIEVABLE

הנהגה!

# The GIANT 1965-1966

## Who's Who in CB Directory

It's finally on the presses, the big, giant, fantabulous, ever lovin' WHO'S WHO IN CB DIRECTORY 1965-66! Yes, the vital statistics on every "In" CB'er on the band; hundreds upon hundreds of listings showing callsigns, names, addresses, telephone numbers, monitoring channels, club affiliations, hobbies, ham calls, etc., also a personal message from almost every CB'er listed especially for you. This rare first edition (a limited print run), containing over 1500 listings, will shortly be mailed out to those CB'ers who have reserved their copies.

How and when do you reserve a copy? You do it NOW! You do it by filling out the form at the bottom of this page and returning it to our office with your remittance. How much? Well, if you are listed in the Directory (having filled out a form from a previous issue and sent it in), the \$1 which you sent in for your listing is deductible from the \$2 cost of the book, and you have only to send in an additional \$1 to receive your copy. If you aren't listed, the price is \$2, postpaid. Dealer inquiries are invited. So send that order in now, we don't know how long the supply will last.

Only **\$2\***

postpaid N.Y.S. Residents please add 2% state sales tax.



\* \$1 directory listing fee is deductible for those CB'ers listed in the book.

Who's Who In CB Directory 1965-66  
% Cowan Publishing Corp.  
14 Vanderventer Avenue  
Port Washington, N. Y. 11050

Name: \_\_\_\_\_ CB Call \_\_\_\_\_  
Address: \_\_\_\_\_  
City \_\_\_\_\_, State: \_\_\_\_\_, Zip: \_\_\_\_\_

I enclose \$ \_\_\_\_\_ for \_\_\_\_\_ copy(ies) of Who's Who in CB. I \_\_\_\_\_ am \_\_\_\_\_ am not listed in this Directory.

Special club subscription rates for \$9

September 1965 • 69



# WASHINGTON OUTLOOK

The following CB'ers were asked by the FCC to show cause why they should not have their licenses revoked:

KL T0120, Marcelino Rivera Auto Sales, Inc., Bayamon, P. R.

KL N5911, James Cheshire, Inkster, Mich.

KNE0187, Clebe Doyle, Canon City, Colo.

KL P5586, B&L Furniture, Rochester, N. Y.

KKI2090, Roger E. Myers, Woodbine, N. Y.

KDB6080, Ernest Copeland, Kite, Ga.

19QA0086, John C. Morrow, Kalamazoo, Mich.

KDD9787, Lawrence W. Frazier, Nashville, Tenn.

KL J2298, William Stynen, Chicago, Ill.

KKK5050, Billy L. McIntyre, Asheboro, N. C.

KHJ6516, James E. Jollie, Dayton, Ohio.

KKK7791, John R. Derby, Hampton, Va.

• These operators had their licenses revoked:

KEA2351, William B. Driver, N. Little Rock, Ark.

KDI2461, Paul K. Ballard, St. Petersburg, Fla.

KLK7610, Floyd O. Whitcomb, Davenport, Iowa.

KDH0200, Marguerite Anderson, Hollywood, Fla.

KL N3827, Paul D. Sullivan, Chillicothe, Ohio.

KKM7406, Arthur Petty, College Park, Ga.

KDI5007, John R. Sukowske, Ft. Lauderdale, Fla.

KFA9933, Lincoln B. Simmons, Los Angeles, Calif.

KGC2091, Edward Bruce McInturff, alias Edward B. Johnson, Casper, Wyo.

KEB3457, Sammy Church, Pascagoula, Miss.

KDE3799, Bud Moates, Aragon, Ga.

KFA0783, Thomas L. Michaud, Compton, Calif.

• The following CB'er received a \$200 monetary forfeiture:

KKA8943, Grandville W. Davis, McKinley, Me.

• The following CB'er received a \$100 monetary forfeiture:

KBE0110, Elden Colbeth, Swans Island, Me.

• These operators had previously issued forfeitures reduced to \$50:

KEJ2646, Ralph E. Fullenwider, Riverside, Calif.

KAK1501, Paul's Fina Service Station, Dallas, Texas.

KKP2719, Thomas L. Odem, Sr., Hialeah, Fla.

• These operators had their forfeitures reduced to \$25:

KLK9098, Albert M. Benson, Jr., Louisville, Ky.

KLC1739, Daniel M. Danton, Portland, Oreg.

KGH1032, Joseph T. Elrod, d/b/a Elrod's Radio & TV Service, Independence, Mo.

KEJ1492, Lenora J. Kindell, Bell Gardens, Calif.

KFA3127, Alpha Baker, Jr., South Gate, Calif.

KKR4304, Robert E. Wickes, Mobile, Ala.

KKP0737, Mitchell Middleton, Delray Beach, Fla.

In other actions, the FCC denied the request for monetary forfeiture of KFA0767, Alice E. Mitchett, Ontario, Calif., and ordered her to pay the full \$100.

They modified the order which revoked the CB license KEB0622, Vernon H. Huff, Jackson, Miss. The effective revocation date was changed from May 3 to August 3.

The show cause proceeding against KIC-0815, William J. Lewis, Rochester, N. Y., was dismissed because the licensee has settled his liability for monetary forfeiture and has taken corrective measures to preclude

a recurrence of the violations which formed the basis for the proceeding.

The FCC designated for a hearing seven applications for a CB license in the CB service by five members of the Greenside family of Mattapan, Mass. (Richard, Michael and Stephen, brothers, and William and Bertha, their parents). Issues include determination of the need and purpose for the 70 Class D units and 1 Class C unit requested and, in view of past violations of the CB rules by family members, whether the applicants are qualified to be licensees in the CB service.

The FCC denied the petition to create a new class of Amateur Radio Service, called the "Hobby License." This petition was submitted by the International Crystal Manufacturing Corp., Oklahoma City, Okla. In denying the petition, the FCC pointed out that international radio regulations require examination and, further, that the Novice ham license, with minimum examination requirement, offers beginners an opportunity to acquire the experience necessary to obtain higher class licenses.



## KBG4303 RIDES AGAIN

*Continued from page 7*

famous "ACBA treatment," is their apparent policy.

It would certainly seem that they didn't make such a hot impression on the Lafayette people in whatever earlier contacts they might have had with them. Possibly Lafayette didn't support their hairbrained "CB'ers March on Washington," or maybe they got to speak to some of ACBA's "charter members" and former "officers" who fled the club in droves when its true commercial and devious nature was exposed.

It's most interesting to note, however, that even the mention of someone starting up a real national CB club sends the ACBA into such a frenzied panic that they have to twist and distort the truth for their membership (and they didn't even do a good job of that it turns out). Possibly this may finally panic them into really doing something for the poor innocent and trusting souls who sent in their \$3 and received very little in return (not counting hot air and promises galore). Maybe someday someone will start a real CB club in competition with ACBA.

Anyway, it's reassuring to know that the ACBA is still in there pitching; just in case you might have been wondering.



## SPECIAL TUBES

*Continued from page 34*

changes made in tube manufacturing and/or testing usually require a higher selling price. In some instances, the structure of the tube is strengthened to assure reliable service in

ruggedized military equipment or demanding industrial applications. In other cases, tubes must undergo an extensive series of tests to assure close control of certain characteristics. Such procedures inevitably contribute to higher manufacturing costs, and thus result in higher prices for all users, whether or not their equipment can take advantage of the particular improvements made in the tubes.

## CONCLUSION

As stated previously, the original choice of a tube type is made by the equipment designer after consideration of many factors—cost, reliability, circuit complexity, availability, and the like. In the long run, it is wise for the amateur to follow the designer's professional judgment. Even though an individual may be willing to pay a higher price for a "better" tube, there is no justification for assuming that the substitution of such a tube will automatically improve the performance of a given circuit. The surest way to continued satisfaction with a piece of equipment is to replace worn-out tubes with new ones bearing the same number (including, of course, A and B versions or double-branded types carrying the same number. Substitution of these later versions may or may not help in your particular situation, but it will not hurt).



## CARD SWAPPERS UNLIMITED

*Continued from page 68*

KNU0079	Dale Martin, 516 N. Pine St. Apt. 5, Anchorage, Alaska
XM112045	Lloyd Tait, 132 Riverside Dr., Penitction, B.C.
XM231020	Byron Orge, P.O. Box 1122, Medicine Hat, Alb., Canada
XM33818	Douglas King, Box 1289, Estevan, Sask., Canada
XM412800	Skippy Massam, 66 Guthrie Ave., Toronto, Ont., Canada
XM414109	Doug Ailles, 48-22nd St., Toronto, Ont., Canada
XM43614	Jacob Fehrman, R.R. 1, Port Colborne, Ont., Canada
XM431259	Denis Dubois, Box 71, Welland, Ontario
XM442411	Bill Kerwins, 287 Nelson St., Sarnia, Ontario
XM522895	Bernard Rachlin, 2615 Kent Ave. #204, Montreal, Quebec
XM53534	Francois Goyer, 259 rue Moisan, Drummondville, P.Q.
XM551755	Leo Dupere, 92 Royal Roussillon, Quebec, Canada
XM56066	Gilles Petit, 409 St. Joseph, La Tuque, P.Q., Canada
Atl. 1616	Kerry Myers, 409 Brunswick St., Brunswick, Md.
Cent. 3250	David Sigo, Rt. 1 - Box 153, Goodland, Ind.
North3020	Robert Ream, 608 High St., Lancaster, Pa.
North3300	Tom Bolling Jr., 233 Temple St., Fredonia, N.Y.
North8002	Terry Henry, 55 S. Lincoln St., Keene, N.H.
WPE1GCC	Terry Henry, 55 S. Lincoln St., Keene, N.H.
WPE1GEM	Edward Madej, 193 Oak St., Indian Orchard, Mass.
WPE2NHW	Gerry Schechter, 3535 Kings College Pl., Bronx, N.Y.
WPE2NIO	Sheldon Shuff, 105-57 Flaxlands 8th St., Brooklyn, N.Y.
WPE2NIR	Tommy Berlinger, 105 Mount Hope Place, Bronx, N.Y.
WPE3FQQ	Donald Schmitt, Box #14, Gettysburg, Penna.
WPE3FSC	Robert Ream, 608 High St., Lancaster, Pa.
WPE4HA	Tom Spain, 1927 N. Junaluska Dr., Richmond, Va.
WPE4ENC	Jimmy Bullock, 1628 Long Ave., Nashville, Tenn.
WPE6ETT	Harry Okey Jr., P.O. Box 1526, La Jolla, Calif.
WPE6GBC	Henry Slade, 136 Tamarack St., Vandenberg AFB, Calif.
VE3PEILO	Keith Ryan, 1641 Grasmere Cres., Ottawa, Ontario
TRQ1000	David Bubeck, 109 E. Main St., Schuylkill Haven, Pa.
OZDR1261	Palle Nielsen, Humlebaekgade 13'', Copenhagen, N. Den.
ONL170	Jacquet Camille, UBA P.O. Box 634, Brussels, Belgium
	Ralph Bryant, 716 Riverside Dr., Fairfield, Conn.
	Ruth Charon, 109 Bowers St., Holyoke, Mass.
	Richie Krug, 11 Emmett St., New Hyde Park, N.Y.
	Central Printing, 920 vandeventer, Fayetteville, Ark.
	Jack Allen, 203 Ave. F, Brooklyn, N.Y.



# PSSSST!

## HEY BUDDY!

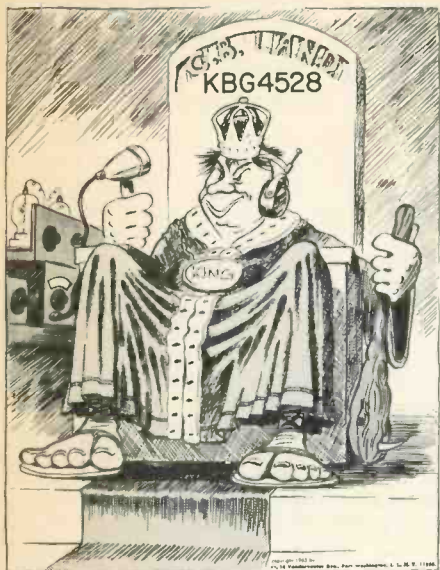

*Were you one of the many readers who wrote to us to ask if we could furnish reprints of our wildest of all S9 covers, the "King of The Band" one we had in February? Well, we can't.*

*BUT we did take this same illustration and enlarge it to a giant 8½" by 11" size, print it in three dazzling colors, and figure out how to personalize it with your call sign on the throne.*

*If this doesn't shake up visitors to your CB shack, nothing will. It looks dandy in a frame and makes a sneaky gift for someone who has everything. It comes postpaid, and personalized with your call (or any other call or name you specify) for only 50¢ in coins (no stamps or checks please).*

*Order this winner now from: King of The Band, S9 Magazine, 14 Vanderventer Avenue, Port Washington, N. Y. 11050.*

## CB SHOP

Rates for CB SHOP are 10¢ per word for advertising which, in our opinion, is obviously of a non-commercial nature. A charge of 25¢ per word is made to all commercial advertisers or business organizations. A 5% discount is in effect for an advance insertion order for six consecutive months.

We do not bill for advertising in CB SHOP. Full remittance must accompany all orders and orders sent in otherwise will not be run or acknowledged.

Closing date is the 15th of the 2nd month preceding date of publication.

We reserve the right to reject advertising which we feel is not suitable.

Because the advertisers and equipment contained in the CB SHOP have not been investigated, the publishers of S9 cannot vouch for the merchandise or services listed therein.

THE BAND BLASTER super Nuvistor microphone amplifier installs between your mic input jack and grid in less than 30 minutes. The poor man's way to be king of the mountain. Only \$9.95, wired and tested from Sentry Mfg. Co., P.O. Box 12322, Oklahoma City, Okla. 73112.

QSL's by Brownie "W3CJL." Since 1939—Quality CB-WPE-QSL cards. Samples 10¢ with catalog 25¢. 3111 Lehigh, Allentown, Pa.

QSL's, 8-12 different beautiful embossed glittering cards 25¢, refundable coupon. Andy's, Bridge St., Amsterdam, N. Y.

CARD SWAPPERS! Want to build up your card collection? Send us 10 of your cards and we will guarantee you 10 different cards in return. Enclose an envelope with 10¢ postage on it, large enough to hold 10 QSL's, we will do the rest. Swapland, % 353 Highland Ave., Middletown, New York 10940.

Heathkit owners, double reception! SK-3 Preselector fits GW-10, GW-11, SK-4 fits GW-12. \$8.99 kit, \$11:99 wired. Postpaid. Free kit, antenna list. HOLSTROM, Box 8640-S, Sacramento, California 95822.

CB CRYSTALS—\$1.75 each postpaid. Any channel, any set. QUAKER ELECTRONICS, Hunhock Creek, Pa.

Radio Announcing. Learn home! Books, Magazines: Disk Jockey, Box 11-CB, Aberdeen, South Dakota 57401.

PLUG IN our shortwave converter and receive any single frequency (AM or FM) between 25 and 180 mc/s. Connects in seconds to any auto radio without tools, switches in or out of circuit. Fully wired and tested, transistorized, and with self-contained battery, you can use it to monitor CB, police, fire, telephone, aircraft, hams, taxi, business band, etc. When ordering, specify channel you wish to receive and also a clear frequency on your radio dial below 1000 kc/s. Only \$37.50, complete. From Sentry Mfg. Co., P.O. Box 12322, Oklahoma City, Okla. 73112.

**POOR MAN'S INVESTMENT**—The U.S. Mint in San Francisco was closed down in 1955—to day its products are getting mighty scarce. Some "S" mint marked Lincoln pennies in circulated condition today sell for as much as \$57, \$65, even \$235. Here's your chance to invest a few cents towards the possibility of having a real winner in a few years. We have a limited supply of good condition "S" pennies and can offer them at only 5¢ each, or 25 for \$1. Please enclose self addressed, stamped envelope. Dates of our choice. Pay for your order with "Mercury" dimes and receive 3 "S" Lincolns for the price of 2. Write E. Steinhardt, 5510 13th Ave., Brooklyn 19, N. Y.

**FREE CB QSL SAMPLES.** From \$2.50 per 100. Radio Press, Box 24S, Pittstown, New Jersey.

**SKYWAY STATIC STRAPS** reduce road noise. Ten braided straps with heavy duty connectors. Install in minutes, complete directions. \$2.50 post-paid or at your dealer. Money back if not satisfied. **THE SKYWAY COMPANY**, Box 51A, Hillsboro, Tenn. 3732.

Free sample packet QSL'S including Alaska with order 1,000 QSL'S \$6.50. Send 10¢ (Refundable) for details. Bob Cleary, Box 468, Binghamton, N. Y.

**CRYSTALS**, Mailed anywhere. Any channel, any set, all \$2.95 each. Thousands in stock. Shipped same day. Cash orders shipped postpaid. Worcester Radio, 164 Main Street, Worcester, Mass. 01608.

**CONVERT** your car radio to a super sensitive shortwave receiver with a Sentry Universal Converter. Will receive any band between 40 and 60 mc/s, convert it to the broadcast band. Wired and tested, less crystal only \$9.95. With crystal (specify band desired) only \$14.95. Sentry Mfg. Co., P.O. Box 12322, Oklahoma City, Okla. 73112.

**SELLING** Beautiful condx General MC-5 unit, full accessories, 9 sets crystals, all power cords for 6/12/110 volts. Will sacrifice at \$125. Gene Pfeiffer, KBG8157, 2032 St. Paul Ave., N. Y. 61, N. Y.

**CB-QSL's** — 200 designs humorous, regular, state maps. Free bonus card. Catalogues — samples 25¢, KCJ1955, Lile Guill, Rustburg, Virginia 24588.

"QSL's. Top quality, reasonable price. Samples 20¢. CB Press, Box 281, Oak Park, Illinois 60303."

**Krome-coated QSL's** \$10.00 per 1000 Crystalon Stock available. Many colors of ink. 10¢ for samples, information. **DOT PRINT SHOP**, Haines City, Florida.

**QSL Cards**—Full Color, Glossy Stock. Free Samples. F. B. Mathews, 1616 Rural Street, Rockford, Illinois 61107.

**POP ART QSL Supplies**, sample 10¢ (coin). SAMCO Pop Art Dept., Box 302, Wynantskill, N. Y. 12198.

**WANTED:** Knight Encoder-Decoder #2553 with 273.3, 304.7, 339.6 cps reeds. Buy or swap. Gene Soyster, Box 743, Northridge, California 91326.

**GOLDEN LINE C/B REPLACEMENT CRYSTALS**

LAFAYETTE
Sonar
Browning

E. F. JOHNSON
Regency

HEATHKIT
HAMMARLUND

POLY-COMM
WRL

METROTEK
hallicrafters
EGL
Courier23

B & K/M
VOCALINE

**READILY AVAILABLE** for these and 150 more **MAKES** and **MODELS**

Don't settle for replacement crystals "almost like" the ones you need for your transceiver. **JK GOLDEN LINE CRYSTALS** are tailor-mated to virtually every set made. Most of them in stock. Buy the crystal—made by acknowledged precision crystal experts—from your **JK** dealer. Insist on the high-performance, 100% guaranteed **JK** crystal.

**CTS KNIGHTS, INC.**  
Sandwich, Illinois

*Super* **STAR BURST**  
CITIZEN BAND BASE STATION ANTENNA



**MODEL SB-100 27Mc (SUPER-STAR BURST) ANTENNA DISPLAYS 54 FEET OF HARD ALUMINUM**

- Signal-To-Noise 6 to 20 db
- Gain (circuit) 9.5 db
- Gain—Super-Star Burst Produces a Big 9 Watts E.R.P.\*
- SWR Hairline to 1—Regardless of Lead Length
- Effective 3/4 Wave Length for Maximum Gain
- Matching Transformer Designed to Minimize T.V.I.
- Internally Grounded—Minimizes Lightning Hazard
- Very Low Angle of Radiation (Horizon Penetrator)
- Impedance 52 ohms
- Drop Over Mount Will Fit Up to 1-7/16" Mast
- Overall Height of Radiator 20 feet

\*Based on 4 Watts Transmission Line Power (Legal In U.S.A.) (F.C.C.—Rules and Regulations: Part 95:43)

**ASTRO** 2000 ANTENNA CORPORATION OF AMERICA

**ASTRO ANTENNA CORP. OF AMERICA**  
2 Rock Spring Road, West Orange, N. J., Dept. S

ENCLOSED IS MY  CHECK  MONEY ORDER  
 \$ 5.00 DEPOSIT, BAL. C.O.D.  
 \$32.50

FOR A SUPER-STAR BURST MODEL SB-100

NAME \_\_\_\_\_  
 ADDRESS \_\_\_\_\_  
 CITY & STATE \_\_\_\_\_



## advertisers index

Alliance Mfg. Co. ....	11
American Knitwear .....	75
Amphenol-Borg Electronics Corp. ....	62
Antenna Specialists Co. ....	1
Astro Antenna Corp. ....	73
Browning Laboratories, Inc. ....	3
Barbett Reproductions .....	46
Channel 9 Decal .....	53
Eastern Electronics .....	75
e.c.i. electronics communications, inc. ....	6
Eico Electronic Instrument Corp. ....	24
General Radiotelephone Corp. ....	Cover 4
Hallicrafters Co. ....	39
Hallmark Instruments .....	76
Harmon Morse Radio .....	75
Heath Company .....	15
Hy-Gain Antenna Products .....	Cover 3
International Crystal Mfg. Co. ....	Cover 2, 58
Johnson, E. F. Co. ....	5
Kaar Engineering .....	61
Knights, C.T.S., Inc. ....	73
Knox Electronics .....	43
Lafayette Radio .....	35
Master Mobile Mounts .....	46
Mathews QSL's .....	43
Mosley Electronics .....	47, 54, 57
Multi Elmac Co. ....	28
New-Tronics Corp. ....	12
Peace Simpson, Inc. ....	10, 63
Petersen Radio Co., Inc. ....	55
Project Aid .....	43
RCA .....	8
Regency Electronics .....	36
Sonotone Corp. ....	53
Squires-Sanders, Inc. ....	56
S9 Subscriptions .....	21, 32, 40
Tennessee Paper & Box Co. ....	43
Texas Crystals .....	52
Tram Electronics .....	49
United Scientific Labs .....	19
Who's Who in CB .....	69
World Radio Labs .....	44

**CB SPORTSMEN!** The famous TR-SONIC FISH CALL — brings the fish right to your hook in fresh or salt water. Sold nationally for \$13.95, only \$8.95 to S9 readers. Complete with batteries. Custom Electronics Co., 2929 Fulton Street, Brooklyn 7, N. Y. Say you saw it in S9.

**CB-QSL-EYEBALL CARDS**, samples, price list 25¢ refundable. XANDER'S, 122 South 2nd St., Lehighton, Pa.

**QSL'S WHOLESALE PRICES!** Different, eye-catching samples. NU-PRINT, 322 Page Blvd., Springfield, Massachusetts 01104.

**Sell or Trade—R390 Receiver** (see S9 Dec. 64, page 31) CB sets Mariner Utica Morrow 5W3B, Radson write Thomas, 11 Sussex North, Lindsay, Ontario, Canada.

**Wholesale Electronics.** Resistors, 3¢, Multimeters \$9.95, Speakers 49¢, Electrolytics 10¢. Hundreds of items. Catalog 25¢. Refundable. Royal, Box 2591, El Cajon, California 92021.

**FREE SAMPLES—CB QSL CARDS—\$2.50** per 100 in 3 colors. Garth Printing Company, Box 51S, Jutland, New Jersey.

**"AUDIO AMP"** — Double your talk power—no internal connections—self contained solid state. \$15.95. Doyle Owens, Box 926, Scottsboro, Ala.

**No Others Like Them!** Sparkling 3-D Cards in space-age designs for QSL — CBL — WPE use. New 3-D Christmas designs, personalized greetings. Samples 25¢ (refundable). 3-D QSL Co., Monson 3, Mass. 01057.

**"Audio-Aid-All"** Clipper Filter Kit, \$10.99; \$14.99 wired. Boosts Modulation, aids reception. SK-20 Preselector for SWL's, kit \$18.98. Postpaid. HOLSTROM, Box 8640-S, Sacramento, California 95822.

**QSL's Gorgeous Rainbows, etc. Top Quality!** Fast Service! Low Prices! Samples 10¢ (refundable). Harms, KD11143, Mystery Hill, No. Salem, N. H.

**QSL's—Quality—Immediate Service—Reasonable** CB QSL Cards. Samples 10¢. Malgo Press—Box 375—Toledo, Ohio 43601.

**Rubber Stamps—Best Quality.** Your 3 lines of printing only \$1.25 including postage. Fast service! Harms, KD11143, 905 Ferneld, Edgewater, Fla. 32032.

**EARN \$\$\$\$** full or part time. Dealerships available for new Civil Emergency Monitor that adapts to car radio to receive Police, Fire, etc. Write Design Marketing, Inc., Dept. "S" Box 6825, Dallas, Texas 75219.

**B & G NOW HAS:** Squires-Sanders 23'er, Harmon-Morse CB-15, Webster 550 Transceivers. **FAMOUS MAKE C.B. CRYSTALS—\$2.10** (3-5) \$1.99 (6-99) (*Specify* Transceiver MAKE, MODEL, CHANNEL, TRANSMIT-RECEIVE) CATALOG 10¢. B & G ELECTRONICS, 516-B LARCHMONT ACRES, LARCHMONT, NEW YORK 10538.



NAMETAGS, your name and call, club engraved on plastic/formica, Two lines—\$1.35. One line—\$1.15. Wide choice of color, sizes, write for Big Club Discount and sample on club letterhead. D-Lux Engraving, Box 2, Bellevue, Nebraska.

Not enough audio? Write for free literature on the miniature preamp and clipper-filter. Both transistor units are self-powered and require no connections inside unit. From \$10.95. Dept. S65, J-A Electronics, Box 645, Teaneck, N. J.

"U.S. GOVERNMENT OFFICIALLY LICENSED RADIO COMMUNICATION STATION" sign for your sun visor. Printed in big white letters on black background, heavy card stock. Looks great! Order it now and receive absolutely FREE a realistic "UNCLE" ID card and a zany surprise sticker for your front door. Only 50¢, 3 sets for \$1, postpaid. Haral Associates, CB Dept., 1133 Broadway, New York, N. Y. 10010.

FREE \$9 SUBSCRIPTION with each and every one of our TR-SONIC FISH CALLS. Sold in stores at \$13.95, we'll let you have one (with 12 issues of \$9) for only \$11.95 if you mention that you saw our ad here. In the ocean, in a river or lake, this device attracts fishes by means of electronic trickery. Comes with batteries, ready to pull 'em in. Electronics, P.O. Box 124, Jamaica 13, N. Y.

QSL'S—BILL'S 6W7263, 905 ALTAMAHA, CHATTANOOGA 12, TENN. SAMPLES 10¢.

Needed: Operation, calibration and alignment data on Hickok Model 640 oscillograph. Gene Pfeiffer, KBG8157, % e.c.i. electronics communications, 56 Hamilton Ave., White Plains, N. Y.

CRYSTALS, Mailed anywhere. Any channel, any set, all \$2.25 each. Thousands in stock. Shipped same day. Cash orders shipped postpaid. Worcester Radio, 164 Main Street, Worcester, Mass. 01608.

NAMEPLATES, decals, tags, signs and labels. Free samples. Seton Corp., Dept. CBJ, New Haven, Conn. 06515.

HEY PUSSY CATS! Want a sneaky way to build up your card swappers collection? We will ship you 25 different cards for only \$1. No printers samples or junk, but REAL CB QSL's from all over, some actually signed by the ops. S. Nussbaum, 1440 50th St., Brooklyn, N. Y. 11219.

## CLUBS-TEAMS-SCHOOLS

SAVE MONEY  
BUY FROM MANUFACTURER

Emblems • T-Shirts • Sweatshirts • Lettering  
Banners • Jackets • Award Ribbons • Pennants

**FREE PRICE QUOTATIONS.. SEND SAMPLE OR SKETCH.**

State Name Of Club - Team - School

Send 35 c For Catalog and Assorted Emblems.

*American Knitwear and Emblem*  
PLAISTOW 14, N.H.

## POWER in Miniature

The CB-15 Measures only 6 1/2 x 6 1/4 x 2 5/8 inches and it weighs only 3 pounds!

1/10th  
the Power  
Consumption  
of Standard  
Tube Units



### The Ultimate in SOLID STATE Silicon Transceiver Design

Solid state circuitry uses silicon transistors only plus ceramic double tuned filters for improved adjacent channel interference rejection.

Features include external speaker jack, dust-proofed enclosed relay, 5-watt input, no interference with TV reception.

Price is only **\$175**

**TAKE THIS AD TO YOUR DEALER AND RECEIVE FREE AN EXTRA SET OF CRYSTALS.**

Some Territories still available

### HARMON MORSE RADIO

Holton, Kansas 66436

Phone 913-364-3126

# PHONE PATCH



## MODULE

This is a complete, sealed-circuit module that provides a means for connecting your telephone lines to your rig, tape recorder, amplifier, etc. So small that it can be built into a telephone.

### PHONE-PATCH TELEPHONE —

New, highly styled telephone with a built in, high quality phone-patch. This unit can also be used as an extension telephone for your shack.

**EASTERN ELECTRONICS, Dept. S-9**  
708 EAST TREMONT AVENUE, BRONX, N. Y. 10457  
Please send me:

- Phone-patch module(s) @ \$9.95 ea. ppd.  
 Phone-patch telephone(s) @ \$29.95 ea. ppd.  
 Telephone(s) only without phone-patch @ \$17.50 ea. ppd.  
 Further information on the above

Name \_\_\_\_\_  
Address \_\_\_\_\_  
City \_\_\_\_\_ State \_\_\_\_\_ Zip \_\_\_\_\_

N.Y.C. Residents please add 5% city sales tax.  
N.Y.S. Residents please add 2% state sales tax.

# New! 8 Channel top-performance CB *and* AM broadcast radio for only \$99.<sup>50</sup>



## **BANNER 85** combines two radios with top performance in both CB and AM broadcast operation!

Hallmark technology has done it again! The sensational new BANNER 85 is an 8 channel, crystal-controlled CB with a built-in AM broadcast band to give you two radios for one low price!

And, you'll get unexcelled Hallmark performance from both. With rugged, hand-wired construction, the CB operation features  $0.3\mu\text{v}$  for 6db S+N/N ratio; 45db selectivity; 4 watts power output and high level modulation. The full fidelity broadcast operation outperforms most AM car radios.

Join the HELP program now with the reliable, low-cost BANNER 85. Write today for complete information.

FCC rules, part 95, applicable to Banner 85 operation.

### **HALLMARK INSTRUMENTS**

P. O. BOX 10941 • 2620 FREEWOOD • DALLAS, TEX. 75220 • (214) FL 7-0184





# 120 WATTS TALK POWER!

## **NEW DUO-BEAM 10** by **hy-gain**

Now, with Hy-Gain's Duo-Beam 10, you can add miles of distance to your Citizens Band range...transmit and receive stronger and clearer signals in the area you've been working. And, because the Duo-Beam 10 is ROTATABLE, you can do it with PINPOINT ACCURACY in any of the 360 degrees surrounding your station! The Duo-Beam 10 is a twin-driven 10 element beam that re-forms the 5 watts output power from your transceiver and funnels it in a "ray-like" path close to the ground to deliver you power equivalent to what you'd get from a CB rig with output power as high as 120 watts. That's "Talk Power." The Duo-Beam 10 is rugged, too...all heavy gauge aluminum construction with iridite treated hardware...designed to survive 80 mph winds. Easy to install on rooftop towers, TV towers, or on a 1 1/2" mast...It's guaranteed to outperform any legal antenna for CB. **Model 1110DB \$99.95 Net**

### **93 Watts TALK POWER...**

**DUO-BEAM 6**—Another new rotatable Duo-Beam by Hy-Gain...twin-driven 6 element model that delivers 93 watts "Talk Power." Guaranteed to outperform any legal CB antenna other than the Duo-Beam 10. **Model 116DB . . . \$69.95 Net**

### **42 Watts TALK POWER...**

**DUO-BEAM 4**—The smallest of Hy-Gain's new rotatable Duo-Beams...a 4 element model that delivers 42 watts "Talk Power." Guaranteed to outperform any legal CB antenna other than the Duo-Beam 6 or 10. **Model 114DB . . \$39.95 Net**

*Available now from your Hy-Gain Dealer or Distributor—*

*Send for complete descriptive literature—Form No. 13*

**HY-GAIN ELECTRONICS CORPORATION**

8448 N.E. Highway 6—Lincoln, Nebraska 68501



Once again General has produced a new and original design to set the pace for the entire Citizens Radio Industry. The new 24 Channel Super MC-8 with Turretuner® is years ahead of the field. Its 30 watt construction, with 100% modulated double sideband transmitter and super sensitive dual conversion receiver are the result of many years of development and testing.

Move up to the professional level in CB radio. Try this outstanding unit at your General Dealer today or write General for complete technical manual and schematic.

General 24 Channel Super MC-8 \$199<sup>50</sup>

Complete with microphone, 110 V AC cord, 1 transmit/receive crystal, Channel 11; and instruction manual



## GENERAL RADIOTELEPHONE COMPANY

3501 West Burbank Boulevard, Burbank, California

Telephone: 849-6891, Area Code: 213

A 615-B  
MULTIFUNCTION  
BRIDGE



FREE IN GENERAL'S  
MONTHLY DRAWING!

August Winner

James S. Ricer, Sr., KCG2072, Linthicum Hts., Md.

Name \_\_\_\_\_ CB  
Call \_\_\_\_\_  
Address \_\_\_\_\_ Ham  
Call \_\_\_\_\_  
City \_\_\_\_\_ State \_\_\_\_\_  
My CB Dealer is \_\_\_\_\_  
Dealer's Address \_\_\_\_\_  
City \_\_\_\_\_ State \_\_\_\_\_

My CB Club is \_\_\_\_\_  
Club Address \_\_\_\_\_  
City \_\_\_\_\_ State \_\_\_\_\_

**Good for October drawing ONLY. (\$9)**

License and operational requirements subject to Part 95, FCC Regulations.

\$9

14 Vanderventer Ave.  
Port Washington, L. I., N. Y.

Controlled Circulation Postage Paid at New York, N. Y.

62M13-64DEC 65

AL BROWDY-11Q396B  
1962 S STEARNS DR  
LOS ANGELES 34 CALIF