

SEPTEMBER 1981

Only 60p

CB

Citizens' Band

Britain's Leading CB Monthly

**Review
Special:**

ANTENNAS

**Finding
your way
through
the Jungle**

**Rig review:
New UK rig**

**Inside CB:
How the
receiver works**

**Your problems
answered:
CB Q&A**

**Legalisation News:
Licences Issued!**



Ever been to a warehouse and been wound up?



wrong stock! wrong prices! no stock! no returns!

NOT AT

ACORN

THE LEADING CITIZENS BAND WAREHOUSE
WE STOCK THE LOT!

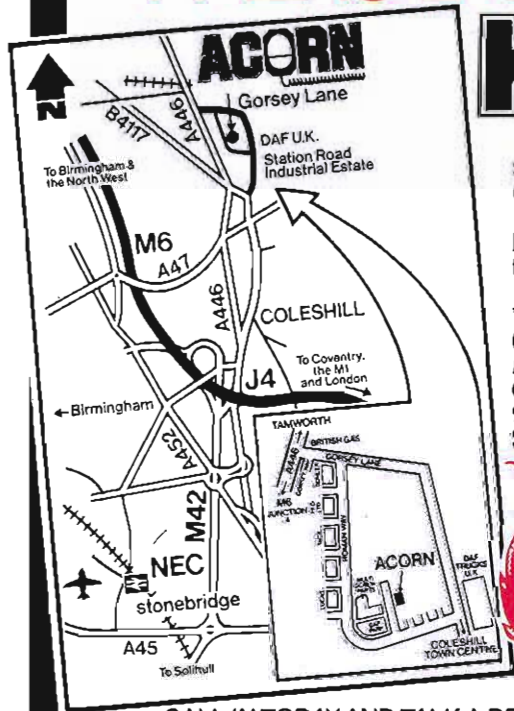

How many times have you called in on your local C.B. Warehouse and found the wrong stock — no stock — wrong prices, in addition to being told that you are unable to return damaged or faulty stock! **NOT AT ACORN buddy!**

In our superbly appointed 3000sq.ft. showroom we stock the lot including all the popular lines plus some specials and to keep ahead of the field, we are adding more and more products to meet demand.

All Acorn's prices are competitive and special discounts are available on bulk purchases. * CASH & CARRY * TRADE ONLY * DELIVERY ANYWHERE IN G.B. (FREE FOR PURCHASES OVER £400) * FREE ADVICE TO NEW RETAILERS. * SPECIAL BIG VALUE STARTER PACKS AVAILABLE.

OPEN MON.-FRI.
 9.30a.m.-6p.m.
 SUN. 10a.m.-4p.m.

**BE A REGISTERED ACORN DEALER BY RETURNING COUPON TODAY
 SPECIAL FREE GIFT OFFER FOR ALL NEW ACCOUNTS**



Name _____

Company _____

Address _____

Tel. _____

Position _____

CALL IN TODAY AND TALK A DEAL WITH ACORN
ACORN TRADING (GB) LTD.

UNIT 43, OFF ROMAN WAY, COLESHILL INDUSTRIAL ESTATE, COLESHILL,
 BIRMINGHAM B46 1JT. TEL: COLESHILL (0675) 64136

CB/9

CONTENTS

Editor:
Rick Maybury
Senior Art Editor:
Andrew Sawyer
Advertisement Manager:
Roy Perryment

Cover this Month

Thanks to Andy Sawyer, our Art Editor, for dressing up this month in the monkey skin and a special hello to Doris, our cleaning lady, for posing with him. Ta to the companies that lent us the twigs and I would just like to say a big hello to my mum — hello mum.

Copyright. All material in this publication is subject to world-wide copyright protection. Permission to reproduce any material in part or whole must be sought from the publisher. All reasonable care has been taken in the preparation of this magazine to ensure accuracy but Modmags cannot be held legally responsible for any omissions or mistakes that may occur. © 1981 Modmags Ltd.

CITIZENS' BAND is normally published on the third Friday of each month prior to cover date.

CITIZENS' BAND, 145 Charing Cross Road, London WC2H 0EE. 01-437-1002. Published by Modmags Ltd. Distributed by Argus Press Sales & Distribution Ltd., 12-18 Paul Street, London EC2A 4JS. Printed by Alabaster Passmore & Sons Ltd., London & Maidstone.

The publishers of CITIZENS' BAND would like to point out that it is at present a contravention of the Wireless Telegraphy Act of 1949 and 1968 to use, manufacture, install or import CB transmitting equipment. It is not the intention of Modmags Ltd to incite, encourage or condone the use of such equipment.

Group Art Editor:
Editorial Assistant:
Drawing Office Manager:
Managing Editor:
Managing Director:

Paul Wilson-Patterson
Judith Jacobs
Paul Edwards
Ren Harris B.Sc
T J Connell

CITIZENS' BAND
CITIZENS' BAND
CITIZENS' BAND
CITIZENS' BAND

SEPTEMBER 1981

VOLUME 1. NUMBER 10.

Update	6
Read it here first	
CB Q&A	12
Can we help?	
Rig Review	14
Veery interesting	
Coming Next Month	16
Important news	
Antenna Review	18
Bandit B40	
Special Offer	20
Summer special	
Rigs, Twigs and Prigs	24
We get a licence	
Antique Accessories	26
Would you believe...	
Antenna Survey	28
We've twigged!	
Channel Check	37
RF Probe	
Inside CB	38
Are you receiving us?	
Mack Chat	41
Rigs and Riots	
Back Chat	43
You tell us	
Club News	46
National news	
Club Directory	48
Biggest yet!	

HENRY A Real Talking-Machine!

The LUCKY HENRY CB radio is a real talking-machine! It has a built-in speaker and a microphone. It's the most reliable CB radio you can buy. It's the only one with a built-in speaker and a microphone. It's the only one with a built-in speaker and a microphone. It's the only one with a built-in speaker and a microphone.

MICROPHONE ADAPTER
SERIES
FREE

For sale everywhere, supplied with fitting instructions for every make of CB apparatus. Send £15 for prompt delivery to LUCKY HENRY PROMOTIONS Twickenham.

SPECIAL OFFER ALL FIVE BOOKS **£20** INC. P&P.

HOW TO SELECT & INSTALL ANTENNAS £3.95 INCL. P&P

CBers SSB HANDBOOK £4.95 INCL P&P

CBers FACT BOOK £3.50 INCL P&P

MODERN CB RADIO SERVICING £5.95 INCL P&P

CB ACCESSORIES YOU CAN BUILD £3.95 INCL. P&P

TRADE ENQUIRIES WELCOME ON ALL PRODUCTS-ASK ABOUT OUR FULL RANGE....

Knight
CB SPECIALISTS

201 DUNSTABLE ROAD, LUTON BEDS.
TELEPHONE: (0582) 425722/3

CB HEAD PHONES
Available with blue, red, yellow and black CUMFY-MUFFS Fits all Rigs & Ears!

£7.95 INC. VAT. & PP

APOLLO
POWER MIKE with Switchable ROGER BLEEP

£15.95 INC VAT P&P

MIDLAND INTERNATIONAL
49MHZ-2CHANNEL WALKIE-TALKIE

COMPLETE WITH WRIST STRAP AND TELESCOPIC ANTENNA- EXCLUSIVE CALL SIGNAL, ALERT TONE, 100MW POWER SUPERHETERODYNE RECEIVER, EASY TO USE. SWITCH ON PUSH BUTTON TO TALK OR SEND SIGNAL. Approx ± 1/2 Mile Range- 9 Volt Battery. (not included)

£29.95 PAIR inc. VAT. P&P

CONVERT YOUR 40ch RIG TO AN **80ch RIG** **£19.95** INC. VAT. P&P

With the **UFO-40** PIGGYBACK BOARD

1 1/2" Square Board will fit inside all rigs Full instructions Easy to fit

DIGALOG TECHNOLOGY INC
DIGI-SCAN 400
FREQUENCY EXPANDER

ILLEGAL ALL OVER THE WORLD **£89.95** INC VAT P&P

1200 CHANNELS SIDEBAND
400 CHANNELS AM

THE TANK
MOBILE LINEAR AMPLIFIER

30Watts AM-60Watts SSB COMPLETE with Patch Lead

£24.95 INC VAT P&P

50Watts AM-100Watts S.S.B. Model
NOW AVAILABLE **£66.59** INC VAT P&P

MAIN AGENTS FOR **de** ITALY
TRADE ENQUIRIES WELCOME



C.B. L.P.
£2.95 INC VAT P&P

TO: KNIGHT CB SPECIALISTS, 201 DUNSTABLE ROAD, LUTON, BEDS.

Please send me the following items:

1 _____ £ _____

2 _____ £ _____

3 _____ £ _____

Use separate sheet if necessary

Please allow up to 21 days for delivery

TOTAL £ _____

SIGNATURE _____

NAME _____

ADDRESS _____

Enclose Cheque P.O. Payable to **KNIGHT CB SPECIALISTS** for £ _____

I wish to pay by BARCLAYCARD ACCESS tick

Card No.

**Britain's foremost
CB specialists**

WANTED!

**REGIONAL
DISTRIBUTORS**

**to expand CB equipment sales operation
& become an important link in national organisation.**

**Selected applicants will be supported with vigorous advertising
and marketing techniques to ensure rapid growth.**

Established Companies only.
Forward References to:

David Jacobs, Managing Director,
Citizens' Band Radio Centre Ltd

337 Kenton Road, Harrow, Middx., HA3 0XS.
Tel: 01-907 1106/3666 Telex: 291871 CBRAD G

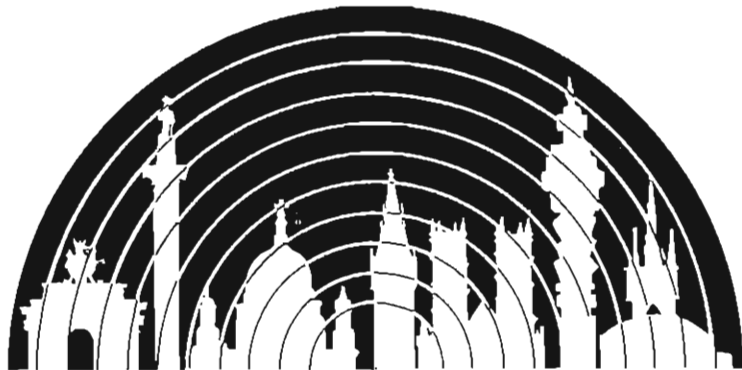

CITIZENS' BAND
Radio Centre Ltd.

Meet The Dealers

Psst. Wanna hear a story? Truth be told you've got no choice as I'm going to tell it anyway. This story is set in the town of Enfield, to the North of London and widely accepted as a pretty reasonable place as towns to the north of London go. The story concerns a new(ish) CB shop, in *Hertford Road*, number 55719 to be precise. Aforementioned shop, once a butcher's shop now bears the name 'Skyriders' and is inhabited by a gentleman known to all and sundry as one Dave Rogers (SB to his intimate friends). Dave is a pretty enterprising chap. He already owns a very successful trucking business, just over the road in fact. Now, Dave, being a bit of a businessman, saw CB as being a good place to be — indeed, he had already opened a fairly small shop in Enfield and business was so good he decided to expand. Dave doesn't do things by halves so after making the appropriate enquiries and spending more money than we've got space to tell, he opened what must rate as one of the best CB shops in a 20-mile radius. Dave's got the lot — you name it, he can supply it, and at a reasonable price too. Skyriders will expand in a big way over the next few months, too. Already space is being cleared for a workshop and trade counter

CB Tapes

Education of those new to the art of CB and quite a few of those who would consider themselves expert and are not, is in short supply.

So cassette tapes such as those produced by *Smile Studio* in Manchester and on sale through Channel One CB centre at Rochford, Essex, must be encouraged.

With certain reservations I recommend their two tapes **Breaking into CB** and **How to SWR** as a detailed introduction for the beginner.

I liked the emphasis on good behaviour on channel and the clear, concise instructions, though I feel listeners may get confused between narrator Anthony Schaeffer's voice changes from phoney American to proper English, and the needless Frank Spencer impressions. Another minor criticism, on the SWR tape, concerns the use of channels 1 and 23 for checking SWR, confusing for those of us who do it on 1 and 40, but perhaps more people than 23 channel rigs than I thought.

A third tape — **How to DX** — was passed on to an experienced DXer for comment and his report was most praiseworthy.

Channel One are at 17 Golden Cross Parade, Rochford, Essex. Telephone Southend (0702) 540455.

SUPERSCRIBE

and at the back, in a very large warehouse, Dave plans to assemble UK FM rigs imported in part from the Far East. This new range of rigs will be carrying the Skyrider badge and Dave is confident that his retail price will give the big boys something of a headache.

Skyriders hopefully will be one of the dozens of companies at our CB show in September, but in the meantime, why not get yourself along to Skyriders? The shop is really friendly: you can get an appalling cup of tea from his machine and Dave (SB), Cockerel and Doctor Dolittle are always on hand to help you with any problems, be they technical or whatever. By the way, we like him too 'cos he sells our mag, but that's another story.

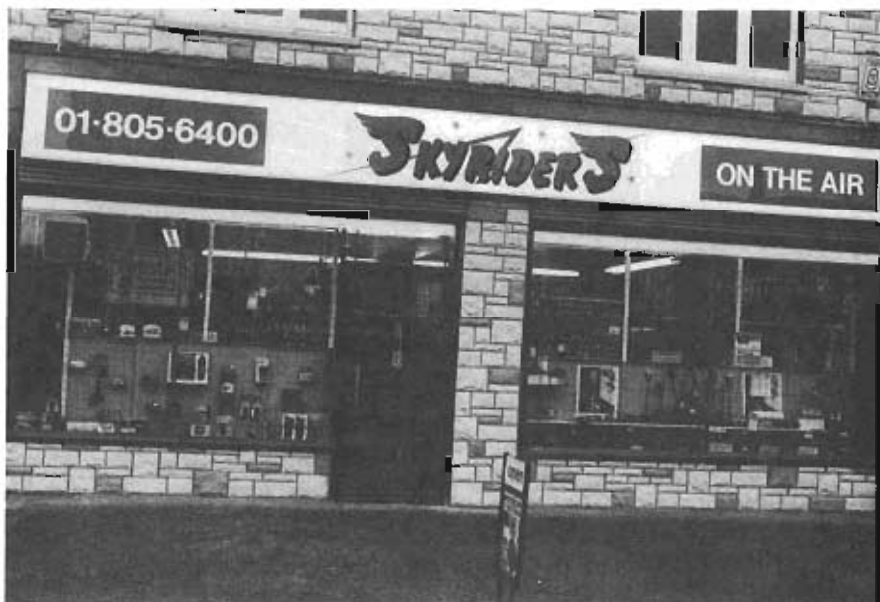

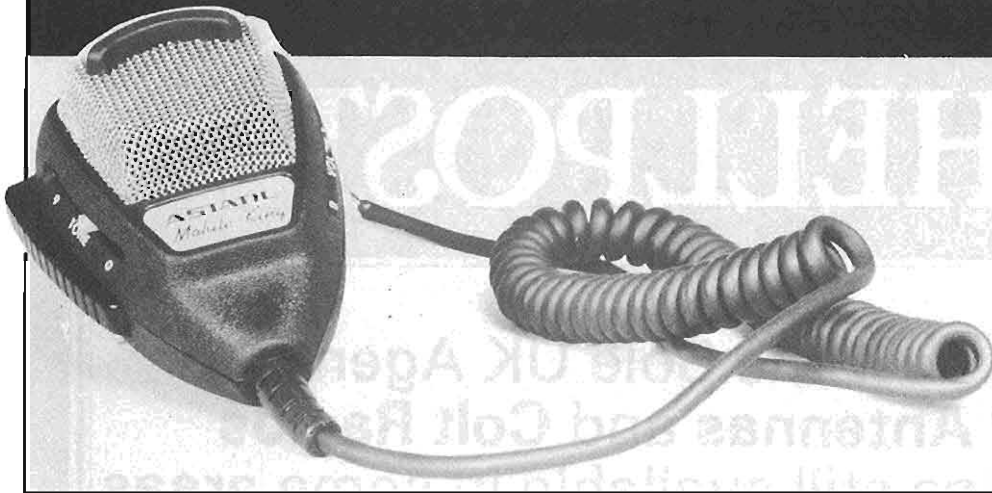

Chatterbox

Hot off the boat is the new Astatic mike designated the **MK 1**. CB purists will know that the Astatic company produce what is generally acknowledged to be the Rolls-Royce of base station mikes — the D104 candlestick. Astatic are also building up a fine reputation for their distinctive range of mobile mikes, known to their friends as 'teardrops' due to their unusual shape.

The MK 1 is basically a processor mike with noise cancelling facilities. It's not a

power mike in the true sense but it does make the best use of the signal, presenting the rig with as clean an input signal as possible and with background noises removed from the signal. The MK 1 is a fairly bulky mike to use. Many will not like the hefty feel at first but, like the other Astatic mikes, to know it is to love it.

In operation the MK 1 performs admirably — the signal can be varied from a sharp crisp treble, ideal for when the skip is up, to a mellow 'bassy' tone that

spans the whole of the bandwidth of 5 kHz.

Skyriders in Enfield are currently the main agents in this country for Astatic products and you may be interested to know that they have a limited number of gold candlestick mikes (very rare) for under £100. The MK 1 can be yours for £34.50, so get along to **Skyriders** at 557 Hertford Road, Enfield (01-805 6400) and have a drool over those gold candlesticks while you're there.

Card Sharps

Getting QSL cards printed can be a pretty expensive business these days so we were pleased to hear of one design studio offering printing services at very reasonable rates.

The outfit is run by Peter Fields who is a commercial artist by trade, and a gentleman known as Sorcerer who does the printing. A typical costing for 250 'Eyeball' cards measuring 3.5" x 2.5" comes out at just £5.00 and the same number of postcard-sized QSL cards comes to £13.50. These prices include post and packing and the guys will design the cards for you if you supply rough artwork. You can contact Pete and Mr. Sorcerer at 60 Dunstan Avenue, Westgate-on-Sea, Kent CT8 8HT or landline them on 0843 33813.



Eyeball The Eyeball

At last, the **Eyeball Bistro** CB restaurant has finally opened. The intrepid staff of *Citizens' Band* magazine volunteered, courageously heedless of the dangers involved, to sample the fare at this establishment.

After first bracing ourselves with a half dozen or so Pina Coladas, we fearlessly ate where no CB journalist had ever eaten before — and we survived. Actually, a menu that includes dishes like Home Office Special Platter can't be all bad, and it's not — it's very

good! The grub is excellent and features like being able to select between live CB transmissions and CB music on each table make it all the more interesting. David Levy, he's the gaffer, tells us that within the next few weeks each table will be equipped with a rig that will enable each lucky diner to order food and drink.

The **Eyeball Bistro** is just off Oxford Circus, at 2 *Princes Street* W1. Give them a tinkle on 01-629 8519.

SHELLPOST LTD

We are now the Sole UK Agents for
HMP Antennas and Colt Radios
Dealerships still available in some areas
Telephone: 061 797 7146 for details.



Colt CB

COMMUNICATION
ANTENNAS

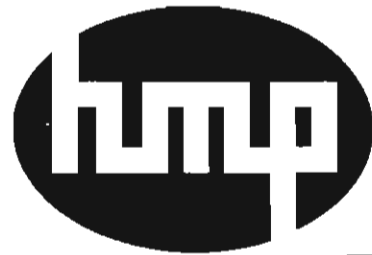

SOLE UK AGENT



COLT IS THE TRADEMARK OF COLT COMMUNICATIONS INC.

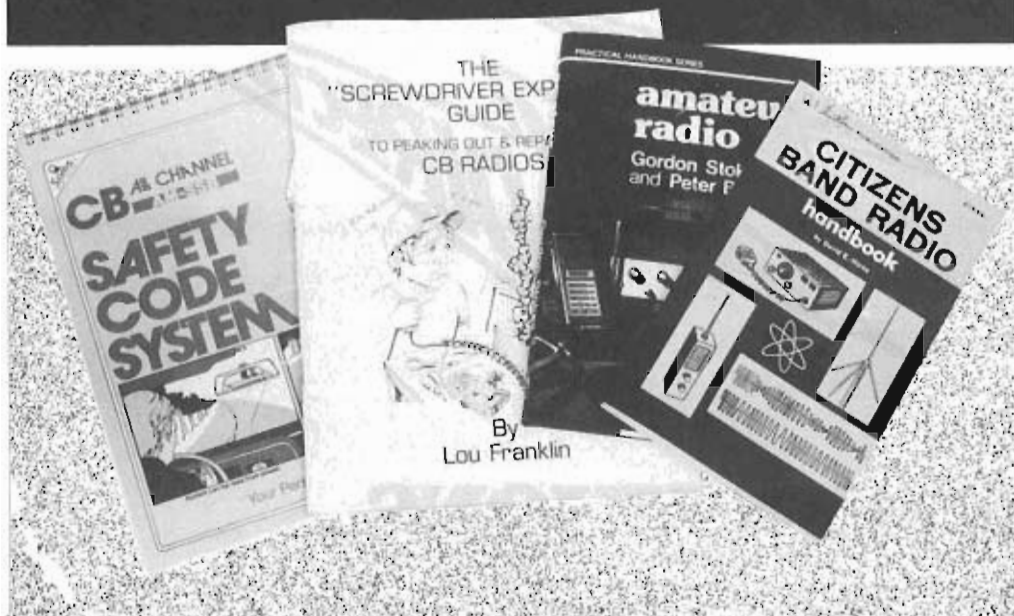

CB At Sea

Apologies for the absence of our feature on Marine CB this month. We were rather pipped at the post by one of our competitor magazines so we decided to hold our feature over for a couple of months. We're going to have to check the CB office for bugs!

By the by, boat owners are currently reeling at the recent increase of marine radio licences, a staggering jump from £6.40 to £17.50.

October Issue

Don't forget there's a free gift in next month's mag — out September 18th.

Book News

Loads of new books for your consideration this month.

First away is:

THE SCREWDRIVER EXPERTS GUIDE

Lou Franklin

Connexions, £4.95.

It may be a little unfair to compare this book with the venerable 'Big Dummies' but this book is a sort of little dummies guide to repairing CB rigs. The book was written in a very down-to-earth manner, leaving the reader in no doubt that CB radios are not really all that complicated after all. Lou Franklin assumes a little technical expertise but points out on several occasions that the majority of rig faults are actually very simple to repair, in fact mostly 'nut and bolt' problems that can be cured with the minimum of tools and test gear.

Although the book was written a few years ago most of the techniques are still valid on present-day CB rigs though sections on FM may be a little sketchy. This book is very highly recommended for all CBers, even if you're not interested in the technical side of the subject, it does lay down quite a few home truths about the nonsense that is said about CB particularly concerning antennas, SWR, rigs and power.

CB SAFETY CODE SYSTEM

Sams Publication

Kona Publications

A very strange book. This ring-bound, loose-leaf book has printed upon its pages

giant sized numbers from 1 to 40. The numbers are also repeated in mirror image fashion, the reason being that you can hold up a certain page while you are driving along in your car and tell a motorist, either behind you or in front of you (hence the mirror image) which channel you are, or about to be, using.

Each page also has the phonetic alphabet — only up to P for some reason — which can be used for passing on limited messages.

Exactly why anyone with a CB should need to tell someone with a CB which channel they are using by visual sign language escapes me for the moment but there is a degree of worth in the system being used to pass on messages in a situation where you may not wish to have an audience on the airwaves.

CITIZENS' BAND RADIO HANDBOOK

David E Hicks

Kona Publications

Like most CB books of American origin there are bound to be chapters that conflict quite heavily with our own situation. However, the CB Handbook is a good solid introduction to the fundamentals of CB and the theory aspects are kept refreshingly straightforward. The book does tend to rather show its age by dwelling rather too long on valve-based systems but the chapters on antennas, maintenance and repair hold good for all CB systems no matter where they are.

AMATEUR RADIO

Gordon Stokes and Peter Bubb

Lutterworth Press

ISBN 0-7188-2477-6,

£8.95

If you're feeling frustrated by the limitations of just 4 watts and yearn to use high power transmitters without worrying every time the door bell goes, then you may like to think about taking the Amateur Radio Exam. This book covers the whole of the RAE course, from the basic fundamentals of electrical and electronic theory right up to how to use amateur radio equipment once you've got your ticket. The book is written in a clear, easy to understand style with plenty of diagrams and photographs. Although the cover price is a little high this is an excellent book and should be of interest to anyone thinking about taking the exam.

Brass Monkeys

Latest addition to the best-dressed breaker catalogue is this solid brass buckle complete with amatching belt that sets off the mouldy old rags a treat. The thoughtful bods at *Tanside Ltd* even gave us a choice, black or brown and medium and large for the colour and length of the belt which is 1.75" wide. A space has been left on the buckle so you can have your handle engraved.

If you can't find them at your local CB shopette get in touch with *Tanside Ltd* at *10 Summers Row, North Finchley, N12 0LD* we wouldn't be at all surprised if they could be contacted on *01-361-0101*. My trousers haven't fallen down yet! By the way, *Tanside* will engrave your handle on free this month if you mention *Citizens' Band* magazine — are we good to you or what? AS

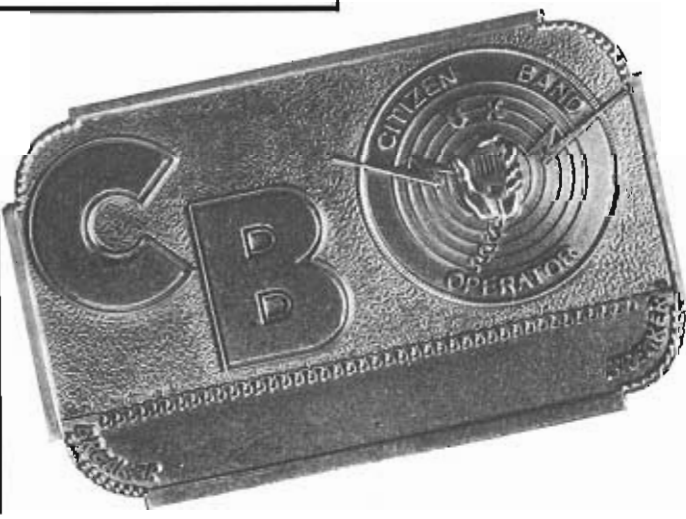

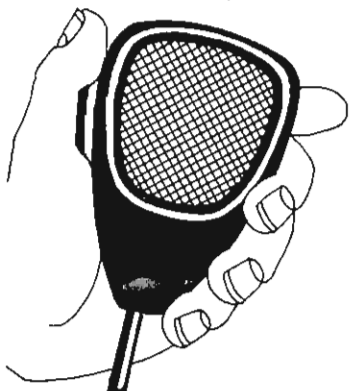

CONNEXIONS WORLD-WIDE CB IMPORTERS

**Buy direct from us
Save time and money**

-  **Huge stocks of all major
U.S., European and Far East
brands available now.**
-  **24 hour trade delivery
anywhere in the U.K.**
-  **Keenest prices on all items.**

TRADE ENQUIRIES: Tel (062-882) 4338/9

Or come and see us at:

**- Connexions -
Furrow Way, Cannon Lane
Maidenhead, Berks SL6 3NY.
Telex: 881 3271 GECOMS G**

Connexions

CB On Radio

Breakers in the Swansea area are well served by *Swansea Sound* the local independent radio station with a show on Sundays called the *Country Breaker Show*. The show, which goes out between 3 — 6 pm, is hosted by Lloyd Coles and a local breaker known as White Knight. The show is based on a C & W format with plenty of CB records thrown in for good measure. For the first two hours of the show breakers are invited to phone in with requests and messages and the station claims that they have already been involved in a number of 10.33s. The show has plenty of news, both local and national plus club gossip. The station covers a fairly wide area from Bridgend to Tenby, so we're told, so listen out for it. By the by, if other local radio stations have specialised CB show etc then why not let us know about it?

Sponsored Swim

Just time for a quick mention for the Eastbourne Breakers who are organising a sponsored charity swim for Sunday 20th August. The swim starts from Eastbourne pier and ends, 18 miles later, at Hastings pier. An informal eyeball starts at Eastbourne

Medical Kit

We're hearing a lot about how CB can save lives, and of course its true — but the real savings can often be made right at the scene of the accident itself where seconds save lives. We are therefore going to tell you all about a medical kit, designed to be carried in the boot of a car and which, if used properly, could put those vital minutes before medical help arrives to good use.

The kit has been put together by **Vickers Medical** and contains all the bits and bobs for keeping blood in its proper place and enough bandages and things to put the National Health service to shame. Where this kit does excel though is in the very clear and concise instruction book. It lays out the fundamentals of first aid in a very clear and easy to understand manner, using clever diagrams and animated illustrations to save those precious seconds. The kit was originally developed in Norway and has been proved for some time in Europe, and while it won't enable you to carry out on-



the-spot brain surgery it will make you better equipped to deal with emergency situations until proper help arrives. Don't forget, it may be *your* life one day so find yourself

£14.94 (inc VAT and delivery) and send it off to **Vickers Medical Engineering**, PO Box 48, Priestly Road, Basingstoke, Hants RG24 9JW and ask for the Motorist Emergency Kit.

pier at 10.30 am — listen out on channel 40 on the day for news and info. The swim is being organised on behalf of the Stuart Henry Multiple Sclerosis fund and a local children's charity.

Amateur Exam

Plenty of CBers seem to be crossing over to the other side by taking the City and Guilds Radio Amateur Exam. With the next round of examinations coming up in December you might like to know that R Benham-Holman Esq is offering to supply a sample set of questions that you can try out to see what your

chances are. The sample exam contains 50 typical RAE questions that should be answered within the 2½-hour time limit. A separate answer sheet is supplied to check your answers. The sample paper costs £1.00 all inclusive, and can be obtained from 'Cobhamden Castle' Beerdown, Uplowman, Tiverton, Devon.

COMPETITION RESULTS

Waving Mike Competition

Usual stuff, millions of brilliant entries — it took days, nay weeks to decide on the winner, winning entry shown below.

First Prize of Instant Stardom and a Shakespeare Knightstick goes to one Les Spence with his very imaginative 'Radio Active' design. Les lives in Brigg, South Humberside, and his prize is currently being sawed in half so it will fit into the postbox.

Second Prize goes to another Les, this time Les Green from Tongham in Surrey. His 'We Love CB' really caught our judge's eye. Les number two

receives a SSE Horn Speaker for his troubles.

Third Prize, a year's sub to the mag, goes to The Senior Citizen (great Handle!) who lives in Ross-shire up north somewhere.

Jan Fabius, our senior judge, awarded three special mentions to Jack Frizzell in Birmingham for 'CB 4 ME', Mrs S C Jones for 'Have A Break, Have A Quick Chat' (nice one) and finally a really excellent entry from C Etchett painted in bright colours but unfortunately a little complicated for a small sticker. His entry was simply 'You Gotcha Ears On' but it was the design that really caught our judge's eye. Many thanks to **Holland Promotions** who will be

producing the winning entry on their range of waving mikes. As we said, some of the proceeds from the sale of the waving mikes will be going to a charity nominated by us for the purchase of CB rigs. We already have a list of charities drawn up and **Holland Promotions** have a tidy sum saved up — we'll be letting you know the names of the organisations involved in the next month or so. Thanks to **Shakespeare** and **SSE** for donating the prizes and a special thanks to Jan Fabius and **Holland Promotions** for producing the winning entry. **Holland Promotions** can be found at 4a Stamford Brooke Road, London W6 (01-743 1964)

so look out for the ad in this issue and remember you'll be helping someone in need with every one that's sold.





CB

Q

AND

A

After only one month CB Q & A appears to be an incredible success. We will try to answer as many queries as possible in the limited space available to us, so please try and help by keeping your letters as short as possible. This month we look at business users, legal problems, and try to clear up some confusion over our very popular Big Bubble antenna project.

First away this month is G Carrol from Bothwell.

*Q I read with interest your article **CB And The Small Business**. I have a small business with four vans and a private car operating in an area with a radius of 15 to 20 miles. I have tried, and failed, to find anyone to advise me on the best type of system for my business. Would it be to my best advantage to wait until CB has Home Office sanction and if so, when is this likely to be?*

I would be grateful if you could help me or put me in touch with someone who could tell me the best type and number of receivers I would have to purchase as well as any supplementary equipment that I might need and, of course, the likely cost of such equipment.

A Small business communication systems have been around for many years but suffer from high capital outlay. CB, on the other hand, offers a reasonably priced communication system but has certain drawbacks. First, range — 10 to 15 miles is the likely reliable range for UK CB equipment. Privacy is impossible using Citizens' Band and unless you use a system with selective call facility you will be prone to interference from other CB users on the same channel. Taking all this into account CB does have a future for small businesses, but you must be aware of the limitations. A quick chat with any communications specialist should put you straight. And as to legalisation date, we are still looking at the autumn and our bet is for a date around early October.

Legal problems are always tricky to answer without knowing the full facts. J P S from Northumberland has a typical query.

Q In June I was visited by a local police officer and a Radio Investigations Officer employed by the PO who confiscated my rig and refused to issue a receipt, despite repeated requests to do so. Could you please tell me:

- a) Whether any other official should have been present?*
- b) Should a receipt have been issued?*
- c) Was the confiscation legal?*
- d) How is it possible to have my rig returned to me — if at all?*

The rig was installed in my parked car outside my house. No statement was written, or was any document signed by any person present.

A We get literally dozens of letters like this each month. In most cases we advise people to forget it. You were busted fair and square. There's a fair chance that the police will not follow up with a prosecution unless you happen to provoke them or have a boot full of rigs. We have found the police to be generally sympathetic towards CB and will not usually bust someone unless they are asked to do so by a PO or C & E official. On the other hand we do know of coppers who make it their life's work to catch CBers on any and every occasion.

In your case you could chase it up, as the police and PO were wrong not to have issued you with a receipt, and provided you made notes of the police officer's name and number and the PO official's identity you could make a complaint. On the other hand you are, by your own admission, guilty of installation and rocking the boat could remind the police of this and the other half dozen or so offences that you can commit when in possession of a CB rig.

Microphones always cause problems because of the non-standard connectors employed by rig manufacturers. R Lloyd from Warwickshire has this to say:

Q You included the K40 microphone as dealer's choice in your microphone survey in the March issue of CB. I have been told that it is necessary to have the K40 specially fitted to your rig as it has some 16 connections and would blow up if it were plugged straight into the rig without modification. Apparently there is some minor modification needed to certain rigs to enable the K40 to charge itself up. If this is correct I feel you should have mentioned this in your article as it will increase the cost of fitting a K40. Equally, I would like to confirm that this is correct before I let someone tamper with my equipment.

A True, some older rigs may not be fully compatible with the K40, but there are precious few rigs like that around these days. Any dealer who sells K40 should have in his or her possession a



The K40 processor mike

booklet that contains the plug connections for just about every rig ever made. Once you have established that your rig is suitable then the dealer should be able to tell you the connections. Provided you can solder reasonably well, fitting a plug will only take a few minutes. If the shop where you intend to buy your K40 is not able to supply you with this information then do not buy the mike — go to a reputable dealer who can. If you have already bought the mike then go along to your nearest K40 dealer and ask if he can help. Any reputable dealer will only be too happy to oblige.

What to buy and where to get it is a common question. Roy Burgess from Henfield asks:

Q After reading the Rig Review in the July edition of Citizens' Band I would like to know when and where the Alpha 1000, 2000 and 3000 CB rigs will be available in my area so that I can inspect before buying.

Below: The Alpha 1000

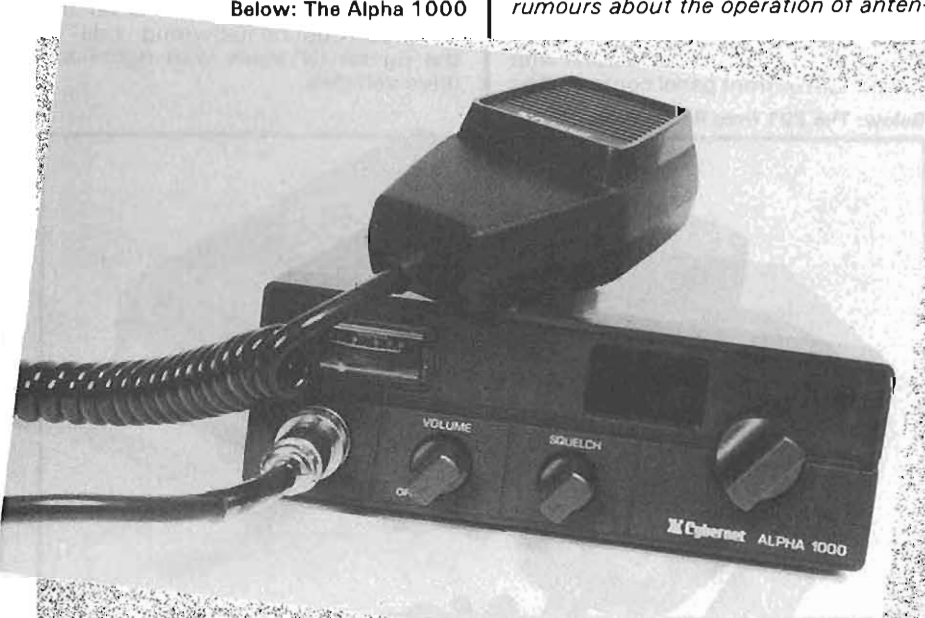

A The Alpha rigs should be generally available from 'day one' in multiple outlet chain stores like Shadow all over the country. If you just can't wait and want to see some other models, why not come up to our show in September where companies like Shadow will be showing their wares, and not only that, they'll be working too 'cos we're licensed.

L Harris believes in getting value for money. He writes from Scotland.

Q I am a regular reader of CB mag though at the moment I only copy the mail. I intend to go on the air as soon as it becomes legal. I do not expect I will have much trouble in selecting a good home base rig — with the help of your magazine. However, there are a few questions I would like answered:

- a) Only 2 watts ERP will be allowed. Does this mean that present antennas are out and that a new type with no gain will appear on the market? If not, how does one cut the 4 watts into two and how will SWRing be carried out with something in the antenna line?
- b) Has the antenna height of 10 metres definitely been set?
- c) Will there be home base rigs covering both frequencies, or will they be separate items?
- d) Finally, I also intend to buy a pair of hand held sets, as small and as powerful as possible. Which of the two frequencies, in your opinion, will be most suitable?

A At the moment the antenna restrictions are one of the most contentious parts of the new specs. A single element antenna of no more than 1.5 metres (ie K40, Moonraker, Bandit, etc) is to be used for both mobile and base stations though it is unclear at the moment whether or not helically wound antennas will be prohibited. What is clear is that any antennas with gain will be specifically prohibited unless the ERP still falls within the 2 watt limit, though as you will see in next month's Inside CB quite a few rumours about the operation of anten-

nas are dispelled. The height restriction now states that should the antenna be mounted higher than 7 metres above the ground a 10 dB attenuator must be fitted into the transmission line. We understand that many rig manufacturers will now be incorporating 'Hi-Lo' switches into the rigs. At the moment we can forget 934 MHz equipment as an alternative to 27 MHz gear. 934 MHz rigs will be available but the prices initially will make them pretty unattractive. We only know of one company with plans to market dual standard rigs but that again is some time away and will only be of interest to specialist users. However, there are some interesting developments for 934 in the pipeline so keep your eyes peeled. Similarly, you can forget 934 MHz hand portable equipment just for the moment.

We finish off this month with some quickies concerning the Big Bubble antenna project.

Q I am unable to get the SWR below 2:1. Should the tube on the tuning stub be inside the coil or just beneath it as shown in the diagrams? I Cogan, Cumbria.

A Our fault. The tube should be inside the coil windings for maximum effect though it will work in the position shown.

Q Will it be okay to fix a jubilee clip to the antenna so that it can be tethered to the ground with wires? A Taylor, Liverpool.

A No, it will not. If you have to tether it do not use wires, use a non-metallic nylon cord etc and do not use any metallic clips to fix the tethers to the antenna as it will upset the SWR.

Q I have a high SWR on my Big Bubble and have tried literally everything. Is the design OK? P Thompson, Watford.

A Yes, Big Bubble is okay but there are pitfalls. Do not mount the BB near vertical drainpipes, large water tanks or any large metallic object. Bubble and Tweek, designer of the BB, has a couple of other suggestions. The aluminium mounting tube that supports the Big Bubble can upset the SWR if it is unusually long: try widening the gap between the mounting tube and the antenna body to 9 inches or even a foot. The feeder coaxial has given trouble on some prototypes because of the sharp bend inside the mounting tube. Try running the coaxial out of the side of the antenna body, keep it at 90° to the antenna for a foot or so and then you can route it to the rig.

CB

CB Q & A

We cannot undertake to answer individual enquiries so it's no good sending us SAEs, although we are considering setting up a personal enquiry service — more news of that in the next few months.

Rig Review

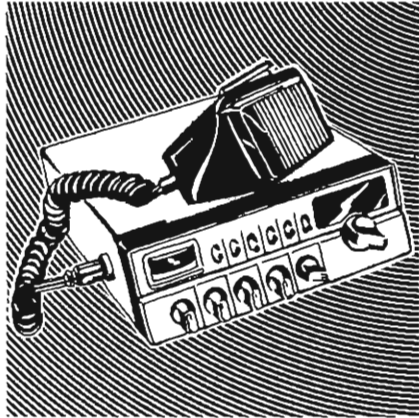

MOBILE RADIO from RADIOMOBILE



Bet you know the name of these rigs.

That's right, Radiomobile, suppliers of in-car entertainment equipment to specialist car manufacturers like Rolls Royce, are planning to market CB equipment in the autumn. With well over 80 different companies now declaring their interest in UK CB we can expect to see a lot more big names in the coming months. In the meantime, have a look at these two rigs from a manufacturer with an enviable reputation for high quality equipment, much of it manufactured in the UK.

It's happening! Companies which we did not expect to venture into the onceslightly dubious world of CB radio are suddenly showing off their equipment, designed specifically for the UK market. One such company is Radiomobile — well known for their high quality range of in-car entertainment equipment.

The two models shown here are half of the proposed Radiomobile range and sit squarely in the upper end of the mobile market. The two models not shown are an as yet unnamed basic mobile rig that will sell for around £60, and a base station unit, again unnamed and as yet with no firm price.

Radiomobile 201

Starting with the 201 we have a very small and compact under-dash rig, almost as small as the Jaws II and with a minimum of front panel controls. The

volume and squelch controls are situated on top of each other on the left-hand side of the front panel and the rotary channel change switch on the far right. In the centre there is a green digital channel display with a rather simple S-Meter marked with the numbers 1 to 4 and (LOC-DX) local and distant. The overall size and shape of the 201 makes it ideal for mounting under the dashboard of virtually any car and although the retail price may seem a little high, it is sturdily built and if Radiomobile's other products are anything to go by, it will soon earn itself a reputation for being top quality equipment.

If there is any criticism of the 201 then it must be about the location of the microphone socket, which is on the American/Continental/wrong side of the rig for us stuck with right-hand drive vehicles.

Below: The 201 from Radiomobile



Radiomobile 202

The 202 is a totally different kettle of fish. This is a top market rig with all the features you'll ever need. From left to right the controls are: volume, squelch, tone, RF Gain, PA, Display Dimmer, Ch 9 select and channel change.

The LED and S-Meter display are identical to that of the 201 with the addition of receiver and transmitter (Rx and Tx) lights and another light to show that channel 9 has been selected. Radiomobile have also included a 'power on' indicator, to confirm that the rig is still switched on in the PA mode when the channel indicator blanks out.

You can see from the picture and data panel that this is not as compact as the 201 — it's approximately as large as a conventional car radio, and it is worth pointing out that it wouldn't necessarily fit into the cut-outs provided on most cars. The most logical position for a rig of this size would be under the dashboard or on top of the transmission tunnel.

Both rigs come complete with a rather unusual looking dynamic microphone and, of course, complete fitting kit and instructions.

Specifications

As far as the specifications for these rigs are concerned we have a few vital statistics for you to consider. Frequency range and power output both conform to UK specs. Receive sensitivity for both models is 0.7 uV and the squelch operates at 0.2 uV (threshold). Operating temperature for both models is between -10°C to +55°C. Audio output is 1.8 watts with 10% distortion into an 8 ohm load. The 201 will draw 0.8 amps in transit an receive mode (max audio output on Rx) and the 202 a little more at 0.9 amps in both modes.

Radiomobile will be offering a complete range of antennas designed to operate on the new frequencies and these will range from a fairly basic CB antenna for around £5 to a deluxe electric antenna around the £40 mark.

Although these rigs are manufactured in the Far East they were designed and styled in the UK by Radiomobile. Radiomobile have no CB manufacturing facilities in the UK at the moment but they will be looking very seriously at the market and possibly consider some kind of manufacturing programme if these models prove popular.

As we said earlier these rigs are not cheap. But if the in-car entertainment market is any kind of guide, then we can expect to see companies like Radiomobile develop an enviable reputation for quality, and are taking the subject of CB very seriously. It'll be interesting to see how many other ICE equipment manufacturers follow their lead.

CB



Above: The 202

RIG REVIEW DATA PANEL

Model	Radiomobile 202					
Supplier/Distributor	Radiomobile Ltd, Goodwood Wks, London NW2					
Typical Price	£120					
Features	Yes	No	Features	Yes	No	
PA Facility	<input type="radio"/>	<input type="checkbox"/>	ANL Switch	<input type="checkbox"/>	<input type="radio"/>	
External Speaker Jack	<input type="radio"/>	<input type="checkbox"/>	NB Switch	<input type="checkbox"/>	<input type="radio"/>	
TX Indicator Light	<input type="radio"/>	<input type="checkbox"/>	Variable RF Gain	<input type="radio"/>	<input type="checkbox"/>	
RX Indicator Light	<input type="radio"/>	<input type="checkbox"/>	Mike Gain	<input type="checkbox"/>	<input type="radio"/>	
PA Indicator Light	<input type="checkbox"/>	<input type="radio"/>	Delta Tune	<input type="checkbox"/>	<input type="radio"/>	
S/RF Meter	<input type="radio"/>	<input type="checkbox"/>	Tone Control	<input type="radio"/>	<input type="checkbox"/>	
Built In SWR Meter	<input type="checkbox"/>	<input type="radio"/>	LED Channel Readout	<input type="radio"/>	<input type="checkbox"/>	
Facilities			Superb	Good	Fair	Poor
Ease Of Controls				<input type="radio"/>		
Built In Speaker				<input type="radio"/>		
Microphone Location				<input type="radio"/>		
Cabinet Construction				<input type="radio"/>		
Quality Of Control Switches				<input type="radio"/>		
Channel Indicator Readability				<input type="radio"/>		
Mounting Bracket					<input type="radio"/>	
Hand Book/Instructions				N/A		
Specifications						
Modes Of Operation	FM only	Dimensions	8 x 6 3/4 x 2 inches			
No Of Channels	40	Supply Voltage	13.8 V DC			
Weight	—					

CB VERDICT

Ease Of Installation XXX Ease Of Controls XXXX

We rate our samples on a scale of one to five. Five stars is the highest rating, three and four stars are good to average and one and two stars mean it's not doing so well.

The Data Panel (right) shows the specifications for the 202. The 201 is basically the same but has fewer controls.

FREE GIFT

FREE GIFT

FREE GIFT

FREE GIFT

FREE GIFT

FREE GIFT

FREE GIFT

FREE GIFT

OCTOBER CITIZENS' BAND

Bet you E1 you read this -- greedy swines, think you're going to get something for nothing, eh? Well you're wrong! To get next month's fabulous FREE -- that's right -- FREE gift, you're gonna have to buy a copy of the mag. Okay, it'll be attached to the front cover of the mag but we're using a specially strong type of Selfotape so's you won't be able to craftily peel it off at your newsagent. Anyway, the FREE gift will automatically self destruct if you try to remove it! Oh, by the way, I nearly forgot, the FREE gift (like the way we make the word FREE stand out by using a bold typeface? It's supposed to make you notice it -- sociology and market research stuff, clever, eh?). Where was I? Oh yes, the FREE gift (there, we did it again!) is an amazing gizmo called a (more bold type to make you notice) RIG CALCULATOR. A RIG CALCULATOR is a sort of thingummyjig that tells you what all the codes and slang mean. It's been designed to be carried in the hip pocket without creating an embarrassing bulge and is guaranteed against woodworm for three months. SERIOUSLY THOUGH, this wonderful gadget is 100% FREE for the purchase price of your favourite CB magazine. Just to top it off we've got a super bumper whizzo fun-packed issue full of rig reviews, a rather interesting microphone survey, a few words about our show, and lots, lots more... DON'T MISS IT!



the best name for CB



radio - communication and accessories around the world

This mark guarantees for quality and technological progress.

Pan International one of the greatest marks for CB, radiocommunications and accessories now conquers the European market also.

Pan will show you some of its super offers in the next number of this magazine.

Distribution in England:
OCT THE TELECOMMUNICATIONS
SPECIALISTS
407 LORDSHIP LANE, LONDON N.17
TEL: 01-808 5656

Pan
INTERNATIONAL



Binatone

You can afford tomorrow's world - today

BREAKER ONE NINE
LOOKING FOR COPY!

GO AHEAD BREAKER!
YOU'RE WALL TO WALL AND
TREE TOP TALL! WHAT'S
YOUR HANDLE?

THIS HERE'S BINATONE
GOOD BUDDY AND I'VE GOT
A MESSAGE FOR ANYONE INTO
CB OR THINKING ABOUT IT!

WE'RE ALL EARS
BINATONE!

WELL AS YOU KNOW
THE BIG DAY IS JUST
AROUND THE CORNER!

YEAH....! THEN WE
DON'T HAVE TO KEEP LOOKING
OVER OUR SHOULDERS EVERYTIME
WE MODULATE!

RIGHT! WE AT BINATONE
WANT EVERYONE TO SLOW
DOWN! DON'T RUSH INTO
CB FEET FIRST!

Antenna Review

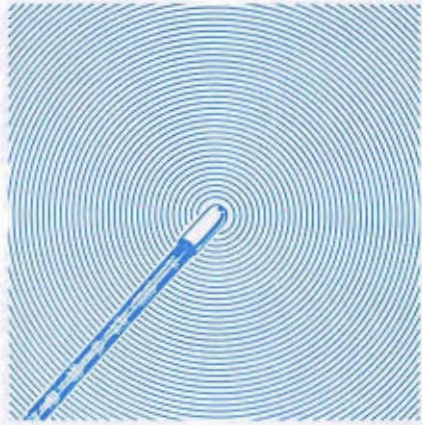

Bandit Steals A Copy

It looks as though the range of antennas available this autumn will be a little limited, to say the least.

However, some existing CB antennas may just conform to the Home Office specifications. We look at one likely candidate in the shape of the Bandit B50, this month's test antenna.

The Bandit range of CB antennas has only just been introduced into the UK, but sharp-eyed readers may have noticed certain similarities between the Bandit and another well-known antenna.

There are several interesting features to note on this antenna, not least its versatility in that it can be mounted in a variety of different ways — a number of different bases will be available from Bandit stockists. The second noteworthy feature is the delightfully simple SWR adjustment. No messing around with Allen keys, spanners or hacksaws, SWR is set by moving two threaded rings up and down on the outside of the coil body.

The actual whip consists of a single length of stainless steel rod either 48 or 56 inches long. This is attached to a sturdy-looking plastic base that houses the coil and the connector that screws into any one of the different mounting components.

For our test this month we have elected to use the basic B50 coil and whip assembly and the B10 magmount option. However, you may like to know that there is a universal ball and socket mount, wing mount, trunk lip mount and magnetic plate mount, suitable for attaching the unit to a pole.

SWR Adjustment

This is undoubtedly the feature that sets this antenna apart from similar

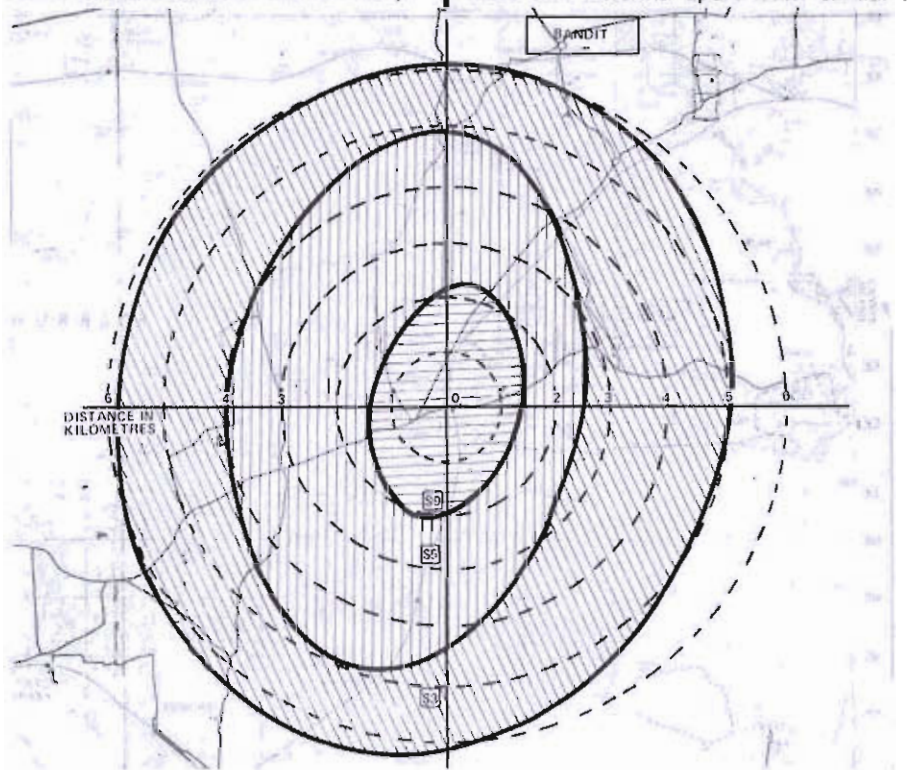

Right: Radiation pattern of the Bandit B50 end B10 magmount.
Opposite page: The Bandit antenna coupled to the mag base as used in our tests.

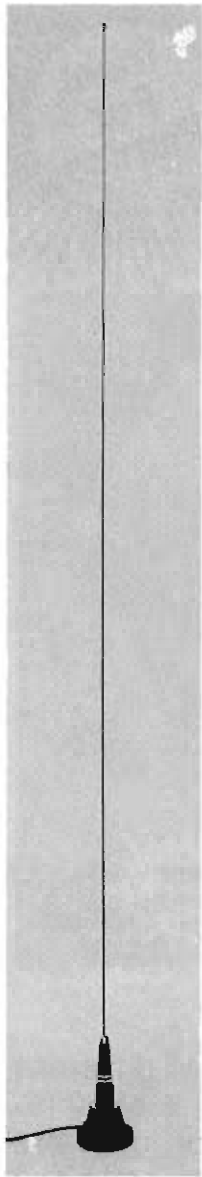

one-piece whips like the K40 and Moonraker. It is both simple and quick to use and is an idea that we would like to see adopted on other antennas. We were able to get the SWR on our test sample to less than 1.3:1 on all of our test vehicles. It is worth noting, however, that towards the top end of the new UK frequencies (UK FM 30-40) we did experience some problems in getting the SWR below 2:1 which might be considered a little too high. However, it would be a relatively simple task for the manufacturers to shorten the whip to accommodate the UK frequencies.

Some concern was expressed by one reviewer about the weather-proofing of the base mount, though in practice we found that these fears were unfounded as our sample has remained completely free from ingress of water and dirt through two weeks of the filthiest weather we can remember. The magnetic base could have been a little stronger, though it is possible that we have been spoiled by the incredibly strong devices attached to K40 and Firestik antennas.

The Results

The first thing we must say is that the maker's claim that this is the 'World's Best CB Antenna' is a little optimistic. That title has yet to be bestowed upon any CB antenna and is unlikely to be, due to the widely differing conditions under which most antennas are used. To date, we are able to judge the relative efficiency of magmount antennas by comparing the results of previously tested devices. So far the K40 is just about the front runner, the Bandit would come a close second, possibly joint second with the Moonraker. We can say quite safely that the Bandit is a good antenna and certainly excellent value for money.

CB

ANTENNA REVIEW DATA PANEL

SPECIFICATIONS

Model	Bandit B50	
Type	Base load — stainless steel whip	
Length	48 or 56 inches	
Frequency Range	26.9 — 27.9 MHz	
Max Power Handling	100 watts	
Impedance	50 ohm	
Cable Supplied	17 feet	
Mounting Details	see text	
Supplier	Bel Ray Lubricants (UK Ltd)	
Typical Price	£15.20	

REVIEW VERDICT

Performance	XXXX	Installation	XXX
SWR Adjustment	XXXXX	Instructions	XX
Construction	XXX	Value	XXX

We rate our samples on a scale of one to five. Five stars is the highest rating, three and four stars are average to good and one and two stars mean it's not doing so well.

The Tests

We have used our standard test procedure to assess the efficiency of this antenna. Just to bring new readers up to date this involves two tests: one static and one mobile. Our test sample is fitted to a stationary mobile and a second mobile follows a pre-arranged route that orbits the stationary test vehicle, sending and receiving signal reports at measured intervals. This is then repeated with the test antenna on the mobile test vehicle and the signals are sent and received between a stationary vehicle. A standard rig and antenna is used in all the tests. With the results obtained we are able to draw up the radiation pattern shown here. This is simplified to make the results more easily understood. The antenna is also subjected to a series of 'lab' tests to assess their durability, quality and construction, etc and finally we hand it over to a panel of CBers for comment.

Binatone

You can afford tomorrow's world—today

MERCY SAKES! WE'VE BEEN SKULKING AROUND BACK ALLEYS AND WAITING FOR THE BIG RUBBER STAMP FOR YEARS!

RIGHT GOOD BUDDY! BUT THERE'LL BE LOTS OF USELESS RIGS OR NON APPROVED FM GEAR ABOUT, AND ANYONE USING THAT HARDWARE WOULD BE BREAKING THE LAW

RIGHT YOU ARE BINATONE! HAD SOME GOOD HARDWARE WAVED UNDER MY NOSE A FEW DAYS AGO!

IF WE ALL USE THE RIGHT GEAR, FM CB WILL BE A LOT OF FUN YOU KNOW WHAT A MESS AM IS IN TODAY!

YOU'RE NOT KIDDING! FM IS CLEANER, QUIETER AND DOESN'T SOUND LIKE A MILLION CROSSED CONNECTIONS ALL THE TIME!

YOU SAID IT, GOOD BUDDY! AND DON'T FORGET THE GET-RICH-QUICK ARTISTS!

Never Before Offered At A Lower Price

One Instalment - No More To Pay

Impervious To Gamma Radiation

Guaranteed Legal

Ideal For Picnics

Never before in the history of Citizens' Band magazine have we ever offered you a T-Shirt. As you can see, it has been custom designed with legalisation firmly in mind. You can wear your CB T-Shirt safe in the knowledge that it does not render you liable to prosecution under the *Wireless Telegraphy Act 1949 & 1968*. We absolutely guarantee that it will not interfere with hospital paging systems or model aircraft, nor will it be liable to seizure under the *Customs and Excise Management Act*.

No SWRing Required

That's right, this T-Shirt requires virtually no adjustment. We can assure you that a **1:1 SWR*** will be experienced every time.

*Slimmer Walleled Reader

Construction

A recent breakthrough in the evolutionary concept of T-Shirt design has enabled us to employ 'Cumfy Cuff*' elasticated aperture control gussets in areas of frictional contact ensuring a snug fit every time.

*Cumfy Cuff contains no polyunsaturated fats or artificial sweeteners.



CB staff eat three Shredded Wheat every day!

How To Order

We have devised a number of different ways to relieve you of your money including cheques, postal orders and credit cards. Each T-Shirt (you can have Sweatshirts too, if you want to be awkward) will be despatched within 14 days of receipt of your order. Just fill out the form below and don't forget to include full remittance, plus the appropriate postage and packing, and we'll do the rest.

T-Shirts £2.95

Sweatshirts £5.95

Yes Please. I would like to be the first kid on my block to own T-Shirts/Sweatshirts (Delete as applicable)

I eat Shredded Wheat regularly and I am a:

Small Person (34/36) . . .

Medium Person (36/38) . . .

Big Person (38/40) . . .

(Tick the type of person that you are)



My Name/Handle is:

My Address/Home 20 is
(BLOCK CAPITALS)

I have enclosed £

My Access/Barclaycard No is:

Please Note. Postage for T-Shirts is 30 pence. Sweatshirts 50 pence.



NEW! SEE BREW FOR C.B.

Come September there's going to be a lot of rubber ducks, smokey bears, 10-4's and convoys buzzing about the airwaves so you better find out what they all mean by getting down to the new C.B. Radio centre at Brew Brothers.

Yep, everything you want to know about C.B. Radio can now be found at Brew.

Our new department stocks aerials, handbooks, instruction packs, microphones; in fact everything except the new F.M. sets, (which don't become legal till September). We'll give you expert advice on fitting, on use and on operation to ensure that you get the most out of this great new craze.

So get yourself down to Brew and learn a thing or two about C.B. Radio now: *We open Mon-Sat 8.30-5.30 Sun 9-1.*

BREW for

C.B. Centre in the Motorist Shop behind the showroom at 133 Old Brompton Road, South Kensington SW7. Tel: 373 3333.



MAIN DEALER

IT'S HERE!

THE K40TM SPEECH PROCESSOR

- Clips anywhere without a clip
- Processes speech with a computer circuit
- Sound sensitive 2 inches or 2 feet
- Two mics with one switch
- Fresh charge with no batteries
- Noise cancelling!
- Guaranteed 12 months against chipping, rusting, cracking and electrical failure

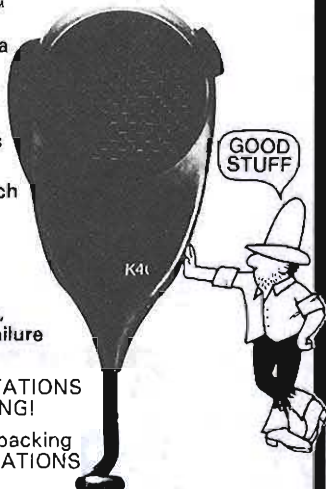

DON'T BE FOOLED BY IMITATIONS
THIS IS THE REAL THING!

£26.95 VAT 15% + packing
to NORTHERN COMMUNICATIONS

NORTHERN COMMUNICATIONS

299 - Claremont Road, Halifax HX36 AW, West Yorkshire.
Tues - Sat 9.45am - 5.30pm
(0422) 40792
24 hr Ansafone Service

Binatone

You can afford tomorrow's world - today

HOW DO WE RECOGNISE
THESE COWBOYS BINATONE?
THESE OLE BOYS
SEEM EVERYWHERE!

PLAY IT SAFE!
WAIT FOR OUR COMPLETE GUIDE
TO LEGAL CB THAT'S COMING SOON-
AND THEN DECIDE

SOUNDS GOOD
BINATONE!

SURE IS! AND LOOK OUT FOR THE
LAUNCH OF OUR LEGAL RANGE OF
RIGS, ANTENNAS AND ACCESSORIES-
ALL AT REASONABLE PRICES!

THANKS BINATONE!
I'LL PASS THE GOOD WORD ALONG
IT'S BEEN NICE MODULATING
WITH YOU! 10-4 WE DOWN!

Binatone International Ltd., Beresford Avenue, Wembley, Middlesex HA0 1YX.
Tel: 01-903 5211/8322. Telex: 923810. Answer back BINA-G.



**another
range**

OCT

ANTENNE

lemm for quality - tested and proven from OCT

These Lemm antenna offer a wide choice of fixings, range and operating characteristics — but their technical excellence and consistent performance are exactly as you would expect from these well established Italian designs.

Lemm antenna are now available from our Tottenham warehouse and — for all our Northern and Midland dealers — are now available with the full OCT range from our new premises in Newark.

407, LORDSHIP LANE, LONDON N17
Tel: 01-808-5656/7

10, VICTORIA STREET, NEWARK, NOTTS
Tel: 0636 74688



PRICES TWOICES PRICES

Legalisation's just around the corner. Licences are being issued, so let's dispel a few rumours and see what's in store.

In the run up to legalisation we've decided to feature a short series of articles designed to keep you up to date with all the latest news and information and hopefully prevent a few rumours being started — rumours that are inevitably generated by lack of reliable information.

The main reason for starting this series at this time is that legalisation, for better or worse, is now almost inevitable on the new frequencies and FM modulation system proposed by the Government. We can say that with a high degree of certainty for two reasons.

First, the Home Office has issued a limited number of licences called *Evaluation And Demonstration Licences for Citizens' Band Radio Apparatus*. After some months of negotiation, Citizens' Band magazine was issued with one of the very first licences early last month. The licence gives us authorisation to operate a fixed number of CB rigs on the new frequencies for test and demonstration purposes.

The second factor is the recent hiccup in the legalisation process. Around the end of June the specifications for the new system which were about to be published were hastily withdrawn for further evaluation. After a period of a few days publication went ahead with the statement that the HO would reconsider the position of a 'European CB system at a later date'. We take this to mean a shift down to the CEPT/FCC frequencies on a common modulation system — more of that later. Don't hold your breath too long for AM because it's just too outmoded these days in the light of

modern FM technology, and as for SSB, well it's a sure bet that the HO will say 'take the RAE exam if you want to talk to people in other countries. CB is a short range, localised personal two-way radio system' — which it is.

At the time of going to press we are awaiting an announcement that will lift **SI 61**, which in a nutshell is the part of the law that prevents importation of CB equipment. Allied to this we can expect a firm announcement for the legalisation date and a few words on operating practice and procedures.

The old chestnut now of course is 'what about the equipment'? Some sources have stated that CB rigs will not be on sale this year — utter nonsense. The reasoning behind these statements is the need to re-design the phase-locked loop (PLL) integrated circuit. The ones used in CEPT/FCC equipment are incapable of modification to the new specs. The truth of the matter is that Sanyo and Toshiba manufacture nearly all the PLLs in CB rigs made in the Far East. We are told that prototypes are already made and full-scale production should be under way by the time you read this. Does anybody really expect the Japanese to muck about with such a potentially lucrative market crying out for equipment? The second possible source or PLLs which may come as a surprise to some is a little nearer home, none other than Plessey who have found a way to adapt a PLL which they already produce for military equipment. It looks as though this will, for the moment anyway, be very expensive. Third, we have companies like WR Electrotek, featured last month, who have designed their own synthesisers from not

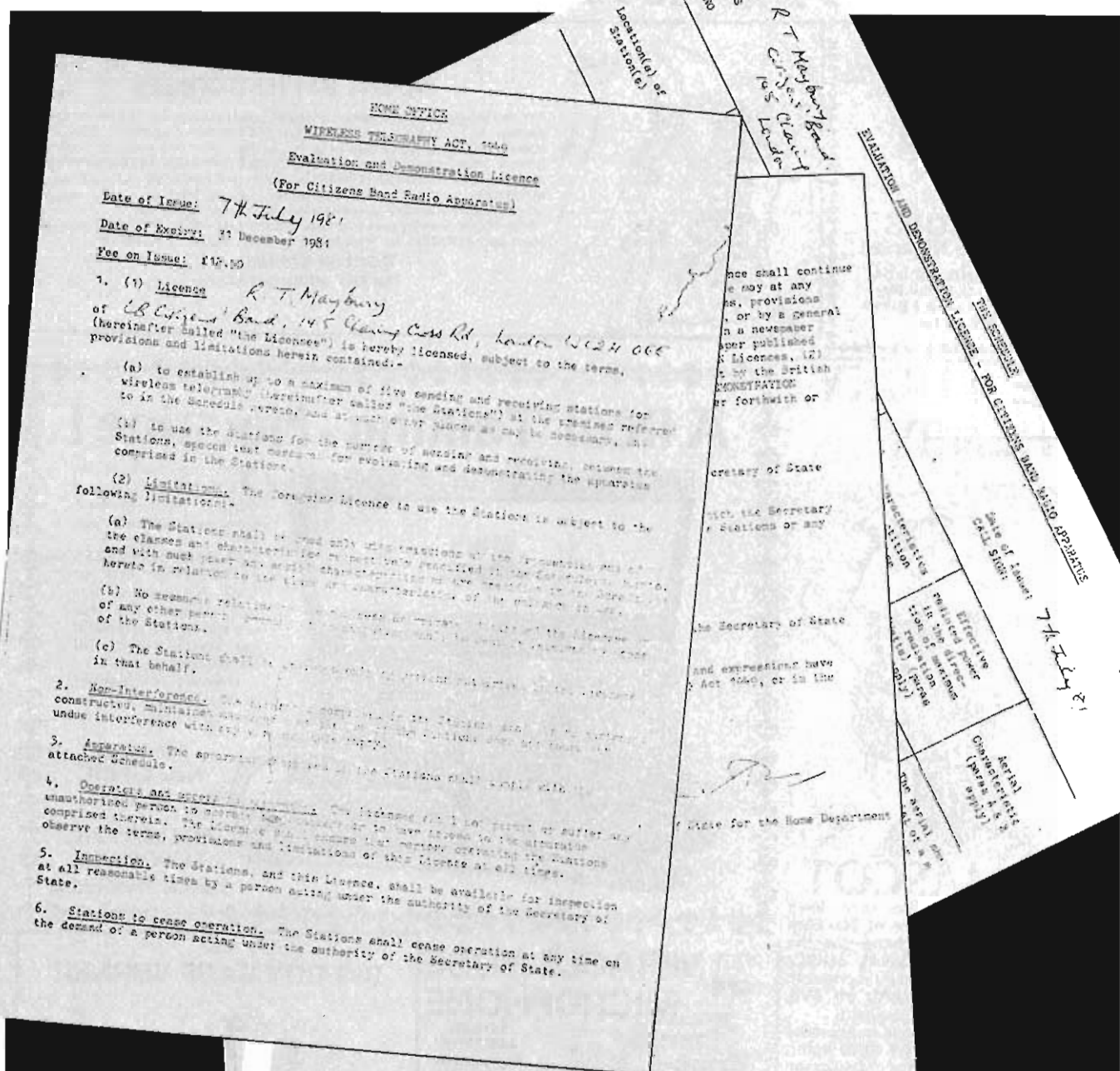

Above: CB Evaluation and Demonstration Licence — The shape of things to come?

one, but a number of separate integrated circuits. Fourth, we know of at least one company that is looking at portable hand-held transceivers which use a number of pluggable crystals instead of a PLL or synthesisers.

Just before we went to press on this issue we drew up a list of all the companies we knew of, which had either shown us prototypes or claimed to have production facilities in the Far East and were going to market CB equipment on L-Day in the UK. The list contained well over 80 reputable companies. If we assume the worst case, and three quarters of these claims are groundless, we are still left with 20 companies which will be selling CB equipment from day one.

That's the state of affairs at the moment. It looks as though the European Parliament are about to announce plans for a 'European CB Band' and we may be hearing some more of this quite

soon. Already there is talk of the EEC seeking an injunction against the Home Office to prevent the introduction of UK CB though it is fairly clear that at this late stage we will be getting CB as per the original specs. The new European Band is rumoured to be 4 watts FM with 40 channels and it is safe to surmise that those channels will be on the FCC frequencies, making the UK system totally non-compatible. Before we get too carried away with this, though, we should point out that the best estimates for setting up such a system put us well into 1982 and if previous attempts at European legislation are anything to go by, it will be at least two years before we need worry about it. This is a serious point to consider and may well be a determining factor as to the future of UK CB. In the meantime, though, we can forget any compatibility between European countries — the only commonality at the

moment is the presence of FCC specification equipment in varying abundance all over the continent and as it is illegal you will still be looking over your shoulder. Indeed we have heard of several frightening tales of what can happen if this type of CB equipment is used in West Germany.

Rumours are currently doing the rounds with alarming regularity. We get to hear an average of three new ones each day but thankfully most people now tend to be a little cautious before passing them on as fact. There does, however, seem to be a fairly common trait whereby if a rumour is repeated often enough it becomes fact. The simple answer is to ignore them, and if you still remain unconvinced give the Home Office a ring on 01-275 3000 and ask them, not us — after all, that's what they're there for isn't it? No, don't answer that!

CB

Antique Accessories

ANTENNA BELT

Thirty years of development behind this half-wave dipole belt. Can be worn for hours on end. No unsightly coils, guaranteed low SWR.



PATTERSONS
As used by the Nigerian
Army and Chinese SPG
AVAILABLE IN BLACK OR CHROME
Sold everywhere for under a guinea
P.W. PATTERSON Ltd.
Brixton UK

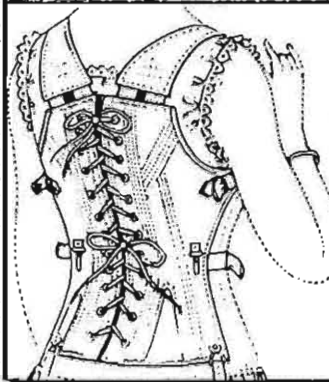

DOCTOR KONNELL'S PATENT BATTERY CORSET

Yes, this solar powered battery corset will power your apparatus for extended periods. As an added bonus Doctor Konnell's Battery Corset will reduce embarrassing tummy bulge and keep you in that 'alert and ready for business' posture. Impress your friends with DOCTOR KONNELL'S BATTERY CORSET, needs virtually no MAINTENANCE, belts and BUCKLES supplied are to MILITARY specification. SOLAR panels are guaranteed for 50 years, regular oil changes will ensure absence of embarrassing ODOURS.
Price 17s 6d. Sent by post to all parts of the EMPIRE. State WAIST measurement and ADDRESS for forwarding on REDUNDANCY payments.

DOCTOR KONNELL & CO
The Old Millhouse, Watford.

THE 'LUCKY HENRY'



RIG MASCOT

Throughout the ages wise men have testified to the effectiveness of TOTEMS and MASCOTS. We now bring you the chance to own the ORIGINAL LUCKY HENRY rig mascot, designed by mongolian tribesmen as a way to WARD off EVIL spirits that can spoil your pleasure. The LUCKY HENRY mascot is guaranteed to ward off the EVIL BUZZY BIRD spirit, known for years to be the bane of dedicated CBers.

For sale everywhere, supplied with fitting instructions for every make of CB apparatus. Send £15 for prompt delivery to LUCKY HENRY PROMOTIONS Twickenham.

A Real Talking-Machine!

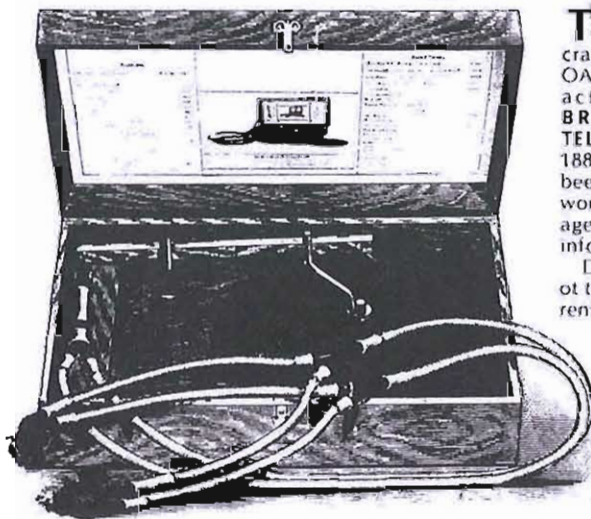

This exquisitely made TCB RIG is hand crafted from genuine OAK and conforms exactly to the new BRITISH WIRELESS TELEGRAPHY ACT of 1881. No expense has been spared with this wonder of the scientific age. Send £1 now for full information.

Delivery is expected to take 100 years at current estimates.

Price of the
New CB RIG
10s 6d.

O'HARAS RIG
EMPORIUM,
Hayes, Middlesex.

MIRACLE NOSE MICROPHONE



FREE
with ten copies
of Breaker
magazine and
two Cornflake
packets. Send to:
181a Tremont
Street,
Scunthorpe.

**STEREO
ADAPTOR**
Replaceable
nasal filter to
prevent clogging
Satisfaction
guaranteed
Send to any part
of the country.
Illustrated
instruction book
FREE

SURPLUS POST OFFICE SPECTACLES

These specially designed optical instruments are constructed from fine materials. Due to an embarrassing stocking problem the 'SPOTARIG SPECS' have failed to fulfill the original design specifications of the General Post Office and are now offered at well below cost price.

A combination of optically corrected glass and built in 'IDENTABREAK' CB receiver enables the wearer to tell whether or not a CB rig conforms to the new GPO specifications.

We have two million SPOTARIG SPECS to dispose of so bulk orders are invited. SPOTARIG SPECS cost just 11s 8d but discounts are given for quantity. SPOTARIG SPECS are available exclusively from

CB CITY
Aldershot



THE BIG-BOY BASE BURNER



Up to 2 megawatts of power from this steam powered LINEAR AMPLIFIER needs no LICENCE, runs from HOUSEHOLD waste material. Built from ROBUST CAST IRON weighs under one TON. Price 17s 6d, delivery £48 13s 6d (Advertisement rates on request)

PERRYMETS PATENT POWER PACKS LTD
Downmarket Promotions Ltd, Surrey.

EXPLODING ONTO THE SCENE

TEL: (05433) 71041

BASE ANTENNAS

Sky Lab
Avanti
Silver Rod
City Star
GPZ 27

MOBILE ANTENNAS

DV 27
DX 27
K 27
DX 27 %
Retractable & Splitter
Electric & Splitter
K40
Rubber Ducks
2ft Firesticks
3ft "
4ft "
5ft "
7ft "

MICROPHONES

Turner Sidekick
Turner M + 3B
Ham Master
K40
007 Pistol Mike
Ham Relay

TEL: (05433) 71041

CENTRAL BROADCASTING SUPPLIES UK LTD

NEW WAREHOUSE
APEX ROAD
BROWNHILLS
WEST MIDLANDS
WS8 7HU
Telephone: (05433) 71041
Telex: 336789 PONTAR

TEL: (05433) 71041

CONNECTORS

PL 259
PL 258
4 Pin Plug
P.A Jacks
Magnetic Mount K40
Cable

LINEAR AMPLIFIERS

Burner 25W & 100W
Variable Amplifiers
Pre-amps
Boosters

ACCESSORIES

P.A. Horns
Ext Speakers
Patch Leads

TEL: (05433) 71041

Equipment Review

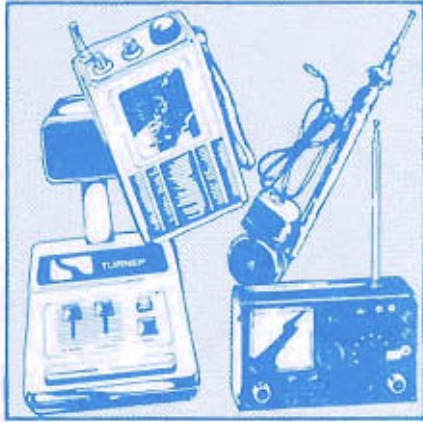

TWIGS for RIGS

There are literally hundreds of different CB antennas on the market. We couldn't hope to test every one so we sent Andy Giles out to put together a selection of some of the best and most unusual mobile antennas currently available. In the next few months we will be taking a similar look at base station antennas but in the meantime have a look at what Andy found . . .

If you decide that you would like to get on the air, the second most important item you'll have to buy will be an antenna. (The first is, of course, the rig.) The antenna is not an optional extra like a power mike or an extension speaker — it is a necessity. If you don't have one you can't transmit properly; well, you can but it doesn't do your rig much good.

The antenna is a vital factor in determining how well your signal gets out and how well your rig receives. An old maxim has been around for many years, and has been said many times but it still bears repeating because it is still true: The easiest way to improve the performance of your rig is to improve your antenna. If you buy an antenna with a gain of 3 dB, that is 3 decibels more than a reference dipole, then your ERP (effective radiated power) will be double the power that you have fed into it. Similarly, if you buy an antenna that has 6 dB of gain, then the output gain would be fourfold, because every 3 dB of gain means a doubling of power. Unfortunately, not all manufacturers play the game and quote the gain with reference to dipole. Some of them quote the gain over a quarter wave and some quote dBi, which is gain over an isotropic source in free space, ie a theoretical point in space that doesn't really exist but if it did it would be radiating equally in all directions. Whenever I see a figure quoted as dBi, I always deduct about 2.5 dB to give a more realistic figure.

One of the major problems that manufacturers face when designing a CB antenna is their length. A full length quarter wave antenna would measure approximately 9 feet and a full wave one would be almost 36 feet long. Most of us are not willing to drive around with that length of fibreglass waving around on our roofs and this has led to the development of the helically wound antenna, this is an

antenna that has a quarter of a wavelength, or five eights of a wavelength, or even a full wavelength of wire wound around a core which is usually of fibreglass. The wire is wound in a special form of a spiral that is called a helix, hence the name helicals. As with all apparently magic solutions, the end result is a compromise. A 9 foot long quarter wave whip will perform better than a 3 foot long helically wound one, but the 3 foot one will be a lot easier to mount on your car.

If you have decided to scrap your AM equipment and start using the FM system when it becomes legal, you may like to take note of the footnote that the Home Office have tucked away at the bottom of the first page of MPT 1320, the document that sets out the technical specifications of the forthcoming British CB system. It says: *"Note: The licence requires that equipments which have provision for the connection of an external antenna shall not be connected to other than a single element rod or wire antenna not exceeding 1.5 m in overall length"*;

The 1.5 m length restriction means that the large percentage of the antennas that are now on sale will be illegal when the ruling comes into force.

A lot of press coverage has been given recently to the monitor that the police have been issued with so that they can tell if your rig is AM or FM, but they don't need anything like that to check on the length of your antenna. A Home Office approved tape measure may well be on its way to every constable in the country for all we know, although that could prove a little expensive in these austere times and it is far more likely that a British specification piece of string that has been cut to length by a police technician will be used instead. It really doesn't matter what they use to measure your antenna with: if it's too long, you could be prosecuted. ●



TWIGS for RIGS

NAME	TYPE/LENGTH	PRICE BAND
THE PAL FIRESTIK	2, 3, 4, 5, 7 ft	B, B, B, B, C

The Firestik range of antennas is made in America by the PAL Manufacturing Company and it has proved so popular that various other companies now make almost identical antennas. In some cases they even make blatant copies and stamp the name Firestik on them.

The basic concept behind the Firestik is very simple: it is just a length of fibreglass rod with some wire wound around it and a plastic sleeve over that. The reason they work so well is that PAL take a great deal of care to ensure that the length of the piece of wire is electrically correct and that it is wound in such a way as to create the optimum radiation pattern. Considerable time has been spent designing a comprehensive range of mounts into which the antennas will fit. There are mirror mounts, trunk lip mounts, various body mounts and an assortment of adaptors that they will convert your existing mount into a Firestik one.

Firestiks are available in 2, 3, 4, 5 and 7 foot lengths and various colours, and they are all incredibly strong. When someone tried to snap the 5 foot Firestik on my car, they couldn't. Unfortunately the metalwork of the car was not as strong as the antenna and I was left with a badly distorted wing which cost more to repair than a new antenna would have.

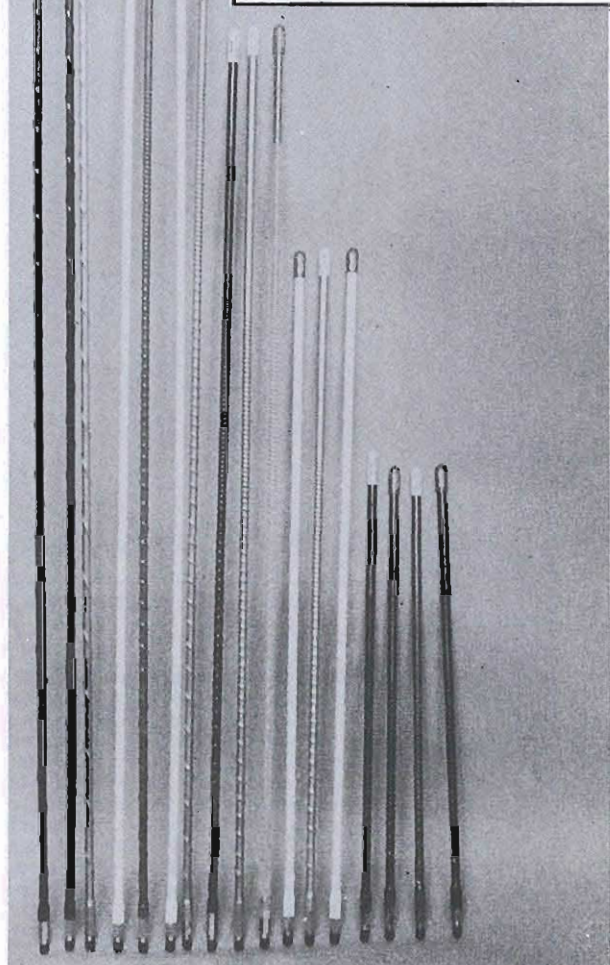

NAME	TYPE/LENGTH	PRICE BAND
CB 24 WOOFER	4 ft	C

This antenna is a variation on the Firestik theme in that it has the standard $\frac{3}{8}$ " x 24 thread Firestik screw fitting, but it is slightly unusual because the coil of wire is inside the fibreglass rod. This makes for a very smooth and slim antenna that doesn't have lumpy bits where the wire is.

NAME	TYPE/LENGTH	PRICE BAND
ROAD HOG	4 ft	B

This is another of the 'stik' antennas and again, it consists of a solid fibreglass rod with a coil of wire wound around it and then covered with a plastic sleeve. It also has a standard ($\frac{3}{8}$ " x 24 thread) Firestik base which enables it to be used with any of the Firestik bases. In fact, unless you take the trouble to read the little plastic cap on the end, you could easily mistake this antenna for a Firestik.

NAME	TYPE/LENGTH	PRICE BAND
VALOR DIAL-A-MATCH	2 ft & 4 ft	C

The Valor consists of a base loaded stainless steel whip approximately 5 ft in overall length. This antenna would be quite ordinary if it weren't for the remarkable way in which the SWR adjustments are carried out. The usual method with antennas of this type is to slide the whip in and out of the base a little bit at a time until you achieve minimum SWR. If you can't get a satisfactory result by doing that, then you have to start snipping little pieces off the end of the whip. The manufacturers of the Valor have come up with a novel idea that does away with all that — they have put two small rings around the outside of the coil and these rings can be screwed up or down until minimum SWR is achieved. This is a far more convenient way of doing it and it should make life easier for a lot of breakers.



NAME	TYPE/LENGTH	PRICE BAND
SHAKESPEARE KNIGHT STICK	4 ft	C

This is Shakespeare's own version of the

'stik' type antenna. It is manufactured in the same way as the Firestik with a solid fiberglass rod with a spiral of wire wound around it, and then covered with a thin plastic sleeve. There is, however, one major difference: the fiberglass core has a teardrop shaped cross section which, Shakespeare claim, allows the antenna to stay upright at highway speeds. It has the standard (3/8" x 24 thread) Firestik base which means that it can be used in conjunction with any of the Firestik bases.

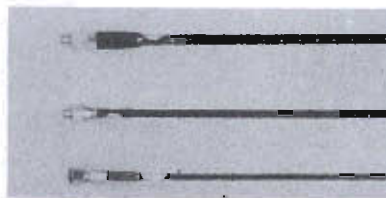

NAME	TYPE/LENGTH	PRICE BAND
MOBILE ONE	7 ft, 5 ft & 4 ft	N/A

These three antennas are not yet on sale in this country but a least one importer has plans to bring them in. They are very nicely made antennas that are manufactured in much the same way as the Firestik. The major difference is that the fiberglass core is far thinner on the Mobile One which gives it a slimmer profile. It has the ubiquitous 3/8" x 24 thread Firestik base so it can be used with any of their bases.

NAME	TYPE/LENGTH	PRICE BAND
DV27	4 ft & 2 ft	B

The DV 27 type of antenna has become one of the classics. It was originally devised by HMP (see also DX 27) and has since been copied unmercifully by numerous companies. It consists of a slim fiberglass rod with wire wound around it. The wire is wound in the form of a helix but more emphasis has been placed on the top of the antenna which gives it a better radiation pattern. Inserted in the top of the antenna is a slim metal rod that has a thread running around it, and it is this rod that is twiddled when adjusting the electrical length for minimum SWR. The base of a DV 27 is quite distinctive and it was designed to be easily unscrewed so that you can take the antenna off your car when you park. The original design was for an antenna some 4 ft long but now 2 ft versions are available from various manufacturers.



NAME	TYPE/LENGTH	PRICE BAND
DX 27	5 ft	B
DX 27 (3/8)	5 ft	B

Both of these antennas are made by HMP, the company that brought out the original DV 27. Although these antennas are almost identical, it is not too difficult to tell them apart because the 3/8 version has far more wire wrapped around it, which can be seen quite easily under the plastic skin. Both antennas have adjustable tips for minimizing SWR and they will both fit onto a standard DV type of base. HMP earned for themselves a very good reputation when they introduced the DV 27 and I can't imagine these two antennas will do anything to damage that reputation.



TWIGS for RIGS

NAME	TYPE/LENGTH	PRICE BAND
JET WING	2 ft	C

The Jet Wing is a most unusual antenna. From tip to base it is approximately 2 ft long and, as can be seen from the photograph, it has an extremely distinctive shape. I can't picture anyone wanting to put this antenna on the roof of a Mini but it is possible that someone, somewhere, has an exotically customised car which this antenna would suit.

Both Max Beerbohm and Dr Johnson have at various times been credited with a quote that was in fact first said by Abraham Lincoln to Robert Dale Owen, when the latter gave him a very long article on spiritualism. He could have been looking at a Jet Wing when he said, "Well, for those who like that sort of thing I should think that is just about the sort of thing they would like".

NAME	TYPE/LENGTH	PRICE BAND
PHILIPS 22EN8423	¼ wave 2 ft	C

This is the first antenna that we have seen from the internationally known Philips group of companies. It is very well made and packaged and comes complete with 14 ft of co-axial cable and a PL 259 plug. It has a frequency range of 26.7 to 28 MHz and the SWR adjustment is carried out by twiddling the screw-in adjuster on the top of the antenna. It can handle up to 25 watts of power and it needs a hole of nearly half an inch in diameter to be drilled in the car's bodywork when you mount it.

Equipment
Review

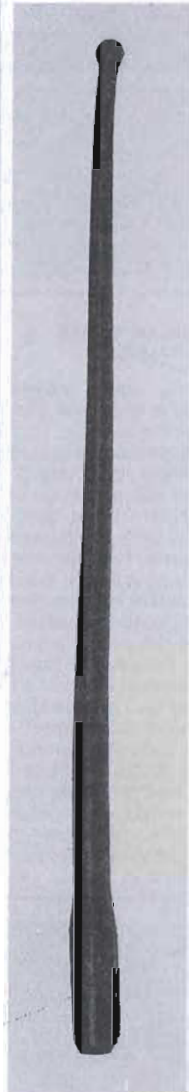

NAME	TYPE/LENGTH	PRICE BAND
RUBBER DUCK	1.5 ft	B

A rubber duck type of antenna is made in much the same way as a Firestik. A coil of wire is helically wound around a core and then a protective skin is put on top of that. The difference between the two is that rubber is used for the core and the outer skin of the rubber duck instead of the fibreglass and plastic that goes into the Firestik. This makes the rubber duck far more flexible and far better able to withstand being knocked and twisted and generally mistreated. Rubber duck antennas can be used mobile but it is more usual for them to be used with a walkie-talkie.

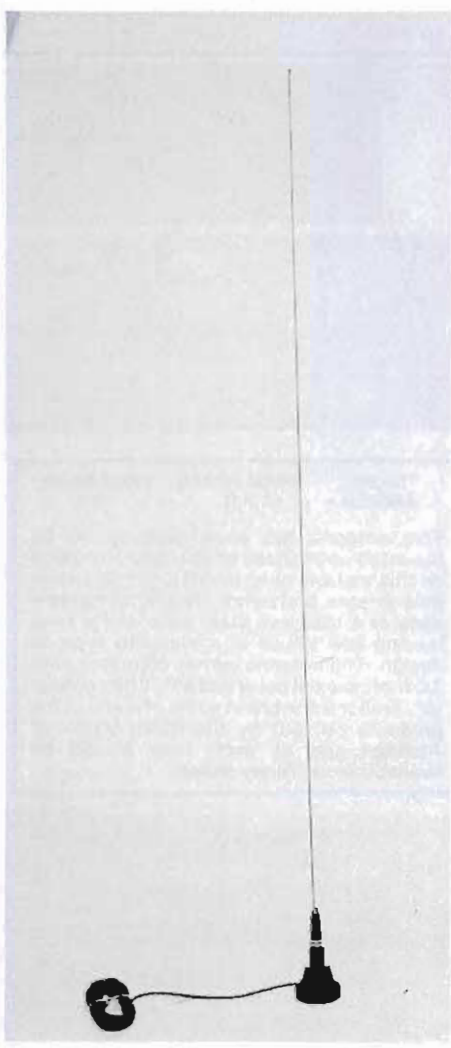

NAME	TYPE/LENGTH	PRICE BAND
BANDIT	5 ft	C

This antenna is virtually indistinguishable from the Valor Dial-A-Match and everything that applies to that antenna also applies to this one. (See also this months Antenna Review).



NAME	TYPE/LENGTH	PRICE BAND
ASP MT178	5 ft	D

The MT 178 is an Antenna Specialists mag mounted based loaded stainless steel whip type of antenna. It is supplied complete with 21 ft of co-axial cable that is terminated in a PL 259 plug. There is also an in-line connector approximately 6 ft away from the magnetic mount. The idea behind this connector is that it allows you to thread the cable around the edge of your bootlid or through the gap at the top of your tailgate, if you have an estate car, and then when you want to remove the mag mount and put it inside the car, you can undo the connector and remove the mount. Without the connector you would have to try to squeeze the entire mount through the gap and sometimes it just won't go, which means that you would have to leave it on the car all the time. Not a good idea as they are so easy to steal.



NAME	TYPE/LENGTH	PRICE BAND
ASP MR440	5 ft	C

The Antenna Specialists MR 440 is a traditionally styled base loaded antenna which consists of a base loading coil and a stainless steel whip. Also supplied with this antenna is a magnetic base that contains a ceramic magnet, 15 ft of co-axial cable and a PL 259 connector.

NAME	TYPE/LENGTH	PRICE BAND
ASP MS264	5 ft	D

The Antenna Specialists MS 264 antenna is a disguised antenna that comprises a stainless steel whip and a body mount that looks much the same as a normal car aerial mount. The package also contains a splitter box so that you can run your rig and your car radio from the same antenna and all the necessary interconnecting leads are also supplied along with all the appropriate plugs.



NAME	TYPE/LENGTH	PRICE BAND
ARCHER	5 ft	B

This antenna has been designed to be mounted on the body of a car and in order to do this you will need to drill a 3/8" (9.5 mm) hole in your bodywork. The antenna consists of a stainless steel whip and a base loading coil which is a standard type of design. The antenna comes complete with 16 ft of co-axial cable and a PL 259 connector. Archer is the brand name of some of the products put out by the Radio Shack of America and as such they should be available from Tandy shops.

NAME	TYPE/LENGTH	PRICE BAND
ARCHER II	5 ft	B

This Archer antenna is similar to the previous one in that it also has been designed to be mounted on the body of the car, and it also consists of a stainless steel whip and a loading coil. The difference is that the coil is in the centre of the whip and not at the bottom. Also supplied with this antenna is 16 ft of co-axial cable and a PL 259 connector.

NAME	PRICE BAND
THREE ADD-ON ANTENNAS FOR WALKIE-TALKIES	B

Hand-held rigs have proved to be very popular with a large number of people including hitch-hikers, mountaineers, ramblers and people who just like to wander about with their rig. There is one criticism that all users seem to have and that is the extreme length of the built-in telescopic antenna. It is very inconvenient to have to extend several feet of telescopic whip every time you want to transmit, yet it is also inconvenient to carry the thing around with the whip extended all the time. In order to overcome this problem several manufacturers have introduced helical whips that can be fitted onto the tip of a fully retracted telescopic whip. The two shown here are a helically wound rubber duck with a slip-on base and a helically wound fibreglass 1/4 wave whip. Both of these antennas are quite short and far more convenient than the original whips. If you should snap your telescopic whip, replacements similar to the one in the photograph are available from several dealers.

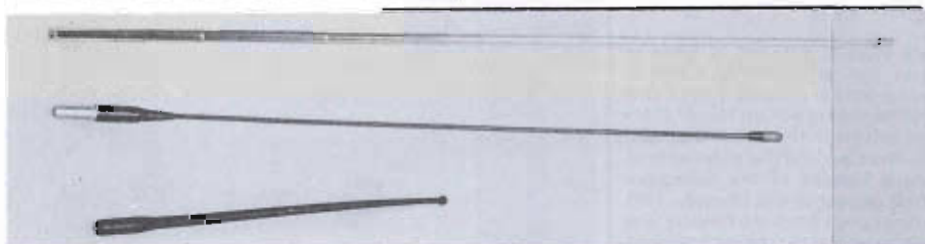

NAME TYPE/LENGTH **PRICE BAND**
K-40 5 ft **D**

The K-40 is one of the most popular antennas sold today as well as one of the most distinctive, with its strangely shaped Metplas (metal and plastic) coil housing which contains not only the short fat coil but also the computer designed isolation chamber that the manufacturers claim dampens static. The coil housing and whip can be easily removed from the base by giving it a quarter of a turn which allows you to pop it into your boot whenever you leave your car unattended. The 58" stainless steel whip has a 180° rounded tip that eliminates the need for a ball and the entire whip can slide in and out of the base a full 2" to make turning easier. The whip is held in place by a small grub screw that can be adjusted with the Allen key that is provided with the antenna.

The antenna is supplied with a base that has been designed to clip onto the edge of a bootlid or, if you want, you can drill a hole in any part of your bodywork and mount the antenna in that. The Unimount is an optional extra and it allows the K-40 to be mounted on almost any part of the car,

as does the other optional extra, the magnetic base which contains the most powerful magnet that I have ever seen in a mag mount.

Part of the base is a bracket that allows the entire antenna to be swivelled by up to 30° to compensate for the slope of the car's body. Also included, and already attached to the base, is 18 feet of RG-58 coaxial cable. It is terminated with a most unusual PL 259 plug which consists of three pieces instead of the usual two. The advantage is that the inner part is extremely small so that it can be passed through small holes in the bodywork without having to remove the plug, as you would have to with a standard PL 259.

The booklet that comes with the K-40 antenna contains two full pages of testimonials from users of this antenna and the manufacturers are so confident that their product is the best on the market that they not only guarantee their materials and workmanship for one year, they also guarantee that the K-40 will transmit farther and receive more clearly than the antenna it replaces. That is some claim, but then again the K-40 is some antenna.

ANTENNA SURVEY DATA PANEL

CB

Name	Length (approx. in feet to nearest 6")	Price Band
Rubber Duck	1.5	B
DV 27	2	A & B
Firestik	2	B
Jet Wing	2	C
Philips 22EN	2	C
Valor Dial-A-Match	2	B
Firestik	3	B
CB 24 Woofer	4	C
DV 27	4	A & B
Firestik	4	B
Knight Stick	4	C
Mobile One	4	N/A
Road Hog	4	B & C
Valor Dial-A-Match	4	C
Archer	5	B
Archer II	5	B
ASP MR440	5	C
ASP MS264	5	D
ASP MT178	5	D
Bandit	5	C
DX 27	5	B
DX 27 ½	5	B
Firestik	5	B
K-40	5	D
Mobile One	5	N/A
Firestik	7	C

Note: The code letter in the price band column is only intended as a rough guide to retail price. Some antennas will be available for less than the price suggested as special offers, etc. Equally, some retailers will charge more for particular antenna — however, the prices we quote should be the average for each particular antenna and this is the price you should aim for when shopping around.

Note 2: Readers may have noticed that the Avanti range of antennas are not included in this survey. This was due to our samples arriving too late to be included. We hope to include Avanti products as an update in a future survey.

PRICE BANDS **A** — Under £5 **C** — £10 to £14.99
 B — £5 to £9.99 **D** — £15 and over

MAYFAIR C.B. CENTRE

11 WESTERN PARADE,
BARNET, HERTS
01-449-3476

EYEBALL OUR PRICES

WHOLESALE AND RETAIL

Bremi power supplies

from	£10.50	Slide mounts	£4.50
DPA2	£22.00	SWR meters	£6.75
DV27 complete	£4.90	Ext. speakers	£6.50
PL 259	42p	Half breeds	£11.00
K40 antenna	£25.45	Noise filter kit	£8.50
P&P	£2.50 each order.		

Also contact us if you intend to launch a CB Retail outlet. We have the best trade prices and also a shop-to-shop delivery service. Over 400 items in stock.



GREAT NEWS FOR ALL YOU CB'ers



GREAT NEWS FOR CB RETAILERS

CB CITY LTD

NOW OFFER WHOLESALE FACILITIES TO THE TRADE. WHERE SERVICE IS THE KEY WORD

LARGE STOCKS AT COMPETITIVE PRICES

FREE (24 HRS) DELIVERY ON £100+ ORDERS (AND ONLY IS CHARGED ON SMALLER ORDERS)

NO MINIMUM ORDER VALUE (IDEAL FOR TOP UP ORDERS)

ONLY BONA FIDE TRADERS SERVED

CALL CB CITY NOW ON HIGH WYCOMBE (0494) 20135 FOR YOUR PRICE LIST OR TO PLACE YOUR ORDER

COMPARE OUR REGULAR LOW LOW PRICES

K40 ANTENNA	£24.95	SKIPMASTER 150W VARIABLE	£129.95
K40 MICROPHONE	£24.95	BREM BURNERS	
AVANTI Full Range including:		25 WATT AM	£22.50
AV241 4 MOONRAKER	£18.95	40 WATT AM	£34.95
AV241T BOOT MOUNT	£21.95	70 WATT AM	£45.00
AV241M MAG MOUNT	£22.50	100 WATT AM	£89.95
AV261 6 MOONRAKER	£39.95	SWR	£6.95
AV174 SIGMA IV BASE	£61.50	PL259 35p	PL258 50p
VALOR ANTENNAS Full Range:		RGB 58p metre	RG58 20p metre
530 24" DIAL-A-MATCH	£11.25		
540 48" DIAL-A-MATCH	£11.75		
560 WARRIOR 60" CENTRE LOADED	£14.95		
520 HALF BREED 1500W	£11.95		
SKIPMASTER 100W VARIABLE	£115.00		

And many other famous brands at knockdown prices, including HMP, Turner, Shakespeare, Lemni, Firetek. Send an S.A.F. now for our latest catalogue.

ARMSTRONG ANTENNAS NOW IN STOCK

Super Powerful Magnetic Mount	R.R.P.	OUR	£25.95
Wing or Roof Surface Mount	£35.00	PRICE	£24.50

CHECK US OUT NOW AT ONE OF OUR BRANCHES

- 85 Ash Hill Road, Ash Aldershot, Hants 0252 318141
- 1, Reading Road, Chineham, Basingstoke, Hants. 0256 53900
- 37 Queens Road, High Wycombe, Bucks. 0494 20135
- 2A Chapel Street, Holsworthy, North Devon. 0409 253504
- c/o A & A Carparts, High Street, Crowthorne, Berks. 03446 77113

CB CITY'S OWN PRODUCTS



POWER SUPPLY	£13.95
TV FILTER	£ 3.50
ADD ON FM CONVERSION BOARD	£ 12.50
POWER SUPPLY 7A	£ 24.95

© CB CITY... (cbrm).

A NEW RANGE OF PRODUCTS WHICH ARE EXCLUSIVE TO CB CITY LTD

POWER SUPPLIES BY 'SURE-POWER'

A POWER SUPPLY YOU CAN USE WITH CONFIDENCE

NEW CONCEPT IN POWER SUPPLIES WHICH ARE SAFE, 100% DESIGNED AND MANUFACTURED IN GREAT BRITAIN

SPECIFICATION: INPUT 220 240V A.C. 50/60HZ OUTPUT 13 BY DC 2.5A CONT. 4A SURGE

SPECIAL FEATURES

- FULLY REGULATED OUTPUT UTILISING SPECIALLY DESIGNED SOLID STATE CIRCUITRY FEATURING INTERNAL FEEDBACK FOR SHORT CIRCUIT AND OVERLOAD PROTECTION
- GOOD QUALITY AND SAFE CONSTRUCTION NO POSSIBILITY OF ELECTRIC SHOCK
- GOOD CABLE CLAMP
- GUARANTEED FOR 12 MONTHS

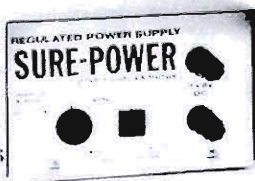

A TRUE 7 AMP VERSION ALSO AVAILABLE

NEW TVI FILTER

- CURES PICTURE INTERFERENCE
- DOES NOT AFFECT PICTURE QUALITY
- THIS FILTER MEETS AND EXCEEDS THE HOME OFFICE SPECIFICATION NO. 44/2A BUT HAS BEEN OPTIMISED FOR 21MHz INTERFERENCE



Have you heard about CB? Citizens' Band radio is to be legalised this Autumn; yes, that's right, our very own personal two-way radio system that can be used in the car, the home — anywhere. As you can imagine, CB will be a real boon to the motorist, the housebound, those who go for outdoor activities — and don't forget that CB can save lives!

With all this in mind **Citizens' Band** magazine, the country's leading CB publication, will be holding a **major** CB exhibition in September, timed as closely as possible to coincide with legalisation. If you want to know more about CB, or you are a CBER, come along to the Royal Horticultural Hall on 11th, 12th, 13th September and see Britain's biggest ever CB show.

There will be stands and exhibits from many of the country's leading CB accessory dealers plus, for the first time ever, working examples of the new legal rigs that will be on sale this Autumn. That's right, a number of manufacturers and importers will be on hand to show the new CB equipment that almost anyone can buy and use.

There's something for everyone, CBERs old and new. The latest accessories and antennas, gadgets — in fact everything connected with CB including the new equipment.

Come along in September and see what CB can do for you. Even if you've never heard of CB, you soon will, so don't miss out — whether you're a motorist or a small businessman with an eye to the future, CB is for you! CB is the future of two-way communications

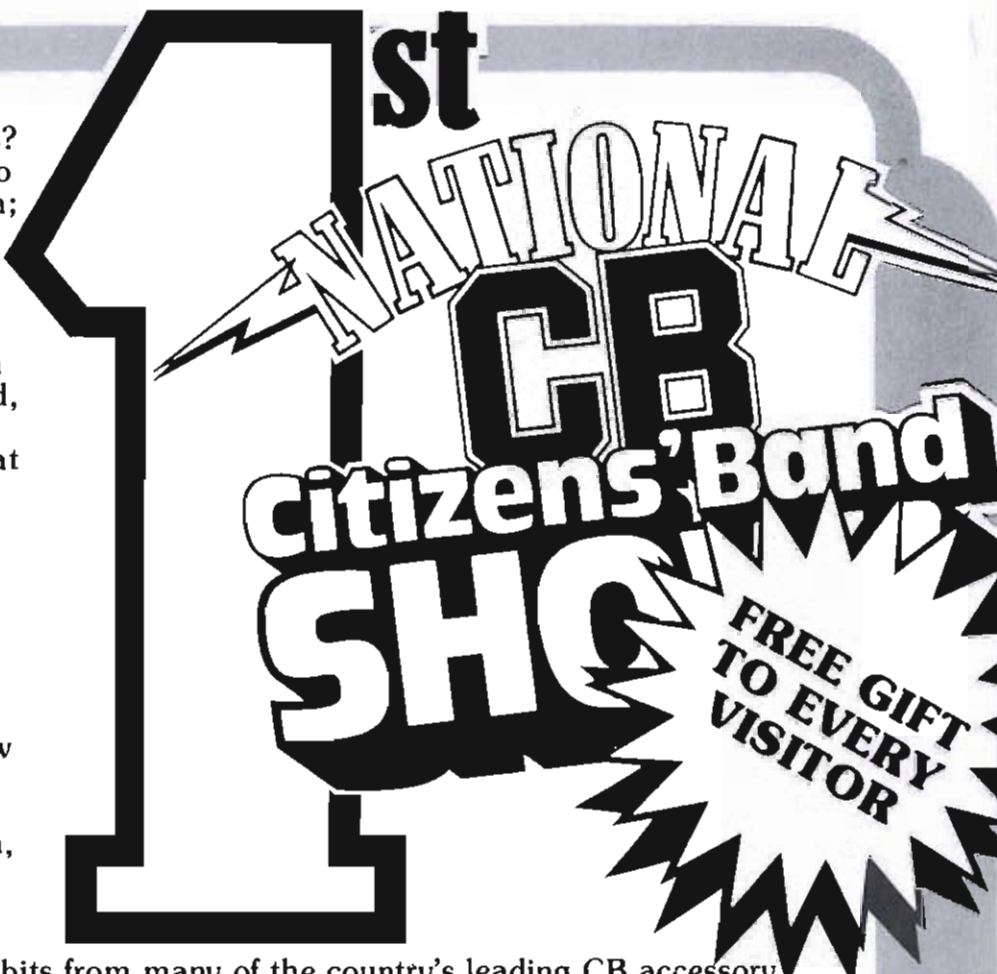

BRITAIN'S FIRST NATIONAL CB SHOW!

**ROYAL HORTICULTURAL SOCIETY HALL,
VINCENT SQUARE, LONDON SW1
(SEPTEMBER 11th-13th INCLUSIVE)**

WHY QUEUE? ORDER YOUR TICKETS NOW FROM:-

Advance Tickets CB81
Modmags Ltd, 145 Charing Cross Road,
London WC2H 0EE.

Please send tickets @ £2.00
. tickets @ £1.00 (OAP or child under 10 yrs)

To
.
.

I enclose PO/cheque for £

This is the **BIG ONE** for breakers. Whether you're a confirmed fanatic or an interested beginner, this is the place to be in September!

OPENING TIMES

Friday 11th Sept 10am-7pm
Saturday 12th Sept 10am-6pm
Sunday 13th Sept 10am-4pm

C&B RADIO ACCESSORIES

CHELMER CB ACCESSORIES

50 DUKE STREET, CHELMSFORD. TEL. 87698 & 351359
AN APPROVED TANDY AND MURA AGENT

SEE US ON STAND 17 AT THE NATIONAL CB SHOW, VICTORIA, 11, 12, 13 SEPT.

MONDAY - SATURDAY - 10-6pm SUNDAY - 10-1pm (Late night Thursday till 8pm)
TRADE ENQUIRIES WELCOME

SPECIAL OFFERS TO THE READERS OF
CITIZENS BAND MAGAZINE.

K40 The Ultimate Mike £24.95 + £1 p&p.
Kraco Ext. Speaker £3.25
Multiband Radios, receives all 40 CB
Channels £13.25.
40 Channel CBs from £55 + £2 p&p.



If you want to visit us, we are just a few minutes from the Derby City Centre, easily accessible via the M1 motorway (junctions 24 to 26) and various major roads within the Derbyshire area. OR you can take advantage of our Regular Delivery Service. We are rapidly establishing regular areas on regular days. Simply phone our warehouse to find when one of our drivers is in your area.

NOW OPEN IN DERBY

International Breakers Warehouse

DERBY'S Biggest CB accessories wholesaler

OUR "20" IS 26 PEARTREE ROAD, DERBY. DE3 8PP
Telephone Derby (0332) 380319

Open Daily 10am-6pm Sunday 2pm-5.30pm Late Night Business by Request.

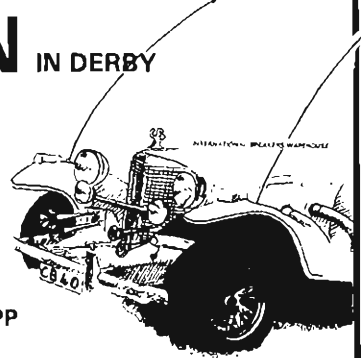

We are Sole DISTRIBUTORS for O.C.T. in DERBYSHIRE
and also have an excellent selection, from other leading importers throughout the country.

BEST PRICES OFFERED ON QUANTITIES. TRADE ONLY.

Write, phone or call in for details.

Or send for one of our comprehensive price lists, which is constantly under review so that we can ultimately offer the best all-round prices.

**TRY US WHEN YOU'VE TRIED THE REST
AND
REMEMBER
IF WE HAVEN'T GOT IT — WE CAN GET IT!!
10-10**

* CBC * CBC * CBC * CBC * CBC * CBC * CBC *



CB CENTRE



HAVE MOVED THEIR RETAIL & WHOLESALE TO NEW & LARGER PREMISES

20c SELSDON ROAD. SOUTH CROYDON. SURREY



01-680-4503



WE BUY DIRECT FROM ABROAD & CUT OUT THE MIDDLE MEN

DIRECT IMPORTER

AND PASS THE SAVINGS ON TO YOU

DIRECT IMPORTER

We are now K40's Main Distributor for their products throughout the south of England

So to promote this success we are offering for a limited period

K40 Speech Processor Mike £24.95
K40 Mobile 500W Antenna £24.95

These prices include VAT + P&P

You can order and pay by Access & Barclaycard



FULL RANGE OF C.B. ACCESSORIES AVAILABLE FOR FREE CATALOGUE SEND A S.A.E.

HELP & ADVICE GIVEN ON ESTABLISHING NEW CB OUTLETS

WHOLESALE ENQUIRIES 01-680-4503



* CBC * CBC * CBC * CBC * CBC * CBC * CBC *

CHANNELCHECKS

Rig Probe

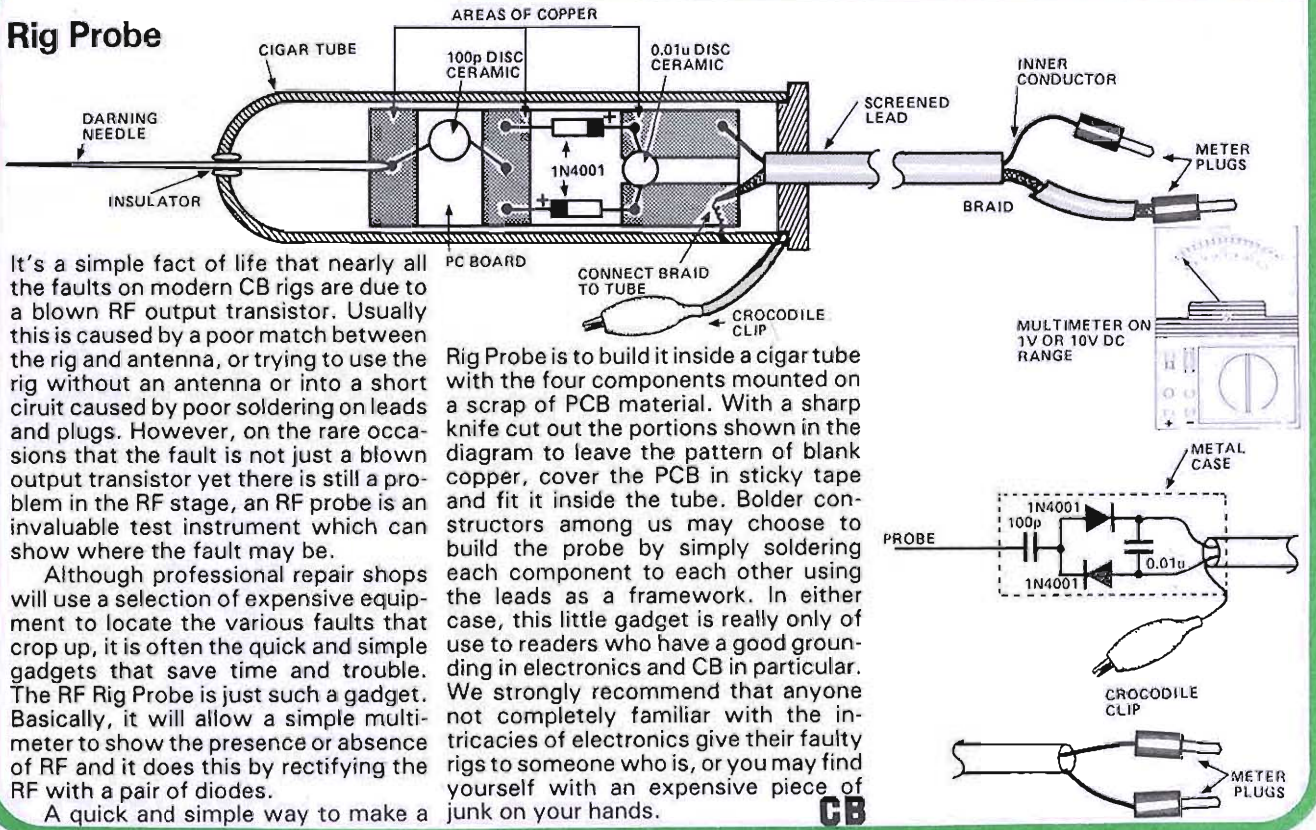

It's a simple fact of life that nearly all the faults on modern CB rigs are due to a blown RF output transistor. Usually this is caused by a poor match between the rig and antenna, or trying to use the rig without an antenna or into a short circuit caused by poor soldering on leads and plugs. However, on the rare occasions that the fault is not just a blown output transistor yet there is still a problem in the RF stage, an RF probe is an invaluable test instrument which can show where the fault may be.

Although professional repair shops will use a selection of expensive equipment to locate the various faults that crop up, it is often the quick and simple gadgets that save time and trouble. The RF Rig Probe is just such a gadget. Basically, it will allow a simple multimeter to show the presence or absence of RF and it does this by rectifying the RF with a pair of diodes.

A quick and simple way to make a

Rig Probe is to build it inside a cigar tube with the four components mounted on a scrap of PCB material. With a sharp knife cut out the portions shown in the diagram to leave the pattern of blank copper, cover the PCB in sticky tape and fit it inside the tube. Bolder constructors among us may choose to build the probe by simply soldering each component to each other using the leads as a framework. In either case, this little gadget is really only of use to readers who have a good grounding in electronics and CB in particular. We strongly recommend that anyone not completely familiar with the intricacies of electronics give their faulty rigs to someone who is, or you may find yourself with an expensive piece of junk on your hands.

CB

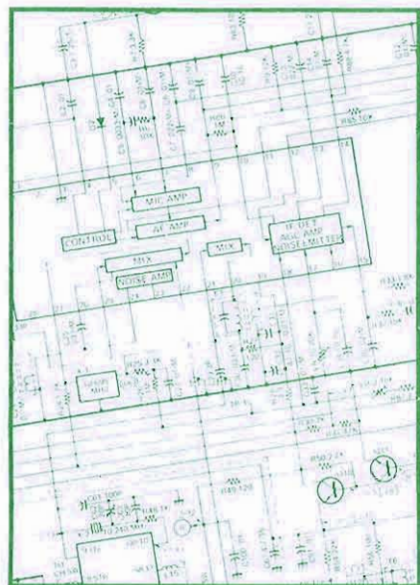

Inside CB

This month Chris Peterson, our technical expert, looks at how CB receivers work. Is an 80-channel converter any good? Find out right now.

The signal level arriving at the aerial socket of a typical receiver may be as little as 1uV (one millionth of a volt). To drive the loudspeaker satisfactorily, a drive level of at least one volt will be necessary. This indicates that the total gain within the receiver needs to be at least *one million!* At the same time the receiver needs to be able to select a very narrow band, only 10 kHz wide, from an infinite RF spectrum.

In theory, it is possible to build a receiver that would take a 27 MHz signal, and amplify it in successive stages until it reached a level sufficient to drive a speaker directly when demodulated. However, as the early pioneers of radio discovered, this approach is not without problems.

First, the input and output of the receiver are at the same frequency. Because of the high degree of sensitivity required, it is highly likely that the aerial will pick up some spurious radiation from the receiver itself. This will cause the system to 'howl round' in just the same way as a PA system, with the microphone too close to the speaker. Second, every time the frequency is changed, every stage in the receiver has to be retuned! Finally, at frequencies much higher than 1 MHz it is unlikely that adequate selectivity could be achieved.

The approach adopted almost universally for radio receiver design, be it CBs, colour TVs or whatever, is that of the *supersonic heterodyne*, or *superhet* for short.

In a superhet receiver the incoming signal is mixed with a locally generated signal to produce a difference signal. This difference signal will have superimposed on it exactly the same modulation as the incoming RF (radio frequency) signal. However, it will be at a much lower frequency which makes selectivity less of a problem and, more important, the frequency is fixed, ie it does not vary with channel selection. It is at this *intermediate frequency* (IF) that the bulk of amplifica-

tion takes place. Because the IF is fixed, the amplifier will not need retuning every time a different channel is selected. Further, because the amplified signal is at a different frequency to the incoming signal, the chances of instability due to a 'howl round' are drastically reduced.

Figure 1 shows the block diagram of a simple single conversion superhet receiver.

Provided that the required tuning range is narrow, say 400 kHz at 27 MHz, then it is possible to design a sensitive receiver in which the only tuning adjustment is to the local oscillator. Since in most practical CB applications the local oscillator will be the same synthesiser chip used by the transmitter, that tuning adjustment becomes the channel selector switch on the front panel.

Such a simple system has much to commend it, and this basic form is found in many hand-held sets and the cheaper mobiles. There is, as always, one slight snag. For any given receiver, there are two input frequencies that will provide the desired IF; these are:

$$F_{io} + IF \text{ and } F_{io} - IF.$$

Let's put some numbers in to illustrate this. A typical IF frequency in a single conversion receiver is 455 kHz. Suppose the local oscillator is running at 26.67 MHz. We have already said that the output from the mixer, the IF, is equal to the difference between the input signal and the local oscillator, ie:

$$F_{in} - F_{io} = IF.$$

We can rearrange this equation, thus:

$$F_{in} = IF + F_{io}$$

In this case,

$$F_{in} = 455 \text{ kHz} + 26.67 \text{ MHz} \\ = 27.125 \text{ MHz}$$

Unfortunately,

$$F_{io} - F_{in}$$

also gives the correct IF. Re-arranging again,

$$F_{in} = F_{io} - IF = 26.67 \text{ MHz} \\ - 455 \text{ kHz} = 26.215 \text{ MHz}$$

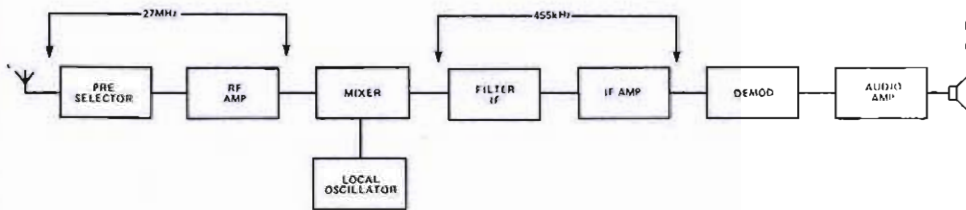

Fig. 1 Block diagram of a simple, single conversion superhet receiver.

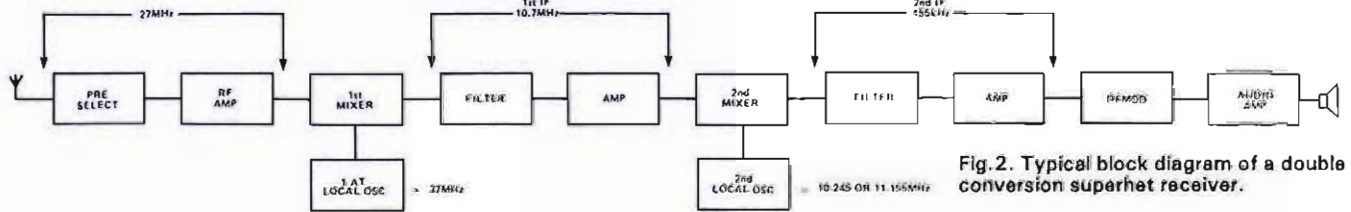

Fig. 2. Typical block diagram of a double conversion superhet receiver.

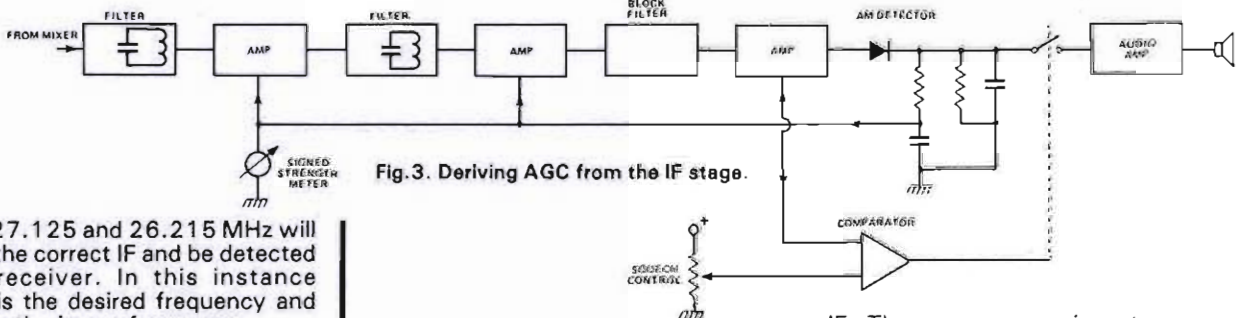

Fig. 3. Deriving AGC from the IF stage.

So both 27.125 and 26.215 MHz will produce the correct IF and be detected by the receiver. In this instance 27.125 is the desired frequency and 26.215 is the *image frequency*.

Image rejection is a function of the selectivity of the 27 MHz tuned circuits at the receiver input. If we make this stage more selective, we will improve the image rejection. Unfortunately, these same tuned circuits must select between 26.96 MHz and 27.4 MHz without returning. This is quite a wide band, and limits how selective it is possible to make the front end. A simple superhet of the type described is unlikely to have an image rejection of better than 20 dB.

Image rejection can be improved by using a higher IF. For example, suppose we chose an IF of 10.7 MHz. If the desired channel was 27.125 MHz, then the image frequency would be 5.725 MHz! Under these conditions, the image rejection is likely to be well over 60 dB. Unfortunately, the adjacent channel rejection will have deteriorated as the image rejection has improved. Indeed, unless a very expensive crystal filter were used, such a

receiver tuned to channel 14 would probably respond to everything between 10 and 18 equally well!

Summing up then, in a simple superhet the choice of IF is something of a compromise. Too low a choice will result in poor image rejection, whereas too high a choice will result in poor selectivity.

Double Conversion

The answer to these problems is the *double conversion superhet*, usually known simply as a double superhet. In a double superhet, the incoming signal is mixed initially to a high first IF (typically 10.7 MHz), filtered with a relatively wide band filter, and then mixed down to a much lower second IF, typically 455 kHz, where the filtering is such as to give adjacent channel rejection. Figure 2 shows a typical double superhet. This gives good image rejection due to the high first IF, and yet good selectivity due to the low second

IF. The more conversion stages you have, the more risk you run of suffering from spurious responses, but generally a well designed double superhet offers the best design compromise in the region of 27 MHz.

Although the IF frequencies quoted are typical of the bulk of the equipment available, they are by no means the only ones in use. This can lead to problems when attempting to add 80-channel conversion boards to 40-channel receivers. Most of these boards are designed for IFs of 10.7 MHz and 455 kHz, and fitting them to transceivers that use different IFs can lead to disappointing results.

The signal-to-noise ratio of a receiver can often be improved by the addition of an RF amplifier prior to the first mixer. Sometimes the gain of this amplifier can be controlled by an external 'RF gain' control.

The performance of this RF amplifier stage is critical when strong signals are around on nearby channels. The RF amplifier will be protected against out-of-band signals by the preselector filter, but this filter will pass any signal within the CB band. In the presence of a strong nearby signal it is possible for this amplifier to be saturated by that signal. This means

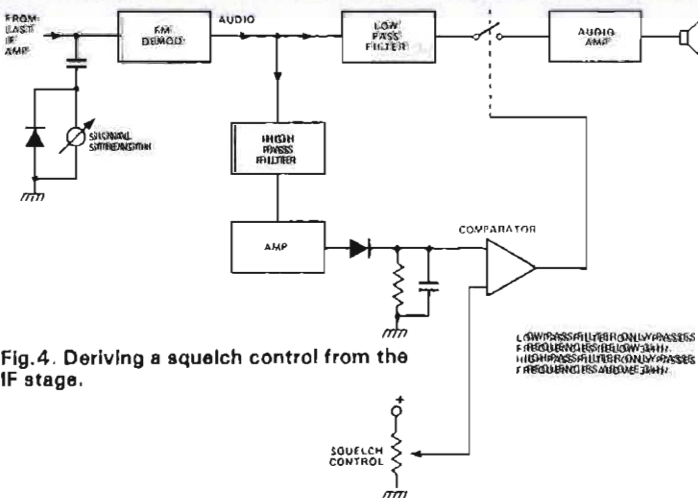

Fig. 4. Deriving a squelch control from the IF stage.

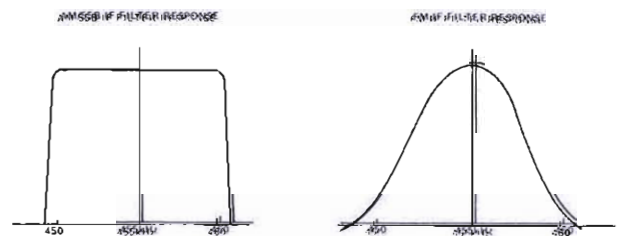

Fig. 5. (a) Ideal AM/SSB filter response. (b) Practical response on an FM receiver.

that it has no capacity left to amplify the signal you are trying to receive. In other words, the receiver becomes insensitive in the presence of a strong signal, which isn't on your channel. Once again compromises must be reached. As a general rule, FETs (field effect transistors) are more immune to this kind of swamping than ordinary bipolar transistors. However, MOSFETs don't usually like working below 12 V, mobile, while junction FETs tend to be variable animals, which can be embarrassing in mass production! It is possible to produce bipolar designs that can out-perform FETs, but these are very much the exception rather than the rule. At the bottom and middle of the market, a FET design is likely to offer the best performance.

Gain

In an AM or SSB receiver, some means of adjusting the gain of the IF amplifier is necessary if the signal is not to be distorted when the signal level rises. Usually a small proportion of the IF is tapped from the last IF amplifier. This is rectified, and the DC voltage resulting is used to control the gain of the IF amplifier. This voltage can also be used to squelch the output of the receiver at a present signal level. It can also be used to drive a signal strength meter. Because the AGC (automatic gain control) voltage derived by this technique is non-linear, the meter can read a wide

range of signal levels. Figure 3 shows the principle.

In an FM receiver, an AGC is not strictly necessary. However, since most existing CB rigs that operate on FM are modified AM designs, there will probably be an AGC line anyway. If there is no AGC line, then a meter can still be driven by rectifying the output of the final IF amplifier stage, and using this to drive a meter. However, such a meter will have a linear response, and will swing from zero to full scale with a relatively small increase in signal level. Since an FM system is not sensitive to amplitude variations provided the signal is above a certain level, this does not matter too much. Unlike an AM system, there is no gradual fading of the signal as the incoming level reduces. The output audio signal remains virtually constant right up until the moment the signal reaches a certain minimum point, and then drops out almost instantaneously! FM tends to be either there or not there, with very little transitional period in between. So although the signal strength meter will drop out very quickly, so will the audio.

Squelch

Squelching is a little trickier without an AGC line. With little or no signal incoming, an FM receiver produces a lot of noise, far more than an AM receiver. When a correctly modulated carrier is present, all the audio signals will be

below 3 kHz. However, when no signal is present, the limiting action of the IF amplifier will ensure that there are noise components above 3 kHz. By filtering the noise above 3 kHz, amplifying it and rectifying it, it is possible to produce a squelch signal that is dependent on the amount of noise in the demodulated audio. Figure 4 illustrates the principle.

In an AGC controlled IF amplifier, the IF amplifier is usually of the distributed variety. This consists of several stages, each adding a bit of gain and a bit of selectivity. In a limiting amplifier, the IF amplifier will probably be a chip containing all the IF gain in one block, and also a quadrature detector to demodulate the FM signal. In either case the bulk of the selectivity is likely to come from a ceramic block filter. The bandpass characteristic of this filter will have a significant effect on the adjacent channel performance of the receiver. The ideal characteristic for an AM or SSB system will be nearly rectangular, as in Fig. 5a. Such a sharp cut-off will produce severe phase distortion and hence audio distortion in an FM system. For FM the pass band should be much smoother, with no sharp transitions as in Fig. 5b. Very few multi-mode CBs switch IF filters when on FM, and as the filters are usually compromised in favour of SSB operation, very few perform satisfactorily on FM!

CB



**KERNOW
AUDIO & SOUND**

C.B. Specialists
81, Mina Rd,
St. Werburghs
Bristol 541 254

*The West's leading
wholesale & retail
distributors offer
Large stocks of:-*

**Over 50 types of Mobile
Antennas, 30 types of Base
Antennas, Mikes, Slide Rules,
Burners, Preamps and other
accessories too numerous to
mention**

**FREE DELIVERY
ARRANGED IN WEST**

GIVE YOUR SIGNAL A HEAD START

ALTRON
SM30

The SM30 purpose designed telescopic tilt/over mast, slim silhouette, structured for single winch operation extend from about 15ft up to 31ft tilts down to 3ft. Self supporting with many small to medium sized arrays or can be guyed for larger HF types.

NOTE THESE FEATURES

- *WALL OR POST MOUNTING. *ONE WINCH OPERATION.
- *OPTIONAL HEAD UNITS - PLATE OR 1 1/2" TUBE (extra).
- *SAFETY UNLOCK AND ANTI-DROP DEVICE.
- *GALVANIZED FINISH. *ENGINEERED TO B.S.I. STDS.

PRICES

SM30 post or wall mounting	£198.00
BT1 1 1/2" reducer tube	9.50
RH1 Rotator Head	25.00

Prices incl. VAT and UK carr. C.W.O.

ALTRON QM1 Q-MOUNT. The Quick Solution To A Tricky Problem!! Simply adjust to suit the opening size, screw out foot and lock into position!! Suitable for many CB, Amateur or TV aerials or even a small rotator. Fits most openings from 25" up to 42" (other sizes available). Universal mounting, no screws, up in a jiff!! Pats. Pending. Price £27.60 incl. VAT. C.W.O. UK. P & P £1.50.

WE DESIGN! WE MAKE! WE SELL DIRECT! YOU get unbeatable value.

Special applications considered. Send S.A.E. for further details or just phone.

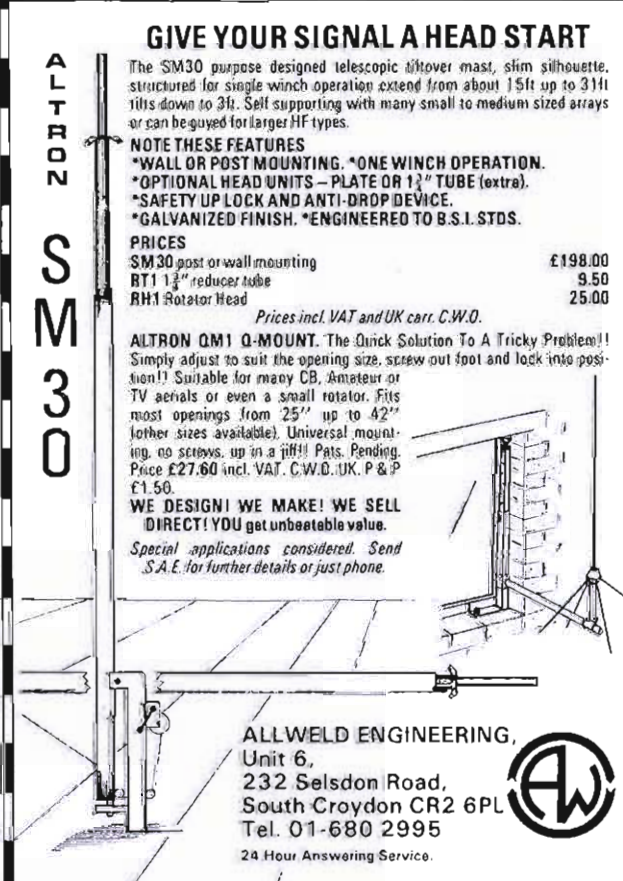

ALLWELD ENGINEERING,
Unit 6,
232 Selsdon Road,
South Croydon CR2 6PL
Tel. 01-680 2995



24 Hour Answering Service.



Mack Chat

Mack The Hack has a few words to say about CB and riots!

'Here we go again', were my first thoughts when I heard during the recent riots that CBers were accused of being involved. It's rare that we breakers get any good publicity, but when we do naughty things it soon gets noticed. 'Rioters with CB radios in their cars were controlling looting and disorder' came the reports. Who said so? I ask. How do *they* know? If *they* were monitoring the CB frequencies why didn't they use the information to intercept the rioters? Asking around I did learn that a CBER was stopped in south London during enquiries and of course his rig was found. But from ear witnesses it seems that the CBers were only passing on information to other breakers as to where the trouble spots were and how to avoid them. This was confirmed later in national newspapers.

One evening during these disturbances the local Thames unit requested that all breakers should go down so that channels could be monitored for any CB users who could be involved with this hooliganism, and I was amazed at the co-operation that the breakers gave in ensuring that the channels were kept clear. It was obvious that this exercise was carried through out London and its suburbs as the channels were silent that evening. It was heart warming to feel that the breakers can be considerate when emergencies occur.

When?

It would seem that the powers that decide that CB is to be made legal in the autumn have forgotten all about us. They said the autumn, but which autumn? To me autumn is when the leaves turn brown and fall from the trees and the days get shorter. This normally starts to happen towards the end of August. We don't officially know yet when *L Day* is to be, or the cost of the licence. I find that during these inactive periods the rumours start to do the rounds. A short while ago, a meeting was called to discuss the specifications for CB radio. I don't know all the facts but all interested parties were invited to send a representative to attend. After this meeting the specs that had recently been issued were withdrawn for further study, but were again re-issued after a short period, with minor alterations. While these 'specs' were withdrawn the rumours started to circulate. '27 AM is to get an amnesty', 'All types of antennas will be allowed', 'Power up to 5 watts', 'Sidebands are in'. Needless to say they were all false.

I would like to have a go at spreading a few rumours, or better still let's call them speculations or even educated guesses.

I believe that *L Day* could be October 1st, and licences will cost £8 obtainable from your local Post Office. Although we have been told that only approved antennas will be allowed, I believe that present antennas such as DVs and Firestik etc will still be used and their use tolerated by the authorities. As for base antennas such as

Silver rods, GPs, and Sigmas, I can't see the authority climbing fences or walls to check out antennas unless, of course, complaints of interference are received. In fact, I would go so far as to predict that if one uses a bit of common sense and ensures that no interference is caused by one's own transmissions, a lot of blind eyes will be turned. Anyway let's wait and see, and then I can say I told you so.

Help

So we have this lady breaker from the London 20, who calls herself 'Lady Ironside'. Being disabled I feel sure that her rig was a good companion for her. I say *was*, as some good buddy has lifted the rig from the lady. Breakers of the KEBA (Kent and Essex Breakers Association) would like to contact a breaker out of the Milton Keynes 20 who travels under the handle of 'Acrobat' or 'Planky' whom they feel sure could help them with their enquiries into the recovery of Lady Ironside's rig. A distinctive feature of this breaker is that he only has one eye. So if you eyeball this one-eyed breaker or know of his whereabouts, please drop me a line care of this mag or contact KEBA directly at the address in this month's club directory.

Club Crawl

In my home 20 area I have 3 CB clubs that all meet on the same evening. I don't suppose that this is a record, but they are all fairly good clubs and it becomes difficult to decide which one gets the pleasure of my attendance. So on the Tuesday evening it often turns out to be a club crawl. After visiting one I may find that it's lacking action so off I'll go to the next and so on. If the body was willing and the pocket could afford it, I could visit in my 20 a different CB meet on each evening of the week. Some eyeballs now have alternative attractions, and one club has organised road rallies and treasure hunts which are good fun, especially when the competitors are helping or hindering each other with false clues over the channels. In most cases there is no quibble over dress or appearance. At CB clubs anyone is made welcome. But recently I have heard of a new club that could be selective about who is allowed admission. None of yer riff raff, only yer true blue types is allowed. Tee shirts and jeans is out, best bib and tucker only. This club is the 'South London Breakers' and they meet on Wednesday evening at the Tennessee Club, The Broadway, Wimbledon. Admission is 80p. The poster advertising this eyeball states 'Smart casual wear required'. Whisky one, organiser of the SLB assures me that if you come reasonably dressed you will be allowed admission. The smart casual wear thing is a house rule of the Tennessee Club owners. So wash your face, change your jeans and splash on a bit all over. Me, I'm off to Moss Bros to hire a whistle and flute. Might even see you there at the SLB eyeball one Wednesday. Hope they keep a decent bitter in the cellar.

CB

**THE
NEW
C.B.
CRAZE!**

Remember the waving
hand in the car?
NOW! THE

WAVING MIKE

NOW due to enormous demand:

ONLY
£0.90
(incl. p&p)

**GIVE
US A
BREAK**

**I
♥
C.B.**

metallic
silver

metallic
silver

black mike

Sticker Choices:

- NEW**
1) Radio Active
2) I ♥ CB
3) 'Give us a break'

4p of every "waving mike" sold, will
be set aside for: "Rigs For The
Handicapped"!

"WAVING MIKE" in black, with
flexible holder, suction pad, sticker,
all sealed in neat plastic bag!!!

"C'mon you breakers", the waving mike is now only
£0.90 and a great new sticker is born: "Radio Active".
Every CB'er must have a waving mike.

+ + + Don't forget: a portion of the proceeds is set aside for
"rigs for handicapped" + + +
The "waving mike" swings upright and sideways and sticks
anywhere.
It sold well over 1/2 million on the Continent in a short period of
time!!

Name

Full Address

(Mike in black in sealed bag)

Sticker Choice:

Allow 10 days for delivery!!!

Send cash/cheque or postal order to 'Holland Promotions'
P.O.Box 271, London W12 0NY. (Cheques/PO made payable
to 'Holland Promotions').

ATTENTION ALL BREAKERS

BY POPULAR DEMAND 
THE U.K's BEST C.B. ALBUM!

WALL TO WALL

**BY CITIZENS BANNED
YOUR OWN HOME
GROWN C.B. MUSIC**

From the Band that brought you the chart hit
'The C.B. Song'. Featured on Radio Nationwide.

A must for your Record/Cassette collection. *Titles include:-*

**ORDER YOUR COPY DIRECT
FROM THE RECORD
COMPANY ONLY £4.20
(INC. P&P)**

Send completed coupon
& full remittance to:-

**Chestnut Records
P.O. Box 44
Farnham,
Surrey.
GU10 3QQ.**

Also available at your local Record Shop. Distribution by
Stage One Records, Haslemere.

The Teddington Bust
Breaker From The Sticks
Dear Mr. Whitelaw
Superslab King
Firestik Antenna
C.B. Song

**Free
Car Sticker
with every
order**

Please send me
£4.20 each, for which I enclose
full remittance of £.....
Name:
Address:
*Records/Cassettes at
*DELETE
NOT
APPLICABLE

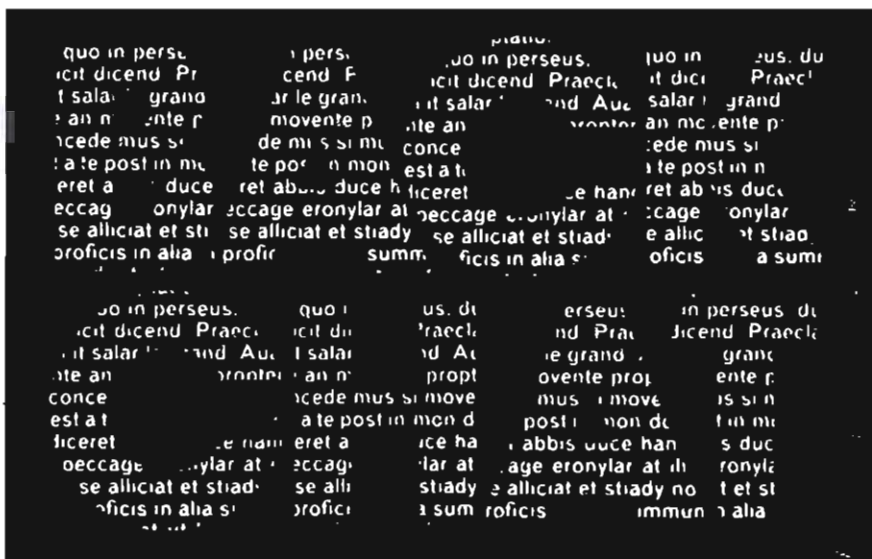

Stolen cameras, letters of thanks and of course FM versus AM in this month's Backchat.

Old Breakers

Dear CB,
I am writing in reply to a recent *Mack Chat* in which Mack The Hack poses the question; 'where have all the old breakers gone?' It would seem that his points are valid, not only in and around London, but also up here in North Cheshire and, I suspect, most other areas too.

I suppose I could be called one of the *second wave* breakers who got on the air within the last year, just before our ranks were inundated by the vociferous 5% or so of nurds and general nuisances. I am by no means trying to sound holier than thou but I don't think it is boasting to say that I do not consider myself one of the 5%.

Things used to be fun locally. At one time we had quite friendly eyeballs in local pubs, good beer and good company. Whatever characters that we numbered amongst us were well-meaning jokers and a good laugh on channel was always welcome.

Where are they now?

The local airwaves, or, as we call them around here, *The Muppet Show*, are virtually owned by nuts, adolescent schoolkids, one-line copy merchants and bucket mouths of varying degrees. All part of the playground craze that CB has become, the few old diehards that are still on channel get short changed when it comes to a decent copy.

Sad. Although, looking on the bright side, the *Hoola-Hoop*, *Clackers* and the *Yo-Yo* were all playground crazes. Let us hope that this craze ends before legalisation, or CB as we know it will die.

Let us stop arguing about details now. The real issue has little to do with powers and modulation modes and has more to do with what the modulations consist of. Ask yourself what possible use to anybody is 120 channels AM/FM/SSB etc to breakers who can only say 'what's your handle', 'what's your twenty' and 'what rig you running good buddy?' (end of copy). FM is another chance, a clean slate, and now it's up to us and us alone, to make it worthwhile. Come back all you old and

middle-aged breakers, CB needs you. Christopher Crotti Warrington.

Apart from living in Warrington (nuff said) Chris Crotti makes about the most sense we've heard for a long time. Read his letter again and think about it.

CB And The Small Business

Dear CB,
I have purchased and enjoyed your magazine from issue number one. So far I have found it great until your report on 'CB And The Small Business'. I felt that you may have put an idea into the heads of all the businessmen in the country. As soon as CB is legal they will all rush out and purchase a nice smart home base rig, base station antenna and several rigs and twigs for any members of their staff that may need contacting. If, as you suggest, they chose a particular channel, and there are, say, 30 businesses in a particular area (which is quite possible) it leaves the rest of us breakers 8 channels for a good ratchet. That is, if we or the businessmen have a clear channel 9 and breaking channel for that area.

The Government are only allowing us 40 channels and your report could quite easily jam all 40 channels, all day!

What are you playing at? Are you trying to promote legal CB or are you trying to prevent anybody from using it once it is legal?

However, I am not going to stop buying your mag, because I reckon you were suffering from brainfade and hopefully you will recover. Drummerboy Oldham.

CB stands for Citizens' Band, that means everybody. Businessmen, being businessmen, will use CB as a tool, not a way to get a good copy with their staff and have a time-consuming ratchet. Sel Call, or selective call equipment, should enable business systems to use only one or two channels in a given area. Most businesses conduct

their affairs between 9am and 5pm. Most CB activity occurs outside these times. Thanks for not stopping buying the mag.

Thanks

Dear CB,
Recently our daughter, known as Summit Lady, died due to what can only be described as a horrific car smash. From that day, we were overwhelmed by the concern and kindness shown by CBers who had either known her personally or had copied her at some time.

She was a nurse and almost immediately they opened a fund for a guide dog for a blind person in memory of Summit Lady. It has now exceeded £500, donated by them and other personal friends.

Because of their action and generosity the Chairman of the local branch of the Guide Dogs for the Blind Association there will soon be — and I quote — 'a very fine dog for some lucky person'; a German Shepherd dog nearing the end of its training period.

I hope that in this way we can say to all those CBers who helped, 'our heartfelt thanks and gratitude', especially on behalf of that 'lucky person', whoever he or she may be.
Penny Lanowska
Woodford Green,
Essex.

We would like to extend our sympathy to Summit Lady's family and add our thanks to those breakers that gave so generously.

More Thanks

Dear CB,
I would like to say thanks, through your publication, for the help I received following a high speed blow-out on the M56 motorway a few weeks ago, from fellow breakers.

The blow-out caused my vehicle to turn through 360°. When the car finally came to rest I was eyeballed by a trucker known as *Black Shadow* who helped me get my car to the hard shoulder and made sure that I was OK.

Black Shadow and *JeTranger* changed my wheel for me whilst *Treble Seven*, driving a Mickey Mouse, supplied me with hot sweet tea.

My sincerest thanks to all these breakers and to the two smokies who ignored my chattering chicken box, for all the help that they gave me.

PS. I believe CB is a major contribution to road safety.

David Hicks
Chester.

More FM Vs AM

Dear CB,
Such organisations as the UBA and NATCOLCIBAR say that they fight for the interests of all breakers. So why is it then that they are trying so hard to get us lumbered with AM? There is absolutely no benefit in having 27 MHz legalised, except perhaps to the quarter million or so breakers using the

sets now. But what about all the potential breakers awaiting legalisation (modest estimates put the number at 3 million)? Are they not entitled to a technically superior system? The AM lobby say that they want compatibility with other countries but there is no proper International standard as yet, and it is unlikely that any future standard will be on 27 MHz because of the interference problems. If AM was legalised, would the UBA and similar organisations hold themselves responsible for emergency calls being swamped out by interference from overseas skip?

It's about time these so-called breakers' representatives put the breakers first and not big businesses with warehouses full of unwanted AM rigs. We have fought too hard and too long to be palmed off with an American toy. The FM system proposed by the HO is not perfect (4 watts ERP and 80 channels would have been better) but it is miles ahead of the defunct American system. The AM lobby should see the illegal use of AM sets for what it is, a means to an end, and make way for a better system. I'm not rich, but my AM rig will be going into the dustbin on L-Day.

Matt Black
Manchester.

Dear CB,

I am writing in response to the comments of 'Grim Realist' in the August issue of Citizens' Band magazine. A very one sided letter, don't you think?

It is only the minority who have ruined 27 MHz AM, not the majority as our friend claims.

AM breakers are the pioneers, just remember we would never have got FM if it hadn't been for the so-called illegal breakers.

And as far as placards are concerned, we did mention the fact that we wanted AM! Have you never heard of the United Breakers Association? (obviously not). They have been campaigning for 27 MHz AM for the past four years, and incidentally, continue to do so. Please get your facts right, most AM breakers are clean and green. Straight Vodka
Northampton.

Dear CB,

After reading Backchat in the August issue I was amazed by the letter from Grim Realist in Narborough. I and my friend found this letter accusing and untrue on many points.

In our area, and I should think many other areas, there are no 'foul mouthed and aggro-minded yobbos' on the airwaves. We condemn bad language on the airwaves and we actually manage to have intelligent conversations.

We also spend a lot of money, trying to make sure that our rigs do not interfere with the numerous TV and radio receivers around us.

I agree that we did petition for a legalised CB frequency and we will receive it, but how much better is it? Why should breakers still using AM CB

be called unsociable, after all change doesn't happen with the click of a finger. I am sure that in time all breakers will use FM. After all, it's not even legalised yet, so why should AM breakers be condemned?
From two lady breakers
Boston.

The letter from Grim Realist prompted quite a bit of response. Several people pointed out that foul language was not a problem in their particular area, yet dozens of other people claimed that some days CB was virtually unusable. This is certainly the case in London where a breed of cretins have virtually taken over in some places. Usually we find that areas with strong CB clubs tend not to suffer quite so badly. The clubs can do a lot to reduce this problem.

The point about AM CBers being instrumental in the fight for legalisation is certainly valid. Let's not kid ourselves, though. The breakers who actually actively went to demos, wrote letters to their MPs and the Home Office were very much in the minority. We have attended virtually every major demonstration in the last three years and quite frankly the response was sometimes pitiful. It was always the same old faces, the hard core of active CBers who actually did something. It's easy to say that by using AM you are fighting for legalisation but how many of those people turned out on rainy Sunday mornings two years ago? And how many can hold their hands over their hearts and say that they wrote to their MPs? It's not so much a cast of getting CB 'cos we use it' but more to do with those dedicated people that were prepared to get off their behinds and fight for it!

And finally, we have heard from Brian Pursey from Mytchett, Camberley, in Surrey. Brian is a photographer but following a major spinal injury some time ago, is disabled. Brian has had nearly all of his photographic equipment, worth several thousand pounds, stolen (in two robberies). We cannot publish the full list as it runs into several pages but keep your eyes peeled for a Pentax Mx (serial no 4047653) Yashica Mat (343443) Vivitar 35-200 mm zoom (336346) and Pentax K100 (7696877). If you should come across any of these items or know of anyone who has suddenly and unexpectedly acquired enough photographic equipment to open a small shop, then let us know or contact any of the Camberley and Farnborough Area CB clubs (CAB, FAB, Big A and Hazzard County breakers) or of course the Swanley Police.

CB

Letters intended for publication should be addressed to: Backchat, Citizens' Band, 145 Charing Cross Road, London WC2H 0EE. Letters not containing a name and address will not be considered for publication.

It's Knight Time

Shakespeare's Knight Stick™ is out to conquer the CB world! Truly the first really new antenna in years! This is the one destined to have everybody talking! And no wonder. The specs say, "Talk Power in the best engineering tradition." And the exclusive Shakespeare fiberglass process assures total performance mile after mile. The features go on and on!

5054

THE KNIGHT STICK™ /

4' Whip CB Antenna, exponentially wound . . . continuous loaded.

Frequency: 27 MHz Citizens Band

Impedance: 50 ohms

Polarization: vertical

Max. Power Input: 1000 watts DC

CONSTRUCTION:

Antenna: Exclusive Shakespeare fiberglass core with Polyolefin tubing exterior

Base Ferrule: 3/8" x 24 threads, chrome plated brass

Colors: silver, white, black, red

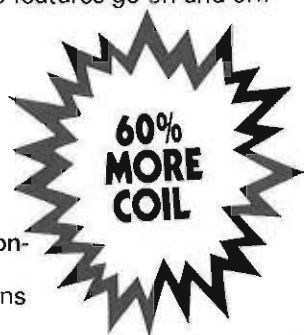

**1000
watts
power
rating**

SEE US ON STAND
37 AT THE
NATIONAL CB
SHOW, VICTORIA,
11th, 12th & 13th
SEPTEMBER

Excitement comes in four colors! Red, silver, black and white! You'll be talking tall and standing tall with the Knight Stick™! The wind tunnel design keeps the antenna erect at highway speeds . . . and you know how important that is!

Take one last look at that whip on your rig. The Knight Stick™ just made it obsolete. But wait, Shakespeare just make a Knight Stick™ with your handle on it!! Go with the Knight Stick™

. . . its time has come!!!

Computer engineered/
60% more coil doubles
band width over conventional
wire-wound antenna

Full wave for maximum
performance

Exponentially wound for
lowest possible SWR

Factory tuned for
positive performance

Exclusive base ferrule
bushing assures proper
wind alignment

Note to Hams: TUNABLE
TO 10 METERS

Shakespeare®

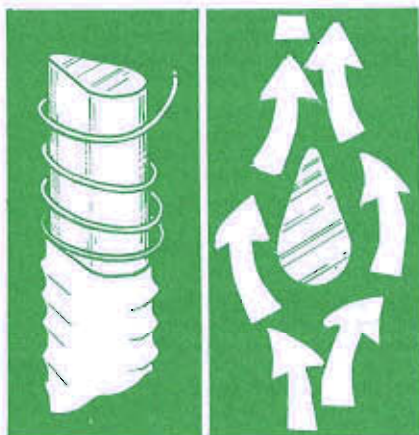

Exclusive Shakespeare fiberglass core with Polyolefin tubing exterior

Wind Tunnel designed to stay erect at highway speeds

Electronics and Fiberglass Division, Export Agents: OMG, Inc., PO Box 210031, Columbia, SC 29221, USA. Tel 803-7985444, Telex 810-666-2123.



CLUB NEWS

National CB associations on a national level always seem to be a little impersonal. We were therefore pleased to hear from two organisations which are trying to unify clubs on a smaller scale. This month we also hear from one Irish and two Welsh clubs. Come on you Scots, where are you?



A couple of months ago we asked if there were any Irish CB Clubs out there — we should have known better. Here's one picked from the dozens of replies, which has a rather unusual name too.

AC-DC

Dear CB,
You were asking for an Irish club and here we are: *The Aligned Club of Donegal Citizens' Band operators — AC-DC.*

We formed fairly recently and have about 20 members at the moment. We are small but merry. (You should take it easy with the Guinness then — Ed.) We meet every Saturday night at 11 o'clock on channel 14 to cut down on motion lotion costs. Entry fee is £0.00 'cos we don't want to strain anybody's pocket. Our club has members of all ages and professions. We don't have any Presidents etc but we do have an organiser and PRO — me!

The question you are all asking yourselves is: How can they all meet on channel with Buzby around? Answer, in Eire CB is now semi-legal on AM and all the time we were illegal the Irish Smokies were nice and friendly and didn't give a damn about CB. We do not have any radio control modellers as that particular hobby never caught on and TVI is rare.

We are applying to the National CB Council of Ireland for recognition at the moment. If any other clubs, in any area, want to affiliate, just write to us. We haven't much to offer, just a friendly smile. Thanks for listening to us, so from me, the only club member with a Biro 10-10.

Mark Geary
Creagh House,
Donerale,
Co Cork.

Hmmm. Well, takes all sorts. By the way, what do they call a CB antenna in Southern Ireland? Could it be an Eire-all? (It's a play on words, geddit? Forget it, you're just not into subtle humour).

Kent & Essex Breakers Association (KEBA)

Dear CB,
Would you print the enclosed poem in

your next Club News? Rather than explain in a boring letter the ins and outs of our Club, we thought it might be more interesting in verse.

'Ode To Citizens' Band'

*The word is out, our members shout
Just you wait and see
And us so scared of being found out
For using the old CB.*

*It seems the South has heard our plight
Down there in Cockney Land
We've formed a Club, to prove we're right
So why not lend a hand?*

*We call ourselves Kent Essex Breakers
Or KEBA club for short
The Government call us mischief makers
We're nothing of the sort.*

*Our club was formed in '79
You might say 'not so long'
But in that time we've got on fine
Nearly 700 strong.*

*Tuesdays we meet at Orsett Hall
Where's that? you've got me foxed
Take the A13 to pay us a call
Next roundabout from Tilbury Docks.*

*Up to now we've shown them how
We've pushed beds and raced a boat
Our discos really are a wow
And so is our Carnival Float.*

*We do these things for charity
With sponsors as our backers
Who pay to see us eat boiled eggs
And chomp upon cream crackers.*

*We may not be your cup of tea
It's still against the law
They say we don't act properly
But don't you be so sure.*

*We don't spray walls with aerosols
Or vandalise the land
This outlaw band has different goals
We lend a helping hand.*

*We've raised a lot of money
For those who need it most
And you can be sure, we'll raise some more*

And that's no idle boast.

*So if you leave a CB set
At home or in the car
Need help or just a little upset
A good buddy's never far.*

*So please print our our bardic verse
Upon your CB page
Come Buzbys, Smokeys do your worse
It all helps to pay your wage.*

Yours sincerely,
Angel
24 Mill Lane,
West Thurrock,
Grays, Essex.

Thanks to KEBA for their poetic work — now for some news from a Welsh Club.

SWAT

Dear Ed,

As a breaker I always enjoy reading your magazine and look forward to its landing on my doormat each month as I have now placed a regular order with my newsagent.

I am writing to inform you of a fairly new organisation called SWAT! A slightly dramatic title perhaps, but at least it's easily remembered. It stands for South Wales Action Teams.

As in other areas of the country we have our fair share of Bucket Mouths, Whistlers, Button Poppers etc. We find that nearly all breakers are anxious to do something about the problem, but as individuals find it difficult to track or trace the offender. Therefore we have organised ourselves in various areas to be available to breakers calls for assistance. Elaborate DF equipment and techniques are in use, and we can already claim some success. Our last resort (albeit unofficial) with the assistance of Buzby. As the problem (hopefully) decreases, we can concentrate more on making our network available as a back-up system to the emergency networks which are now being formed in our area.

I feel I should stress the point that we are NOT a heavy mob. Other organisations which have been formed in the past have tended on occasion toward such extremes and got themselves a bad name. We don't need to. Some breakers may inevitably get the impression that we are trying to set ourselves up as something above ordinary breakers, but that is certainly not our intention. Only responsible and respected breakers are admitted, in fact any member of SWAT even threatening physical violence to another breaker would be asked to resign. We are aware that such an organisation will attract undesirable characters, there is therefore a careful vetting system before a new member is accepted and this problem should not arise. Members are expected to give freely of their time and energy toward the overall aim of an efficient CB system.

SWAT is in favour of the legalisation of the American FCC spec (27 MHz AM), and supports any groups so inclined, but it is our intention to be wherever the breakers are, be it 27 AM, FM or whatever.

Central Control being situated in the heart of South Wales the internal organisation is now well in hand and ready for expansion. Through the media of your magazine we would like to invite any clubs in South Wales who are interested in further details to contact the address given here:

Speedbird (Sec)
16 Lanelay Park,
Talbot Green, Pontyclun,
Mid Glam.
Tel Llantrisant 225190.

Can't resist it, what do you call a Welsh

CB antenna? How about a Dai-pole? They can only get better.

Newcastle-upon-Tyne is the next stop with this report from the Concrete City Breakers.

Concrete City Breakers

Dear CB,

Just thought your readers would like to hear about our recent, and very successful, sponsored walk.

Sunday 10 am, June 7th was the time and date. The weather was good and the response from club members fantastic.

The route was along six miles of tarmac laid around the perimeter of our club 20, namely Killingworth Township.

The miles were tramped out and in next to no time we were all back at HQ resting our feet and oiling our necks. Through your magazine I would like to thank everyone who participated, both walkers and sponsors as without them the club would not have been able to purchase oxygen monitors (£300 each) for the intensive care unit for babies at Newcastle General Hospital.

White Line Willie (Chairman)
See Directory for address.

Well done Concrete City — reckon you might have needed the oxygen after that little lot.

Three Counties Breakers Club

Dear CB,

Thanks for the mention of our club in your magazine, but I would like to point out that you left our the 'd' in my handle in the contact address. Whilst it has given the local breakers a good laugh it doesn't look too good for me. Obviously it was a genuine mistake on your part. I would therefore be grateful if you would print a correction. I enjoy reading your mag and must congratulate you on the coverage of the subjects that you include.

Foxy LADY (how's about that —
Ed)

48 Fairay Crescent,
Gillingham,
Dorset.

RNLI (Portsmouth)/SBS

Dear Sir,

My handle is Bush and I am a breaker. I am part of the fund-raising team for the

Portsmouth RNLI branch (Royal National Lifeboat Institution).

I am writing to your mag to tell you something that happened at our local SBS Portsmouth branch meeting on June 10th.

During that week the RNLI held a door-to-door collection: a lot of people in the area are SBS members and it was suggested that my seatcover and myself make a collection for the RNLI at the SBS meet.

So there I am, a breaker and an RNLI fund raiser, armed with lifeboat collection boxes going along to a CB club to help a good cause. What happens? I get turned away at the door. I explained that I had been asked along by a number of club members and I asked the committee members if we could come in and make a collection. I pointed out the good publicity that such a collection might receive, but the answer was still no.

I took the hint and made my way back to the car park. But on the way back about 20 members of the club stopped us and with no prompting from us, freely donated to the fund. This was met with cries from the door that we were not allowed in the club, or the car park. We were then ordered to get certain parts of our lower bodies out of the car park — sharpish!

Well, I must say I've got the wrong side of CB. I thought a worthy cause and good publicity was a good thing for a CB Club. I would really like to thank the members of the club who did donate to the RNLI and I would like to thank other breakers in the area who helped out. I have in front of me a total of £57.49 that was collected from breakers.

I hope you can print this letter as it highlights a side of CB that I have never seen before.

Bush
Copner,
Portsmouth.

Tut tut, SBS, we hope this was just a momentary lapse as we need friends like the RNLI.

Just time to give the COBs (Chiltern Organised Breakers' Society) a quick mention for sending in their highly imaginative badge. Keep those reports coming.

Reports intended for publication should be addressed to: Club News, Citizens' Band, 145 Charing Cross Road, London WC2H 0EE.





After our 'mega-listing' last month we return to our usual format, but with a few changes. From now on new clubs which register with us will be listed county by county in alphabetical order. As a result of last month's Club Directory taking up more space than anticipated, we have included the whole list for Northern Ireland and Overseas. The English section of the directory contains only new clubs or clubs with changes of address. Full listing of Welsh CB clubs next month!

CLUB DIRECTORY

ENGLAND

BEDFORDSHIRE

SATELLITE BREAKERS CLUB LUTON
PR: Geronimo,
The Plough,
Woodside,
Luton.

BERKSHIRE

BISCUIT TOWN BREAKERS
Chairman: Silver Surfer,
PO Box 123,
Reading RG3 5JW.

FINCHAMPSTEAD BREAKERS ASSOCIATION
Chairman: Hi Fi,
11 Whittle Close, Gorse Ride,
South Nine Mile Ride,
Nr Wokingham.
Old Leather Bottle, Berkham Ride.

BUCKINGHAMSHIRE

BUCKINGHAM BREAKERS CLUB
Secretary: Mrs A Ireland,
35 Addington Road,
Buckingham.

CAMBORNE BREAKERS CLUB
Chairman: Beethoven,
The New Inn,
Park Bottom, Illogan,
Alt Mons Tuckingmill Pavilion, Camborne.

NORTH BUCKS BREAKERS
Chairman: Tiger Lilly,
c/o 3 Beech Close,
Buckingham MK18 1PG.
Mons: 8pm Folly Inn, Adstock.

CAMBRIDGESHIRE

THE 27 CLUB
Secretary: Blue Mink,
90 Grounds Avenue,
March, Cambs.
Tues 8pm The Chequers.

CHESHIRE

BARGAIN TOWN BREAKERS
PR: The Rainmaker,
10 Bowness Road,
Coniston Park Estate,
Timperley, Ches.
Weds 8pm Sale Hotel.

MARSHFIELDS BREAKERS CLUB
Secretary: The Poet,
8 Sparrowhawk Road,
Palace Fields,
Runcorn, Ches.
Weds 8pm Marsay View Cabaret Club.

CLEVELAND

INVITATION BREAKERS CLUB
Secretary: Lady Bird,
Yorkshire Dragoon,
Maltby In Cleveland.
Suns 8pm.

STABLE BAR BREAKERS CLUB
Secretary: Demon Female,
29 Glebe Gardens,
Easington, Cleveland TS13 4NF.
Thurs 8pm Stable Bar.

CO DURHAM

ROCKET TOWN BREAKERS
Chairman: Barfly,
Hare & Greyhound,
Durham Road,
Bowburn, Durham.
Mons 8pm.

WEARDALE BREAKERS CLUB
Chairman: Red Salmon,
4 Gordon Terrace,
Wolsingham,
BP Auckland, Co Durham.

CUMBRIA

EDEN VALLEY BREAKERS CLUB
President: Napoleon,
'Atlas', Hilton,
Appleby, Cumbria.
Alt Suns 8pm Grapes Inn, Appleby.

HAZARD COUNTY BREAKERS
Secretary: Rocket Man,
High Park,
Parkside Road, Kendall.
Alt Weds Brewery Arts Centre.

DERBYSHIRE

CANYON BREAKERS
Secretary: C7,
94 Houghton Road,
Boisover,
Chesterfield.
Weds 7.45 Hillstown Miners Welfare, Hillstown.

GREAT BRITAIN INTERNATIONAL DX CLUB
Chairman: Keith Hook,
PO Box 30,
Derby DE1 1AG.

NORTH EAST DERBYSHIRE 10-4 CLUB
Chairman: I.S. Buckland,
c/o The Shoulder Of Mutton,
Herdstoft, Nr Pilsley,
Chesterfield, Derbys.
Weds 8pm.

DEVON

BUNKER BREAKERS CLUB
Secretary: Silver G,
100 Babbacombe Road,
Torquay, Devon.
Weds 8pm Courtlands Hotel.

DORSET

CLUB BREAKERWAY
PR: Gramana,
2a Rossmore Road,
Upper Parkstone,
Poole, Dorset BH2 3NH.
Mons 7.30pm Flights Refuelling Sports and
Social Club, Merley Park, Wimborne.

PURBECK ONE-NINE CLUB
Secretary: Daphne Ferne,
134 Northmoor Way,
Wareham, Dorset BH20 4BG.

THREE COUNTIES BREAKERS CLUB
Secretary: Foxy Lady,
48 Fairey Crescent,
Gillingham,
Dorset.

ESSEX

BEECH BREAKERS CLUB
PR: Power Hammer,
123 Willingale Road,
Loughton, Essex.
Suns 7.30pm Blacksmiths Arms, Thornwood
Common, Nr Epping, Essex.

GOLDEN GATE BREAKERS CLUB
Secretary: Tim Naisbett,
c/o The Deva Restaurant,
Cliff Road, Dovercourt,
Harwich, Essex.
Tues Deva Restaurant.

KENT & ESSEX BREAKERS ASSOCIATION
Secretary: Angel,
24 Mill Lane,
West Thurrock,
Grays, Essex.

QUAKER BREAKER CLUB
Secretary: Pinball Queen,
c/o Waggon & Horses,
East Street,
Saffron Walden, Essex.
Weds 8pm Waggon & Horses.

GLOUCESTERSHIRE

DEAN FOREST BREAKERS CB CLUB
PR: A.E. Griffin,
Bream Rugby & Social Club,
High Street, Bream,
Lydney, Glos.
(0594) 56230.

MALVERN BREAKERS ASSOCIATION
PR: CB Bear/The Duke,
PO Box 16,
Malvern WR14 4RR.
Weds 8pm Gandolfi, Hanley Swan, Malvern.

HAMPSHIRE

AIRWAVES BREAKER CLUB BOURNEMOUTH
Secretary: Furcoat,
89 Rochester Road,
West Howe, Kinson,
Bournemouth.
Weds 8pm Bluebirds Social Club Longham.

BANDIT DX CLUB
President: A.G. Turnbull,
27 Bicton Walk,
Warren Park, Havent,
Hants PO9 4NA.
Fris & Suns The Hide PH, Weycock Farm,
Cowplain.

NEW FOREST CB CLUB
Secretary: Sheila Rice,
12 Westcott Road,
Holbury, Hants.
1st Tues each month.

40 CHANNEL BREAKERS
Secretary: Lady Telisman,
c/o 57 Bridgemary Road,
Bridgemary, Gosport,
Hants.
Weds 7.30pm Hoeford Inn.

HEREFORDSHIRE

BOOKTOWN BREAKERS CLUB
Chairman: Green Apple,
83 Wyeside,
Hay-on-Wye, Hereford.
Suns 8.30pm The Granary PH.

WYE VALLEY BREAKERS CLUB
Secretary: Mother Goose,
106a East Street,
Hereford HR1 2LW.
Thurs 8pm Priory Hotel, Stretton Sugwas.

HERTFORDSHIRE

BROWN BOTTLE BREAKERS
PRO: City Boy,
Newsdesk,
c/o 18 Springfield Road,
St Albans, Herts.
Mons Baton PH & The Hall (rear British Legion St
Albans).

HUMBERSIDE

BIG TOP BREAKERS
Secretary Milky Wey,
5 Council Villas,
Helton Ross, Barnetby,
S Humberside.
Fris 8pm St Barnabas Church Hall, Barnetby.

DIXIELAND BREAKERS
Secretary: Silver Bullet,
PO Box 25,
Grimsby, S Humberside.
Alt Mons 'S & S' (S...t and Shovel) S
Killingholme.

GOOLE CB ASSOCIATION
Secretary: Wheels,
c/o Lowther Hotel,
Aire Street, Goole,
N Humberside.

STEELTOWN BREAKERS
Secretary: Suzi O,
c/o 12 Keelby Road,
Scunthorpe,
S Humberside DN17 2ND.
Mons 8pm The King Henry.

KENT

LEMA TANGO SIDEBAND CLUB
PR: Kim Mendoza,
21 Longfield,
Tanterden,
Kent.

MKCBC
Chairman: Wheeler Dealer,
22 The Broadway,
Maidstone, Kent.
Suns 7.30pm Queens Head Hotel, Maidstone.

TUNBRIDGE WELLS CB ASSOCIATION
Secretary: Polar Bear,
PO Box 38,
Tunbridge Wells,
Kent TN2 3DG.
Mons 8pm Robin Hood.

LANCASHIRE (MANCHESTER)

BACK ROAD BREAKERS
President: Rolling Thunder,
c/o Liberal Club,
Garstang,
Nr Preston, Lancs.

LAMBS OF PRESTON
Chairman: G. Hilton,
14 Nurter Road (??),
Preston,
Lancs PR1 8SA.

MONKSVILLE BREAKERS
Secretary: Lady C,
27 Queen Street,
Whalley, Nr Blackburn,
Lancs.
Mons Spring Mill, Langmo.

LINCOLNSHIRE

SUPERCHARGER BREAKERS CLUB
Secretary: Peanuts,
17 Lancaster Drive,
Coningsby, Lincs.
Thurs 7.30pm Coningsby Community Hall.

MERSEYSIDE

ASSOCIATION OF MAGHULL BREAKERS
PR: High Wire,
69 Vetch Hey,
Netherley,
Liverpool.

WIRRAL CB ASSOCIATION
Secretary: T. Seager,
76 Neston Gardens,
Birkenhead,
Merseyside L41 8AZ.

MIDDLESEX

HEART OF OAK BREAKERS CLUB
PR: Scarlet Lady,
c/o Heart Of Oak,
Feltham Road,
Ashford, Middx.
Suns 7.30pm.

NORFOLK

CANARY CITY BREAKERS CLUB
Secretary: John Fuller,
1 Bussey Road,
Norwich NR6 6JE.
First Tues each month Ebenezers Freehouse,
Salhouse Road, Norwich.

MID NORFOLK BREAKERS CLUB
Secretary: Electric Frog,
18 Darwin Walk,
Littlefields, East Dereham,
Norfolk.
Alt Tues Breakers Yard.

WEST NORFOLK BREAKERS CLUB
Chairman: Moonraker,
7 Queen Elizabeth Avenue,
Kings Lynn, Norfolk PE30 4BY.
Alt Fris 8pm Fairstead Community Centre.

NORTHUMBERLAND

CONCRETE CITY BREAKERS
Chairman: White-Line-Willie,
32 Exeter Close,
Cramlington,
Northumberland.

CRAMLINGTON BREAKERS CLUB
Chairman: Mighty Mouse,
c/o Shankhouse Central Social Club,
Clifton Road, Cramlington,
Northumberland.
Alt Fris 7.30pm.

NOTTINGHAMSHIRE

AIRWAVES INTERNATIONAL BREAKERS CLUB
Secretary: Chris McGee,
47 St Albans Road,
Bullwell,
Nottingham NG6 9JQ.
Weds 7.30pm Newstead Abbey PH, St Albans
Rd, Bullwell.

AMBER VALLEY BREAKERS CLUB
PR: Trapper J,
46 Market Place,
Ironville, Notts NG16 5NJ.
Leabrooks 602125 for details.

CARLTON & LANGOLD UNITED BREAKERS
Secretary: Hawker 1,
13 Craigston Road,
Carlton-in-Lindrick,
Nr Worksop, Notts S81 9NG.
Wads Costhorpe Social Club.

NOTTINGHAM INDEPENDENT BREAKERS
Secretary: Bad Hat,
PO Box 64,
Nottingham NG2 4DU.
Thurs 8pm Wilford Moderns Rugby Club.

OXFORDSHIRE

CHILTERN ORGANISED BREAKERS SOCIETY
Chairman: Centipede,
Mon 8pm Chilton Club, Chilton Village, Oxon.

SHROPSHIRE

SEVERN CITY BREAKERS CLUB
PR: Southern Comfort,
PO Box 2,
Shrewsbury.

SOMERSET

CHOPPERTOWN BREAKERS
Chairman: Flying Tiger,
72 Rivers Road,
Yeovil,
Somerset BA12 5RJ.
Alt Suns Liberal Club Yeovil.

Scotland N.Ireland & Overseas

WEST SOMERSET BREAKERS

Chairman: Black Dog,
c/o The Red Lion Hotel,
Minehead, Somerset.
Suns Red Lion.

STAFFORDSHIRE

CENTRAL ENGLAND BREAKERS ASSOCIATION

PR: Medicine Man,
41 Humphries Road, Low Hill,
Wolverhampton, West Midlands.
Tues 8pm Staffordshire Volunteer, Collinswood
Road.

FOUR ACES BREAKERS CLUB

Secretary: Karen Laud,
76 Riverway,
Measham,
Burton-On-Trent, Staffs.
Mons 7.30pm Green Man, Clifton Campville.

SUFFOLK

CONTAINER TOWN BREAKERS CLUB

Chairman: Bobcat,
14 Undercliff Road,
West Felixstowe.

SURREY

KINGSTON GROUP BREAKERS

President: Apollo 13,
45 Portland Road,
Kingston, Surrey.
Mons British Oak, Richmond Road, Kingston-on-
Thames.

NORTH LEAMINGTON CB CLUB

Chairman: Supertramp,
c/o The New Binswood Tavern,
Rugby Road, Milverton,
Leamington Spa.

SKY BLUE CITY ZEN BAND RADIO CLUB

PR: Sandra Witter,
3 Howat Road, Keresley Road,
Coventry CV7 8JN, Warwicks.
Mons 8pm Sky Blue FC Supporters Club,
Highfield Road.

YORKSHIRE

ATTIC BREAKERS CLUB

Chairman: Rally Man,
7 Rickaby Close,
Bridlington,
East Yorks YO16 5BP.
Alt Thurs 8pm 'The Attic'.

BRAMLEY AND DISTRICT BREAKERS CLUB

President: Shantymen,
201 Leeds And Bradford Road,
Bramley, Leeds 13.

CHANTREY BREAKERS CLUB

PR: Mousey,
134 Fraser Road,
Sheffield 8.
Thurs 8pm Big Tree Hotel, Chesterfield Rd.

EARTH QUAKE CITY BREAKERS CLUB

PR: Bonka Lou,
DL 71, Rotheram Record,
Regent House,
Rotherham.

NORTHERN BREAKERS ASSOCIATION

Secretary: Silver Dream,
Low Moor Working Mens Club,
Huddersfield Road,
Low Moor, Bradford.
Fris 8pm.

PUDSEY FM CB RADIO CLUB

President: R. Moneagle,
54 Harley Drive,
Swinnow,
Leeds LS13 4QZ.

SLAB TOWN BREAKERS CLUB

Secretary: Captain Scarlet,
7 Parkwood Avenue,
Beeston, Leeds 11.
Thurs 8pm East & West Ardsley Social Club,
Bradford Road.

STAINCROSS BREAKERS CLUB

Chairman: A. Walmsley,

Staincross Hotel,
Barnsley,
Yorks.

STEEL CITY AIR PIRATES (SCAP)

Secretary: Gas Burner,
95 Crowder Avenue,
Longley, Sheffield S5 7QL.
Tues 7.30pm The Fairfield Inn, Neepsend Lane.

TWIN TOWN BREAKERS HIGH NUMBERS CLUB

Chairman: Red Ranger,
3 Athol Square,
Norton, Malton,
Yorks.

WHITE ROSE BREAKERS

Secretary: Lump Hammer,
14 Lown Hill,
Acomb, Yorks.
Third Thurs 8pm Melbourne Hotel.

SCOTLAND

We have listed new Scottish Clubs in
alphabetical order due to our inability to
comprehend Scottish geography. Anyone wishing
to send us a county map for Scotland, complete
with a comprehensive index, will be suitably
rewarded.

A 78 CB BREAKERS CLUB

Secretary: Melody Maker,
c/o 117 Main Street,
Largs KA30 8JJ.
2nd Weds 7.30pm, local school.

CHINA TOWN BREAKERS

PR: The Vixen,
72 Kirkland Crescent,
Dalry, Ayrshire.
Thurs 8pm Royal Hotel Dalry.

CUCKOOLAND BREAKERS CLUB

Chairman: Lucky Eddie,
PO Box 2,
Penicvik.
Thurs Navaar Hotel.

EDINBURGH BREAKERS CLUB

Secretary: Karen Mowall,
Sinatra's Lounge Bar,
St James Centre,
Edinburgh.
Mons 8pm as above.

FORFAR AND DISTRICT BREAKERS CLUB

Secretary: Star Fighter,
40 Threewells Drive,
Forfar.
Mons 7.30pm Stag Hotel Forfar.

GREATER EASTERHOUSE BREAKERS CLUB

PR: J. Prow,
133 Lochend Road,
Glasgow G34 0LW.

GLASGOW CB CLUB

President: Ian Patterson,
147 Trossachs Road,
Rutherglen,
Glasgow.

JOLLY RODGER CLUB

Secretary: Jim Thompson,
Pitcairn Road,
Cardenden, Fife.
Alt Suns Ambassador Hotel.

MAC DX CLUB OF SCOTLAND

Secretary: The Pathfinder,
PO Box 43,
Inverness.
Tues 8pm The Hayloft.

PEEBLESHIRE CB CLUB

Secretary: Bill Scott,
42 Old Town,
Peebles.

ROCK BREAKERS

Secretary: Red Feathers,
2 Sunderland Avenue,
Castlehill, Dumbarton.
Alt Tues Denny Social Club.

ROCKY MOUNTAIN BREAKERS

PR: Gareth Evans,
36 Coyhill Road,
AIness.

ROYAL T BREAKERS

Secretary: The Saint,
3 Manse Street,

Tain,
Ross-shire.

WEST END BREAKERS

Chairman: Ian Morrison,
The Newbiggin Hotel,
Newbiggin Hall Estate,
Newcastle.
Thurs 7.30pm.

NORTHERN IRELAND

ALIGNED CLUB OF DONERAILE

PRO: Mark Geary,
AC/DC, Creagh House,
Doneraile, Co Cork.

CARLINGFORD LOUTH BREAKERS CLUB

Chairman: P.J. Rodney,
112 Clermont Gardens,
Warrenpoint BT 343 LH,
N. Ireland.

CLEAN AIR ASSC

Secretary: Sid Maguire,
113 Malone Avenue,
Belfast 9 6EQ.

CRAIGAVON CB CLUB

Chairman: Steve Cairns,
Room 101, Country Club,
Craigavon.

EAST ANTRIM CB CLUB

PO Box 4,
Antrim,
Northern Ireland.

HELENS BAY CB RADIO CLUB

Chairman: Gary Jones,
10 School Avenue,
Rathgael Road,
Co Down, N. Ireland.

LAGAN VALLEY CB CLUB

Poste Restante,
GPO, Lisburn,
N. Ireland.

LAZY K RADIO CLUB

PO Box 55,
Portadown,
Northern Ireland.

NORTH SIDE BREAKERS

Chairman: Live Wire,
c/o Lendsdown Court Hotel,
Antrim Road,
Belfast BT 14.

RAINBOW BREAKERS CBRC

Secretary: Harry-O,
PO Box 56, Cookstown,
BT80 8AX, N. Ireland.

SMOKECITY CB CLUB

Secretary: Sid Maguire,
113 Malone Avenue,
Belfast 9 6EQ.

TUNNEL TOWN BREAKERS CLUB

Secretary: J. R. Millen,
PO Box 28, Coleraine,
BT52 1NR, N. Ireland.

OVERSEAS

BREAKER ONE FOUR CLUB

Secretary: O.K. Corral,
Napier Barracks, BFPO 20.

HAMELN CB CLUB

Chairman: The Bodger,
Postfach 277,
3250 Hameln 1,
West Germany.

RHEIN CUPPERS CB CLUB

President: 7-11,
BFPO 40.

SANDCASTLE QSL SWAP CLUB

Ian Shrader,
Box 167, Pacific Beach,
Washington 98571, USA.

SLEEPERS UNITED

Chairman: Neil Allen,
MT Troop, MQ SQN,
3 RTR, BFPO 16.

WALES

Still no room for Welsh CB Clubs —
guaranteed next month.

CB

FM RADIO AND CB RECEIVER

Listen to:

- Air-PB-WB Transmissions
- TV-FM Transmissions
- CB Transmissions (channels 1 to 40)

Controls

- Tuning — Squelch
- Band Selector

Accessories

- Telescopic Antenna. Earphone Jack. DC Adaptor Jack.

SPECIAL OFFER

to Readers of
Citizens' Band
£13.90
plus 50p
post and packing
(quite legal to use)

Trade enquiries
invited



M.G.F. ELECTRONICS
21 FERNLEIGH ROAD
GLASGOW G43 21JD.
Telephone: 041-637 6109

CB

ACCESSORIES

TRADE/WHOLESALE ENQUIRIES WELCOME

B. BAMBER ELECTRONICS
COMMUNICATIONS HOUSE
5 STATION ROAD, LITTLEPORT, CAMBS CB6 1QE
PHONE ELY (0353) 860185

Multitesters 100,000 opv

AC volts - 0 - 5 - 10 - 250 - 1000
 DC volts - 0 - 0.5 - 2.5 - 10 - 50 - 250 - 1000
 DC current - 0 - 10ua - 2.5ua - 500ua - 0 - 5 ma - 50 ma
 - 500 ma - 10 amp
 AC current - 10 amp
 Resistance - 0 - 20 ohms - 200 ohms - 5 K ohms - 200 K ohms - 50 K ohms - 200 K ohms - 5 meg ohms - 50 meg ohms

As a transistor tester:
 HFE - 0 - 5 (NPN) - PNP
 ICD - 0 - 5 ua (NPN - PNP)
 Dims - 1.78 x 140 x 70 mm
 Please add 30p P.P. per unit order as MT 20

Multitester 1,000 opv

AC volts - 0 - 5 - 150 - 500 - 1000
 DC volts - 0 - 15 - 150 - 500 - 1000
 DC current - 0 - 1 ma - 150 ma
 Resistance - 0 - 25 K ohms - 1.00 K ohms
 Dims - 90 x 61 x 30 mm
 Please add 30p P.P. per unit order as MT

Multitester 20,000 opv

AC volts - 0 - 10 - 50 - 100 - 250 - 500 - 1000
 DC volts - 0 - 0.5 - 5 - 25 - 125 - 250 - 500
 1000
 DC current - 0 - 50 ma - 0.5 ma - 250 ma
 Resistance - 0 - 3 K ohms - 300 K ohms - 3 meg ohms
 - 20 to + 63 db
 Dims - 1.27 x 80 x 32 mm
 Please add 30p P.P. per unit order as MT 7

Headphones

High velocity mylar diaphragms. Coiled lead. Finished in a combination of brass/aluminium.

Impedance - 8 ohms
 Frequency response - 15 - 22000 HZ
 Weight - 350 gms

Please add 30p P.P. per unit order as PH 12

ARROW AUDIO CENTRE
20 NORTH BAR BANBURY OXON OX16 0TF.
TELEPHONE BANBURY (0295) 3677
TERMS: CHEQUE/PO WITH ORDER. CALLERS WELCOME

RADIO AND ACCESSORIES

CHANNEL ONE

52" for loft installation to improve reception. Preset for DV 27s and FIRESTICK aeriels.

Special Offer £7.25
inc. Post & Packing

A complete kit (52") with DV 27 aerial is only...
£12.25 inc. Post & Packing

GROUND PLANE KITS

ALSO AVAILABLE £11.75 inc. Post & Packing
 9ft kits - only... FULL RANGE OF CB ACCESSORIES IN STOCK
 ALL TRADE ENQUIRIES WELCOME
 All prices include VAT

17 GOLDEN CROSS PARADE, ROCHFORD, ESSEX

Tel: (0702) 540455

C.B. RADIO ACCESSORIES

**WE OFFER: ALL LEADING MAKES
COMPETITIVE PRICES
QUICK DELIVERY**

OPEN TO THE TRADE ONLY

MON-FRI 9-6

SAT-SUN 10-2

**156/158 BROOKER RD
WALTHAM ABBEY ESSEX**

Telephone: Lea Valley (9) 762472 Telex: 24507

GLOBE

Mercy Sakes! we got us a celebration!

With this brand new range of customised pottery, featuring a CB flash

A. Half Pint Tankard £2.65. With Handle £3.35

B. Pint Tankard £3.25 With Handle £3.95

C. Mug £1.05 With Handle £1.75

D. Small Ashtray £1.10

E. Large Ashtray £3.25

NOTE: Add 50p on each item for Postage & Packing

LET BUDDIES KNOW YOU, WHENEVER YOU DRINK

This super range of pottery manufactured in Devon, is now available with a Red, White and Black, CB flash (PLUS YOUR HANDLE ON THE TANKARDS AND MUG IF REQUIRED) A Pint Tankard, A Half Pint Tankard, A Mug, an Ashtray, and a Super Large Ashtray, all with metallic finished trim, makes a range that will get a big affirmative from YOU!

PUT THE HAMMER DOWN, AND FILL IN THE COUPON, INCLUDING YOUR HANDLE, (if required) AND POST TODAY!

George Williams Partnership, P.O. Box No 7, 1A, Lower Street, Dartmouth, Devon, TQ6 9DF

George Williams Partnership, P.O. Box No. 7, Dartmouth, Devon. TQ6 9DF.

- A Half Pint Tankard £2.65
 With Handle £3.35
- B Pint Tankard £3.25
 With Handle £3.95
- C Mug £1.05
 With Handle £1.75

- D Small Ashtray £1.10
- E Large Ashtray £3.25

Fill in the number of items in the appropriate box
*Note: Add 50p on each item for Postage & Packing

I enclose cheque/postal order for £

or debit my



Barclaycard/Access No

Signature

Address

Name

Handle

Allow 21 days for delivery

ELECTRONIC GAMES

COLOUR CARTRIDGE T.V. GAME



SEMI-PROGRAMMABLE T.V. GAME
+ 4 Cartridges + Mains Adaptor
Normal Price £73
NOW REDUCED TO: **£39.50** inc VAT

DATABASE T.V. GAME



FULLY PROGRAMMABLE CARTRIDGE T.V. GAME
14 Cartridges available
Normal Price £87.86
NOW REDUCED TO: **£59** inc VAT

ATARI T.V. GAME



The most popular T.V. Game on the market with a range of over 40 cartridges including SPACE INVADERS with over 112 games on one cartridge.
Normal Price £95.45
NOW REDUCED TO: **£95** inc VAT

SPACE INVADERS



Hand-held Invaders Games available £19.95
• Invaders Cartridges available to fit ATARI RADOFIN/ACTRONIC/PHILIPS 7000
• Cartridges also available for MATTEL/TELENG/ROWTRON/DATABASE/INTERTON

CHESS COMPUTERS



MANY UNITS ARE COVERED BY THE EXCLUSIVE SILICA SHOP 2 YEAR GUARANTEE

We carry a range of over 15 different Chess computers:
Electronic Chess £29.95
Chess Traveller £39.95
Chess Challenger 7 £79.00
Sensory 8 £119.00
Sensory Voice £269.00
SPECIAL OFFERS:
VOICE CHESS CHALLENGER
Normal Price £245 NOW £135.00
SARGON 2.5, DORIS 2.5
Normal Price £273.70 NOW £199.95
All prices include V.A.T.

TELETEXT



ADD-ON ADAPTOR £199

THE RADOFIN TELETEXT ADD-ON ADAPTOR

Plug the adaptor into the aerial socket of your colour TV and receive the CEEFAX and ORACLE television information services

THIS NEW MODEL INCORPORATES:

- Double height character facility
- True PAL Colour
- Meets latest BBC & IBA broadcast specifications
- Push button channel change
- Unnecessary to remove the unit to watch normal TV programmes
- Gold-plated circuit board for reliability
- New SUPERIMPOSE News Flash facility

SPEAK & SPELL

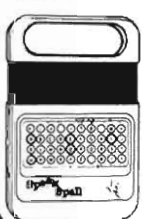

Normal Price £49.95
NOW REDUCED TO:

£39.50 inc VAT

Teach your child to spell properly with this unique learning aid. Fully automatic features and scoring. Additional word modules available to extend the range of words.

ADDING MACHINE OLYMPIA HHP 1010



Normal Price £57.21
NOW REDUCED TO:

£34 inc VAT

Uses ordinary paper
No need to buy expensive thermal paper
Fast adding PRINTER-CALCULATOR 2 lines per second, 10 digit capacity
Uses normal adding machine rolls. Battery or mains operated.
Size 9 1/2" x 4 1/4" x 2 1/2"
*Extra adaptor extra!

24 TUNE ELECTRONIC DOOR BELL



Normal Price £19.70
NOW REDUCED TO:

£12.70 inc VAT

Plays 24 different tunes with separate speed control and volume control. Select the most appropriate tune for your visitor, with appropriate tunes for different times of the year!

MATTEL T.V. GAME

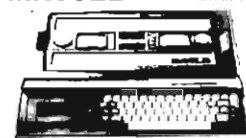

The most advanced TV game in the world 20 cartridges available. Add on KEYBOARD coming £199.95 inc VAT soon to convert the MATTEL to a home computer with 128K RAM. Fully expandable and first available on Microdot Basic. Other accessories will be available later in the year.

HAND HELD GAMES EARTH INVADERS



These invaders are a breed of creature hitherto unknown to man. They cannot be killed by traditional methods — they must be buried. The battle is conducted in a maze where squads of aliens chase home troops. The only way of eliminating them is by digging holes and burying them.

£23.95 inc VAT

HAND HELD GAMES GALAXY 1000

£19.95 inc VAT



The 2nd generation Galaxy Invader. The invaders have re-grouped and have a seemingly endless supply of spacecraft whilst the player's arsenal is limited to just 250 missiles to be launched from 3 missile stations. You have to prevent the invaders landing or from destroying your home defences.

THE OLYMPIA — POST OFFICE APPROVED TELEPHONE ANSWERING MACHINE WITH REMOTE CALL-IN BLEEPER

This telephone answering machine is manufactured by Olympia Business Machines, one of the largest Office Equipment manufacturers in the UK. It is fully POST OFFICE APPROVED and will answer and record messages for 24 hours a day. With your remote call-in bleeper you can receive these messages by telephone wherever you are in the world. The remote call-in bleeper activates the Answer/Record Unit, which will at your command repeat messages, keep or erase them, and is activated from anywhere in the world, or on your return to your home or office. The machine can also be used for message referral, if you have an urgent appointment, but are expecting an important call. Simply record the phone number and location where you can be reached. With optional extra



bleepers (£13 each) this facility can be extended to colleagues and members of the family. Using a C90 standard cassette you can record as many as 45 messages. The announcement can be up to 16 seconds long and the incoming message up to 30 seconds long. The machine is easy to install and comes with full instructions. It is easily wired to your junction box with the spare connections provided or alternatively a jack plug can be provided to plug into a jack socket. Most important, of course, is the fact that it is fully POST OFFICE APPROVED. The price of £135 (inc. VAT) includes the machine, an extra-light remote call-in bleeper, the microphone message tape, a C-90 matrix adaptor. The unit is 9 1/2" x 6" x 2 1/2" and is fully guaranteed for 12 months. The telephone can be placed directly on the unit — no additional desk space is required.

£135 inc VAT

PRESTEL VIEWDATA

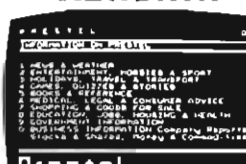

The ACE TELCOM VDX1000 Prestel Viewdata adaptor simply plugs into the aerial socket of your television and enables you to receive the Prestel Viewdata service in colour or black & white.

- Features —
- Simplified controls for quick easy operation
 - Special graphics feature for high resolution
 - State-of-the-art microprocessor controller
 - Standard remote telephone keypad with Prestel keys
 - Auto dialler incorporated for easy Prestel acquisition
 - True PAL colour encoder using reliable IC chipsets later and data line incorporated for minimum picture interference maximum fidelity
 - Includes convenient TV — Prestel switchbox
 - Easily connected to standard home or office telephone lines
 - Fully Post Office approved

SPECIAL PRICE **£228.85** inc VAT

FOR FREE BROCHURES — TEL: 01-301 1111



For free illustrated brochures and reviews on our range of electronic games please telephone 01 301 1111. Free delivery service available. To order by telephone please quote your name, address and ACCESSBARCLAYCARD number, and view the nearest Post Office banking Freecharge Express 48hr delivery service available.

- CALLERS WELCOME — Demonstrations daily in our Sidcup shop open from 9am-5pm Monday-Saturday (Last Closing Thursday 7pm) — Late Opening Friday 8pm
- 2 YEAR GUARANTEE — All goods are covered by a full year guarantee and many are further covered by our exclusive Silica Shop 2 year Guarantee
- MONEY BACK UNDERTAKING — If you are unsatisfied with your purchase and return it within 7 days we will give you a full refund
- AFTER SALES SERVICE — Available on all machines out of guarantee
- COMPETITIVE PRICES — We are never knowingly undercut
- HELPFUL ADVICE — Available on the suitability of each machine
- CREDIT FACILITIES — Full credit facilities available over 12, 24 or 36 months at competitive rates of interest
- PART EXCHANGE SCHEME — available on second hand machines
- CREDIT CARDS WELCOME — Access/Barclaycard/Amex/Club American Express

SILICA SHOP LIMITED C80981
1-4 The Mews, Hatherley Road, Sidcup, Kent DA14 4DX
Telephone: 01-301 1111 or 01-309 1111

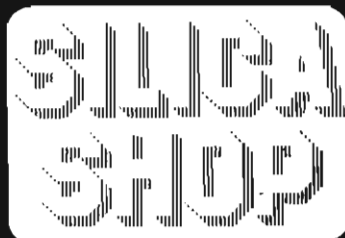

DON'T BE CONNED

EYEBALL OUR PRICES

FOR A GREAT SELECTION AT THE
LOWEST PRICES COME TO
HAMMERSMITH

CB CENTRE

OR SEND FOR MAIL ORDER LIST.
THIS MONTH'S SPECIAL OFFERS:

SLIDE MOUNT	£4.75
SILVER ROD	£22.85
K27 £8.80	K40 £28.95
CAR MIKE	£9.50
SWR METERS	FROM £7.50
DV27	£4.95
POWER SUPPLIES	FROM £13.75

WE WILL BE ONE OF THE FIRST WITH A RANGE OF
THE BEST LEGAL FM RIGS ON THE MARKET
INTERCEPTOR.

- *WE CAN GET YOU STARTED
- *WE CAN KEEP YOU ON THE AIR
- *WE'VE GOT THE TEST GEAR FOR THE SPECIALIST
- *IF YOU ARE IN THE TRADE, WE'VE GOT ALL YOU NEED TO GET SELLING AT THE BEST TRADE PRICES

SO C'MON DOWN TO:
HAMMERSMITH CB CENTRE,
216 KING STREET, TEL: 01-748-6982
HAMMERSMITH, OPEN: 7 DAYS A
LONDON, W.6. WEEK

BUY RIGHT

INTERESTED IN RADIO?

You must be, or you wouldn't be reading this. But do you know about the exciting things you can do if you become a licensed radio amateur? Like talking to people on the other side of the world, exchanging pictures by television, and experimenting on frequency bands up to microwave, or with satellite communications!

It's not as difficult as you might think... want to find out more? Then read Britain's No. 1 magazine for the radio enthusiast.

Practical Wireless

 EVERY MONTH

The South West

Breaker Show 81

The Bristol Exhibition Complex

Canons Marsh, Bristol

AUGUST 28-29-30-31

Adults - £1.50 Children/OAPs - 50p

Organisers:

 **Stevens-West Exhibitions Ltd.**
3 Bridge Street, Godalming Tel: 0473-4460/80

- ★ Trade Stands
- ★ Club Stands
- ★ Films
- ★ Disco
- ★ Competitions

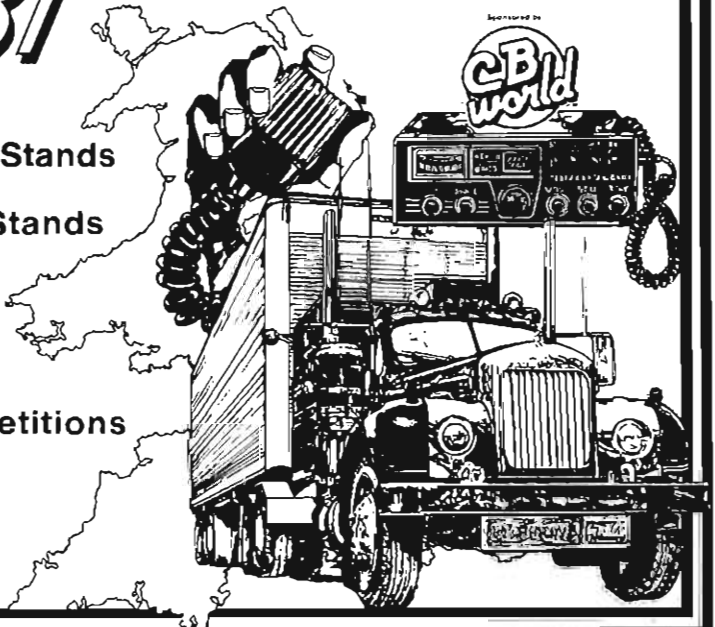

TELECOMMS

We stock
over 1000 items.
Send for our full list.

We have over 1000
sq. ft of showrooms
— well worth a visit.

★ South Coast CB Superstore ★

Same Day Despatch. Our Hotline 0705 662145. Simply ring quoting your Barclaycard/Access number for immediate despatch of items listed

BASE STATION ANTENNAS

Starduster/Skylab 6.2 Dbs	£21.74
Silver Rod 3.8 Dbs	£26.84
GPA 27 Half Wave End Fed 3.2 Dbs	£21.56
City Star De-Luxe Base Antenna	£28.95
Alcomm DPA II VR Very Popular 4 Dbs	£24.95
Avanti Sigma IV highest gain base ant.	£69.95
Avanti PDL II Quad Ant. 12 Dbs	£106.26
3 Element Beam, 8 Dbs	£34.41
Sattelite Dipole 2.2 Dbs gain	£10.26
C.T.E. Boomerang loaded base ant.	£10.78
Phillips ¼ wave base ant. fascia mounting	£25.44

MOBILE ANTENNAS

Avanti 6 ft Moonraker Mag Mnt.	£49.95
Avanti 4 ft Moonraker Mag Mnt.	£26.56
C.T.E. MG27 base loaded mag mnt.	£10.33

We stock the complete range of C.T.E. Avanti, Valor and Sirtel antennas. Ring us for a quote.

LINEARS/PRE-AMPLIFIERS

C.T.E. Mini Tank 50 watt SSB/AM/FM	£25.53
C.T.E. Colibri 60 watt SSB 30W AM	£39.95
C.T.E. Colibri 100 watt SSB 50W AM	£59.69
C.T.E. Jaguar 200 watt SSB mobile	£123.86
C.T.E. Spaedy 140 watt mains amp.	£97.29
C.T.E. Jumbo 600 watt mains amp/pre-amp.	£199.77
C.T.E. Galaxy 1000 watt mains amp/pre-amp.	£363.75
C.T.E. "On Air" pre-amp de-luxe model	£24.61
Zetagi P27/1 pre-amp	£17.18

POWER SUPPLIES

3/5 amp 13.8 volt	£12.24
3/5 amp 13.8 volt De-Luxe	£13.70
5/7 amp 13.8 volt	£19.83
C.T.E. RG1 200 12 amp adjustable	£99.95

INDOOR/LOFT ANTENNAS

C.T.E. GP 127 popular loft ant.	£17.71
C.T.E. Mini Boomerang	£16.68
Ground Plane kit for DV27 loft mnt.	£7.85

SWR METERS

Basic SWR Meter	£8.54
SWR/Power Meter	£12.42
C.T.E. FM1000 SWR/2kw power meter	£28.64

C.T.E. Twin meter SWR/100w power meter	£19.95
Reace RC 1000 SWR/mod/power (3 meter unit)	£57.78
Zetagi SWR/power meter 2kw	£25.09
Zetagi SWR/power meter 2kw twin mtr.	£41.71

ANTENNA ACCESSORIES

Zetagi TM1000 2kw ant matcher/SWR/power	£58.75
Zetagi M27 500wt. matcher	£14.86
Zetagi MM27 100wt matcher	£9.59
Zetagi ant. Splitter FM/MW/CB	£9.32
C.T.E. 2 way ant. switch	£7.25
C.T.E. 3 way ant. switch	£8.86
C.T.E. De-Luxe ant. splitter AM/FM/CB	£6.95
C.T.E. 300Wt ant. matcher	£13.69
C.T.E. Super TVI filter	£10.58
Ferrite rings (per pair)	£1.60
Retractable Mast 6 meter	£20.70
Retractable Mast 9 meter	£31.05
Wall Brackets 12" stand off (pair)	£6.77
Wall Brackets 18" stand off (pair)	£7.90
Double Chimney Lashing Kit	£5.86
Dummy Load 30 watt	£6.80
Dummy Load 5 watt	£1.06

ACCESSORIES

PA Horn 15 watt	£9.23
PA Horn 5 watt	£5.08
Kraco Extension speaker	£5.09
Headphones with boom mic	£12.50
C.T.E. Communications Headphones	£6.79
Slide Mount (sledge)	£4.95
C.T.E. Car Alarm with Pocket Bleeper (range 5 miles)	£85.45
C.T.E. Frequency Counter FD40 5 digit	£88.67
C.T.E. Frequency Counter FD50	£59.27
C.T.E. Frequency Counter FD3000 6 digit	£99.28

POWER MIKES

Ham Master 4500 Base Mic (or equivalent)	£36.95
Ham Master 4200 Base Mic (or equivalent)	£29.00
K40 Power Mic	£27.00
Cobra Power Hand Mic	£16.31
Turner JM + 2V quality hand Power Mic	£27.05
Turner Expander 500 De-Luxe Base Mic	£48.95

Allow £2 post/packing on all small items.
Masts etc. tel. for postage before ordering.

Main Distributors for C.T.E., Zetagi,
Sirtel, Avanti, OCT, Phillips, Bremi

We are seeking specialist trade
outlets. Interested retailers contact
Mike Devereux.

OVER 20 YEARS EXPERIENCE IN THE
COMMUNICATIONS BUSINESS

The Souths Leading Wholesaler!

189 LONDON ROAD, NORTH END
PORTSMOUTH (0705) 662145
TELEX: 86646 VYNER G.



**AT LAST IT'S HERE
WHAT YOU'VE BEEN
WAITING FOR!**

THE WHISKY = MAX!

Ground Stainless Steel tapered 'invisible' whip section top.

Slim line inconspicuous alloy lightweight centre.

Milled alloy block with standard 50239 connector, with protective cover supplied.

Three short ground radials for high performance and easy tuning supplied.

Standard 1" diameter tube fits NCMKI chimney lashing kit or can be used for self supporting ground mounting.

This simple to install, light weight, durable home station or portable antenna goes unnoticed in most locations, gives fantastic results even with low power rigs, when compared with many alternatives. With a coverage from 26-30Mhz and an overall height less than 110 inches. It is just what's needed in today's crowded environment.

Try it, and see! £21.95 inc. VAT + carriage

NCMKI chimney lashing kit.

CCKI Cable kit inc. 30' coaxid. connectors and fixing clips £3.95p + 50p p&p.

STOP TVI BEFORE IT STARTS

LOW PASS FILTER for inline use with transceivers. £5.00
Short coupling lead. £1.70

HIGH PASS FILTER for use in TV antenna lead. Allows only UHF signals to pass through, complete installed in seconds. £5.00

NORTHERN COMMUNICATIONS

AMATEUR * COMMERCIAL * MARINE
299-303 Claremount Road, Halfax. HX36 AW. West Yorkshira.
Open Tues-Sat. 10.00 am - 5.30 pm
24 hr Ansaphone Service. (0422) 40792



**All your C.B. accessories
available NOW in
S.E. London, N.W. Kent
area. Open 7 days a week.**

ORPINGTON 22491

BREAKERS.

Break into a T-Shirt or Sweatshirt professionally screen printed with YOUR club Logo or design. Artwork FREE. Designs originated. Minimum order only 10. Realistic prices. Only best quality English and U.S.A. garments used. Prompt Personal Service. Send coupon for details to:



**Artist:k
designs**

55 Low Road, Stowbridge,
King's Lynn, Norfolk PE34
3PE. Tel. (0553) 810835.

NAME

ADDRESS

CB/9/81

TWO-WAY WALKIE-TALKIE SYSTEM

Transmit or receive spoken and morse code messages.

2 unit set

Only **£13.90**
+ p/p 50p

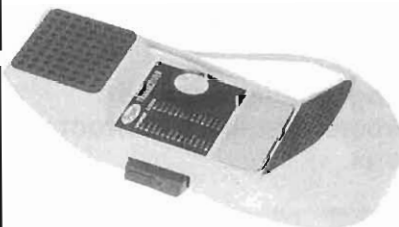

M.G.F. ELECTRONICS
21, Fernleigh Road,
Glasgow G43 2JD
Tel: 041-637 6109.

Note all July orders will be treated in strict rotation after 1.8.81.

Important: Customers should note that these units are not licensable for use in the U.K.

CLASSIFIEDS

RATES

1-3 insertions £5 per scc
4-11 insertions £4.50 per scc
12+ insertions £4 per scc
20p per word (Min. 15 words)
Box No. £1.50 extra

All advertisements in this section must be pre-paid.
Closing Date: 3rd Fri. month preceding publication.

Advertisements are accepted subject to the terms and conditions printed on the advertisement rate card (available on request).

SEND TO CB CLASSIFIED

145 CHARING CROSS ROAD, LONDON WC2H 0EE.

TEL: 01-437 1002 Ext. 50.

PACKER COMMUNICATIONS THE TVI SPECIALISTS

Note: We can make the best low pass filters you can buy — we don't! Unless you have a defective transmitter TVI can be cured only at the receiver.

Our filters are designed in Britain
Manufactured in Britain
for the British system

UL-8 UHF Hi-pass probably the best you can buy £6.85
UL-4 Braid Breaker for FM Stereo £6.15
HF-DIN for hi-fi speaker leads £7.55

Prices include VAT & P&P.

CONISTON
CUMBRIA
LA21 8HQ

SAE details
09664-678 or 0229-89448.

CB RADIO CONVERSIONS

Set extra channels from most CBs with just a resistor using our P.L.L. Chip Data. Also crystal changing information and much more. Send £1 for details:

J. McMahan, Selectronics Inc, P.O. Box 5, Ennis, Co. Clare, Ireland.

SELECTRONICS — TECHNICAL SERVICES TO THE HOME HOBBY AND INDUSTRY.

CALLING ALL CLUBS — Stickers, Patch Badges, Posters, Pens, QSL Cards, Key Fobs, Pennants and much, much more. Supplied to your design. Royal Wedding year QSL cards in stock — 6 for £1.00 plus 20p P&P. Raymac Display, National Works, Bath Road, Hounslow, Middx. Tel: 01-570 9116.

HANDLE KEYRINGS "Bring it on back" to — your handle black or red 90p or 1.60p for two. 100 page log book and pen £1.80. JRs CB Stationary, 46B Bath Street, Ilkeston, DE7 8FD.

CLOSE ENCOUNTERS GROUP Personal introductions/dances, parties, talks, social events. Meet interesting attractive people. All Areas. Tel: 01-278 0203, 051 931 2844.

ANTI-T.V.I. C.B. base station aerials, half wave dipoles £30 complete. Leaflet SAE, Anti-T.V.I. guide £1. G2DYM Aerials, Beerdown, Uplowman, Tiverton, Devon.

EYEBALL BADGE. Super classy pin-on badge with your handle printed in gold. Approx 3" x 3/4". P.V.C. 85p each, 5 for £3.75. Send cheque or P.O with SAE to The Name Machine, 5 Foregate, Highgate Park, Fulwood, Preston, Lancs PR2 4LA.

CRYSTALS

27 & 35 MHz. Large stocks from £1.65 (pp 40p). Send SAE for list of frequencies & CB accessories. TELERADIO, 325 Fore Street, London N9 0PE. Tel. 807 3719.

BARGAIN TIME at Guildford CB. 40 channel rig kits £55, 320 channel President Madisons £195, 100W burner £69, DV27 £5.75, Bremi 200W SSB mains burner £85, SWR meter £6.90. Hundreds of ICs enormous stocks. SAE for list 0483 77550.

FREE! £5 worth of CB gifts! Special Offer on this months CB brochures! radio's, antennas, microphones, base stations etc! send 14p stamp to Falcon CBR, 12 Newington Green Road, London N1.

WANTED

Companies who are selling to CB shops to sell our exciting new products. Well connected agents may also apply.
**Ring Roger More at Dimex
021-704-3551**

QSL CARDS — choose from our novel selection £3.40 per 100. Send S.A.E. for illustrated list. Sandhurst Publications, 49C Yorktown Rd, Sandhurst, Camberley, Surrey.

CB PROTECTION. Microchip controlled vehicle alarm. Monitors for unauthorised entry. Easy to fit, complete with cable, keyswitch + 2 security keys. £12.50 post free. CB/1 51. Baron Court, Stevenage, Herts SG1 4RS.

HAVE YOU SEEN THE GREEN LIST? 1000s of components (CB, Radio & Electronic). Aerials, Plugs, SWR Meters & Accessories at unbelievably low prices. Something for everyone. Send 30p for list & receive free CB gift. Mail Order Only. Myers, (Dept CB), 14-16, Clifton Grove, Harehills, Leeds 9.

C.B. LOG BOOK

Record All Your Copies
An Important C.B. Accessory
For D.Xer's and A.M. users
Only 75p per book or much less for 10 books only £4.95p.
VAT and P.&P. Incl. for U.K.
Send Cheque or Postal Order to:
**Roy Sarver Limited,
44, Rickards Street,
Pontypridd, Mid Glamorgan
CF37 1RE**

RIG SPARES. C495 60p, C1306 90p, C1307 £2.15, C1923 25p, C1957 50p, D471 40p, 1S34 6p, 1S953 6p, 1SV50 £1.00, TA7205 £1.80, TA7310 £1.80, CRYSTAL 10.24 MHz £3.00; Plus 30p postage. BITZ, P.O. Box 64, Nottingham.

"GET YOUR EARS ON!"

CB and Trucking records and tapes extensive range.

Send SAE for list to:
**CB and Trucking Sound
10 Market Place,
Hatfield,
Hertfordshire.**

COMPONENTS ICs, CRYSTALS, FM BOARDS

Large selection, low prices, speedy postal service.
Guildford CB
0483-77550.

EYEBALL MARKET

At the Giant Annual
Vintage Air Display.
Crowds of over 70,000
at the
Essex Show Ground
on
August 30th/31st
For site space telephone:
0279 813237.

FAST

**BLOWN YOUR RIG?
REPAIRS AND FITTING
AND YOUR 20.**
01-467 4879

HERE ARE THE I/C NOS. YOU HAVE BEEN WAITING FOR

TA 7206P £2.35 each.
MB 3712 £2.35 each.
TA 7310P £2.30
TA 7222 £2.85
LA 3350 £2.35
Ex-stock same day delivery. All fully tested and
new. Terms: Cash with order plus p&p 50p.
We shall soon be stocking power transistors.
Please let us know your requirements.
Write for quantity discounts of 10 up pieces per
line item.
2SC2078 equiv to 2SC1306 £2.80
LC7120 £5.90
LC7130 £6.60
LC7131 £5.70

The above 4 nos. available 3 weeks, all other items
delivery by return.

**R. Guess Electronics,
13 Crabtree Hse, Archery Rd,
St Leonards-on-Sea, East Sussex
TN38 0YN.**

SEND YOUR COUNTRY FLAG with
your next QSL card — Irish Tri-Colour
or Union Jack — 1 1/2" x 1" on stick. 50
flags — £2.80 inc P&P. For immediate
despatch. Send cheque/PO to Wilcur
Enterprises, 35 Woodview, Pinecroft,
Douglas, Cork, Ireland.

A GREAT IDEA FOR BREAKERS

C.B. RIG SIGNS

FOR INSTANT MODULAYSHUN

Imagine your Handle on a sign 24" x 6"
Made from white wipe clean abs plastic.
Type A. Interior rig signs suitable for rear, side & front
windows (supplied with adhesive pads) . **£Only £2.99 each**
Type B. Exterior rig signs suitable for doors, panels, boots &
bonnets (heat sealed magnetic tape) **Only £4.99 each**
Whatever your choice, be proud of your Handle.
Order your rig signs by sending a P/O together with your
Handle written in block capitals to:
**Consul, 135 Cherrywood Gardens, Porchester Road,
Nottingham.**
No hidden extras. All prices include P&P to the UK. Allow
21 days for delivery.

HANDLE TAGS

Your handle hand-cut in real
cowhide. Use as key ring or hang it
anywhere!

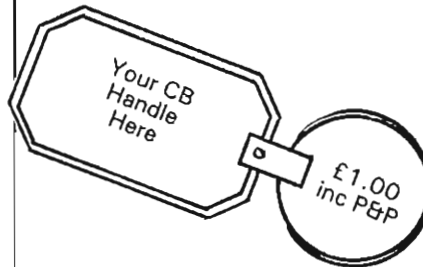

State handle and colour choice:
Tan, Dk Brown, Red, Blue &
Green. Terms: Money with order.
Orders despatched by return post.

**Pete Kelly
Craft Market,
Church Lane,
Barnstaple,
N. Devon.**

GUILDFORD CB

Excellent stocks of all your CB needs. Lowest
prices, rig kits 200 watt S.S.B. amplifiers from £69.
S.W.R. meters £6.90.
SAE for list.
Trade enquiries welcome.
0483-77650.

**HANDLECARDS 1000 £7.20 Q.S.L.
CARDS 5000 £38.** (S.A.E. samples).
C.B.Print, 89 Derwent Street, Con-
sett, DH8 8LT.

SILVER ROD £19.95
1/4 WAVE BASE DIPOLE £10.50
and lots more goodies:
AVANTI, HIGH GAIN, TURNER rigs.
We have been in the twig business for 24 years
AAC LTD., 132 Harmon Hill, E18.
01-630 8118.

AD INDEX

Acorn Trading	2
Allweld Engineering	40
Arrow Audio Centre	51
Artistik Designs	56
B. Bamber Electronics	51
Binatone International	17, 19 & 21
Brew Brothers Ltd	21
CB Centre	37
CB City	34
CBRC Ltd	5
The CB Scene	56
Central Broadcasting Supplies	27
Channel One	51
Chelmer CB Accessories	36
Chestnut Records	42
Connexions	10
CTE International	59
The George Williams Partnership	62
Globe Communications	52
Hammersmith CB Centre	54
Holland Promotions	42
International Breakers Warehouse	36
Kernow Audio & Sound	40
Knight CB Specialists	4
Kona Publications	60
Mayfair CB Centre	34
M.G.F. Electronics	51 & 56
Northern Communications	21 & 56
OCT	22 & 23
Pan International	17
Practical Wireless	54
Shakespeare	45
Shellpost Ltd	8
Silica Shop	53
Stevens-West Exhibitions	54
Telecomms	55

ANGLIA COMPONENTS

**BURDETT ROAD, WISBECH
CAMBS PE13 2PS
TEL: 0945 63281
TELEX: 32630**

**PLEASE MENTION
CB WHEN
REPLYING TO
ADVERTISERS**



Sole UK Distributor:

DIGITEK

UNIT 3, MITCHAM INDUSTRIAL ESTATE
85 STREATHAM ROAD, MITCHAM, SURREY CR4 2AP
Telephone: 01-640 6910. Telex: 945414 FORMAN

C.T.E. INTERNATIONAL s.r.l.
MANUFACTURERS OF HIGH QUALITY CB ACCESSORIES IN EUROPE FOR OVER 10 YEARS

QUALITY AT THE RIGHT PRICE

We apologise to all Citizens' Band readers that we are unable to exhibit at their National Citizens' Band Show at the Royal Horticultural Halls, Victoria, London on the 11th, 12th, 13th September. However we are exhibiting at:

**THE GREAT
EUROPEAN
PARADE**



**milan fair
september 3.7
1981**

Anyone attending this fair will be welcome on the CTE stand for coffee, wine, cheese, etc.

Our catalogue includes:

LINEAR AMPLIFIERS

Galaxi 1000
Jumbo 600
Speedy 140
Jaguar 200
Colibri 100
Colibri 60
Mini Tank 50
Mosquito 50

STABILISED POWER SUPPLY

AL2000 2a
RG340 3/4a
AL5000 5a
RG620 2a
AL3000 3a
AL6000 5a
RG1000 10a
RG1200 12a

ACCESSORIES

27-375
27-380
27-422
27-112
27-113
27-116
27-143

SLIDE MOUNT

FU-400
12-175
12-185

ANTENNAS COMPLETELY PREPARED FOR IMMEDIATE USE

AP27
Sirio 27
Mini Boomerang
Boomerang

BASE STATION ANTENNAS

Gp127
GP270
GP272
GP278
Skylab
Big-Star
Spit-Fire
Cubical 2

MOBILE ANTENNAS AND ACCESSORIES

Fox 27
MG27
Gutter Mount
Roof Connection

WATT METERS — SWR METERS — FREQUENCY

RANGE METERS
27-7000
27-120
27-110
27-230
27-1000
FD 40



FD 50
FD 3000
FD 1000

SPECIAL MOBILE ANTENNAS BASE ATTACHMENT FOR 5 ARIEL

Base Combi
Stem Alfa 27
Stem Eco 27
Stem Golf 27
Stem Delta 27
Stem Tango 27

UNIVERSAL ANTENNAS FOR
BOATS AND CARAVANS
Marina 27
Squalo 27

New items now available Alcom Cordless Telephone



**Digitek Cordless 3000 Telephone
AP500 Car Alert/CB Pager
RD77 Radar Detector**

**WE STILL HAVE OPENINGS IN VARIOUS PARTS OF
THE COUNTRY FOR WHOLESALE AND RETAIL
DEALERSHIPS.**

**IT'S
HERE**

From the people who brought you
'The Big Dummy's Guide'...

THE BRITISH CB BOOK

Beginner or expert, you cannot afford to
ignore it!

- * **Equipment & Installation**
- * **British slang including towns and cities**
- * **AM v FM - the argument**
- * **How the Home Office got it wrong**
- * **Sideband and DXing**
- * **Complete FM specs**
- * **The law and you**
- * **Home Office 900 Mhz tests**

**AND LOTS
MORE** complete with
cartoons, pictures and diagrams

NOW AVAILABLE FROM:

KONA PUBLICATIONS
335 City Road
London EC1V 1LJ
Tel: (01) 278 6914

LCL IMPORTS LTD
101 Dixons Green
Dudley, West Midlands
Tel: (0384) 59185

£2.95

