

CB

Citizens' Band

Britain's Leading Communications Magazine

99p

BEGINNERS START HERE

Everything you were
afraid to ask...

ON TEST:

Italian 'Export' Antenna

ACCESSORY ROUNDUP

Pick of the gadgets



PLUS

Unique buyers' listings

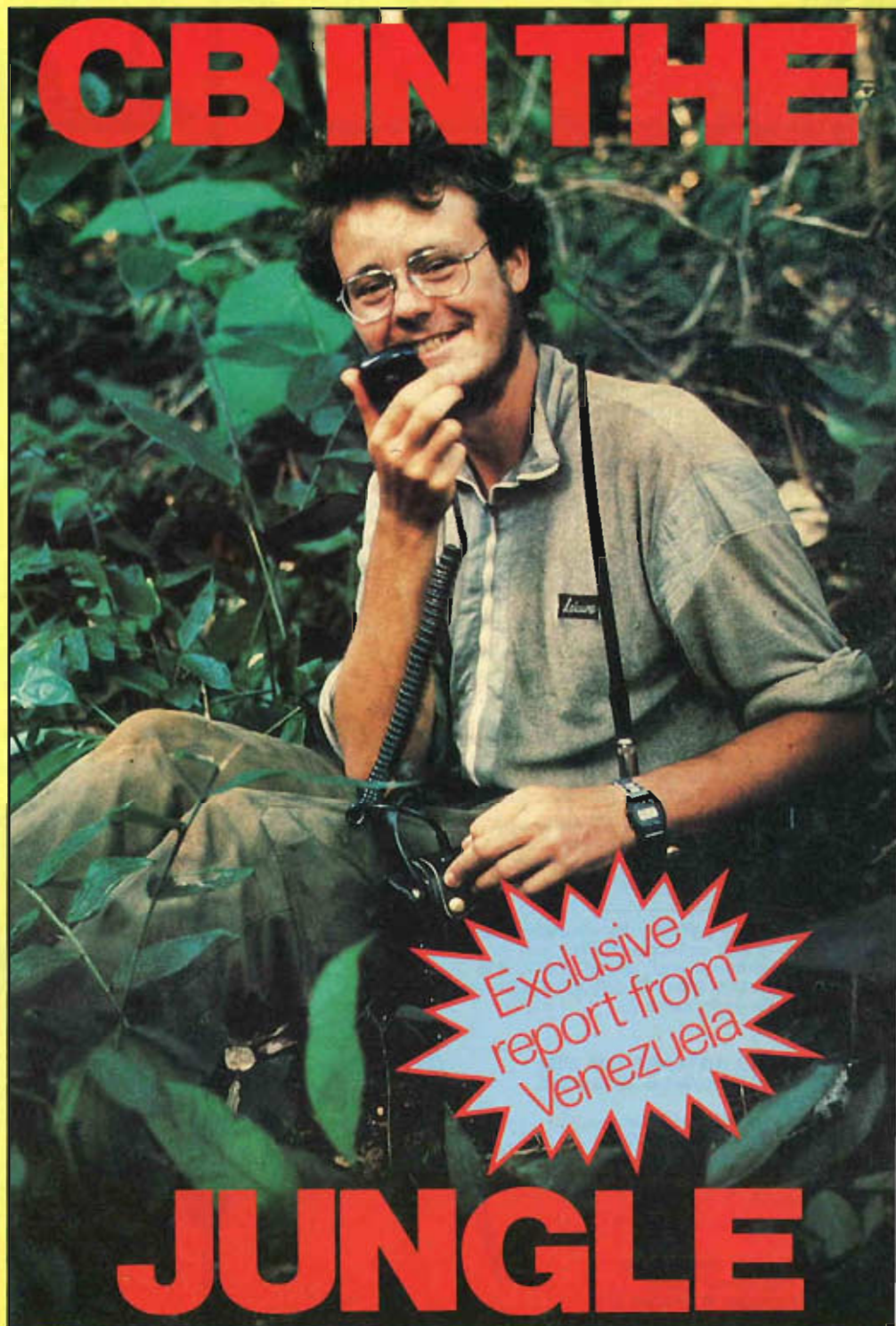

Exclusive
report from
Venezuela

JUNGLE

THUNDERPOLE III

- The Thunderpole III™ from the UK market leader of the fastest-selling high-performance legal base station antenna.
- New centre-loaded, helically wound coil with low radiation angle — shrink-wrapped for all-weather protection.
- The amazing extra performance you expect from the world-famous Thunderpole range.
- "Citizens' Band's" own tests indicate that the new Thunderpole III is one full S-point better than the original Thunderpole. (Technical note: This can give you 6db or the power equivalent of running 16W into a 1/4 wave antenna).
- Beefy, bigger diameter radiating element 1.65m long, making the most of the new H.O. Specifications.
- Precision-machined alloy base with 3 angled ground planes, each 2.67m long, cross-braced and incorporating new, extra-strength, insulated nylon supports.
- Big power 500W — Wide frequency band covering 120 channels — Low SWR.
- Suitable for all modes — AM, FM, SSB.
- Pole mounting base to fit 1 1/4 in. dia.
- Price just

£25 incl. V.A.T.

- Special kits to convert your Thunderpoles I and II into the latest Mk.III with new centre-loaded coil available.

THUNDERPOLE STRIKES AGAIN! "Citizens' Band" magazine on the fantastic Thunderpole range:

"A well constructed, easily assembled and erected, excellent performance legal antenna with the added bonus that it is pre-tuned. The Thunderpole was the best all-round base station antenna tested, looking and performing almost the same as the famous illegal Starduster." (on: the original Thunderpole).

"On test the Thunderpole Mk.III performed very well and contact was maintained even when the mobile test vehicle encountered a strong signal on the next channel in our notorious blackspot."

"In conclusion we consider the Thunderpole III to be a strong and well-constructed, top performance antenna and, priced at £25, it is no more expensive than the original Thunderpole, which must be good value."

THUNDERPOLE ANTENNA U.K. LTD.
a subsidiary of Freeman & Pardoe Ltd.
Tything Road,
Arden Forest Industrial Estate,
ALCESTER, Warks. B49 6ES.

Phone: Alcester (0789) 762 673.

Ask for Thunderpole III™
at your local CB stockist now.

The Thunderpole design and
name are registered trade
marks of Freeman & Pardoe Ltd.
© Freeman & Pardoe 1984

WITH
HELICALLY
WOUND
CENTRE-
LOADED
COIL

The III-
One Step Ahead of
the Rest!

"HI BREAKERS!
Why don't you jump the skip
and make the trip with the centre-
loaded, helically wound
THUNDERPOLE III"

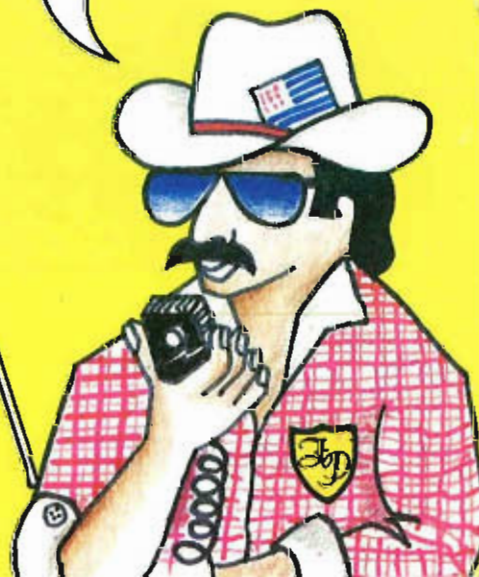

CB Citizens' Band



Inside this month

Brian Wright takes a look at some special accessories on the market, designed to enhance the performance of your set up.

Editor..... Eamonn Percival
Group Editor..... Sue Sharp
Ad Manager..... George Kynicos
Designer..... Jeff Hamblin
Publisher..... Ray Lewis
Publishing Director.... John Foster
Chairman..... Jim Connell

Normally published on the third Friday of the month preceding cover date.

Citizens' Band Magazine A.S.P. Ltd., 1, Golden Square, London W1R 3AB. Telephone 01-437 0626. Typesetting and origination by Characters (Reading) Ltd., Reading, Berkshire. Printed by Simpson Drewett and Co. Ltd., 70 Sheen Road, Richmond Surrey. Distribution by Argus Press Sales and Distribution Ltd., 12-18 Paul Street, London EC2A 4JS.

The contents of this publication including all articles, designs, plans, drawings and programs and all copyright and other intellectual property rights therein belong to Argus Specialist Publications Limited. All rights conferred by the Law of Copyright and other intellectual property rights and by virtue of international copyright conventions are specifically reserved to Argus Specialist Publications Limited and any reproduction requires the prior written consent of the Company. ©1985 Argus Specialist Publications Limited.

Contents

MAY 1985

VOLUME 5 NUMBER 6

Update	6
This and that	
Back Chat	8
Points of view	
Q & A	10
Alec gets smart	
Understanding PLL Synthesizers	26
Frequency generation explained	
CB in the Jungle	30
A Venezuelan adventure	
Antenna Review	34
The Lemm Export examined	
QSL	23
More card games	
Beginners' Q & A	32
What's a CB?	
Truckstop	17
Gismo the abominable snowman	
Lady Breakers	21
Filly gets sentimental	
Mack Chat	15
Mack gets mobbed	
Accessories Roundup	18
A look at some special "extras"	
Twong	37
Oh no, not again	
Readers Services	42
Back numbers, subscriptions etc	
Reference Section	43
Quick look-up buyers' guide	

Prices quoted are those prevailing at press dates and are subject to alteration due to economic conditions. You are advised to telephone prior to ordering or sending money.



TELECOMMS

SAME DAY DESPATCH

(SUBJECT TO AVAILABILITY)

NEVADA 934 MHz PERSONAL (CB) RADIO



NEVADA 934 MHz SWR/POWER METER

Power:
10w Full Scale
50w Full Scale.

£89.95



NEVADA HRA-900 934 MHz MAST HEAD PRE-AMPLIFIER

An extremely low noise high quality pre-amp that mounts at the top of your mast. Gain 15 dB. Noise figure 0.8 dB max. This unit will double the received range on many sets.

£159.95



CYBERNET BETA 3000 PROFESSIONAL

The most comprehensive 27 MHz Rig available in the UK.
* Selcall * Up/down key on mic * Ch 14 key on mic * Ch 9 key on mic * Roger bleep * Auto scan for busy channel
* Auto scan for free channel
* Skip/Lockout facilities on scan
* Ch 9 priority
A truly professional unit.

£169

KAISER CBX 40

40 Channel Hi-Spec hand held. This is the Rolls Royce of hand helds with crystal filters fitted as standard, and rugged construction uses handy rubber duck antenna.

£98



SKYLAB BASE ANTENNA

High performance base antenna with a full 1/4 wave radiator handles up to 1 kw of power with a terrific 7 dB's of gain. Provides optimum sensitivity on receive. Our special price

£24.95 inc p&p.

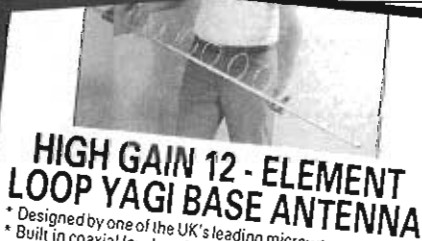

HIGH GAIN 12 - ELEMENT LOOP YAGI BASE ANTENNA

* Designed by one of the UK's leading microwave engineers.
* Built in coaxial low loss feeder system. To 'N' socket.

SPECIFICATIONS:

Gain: 18 dBi Front - Back: -25dB
Weight: 0.7Kg Overall length: 53.5"
No wiring necessary. (Patent pending)

£49
Plus £5 p & p



CYBERNET DELTA 1 934 MHz TRANSCEIVER

NOW AVAILABLE FOR IMMEDIATE DESPATCH!

- * Highly Sensitive RX
- * Auto Scan
- * 16 ch. memory

£355

+ £5 SPECIAL DELIVERY

H.P. AVAILABLE
(Subject to status)
Just £35 deposit. Ring for details.
(A.P.R. 36.8%)

NEVADA 934 MHz HIGH QUALITY ANTENNAS

PA7 - E BASE ANTENNA

7.14 dbi omni stacked 5/8 wave

£66 incl p & p

P7M - E

Quality Mobile Mag mount (7.14 dbi)

£44 incl p & p

P7R - E

Quality Mobile gutter mount (7.14 dbi)

£44 incl p & p

934 MHz ENTHUSIASTS CATALOGUE

Send in £1 for our special 934 MHz catalogue, and receive a £2 Telecomms voucher. Contains technical info + full details of our product range.

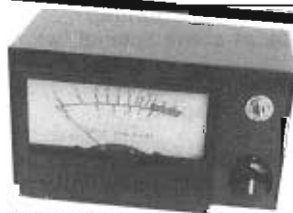

EXTENSION 'S' METER FOR CYBERNET DELTA 1

This meter is a 'must' for any 934 MHz enthusiast - just plugs straight into the back of the Delta 1 or can be used on any rig of your choice.

£17.75



RADIO TECHNIC NEW M40 FM TRANSCEIVER

We can honestly say that this is the highest performance rig that we have tested under £100. Not to be confused with the DNT this set has been individually supervised and tested in the UK. Each set has fitted a special crystal filter and new J fel Bi-polar mixing transistor to cut cross modulation ("Bleed over") and minimise blocking.

£59.95



SAME DAY DESPATCH

HOTLINE (0705) 662145

TELEX: 869107 TELCOM G

THE U.K.'S LEADING C.B. DISTRIBUTOR

ALL ITEMS ARE AVAILABLE FROM OUR AUTHORISED DEALERS THROUGHOUT THE U.K. - OR DIRECT

ZETAGITM 1000
A combined matcher, SWR & power meter, antenna switch rated up to 1000 watts.
£49.99



PULSAR 27 MINI BEAM
A compact Beam that will even fit in the loft. Gives approx 3 dB gain. This unique design will reduce 'bleed over' from close stations, with side rejection in excess of 20dB.
£39.95



TURNER JM + 2U
This is the CB power mike that has been used more than any other on the market. The mike delivers extra punch that ensures maximum range.
£26.95



ZETAGI 1220S 25 Amp
Variable Voltage Power Supply
£119



TURNER EXPANDER 500 BASE MIC
After a long absence we now have this superb base microphone back in stock.
£59.95



SADELTA ECHO MASTER BASE MICROPHONE
This is the top of the Sadelta range - with a mellow powerful echo that will make your rig sound like a million dollars. For one month only we will give you the chance to buy this superb microphone at this reduced price. Hurry before we sell out!
£49.95



ZETAGI 202 SWR/POWER METER
Unique cross pointer high accuracy meter. Reads power from 1 to 1000 watts.
£29.76



ZETAGI B150 POWER AMPLIFIER
70 - 100 watt amplifier
FREQ: 26-30 Mhz
POWER: 70 - 100 W AM/FM
140 - 180 W SSB.
£46



DEALERS JOIN THE WINNING TEAM
- we are Sole UK distributors for Zetagi, Sadelta, CTE, Tarren, Cybernet, Nevada, Zenith. Contact Bob Devereux or Phil Jefferies in our UK Trade Sales office NOW!

NAVADA TC35 25 WATT RF AMPLIFIER
High quality 25 watt power amplifier
£19.95



ZENITH SPEECH PROCESSOR P202
NEW MK 11 VERSION
The new improved Mk 11 version built in the UK will boost your 'Talk Power' out of all recognition. Increase your range, and improve the clarity of your speech. Used with your existing microphone, it can be operated as a power microphone, speech processor, or simply switched out all of the rig with which you wish to use it, so that we may send it ready-wired for your transceiver.
£34.95



NEW MARINE ANTENNAS
FROM CTE INTERNATIONAL
Two outstanding marine antennas constructed from fibreglass and toughened nylon. Freq. 26-30 Mhz. Power 50 Watts. Length 1-6 Metres.
AZZURA 27 £26.50 **AZZURA 40 £31.95**
inc p&p.



NEVADA TC27 RX PRE-AMP
British made high quality pre-amplifier
• Adjustable Gain - 6 to + 18 Dbs
• Unique TX Power Feature
• Fully Guaranteed
£19.95



CTE INTERNATIONAL CUBICAL 2
2 element Hi-gain quad beam. This superb 2 element beam has a genuine 9 dB gain with a massive 28 dB front to back ratio. Undoubtedly the best 2 element beam on the market. Power 2kw. Freq. 26.5 - 28 Mhz.
£59.95
PLUS £5.50 CARRIAGE (U.K. MAINLAND)

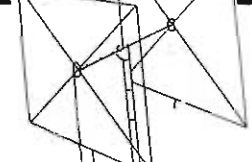

A.K.D. PRECISION DIRECTOR FINDER
Designed specifically for pin-pointing close-range signals and interference. It incorporates S-Meter and Audio Monitor (earphone supplied) and a variable RF Gain.
So long wallies!
£29.95



THE NEW 1985 CATALOGUES

Dear Breaker,
You will be pleased to know that our NEW 1985 27MHz CB catalogue is now available. This year it's even bigger and better than before - packed full of pictures and technical information and a must for any CB radio enthusiast. Why not send off £1 for your copy today and in addition receive a £2 Telecomms voucher?

Thousands of breakers have already discovered how surprisingly easy it is to shop with our Mail Order Service. Our Hotline team Helen, Shirley and John must hold the record for the fastest despatch in the country - one customer in Lancashire received his order within 12 hours of telephoning them!

We've become the biggest by being the best - so why not write to us today and get on the Telecomms Wavelength too?

Yours sincerely
Mike Devereux
Mike Devereux
MANAGING DIRECTOR



USE YOUR CREDIT CARD FOR IMMEDIATE DESPATCH

TELECOMMS, 189 LONDON ROAD, PORTSMOUTH, HANTS PO2 9AE





UPDATE

**NEWS
FROM
THE
WORLD
OF
CB**

**NEWS
FROM
THE
WORLD
OF
CB**

**NEWS
FROM
THE
WORLD**

Editorial

As summer approaches, we are now settled into our new offices in the heart of the West End although, personally, I'm still not quite used to dicing with death each morning as I cross busy roads, which seem to be full of crazed cab drivers seemingly intent on mowing down as many pedestrians as possible. And you thought hedgehogs had it rough!

Well, there's lots to get through in this issue. We continue with Lou Franklin's explanation of PLL synthesizers, Keith Townsend answers some of the more basic questions that newcomers to CB might perhaps be afraid to ask, and Brian Wright puts in for overtime and checks out some of the accessories available. All this in addition, to how CB can be a boon in the Venezuelan jungle plus lots of regular features.

Well, our recent AKD competition was certainly a success. Our mailbag's full and the postman wants compensation for a strained back. Seriously, though, it

was quite illuminating reading through the hundreds of entries. As a tie-breaker, we asked what piece of legislation you would put through Parliament if you could. Lots of you wanted to introduce exams to obtain a licence, more of you wanted inbuilt ID codes on transmission, and even more of you suggested that licences should be produced before rigs could be purchased.

One of the competition questions seemed to puzzle a few. We asked what R.R.D. stands for and, while the majority of the answers was correct — Radio Regulatory Division — some of the wrong answers were amusing: "Roger Rig Doctor", "Radio Radial Direction", "Rare Radio Demonstration", the cryptic sounding "Range Radio Dimension". One entrant wrote "Never heard of it — is it a misprint?!" Anyway, the winners have been notified and their prizes are in the post.

Eamonn Percival

Aces Come Up Trumps

A group of South Derbyshire breakers recently managed to raise £480 for hospital equipment which could prevent cot deaths.

Members of Church Gresley Four Aces CB Club presented the cheque to Burton General Hospital to buy machines which monitor breathing. Henry Hodgkinson (Gaffer) shaved off his much-loved beard and raised £69, while Brenda Measures (Double Top) organised a raffle which raised £85. The rest of the money came from individual donations.

The Four Aces Club's didn't stop there. At the time of going to press, they were organising a sponsored 24-hour modulation and a three-hour darts match. Our thanks to Red Robin, who told us about it.

Mass Charity Eyeball

A mass charity eyeball and gala is to be held on Sunday 23rd June at Graves Park, Sheffield, in aid of various charities supported by each club participating. Any clubs interested in putting up displays or stalls will be welcome to attend the event which will include majorettes displays, games, live music and dancing, a Miss CB competition, sideshows and trade stalls. Further details can be obtained by writing to the Secretary, Graves Park Eyeball, PO Box 244, Sheffield.

CB Aid in Big Freeze

The Bournemouth Evening Echo recently carried a story about how breakers and radio amateurs provided an "invaluable back-up service" for the county's road engineers during the winter freeze-up.

County Emergency Planning Officer Ken Floyd said: "Throughout the snow emergency, they were providing a constant flow of minute-to-minute information on the state of the roads. Drivers with CB radios were our eyes and ears all over the county."

CB radio clubs and radio amateurs had been co-operating in joint training with the county council's emergency planning section for any widespread emergency and when the bad weather arrived, it gave

them a chance to try out the effectiveness of their plans.

RAYNET — the Radio Amateurs Emergency Network — were at the same time providing a point-to-point radio network.

"We have a CB set at the county emergency centre in County Hall", said Mr Floyd, "and in an adjacent room is the radio system used by the county surveyor's department to co-ordinate snowplough and road-clearing operations."

"Through our CB set, we were able to pass on up-to-date information to drivers on the road and receive back information from them using the appropriate contact channel. This two-way flow of information proved invaluable."



Modern-day Knight

Things certainly ain't what they used to be. Cromwell never thought he'd see the day when a Knight had to use a walkie-talkie to go into battle.

Obviously, this chap from the Sealed Knot

Society found he could direct operations better by communicating with his front line Roundheads as they re-enacted the siege of Flint in North Wales.

Photo: Chris Birchall.

Grey Beard's Gleanings

Hello again, My thanks to all of you who have written and/or sent me QSLs. Unfortunately, I am unable to guarantee a reply if you haven't enclosed a Self Addressed Stamped Envelope (SASE); sorry.

Amongst the many items of news that arrived here lately, is the news that Sandpiper of the Tulloch Breakers DX Club, is very successfully putting new CBers on the air in the Perth area. Not content with this, the Tulloch club are holding an Easter Eyeball and dance on 30th March. The Club is hoping to raise some £700 in order to purchase equipment for the

handicapped children at Tulloch School. Good luck in your efforts, Sandpiper. For further details write to: Sandpiper, PO Box 30, Perth, Scotland.

Many of you will belong to CB clubs that are actively involved in fund-raising activities, so if you let us know in plenty of time we will attempt to give you some publicity.

Now for a sadder tale. A disabled CBER wrote to tell me that he couldn't locate a supplier of the centre-loaded antenna designed to fit onto his Kaiser 40ch FM hand-held, despite the fact that this antenna is featured in lots of advertisements. I have seen. No one appears to have heard of it. That is, unless you know better?

Stolen Goods

If anyone is offered any of the following amateur radio equipment, think twice — it didn't "fall off the back of a lorry". A Yaesu FT708R transceiver, a kit-built 70cm linear amplifier, an Oscar 2m/70cm dual-band antenna, a home-made duplexer and a standard Yaesu PA3 car adaptor were stolen from Roy Bailey of

Newbury, Berkshire on the night of the 13th February.

If you are offered any of these items, please contact your local police station and/or Roy himself on 048839-441. He is offering a reward of £25 for information leading to the recovery of his equipment. For single items, the reward will be in proportion to the value.

Truck King Catalogues

Truck King of Garston, Hertfordshire, have asked us to apologise, on their behalf, to anyone who has ordered catalogues and not yet received them. Due to unforeseen production difficulties, there has been a delay but they tell us they are glad to report the catalogues are now available.

Sorry

Our apologies to anyone who was misled by an error which crept into the Best of British feature in the March issue. A slip of the pen transformed inches into feet when we described the Les Wallen Thunderbolt as measuring 32 feet in length! Sorry, Les.

Shortly, I will be fitting a noise-squelch to my Harrier HQ to complement my crystal filter, further news, as and when.

Recently, I learned of an antenna that must be the flat dweller's dream. It is in the Gemec Range. An SASE to: K.E.P. Rowe, Freepost PO Box 6, Pershore, Worcs WR10 1BR will reveal all!

I would like to hear from anyone that uses an extension speaker with a built-in filter, please? I would like to be in a position to offer advice on this subject so please let me know the make/model and if you did/didn't notice any benefits from the one that you use. Well, that's it for this time, 73's,

The Grey Beard

21-Day Marathon

Down in St Austell, Cornwall, six breakers recently took part in an incredible marathon for charity which lasted no less than 21 days. At 12 noon on 28th January, Freightmaster, Toryano, Topaz, Executioner, Alien and Flying Tiger started the event and completed it on 18th February, raising £600 for the Penrice Maternity Hospital which will buy medical supplies.

It was worked in sets of three pairs in two shifts and no less than 6,749 copies were recorded. The event was covered by TV South West, Radio Cornwall and the Cornish Guardian. In addition, the Guinness Book of Records are checking to see if it qualifies for a record. Well done to all those breakers, not forgetting Silver Cloud who helped organise it.

STOP PRESS

Bremi (UK) Limited, of Unit 6, Innage Park, Holly Lane Industrial Estate, Atherstone, Warwickshire, recently informed us that, contrary to strong rumour around the CB business, they have not ceased trading, nor are they likely to.

Due to difficulties in Italy, there was a temporary lack of supplies to the UK. This has now been resolved, they tell us, and the full Bremi range is now available, along with a new range of antennas.



Some thoughts on frequency allocation, among our readers' letters this month

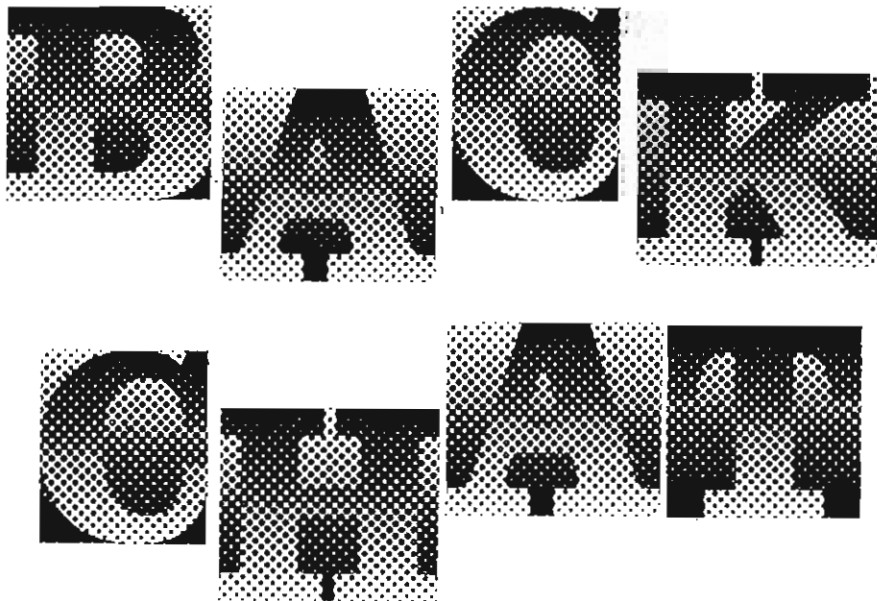

No to CEPT Proposal

Martin Wright of High Wycombe doesn't appear to like restrictions. . .

It is some time since I last commented on UK CB. That was to advise that the UK frequencies would not be enjoyed for too long; needless to say the day of change is near.

This change has, as expected and predicted, been explained by the need to reach 'harmonisation' within the EEC in respect of CB services.

Do not be deceived. The forthcoming CEPT 'standard' is not in itself a standard. At face value it may well seem to be so, but it is not a full technical spec, and is wide open to 'interpretation'. For example, there is nothing to stop any Member State from relaxing this standard in respect of more channels, higher power, and freedom to use modes in addition to FM, France being as good an example as any where AM and SSB are now permissible. Try bringing a French rig into the UK under the rights you are claimed to enjoy according to the Treaty of Rome and see how far you get.

This CEPT standard furthermore has no legal status whatsoever as far as the Community is concerned. It has not been passed by the European Parliament, nor has it been issued with the authority of the Council of Ministers. It is no more than a suggestion put up by the non-elected quango the CEPT, a quango that does not have a single representative from any of the CB user groups of Europe.

There is only one 'standard' for CB in Europe and that is to give full recognition to all modes and the use of the frequency band from 26 to 28 MHz. In fact, accepting what is common custom and practice. All this nonsense of stupid, trivial restrictions on antennas, playing with the odd few watts of output, and ridiculous claims concerning how many or few microwatts of spurious will or won't cause interference has got to be ended.

It is regrettable that the only apparent way of achieving the freedom of communications that have been sought for the past 40 years, yes 40 years, is to wilfully disregard the law. But that is a fact of life shown only too clearly by history. The BBC Radio 1 would not be a popular music channel if it had not been for the pirate broadcasters; we would never have achieved the forthcoming community radio provisions had it not been for the pirate stations.

The lawful way of achieving the freedom we seek is to petition your MPs both in the House of Commons and in Brussels. Not by writing just one letter, but by writing every week demanding action. Use normal brown commercial envelopes and, if possible, type the address. This itself ensures that your letter will at least be opened. The sheer persistent weight of mail will on its own be enough to overload any MP and bring action. Do not be put off by hollow assurances of concern, keep it up, be persistent, make a nuisance of yourself. Remember it is your MP and it is you that pays for his/her crust from your taxes and it is the MP's duty to represent your wishes.

The addresses are:

The House of Commons, Westminster, London SW1A 0AA. 13p postage.

The European Parliament, Brussels, Belgium. 22p postage.

With luck, if you start now, perhaps by 1986 all these MPs will have got sufficiently fed up with being pestered to have got off their butts and done something constructive, instead of being passively acquiescent to the steady stream of negative repressive laws and regulations that have been the rule over the past years.

It has probably been the result of such persistence that has brought this present inadequate CEPT proposal. After all, Government has enough to do without inventing work. Clearly the efforts of a few are not enough, it needs the weight of tens of thousands

to bring to reality what I am sure we all want, a comprehensive radio communications facility of adequate channels and range to be of practical use. Together with regulation and monitoring aimed specifically at silencing the disruptive anti-social minority, rather than those who use the equipment for its intended purpose of providing reliable two-way radio communications over a range greater than a mere mile or so.

The future for CB lies in your hands and yours alone, do nothing and you will get nothing. UK FM MPT 1320 was a face-saving compromise doomed from the outset by deliberate encouragement of abuse to establish a totally false case upon which the DTI could 'substantiate' all its dire warnings and reservations. Is it really any surprise that so many resort to 25 watt linears, oversize antennas and extra illegal channels in the light of the limitations imposed by the MPT 1320 specification?

200 channels is not unreasonable. 25 watts output is not unreasonable. Efficient antennas are not unreasonable.

The far superior range and propagation of AM and SSB are not unreasonable.

What is unreasonable is the attitude that the user public is incapable of using plug in filters to avoid interference. The £30m+ from licences and VAT is not spent silencing the abusive element.

The public is denied the freedom to communicate within the EEC.

CB is some sort of back-door amateur radio.

CB is a trivial toy, unworthy of band-planning for effective use by the emergency services in conjunction with the public at large.

There is no room in the RF spectrum to permit more channels, when there is no significant use other than CB between 26 and 28MHz.

Perhaps those of you who really do want to see CB treated with the respect it deserves will once again take up the challenge and this time not give up before the goal is realised.

A Sidebander Writes

Martyn, from Devon, offers some thoughts on frequency allocation. . .

On many occasions, you have published letters about the "DX-Local" controversy; with the possibility of extra channels coming our way, I would like to offer my few pennyworth of thoughts.

I'm assuming that the new European standard channels will be the old AM "naughty forty" i.e. 26.965 - 27.405MHz on FM which will give us UK breakers 80 channels in total to play around with. Our present legal 40 channels could be maintained for local copies, information etc. The new 40 could be for the more serious user, who is into short-range DX (say, 40 miles plus), and obviously for the UK motorist holidaying in Europe, not forgetting the international trucker, using

the same calling and emergency channels.

But what about the serious DXer? We still have an "officially" unused frequency area — channels 41 to 55 (27.415 to 27.585MHz), possibly for sideband usage which will immediately bring protests about SSB bleedover. To alleviate this problem, allocate, say, channels 43 to 53 (27.435 to 27.565MHz) USB and LSB but, unlike Mr Evans' suggestions (Back Chat, March 1985), limit power to 12w PEP and antenna specs to, say, 6dB gain on beams and unity gain on omnidirectionals. Admittedly, it's a small slice of the pie for sidebanders but, perhaps after a trial period, the frequency allocation could be extended if usage of the new FM channels turns out to be less than anticipated.

Obviously, none of these ideas would work without the co-operation of the countries involved and they won't deter the wallies from their usual half-witted attempts at disruption, but perhaps an increase in the cost of multi-mode radios will help a little; plus a three-tiered licence system. At present, we pay £10 for 40 channels. How about another £10 for the extra 40 FM plus £5 for SSB usage — not a lot more to pay for a bit of freedom of choice. Ahah, I hear you say, the unlicensed will still remain the unlicensed, but perhaps the increased revenue going to the DTI will strengthen their resources in the fight against misuse.

Like "Bob from Kent" (Back Chat, March 1985), I'm inclined to think that a test will encourage more unlicensed operation, but it would do no harm in ascertaining that those breakers interested in serious DX on SSB have some idea of the procedures and courtesies involved.

Ahoy There

Tales of CB at sea from Hairy Hound of Gosport. . .

I have noticed that over the past two or three years you have had many queries regarding the mounting of CB aerials on boats and other non-conductive surfaces. I have been using a CB whilst afloat on both a marine ply cab cruiser and a GRP trawler with a marine ply



wheelhouse for the last three years.

On both boats, I use a large litho printing plate (3ft square). On the 15ft cabin cruiser, this is fastened directly under the cabin top, and then painted. On the trawler, it is on top of the wheelhouse, and painted with fluorescent paint.

On both boats, the SWR is less than 1:1.2 and, using a Fidelity 2000

(now three years old) and working in the Solent, I have had copies as far as Ludlow, Salop (70 miles), Guernsey (100+ miles), Plymouth (140 miles, to a breaker actually mobile), Torquay, Brixham, Start Point (120 miles) and, of course, Scotland on the skip. These copies have all been on a straight 4 watt output through an original Cherokee Halfbreed and all around 8am to 10am on a Sunday morning while out angling.

As a comparison one day whilst talking to another marine mobile who was out off Littlehampton, we tried to contact each other on a channel that was not being used on the marine VHF (distance approximately 30 miles). The marine VHF rigs put out 25 watts but nothing could be heard either way, while on the CB at 4 watts, S7 both ways.

The litho printing plates can frequently be obtained just for the asking after use or occasionally from a scrapyard. Composition of the plates is mainly aluminium and, after three years, there is still no sign of oxidation. Incidentally, the South Devon contacts are on a regular basis.

Join Together

Silver Grey Lady of Corby's Venture Club wants some contacts. . .

After reading the letter from Paul Quasar of the Advance Group in your February issue, I realise that we at the Venture Club are doing the same thing. The reason we started the petition is because of the actions of some of the breakers in our area. A lady breaker, who is also a mother of four, put a call out for help after suffering an epileptic fit, while her husband was out with her two daughters. Her two sons were asleep upstairs. She was frightened and needed help desperately. The only thing she could get to was her CB rig to call for help, but here she was met with taunts and abuse. She finally managed to contact another lady breaker who phoned the police. The police went to get her husband and, when he arrived home, he found her on the floor. Thankfully, she was alright, but this is not the case of the lady breaker who helped. She can't go on to her rig without suffering verbal abuse. This is a pity as she is the kind of breaker who will help anyone — I have known her to send her husband out at night to help a breaker out. She also helps our monitors when they are busy.

We were asked by our members if we could do something about these so-called breakers before someone is hurt, so we started the petition. Our club is a member of the Affiliated Radio Club in Northamptonshire and we have asked the 24 Club, who are also members, to help us in our stand. We would like to send copies of the petition out to as many people as possible so I would like to ask your readers to write to me with their handles and addresses. Please send them to Silver Grey Lady, c/o The White Hart, High Street, Corby, Northampton. For those of you that are in the area on the second Thursday of the month, we meet at the White Hart. You will be made welcome.



QUESTIONS & ANSWERS • QUESTIONS & ANSWERS • QUESTIONS & ANSWERS • QUESTIONS & ANSWERS

To Beam or Not to Beam

Tony Martin, of Leamington Spa, is looking for a way to overcome the age-old problem of hostile terrain...

Q My home is surrounded by higher ground and this means that my range is severely restricted. I do not wish to use a power amplifier, since I am told that this can cause interference and so I am considering setting up a beam antenna. Please can you explain the advantages of such a set-up and advise me of any possible problems?

A Beam antennae directionalise the outgoing signal by funnelling the majority of the radiated energy in a forward direction and they have a similar effect on received signals, so that in order to offer good performance in all directions they must be mounted on a rotator which enables them to turn through a full 360°. Leaving aside the fact that their use at 27MHz is not legal, your first problem is likely to be sheer size, since the radiating element alone is likely to be some 5.5m long, with a slightly longer reflector. The overall area of the antenna will be dictated by the number of elements it contains.

The greater the number of elements, the narrower the angle of radiation and reception and this might lead to some difficulties if you wish to maintain contact with stations at varying angles to the beam. It should offer an increase in range in the direction in which it is pointing but will significantly reduce performance in other directions and, whilst it would undoubtedly help you to overcome the problems of unfriendly terrain, I doubt whether the expense would be repaid in terms of improved performance.

More PSU Problems

Tony, from Ipswich, is yet another of our readers beset by difficulties with an inefficient psu...

Q I have a Harrier CBX, which is used as a base station. I use a perfectly ordinary 3 to 5 amp power-pack, which worked fine for a time but which now gets very warm after about half an hour of use. As it heats up it begins to buzz loudly and I get occasional reports of a

buzzing noise on my signal. Please can you identify the problem?

A There are two possibilities here, Tony. The designation of your power supply means that it was designed to deliver a steady 3 amps at 13.8 volts, with a capacity to deliver 5 amps for very short periods of time. The first possibility is that your rig is set to deliver somewhat more than the usual 4 watts and that this is leading to an increased current drain on the power supply. This can easily be checked by means of an R.F. power meter.



The other possibility is, I regret to say, only too common. Many of the cheaper imported power supply units are extremely inefficient and only deliver the required amount of current under extreme duress. The buzzing sound which you report as sometimes being heard on your transmissions suggests that the supply is having to work harder than it should and the noise from the psu itself is probably the result of loosely wound laminations within its coils.

My advice is to try another psu and, if this cures the problem, to invest in one of a good quality.

The Howler

Down in Harrow, Big Bear's mates reckon he is making some real weird noises...

Q I use a Uniace rig with a centre loaded mag mount on my Cortina and am very pleased with it but other breakers tell me that when I transmit whilst moving my rig puts out a high pitched whine, which I suspect may be coming from the gearbox, since they

have suggested that they can tell when I change gear by a change in the transmitted tone. Both rig and car are entirely standard and I am at a loss as to how to cure this noise. Please can you help?

A From your description of the transmitted noise I am sure that you will find the culprit to be the alternator. The reason for the change in tone as you change gear has nothing to do with the gearbox itself but is attributable to the change in engine revs which accompanies each gear change.

The simple solution is to fit a coaxial suppressor to the alternator in order to earth the interfering signal. You do not say where on the car the antenna is mounted but siting it as far from the engine compartment as possible might also reduce the problem.

The Tourist Trap

Big A, of Stamford, Lincs, wants to take his rig on holiday...

Q I intend to tour the continent this year. I propose to visit France, West Germany, Austria and Yugoslavia and would like to know if I can take my FM rig with me. I know that AM is legal on the continent and illegal here but, if I had an AM rig, would I be able to take it out of England for use abroad?

A A somewhat loose agreement exists between the British and French authorities, under which you would be permitted to use your rig in France but I am unaware of any such agreement affecting use in either Germany or Austria and I would be most reluctant to take any form of radio transmitter into Yugoslavia, or any other East European country.

Although the use of AM is legal in France, most European countries permit only FM and, although I imagine British Customs would be delighted to let an AM rig out of the country, the one thing they certainly would not do is to let you bring it back in again.

Problems should be sent to:
**CB Q&A, Citizens' Band,
 1, Golden Square,
 London W1R 3AB**

WATCH OUT HERE COME THE T-BOLTS

FROM THE MODULATOR PEOPLE

Two new antennas from the Modulator People are coming your way – fast!

Thanks to our careful research and design, Modulator now offer you the T-bolt and Super T-bolt antennas. Both are completely suitable for all mobile CB applications.

The 33" long T-bolt has a power handling of 500W, a power normally attributed to antennas twice its size.

Even more powerful is the 46" long, centre-loaded Super T-bolt, which will handle 1kW. The gain on both these antennas is fantastic.

Superior chromium-plated brass $\frac{3}{8}$ " UNF. thread mountings and stainless spring steel whips are standard on both T-bolt models.

enquiries to:

LES WALLEN MANUFACTURING.

PEMBROKE WORKS, RAMSGATE ROAD,
SANDWICH, KENT, CT13 9NW.
TELEPHONE: (0304) 614598.

"AN ALL BRITISH RIG" *Citizens' Band, July 1983*



"1040" Fitted Selective Calling Buttons*

"THE TRANSMITTER CLEANLINESS IS QUITE REMARKABLE" *Citizens' Band, Rig Review, July 1983*



*Model shown fitted
cat-call
£157+VAT

- ★ Includes EMS speech processor fitted.
- ★ Poseidon base and 1040 portable models.
- ★ Choice of colours — no extra cost.

Optional extras:

- ★ Cat-call selective call and answerback.
- ★ Two-tone horn pager selective call.
- ★ EMS audio squelch noise limiter.

Other products:

- ★ Poseidon auto-call base monitor.
- ★ Infra-red beam with pocket pager.



E.M.S. COMMUNICATIONS DIVISION

Grove Street, Wantage, Oxon. OX12 7AD
Telephone 023 57 3518 Telex 837303

TRUCK KING & CB STORE

THE TRUCKERS SHOP

AS ONE OF THE UK'S OLDEST ESTABLISHED CB SPECIALISTS (TRADING SINCE 1979) WE HAVE THE WIDEST RANGE OF CB'S AND ACCESSORIES IN THE COUNTRY. ALL MAIL ORDER ITEMS ARE CHECKED & TESTED BEFORE DESPATCH AND FULLY GUARANTEED.

50-60 RADIOS ALWAYS IN STOCK NEW & USED.

PERSONAL CALLERS PART-EX WELCOME

We are open Monday to Saturday 9 to 6:00. We are 1 min. Junc 6 M1. Take A406 to Watford, left at Horseshoes crossroads and we're 100 yards on the right - no parking problems or yellow lines.

All Prices quoted include Post & Packing.

Off Junction 6 M1. 867 St. Albans Rd. Garston, Herts. Tel: (0923) 661673

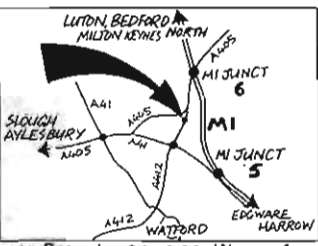

THESE FOUR RADIOS ARE NOW AVAILABLE WITH OUR 160 CHANNEL CONVERSION WHICH GIVES 40 LEGAL UK CHANNELS PLUS LOW, MID AND HIGH BAND, FCC FREQUENCY, FM

1. AUDIOLINE 340 ★

£46.00

This compact mobile Uniden Boarded Unit quite rightly enjoys a first class reputation. Features Volume, Squelch, Hi-Low Tone Control and variable power switch. Generally accepted as being one of the finest, most reliable units on the market with superior bleedover rejection the 340 has to be top of the list when choosing a mobile. 40 ch. £46.00 160 ch. £86.00

2. OSCAR ★

£48.00

A high quality Cybernet boarded radio which gives excellent performance, designed for gimmick free mobile use, it features volume, squelch, ch. 9 switch, detune and attenuator. Its performance is on a par with similar boarded Yorks, Rotels, Hamers etc. Highly recommended. 40 ch. £48.00 160 ch. £88.00

3. MAXCOM 30E ★

£56.00

This top of the range radio features crystal filtering, RF & mike gain, PA facility, DX switch, tone switch and high SWR indicator. (this radio is featured in this magazine's reference section). Excellent value and performance. 40 ch. £56.00 160 ch. £98.00

4. UNIACE 300 BASE STATION ★

£159.00

Whilst maybe not as flashy as some of the Base Units now long discontinued (the one's with an engine and built in teasmid). This one's still around and in greater demand than ever. Without a doubt the finest Base Station made for the UK market it features Volume, Squelch, Tone Control, PA facility, 240 or 13.8 volt power feed, variable power and mike gain, but the crunch is in its excellent circuitry and filtering which kills bleedover and cross mod without being deaf. Treat yourself to the ultimate. 40 ch. £159.00 160 ch. £199.00

Uniace
100 40 ch. £52, 160 ch. £92.
Uniace 200 40 ch. £78, 160 ch. £118.

These Four Radios All From Stock - ALL UNDER £30.

5. MAXCOM 4E ★

£28.00

An extremely rugged little basic mobile. Features same as Midland 2001 plus power attenuator. Good 'statter' radio or where a cheap reliable mobile is required.

6. MAXCOM 16E ★

£27.50

Bulk purchases means we can offer this mid range radio at a giveaway price. Features volume, squelch, RF gain, ch. 9 switch and attenuator.

7. LOWE TX40 ★

£29.00

Another good mid range radio which has all the facilities of the 6E plus detune and PA function.

8. GRANDSTAND BLUEBIRD ★

£28.00

Bankrupt stock purchases enables us to offer this crystal filtered unit which features volume, squelch, LED 'S' meter, and channel 9 switch at a budget price.

9. MINI-ECHO EA-100 ★

£22.50

An economy priced echo reverbulator that gives a big sound. Adjustable for echo depth, 9 volt battery powered (not supplied). Please give CB make when ordering.

10. SEIF RA-201 ★

£31.00

Deluxe version of the Mini Echo which also features adjustable echo depth. A very popular unit.

11. MELOS DE 1 ECHO CHAMBER ★

£79.00

The famous 'chamber box' has all the controls for a complete range of sound effects. Features BBD echo system, mike volume, echo repeat, delay time, direct/bypass balance. 240v powered comes complete with microphone adaptor lead. (Please state make and model of CB when ordering).

12. DM 101A AND DM 106ALC ★

DM 101A £13.00
DM 106ALC £15.00

Now in these stores from quality Japanese mike manufacturer AMI. These two excellent power mikes are both 6 volt PP3 powered (supplied with a slider power control, the 106ALC also features a limiter control which reduces overmodulation. Both are supplied ready wired (state CB make & model).

13. ES-880 ECHO BOX ★

£44.00

The most powerful echo unit available! Top quality Japanese unit features include LED level indicator for maximum performance, earpiece so you can check your speech quality. If you want to upgrade your 'talk power' don't miss the ultimate DX unit! Supplied ready wired (Please quote your CB make and model when ordering).

14. REPLACEMENT MIKES ★

£7.50

Two first class replacement mikes which are supplied ready wired (Please state CB make and model). The Alkal 'Coffin' mike is the standard replacement model for York, Rotel, Audioline, Uniden etc. but can be wired for any radio. The Japanese made AMI gives extremely clear, sharp speech and is especially recommended for curing 'woolly' or 'bassy' problems on your modulation.

15. DM510 POWER MIKE ★

£9.50

A moderately priced hand held dynamic microphone to boost up your modulation featuring a rotary power control. Comes ready wired for your CB and complete with 1.5v battery. (Please quote your CB make and model when ordering).

16. ONE HANDER AUDIOLINE 342 ★

£62.50

The greatest security CB ever - you just unplug it and take it with you! Sfm calculator style hand unit has all the control features - LED Display, Up/Down Scan, Volume, Squelch, Hi-Low Power, Channel Lock-on Switch, Tone Control and Internal Speaker plus of course the usual excellent Uniden Circuitry which gives crisp, clear copies. The compact power box which feeds the hand unit stays away out of sight under your seat or in the glove or dash. Beat the car thieves and still enjoy excellent CB performance.

17. ALTAI ECHO POWER MIKE ★

£23.50

Dense boarded - similar to Sirel CB-2002 but improved design and layout - this top quality hand mike features a slider power control and internal echo control. Supplied ready wired for your CB complete with 9v battery (Please quote your CB make and model when ordering).

18. TURNER JM+2/U ★

£34.00

One of the top quality CB power mikes, its 2 stage amplifier gives high gain and output level, suitable for both FM and SSB. Wiring and 7 volt battery included. (Please give CB make when ordering).

19. ASTATIC TEARDROP ★

£38.00

It's all been said about this USA manufactured Mike. Without a doubt the finest mobile power microphone available for the cleanest sharpest modulation ever. Suitable for FM or SSB. Supplied with battery and ready wired (quote CB make and model).

20. ASTATIC SILVER EAGLE £68.00

The base station equivalent of the Teardrop is undoubtedly the most efficient home base mike you'll ever use. We guarantee devastating DX modulation! All chrome finish with the distinctive Eagle engraved head. USA made and complete with battery and ready wired (quote CB make and model).



21. DNT HF-12/3 £10.95

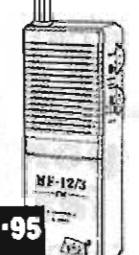

3 Channel hand held operational on channels 7, 14, 19. Features volume and squelch, telescopic antenna, built in mike, call tone and charger socket. Powered by 8 x 1.5 volt HP 7 batteries or Ni-cad supply. (not supplied) 0.5 watt output.

22. THUNDERBOLT AND SUPER THUNDERBOLT £7.50

Base and centre loaded two new compact high performers from Les Wallen. Both have high power ratings for linears and Citizens band' in a recent review gave 5 stars for performance on the centre load. Base load is especially popular for hatchback mounting where its unobtrusive size gives excellent performance.

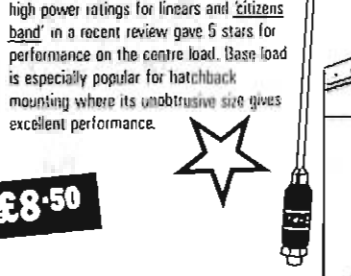

Out-performs anything you've ever used

25. SUN 208 SEIO MOBILE ANTENNA AND GUTTER MOUNT £33.00

New, from one of Japan's leading amateur antenna manufacturers this top quality mobile uses an Oscar type 'M' fitting for extra stability. Low SWR (may require very slight trimming). Wide bandwidth to cover 2 Mhz security grab screw. Followover facility for car parks, parking etc. Finest quality sprung stainless steel. 400 watt power handling and 4 db gain stated by manufacturer. Will out perform any mobile you've ever used including K40, Oscar, Armstrong Moonraker etc. Supplied with cable, PL and 'M' type mount for body fitting at £27 or complete with Matt Black gutter mount at £33 (illust.)

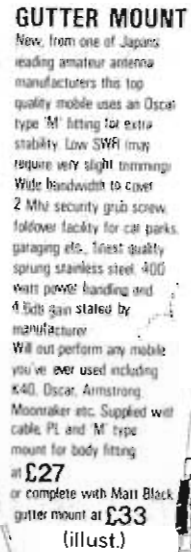

3 WAY SWITCHER WITH DUMMY LOAD £10.50



BRL5 Charlie. Will handle upto 500W. FM input to switch upto 3 antennas plus 5 watt dummy load selector.

23. THUNDERBOLT £8.50

Base and centre loaded two new compact high performers from Les Wallen. Both have high power ratings for linears and Citizens band' in a recent review gave 5 stars for performance on the centre load. Base load is especially popular for hatchback mounting where its unobtrusive size gives excellent performance.



MODULATOR EXPERT LEGAL HOME BASE ANTENNA 24. £22.50

1/2 wave dipole format utilising a 12" centre loaded coil makes this a tidy, well made and effective base station antenna.



27. BREMI MATCHER BRL 15 £7.95



This good quality unit is useful for safeguarding high SWR problems and has a power handling capacity of 100 watts.

28. TRC-175 7 VOLT BATTERY £2.95



The one no one ever seems to have in stock when your Turner or Cobra mike battery is on its last legs. We've got it!

OVER 60 DIFFERENT ANTENNAS IN STOCK

The perfect indoor antenna for flats, lofts etc. If you can't mount an outside twig this has to be the right alternative. 3 short loaded radials, helically wound top loaded whip. Quality 1/2 wave performance and it stands just 6" high. Can also be mast mounted for external use if a discreet antenna is required.

26. LEMM MINI GP. £18.00

3 short loaded radials, helically wound top loaded whip. Quality 1/2 wave performance and it stands just 6" high. Can also be mast mounted for external use if a discreet antenna is required.

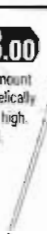

29. AUTOMATIC ANTENNA ROTATOR £44.00



Suitable for most light and medium weight beams. 360° drive unit and 5 terminal control box. Comes complete with well illustrated instruction sheet. A good quality unit at a special budget price. (5 core wire 10p a metre if required).

30. SWR 176 SWR-POWER-MATCHER £16.95

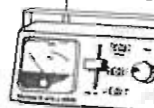

Gives SWR readings for 26-30 mhz, power readings upto 50 watts plus a switchable antenna matcher. A first class piece of home base equipment at only £16.95. The 178 Model (not illustrated) gives a power reading upto 100 watts at £28.00. Please note each unit is tested and calibrated before despatch.

31. ZETAGI B300 PS MOBILE LINEAR £129.00



Gives six stage power output upto 200 watts FM with a power output of upto 10 watts plus a built in pre amp. Excellent. Linears which we've found extremely reliable.

32. BREMI BRG201 SWR-POWER METER POWER UPTO 1KW! £18.00



A very reasonably priced SWR Meter which covers 3-200 Mhz. With a power handling capacity of 2000 watts. Power Meter covers 26-30 Mhz in stages of 1, 10, 100, 1000 watts. Economy Priced at £18.00

33. HANDHELD ACCESSORIES £6.95

Suitable for Maxcom 7E and all other types of handheld: a) Rubber duck, this replaces most telescopic hand held antennas by either slotting over existing antenna base or by screwing in directly to antenna stud. b) Rechargeable AA 1.25 volt Nicads - top brands (Fuji, Sunrise, Hitachi according to stock) c) Nicad charger plugs direct between mains and hand held, suitable for Alba, Harvard, Maxcom etc. State make and model when ordering.



34. LESON TW232 DESK MIKE £35.50



The famous 4200 type desk mike is ideal for both FM and SSB use and is specially designed for high modulation capability. Features include rugged die cast body, built in speech compression amplifier, variable amplifier gain control and lock on PTT facility - Supplied ready wired (Please quote your CB make and model when ordering). Supplied with Dv battery.

35. HAM MASTER EXTENSION SPEAKER £11.50



Despite its price we sell more of this high quality speaker than any of the others. Features a noise suppressor switch, fully rotatable mounting and a high clarity loudspeaker with strong magnet, complete with plug and cable. Hearing is believing!

36. BREMI BRG27 PRE-AMP £18.00



High quality preamp especially suited for base station use, gives high Db gain. Suitable for AM-FM-SSB. Requires 12 volt power. Very Good Value at £18.00

37. BREMI ROBOT VOICE £27.00



Gives a variety of Robot 'Metal Mickey' voice effects. Requires 12 volt power feed, comes ready wired for your rig (quote CB make and model).

MAKE SURE OF YOUR COPY SEND £1.00

TRUCK KING THE 1985 CATALOGUE



MAIL ORDER To: TRUCK KING, Dept. CB5/85, 867 ST. ALBANS ROAD, GARSTON, WATFORD, HERTS. Enquiries/VISA/ACCESS orders phone 0923-661673.

All prices quoted include post & packing. Overseas orders add 20% (£ Sterling only please)

QTY	ITEM	£

OUR NEW 1985 CB AND TRUCKING CATALOGUE FEATURES AND ILLUSTRATES 300 CB ITEMS. THE UKS MOST COMPREHENSIVE EVER LISTING. ALL REGULAR STOCK LINES PLUS OUR FULL RANGE OF TRUCKING STOCK - DISCOUNT VOUCHERS WORTH UPTO £10.00 INCLUDED. TO GET YOUR COPY NOW SEND £1.00 CHEQUE/P.O. - DON'T MISS OUT.

Name _____ I enclose Cheque/P.O. for £ _____ payable to Truck King
 Address _____ I wish to pay by ACCESS VISA (Tick) Card No. _____
 ACCESS/VISA orders phone 0923 661673

PLEASE USE A SEPERATE SHEET OF PAPER IF YOU NEED MORE ROOM OR DO NOT WISH TO CUT YOUR MAGAZINE.



TAR AERIALS AND COMMUNICATIONS

THE COMMUNICATIONS CENTRE
KING WILLIAM STREET, AMBLECOTE
STOURBRIDGE, WEST MIDLANDS, DY4 4CY

Aerial Components Lashings & Masts

THE 'TAR 40' MAST

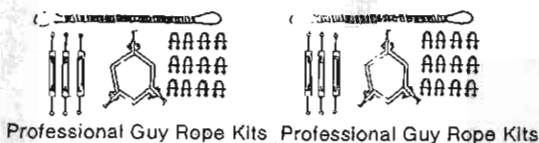

Professional Guy Rope Kits Professional Guy Rope Kits

CONTENTS
8 sections 2" dia x 5'
Aluminium sections.
2 TAR Guy Rope Kits.
1 Base Plate

★ SPECIAL OFFER ★

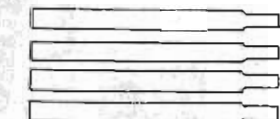

A four section 1 1/2" dia. aluminium mast only **£12.95 + £2.50 P&P**

ONLY £55.00
+£5 carriage

1 1/2" dia. steel sections
3 sections 6' long
18' in total
ONLY £6.00
+ £2.50 P&P



T&K BRACKETS

12" - £4.50 per pair
18" - £5.50 per pair
24" - £6.50 per pair
P&P £2.50 per pair

STAND OFF BRACKETS

6" - £1.40 each
9" - £1.80 each
P&P £1.00



MAST CLAMPS

2" Universal
£2 each + £1 P&P

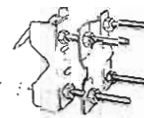

JOINTING SLEEVE

Joins 2 x 2" dia. masts
£3.50 + £2 P&P

GUY RINGS

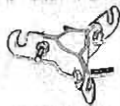

3 way £1.75 each
4 way £2.00 each
P&P £1 each



Professional Guy Rope Kits

Contents
A. Standard 7 x .56mm strands
B. Heavy duty 7 x 1mm strands
Standard **£8.95**
Heavy Duty **£9.95** P&P £2.50

1 x 3 way guy ring
6 x thimbles
12 x wire rope grips
3 x turnbuckles
30 metres wire rope

COPPER WIRE



150' coils 1.6mm dia.
Hard drawn £7.95
Soft enamelled £6.95
P&P £1.50

BASE ANTENNAS



The GAP BASE STATION ANTENNAS shown here use the unique "ADJUSTACOIL" for easy SWR adjustment without altering radiator
G.A.P. Skybreaker..... £18.95
G.A.P. 27MHz 1/2 wave..... £14.95
G.A.P. 27MHz 1/4 wave..... £16.95
Gamma SuperMag..... £ 7.50
G.A.P. Avenger..... £19.95
G.A.P. Lofty..... £19.95
G.A.P. Skybreaker 11..... £21.95
G.A.P. Avenger 11..... £21.45
G.A.P. Lofty 11..... £21.95
Post and package £2 each item

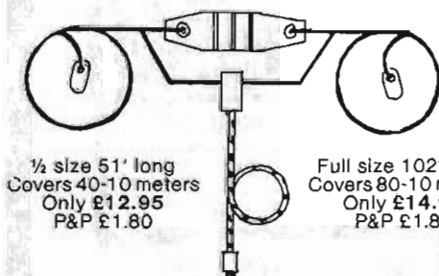

1/2 size 51' long
Covers 40-10 meters
Only **£12.95**
P&P **£1.80**

Full size 102' long
Covers 80-10 meters
Only **£14.95**
P&P **£1.80**

Makes an ideal S.W.L. antenna

CB DIPOLE KITS
Ideal for fixed or portable use.
£4.95 + £1.00 P&P
Contains: enamelled copper wire, 2 egg insulators, dipole centre and nylon guy line.

SPECIAL MOBILE ANTENNA OFFER SUPERSCORPIONS
Model M-2000
Man'fd by antenna specialists
Trunk or Roof **£12.50**
Mount **+£1.50 P&P**

MURA CBM20
Power/SWR/FS meter complete with lead



A good quality meter for only **£18.00 inc. P&P**

COAXIAL CABLE
Fit the best, your equipment deserves it.
Popes H100 80p/m + 6p/m p&p
British UNMET 70p/m + 8p/m p&p
RG.68 25p/m + 3p/m p&p

OUR PRODUCTS ARE FAR TOO NUMEROUS TO LIST. SEND £1.00 REFUNDABLE AGAINST ANY PURCHASE FOR OUR CATALOGUE LISTING OUR ENTIRE RANGE, INCLUDING:

- ★ All parts and components for the DIY antenna constructor
- ★ Comprehensive range of our masts, brackets and lashing equipment.

TRADERS
Masts & aerial brackets
You name it we either make it or stock it.
Ring for details

Telephone for our latest price on all popular CB rigs and accessories

We are also stockists of Yaesu, Trio and most popular makes of amateur radio equipment and accessories

STOURBRIDGE
(0384) 390944
370987

CB AUTO SQUELCH
Possible the best FM noise squelch module available. Fits inside the CB rig. Fully guaranteed. Still only **£12.95**. Supplied with full instructions. Please state type of rig.

PARA DYNAMICS
R.F. Dummy Load Wattmeter 50 Ohms. Power Scales 0-5 watts, 0-15 watts SWR is less than 1.1:1 Frequency range 3-220MHz **£15.00** inc P&P

CRYSTAL FILTERS
ONLY UNIDEN 10, M15A **£4.50**
10.7MHz crystals inc. P&P

CERAMIC EGG INSULATORS
£3.00 for 6 inc P&P

HAM RADIO ENTHUSIASTS
These two books are a must
1. A Guide to Amateur Radio
2. The Radio Amateurs Exam Manual **£7** the pair inc p&p

THUNDERPOLE Mk III's
£25.00 inc carr.

BASE MIKES
The most popular on the air today
HAM MASTER 4200 Only **£32.50**
LESON TW232 **+£1.50 P&P**

SUN KG208 and GUTTER MOUNT
One of the best CB mobile antennas available
Our price **£26.00** complete



Mack chat

Mack makes it as a celebrity down in Clacton-on-Sea

You went and done it to me again didn't you. No sooner had I written that there ain't no no eyeball meets anymore, then the invitation for two of these events reached me. The first one matured when our Editor phoned me to tell me that a new CB shop was opening in Clacton and the owner had asked if I would like to go to the official opening to put myself about and sign a few copies of the mag for the fans. After another telephone call to the owner Glen Lister, a date was set for this mass eyeball. As you may have noticed if you are a regular reader, I spend a lot of time during the summer months in the Clacton area. So the opportunity to meet some of the breakers of the town appealed to me.

February 2nd was the date set for the event and, fortunately, the weather was fine so, with my wife and daughter in tow, we arrived in Clacton around 11.30 am. Where were the brass bands and bunting to herald the arrival of such a great personality? There was none, neither were there the crowds of Cbers that one would expect to see at such a historical event. Mind you, during the rest of the day a number of people did turn up, and I enjoyed the day. It gave me the opportunity to investigate and play with some of the latest CB bits that Glen had in the shop. The name of the store is Coastal CB and Trophy and you will find it at 127 Old Road, Clacton on Sea. One side wall of the shop is taken up with trophies of every description for all sporting and other activities and it was a surprise when Glen presented me with a CB trophy. I've not had one of these before, so all you club officials take note: if you need any CB trophies to commemorate your CB activities give Glen a call and I am sure he will fix you up.

Back to the CB side of the business, I noticed that the prices on many items were very cheap and I asked why does one open a CB shop these days when many people say that CB is dying and the few shops that are still around claim that they are finding things tough. Glen, who is himself an active Cber, replied that he could not find the CB equipment that he required in his area and a good CB shop in Clacton would do well. I do agree with him as there have been some shops in the town or nearby but their range of goods were small and expensive, and have long gone. Coastal CB is open 6½ days a week, so, if you are in the area give a call on the 19 or 37 for 'Woodsman' or Coastal CB.

The other big eyeball of which Des Currie sent me the details and invitation is the 1985 CB Radio Big Meeting. This takes place on Sunday 28th April, 1985, 11 am until 4pm at Derwent Valley Breakers, Stanley Youth Centre, Co Durham. It seems like it will be a good day for those that attend, as many clubs of the north will be giving support. I would love to attend but I'm afraid it's too far to travel just for the half-day but hopefully this could be the sign of the future and maybe we could see more of these events a bit nearer to the south of the country.

Events seem to be happening in twos this month as I have found yet another new CB shop. Well it's not really a new shop as this was a CB shop that closed down and for



six months remained empty and disused so I was surprised when passing recently to see that it had reopened and was trading under a new name. City Communications Ltd is at 112 Pitfield Street, London N1. Being as nose-y as I am, I had to go see what was going on and when I entered the shop I was taken aback, I saw rigs. Yes, I know CB shops sell rigs but this shop had *lots* of rigs. In fact, I haven't seen so many different models of rigs for a long time. I counted 30 along the shelves that covered one side of the shop. This organisation is run by Chas and Dave — no not the singing ones, the Cbing ones. These guys are your real Cber type. Their reason for opening the shop is because it was something that they had always wanted to do, and with the shop and its location, the opportunity arose and the lads took it. If you are passing, pop in for a chat as this is a very friendly shop, and have a good browse around as you could find some long sought-after bits, as this shop has boxes of rare CB equipment.

Do you take much notice of the claims by some manufacturers of the DB or DBI gain that they give to their antennas. I don't as I am more interested in how many 'S' points or 'pounds' the signal is on one antenna than the other. In the past I have not been very happy with the beam antennas for 934 that have been on sale; the ones that I have tried did not work. So when I was given one of those Nevada 12 element loop yagis from Telecomms of Portsmouth I wondered would it work or would it be yet another failure. Happily, I can report it was a success. The antenna is slightly heavier than I expected but that's because it is built of steel with the elements brazed on to the boom and well finished with a covering of metallic paint. My tests for the beam gave me five 'S' points more than my dipole and a dipole is rated at zero gain. So at last I have found a beam antenna that works and those other users of the 934 frequency that have purchased these Nevada beams agree with me.

The other evening I was in QSO with a station in Tatsfield, a distance of 24 miles from my home QTH. Nothing exceptional about this, one would say. True, but this other station was using a portable 934 hand-held rig. Lloyd of Roger Dee is well known in the 934 CB fraternity. His company at 20 London Road, Dunton Green, Sevenoaks, Kent, is marketing this ½ watt single-channel portable at just under £200. A bit high, you must agree, but Lloyd hopes to sell this rig for commercial uses. He also has plans in the future to produce a 20-channel, 2 watt hand-held at around £400.

934 radios are not cheap, but Selectronics, the 934 people of Canvey Island, Essex have a supply of second-hand Reftecs for sale. They have all been serviced and carry a guarantee. The price of these rigs is from £150 to £250, so if you have ever considered the 934 frequency, now is your chance. For the price of one of these rigs and, say, another £15 for a 4-element beam and coax, you too could enjoy CB as it used to be, wally-free (sounds like an advert this does). All these rigs, by the way, can be converted to 40 channels when we get them in the future.

MOONRAKER

MODEL FM 27

Power 500 Watts
Broad band coverage
25.5-28.5 MHz.
Pre-SWR'd & individually tested.
High quality, tapered stainless steel whip.

Golden Lance

CL2000

Power 500 Watts. Broad band coverage
25.5-28.5 MHz. Pre-SWR'd & individually tested. High quality, tapered stainless steel whip.

Golden Knight

6.5 db GAIN

The Supreme Golden 5/8 Wave Antenna - featuring specially designed radiation pattern, including top radials angled for optimum distance coverage.

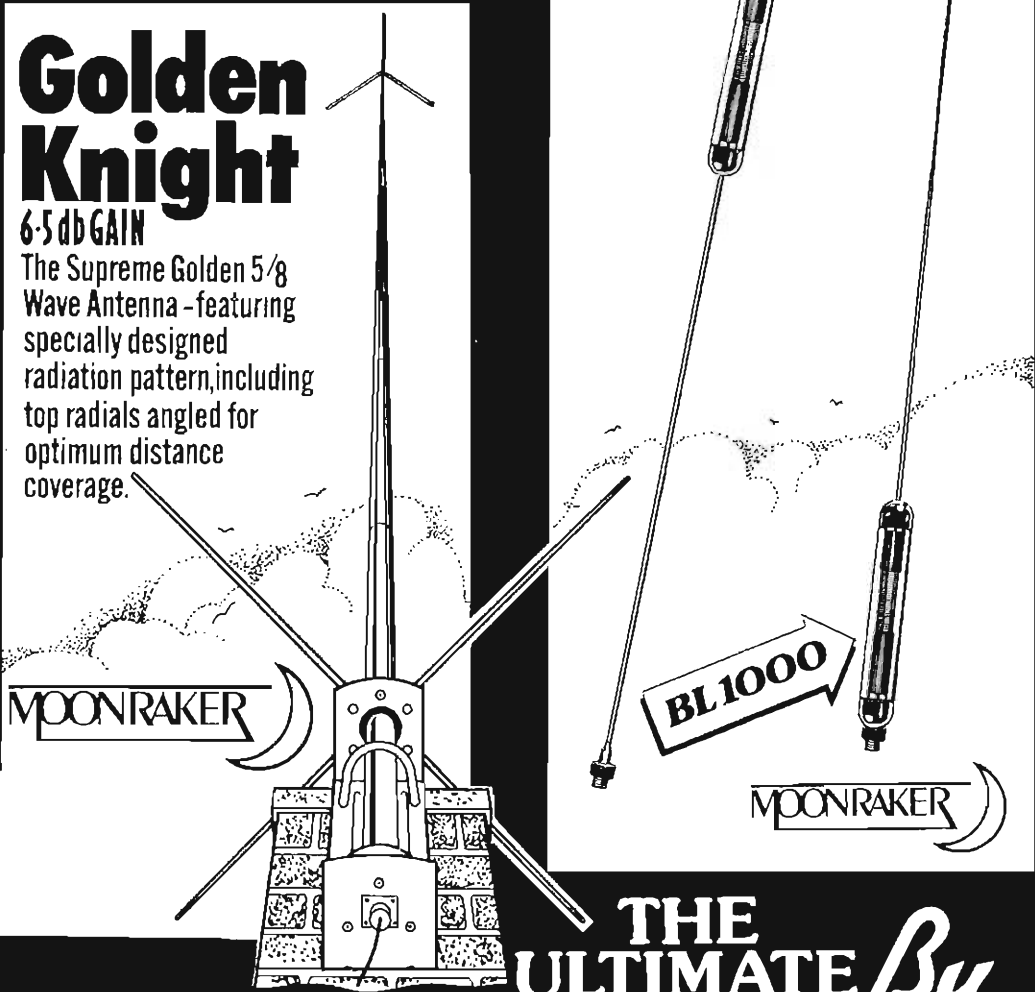

DISTRIBUTORS:

TRADE ENQUIRES WELCOME



All Moonraker products are designed and manufactured to Superior Standards. Available from your local CB Store.

THE ULTIMATE *By Design*



Gismo delivers A Winter's Tale

I stopped overnight on the services on the M62 at Birch recently. On the side, the best meal I have ever had at a motorway services, but the price of £5.60 for roast beef, a sweet and a coffee is out of the reach of most big-wheelers! It was a really rough night, a gale was blowing, snowing, freezing cold.

When I left at about 4am, I took note of the diversion signs for high-sided vehicles, asking them to divert onto the A640. I left the slab and progressed up over the hills towards Saddleworth. The wheels slipped a bit, but I managed to keep rolling. I dropped down into Denshaw, but, at the crossroads, I didn't know which way to go, as there were no more signs. A quick look at the map showed that back to the Mike 62 was about three miles, if I went left. The snow was blowing off the moors like a blizzard. I started up a steepish hill and that was that. My wheels were spinning and I could not pull forward any more. I put the handbrake on and started to slide backwards downhill. Behind me were parked cars, and some terraced houses. Back into gear I went, this time crawler, and I held the hill with my wheels spinning.

You can imagine the thoughts rushing through my mind. With the snow blowing off the moors, it wouldn't take long to get snowed in. The engine was cooling fast, I had the blower on heating the screen, and the wipers on fast-wipe couldn't keep up with the snow. I could see myself being stuck the weekend in Denshaw. I got hold of the mike and shouted out for assistance on the CB, first on channel 19 and then on channel 9. No response. The wheels had edged forward an inch or two as the snow had melted by the constant turning and I suppose heat of the tyres. I tried the handbrake again, but the truck still slipped back on the hill, so I continued to keep it in crawler with the wheels spinning on the snow and ice, holding it, slightly gaining an inch or two every minute or so.

I have had a radio telephone for four or five years now, and I called the operator and asked him to get me some local assistance fast. First he connected me to the Manchester police and, after another couple of calls, I eventually found a sympathetic sergeant, who promised to send out a couple of Range Rovers. About half an hour of crawling and melting my way uphill, I managed to cover about 50 yards. In the distance a mile or so away on the road I had left, I saw a yellow flashing light. With my wheels still turning away in crawler, I saw a glimmer of hope. I watched it cross the moors up to Denshaw and go back again. I got onto the landline and got my sergeant friend back again and asked if he could get the gritter or snowplough via the radio, and get him to come back again and come up my hill. He was sympathetic and said he would try. After what seemed like an eternity had passed, my phone rang. It was the sergeant telling me the Range Rover was looking but couldn't find me. I certainly wasn't on the A640, so he said. He decided to send his men over my route until they found me, starting at the motorway.

After what seemed like an age, with the engine on a

fast tickover and the wheels spinning away, I had managed to climb a few hundred yards away from the houses and the parked cars. I saw another set of lights in the same direction as I had seen the yellow flashing ones. I watched it cross the moors again and drop into the village behind me. A few minutes later I saw the unmistakable blue light, again on the same road. Normally the sight of a blue light is the last thing a trucker wants to see, but I was delighted to see the smokeys coming. I put my rear fogs on and my hazards. I must have looked like a Christmas tree up there in the snow on that hill. I realised that the first set of lights was, in fact, a big wheeler and he was coming up behind me. The smokey arrived and I began to creep up the hill a bit, past a gap where the snow was driving through the dry stone wall. The smokey on the nearside wound his window down and told me he was going on to see if I could get through ahead. It could be six feet deep further on! I continued to crawl up the hill, a few feet at a time now.

The truck behind me was a four-wheeler, and he decided to go back down, an option not available to me with my trailer behind me. A snowplough came up behind me, with two men in the cab. With their four wheel drive tipper they didn't have the trouble with traction I had. I let the artic roll back until I was on the road they had cleared and I climbed out of crawler at last, up a few gears at least, the first time I had been out of crawler and the first time the wheels had gripped for over an hour.

The smokey came back to me and then I realised for the first time that they were on channel. He told me over the Chicken Box that I could get through to the motorway and they would follow on behind. I told them to cover up the signs, they said they already had, and in fact had tried to get them removed, as big wheelers came off the slab, came up here and got blown over up here. I asked them their handles, and they came back with Blue Bear and Flatfoot! They chatted to me over the top and pointed out the place where, in 1979, the snow was 20 feet deep on this road! They left me with the old police reply that it was all in a day's works. I thanked them over and over again, rejoined the slab and headed eastbound and homeward bound very relieved that I would not be weekendend at Denshaw!

My monitor of the month is Silver Fox (John Taylor) who monitors the Weatherby area, location of one of the most deadly foe of us big wheelers, the Weight Watchers! The A1 Truckers Club presented him with a sweater with their name and his handle on, in appreciation of his monitoring. John is retired and devotes all his spare time to monitoring the 19. I spoke to him myself when I got held up at a local cardboard case company at Wetherby last year, when he was trying to live down burning a kettle or tea-pot, I seem to remember! Thank you Silver Fox for your excellent work in what is a very important area, with the Weight Watchers just down the Roman Road, that terrible camber on the doughnut, and all the fender-benders that occur around that twenty.

ACCESSORIES ROUNDUP

With a vast range of CB accessories on the market, Brian Wright checks out a selection to see exactly what they do and how they do it

With many hobbies, sports or pastimes, after having bought the basic equipment to pursue a particular interest, many people derive a great deal of pleasure from improving and extending their equipment by purchasing various add-ons or accessories. These accessories sometimes either improve the performance of the basic equipment or just simply make the equipment more interesting to use; either way the user can derive more pleasure from his or her hobby.

This is just as true for CB radio as for anything else. A glance at the CB advertisements or a quick look around your local CB shop will show you the increasing range of interesting accessories available. Many breakers, especially the relatively new ones, are not always very well informed as to what is available, or what the advantage of this or that piece of hardware is. Whilst most CB shops will explain the virtues of these accessories, many people do not bother to ask, some perhaps because they do not want to expose their ignorance in a shop full of 'knowledgable' breakers. We are therefore featuring a group of useful accessories this month with a brief explanation of their functions.

We will start with a device so simple and so extremely useful that we are surprised that it has not been available before. This unit is the Micmaster from BBTronics and it is a clever switchbox adaptor for matching any four pin mic to any rig with a four pin socket. At first you might think that doesn't sound very useful at all but, like the designer of the Micmaster, in my rigdoctoring days I myself was confronted with an endless stream of breakers wanting this or that mic required to suit their rig. The amazing thing was that very often the same breakers would arrive again and again as they tried mic after mic in their search for perfection. The Micmaster is not only useful in matching the mic to the rig — from the settings of the switches it is possible to tell which wires need to be changed and where to, if the user wishes eventually to permanently rewire the plug by soldering.

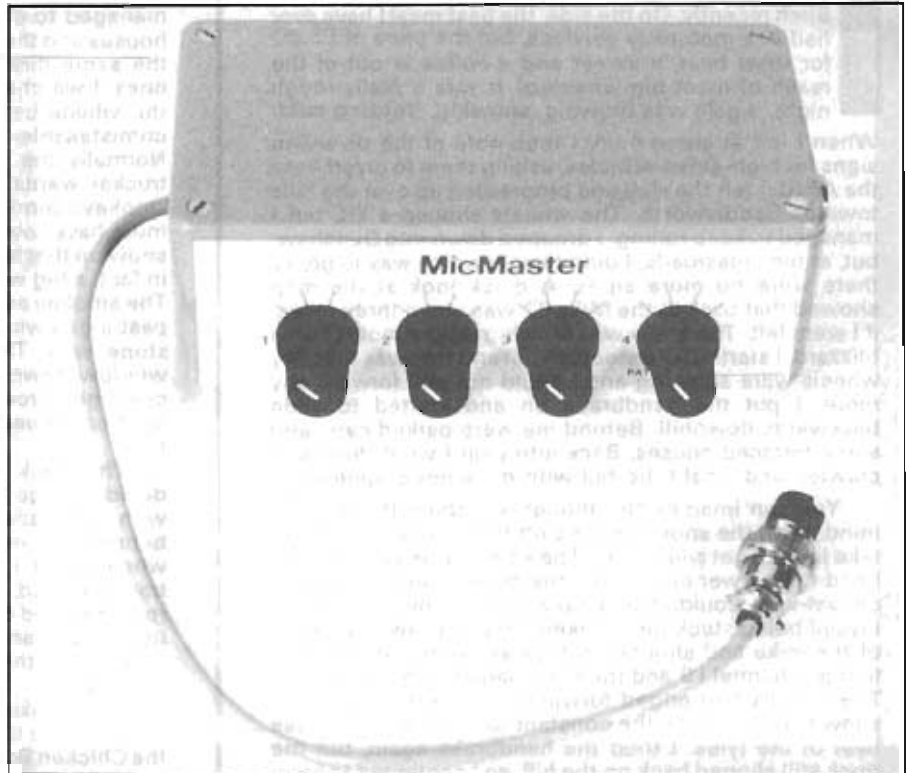

BBTronics Micmaster

The Micmaster is contained in a grey plastic box 150mm long, 50mm deep and 80mm wide; it has a socket at one end for the mic and a flying lead the other end with a plug attached, to fit the rig. On the front are four switches numbered 1-4 and each switch has four positions, indicated by four radial lines. From the position of each switch it is possible to tell which mic pin is connected to which output or rig pin. For example, if switch 1 is set on position 3 then the wire from mic pin 1 needs to be soldered to pin 3 instead of 1.

Of course the Micmaster can simply be left in circuit if you do not wish to resolder the wires. This is very useful if you have to borrow a mic temporarily if yours has packed up. The instructions for the Micmaster explain how to proceed to determine how the switches should be set and

this is quite straightforward and only takes a few minutes. If you already know how the wires need to be changed but don't wish to resolder them, then the Micmaster switches can be preset. For example, if it is known that the wires on pins 1 and 2 on the mic plug need swapping then the switches 1 and 2 would be set as follows — 1 set to 2 and 2 set to 1.

It can be seen from the above, how useful this item is, especially to those compulsive mic swappers. The Micmaster is produced by BBTronics, 48, Arlington Drive, Leigh, Lancashire and retails at £11.95.

While we are on the subject of switching devices, Nevada Communications produce a useful two-way Antenna Switch, the TC2W, which is neat and well-made. The TC2W has one SO259 socket marked 'common' for the antenna coax from the rig and

two more on the other side marked 'A' and 'B' for connection to two separate antennas. On the front face is a switch for switching either antenna into the rig.

Again, at first sight, not a very useful accessory, but there are several uses. One of its most useful applications would be for those breakers who live in busy areas and who suffer from bleedover. If these breakers were to have two antennas, one high performance and one low performance, they could use the lower performance antenna when experiencing bleedover (providing their copy was in range of the small antenna) and then switch to the higher performance antenna for long copies when the channels were less busy. Of course the switch could be used in reverse, thereby allowing two rigs to be switched alternatively into one antenna. The Nevada Antenna Switch TC2W retails at £6.50.

The majority of homebase breakers use mobile rigs, mainly because they are cheap, and many start out by powering these from a dirty old car battery, until the wife or mother declares that either she or the battery must go. It is then time to think of either giving up CB or purchasing a mains power supply. A substantial power supply that we looked at recently was the Bremi 13.8 volt 5 Amp Stabilized Power Supply, BRS 31. The Bremi BRS 31 is capable of supplying 5 amps without appreciable drop in voltage, which is more than enough for any legal rig (and a few illegal ones of 10w or more). The BRS 31 has a black metal case and a black front panel printed with white lettering. On the front panel is an on/off switch with a red indicator lamp and a black and red terminal for connecting to the rig power supply lead. This is a quite substantial power supply which should stand a lot of use. The stabilization was very good on our sample, a quick check revealed the BRS31 was indeed 13.8V off load, falling to 13.5V at 1 amp, 13.1V at 3 amp and 13V at 4 amps load, which is quite good for this type of power supply. This power supply boasts 'electronic protection with current limiter', but it is not a good idea to put this to the test unnecessarily — so we didn't. The Bremi BRS 31 retails at £21.90.

The Nevada TC2W antenna switch

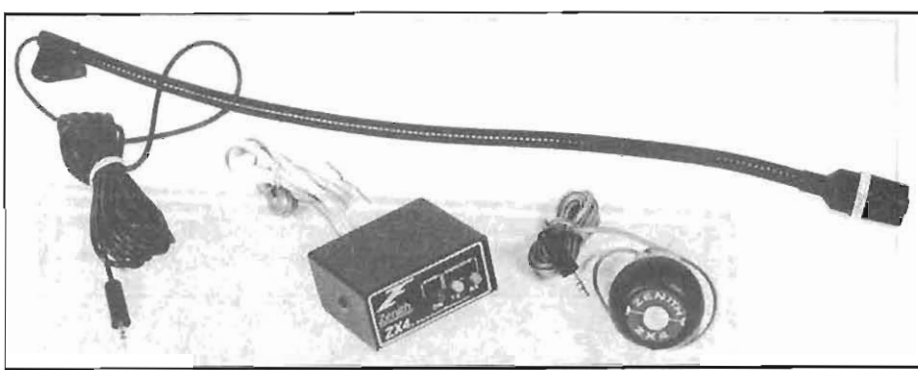
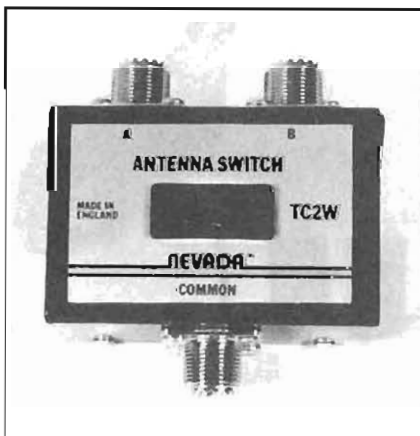

The Zenith ZX4 switching unit and DM7 safety microphone



Bremi BRS 31 power supply unit

One of the main problems of modulating whilst mobile is having one hand off of the wheel or being unable to change gear while holding the mike up to the mouth. A not uncommon problem is of getting the mic lead tangled around the wheel when turning sharply — well fear not, help is at hand in the form of the Zenith Electronics ZX4 Switching Unit and DM7 Safety Microphone. The Zenith Safety mic consists of a mic on the end of a 400mm long flexible boom, which can be screwed to the vehicle, a leather bound gear knob with integral switch and an extremely small control unit. The flexible mic boom can be bent to any suitable position near the driver's mouth and a lead with a small jackplug plugs into the control unit. The gear-knob replaces your original knob and is very smartly bound in real leather.

On top of the knob is a small push-button switch for operating the rig from TX to RX and RX to TX. The wire from the gearknob has another small jackplug and fits into the control box alongside the mic plug. The control box has a cable at the rear which requires a plug to fit the rig mic socket, there is also a red wire which should be wired to the +12 volts via the ignition switch or rig switch. On the front of the control box are three LEDs, red for power on, yellow for TX and green for RX.

The mic is extremely simple to operate; simply press the push-button on the gear knob once and the rig will go into transmit, indicated by the LED on the control unit. Both hands are now free for driving while modulating into the mic, positioned by the mouth. When the modulation is over, simply press the button on the gear knob once more and the rig flips back into receive, again indicated by the LED on the control unit — just like using a base mic with a locking switch. The

latching is achieved in the control box rather than having a latching switch in the gear knob. This mic would be very useful to breakers who do a lot of mobile breaking and would certainly remove most of the dangers of mobile modulating. Every part of the unit is well made and of smart appearance. The complete unit retails at £25.85.

Another problem when using a rig mobile, especially in a noisy vehicle, is the fact that rig speakers usually face downwards and more often than not the rig is mounted at a fairly low level. The result is that the rig speaker sounds muffled as the sound has to reflect off of the carpeted floor which absorbs the high frequencies. The solution is to fit an extension speaker on top of the dashboard or somewhere similar. We tried a suitable speaker for this purpose this month, the Rama model MS-40CB, and it performed quite well. It is a 4in speaker housed in an attractive black plastic housing with a bracket for mounting by means of two screws. The speaker can be rotated vertically on the bracket for the best position by slackening two knobs. It is prevented from vibrating out of position by ratchet type teeth either side of the housing. This is a fairly large speaker of this type, its dimensions being 195mm(W) X 142mm(H) X 58mm(D). With the speaker pointing directly at the driver, interference noise can be quite painful on the ear and to overcome this, a noise filter switch is fitted on the front face, this effectively filters out the high pitched noise and is quite useful. The MS-40CB can handle a nominal 3 watts audio but is capable of 5 watts maximum. It comes complete with lead and jackplug to fit most rigs and retails at £7.95.

With UK regulations limiting CB RF output power to 4 watts and antenna regulations reducing this to around 2

Rama extension speaker

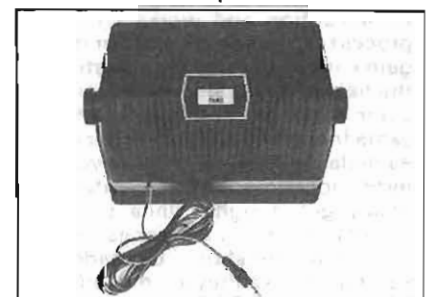

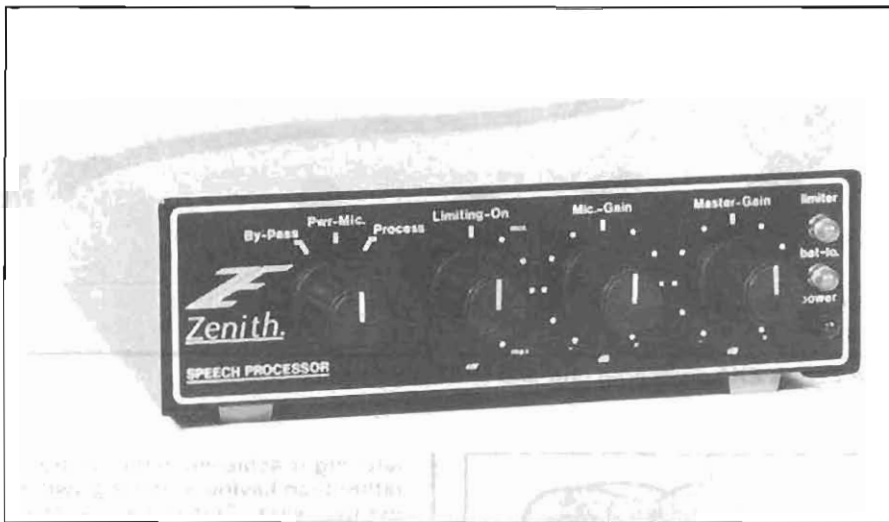

Zenith speech processor

watts effective radiated power, one of the best ways of increasing operating range is to increase 'talk power' i.e. get the most possible modulation on the RF carrier. The best way of achieving this is to use some form of audio signal amplification and processing such as filtering and compression. Zenith produce the P-202 Speech Processor for just that purpose. This is quite a large unit, almost as large as the smaller rigs. The P-202 is plugged into the rig mic socket and the mic plugged into the P-202, power is supplied by two internally fitted PP3 batteries. Power consumption is only 1.5mA on transmit so that the PP3s should have a reasonable life and, in fact, a 'low battery' indicator lamp is included on the front panel.

There are four knobs on the front panel, the left hand one being the function switch allowing the unit to be bypassed, selection of power mic function or speech processor. The next knob selects the amount of limiting, the third knob is the mic-gain and the right knob is the master-gain. On the right of these knobs are three LEDs — limiter, battery low and power indicators. With the selector switch on 'bypass', the mic is connected directly to the rig but selecting 'power mic' switches on the mic amplifier and selecting 'processor' of course switches on the speech processor. Whilst these type of units really work well on AM and SSB they don't generally do so much to improve FM but in my experience they will generally work quite well on FM (depending on the rig) if more time and effort is taken in setting them up properly. This unit is no exception and works well in the processing mode if the limiter and gain knobs are carefully adjusted, with the help of a reliable friend listening at some distance. You may find that the same friend will alter his or her opinion each day for a week or so as you make minor adjustments, but eventually you finally get it right. Once sure, from reports at varying distances, that it is correct, a note should be made of the settings in case they are moved. The P-202 retails at £34.95.

Another useful accessory for improving 'talk power' at long distance (and fun to use at any distance) is an echo chamber and the ES 880 works well in this respect and is a smart good looking little unit. Again, this fits between the mic and the rig, with the

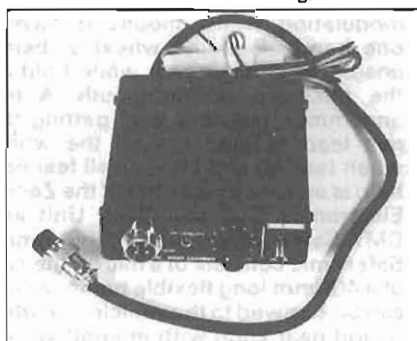

ES 800 echo chamber

normal 4-pin plugs and sockets already fitted. The front panel has the mic socket to the left, then a level indicator (LEDs), a level control, a power switch and a monitor jack for which an earpiece is provided. The earpiece is very useful for listening to and adjusting

The Nevada TC27RX pre-amplifier

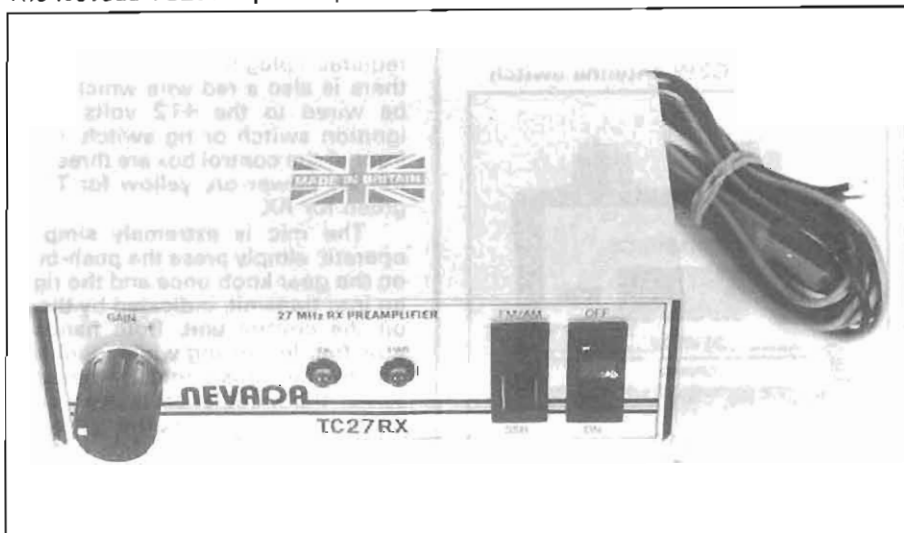

the echo without transmitting. At the rear of the case is a preset control which adjusts the repeat frequency of the echo. The dimensions of the ES 880 are 90(W) X 25(H) X 92(D) mm. Many breakers find these units annoying especially if turned up too high with a power mic but they really do help on those long distance copies. The ES 880 is a high quality echo chamber, is easy to set up and retails at £44.

All of this getting out is all very well but if you can't hear the other breaker very well then it's not much use. To this end we tried the Nevada TC 27 preamp, which is suitable for AM/FM and SSB, gain is variable from -6dB to +18dB and it really works. Many preamps that we have tried have actually attenuated the signal but the TC 27 certainly makes the S-meter needle jump up. Again, preamps don't do as much for FM as for other modes as, although the signal goes up, the signal noise ratio remains usually about the same. However, using the TC 27, quite a few inaudible breakers in the back of the box came up to an acceptable level and we were quite impressed. The 6dB negative gain facility is useful for attenuating strong signals especially if causing bleedover etc. The unit is powered from the 12 volt power supply and must not be used with a transmitter of more than 15 watts. The Nevada TC 27 RX pre-amplifier retails at £19.95.

Westward Electronics, makers of the Westward PT2 (see story titled 'CB in the Jungle' elsewhere in this issue), offer several accessories for use with their transceiver, two custom stainless steel whips for fitting directly into the portable, one a straight type and the other a more flexible, tapered version. They are pretuned for SWR and give the PT2 the performance of a mobile installation when used as a portable. A magmount to receive the whips is also available, enabling the system to be transferred to a vehicle.

Real leather carrying cases for the PT2 are also available, with custom carving of handles or even illustrations carved into the leather to individual specifications.

LADY BREAKERS



Filly does her bit

I was going to start this little story off by saying "Here's a heart-warming tale to warm the old cockles", but on reflection, you'd all think "Yuck! what mush!", and promptly turn the page. Wouldn't you, eh? So I thought I'd be clever and trick you into thinking this was one of my usual witty, offbeat anecdotes and introduce the sentiment gradual, like.

Anyway, it was a Sunday, which meant absolutely nothing was happening in our quiet backwater. I was out in the sun washing the Mini, listening to the hum of the bees, the chatter of the birds, the barking dogs, next door's radio, my husband's lawnmower, the local clay pigeon shoot club — well, OK, maybe it wasn't so quiet, but you get the picture. Anyway, there I was, minding my own business as ever, when something tapped me on the shoulder and I jumped three feet in the air, tipping over my bucket.

Behind me stood the old lady from Sunnyways, a rather secluded, in-need-of-repair cottage on the outskirts of the village.

"I hope I'm not interrupting you", she began.

"Oh, no, not at all", I said politely, picking up the bucket and mopping my streaming jeans.

"You see, I have a proposition to make", she went on, looking at me rather nervously. I looked at her, puzzled.

"It's my cottage", the old lady said. "It's a hundred years old, you know," I couldn't believe it) "and the roof's leaking, and there's a lot of damp in the kitchen, and the back door is literally hanging on by its hinges, dear..."

"Er, oh dear", I said helplessly.

"It's not the Council's, you see, dear, I have to do all the repairs, on my pension and all, and you see..."

I thought I did see. I also felt thoroughly guilty. The poor old dear lived all on her own, no one ever bothered to look in on her, and she had finally been forced to ask for help.

"That's all right, Miss Everett, I'll bring my husband round and we'll see what we can do," I began.

"Oh, no, dear, I'm not asking for charity. That is, I would certainly like a helping hand, but I've never taken something for nothing, and I've heard you all talking, you see."

"Er — talking?"

"Yes, on the radio, like."

"On the radio?" I repeated, foolishly.

"Er, you mean, on Citizens' Band?"

"Is that what they call it, dear?"

That's it. My telly's been on the blink, you see, and I get bored with the radio, the BBC, I mean, all howling music and talk about the Economy, so I listen to you all talking. Better than the telly, it is, sometimes."

"You've got a rig — er, a Citizens' Band radio?" I asked, fascinated. Ye gods, I thought, had we ever talked about her? Referred to poor old dears or silly old codgers?

"Yes, I know it's a rig, dear, and I've got a twig and all. My nephew got me it for Christmas, thought I'd be less lonely. And I am. Only, it seems to me you've got no-one to take messages for you, have you? Times I've heard one of you leave a message with someone, and they forget it. You see, I listen most of the day, I'm always in, and I thought, perhaps, I could pass messages on for you. And maybe, in return..." She stopped, looking a bit embarrassed, an old lady who's never taken anything from anyone. I knew she even refused meals on wheels. And this was the only thing she could give. What could I say?

"Well, that would be great, really great", I said with enthusiasm. "It would be marvellous if you wouldn't mind taking messages for us. We're a ramshackle lot, I know. Just name the day, and we'll come round and put the roof and the damp and the door right. What made you talk to me about it, by the way?"

"Oh", she said, turning to go. "I hear your voice more than anyone's. And they talk about you more than anyone."

I wasn't quite sure how to take that, but I let it go. I suppose I'm the nearest thing to a celebrity the village has got, which should give you some idea how much of a backwater we are!

It all worked out very well. Mrs Everett (Auntie, she insisted her handle should be) turned out to be sharp as needles. Once she'd found the confidence to actually press the button and talk, there was no stopping her. She saw off any wally that dared raise its head ("Young man, you should be ashamed of yourself!"), chatted up all the passing lorry drivers (who dote on her), and generally took over. She even does a couple of hours each day helping to monitor channel 9. She says she's forgotten what lonely means.

There, I told you it was heart-warming. Ahhhhh. But it made everyone a bit more aware of all the overlooked or forgotten members of the community, I must say. Pity we didn't think of it before.

The Eagle, Falcon & Hawk have landed

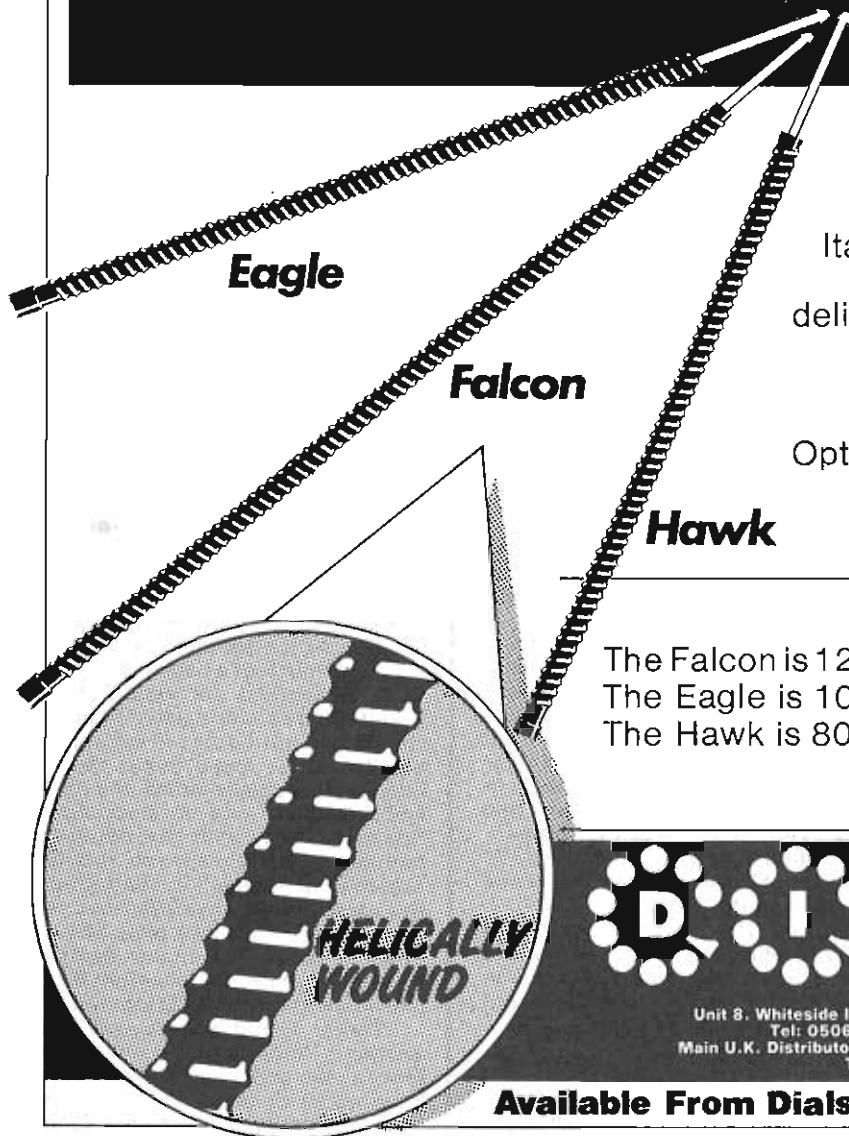

These Superior Quality Italian Manufactured Antenna are in Three Sizes but each deliver superb Power.

All are Helically Wound and Top Loaded to achieve Optimum Range.

The Falcon is 120cm Long and Only	£3.95
The Eagle is 100cm Long and Only	£3.50
The Hawk is 80cm Long and Only	£2.95

DIALS

Unit 8, Whiteside Industrial Estate, BATHGATE, West Lothian.
Tel: 0506 633386 Telex: 72165 ATT Dials.
Main U.K. Distributors for BREMI-HAM INTERNATIONAL MAXON
Trade Enquiries Welcome

Available From Dials Or Most Good C.B. Shops

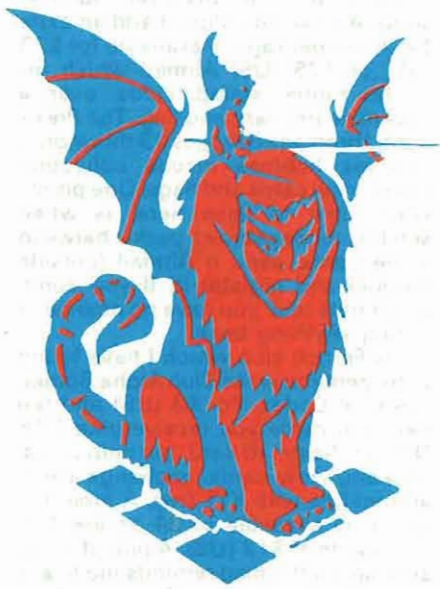

QSL club news from home and abroad, courtesy of David Shepherdson

This month, I want to start with some good news. Regular readers of these pages will remember that, way back in September 1984, I mentioned that Tony Yewen (The Rambler) had written in asking about the Dutch Trucking Club of Holland. He had sent off £12 to this club and hadn't received anything back. So, I asked if anyone out there had any info on this "club". Well, you responded! Tony was not the only one to have been ripped off by the then-president. Anyway, after many months and letters from several people, my thanks go to the person who found the new address of the club and asked them to get in touch with me. Koos, the new President of the Dutch Trucking has written promising to help by honouring any one who was ripped off providing proof is sent. Koos also says that because they have paid so much for the club, these packages will not include a club stamp. If anyone wants the address to claim their package, then drop me a line with a stamp, as until I hear from the people who have received a reply, I will not include its address in these pages.

Home now with the news of the Red Chief Club of Preston. This club closed earlier this year due to personal reasons but members' cards will not be lost as it has been arranged that these will be passed out via the Great British QSL DX Club of Consett. Any RC members with queries should write to the GBQDC enclosing a SASE. Also, the RC Club donated all their stocks of club Christmas and eyeball cards, along with a large part of their personal collection, to the Ghost Rider Appeal Auction which was held at Stanley on January 26th.

Last month I mentioned that I had taken over the Big Ben Club, and now I can give you the details of the new club and its package. It will now be known as the New Big Ben Club (1985) and is part of the Dragonrider QSL Club. The BB was one of the first clubs I joined and, when I heard it was closing, I decided to see if it could be

COMMUNICATION THE QSL WAY

saved and not go the way of most of the other original clubs. Anyway, once I had received the rather large parcel from Colin (the ex-President), I redesigned the club package as follows. Originally it cost £8 to join; well now, it costs only £4 with five personal QSL cards for an even better package than before! I do ask that these are your personal cards please. Other clubs' cards and printers' stock cards are perfectly acceptable to fill out your QSL packages when accompanied by one or more of your own cards, but not really when used to join another club. For your £4 you will receive, by recorded delivery, your packet which will include your unit number, ID card, certificate, rubber stamp, club stickers, 20 or more exchange QSLs, invites to recommended clubs, DX and QSLing tips, local view cards, lots of tourist info, ten new design two-colour gloss club QSL cards, invites for you to pass on, a surprise item and, while stocks last, a key ring. Also, if you are not already a Dragonrider, then membership of the parent club as well! All for £4 plus five personal cards and XYL/M free too. As a special offer to members of the original Big Ben, a membership package is available for £2, which is as above just minus the stamp. The new club has nothing to do with the Duke, the founder of the original club, and all invites without my address on should be destroyed please. You are all most welcome to join, and payment can be in cash, postal order or UK cheque, made out to the DR Club, along with your five personal cards.

Right, some names and addresses before I run through some clubs I've been putting off for a while. There has just been so much to mention these have just been skipped over until now. First up comes a selection of gold-foil type cards, from Ashby-de-la-Zouch, where one type is printed, comes Harold (The Stud) with a nice set, even an eyeball card in the same style! From Ann (Lucky Lady) of Wolverhampton comes a large pipe from the following members of her club, which I believe is for local breakers only. Ray (Shark-

hunter), Mick (Farmer Giles), Ken (Rubber Legs), Bill (Manitou), Kelvin (Radar), Mary (Lady Snowball), Tony (Helping Hands) and Margaret (Primrose). These are all printed by Mick (Pedigree) who trades as Midas Cards. Congratulations go to Ann and Harry on their silver wedding anniversary; here's to the next 25 years! In last month's special on QSLing, I said that this type of card was available from £6 per 100. Since then, I've found out that that is the re-order price! So apologies to anyone who had a shock at the difference in price if you asked about a card. If you are interested in these cards, the first 100 cost £18 but that includes making the block.

Right, Club time and the first one up here is Sierra Tango DX Club of Braintree in Essex. For £5, cash or postal order, your package will be on its way to you and includes your ST No, certificate, club roster and stickers, ten club cards, ten QSL certificates, exchange cards and info. There are two club stamps available at £3 each. One shows a shield with three swords, and the other a coat of arms. Both are circular with the "Skip Talkers" and club AD shown and come fully-mounted. Other extras include full colour QSL cards, matches, key rings, pens, PVC wallets and sew-on patches.

News in from the Yankee Papa Int' and Echo Whisky Clubs of Bracknell to say that they have joined forces to offer either single or joint memberships. For £2 and ten cards, you can obtain your YP No, ID card, certificate, ten club cards etc, while for £3 and ten cards you can get your EW No etc, like with the YP Club, but with a key ring included. However, discount membership is available when joining both together costing £4, with rubber stamps at £3 each, or £5 the pair.

The Vice President of the Sierra Victor Club has dropped me a line with info on the club's offers. There are so many items that, for a full list, please drop either Peter (SV 001) or Glen (SV 18) a line with a SASE. For an example, there are seven designs of cards available ranging from £2 per 100 to £6, five different club stamps all at £3 each, with log books, transfers, DX certificates, newsletters and so on available. For current details and membership costs, please send a SASE with a request to the club address.

News in from Headache Control (Fred) of Northampton with details of his latest Currie QSL card, and saying that he is looking forward to seeing as many of you at the meeting at Stanley. Membership of the Headache Control costs £5 and ten or more cards, and your package consists of at least your "Headache" No, certificate, ID card, unmounted stamp (and it's a big 'un!), souvenir of Northampton, five club cards, five club envelopes, roster and lots more. The meeting Fred's referring to is, to give it its full title, "The 1985 CB/Radio Big Meeting" and is jointly organised by the G8QDC, RDX and Derwent Valley Junior Breakers (with apologies for missing them off until now). It's a free admission indoors meet for QSLers, DXers and Cbers; in

fact everyone who is interested! There will be clubs to join, both free membership and fee-charging, eyeball badge engraving and lots more. See the Events slot for time and place. There are dozens of clubs expected to attend so come along and meet the clubs and people you've QSLed and never meet, and see if they are as you expected. Bring a bit of money as most clubs will probably have special offers on club items on the day. For example, Zulu Whiskey will have a limited supply of club stamps at £2 each, club cards at £2 per 100, and both for £3.50, but only at the meeting. So bring your club ID cards or whatever, bring some swap cards, bring some money but, most importantly, bring yourselves! The final message about this comes from the ZW President, Gordon, who asks for all clubs attending to bring a good supply of invites to exchange with other clubs to save on postage.

Stepping overseas for a while now with info on the Cosmos Eleven DX Club of Japan. For ten personal cards

and \$1 (US) you receive your CE No, ID card and club info. This is sent Surface, so for Airmail you should add an extra \$2. A full package is available for \$23 (US) or \$25 (US) Airmail which includes rubber stamp, cards, even a Japanese pennant and flag. The President, Hiromasa (Hiro), is 23 this month and his hobbies include collecting coins, view cards and flags. One point I would like to raise here, is when sending money abroad, pack it between some cards, send it Airmail (outside Europe) and register it! If you don't, and it gets lost, you have no chance of getting anything back.

A French club which I have found to be genuine is the Club Alpha Romeo (CAR) of Cedex. For \$8 (US) and ten personal cards you receive your CAR No, certificate, ID card, ten club cards, stickers, view cards, exchange cards and invites with XYL free. A mounted stamp is available at \$4 as are 100 club cards at \$12 (US). A pile of cards sent up via the mag reminds me to ask if you want a mention, drop me a line, either via the mag or direct c/o the DR & BB Clubs, if you want a reply then please do send return postage. Top of the pile is Andrew (Caveman) with a Currie card and he likes swopping QSLs and guarantees to all cards received. Another Andrew (Silver Mirror) of Worcs QSLs with a two-colour gloss card and asks for a mention, whilst Sally (Tank Lady) sends a set of Ensigns out including a rather amusing one with an 'L' plate on! Sid (Sailor) and Mary of Essex ask for a mention as 100% QSLers. Sid is disabled and spends most of his time on his rig and really enjoys both his rig and QSLing. Dave (Knightrider) of Hampton sends in yet another Currie



card, with news of his local CB club which has a QSL section. Now, I've a message here for China Doll of Oxford. It comes from a local breaker who just wants to say thanks and well done to her for all her work in giving help and directions to lost truckers and reps on channel 23. Well done China Doll, keep it up.

Right, a quick mention for the Cutty Sark POMA swap meeting held the other weekend. It was well attended by QSLers from all over the UK and Europe, with one bit of news that was a surprise to many. This was that Tony (CS 1) had handed the club over to Ron (CS 2) and had also decided to retire from QSLing. As I told you Tony, the hobby will miss you, but I appreciate your reasons and wish you all the best. Also good luck to Ron, the new President. Membership now costs £4 which will fetch a package including stamp, certificate, ID card etc.

Forthcoming Events that I know of at present are the Big Meeting at Stanley Youth Centre, Co Durham, on the 28th April between 11am and 4pm. Admission is free, all are welcome and many clubs are expected. It will be signposted from the Chester-le-Street turn-off from the A1 motorway.

The other one I have details of is the Firebirds organised Poma Card meeting to be held at the St. Stephens Community Centre, Canterbury, on June 8th. Everyone is welcome to come and three Dutch clubs will be attending as these have asked the

Firebirds to organise it. They are the Cheesebearers, Old Dutch Fisherman and Happy World clubs.

Before I close, a bit of bad news in a letter from Brian (Witch King) who writes in to warn us about the Liberty Sideband Club of Maryland, USA and the Radio Ontario Sidebanders, Canada. Brian has sent money off to both these clubs and hasn't received anything back from either. Please be advised!

If you have any comments, want a mention or have any news of QSLing events, please drop me a line, enclosing return postage if you want a reply

and I'll see what can be done. If it's at all urgent, then send it direct to me please; if sent via the mag, it can take a little while until I get it.

One bit of late news, last month I asked if Nige of the Tower Town would like to get in touch about the lack of replies his club have been giving of late. Well, Paul, the guy who deals with the post for the club, has been away in York for four months and apologises for the delay but he is back now and is doing his best to catch up. Okay, that's definitely it for this time; all the best numbers.

COMMUNICATION THE
QSL
WAY

QSL Services' Addresses:

Currie Cards	89 Derwent St, Blackhill, Consett, Co Durham.
Ensign Cards	58b Market Street, Ashby-de-la-Zouch.
Midas Cards	40 Marklew Cl., Shire Oak, Brownhills, West Midlands.
Poma Cards (Via UK Rep. Ray)	PO Box 16, Canterbury, Kent.

When writing to any club or service, always enclose return postage to assist with their reply.

COMMUNICATION THE
QSL
WAY

QSL Club Addresses:

Club Alpha Romeo	PO Box 1011, 66010 Perpignan, Cedex, France.	Mary (Lady Snowball)	3 Castlefort Road, Walsall Wood.
Cosmos Eleven DX Club	PO Box 157, Toyohashi 440-91, Japan.	Kelvin (Radar)	14 Marklew Close, Shire Oak, Brownhills, W. Midlands.
*Cutty Sark QSL Club	16 Alanthus Close, Lee Green, London.	Bill (Manitou)	BB 15, PO Box 154, Wolverhampton.
Firebirds QSL Club	PO Box 9, Brighton, East Sussex.	Ken (Rubberlegs)	13 Stockton Road, Reigate, Surrey.
Great British QSL DX "Headache Control"	PO Box 5, Consett, Co Durham.	Mick (Farmer Giles)	PO Box 154, Wolverhampton.
Romeo Delta X-Ray	33 Nicholls Court, Thorplands, Northampton.	Ray (Sharkhunter)	BB 115, PO Box 154, Wolverhampton.
Sierra Tango DX Club	10 Wallace Street, Rutherglen, Glasgow, Scotland.	Ann (Lucky Lady)	BB 3, PO Box 154, Wolverhampton.
Sierra Victor	PO Box 314, Braintree, Essex.	Harold (The Stud)	80 Ridgeway Road, Ashby-de-la-Zouch, Leics.
*Yankee Papa/Echo Whisky	43 Gredon Rise, Sileby, Leicester.	Sally (Tank Lady)	PG Box 55, Horsham, Sussex.
Zulu Whiskey Int'	PO Box 61, Bracknell, Berks.	Dave (Knightrider)	HM 20, PO Box 11, Hampton, Middlesex.
*Big Ben (1985)	PO Box 14, Brighouse, West Yorkshire.	Andrew (Silver Mirror)	10 Elm Road, Evesham, Worcs.
Dragonrider Club (DR 1)	c/o Dragonrider Club.	Andrew (Caveman)	3 Manor Close, Bilbrook, Codsall, Nr. Wolverhampton.
*New Addresses	3 Tarn Villas, Cowpasture Road, Ilkley, West Yorks.	Ann (Devil Woman)	PO Box 5, Stornoway, Isle of Lewis, Scotland.
		Sid & Mary (Sailor)	250 Rochford Road, Southend-on-Sea, Essex.
		Tony Yewen (The Rambler)	PO Box 1, Wednesbury, West Midlands.
		Brian (Witch King)	BT 160, PO Box 123, Reading, Berkshire.

QSLer Addresses:
Tony & Margaret

5 Blakenhall Close, Blakenhall, Walsall.

UNDERSTANDING PLL SYNTHESIZERS

Sample PLL Synthesizer

Refer to Figure 2, which illustrates the basic design. This particular circuit is probably the most common second-generation example of an American 40-channel AM radio, and has been found under dozens of brand names. Also refer to the chart of Figure 3, which is a complete breakdown of all the important circuit constants we'll be discussing.

PLLs may be categorized according to the number of crystal oscillators; our example uses two crystals. Three-crystal systems are also common, particularly for SSB use. Current state-of-the-art now uses a single 10.240MHz crystal and a very sophisticated PLL chip and is widely found in British and American rigs. The single-crystal PLL design has the advantages of low cost, simplicity, and high resistance to illegal frequency modification. It is no accident that the most popular (albeit illegal) radios in Britain at the moment are those using the PLL02A or similar chip. The reasons will become obvious shortly.

The key to the PLL's ability in synthesizing all the required frequencies lies in the Programmable Divider, which is the only section controllable from the outside world at the Channel Selector switch. It is the operator's choice at the Channel Selector which begins the whole process.

Suppose we wish to operate on CB Channel 1, which is 26.965MHz. (American channels used here for simplicity.) With the Channel Selector in this position the Programmable Divider receives a very specific set of instructions at its programming pins, which are physically connected to the switch. The instruction set is called an "N-code." This N-code is merely a divisor which will divide down the signal appearing at PLL pin 2 by a fixed amount. As shown in the chart of Figure 3, the divisor or N-code for CB Channel 1 is 330; at Channel 40 it is 286, etc. The number 330 is the direct result of applying a DC voltage to certain program pins on the PLL while earthing certain others. Recall that the PLL requires a digital or "binary" counting system rather than the common decimal system used by human beings. In the binary counting system, each successive program pin is given a different weight or significance which is exactly twice that of the one preceding it, such as 1,2,4,8, etc. Program pins containing the voltage are indicated by a "1" in the chart and those which are earthed are indicated by a "0" such that all 40 channels have sets of binary instructions. A chart like this showing the state of each pin is called a "Truth Chart."

The N-code number 330 was derived as follows: Shown here is a small section of the Truth Chart. Notice that above each PLL program pin is another number we've called "Powers of 2", such as 2,4,8, all the way up to 256 because this is precisely how a binary counter counts. By reading across the channel column from right to left and adding up the weights on those pins where a "1" appears, the N-code divisor is determined.

POWERS OF 2	1	2	4	8	16	32	64	128	256
PLL PROGRAM PIN NUMBER	15	14	13	12	11	10	9	8	7
TRUTH STATE, CHANNEL 1	0	1	0	1	0	0	1	0	1

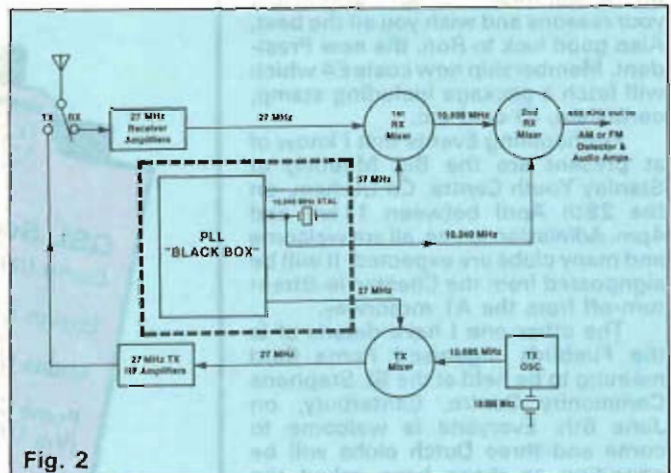

Fig. 2

In this example, we have $256 + 64 + 8 + 2 = 330$. The reader is invited to verify the N-code for any other channel in the Chart (Figure 3).

In this particular radio, the states of program pins 7 and 8 do not change regardless of which channel we observe. Rather they are permanently wired such that pin 7 is always connected to the DC voltage ("1") and pin 8 is always connected to earth ("0"). Since the PLL device contains a total of 9 binary programming pins (pins 7-15), it will be seen that such a device has a potential channel capability of $2^9 - 1$ or 511 channels! Only 40 channels are required for CB purposes but it's quite clear now that by proper switching of the programming pins, many more (illegal) frequencies are possible. Later we'll examine the kind of steps manufacturers are taking to make this possibility more difficult.

Now we'll move to the VCO section of the PLL. This VCO operates in the 17MHz range; specifically, 17.18MHz at Channel 1, up to 17.62MHz at Channel 40. The VCO is controlled by an error voltage received from the Phase Detector. The Phase Detector in turn is looking for a match between the outputs of the Reference Divider and Programmable Divider. The Reference Divider is very accurately controlled by the 10.240MHz crystal oscillator whose signal is divided down digitally by the number 1,024 to produce the 10KHz channel spacings. If the Programmable Divider should also happen to produce a 10KHz output the result would be perfect i.e., no error correction from the Phase Detector, and the loop would be locked.

What would it take to produce a perfect 10KHz output from the Programmable Divider? We already know that the Programmable Divider is set up to divide whatever signal it sees by the number 330. If it should see, for example, a signal of exactly 3.3MHz appearing at PLL pin 2, its resulting output would be 10KHz. ($3.3\text{MHz} \div 330 = 10\text{KHz}$.) If therefore a signal of exactly 3.3MHz is produced, everything will be perfect!

As it happens there is a very easy way to do this by

ING CB ZERS

Lou Franklin
("Supasparks")
concludes his easy-
to-follow guide to
how frequencies are
generated

cleverly "borrowing" some existing circuitry. If a bit of the Reference Oscillator's 10.240MHz energy is tapped off and passed through a tuned circuit designed to act as a doubler, the result will be 20.480MHz (2 X 10.240MHz.) Here's where that very important mixing principle enters the picture: By mixing the 20.480MHz signal with the 17.18MHz Channel 1 signal, sum and difference frequencies are produced. The sum frequency is 20.480MHz + 17.18MHz = 37.660MHz. The difference frequency is 20.480MHz - 17.18MHz = 3.3MHz. The 3.3MHz signal is precisely what's needed to lock the loop on CB channel 1. And the 37.660MHz signal is not wasted either; it is taken off to be used as an injection signal to produce the first receiver IF by mixing it with the incoming 26.965MHz Channel 1 signal.

What happens if the resultant mixture entering the Programmable Divider is not exactly 3.3MHz? Since the

Fig. 3

Circuit Constants & Truth Chart For Sample PLL Synthesizer Described in Text

Channel No.	Channel Freq. (MHz)	"N" digital codes	VCO Freq. (MHz)	Rx 1st IF Freq. (MHz)	15	14	13	12	11	10	9	8	7
1	26.965	330	17.18	37.66	0	1	0	1	0	0	1	0	1
2	26.975	329	17.19	37.67	1	0	0	1	0	0	1	0	1
3	26.985	328	17.20	37.68	0	0	0	1	0	0	1	0	1
4	27.005	326	17.22	37.70	0	1	1	0	0	0	1	0	1
5	27.015	325	17.23	37.71	1	0	1	0	0	0	1	0	1
6	27.025	324	17.24	37.72	0	0	1	0	0	0	1	0	1
7	27.035	323	17.25	37.73	1	1	0	0	0	0	1	0	1
8	27.055	321	17.27	37.75	1	0	0	0	0	0	1	0	1
9	27.065	320	17.28	37.76	0	0	0	0	0	0	1	1	1
10	27.075	319	17.29	37.77	1	1	1	1	1	1	0	0	1
11	27.085	318	17.30	37.78	0	1	1	1	1	1	0	0	1
12	27.105	316	17.32	37.80	0	0	1	1	1	1	0	0	1
13	27.115	315	17.33	37.81	1	1	0	1	1	1	0	0	1
14	27.125	314	17.34	37.82	0	1	0	1	1	1	0	0	1
15	27.135	313	17.35	37.83	1	0	0	1	1	1	0	0	1
16	27.155	311	17.37	37.85	1	1	1	0	1	1	0	0	1
17	27.165	310	17.38	37.86	0	1	1	0	1	1	0	0	1
18	27.175	309	17.39	37.87	1	0	1	0	1	1	0	0	1
19	27.185	308	17.40	37.88	0	0	1	0	1	1	0	0	1
20	27.205	306	17.42	37.90	1	1	0	0	1	1	0	0	1
21	27.215	305	17.43	37.91	1	0	0	0	1	1	0	0	1
22	27.225	304	17.44	37.92	0	0	0	0	1	1	0	0	1
23	27.255	301	17.47	37.95	1	0	1	0	1	0	0	0	1
24	27.238	303	17.45	37.93	1	1	1	0	1	0	0	0	1
25	27.245	302	17.46	37.94	0	1	1	0	1	0	0	0	1
26	27.265	300	17.48	37.96	0	0	1	0	1	0	0	0	1
27	27.275	299	17.49	37.97	1	1	0	0	1	0	0	0	1
28	27.285	298	17.50	37.98	0	1	0	0	1	0	0	0	1
29	27.295	297	17.51	37.99	1	0	0	0	1	0	0	0	1
30	27.305	296	17.52	38.00	0	0	0	0	1	0	0	0	1
31	27.315	295	17.53	38.01	1	1	1	0	0	1	0	0	1
32	27.325	294	17.54	38.02	0	1	1	0	0	1	0	0	1
33	27.335	293	17.55	38.03	0	0	1	0	0	1	0	0	1
34	27.345	292	17.56	38.04	0	0	1	0	0	1	0	0	1
35	27.355	291	17.57	38.05	1	1	0	0	0	1	0	0	1
36	27.365	290	17.58	38.06	0	1	0	0	0	1	0	0	1
37	27.375	289	17.59	38.07	1	0	0	0	0	1	0	0	1
38	27.385	288	17.60	38.08	0	0	0	0	0	1	0	0	1
39	27.395	287	17.61	38.09	1	1	1	1	1	0	0	0	1
40	27.405	286	17.62	38.10	0	1	1	1	1	0	0	0	1

NOTES: 1) HIGH Level ("1") - 4.5 to 5.5 VDC; LOW Level ("0") - GND.
2) Pins 7 & 8 permanently wired HIGH & LOW respectively for all 40 channels and are often not even shown in the TRUTH CHART

N-code is set up to divide by the number 330, any signal other than precisely 3.3MHz will produce an output somewhat different than the required 10KHz. For example, if a signal of only 3.1MHz is presented to the Programmable Divider, the result would be 3.1MHz ÷ 330 = 9393.94MHz. The Phase Detector will now sense this error and will produce a correction voltage which will drive the VCO up or down slightly in frequency until an exact match is found again. Although it may take some trial-and-error experimenting before an exact match occurs, the entire process happens in a matter of

micro-seconds. The PLL is a very smart computer indeed!

Our basic PLL example is now complete; everything else occurring around the loop is a bonus. We've already seen how one of the resultant mixer signals, 37.660MHz, is used to provide IF injection for the receiver section. When mixed with a Channel 1 signal of 26.965MHz, the difference product will be 37.660 - 26.965 = 10.695MHz. (The sum product is ignored.) Refer again to Figure 2. Notice we can make a very clever third use for the 10.240MHz crystal oscillator: By mixing it with the 10.695MHz IF just produced, a second or "low" IF occurs. The second IF is 10.695MHz - 10.240MHz = 455KHz. (Sum product ignored again.) Almost all AM or FM receiver circuits use this "double conversion" technique. It is the most common method and is found in automobile radios, scanners, FM stereos, and many other receivers besides CB radios. It is precisely because so much electronic equipment operates at 10.7MHz and 455KHz that it would also find its way in CB usage; a great deal of existing circuit hardware is available for these universally-accepted IFs. The parts are cheap, effective, and readily available to manufacturers.

What about the Transmitter section of this CB transceiver? In this circuit, the on-channel operating frequency is produced very simply. A separate 10.695MHz crystal oscillator mixes with the 37.660MHz output of the PLL in the Transmit Mixer stage. Its output is 37.660MHz - 10.695MHz = 26.965MHz (Channel 1) which is then amplified through the transmitter stages.

We've made no mention so far of AM vs. FM vs. SSB modes of operation. The reason is because these differences basically have nothing to do with the PLL function itself, except in the case of SSB. For SSB at least three sets of frequencies are required in a multimode transceiver, one AM, one for USB, and one for LSB. Since the USB/LSB frequencies are only slightly different from the main AM or FM carrier, they are typically generated either by switching in separate offset crystal oscillators or by switching in other components which detune the main crystal oscillator just a bit. In addition the Clarifier or Fine Tune panel control is also connected to this sensitive area to allow the operator a small bit of frequency shift. See Figure 4.

There is no important difference between AM vs. FM operation with regard to the on-channel carrier; it's the same in both modes. For FM transmission though, the PLL Mixer stage is used to produce the required frequency deviation; a tiny signal which varies at an

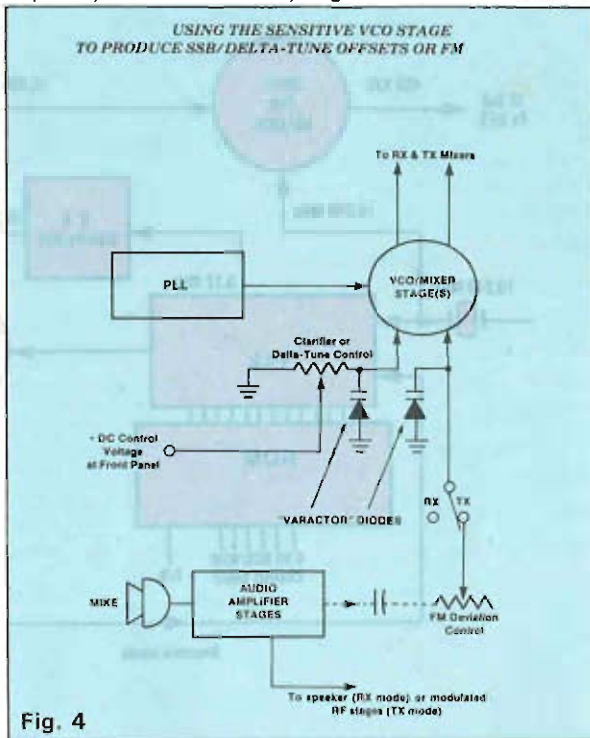

Fig. 4

audio rate is applied here to produce FM. Figure 4 shows this connection point in the PLL circuit. FM reception is also identical to AM reception as far as the PLL is involved. The difference between AM and FM reception occurs only in the way the signal is detected after all the standard IF conversions are made.

Other Channel Spacings

Mention was made of the fact that the British Home Office CB specs call for channel frequencies which appear to be completely incompatible with those of

10.240MHz signal by 1,024 to get 10KHz spacing, they can also divide it by 2,048 to get 5KHz spacing. ($10.240\text{MHz} \div 2,048 = 5\text{KHz}$.) Such a device will produce continuous 5KHz frequency increments all along its operating range.

With the Home Office specs calling for a Channel 1 frequency of 27.60125MHz, it would be very easy to use a PLL chip that generates a frequency of, for example, 27.600MHz, and by the simple addition of some adjustable capacitance or inductance at the Reference Oscillator or PLL Mixer, offset this frequency by the required 1.25KHz to generate the British 40-channel CB band. This is exactly the same method which is commonly used for the SSB offsets previously described. See Figure 5. Of course this adjustment would be internal to the radio and fixed at the factory. However the interested CB experimenter could make front-panel shifting possible so that the final operating frequency could be made compatible with the frequency assignment of any other country's CB band.

Recent Developments — Rom PLL

The popularity of CB radio today has resulted in services which are very overcrowded and often impossible to use for reliable radio communications. For this reason many CB operators feel justified in "rolling their own" frequencies outside of the officially-authorized channels. We've pointed out how easy it is to generate a very large number of frequencies by simply changing the voltage states on the PLL programming pins or by substitution/shifting of crystal oscillators. The net result of all this illegal CB operation has been to force manufacturers into new PLL designs which are more tamper-proof. The PLL chip has thus been called upon to perform many more functions than originally intended and the newest generation of ICs reflect this trend. They are much more sophisticated. However in the process of complicating the internal chip functions, the external parts requirements have been simplified, resulting in CB equipment prices which have been kept affordable to the public.

The major PLL design trend has concentrated on an IC with the following characteristics:

1. Operation of entire radio with single 10.240MHz crystal oscillator;
2. Immunity to external programming changes which the operator could previously perform by changing electrical potentials on the IC pins.

Refer to Figure 6 which illustrates a PLL design using some of these changes. Note that the difference between

Fig. 5
OFFSET TUNING FOR NON-STANDARD
U.K. RIGS, SSB, etc.

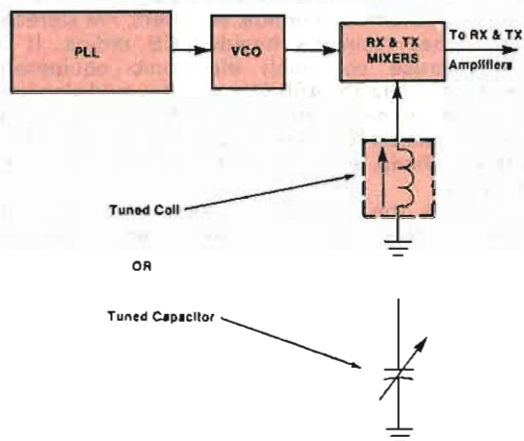

Tuning circuits offset VCO frequencies by proper amount to produce desired frequencies, external to the PLL chip itself.

other countries. The reader should realize by now that it is quite easy to generate virtually any set of desirable frequencies with PLL synthesis. While the CB channel spacing of most other countries is assigned in 10KHz increments ending in the number "5" (26.965, 27.405, etc.) there are many PLL chips having the capability of ending in the "0" numbers too, such as 26.960 or 27.410. These chips employ Reference Dividers which are externally switchable such that they can create 10KHz or 5KHz steps. Instead of only dividing the

Fig. 6

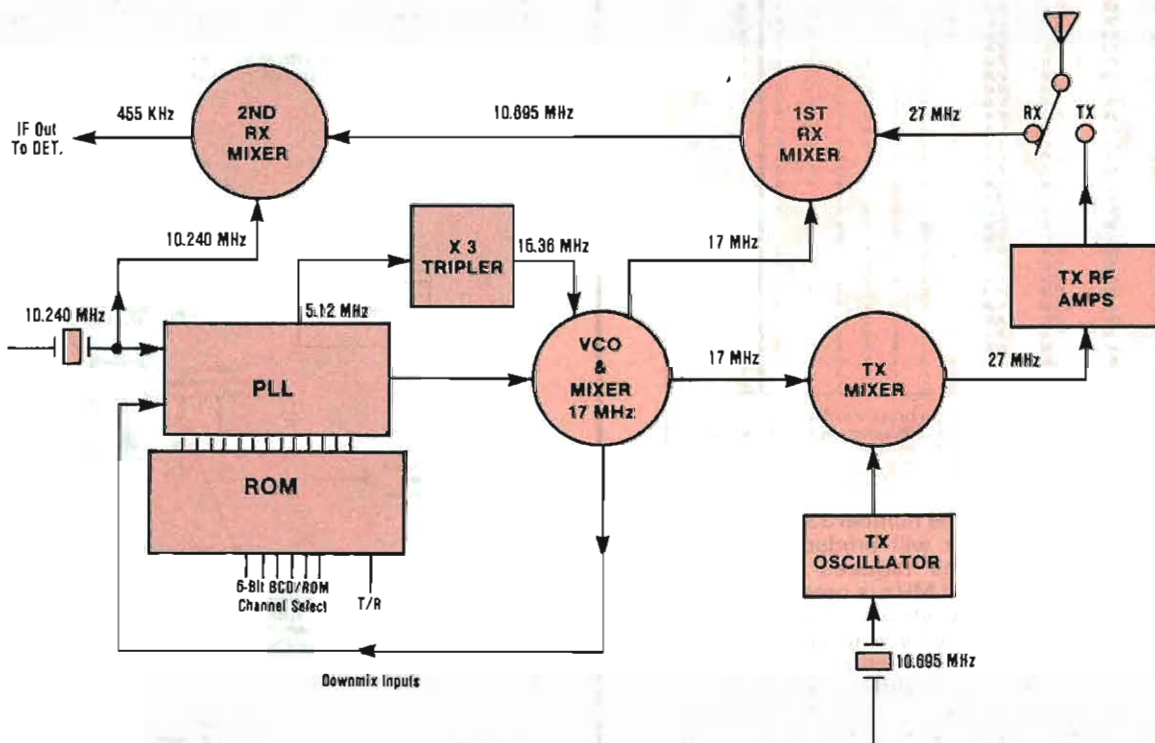

this circuit and that of Figure 2 is (1), an additional IC pin called "T/R" which is required when shifting between Receive and Transmit modes; and (2), internal to the chip, safely out of reach by the operator, is a special sub-section called a ROM Code Converter.

The ROM Code Converter is the key to illegal channel prevention. The required legal channel N-codes for only 40 channels have been permanently written into the PLL IC during manufacture. ROM in fact is widely used in other computers and stands for "Read-Only-Memory." The programming lines that connect the PLL to the outside world at the Channel Selector switch are used solely to command the ROM to release its stored N-code information to the Programmable Divider, which then performs the appropriate signal division as in our earlier example. Note also that there are now only 6 program lines leading from the PLL IC to the Channel Selector. Recall the earlier example had 9 program lines which in the binary number system made it capable of a possible 2^9-1 or 511 channels. The reduction to only 6 program lines makes it obvious that even if the PLL did not contain ROM, it would be capable of only a possible 2^6-1 or 63 channels. The use of ROM reduces this number to exactly 40. The ROM can only recognize 40 different combinations of voltages/earths ("1s" & "0s") coming to it from the Channel Selector. Any attempt by the operator to force a programming change by applying a different set of voltages/earths will either go unrecognized by the chip or will actually cause the transmitter circuitry to shut down.

Note also that this chip provides a 5.12MHz output pin. A simple $\div 2$ circuit in the Reference Divider section allows this feature. ($10.240\text{MHz} \div 2 = 5.12\text{MHz}$.) If the 5.12MHz signal is then tripled by a tuned circuit, a signal of 15.360MHz ($5.12\text{MHz} \times 3$) is produced that can be mixed with the VCO signal. This on-chip output pin saves the expense of one more crystal oscillator circuit. The 15.36MHz signal is mixed with the VCO and the difference frequency is selected. This difference frequency is called the "downmix" signal which then enters the Programmable Divider as before. The ROM divides the downmix signal into 5KHz segments rather than 10KHz segments; the reason is shown next.

Since in this circuit there is now only one additional frequency (10.240MHz) available for mixing purposes, the VCO is required to shift its frequency between Receive and Transmit modes in order to produce the proper Transmit frequency. Recall the simpler PLL circuit had its own 10.695MHz crystal oscillator. However now in order to produce a 10.695MHz signal, the VCO must shift up by 455KHz ($10.240\text{MHz} + 455\text{KHz} = 10.695\text{MHz}$.) This is done by changing the count in the

Programmable Divider itself by way of the special T/R pin on the IC. The T/R pin when activated by pressing the microphone button causes an upward shift of 91 counts inside the Programmable Divider, thus giving the needed 455KHz shift ($91 \times 5\text{KHz} = 455\text{KHz}$.) The shift is another automatic built-in feature of this PLL.

Figure 7 shows the actual PLL circuit of current production UK-FM rigs using the Sanyo LC7136 or LC7136 PLL chip. This circuit represents the final step in PLL designs which makes illegal channel modifications virtually impossible. There are several differences from that of Figure 6:

1. The T/R shift not only changes the N-Code between modes, but also shifts the VCO frequency by 3MHz. Thus in the Transmit Mode, a 13MHz VCO signal is doubled to the correct 27MHz channel while in the Receive mode, a 16MHz VCO signal is used for the first Receive Mixer injection as in previous designs.
2. There is no downmix stage at all; the chip is capable of direct VCO division in the 16MHz range.
3. Pins have been added to the chip to simplify the recall of either Channel 9 or Channel 19 from the front panel; a switch option may be present which simply calls up the correct N-Code from the ROM.

To summarize, those PLL designs which appear to be the simplest in terms of the number of parts used are actually the most difficult to modify for unauthorised operation. In the example of Figure 6, the only way to change frequencies would be to provide an external signal to mix with the VCO signal. If the 15.36MHz signal were disconnected and another signal from a separate oscillator circuit replaced it, new frequencies would be generated. For example, 14.91MHz would generate the 40 channels below FCC Channel 1, and 15.81MHz would generate the 40 channels above FCC Channel 40. In fact this is exactly what is done in many rigs appearing in Europe and the UK in recent years. This modification is obviously more trouble than the simple chip program changes described earlier. However for the determined radio hobbyist anything is possible!

Lou Franklin is a long-time CB and amateur radio operator, and author of the popular "SCREWDRIVER EXPERT'S" GUIDE and THE CB PLL DATA BOOK from which the above article was condensed. These books are currently available in the UK from ROGER D COMMUNICATIONS of Nottingham. For a complete catalogue of unusual CB specialty books, plans and accessories, write to Lou's firm, CB CITY INTERNATIONAL P.O. BOX 31500, PHOENIX AZ 85046 USA. Please include 3 or 4 IRCs to help cover Air postal costs.

Fig. 7

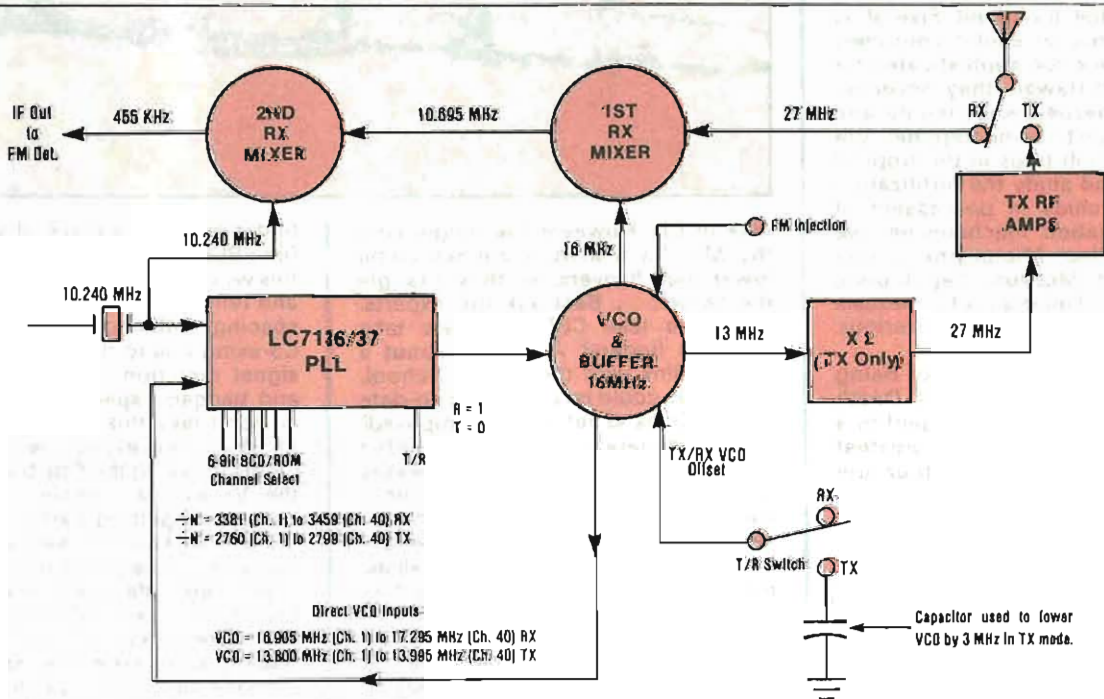

CB IN THE JUNGLE

Last year, an expedition from Oxford University's Plant Sciences department set off to penetrate the undisturbed tropical rain forests of Venezuela. Jim Hyndman brings us this exclusive report of how they used CB to communicate

It was a normal autumn day in Oxford. The dreaming spires were occluded by a grey mist, and rain pummelled the skylight of the departmental library. Its comatose occupants snorted Tippex and pored over the annals of botanical literature. But was this real botany? So much for the field trips. One day we might venture as far as Didcot, or even Swindon, to survey the effects of acid rain on trampled anthills, though even this was still a dream. Until now, fieldwork meant gently subsiding into a squelchy area of Port Meadow.

We had to get our act together and get out, and so it was that the roots of the Oxford University Expedition to Venezuela 1984 took hold. Five of us started to write to exotic countries. Clearly we were too sophisticated for Barbados and Hawaii, they never replied, but Venezuela was friendly, and a project began to come together. We planned to climb trees in the tropical rain forest, and study the fertilization of various orchids in possession of bizarre pollination mechanisms; we hoped to collect Microhymenoptera for the British Museum, Lepidoptera for the National University of Venezuela (UCV), and to chase the mysterious arboreal grasshopper.

Though there was a risk of being eaten by the infamous Certain Death Woogi-Woogi ants, or kidnapped by a tribe of Howler Monkeys, our greatest danger was of losing each other; our jungle would have enough ground vegetation to choke a megawatt trimmer, and people have been known to lose themselves while only several feet from their companions. And what if the Arumbayas attacked us with curare blowdarts? Would we use flares, or homing hummingbirds to alert base camp? Commonsense ushered in the

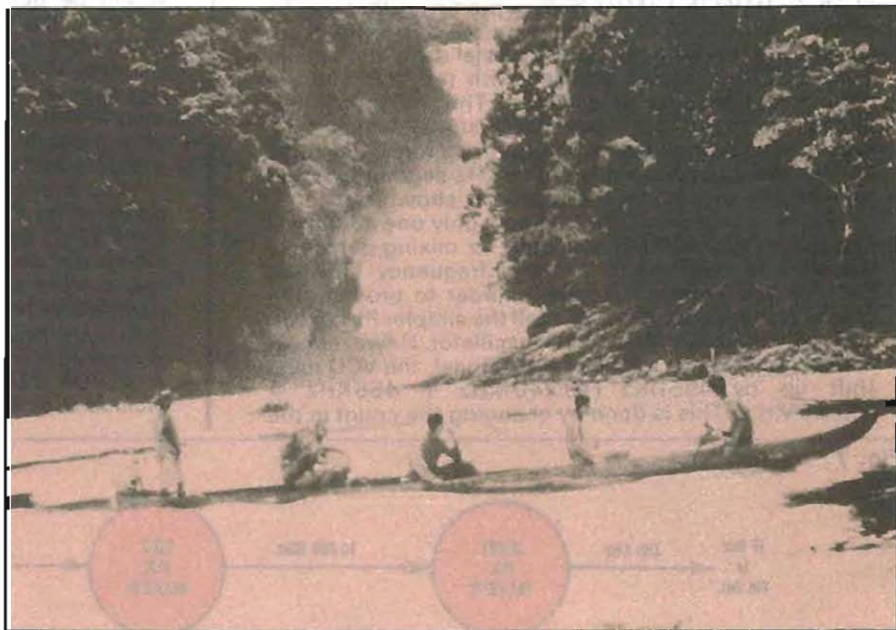

idea of CB. However the jungle isn't the M1; for a start, branches come lower than flyovers, so they'd tangle the twigs . . . Best ask the experts. Could we take CB? Could we take direction finders? And how about a satellite link with the Botany School, so that we could relay crucial eco-data back to England before it decomposed?

Unfortunately, NASA couldn't launch the satellite that Plessey wouldn't develop, nor would Venezuelan Airlines fly out a BBC detector van. We could purchase certain direction finders used to locate wallies, but their range was generally less than shouting distance. However we did get an interesting reply from Paul Essery of Short Wave magazine; he suggested that we made a direction

finder by using a piece of scrap glass fibre PCB as a boom, minus copper. To this we could attach the dipole, director, and reflector elements, cut to formula spacing, with choc. block connectors. Co-axing this to the CB would give us signal direction. Sadly, lack of time and baggage space ensured that we couldn't take this interesting gadget.

We could expect two major problems in taking the CBs themselves to the Venezuelan jungle. The first of these was getting permission to use CB; in that kind of country you'd probably need a permit to blow your nose, signed and stamped in triplicate: a copy for him, a copy for the bin, and if you were lucky, a copy for yourself. Usually it took six written applications, a phone call, and three months to be

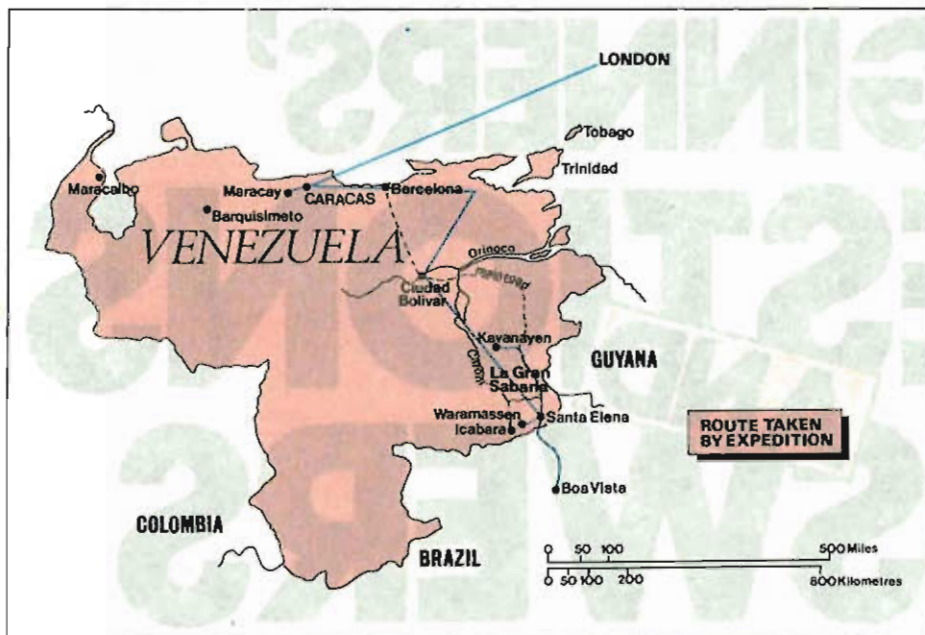

told "No permiso, no permiso, no permiso" British CB sets are different to those permitted in Venezuela — using the native sets would risk the channels being really silted up. We decided to risk the airport X-rays and take British ones.

If we got the sets into the country, temperature and humidity would breed fungi that would make short work of circuitry. We were advised to counter this by using anti-static and demister sprays, and to coat the boards with PCB laquer. Furthermore, dry batteries don't grow like passion-fruit, and our baggage space could hardly stretch to spares for the expedition walkman.

I was prepared to prise open a set and tip in a can of Ronseal or Lyle's golden, but this might've made the set null and void like it would the guarantee. It was here that Mervyn Stanley of Westward Electronics, Devon, came to our rescue, offering us the loan of a couple of PT2 transceivers: rugged and built to take the odd knock, they would be able to withstand the rigours of jungle life. He tropicalized them by covering the boards with silicone grease. They ran from a 2.5 Ah battery that could be recharged from a jeep, and by using the call up facility, and switching off those fancy LEDs, life between charges could be measured in weeks.

Several thousand miles from our rainy department, we touched down in Caracas many hours late. In this beautiful but violent city, burglaries are commonplace, and it would've been safer to leave our valuables in a call box at Paddington than in a hotel here, so we carried ours. Admittedly, we were held up at gunpoint on one occasion, but only by the National Guard, who mistook our malaria pills for acid tabs.

Thus in Caracas, the only thing we appreciated about the sets was their weight: at 4.4 Kg apiece, plus a bouquet of zooms and telephotos, the collar bones began to crack. After a fortnight's permit pursuit, we flew to Ciudad Bolivar, halfway down the

country, to stock up with hammocks, mosquito netting, and enough plastic sheeting to build a marquee. From there, we took a Twin Otter with a baggage compartment smaller than a Sinclair C-5 boat to Santa Elena on the Brazilian border. Amongst other things, our PT2s helped bend the needle on the airport scales, and we had to leave half our luggage behind, to be flown on a few days later.

Santa Elena is a charming conglomeration of bungalows, warehouses, and one-eyed dogs. Here we made some very good friends, the most valuable being Rear Admiral Daniel Gamez, who at once appointed himself our field agent, loaded our gear into a huge Chevy truck, and drove us 50Km westwards to an Indian village, Waramassen. We based ourselves in a hut twenty minutes from the village, surrounded by jungle. After having evicted the scorpions that lived in it, the team then walked under a swarm of killer bees (they *do* exist!), and yours truly took an impromptu bath with a water snake. Our first forays over, we set off with the PT2s to survey the area for promising trees. If a couple of us located one, then we'd guide the others to it over the airwaves, until shouting distance. Our first TX was so corny you could eat it from a cob, something along the lines of "Mowgli to Tarzan, I've got us an orchidized one-fifty footer." "Ten-four, Jungle Boy, what's your twenty?"

When not in use, we kept the sets in polythene bags with silica gel. The gel was contained in fashionable Caracas stockings, so recycling it simply meant untying the knots and tipping it out into a pan over the primus every few days; a vital procedure otherwise the polythene bags would only enhance the effects of heat and humidity.

After some weeks at Waramassen we'd done our collecting, but had been unable to find the right orchids, so we decided to move a few hundred miles to the north into the Gran Sabana, to Kavanayen, a remote mission surrounded by table top

mountains. Once again the Admiral, and CB, solved our transport problems. We spent a number of days just outside Santa Elena, negotiating via the airwaves with him, while he persuaded the National Guard to give us a lift in a rumpety-bumpety army truck.

At Kavanayen we found the right orchids: antisocial bees rose before dawn to do their business, so we were up at 4am to do ours. Two weeks later, we had enough data to clog an IBM mainframe, and disprove at least one theory concerning orchid pollination. Our objective achieved, we returned to Santa Elena.

Our CBs had undoubtedly been a useful part of our kit. Their versatility and range makes them indispensable for any vehicle-based expedition. As we were on foot, we found their day to day use a bit strenuous, although when we did venture into the jungle with them, it was very reassuring to know that you were never more than a switch on the mike from someone else.

If lighter sets were to be used, they would need a call-up facility, and have to be as tough as the PT2s. Batteries would have to be carefully stored with desiccated silica gel.

As we prepared for our return to Caracas, the PT2s found one final use. In the freaked out town of Santa Elena, they all believe that, one day, the extraterrestrials will pay them a visit; so much so that some have built a seven-sided temple to intercept alien vibes. The Admiral and his associates used our sets to scan the channels eagerly; strange gurgling sounds at channel 24 just had to be a cosmic transmission, so the sets have now probably been officially approved by the Venezuelan Navy!

Twelve hours from Caracas, flight VA 716 scythed through the fog and drizzle over Heathrow. Once again the upper 27MHz was flooded with chatter.

"Bagheera to Howler Monkey, swarm of vicious biting angry Woogi wasps heading your way. . ."

"Get off, you great wally. . . er, as I was saying before this berk interrupted me, was that. . ."



BEGINNERS' QUESTIONS AND ANSWERS

Keith Townsend considers some of the questions newcomers to CB might want to ask

It was not until CB came to Britain that the average man and woman in the street had their first opportunity to sample radio communications. Until then the public use of radio had been restricted to those with either the will to pass the radio amateurs' examination or the funds to run a radiotelephone. Recent years have seen a dramatic change in the use of private radio in this country, as thousands have taken the opportunity to make use of the airwaves for the first time and, at the outset it can be a bewildering hobby, full of technical phrases and complicated-looking gadgets, most of which soon lose their mystery as the enthusiast delves deeper into his new-found pastime.

Originally envisaged as a low-cost, short range form of communication for all, CB can offer a great deal of fun for a relatively modest outlay. The basic requirements of rig, antenna and power supply can be had for as little as about fifty pounds and, like most worthwhile hobbies, this can be added to as your pocket permits. Most commonly available rigs are designed to run off the 13.8 Volt direct current supply of the average motor car, with purpose built base station rigs costing considerably more but the simple addition of a suitable power supply unit converts domestic electricity to the required form, meaning that the same radio can be used in the car and in the home.

How far can I transmit?

One of the most often asked questions by new breakers is "How far can I expect to transmit?" and it is one of the hardest to answer. Effective range depends on so many factors, some of which are well beyond the control of the operator and so there can be no hard and fast rule. The more efficient the antenna you use, the

better will be your transmission range but signals are affected by the topography of the area in which you live, as well as by the presence of large buildings, other nearby antennas and even the weather. Other operators will also play a large part in determining your range, as the type of transmission known as frequency modulation, which is permitted in this country and which is rapidly becoming the norm throughout the international community, is

out. It can be most interesting to switch on your radio on days such as this and the results are often well worth the other inconveniences of such weather.

What is Skip?

Another significant factor to effect range is known as 'skip'. Although not much in evidence at the moment, skip is the result of signals being reflected

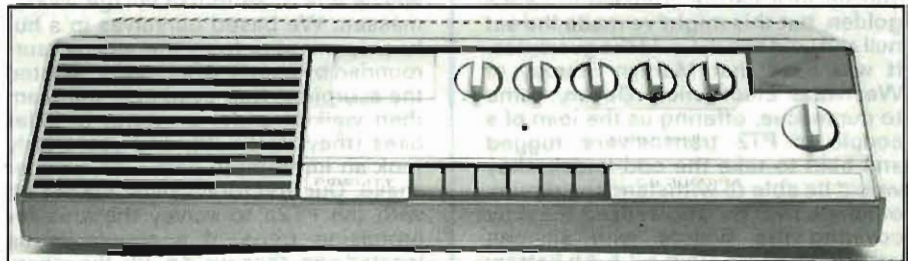

Base stations cost considerably more than mobiles

such that only the strongest signal available will register at your receiver, so that if a station sited close to you is operating on the same frequency as yourself you will be unable to hear signals from further afield.

The combined effect of all these factors means that if you live in a large city, or deep in a valley, you may not often achieve much more than four or five miles, whereas those living on flat, open land might easily expect ranges in the region of twelve to fifteen miles. There are, of course, occasions when you will be able to work stations which are normally well beyond your range, such as when misty weather creates a phenomenon known as 'ducting', in which the transmitted signal is carried along in the shallow corridor created by the presence of two layers of air at different temperatures, returning to earth only where the corridor fades

back to earth by the ionosphere at very considerable distances and results from high levels of sunspot activity. The present sunspot cycle is such that this type of propagation is unlikely to be widespread for about the next five years but watch out for some spectacular results at very modest power levels once the level of sunspot activity increases.

Do I need a licence?

CB radio is one of very few hobbies requiring a licence but don't let that put you off. Licences are available to everyone over the age of 14, regardless of technical understanding. Obtainable from local Post Offices at a cost of £10 for every three sets to be used, they set out the simple conditions of use and explain the basic responsibilities attendant upon using a device such as a radio transmitter in such a manner as

to cause no inconvenience to others.

How do I choose a CB?

Buying CB equipment is very much a matter of personal choice. The prices of the various transceivers available can vary enormously and, having decided upon how much you intend to spend, the tried and tested method is to choose the radio within your price range which offers the best reception, since the quality of the transmitters is unlikely to offer much variation. Should you decide to buy the more familiar mobile type of radio, you will, of course, also require a power supply unit capable of converting domestic 240 volt electricity to the required 13.8 volts DC and here a little care is needed. Many of the cheaper versions offer a very low power output and although even these will power a CB set successfully it pays to invest just that little bit more and to buy one with a rating of at, the very least, 5 amps, in order to ensure that in use it is operating well below its maximum capacity.

What sort of antenna do I need?

Just about the most complicated part of setting up a CB station is the erection and tuning of the antenna. Government specifications require that you use an antenna with a single radiating element, the overall length of which must not exceed 1.65m and, although there is a great temptation to install one of the many larger types available, compliance with this particular regulation does at least ensure that we all have an equal opportunity for our signals to be heard. Most mobile antennae come complete with the required length of coaxial cable but many fixed ones do not and it may be necessary to buy the cable separately. Here it pays to remember that the aerial and its accessories will be subject to all kinds of weather over a prolonged period and this is another area in which it pays to spend that little extra. Tuning the antenna to the desired frequency band will require the use of a standing wave ratio meter. A simple device for measuring the relationship between radio, feeder cable and antenna, these are readily available from CB suppliers and come complete with instructions for use, though since they are an item whose use will be required only occasionally, it is worthwhile considering sharing the expense with other operators.

What is a power mike?

At this stage you have all you need to get on the air and before long you will hear talk of power mikes, echo mikes, pre-amps and the other, often bewildering array of accessories that surround your new hobby. Some of these offer distinct advantages, whilst others do little more than reduce the amount of your bank balance. Power mikes, for instance, were initially

designed for use with AM and SSB radios, neither of which is licensable in this country, and operate on the principle that in these types of transmission the strength of signal can be increased by a stronger audio content. Their use with frequency modulated radios is perfectly acceptable but, since the strength of signal transmitted is constant, their only advantage is that many of them incorporate a degree of speech processing, in which the upper and lower ranges of the audio frequencies are suppressed, with the effect that the audio quality is improved and may sound just that little bit more punchy. Echo mikes, on the other hand, are nothing more than a gimmick.



A bit more punch with a power mike

Their sole function is to add reverberation to the speech content of a signal and many operators regard them as little more than a toy.

What is a pre-amp?

Receiver pre-amplifiers can perform a useful function, improving reception over a given range but offer the disadvantage that in some cases you will be able to hear stations who cannot hear you. When choosing a pre-amp, always go for one which fits at the mast-head, close to the antenna, since it will offer far greater efficiency than a similar device fitted close to the radio. The big fault with many of these devices is that in increasing the strength of signal received they also increase the reception of background noise, so before buying, always make sure that your choice has a high signal to noise ratio and, since you may not always wish to use it, that it is switchable. A very useful accessory which is often overlooked is a 50 ohm dummy load. Never run a transmitter without first ensuring that it is fitted with an adequate means of dissipating the energy created. The antenna will usually take care of this but may be replaced by a dummy load on those odd occasions when you wish to test your set without radiating a signal. Failure to use one or the other will result in a build up of heat sufficient

to cause serious damage to the radio. Another device prominently on display in most CB shops is the antenna matcher. More correctly termed an antenna tuning unit, its purpose is to permit easy tuning of the antenna to the desired frequency range. Many experienced breakers are of the opinion that if your antenna is so poorly matched as to require the use of an a.t.u. you would be well advised to take it down and replace it. Tuning units are extremely wasteful of transmitted power and are really little more than a means of disguising poor installation.

What do the controls do?

Once you have established your station, take a little time to get used to the set's controls and, to use an often repeated expression, 'learn to drive it.' Most of the controls are self explanatory and the handbook supplied with the set will ensure that you have no difficulty in using the controls. The only ones whose functions might, at first, be less than clear are those marked 'squelch' and 'hi-low.' The squelch control is an adjustment of the receiver's sensitivity and its correct adjustment will ensure the proper reception of signals without the presence of a rather unpleasant background hiss. Opening the squelch will bring in the hiss but allow the reception of signals which are that bit too weak for normal reception, whilst closing it will increase the strength of signal needed before it can be heard. Whilst the squelch control affects the receiver, the hi-lo switch varies the strength of the transmitted signal by changing the power output of the radio. Initially fitted as a direct response to the regulation demanding a 90% reduction in transmitter power where the antenna is sited more than 7m above ground level, this device has proved to be most useful in other situations. For example, it is not necessary to use more power than is needed to ensure that you can maintain contact with the station you are working and if this can be achieved on low power you will ensure that other operators who may be using the same channel but who are beyond your reception range, do not suffer interference. This has the distinct advantage of permitting greater occupancy of the band.

As you will soon discover, it is absolutely impossible to anticipate all of the questions which you are likely to think of during your first few weeks in this exciting new hobby but take comfort from the fact that you are by no means alone in not understanding everything. As your experience grows, so will your skill as an operator and, most probably, your curiosity, too. Never be afraid to ask for help. Almost the first thing that you will learn is that your fellow breakers, all of whom have learned in exactly the same manner, will be more than willing to help you to overcome any initial problems and to ensure your enjoyment of the whole new vista which radio communication has opened up to you.

EXCELLENT EXPORT

Antenna Review



This month, Brian Wright looks at the Italian Lemm Export 200

One of the disadvantages with 27MHz CB is the relatively large antennas generally required for efficient operation. Even though the length limit in the UK is 1.65 metres, taking full advantage of this length can sometimes present problems. A base station antenna of this length would not present too many difficulties but as these antennas are usually placed high above the ground, an artificial groundplane is required for effective operation. This groundplane usually takes the form of a rod (for dipole) or several rods of around 2.5 metres long for efficient operation, thus making the siting of the antenna sometimes difficult. However, designers have tried to overcome this problem by designing ingenious compact forms of groundplanes which sometimes carry the penalty of reduced performance — but not always, and some good designs have emerged. If you have ever used a long telescopic antenna on a handheld, you will also appreciate the problems here as it tangles in everything you walk past and soon ends up damaged. The solution is to purchase one of the shorter flexible handheld antennas which are generally either helically wound or made of conductive rubber with a loading coil (rubber duck). In most cases there is a slight drop in performance over the telescopic antenna, but that is more than compensated for by the convenience.

For mobile operation, an antenna of 1.65 metres does not appear to be a problem at first sight. However, if the aerial has to be mounted high up such as on a lorry or van, or even on some cars (if only by preference) then the antenna can strike overhead obstructions such as trees, garage roofs etc. The simple solution of course is to use a very short antenna. The only problem is that this usually results in a severe loss in performance unless the antenna is carefully chosen. The problem is of course that unless you know someone who has tried a particular antenna, you only know how it performs after you have spent your money. To help you spend your hard-earned cash wisely, we at *Citizens' Band* perform an impar-

tial comparative test on a different antenna each month and for those interested in short antennas we have this month tested the .7 metre long centre-loaded Lemm Export 200.

The Export 200 is supplied fully assembled in a plastic sleeve without instructions, as these are hardly necessary. Approximately 4 metres of cable are supplied fitted to the vehicle mount which is also supplied assembled. The only item to be purchased separately is a PL259 plug which will of course have to be fitted to the coax by the installer. This is, therefore, a complete antenna system apart from the plug to fit the user's rig.

A 10mm hole in the vehicle is required for the mount/insulator assembly which is secured in place by a stainless 6mm bolt from the underside. The whole underside assembly is then protected by a flexible cap that clips over it with the coax protruding from one side. The top side of the mount has a black sealing ring and a black insulator with a short chromed portion protruding for mounting the antenna.

The antenna is fixed to the mount by means of a horizontal bolt with a large wing nut (similar to the old DV27 antenna) which allows angular adjustment in one plane, so it is suitable for mounting on a sloping surface. The lower half of the whip is about 180mm long and sleeved in black plastic with an average diameter of 8mm. The centre-loading coil assembly is around 150mm long and the coil is sleeved again in black plastic of 25mm diameter

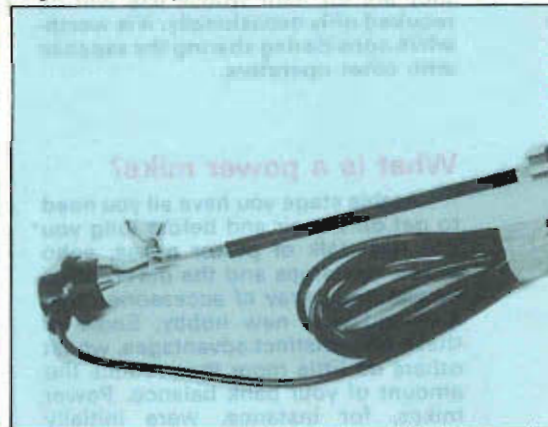

with a chromed boss protruding from each end. Into the top of the coil assembly is fitted a 130mm long, 7mm diameter rod which forms part of the upper whip. The top of this 7mm diameter whip is hollow with a collet into which slides the 2.5mm diameter upper half of the top whip. A bright red well-fitted plastic tip completes the antenna. The overall length including the mount is around .7 metres depending on SWR adjustment.

SWR adjustment is extremely simple on the Export 200, the finger-tightened collet is simply slackened, the top portion of the whip slip up or down to the required position and the collet ferrule again tightened by hand to secure the whip.

There is a generous amount of adjustment available before the whip need be cut. Our sample needed the whip slid fully into the hole for correct adjustment and this gave us 1.1:1 on channel 20 rising to around 1.4:1 on 1 and 40. This slight rise is to be expected with short antennas but was quite low for one of this size.

Although we test short antennas like this on the car roof, to be honest we did not expect too much from a unit of this size when we set out on test. It soon became obvious, however, that the Export 200 was performing very well by any standards and as you can see from the test pattern, an antenna of 1.5 metres or more would not be ashamed of a performance like that. In fact, copies were strong and clear throughout the test and we had to go to our test route limits to get down to an S3 signal. At one point a breaker on homebase that we know 14 kilometres from the test vehicle claimed to be receiving an S8 signal from the test antenna and was, in fact, received at S7 by the test vehicle. This brings us to a point that we noticed throughout the test: the Export 200 not only put out a good signal but received just as well.

Summing up then, we would consider the Export 200 to be a very useful antenna; in fact it is the best performance antenna of this size that we have tested. Construction is of very good quality and tuning is simple. The antenna, complete with mount and cable, is good value at £15.95 and being robust should have a good service life.

Our thanks to TV Radio Aerial Services, London Road, Apsley, Hemel Hempstead, for kindly supplying the test sample.



Lemm Export 200

ANTENNA REVIEW DATA PANEL

SPECIFICATIONS

Model	LEMM EXPORT 200
Type	CENTRE LOADED MOBILE
Length	0.7 METRES
Frequency Range	27MHz
Max Power Handling	250 WATTS
Impedance	50ohm
Cable Supplied	4 METRES OF RG58
Mounting Details	MOUNT SUPPLIED (SEE TEXT)
Supplier	—
Typical Price	£15.95

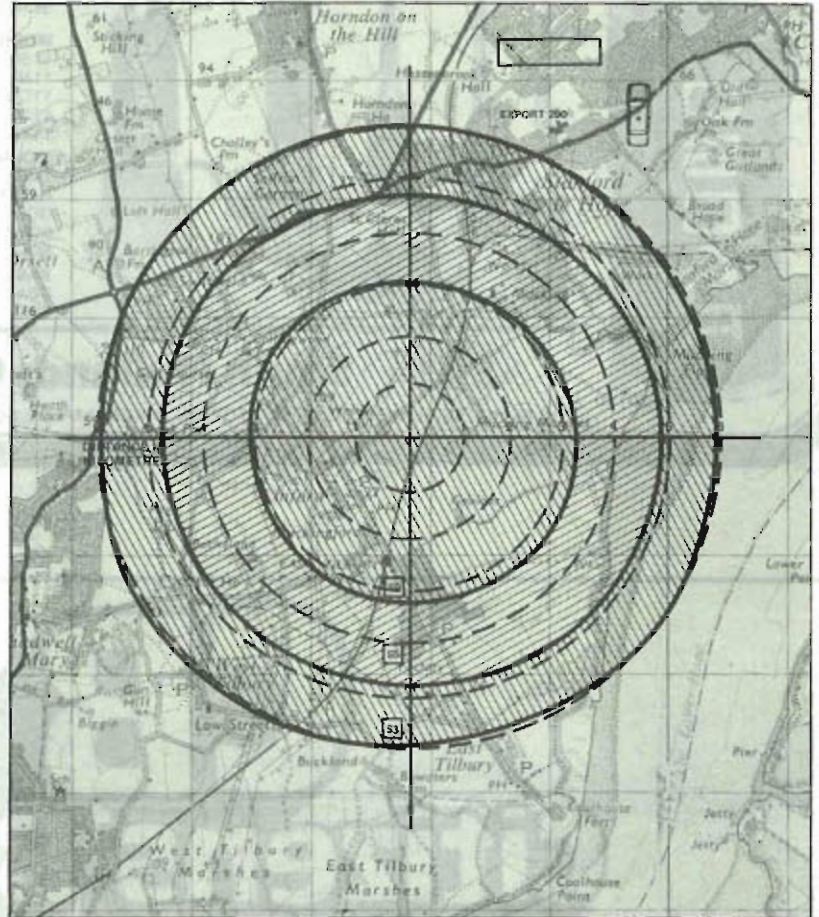

REVIEW VERDICT

Performance XXXX	Installation XXXX
SWR Adjustment XXXX	Instructions —
Construction XXXX	Value XXXX

We rate our samples on a scale of one to five. Five stars is the highest rating, three and four stars are average to good and one and two stars mean it's not doing so well.

The Tests

We have used our standard test procedure to assess the efficiency of this antenna. Just to bring new readers up to date this involves two tests: one static and one mobile. Our test sample is fitted to a stationary mobile and a second mobile follows a prearranged route that orbits the stationary test vehicle, sending and receiving signal reports at measured intervals. This is then repeated with the test antenna on the mobile test vehicle and the signals are sent and received between a stationary vehicle. A standard rig and antenna is used in all the tests. With the results obtained we are able to draw up the radiation pattern shown here. This is simplified to make the results more easily understood. The antenna is also subjected to a series of 'lab' tests to assess their durability, quality and construction, etc and finally we hand it over to a panel of CBers for comment.

OSCAR

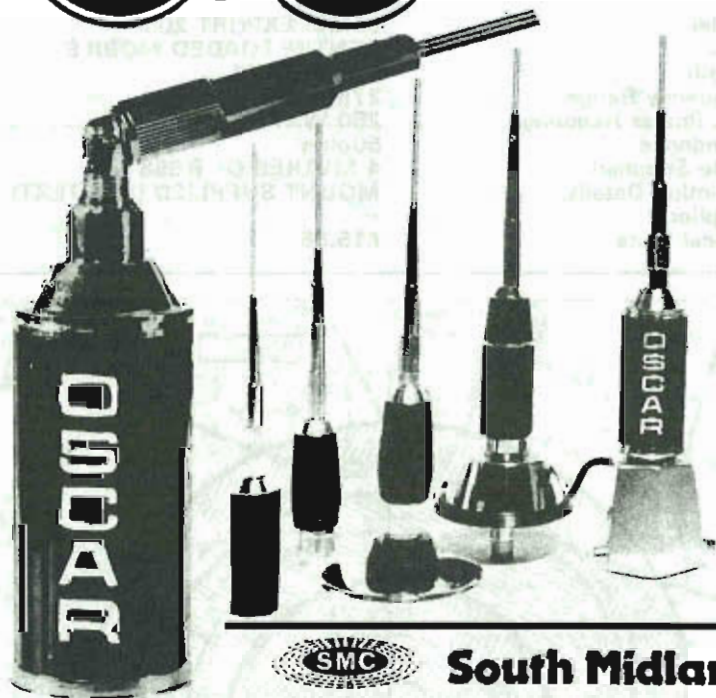

THE PERFORMERS

- ★ A range of five Antennas
- ★ A range of five Mounts
- ★ Foldover Standard

OUTPERFORMS THE BEST

Unlike K40/ARMSTRONG, both designed for the American market, quoting American testimonials, the OSCAR has not been outperformed in any properly conducted scientific UK tests.

MOBILE

11SE Pictured	£19.95 inc p&p 2.20
11NE Slimline Folding	£18.88 inc p&p 2.20
11CM C/W Mag Mount	£21.80 inc p&p 2.65
11CE Compact	£11.50 inc p&p 2.00
11ZE Economy	£10.35 inc p&p 2.00

MOUNTS

TMCAS Trunk Mount	£10.65 p&p 1.90
H D TMCA Trunk Mount heavy duty	£16.10 p&p 2.00
GCCA Gutter Clip & Cable	£11.50 p&p 1.90
SOWM Wing Mount	£4.95 p&p 1.00
SOCA Cable Assembly	£5.85 p&p 1.50

BASE STATION ANTENNAS

CBA 11 GP full size inclined radials	£29.90 p&p £2.65
SMC 11 V 11 S 11 shortened inclined radials	£29.90 p&p 2.65



South Midlands Communications Ltd.

S.M. HOUSE, RUMBRIDGE STREET TOTTON, SOUTHAMPTON, SO4 4DP, ENGLAND TEL: TOTTON (0703) 867333

CB Citizens' Band

Letters

We are always pleased to receive letters from readers, but at times it is impossible to answer them all. We do try to get round to answering letters with an S.A.E. but this may take some time.

It is assumed that letters we receive are intended for publication unless they say otherwise. Letters for particular features like Back Chat, Q & A and Club News should have that marked on the envelope and the correspondent's full name and address, although this will not be published if requested. Readers who are hoping for publicity for events and competitions should bear in mind that the magazine goes to press at least two weeks before the magazine appears

in the shops, and editorial copydates are usually a month before the 'press' date. Please remember this when sending any information in.

Writing for CB

We welcome readers' contributions, especially if they cover a new aspect of CB or are D.I.Y. projects. You may not be aware of how work should be presented — if in doubt write for advice!

Telephoning

It is very difficult to deal with telephone queries as most of our energy has to go into putting the magazine together. If you can deal with it by letter, please do.

TWO

JOHN RICHARDSON

GOOD GRIEF! HE'S BEING HELD UP AT SUNPOINT!

LOOKIT OUR HERO, THE GODLING THWONG, BRANSON OF ZEUS, PROTECTOR OF C.B.ERS, IMMORTAL, AN' DRUNK...!

SHANT!
MINE, FRIEND, KARL IS POINTING HIS BANG-STICK AT YOU!
NOW YOU VILL KOMMEN MIT US...
OR KARL WILL MAKE IT GO BANG IN YOUR KOPF!

BANG!

NOW ZAT DU HABEN SHOTTEN DER KOPF OUTEN DAS C.B. LOONY, VE CAN GO MAKEN ZE PLANS INTO AKTION WENST! YA?
JAWOHL!

TOOT!
HIT HIM BASS?

BWAH! THWONG!! MY HERO! I SAW IT ALL!
SOB!

WHY? WHY? WHY DID THOSE TWO MEN MURDER YOU? WHY?
WHAT REASON COULD THEY HAVE?
WHY? OH, WHY?
WHY? WHY? WHY?
WHY? WHY?
WHY?
OH, WHY?
WHY?
WHY?
I DUNNO!

...IT'S A GOOD JOB I'M IMMORAL AND CAN'T BE KILT!
I RECKON THEY WERE AFTER MY NEWCASTLE NECTAR!
SNEESH!

BAT THWONG AM WEDDING...
DAT DEBE LOONY GUY, VOT YOU SHOT IN DER KOPF, VOS DER ONLY GUY IN THE UNIVERSE VOT COULD PICK UP ALL DER C.B. CHANNELS ZIMULTANEOUSLY! WUND NOW VE ARE FREE TO USE DER SHPER CHANNEL DODGER FUR DER ORDER PASSANK! HOH!!
YA?
JAWOHL!
WASTY MANS!

NOW VE JUST VAIT FUR DER AGENTS TO KOMMEN OU ZE AIR! UNT VE TRANZMIT ZE ORDERS FUR DEM!
HON!
JAWOHL!

MEANWHILE...
ME MAKE SURE ALL NEWCASTLE NECTAR IS SAFE!
ME EAT IT ALL!
OCK-OCK-OCKLE-OCKLE-OCKLE-OCKLE-OCKLE!
GUTTY!
YOU!

HORP!
ALL LIME NOW!
NOCKUP!
KNUK!
GLOOP!

HAW! Y'CAUT CATCH OU' THWONG TWICE!
SHANT!
MY CHAPPIE HAS A GUN TO YOUR HEAD! COME WITH US OR HE WILL SILENCE YOU!

HAW-HAW-HAW-HAW-HAW!
HAW-HAW-HAW-HAW-HAW...

GOOD GRIEF! THIS MAKES TWO TIMES!
POX!

IT DODSEN'T WORK, Y'KNOW! BELTING HIM IS JUST A WASTE OF EPLUSTOLAST!
NOT SO, MY DEAR! WE AT M.I.3. NEED THIS LOONY. WE ARE GOING TO USE HIM TO SAVE THE COUNTRY!

WE BELIEVE TWO INCREDIBLY DANGEROUS MEN ARE USING A DEVICE TO HELP THEM MARCH A PLOT WHICH COULD BRING DOWN OUR COUNTRY!
EH?

ONLY THE LOONY CAN INTERCEPT THAT DEVICE AND STOP THE PLOT WHICH IS SO DIABOLICAL THAT I CANNOT YET TELL YOU WHAT IT IS...
BWA!
WHEN CAN YOU TELL US...

NEX NUNT!

WHY DID THE OXFORD UNIVERSITY CHOOSE THE WESTWARD PT?

(for their jungle expedition)

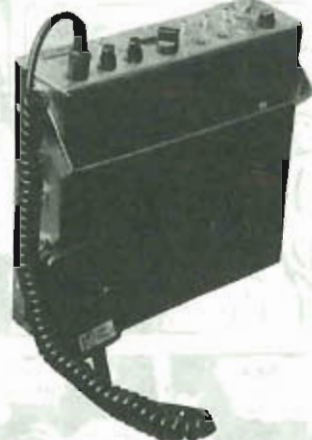

BASE USE

No other base station offers an advanced, active power supply with very low noise, and automatic standby on the internal battery—when the mains has failed, you may need that emergency call!

MOBILE

No other mobile can be instantly transferred from one vehicle to another, be isolated from the vehicle electrical system for less interference, and give FULL performance in TX & RX.

PORTABLE

No other portable offers high capacity battery (3 working days use) and rapid integral charger (5 hours) with performance equal to a mobile when using s/s whip (op. extra), PL259 ant. socket.

**BECAUSE ITS THE
BEST TRANSCEIVER
MONEY CAN BUY!**

Attractive and durable s/steel cabinet, selective calls can be fitted to increase the effectiveness of your business and custom mods to order. Extras include s/s whips, mag. mounts, and hand crafted real leather case with custom carving of illustrations and handles if required.

NORTH EAST

D.A.S.
58 Lark Lane,
Liverpool L17 8YA
Tel: 051-727 6013

WEST MIDLANDS

C.B. Cabin
81 Church Street,
Brierley Hill
Tel: 0384 71905

LONDON

Balaam Street Motors
224 Balaam Street
Tel: 01-472 9835

Price less than many mains only sets. See your dealer, or SAE for full details to:
Westward Electronics, The Mill House, Tuckenhay, Totnes, Devon TQ9 7EL. Tel: 080423 336/370.
Trade enquiries welcome. Tel: 0803-864470

A BETTER DEAL from GUILDFORD CB

(Just a few examples from our enormous range)

RA201 Reverb Echo Box. Best Control & Cleanest Echo of them all	£27.90
Funkmaster Extension speaker with filter	£8.90
Ball Speaker	£3.90
3 way antenna switch with dummy load	£3.95
S.W.R. meter	£5.75
S.W.R. power meter with patchlead	£7.95
S.W.R. meter with matcher	£15.95
Rotator medium duty	£38.00
K40	£32.50
Oscar Whip	£18.85
Oscar Gutter Mount	£9.49
Valor halfbreed and Warrior	£11.95
Modulator Super Thunderbolt	Centreload £8.50 Baseload £6.90
Modulator 2 (original)	£11.50
Super Modulator 2 Centreload	£12.50
Z27 £9.50 New centreload	£10.95
DV27 complete	£6.75
Superstick/Firestick 2½' £4.95 4' £7.90 5' £9.60 7'	£11.95
Complete Gutter Mount and cable for above aerials	£6.99
Complete Magmount and cable for above aerials	£9.00
Commtel Sigma 4	£49.00
Thunderpole III	£22.00
Gap ½ wave	£12.95
ASP 3GP Silver Rod	£15.95
Silver Arrow	£18.00
Modulator Saturn	£15.90
Firestick Macho Base (Genuine Original) Home Base	£19.90
Replacement telephone	£9.85
10 Memory Phone	£16.00
Cordless telephone	£59.75
Scotch Lifetime E180 tapes	£4.99
Japanese unbranded E180 tapes — good quality	£3.99
Hammaster 4500 Homebase mike	£32.00
Hammaster 4200/TW 232 Leson	£32.00
Saldelta Echo Master Base mike	£51.50
DM 510 Power mike	£5.99

Trade Enquiries Welcomed — Best prices for bankrupt stock

Altai Echo Mike	£19.99
Tarren 30 VA Power Supply	£12.80
Bremi 100 Watt Homebase AMP/Zetagi BV131	£85.00
P27/1 Nevada Preamp — Pull in all those signals	£19.90
Nevada 25W Linear — switch on front	£19.25
Yaesu 290R 2 Meter Multimode	£295.00
Sun 2 Meter Gutter Mount complete — aerial	£24.90
Harvard SOS Emergency CB	£29.90
Maxcom 30E	£49.95
Harvard Mobile, RF gain, roger bleep, tone control, digital signal readout, PA	£44.90
Saphire 4000X Cybernet board	£59.90
Radiomobile 201 Cybernet board	£44.10
Audioline 340 — Uniden board	£42.00
Audioline one hander — Uniden board	£56.00
Grandstand Bluebird	£39.95
Oscar/Special Transceiver usual price £89.95 Our price	£49.95
Commtel Base Station (with FREE aerial)	£49.95
Fidelity 3000 Homebase	£65.00
2½ Watt Harvard 40 Channel Walky Talky	£49.00
Pair of Walky Talkies 49MHz (For the kids!)	£11.90
934 Reftec	£278.00
Commtel scan — the ultimate 934 memory, scan, strong signal Made by NPR.	£429.00
Uniden dual bander 934/27	£399.00
Cybernet — Delta 1, 934	£355.00
Full range of aerials, S.W.R. meters etc. for 934 from	£9.90

Send large S.A.E. for free 1,000 Items price list or ring your order — Visa, Access, American Express — Tel: 0483 574434 or mail to:

Guildford CB., 34 Aldershot Road, Guildford, Surrey GU2 8AF

Qty	Item	Price
NAME	Post	2.00
ADDRESS	Total	



GET OUT ON A



KESTREL 934MHz AERIAL

HIGH IMPACT RESISTANT
GLASS FIBRE CASE.

HIGH GRADE MATERIALS
AND UNIQUE
CONSTRUCTION ENSURE
THE ULTIMATE
PERFORMANCE AND
RELIABILITY.

PRE SET V.S.W.R.

SHOCK ABSORBING
SPRING TO TAKE THE
KNOCKS.

HEAVY DUTY GUTTER
MOUNT OR MAGNETIC
MOUNT.

4 Metre RG 58 U COAX
CABLE — CAN BE CUT TO
ANY LENGTH.

7.5 DBI GAIN.

£44.95

£46.95

YAGI BEAMS

"N" Type low loss
connector

High grade
copper elements
for maximum
performance.

Precisely tuned for
minimum S.W.R.

Totally sealed connector
block to prevent moisture
ingress.

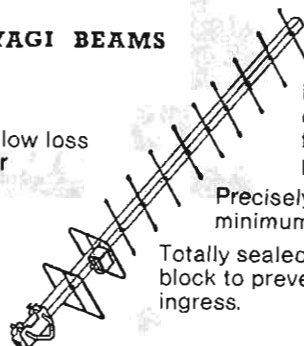

	4 ELEMENT	10 ELEMENT	20 ELEMENT
GAIN	11 DBi	17.5 DBi	21 DBi
BANDWIDTH	54°	36°	24°
LENGTH	18"	35"	64"
RETAIL PRICE	£29.95	£39.95	£52.35

FROM YOUR LOCAL RETAILER, OR IF IN DIFFICULTY AVAILABLE DIRECT



KESTREL ELECTRONICS

ACORN HOUSE

DEVITTS GREEN LANE, ARLEY, COVENTRY CV7 8HP
0675 81605

CREST

CRESTBYTE LIMITED

PRODUCTS FOR 934 MHz

Still available ex-stock

AP-104 /MKII

Outstanding as a mobile
pre-amplifier



NEW! TWIN INPUT PRE-AMP

AP-205

Switch beam & colinear
from your rig - Single
feeder cable from two
aerials at the masthead.

Same low noise, high gain
two stage pre-amp as AP104



Low noise
Two stage design
20dB gain
Low Insertion loss
12-14 VDC operation
Automatic RF switching
Low loss relays

USE AT MASTHEAD OR BEHIND
YOUR RIG FOR SUPERB
PERFORMANCE

model AX-934

Omni-directional four element
Professional colinear aerial
for 934 MHz.
Complete with mounting bracket.
Gain of approximately 7.5 dBi.
Length - 1.5 meters.



model SW-934

S.W.R. & POWER METER
Frequency range - 900-950 MHz
Power range - 10 watts
Impedance - 50 ohms
Connectors - BNC
Dimensions - 140 x 105 x 50 mm.

ORDER MESSRS. CRESTBYTE LTD.
Unit J. Gregory Rd.
James Carter Ind. Est.
Mildenhall, Suffolk.
PLEASE SUPPLY
Qty Tel. 0638 717948

- AP-205 Twin Pre-amp
£149.95 incl VAT & P&P
- AP-104 Pre-amp Mk II
£89.95 incl VAT & P&P
- AX-934 Aerial.
£59.50 incl VAT & P&P
- SW-934 Meter.
£49.50 incl VAT & P&P

Cheque/P.O. Payable to
CRESTBYTE LTD. TOTAL £

Please mention

CB Citizens' Band

when replying
to all
Adverts

The New

1985 Catalogues from Telecomms

934 Mhz Personal Radio Edition

For the first time in the UK a fully comprehensive catalogue of equipment for this exciting new band, together with many pages of vital technical information. Send £1 now for your copy and receive a £2 Telecomms Voucher.



27 Mhz CB & Amateur Radio Edition

Over 40 pages crammed full of CB products for the UK together with useful technical information. This catalogue is a must for any 27 Mhz CB or amateur radio enthusiast.

Send £1 today for your copy and receive a £2 Telecomms Voucher.



TELECOMMS THE UK'S LEADING
PERSONAL RADIO
DISTRIBUTOR

189 London Road, North End,
Portsmouth, Hants. PO2 9AE.
Tel: (0705) 662145. Telex: 869107. Telcom G.

MARKSMAN PRODUCTS

Makers of First Class C.B. Equipment



'MISTER STICK'

We can now offer the 'Mister Stick' in two lengths and two finishes. The original length, being ideal for truckers who demand that extra height, and the new, more compact size. Both types are available now in luxury chrome on brass, or all stainless steel construction. Performance on both being equal. (For report, see March edition of this magazine.)



Prices are:

Chrome on brass	£16.00 inc VAT
All stainless steel	£17.50 inc VAT
Post and packing	£1.25 extra

Please allow 14 days for delivery.
Trade enquiries welcomed. Club discounts for orders of 10 or more direct from us at 12½%.

Please contact us at:

Marksmen Products Ltd,
P.O. Box 40,
Milton Keynes,
Bucks,
MK6 2UT
Telephone 0908 564130

BBTRONICS

Having trouble matching a mic to a rig? Your problems are over. . .

NOW!

Fit any standard mic to any standard rig in seconds

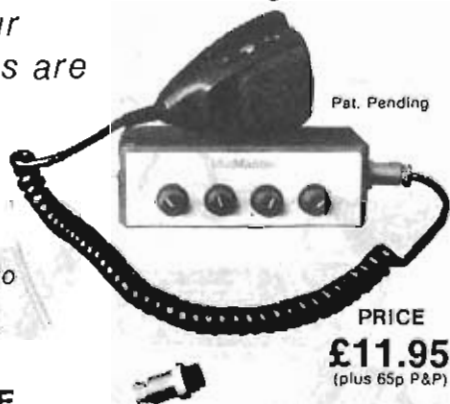

Pat. Pending

PRICE
£11.95
(plus 65p P&P)

WITH THE

MICMASTER

The new MicMaster guarantees a perfect match. Any standard mic to any standard rig for immediate use. Removes the need to spend time and money on rewiring.

**MONEY RETURNED
IF NOT SATISFIED**

Send cheque or P/O to:
BBtronics, 48 Arlington Drive, LEIGH, Lancashire.
Money returned if not satisfied.

Please send me MicMasters
NAME.....
ADDRESS.....

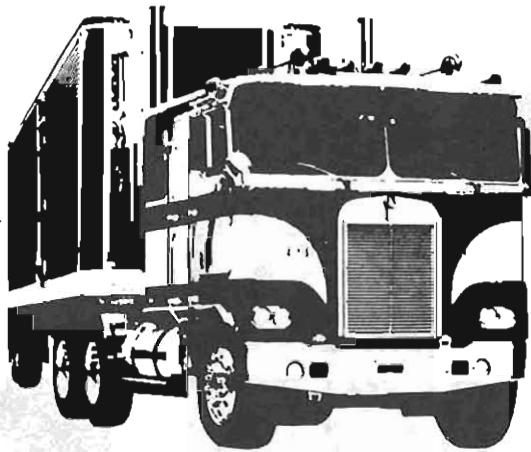

RIGS-N-TWIGS

CB RADIO & ACCESSORY CENTRE

11 The Parade Hengrove Bristol BS14 9DB Tel Bristol 717771

OPEN MON-TUES 10.00—6.00
 WED 10.00—1.00
 THURS-FRI 10.00—7.00
 SAT 10.00—5.30

C.B. RADIOS FROM £20.00
 P.A. HORNS FROM £3.95
 SLIDE MOUNTS FROM £2.50
 25WATT AMPLIFIER WITH
 PRE-AMP £25.00

REPLACEMENT MICS £5.50
 D.V. 27 £6.00
 3.5 AMP P.S.U. £12.95
 EXT. SPEAKER FROM £3.95

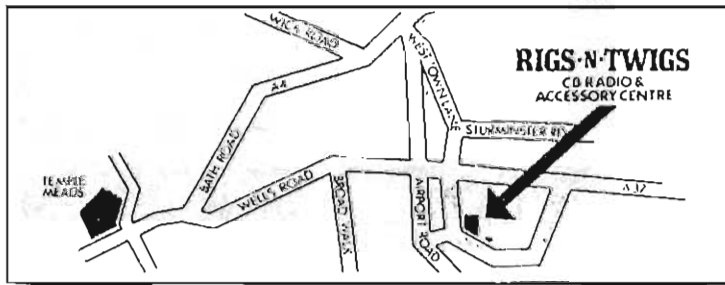

We are distributors for all major UK manufacturers and carry a range of CB's and accessories to numerous to mention.

Mail order enquiries welcome.
PLEASE PHONE FOR DETAILS

THE GEMEC ANTENNA RANGE (GETTING READY FOR EUROPE)

THE GEMEC GAMMA

Known affectionately by the test crew as the Jolly Green Giant, this 1/2 wave feed by a 1/4 wave matching stub will out perform many a 5/8 wave without having to have ground planes fixed. Illegal on British CB it would be ideal for a DX holiday in France.



Price £62.50

For further details of the GEMEC RANGE
 Write to:

**K. E. P. ROWE, FREEPOST,
 P.O. BOX 6, PERSHORE,
 WORCS WR10 1BR.**

Access and Barclaycard welcome.

See your dealer first, any problems, we will ship
 direct to you.

TELEPHONE 0386 556655

British Code of Advertising Practice

ADVERTISEMENTS IN THIS PUBLICATION ARE REQUIRED TO CONFORM TO THE BRITISH CODE OF ADVERTISING PRACTICE. IN RESPECT OF MAIL ORDER ADVERTISEMENTS WHERE MONEY IS PAID IN ADVANCE, THE CODE REQUIRES ADVERTISERS TO FULFIL ORDERS WITHIN 28 DAYS, UNLESS A LONGER DELIVERY PERIOD IS STATED. WHERE GOODS ARE RETURNED UNDAMAGED WITHIN SEVEN DAYS, THE PURCHASER'S MONEY MUST BE REFUNDED. PLEASE RETAIN PROOF OF POSTAGE/DESPATCH, AS THIS MAY BE NEEDED.

Mail Order Protection Scheme

If you order goods from Mail Order advertisements in this magazine and pay by post in advance of delivery will consider you for compensation if the Advertiser should become insolvent or bankrupt, provided:

1. You have not received the goods or had your money returned; and
2. You write to the Publisher of this publication; summarising the situation not earlier than 28 days from the day you sent your order and not later than two months from that day.

Please do not wait until the last moment to inform us. When you write, we will tell you how to make your claim and what evidence of payment is required.

We guarantee to meet claims from readers made in accordance with the above procedure as soon as possible after the Advertiser has been declared bankrupt or insolvent (up to a limit of £2,000 per annum for any one Advertiser so affected and up to £6,000 per annum in respect of all Insolvent Advertisers. Claims may be paid for higher amounts, or when the above procedure has not been complied with, at the discretion of this publication, but we do not guarantee to do so in view of the need to set some limit to this commitment and to learn quickly of readers' difficulties.)

This guarantee covers only advance payment sent in direct response to an advertisement in this magazine (not, for example, payment made in response to catalogues etc, received as a result of answering such advertisements). Classified advertisements are excluded.

MAIL ORDER ADVERTISING

CB Citizens' Band

READER SERVICES

Back Issues

The following issues of Citizens' Band are still available as back numbers. The cost of each magazine is £1.50. This includes packing and posting. Please allow 28 days for delivery.

Issue	Major feature
February 1984	Maxcom 30E
March 1984	Consum 1320
April 1984	Grandstand 27/934MHz. transverter
May 1984	Grandstand 27/934MHz. transverter
June 1984	Scanning and Telephone supplement
July 1984	Walkie talkie round-up
August 1984	Audioline 341
September 1984	AR2001 scanner
October 1984	Cybernet 934MHz.
November 1984	CTE antennas
December 1984	Panoramic CB scanner
January 1985	SWR survey and Breaker's Basics
February 1985	Understanding CB specs.

Binders

To keep your copies of Citizen's Band neat and tidy, binders are available to hold 12 copies of the magazine. Each binder costs £5.00 and this price includes packing and postage.

Subscriptions

Citizens' Band is available on subscription at the following prices:

UK and BFPO	£15.00
Overseas (excluding U.S.A.)	£17.00
Accelerated Surface Post	
U.S.A.	\$21.00
Accelerated Surface Post	
Airmail	£42.00

Each subscription lasts for twelve issues of the magazine.

Ifonet Ltd, Times House, 179 The Marlowes, Hemel Hempstead, Herts. HP1 1BB. Tel: 0442 48435.

- Please send the following back numbers of Citizens' Band, price £1.50 inclusive.

.....

- Please send..... Citizens' Band Binders price £5 each inclusive.

- Please start my annual subscription to Citizens' Band with the (month) issue I enclose for a year's subscription.

All cheques payable to A.S.P. Ltd.

Total cost of Order £.....

Please allow 28 days for delivery

I enclose my cheque/postal order for above amount payable to A.S.P. Ltd.

Please debit my Access/Barclaycard (delete as necessary)

Card

No.

Name

Address

Post Code Date

Signature



Citizens' Band

REFERENCE SECTION

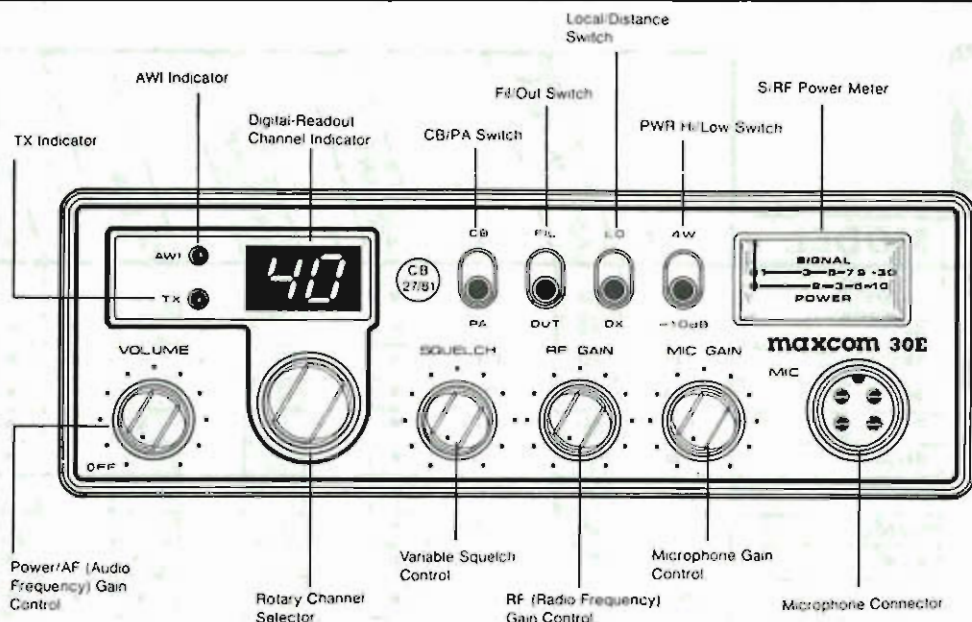

A CB SET AND ITS CONTROLS

VOLUME

Sometimes called *Audio Frequency Gain* control. Usually combined with the 'power on' switch. The volume control will only increase or decrease the loudness of the incoming signal — it won't alter the strength of it or affect the transmitted signal.

CHANNEL SELECTION

For choosing the channel you transmit and receive on.

CHANNEL INDICATOR

Displays, usually by LEDs, the channel you have selected. Some channel displays are of liquid crystal or fluorescent. The digits are normally bright red, green, orange or blue and visible in all but the most direct sunlight.

SQUELCH

The squelch control is used for quieting background hiss or the babble of distant signals. The control is turned slowly, usually to the right, until the background noise disappears. The squelch circuit will then only open to let through a stronger signal than those you have quieted out. As soon as the stronger signal goes, the circuit closes. Care must be taken not to turn the squelch control up too far, as then only a very strong signal will open it.

SIGNAL/RF METER

On most sets this is of the 'moving needle' type against an analogue background. Some sets do have a bar of LEDs that light up to show the strength of either the received signal or the transmission. It shows the *relative* strength, not a reading in dB or Watts. These meters cannot be 100% accurate and different rigs will give slightly different readings for signals of the same strength.

RF GAIN

This controls the reception sensitivity of the set. When decreased the set is less sensitive, and when increased the set is more sensitive to weaker signals. Reducing the gain helps prevent overloading when talking to someone who is very close.

Some sets, instead of having a suitable rotary control, have a flick two position switch marked *local* and *distance*. Full sensitivity is the distant position.

MIC. GAIN

Adjusts the sensitivity of the microphone amplifier circuit and controls the audio from the microphone that is used to modulate the signal.

CB/PA SWITCH

This switch turns your CB set into a low public address amplifier, when an external speaker is fitted into the socket on the back of the rig. Anything said into the microphone is amplified and broadcast through the speaker and not transmitted from the antenna.

TOPE OR FILTER CONTROL

This can either be a rotary or flick switch. It controls the tonal quality of received signals in accordance with the users preference.

POWER ANTENNA

Reduces the transmitter power from 4Watts to 0.4Watts. The attenuator should be used if your antenna is mounted more than 7 metres above the ground.

RX/TX INDICATORS

These light emitting diodes light up to show if you are receiving (RX) or transmitting (TX).

ANTENNA WARNING INDICATOR

This a warning indicator which is activated by trouble in the antenna system e.g. a bad mismatch or damage to the antenna or cable. You should stop transmitting if this lights up, and correct the problem.

Your set may also have the following controls

CHANNEL 9 SWITCH

This is an 'over-ride' switch that will immediately select channel 9 without using the channel selector to find it. It is fitted to save time in an emergency.

DELTA TUNE

This is not a common feature on British sets, where frequency and stability are closely specified. It is a fine tuning device for tuning in stations that are operating slightly off frequency.

DIMMER

Works on the same principle as a domestic light dimmer, and reduces the amount of illumination on displays and dials on the CB set. A few sets have an automatic dimmer built in, which measures the lighting level through a photo-electric cell and adjusts the illumination accordingly.

ANL/NOISE BLANKER

The Automatic Noise Limiter or Noise Blanker is designed to reduce interference from a car's ignition system by desensitising the receiver slightly. If the ignition circuit is already adequately suppressed it will not make any difference.

CHANNEL BUSY/FREE INDICATOR

This is usually a LED that illuminates when a particular channel is in use or is free. This is gauged by the amount of 'traffic' on the channel which has to be at a certain level before the indicator is activated. Sets have either a 'free' or 'busy' indicator, not both.

FM RIG CHECKLIST



NAME	MODEL	RETAIL PRICE	NO. OF CHANNELS	SUPPLY VOLTAGE	SQUELCH	NB SWITCH	ANL SWITCH	MIKE GAIN	RF GAIN	STONE CONTROL	S/RF METER	S/RF LED R/O	HI/LO OUTPUT	PA FACILITY	EX. SPEAKER JACK
AMSTRAD	CB901	£40	40	13.8VDC	•				•	•		•	•	•	•
AUDIO LINE	341	£60	40	13.8VDC	•			•	•	•	•	•	•	•	•
AUDIO LINE	340	£40	40	13.8VDC	•			•		•	•	•	•	•	•
AUDIO LINE	342	£115	40	13.8VDC	•					•	•	•	•	•	•
COLT	295	£49.99	40	13.8VDC	•				•	•	•	•	•	•	•
COMMTEL	GT858	£30	40	13.8VDC	•					•	•	•	•	•	•
COMMTEL	GT688	£35	40	13.8VDC	•				•	•	•	•	•	•	•
COMMTRON	CB40F	£70	40	13.8VDC	•					•	•	•	•	•	•
COMMTRON	CXX	£69.95	40	13.8VDC	•				•	•	•	•	•	•	•
COMMUNICATORS	NI-440DX	£60	40	13.8VDC	•				•	•	•	•	•	•	•
CYBERNET	BETA 1000	£70	40	13.8VDC	•						•	•	•	•	•
CYBERNET	BETA 2000	£85	40	13.8VDC	•				•	•	•	•	•	•	•
CYBERNET	BETA 3000	£100	40	13.8VDC	•				•	•	•	•	•	•	•
DNT	M40FM SPECIAL	£100	40	13.8VDC	•				•	•	•	•	•	•	•
FIDELITY	CB 1000M	£70	40	13.8VDC	•					•	•	•	•	•	•
FIDELITY	CB 2000M	£90	40	13.8VDC	•			•	•	•	•	•	•	•	•
FIDELITY	20001 FM	£70	40	13.8VDC	•			•	•	•	•	•	•	•	•
GRANDSTAND	BLUEBIRD	£50	40	13.8VDC	•					•	•	•	•	•	•
GRANDSTAND	HAWK	£30	40	13.8VDC	•				•	•	•	•	•	•	•
GRANDSTAND	GEMINI	£60	40	13.8VDC	•	•			•	•	•	•	•	•	•
GRANDSTAND	LA 83 934 MHz	£400	20	13.8VDC	•					•	•	•	•	•	•
INTERCEPTOR	INTERCEPTOR	£80	40	13.8VDC	•				•	•	•	•	•	•	•
INTERCEPTOR	TC400	£95	40	13.8VDC	•		•	•	•	•	•	•	•	•	•
INTERCEPTOR	ONE HANDER	£100	40	13.8VDC	•			•	•	•	•	•	•	•	•
JOHNSON	JOHNSON	£50	40	13.8VDC	•				•	•	•	•	•	•	•
LAKE	MANXMAN 850	£32.50	40	13.8VDC	•					•	•	•	•	•	•
LAKE	MANXMAN 950	£37.50	40	13.8VDC	•				•	•	•	•	•	•	•
LOWE	TX 40	£60	40	13.8VDC	•				•	•	•	•	•	•	•
MAGPIE	AUTOSCAN 5000	£120	40	13.8VDC	•			•	•	•	•	•	•	•	•
MAXCOM	4E	£50	40	13.8VDC	•					•	•	•	•	•	•
MAXCOM	6E	£48	40	13.8VDC	•				•	•	•	•	•	•	•
MAXCOM	20E	£50	40	13.8VDC	•					•	•	•	•	•	•
MAXCOM	21E	£50	40	13.8VDC	•					•	•	•	•	•	•
MAXCOM	16E	£40	40	13.8VDC	•					•	•	•	•	•	•
MAXCOM	30E	£65	40	13.8VDC	•			•	•	•	•	•	•	•	•

This listing includes most of the rigs available for FM CB. Some rigs are still not on the market, but may be picked up second-hand or may be found in old stock at some shops. The prices quoted are recommended retail prices or typical price — they may vary considerably from shop to shop and area to area.

MOBILES

TX IND. LIGHT	RX IND. LIGHT	CH 9 SWITCH	MIKE POSITION	COMMENTS	ADDRESS	NAME
●	●	●	SL	Report Feb '82	Amstrad Consumer Electronics, 1-7 Garman Rd., London N17	AMSTRAD
●	●		SL		Telecomms, 189 London Rd, North End, Portsmouth	AUDIOLINE
●				Report Feb '82		AUDIOLINE
●	●					AUDIO LINE
●			FL		K B & Co Ltd., 202 Cheatham Hill Rd, Manchester	COLT
			SL		Globe, 166 Brooker Road, Waltham Abbey, Essex	COMMTEL
			SL	Dimmer Switch Features		MMTEL
●		●	FL		Roger D, 831 Mansfield Rd, Notts	COMMTRON
●			FL			COMMTRON
●	●	●	FL	Roger Beep Feature		
			SL		Goodmans Loudspeaker Ltd., Downley Rd, Havant, Hants PO0 2NL	CYBERNET
●	●		FL	Report May '83		CYBERNET
●	●	●	FL	Report September '83		CYBERNET
●			FL	Report July '82		DNT
			SL	Report December '81	Fidelity Radio Ltd., Victoria Rd, London NW10	FIDELITY
		●	FL	Report March '82		FIDELITY
		●		Report September '82		FIDELITY
●			SL		Ben-Ware Ltd., Ripon Way, Harrgate, N Yorks	GRANDSTAND
●	●		SL			GRANDSTANO
●			SL			GRANOSTANO
●				Features combined with Bluebird (included)		GRANDSTANO
●	●		SL		Telecomms, 198 London Rd, North End, Portsmouth	INTERCEPTOR
●	●		FL			INTERCEPTOR
●	●		FL			INTERCEPTOR
			FL	Great GT868 chassis	Star Warehouse, Chalk Farm Rd, London	JOHNSON
			FL		Roger D, 831 Mansfield Rd., Nottingham NG5 3GF	LAKE
			FR	Report April '83		LAKE
●	●		FL	Report March '83	Lowe Electronics, Matlock, Derbyshire	LOWE
●		●	FL	Report November '82	Maggie Electronics, PO Box 35, Andover, Hants SP10 2LG	MAGPIE
●			FL		AM House, 9A Old's Approach, Tolpits Ln, Watford, Herts	MAXCOM
●		●	FL			MAXCOM
●		●	FL			MAXCOM
●		●	FL			MAXCOM
●		●	FL			MAXCOM
●			FL	Report Jan '84		MAXCOM

REFERENCE



NAME	MODEL	RETAIL PRICE	NO OF CHANNELS	SUPPLY VOLTAGE	SQUELCH	NB SWITCH	ANL SWITCH	MIKE GAIN	RF GAIN	STONE CONTROL	S/RF METER	S/RF LED R/O	HI/LO OUTPUT	PA FACILITY	EX. SPEAK
MERCURY	10 40	N/A	40	13.8VDC	•			•		•		•	•	•	
MURPHY	DS-602	£25	40	13.8VDC	•						•		•		
MUSTANG	CB1000	£49.95	40	13.8VDC	•					•			•		
MUSTANG	CB3000	£59.99	40	13.8VDC	•				•	•	•		•		
NATO	40M	£69.95	40	13.8VDC	•			•	•	•			•		
NATO	2000	£189.95	40	13.8VDC	•	•	•		•	•	•		•	•	•
OSCAR	OSCAR I	£85	40	13.8VDC	•						•		•		
OSCAR	OSCAR II	£49	40	13.8VDC	•						•		•	•	
REFTEC	934	£300	20	13.8VDC	•						•				
ROTEL	RVC 220	£50	40	13.8VDC	•						•		•		
ROTEL	RVC 230	£70	40	13.8VDC	•				•	•	•		•		
ROTEL	RVC 240	£90	40	13.8VDC	•			•	•	•	•		•		
SIRTEL	SEARCHER	£40	40	13.8VDC	•						•		•		
TANDY	TRC2001	£80	40	13.8VDC	•						•		•		
TANDY	TRC2002	£70	40	13.8VDC	•						•		•		
TANDY	TRC2000	£100	40	13.8VDC	•			•	•		•		•		
TANDY	TRC1004	£79	40	12VDC	•								•		
TANDY	TRC2003	£130	40	13.8VDC	•								•		
UNIDEN	UNIACE 100	£69.95	40	13.8VDC	•						•		•	•	
UNIDEN	UNIACE 200	£89.95	40	13.8VDC	•			•	•	•	•		•	•	
WESTERN	COMPACT 40	£34.50	40	13.8VDC	•						•		•		
WESTWARD	P.T.2	£169.95	40	13.8VDC 240V	•						•		•	•	



NAME	MODEL	RETAIL PRICE	NO OF CHANNELS	SUPPLY VOLTAGE	SQUELCH	NB SWITCH	ANL SWITCH	MIKE GAIN	RF GAIN	STONE CONTROL	S/RF METER	S/RF LED R/O	HI/LO OUTPUT	PA FACILITY	EX. SPEAK
AUDIOLINE	345	£139.95	40	240VAC	•			•	•	•	•		•	•	
COMMTEL		£65	40	240/12V	•						•				
DNT	B40	£TBA	40	240VAC	•						•		•		
DNT	B2740	£TBA	40	240VAC	•						•		•		
DNT		£TBA	40	240VAC	•						•		•		
FIDELITY	CB 3000M	£125	40	240VAC	•				•	•	•		•	•	
GRANDSTAND	BASE	£220	40	240VAC	•				•	•	•		•		
HAM INT.	JUMBO	£254	40	240VAC	•		•	•	•				•	•	
HAM INT.	CONCORDE II	£164	40	240VAC	•	•	•		•				•	•	
HARVARD	H401	£149.95	40	240VAC	•			•	•	•	•		•	•	
MIDLAND	76-200	£150	40	240VAC	•						•		•		
REFTEC	ES 934	£450	20	240V	•						•		•		
UNIDEN	UNIACE 300	£149.95	40	240VAC	•			•	•	•	•		•	•	
WESTWARD	P.T.2	£169.95	40	240V/12V	•						•		•	•	

MOBILES

TX IND. LIGHT	RX IND. LIGHT	CH 9 SWITCH	MIKE POSITION	COMMENTS	ADDRESSES	NAME
•	•		FR	Report July '83	E.M.S. Communications, Grove St, Wantage, Oxon LX21 7AD	MERCURY
•	•		FL		Murphy Electronics, Wemby, Middx	MURPHY
•	•		FL		K.B. & Co Ltd, 202 Cheetham Hill Rd, M/cr.	MUSTANG
•	•	•	FL			MUSTANG
•			FL		Roger D, 831 Mansfield Rd, Nottingham NG5 3GF	NATO
•			SL	Report January '83		NATO
		•	FL	Cybernet 134 chassis rep. April '82	S.M.C. Runbridge St, Totton, Hants SO4 4OP	OSCAR
			FL	Report Oct '83		OSCAR
•			FL		RF Technology, Leyton Ave Ind Est, Mildenhall, Suffolk	REFTEC
•			FL	Cybernet chassis	Rotel Hi-Fi, 2-4 Erica Rd, Stacey Bushes, Milton Keynes	ROTEL
•	•	•	SL	Cybernet chassis		ROTEL
•			SL	Cybernet chassis		ROTEL
•			FL			SIRTEL
•	•		SL		Tamo Way, Tower Bridge St, Walsall, Staffs	TANDY
•			SL			TANDY
•			SL			TANDY
•			—			TANDY
			SL	Report Nov '82		TANDY
•			SL	Report Sept '82	Cravenminster Ltd, Unit 8, Ind Est, Llandudno Junct, Gwynedd	UNIDEN
•	•		FL	Report Feb '83		UNIDEN
•	•		SL		Western Electronics, Fairfield Est, Louth, Notts	WESTERN
			FL	Report Nov '83	Westward Electronics, The Mill House, Westward Tuckenhay, Totnes, Devon 086423 336/370	WESTWARD

BASES

TX IND. LIGHT	RX IND. LIGHT	CH 9 SWITCH	MIKE POSITION	COMMENTS	ADDRESSES	NAME
•					Telecomms, Portsmouth and Globe, Essex	AUDIOLINE
			FR	Report December '83. Also comes with telescopic antenna		COMMTEL
•			FL	Rewiew May '82		DNT
•		•	FR	Report May '82		DNT
•		•	SR	Report May '82		DNT
		•	FL		Fidelity Radio Ltd, Victoria Rd, London NW10	FIDELITY
•			FL		Bee-Ware Ltd, Rippon Way, Harrogate, N. Yorks	GRANDSTAND
•			SL			HAM INT.
	•	•	FL			HAM INT.
•			FL			HARVARD
•	•		FL			MIDLAND
•	•		FR	See company for further features	RF Technology, Leyton Ave, Ind. Est, Mildenhall, Suffolk	REFTEC
•			FL	Reviewed August '83	Cravenminster Ltd., Unit 8, Industrial Est, Llandudno Junction, Gwynedd	UNIDEN
			FL	Report Nov '83	Westward Electronics, The Mill House, Tuckenhay, Totnes, Devon, Totnes, Devon 086423 336/370	WESTWARD

REFERENCE



NAME	MODEL	RETAIL PRICE	NO. OF CHANNELS	SUPPLY VOLTAGE	SQUELCH	NB SWITCH	ANL SWITCH	MIKE GAIN	RF GAIN	TOPE CONTROL	S-RF METER	S/R/L LED R/O	HI/LO OUTPUT	PA FACILITY	EX. SPEAKER
DNT	HF 12/3	£47.55	3	BATTERIES	•										
HARVARD	WT44		40	BATTERIES	•								•		
KAISER	CBX40	£80	40	BATTERY	•					•			•		•
MAXCOM	7E	£49.95	40	BATTERY	•								•		
MIDLAND	75-720	£59.95	40	12VDC	•										
TANDY	TRC1001	£119		BATTERY	•					•			•		•
WESTWARD	PT2	£159.95	40	Int. Batt.	•					•			•	•	•

PHONE CHECKLIST

Approved phones are marked ●

NAME	MODEL	PRICE	FREQUENCY	RANGE	RECHAR. BATT.	IN USE LAMP	INTERCOM	AUTO DIAL	EXTERNAL ANT.	SECURITY CODE	HANDS FREE
A-PHONE	TP125	£80	49MHz., 1.6-1.8MHz	230m	•	•		•			•
BT	HAWK ●	£155	47MHz., 1.7MHz	100m		•		•		•	
FIDELITY	WANDERER ●	£170	47MHz., 1.7MHz	200m	•	•	•	•	•	•	
FREEDOMPHONE	3500	£199	49MHz., 1.7MHz	200m	•	•	•	•			
HANDY PHONE	HP 1001	£199	49MHz., 35MHz		•	•	•	•	•	•	
MAXCALL		£116	49MHz., 1.7MHz	100m	•	•	•	•			•
MAXCOM	MCP150A	£89	49MHz., 1.6-1.8MHz	800m	•	•		•			
MAXCOM	MCP 120	£70	49MHz., 1.7MHz	700ft		•		•			
MAXCOM		£99	49MHz., 1.7MHz	200m	•	•	•	•			
PACER	7800	£149	49MHz., 1.7MHz	500m	•	•	•	•			
SUPERFONE	CT600	£116	49MHz., 1.7MHz	100m	•	•	•	•			
SUPERFONE	CT650	£199	49MHz., 1.7MHz	230m	•	•	•	•		•	•
SUPERFONE	CT505	£299	49MHz., 70MHz	1Km	•	•	•	•	•	•	•

PORTABLES

TX IND. LIGHT	RX IND. LIGHT	CH 9 SWITCH	MIKE POSITION	COMMENTS	ADDRESS	NAME
						DNT
				External antenna facility	Globe, 168 Brooker Road, Waltham Abbey, Essex	HARVARD
					Telecomms, 189 London Rd. North End, Portsmouth	KAISER
					A.T.M., AM House, 9A Old's Approach, Tolpits Ln, Watford Herts	MAXCOM
					Plustronix Ltd., Hempstalls Ln, Newcastle-under-Lyme, Staffs	MIDLAND
					Tame Way, Tower Bridge St, Walsall	TANDY
			FL	Report Nov '83	The Mill House, Tuckenhay, Totnes, Devon 080423 336 / 370	WESTWARD

The range of telephones and communications accessories available to the consumer is increasing rapidly. Not all equipment is approved by British Telecom — so look for the tag with the green dot if you want 'BT Approved' accessories.

CORDLESS PHONE

STANDBY	BATT. IND.	PRIVACY BUTTON	COMMENTS	ADDRESS	NAME
•			Report Feb '84		A-PHONE
•	•		Report July '84	Local BT Sales Offices	
•		•	Report July '83 BT Approved		FIDELITY
			Report May '83	Fidelity Ltd., Victoria Rd., London NW10	FREEDOMPHONE
•		•	Report Aug '83	Thanet Electronics Ltd., Reculver Rd., Beltinge, Kent	HANDY PHONE
			Report June '83		MAXCALL
	•		Report Oct '83	Maxon Group, AM House, 9A Old's Approach, Tolpits Ln., Watford, Herts	MAXCOM
•	•	•	Report May '84		
			Report May '83		MAXCOM
			Report May '83		PACER
		•	Report April '83	Superfone Communications, London NW2	SUPERFONE
		•	Report April '83		SUPERFONE
•			Report April '83		SUPERFONE

ANTENNA CHECKLIST

Name
Lists antennas by name and model number and gives you, where possible, the name and address of the manufacturer or distributor.

Construction
The majority of home base antennas are made of aluminium and mobile antennas from stainless steel, but fibre glass can be

The D.T.I. specs for CB antennas are now more liberal than those originally in force, with the base loading restriction removed to permit any type of loading as long as the antenna is 1.65m in length (or less) and no more than 55mm in diameter. This revised checklist now includes the many new antennas released after this change of heart.

CONSTRUCTION	LENGTH	MAX POWER	TYPE	LOADING	MOUNT	PRICE RANGE
AL AL AL AL	1.5 1.6 1.54 1.54	100 500 500 500	B B B B	B B C C	Pole Pole Pole Pole	D E E C
FG SS AL	Various	Various	B M	T C B CW	Various	A-H inc.
SS SS SS SS SS SS SS SS SS	1.08 1.05 1.08 1.05 1.08 1.08 1.08 1.08 1.05	1000 1000 1000 1000 1000 1000 1000 1000 1000	M M M M M M M M M	B B B B B B B B B	Surface Spring Surface Boot lip Spring Boot lip Mag. Spring Mag. Side Side, Fold over & Quick Disconnect	F F F G G G G G G
SS	0.6	50	M	B	3/8" thread	D
SS SS SS SS	1.22 1.22 1.22 1.22		M M M M	B B B B	Stud Trunk Mag. Mag.	D E E G
SS SS SS SS SS SS SS SS SS SS SS	1.42 0.61 1.22 1.42 1.42 1.22 1.42 1.22 1.22 1.42 1.22 1.22		M M M M M M M M M M M M	B B B B B B B B B B B B	Mag. Mag. Mag. Mirror Drill Thru Drill Thru Various Various Various Various	G F F E E E D D D D D D
SS SS AL	1.62 1.38 1.65	1000 1000 1000	M M B	B C T	3/4" thread 3/8" thread Pole	C C E
SS AL	1.5 1.5		M B	B B	Various	C D
SS FG SS	1.5 1.5 1.5		M M M	B B B	3/8" thread 3/8" thread 3/8" thread	
AL SS SS	1.5 1.5 1.5		B B B	B B B	Clamp Pole Clamp	E F F
AL AL AL	1.5 1.5 1.65	250 500 500	B B B	B B C	Pole Pole Pole	E F F
AL AL AL AL AL AL SS	1.6 1.5 1.5 1.65 1.65 1.65 1.65		B B B B B B M	B B B C C C C	Pole Bracket Pole Bracket 3/8" thread	D C D E E E E

NAME	ADDRESSES	MODEL
AERIAL SUPPLIES	Aerial Supplies (Redditch) Ltd. 5 Widney House, Bromsgrove Road, Redditch, Worcs. (0527 62620/60107)	Silver Star Silver Arrow Javelin Javelin Dipole
ALLGON	Communications, 10 North Street, Strood, Kent.	Various
ARMSTRONG	Stateside Trading Ltd. Audley Avenue, Newport Shropshire	SAM 10 SAM 20 TAK 10 TAK 20 MAG 10 MAG 20 BDY 20 PEC 20
ARCHER	Tandy Corp. Tameway Tower, Bridge Street, Walsall, West Mids.	21-904
AVANTI	CB Radio Centre Ltd. 337 Kenton Road, Harrow, Middlesex	AV 241 AV 241T AV 241M AV 241MM
BANDIT	Telecomms, 189 London Road, North End, Portsmouth	B10 B15 B16 B20 B30 B30 B40 B40 B60 B60 B60
BREMI UK LTD.	Unit 6, Innage Park, Holly Lane Industrial Estate, Atherstone, Warks.	B27S C27S HB27S
CB SERVICES	97 Crab Lane, Harrogate, North Yorks.	Bullwhip Knuckleduster
COMMTEL	Near Third Drive, Fengate, Peterborough	Rocket Shuttle Sterlight Shuttle Star Signal searcher Messenger Signal keeper
FREEMAN AND PARDOE	Tything Road, Arden Forest Ind. Est, Alcester, Warks.	Invader Thunderpole II Thunderpole III
GAMMA AERIAL PRODUCTS	Lyo, West Midlands (0384 891132/891474)	Skybreaker Avenger Lofty Skybreaker II Avenger II Lofty II Firefly

na Checklist will give you the following information:

used in some models. The list tells you what material the antenna is manufactured from.

Length

The legal maximum length of an antenna is 1.65m, base or mobile.

Maximum Power

This is intended as a guide

only, as the law only permits an effective radiated power of two watts. The power rating will give some indication of sturdiness. Figure refers to watts.

Type

Indicates whether a mobile or base antenna.

Loading

Indicates the type of

electrical loading of the antenna; top, centre, bottom or continuously wound.

Mount

This gives some idea of the mount or type of mount appropriate for the antenna concerned. Home base antennas are usually pole

mounted, but can be house gutter mounted. Mobile antennas are either mag. mounted by a strong magnet, attached to the car gutter or boot lid edge whilst others are physically attached in the same way as a car radio antenna. Mobile antennas with 3/8" thread usually will fit a range of mounts.

KEY		Loading	
Construction		B — £5-£9.99	
SS — Stainless Steel		C — £10-£14.99	
AL — Aluminium		D — £15-£19.99	
FG — Fibreglass		E — £20-£24.99	
Type		F — £25-£29.99	
B — Base		G — £30-£39.99	
M — Mobile		H — £40 plus.	
		CW — Continuously wound	
		Price Bands	
		A — £1-£4.99	

NAME	ADDRESSES	MODEL	CONSTRUCTION		LENGTH	MAX POWER	TYPE	LOADING	MOUNT	PRICE RANGE
			AL	FG						
HAM	Dials Wholesale, Unit 8, Block 2, Whitegate Indust. Est., Bathgate, West Lothian	Balcostar DV27 DV27TW	AL		1.2	200	B	C	Bracket	D B B
			SS		1.39	100	M	T		
			FG		1.19	100	M	T		
HOT ROD	Stateside Trading Ltd, Audley Avenue, Newport.	FM UK	SS		1.27		M	B	3/8" Thread	B
LES WALLEN MANF.	Pembroke Works, Ramsgate Road, Sandwich.	Modulator LC M.D.X. Long M.D.X. Short Mini M.O.X. Mini 27 T-Bolt Return Exper	SS		1.65	1000	M	B	3/8" Thread 3/8" Thread 3/8" Thread 3/8" Thread 3/8" Thread 3/8" Thread Pole/wall Pole/wall	C C C B B B D D F
			SS		2.00	1000	M	B		
			SS		1.55	1000	M	B		
			SS		1.10	100	M	B		
			SS		1.40	600	M	B		
			SS		0.83	200	M	B		
			AL		1.00	500	B	CW		
			AL		1.00	1000	B	C		
			AL		1.00	1000	B	C		
MARKSMAN	Marksmen Products, PO Box 40, Milton Keynes MK6 2UT (0908 688916)	Mister Stick	SS		1.19	Above legal limit	M	C	3/8" UNF	D
R.W. BADLAND LTD.	Roetan Trading Estate, Providence Street, Lye, Stourbridge, West Midlands (Lye 3160/5051)	Rebel 1 Rebel II Rebel Raider Rebel Bullet Red Devil	SS		1.6	500	M	B	3/8" Thread 3/8" Thread 3/8" Thread 3/8" Thread 3/8" Thread	C C C C C
			SS		1.6	500	M	B		
			SS		1.6	500	M	C		
			SS		0.61	50	M	B		
			SS		1.52	500	M	CW		
			SS		1.52	500	M	CW		
REVCO	Telecomms, 189 London Road, North End, Portsmouth.	Revco	SS		1.0	100	M	B	Various	B
SMC	Rumbridge Street, Totton Street, Hants	Oscar C8A 11GP Oscar 11V11S11 Oscar 11CM Oscar 11CE Oscar 11NE Oscar 11SE Oscar 11ZE	SS		1.5		B	B	Mag. Foldover Base Pull up Foldover Base	F F D C C C C B
			SS		1.6		B	B		
			SS		1.2		M	B		
			SS		1.2		M	B		
			SS		1.5		M	B		
			SS		1.5		M	B		
			SS		1.5		M	B		
			SS		1.5		M	B		
TAGRA	CB Radio Centre, 337 Kenton Road, Middlesax.	T40	SS		1.4	500	M	B	Various	E
THORO'BRED	Pixtron UK Ltd, 10 Victoria Street, Newark, Notts. (0636 74688 Telex: 377827)	Z 27 Z Mag 251 C 27 C Mag HQ	SS		1.62	1700	M	B	3/8" Thread 3" Dia Megnet 5" Dia Megnet 3/8" Thread 5" Dia Megnet Pole	B C C C D D E
			SS		1.62	1700	M	B		
			SS		1.60	100	M	B		
			SS		1.60	1700	M	C		
			SS		1.60	1700	M	C		
			PVC		1.58	1000	B	T		
VALOR	W.T.A. Electronics Ltd, 111 Cromer Road, Halesdon, Norwich (0603 47694)	Warrior 550 Half Breed 520 Half Breed 510 Half Breed 500 Diel-a-Match 540 Diel-A-Match 630 Rubber Duck 300 Pro Am PLB 27 Road Hog 338 Road Hog 335 Road Hog 336 Road Hog 337 Road Hog 831 Road Hog 838 Road Hog 836 Road Hog 836 Black Magic 333 1/2 Black Magic 333 Black Magic 332 Black Magic 333 1/2 Black Magic 833	SS		1.62	1500	M	B	3/8" Thread 3/8" Thread 3/8" Thread 3/8" Thread 3/8" Thread 3/8" Thread 3/8" Thread 3/8" Thread 3/8" Thread 3/8" Thread 3/8" Thread 3/8" Thread 3/8" Thread 3/8" Thread 3/8" Thread 3/8" Thread 3/8" Thread 3/8" Thread 3/8" Thread 3/8" Thread	C C C C C C C C C C C C C C C C C C C C
			SS		1.62	1500	M	B		
			SS		1.2	1500	M	B		
			SS		0.9	1500	M	B		
			SS		1.2	100	M	B		
			SS		0.5	25	M	B		
			SS		0.35	25	M	CW		
			SS		1.62	200	M	B		
			FG		0.9	1000	M	T		
			FG		1.2	1000	M	T		
			FG		1.52	1000	M	T		
			FG		1.75	1000	M	T		
			FG		0.6	500	M	T		
			FG		0.9	1000	M	T		
			FG		1.2	1000	M	T		
			FG		1.62	1000	M	T		
			FG		0.75	500	M	T		
			FG		1.2	500	M	T		
			FG		1.62	500	M	T		
			FG		0.75	500	M	T		
FG		1.2	500	M	T					
WTA	W.T.A. Electronics Ltd, 111 Cromer Road, Halesdon, Norwich. (0603 47694)	Wot Pole I Wot Pole II Wot Stick I Wot Stick II	AL		1.6	1000	B	B	Pole Pole 3/8" Thread 3/8" Thread	B C A B
			AL		1.6	1000	B	B		
			SS		1.5	1000	M	B		
			SS		1.6	1000	M	B		
VAN ORDT	Knight Communications, Unit 19 Britannia Estate, Leagrave Road.	Audio King	SS		1.5	2000	M	B	3/8" Thread	G

THE C.B. SHOP

Radio Communication Specialists

Access & Barclaycard welcome
Part Exchange welcome

5 Odeon Arcade,
Hallgate,
Doncaster,
South Yorkshire,
DN1 3LZ

Tel: Doncaster (0302) 66352

EXTRA CHANNELS ON MOST LEGAL 40 CHANNEL FM RIGS

This is your chance to get away from the wallies, mike keyers, music players etc.

Join the growing number of breakers enjoying the peace and quiet on our extra channels. Ideal for clubs, business circles etc. Available in easy fit module from only **£10.95** each (inc. p&p) or fitted by us, fully guaranteed only **£19.95** (inc. p&p and insurance).

We now offer a fast Mail Order Service on **ALL** CB equipment. Probably the lowest prices anywhere. Also we have a fast rig repair service, phone **TODAY**.

Please write enclosing S.A.E. for our latest catalogue. And for personal attention to any rig problems or questions about CB in general, phone **Doncaster 0302 69007** weekdays between 6pm-7pm and ask for Andy.

★ **THIS MONTH'S SPECIAL** ★

HAM INTERNATIONAL BIG MAC

7/8 wave home base antenna

only **£79.95** inc VAT

GRENADA HOME BASE CABINETS

with Power Supply and SWR Meter built in.
A BARGAIN AT ONLY **£19.95+£3.00 p&p**



HAM INTERNATIONAL MAIN DEALER FOR SOUTH WALES

C B T

1 Prince of Wales Rd.,
Swansea
(0792) 463821

Ham Relax Power Mike.....	£19.95 (B)
Ham 232S Processor Base Mike	£44.99 (D)
Ham 232DX Processor Base Mike	£49.99 (D)
Ham Antenna Matcher with through switch	£10.99 (C)
Ham 10-12 amp Power Supply.....	£54.99 (E)
Ham Thunderbird Base Ant 5/8 wave.....	£28.95 (E)
Ham Sexy base antenna 88 wave	£55.00 (E)
Ham Big Mac Base Ant 7/8 Wave.....	£75.00 (E)
Ham Frequency Counter HFC01.....	£69.95 (C)
Frequency Counter 6 digits.....	£55.00 (C)
Ham extension speaker with filter	£8.99 (C)
Ham replacement mike (as originally supplied by Ham).....	£6.99 (B)
Ham LA 120 100 watt am/fm - 200 watts ssb variable with preamp	£159.00 (E)
Ham LA 60 50 watt am/fm - 100 watts ssb variable with preamp	£110.00 (E)
SEIF reverberator RA 201	£34.95 (D)
Ham ROS-90 SWR-FS-Antenna Matcher.....	£15.95 (B)
Ham ROS-4 SWR-Power-FS.....	£12.99 (B)
Ham Ros-6 SWR-Power modulation meter.....	£39.99 (B)
Fidelity 2000 80ch. FM.....	£89.99 (D)
York 863 40 channel FM.....	£89.99 (D)
York 863 80 channel FM.....	£89.99 (D)
York 863 180 channel FM.....	£99.99 (D)
York 861 40 channel FM.....	£49.99 (D)
York 861 80 channel FM.....	£69.99 (D)
Binatone 5 star 160 channel FM.....	£105.00 (D)
120 channel expansion boards (state rig) for FM rigs.....	£29.99 (C)
Avantil Moonraker 4 element beam	£135.00 (E)
Sunny 200s 100 watts AM/FM 200 watts SSB.....	£99.99 (D)
MM2 front facia.....	£8.00 (B)
MM2 front facia overlay	£6.00 (A)
Concorde 2 front facia.....	£8.00 (B)
Cobra 148 original rig bracket	£4.99 (B)
Multimode II and Concorde II handbooks.....	£3.00 (A)
Multimode Two rig bracket	£4.99 (B)
Cordless Telephones.....	From £50.00

Spares available for Ham Models

POSTAGE RATES: (A) 50p (B) £1.00 (C) £2.00 (D) £3.00 (E) £5.00
Please allow up to 28 days for delivery

To obtain our catalogue on C.B. equipment send £1.50 to **C.B.T., 1 Prince of Wales Road, Swansea**, Catalogue contains the MMIII CONCORDE III & JUMBO III

ACCESS AND BARCLAYCARD ACCEPTED

"AGRIMOTORS"

(J. W. C. HUNT)

MERTON "CB" RADIO CENTRE
MERTON, OKEHAMPTON, DEVON. EX20 3DZ
Tel: BEAFORD (08053) 200

27 M/hz

We carry large stocks of 27 M/hz equipment including most makes of: C.B.27 M/hz Transceivers, Antennas both Home Base and Mobile, V.S.W.R. and frequency counting equipment, Watt meters, etc. etc. Power Supply Units from 3 to 12 AMPS, 13.5V. regulated. Masts, Poles, Chimney Lashing Kits, Co-axial Cables, R G.58 to H100 types always in stock, plugs and fittings of all descriptions, Reverberators, Mikes - H/Base, H/Held, Power, Echo, etc. Bury's Auto-Squelch stocked and fitted.

934 M/hz

We are dealers for: "Reftec", Comtel "Kestrel", "Craven Minster Dual Bander 27/934" Transceivers and have all makes in stock. All types of 934 M/hz Antennas, Mobile Colinears, Gutter mounts, Roof Mag Mounts, Roof through fittings etc. Home Base Professional Colinears, Yagi Beams, Helical Coil (Circular Polarisation) and quads. RG213UBX and H100 Coax Cables, all "N" and "BNC" type fittings, S.W.R. meters, combined V.S.W.R. and Watt meters, Masthead or rear of "Rig" Pre-amplifiers (20D.B.gain) by Crest Byte, Rotators by Kopec and Hirschman. Antennas by "Reftec", Les Wallen, Targe and T.A.P. Ltd.

28/144 M/hz

AMATEUR BAND EQUIPMENT

3.5 to 28 M/hz broad band linear amplifiers (mobile), 144 to 170 M/hz broad band (mobile) Linear Amps, Home Base and Mobile Antennas, Colinears, "Slim Jim" types, etc. etc.

Hours: 9am-1pm. 2pm-6pm.
Mondays to Saturdays (inclusive)
Sundays - by appointment

AUTO-SQUELCH

AUTO-SQUELCH

AUTO-SQUELCH

- * Fits neatly inside rig.
 - * Size approx. 30 x 20 x 15mm.
 - * Cuts out FM hiss and SSB signals between transmissions
 - * Works independently of signal strength or noise levels - so requires no adjustment
 - * Does not affect weak signals.
 - * Can be overridden by normal sq control if desired
- Suitable for most popular FM CB rigs and multi-mode rigs (FM section). Full fitting instructions etc. and technical back up available.

Now available from good CB shops

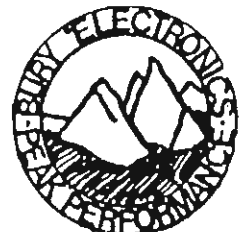

Bury Electronics

Home Farm House
Lower Brailes
Banbury, Oxon
OX15 5HZ
TEL: Brailes 432



CITIZENS' BAND

Lineage:

35p per word (minimum 15 words)  
Semi display: £7.00 per single column centimetre.
 Ring for information on series bookings/discounts.

All advertisements in this section must be prepaid.
 Advertisements are accepted subject to the terms and conditions printed on the advertisement rate card (available on request).



01 - 437 0699

Send your requirements to:
Citizens Band Classified,
ASP LTD., 1 Golden Square, London W1

CARDS, STICKERS & BADGES

RUBBER STAMPS

Personalise your QSL, special designs no problem. Discounts for quantity. Two day service. SAE for catalogue.
BEN NEVIS, 42-44 Princes Road, Hull.
Tel: (0482) 48134.

GLOSSY EYEBALL CARDS

many colours with Gold/silver/coloured lettering. £3.70/100 including P&P. SAE order form and samples. Sharp Graphics, PO Box 3, Grangemouth FK3 9BD. (0324) 473432.

PRINTING for Breakers. Artwork provided if required. SAE for price list: P. J. Printing, PO Box 1, Burnham-on-Sea.

LOW COST Rubber Stamps and printing. Free catalogue. Jones, St. Ivy, North Road, Queenborough, Kent. (0795) 665789.

EYEBALL CARDS with matching motif QSLs to your own design. Done in metallic hot foil on coloured gloss card. Tonbridge For details ring 0732 354026. (Tango Polecat). B.J.S. Printing.

PERSONAL QSL and eyeball cards on glossy yellow, blue, beige or white card. QSL £8.00. Hundred eyeball £3.50. Coloured ink extra. Postage and packaging £1.00 and £0.70. SAE for sample and price list. Stylaprint, 1 Overton Close, Navenby, Lincs. 0522 810493.

PLANS

SURVEILLANCE DEVICES, Bug Detectors, Voice, Scrambler, Directional Microphone, Many others. SAE for list, Plan Centre, Old String Works, Vye St., Ledbury HR8 2AA.

PERSONALIZED embroidered badges. Circular 3 3/4 in. dia. or rectangular 4 in x 2 in. Black or white background. Thread colours red, white, blue, yellow, orange, green or black. (No pictures or logos). Club name, league, team, etc. + your name, handle, etc. Suitable for any sport. Top quality. Washable. No minimum quantity. Send £1.50 per badge. Cheques, PO's, Barclaycard or Access. Black American style peak caps. £3.50 each. Binder Sewing Centre, 3 Fairfax Way, Deepingate, Peterboro. 0733 40449.



PERSONALISED QSLs 1,000 £15, Handcards £9.50. (DIY QSLs 100 £2.50. Handcards £1.10: 100 of each £3.00 C.W.O. only). SASE for catalogue. Currie QSL's, Room 2, 89 Derwent St., Consett, Co. Durham DH8 8LT.

DO YOU RUN A CLUB? Send £2 for sample club pack and we will credit you £4 off your first order (£18 or over). Plastic QSL and club cards, stickers, badges, wallets, etc. Suppliers to CB clubs for 6 years. Raymac, P.O. Box 75, Hounslow TW3 2HZ.

ACCESSORIES

NATO 2000 OWNERS. Getting bleed over, cross mod images? Our custom crystal filter provides dramatic improvement in selectivity. Simple to fit instructions provided. (Also fits Superstar 2000, Tristar 777). £9.95 inclusive. Golf Communications, P.O. Box 60, Rickmansworth, Herts WD3 3PZ.

GENERAL

SUPER DEALS!

PACKAGE A

Mobile 27MHz Transceiver
 40 Channel legal FM Rig
SUPERB QUALITY
 Aerial — with Plug supplied
 SWR Meter
 Patch lead

PACKAGE B Home Base

3-5 amp power supply —
GOOD QUALITY (safety approved)
 40 Channel 27MHz transceiver
 Legal case station aerial
(GOOD QUALITY)
 At least 15m good quality, low-loss cable
 SWR Meter Patch lead

**ALL THIS FOR
 JUST £63.00**
 + £5 P&P

**ALL FOR ONLY
 £99.00 + £6 P&P**

WIDE RANGE OF EXTRA GOODIES AVAILABLE!

★ **SEND SAE FOR "GOODIES" LIST** (including Trade Prices + VAT).
 ★ **EVERYONE WHO SENDS SAE WILL RECEIVE A**  **FROM US!**

★ **RTC, 148/9 Manchester Road, Ext. 9, Swindon, Wilts. Tel: (0793) 34136**

ACCESSORIES

EXPANSION BOARDS for SSB & UK FM Rigs. Expand legal rigs by up to 120 extra channels FCC £22.50. Add UK channels and extra bands to SSB/FM rigs. From £9.50. Crystals supplied. SAE details: 16 Bainbridge Close, Grange Park, Swindon, Wilts SN5 6BD.

MIDNIGHT BOARD

Channel Expansion System
 Easily fitted to: uniden, audio line, maxcom, cybernet, rotel, Harrier, Harvard & many more.
 Prices inc. carriage & VAT
 r-9 £11 each, 10-24 £7.50 each, 25-99 £8.25 each, 100 + £5 each

Send P O or Cheque to:

K. T. V.

Stonehouse St.,
 Middlesborough, Cleveland.
 Tel: 0642 829238

CLUBS

LIMA TANGO DX Group Ille membership £2. Cards, stickers and lots more. PO Box 17, Lowestoft, Suffolk NR32 5ET.

WHOLESALE

Giant vans with unrivalled giant range of CB accessories. At your shop's doorstep regularly. (200 miles radius)



TRADERS contact us, reverse the charges and **MAKE MONEY!**

Pama House, 433 Wilmslow Road, Manchester M20 9AF
Tel: 061-445-8918
061-434-5701

COMPONENTS

FOR FREE LISTS! of more than 300 LOW COST high quality components write or phone today to BOURNE-MOUTH OPEN CHANNEL, 335/7 Charmminster Rd, B'm'th, Dorset BH8 9QR. Tel (0202) 518766.

TA 7205 £1.50, MB 3712 £1.99, 2SC 1307 £1.50, 2SC 1306 99p, MC 3357 £2.99, LC 7137 £2.99, LA 1230 £1.99, LA 4422 £1.99, ECT Autosquelch £9.99, Bleedover Filter £2.50, Mike Screws. Power Supply Components. Tel: (0603) 46294.

WE WOULD LIKE to apologise to the customers of GCB Ltd and to our readers for the advertisement for components placed in the April issue. This should not have been printed as it was withdrawn by GCB Ltd. Import prices were quoted which apply strictly to trade and are also subject to VAT.

IC's
Transistors
Roger D
S.A.E. for prices of component
7, Thyra Court,
Nottingham,
NG3 5GT.

QUALITY I.C.'s, transistors etc. CB Guide Book, originally £2.95, now 75p. Orders over £5 post free, other 50p. S.A.E. for lists. Cybernet—Nevada 934MHz equipment. CB patches 10p. Tower Components, 201 Freeman Street, Grimsby, Sth Humberside. (0472-360037).

VIDEO

XXX VIDEO

Telephone (day or night)
0373 - 830563
FOR DETAILS

Glossy list from: XXX Video Club,
2 Streatham High Road,
London SW18
(You must be over 18 to ask for details)

BECOME A RADIO AMATEUR the easy way. Ham radio course video, £24. 1 Grice Close, Kessingland, Lowestoft.

WANTED

CRYSTAL FILTERS 10.695 MHz, 7 kHz BAND WIDTH, 1k impedance, HC-18/U, 3-lead. Direct replacement for old ceramic filter in most rigs £3.80 inc. VAT/post. CRYSTALS. Many common frequencies in stock at £4.50. Ordered frequencies not in stock will be made in 8-10 weeks. Faster delivery available. Trade quotes for quantities. Many other types of crystals and filters. SAE lists. Gollidge Electronics, Merriott, Somerset TA16 5NS. Tel: (0460) 73718.

D.I.Y.

EXTRA CHANNELS FROM £1.00

Info/Diagrams £10. Midnight crystals £5.25. Midnight board £10.50. Oric-1 Eprom Programmer plans £8.50. Send SAE for details of our Roger bleeps, K-tones, Musicals tones etc. GISO.
40 Baker Close, Southgate.
Crawley, Sussex.
TEL: 0293-543899

SSE
Solid State Electronics (UK) Ltd.
41 The Green, Oving, Southamptn
SP4 0DQ. Tel: (01235) 86433 or 86434
CRYSTAL FILTER SSE 10.895A
High quality 850ohm Impedance. Custom designed for UK FM units. Complete with resistor kit. 1000's sold since 1983!
CERAMIC FILTER CFW 455HT
Very good quality 455KHz 2nd if filter replacement for 4 pole or wide band 6 pole filter.
L9 IF TRANSFORMER
Again in stock after large demand. For installation in some Cybernet 134-135 PCB, when installing SSE crystal filter.
MODIFICATION PLANS
Plans for crystal filter mods to many UK FM units and NATO 2000 etc. Price £1. You will receive auto update as released if required.

BOOKS & PUBLICATIONS

**CB PLL DATA BOOK
NEW INT'L EDITION**

How they work and how to modify them. Complete specs on every PLL device including all U.K. chips. Easy non-technical reading!

"SCREWDRIVER EXPERTS' GUIDE

The bible of DIY CB repairs! Each book or both for

£11.95 **Roger D** £21.50
7 Thyra Court, Nottingham NG3 5GT

**SERVICE
MANUALS**

Ham Concorde 2, Ham multi-mode 2, Ham Jumbo 2, Ham Viking, Ham Puma, Cobra 148
GTL DX, PC 879 and PB010.
Colt 1600 DX, Tristar 777,
York 863, York 861.

All above at **£6.00 + £1.00 p&p** each.

Other rigs and spare parts available.

CBT

1 Prince of Wales Road,
Swansea. (Tel: (0792) 463821.

RIGS & TWIGS

GOLDFINGER CB

Turner mics and base mics. Quads from **£89.99**. Densi base mics with graphic equaliser. Avanti antennas.

32 Canmore Street,
DUNFIRMLINE, SCOTLAND
Tel: (0383) 739110

RIGS & TWIGS

PARKSIDE CB CENTRE

"Cybernet 934MHz £325.00", Modulator Expert Home Base £19.95, Super Modulator II c/load £10.95, Modulator Thunderbolt £7.95. ES880 Echo Chamber £39.95. Ind. Telc. 25w linears £14.95. CTE 70 Watt linears £36.95, Zetagi BV131 £77.95, Maxcom 20E £29.95, Oscar (Cybernet Chassis) £42.95, Rotel RVC 240 £67.95, Harvard 420m £54.95, Cybernet Beta 3000 £63.95, Harvard 410T hand-held £39.95, Maxcom MX 7E £39.95, Maxcom 30E £49.95, DNT840 FM Home-Base £43.50.

Full range of CB Mobile and Home Base Antennas and Accessories Telephone orders available + P&P

Thursford, Fakenham, Norfolk. Tel: (0328) 77402

**DON'T LEAVE IT TO
CHANCE — GIVE
YOUR BUSINESS A
BOOST BY
ADVERTISING IN CB**
Phone
01-437 0699
for details

FREE CATALOGUE! Available NOW write or phone for your copy today to BOURNE-MOUTH OPEN CHANNEL, 335/7 Charmminster Rd, B'M'th, Dorset BH8 9QR. Tel (0202) 518766.

AVON

PATCHWAY CARS CB CENTRE

Gloucester Road, Patchway,
Bristol. Tel: (0272) 694331.
Mon-Fri 8-5.30pm, Sat 8-4pm,
Sun 10-2pm.

Retail dealer stocking all types of
CB and communications equip-
ment including

CYBERNET DELTA-1, 934 and
CORDLESS TELEPHONES.

CAMBS.

Tower Communication



Everything for the 27MHz &
934MHz CBER, Radio Amateur
or SWL.

★ First Class Sales & Service ★
59 High Street,
Haddenham, Cambs.
Tel: Ely (0353) 740306

ESSEX

CB RADIO & MODEL HOBBIES

Parndon Mill, Parndon Mill Lane
(next to rugby club), Harlow.
TELEPHONE: 0279 418817

Open: Mon-Sat 9.30am-6pm
Sundays 10am-12am

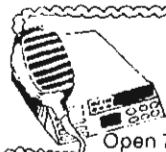

BREAKERS WORLD

2 High St.,
Bordon, Hants.
Tel: (04203) 4684

Open 7 days a week
Fully equipped work-
shop

MON-FRI - 10.30-6.30pm.
SAT - 10-6pm, SUN - 10.30-1.30pm.

BEDFORDSHIRE

TREADORS DAVID BULL G6 PJE

Tel: (0582) 391233

213 High Town Road, Luton LU2 0BZ.
934 MHz STOCKISTS

OPEN: 9-5.30 Mon-Sat, closed Wed.

CB Specialists, full service facilities,
large range of CB's and equipment.

DERBYSHIRE

DERBY ELECTRONICS

41 St. Thomas Rd, Derby
Tel: (0332) 774825

CB SPARES, SALES & SERVICE
TAXI RADIO SALES & SERVICE

OPEN MONDAY-SATURDAY
9 am-6 pm

WOODFORD CB CENTRE

528 Chigwell Road, Woodford,
Bridge, Woodford Green.
Tel: 01-504 9652

Open Mon-Sat 10-6pm
Large range of CB equipment.

HERTFORDSHIRE

RICKMANSWORTH COMMUNICATIONS CENTRE

37/39 Station Road, Rickmansworth.
Tel: 0923 770634

Open 7 days a week Mon-Sat 9-6.30
Sun 10-12, 2-4

Largest selection of CB Radio equip-
ment in the country

CIVIC

We have the best stocks in
the area of CB equipment
* Repairs * Aerial Erection

44 Mill Street, Bedford
Tel: 68174

AGENTS FOR NEVADA 934

DEVON

AGRIMOTORS

Merton CB & Radio Centre
Merton Garage & Post Office, Merton,
Nr Oakhampton EX20 3DZ

Open 6 days 9-6

(Sundays by appointment)

Specialists in 934MHz
Suppliers of all 27Mhz and 934Mhz
equipment

COASTAL CB AND TROPHY COMPANY

127 Old Rd., Clacton-on-Sea,
essex. (0255) 74292

Open 7 days a week 9-5pm.
Sundays 9-12pm.

Possible the cheapest in East
Anglia.
Mail order or Securicor delivery.

HUMBERSIDE - SOUTH

Cleethorpes CB Centre

(Corrigans)

15 Grimsby Road, Cleethorpes.
Tel: 0472 40703

OPEN:
Monday-Saturday 9.30 am - 6 pm

BERKSHIRE

INTERCOMMS CB & TELEPHONES

Rigs, Aerials & Accessories.
Repairs and conversions —
crystal filters, K-tones etc.

Ascot TV Centre, Silwood Road,
Ascot, Berks.
Tel: (0990) 20234
Agents for 934 MHz

DORSET

BOURNEMOUTH OPEN CHANNEL

335/7 Charminster Road,
Bournemouth, Dorset BH8 9QR
Tel: (0202) 518765

Open 6 days 9-5.30
Instant credit & full service
facilities

Free Mail Order Catalogue available.



HAMPSHIRE

CB WORLD



2 Market Way, Portsmouth,
Hampshire PO1 4BX.

Wholesale and Retail SAE for price
list.

PORTSMOUTH 732234

9am-5.30pm 1pm Wednesday

KENT

IMAGEFREE

COMMUNICATIONS

1-36 Station Road, Rainham, Kent
Tel: Medway (0634) 373960 Ext. 2

Open 7 days a week.
Stockists of 27MHZ 934MHZ and
P.M.R. Reftec, Nevada, Cresbyte.
Mail Order Available.

BUCKINGHAMSHIRE

VANNER C.B. CENTRES

3 Croft Court,
Stony Stratford,
Milton Keynes MK5 59BT
34 Gloucester Avenue,
Northampton NN6 7QJ
9.30-5.30 Closed Thursdays

Mail Order
Access/Barclaycard

DURHAM

IAN FISHER

Communications of Stanhope
CB Works

Bondisle Way, Stanhope,
Bishop Auckland, Co. Durham
DL13 2YT
(0388) 528464

Distributors of 934MHz rigs also 27MHz
rigs and repairs. Coaxial cable. Base station
antennas + mobile antennas + all accessories.
OPEN MON-SAT 10.30am-6.30pm

TELECOMMS

189 London Rd., Northend,
Portsmouth, Hants.
Tel: (0705) 862145.

The UK's largest manufacturer,
Importer, distributor and retailer
of CB equipment. Open Mon-Sat
9.30-5.30 (Wed. closed 12.30).
Callers welcome, also mail order,
see adverts elsewhere in mag.

FABULOUS PHONES

CB & Telephone equip. suppliers
72 High Street, Orpington
Tel: (0689) 74051

Open: Mon - Sat 9am - 5.30 pm

ONE STOP ELECTRONICS

126A Maldstone Road,
Rochester.

Tel: 0634 400179

The shop for the sale & servicing of all radio communication equipment. Components available. Open 7 days a week.

LONDON

PROTEL AERIALS AND COMMUNICATIONS

Manufacturers and suppliers of CB equipment and aerials, OXTV equipment and aerials, also other specialist aerials. Large range of brackets and masts also available.

295-297 Ballards Lane, N12
Tel: 01-445 4441

TRADE ENQUIRIES WELCOME

WEST MIDLANDS

SQUARE WHEELS

BIRMINGHAM'S LARGEST
CB SPECIALISTS

*appointed Birmingham's Cybernet
934 stockists
*appointed K.S. Services expansion
engineers.

WE INVENTED THE
MIDNIGHT BOARD
82 EDGEWOOD ROAD
REDNAL, BIRMINGHAM

CB CB SEE ME!

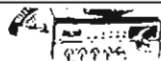

Wissaye Valley CB Centre,
West Dereham Road,
Wretton, Kings Lynn

East Anglias leading CB retailer
Open 7 days a week 9-9pm.
Tel: Stoke Ferry 500513

 10, North Street,
Strood, Kent.
Medway (0634) 716422

OPEN 6 DAYS

For All Communications Equipment
including CB, Amateur/Commercial
and Marine

Call us for details of our Mail Order Service

LEICESTERSHIRE

EVERITE COMMUNICATIONS 934 SPECIALISTS

Agents for Commt. UNIACE, Wallen,
Radios and equipment always in stock
Low mileage Refites available.
Send S.A.E. for lists. Equipment delivered
within 50 miles.

OPEN SIX DAYS
MAIL ORDER A SPECIALITY
5 Coventry Road, Hinckley, Leics.
Tel: Hinckley 611569 Evenings 837431

City Communications

The BIGGEST & BEST
RANGE of all the
latest CB Equipment
& Accessories

OPEN: Mon.-Sat. 10am-6pm
City Communications Ltd.
112 Pitfield Street, London E1.
Telephone: 01-739 9991.2

MANCHESTER

Centre Base 1

Full range of CB accessories
and equipment in stock.

433 Wilmslow Road,
Withington
(opp. Library)

 Tel: 061-445-8918
061-434-5701

PARKSIDE CB CENTRE Fakenham.



Tel: Thursford 402
Open: 6 days 9 - 6
27MHZ and 934MHZ

Large Stocks & Mail Order Available

OXFORDSHIRE

MODULATIONS COMMUNICATIONS

62 Wootton Road,
Abingdon, Oxon.
Tel: 0235 - 21400

Open 7 days Mon-Sat
9-5:30pm Sun 9-12.

Instant credit facilities. Agents for 934
MHZ. Wholesale, Retail and Mail
Order. Send £1.00 for catalogue.



MERSEYSIDE



PHONE US FIRST OPEN 7 DAYS
Speedy Repair Service. All leading
brands in stock. The Mobil Garage
(opp the Grafton Rooms), West Derby
Road, Liverpool 6. Tel: 051-263 2010

ALPHA'S CB CENTRES

224 Balaam Street, London E13
Tel: 01-471 5589

Open: Mon - Sat 9am - 7pm
Sunday 10am - 2pm

ALSO
EX ZULU/ONE/FOUR,
132 Leytonstone High Road, E15.
Tel: 01-555 8045. Open: Mon-Sat
9am-5:30pm.
T/A Balaam St. Motors

BREAKER ELECTRONICS 27MHz and 934MHz

Sole Leicestershire agents for the
CYBERNET DELTA 1
personal radio. Nevada 934, Commtel 934
and Les Wallen, all repairs carried out on
the premises by a qualified engineer.
21 Trinity Lane, Hinckley, Leicestershire
Open 9.30-6 Mon-Sat. 10-12 on Sundays

X.L. RADIO C.B. CENTRE

133-135 ASKEW ROAD, W12
Tel: 01-743 2795

YOU'VE BEEN TO THE BEST
NOW TRY THE BEST

London's largest stockists of
27MHz and 934MHz equipment

Repairs/installations
Cordless phones and car alarms
Mail Order Service

OPEN MON-SAT 9-6 THURS 9-1

Generate drop-in
trade with
BREAKER BASES
for as little as
£15.75

SCOTLAND

JRD EQUIPMENT

83 Station Road, Ellon,
Aberdeenshire. Tel: (0358)
20294.

We stock everything for the CB
enthusiast. Open every day of
the week.

LINCOLNSHIRE

27/934MHz cb
LINCOLNSHIRE
AGENTS FOR
NEVADA 934



Come and see us at
Mittler Telecommunications
The Parade, Cherry Willingham,
Lincoln. Tel: (0522) 764279

(24 hour answering service.
Free parking for up to 50 cars)

IS YOUR COUNTY ON THESE PAGES?

IF NOT,
WHY NOT?

NORFOLK

B A YEOMANS & SON

65 North Walsham Rd.,
Norwich, Norfolk Tel: 46294

Discount CB/Anything electrical.
Savings just a phone call away.
Used CB bought and sold.
CB REPAIR SPECIALISTS

Johnston
Communications
63 Barclay Street,
Stonehaven. Tel: 0569
64618. Mon-Sat, 9am-5pm

Scotlands largest retail distributor.
Trade enquiries invited. Import-
Export-Wholesale-Retail-Mail Order
Send 50p Postal Order for huge list
Official order for Trade List.
Agent for all major UK manufacturers

CB Citizens' Band

BREAKER BASES

SOMERSET

YOUR SOMERSET BASE STATION

The Triangle, Castle Cary, Somerset (0963) 50433

Large selection of rigs, cordless phones, extension phones and accessories, the best and cheapest in the West! Open 6 days. Easy parking. 9am-1pm, 2pm-5.30pm.

SURREY

GUILDFORD CB

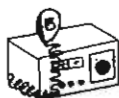

Surrey's biggest stockists of CB equipment and accessories.

Low prices, technical know-how
Repairs: 936 and Amateur
Cobras and Yesu wanted
34 Aldershot Rd., Guildford 574434

SUSSEX

The C.B. Centre



Inrange Ltd, 8 Marine Court, St. Leonards on Sea.
Tel: Hastings (0424) 443185/442025
Open: 7 days. Mon-Sat 9.30-6.30
Sun 10-2.30. Retail & Wholesale.

WEST MIDLANDS

BUFFALO BILL

CB Radio & Accessories
100 Walford Rd., Sparkbrook
Birmingham 11 021-772 2066

"We can make your Radio Active"

OPEN 6 DAYS 10-6

SUFFOLK

MARSHION ELECTRONICS
366 Spring Road, Ipswich, Suffolk.
TEL: Ipswich (0473) 75476

Open: 9.30-5.30 Tues-Sat
CB 934 and electronic components

WHY NOT TRY US FIRST?

164 London Road, Hackbridge, Surrey.
Tel: 01 - 647 4758
Open 7 days a week. Mon-Sat 9-7,
Sun 9-1. Repair facilities carried out on the premises by our technicians.

G.W.M. RADIO LTD.

Long established stockist of Ham & CB equipment. Repairs undertaken. Wide range of accessories.

40/42 Portland Rd., Worthing
Tel: 0903 34897

CB WORLD

37 Colehill Rd., Birmingham
B38 80P. Tel: 021-784 4523
SAE for price list 10-6pm Mon-Sat
10.30-12.30 Sun

FOR THE CHEAPEST AERIAL PRICES IN THE MIDLANDS

HEWARD'S HOME STORES LTD (Established 1963)

822/4 Kingstanding Road,
Birmingham B44 9RT.
Tel: 021-354 2083

G4RJM with 38 years in The Radio Trade Ham Equipment urgently wanted Open: Mon-Sat 9-6
WE WELCOME ALL CB'ers

STAFFORDSHIRE

STAFFORD COMMUNICATION & CAR CENTRE

C.B. & Telephone equipment plus full range of car spares and accessories.

3A Bridge Street, Stafford.
TEL: Stafford 212574

CB CENTRE

20C Selsdon Road, Sth Croydon.
Tel: 01 - 880 4503

All CB equipment available. Good repair service. Telephone equipment and answer phones.

OPEN:
9.30am-6pm Monday-Saturday.

TECHNICENTRE

CB, telephones & accessories
91 Bohemia Road,
St. Leonards, Hastings.
TEL: 425-951

ALSO

Ashford Market, Saturday.
Haywards Heath, Sunday.

YORKSHIRE

• RADIO AMATEURS AND C.B. PEOPLE TALK TO •

34 NEW BRIGGATE LEEDS LN 101

LAFC COMMUNICATIONS CENTRE

ELECTRONIC COMPONENTS - TELEPHONES
VIDEO - AUDIO LEADS - STYL
LEEDS 422237 THE PROFESSIONALS!

unifone

TRIO ICOM YAESU
LARGE RANGE OF ACCESSORIES

WALES

CAERPHILLY CB CENTRE

Rigs 55 Van Road, Caerphilly, Twigs
Mid Glamorgan,
Tel: 0222 882450

Easy parking 10am-1pm, 2-15pm-6pm
6 days. Keen prices. All accessories.
Good service by Rig Doctor

LEN BERRY ELECTRONICS LTD.

We monitor channel
0723-373914
or eyeball at:
147 VICTORIA ROAD,
SCARBOROUGH,
YORKSHIRE

RATES OF CHARGE:-

35p per word per issue (minimum 15 words).
£1.00 per single column centimetre.
Ask for information on series discounts.

Phone

01-437 0699

for details

**Don't leave it to chance!
Give your business a boost
by advertising in**

CB MAGAZINE

Ring Jason on 01-437 0699 for details

FOR SALE

MINIATURE SURVEILLANCE TRANSMITTERS

FROM £19.95

FULL RANGE including Telephone Monitors and High Power Microphones. (listens through 1 foot solid concrete). Professional Quality. Listen to conversations up to 3,000 meters away. Send S.A.E. for Brochure **KNIGHT COMMUNICATIONS LTD.** Unit 19, Britannia Estate, Leagrave Road Luton LU3 1RJ. Telephone: (0582) 453002



Don't leave it to chance! Give your business a boost by advertising in CB. Phone 01-437 0699

934 FOR SALE. Commtel, 1 month old, cost £495, accept £295; 11 months guarantee from us. Yeomans CB, Norwich 0603-46294.

UNIDEN 100s TO CLEAR: £4595 free P&P. One year guarantee. Payable to AECOMM, 48 Shenley Lane, Birmingham, B29 5PN.

RIG DOCTORS

POWER SUPPLY REPAIRS
We offer a fast repair service on most makes of D.C. power supplies in the 1 to 30 amp range, crowbar circuits, etc. also fitted.
For full details please ring **0536 743496**

POWER SUPPLIES

Power Supplies for

Homebase and Hobbyist: All British Manufacture
Top quality construction and performance: Complies with all Safety Requirements: Outputs 13.8V DC. 3-5 amp **£12.50.** 5-7 amp **£19.50.** +£2.00 P&P. Send cheque or P.O. with order. Allow 28 days for delivery. Trade enquiries welcome.

POWERAIL ELECTRONICS LIMITED
Tel: 0582 600277
6B PRINCES STREET, DUNSTABLE, BEDS. LU6 3AX

MISCELLANEOUS

PERSONALISED LEATHER BELTS HAND MADE

ROCKFORD LEATHER BELTS
in top-quality cowhide with solid brass CB buckle

£7.50
+50p p&p (colours brown, tan, black)

Other personalised leather goods made to order

Crawton Leather Co
Lamton, Sandness
Shetland Isles
Tel: Sandness 286



TO FILL THIS SPACE 'phone Jason on 01-437 0699 NOW!



CLASSIFIEDS
Where else do breakers go to buy and sell?
Ring **01-437 0699** for details

CLASSIFIED ADVERTISEMENT — ORDER FORM

IF YOU HAVE SOMETHING TO SELL, NOW IS YOUR CHANCE. DON'T TURN THE PAGE — TURN TO US!

RATES OF CHARGE: 35p per word per issue (minimum 15 words) £7.00 per single column cm. Please indicate heading you require and post to: **CITIZENS BAND, Classified Dept., 1 Golden Square, London W1R 3AB.**

Please place my advert in **CITIZENS BAND** for issues commencing as soon as possible.

I am enclosing my Cheque/Postal Order/International Money Order for: (delete as necessary) £..... (Made payable to A.S.P. Ltd)

Please use **BLOCK CAPITALS** and include post codes.



OR Debit my Access/Barclaycard (Delete as necessary)



Name (Mr/Mrs/Miss/Ms)

Address

Signature..... **Date**.....

Daytime Tel. No.

All classified advertisements must be paid for in advance.

ES 880 ECHO CHAMBER

**Importers
and Distributors**



SHARMAN'S WHOLESALE

DISTRIBUTORS FOR:

HARVARD[®]

maxcom

DNT



BREMI[®]



Extensive ranges
of CB equipment in
stock at the best prices for you!

STRICTLY TRADE ONLY



IND. TELE

**Quality Power Supplies and Linear
Sole Importers and Distributors.
Power Supplies 3amp·5amp·10amp
Linears.**

**25 WATT SWITCHABLE 70WATT SWITCHABLE
100WATT SWITCHABLE 200WATT SWITCHABLE**

**3 BURY NEW ROAD, MANCHESTER M8 8FW
TEL 061-834-9571 TELEX 665446 Sharma G**

RING NOW FOR OUR SECURICOR DELIVERY DETAILS!

The Professionals

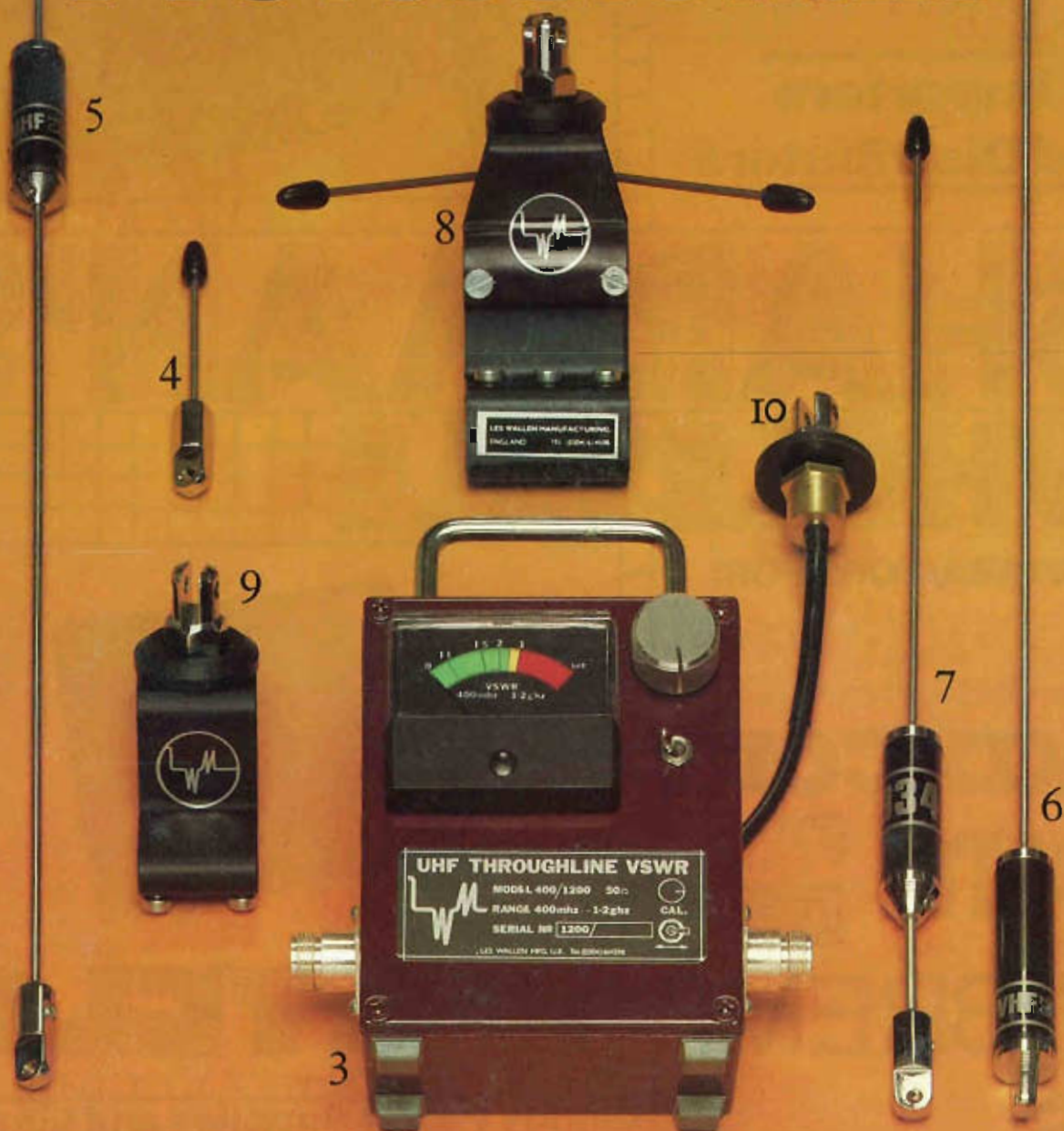

Professional, is the only word needed to sum up this new range of 934 MHz antennae and accessories from Les Wallen. Problems that are normally associated with this frequency have been completely overcome, bringing to you a range of 934 equipment that is both highly efficient and competitively priced. Items from the Les Wallen Professional Range include:-

- | | | | |
|---|----------|--|--------|
| 1. 934 MHz base colinear (8 x 1/2 wave + 1 x 1/4 wave elements) | £55.35 | 8. Gutter mount bracket complete with ground-plane assembly for 934 MHz/Cellular | £7.75 |
| 2. 934 MHz mobile colinear, gutter mounted, trunk-lip mounted, (elements as item 1) ... | £37.50 | Gutter mount only | £4.35 |
| 3. VSWR Throughline meter 400/1200 MHz.... | £67.00 | 9. Hatch/trunk-lip mount c/w ground-plane assembly for 934 MHz/Cellular | £7.15 |
| 4. 1/4 wave mobile antenna for 934 MHz / Cellular radio (state which) | £20.05 ● | Hatch/trunk-lip mount only | £3.95 |
| 5. 5/8 over 3/8 UHF mobile, 420-480 MHz | £24.65 | 10. Low loss antenna mount c/w 4m coax for up to 1.3 GHz as supplied with items 4 & 7... | £12.90 |
| 6. VHF 3/8 wave mobile 140-180 MHz | £24.00 | | |
| 7. 934 MHz or Cellular 3/8 over 1/4 wave mobile (state which) | £24.55 ● | ● Price on antenna includes the low-loss mount, if required separately deduct | £12.90 |

All prices shown are RRP, inc. VAT.
All enquiries to:



LES WALLEN MANUFACTURING
PEMBROKE WORKS, RAMSGATE ROAD, SANDWICH, KENT CT13 9NW.
TELEPHONE: (0304) 614598.