

CEED

COMPLIANCE

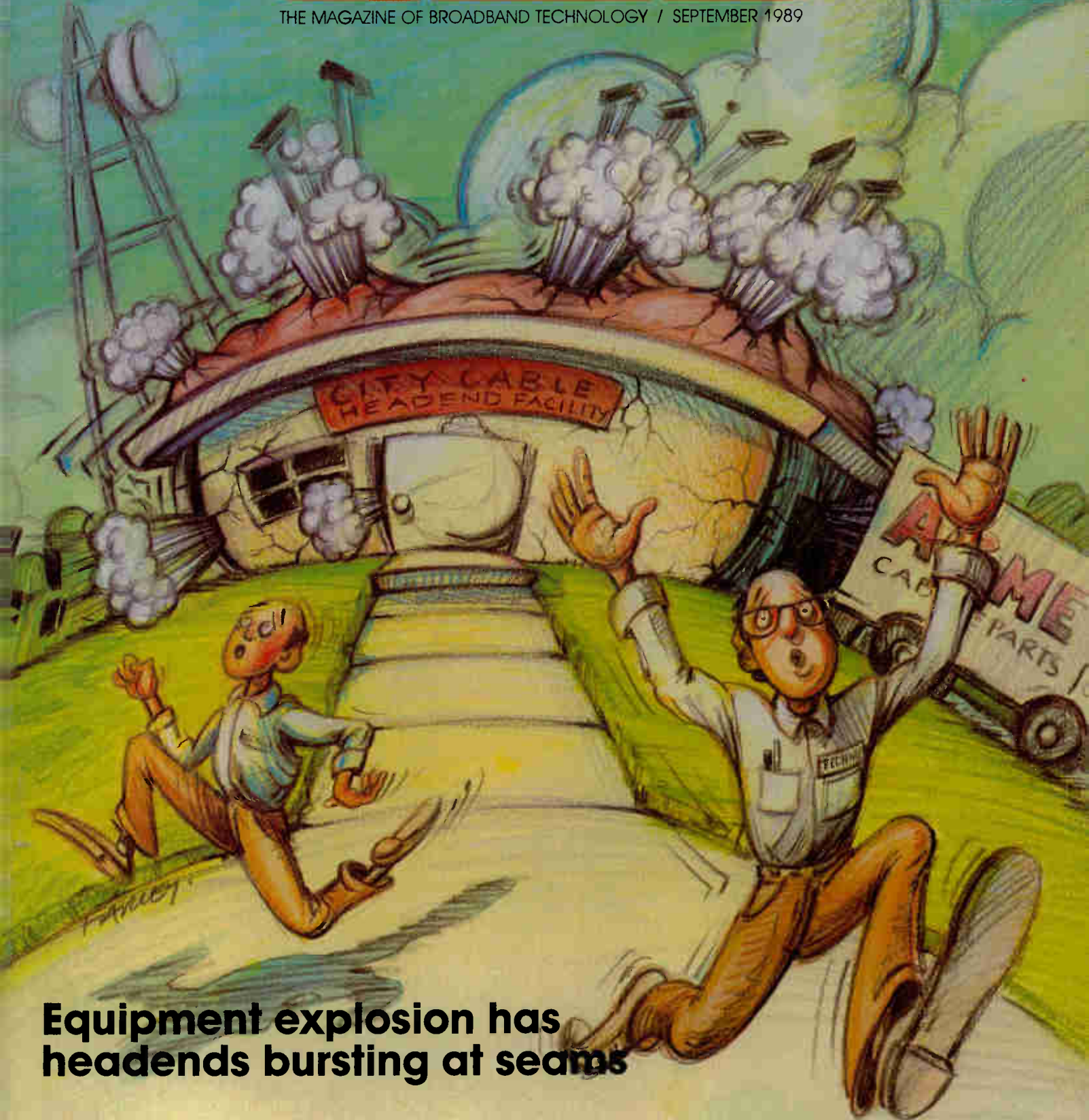

THE MAGAZINE OF BROADBAND TECHNOLOGY / SEPTEMBER 1989



Equipment explosion has headends bursting at seams



Panasonic Built. From The Inside Out.

Every time you install a Panasonic® CATV converter, you're assured of uncompromised quality and performance. Because Panasonic CATV converters are designed and manufactured by its parent company, Matsushita Electric. Which means each CATV converter is Panasonic built. From the inside out.

Take the Panasonic TZ-PC140/170 Series. Employing the latest in manufacturing technology, Panasonic converters are built to exceptionally high quality standards. It's the quality your subscribers have grown to expect from Panasonic. And that will help avoid costly service calls.

And to provide today's subscribers with the sophistication they associate with all Panasonic video products, the TZ-PC140/170 Series provides features like BTSC stereo compatibility, skip-scan tuning and remote volume control (170 Series), to name a few.

Panasonic CATV converters. Built for you and your subscribers the way all converters should be. From the inside out.

Panasonic Video Communications

For more information call:
Northeast 609-589-3063 Midwest 513-530-9216
Southeast 404-925-6845 West 415-947-0147

Reader Service Number 1

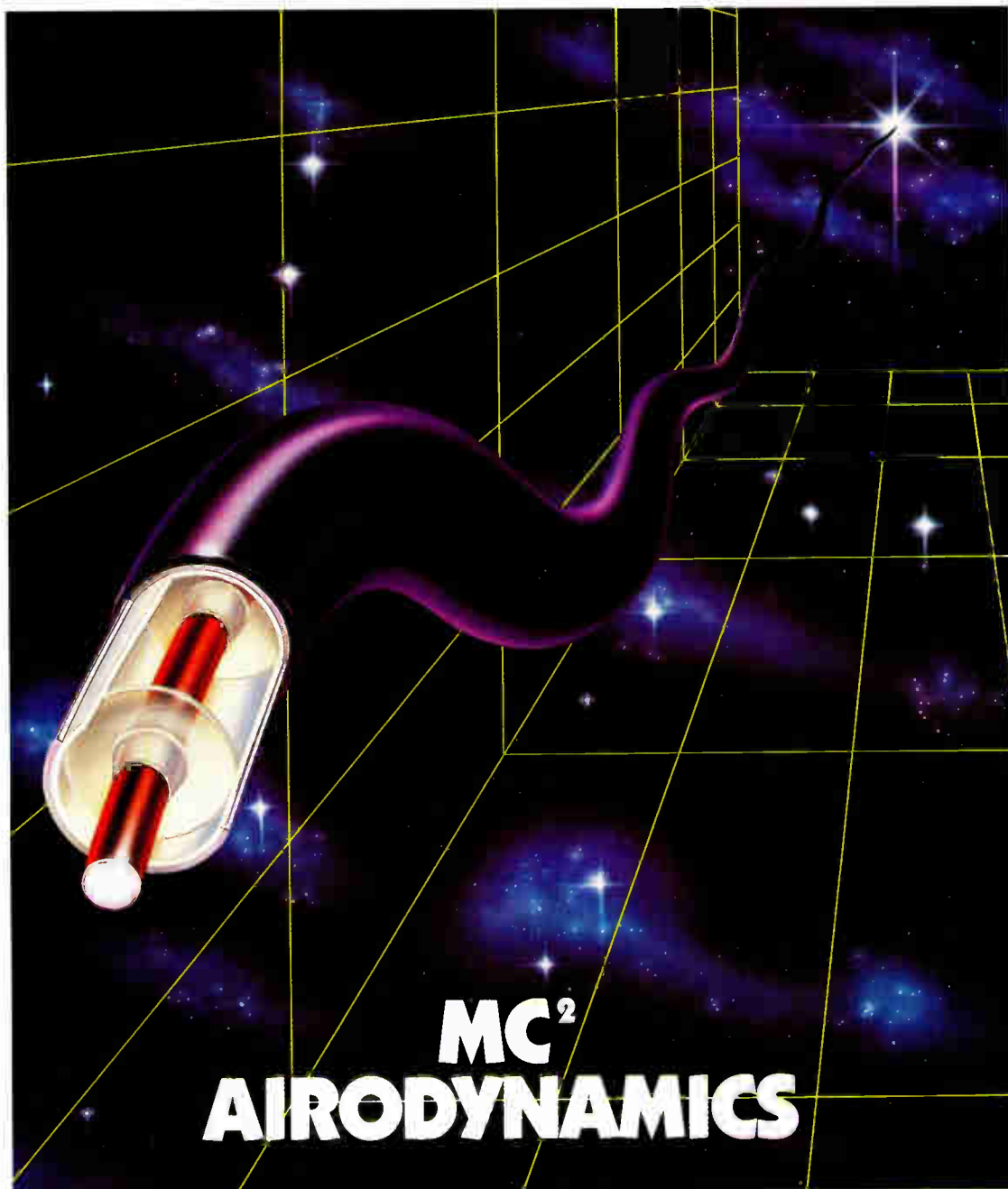

MC² AIRODYNAMICS

Perfection in Dielectrics.

Trilogy Communications built a better coaxial cable – MC² – and the CATV industry is letting us know about it.

The MC² air dielectric combines excellent product durability and flexibility with air-tight fully-bonded construction. Our 93% velocity of propagation provides the purest signal over the longest distance – fewer amplifiers

means immediate savings.

All this plus the highly respected Trilogy program of delivery and service provides our customers with the attention and performance that are second to none.

Our most prized dynamics are your acceptance of our best effort so far – MC² air dielectric coaxial cables.



Reader Service Number 2

Trilogy 

COMMUNICATIONS INC.

Call or write for our free sample and brochure: TRILOGY COMMUNICATIONS INC., 2910 Highway 80 East, Pearl, Mississippi 39208
800-874-5649 • 601-932-4461 • 201-462-8700

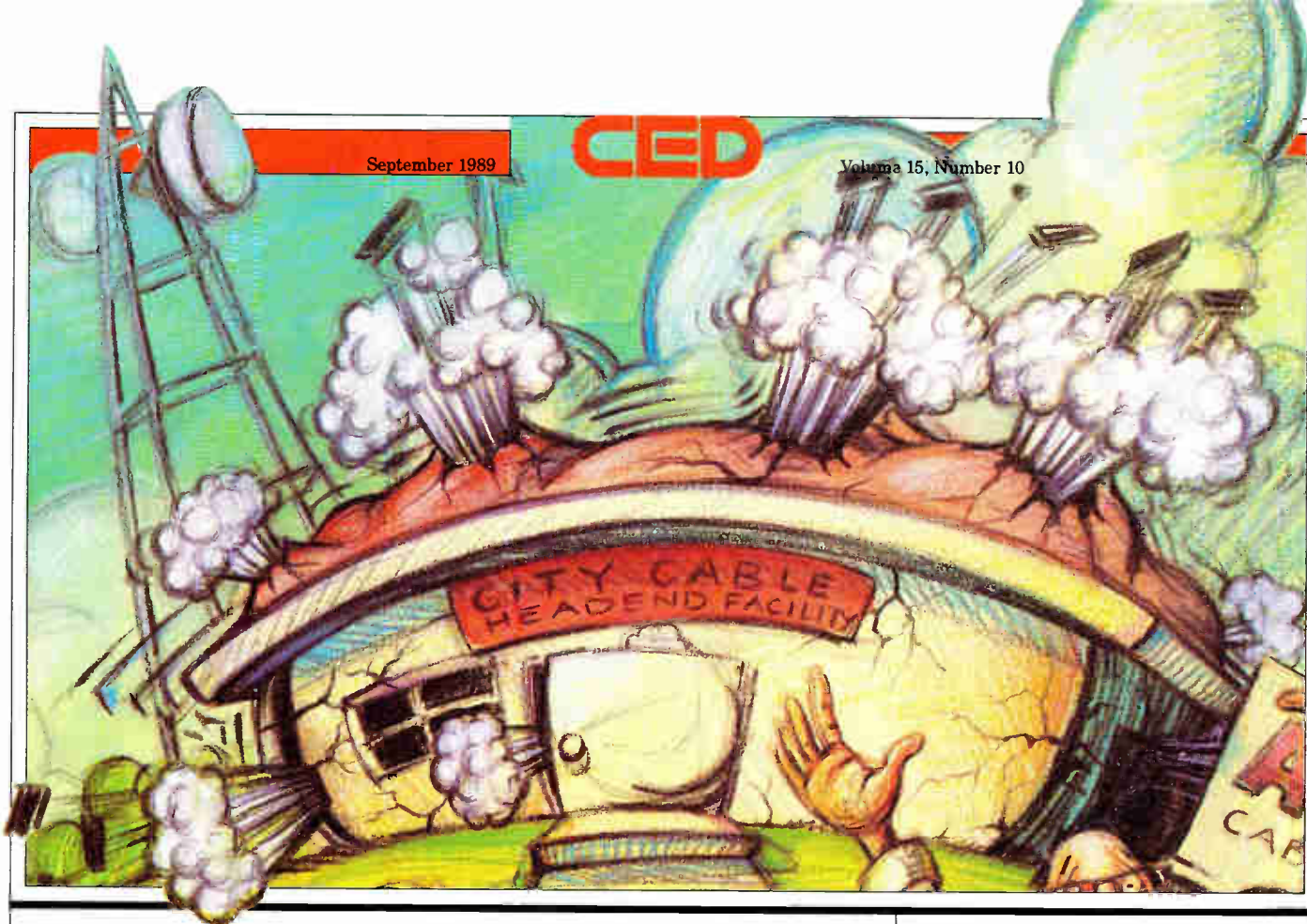

Bursting at the seams

With ever more equipment being added to headend facilities to accommodate channel expansion and new technologies, space is becoming a critical issue. Some possible alternatives and methods to ease the overcrowding are explored in this feature.

28

About the Cover:

The proliferation of headend equipment is causing facilities to "burst at the seams" like never before, causing operators to spend millions on new facilities. Methods of reducing headend overcrowding are discussed in this feature story on page 20.

Too hot to handle

As operators push more channels down ever-longer systems, it's important that amplifiers adequately dissipate heat, especially when they're placed inside enclosures.

34

Illustration by Malcolm Farley.

Real world usage of multi-channel AM fiber trunks

Carl McGrath with AT&T Bell Laboratories explores the design, characterization and performance capabilities of AM optical technology for use in CATV applications.

48

CLI COMPLIANCE

Testing, testing...

ATV testing is becoming crucial as proponents gear up for the final step in the HDTV race. How those tests should be set up to insure compatibility with cable is the focal point of this story by Walt Ciciora of ATC.

54

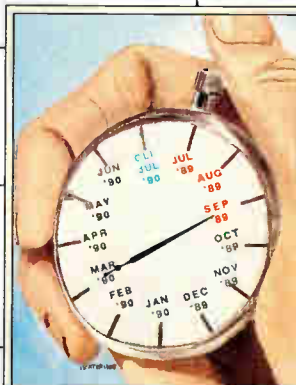

CLI program shows positive results. See page 76.

Where do all those converters go?

Shellie Rosser of Anixter Cable TV discusses what happens to old converters and what operators can do to remove the excess from their inventories.

70

DEPARTMENTS

- In Perspective**8
- Color Bursts**12
- Spotlight**16
- Frontline**18
- From the Headend** . . .20
- Looking Ahead**22
- Capital Currents** . . .24
- Return Path**26
- SCTE Focus**66
- In the News**79
- Classifieds**87
- Ad Index**89
- What's Ahead**90

CLI COMPLIANCE

System still benefiting after 3 years

Three years after implementing a leakage control program, Metrovision of Michigan is still reaping the benefits. In this paper, Victor Gates and Clay Collins of MetroVision compare system performance before and after CLI compliance.

76

©1989 by International Thomson Communications Inc. All rights reserved. CED (USPS 330-510) (ISSN 1044-2871) is published monthly except twice in May

by International Thomson Communications Inc., 600 S. Cherry St., Denver, CO 80222. ©September 1989, Volume 15, Number 10. Subscriptions free to qualified industry readers. All other one-year subscriptions are \$36, prepaid in U.S. funds only. Second-class postage paid at Denver, CO, and additional mailing offices. CED is published on behalf of the cable television and broadband communications industries. POSTMASTER: Please send address changes to CED Circulation, 600 S. Cherry St., Suite 400, Denver, CO 80222. MEMBERS OF THE BPA.



Six VideoCiphers[®] and Receivers in only 15 inches



Whether you are building new headends or adding scrambled channels, the Nexus VCMB and Nexus Satellite Receivers offer you a unique solution to rack more channels in less space. Contact us for more details.

All Nexus Headend products are covered by the famous Nexus 5 Year Warranty. Videocipher[®] Modules covered by General Instrument's warranty.

Nexus — Definitely Ahead of Our Time

Tel: (206) 644-2371 Bellevue, WA. or (604) 420-5322 Burnaby, BC. Fax: (604) 420-5941
Write: NEXUS ENGINEERING CORP., 7000 Lougheed Hwy., Burnaby, BC. V5A 4K4

NEXUS
ENGINEERING CORP.
PERFORMANCE
YOU CAN SEE

rely on

Take the heat off new Heat Dissipat

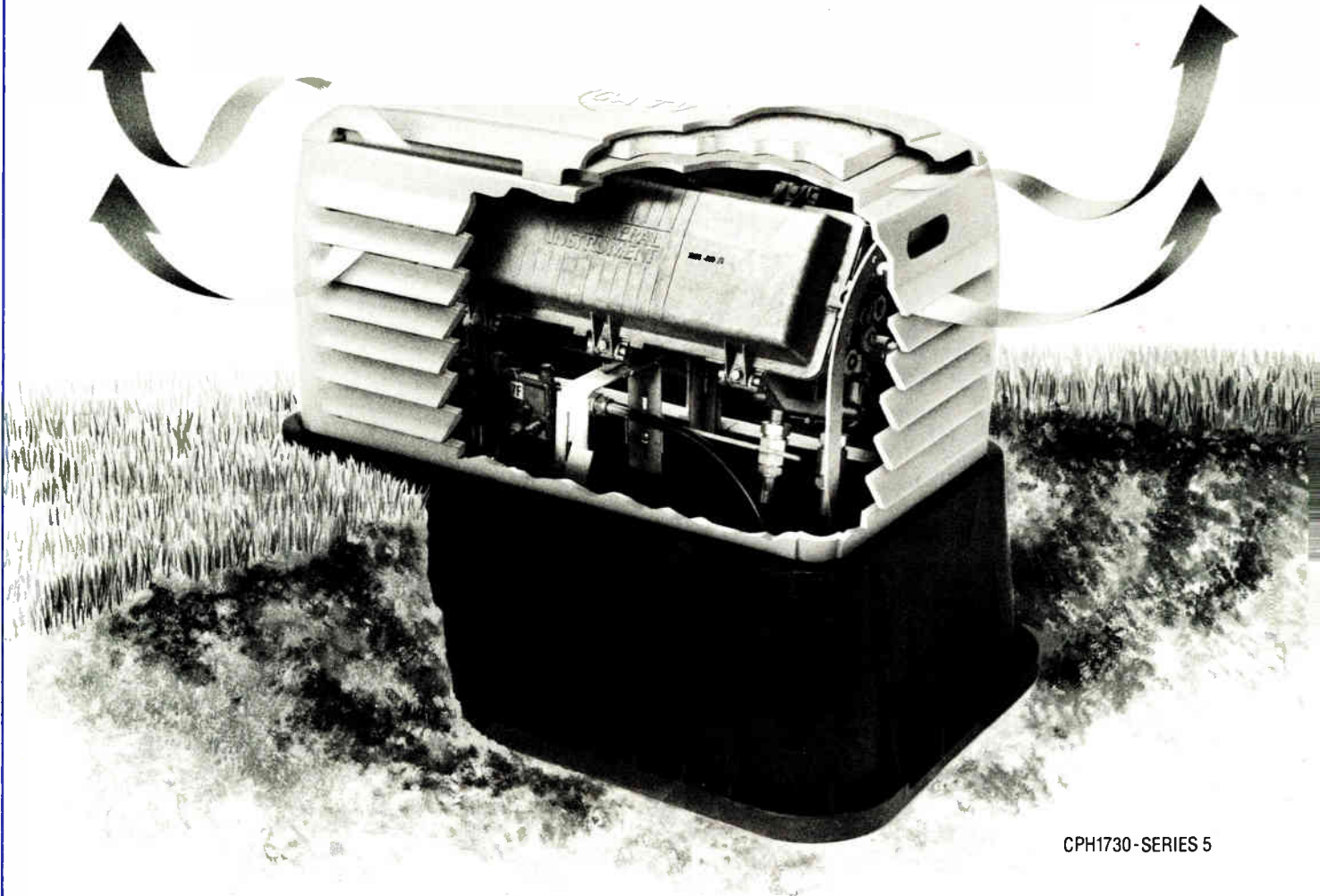

CPH1730-SERIES 5

MARKETED EXCLUSIVELY BY

 **Integral
Corporation**

Channell Commercial Corporation

800/423-1863

800/345-3624
in CA

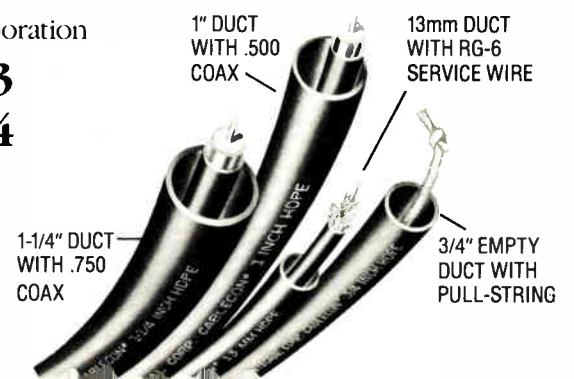

with Channell's on Covers (HDC™)!

Channell and Integral... Setting the standards for underground plant.

Have you considered what heat can do to your line extenders and trunk amplifiers after you splice them into pedestals? Excessive heat on CATV active devices is known to cause component reliability problems. It can keep your technicians busy in summer months responding to signal outages or necessary amplifier adjustments. That's why Channell has developed the *new* "Series 5" Heat Dissipation Covers (HDC).

These single insulated, dual cavity covers are 75% more efficient than metal in dramatically reducing temperature extremes

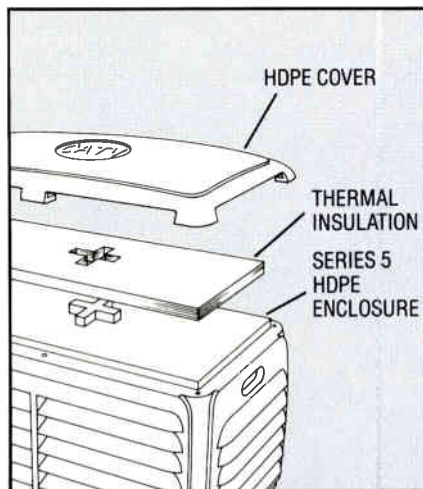

in your amplifiers, especially on the IC boards and power supplies. Independent field testing of "HDC" covers against competitive metal enclosures indicates this percentage could be even higher,

depending upon the size of metal enclosure used in relationship to the amount of active and passive equipment spliced in it.

To prolong the life of your active equipment and increase system reliability, contact Channell today. Let us show you how our "HDC" covers can take the heat off your active devices, and assist you in preventing premature underground amplifier component degradation.

Put our high standards to work for you in your underground plant. Ask for information on Channell's complete family of above and below grade pedestals and enclosures, and Integral's full line of fiber and coax Cablecon® products.



CPH1230-SERIES 5



DCPH2436-SERIES 5

 **Channell
COMMERCIAL
CORPORATION**

800/423-1863

800/345-3624 in CA

Reader Service Number 4

See us at the Great Lakes Expo, Booth #220.

Steering the industry in new directions

Two significant milestones took place in the history of cable industry research and development efforts this past month that bear some mention. Cable Television Laboratories, or CableLabs as it's more commonly known, made two important announcements: that it reached an agreement with the Advanced Television Test Center (ATTC) to share testing facilities and the completion of its first informational seminar for its member MSOs.

These events are significant if for no other reason than they show CableLabs has finally made it through a maddeningly long birthing process and found a home and a purpose. But beyond those immediately obvious conclusions, these achievements represent the importance of the Labs, which is not to be understated. John Malone's dream of a highly respected, unbiased and necessary research and development arm for the industry has apparently come true.

The fact that the Labs successfully lured Richard Green and Craig Tanner from high profile engineering positions with broadcasters gave us a hint that perhaps CableLabs was a good idea. Grabbing Tom Gillett from a telco, the successful hosting of a well attended seminar on fiber optics and the completion of a working agreement with a broadcast test center confirms the notion.

Actually, the ATTC has been actively seeking the cable industry's cooperation and support of its purpose, which is to test and evaluate every advanced television proponent system that is developed. The cable industry balked for a long time, never believing that pouring vast sums of money into testing systems that obviously will not work was the way to proceed.

As it turned out, holding out was a wise move. With the \$2.5 million agreement (see page 14), everyone has what they want: ATTC gets the funding it's been seeking and cable keeps its role minimized to prudent testing of viable systems to insure they're capable of being carried down today's and tomorrow's cable plants.

By making that deal, the cable industry has shown that it plans to spend its money wisely, not duplicatively. There's no reason to spend millions on office space, fill it with tons of test equipment and scores of engineers when that's already been done elsewhere. Lab officials say they plan to follow that course whenever possible, which should come as good news to the MSOs who shell out the \$9 million or more which make up the Labs' annual operating budget.

With the completion of its first seminar, CableLabs demonstrated to its staunchest critics that it has no intention to usurp the role that vendors have traditionally taken in cable TV product development. Instead, interactive discussions of technology, long-range strategy and technological implementation relied to some degree on those vendors to make cable operators smarter and (hopefully) better positioned to handle future competitors.

All of this is good news. Although CableLabs will probably never come close to the level of spending reached by either Bell Labs or Bellcore, the Boulder, Colo.-based Labs understands its charter and seems to know its ultimate destination. So, although the industry was moving forward technologically in the past, now it seems there is finally a rudder in place to guide the advancements.



Roger J. Brown
Roger Brown, Editor

William McGorry, Group Publisher
Robert C. Stuehrk, Associate Publisher

EDITORIAL
Roger Brown
Editor

Kathy Berlin
Managing Editor

George Sell
Contributing Editor

CONSULTING ENGINEERS

Chairman
Wendell H. Bailey, NCTA VP, Science and Technology

Members

Jim Chiddix, Senior VP, Engineering and Technology, ATC

John Dawson, Engineering Consultant
Roy Ehman, Director of Engineering, Jones Intercable

Tom Elliot, Director of Research and Development, Tele-Communications Inc.

Jim Farmer, Principal Engineer, Scientific-Atlanta

Paul Helmbach, VP Engineering, Home Box Office

Fred Kaiser, President, Alpha Technologies

Dave Large, Director, Video Product Planning, Raynet Inc.

Robert Luff, VP Technology, Jones Intercable

Steve Raimondi, VP Engineering, UA Cablesystems Corp.

Joe Van Loan, Engineering Consultant

PRODUCTION

Jeff Knight, Production Director

Don Ruth, Art Director

Elaine Callahan, Production Manager

Dick Benson, Circulation Director

ADVERTISING

Cathy Wilson, National Sales Manager

Judy Medley, Account Executive

Curt Stocker, Classified Sales Manager

MARKETING AND SUPPORT

Michelle Pazar, Author Support and Quality Assurance

Linda Hendrick, SCTE Chapter Support

OFFICE

Denver 600 S. Cherry Street, Suite 400, Denver, CO 80222 (303) 393-7449. Fax (303) 393-6654.

ITCI

INTERNATIONAL THOMSON COMMUNICATIONS INC.

Perhaps our most important contribution to CATV powering is restoring meaning to the word reliability.

In the past fifteen years we've made some very significant contributions to the CATV industry. We've developed the most efficient standby power concepts. We've developed the powering technology that delivers the cable signal with unprecedented reliability. In fact, every major standby power innovation has come from Alpha, including complete status monitoring, automatic performance monitoring, uninterrupted power output, and more. But what makes us proudest is to hear people in the industry say we've brought respectability to the standby power business.

Standby power systems were introduced to make CATV signal delivery more reliable.

Ironically, many of the standby systems were notoriously unreliable. They gave the entire industry a black eye.

We've worked very hard to design and build products that keep working under the most demanding environmental conditions. The fact that we're continuing to grow at an increasing pace while others have faded or disappeared shows that our concern for quality is right. And when our customers tell us we've restored confidence in standby power systems, that's the payoff.



Alpha Technologies. We're here to back you up.



3767 Alpha Way, Bellingham, WA 98226-8302
TELEPHONE 206-647-2360 FAX 206-671-4936

5700 Sidley St., Burraby, B.C. V5J 5S5
TELEPHONE 604-430-1476 FAX 604-430-8903

Reader Service Number 5

COLOR BURSTS

Comcast activates phase one of West Palm Beach fiber rebuild

Jerrold formally made its entrance into the fiber optic equipment fray with the activation of a 33-mile FM fiber run linking two headends in Comcast Cable's West Palm Beach, Florida system rebuild.

The event marked the deployment of the first FM product to come out of Jerrold's Cableoptics program, which is part of the Applied Media Lab, a research and development facility located at Jerrold's headquarters in Hatboro, Pa.

The three-year, \$20 million rebuild by Comcast will result in a reduction of headend facilities and several present FM microwave hops will be eliminated. All-new electronics will push the system's capacity to 550 MHz from 270 MHz, although only 60 channels are slated to be activated immediately.

A master headend facility will house the system's ad insertion gear and will be linked by fiber to three hub sites, says Cratin Gautreaux, Comcast's Southeast regional director of engineering. In all, six present-day sites will be reduced to four facilities and the introduction of fiber will allow for growth in the northern and southern sectors of the franchise area, one of the fastest-growing in the Sunshine State.

The system can deliver 16 channels per fiber and a cable consisting of 10 optical fibers was used during construction. Although Comcast has an output performance goal of 60 dB signal-to-noise, the Jerrold system was delivering as much as 64 dB in some cases, says Gautreaux. He added that in the future, AM fiber products will probably be utilized to complement the FM equipment.

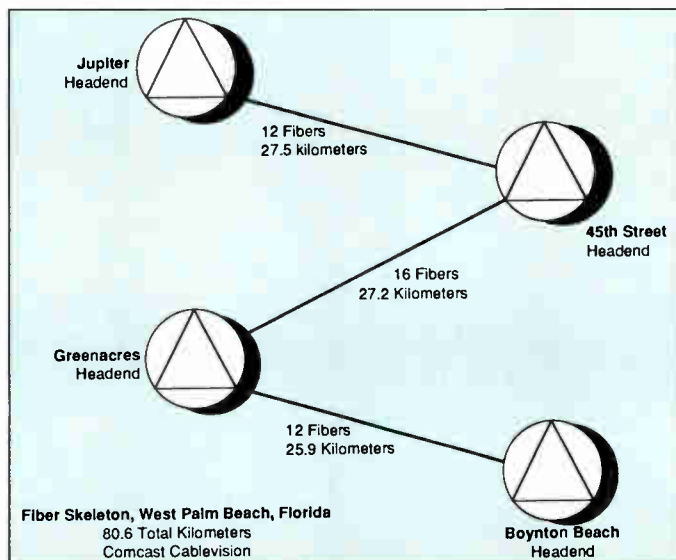

C-Cor, Comlux combine to develop digital fiber gear

For years now, digital fiber optic approaches for delivery of cable signals has been eschewed because of their high costs. But a joint development agreement between C-Cor Electronics and Comlux, a California-based manufacturer of

WORKING

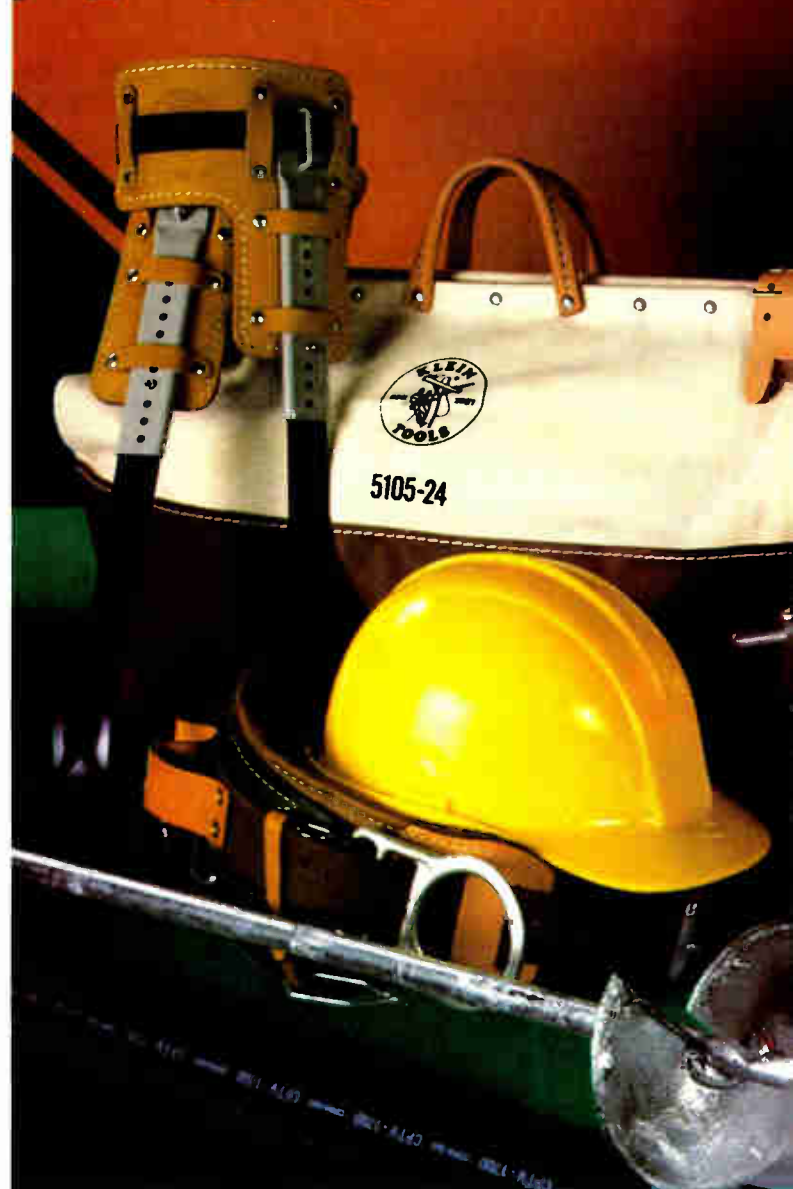

Some suppliers could care Next time, try MIDWES*

Need construction material? Now? No problem. We've got it. Pedestals. Hard hats. Screw anchors. Tool bags. Connectors. Sizing tools. Strand lashers. Coring tools. Gloves. Ground rods. Heat shrink. Safety cones. Lashing wire. Nuts. Bolts. And more!

Corporate Office
Charleston, WV
304 343-8874

Central Region
Lafayette, IN 800 382-7526
Outside IN 800 428-7596

Clarksburg
Ohio



less about your construction material needs. CATV. The supplier who gives a dam.

All from quality manufacturers and ready to ship nationwide.

For quick service, call any of our offices today. Just tell 'em the Beav sent you.

MIDWEST
CATV

A division of Midwest Corporation

More than supplies. Solutions.

Reader Service Number 6

Western Region
Denver, CO 800 232-9378
Phoenix, AZ 800 782-4566

Eastern Region
WV 304 624-5459
WV 800 532-2288

Northeastern Region
Pottstown, PA 215 970-0200
Outside PA 800 458-4524

Southern Region
Ocala, FL 800 433-4720
Outside FL 800 433-3765

Southwestern Region
Dallas, TX 214 271-8811
Outside TX 800 421-4334



digital fiber gear, to produce an all-digital system using off-the-shelf components shows all the promise of bringing digital technology to the trunk and "backbone" level.

Right now, digital products for that use are "very competitive" with FM gear, says Ken Regnier, Comlux vice president of marketing. But, he added, a mystique still exists that needs the be "exploded."

Regnier adds that the product development will involve some level of research and development, but no breakthroughs in technology. "A lot of it is redeployment of today's equipment," says Regnier. Comlux, a company with roots back to 1980, is presently offering third-generation gear that has been designed primarily for data and broadcast video uses, although Suburban Cable in New Jersey presently uses Comlux equipment.

Comlux's approach has been to develop and offer wideband, not compressed, high data rate gear that delivers eight channels per fiber up to 40 km unrepeated. The system has a 28 dB loss budget.

Regnier promises that the industry will see the fruits of the C-Cor/Comlux venture "very shortly," probably at the Western Cable Show in Anaheim in December. "There's a healthy amount of business (available) for manufacturers," says Regnier. And there's plenty of room for product development or improvement. One possible product that could appear would be a pole- or strand-mounted receiver, which today must be housed in a controlled environment.

So far, response from the industry has been favorable, says Regnier. "The VPs (I talk to) understand the basics of digital and want it, if it's here today."

Testing advanced television

In an unrelated development, C-Cor and the David Sarnoff Research Center recently completed the first cable transmission testing of the ACTV-1 signal. ACTV-1, (Advanced Compatible Television) is an improved definition signal developed by Sarnoff as an interim step toward full advanced television. It is completely compatible with present-day NTSC signals.

For the test, the signal was sent through C-Cor equipment at the manufacturer's State College, Penn. headquarters. The results showed that ACTV-1 was compatible with C-Cor equipment and that "a wide aspect ratio, enhanced-resolution picture (could be

sent) over conventional cable," says James Carnes, vice president of consumer electronics and information sciences at Sarnoff.

HDTV testing put on fast track

Speaking of advanced television, Richard Wiley, chairman of the FCC's Advisory Committee on Advanced Television Service, has called a September 28 meeting to develop a testing schedule for all advanced television proponent systems. Wiley has said that the schedule needs to be developed and adhered to if a recommendation is to be made to the FCC by late 1991.

So far, Sarnoff has said it will deliver its ACTV-1 system on April 2, 1990, for testing. In all, about 12 systems from eight proponents are expected to be tested over a year's time. Testing will occur at the Advanced Television Test Center, a facility formed by a coalition of broadcasting companies and television industry organizations.

Other proponents who plan to deliver systems for testing include: Faroudja Laboratories, Massachusetts Institute of Technology, New York Institute of Technology, NHK, North American Philips, PSI and Zenith Electronics.

Separately, it was announced that ATTC and CableLabs will cooperate to test those advanced television systems for suitability with today's cable television systems.

The agreement calls for CableLabs to pay ATTC up to \$2.5 million over three years for the use of its facilities and ATV test signals. The signals will be run through a coax and fiber cable test bed approximating an actual cable system and tested against parameters that are important for cable carriage. Also, data on the effects of retransmission of broadcast signals over cable will be compiled.

CableLabs terms fiber meet 'success'

After a seemingly long birthing process, CableLabs hosted its first industry seminar and, judging from the reaction of attendees, can call it a complete success.

More than 100 people representing 40 MSOs made the trip to Boulder for a three-day fiber optic status report,

called "Fiber Optics: Strategy, Tactics and Implementation."

The seminar, which featured experts in fiber optics leading interactive discussions with the attendees, was timed with 1990 capital and budget plans in mind, says Richard Green, president and CEO of CableLabs. "I'm very pleased with the results," he says.

Three segments made up the seminar: strategic planning, technical approaches and case studies presented by MSOs with fiber installation track records. The strategic approach CableLabs is taking to fiber is based on the S-curve theory on technology lifecycles. Based on the assumption that for an incumbent to retain competitiveness, there must be continual improvements in the product itself, this theory was closely scrutinized by the attendees.

US West lands portion of Hong Kong

Determined to gain experience as a cable television operator but unable to in the United States, US West is looking overseas to get its feet wet. The aggressive RBOC has a 25 percent equity stake in the consortium which was just awarded the franchise for Hong Kong, potentially the world's largest cable system.

The four-year process resulted in a license being granted to Hong Kong Cable Communications (HKCC) to install and operate the system. The consortium is led by Wharf Holdings and includes a real estate firm, a Belgian cable operator and a movie conglomerate in addition to US West.

The license calls for HKCC to offer about 15 channels of programming when the system is built in 1991, eventually offering 28 channels to as many as 1.5 million homes. Despite the large number of homes passed, the system will consist of only about 1,200 miles of plant; densities in Hong Kong approach 2,000 homes per mile.

The franchise award came as a surprise to some observers who expected it to be granted to Hongkong Telecommunications, which has a monopoly on the city's telephone service and utilizes fiber optics. However, the government decided a second telecommunications network would be more beneficial to the city in the long run. Hongkong Telecom's monopoly franchise runs out in the mid-1990s. ■

—Roger Brown

The widest choice of power supplies made in the U.S.A.

FERRO

Amps

2



9



4



12



6



15



18



STANDBY

Amps

4



9



6



12



15



Now, you'll cut your power bill down to size.

Why buy 15 amps and run, inefficiently, at 9 amps?

Now, buy only the power you need! Lectro has 7 different power supplies, the widest range in the industry by far. Lectro's efficient, Sentry II, plug-in, modular standby power supplies are available in 5 different sizes, too. Nobody else comes close.

Less is more! The less power you waste, the more money you make. And if your capacity changes, just unplug one Lectro module...and plug in another!

Lectro is in the business to meet your needs today. When you need even more tomorrow, we'll be the first to respond. Again.

Call 1-800-551-3790.

In Georgia, (404) 543-1904

 **Lectro**

P.O. Box 567
420 Athena Drive
Athens, GA 30601

More power to you. Reader Service Number 7



David Pangrac

Attacking life with confidence

"When you deal with flying and aerobatic flying (as a pilot), you discover that you get a whole different perspective on yourself," says David Pangrac, director of engineering for American Television and Communications Corp. "I tend to be able to have a lot of confidence in the things I attack. Maybe I shouldn't, but that's how it comes out."

How it does come out is on top. As the 1989 winner of the Vanguard Award for Science and Technology, Pangrac was chosen in recognition of his development of the "fiber backbone" concept for AM broadband transmission. Pangrac does not see the idea he conceived as a "brilliant scheme to do anything in particular—it was more a way to reduce the number of people complaining about our (ATC's) service."

This evolutionary concept is instrumental in Pangrac's entrepreneurial background. In 1964, after spending four years in the United States Navy as an aviation electronics technician, Pangrac and an associate started a small electronics company in Minneapolis which later became part of the Team Electronics chain. However, a dispute erupted with Team management, and Pangrac closed up shop.

About a week later, Pangrac and a different partner became involved with

providing television service to mobile home parks. Pangrac's company, MATV Systems Inc., would offer a free underground antenna system to mobile home park owners in exchange for the park owner banning outdoor TV antennas. The homeowners would then be charged monthly for the service.

Along comes cable TV

One day, a park owner called to have an antenna installed. However, in order to build, Pangrac needed permission from the city council. While at that meeting, he was asked to "wire" the city as well. "That turned out to be the first cable system we built," reflects Pangrac. "And, well there's a whole story in that alone, but I built the entire system without getting a pole agreement, because I didn't know you needed them."

None the less, word about cable TV got out to the adjoining town, and Pangrac was asked for a franchise agreement to present to city council. Shortly thereafter, Pangrac had agreements for 10 Minnesota communities, each one a little bigger in size.

"That's when we ran out of money," says Pangrac. That's when the two men obtained additional partners and eventually sold the system to a "little guy with purple shoes and green socks that lives in Los Angeles." Because the new owner had an agreement with Cadco, Pangrac ended up using Cadco's brand new equipment for small systems. And like any new equipment, there were some problems that existed. Everytime Pangrac attempted to turn something on, something else would quit.

Eventually, Cadco sent out its field engineer to evaluate Pangrac's problems. After Pangrac showed the engineer how he was modifying the equipment, the engineer took the equipment and left. "One day I got a call from Cadco asking me if I wanted to come visit," chuckles Pangrac. "They offered me a job."

After two years with Cadco in Oklahoma, the company had a change of management and moved the office to Dallas. Pangrac and other field engineers decided to stay behind and started a small engineering firm that built cable systems. Unfortunately, FSP&W was successful but under capitalized. Deciding to disband before getting into serious financial problems, Pangrac then moved into real estate.

Pangrac ended up managing the

Century 21 office in Mustang before teaming with another broker to open their own firm. Once again, everything was going smoothly until the company got hit by the money crunch on financing new homes. However, it wasn't all bad: Cox Cable was building Oklahoma City and was having problems. Both Pangrac and his partner went to work for Burnup & Sims, the contractor for the job, and ended up being offered a permanent position with Cox. "From that point on," says Pangrac, "I've kind of stuck with cable."

In 1982, after accepting a position with Cox as regional engineer in Vancouver, Wash., Pangrac called ATC asking if a divisional VP position was still open. Finding the position available, Pangrac walked away from the money he had put down on a house in Vancouver and went to work in ATC's Kansas City division.

"It was absolutely a good move," states Pangrac. "Cox was a good company to work for but at ATC they seemed very interested in supporting innovative ideas. In other words, they allowed me and my staff to generate a lot of neat ideas."

A supportive environment

This was the environment that stimulated the fiber backbone. And it also fostered Pangrac's success with ATC. In 1987, Pangrac was promoted to director of engineering for ATC corporate. Although it's an engineering position, Pangrac enjoys it because it's so sales oriented. "Almost everything I do is sales," adds Pangrac. "If you look at this fiber project we've done, a lot of my time is spent speaking. And frankly, that's sales...."

To Pangrac, that concept has developed into a "unique" approach to fiber by the entire cable industry. "We also look in other industries," says Pangrac. By learning how other industries use fiber, "we come up with concepts that may have some (use) for our industry."

Meanwhile, Pangrac spends a lot of time reading and flying airplanes. (After his stint in the service, Pangrac gained all his pilot ratings—commercial, multi-engine, etc.) To Pangrac, "flying not only builds a good perspective of who you are, but you learn your limitations." Perhaps, in Pangrac's case, there weren't many limitations—there was more a harnessing of that perspective and attacking life with confidence in hand. ■

—Kathy Berlin

the
SOURCE

The new Saturn 3.1 meter antenna.
Exclusively from Midwest Communications.
The premier antenna for C- or Ku-Band
reception.

Dish and mount pedestal are precision-
formed of high-grade steel. For durability.
And years of consistent, low-maintenance
performance.

This compact, affordable antenna from
Midwest comes packed in one box, ready
for easy ground or rooftop installation.

Save time, money and maintenance.
With the Saturn all-steel 3.1 meter antenna.
With a 10 year limited warranty –
Exclusively from The Source,
Midwest Communications.

Reader Service Number 8



MIDWEST
Communications Corp.

One Sperti Drive
Edgewood, KY 41017

1-800-543-1584

In Kentucky, 606-331-8990





None of their business

Lately, I've been sitting behind a mound of paper. Stacks and stacks of reports, meeting minutes, reference papers, letters, replies, vendor literature and analyses are piled on my desk. The contents of those piles is almost every written thing imaginable concerning the issue of high definition television (HDTV).

In general, this plethora of paper is not new on this particular issue. What is new is where the information is coming from today. Improved television signals and all other subjects with those strange initials—HDTV, IDTV, EDTV, HDNTSC, SuperNTSC, B-NTSC, VHS, S-VHS, EDBeta—attract a lot of attention from our own industry (the television industry) and from the consumer and trade press. Lately, however, this subject has begun to attract attention from groups with no direct correlation with the television or entertainment business.

We are now seeing players from the Congress (both the House and the Senate), the Department of Commerce, the Defense Department, various military agencies and a number of unknown (and unknowable) secret agencies. Each player wants to have their say about HDTV. This fact alone explains the bulk of changes that I see in the HDTV river of paper crossing

*By Wendell Bailey, Vice President
Science and Technology, NCTA*

my desk.

Content disturbing

There is a disturbing theme displayed in these papers and reports. Each paper is proposing to allow the U.S. Government (in the form of various agencies) to "jump start" HDTV and thereby, the consumer electronics industry in America. This will be done by the application of certain time-tested government initiatives—which have proved many times to be ineffective and costly; that will produce results significantly different from the original, well-meaning goal.

Several examples include establishing Blue Ribbon committees to analyze issues; establishing project teams to formulate plans; asking Congress to pass special legislation; asking the administration, i.e. the President, to declare a national goal and to put his considerable prestige behind such an endeavor; and the government falling prey to the "if wishing could make it so" disease.

An interesting question to ask is, "Why is the defense department the band leader in this attempt to save the consumer electronics industry?" One can see some realistic connections between HDTV and defense department interests and issues, most notably in the area of high definition display terminals. (Terminals used in such areas as radar consoles, aircraft simulation devices and surveillance equipment.)

One can, arguably, see the defense department's concern over the issue of computer chips. But the question I keep asking myself is, "Can well-meaning and sincere government entities actually affect this issue in a positive way?" More importantly, "Do these same well-meaning and sincere agencies actually know what the issue is?"

Changing goals

I have an uneasy feeling that somehow, somehow, the goal of improved television images for the public is no longer what HDTV is all about. If, in fact, that is the case, then the people whose pocketbooks are about to be assaulted will have to face a rude awakening.

The only way the price, or more importantly, the cost of improved imaging will be reduced to a reasonable level will be if consumer electronics is the primary user of a technology. In

other words, when big government agencies design things, the end product is not directly useful to the public in the short- to medium-term. This isn't because the public can't use the product sooner, but because no one can afford to use them.

If the consumer electronics industry and the public work together on improved images—specifically for television programming—I have little doubt that the issues of reasonable improvement for a reasonable cost will be the guiding focus. As long as those two goals are the important ones, it's likely that improved television pictures will arrive sooner rather than later.

Help could delay process

If the defense department and other government groups succeed in taking control of this issue in order to "save" the consumer electronics industry in America, I predict that it will be much longer before we actually see serious improvement in television pictures or displays. Secondly, those improvements will be specifically oriented toward the needs of groups other than the consuming public. And finally, the cost to utilize the technology in consumer electronics will be higher than would otherwise be the case.

These last two points are important in the context of the HDTV debate as it has developed so far. Several well-respected CATV experts have suggested time lines of two to three years for the FCC to announce agreement on a terrestrial broadcast standard. This has to occur before the consumer electronics industry can begin to seriously put equipment into the home.

The most optimistic forecasters claim that it will be seven years before we get to 1 to 2 percent penetration and up to 10 years before we get to 10 percent penetration. The 10 percent number is deemed to be the curve upturn. This all adds up to 10 to 13 years for HDTV to become a significant consumer electronic product.

If I may make a humble observation, we are the television industry and we have direct contact with the consuming public. This industry, more so than the other camps, has a good grasp of the cost improvement ratio necessary for public acceptance of HDTV. We need to reassert our primacy in this debate. The benefits will come sooner and be more affordable than if other groups have their way. ■

Can You Tell the Difference?

PROBABLY NOT! THE QUALITY OF PYRAMID PEDESTALS MAKES THEM SECOND TO NONE

Yes, Pyramid pedestals are now better than ever with some differences. For example, paint is electrostatically applied with computer-controlled equipment. This results in a long-lasting—average 25-years in use—finish that successfully meets stringent REA specifications and ASTM testing.

With Pyramid it's easy for installers to open the lid without paint-damaging tools. Convenient hand-holds are part of the pedestal's lid.

Your active equipment will stay cooler. You'll find that Pyramid pedestals provide more ventilation louvers than the competition which allows for maximum heat dissipation.

Next time you need pedestals choose Pyramid and call Hudson for a quote. Pyramid's approved by the major MSOs and is in stock at each of our nationwide warehouses.

So try Pyramid by calling Hudson. We get your order right the first time or we pay the freight!

HUDSON
SUPPLY COMPANY, INC.

Experience that Cares.

Los Angeles

1-800-441-0666

FAX (818) 964-3664

Chicago

1-800-331-2258

FAX (312) 640-0568

Atlanta

1-800-343-9919

FAX (404) 979-9622



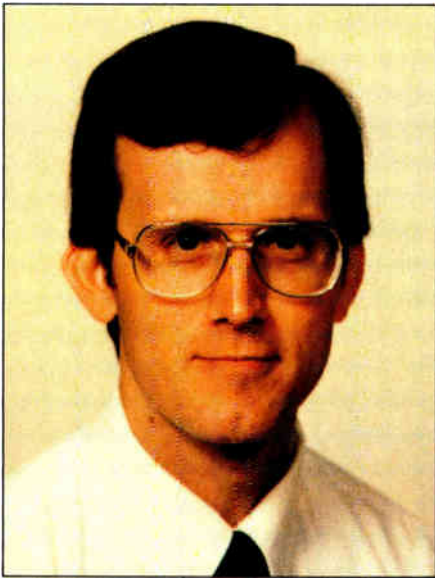

C/N₀ vs S/N

In a Satellite Earthstation environment, carrier-to-noise ratio (C/N) and its relationship to baseband video signal-to-noise ratio (S/N), is an often misunderstood topic. For example, let's say that we have been asked to compare the S/N performance of two competitive satellite receivers. Not knowing anything else about the two receivers, and with each receiver using the same signal source, the C/N of Receiver #1 is measured to be 14 dB while the C/N for Receiver #2 measures 12 dB at each receiver's IF port.

Since the two receivers exhibit a 2 dB difference in measured C/N, we could probably conclude that the baseband video S/N performance of Receiver #1 must be 2 dB better than that of receiver #2...or is it? Or how about this one..."If we narrow-up the IF filter, we'll increase our C/N ratio and therefore improve our baseband video S/N ratio." Sound familiar? With these myths in mind, let's take a more in-depth look at the actual relationship between C/N and baseband video S/N.

When analyzing a satellite link, or when comparing the performance of two unknown satellite links, the term C/N ratio can become very ambiguous since it is a function of the predetection IF bandwidth of the respective satellite receivers; Each IF bandwidth may, in

By Chris Bowick, Director of Engineering, Headend and Earth Station Products, Scientific-Atlanta

fact, be different. For that reason, it is often more convenient to define a new term called Carrier-to-Noise Power Density (C/N₀) which eliminates the IF filter ambiguity. The relationship between C/N and C/N₀ is given by:

$$C/N_0 = C/N + 10 \log (B_{IF})$$

where B_{IF} is the IF bandwidth of the satellite receiver in Hz, and C/N₀ is expressed in dB-Hz.

As Clayton¹ has shown, the baseband video S/N ratio (above threshold) out of a satellite receiver is a function of the receiver's C/N₀ and its baseband video roofing filter and is *not* a function of its C/N ratio or IF bandwidth. In equation form he shows the relationship as:

$$S/N = C/N_0 + 10 \log \frac{12 * F_s^2}{bn^3}$$

where C/N₀ is the Carrier-to-Noise Power Density in dB-Hz, F_s is equal to half of the peak-to-peak deviation (in Hz) produced by that portion of the video waveform being defined as signal (usually excluding sync), and b_n is the noise bandwidth (in Hz) of the base-

C/N ₀	C/N (vs IF Bandwidth)			S/N
	27 MHz	32 MHz	36 MHz	
95	20.7	19.9	19.4	57.6
90	15.7	14.9	14.4	52.6
88.31	14.0	13.3	12.8	50.9
85	10.7	9.9	9.4	47.6

Table 1

band video filter function which includes the video roofing filter and deemphasis network. The value of b_n when using CCIR 421-3 noise weighting is 1.574 MHz.

For typical C-band applications using 10.75 MHz deviation, and using CCIR 421-3 noise weighting, the relationship between C/N, C/N₀, and the corresponding theoretical baseband video S/N is shown in Table 1. Note that for every value of C/N₀, there is a single theoretical value of baseband video S/N, but the C/N is dependent upon receiver IF bandwidth. A 90 dB-Hz C/N₀ should therefore yield a 52.6 dB baseband video S/N ratio, but the measured IF C/N could be almost anything, depending upon the receiver's IF bandwidth.

You can use this information to your advantage while scrutinizing various manufacturer's data sheets. There are data sheets floating around, for example, that claim a 52 dB baseband video

S/N with an IF C/N of 14 dB and a 27 MHz IF filter as standard! As shown in the Table, the theoretical maximum video S/N would be 50.9 dB. "It just don't add up!"

A better intuitive feel for why the IF bandwidth of a satellite receiver does not affect its baseband video S/N performance can be gained by reference to Figure 1. In this Figure², a typical FM demodulator's baseband triangular noise spectrum is shown.

The baseband noise level rises in amplitude with frequency until reaching a point equal to one-half of the predetection IF bandwidth (for a 32 MHz IF filter, for example, this frequency would be 16 MHz). It then decreases rapidly.

This is the well known triangular noise spectrum of a classical FM demodulator. Note that all of this noise is a *potential* contributor to the degradation in baseband S/N performance. However, shown superimposed on the triangular noise spectrum of the FM demodulator is the typical response of a video low-pass or roofing filter found on almost all satellite receivers.

The effect of this roofing filter is to eliminate any noise contribution outside of its passband (typically around 4.5 MHz). As you vary the IF filter bandwidth, the 1/2 IF breakpoint on the triangular noise spectrum will vary accordingly, but as long as this breakpoint doesn't encroach on the roofing filter's passband, the roofing filter, and *not* the IF filter, will always contribute to the baseband video S/N performance. ■

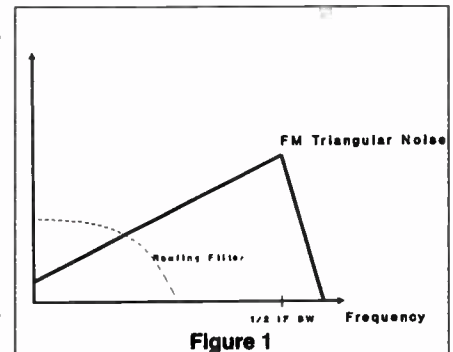

Figure 1

References

1. Clayton, Lorimer Dr., "FM Television Signal-to-Noise Ratio," Scientific Atlanta Satellite Communications Symposium, 1981.
2. Womble, Dave. Internal Discussions, Scientific Atlanta.

Now in stereo.

A stereo generator ought to do more than just light the MTS indicator on a subscriber's television set.

It ought to provide clear channel separation, a crisp audio signal, and reliable performance.

It ought to have advanced

features like built-in commercial insertion, a 4.5 MHz output and an AGCL circuit.

And a real DBX® noise suppression system instead of an imitation.

It ought to save precious rack space. And it ought to save money.

Fortunately, one stereo generator does all that. And more. The new CSG-60 from Standard Communications.

The CSG-60 is almost half the cost of conventional units when you purchase them two at a time in the convenient side-by-side rack mount. It has features found only on much more expensive units. And because it's from Standard, you can count on set-it-and-forget-it reliability.

To get the full story on the CSG-60, contact the SATCOM Division for the Standard representative near you.

DBX is a registered trademark of DBX, Inc.



**Standard
Communications**
SATCOM Division

P.O. Box 92151
Los Angeles, CA 90009-2151
Telephone: (800) 243-1357
In California: (800) 824-7766
(213) 532-5300 • Telex: 67-7173

Represented in Canada by:
DGH Communication Systems Ltd.
Scarborough, Ontario • 416 / 499-4746





How to lie with specifications

In the '50s, there was a popular book called *"How to Lie With Statistics."*¹ The book, while providing some basic insights into statistics, made the point that it was possible to use pieces of absolutely factual information in ways which led a reader to a conclusion which was not necessarily factual. I am concerned that we are facing somewhat the same situation today when it comes to specifications.

There are a variety of ways to measure the noise and distortions which our cable television systems add to the signals they carry. As an industry, we have pretty much settled on the use of CW carriers from a multichannel signal generator as a standard against which we would specify the performance of CATV amplifiers and other equipment.

We do not, of course, carry CW carriers on our systems; our carriers are modulated with real video. That video comes from a variety of sources, and those sources are not usually synchronized. It is therefore true that the power loading of our systems is measurably lower than the power loading using CW carriers. Maximum power on a given channel occurs during the synchronizing pulses, at which point the carrier should be 87.5 percent

By Jim Chiddix, Sr. Vice President, Technology and Engineering, ATC

modulated.

It is statistically very rare that those synchronizing pulses will occur simultaneously, and it has long been known that operating levels in a system modulated with asynchronous video can be raised somewhat, giving an improvement in carrier-to-noise ratio, without exceeding the intermodulation distortion levels generated by CW carriers at a lower level.

Alternatively, as was proposed by "Sruki" Switzer some years ago, the sync pulses of video signals can be deliberately locked together, using frame-store synchronizers, so that peak-power-related distortions occur when there is no picture information on any channel: during the sync pulse. This allows levels to be run significantly higher, and improvements can be taken in both the C/N ratio and intermodulation distortion specifications.

Revisiting old techniques

In the last year, as our suppliers strive to provide better operational characteristics in AM fiber equipment, it has been noted that the CW carrier measurement technique is relatively harsh. Because AM systems operate such tight margins, the whole issue of measurement techniques has been reopened. "Why should we penalize ourselves with excessively conservative measurement techniques when the goal is merely to provide good video to our customers?" they ask. And that's an excellent question indeed. It is time to revisit the way we make measurements, and to determine precisely what those measurements mean in terms of subscriber quality.

The danger is, however, that people who are specifying equipment for CATV systems will be confused by the mixture of apples and oranges. If we take an AM fiber link which is spec'd using asynchronous video sources ("real signals") and compute its performance in a system where other specifications are based on more traditional CW measurements, we will have a meaningless answer.

The purpose of specifications is, after all, to allow us to communicate on a common basis regarding the performance that we can expect from our equipment. If we allow the rules to be arbitrarily changed, that communication begins to break down, and discussions of system specifications begin to lose meaning.

The fundamental standards which define video quality to the subscriber were established in 1959 in a report to the Federal Communications Commission by the Television Allocations Study Organization (TASO). That report described the result of consumer research on a sample of real viewers with regard to the effect of noise degradation on perceived signal qualities. A 45 dB signal-to-noise ratio (defined as the ratio between the RMS power of the VHF signal during the sync pulse to the RMS power of the noise in a 6 MHz-wide VHF channel) was defined to provide an "excellent signal."²

In the 30 years since, there has been no further definitive work to establish a correlation between the viewers' perception of signal quality, signal-to-noise ratio, and closely related carrier-to-noise performance, let alone the kinds of intermodulation degradation that we generate in today's multichannel cable television systems.

It makes sense, therefore, that at the very least we go back and revalidate this basic standard of operating performance. Having done that, we should correlate noise and intermodulation measurements made with CW carriers to those results, and to measurements made with asynchronous signals. Because the synchronizing pulses in asynchronous signals line up in random ways, we also need to establish statistical standards defining the performance of asynchronous signals over time, and the percentage of time during which we are willing to ignore the "worst case" synchronization of most of those pulses.

Establishing these parameters is not a trivial matter. Once done, however, we can all communicate effectively regarding the ways in which we make measurements, and what those measurements ultimately mean to our subscribers. The pursuit of this work is perhaps the logical bailiwick of Cable Labs. But until this work has been done, we must be very careful about allowing hardware developers to arbitrarily change the definitions of the specifications we use. ■

References

1. *How to Lie With Statistics*, Darrell Huff/Irving Geis, W.W. Norton, 1954.
2. *The relation of RF C/N and baseband S/N*, Lawrence W. Lockwood, *Communications Technology* magazine May, 1989.



We've cast a new light on efficiency.

Efficiency comes in many colors...and Lectro has them all for you.

- Super efficient units for lower power bills.
- Simple, plug-in modular designs for quicker, safer maintenance.
- Status monitoring compatibility with all major electronic vendors.
- The savvy of 50 years in the business

and the promise we're here when you need us.

- Superior technology and quality for indefinite life.
- The widest, and most available product line to meet your needs.

Lectro means efficiency. Make us prove it.



See us at the Great Lakes Expo, Booth #541.

Reader Service Number 11

ANIXTER
CABLE TV

WEST-ANAHEIM: (714) 779-0500, (800) 854-1443; **DENVER:** (303) 740-8949, (800) 841-1531; **SEATTLE:** (206) 251-8780, (800) 426-7665; **MIDWEST-CHICAGO:** (312) 350-7788, (800) 544-5368; **CLEVELAND:** (216) 526-0919, (800) 321-8068; **DALLAS:** (214) 446-CATV, (800) 231-5006; **IRON MOUNTAIN, MI:** (906) 774-4111, (800) 624-8358; **SKOKIE, IL HDOTRS:** (312) 877-2600; **EAST-ATLANTA:** (404) 995-5110, (800) 241-5790; **LONG ISLAND, NY:** (516) 293-7788, (800) 645-9510; **NEW JERSEY:** (201) 328-0980, (800) 631-9603; **ORLANDO:** (407) 240-1888, (800) 477-6396; **CANADA-CALGARY:** (403) 250-9646; **MONTREAL:** (514) 836-3836; **TORONTO:** (416) 625-5110; **VANCOUVER:** (604) 321-5885.

In an emergency, weekends and holidays or after 5 P.M. call toll free 1 (800) 323-8166.
CORPORATE OFFICES, ANIXTER CABLE TV, 4711 Golf Road, Skokie, IL 60076, (312) 677-2600



New faces at FCC

A new broom has swept unusually clean at the Federal Communications Commission. Just nine months into the new Administration, President Bush has already appointed a new chairman and two other new commissioners, and, by the time you read this, he may also have filled a fourth vacancy, leaving Commissioner James Quello as the only holdover from the Reagan era.

Rarely has there been such a complete turnover at the FCC. Until 1986, there were seven commissioners, with staggered seven-year terms. This made it difficult for a new President to revamp the Commission in a short period of time.

But the change to five commissioners with five-year terms makes it easier for a President to exert control over the Commission. The only check on the President's power is the power of the Senate to withhold confirmation of his nominees. Ironically, it was the exercise of this power by the Senate during the second Reagan term that gave President Bush the chance to revamp the Commission so quickly.

Frustrated by the deregulatory agenda of the Reagan-era FCC, and ultimately enraged by the FCC's abolition of the fairness doctrine, the Senate—which returned to Democratic control in 1986—simply refused to vote on the President's nominees to fill the unex-

pired terms of Chairman Fowler and Commissioner Dawson when they resigned.

New commissioners

No more than three of the five Commissioners may be members of the same political party. Commissioner Quello is a Democrat, and the President has now named three new Republicans to the Commission: Alfred Sikes, the new chairman; Sherrie Marshall; and Andrew Barrett.

The new commissioners are no strangers to telecommunications regulation. Chairman Sikes was formerly head of the National Telecommunications and Information Administration (NTIA), the communications policy arm of the administration in the Department of Commerce. Commissioner Marshall served as director of the office of legislative affairs at the FCC under Chairman Patrick. And Commissioner Barrett has nine years as a member of the Illinois Commerce Commission, which regulates telecommunications common carriers.

Still, the direction in which they will take the FCC is not yet clear. There seems to be an expectation in Washington that Chairman Sikes and his new colleagues may be less ideologically driven and more pragmatic than Chairmen Fowler and Patrick. The ideological zeal of the Reagan appointees was evident not merely in their broad deregulatory agenda for broadcasting but also in their determination to eliminate what they perceived as impediments to marketplace competition for cable operators, such as the compulsory copyright license and the telephone company-cable television cross-ownership prohibition.

The new FCC may be more likely to take into account other countervailing policy concerns in identifying the public interest. For example, Chairman Sikes, a former broadcaster, is probably less likely than his predecessors to view television as just another commodity in the marketplace. At NTIA, Chairman Sikes seemed especially concerned about keeping the United States competitive in the global telecommunications market.

At the FCC, the Chairman generally is the dominant force. While each Commissioner, including the Chairman, has one vote on decisional matters, it's the Chairman who fills the agency's senior staff positions and who controls the Commission's agenda. So,

soon there will probably be new chiefs of the Mass Media and Common Carrier bureaus and other new key policy makers, and we'll all be reading the tea leaves to try to predict the path that the new FCC will follow.

Settling in

Once the new Chairman and Commissioners settle into their jobs, they will find several key cable-related issues to be dealt with before long. For example, the FCC has not yet resolved whether to recommend that Congress retain, eliminate or modify the telcable cross-ownership prohibition. Although all public comments were filed months ago, Chairman Patrick (who favored elimination of the prohibition) never brought the matter to a vote because he seemed unlikely to gain a second vote from either Commissioner Quello or Commissioner Dennis.

Another important issue that will be on the new FCC's agenda is the issue of cable rate deregulation and effective competition. The 1984 Cable Act, which deregulates cable rates where there is effective competition, requires that the FCC review its definition of "effective competition" periodically and also that the FCC report to Congress in October 1990 on the effects of deregulation on competition in the marketplace.

The FCC has already begun an investigation of the effects and continued validity of its determination that cable systems face effective competition, and are therefore free of rate regulation, whenever three broadcast stations are available over the air in the cable community.

The new commissioners will also continue the agency's consideration of what role high definition television should have in the video marketplace and whether HDTV should be subject to regulatory standard. This is a subject that was of some interest to Chairman Sikes when he was at NTIA.

For those of us who meet with and argue before the FCC, this is an exciting time. New Commissioners and a new Chairman will bring new assistants and policy-making staff to the agency. This means not only the challenge of arguing the industry's position to new people but also, if past experience is any guide, the pleasure of meeting and working with a new group of interesting and intelligent public servants who will be taking on the responsibility of developing national communications policy. ■

By Michael Schooler, Deputy General Counsel, NCTA

Chicago Sun-Times
 AUG 11, 1988
**Bogus bolts
 plague U.S.**

MILLIONS OF FASTENERS used in the construction of bridges, buildings and other structures may be in high tension because of a nationwide epidemic of counterfeit bolts, according to a report by the U.S. Dept. of Commerce.

The report, which was prepared by the U.S. Dept. of Commerce's Bureau of Economic Analysis, says that the problem is particularly acute in the case of bolts made in Japan and sold in the U.S. under the name of American-made bolts.

The report says that the counterfeit bolts are often sold at a lower price than the genuine article, and that they are often used in critical applications where failure could be catastrophic.

The report also says that the counterfeit bolts are often sold in large quantities, and that they are often used in critical applications where failure could be catastrophic.

**The high cost
 of cheap bolts**

By John Morwin

IN December ironworker Calvo Davis, 51, knelt on a girder, torque wrench in hand, twisting a bolt 65 feet above the ground in Springhill, Tenn., where GM's Saturn plant is building. Routine work until, suddenly, the head of the bolt snapped off and Davis, thrown off balance, plunged to his death.

Davis' death was more than a regrettable industrial accident. In fact, Davis was a victim of what is beginning to look like a nationwide plague: the widespread use of counterfeit and substandard industrial bolts made abroad and smuggled into the U.S. These bolts turn up in office buildings, bridges, power plants, military equipment and a good deal more. At the Pentagon's top conservators, General Dynamics and LTV, and a probe

REPORT
FALSELY MARKED BOLTS FLOOD U.S.; IFI WARNS OF 'CATASTROPHIC FAILURES'

MILLIONS OF FASTENERS used in the construction of bridges, buildings and other structures may be in high tension because of a nationwide epidemic of counterfeit bolts, according to a report by the U.S. Dept. of Commerce.

The report, which was prepared by the U.S. Dept. of Commerce's Bureau of Economic Analysis, says that the problem is particularly acute in the case of bolts made in Japan and sold in the U.S. under the name of American-made bolts.

The report says that the counterfeit bolts are often sold at a lower price than the genuine article, and that they are often used in critical applications where failure could be catastrophic.

The report also says that the counterfeit bolts are often sold in large quantities, and that they are often used in critical applications where failure could be catastrophic.

**DEMAND
 JOSLYN**

GET IT NATIONWIDE FROM

**TVC
 INC**

WEST



934-E Calle Negocio, San Clemente, CA 92672
 (714) 361-2011

EAST



**TVC SUPPLY
 COMPANY INC.**

1746 E. Chocolate Ave., Hershey, PA 17033
 (717) 533-4982, (800) 233-2147
 In Pennsylvania: 800-482-2398

RETURN PATH

Standing by a different method

Editor,

I've just read the article, "Battery Standards for CATV Standby Powering" (*CED*, July '89, p.60). While I thought most of the article was good, there were some areas that I feel need to be talked about.

I have no problem with having an article written by staff members of competitive products as long as they remain generic. I feel this article has a bias toward the products the authors represent.

Not very far into the article the comment is made, "Some designs remain that use a 24 volt source, although these have largely passed from common usage." While there may be only one company left producing 24 volt standby power supplies (Control Technology Inc.), we continue to do a good business with them. They continue to provide an economical solution to engineers who don't load their power

supplies over 12 amps, think that the standby time of a 24 volt system is more than adequate, and like the savings of one-third of their initial battery costs up front.

This article also dealt with several types of battery chargers, but our method of battery charging was not even mentioned. Naturally, it came as no surprise that float charging was the preferred choice since this is the method used by the author's product.

By the way, the article said, "Float charging systems must be temperature compensated to avoid overcharging..." I must submit that this is another "mini-ad" for a product produced by the authors. Temperature compensation might be important, but how do you measure the temperature of the electrolyte (the only true indicator of how hot or cold the battery is) in a sealed battery?

As I stated, this article has some good information in it. However, it also contained statements which made it appear that the only proper equipment to use was equipment manufactured by the authors. This just is not true. And now, because of the article, not

only Control Technology but all other standby power supply companies and at least one battery manufacturer will have a built-in prejudice to overcome when dealing with our customers.

Do you think this is right?

Gene Faulkner
Sales Manager, CATV Products
Control Technology Inc.

CED had no deliberate intention to prejudice its readers regarding the purchase of standby power and/or batteries. Although the proper credit was inadvertently deleted from the article, this paper originally appeared in the 1989 NCTA Technical Papers, an outstanding source of generic technical information.

If, however, anyone or any firm feels they were misrepresented in the article, CED apologizes profusely.—Ed.

Anyone wishing to voice their opinions or comments on articles published in CED may do so by writing:

Editor
CED Magazine
600 S. Cherry, Ste. 400
Denver, CO 80222

BASEBALL, HOT DOGS, APPLE PIE & JCA

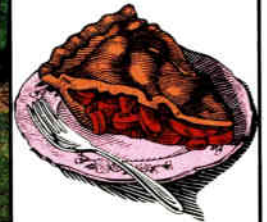

For quality CATV products, let the experienced JCA team GO TO BAT FOR YOU.

CALL

JERRY CONN ASSOCIATES, INC.

P.O. Box 444, Chambersburg, PA 17201

(800) 233-7600 (In USA) or (800) 692-7370 (In PA)





The new Wavetek SAM 2000. Push a button and your old world comes to an end.

See us at the Great Lakes Expo, Booth #116 and 118.

After you try the new SAM 2000, anyone else's signal level meters will seem like a waste of time.

By comparison, they are.

Because Wavetek's SAM 2000 has just redefined what a signal level meter should do, and how fast it should do it. So the world of Cable TV testing as you've known it has just ended.

Direct LCD display with auto-ranging provides precise measurement with no interpretation required and indicates a comprehensive list of measurement parameters. All through quick, easy keyboard control.

FAV key allows fast checks on user programmed channels such as pay channels.

CAL feature permits instant field calibration for temperature variations and test probe, and it even shows when an error in calibration has occurred.

HI/LO pilot button quick-steps between system pilots.

Semi-automated C/N test prevents errors in measurement of this critical system parameter. The SAM 2000 easily locates power supply or filter problems through measurement of system hum modulation.

Two-button tilt function displays mathematical difference between the programmed hi and lo pilot, with realtime update.

Two-button Delta Video/Audio feature quickly displays video-audio level ratio.

The SAM 2000 comes packaged in a compact, lightweight, extremely durable weatherproof ABS plastic case, with built-on strand hooks. Even when open it can handle a sudden shower. And for night use an optional battery powered light illuminates the entire face of the unit.

The new Wavetek SAM 2000. In every way, it's designed to make the most of your time. So don't waste any in getting one.

For more information and the name of your nearest Wavetek sales rep, call us at 1-800-622-5515. In Indiana, 317-788-5965.



Reader Service Number 14

WAVETEK®

No room at the 'inn'

These days, the cable industry is centering much of its attention on fiber optics and the improvements the technology will bring. One of the biggest attributes of fiber is its almost unlimited bandwidth, which promises to allow operators to offer ever more channels to subscribers.

But beneath that desired attribute lies a fundamental operational problem: How do you shoehorn ever more equipment into a headend facility designed a decade ago to deliver no more than 20 channels? The problem is a very real one. When Tele-Communications Inc.'s Director of Engineering Dave Willis was asked about the availability of headend space, his answer was a quick, "Space? You have space?"

Although satirical in nature, Willis' answer sums up the problem, which has been growing steadily and is rapidly reaching the boiling point.

Most of this wall-bursting problem can be attributed to two factors. The first, which was an off-shoot of the 1984 Cable Communications Act and the coinciding deregulation of the industry, was a substantial expansion of channel offerings by operators. The second, and perhaps more significant circumstance, was the advent of satellite scrambled services and the VideoCipher II descrambler. Who would have guessed, when designing headends several years ago, that *seven inches* of vertical rack space would be needed—per channel—for a satellite descram-

bler unit?

On top of this, as technology continues to advance, other equipment is collectively consuming additional space. "It's like the lyrics to an old blues song, 'if the washing don't get you, the rinsing surely will'" says Tom Jokerst, assistant vice president and director of engineering for Continental Cablevision. "Only in this case it's, 'if the satellite descramblers don't get you, the BTSC encoders will.'"

"And don't forget," adds Wendell Bailey, vice president science and technology for the NCTA, "that everytime you add racks and equipment, there's two other components that come along with it. One is electrical consumption to power the equipment. And with the

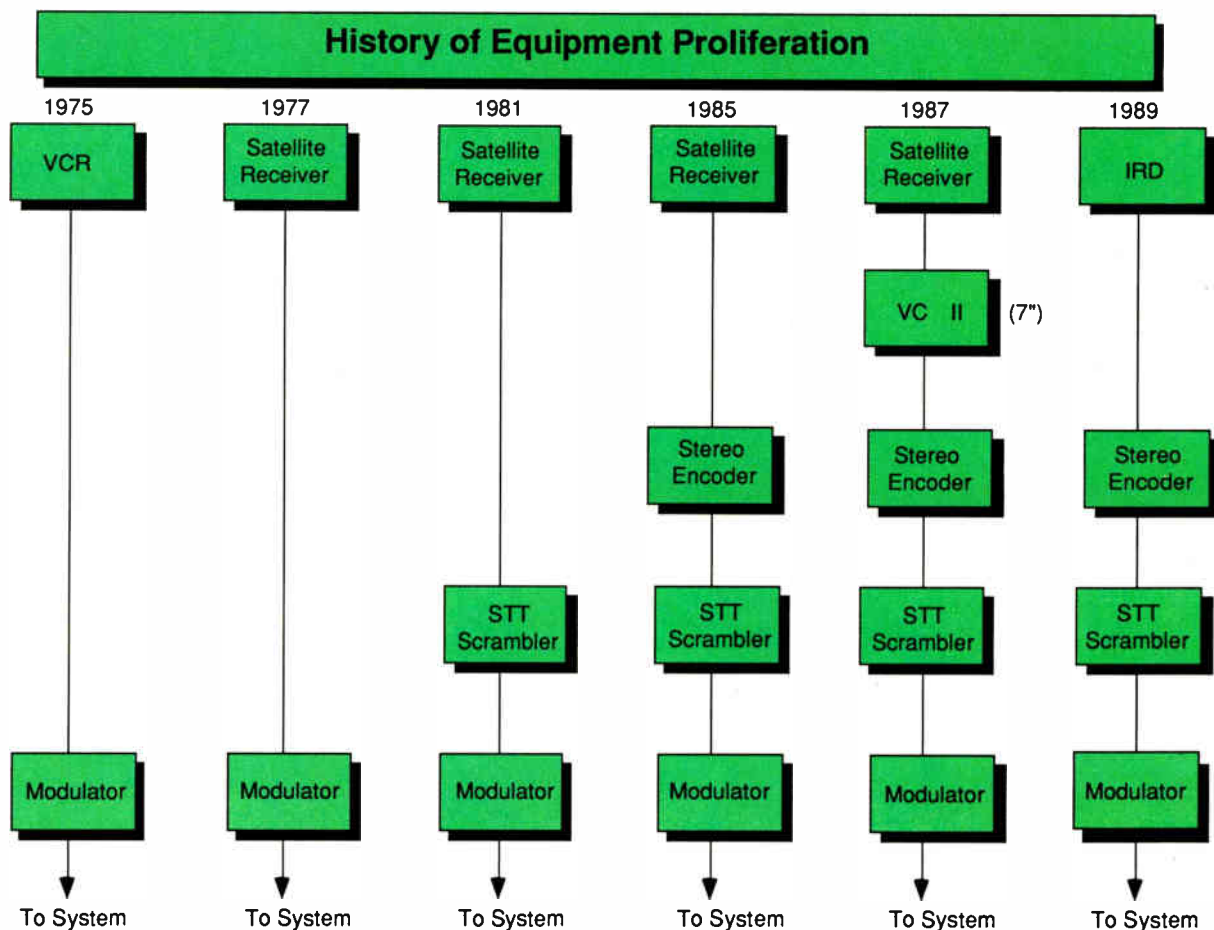

COURTESY OF SCIENTIFIC-ATLANTA

How Do You Fit 10¹/₂" Of Equipment Into 3¹/₂" Of Space?

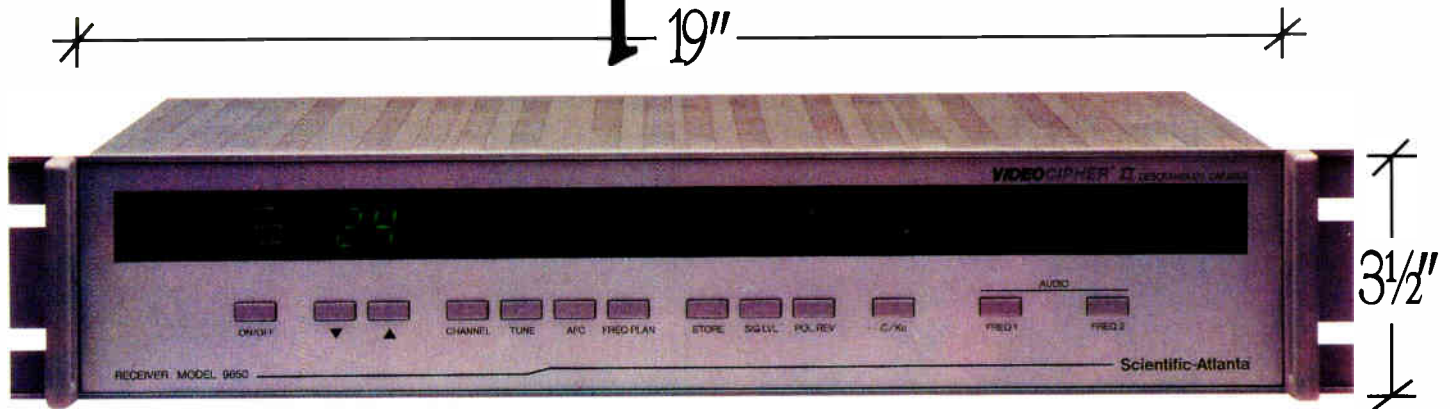

You use the industry's first integrated receiver/descrambler—the 9650 IRD! With headend space at a premium, the 9650 IRD is the best way to beat today's rack space squeeze.

Combine the industry leading 9640 receiver with a VideoCipher® II descrambler in one unit and you have it! Seven inches of extra rack space, assured compatibility, and reduced cabling.

Order the 9650 IRD without the descrambling module now and you can

The 9650 IRD.

add descrambling capability when you need it.

You'll fit twice the channels in the same rack space with perfect compatibility. Add up the difference. The 9650 IRD — we do it right. Call or write Scientific-Atlanta Dept. AR P.O. Box 105027 Atlanta, GA 30348 1-800-722-2009.

Scientific Atlanta

Our customers are the winners.

power you have an unescapable side product—heat. That means you have to supply air conditioning along with the electricity, both expensive propositions.”

What to do?

The obvious answer to the problem is to expand the size of the headend building. Although that's an obvious solution, it isn't necessarily the right one. In many cases, expansion wasn't part of the initial plans when the building was placed close to the base of a guiding tower and a door was put in at the opposite end. TCI's Willis sees each building as being an individual case. "Some buildings are wood frame and to expand it all you need do is pour an additional piece of pad immediately contiguous to the existing pad and knock out one wall," says Willis.

"Many headend buildings are pre-fab, what we call the ice cream truck kind of building," he continues. "Those are difficult to impossible to expand. Some of the block buildings are relatively easy to expand unless they have a slab roof and then they're a problem."

Other considerations when expanding headends are land restrictions, cost and "expansion is difficult to do and still maintain service continuity," says Jokerst. "That's the tough part." In order to avoid this, a second option voiced by several in the engineering community is the rearranging of available floor space—finding a more efficient way of packing things (which may mean sacrificing equipment spacing and cooling).

Depending on the ceiling size, one option is to put in taller racks. Unfortunately, you "compromise something there on maintenance simply because you have to get on ladders to reach equipment," says John Walsh, vice president of ATC's Cablevision of Central Florida. Minimizing equipment protruding from along the wall is another aspect Walsh considers. "You don't just lose the square footage where that piece of equipment sits," states Walsh. "If you take the distance from the wall surface out to the furthest point of the room that the equipment extends, take that times the full length of the room, you lose that amount of floor space.

"You lose it because you've got to be able to maneuver between equipment against the wall and the row of racks farther out from the wall," Walsh says. "You want to keep the interior walls of the building very uniform,

without things like generators or compressors sticking out. Things like that can go outside or in separate buildings attached to the main building. If they must be inside, the way to approach it is to put them all along one wall."

Walsh's system also uses a computer generated drawing program (using an IBM or IBM compatible PC and soft-

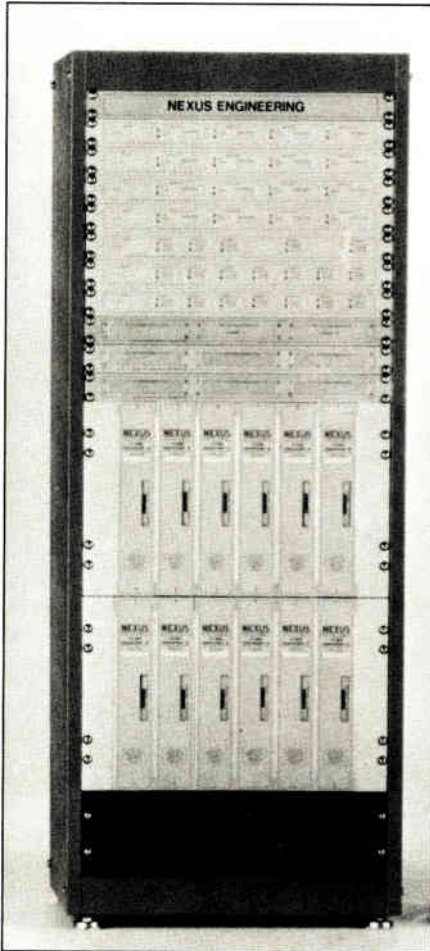

Nexus' NX 100, 21-channel headend

were called Generic CADD) that details the layout of the racks, the exact routing of the wiring, floor plan and elevation plan of each rack, showing exactly where each piece of equipment goes. "The nice thing about having it on a computer system is, as the wiring changes—and it changes all the time—it's very easy to update those drawings," says Walsh. "It's like trying to move furniture around in your home," he adds, "instead of moving pieces, you just move it around a computer screen and the drafting is done on a plotter by a machine."

Still need help?

If all this moving, squeezing, consoli-

dating or expanding seems a bit much, there are still a couple of other alternatives. Many headend equipment manufacturers recognized the problem associated with the VideoCiphers and responded by offering an integrated receiver/descrambler (IRD). Mason Truluck, director of the Satcom division for Standard Communications, always felt there was a market for such a product.

"All of a sudden," explains Truluck, "the MSOs decided that they too wanted that product and they made a direct change. I think they looked at their expansion plans over the next couple of years and figured out they had run out of rack space and room. We have customers right now that are taking out stand-alone VideoCipher units and putting in IRDs."

Standard's IRD contains the Standard Agile 40C/K, a VideoCipher descrambler and its own built-in power supply in two rack spaces. The company also offers a stereo generator with two BTSC encoders in one ¾-inch high rack and will be introducing, in 1990, the CVM550 (commercial video modulator/550 MHz) that has the capability of integrating the BTSC generator right into the modulator.

Scientific-Atlanta has also been working on smaller headend products, since 1982, says Steve Havey, marketing manager for headend and earthstation products. "We introduced the model 6680 receiver which took up half the space of the previous model 6602 and also introduced the 6330 modulator and 6130 processor which allowed for four modulators in 5¼ inches of rack space," says Havey. "This was more than twice as many modulators as you could previously fit in the same amount of rack space."

Space problems exist with virtually every customer Scientific-Atlanta talks with today, according to Havey. The IRD receiver is a product "cable operators have been asking for since shortly after a consumer version was developed years ago," adds Havey. "And we're looking at things going forward that would reduce the requirement."

A different approach is taken by Nexus Engineering Corp. with its VideoCipher Mainframe Board (VCMB) and the NX 100 headend. The VCMB houses six VideoCiphers in 12 inches of rack space. It contains vents on four faces which induces passive cooling and maximizes air flow over the boards. The NX 100 is a 21-channel headend that consists of 14 satellite receivers, 12 VideoCipher II descramblers, 14

television modulators and seven off-air processors in 49 inches of rack space (see Figure 1).

"Initially, reaction to the VCMB or NX 100 is cosmetic," says Leonard Zapalowski, director of CATV sales and marketing for Nexus Engineering. "When they see the size of the headend, they shake their head and say 'wow, how did you do that?' But if you look at what else is going on, to be able to stick all your major sources of heat in 12 inches of rack space and find a way of optimizing that heat—is revolutionary."

Do it yourself

To many operators, the integrated equipment is part of the solution, *if* you need additional equipment and *if* your budget allows for new equipment. As Continental Cablevision expanded its systems and packed more equipment into headends initially designed for 12 channels, Jokerst's answer was not in extra buildings or additional equipment, but in compacting the VideoCipher descramblers.

"We took the power supplies and the descrambler cards out of the VideoCipher units and repackaged them into our own configuration with a compaction ratio of about three to one," says Jokerst. "So we can put six VideoCiphers in the same rack space as it would have taken to put two of the conventional VideoCiphers. I talked to General Instrument quite a bit about this before we did it," continues Jokerst. "I didn't want to embark on this project if they were going to do something similar themselves. However, GI was adamant about its philosophy of the unit not requiring a fan to cool the circuitry. It was a reliability issue."

In order to accommodate the tight packaging of the compacted units, Jokerst (along with Chuck Harper, a field engineer for Continental) used "muffin" fans (100CFM Dayton fans) to force air over the power supplies as well as the descrambler circuit boards. The chassis is designed so that circuit cards are on sliding rails to facilitate insertion and removal (Figure 2).

"We feel that the reliability may have been slightly improved by the repackaging and additional cooling," states Jokerst. "Our measurements of the unit, in the same headend—the temperature on the components in the non-modified VideoCiphers were actually warmer than in our compacted unit. So we feel we probably did make some marginal improvement on the

reliability just by lowering the heat within the circuitry."

There are a couple of disadvantages to this approach. One, the removal of the internal circuit boards will void the warranty on the descrambler. So if the unit fails, it has to be put back into its original configuration to send back to GI. Continental's answer to this is to use units which are already out of warranty or nearing that status, and to "pre-qualify" units as being in good working order before the GI chassis is removed.

A second problem is that in the event of a headend air conditioner failure, the descramblers may become hotter in the compacted configuration than if they were in the original enclosure. To Jokerst, this is not an overriding concern, as thermal breakers can be installed to shut down power and prevent units from overheating.

"The only 'real' concern I have on the unit," says Jokerst, "is if GI decides to add hardware to the circuit boards or add different circuit boards to the descrambler. This could happen as a result of 'hackers' busting the scrambling software and/or hardware. If this should occur, I would anticipate that, at worst, we might only be able

to fit five descramblers per chassis instead of the present six."

However, according to Mike Walker, vice president of communications and industry relations for General Instrument's VideoCipher division, there aren't any current plans to revamp the present VideoCipher II. Instead, the plan is to roll out a second generation product in the consumer market in January 1990, and offer a preliminary design of a commercial unit in the September/October 1989, time frame.

This new unit, VideoCipher II Plus, promises to be a "significantly enhanced security product which is designed to restore higher levels of security into satellite TV," says Walker. It will also be able to receive an expanded number of program channels. Although improved security is the primary focus of the new unit, feedback from major MSOs forced VideoCipher to include in its "marching orders" the ability to fit four commercial descramblers into the space where one unit resides today.

VideoCipher is aiming at having the first commercial Plus unit out in the middle of 1990—at the same size as the original VideoCipher. Approximately six months after its introduction, the new, small-sized version of VideoCi-

Imagine if C-COR also rebuilt cities.



pher II Plus will be available, according to Walker.

Not a singular problem

VideoCiphers aren't the only culprits in the "space wars" presently taking place. Another factor which has contributed to the lack of available space is headend sites with AML microwave equipment, primarily the high-power version. Because the equipment is normally in seven-foot racks, with only four channels of high-power AML to a rack, microwave becomes a major contributor to the problem. For Cablevision's Walsh, the answer is to eliminate the microwave by converting to fiber optics.

"I take it from the standpoint that fiber best serves our long-term needs for channel capacity and coverage of large areas," says Walsh, "but we are in the process of replacing the microwave with fiber. In fact, over half of our microwave hubs are backed by fiber now and all of them will be backed by fiber by the end of this year. In planning a recent remodeling of a headend," continues Walsh, "we took into consideration the amount of space that we would gain by removing the microwave equipment and how that space could be utilized for channel expansion."

"In a lot of ways, fiber optics could help," agrees Tony Werner, vice president of engineering for Rogers Cablesystems in Eastern Canada. "In the years to come we may not decide to keep our headend located where we pick up our TVRO signal. If we move it, we've got the ability, with the fiber network, to find one that doesn't have perfect TVRO reception. It could be a site that meets all our other administrative, parking, space and cost requirements. We could then find a smaller plot of land with TVRO reception and use the fiber optics as a transport system."

Del Heller, vice president of engineering for Viacom Cable, also sees using optical technology as a chance to replace some headend facilities. "Implementing fiber optics doesn't necessarily mean you need less headend space," says Heller. "But it gives you the opportunity to accomplish two things. One is to improve your system performance and at the same time, having to build a new facility anyway, you could certainly make it large enough to accommodate your growth needs.

Looking to the future, Heller would

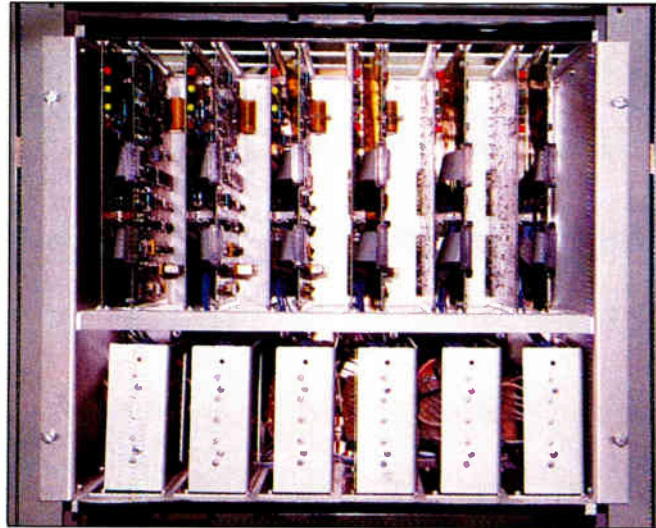

Continental's compacted descrambler mainframe

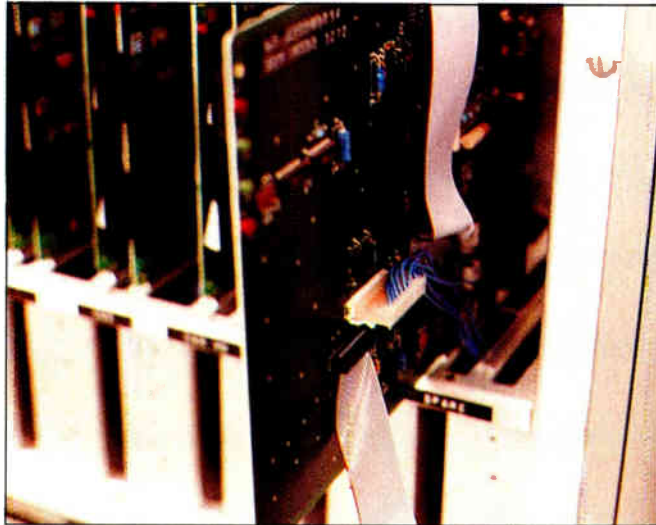

Closeup of descrambler cards and power supplies

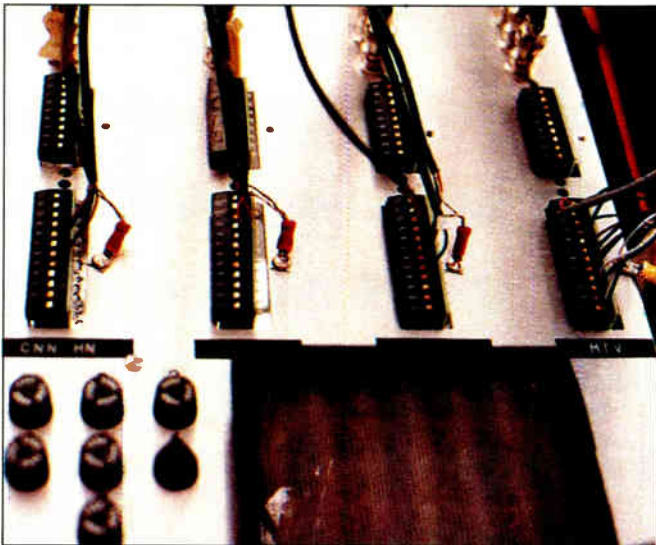

A back side view of the descrambler mainframe

"allow for 70 channels worth of equipment, as a minimum, because most of our rebuilds will only be to 60 channel capacity. That will enable us some additional space for future things (return channels and government access channels) that you never conceive of right now."

Future needs

Although the consensus seems to be to allow for approximately 62 to 77 channels, Jokerst feels 750 MHz is more applicable. "We're considering state-of-the-art bandwidths," explains Jokerst.

"Looking at the fact of how difficult headends are to build or to modify existing buildings, that's the area you should skimp in last. It's always easier to upgrade air conditioning and utilities if you need it than looking for additional space later."

Regardless of the current situation or what the future holds for headend expansion, Jokerst remains optimistic. "I hope this problem gets worse," he says. "The alternative is that if it doesn't get worse, it means we're not doing anything in the industry. These are the kinds of problems I look forward to, it means things are going well." ■

—Kathy Berlin

PERFECT STABILITY

INTRODUCING THE



PICO PERFECT TRAP

OVER HOT,
OVER COLD,
OVER WET,
OVER DRY,
OVER and
OVER and
OVER ...

Pico's **New Mini PT** leapfrogs all existing trap technology with an exciting discovery! By using circuitry so advanced,* in the industry's only hermetically sealed and welded design, the **PT** achieves perfect notch stability time after time, weather or not.

Call for a sample today and test the **Mini PT** — the new standard by which all other traps are judged.

***PATENT PENDING**



PICO PRODUCTS, INC.

CATV DIVISION
103 Commerce Blvd.
Liverpool, NY 13088
(315) 451-7700
FAX #(315) 451-7904

Inside the U.S.
CALL TOLL FREE
1-800-822-7420

Pico's **PT** is the only trap which exceeds the 1990 FCC requirements, established by the Cumulative Leakage Index, by 17dB - 25dB.

Amplifiers and enclosures: The heat dissipation question

A by-product of the powering of electronics is heat. And heat, in turn, can do severe damage to electronic devices.

Cable television distribution amplifiers not only must perform at their best in what are often hostile environmental conditions—freezing cold winters, blistering hot deserts, murky wetlands, climates where the temperatures swing dramatically—but they also generate their own heat: as do the other devices that are installed around amplifiers such as power supplies, traps and various modules.

The electronic guts of an amplifier are housed inside a metal shell housing. This housing, while it acts to contain heat, can serve to dissipate a certain amount of the internal heat by virtue of its design. The heat sink, external fins and other dissipation features of the shell design will perform best depending on how it is permanently mounted in the field.

When mounted on the overhead strand, it is horizontal and tilted, and surrounded by nothing more than the open air. While the heat rises inside the shell higher than the ambient air, nevertheless the shell will dissipate that heat adequately, in most cases.

Building up heat

When the amplifier and its shell are mounted underground or at ground level, it must be placed inside an enclosure or pedestal. This adds to the problem of heat dissipation, especially if the enclosure is not designed to ventilate the internal heat by means of well placed louvers and attention to convection principles. Sun loading on the top of the enclosure will also cause heat to rise within an enclosure.

In the field, many technicians fail to realize that the more open and unobstructed air space there is inside an enclosure, the more likely the ventilation features of the design of the enclosure will work. However, that very space becomes a convenient location for additional equipment to be mounted. But not all the blame for this

should be leveled at the field technician. Operators will often purchase enclosures that are smaller and less well designed at lower cost and try to put "10 pounds of stuff in a 5-pound can."

Because of unavoidable space limitations, in some pedestal mountings the amplifier shell must be mounted vertically. With traditional designs of amplifier shells, the vertical mounting can negate or reduce the heat dissipation

capabilities of the shell design. Therefore, the design of enclosures is also critical to the heat dissipation requirements of amplifier electronics.

Magnavox CATV recently redesigned its amplifier shell housings based on surveys of its customers, and as part of a factory need to create new tooling for their manufacture. The new design features 3/4 inch fins reconfigured at an angle of 45 degrees. In computer models, this fin design dissipated 13.5

TEST RESULTS AMBIENT HIGH TEMPERATURE EXTREME - 101°F

	PEDESTAL AIR TEMP. (°F)	HOUSING AIR TEMP. (°F)	POWER SUPPLY MODULE TEMP. (°F)	IC CHIP TEMP. (°F)
CHANNELL CHP1730 - SERIES 5	95	140	135	141
RELIABLE TV1024	100	150	150	152
RELIABLE TV1832/ATTIC	95	149	155	169
RELIABLE TV1228	102	159	159	163
CHANNELL CPH1730	90	142	158	149

TEST RESULTS AMBIENT LOW TEMPERATURE EXTREME - 52°F

	PEDESTAL AIR TEMP. (°F)	HOUSING AIR TEMP. (°F)	POWER SUPPLY MODULE TEMP. (°F)	IC CHIP TEMP. (°F)
CHANNELL CHP1730 - SERIES 5	61	99	95	100
RELIABLE TV1024	63	105	107	109
RELIABLE TV1832/ATTIC	62	106	110	128
RELIABLE TV1228	65	111	109	115
CHANNELL CPH 1730	63	98	117	105

By George Sell, Contributing Editor



Imagine if C-COR also rebuilt cities.

Like our cable system rebuilds, everything would be designed and built to easily accommodate growth. Or if you preferred, we'd custom build it. Your warranty would be three times the industry standard. Emergency repairs would be handled in 48 hours. And you could reach city manage-

ment anytime on our 24-hour hotline.

It's this kind of innovative service, advanced product line and commitment to quality that's made us the talk of the town. To discuss what we can do for your business, call 1-800-233-2267. In PA, 1-800-356-5090. Or write: C-COR,

60 Decibel Road, State College, PA 16801.

You can have the cable system of the future, today. As for tomorrow's cities, we're still working on it.

C-COR[®] Reader Service Number 18
ELECTRONICS INC We're Out To Give You
The Best Reception In The Industry.

AMPLIFIERS

watts at 25 degrees Centigrade (25C) over ambient in both horizontal and 90-degree positions. This compares favorably with the older fin design, which dissipated 13.5 watts at 25C over ambient in horizontal applications, but could handle only 7.6 watts at 25 degrees over ambient when mounted vertically, according to engineers at Magnavox.

IC failure and heat

In an article titled "Equipment Reliability Prediction" published in *Communications Technology* in May 1985, then Vice President of Engineering for the Jerrold Division of General Instrument, James R. Van Cleave, showed the applicability of standardized methods used by the military services for determining or estimating reliability of electronic devices under various conditions. Cleave cited a DOD (Department of Defense) handbook, "MIL-HDBK-217, revision E," the contents of which are also known widely as "MIL-SPECs" as the basis for his arguments.

According to Van Cleave, outside plant equipment failure rates can be predicted using calculations that fall

between the MIL-SPECs for "Naval Unsheltered" and "Naval Sheltered." While it is not this article's intention to establish actual prediction calculations and testing based on Van Cleave, it is significant that he draws certain conclusions about IC failure rates as

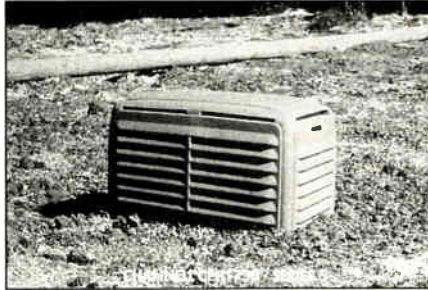

Reliable TV-1832 with Attic

they apply to cable television.

He points out that failure rates from constant temperature test set-ups will always be better than field (real world) tests. And, he says, "The closer a part operates to its maximum ratings, the more prone to failure it is." He goes on to say:

"Minimizing operating temperature, however, isn't so easy and heat becomes a chief contributing factor, especially on the new trunk, bridge and line

extender amplifier approaches of power doubling, feedforward and dual feedforward. Power doubling doubles the heat over that of a single push-pull cascode IC. A feedforward stage generates about 3.5 times that of a push-pull cascode IC.

"Also from the MIL-HDBK-217, Table 5 says that *transistor failure rate essentially doubles for every 9C degrees (16.2F degrees) increase in die temperature*. This means that power doubling technology, which promises reliability improvement due to redundancy, does generate more heat which, if not reckoned with, could negate the reliability goals. A power doubling IC that simply parallels each of the four transistors with four more, produces twice the heat for the same size IC substrate. If the four transistor die operates at 30F degrees above the housing temperature, the eight power doubled die could operate at 60F degrees above, if all else remained unchanged. In this case, going to a power doubled IC would increase the failure rate by almost four over that of a push-pull cascode IC. And, of course, failure of any of the eight transistors, usually in shorting mode, would cause catastrophic failure in IC gain."

Van Cleave urges, "The need to

**Adding to your
AML Microwave System?
Space a problem?
Power and Air Conditioning
too small to handle New Load?**

**— The Alternative —
AML Specialties MTV 510A**

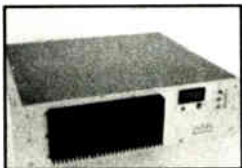

Up to 8 Channels in an 8' rack.
2/3 less power consumption than
KLYSTRON equipment. Up to 5
WATTS of RF output power.
+7dB noise figure better over a
KLYSTRON.

Common carrier-type quality and reliability
And much, much more. Pricing, warranty and delivery.
AML Specialties offers a competitive alternative.
Dedicated to the AML Microwave user's exacting
requirements.

AML Specialties Inc. M/W Prescription Specialists

AML
SPECIALTIES INC.

3975 Broadlawn
San Diego, CA 92111
(619)569-7425
FAX(619)569-0983

Reader Service Number 21

New Product

**RISER-BOND
INSTRUMENTS**

Model 1210
TIME DOMAIN REFLECTOMETER
CABLE FAULT LOCATOR

- SUPERTWIST LIQUID CRYSTAL DISPLAY
- AUTOMATIC DISTANCE CALCULATION
- WAVEFORM/DATA PRINTER STANDARD
- RECHARGEABLE NICAD BATTERIES STANDARD
- TESTS ALL TYPES OF METALLIC PAIRED CABLE
- LIGHTWEIGHT, COMPACT AND RUGGED PACKAGING
- EASY TO OPERATE



\$4,395
Complete

For more information or to place an order call or write:

**RISER-BOND
INSTRUMENTS**

505 16th STREET P.O. BOX 188
AURORA, NEBRASKA 68818
402-694-5201

Reader Service Number 22

BY THE YEAR 2000, ALL AMPLIFIERS MAY BE THIS GOOD.

**With the
Magnavox
Spectrum
2000 Series
you don't have
to wait that long.**

Introducing the shape of the future in amplifiers. Developed through extensive research, the new *Spectrum 2000* is the most technologically advanced amplifier series available. Inside and out.

Designed to shield your broadband electronics from the merciless elements, the *Spectrum 2000* housing* is unlike any other. Computer designed convection fins provide superior heat dissipation in either vertical or horizontal installations—keeping internal modules cool. Plus, our improved weather and RF seals lock out external elements.

Our extended 5/8 inch ports are standard and are designed to accept a heat-shrink seal where the cable enters the housing. And our optional right angle ports even eliminate the need for 90° and 180° connectors making it a snap to mount in aerial, vault and pedestal installations. For ease of maintenance, the cover is reversible and always opens

*Patent Pending

in the most convenient way. And it closes tight so no special tools are needed.

The *Spectrum 2000*'s 600 MHz 2-way chassis features improved surge characteristics for protection against transient power surges and color coded fuses for quick identification and easy replacement.

Available in a variety of bandwidths and bandsplits for worldwide usage, the *Spectrum 2000* amplifier is compatible with all Magnavox modules manufactured since 1972.

Bring your broadband system into the next century with the *Spectrum 2000* amplifier series. Call your Magnavox representative for more information.

MAGNAVOX

CATV SYSTEMS, INC.

100 Fairgrounds Drive, Manlius, NY 13104
(315) 682-9105 Fax: (315) 682-9006
1-800-448-5171 (In New York 1-800-522-7464)

AMPLIFIERS

failure can mean loss of revenue from outages, increased maintenance costs and truck rolls.

frigeration or fans would make that job easier, but such approaches would be costly, given the hundreds or thou-

shielding insulation, as well as metal heat sink mounting bracketry, and the materials with which the enclosure itself is made.

The state of the art of CATV enclosure design, without using refrigeration or fans, is represented by Reliable Electric Utility Product's TV 1832/A, a metal unit with an attic lid, and Channell Commercial Corp.'s CPH 1730 with the Series 5 lid, a plastic unit. Both units maximize heat dissipation by utilizing louvers and vents that promote convection and lids that pass hot air to the outside by heat's natural vertical movement.

Given the similarity of air flow mechanics produced by their designs, any differences between the two may result from the fact that Reliable uses galvanized steel with an aluminum top, and Channell uses high grade extruded plastic for the construction of the enclosure's surrounding containment walls.

LOW IC CHIP TEMPERATURE

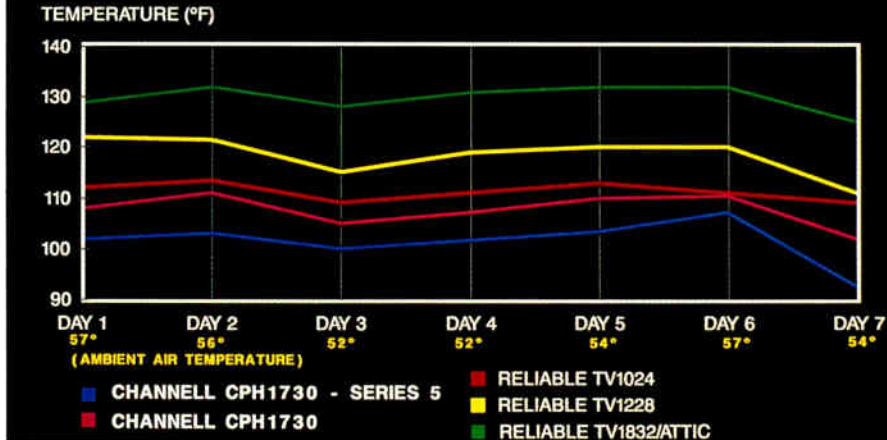

Enclosures and heat

Enclosure design must not only protect the electronics from the environment, but it must also deal with the inside temperature and conditions. Re-

sands of amplifiers typically used in a single cable system plant.

So, the enclosures themselves must be designed to maximize the internal flow of air by convection using vents, louvers and "attic" lids with sun-

A field test of enclosures

Like many cable operations, Sacramento Cable has had its difficulties with the temperature swings. In the mid-1980s, it used enclosures that were

OUTSTANDING

IN STRENGTH AND PERFORMANCE

Cable Prep's RTH-4500 Ratchet T Handle for ease of operation

- Easy to install on any coring or stripping/coring tool with a 3/8" shaft with 3 flats.
- Can be purchased separately or at a discounted price with a new CABLE PREP SCT or DCT tool.
- Self contained unit - maintenance free.
- Fully backed by Cable Prep.
- Competitively priced. • Made in the U.S.A.
- Service-oriented manufacturer.

So user friendly it can be used with our competitor's tools!

cable prep
BEN HUGHES COMMUNICATION PRODUCTS CO.
 207 Middlesex Avenue, P.O. Box 373
 Chester, Connecticut, 06412-0373
 (203) 526-4337 FAX: (203) 526-2291

We make your job easier!

Copyright, 1989 Ben Hughes Communication Products Co.

DISTRIBUTION EQUIPMENT REPAIR!

- \$26.00 plus parts (300 mhz or over)
- Most makes and models repaired
- 90-day and one-year warranties
- 5-10 working day turnaround
- Complete repair reports

Call for quotes on Headend and
Stand-By Power Supply repairs.

800-346-3083

**Midwest
CATV Engineering**
1818 N. Went Street, Mishawaka, IN 46545

Reader Service Number 25

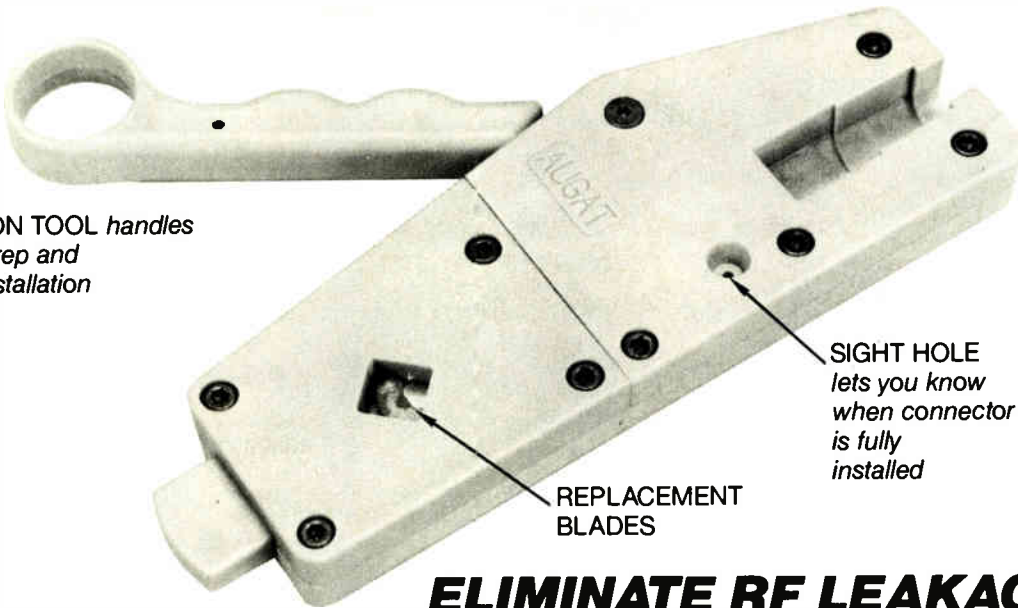

COMBINATION TOOL handles both cable prep and connector installation

SIGHT HOLE lets you know when connector is fully installed

REPLACEMENT BLADES

Connector/cable color coding printed on tool for easy reference

**ELIMINATE RF LEAKAGE.
GET MAXIMUM PROTECTION.
INCREASE SERVICE LIFE.**

ALL WITH JUST A SNAP!



LRC's Snap-N-Seal™ "F" connector does it all, and it installs in a snap.

Snap-N-Seal's 360 degree compression on the cable jacket ensures a complete radial seal — virtually eliminating RF leakage. Snap-N-Seal™ has a triple seal for maximum protection against harsh environments. This adds up to increased life of drops and reduced maintenance costs.

Snap-N-Seal™ is also a snap to install — no more crimping. LRC even offers a convenient all-in-one tool for installation.

Put a little snap in your "F" connector installations. Call or write Augat Communications Group, LRC Electronics, P.O. Box 111, Horseheads, NY 14845. 607-739-3844.

Also, ask about these LRC tools and options:



Open end installation wrench, featuring 1/2" - 7/16"



Weather cap to protect disconnected drops from environmental conditions allowing re-use of the connector.

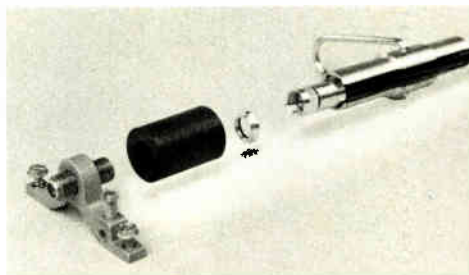

Security shield and security shield tool

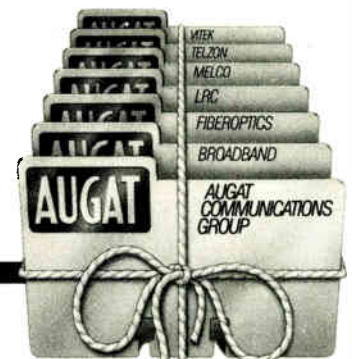

WE'RE AUGAT COMMUNICATIONS GROUP. WE TIE IT ALL TOGETHER... WITH EASE.

Reader Service Number 26

AMPLIFIERS

chosen for their aesthetic qualities, only to find that in the 100-degree plus temperatures, it did not dissipate heat well enough. "We found that because of heat in Sacramento County, we would have been literally killed underground," says Lee Ericson, director of engineering, "because the heat build-up inside of the standard pedestals is such that those amplifiers would never have survived."

Sacramento Cable asked several enclosure manufacturers to help. Prototypes for various designs were supplied and a field test was organized. The results of this testing made the manufacturers return to the drawing boards.

In 1988, another test was conducted in Sacramento, this time with five production model enclosures: Reliable's TV-1024, TV-1228, TV-1832/A with attic cover, and Channell's CPH 1730 and CPH 1730 with the Series 5 cover.

For seven consecutive days and nights from September 30 to October 6, these units were tested with the same active gear in each: A Jerrold X housing, 2000 Series amplifier with power doubling bridger, feedforward trunk, redundant power supply, reverse module and diplex filtering. Integral Corp. 1/4-inch conduit with Comm/Scope 0.625 jacketed

flooded cable was used. The power supply used was an Alpha 60VAC standby providing 63.4 VAC to 62.1 VAC to all equipment.

Thermocouples were placed in the following spots: one in the shade to measure ambient temperature, one in free air space inside the enclosures, one in free air space inside the amplifier housing, one between the power supply module and the housing, and one floating on the IC chip inside the feedforward module. Results were recorded using a Doric Minitrend Model No. 205 digital environmental recorder. The thermocouple's measurements were recorded directly by computer. A total of 21 thermocouples were used and the results printed out every 30 minutes throughout the testing.

The test area outside and behind the offices measured 900 feet by 600 feet. The enclosures were placed approximately 150 feet apart and carefully positioned so that all received the same amount of impact from environmental conditions.

The ambient temperature varied over the seven-day period from 52 degrees to 101 degrees (see graph). It just so happened that the hottest day was the first and the coolest day the seventh (84

degrees). The coolest night fell on the fourth night.

The objective of the test was to track, over time and temperature, the heating and cooling effect of metal and plastic enclosures as that relates to heat retention and dissipation. The testing was conducted by technicians with Sacramento Cable. This test data was compiled and supplied to the author by Channell Commercial Corp.

Apples-to-apples

Because apples-to-apples comparisons are more meaningful, the test results that we will compare will be limited to the CPH 1730/Series 5 and the TV-1832/A.

The test results in the ambient high temperature extreme of 101 degrees indicate the coolest reading on the IC chip as 40 degrees over ambient, or 141 degrees, using the Channell CPH 1730/ Series 5. Reliable's best showing was with the TV-1024 at 51 degrees over ambient, or 152 degrees on the chip. Reliable's TV-1832/A had the worst figures for the IC at 68 degrees over ambient, or 169 degrees. (Note: all figures given are in Fahrenheit.)

In low temperature extremes of the



Extended Value

Broad application Mini Trunk Line Extender Triple Crown Model: LA4229. Over two decades of innovative electronics experience is built into each and every Triple Crown amplifier. This assures you of dependable performance and excellent value.

- Selectable Bandwidth up to 450 MHz.
- Dual integrated circuit design.
- Automatic Level Control (LA4229ALC).
- 29dB Gain.
- Two way capability.
- Single "snap-in" module.
- 18-60 Volt switching mode high efficiency power supply.
- All input and interstage Controls built in.
- External test points.
- Corrosion resistant housing with stainless steel hardware.

4560 Fieldgate Drive
Mississauga, Ont. L4W 3W6

(416) 629-1111
800-387-3205 (U.S. Only)

Reader Service Number 27

TRIPLE CROWN ELECTRONICS

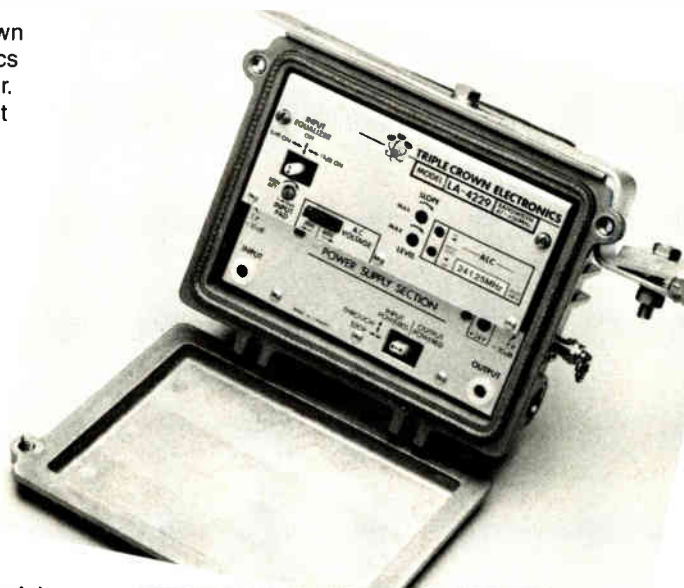

ONLY \$250.00
\$275.00 with ALC



TFC-450 AND TFC-600



SEARCHER PLUS



FDM-4



C.L.I.C.S.



FDM-3



SEARCHER



FDM-5

ARE YOU SEARCHING FOR CLI COMPLIANCE EQUIPMENT? ONLY TRILITHIC HAS IT ALL!

TRILITHIC is the only source for all your CLI compliance needs.

- The new SEARCHER PLUS provides vehicle mounted and handheld CLI measurement capability.
- The TFC-450 and TFC-600 frequency counters keep your carriers on frequency.
- The SEARCHER midband channel receiver and the FDM Series of dedicated carrier receivers offer affordable leakage monitoring.

- C.L.I.C.S. (Cumulative Leakage Index Computing Software) wraps it all up.

Search high and low — only TRILITHIC has everything you need for CLI compliance. You just supply the leaks.

For more information on TRILITHIC'S complete line of CLI instrumentation and accessories contact TRILITHIC or your authorized TRILITHIC representative.

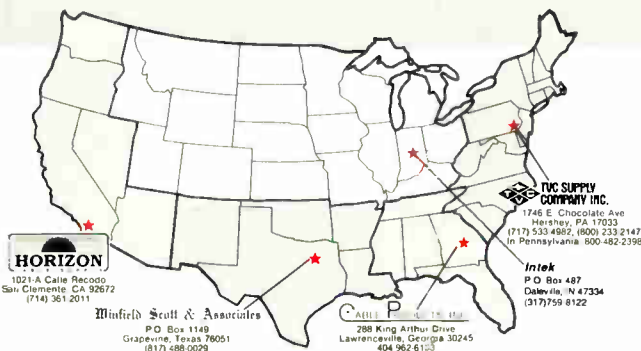

contact us at:

- ★ **TRILITHIC INC.**
3169 N. Shadeland Ave.
Indianapolis, Indiana 46226-6233
(317) 545-4196
Toll free outside Indiana: (800) 344-2412
TLX: 244-334 (RCA) FAX: (317) 547-2496

AMPLIFIERS

test data of 52 degrees ambient, Channell had the best showing for IC temperature at 48 degrees over ambient, or 100 degrees. Reliable had 76 degrees over ambient, or 128 degrees.

In both the highest ambient temperature and lowest, there was a difference in temperature on the IC, between the result for the Reliable and Channel enclosures, of 28 degrees or an increment of about 15.5 degrees Centigrade.

Reactions

Using the MIL-HDBK 217 figures presented by Van Cleave, that would mean that the Reliable TV-1832/A better than tripled the failure rate for the IC chip.

It is debatable whether this kind of analysis would be meaningful in terms of actual failures occurring in a cable system distribution plant. According to Pavlik at C-Cor, "Just a couple of degrees is the typical thing that you run into." Pavlik would rather look at the life expectancy ratings of ICs. "If I remember, the hybrid life at 100C is supposed to last something like 235 years," he says. "So, they can call me when it craps out."

C-Cor National Marketing Manager

John Hastings says, "Whether 15 degrees makes the difference between 35 years reliability and 50 years reliability, probably nobody cares. Still, I

That is sort of a given. Even if we didn't know what the temperatures were, it just had to be the cooler, the better."

C-Cor was asked by a customer in

SUMMARY OF TEST RESULTS FOR IC CHIP

PLASTIC vs. METAL

	CHANNELL CPH1730 - SERIES 5 ENCLOSURE RESULTS	BEST COMPARISON IN RELIABLE TV 1028 ENCLOSURE	TEMPERATURE DIFFERENCE (°F)
AMBIENT HIGH TEMPERATURE			
DAY 1 - 101°F	142°F	153°F	11
DAY 7 - 84°F	105°F	128°F	23
AMBIENT LOW TEMPERATURE			
DAY 1 - 57°F	102°F	112°F	10
DAY 3 - 52°F	100°F	108°F	8

am sure it has to have some effect. I am not sure what that is."

Hastings goes on to say, "All things being equal, the cooler the pedestal, the more you extend the life of the product.

Southern California for advice in choosing which pedestal would be best for its hot environment. C-Cor supplied the customer with Channell's data from the Sacramento field test for analysis.

TV MODULATION MEASUREMENT SYSTEM

Set TV Modulators with Digital Accuracy

**DEPTH OF MODULATION
VMM**

The VMM video modulation meter measures depth of modulation in percentage at the 45.75 MHz I.F. output of the TV modulator.

**BASEBAND VIDEO LEVEL
VVM**

The VVM video volt meter measures video baseband sync., white and composite separately in volts peak to peak or I.R.E. units.

**AUDIO MODULATION
AMM**

The AMM audio modulation meter measures TV audio loudness in dB at the 41.25 MHz I.F. output of the TV modulator.

\$225.



\$875.



VMM
Video Modulation Meter

\$369.

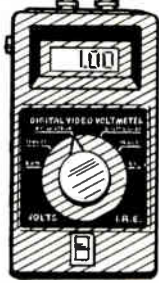

VVM
Video Volt Meter

\$675.



AMM
Audio Modulation Meter

(714) 979-3355
(800) 235-6960

F M SYSTEMS, INC.
3877 S. Main Street
Santa Ana, CA 92707

FAX
(714) 979-0913



Lemco

the
tools
of the
trade

Call for your free
catalogue.

(800) 233-8713

Reader Service Number 30

**You may get by
having your
electromechanical
converters repaired by
unskilled workers...**

**...but why take chances on your
addressables?**

**AT ACES, ONLY THOROUGHLY TRAINED TECHNICIANS REPAIR
ADDRESSABLE AND DIGITAL CONVERTERS.**

**THAT'S WHY WE'RE KNOWN AS
THE ADDRESSABLE CONVERTER
REPAIR SPECIALISTS.**

**Call your
Anixter Cable TV representative for information!**

ACES **ANIXTER
CONVERTER &
EQUIPMENT SERVICES**

**1-800-336-ACES
1-512-258-1606**

**505 Cypress Creek Road
Cedar Park, TX 78613**

**1-800-552-ACES
1-619-241-2002**

**14029 Amorgosa Ave.
Victorville, CA 93292**

**CORPORATE HEADQUARTERS: ANIXTER CABLE-TV, 4711 Golf Road, Skokie, IL 60076 (312) 677-2600 — Telex 289464
©1989 Anixter Cable TV**

AMPLIFIERS

"When we used the data that they provided based on the tests that were run in California," relates Hastings, "we felt that they could really use either of those pedestals without any degradation. But, you know, we always added that given the choice, always select the pedestal that will operate cooler, and in this case that would be the Channell Commercial (units)," Hastings concludes.

Jerrold's Manager of Mechanical En-

gineering, Dick Hoffman, says, referring to operating temperatures for ICs, "Their specified operating temperature in almost all cases is 100C or 212F, so by the time you add a 60 degree, delta T, to the 140F ambient (high temperature limit suggested for amplifier operation), you are at 200F. You are still 12F within the standard operating limit on the component. And that is typically the target of all the designs."

Hoffman adds, "Looking at it from our standpoint, we have to have some limit to which we design an equipment for a specific price." Hoffman argues, "We have a target. A target is given to us by our vendors (IC manufacturers), and we stay well within that target that they give us."

Regarding the proper practice for the installation of active gear in enclosures and pedestals, there is wide disagreement as to who should be responsible, the amplifier manufacturers, the operator's technical staff, construction companies or enclosure manufacturers.

"To the best of my knowledge," says C-Cor's Pavlik, "we've had customers mounting amplifiers in steam ducts, under warrantee." Jerrold's Hoffman says, "The field people interface with the turnkey (contractors) relative to our equipment. We provide mounting devices, clamps for strand mounting or threaded holes for mounting in pedestals. So we do provide that. I guess we don't really control how one of our customers would do that. We don't sell pedestals, for instance, or control designs for pedestals." He adds, "Jerrold, General Instrument is not responsible for that. Typically, we are not even given the option to be responsible. Cable construction companies do this and select the pedestals, and so do our customers."

But more to the issue of failure rates and reliability, Hoffman says, "We specify an operating range for equipment (-40F to 140F) and as long as the customer utilizes our equipment within that operating range then the reliability data relative to our equipment states that, if they do something to change that environment, for instance, to raise the environmental temperature, then, of course, there is going to be degradation of anybody's equipment. As far as I know, the range is standard throughout the industry."

This may be the case in the cable industry. But using the military's 25 years of work in establishing reliability standards for the same kind of electronic equipment and ICs as the cable industry uses, as compiled in MIL-HDBK 217, might give a better handle on reliability of plant.

The MIL-SPEC was created for establishing reliability when a combat crew's lives might be at stake, and that's a whole lot more critical than trying to avoid a system outage during the Super Bowl when nothing's at stake except subscriber satisfaction and an operator's revenue. ■

\$25,000*

FACTORY DIRECT PRICING DELIVERS!

Telsta's "Sweet Deal" Package can put a new 1989 A-28 van-mounted Telsta on the road for you with no hassle or headaches and at the lowest factory direct prices.

You'll get the most wanted lift in the CATV industry—fully equipped and ready-to-go.

You'll get fast delivery because we have chassis in stock at five locations across the country.

You'll get the strongest warranty in the industry backed by the strength of Telsta's nationwide network of parts centers and fleet of mobile service technicians.

And you'll get your Telsta direct from the factory with no third-party markup, no dealers, no aggravation. Pick up the phone and call our toll free direct sales line now. Then relax because it's that easy.

CALL TOLL-FREE: 1-800-521-5351



Utility version also available. Call for your special price.

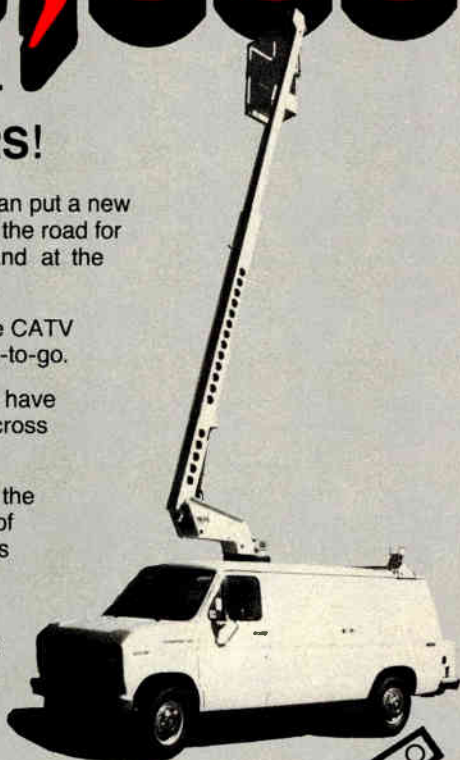

TELSTA®

A LIFT ABOVE THE REST

General Cable Company

P.O. Box 666, 5600 West 88th Ave.
Westminster, Colorado 80030
Phone: 303/427-3700

Facilities in Hayward, CA; Frederick, MD; Lithonia, GA; Muncie, IN

A Unit of Penn Central Industries

* Prices slightly higher in California. Prices good for 1989 chassis only. All prices FOB Telsta plant excluding taxes and registration.

Reader Service Number 32

Innovation Leads the Way

Protect and Secure
your Traps Against
Tampering by
Unauthorized Persons

SC 70
Top Shield



Construction and Subscriber Hardware Specialist



SACHS®

Sachs Communications Inc.
90 West Service Road, Champlain, N.Y. 12919-9703
CALL TOLL FREE 1-800-361-3685

Multi-channel AM fiber optic trunks: From lab to reality

In the past 12 months practical multi-channel AM fiber optic links have moved from the R&D lab into real-world applications. In this paper, we focus on the design, characterization and performance capabilities of systems intended for use with signal spectra covering 20 to 80 CATV channels using distributed feedback (DFB) laser diodes and single mode optical fiber.

We discuss first the fundamental concepts used in a direct modulated AM laser based communications link. The noise and other degradation sources are identified and techniques used in mitigating their effects on performance are presented. Measurement techniques and practical results are also discussed.

We then discuss results on several laboratory demonstrations and field installations using the broadband AM link technology, with attention to the implementation issues faced by operators in the real-world environment of CATV networks.

A year ago in Los Angeles, we heard several papers¹ on the architectural and technical aspects of fiber optic transmission for the CATV industry. Digital transmission, a combination of sophisticated encoders, decoders (CODECs), and off-the-shelf, mature, telephony-oriented transmission equipment, had been with us for many years. Frequency modulation (FM) based systems were also available and being deployed in several markets. It was proposed, however, that neither digital nor FM were on an appropriate cost-performance track to meet the most critical needs of the CATV operator—the trunking and distribution portions of the network. The solution? AM (amplitude modulation).

Why AM? What was really being

By Carl J. McGrath, AT&T Bell Laboratories

©NCTA. Reprinted with permission from the 1989 NCTA Technical Papers

said was the following:

"We know how to build high quality stacked VSB/AM signals in our headends. The equipment is mature, cost effective, familiar and exists everywhere. We have set-top converters and TV front ends in everybody's house, and they expect that stacked VSB/AM spectrum. And we can't afford to change everything at once, so whatever we add must be compatible on an incremental basis if we're to evolve to a fiber-based network over a number of years."

Cost and available technology make AM an obvious choice for CATV fiber optic trunking. We have already observed that per-channel digital and FM systems were applicable only to the high end part of the network (i.e., super trunking) and broadband interfaces for these techniques are not yet available. The challenge then for technologists is to solve the signal processing problem in the most direct manner—minimize the processing and maximize the performance of the transmission channel.

We at AT&T Bell Labs summarized these demands in the following set of design objectives:

1. The system must be cost effective.

2. The system must fit into existing architecture, yet be flexible enough to incorporate evolution.

3. The system must be compatible with the physical and environmental constraints of the typical CATV network.

4. The system must be installable and maintainable by the typical CATV technician.

5. The system must perform, now, and the technology must be capable of moving ahead with the advances in channel capacity, network size and demands on performance anticipated for the future.

During 1988, several labs worked the issues that surfaced in L.A. and by year end, AM products were announced, delivered, installed and put into service by several MSOs. Two basic architectures have emerged, one which recognizes the present limitations of off-the-shelf laser devices and uses several lasers in parallel to handle the spectrum, and a "home-run" single laser

AT&T Bell Laboratories CATV Trunk Design

Fiber Loss - dB	=	5.15
Received Opt Power - dBm	=	-4.05
PIN (standard)		
Detected current - ma	=	0.345
Signal power out - dBm	=	-48.2
at Impedance - ohms	=	50
SYSTEM (Under Test)		
Analyzer floor dBm/Hz	=	-131.90
Analyzer Impedance ohms	=	75.00
PIN detected current - ma	=	0.316
Tone Out GB2 -dBm	=	-4.2
Tone Out GB1 -dBm	=	-19.4
Tone Out FE -dBm	=	-29.1
Noise GB1 + GB2 -dBm/Hz	=	-130.60
Noise Noise GB2 dBm/Hz	=	-125.00
Noise FE + GB1 + GB2 dBm/Hz	=	-122.30
		12:06 PM
Calculations -->		
Responsivity ma/mw	=	0.877
Index of Mod	=	0.071
Calculations -->		
GB2 Effective Gain dB	=	15.20
GB1 Effective Gain dB	=	9.70
NF GB1 + GB2 dB	=	12.63
FE Transimpedance ohms	=	602.76
FE Noise pa/sqrtHz	=	12.37
LASER RIN dB/Hz	=	-150.92
C/N FE OUT dB	=	52.77

Table 1

WE DON'T BITE THE HAND THAT INSTALLS US.

Specify Times T6 coax for the most rugged trunk and feeder cable in the business. Also the most flexible and trouble-free.

With up to half the bend radius of the competition.

That's because only Times T6 is triple bonded.

The center conductor, dielectric, outer conductor,

and jacket operate as one mechanical unit. And

if the cable is somehow damaged, the dents

are clearly visible. So your installer

won't put up cable with unseen

defects inside. It also helps

prevent center conductor pull-outs during cold snaps. T6 also

offers full 600 MHz bandwidth. And the price won't break you

either. Costs are competitive with cable that gives less — and risks

more. For more information, call 1-800-TFC-CATV. Or write

us at 358 Hall Avenue, Wallingford, CT 06492.

We'll bend over backwards to help you.

Or frontwards. Or whichever way you need.



TFC

TIMES FIBER COMMUNICATIONS, INC.®
an *LPL* company

Where technology meets the bottom line

Reader Service Number 34

Distributors:

The Drop Shop
800-526-1100

Hudson Supply
Company Inc.
800-441-0666

Midwest CATV
317-448-1611

Power and Telephone
Supply Company
800-238-7514

TVC Supply Company Inc.
800-233-2147

Deskin Sales (Canada)
800-268-9832

VERSALIFT

GAIN MORE SIDE REACH AND BETTER LINE ACCESS WITH THE NEW TEL-29EA



Boom-tip-mounted bucket puts your operator two feet closer to that hard-to-reach splice. And it provides line access from 3 sides of the bucket, eliminating expensive rotators.

Positive hydraulic bucket leveling gives a solid, stable work platform, leading to increased productivity and greater worker satisfaction.

A "cat-track" carrier system for control, air and hydraulic lines means less maintenance, more "up-time."

The VERSALIFT TEL-29EA can be mounted on any 10,500 dual rear wheel chassis with 60" C.A. and can be tailored to meet any aerial work requirement.

See your VERSALIFT Distributor for complete specifications, pricing and a demonstration!

**It's TIME to
check out VERSALIFT!**



TIME
MANUFACTURING COMPANY

P.O. Box 20368 Waco, Texas 76702-0368
(817) 776-0900 TELE (910) 894-5218 FAX (817) 776-7531

T E L - 2 9 E A

Reader Service Number 35

VERSALIFT

AM TRUNKS

broadband architecture which demands premium performance from its components but delivers the simplest implementation.

In the following sections, we discuss the latter—a "home-run" architecture delivering 40 to 80 high quality CATV signals. Our focus is first on the technology issues, fundamental limitations and device characteristics, and finally on achieved performance.

A simple system model

A simple model of a fiber optic CATV trunk system is shown in Figure 1. The headend electronics here are modeled as N ($N = \#$ of channels) video modulators, converting a baseband video + audio signal to a VSB/AM signal at frequency f_n . The individual outputs are passively combined in several stages to form the composite spectrum.

For our initial analysis, we will consider the performance with unmodulated carriers (CW case), resulting in frequency and time domain characteristics shown in Figures 2a and 2b, an analytical view of 42 cosinewaves summed together.

The laser transmitter is assumed to consist of an amplifier/driver device and a laser diode, at this level viewed as a current to light (optical) power converter. The laser launches this power into a single mode optical fiber, characterized by loss and dispersion (bandwidth), which delivers the power to a photodetector diode at a remote location. The photodetector converts the incoming optical power to current, which is amplified and delivered to a load, here assumed to be a coax cable distribution network.

A look at the component parts

Laser. The laser diode converts input current (modulation) to output light, a relationship often shown diagrammatically as in Figure 3a. This "L-I" characteristic shows several important parameters often considered when specifying lasers:

1. **Threshold**—The current level at which lasing (stimulated emission) begins.

2. **Efficiency**—The slope of the L-I characteristic, often referred to as dL/dI , in $mw(opt)/ma$.

3. **Linearity**—In general, you can only detect poor linearity from an L-I plot, not good linearity. A perfectly linear device follows a straight line over the region of operation, yet the deviation from "ideal" permissible for CATV

AM TRUNKS

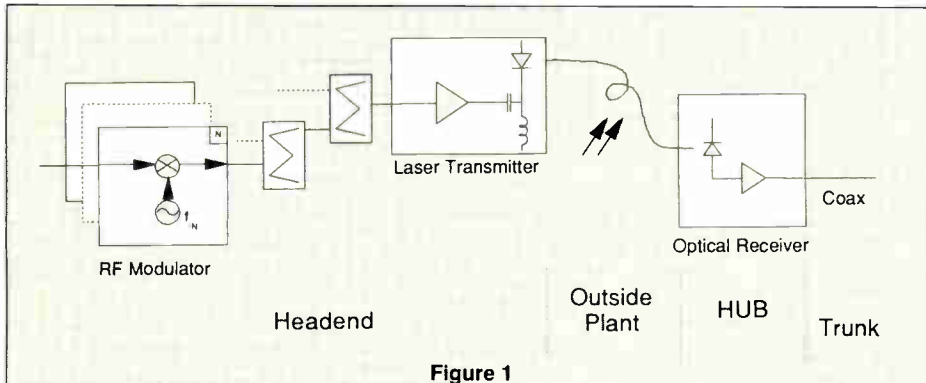

Figure 1

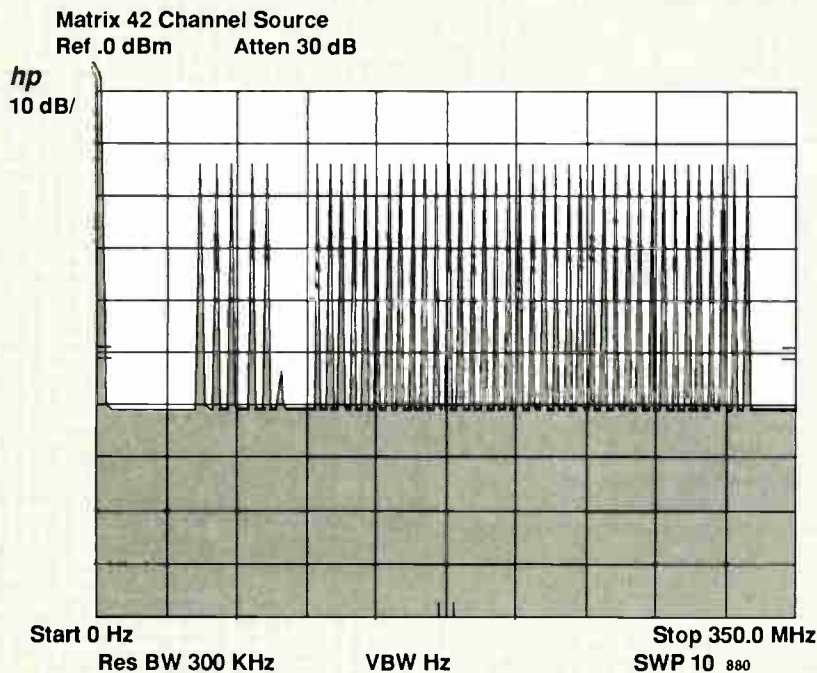

Figure 2a

applications is generally not measurable using L-I techniques.

4. Maximum output—There is no simple definition of the maximum optical output from a laser device, rather it is a complex and device specific set of rules ultimately limiting the current density in the semiconductor junction. Most lasers exhibit a noticeable "rollover" or "current saturation" effect as shown in Figure 3a, where the non-linear L-I relationship becomes noticeable. For CATV applications, the maximum power is somewhat below this "observable" point on the L-I curve.

Not addressed on Figure 3 is the noise performance of the laser, normally specified as the Relative Intensity Noise (RIN). RIN is a significant contributor to overall AM link performance and will be discussed further below. As a device parameter, it is

highly dependent on device structure and packaging.

Intensity modulation, or modulating the amplitude of the optical oscillator (laser), is achieved by changing the current level in the device. Since we know our signal (time domain, Figure 2b), is symmetrical about zero mean (it is a sum of zero mean sine waves), a DC operating point for the laser will need to be established if the RF modulation is to see a uniform $I \rightarrow L$ conversion over its amplitude range, as depicted in Figure 3b.

Optical isolator. A laser may be viewed as an oscillator whose amplitude and stability characteristics are strong functions of cavity (semiconductor material) purity, current stability, thermal stability, and input energy from intended and unintended sources. A significant source of unintended energy is a reflection somewhere in the



✓² REMOTES

■ The latest, most innovative compatible remotes from ABC.

■ Models are compatible with virtually all popular converters.

■ Multiple favorite channel access available on all remotes.



5730 E. OTERO • SUITE 700 • ENGLEWOOD, CO 80112
IN CO: 303-694-6789 • OUTSIDE CO: 800-777-2259

Reader Service Number 36

output circuit which, due to (optical) impedance mismatch, couples energy from the load back into the oscillator at a random time, a function of the propagation time from the laser to the point of mismatch. As we will discuss later, we have determined that certain limits must be placed on the amount of reflected power that may return to the laser.

An isolator is a device that has very low insertion loss in one direction, high insertion loss in the other. These devices, mounted in or near the packaged laser, provide the necessary limiting of reflected power.

Fiber and connectors. A detailed discussion of fiber and connector systems is beyond the scope of this paper. For our purposes, we need consider only the loss of the fiber and installed connectors (in dB) and, to some extent, the reflection performance of the complete optical circuit. In the context of this work, with lasers at $\lambda = 1.3\mu$ wavelength, the fiber dispersion is low enough to be insignificant, or in essence, the transmission medium is assumed to have infinite bandwidth.

Optical detectors. Optical power transmitted through the fiber must be converted back to an electrical signal

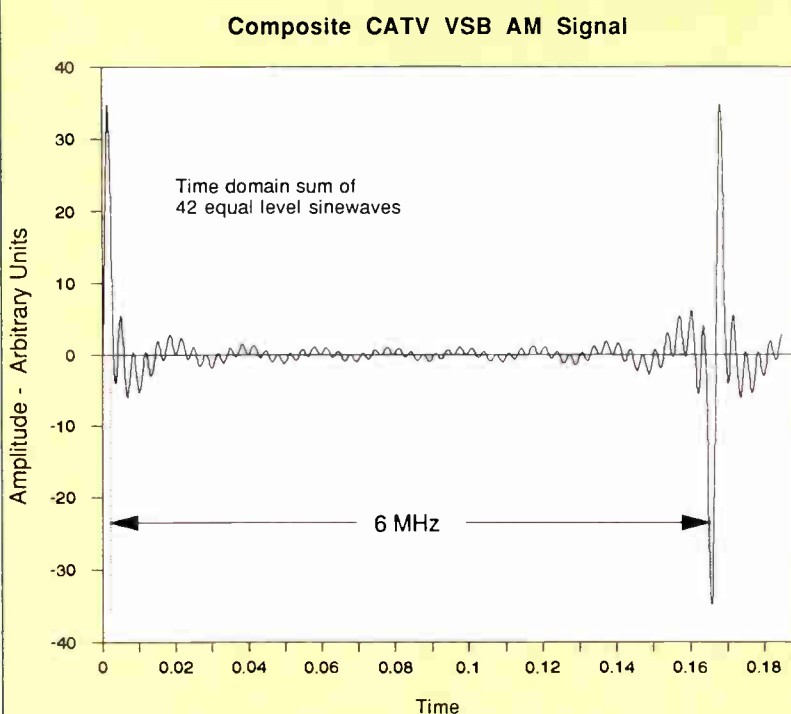

Figure 2b

for input to the coax cable network. Semiconductor diodes, typically *In-GaAsP* or *Ge* at $\lambda = 1.3\mu$ wavelengths,

are ideal for this application due to their small size, high bandwidth, high reliability and low voltage operation. Two types of diodes are candidates; PINs and avalanche photodiodes (APDs).

As we will see below, APDs are not applicable for high channel load applications since a significant portion of the noise in the system is present at the input to the detector in the form of laser noise and shot noise, both of which would be amplified by the APD along with the signal.

The PIN diode is characterized by an efficiency, η , in units of ma (detected) per mw (optical) input. Typically η is defined and measured to include the loss of the connector and fiber pigtail. A PIN diode is typically modeled as a current source, shunted by a parasitic capacitance. The bandwidth of this current source is much larger than the CATV spectrum and is not of concern, although the parasitics in the package will combine with other receiver components to limit the overall system performance.

Amplifiers. Amplifiers and drivers are used at various points in the overall system to match the typical CATV RF levels to those appropriate for laser based systems. These amplifiers are conceptually no different from units used in coax amplifiers, and are likewise characterized for noise figure, linearity and bandwidth performance.

Quality and Performance done
the Rite Way



offers you more:



- Fiber optic
- Underground
- Aerial
- Cable
- Construction
- Strand Mapping
- Splicing



Rite Cable Construction
Provides All Your
Engineering & Construction
needs, including Fiber Optics
704/324-9688

AM TRUNKS

Typical LASER L - I Curves

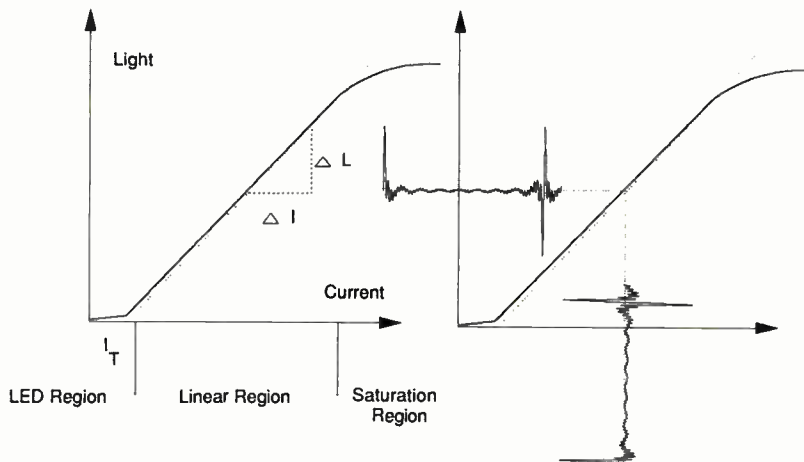

Figure 3a

Figure 3b

The required performance will be discussed as part of the actual analysis of a laser based trunk, to follow.

Trunk performance criteria

The key performance criteria² for CATV trunk applications are:

C/N (carrier-to-noise). The dB ratio of the peak carrier power for a given channel to the noise floor near that carrier, assuming a noise bandwidth of 4 MHz.

CTB (composite triple beat). The dB ratio of the peak carrier to the peak power in the composite third order intermodulation tone which for CATV signals appears at the carrier frequency.

CSO (composite second order). The dB ratio of the peak carrier to the peak power in the composite second order intermodulation tone. For standard and IRC frequency plans, the CSO appears at the carrier ± 1.25 MHz. For

the HRC frequency plan, the CSO beats appear at the same frequency with the CTB beats.

We will look at C/N and intermodulation performance separately, since the noise performance of most components is well understood and may be accurately modeled. Intermodulation performance, on the other hand, must be measured and characterized on each individual unit.

Noise sources in a fiber AM link

We will use the model³ shown in Figure 4 to discuss noise sources. Regardless of source, we are ultimately interested in the total noise present at the input to the front end amplifier at the receiver. This approach also makes comparisons among these sources simpler. There are three dominant noise sources, modeled here as current sources since the receiver diode (PIN) is modeled as an ideal current source. We

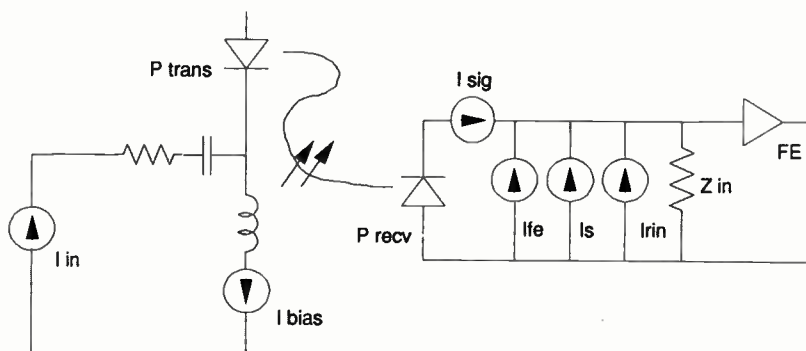

Figure 4

AN OPEN DOOR TO SUCCESS

CONVERTER REPAIR DEPT.

AUTHORIZED PARTS ONLY

Authorized Parts Company

has the quality repair parts needed to keep repair departments within budget and on schedule. APC has redesigned many new parts to be better than original, so operators can reduce service calls and save money.

Call for a catalog.

(312)658-6900
Authorized

Parts Company

208 Berg Street Algonquin, IL 60102

Reader Service Number 38

CATV Trunk Lightwave System

Intermodulation Analysis - Composite Second Order (CSO)

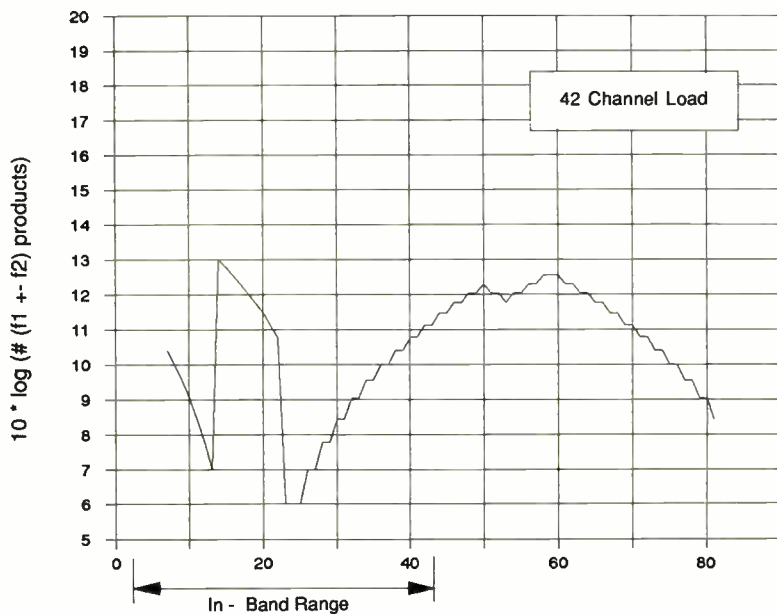

CATV Channel
Figure 5a

review these noise sources in detail below.

Front end noise. All electronic amplifiers add noise to the input signal when delivering the output to a load. In RF systems, we typically deal with an amplifier in terms of its noise figure, a measure of the equivalent noise power that appears at the input. For this analysis, that noise power is converted to an equivalent current, commonly expressed in picoamperes per square root of Hertz (pa/\sqrt{Hz}).

The equivalent input noise is a function of many circuit and device parameters. It is generally not flat across the frequency spectrum of interest, may vary with temperature and load conditions. It must be characterized for each device or family of devices considered for use.

Low noise digital fiber optic system receivers have achieved equivalent input noise currents in the 3 to $5 pa/\sqrt{Hz}$ range, although these receivers are typically limited in their RF output capability and are not yet useful in broadband CATV applications. Amplifiers useful for these broadband applications are more typically in the 12 to $16 (pa/\sqrt{Hz})$ range. Further improvements in this performance can be expected as CATV applications expand the need.

Shot noise. The conversion of light energy, which arrives at the PIN junction in photon "packets," each at

a particular energy level, to an electrical current flow involves the generation of hole-electron pairs in the Intrinsic junction region as the discrete photon energy "packets" are absorbed. The effectiveness of this conversion is a statistical function and the deviation from perfect conversion is referred to

as quantum or shot noise on the detected signal. It is given by:

$$i_s^2 = 2e I_p A^2/Hz$$

where e = charge on electron
 I_p = detected current

This noise is assumed to be spectrally flat over the CATV region of interest. Shot noise represents a fundamental limit on overall noise performance, to be asymptotically approached as other noise sources are reduced through improved device performance.

Relative intensity noise—RIN. The final dominant noise source, in the AM system, is laser intensity noise. When observed at the receiver, RIN is a function of many electro-optic and optical mechanisms, including

- Quantum effects in electron to photon conversion in the laser
- Reflection effects on the laser cavity
- Mode partitioning and modal dispersion
- Phase noise to intensity noise conversion in external reflective cavities.

RIN is a device performance parameter and must be specified and measured for each device. Because it is critically dependent on the optical circuit configuration, it is important to carefully specify and characterize the test setup when measuring laser RIN. In addition, intensity noise has a potential for significant spectral shaping, depend-

CATV Trunk Lightwave System

Intermodulation Analysis - Composite Triple Beat (CTB)

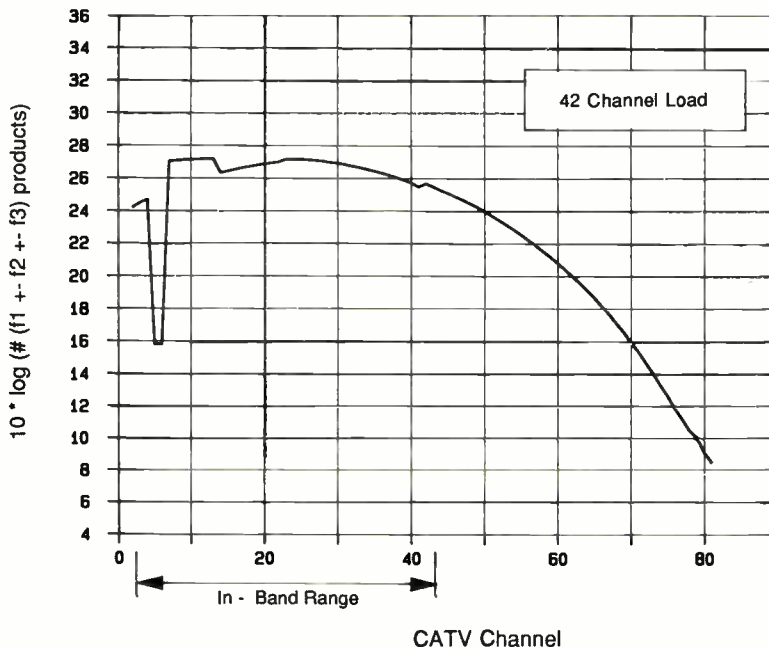

CATV Channel
Figure 5b

PI SERIES* CONNECTORS

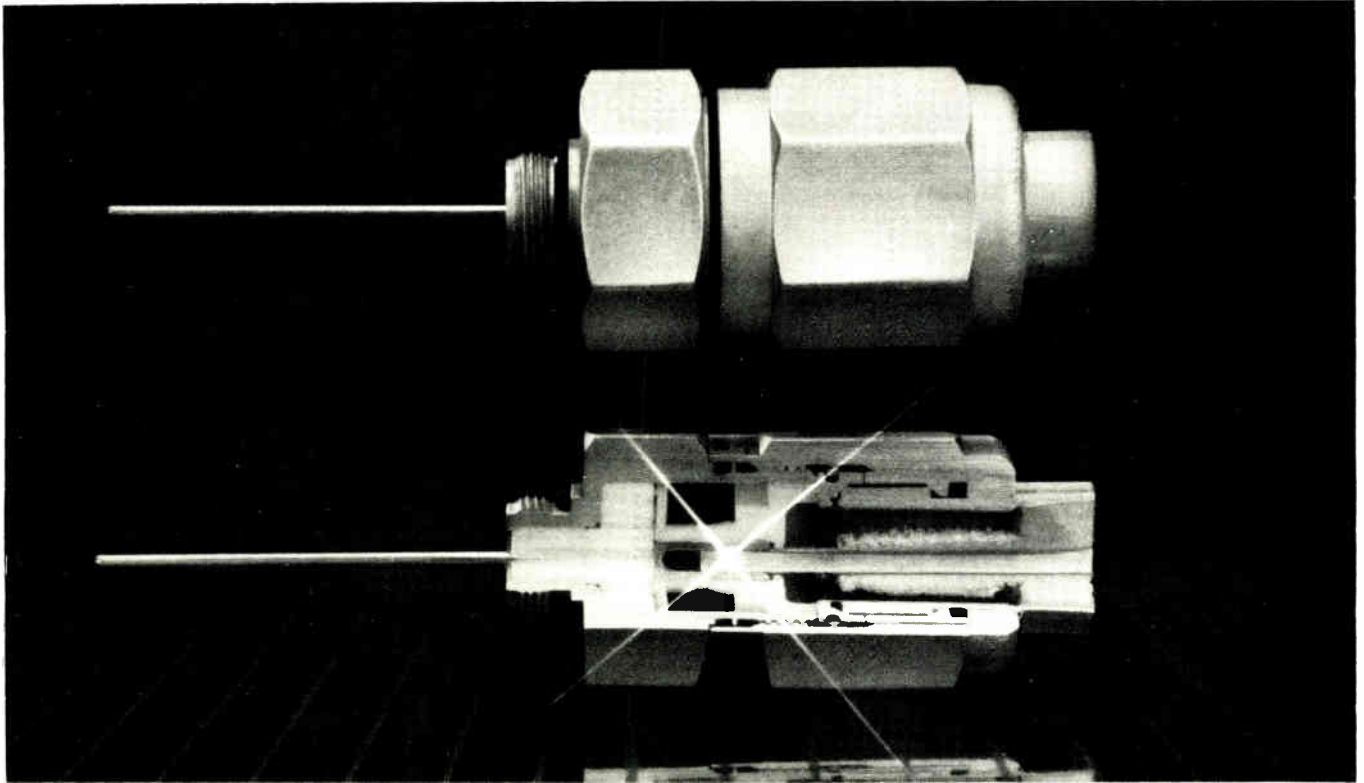

*PATENT PENDING

Interface Excellence From Pyramid.

Pyramid Industries offers a unique design in two-piece trunk and feeder connectors; the PI Series. The PI Series yields both a stainless steel sleeve and both cable seizing mechanisms together within the nut assembly.

PI SERIES FEATURES:

- Two piece construction.
- 75 ohm impedance; 30 db return loss thru 600 mhz.
- Machined 6262-T6 aluminum body; Iridite finish for maximum weather resistance.
- Teflon and Delrin insulators; machined brass contact.
- Captive Stainless Steel Sleeve located and protected within nut sub-assembly; protects sleeve from damage or removal.
- Low-end torque required during wrenching operation; metal to metal positive stop.
- Cable jacket is sealed by means of an EP O-Ring located in nut sub-assembly; provides weather seal.
- Visual alignment of center conductor into seizing mechanism; insures connection.
- Captive sleeve and cable gripping mechanism "float" within restrictions of nut sub-assembly; eases cable insertion.
- Lightweight design reduces shipping costs; eases handling.
- Part number embossed on assembly; simplifies reordering and connector to cable match-ups.
- Rugged design considerations for maximum durability.
- High level of mechanical and electrical integrity; provides consistent performance, reliability and long life.

Call Pyramid Industries today for your free sample of PI Interface excellence.



PYRAMIID
INDUSTRIES, INC.

DISTRIBUTED BY: TONER CABLE 1-214-675-2055; SIGNAL VISION 1-714-536-8966; POWER & TELEPHONE SUPPLY 1-800-281-7341; WESTERN CATV 1-800-531-2299; REX COM COM 1-424-994-3378; THE COUNTRYMAN 1-800-528-6820; WELLS ENTERPRISES 1-408-963-8830

800-528-4529

3700 NORTH 36TH AVENUE
P.O. BOX 23169
PHOENIX, ARIZONA 85063
(602) 269-6431 FAX (602) 272-7372

Reader Service Number 39

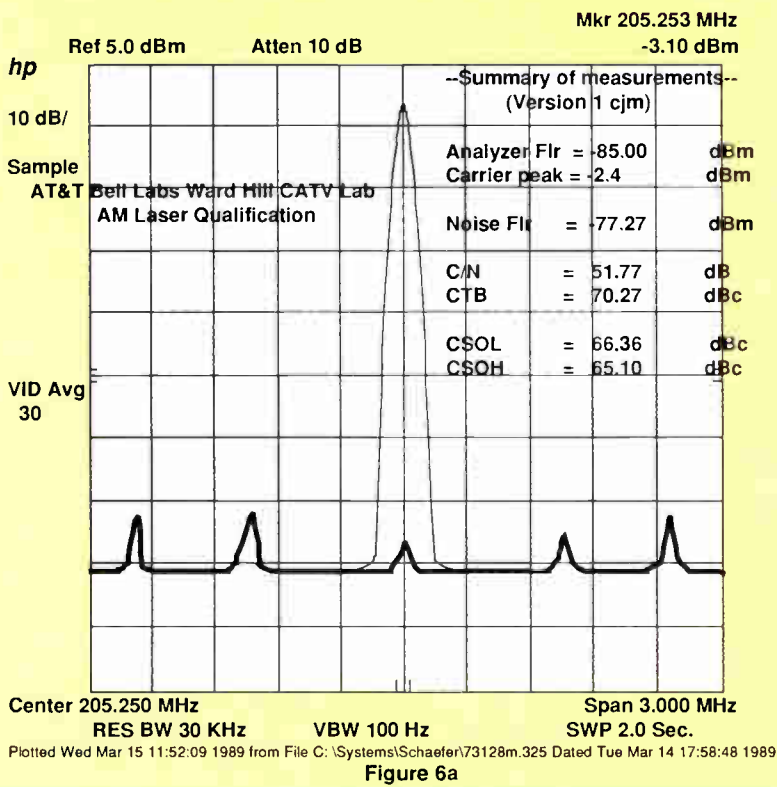

Figure 6a

To obtain the C/N ratio, we now must look at the achievable per channel carrier amplitude. Referring back to Figure 2a, our signal is modeled as a sum of N equal amplitude sine waves.

$$P_{TRANS}(t) = P_{cw} \left[1 + \sum_{i=1}^N m_i \cos(\omega_i t + \Phi_i) \right]$$

Each channel i has a unique frequency defined by the frequency plan in use (STD, HRC or IRC), and even if phase locking HRC and IRC are used some random phase Φ_i will be introduced by electronics and combiner cabling. For large N, $N > 40$ or so, we will therefore assume that the resulting amplitude distribution for P_{TRANS} is Gaussian. If we further assume that we do not wish to exceed the laser threshold with probability > 0.1 percent, the L-I characteristic shown in Figure 3a limits the achievable index of modulation, m_i , to about 4.4 percent for $N = 42$ channels. In general, given m_i for a channel, the ms carrier power is given by:

$$C = \frac{m_i}{\sqrt{2}} P_{RECV} \cdot \eta \quad m_{a,rms} \text{ for } \eta \text{ in } ma / mw$$

and

$$C/N = 10 \log \left[\frac{C^2}{i_{tot}^2 \cdot 10^{-9} \text{ ma} / \text{pa}} \right]$$

ing on the dominant source of intensity variation. Reflection induced intensity noise can be particularly frequency dependent due to transit times between the reflectors and the source.

Typical multimode (Fabry-Perot) digital system lasers have RIN performance in the -110 to -140 dB/Hz range, and laser noise is of little concern with respect to error rate performance. For AM CATV applications, RIN must be better than -145 dB/Hz for typical system applications. We have routinely achieved RIN performance from distributed feedback (DFB) lasers, with optical isolators, that span the range of performance from -148 to -152 dB/Hz in system level applications.

Noise measurement and C/N. When viewed as equivalent unity bandwidth current sources, it is relatively easy to separate the total noise power into its component parts. First we assume:

$$i_{tot}^2 = i_{FE}^2 + i_S^2 + i_{RIN}^2$$

The frontend noise power, i_{FE}^2 , is independent of the presence of an input optical signal and hence may be measured with the laser shut off. Secondly, the shot noise is a function of the DC detector current and may be calculated under those conditions. The RIN component then is derived by subtracting the i_{FE}^2 and i_S^2 components from the

total. Device data sheets typically specify laser RIN as a dB ratio, so:

$$RIN = 10 \log \left[\frac{i_{RIN}^2}{\eta P_o^2} \right] \quad \text{dB / Hz}$$

CATV Trunk Lightwave System

Intermodulation Analysis - Composite Triple Beat (CTB)

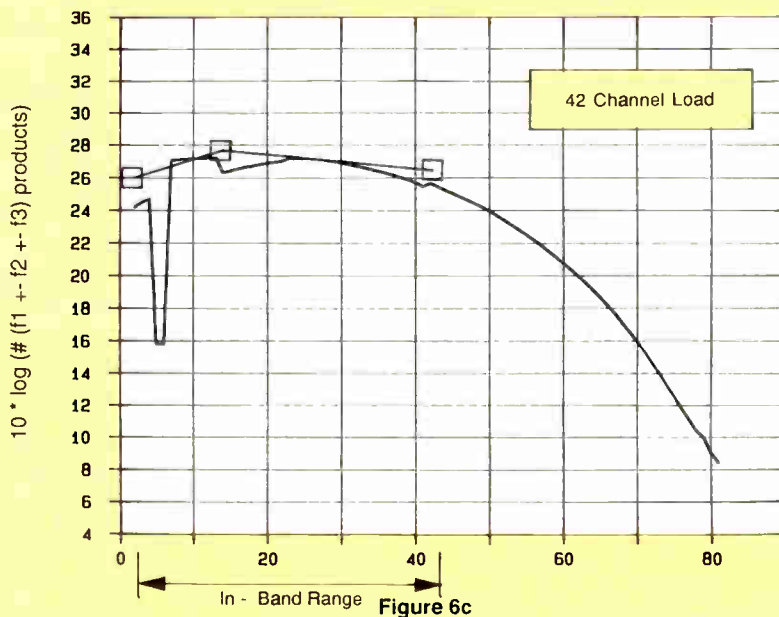

Figure 6c

CATV Channel

CATV Trunk Lightwave System
Intermodulation Analysis - Composite Second Order (CSO)

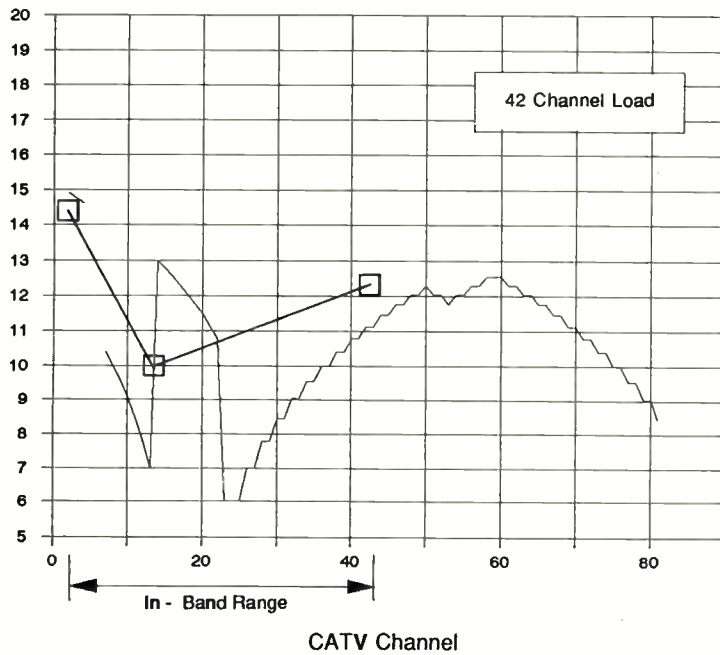

Figure 6d

is measured as the CSO and CTB interference power. It is normally measured relative to the carrier peak and reported in dBc, dB relative to the carrier.

Each composite second or third order beat is theoretically made up of a countable number of equal amplitude beats, assuming that the generating spectrum is flat, or in other words, $m_i = m_j$ for all i, j . If we assume that these beats are uncorrelated in frequency and phase, then the expected channel to channel relative differences in intermodulation performance will follow $10 \log(N)$, where N is the number of second or third order products. In Figure 5a, we show a plot of the predicted second order intermodulation performance, for 42 CATV channels. In Figure 5b, we show a similar plot for third order beats.

In a real laser system, the achievable index of modulation, m_i , will be governed by the second and third order distortion coefficients a_2 and a_3 above, rather than by the simple Gaussian-threshold relationship reviewed in the idealized look at achievable carrier-to-noise performance above. We have achieved system level performance with

Continued on page 86

We will defer a detailed look at this equation until intermodulation is discussed, since it directly impacts the achievable index of modulation, m_i .

Intermodulation noise—CTB and CSO

The theory and mathematics of intermodulation noise were well developed⁴ in the early days of broadband (relative) linear telephony and further analyzed in the early days of CATV⁵, when channel loads on coax began to exceed the original 13 off-air channels.

Basically, if we model the transfer characteristic of any transducer (amplifier, laser, detector, etc.) as a third order polynomial

$$e_{out} = a_1 e_{in} + a_2 e_{in}^2 + a_3 e_{in}^3$$

and apply our

$$P_{TRANS}(t) = \sum_{i=1}^N m_i \cos(\omega_i t)$$

signal spectrum, the resultant e_{out} is shown to consist of linear terms plus countable intermodulation products at frequencies related to $\omega_1 \pm \omega_2$ due to $a_2 e_{in}^2$ expansion (second order non-linearity) and $\omega_1 \pm \omega_2 \pm \omega_3$ due to $a_3 e_{in}^3$ expansion (third order non-linearity).

In CATV, unlike telephony, the energy in each channel is highly concentrated at the carrier frequency, resulting in intermodulation products which fall in very narrow frequency ranges.

The composite power in these frequency bands, a power based summation of the intermodulation products,

WE NEVER SAID IT WAS LOW COST

THE LINE-WARD LINE-LAYER

PREFERRED BY PROFESSIONALS FOR OVER 16 YEARS

- Handcrafted, Solid Construction
- Moves On Tracks, Not Wheels, For Superior Traction
- Efficient, All-Mechanical Drive—No Recurring Oil Leaks
- Ever Reliable Kohler 16 Hp. Engine—Optional Electric Start
- Up To 16" In Depth
- Quick Service & Parts Delivery
- Boring Attachment Available

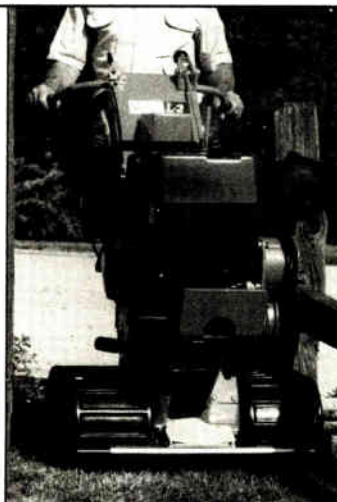

Don't Settle For Less!

SEE FOR YOURSELF

Call For A Free On-Site Demonstration Of The L-2 Model Or Write For Our Color Brochure



Line-Ward Corp.
157 Seneca Creek Road
Buffalo, New York 14224
(716) 675-7373

JUST THE BEST!

Cable testing for advanced television systems

The cable industry is a diverse collection of companies with different approaches, goals and opinions. There really can't be just one cable industry position on Advanced Television systems (ATV). I've put forth my thoughts on the subject based on talking with others in the cable industry, other related industries and potential competitors. But after all is said and done, this is just one opinion.

Rational expectations

Realistically, when can we expect ATV to arrive? When will proponents have hardware to test? When can testing begin? And how long will it take? As long as we're exploring our crystal ball, when can we expect ATV to be commercially significant?

The Federal Communications Commission (FCC) has created an Advisory Committee of industry experts to recommend a course of action. Ultimately, the FCC is the only entity in the U.S. which is empowered to decide the outcome for terrestrial broadcast. The FCC Advisory Committee has three subcommittees and a passel of Working Parties. The Systems Subcommittee Working Party 1 (SSWPI) is charged with the initial analysis of proponents.

This is the point at which proposals are submitted to the Advisory Committee for consideration. SSWPI conducted a "Hell Week" during which all proponents presented their systems and answered questions. One of the important questions concerned the availability of hardware for testing. Many promised fourth quarter 1989 while some said mid-1990 would be the earliest possible delivery date.

Anyone experienced in engineering knows Murphy's laws and how they apply to delivery schedules. The well intentioned promises made by proponent management and the reality of producing the hardware by proponent engineers will likely have some discrepancy. Hardware availability forms an

important limiting condition on testing. Testing cannot begin without hardware. Testing should not begin until a steady flow of proponent hardware is available. Otherwise, costly periods of inactivity will inefficiently consume limited testing budgets.

Cable Labs is scheduling its own mini "Hell Week" to serve as the mechanism for proponents to indicate their interest in being considered for cable application. These sessions are likely to last one or two days and concentrate on the cable aspects of proponents' systems.

At the 1989 Electronics Industries Association Winter Consumer Electronics Show in Las Vegas, there were three panel sessions on High Definition Television. Alex Felker, FCC Mass Media Bureau Chief, probably made the most important statement about HDTV standards: "...we're already about 18 months into this process...and in many ways we haven't come all that far...we're looking at somewhere around another 18 months, perhaps another two years before testing is complete and the Commission would be in a position to select a transmission standard."

After testing is complete, a few months will be required by the FCC Advisory Committee to digest the results and make its recommendation to the Commission. The Commission can only then make its decision. A year or so longer and the first products will be introduced.

A staff of volunteers

The Advisory Committee's System Subcommittee Working Party 2 (SSWP2) is charged with the actual testing. Of course, SSWP2 has no budget and is staffed with volunteers. It must be dependent on others to implement the tests. Specifically, the Advanced Television Test Center (ATTC) and Cable Labs are expected to be helpful.

SSWP2 produced an interim report in February of this year. It was reported that ATTC expects to be ready for testing in October of 1989 and that testing will take from one-and-a-half

to two years. This is in agreement with the assessment by Alex Felker.

The growth in penetration of consumer electronics products is a well known phenomena. Experience with radio, black and white TV, color TV, and VCRs provides guidance in making predictions on how HDTV will grow. Typically, when first introduced, a new consumer electronics product is very expensive and growth is very slow. When the first black and white television receivers were introduced, they cost about as much as a compact car. Likewise, when the first color TV receivers were introduced, they cost as much as a compact car of that day. It would be reasonable to expect the first HDTV receivers to cost about as much as a Hyundai.

The growth curve for these kinds of products involves a long, shallow rise over 10 to 12 years, reaching less than 10 percent of TV households. Then a certain price point is reached and the penetration curve turns almost straight up. A 70 to 80 percent penetration is achieved in just three to four more years. It is rational to expect that it will be between 12 and 15 years before commercially significant penetration of HDTV receivers is achieved. Any more aggressive projection is out of line with past experience and begs for an explanation of the deviation.

Cable Labs

The cable industry formed an R&D consortium in 1988. The consortium is called Cable Television Laboratories, or Cable Labs. It is funded by members at the rate of two cents per cable subscriber per month. This generates slightly in excess of \$8 million per year. This funding supports many activities. Just one of the activities will be ATV testing. It is important to realize that only a minority fraction of the budget is available for ATV. Some have assumed that ATV testing will be the principal activity of the Cable Labs. This is incorrect. It is expected that Cable Labs' ATV work will at least partially support the efforts of the FCC Advisory Committee.

At this point in time, Cable Labs has

By Walter S. Ciciora, Ph.D., Vice President, Technology, American Television & Communications

DISCOVER THE CLEAR CONNECTION

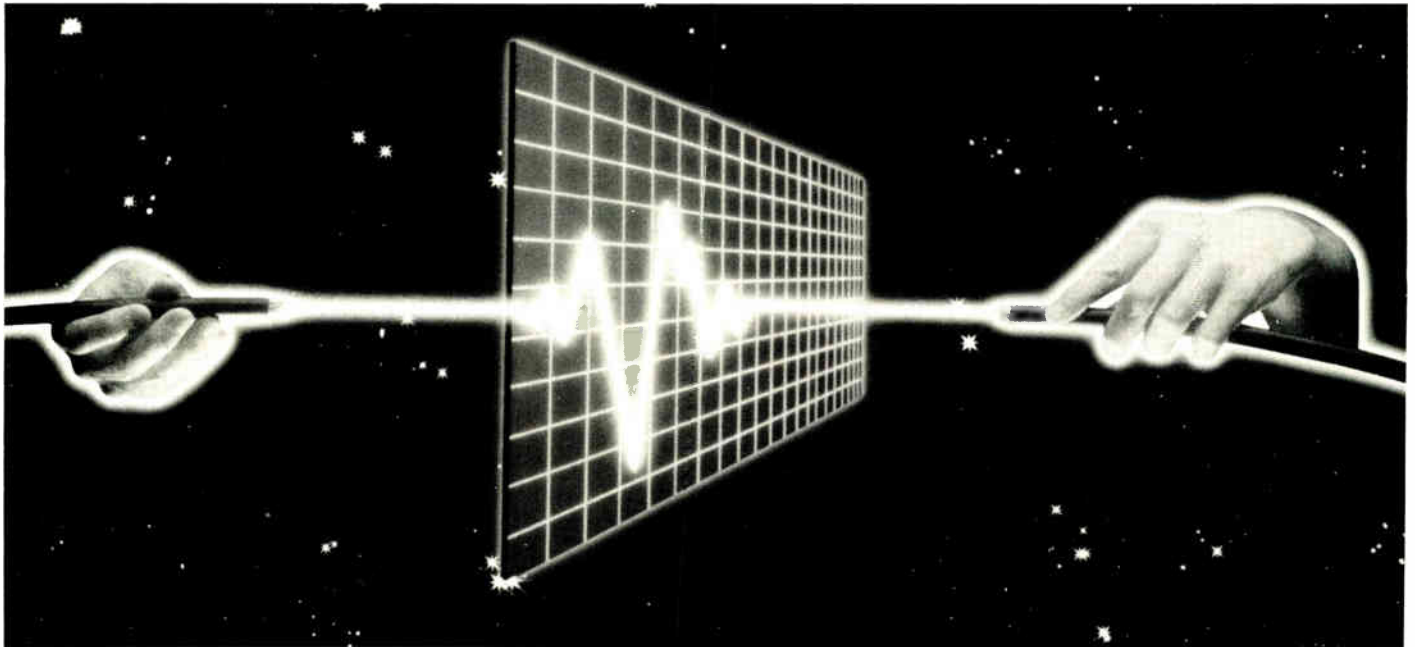

U S WEST Communications Fiber Optic Technology

It's no secret that the wave of the future is fiber optic technology. With U S WEST Communications, you can capture your future today and stay on the leading edge of the cable television industry!

With our experience in fiber optic technology, we're ready to meet your transport needs now. Our 14-state region covers one third of the nation, from Canada to Mexico, including Arizona, Colorado, Idaho, Iowa, Minnesota, Montana, New Mexico, North Dakota, South Dakota, Nebraska, Oregon, Utah, Washington and Wyoming. Fiber optic facilities are available to cable television operators throughout much of our territory.

Our IntraLATA multi-channel video transport system provides you with:

- An advanced fiber optics network with underground cable.

- The replacement of AML microwave links with fiber optic trunk service, allowing for super-trunking of the cable TV signal.
- Broadcast quality signal strength, by inter-connecting your headends with broadcast TV studios.
- Optical systems designed to deliver up to 60 db SNR.
- Cost-effective and reliable maintenance with 24-hour staff and a built-in alarm system.
- An economical way to increase your channel capacity and reduce your amplifier cascade.

Let's discuss how we can help you design a multi-channel video transport system with crystal clear signals!

Call today! Justin Cislighi, (303) 896-4691.

USWEST
COMMUNICATIONS 

limited staff and is just beginning to establish a permanent location. Much of the work must be done by volunteers while Cable Labs is establishing itself. Time is required to hire staff, plan tests and implement them. If the rational expectations discussed above are correct, there will be ample time to do the testing in a professional and reasonable manner. The fact that test facilities, staff and plans are not yet firmly established is not a problem if placed in the proper time perspective. Adequate progress is being made.

Cable Labs has appointed Walter Ciciora of American Television and Communications as its director of Advanced Television Projects. He is on part time loan from ATC for this effort. In this capacity, he has responsibility for formulation and conduct of ATV programs and efforts including HDTV testing. In addition, Nick Hamilton-Piercy of Rogers Communications serves as chairman of the ATV Subcommittee of the Cable Labs Technical Advisory Committee. The ATV Subcommittee advises and oversees Cable Labs efforts in ATV.

Cable Labs is most anxious to cooperate with broadcasters in general and on ATV issues in particular. Cable Labs has a cooperative attitude toward ATTC. One example of how Cable Labs and ATTC are working together toward common goals, consulting work on subjective test plans are jointly being sponsored. Cable Labs and ATTC have freely shared information and opinions on testing procedures and plans. There is every reason to expect that this cooperation will continue. We have many of the same goals and objectives and wish our viewers to be satisfied.

Limited resources

Because of limited resources, Cable Labs is interested in finding suitable existing facilities to hire for handling the tests. Either a single facility to conduct the entire project or a collection of facilities to address various aspects of the tests are being considered. These facilities must be competent, respected, affordable, available and free from conflict of interest. A search is underway for such facilities. A number of research, industrial, academic and government labs are being considered as well as specialized efforts, such as ATTC. Only as a last resort will Cable Labs seek to build its own facilities and hire its own staff. This latter course of action has the

serious drawback of deciding what to do with it after the HDTV work is complete. This is a particularly troublesome issue for the staff which would have to be temporarily hired.

Another consequence of limited resources is that the testing objectives must be limited. There are two ways of applying limited resources. A limited number of proponents can be thoroughly tested or all proponents can be tested in a limited way. The former approach is to be preferred. Testing all proponents poorly may not help in making a choice, or worse yet, may yield an erroneous result. Prudence requires limiting the field so careful testing of a limited number of proponents will result in meaningful answers.

Cable goals

With the above discussion as background, what are cable's goals in ATV? The two most important goals are that cable must preserve its ability to compete and that cable must be able to deliver the signal chosen by the broadcasters. The cable subscriber must see no apparent loss of quality when terrestrial broadcast signals are received via cable. It is important that this be done cost effectively. Being able to compete boils down to the need to insure that no artificial ceilings are placed on the quality cable can deliver. Cable's most important competitors in the ATV arena are: 1) pre-recorded media, 2) telco, 3) direct broadcast satellite (DBS) and 4) broadcast. The first three of these are in a position to deliver truly excellent video. Cable must not be second rate.

A third goal is that of compatibility. The 140 million television receivers built to the current technical standard, called the National Television Systems Committee (NTSC) standard, will be around for the foreseeable future. They must be served. But must all ATV signals be viewable on NTSC receivers? For those signals which are viewable in both formats, what is the best way to achieve this?

A fourth goal is a need to insure that ATV is capable of those things that are somewhat unique to cable service. Included here are the need for addressability, truly secure scrambling and delivery via satellite to cable head ends. These must be accomplished cost effectively. They must not be Band-Aids or add-ons. They must be built into the ATV system itself.

Addressability is the capability to

individually control each subscriber's access to programming for which fees are expected. The addressing signal must be secure, fast enough and capable of a large enough audience. Addressing of cable subscribers must be under the direct control of the cable operator. The scrambling must both hide the video from young eyes so parents don't object and be undefeatable to those who would wish to steal the programming. If the video can be occasionally made unrecordable on consumer's VCRs, perhaps early pay-per-view "windows" can be enjoyed. But this capability must be switchable to a recordable mode for more normal use.

The last goal is cost. Cost includes the matters of spectrum space, level of signal quality and the most difficult question of all: "How good is good enough?" Cost also has a time horizon. Quality which is adequate today may be embarrassing tomorrow.

Critical issues

A number of critical issues remain unresolved. These problems must be solved if meaningful tests are to be conducted.

The various proponents have built their systems on one of four different sets of scanning parameters. Several of the proponents claim that if the test video is not generated in their particular format, they will be so disadvantaged that they might just as well not participate in the tests. There is another group of individuals which claim that only the 1125/60 production standard should be used as original source material. Some elements of that group are trying to abuse this issue to build a case that 1125/60 should be the only production standard. These positions are incompatible and must be resolved.

A practical aspect in all this is the very limited availability of equipment in any of these scanning configurations. If equipment is not available, testing cannot be done. If important proponents decline to participate because of inappropriate input signals, testing likewise cannot commence. This will not be easily resolved.

All systems proposed for terrestrial broadcast and cable involve the compression of bandwidth from studio grade 30 MHz signals to 6 MHz or some similar but much smaller value. All systems promise near perfect still pictures. This is not expected to be a major difficulty. The trouble arises when motion sequences are considered. Here's where noticeable differences can be

expected. The design of the input video and the test procedures to ferret out the differences between the proponents is vitally important.

The issue is made complex by the above discussed apparent need for four different scanning parameter sets. In particular, proponents with progressive scanning rather than interlaced scans claim that a progressively scanned source is necessary if their motion methods are to be adequately tested. Conversion from interlace to progressive scan cannot adequately make up for the motion information lost in the taking process.

Tubes cause smears

A further complication is the problem of camera lag and camera light sensitivity. Current ATV cameras are tube based, not employing Charge Coupled Devices (CCDs). These tubes have artifacts generating smears on moving objects which mask the motion artifacts created by the proponents' systems. If motion performance is to be adequately tested, a source of lag free video must be found. This will be difficult.

Another issue revolves around the display device used for testing. Anyone experienced in video system testing knows that differences between display devices can overwhelm differences between systems under test. The best approach is to observe all proponents on the same display device. However, the fact that there appears to be four different scanning parameters makes the problem exceedingly difficult. There is an interaction between the scanning raster and the dot structure of the shadow mask tube resulting in a Moire pattern which looks like a large finger print on the screen. The design of display devices is an art which seeks balance between conflicting requirements. One of the requirements is to minimize the Moire pattern. This is difficult enough when only one scanning raster is involved, but to accommodate four parameters may be asking too much.

One possible solution is to fund one manufacturer's effort to make several display devices with carefully matched electron guns and identical phosphor formulations, preferably from the same batch. The drive circuitry would have to be the same and the adjustment of the displays carefully supervised with specialized test equipment. This approach will be expensive, time consuming and controversial. Ignoring the

display problem will only result in a less creditable result subject to later challenge. The likelihood is that the tests would eventually be repeated more carefully after legal action.

Shedding more light

Another display related issue is the impact of the viewing conditions on the subjective observers' results. A common problem with currently available

ATV displays is that they are not very bright. Every ATV demonstration to date has taken place in darkened rooms or with a bezel to exclude ambient light. The subjective viewing tests must be designed to minimize the negative impact of these display deficiencies on viewer response.

A further deficiency of current displays is their size. This makes testing difficult when it is realized that viewers need to be no further than 1.5 times



Frequency of Choice

Applied Instruments multi-carrier signal generators give you frequency of choice. Your choice of four individually or simultaneously activated RF carrier frequencies can be factory installed into either of two models. The rack-mountable 1645 model is designed for forward alignment of broadband local area networks. The fully portable 5112 model, designed for return alignment, features rechargeable NiCad batteries that provide up to 6 hours of continuous field use and RS 232C circuitry for remote activation. Together, they give you a complete multiple application RF test system for evaluation and maintenance of broadband local area networks. Delivery of custom built units takes as little as four weeks. Exercise your frequency of choice today. Call Doyle Haywood, President, Applied Instruments, or write for our full color brochure.

317-782-4331

Applied Instruments, Inc.
51 South 16th Avenue
Beech Grove, IN 46107



APPLIED INSTRUMENTS, INC.

BROADBAND COMMUNICATION INSTRUMENTATION

Reader Service Number 42

the picture height if careful testing of motion artifacts is to be accomplished. As discussed above, motion artifacts are the likely area of critical difference between various proponents. An experience at the 1989 EIA Winter Consumer Electronic Show in Las Vegas put this matter into perspective.

Panasonic displayed a prototype Improved Definition Television (IDTV) receiver with three-by-four aspect ratio and 70 inches of diagonal measure. The receiver displayed pictures from a video disk source. Most observers positioned themselves at about 1.5 times picture height. At that distance, moving objects in the picture were tracked by turning the head and moving the eyes. Under these conditions, the usual ATV bandwidth reduction technique of allowing moving objects to have less resolution than stationary objects results in unpleasant effects. Pre-recorded ATV media may be free of such problems, resulting in unfavorable comparisons between tape and disk versus cable and broadcast. Only by viewing the test at 1.5 times picture height can these problems be properly included in the test results. Greater viewing distances will mask the effect and provide incorrectly optimistic results. These results will be invalid when viewers have large screens.

Another critical issue involves whether testing will be done on a proponent-by-proponent basis or on an impairment-by-impairment basis. The first approach involves setting up a proponent and running through all subjective tests. The remaining proponents are taken in sequence, one at a time. Of practical necessity, different sets of viewers would be involved from proponent-to-proponent.

The second approach requires recording all test results for later play back. Then all proponent results of a single impairment test, say multipath, are presented to one group of observers, and the results tabulated. This approach is likely to be the more valid since all proponents are observed by the same group of subjects for a particular impairment. Testing by proponent will result in tests being done by different observers.

Much discussion has taken place over whether incomplete systems should be tested. "Incomplete" has usually meant systems without the sound transmission method in place. Proponents have argued that they do not have the time to prepare sound equipment and since sound will be digital, it doesn't matter anyhow. Others have pointed

out that allocation of the spectral resource between sound and picture involves trade-offs that must be included in the testing. Left out of this discussion has been the fact that the addressability and encryption technique signals also involve trade-offs that need to be tested. A strategy for dealing with this ignored issue needs to be evolved.

There are many other unresolved issues of lesser importance. Those discussed above are of a "show stopping" nature. They need fair, affordable answers to which proponents will agree. Without this, testing cannot fairly begin. If testing is forced without adequate resolution of these issues, the lawyers will consume more time and money than is saved by taking short cuts.

Likely form of cable testing

The FCC Advisory Committee Planning Subcommittee Working Party 4 (PSWP4) is charged with considering alternate media, including cable. It has created a test plan. This plan is not a test procedure, but a statement of what is to be tested, and broadly speaking, how it is to be tested. The detailed procedure is left to those who will be doing the testing. Presumably, this means Cable Labs and/or Cable Labs contractors.

While details have not yet been set, a few general principles can be described. Even these are subject to review and revision by Cable Labs staff.

Cable has two main categories of interests: 1) those proposals which would be suitable for use to deliver cable signals to the home, and 2) those proposals which are likely to be used by broadcasters for terrestrial delivery. Since cable will want its subscribers to have access to broadcast signals, cable wishes to contribute to efforts aimed at insuring quality delivery of broadcast signals to cable homes. In the best of all worlds, these two sets of proposals could be merged. But we must be prepared to deal with the possibility that the surviving cable and broadcast systems will be distinct. Most likely, a review of the proposals will reveal a number which fail to serve either of these purposes and can be eliminated without test.

There will likely be a small number of objective tests done by experts to determine if any of the proponents are technically incompatible with cable technology likely to be practical in the

time frame when ATV is commercially significant. The surviving proposals will then be tested for the range of impairments over which they provide some degree of reasonable performance. A common set of ranges for levels of impairments to be used in all tests will be determined by the panel of experts.

It is most desirable that all surviving proponents be tested over identical ranges and the results recorded, preferably in digital format. Then the tapes are edited so that all surviving proponents' responses to a given set of impairment values can be displayed in random order to the same group of subjective observers who will scale their observations. This impairment-by-impairment approach insures most equal treatment of all tested proponents. The test results will then be weighed by Cable Labs staff and compiled into system evaluations to determine the system or systems to be supported.

Cable Labs will likely use a test bed to simulate a cable system for the tests. Impairments to be tested include, but are not limited to, random noise, impulse noise, power supply noise, non-linear effects such as composite triple beat and cross modulation, micro reflections from cable impedance mismatches, and phase noise introduced by converters and modulators. Satellite links, microwave links, FM super trunk cable links, and fiber links will likely be included or simulated in the tests.

In the interest of being cost effective, a set of screening tests will be sought which can be used to limit the number of surviving proponents which will be subject to the more complete testing. The first step in the process will be the Cable Labs "mini Hell Week" during which proponents will indicate their interest in cooperation with Cable Labs and commit to joint efforts. A search will be made for "leading indicator" or "surrogate" tests which can comprehensively represent performance to a group of related impairments. This strategy not only saves time and money, but lessens the burden on the subjective observers.

Of course, the final surviving proponents will likely be tested on a selection of actual cable systems, probably with simultaneous delivery via satellite. It is likely that the broadcasters' chosen system will be finally tested via off-air pick up and fiber studio link to cable head ends. These ultimate tests will insure nothing was overlooked in creating the cable test bed.

Other issues

There are a number of other issues which must be understood if valid testing is to be undertaken. They will be discussed in the spirit of shedding light on cable's objectives and needs in testing ATV proponents.

ATV and really large TV screen displays are so synergistic that I believe one can't happen without the other.

All of the early consumer research on ATV has indicated that viewers see little difference between NTSC and ATV if they are more than three or four picture heights away from the display. In normal living rooms, people sit six to eight feet from the screen. For ATV to be noticeably better than NTSC, the screen must be two to three feet high. Since TVs are normally described in terms of diagonal measure, the size screen needs to be 50 to 75 inches for the wider aspect ratio. Less than that and most viewers won't see the difference between NTSC and ATV.

Conversely, anyone who has seen a large NTSC projection set is dismayed at how poor the picture can be. This is due to the shortcomings of NTSC, which was created at a time when technology had to strain to provide a 12-inch picture. ATV is critical to the sale of large-screen TVs.

Research on cost effective, bright, large screen displays is well underway in Japan and elsewhere. However, consumer products are still about 10 years away. This is very much in concert with the time frames described earlier. Large screens and the growth in penetration of ATV will go hand in hand. Incidentally, the need for a large screen to enjoy ATV will keep ATV as an upper price point product. It is unlikely that inexpensive receivers in the \$200 to \$300 range will ever be anything other than good old NTSC.

Pre-recorded media

The most immediate cable competitive concern is over pre-recorded media. Magnetic and optical recording technologies are the video arts which have made the most progress in the last 10 years. They are also the areas most likely to make dramatic progress in the future. A startling demonstration was provided to the National Cable Television Association HDTV Blue Ribbon Panel members who participated in the March 1988 visit to Japan.

Mitsubishi showed a 20 MHz baseband VCR prototype which recorded and played back near-studio quality, wide screen HDTV. Since the recording was at baseband, no video compromises were required. There were none of the motion artifacts we've come to expect from bandwidth-reduced HDTV. The mechanism of the prototype machine was nearly identical to standard VHS design. What we saw was an eminently practical approach. Mitsubishi subse-

quently demonstrated the device at the 1988 NCTA convention in Los Angeles.

The 1988 Institute of Electrical and Electronic Engineers, International Conference on Consumer Electronics included several papers on digital VCRs for consumer electronics. The IEEE-ICCE technical papers generally appear two to five years before products are introduced. The message is clear: consumers will have digital quality VCRs in the near future. First they

CAUGHT WITH YOUR CHANNELS DOWN ???

WHEN A FIXED CHANNEL PROCESSOR OR MODULATOR FAILS YOU'RE STUCK UNTIL IT'S REPAIRED. NOW MULTICOM HAS TWO RELIABLE AND ECONOMICAL ALTERNATIVES.

FREQUENCY AGILE HETRODYNE SIGNAL PROCESSOR

S450P

Jerrod



- * Accepts VHF, UHF, and all cable channels to 450 MHz
- * IF conversions versus demod/remod configuration

- * Front panel dipswitch channel selection
- * FCC offsets
- * 60 dBmV output

FREQUENCY AGILE MODULATOR

S450M

Jerrod



- * Frequency agile over entire 50 to 450 MHz bandwidth
- * IF conversions versus demod/remod configuration

- * BTSC stereo compatible
- * 60 dBmV output

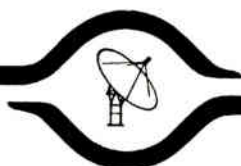

MULTICOM, INC.

CALL TOLL FREE:

1-800-423-2594

1-800-342-8840 IN FLORIDA

will record ordinary NTSC, then they will evolve to ATV.

The optical disc is slowly building momentum. A huge and growing list of titles are available. Rental stores are popping up. The disc is a low noise media providing cleaner video. The best pre-recorded video I've ever seen comes from a Sony professional HDTV video disc. The absence of noise adds tremendously to the realism.

From cable's perspective, the concern is this: five to 10 years from now, a subscriber rents or buys a disc or tape to view at home on his large screen display. Afterwards, he continues viewing a cable channel such as HBO. The tape or disc was recorded at baseband using 20 MHz to 30 MHz with no compromises. The cable signal is bandwidth compressed video with motion and other artifacts. On the large screen, the direct comparison may prove disturbing.

Broadcast

Broadcasters are in an extremely difficult position. Spectrum is scarce. Most importantly, the spectrum that is available may not be of sufficient quality to provide ATV in all locations. Broadcasters face the problem of multipath. Reflections from hills, mountains, towers, airplanes, buildings, etc. cause multiple signals to be received. These appear on the screen as ghosts or as blurring of the main signal. The vestigial sideband nature of the signal makes the ghosts particularly bothersome. ATV's doubled number of scan lines means that the scanning speed is doubled. This doubles the displacement of a ghost on the screen. Since the objectionability of a ghost is an exponential function of its displacement, ATV ghosts are nastier than NTSC ghosts of the same severity. Additionally, many ATV systems use time compression to separate the luminance information from the chrominance signals. When these signals are uncompressed in the receiver, a single ghost is converted into two ghosts with different locations and sizes.

The consumer electronics industry has worked on "ghost cancellers" for a couple of decades. They still remain impractically complex systems with marginal performance for even the less demanding case of NTSC. It is likely that ghost cancelling will remain out of reach for quite some time to come.

The importance of direct broadcast studio links to cable headends will increase with ATV. This technique best

serves cable subscribers and broadcast viewers alike. This especially makes sense when we consider that ATV is a large-screen, relatively expensive phenomena, to be enjoyed in the primary viewing location of the home. In the time frame when ATV becomes commercially significant, cable penetration will be at least 80 percent of households. Most anyone with an interest in video will be a cable subscriber. From this we conclude that at least 90 to 95 percent of initial purchasers of ATV receivers will be cable subscribers.

Compatibility

"Compatibility" is a rubber word often stretched to meet the needs of the moment. One respondent to the FCC's Notice Of Inquiry (NOI) has created an elaborate six-level hierarchy of compatibilities. From the cable operators' perspective this is nonsense. NTSC compatibility can only mean that an ATV signal is also viewable on essentially all existing NTSC receivers with acceptable quality and without adaptor boxes or modification of the subscriber's NTSC receiver. Anything else is simply not "compatible."

The last thing we need is to be put in the position of having to provide adapter boxes so existing subscribers can continue to view current programming.

Single universal standard

In the best of all worlds, a single universal ATV standard would reduce consumer confusion and increase efficiencies. Lower prices and faster adaptation of ATV would result. It would provide a "level playing field" for all video delivery competitors. Price, service and quality of programming would be the instruments of competition. The example of the free market approach to AM-stereo clearly displays the problems of multiple standards.

Unfortunately, we do not live in the best of all worlds. In our world there are real, physical differences between video delivery methods. Video has changed a lot since the simple days when black and white TV was introduced. Then the consumers' only choice was off-air reception. Compatibility then meant only that all broadcasters used the same technical standards so the consumer could get by with only one receiver. When color was introduced, cable was an insignificant part of the video scene. Compatibility again

meant that all broadcasters used the same technical standards. But "compatibility" gained an additional meaning. The old black and white receivers had to be served by the same signal that put color pictures on new sets.

Today the situation is much more complex. The consumer not only receives signals off-air, he also subscribes to cable, rents tapes and discs, and maybe has a DBS dish receiving frequency modulated video. Furthermore, he hears of the phone company wanting to provide digital video signals over fiber. Since these delivery means are diverse in their fundamental technology, a single universal standard is impossible. Vestigial sideband amplitude modulation (VSB-AM), FM satellite, digital fiber, and tape and disc recording are just too different in their basic technologies to come under a mandatory, comprehensive, single universal standard. This would be like coming up with a single universal standard for home heating which applies to gas, oil, coal, wood, cow dung and electricity.

The regulatory situation is also much more complex. While the FCC has rigid control over some of the video transmission means, it has virtually no control over others. For example, no one asked the FCC for permission to introduce Super-VHS. Likewise, no one needs to ask for permission to introduce a prerecorded ATV format. Unless this is changed in ways that seem highly unlikely at present, a single universal standard is simply impossible! Cable must retain its ability to compete in this complex new world.

Signal robustness

The broadcasters' signal is important to cables' subscribers. They expect it. When broadcasters begin transmitting ATV signals, cable subscribers will insist on receiving those signals over their cable connection.

Cable's concern over the broadcaster's signal is primarily over robustness. Cable processes the signal many times before it reaches the subscriber. In doing so, the signal may become bruised. If the broadcasters achieve ATV in the present 6 MHz, they will have to squeeze even more information into the existing bandwidth. This will most likely reduce the robustness of the signal and make it more subject to damage. The cable industry must work with the proponents of systems means for use in terrestrial broadcast to minimize this cable hazard. ■



Introducing the Sony FSR-1100 high-performance C/Ku satellite receiver.

Better signal reception means more satisfied viewers. And whether it's CATV, SMATV, broadcast or business television, a better picture starts with the FSR-1100 satellite receiver from Sony.

Performance/Feature Highlights

- Typical threshold extension: 7 dB
- Selectable 24/31 MHz IF bandwidth
- 3 audio outputs: 2 tunable plus 1 fixed subcarrier
- Easy-to-use 10-key tuning plus video fine tuning
- 2-digit strength indicator for precise antenna positioning
- 24 preset C band channels. Programmable memory for presetting of Ku band channels plus audio subcarrier frequencies, polarization and IF bandwidth
- Composite and auxiliary outputs for compatibility with most external decoders
- Input frequency band: 950 MHz-1450 MHz

Simply put, the FSR-1100 is one of the most flexible, reliable, high-performance commercial satellite receivers for the money. And that's a claim backed by Sony's unparalleled experience in professional broadcast and industrial video equipment.

Whether you're operating in Ku or C band, the FSR-1100 delivers superb video and audio reception. Sony's unique adjustable detector

bandwidth can provide improved picture quality under adverse signal conditions. And advanced operating features provide unsurpassed ease of use.

HEMT LNB's

For heightened Ku band performance, look into Sony's ultra-low-noise block down converters. The first LNB's in the U.S. to utilize Sony's advanced HEMT (High Electron Mobility Transistor) technology, Sony's LNB's achieve exceptionally low noise figures, to 1.6 dB (typical). For sensitivity, stability, reliability and uniformity, they establish new standards of performance, surpassing all currently available GaAs MESFET units.



Sounds impressive? Just imagine how impressed your viewers will be. Write or call for more details on these and other Sony Satellite Communications products.

SONY®

Satellite Communications, Information Systems Company, Sony Corporation of America, Sony Drive, Park Ridge, New Jersey 07656 (201) 930-7022; Or contact the following authorized Sony Satellite Communications Dealer: Midwest Communications Corp., One Sperti Drive, Edgewood, KY 41017 (800) 543-1584 (606) 331-8990

SONY BRINGS A BETTER PICTURE DOWN TO EARTH.



Building with blocks: A guide to basic AML

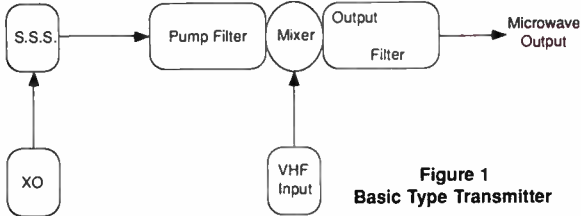

Figure 1
Basic Type Transmitter

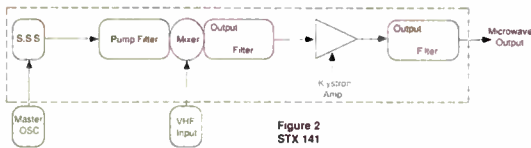

Figure 2
STX 141

This story was derived from recent presentations made by Mr. Walker to numerous local SCTE chapters and state cable TV conventions.

Off-air television signals have always been free for the taking. All anyone ever needed was an antenna, a television set and a place to plug it in. In the beginning, this arrangement made most people happy—the price was certainly right and there was no other choice anyway. But others were less than pleased, especially if they had to make do with faint, snowy television images that had flickered in from distant transmitters. For them, free television meant no television; hardly a bargain no matter how free it was.

The birth of CATV

Eventually, such would-be, want-to-be television viewers got fed up with at best second rate reception. Frustrated, they began banding together, here and there setting up their own community antennas and routing the signals through cables to their homes. That's the way cable television was born.

Since they were in on the ground floor of the emerging industry, these pioneer cable television users have always grasped new developments in cable technology easily. Not so lucky are latecomers to cable television, who

By Dane Walker, Microwave Systems Engineer, Hughes Aircraft Company, Microwave Products Division

must play catch up ball with unfamiliar concepts and ever changing terminology. Just about the time their local operators get a handle on dBmV's and figure out how to read a field strength meter, someone throws microwaves at them.

"I'll never understand this stuff," they cry. "I can barely microwave a turkey without burning the wings, so how can I expect to run a microwave CATV system?"

Fortunately for them, understanding microwave cable systems is really quite simple. All that is required is a basic grasp of what such a system re-

quires. The upconverter is fed with two signals; the local oscillator signal and the incoming VHF signal. The local oscillator normally comes from a solid state source (SSS) which is kept on the correct frequency by the crystal oscillator (XO), also known as the master oscillator: The output frequency of the SSS is the same as the 171st harmonic of the XO. The local oscillator signal is mixed with the incoming VHF signal (54 MHz to 550 MHz), resulting in four signals: the two original signals, plus signals that represent the sum and the difference of those two frequencies. Completing the basic upconverter is a filter that is tuned to the sum of the two original signals after they have passed through the mixer.

Figures 1 and 2 compare the basic AML transmitter with the Hughes

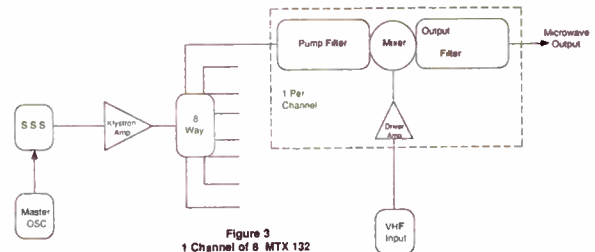

Figure 3
1 Channel of 8 MTX 132

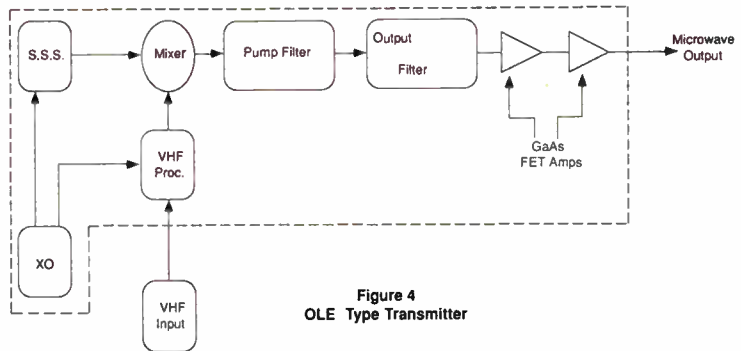

Figure 4
OLE Type Transmitter

ally involves. In most cases, all an AM modulated microwave system (AML) involves is a heterodyne upconverter for the transmitters and a heterodyne downconverter for the receivers.

Transmitters

In a basic AML transmitter system,

the upconverter is fed with two signals; the local oscillator signal and the incoming VHF signal. The local oscillator normally comes from a solid state source (SSS) which is kept on the correct frequency by the crystal oscillator (XO), also known as the master oscillator: The output frequency of the SSS is the same as the 171st harmonic of the XO. The local oscillator signal is mixed with the incoming VHF signal (54 MHz to 550 MHz), resulting in four signals: the two original signals, plus signals that represent the sum and the difference of those two frequencies. Completing the basic upconverter is a filter that is tuned to the sum of the two original signals after they have passed through the mixer.

Figures 1 and 2 compare the basic AML transmitter with the Hughes

produce the combined outputs, the normal levels for an STX-141 system can range from +36 dBm for a single channel system to +17 dBm for an 80-channel, 16-output transmitter.

In all cases the transmitter array is fed from only one master oscillator (MXO), which replaces the XO in Figure 1. Since all the transmitters receive the same MXO, each SSS is putting out the same frequency. Therefore, only the MXO must be regenerated to downconvert back to the original VHF input frequencies at the receive site.

Like the STX-141, the MTX-132 transmitter (Figure 3) also has a klystron amplifier, only now it is used to increase the level of the SSS to +45 dBm, 30 watts. This signal is then fed into an 8-way divider made up of magic tee's that in turn feeds eight separate upconverters. The MTX-132 also has a 20 dB gain driver amplifier for the incoming VHF.

As with the basic transmitter, the microwave LO (SSS output) now mixes with the VHF to produce the microwave output and, as with the STX-141, each upconverter now feeds into the output multiplex to produce the combined output. The MTX-132 will run

from +16 dBm for an 8-channel, 2-output transmitter to +7 dBm for an 80-channel, 16-output transmitter. Both the STX and MTX transmitters have some components that must be tuned, so parts cannot simply be removed from one unit and placed in another without retuning the transmitter. Even though we are working at microwave frequencies, most of the tuning is much easier to accomplish than when working on a single channel processor.

At the other end of the power scale is the OLE type transmitter shown in Figure 4. These operate in much the same way as the MTX and STX transmitters, differing only because they take a broadband input of 54 MHz to 550 MHz and produce microwave outputs of 12.7 GHz to 13.250 GHz. The basic OLE unit is very close to the STX-141 in theory, except that the OLE uses all solid state GaAs FET amplifiers instead of klystrons and, due to the broadband nature, is limited in output

level by "CTB" (composite triple beat).

Receivers

All AML receivers, like their counterpart transmitters, work about the same. Some employ composite AGC with crystal oscillators to keep the SSS on frequency, while others use a phase

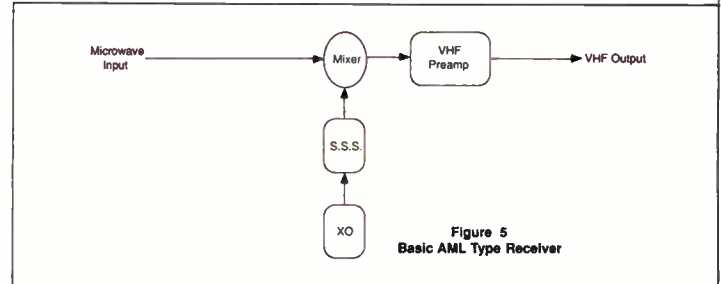
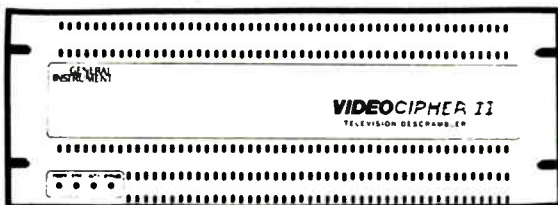

Figure 5
Basic AML Type Receiver

lock system to keep their internal voltage controlled crystal oscillator (VCXO) locked to the MXO at the transmitter site. Still, very much like the transmitters, all AML receivers can be understood in simplified form. Figure 5 shows the signal from the transmitter (LO + VHF) and a signal from a SSS locked to an XO as it enters the mixer. Like the basic transmitter, the output signals of the receiver mixer

***VIDEOCIPHER II REPAIRS**

Fast Turnaround for Out of Warranty Repairs



*** VIDEOCIPHER II DESCRAMBLER REPAIR**

****Fast Turnaround for Out of Warranty Repairs**

**Turnaround for most units 10 days or less. We do not repair units with loss of memory. Call Cindy for more information.



1575 N. 105th E. Ave./ Tulsa, Oklahoma 74116

(918) 836-8348

*VideoCipher® is a Registered Trademark of General Instrument Corporation

Reader Service Number 45

**CLI FEVER?
FIBER-ITIS?
SORE SUBS?
Call in the Specialists!**

WE HAVE THE PRESCRIPTION

AUGAT

CATEL

EASTERN

FEDERAL TELECOM

KLEIN TOOLS

MONROE ELECTRONICS

MULTILINK

POWER TECHNOLOGIES

TELECOM. PRODUCTS

WAVETEK

W. Whitaker

& ASSOCIATES

800-433-8775



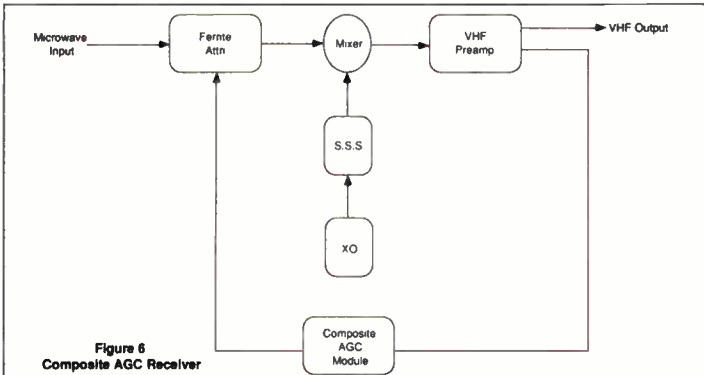

Figure 6
Composite AGC Receiver

will be both of the inputs plus the sum and difference of the two.

The mixer output then is fed into a VHF preamp, which also serves as a VHF filter. All that is left is the VHF signal and an amplifier signal. The normal level into a receiver is about -45 dBm (AGC threshold), which if not amplified would produce only a level of about -2.25 dBmV out of the mixer—not very useful in a cable system. Using the amplifier will raise the output level into the much more useful +20 dBmV range.

In Figure 6, a simple AGC stage is added to the basic receiver of Figure 5. Since the receiver has a fixed gain, the output level will change with any change to the input level. The AGC circuit simply holds the input level to the mixer at a constant level of approximately -45 dBm. As the input level changes due to rain or whatever other reason, the AGC will try to hold the input to the mixer at approximately -45 dBm. Once the input level falls below about -45 dBm input (AGC threshold),

of the receiver. If the output of the receiver is tilted, the cause is more than likely a tilted input or a failure in the mixer/preamp of the receiver. Changing the AGC output level normally will have no effect on the tilt, but only

incoming signal from the PTF. As this is the same signal used to lock up the SSS at the transmitter site, the SSS in the receiver will be on the same frequency as the SSS in the transmitter(s).

The transmitter(s) are the sum of the LO and VHF, while the receiver output is the difference of the input LO. The result is a VHF signal out of the receiver on the exact same frequency that is fed into the transmitter.

$$\begin{aligned} \text{Transmitter output} &= \text{VHF} + \text{LO} \\ \text{Receiver output} &= \text{TX output} \\ &\quad - \text{LO} \\ &\text{or} \end{aligned}$$

on the output level.

Figure 7 shows the AML receiver with pilot tone AGC and phase lock.

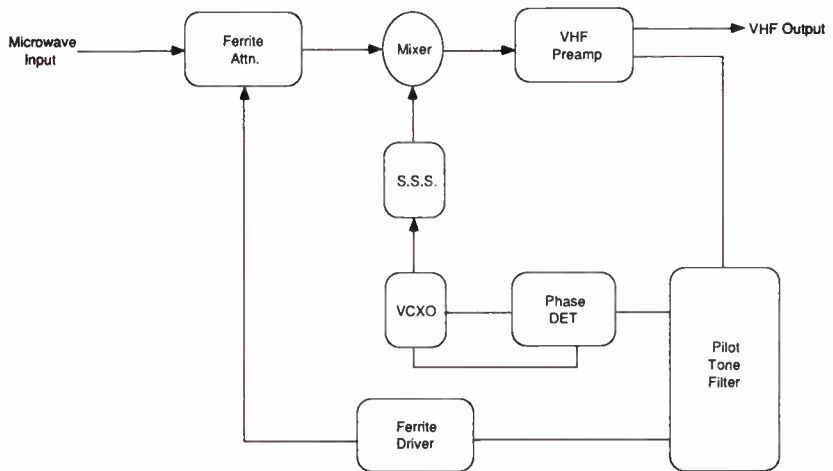

Figure 7
Phase Lock Pilot Tone Receiver

The AGC works much like composite receiver except that it uses only the pilot tone for level reference. Its major difference is in the phase lock loop that keeps the receiver's XO on frequency. The output of the mixer/preamp is split, with one output going to the AC VHF diplexer to feed the cable systems and the other output feeding a pilot tone filter (PTF).

The filter does what the name implies; it filters for just the pilot signal. One of its outputs feeds the ferrite driver for AGC control of the receiver, while the other feeds a phase detector. The phase detector looks at the signal from the PTF and from the VCXO. It then produces a voltage that feeds to the VCXO, keeping it in phase with the

$$\begin{aligned} &(\text{VHF} + \text{LO}) \\ &- \text{LO} \\ &\text{or} \\ &\text{VHF} \end{aligned}$$

That's about all there is to an AML system. Yes, each system is different, but on close inspection the similarities far outweigh the differences.

When working on any equipment, don't be afraid to ask questions. Talk to the factory reps every chance you can. Most are more than willing to help. And as the Tektronix tag reads (Figure 8):

"Before operating, read your instruction manual."

AML microwave systems really are much easier to maintain than we sometimes think. Two things to keep in mind:

1. Kiss Theory: "Keep it simple stupid," which comes from the aerospace industry.

2. "Don't Look for Zebras." Zebras are the obscure diagnosis to avoid in the practice of medicine. ■

Figure 8



"BEFORE OPERATING." Read your instruction manual.

the output level, along with the carrier-to-noise, also will drop decibel for decibel.

Tilted output

Thus, the receiver output can never be greater than the NO AGC output of the receiver. Also, since the AGC acts on all channels simultaneously, it will have no effect on the output response

REMEMBER THESE ADS?

THEY FIRST RAN IN 1985. We brought them out again to remind you we've been talking about signal security for nearly five years.

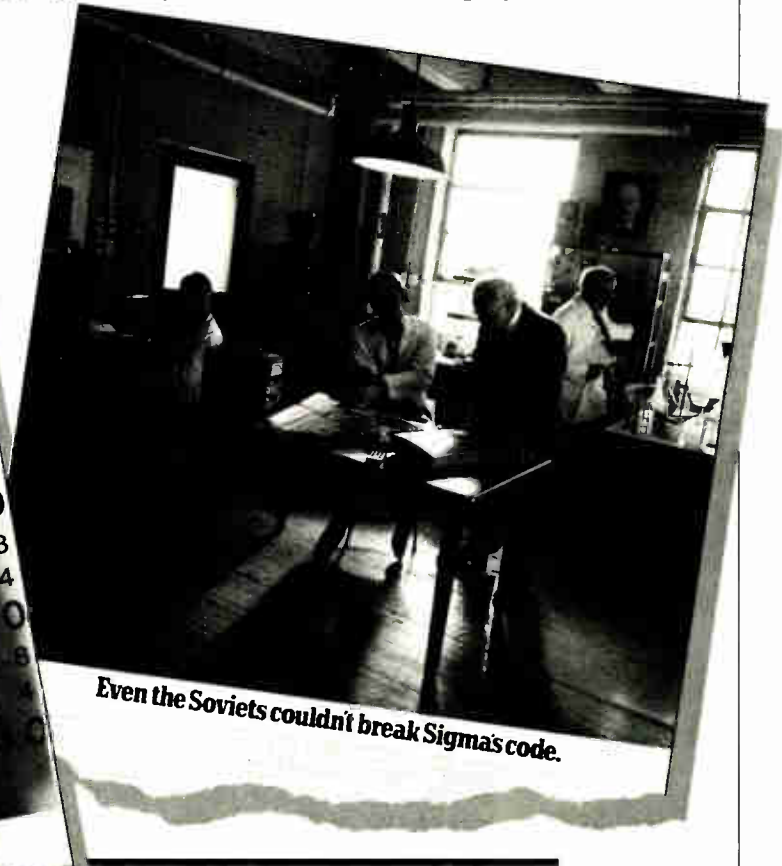

No other addressable system can protect your revenues like Oak Sigma. With over half a million units shipped, Sigma's encryption-based encoding has never been cracked. Never.

No other manufacturer of home cable (or satellite) security products can make that statement — not even for some of their "brand new" models.

Getting serious about signal security is just good business. Especially now that cable's most secure addressables

cost no more than some virtually defenseless systems. If you're making a multi-year security system investment, can you risk having anything less?

If you're ready to get serious about security, call us to arrange for a no-obligation demonstration of the toughest signal protection available — Oak Sigma.

ODANK Communications Inc.
 16516 Via Esprillo • Rancho Bernardo, CA • 92127 • (619)451-1500

Heading for converter overpopulation

Converters have done a lot for the cable television industry in the last 20 years. By enabling subscriber's television sets to receive more than 12 channels, they have opened up tremendous revenue opportunities as new services have become available. By incorporating programmable descramblers into converters, it became possible to secure the increasing revenues from theft of service. By adding addressability to the converter descramblers, we can now offer additional revenue-generating services, such as pay-per-view.

Over the last 12 years, cable systems have purchased more than 60 million converters from equipment manufacturers, and are expected to buy another 6.4 million units per year through 1991, for a total of 85.6 million converters. With industry projections for a 1991 subscriber base of 50 million, an inventory surplus is mounting.

How did we get here? With so many more converters than subscribers, why are new converters still being purchased? And, perhaps most importantly, what can the cable operator do to reduce surplus inventory, yet keep pace with the state-of-the-art?

Genealogy of the converter

One reason for the current overpopulation is the rate at which technology progresses. Remember the block converter? It was widely used in the mid '70s, and can still be found in subscribers' homes today. The block converter took a "block" of channels carried on the cable system outside of the TV set's range (generally in the midband) and converted the entire set of seven to 21 channels to another range of frequencies that the set could receive—often in the UHF band, where poor quality of the set's UHF tuner would wreak havoc on the signal.

By the late '70s (only five years later)

By Shellie Rosser, Vice President, Corporate Marketing & Communications, Anixter Cable TV

©NCTA. Reprinted with permission from the 1989 NCTA Technical Papers.

varactor-tuned converters had already rendered block converters obsolete. With enhanced frequency stability and adaptability to scrambling techniques for signal security, a new standard emerged. Now the TV set constantly looked at only one frequency—the converter's output channel—and a wide range of functions and processes could be imposed on the signal before it was passed on to the set for viewing.

Early versions of these converters simply converted from two to 26 channels to the same output frequency (2, 3, or 4), and functionally increased the bandwidth of the television set. Mechanical pushbuttons, slide switches and rotary dials were all used for channel selection on the converter.

Later versions came on the market with bandwidth capability to 42 channels, and some incorporated programmable decoders. These units were highly popular in the early '80s and are still widely used, although addressability is steadily replacing them. With a decoder built into the converter, specific channels to be decoded are programmed into the unit (encoders are matched with the corresponding channels' modulators at the headend).

So when a subscriber selects a pay (scrambled) channel that the unit has been programmed for, the channel will be automatically decoded and a viewable picture presented to the TV set. If an unauthorized channel is selected, the decoder simply passes the scrambled signal through, and presents an unviewable picture to the television.

The programmable decoder can be reprogrammed to descramble any (or all) scrambled channels, so a black market quickly developed for these converters. Cable operators bought them from manufacturers at \$60 to \$75 each, and consumers were now buying the same product for \$100 to \$200 on the pirate market and receiving "free" cable service. Loss of hardware and loss of revenues (often from subscribers who dropped service, but kept their converter/decoders) prompted many system operators to move into addressability in the early to mid '80s.

With addressable systems, digital technology facilitated deactivation of

the entire converter when a subscriber disconnected. Addressability brought remote control of the subscriber's device to the cable operator, so service level changes could be implemented from a customer service representative's keyboard (rather than relying on retrieval of the box from the home and replacement with a reprogrammed unit). And in the late 1980s, a new revenue stream has emerged that only addressable technology can deliver: pay-per-view (PPV).

Now subscribers can buy more programming from their cable systems than they have before. In addition to regular subscription service, they can also buy individual movies or events, and be remotely authorized to view single segments of programming.

Technological advances have moved so quickly and the industry's needs changed so dramatically over the last decade, that cable systems have often been faced with a converter's depreciated life (7 to 8 years) far exceeding its life as a state-of-the-art device (2 to 3 years). New units are often purchased to replace converters that are still quite serviceable, but not adequate for maximizing the revenue potential of subscribers in that particular system. And the older converters are delegated to excess inventory status, often necessitating substantial write-offs.

Changing customer needs

In addition to the new wave of addressability, another trend is developing, which demands that subscriber devices be "consumer electronics-friendly." In other words, if the subscribers' TV sets have wireless remote, we can no longer give them pushbutton electromechanical boxes that make them walk across the room to change channels. If they already have volume control on their television sets, they want volume control on their converters. A subscriber with a VCR now must have a compatible program timer in the addressable converter.

Recent changes in consumer electronics have contributed as much to the continued demand for new converters, as the addressable evolution has. Even

“I have such problems with my cable equipment.”

“Really? Not us. We have a Pioneer cable box which does amazing things.”

“I bought a VCR switcher so I could watch one channel while I taped another. Now I have all these wires and I can't figure out which buttons to press.”

“For me, it's easy. A special Pioneer VCR filter hooked up to my Pioneer converter means no extra wires and no buttons to switch.”

“I also have three remotes — for the TV, the VCR and the cable box.”

“Really? I have one Pioneer remote that controls all three.”

“I wish my cable company used Pioneer.”

CONVERTERS

in systems where trapping is used for security, rather than scrambling/addressability, older (electromechanical) converters are being replaced by digital converters that offer consumer-friendly features.

As cable operators upgrade their systems to satisfy subscribers' demands for additional programming (through increased channel capacity and PPV offerings), older converters are being displaced by new addressable or digital products.

These displaced converters are sometimes used in a less sophisticated sister system, or in non-addressable subscribers' homes, or even on additional outlets in addressable homes. Under these circumstances, the older converters continue to generate revenue, to "earn their keep" at least until they are fully depreciated.

But more often, when a wholesale system upgrade is undertaken, thousands of converters are taken out of homes to end up in one of two places:

1. Cable system inventory—converters will sit idle, in a warehouse corner, until another system lets it be known that there is a requirement for them.

2. Equipment brokers—brokers often buy "lots" of unused or obsolete con-

verters for resale.

Cable system inventory

When converters are in a system's warehouse, not only do they not earn revenues, they incur significant costs in space, material management, and in some cases, interest charges on the original purchase. Often, the excess inventory is not properly accounted for, so that when a requirement for the product does surface in a sister system, no one knows that the units are available. Additional products are purchased, and the excess converters remain idle.

Equipment brokers

Sales of excess converters to equipment brokers is preferable to the costs of maintaining unused inventory for extended periods of time, but another set of issues must be considered.

1. The broker's credibility and reputation is a primary concern, especially if the converters include descramblers.

2. The market value the broker can offer is often well below the product's book value, and may not be easily collected.

3. Brokers operate in a "spot market" with pricing that fluctuates widely with supply and demand cycles. It is generally necessary to shop several brokers for the best price, which will undoubtedly be quoted by the one who has a buyer already lined up.

4. Brokers typically buy and sell equipment in "as is" condition, offering the selling system less than the true value of their excess inventory, and charging more than fair value to the buying system.

Another solution

Anixter Converter and Equipment Services (ACES) is a primary repair agent for converters for many of the major MSOs as well as independent cable systems. Because ACES refurbishes converters and sells equipment that performs to original manufacturer's specification, full value for a system's excess inventory can be offered. If a system purchases new converters from Anixter Cable TV in upgrading to new technology, a credit for trade-in value can be given which may substantially reduce the system's net capital outlay for state-of-the-art technology. ■

ADVERTISEMENT

CONVERTER CALLBOOK

The following companies have paid a fee to have their listing appear in the Converter Callbook.

Addressable



Cable Link Inc. (614) 221-3131
FAX (614) 222-0581

280 Cozzins Street
Columbus, OH 43215-2353

PERSONNEL: E. Jack Davis, President,
Bill Holehouse, VP of Sales

DESCRIPTION: Cable Link, Inc. is a leading distributor of refurbished equipment, our products include addressable/non-addressable converters, linegear, headend, traps, passives, parts, and new character generators. We service Jerrold, Scientific Atlanta, and Oak addressable converters. We provide Computer Aided Design (CAD), strand mapping and other related design work.

JERROLD

Jerrold Division (215) 674-4800
General Instrument Corp.

FAX (215) 957-8227

2200 Byberry Road
Hatboro, PA 19040

PERSONNEL: Ed Ebenbach, Dan Moloney

DESCRIPTION: Jerrold's addressable product line consists of controllers, scramblers and converters in a systematic approach to signal security and subscriber satisfaction.

All Jerrold IMPULSE 7000 and TOCOM 5507 addressable converters can be upgraded to impulse capability and all offer such features as last channel recall, favorite channel programming and remote control.



Oak Comm. Inc. (619) 451-1500
FAX (619) 451-1505

16516 Via Esprillo
San Diego, CA 92127
PERSONNEL: John Donohue, President;

Tony Wechselberger, Sr. VP/Domestic Operations
DESCRIPTION: Converters, converter/decoders, addressable pay-TV systems, control software, satellite signal security systems.



Pioneer Communications (201) 327-6400
of America Inc.
WATS (National) (800) 421-6450
FAX (201) 327-9379
(201) 327-0963

600 East Crescent Avenue
Upper Saddle River, NJ 07458

PERSONNEL: David Nicholas, National Sales Manager

DESCRIPTION: Pioneer manufactures a complete line of addressable converter equipment featuring the BA-6000 addressable converter—a 550 MHz converter offering multi-vendor scrambling compatibility, volume control, integrated IPPV options, VCR timer, clock display and downline loadable system parameters including output channel. Pioneer supplies various addressable controller configurations and offers a SmartRemote™ and VCR Filter.

CONVERTER CALLBOOK

Scientific Atlanta

Scientific-Atlanta(800) 722-2009
FAX(404) 925-5445

P.O. Box 105027

Atlanta, GA 30348

PERSONNEL: Andrew B. Meyer, Stephen K. Necessary

DESCRIPTION: Supplier of complete addressable systems, including set-tops, IPPV, control systems and scramblers. Addressable set-tops include the model 8590 which features volume control, advanced scrambling capability and several unique and subscriber friendly features, plus the 8570 and 8580 RF addressable set-tops. Each addressable set-top can utilize either RF or telephone IPPV.



Zenith Electronics Corp. . .(312) 391-7702
FAX(312) 391-7253

1000 N. Milwaukee Avenue
Glenview, IL 60025

PERSONNEL: Robert Cunningham, Vito Brugliera

DESCRIPTION: Advanced baseband and RF addressable converter/decoder systems featuring real-time, two-way IPPV capability. Exclusive Phonevision ANI System and Command Series controllers for fast IPPV.

Non-Addressable



Cable Link Inc.(614) 221-3131
FAX(614) 222-0581

280 Cozzins Street

Columbus, OH 43215-2353

PERSONNEL: E. Jack Davis, President, Bill Holehouse, VP of Sales

DESCRIPTION: Cable Link, Inc. is a leading distributor of refurbished equipment, our products include addressable/non-addressable converters, linegear, headend, traps, passives, parts, and new character generators. We service Jerrold, Scientific Atlanta, and Oak addressable converters. We provide Computer Aided Design (CAD), strand mapping and other related design work.

OAK Communications Inc.
16516 Via Esprillo, Rancho Bernardo, CA 92127 (619) 451-1500

Oak Comm. Inc.(619) 451-1500
FAX(619) 451-1505

16516 Via Esprillo

San Diego, CA 92127

PERSONNEL: John Donohue, President; Tony Wechslerberger, Sr. VP/Domestic Operations

DESCRIPTION: Converters, converter/decoders, addressable pay-TV systems, control software, satellite signal security systems.

Panasonic

Communications & Systems Company

Panasonic Comm.(201) 392-4460
& Systems Company

FAX(201) 348-7549

One Panasonic Way 3E-7

Secaucus, NJ 07094

PERSONNEL: Dick Strabel, General

Manager; Jim Slade, Marketing Manager

DESCRIPTION: Panasonic produces a full line of highly reliable non-addressable CATV converters. Included in the product line are models which feature volume control, parental control, baseband output, and remote control.



Pioneer Communications .(201) 327-6400
of America Inc.

WATS (National)(800) 421-6450

FAX(201) 327-9379
(201) 327-0963

600 East Crescent Avenue

Upper Saddle River, NJ 07458

PERSONNEL: David Nicholas, National Sales Manager

DESCRIPTION: Pioneer manufactures a complete line of non-addressable converters featuring the BC-4600—a 550 MHz, wireless remote converter with volume control/mute, volume indicator, sleep timer, parental control with remote override, favorite channel recall and SmartRemote™ compatibility. Programmable features include the output channel, frequency offsets, channel mapping and remote and parental control enable/disable.

REGAL
Technologies Ltd.

Regal Technologies Ltd. . .(312) 677-2600
FAX(312) 677-1097

4711 Golf Road
Skokie, IL 60076

PERSONNEL: Chuck Krone, Diane Scaletta

DESCRIPTION: Regal Technologies Ltd. is the manufacturer of the Regal Family of Converters. The newest converter is the Regal RE-83. This is a full feature 550 MHz unit that is completely down-loadable.

Features include parental guidance, channel mapping, Barker channels, and many more. The RE-83 has the smallest footprint of any full feature converter.

Scientific Atlanta

Scientific-Atlanta(800) 722-2009
FAX(404) 925-5445

P.O. Box 105027

Atlanta, GA 30348

PERSONNEL: David E. Levitan, Stephen K. Necessary

DESCRIPTION: Number one supplier of basic, infrared programmable (non-descrambling), programmable descrambling and volume control basic set-tops. Produce smallest, most reliable, full-featured and subscriber friendly non-addressables available. Compatible with Hamlin, Jerrold scrambling. 99 percent reliability guarantee covers all major performance specifications. Offer programmable control of remote enable/disable, channel lineup, electronic parental control.



Zenith Electronics Corp. . .(312) 391-7702
FAX(312) 391-7253

1000 N. Milwaukee Avenue

Glenview, IL 60025

PERSONNEL: Robert Cunningham, Vito Brugliera

DESCRIPTION: Deluxe, affordable, 500 MHz cable converter featuring remote control, automatic fine tuning, favorite channel scan, flashback, BTSC stereo compatibility and switch-mode power supply for reduced power consumption and cool-running operation.

Suppliers/Distributors

ANIXTER
CABLE TV

Anixter Cable TV(800) 323-8166
FAX(312) 677-9480
4711 Golf Road

CONVERTER CALLBOOK

Skokie, IL 60076

PERSONNEL: Marty Ingram

DESCRIPTION: Anixter is a full range supplier of both addressable and non-addressable converters. The Jerrold products include the DP-7, DPV-7 addressable units as well as the DQN-7 non-addressable converter. In addition to the Jerrold products, Anixter inventories a complete line of the Regal products including the new RC-83 converter.



Cable Link Inc. (614) 221-3131
FAX (614) 222-0581

280 Cozzins Street

Columbus, OH 43215-2353

PERSONNEL: E. Jack Davis, President,
 Bill Holehouse, VP of Sales

DESCRIPTION: Cable Link, Inc. is a leading distributor of refurbished equipment, our products include addressable/non-addressable converters, linegear, headend, traps, passives, parts, and new character generators. We service Jerrold, Scientific Atlanta, and Oak addressable converters. We provide Computer Aided Design (CAD), strand mapping and other related design work.

**Cable Services Company Inc.**

2113 Marydale Ave., Williamsport, PA 17701 • 717/323-8518
 1-800-233-8452 Nationwide

Cable Services Co. Inc. . . . (800) 233-8452

WATS (State) (800) 332-8545

FAX (717) 322-5373

2113 Marydale Avenue

Williamsport, PA 17701-1498

PERSONNEL: Sales Department

DESCRIPTION: Distributor of new fully-warranted converters for Scientific-Atlanta, Jerrold and Oak. We stock for immediate sale the full line of set-tops, programmable and addressable converters. Limited quantities of used-reconditioned converters available.

Repair Services

**ANIXTER
 CONVERTER &
 EQUIPMENT SERVICES**

Anixter Converter (800) 336-2237
and Equipment Services (ACES)

FAX (512) 331-8676

505 Cypress Creek

Cedar Park, TX 78613

PERSONNEL: Jack Hooper, General

Manager; Clayton Monzingo, National Sales

Manager

DESCRIPTION: Converter service for the cable television industry throughout the United States. Qualified for service on Jerrold, Hamlin, Regal, Scientific-Atlanta, and Oak converters, specializing in digital and addressable converter repairs. ACES also sells remanufactured converters to the CATV industry.



Cable Link Inc. (614) 221-3131

FAX (614) 222-0581

280 Cozzins Street

Columbus, OH 43215-2353

PERSONNEL: E. Jack Davis, President,
 Bill Holehouse, VP of Sales

DESCRIPTION: Cable Link, Inc. is a leading distributor of refurbished equipment, our products include addressable/non-addressable converters, linegear, headend, traps, passives, parts, and new character generators. We service Jerrold, Scientific Atlanta, and Oak addressable converters. We provide Computer Aided Design (CAD), strand mapping and other related design work.

ColorView Services

ColorView (800) 824-1943
Services Inc.

FAX (505) 884-0145

4946 Jefferson N.E.

Albuquerque, NM 87109

PERSONNEL: Tony Grundler, General
 Manager; Kathy Cooper, Marketing Director

DESCRIPTION: Established 1953. Converter
 repair service, all phases. We pay freight
 both ways. Six month warranty.

Programmable/addressable Jerrold, Oak,

Hamlin, Scientific-Atlanta, Panasonic.

Volume discounts.

**EF Industries**

First in the Essential Technology: Service

E.F. Industries (213) 777-4070

FAX (213) 754-7705

12624 Daphne Avenue

Hawthorne, CA 90250

PERSONNEL: Scott Farris, Sales
 Representative; Victor Palousek, Operations
 Manager

DESCRIPTION: E.F. Industries applied its
 experience in the demanding computer
 repair industry to servicing addressable
 Zenith "Z-TAC" and Jerrold converters.
 The result; excellent turnaround time and

quality at competitive prices for repair of
 entire converter or subassemblies. Free
 price list.

**Long Cable Electronics****Long Cable Electronics**

Converter Repair (518) 393-5415

Converter Parts (518) 393-7976

FAX (518) 393-7977

112 Erie Blvd.

Schenectady, NY 12305

PERSONNEL: Ned Zibro, Repair/Sales; Jim
 Chamberlain, Converter Parts

DESCRIPTION: Converter Repair—low
 cost, flat rate billing, quick turnaround on
 most brands. Up to date facility specializes
 in addressable repair. Sales—large inventory
 of rebuilt converters available. Converter
 Parts—many hard to find parts available,
 cosmetics, semi-conductors, hardware. FREE
 catalog—useful substitution guide.



SCI CATV Services (619) 438-1518

FAX (619) 438-6878

2245 Camino Vida Roble

Carlsbad, CA 92009

PERSONNEL: Tim Mullennix, General
 Manager, Tom O'Brien, Sales Manager

DESCRIPTION: SCI provides the highest
 in quality assurance, excellent customer
 service and the most technologically advanced
 repair staff. As a division of a Fortune 500
 manufacturer, we have access to sufficient
 equipment to meet any repair need for
 Jerrold, Pioneer, Scientific-Atlanta, and Oak
 addressable products. Count on SCI for
 quality.

Scientific Atlanta

Scientific-Atlanta (800) 722-2009

FAX (404) 925-5445

P.O. Box 105027

Atlanta, GA 30348

PERSONNEL: Oliver Cooper, Angela York

DESCRIPTION: Scientific-Atlanta's
 converter repair service, located in Tempe,
 Arizona, offers in and out-of-warranty repair
 on all our converters. Repair is component
 level, assuring quality repair. All repairs
 come with a ninety day warranty. Cosmetic
 repair is also available. Turnaround time is
 thirty days or less.

Fact.
Fact.

CLIDE is the **first** CLI management software fully approved by Wavetech for CLM-1000 compatibility.

CLIDE offers the following **standard** features:

- I3000 calculation method
- Leak Cost Analysis Reports
- CLI Reports
- User-friendly screens, with pop-up menus and windows
- CLIDE to CLIDE file transfer via telephone modem
- Easy installation
- Novell networkable
- Compatible with Wavetech CLM-1000 leakage Detection Meter, Psion hand-held computer, and Tandy RS-102 laptop computer.

Fact.

Wavetech has selected CLIDE as **the** CLI management software to accompany their CLM-1000 leakage Detection Meter.



***CLIDE for CLI —
No less, no more.***

Telecommunication
Products Corporation

1331 South 7th Street
Chambersburg, PA 17201

A totally proven approach: 3 year comparison



For three years MetroVision of Michigan has operated a ground based leakage control program. This program is based on the paper presented in Los Angeles for the 1988 NCTA Technical Papers.

ble before the beginning of the next drive out. The first pie chart shows that in 1987, repairs were primarily drop connectors, with "No Problem Found" at a lower percentage. Pie chart 2 shows that in 1989 drop

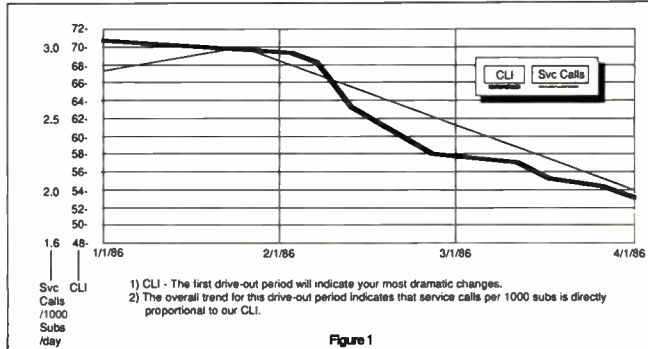

Equipment Used

Equipment requirement for 48 miles of plant per day.

# of People	Meter	Vehicle	Dipole Antenna	Miles of Plant	Miles Per Hour	Mileage on Prints	Hours of Driving
2	1	1	1	48	8	48	6

Divide your miles of plant by 48 to determine the level of people and equipment needed to drive out 100 percent of the system, then divide by two to get the drive out done in two days.

There are many different manufacturers of leakage detection equipment. We have found the equipment capable of quantifying the level either in dBmV or $\mu\text{V}/\text{m}$ to be the best suited for quarterly monitoring.

Table A

An equipment table is provided to show the number of people and equipment needed for the number of miles to be driven (see Table A).

Each quarter, 1,220 miles of plant are driven during the weekend. This has been done 12 times. The original outcome was that 1,283 leaks were found; and repair started at a level of $150 \mu\text{V}/\text{m}$ or higher until these leaks were corrected.

In 1987, 22 leaks were found above $150 \mu\text{V}/\text{m}$ and repaired immediately. The remaining 1,261 leaks, from $20 \mu\text{V}/\text{m}$ to $150 \mu\text{V}/\text{m}$, were fixed during the course of daily work—at least two per day per tech. Repair work was not always completed before the beginning of the next drive out.

In 1989, drive outs are showing 1,108 total leaks with four or five leaks above $150 \mu\text{V}/\text{m}$ and the remaining leaks between $20 \mu\text{V}/\text{m}$ to $150 \mu\text{V}/\text{m}$. Completion of all repairs is now possi-

connector problems decreased by about two-thirds. This is attributable to the drop connector craftsmanship standards that were introduced.

In the "No Problem" category from 1987 to 1989, we see a 19 percent increase; I believe this is due to better repairs. It was found that as higher level leaks were corrected, we in fact corrected some lower level leaks. In 1987 we had not completed leakage repair in some areas that had a large num-

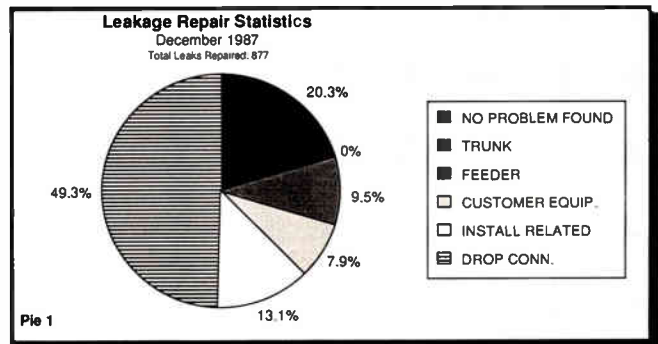
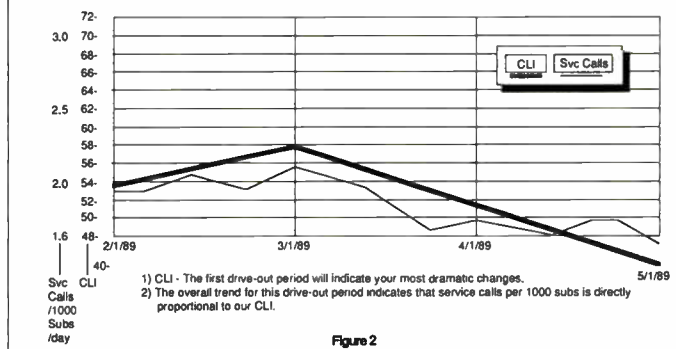

By Vic Gates, Regional Engineer, MetroVision and Clay Collins, Regional CLI Coordinator

WINDOW II™

Now the ComSonics Window™
offers more than ever...

- **Full Spectrum Awareness**
Balancing
Troubleshooting
- **Easy to Use**
Auto Ranging, Auto Scaling
Self Calibration & Self Diagnosis
- **Memory and Print-out**
35 Storage Locations
Graphics & Chart Printout
- **Multi-Purpose Functions**
Sweep Mode for Full
Spectrum Display
Zoom Mode for Carrier Levels
Tune Mode for Spectrum Analysis
- **Durability & Reliability**
Tough ABS Construction
Weather Resistant
High Contrast LCD

2 YEAR WARRANTY!



COMSONICS®, INC.

Toll Free 1-800-336-9681
In Virginia Collect 1-703-434-5965

Reader Service Number 50

COMPLIANCE



ber of actual leaks; but, by 1989 all areas had been cleaned up. We are now finding that we record some leaks more than once from different locations. (Graph 1 represents a comparison from 1987 to current 1989.)

In the first three months of 1986, service call rates related to CLI level is shown in Figure 1, where the average CLI was 63 and the average number of service calls per 1,000 subs per day was 2.5.

In '89 our service call rate related to CLI level is shown in Fig. 2, where the average CLI is 54 and the average service call per 1,000 subs per day is 1.8.

This relates to an overall reduction of 0.7 service calls per 1,000 customers per day. In 1,220 miles of plant we have 62,000 customers. With this 0.7 reduction, we reduce service calls by 43 a day or 217 per week.

There are four factors to consider:

1. In 1986, there were 1,000 miles of plant. In 1989 there are 1,220 miles.

2. In 1986, there were 49,770 customers. In 1989, there are 62,000 customers.

3. There is an on-going preventive maintenance program that includes balancing, power supply maintenance, new drop procedures and standards for drop connector craftsmanship.

4. No technicians have been added in the last three years.

Under our normal growth patterns, we would have added three technicians to take care of the additional 210 miles of plant. We did not find it necessary to add more installers to implement the drop standards procedure.

We are enjoying benefits simply

because of an investment in time, leak detection equipment, computers and adhering to the program described. But

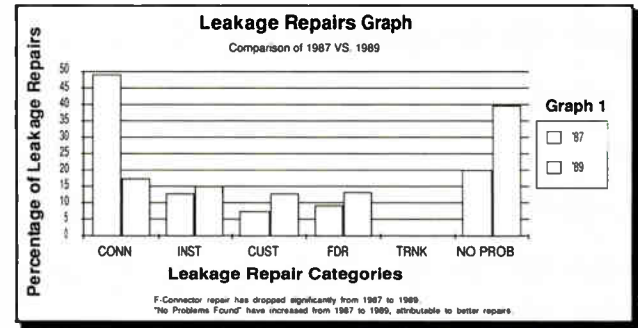
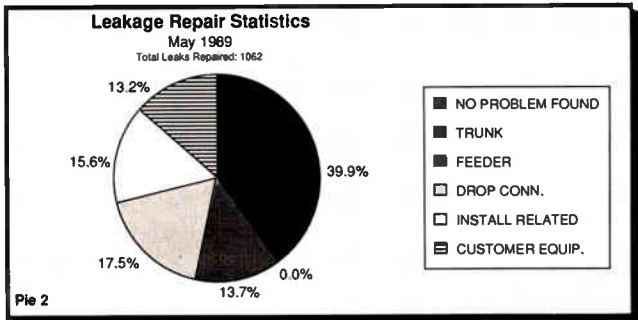

more important, by reducing service calls we've made our customers more confident in cable TV. ■

SECURITY ENCLOSURES
FOR SINGLE & MULTIPLE DWELLINGS

MTE



- No rusting ever
- Super-tough strength
- Easy installation

MSE

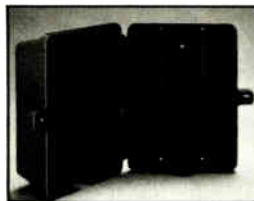

- Excellent chemical resistance
- Non-conductive



TUFFBOX

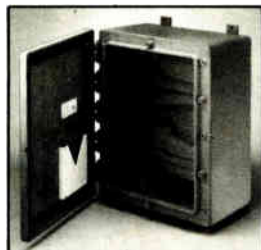

CABLESAFE

CABLETEK CENTER PRODUCTS, INC.
850 TAYLOR STREET, ELYRIA, OH 44035
1-800-562-9378 • ELYRIA 216-365-3889



R. Alan

Communications

Exclusive Midwest
Manufacturers Rep for:

- ALPHA TECHNOLOGIES
- JOHNSON CONTROLS
- Standard Communications
- FM Systems
- LES
Leakage Elimination System
- AD SYSTEMS
- CableTrac Inc.

& more

800-367-1450

See us at the Great Lakes Cable Expo
Booths 133,135, 137 & 139

Cable Games come to Vail

Modeled after the Olympic Games, the first "Cable Games" event of its kind was organized at the Colorado Cable Television Association's annual convention in Vail, Colo.

Ten individuals competed in four categories (fault testing, drop cable splicing, 0.500-inch cable splicing and

distribution) and were timed against the clock. Points were deducted if critical procedures were missed or for poor craftsmanship.

Participants included:

- Eric Kesinger, Custom Enterprises of Colorado
- Paul Broeckect, United Cable

- Shawn Bargas, United Cable
- Dick Hall, United Cable
- Greg Yslas, United Cable
- Romeo Battazzi, Columbine, Ft. Collins
- Paul Eisbrener, Columbine, Ft. Collins



Don Grooms of Jones Intercable (left) tests an amplifier while Herb Longware of Magnavox evaluates his performance.

Photo by Rob Stuehrk.



Bill Down of Gilbert (far left) shows Romeo Battazzi of Columbine Cable, Ted Hartson and Greg Yslas of United how to splice a cable.



The Cable Games drew a crowd.

Collins

- Greg Jolliffe, Columbine, Ft. Collins
- Robert Wignes, Jones Intercable
- Don Grooms, Jones Intercable.

The winners

Three winners were named for each category. The results were as follows:

TDR (fault testing): Gold medal, Greg Jolliffe, Columbine Cable; Silver medal, Romeo Battazzi, Columbine Cable; and Bronze medal, Dick Hall, United Cable.

Distribution: Gold medal, Greg Jolliffe, Columbine Cable; Silver medal, Dick Hall, United Cable; Bronze medal, Paul Eisbrener, Columbine Cable.

0.500-inch cable splicing: Gold medal, Dick Hall, United Cable; Silver medal, Paul Eisbrener, Columbine Cable; Bronze medal, Greg Jolliffe, Columbine Cable.

Drop cable splicing: Gold medal, Greg Yslas, United Cable; Silver medal, Dick Hall, United Cable; Bronze medal, Paul Eisbrener, Columbine Cable. ■

Price reduction for CLR-4

Wavetek RF Products Inc. has reduced the list price of its Model CLR-4, a four-channel scanning leakage detector. The CLR-4 provides both a variable tone leak locator as well as a video sync. Crystal controlled, the CLR-4 previously had a list price of \$450 (for channels 2, 3, D and R with FCC offsets). The price has been reduced to \$349. Special frequency units have been reduced to \$450. For more info call (317) 788-9351.

A new TV 60LPSB has been an-



Wavetek's CLR-4 leakage detector

nounced by **Reliable Electric**. The 60LPSB is a round corner, square design cable TV distribution closure. The unit serves as an above ground pedestal for taps, couplers and splitters. The standard TV 60LPSB includes a single 90-inch mounting stake and an offset tap mounting bracket. For details call (312) 455-8010.

Multiplex Technology Inc. has announced a dual agile modulator which features two modulators

mounted in a single, 19-inch chassis. The Model 1020 accepts incoming video signals from VCRs, satellite receivers, CCTV cameras or other sources. Each modulator has a temperature compensated

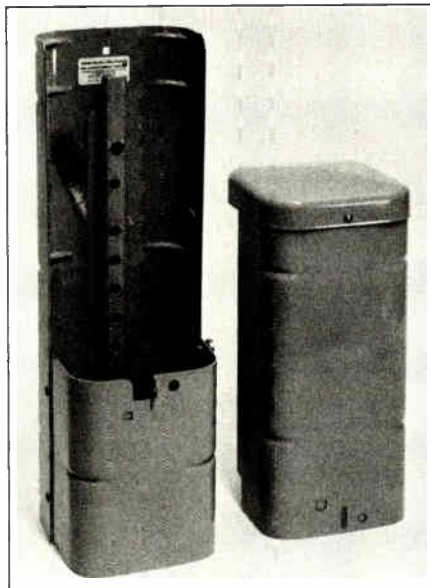

Reliable Electric's TV 60 LPSB CATV closure

quartz crystal oscillator and a frequency synthesizer which is controlled by the central microprocessor. Call (714) 680-5848 for details.

Introduced by **Viewsonics** is a pocket-size Step Attenuator with dimensions of 4 3/4 inches by 1 3/4 inches by 1 3/4

inches and a weight of eight ounces. The VSSA-42 has an attenuation of 0 dB to 42 dB in 1 dB steps. The toggle switches have attenuation steps of 1, 2, 3, 6 and 10 dB. The Model VSSA-42 is priced at \$39.50 each.

Also announced by **Viewsonics** is the VSABS-4 kit, containing a A/B switch, a jumper cable and a reverse matching transformer with a four foot lead. The VSABS-4 is packaged in a plastic bag with header card and installation instructions and is priced at \$6.95 each. For additional info on both items call, (800) 645-7600. In New York call, (516) 921-7080.

Hand-held power meters

Siecor Corporation has introduced a new family of hand-held compact power meters (CPMs) for both single mode and multimode fiber optic cabling systems. Used for measuring optical power at all wavelengths, there are



Siecor's compact power meter

three models: 850 nm, 850/1300 nm and 1300/1500 nm. Additional features of the CPMs include interchangeable connector adapters available in common industry types. Each CPM is powered by a nine volt battery and measures 4.3 inches by 2.4 inches by 1.7 inches. For more info call, (704) 327-5000.

A wavelength division multiplexer (WDM) from **AMP** is used to combine



THE BEST IN EQUIPMENT & REPAIRS

HEADEND
DISTRIBUTION
TEST EQUIPMENT

- RECEIVERS • MODULATORS • PROCESSORS • FCC OFFSETS
- TRUNK AMPLIFIERS • LINE EXTENDERS
- FSMS ANALYZERS • LOCATORS • SWEEP SYSTEMS

AUTHORIZED
WARRANTY
SERVICE

- WAVETEK TEST EQUIPMENT
- ALPHA TECHNOLOGIES POWER SUPPLIES
- CA TEL HEADEND

NO-NONSENSE 90-DAY WARRANTY! • EMERGENCIES—NO EXTRA CHARGE

JERROLD IN STOCK

- NEW 450 MHz EQUIPMENT
- TRUNK — SJ-2-SS • SJ-1-SS
- DISTRIBUTION — JLC/JLP LINE EXTENDERS — PASSIVES
- HEADEND — AGILE • S 450 M Modulator • S 450 P Proc.

SELLING EXCESS USED OR NEW EQUIPMENT
CALL NCS FOR THE BEST PRICES

NCS INDUSTRIES, INC., 2255-E Wyandotte Road, Willow Grove PA 19090
800-523-2342 IN PA: 800-492-2032

SEE US AT THE GREAT LAKES CONVENTION
BOOTH #125

IN THE NEWS



AMP's wavelength division multiplexer

or separate two optical signals on wavelengths of 1300 nm and 1550 nm. The WDM provides low crosstalk between the two wavelengths, in unidirectional or bidirectional applications. Units are available with one meter of 3-mm cable, using 2.5-mm threaded FC-style connectors, biconic connectors, 2.0-mm threaded D4-style connectors or without connectors supplied. For details call, (800) 522-6752.

Hewlett Packard has introduced two portable RF spectrum analyzers and a portable tracking generator. The HP 8560A spectrum analyzer covers the frequency range from 50 Hz to 2.9 GHz, while the HP 8561B spectrum analyzer offers continuous-sweep capa-

bility from 50 Hz to 6.5 GHz. Both analyzers feature resolution bandwidths from 10 Hz to 2 MHz. The HP 85640A tracking generator can be combined with both analyzers, and the HP 8561A, HP 8562A and HP 8562B analyzers, to allow scalar network measurements.

Hewlett Packard has also announced the HP 5347A 20 GHz counter/power meter and the HP 5348A 26.5 GHz counter/power meter. Each instrument has the combined capability of a CW-microwave counter and a true power



Hewlett-Packard's HP 5348A microwave counter/power meter

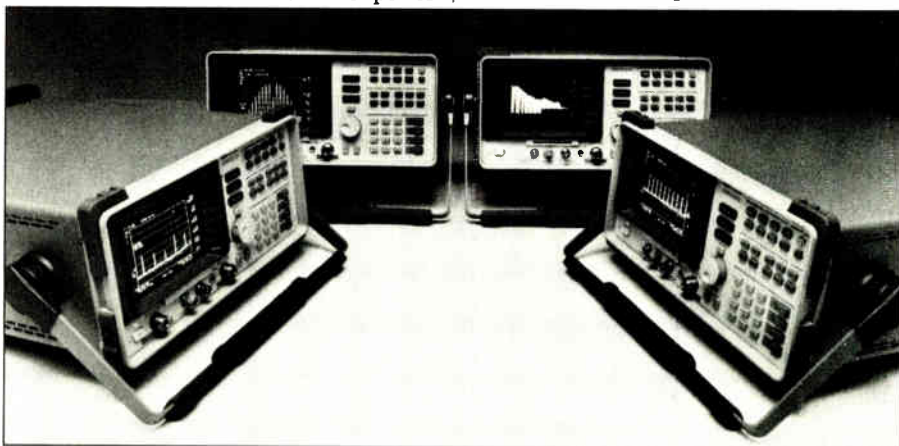

Hewlett-Packard's HP 8590B and HP 8591A (left) and HP 8593A and HP 8592B (right).

A very special thanks
to all of our customers.
We've become the
quality contractor we are
today because of your
trust and support.

Yours very truly,
Jane & Harry

Lakeshore Cable Contractors, Inc.

Please stop by and visit us at the Great Lakes Cable Expo,
Booth #235.

Reader Service Number 54

YES,
Cable Cares

October 3-5, 1989

Call the Registration Supervisor
609-848-1000



Reader Service Number 55

Communications Engineering and Design September 1989 81

meter. Because the HP 5347A and 5348A use separate inputs for measuring power and frequency, the units are compatible with many of the power sensors in HP's stand-alone power meters. A power-measurement accuracy of 0.16 dB is possible with the both power meters.

And lastly, Hewlett Packard introduced a vector-voltmeter module designed for RF voltage and phase measurements. The HP 70138A vector-voltmeter is a sampling receiver that

operation and 19 inch rack mounting (3 1/2 inches high). Call (800) 544-0233 for more info.

Philips ECG has announced the addition of the Model TV-1100 to its line of cable converters. The TV-1100 upgrades any TV set to cable-ready status and provides infrared remote control. The unit will convert VHF channels 2 through 13 and cable channels 14 through 76 to a switch selectable output channel, 2 or 3. Other features of the TV-1100 include scan

recordable video encryption system designed for both television transmission and videocassettes. The VES-200 system provides simultaneous video and audio encryption for video transmissions and pre-recorded videocassettes. The unit consists of a rack-mountable encoder unit and multiple decoder units, each approximately the size of a VCR. The VES-200 features a simple keypad and 24-character alphanumeric display menu and prompts. The VES-200 accepts NTSC analog TV video input (RS-170A), digitizes and encrypts the signal, then converts it back to analog output. For details call, (415) 691-2900.

On the move

Steven Raimondi has been named senior vice president of engineering at United Artists Cablesystems Corp. Raimondi will be responsible for overseeing the engineering functions for all of UA's cable systems. Raimondi joined UA in 1969 as a system chief engineer.

Richard Leghorn, president and founder of Eidak Corp., has been selected to receive the New England Cable Television Association's Pioneer Award. Leghorn has been involved in the cable industry since 1966, owning and operating nine cable systems in five states and serving on the board of the NCTA.

John Wesley Nash has joined Communications Engineering Inc. as



Jim Oldham

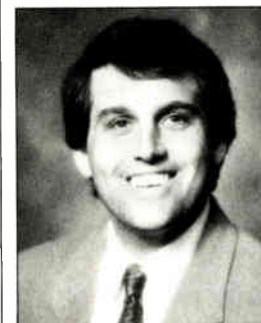

Tony Finger

vice president of engineering. Nash will be responsible for corporate planning, project management, new technology investigation and implementation, system design and execution, scheduling, vendor interface and manpower management.

Comm/Scope Inc. has announced several new appointments. Jim Oldham has been named regional sales



BK Precision's 550 MHz frequency counter 1804

measures CW RF signals and has identical specifications to the benchmark HP 8508A vector voltmeter. For info on all HP products call, (800) 752-0900.

The Model 1804 Frequency Counter has been introduced by B&K Precision, a division of Mextec International Corp. The Model 1804 features measurement to 550 MHz, eight-digit LED display, low-pass filter, 1 second and 0.1 second gates and an overflow indicator. The Model 1804 has a direct range of 5 Hz to 100 MHz and prescale range of 10 MHz to 550 MHz. The unit measures 2 inches high by 6.5 inches in width by 6.75 inches in depth and weighs approximately 24 ounces. An AC power adapter is supplied with the Model 1804. For more info call, (312) 889-9087.

Developed for HRC head-end equipment is Frequency and Time Systems Inc.'s FTS 1060, rack-mounted oscillator. The FTS 1060 provides a reference for broadcast frequencies, in order to meet the FCC's ± 1 Hz requirement (regulation 76.613, interference from a cable television system). The quartz frequency standard features two 6.0003 MHz outputs, low aging rate of ± 0.06 Hz/year, 115 ac

up/down or direct channel access, favorite 10 channels memory and last channel recall. For more details call, (800) 225-8326, in MA, (617) 890-6107.

Belden Wire and Cable has introduced a 75 ohm video cable (8281F) for rack system installations, CCTV systems and equipment/signal connections. The 22 AWG bare copper conduc-



Belden's 8281F video cable

tor is insulated with Polyethylene. Two tinned copper braid shields provide 98 percent physical coverage from external interference. The cable is jacketed with a matte finish PVC compound. The 8281F is available from stock in 500 and 1,000 foot put-ups. For more info call, (312) 577-6330.

Available from Macrovision is a



Stan Von Feldt

manager out of Las Vegas, Nev. **Tony Finger** is regional sales manager out of Dublin, Ohio, and **Stan Von-Feldt** will be regional sales manager residing in Aurora, Colo.

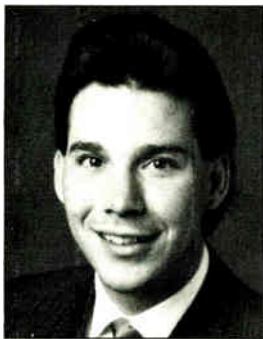

Clayton Dore

Clayton C. Dore was named manager of technical services for the **Satcom** division of **Standard Communications**.

Dore will be responsible for providing technical support and field service for Satcom's customer base. He will also oversee the division's Gold Standard and Lifetime Loaner Program.

Uniden Corp. of America announced the addition of **Rick Hebert** as the commercial sales manager for the company's satellite division. Hebert is responsible for establishing a distribution network for Uniden's new line of commercial satellite receivers and BTSC (MTS) stereo modulators.



Bob Cook

Channell Commercial Corp. has announced the appointment of **Robert W. Cook** to the newly created position of customer service and development manager. Cook has been in outside sales for Channell for over five years and most recently, was Channell's Pacific South-west sales representative.

Laser Precision Corp. has named **Wesley D. Simpson** as director of marketing for both the fiber optic and radiometric product lines. Simpson will be responsible for over-seeing the company's product line for the Utica division.

Laser Precision Corp. has named **Wesley D. Simpson** as director of marketing for both the fiber optic and radiometric product lines. Simpson will be responsible for over-seeing the company's product line for the Utica division.



James Randolph

AML Specialties Inc. has appointed **James Randolph** as the vice president of customer services and assurance. Randolph comes to AML Specialties with over thirty years of hands on engineering and

technical expertise in microwave communications.

75 Ohm traceability

The Society of Cable Television Engineers (SCTE) has announced that 75 ohm traceability has been established at the National Institute of Standards and Technology (NIST). Seventy-five ohm traceability will impact manufacturers and users of 75 ohm test equipment, cable, connectors and active and passive devices.

The SCTE is currently soliciting proposals for papers to be presented on technical panels during the 1989 Western Show, December 13-15, in Anaheim, Calif. Submissions, which should include an abstract of the proposed paper or presentation, must be sent to Bill Riker at SCTE national headquarters no later than October 1, 1989.

Hudson Supply Company announced a multi-million dollar commitment to **Times Fiber Communications**. The 12-month agreement includes an inventory commitment of approximately \$0.5 million. For additional info call, (818) 913-4134.

Jerrold's Digital Cable Radio announced commitments from cable operators representing more than one million subscribers. The new systems that have committed to DCR are Cox Cable of Hampton Roads, Va.; Comcast, Willow Grove, Pa.; Hauser, Montgomery County, Md.; Multimedia's Tar River Cable, Rocky Mount, N.C.; Harron, Malvern, Pa.; and Susquehanna Broadcasting, York, Pa. DCR subscribers will receive 16 channels of commercial-free, CD-quality music when the service is available in late 1989. For more details call (215)

957-8290.

In other news, **Jerrold** has announced a reduction in the price of its EIA multiport units. Originally priced at \$275, the units are now available at a cost of \$140. For information call, (215) 674-4800.

Zenith Electronics announced a \$32 million agreement to supply two-way interactive cable TV decoders to **KBLCOM Inc.** Under the five-year agreement, Zenith will supply Z-TAC II baseband addressable Z-TAC II decoders with built-in two-way interactive "Z-View" capabilities for installation in KBLCOM's subscriber homes in San Antonio, Texas, and other U.S. locations. Call (312) 391-8181 for info.

Connifer Corp. has announced an agreement with the **David Sarnoff Research Center**. The Sarnoff Center will be involved in research and development, product and design audit, and assisting in Conifer's manufacturing operations. For more details call, (319) 752-3607.

Pioneer Communications of America Inc. has announced an agreement with Cox Cable San Diego for the purchase of \$20 million in Pioneer equipment, including BA-6150 addressable converters and an M3P addressable controller. The \$20 million order includes 180,000 units that will replace all addressable converters in the San Diego system. The first new converters will be installed in January, 1990, with the entire converter changeout taking place over the following 18 months.

Pioneer also announced the sale of standard converters worth approximately \$1.3 million to American Television & Communications (ATC). ATC purchased BC-4500 converters for its Fayetteville and Charlotte, N.C., divisions and BC-4600 converters for its Jackson, Miss. system. For additional info call, (201) 327-6400.

CableData announced the signing of a renewal contract with Continental Cablevision to provide billing and MIS services for 67 Continental systems. The three-year contract includes a two-year extension option and supercedes all existing contracts between the two companies. CableData currently processes 1.8 million Continental subscribers. Call (916) 636-5800 for more info.

A new six-page, full-color illustrated brochure is being offered by **Ortel Corp.** *Microwaves in a New Light* provides information on the company's laser fiber optic products. For more info call, (818) 281-3636. ■

—Kathy Berlin



Wesley Simpson

Continued from page 57

indices, m_i , in the typical range of 2.5 percent to 5 percent.

Typical results

In Figures 6a, b, c and d, we summarize the results of measurements on a 42 channel laser trunk link. Figure 6a is a spectrum analyser plot for a typical channel under test, showing the carrier, noise floor and second and third order composite intermodulation tones and the measurement results.

Table 1 (see page 48) is a derivation of the specific noise and device performance characteristics from those measurements.

Figures 6c and 6d plot the broadband performance of the device on the theoretical $10 \log(N)$ plots presented in Figures 5a and 5b. Measured parameters and broadband results can be compared with the theory and models above.

During the presentation, we will look at more statistical data from the Laser Link™ units delivered to CATV MSOs during the first quarter of 1989.

Summary

We have reviewed many of the performance degradations and system considerations which are key to the application of AM modulated lasers in the CATV trunk networks. While the overall application is still in its infancy, these performance models will provide a foundation for unit to unit comparisons as well as evolutionary trends. ■

Acknowledgements

Credit is due to many members of staff in AT&T Bell Labs for their support and ideas in attacking these issues. I would like to particularly mention G.L. Fenderson and M.S. Schaefer who helped on the refinement of these models and the development of real hardware to test them.

I would also like to thank those members of the CATV engineering community who have openly shared their ideas, needs, techniques and time in helping our efforts. In no particular order, special mention to Louis Williamson, Dave Pangrac, Jim Chiddix, "Shorty" Coryell, Tom Elliot, Richard

"Rex" Rexroate, Dick Kreeger, Jack Ramsayer, John Walsh, Jim Hayworth, Bob Luff and Hugh Bramble.

References

1. Several Papers in Session "Fiber Optics and Cable: Present and Future Trends," in the 1988 NCTA Technical Papers.

2. For a complete look at CATV trunk requirements and measurement techniques, see "NCTA Recommended Practices for measurements on cable television systems." National Cable Television Association, First Edition, 1983.

3. See Senior John M.: "Optical Fiber Communications: Principles and Practice," Prentice-Hall International Series in Optoelectronics, ISBN 0-13-638248-7, 1985 for a general treatment of analog fiber transmission alternatives.

4. Members of the technical staff, Bell Telephone Laboratories: "Transmission Systems for Communications," Fifth Edition, 1982.

5. Simons, K: "The Fundamentals of Distortion in CATV Amplifiers," Jerrold Electronics Corp., 1967.

CONTINUING THE COMMITMENT...

CED is committed to providing its readers the tools they need to keep up with this rapidly changing industry. Just look at some of the special services we offer:

- **Signal Leakage Handbook.** This practical guide provides everything you need to know to meet the FCC's July 1, 1990 deadline for CLI compliance.
- **CATV Buyers' Guide.** A complete, up-to-date reference of all hardware vendors and service providers presently operating in the cable industry.
- **Frequency Allocation Chart.** The annual chart is updated to show which areas are restricted from use and who shares spectrum with CATV.

To order additional copies of any of the above publications, call or write:

CED Magazine • 303/393-7449

600 S. Cherry St. Suite 400, Denver, CO 80222

Order Now!

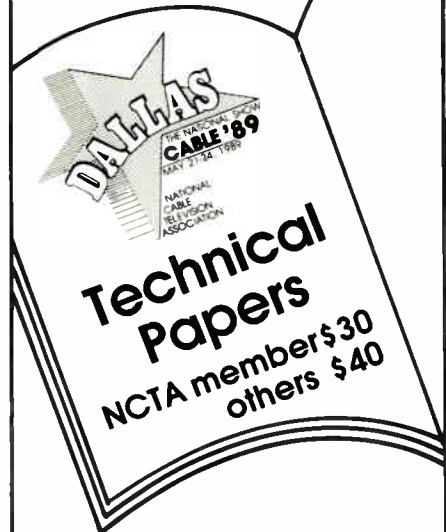

Pre-paid mail orders only.
Price includes shipping.
Send check with request to:
NCTA
Science & Technology Department
1724 Massachusetts Ave., N.W.
Washington, D.C. 20036

CLASSIFIEDS

HELP WANTED

Baker Scott & Co. EXECUTIVE SEARCH

1259 Route 46 Parsippany, NJ 07054 201 263-3355

Specialists in the COMMUNICATIONS
INDUSTRY

CABLE TV/BROADCAST TELECOMMUNICATIONS
DIVISION DIVISION

POSITIONS AVAILABLE AT ALL LEVELS OF
MANAGEMENT, COAST TO COAST

Call or write in CONFIDENCE

FEE PAID

"WE DON'T TALK CABLE, WE KNOW CABLE"
PRINCIPALS DAVID ALLEN & JUDY BOUER

CONSTRUCTION PERSONNEL

Your
Career Picture
Is Bright In
CABLE TV

STATEN ISLAND CABLE is a rapidly expanding operation involving a 700 mile system in Staten Island. Our growing success has created exciting opportunities for construction people. We're seeking individuals who must have extensive experience in CATV aerial and underground construction, and the ability to read and utilize maps. These positions are currently available:

CONSTRUCTION SUPERVISOR

High School graduate with the above-mentioned qualifications, plus ability to read and utilize diagrams. Previous supervisory experience a big advantage.

CONSTRUCTION CREW

Personnel for these in-house crew positions will be responsible for day-to-day construction extensions and maintenance of plant utility requirements.

We offer an excellent salary based on your experience, plus outstanding benefits package. Send resume and salary history, indicating which of the two positions you're seeking to:

HENRY SCHWAB
c/o Personnel Manager
STATEN ISLAND CABLE
100 Cableway
Staten Island, NY 10303
An Equal Opportunity Employer

Leader in the placement of Cable Television Professionals
Call toll free 1-800/433-2160; In Texas call collect 817/599-7623.

REGIONAL ENGINEER—Rocky Mountains AML
a must. \$35K

REGIONAL ENGINEER—Fast track, high growth.
East \$50K

DISTRICT ENGINEER—Special projects
midwest locale. \$40K

CHIEF ENGINEER—Remote northeast location.
\$40K

PLANT MANAGER—West coast, high growth.
\$40K

MANAGER/ENGINEER—New acquisition.
Southeast \$30K

SYSTEM ENGINEER—Rocky Mountains
addressability, AML. \$40K

PROJECT MANAGER—Total rebuild, fiber hop.
East \$40K

PLANT MANAGER—Southeast \$30K.

PROJECT ADMINISTRATOR—Tracking work
flow. West \$38K

CHIEF TECHNICIAN—Great Lakes region. \$27K

CHIEF TECHNICIAN—Growing MSO Southeast
\$26K

CHIEF TECHNICIAN—Atlantic States. \$25K

C.A.D. DESIGNER—Numerous opportunities
nationwide. \$30-35K

HUB ENGINEER—AML, FML, a must. \$35K

CHIEF TECHNICIAN—Midwest urban. \$26K

LINE TECHNICIANS—Opportunities nationwide,
companies will relocate. \$10/hr-\$15/hr



JIM YOUNG & ASSOCIATES

One Young Plaza 1235 Ranger Highway Weatherford, TX 76087

Call for information about these and many other opportunities nationwide.

REGIONAL ENGINEER WANTED

Engineer wanted for 4 small systems located in Western Nevada near Lake Tahoe and Reno. Must be qualified in electronic theory and cable television. Applicant must be experienced in microwave head-end distribution, supervision and personnel training, as well as cable TV rules and regulations. Send resume to:

Columbia Cable
335 W. Melinda Dr., #2
Phoenix, AZ 85027

CABLE TV TECH HERITAGE CABLEVISION

Have knowledge of basic electronics applicable to CATV. Capable of pole-climbing and CATV plant work incl. cable splicing; capable of trouble-shooting, customer drop back to and including the distribution amplifier. Previous CATV exp. req. Send resume to: P.O. Box 114, San Jose, 95103-0114. EOE.

WANTED:

CATV DESIGNERS—Experienced in 2-way broadband design and powering of CATV systems.

CATV DRAFTPERSONS—Experienced in ink, film lead and graphite with good manual lettering and Leroy lettering ability. A career opportunity. Send resume to:

TransAmerica Energy Assoc. Inc.
1301 Hightower Trail, Ste. 300
Atlanta, GA 30350
ATTN: Edwin A. English,
System Design Supervisor

CABLE SEARCH ASSOCIATES

Professional Search
and Placement

Call or Write WICK KIRBY
(312) 369-2620
P.O. Box 2347, Naperville, IL 60567
FAX: 1-312-369-0126

Let Classifieds work for you!

For more information, call Curt Stocker at (303) 393-7449 or write: CED magazine, 600 S. Cherry Street, Suite 400, Denver, CO 80222.

EQUIPMENT FOR SALE/RENT

AERIAL BUCKET TRUCKS

Large selection geared for CATV
STANDARD TRUCK & EQUIPMENT CO.
 1155 Hill St. S.E.
 Atlanta, GA 30315
 Phone: 1-800-241-9357  **BUCKET TRUCKS**

EMERGENCY ALERT SYSTEMS

by
Idea/onics
 69 channels 14 day delivery
 compatible with all headends
 —AFFORDABLE—
(701) 786-3904
24 and 88 channel units
 also available

WANTED: SURPLUS CABLE EQUIPMENT

Jerrold, Oak, Hamlin & Scientific
 Atlanta equipment.
Highest Prices Paid
Cable Equipment Brokerage Co.
(818) 709-3724

Commercial VideoCipher Repair
FAST Turnaround!!

Tulsat Corp. (918) 836-8348
 1575 N. 105 E. Ave. Tulsa, OK 74116
 We also purchase or trade dead or alive
 red, white, or yellow label VCII's.

Scrap Problem
No Problem

Best prices for reek out
COAXIAL CABLE
Iron Man Metal's
(619) 329-IRON

Best service with
MOBIL COILER FOR
ROAD SIDE PICK UP

Fully Licensed
 Insured and Bondable
 Reference Available

Bucket Trucks—Used

Telsta, Versa-Lift, Digger Derricks—10 in
 Stock. 30 other Utility Construction Trucks.
 "We Buy and Sell"
Opdyke, Inc. (Philadelphia Area)
 3123 Bethlehem Pike (215) 721-4444
 Hatfield, Pa. 19440

CHANNELCUE

Audio/video switching
 equipment repair
 Line equipment
 and meter repair



LEE ENTERPRISE
 623 4th STREET • P. O. BOX 590 • DESHLER, NEBRASKA 68340
 (402) 365-7520

QUALITY REFURBISHED CATV EQUIPMENT



(614) 221-3131
CABLE LINK, INC.

Anthony's **ANTHONY'S**
 MANUFACTURING SERVICE

PLOW BLAOGES
 Irrigation/Wire/Combination
 For Any Machine—For Any Application
 1-800-383-PLOW
 (719) 475-PLOW P.O. Box 17701
 Colorado Springs, CO 80935



VIDEO SUPPLIES

CABLES • CONNECTORS • CANARE • BELDEN • SWITCHCRAFT • D.A.S. • TIES •
 BATTERIES • NEUTRIK • 60 INTERFACE BOXES • TAPE • 500 DIFF. TAPE LABELS • GAFFERS
 TAPE • CASES • PATCH BAYS • LIGHTS • ACOUSTIC FOAM
 • FORMS • MICROPHONES • SONY • STANDS • MOUNTS
 • WIND SCREENS • ZEPPELINS • FIBRE OPTICS • RACKS
 • DUCT • REELS • TESTERS • FILTERS • CHEMICALS • TOOLS
 • ON AIR LIGHTS • DEGAUSSERS • INTERFACE DEVICES
 • HEADPHONES • CLIPS • SWITCHES • AMAS WBS CABLE
Very Unique Professional Catalog FREE!
MARKERTEK VIDEO SUPPLY
 145 Ustler Ave., Saugerties, NY 12477 U.S.A.
 TOLL FREE **1-800-522-2025**
 In NY: 914-246-3036

BUSINESS DIRECTORY

NaCom

BUILDING COMMUNICATION SYSTEMS THROUGHOUT AMERICA

- Installations (including fiber optics)
- Converter exchanges, PPV, audits, special projects
- MDU, SMATV, & LAN Pre/postwiring
- Strand mapping, engineering, signal leakage
- Design (AutoCAD)
- Aerial/underground construction

1900 E. Dublin-Granville Rd., Columbus, Ohio 43229
 614/895-1313 • FAX 614/895-8942

White Sands

Jumper Cables

Custom connectors and cables for all aspects of CATV.
Gilbert AHS All types of cable from
Magnavox Belden
Pyramid F59-81 Times
LRC and others Comm Scope
 Quick delivery on all colors with lengths from 6" to 15'.

Write or call: (602) 581-0331
 335 West Melinda Drive, Phoenix, AZ 85027

BUSINESS DIRECTORY



CONTRACT INSTALLERS, INC.

UHF Radio Equipped Trucks • Uniformed Installers

HOUSE INSTALLATIONS
Aerial - Underground - Pre-wire
APARTMENT INSTALLATIONS
Post wire - Pre-wire - Commercial Building
Tap Audits

Install or Remove Traps and/or Converters
Drop change over for System Rebuilds

LENNY FISCHER P.O. Box 1564
(414) 582-7087 Appleton, Wisconsin 54913-1564

R. R. (Rich) Barks
E. D. (Dan) Stone
National Sales Representatives
Cable Television
Services

1111 Woods Mill Road
Ballwin, MO 63011
(314) 891-4123
1-800-443-0738

Fiber Optic and Coaxial System Designs
Turnkey Installation Services
On Site Project Management
System Design (D3 Program)
CLI Surveys (including MTCE Services)
Mapping Services (Base, Strand, As Built) Linex CAD System



CABLE CONSTRUCTORS, INC.

IRON MOUNTAIN, MICHIGAN
COAX - FIBER

QUALITY SERVICE PERFORMED ON A TIMELY BASIS
- SINCE 1957 -

MAPPING - DESIGN - CONSTRUCTION - ENGINEERING

CABLE CONSTRUCTORS, INC.

1-800-338-9292

KLUNGNESS ELECTRONIC SUPPLY (KES)
1-800-338-9299

ColorView Services, Inc.

800-824-1943

SINCE 1953

CONVERTER REPAIR

REALISTIC TURNAROUND

PROGRAMMABLE & ADDRESSABLE

JERROLD HAMLIN PANASONIC OAK SCIENTIFIC ATLANTA TEXSCAN
ASK ABOUT OUR PRICES! SIX MONTH WARRANTY!
ALBUQUERQUE, NEW MEXICO

**Nationwide C.A.T.V.
Auditing Services Inc.**

- Door-to-door verification of addresses and services being received.
- RF leakage indicators to comply with FCC Ruling Docket #21006, effective 7/1/90.
- Documentation and correction of G095 infractions (Drop Clearance).
- Termination of all open ports.
- The updating of Bridger Maps.
- Installation of Raychem fittings.

1-800-726-2405 John MacLean General Manager

TSB, Inc.

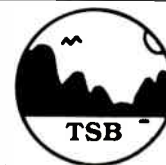

- Design, Strand Map, As-Builts
- CAD Drafting Service
- Headend Racking and Renovations
- CLI • Audits
- Onsite Technical Training
- Structural Analysis of Towers

PO Box 244
(605) 665-1393

Yankton, SD
57078

	Reader Service #	Page #
AML Specialties	21	36
Aces	31	45
R. Alan Comm. Inc.	52	78
Alpha Technologies	5	11
Anixter Cable TV	11, 58	23, 92
Applied Instruments	42	61
Atlantic Cable Show	55	81
Augat Broadband	23	39
Augat/LRC Electronics	26	41
Authorized Parts	38	53
Automation Techniques/Tulsat	45	67
C-COR Electronics	16, 18	31, 35
Cable Exchange	36	51
Cable Link	19	38
Cable Prep/Ben Hughes Comm.	24	40
Cable Tek Center Products	51	78
Channel Commercial	4	6-7
Comsonics	50	77
FM Systems	29	44
General Cable Apparatus Div.	32	46
Hudson Supply	9	19
Jerry Conn Associates	13	26
Lakeshore	54	81
Lectro Products Inc.	7	15
Lemco Tool	30	44
Line-Ward	40	57
Magnavox CATV	20	37

	Reader Service #	Page #
Midwest CATV	6	12-13
Midwest CATV Engineering	25	40
Midwest Communications	8	17
Multicom	43	63
NCS Industries	53	80
Nexus Engineering	3	5
Oak Communications	47	69
Panasonic	1	2
Pico Products	17	33
Pioneer Communications	48	71
Pyramid Industries	39	55
Reliable Electric	57	91
Riser-Bond	22	36
Rite Cable Construction	37	52
Sachs Comm. Inc.	33	47
Scientific-Atlanta	15	29
Sony	44	65
Standard Communications	10	21
TVC Inc.	12	25
Telecommunication Products Corp.	49	75
Time Manufacturing	35	50
Times Fiber	34	49
Trilithic/Texscan Inst.	28	43
Trilogy Communications	2	3
Triple Crown Electronics	27	42
U.S. West Comm.	41	59
W. Whitaker & Assoc.	46	67
Wavetek	14	27

WHAT'S AHEAD

SCTE

The SCTE is currently soliciting proposals for papers to be presented on technical panels during the 1989 Western Show, December 13 through 15, in Anaheim, Calif. Submissions, which should include an abstract of the proposed paper or presentation, must be sent to Bill Riker at SCTE national headquarters no later than October 1, 1989.

September 10-12 *The Dakota Territories Meeting Group* will present a technical seminar on CLI at the South Dakota Association meeting, Sylvia Lake Lodge, Hills City, S.D. Call A.J. Vandekamp, (605) 339-3339 for more details.

September 12-13 *Florida Chapter* will hold a technical seminar September 12 for the Central Florida Group at the Holiday Inn North in Lakeland, Fla. The Gulf Coast Group's seminar will be presented on

September 13. For info on either seminar call Denise Turner, (813) 626-7115.

September 13 *Oklahoma City Chapter* will hold a technical seminar on "Fiber Optics" with Wendell Woody of Anixter Cable TV and Dave Pangrac of ATC at the Applewoods Restaurant, Oklahoma City, Okla. For more info call Herman Holland, (405) 353-2250.

September 14 *Big Country Meeting Group* will hold a technical seminar in San Angelo, Texas. Call Albert Scarborough, (915) 698-3585 for details.

September 14 *Golden Gate Chapter* will present a technical seminar on "Equal Employment" with Steve Effros of the Community Antenna Television Association at the Italian Gardens Restaurant in San Jose, Calif. Federal policy regarding EEO and other

legal issues will be presented. For additional info call John Parker, (408) 437-7600.

September 16 *The Cactus Chapter* will conduct a technical seminar. Call Harold Mackey Jr., (602) 866-0072 for more info.

September 20 *North County Chapter* will hold a technical seminar. BCT/E examinations are tentatively scheduled. For more info call Douglas Ceballos, (612) 522-5200, ext. 705.

September 20 *Razorback Chapter* will present a technical seminar at the Days Inn in Little Rock, Ark. Call Jim Dickerson, (501) 777-4684 for details.

September 20 *The Dairyland Meeting Group* will hold a technical seminar. For more info call Bruce Wasleske, (715) 842-3910.

C-COR[®] ELECTRONICS INC

C-COR Electronics "state of the art" seminars are three-day events designed to instruct relatively new technicians in basic theory, installation and maintenance of cable TV systems. Attendance is limited to a maximum of three persons from one system. The fee is \$195.

September 19-21 *C-COR Electronics Seminar* will be held in Dallas, Texas. Call Teresa Harshbarger, (800) 233-2267, ext. 326 to register or for details.

October 17-19 *C-COR Electronics Seminar* will be held in Boston, Mass. Call Teresa Harshbarger, (800) 233-2267, ext. 326 to register or form more info.

November 14-16 *C-COR Electronics Seminar* will be held in Phoenix, Ariz. Call Teresa Harshbarger, (800) 233-2267, ext. 326 to register or for additional info.

MAGNAVOX CATV SYSTEMS CO.

The Magnavox CATV Systems mobile training center is a fully-equipped laboratory on wheels for cable training. The three-day seminars combine instruction in theory and practical hands-on training, using gear and test equipment common throughout the industry. The fee is \$300.

September 12-14 *Magnavox Mobile Training* will be held in Columbus, Ohio. Call Amy Costello Haube, (800) 448-5171 (in

NY state, (800) 522-7464) to register, or for additional info.

September 18-20 *Magnavox Mobile Training* will be held in Detroit, Mich. Call Amy Costello Haube, (800) 522-7464) to register, or for additional info.

September 25-27 *Magnavox Mobile Training* will be held in Indianapolis, Ind. Call Amy Costello Haube, (800) 522-7464) to register, or for additional info.

Et cetera

September 20-22 *Great Lakes Cable Expo* will be held in Columbus, Ohio. The expo's theme is "A Challenging Picture" and will examine industry challenges and methods to

meet them head-on. Topics include community relations and industry image, the threat of re-regulation and the promise of new technology. For more details call (614) 272-0860.

FAST FIELD SECURITY FOR YOUR CABLE TV PEDESTAL

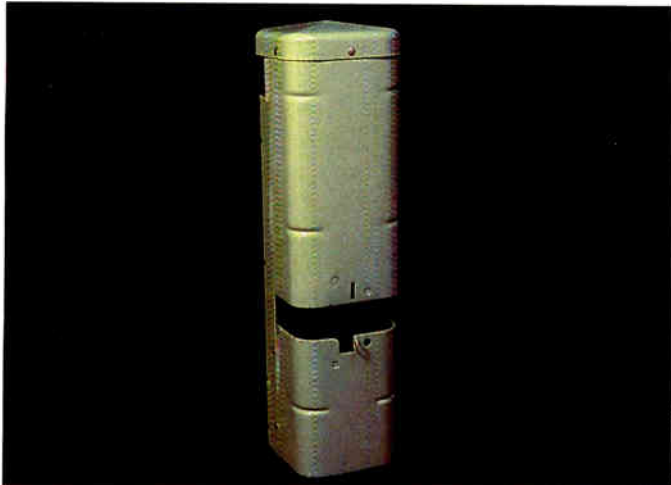

Pedestal cover with knock out in place.

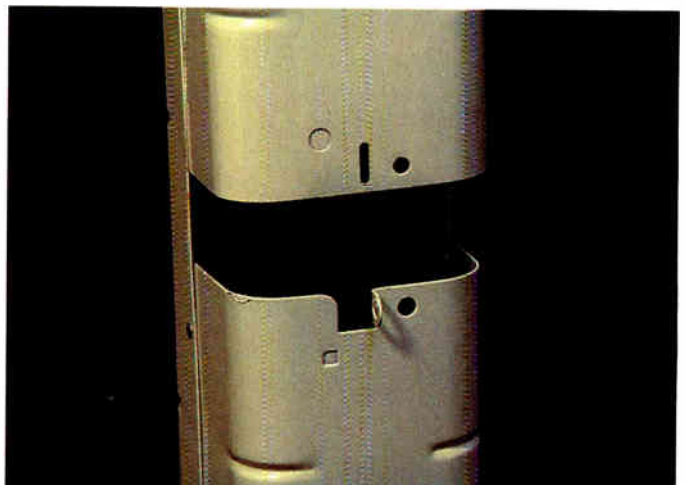

Knock out is easily removed with hammer and ordinary screwdriver.

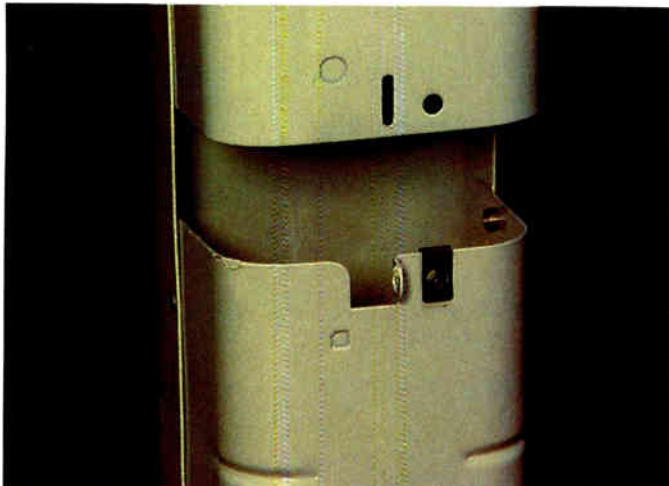

Locking clip fits over pedestal in seconds.



Star Lock is tightened and removed only with special screwdriver type key for maximum security.



Only Reliable pedestals come with factory-provided knock outs for installing **Diversified Control Systems** Star Locks.

A small but important feature...

because it provides maximum security for cable TV pedestals or apartment boxes

fast and easy right in the field.

Hasp broken or missing? No problem. Diversified's Star Locks are designed to deliver a secure closure without using the hasp.

It's a great combination: Star Locks and Reliable Electric, the best-selling pedestals in the industry. And you can get them both from one trusted source: Anixter Cable TV.

Reader Service Number 57

RELIABLE

RELIANCE COMM/TEC

ANIXTER
CABLE TV

WEST-ANAHEIM: (714) 779-0500, (800) 854-0443; **DENVER:** (303) 740-8949, (800) 841-1531; **SEATTLE:** (206) 251-6760, (800) 426-7665; **MIDWEST-CHICAGO:** (312) 364-7000, (800) 544-5368; **CLEVELAND:** (216) 526-0919, (800) 321-8068; **DALLAS:** (214) 446-7337, (800) 231-5006; **IRON MOUNTAIN, MI:** (906) 774-4111, (800) 624-8358; **SKOKIE, IL HDQTRS:** (312) 677-2600; **EAST-ATLANTA:** (404) 995-5110, (800) 241-5790; **LONG ISLAND, NY:** (516) 293-7788, (800) 645-9510; **NEW JERSEY:** (201) 328-0980, (800) 631-9603; **TAMPA:** (813) 626-7115, (800) 282-9164; **CANADA-CALGARY:** (403) 250-9646; **MONTREAL:** (514) 636-3636; **TORONTO:** (416) 625-5110; **VANCOUVER:** (604) 321-5885

In an emergency, weekends and holidays or after 5 P.M. call toll free 1 (800) 323-8166.
CORPORATE OFFICES, ANIXTER CABLE TV, INC., 4711 Golf Road, Skokie, IL 60076, (312) 677-2600

© 1989 ANIXTER CABLE-TV

Picture Perfect.

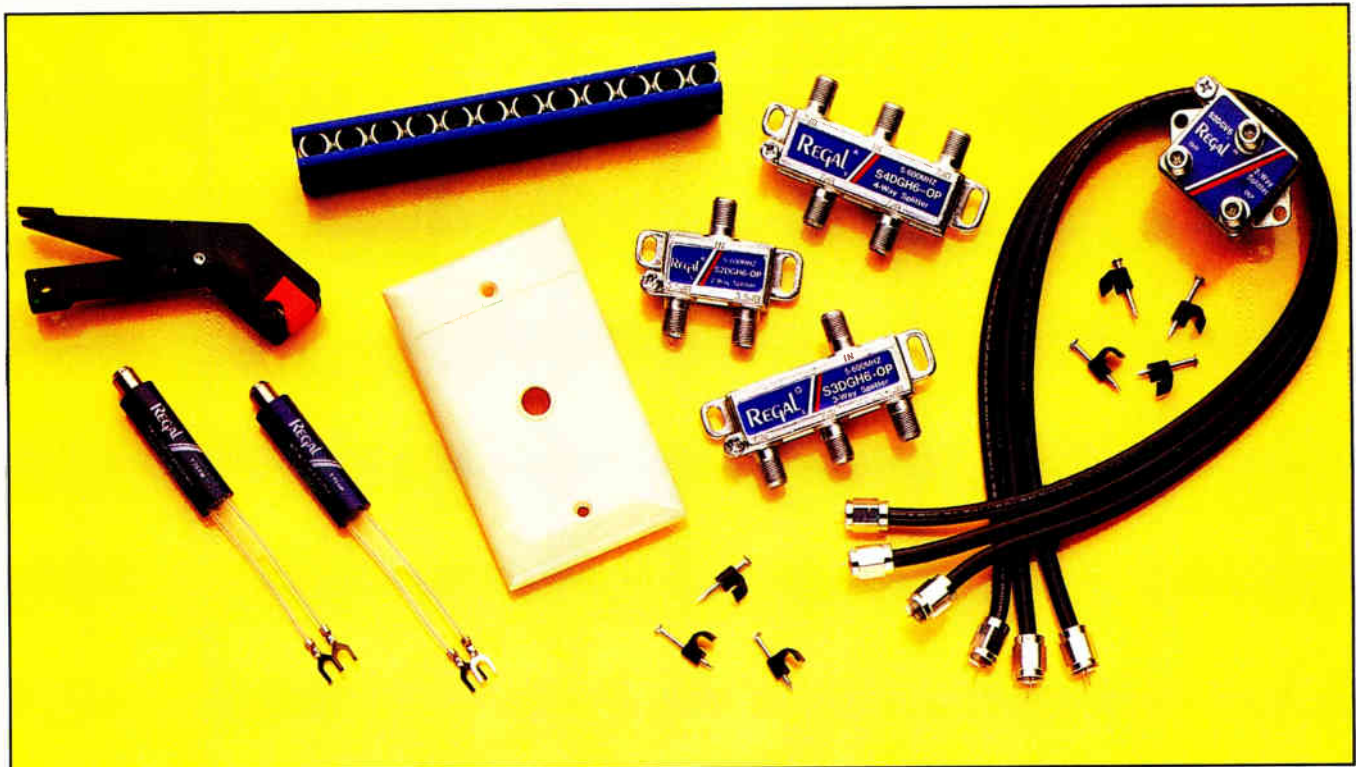

Quality Drop and Installation Material from Anixter Cable TV.

Quality matters. To your picture, your dependability...your customers. So why settle for drop and installation material from so-so manufacturers and suppliers, when Anixter Cable TV offers the best products and service available? Anixter can take you from the tap to the converter with qual-

ity products such as Diamond hardware, Regal passives, and Raychem F-connectors—everything you need delivered on-time from a regional warehouse near you. Call Anixter for picture perfect results—every time.

ANIXTER
CABLE TV

See us at the Great Lakes Expo, Booth #541.

Reader Service Number 58

WEST-ANAHEIM: (714) 779-0500, (800) 854-0443; **DENVER:** (303) 740-8949, (800) 841-1531; **SEATTLE:** (206) 251-6760, (800) 426-7665; **MIDWEST-CHICAGO:** (312) 350-7788, (800) 544-5368; **CLEVELAND:** (216) 526-0919, (800) 321-8068; **DALLAS:** (214) 446-CATV, (800) 231-5006; **IRON MOUNTAIN, MI:** (906) 774-4111, (800) 624-8358; **SKOKIE, IL HDQTRS:** (312) 677-2600; **EAST-ATLANTA:** (404) 995-5110, (800) 241-5790; **LONG ISLAND, NY:** (516) 293-7788, (800) 645-9510; **NEW JERSEY:** (201) 328-0980, (800) 631-9603; **ORLANDO:** (407) 240-1888, (800) 477-8396; **CANADA-CALGARY:** (403) 250-9846; **MONTREAL:** (514) 636-3636; **TORONTO:** (416) 625-5110; **VANCOUVER:** (604) 321-5885.

In an emergency, weekends and holidays or after 5 P.M. call toll free 1 (800) 323-8166.
CORPORATE OFFICES, ANIXTER CABLE TV, 4711 Golf Road, Skokie, IL 60076, (312) 677-2600

©1989 Anixter Cable TV