

CED

Signal Leakage Handbook

A practical guide for cable system operators



A practical guide for
cable system operators

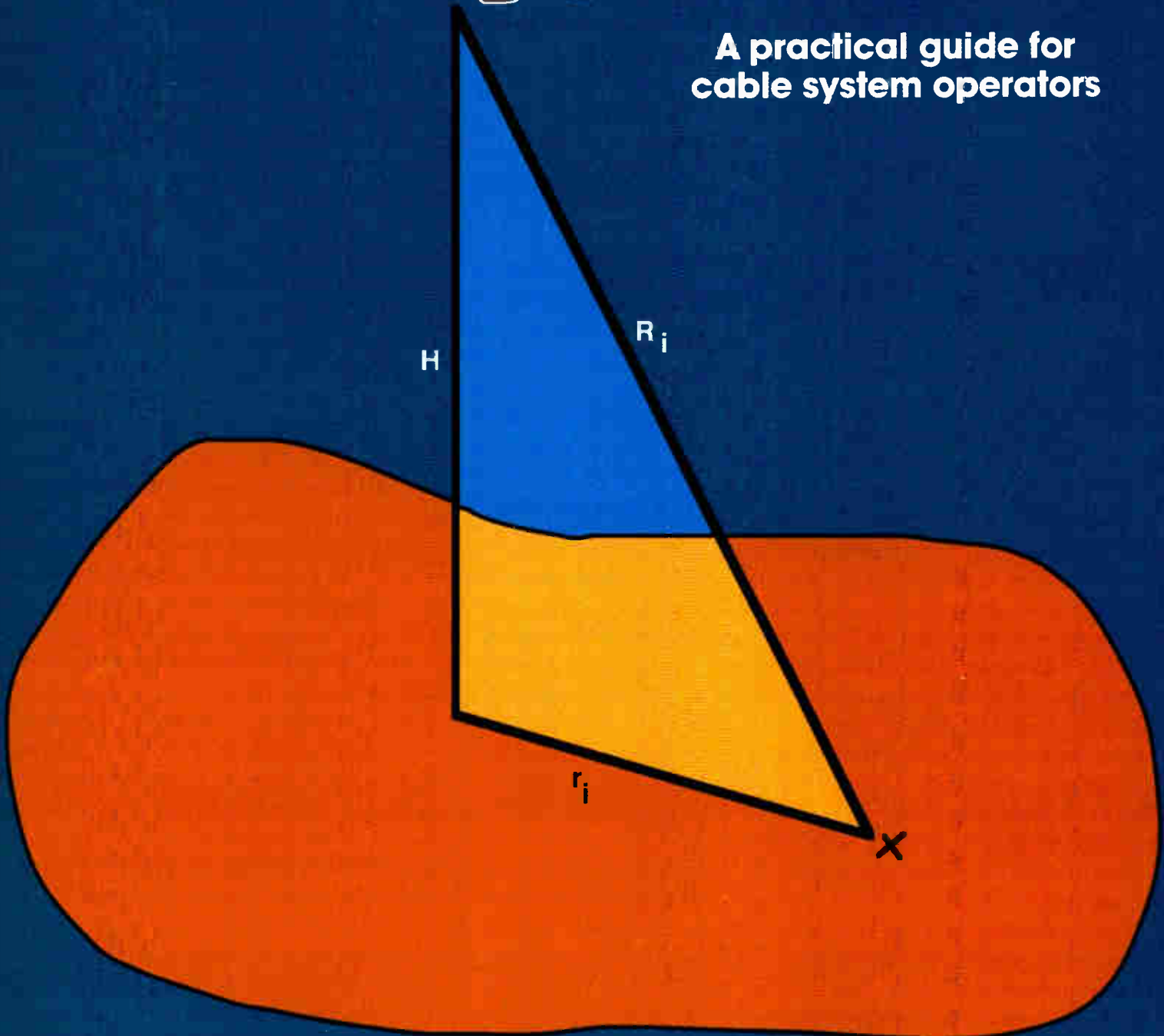

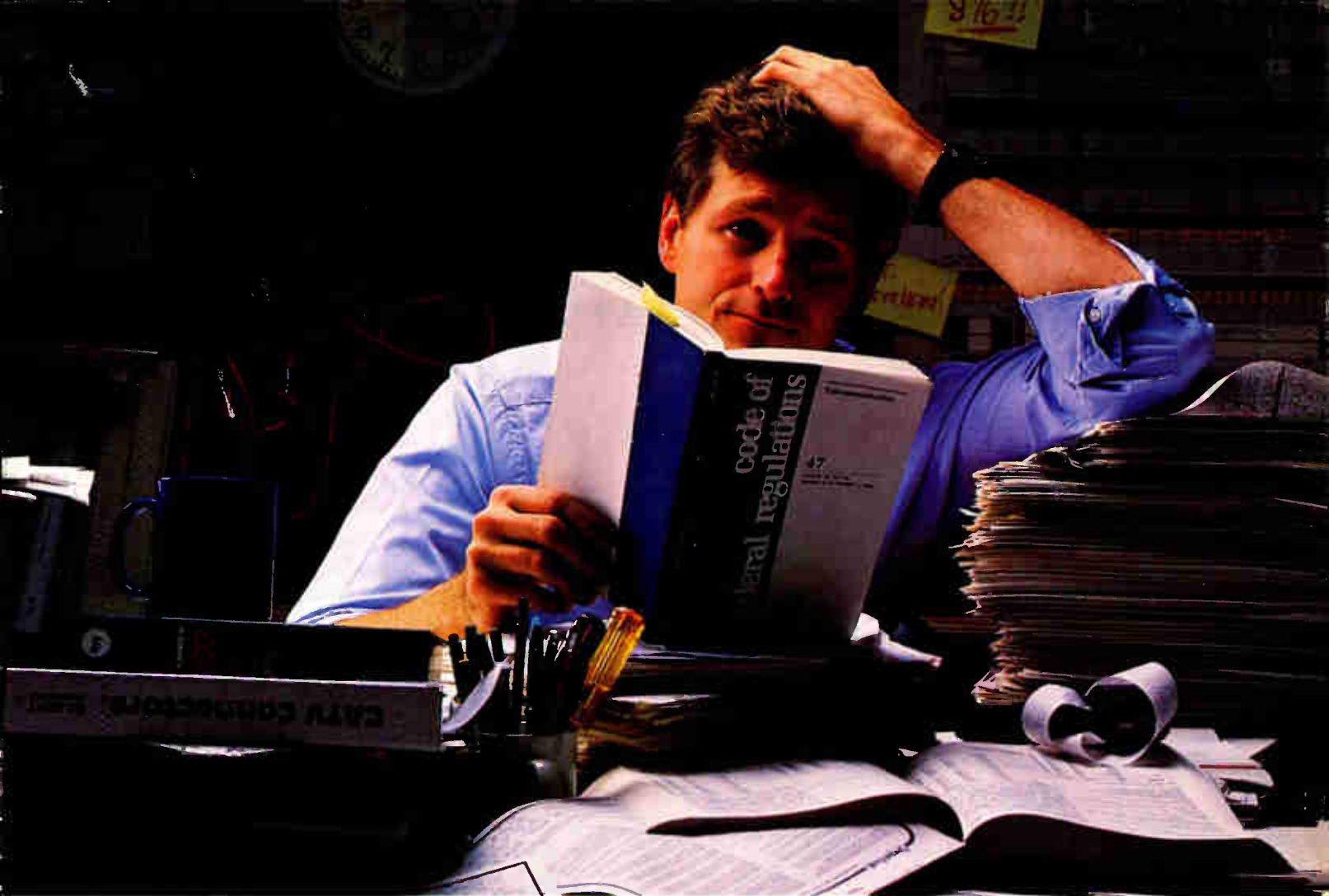

Don't worry.



With the FCC's Compliance Regulations, the way you seek, find and document cable leakage will be under careful scrutiny. It's going to take more technician time. It's going to take more administrative time. So, to play by the new rules, it's going to cost you. But if you don't play by them and get caught, it will *really* cost you.

Welcome to that comfortable spot between a rock and a hard place.

But wait, compliance is simply a function of locating, documenting and repairing leaks. And locating and documenting leaks is simply a function of the right equipment.

Presenting the new *Wavetek Cable Leakage Instrument (CLI) Series*.

The new CLM-1000: Amazing.

If you had one instrument to buy to solve your leakage problems, this would be it. It measures field

strength at any frequency from 50 to 550 MHz. At any range from 9 to 100 feet. And what it finds, it remembers, so you've got foolproof recall to simplify your documentation.

The end of calculated risks.

With just the push of a button, the CLM-1000 takes precise measurements. The dipole antenna receives signals as far as 30 meters and as weak as 20 $\mu\text{V}/\text{m}$. All you do is approximate and input the distance between the antenna and the leak. The system automatically converts the measurement to a 3-meter distance. No number crunching with conversion tables or formulas. No question about accuracy. All the information you need is dis-

played in an easy to read two-line LCD display, including analog level bar. Nine instrument stored setups simplify even the most complicated situations.

As easy as rolling off a log.

The CLM-1000 contains a complete logging system. At the touch of a button you can store all the measurement data, leak location, date and time of measurement. Then you can print it out on site, or save it for downloading to your office PC.



The CLM-1000 memory bank automatically provides a detailed log — just for the record.



CLM-1000 digital readout takes guesswork and interpretation out of settings and readings.

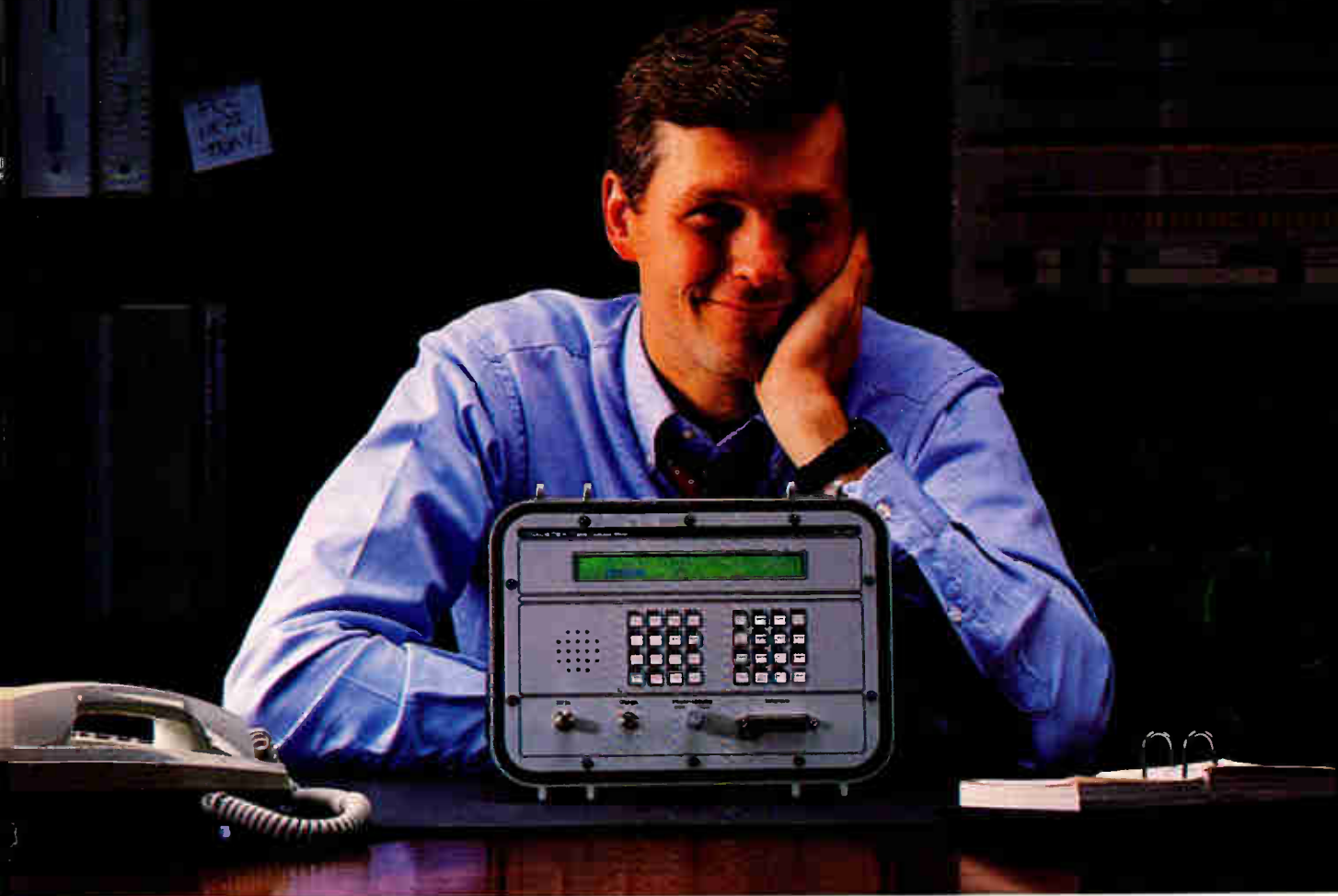

Be happy.

It's easy. And so is retrieval, which cuts data tracking time to a minimum. So you can say goodbye to recording errors.

For the record, the CLM-1000 is the most precise, versatile field strength meter you can buy.

When second best will do.

For instances when you don't need all the sensitivity, memory and documentation capabilities of the CLM-1000, Wavetek has two new very trustworthy hand held CLI receivers. The CLR-1 and CLR-4. Both almost operate themselves and are virtually goof-proof.

CLR-1: One track mind.

Designed for easy, near-field use, the CLR-1 can detect and verify leaks at a subscriber installation or an amp. It tunes into one cable channel and gives you a precise reading. Locator tone pitch and

LED readout verify leakage level. No knobs, no needles. And no signal generator is required.

All at a price that makes the CLR-1 impossible to do without.

The CLR-4: When there's more going on.

The CLR-4 covers the CATV spectrum, scanning four different channels simultaneously, or one at a time. It can tune channels 2, 3, D, and R as well as others.

An exclusive Wavetek lock-out feature prevents interference from strong competing signals. LED's and locator tone pinpoint the leak source, quickly and precisely.

And all this technology is yours for a remarkably low price.



CLR-1 (right) and CLR-4 give you two very affordable and goof-proof ways to locate leaks.



Let the CLM-1000 do the walking, since it can detect and measure leaks up to 100 feet away.

Compliance made easy.

Although compliance is mandated by law, in the long run, everyone will benefit from it. And it doesn't have to be difficult.

It's really just a matter of applying the right equipment. With Wavetek's new line of CLI's, you've got the right equipment.

Make it easy on yourself. Call Wavetek at 1-800-622-5515 for more information and the name of your nearest rep. In Indiana call 317-788-5965. Then, don't worry. Be happy.

Reader Service Number 1

WAVETEK®

Table of Contents

- 12 Your own personal copy of the rules**
FCC Rules mandate that operators of cable systems have a copy of Title 47, Part 76 of the Code of Federal Regulations. Here we've reprinted Sections 76.301, 76.605, 76.610 through 76.616, 76.618 and 76.619 from the most recent Code for your convenience.
- 20 What do these regulations mean?**
It's easy to get bogged down in legalese when reading the regulations, so Brian James with the NCTA explains the sections within Part 76. He examines how each rule affects a system in layman's terms.
- 24 The beginning of signal leakage—and CLI**
Why all the fuss about signal leakage? Ted Hartson with Post-Newsweek Cable goes back to when signal leakage was first noticed and explains how it grew into the current CLI regulations.
- 28 Yes, the FCC is very serious about CLI**
Many questions posed by operators have a ring of familiarity to them. Editor Roger Brown presents those questions to John Wong of the FCC.
- 32 What is Cumulative Leakage Index?**
Robert Dickinson with Dovetail Systems Corp. goes in-depth to discuss CLI and the formulas necessary to compute the index.
- 40 Using the flyover to qualify a system**
In a shift from the focus on ground-based measurements, Robert Dickinson of Dovetail Systems Corp. explores the flyover as a possible alternative for qualifying a cable system under the leakage requirements.
- 44 Computing CLI: a 'softer' approach**
With the various software applications available for CLI computations, it's often difficult to make a purchasing decision. This article discusses programs and contractors available to aid in the measurement and collection of signal leakage data.
- 50 A good job requires the right equipment**
The hardware available for leakage detection is the focus here with attention given to prices, specs and features of the different products.
- 56 One approach that does work**
Victor Gates and Clayton Collins of MetroVision, Inc. explain how their computer-aided program to manage leaks has resulted in great success.
- 61 Are the rules fair to the 'big guys?'**
Large systems are at a disadvantage when it comes to adhering to FCC rules, according to Bob Saunders of Sammons Communications Inc. Here, he reviews the situation and presents some solutions for large operators.
- 64 'I'm getting MTV, not air traffic control...'**
Larry Warren of Anixter Cable TV looks at current aeronautical technologies and how cable signal leakage actually affects its associated equipment. Major causes of leakage and repair solutions are also discussed.
- 72 Tips and more tips**
There are several helpful ideas about how to actually detect and measure leakage and how to pass the CLI test. Some of those helpful hints, pulled from recent seminars on the subject, are given here.
- 74 What have you learned about CLI?**
Now that you've completed this issue, test yourself with this 'pop quiz' on CLI.

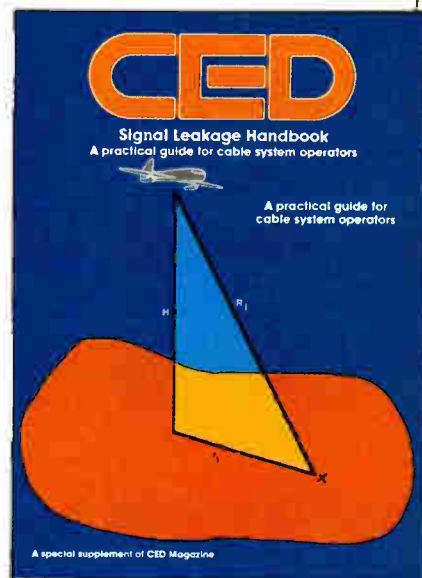

Why **CLIDE** for **CLI**?

Easy to install.

CLIDE's installation process is a breeze. Color prompts ask you a few quick questions about your computer. Answer the prompts, re-boot your machine, and you're done! CLIDE runs on any IBM PC/XT/AT or compatible with 640K RAM, DOS 2.1 or higher, and a hard and floppy disk drive.

Easy to operate.

CLIDE provides an easy method of monitoring RF signal leakage levels. It is completely menu-driven, with on-line help available at the touch of a key. All leakage data and subsequent leak repair data is stored and printed to form your FCC leakage report log. A wide variety of reports provide you with the information you need to show the FCC. Data entry is quick... data output is quick... because we know you're busy!

Easy on the budget.

CLIDE is designed for low-cost, ground-based inspection rather than costly aerial flyovers. Also, three price structures are available to match your budget: CLIDE alone, CLIDE with the PSION remote data collector, or the COMPLETE CLIDE KIT, which includes CLIDE, PSION, and a handy RANGE FINDER, which tells you in a glimpse how far you are from the pole or leak source.

Control Leakage Index Data Easily



By July of 1990,
we want you to feel as relaxed
as CLIDE looks. Buy CLIDE
now. Don't settle for less.



TELECOMMUNICATION PRODUCTS CORP.

1331 S. 7th Street, Chambersburg, PA 17201

(717) 267-3939

HAVE YOU SEEN US LATELY?

WE'RE HOT!

Long Systems, Inc.

A New Tradition In Cable Software





CABLES' CHOICE FOR COOLING OFF SIGNAL LEAKAGE.

8388 Vickers Street, Suite 201, San Diego, CA 92111

1-800-669-2043

(619) 278-2700

Reader Service Number 3

FAX (619) 292-6231

Copyright Long Systems 1989

Teamwork: quickest road to compliance

Even though the CATV trade shows and conventions have been dominated lately by technical discussions relating to HDTV and fiber optics, the issue of cable system leakage is finally beginning to heat up. Although the industry has essentially had four years to gear up to meet the July 1, 1990 deadline, for many operators, the problem is just now getting the attention it deserves.

The purpose of this Signal Leakage Handbook is to provide you, the operator, with as much practical and applications information as possible. In this supplement you'll find information about detection hardware, computer software programs, when to do a flyover, how to compute CLI and how to start a leakage detection and repair program.

After you've read the articles, you'll realize that implementing a signal leakage program isn't really a technical issue, it's an operational matter. But because it deals with the cable system's outside plant, the engineering department will be deemed responsible for making sure the FCC is happy with your system.

There are probably two ways operators could approach the implementation of a leakage program: the engineering department could grouse about not having enough time or money to do the job right; or top management at the system level could huddle and determine the best way to make sure they're in compliance.

Bear in mind leakage problems won't get just the engineer in hot water with the FCC. Systems not complying will pay with their pocketbook or, in extreme cases, by turning certain channels off (which would have serious implications well beyond the engineering department). Systems must realize the best way to get into and remain in compliance is through teamwork: compliance with the leakage rules should become one of a system's highest priorities.

Systems that don't now monitor for leakage are in for a few surprises. Remember, once a leakage program is implemented, it becomes part of the operation of a system. The CLI rules won't expire—they're intended to be on the books *forever*. So it's time to take the entire matter seriously because you can bet the FCC and the FAA are going to.

If you haven't already, take the time now to meet with the other members of your management team and determine how you're going to meet the compliance deadline. Then go out and see if your plan works. But start now, because if you wait until the last minute, you'll probably be among the first systems to be visited by your local FCC inspector. By then, it's much too late.

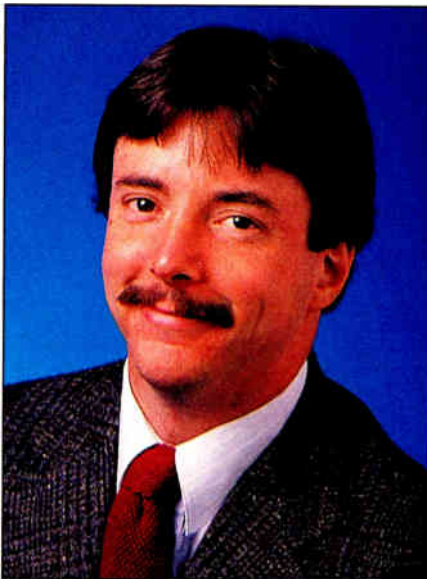

Roger J. Brown

Roger Brown
Editor

William McGorry, Group Publisher
Robert C. Stuehrk, Associate Publisher

EDITORIAL

Roger Brown
Editor

Kathy Berlin
Managing Editor

George Sell
Contributing Editor

CONSULTING ENGINEERS

Chairman

Wendell H. Bailey, NCTA VP, Science and Technology

Members

Jim Chiddix, Senior VP, Engineering and Technology, ATC

John Dawson, Engineering Consultant

Roy Ehman, Director of Engineering, Jones Intercable

Tom Elliot, Director of Research and Development, Tele-Communications Inc.

Jim Farmer, Principal Engineer, Scientific-Atlanta

Paul Heimbach, VP Engineering, Home Box Office

Fred Kaiser, President, Alpha Technologies

Dave Large, Director, Video Product Planning, Raynet Inc.

Robert Luff, VP Technology, Jones Intercable

Steve Raimondi, VP Engineering, UA Cablesystems Corp.

Joe Van Loan, Engineering Consultant

PRODUCTION

Jeff Knight, Production Director

Don Ruth, Art Director

Elaine Callahan, Production Manager

Dick Benson, Circulation Director

ADVERTISING

Cathy Wilson, National Sales Manager

Judy Medley, Account Executive

Curt Stocker, Classified Sales Manager

MARKETING AND SUPPORT

Michelle Pazar, Author Support and Quality Assurance

Linda Hendrick, SCTE Chapter Support

OFFICE

Denver 600 S. Cherry Street, Suite 400, Denver, CO 80222 (303) 393-7449. Fax (303) 393-6654.

ITCI

INTERNATIONAL THOMSON
COMMUNICATIONS INC.

Perhaps our most important contribution to CATV powering is restoring meaning to the word reliability.

In the past fifteen years we've made some very significant contributions to the CATV industry. We've developed the most efficient standby power concepts. We've developed the powering technology that delivers the cable signal with unprecedented reliability. In fact, every major standby power innovation has come from Alpha, including complete status monitoring, automatic performance monitoring, uninterrupted power output, and more. But what makes us proudest is to hear people in the industry say we've brought respectability to the standby power business.

Standby power systems were introduced to make CATV signal delivery more reliable.

Ironically, many of the standby systems were notoriously unreliable. They gave the entire industry a black eye.

We've worked very hard to design and build products that keep working under the most demanding environmental conditions. The fact that we're continuing to grow at an increasing pace while others have faded or disappeared shows that our concern for quality is right. And when our customers tell us we've restored confidence in standby power systems, that's the payoff.

Alpha Technologies. We're here to back you up.



3767 Alpha Way, Bellingham, WA 98226-8302
TELEPHONE 206-647-2360 FAX 206-671-4936

5700 Sidley St., Burnaby, B.C. V5J 5E5
TELEPHONE 604-430-1476 FAX 604-430-8908

Reader Service Number 4

Part 76: FCC Rules and Regulations

76.301 Copies of rules

The operator of a cable television system shall have a current copy of Part 76, and is expected to be familiar with the rules governing cable television systems. Copies of the Commission's rules may be obtained from the Superintendent of Documents, Government Printing Office, Washington, D.C. 20402, at nominal cost.

76.605 Technical standards

(a) The following requirements apply to the performance of a cable television system as measured at any subscriber terminal with a matched termination, and to each of the Class I cable television channels in the system:

(1) The frequency boundaries of cable television channels delivered to subscriber terminals shall conform to those set forth in 73.603(a) of this chapter: *Provided, however,* That on special application including an adequate showing of public interest, other channel arrangements may be approved.

(2) If no frequency converter is supplied to the subscriber the visual carrier frequency shall be maintained $1.25 \text{ MHz} \pm 25 \text{ kHz}$ above the lower frequency boundary of the cable television channel. If a frequency converter is supplied to the subscriber by the cable television system, the following requirement shall be applied at the interface between the converter and the subscriber's terminal equipment: when the visual carrier at the output of the converter has been tuned to a frequency 1.25 MHz above the lower frequency boundary of a cable television channel with the converter stabilized at an ambient temperature between 20°C and 25°C , the frequency of the visual carrier shall not vary more than $\pm 250 \text{ kHz}$ for a period of at least three hours, during which period the ambient temperature may vary $\pm 5^\circ\text{C}$ about the initial ambient temperature.

Note: A relaxed frequency tolerance will be permitted when both of the

following conditions are met: (a) The signal is received by means of a television broadcast translator station, and (b) the cable television system carries signals on neither an upper nor a lower channel adjacent in frequency to the channel on which the translator signal is carried. In such cases, the visual carrier frequency shall be maintained $1.25 \text{ MHz} \pm (25 + T) \text{ kHz}$ above the lower frequency boundary of the cable television channel, where T is the frequency tolerance in kHz allowed the television broadcast translator station pursuant to 74.761 of this chapter.

(3) The aural center frequency of the aural carrier must be $4.5 \text{ MHz} \pm 5 \text{ kHz}$ above the frequency of the visual carrier.

(4) The visual signal level, across a terminating impedance which correctly matches the internal impedance of the cable system as viewed from the subscriber terminals, shall be not less than the following appropriate value:

Internal impedance:	Visual signal level:
75 ohms.	1 millivolt.
300 ohms.	2 millivolts.

(At other impedance values, the minimum visual signal level shall be $0.0133Z$ millivolts, where Z is the appropriate impedance value.)

(5) The visual signal level on each channel shall not vary more than 12 decibels within any 24-hour period, and shall be maintained within:

(i) 3 decibels of the visual signal level of any visual carrier within 6 MHz nominal frequency separation, and

(ii) 12 decibels of the visual signal level on any other channel, and

(iii) A maximum level such that signal degradation due to overload in the subscriber's receiver does not occur.

(6) The peak-to-peak variation in visual signal level caused by undesired low frequency disturbances (hum or repetitive transients) generated within the system, or by inadequate low frequency response, shall not exceed 5 percent of the visual signal level.

(7) The amplitude characteristic shall be within a range of ± 2 decibels from 0.75 MHz to 5.0 MHz above the lower

boundary frequency of the cable television channel, referenced to the average of the highest and lowest amplitudes within these frequency boundaries.

(8) The ratio of visual signal level to system noise, and of visual signal level to any undesired co-channel television signal operating on proper offset assignment, shall not be less than 36 decibels. This requirement is applicable to:

(i) Each signal which is delivered by a cable television system to subscribers within the predicted Grade B contour for that signal, or

(ii) Each signal which is first picked up within its predicted Grade B contour, or

(iii) Each signal that is first received by the cable television system by direct video feed from a TV broadcast station or a low power TV station.

(9) The ratio of visual signal level to the rms amplitude of any coherent disturbances such as intermodulation products or discrete-frequency interfering signals not operating on proper offset assignments shall not be less than 46 decibels.

(10) The terminal isolation provided each subscriber shall be not less than 18 decibels, but in any event, shall be sufficient to prevent reflections caused by open-circuited or short-circuited subscriber terminals from producing visible picture impairments at any other subscriber terminal.

(11) As an exception to the general provision requiring measurements to be made at subscriber terminals, and without regard to the class of cable television channel involved, radiation from a cable television system shall be measured in accordance with procedures outlined in 76.609(h), and shall be limited as follows:

(b) Cable television systems distributing signals by using multiple cable techniques or specialized receiving devices, and which, because of their basic design, cannot comply with one or more of the technical standards set forth in paragraph (a) of this section, may be permitted to operate provided that an adequate showing is made which establishes that the public interest is benefited. In such instances the Commis-

Reprinted from the Code of Federal Regulation, Title 47.

the

SOURCE

Take your signal from Sony.



For CATV, SMATV, broadcast or business television, the FSR-1100 is the most reliable, flexible, high performance commercial satellite receiver available for the money.

Whether you're operating on the Ku or C band, Sony's FSR-1100 receiver provides the superior video and audio reception viewers expect. The FSR-1100's unique adjustable detector bandwidth allows quality reception even under adverse signal conditions. And its advanced operating features make it easy to use.

When you choose the FSR-1100 you're choosing Sony quality. Sony's unsurpassed experience and commitment to excellence in professional broadcast and industrial video equipment coupled with Midwest's outstanding support and service make a winning combination that can't be beat. Get the picture? You will if you take your signal from Sony.

For more information about the Sony FSR-1100, call one of our sales representatives today.

SONY® is a trademark of Sony.

Reader Service Number 5

M
MIDWEST
Communications Corp.

One Sperti Drive
Edgewood, KY 41017
1-800-543-1584
In Kentucky, 606-331-8990

sion may prescribe special technical requirements to ensure that subscribers to such systems are provided with a good quality of service.

Note 1: The requirements of 76.605(a)1) through 76.605(a)(10) do not apply directly to cable systems. These rule sections or less stringent versions of them may be used as standards by state or local regulatory authorities. No technical parameter in excess of the above rule sections may be required.

Note 2: The requirements of this section shall not apply to devices subject to the provisions of 15.601 through 15.626.

76.610 Operation in the frequency bands 108 MHz to 137 MHz and 225 MHz to 400 MHz—Scope of application

The provisions of 76.611 (effective July 1, 1990), 76.612, 76.613, 76.614 and 76.615 are applicable to all cable television systems transmitting carriers or other signal components carried at an average power level equal to or greater than 10^{-4} watts across a 25 kHz bandwidth in any 160 microsecond period, at any point in the cable distribution system in the frequency

bands 108 MHz to 137 MHz and 225 MHz to 400 MHz for any purpose. For grandfathered systems, refer to 76.618 and 76.619.

Note 1: See the provisions of 76.616 for cable operation near certain aeronautical and marine emergency radio frequencies.

Note 2: Until January 1, 1990, the band 136 MHz to 137 MHz is allocated as an alternative allocation to the space operation, meteorological-satellite service and the space research service on a primary basis. After January 1, 1990, the space service will become secondary to aeronautical mobile service radio. Until January 1, 1990, the band 136 MHz to 137 MHz is excluded from the rule sections regarding protection of aeronautical frequencies.

[50 FR 29399, July 19, 1985]

76.611 Cable television basic signal leakage performance criteria.

(a) No cable television system shall commence or provide service in the frequency bands 108 MHz to 137 MHz and 225 MHz to 400 MHz unless such systems is in compliance with one of the following cable television basic

signal leakage performance criteria:

(1) prior to carriage of signals in the aeronautical radio bands and at least once each calendar year, with no more than 12 months between successive tests thereafter, based on a sampling of at least 75 percent of the cable strand, and including any portion of the cable system which are known to have or can reasonably be expected to have less leakage integrity than the average of the system, the cable operator demonstrates compliance with a cumulative signal leakage index by showing either that (i) $10 \log I_{3000}$ is equal to or less than -7 or (ii) $10 \log I$ is equal to or less than 64, using one of the following formula:

$$I_{\infty} = \frac{1}{\delta} \sum_{i=1}^n E_i^2$$

$$I_{3000} = \frac{1}{\delta} \sum_{i=1}^n \frac{E_i^2}{R_i^2}$$

where:

$$R_i^2 = r_i^2 + (3000)^2$$

r_i is the distance (in meters) between the leakage source and the center of the cable television system;
 e is the fraction of the system ca-

Our Line Of Distri

Today the challenges of taking your delivery system further are enormous. Higher signal quality. More channels. Better reliability. Flexibility. That's why Scientific-Atlanta has developed the Total Systems Architecture™ approach to provide you with the tools to advance your delivery system and protect your investment.

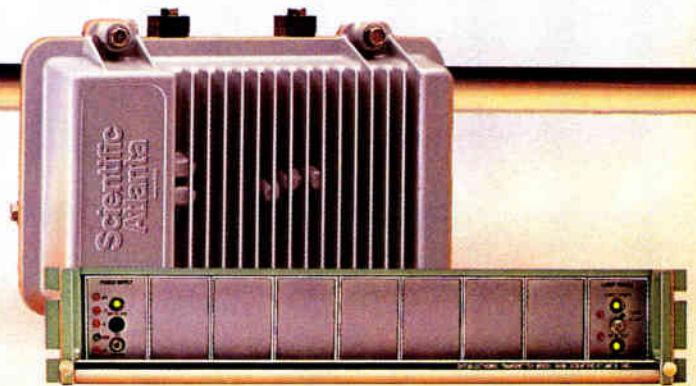

FIBER OPTICS.

The ultimate in signal quality, with built in optical isolator and RF switch. Capability for up to four laser transmitters and three receivers. It's compatible with all coax systems. You can depend on Scientific-Atlanta's design experience and support.

blelength actually examined for leakage sources and is equal to the strand miles of plant tested divided by the total strand miles in the plant;

R_i is the slant height distance (in meters) from leakage source i to a point 3000 meters above the center of the cable television system;

E_i is the electric field strength in microvolts per meter ($\mu\text{V}/\text{m}$) measured pursuant to 76.609(h) 3 meters from the leak i ; and

n is the number of leaks found of field strength equal to or greater than 50 $\mu\text{V}/\text{m}$ pursuant to Section 76.609(h).

The sum is carried over all leaks i detected in the cable examined; or

(2) prior to carriage of signals in the aeronautical radio bands and at least once each calendar year, with no more than 12 months between successive tests thereafter, the cable operator demonstrates by measurement in the airspace that at no point does the field strength generated by the cable system exceed 10 microvolts per meter ($\mu\text{V}/\text{m}$) RMS at an altitude of 450 meters above the average of the cable system. The measurement system (including the receiving antenna) shall be calibrated against a known field of 10 $\mu\text{V}/\text{m}$ RMS produced by a well characterized an-

tenna consisting of orthogonal resonant dipoles, both parallel to and one quarter wavelength above the ground plane of a diameter of two meters or more at ground level. The dipoles shall have centers collocated and be excited 90 degrees apart. The half-power bandwidth of the detector shall be 25 kHz. If an aeronautical receiver is used for this purpose it shall meet the standards of the Radio Technical Commission for Aeronautics (RCTA) for aeronautical communications receivers. The aircraft antenna shall be horizontally polarized. Calibration shall be made in the community unit or, if more than one, in any of the community units of the physical system within a reasonable time period to performing the measurements. If data is recorded digitally the 90th percentile level of points recorded over the cable system shall not exceed 10 $\mu\text{V}/\text{m}$ RMS; if analog recordings is used the peak values of the curves, when smoothed according to good engineering practices, shall not exceed 10 $\mu\text{V}/\text{m}$ RMS.

(b) In paragraphs (a)(1) and (a)(2) of this section the unmodulated test signal used on the cable plant shall: (1) Be within the VHF aeronautical band 108 MHz to 137 MHz or any other

frequency in which the results can be correlated to the VHF aeronautical band and (2) have an average power level equal to the average power level of the strongest cable television carrier on the system.

(c) In paragraph (a)(1) and (2) of this section, if a modulated test signal is used, the test signal and detector technique must, when considered together, yield the same result as though an unmodulated test signal were used in conjunction with a detection technique which would yield the RMS value of said unmodulated carrier.

(d) If a sampling of at least 75 percent of the cable strand (and including any portions of the cable system which are known to have or can reasonably be expected to have less leakage integrity than the average of the system) as described in paragraph (a)(1) cannot be obtained by the cable operator or is otherwise not reasonably feasible, the cable operator shall perform the airspace measurements described in paragraph (a)(2).

(e) Prior to providing service to any subscriber on a new section of cable plant, the operator shall show compliance with either: (1) The basic signal leakage criteria in accordance with

tribution Products Will

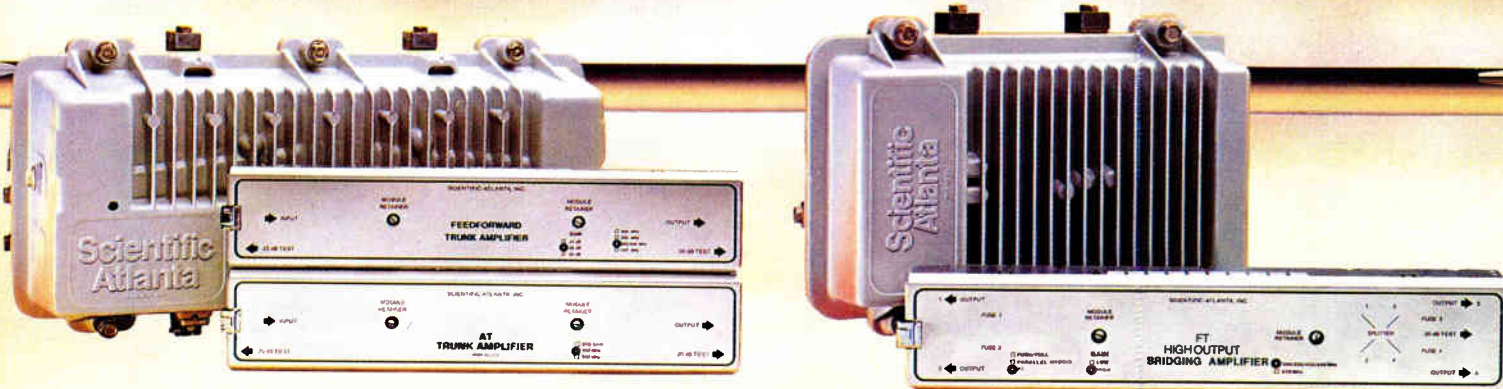

FEEDFORWARD AND AT AMPLIFIERS.

Get a full line of "drop-in" upgrades. Mix and match to grow capacity more economically. AT outdistances conventional power doubling, stretches spacing and maintains high picture quality. Feedforward amplifiers have over 99% reliability, earning us the industry's largest installed base.

FT BRIDGER AND LINE EXTENDER.

Super trunk performance out to the feeder, with output needed to deliver up to 27 more channels without respacing. FT takes high quality AT, feedforward, or fiber signals to the home. With twice the output of power doubling, half the distortion and 27% less power consumption, FT runs cooler and more reliable.

paragraph (a)(1) or (a)(2) or this section for the entire plant in operation or (2) a showing shall be made indicating that no individual leak in the new section of the plant exceeds $20 \mu\text{V}/\text{m}$ at 3 meters in accordance with 76.609 of the Rules.

(f) Notwithstanding paragraph (a) of this section, a cable operator shall be permitted to operate on any frequency which is offset pursuant to 76.612 in the frequency band 108 MHz to 137 MHz for the purpose of demonstrating compliance with the cable television basic signal leakage performance criteria.

76.612 Cable television frequency separation standards

All cable television systems which operate in the frequency bands 108 MHz to 137 MHz and 225 MHz to 400 MHz shall comply with the following frequency separation standards:

(a) In the aeronautical radiocommunication bands 118 MHz to 137 MHz, 225 MHz to 328.6 MHz and 335.4 MHz to 400 MHz, the frequency of all carrier signals or signal components carried at an average power level equal to or greater than 10^{-4} watts in a 25 kHz

bandwidth in any 160 microsecond period must operate at frequencies offset from certain frequencies which may be used by aeronautical radio services operated by Commission licensees or by the United States Government or its Agencies. The aeronautical frequencies from which offsets must be maintained are those frequencies which are within one of the aeronautical bands defined in this subparagraph, and when expressed in MHz and divided by 0.025 yield an integer. The offset must meet one of the following two criteria:

(1) All such cable carriers or signal components shall be offset by 12.5 kHz with a frequency tolerance of ± 1 Hz (Harmonically Related Carrier (HRC) comb generators only).

(b) In the aeronautical radionavigation bands 108 MHz to 118 MHz and 328.6 MHz to 335.4 MHz, the frequency of all carrier signals or signal components carried at an average power level equal to or greater than 10^{-4} watts in a 25 kHz bandwidth in any 160 microsecond period shall be offset by 25 kHz with a tolerance of ± 5 kHz. The aeronautical radionavigation frequencies from which offsets must be maintained are defined as follows:

(1) Within the aeronautical band 108 MHz to 118 MHz when expressed in MHz and divided by 0.025 yield an even integer.

(2) Within the band 328.6 MHz to 335.4 MHz, the radionavigation glide path channels are listed in Section 87.501 of the Rules.

Note: The HRC system, as described above, will meet this requirement in the 328.6 MHz to 335.4 MHz navigation glide path band. Those Incrementally Related Carriers (IRC) systems, with comb generator reference frequencies set at certain odd multiples equal to or greater than 3 times the 0.0125 MHz aeronautical communications band offset, e.g. $(6n + 1.250 \pm 0.0375)$ MHz, may also meet the 25 kHz offset requirement in the navigation glide path band.

[50 FR 29400, July 19, 1985]

76.613 Interference from a cable television system

(a) Harmful interference is any emission, radiation or induction which endangers the functioning of a radionavigation service or of other safety services or seriously degrades, obstructs or

Take You Further Th

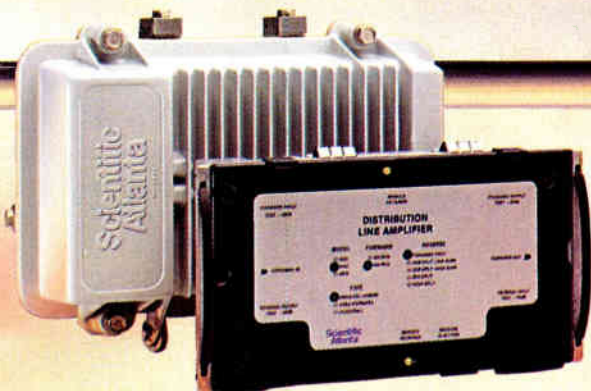

4-PORT DISTRIBUTION AMPLIFIERS.

Total flexibility is the key. Use a distribution amplifier for the trunk or feeder. Choose: push/pull, parallel hybrid or feedforward with bandwidth options that range to 550 MHz and beyond. Amplifier housings add flexibility, with internal splitters and AGC options.



TAPS AND PASSIVES.

Easy to install and almost impossible to break. Solid brass ports and powder based coating protect against corrosion. Ports are lengthened to accommodate locking terminators, security shields or weather boots. Modular design allows for easy upgrades and backward compatibility.

repeatedly interrupts a radiocommunication service operating in accordance with this chapter.

(b) The operator of a cable television system that causes harmful interference shall promptly take appropriate measures to eliminate the harmful interference.

(c) If harmful interference to radio communications involving the safety of life and protection of property cannot be promptly eliminated by the application of suitable techniques, operation of the offending cable television system or appropriate elements thereof shall immediately be suspended upon notification by the Engineer in Charge (EIC) of the Commission's local field office, and shall not be resumed until the interference has been eliminated to the satisfaction of the EIC. When authorized by the EIC, short test operations may be made during the period of suspended operation to check the efficacy of remedial measures.

(d) The cable television system operator may be required by the EIC to prepare and submit a report regarding the cause(s) of the interference, corrective measures planned or taken, and the efficacy of the remedial measures.

(Secs. 1, (302); (82 Stat. 290); 47 U.S.C. 151, 302)
[42 FR 41296, Aug. 16, 1977]

76.614 Cable television system regular monitoring

Cable television operators transmitting carriers in the frequency bands 108 MHz to 137 MHz and 225 MHz to 400 MHz shall provide for a program of regular monitoring for signal leakage by substantially covering the plant every three months. The incorporation of this monitoring program into the daily activities of existing service personnel in the discharge of their normal duties will generally cover all portions of the system and will therefore meet this requirement. Monitoring equipment and procedures utilized by a cable operator shall be adequate to detect a leakage source which produces a field strength in these bands of 20 μ V/m or greater at a distance of 3 meters. During regular monitoring, any leakage source which produces a field strength of 20 μ V/m or greater at a distance of 3 meters in the aeronautical radio frequency bands shall be noted and such leakage sources shall be repaired within a reasonable period of

time. The operator shall maintain a log showing the date and location of each leakage source identified, the date on which the leakage was repaired, and the probable cause of the leakage. The log shall be kept on file for a period of two (2) years and shall be made available to authorized representatives of the Commission upon request.

[50 FR 29400; July 19, 1985]

76.615 Notification requirements

All cable television operators shall comply with each of the following notification requirements:

(a) The operator of the cable system shall notify the Commission annually of all signals carried in the aeronautical radio frequency bands, noting the type of information carried by the signal (television picture, aural, pilot carrier, or system control, etc.) The timely filing of FCC Form 325, Schedule 2, will meet this requirement.

(b) The operator of a cable system shall notify the Commission before transmitting any carrier or other signal component with an average power level across a 25 kHz bandwidth in any 160 microsecond time period equal to

an Anyone Else.

Our Total Systems Architecture™ approach to CATV means we can take you further than anyone else. And we'll get you there more efficiently, reliably and, in the long run, more economically.

At Scientific-Atlanta — we do it right.
Call or write Scientific-Atlanta
Dept. AR, P.O. Box 105027
Atlanta, GA 30348 1-800-722-2009.

Scientific Atlanta

Our customers are the winners.

Reader Service Number 7

or greater than 10^{-4} watts at any point in the cable distribution system on any new frequency or frequencies in the aeronautical radio frequency bands. Such notification shall include:

(1) Legal name and local address of the cable television operator;
 (2) The names and FCC identifiers (e.g. CA0001) of the system communities affected;

(3) The names and telephone numbers of local system officials who are responsible for compliance with 76.610, 76.611 (effective July 1, 1990), and 76.612 through 76.616 of the Rules;

(4) Carrier and subcarrier frequencies and tolerance, types of modulation and the maximum average power levels of all carriers and subcarriers occurring at any location in the cable distribution system.

(5) The geographical coordinates of a point near the center of the cable system, together with the distance (in kilometers) from the designated point to the most remote point of the cable plant, existing or planned, which defines a circle enclosing the entire cable plant;

(6) description of the routine monitoring procedure to be used; and

(7) For cable operators subject to 76.611 (effective July 1, 1990), the cumulative signal leakage index derived under 76.61(a)(1) (effective July 1, 1990) or the results of airspace measurements derived under 76.611(a)(2) (effective July 1, 1990), including a description of the method by which compliance with basic signal leakage criteria is achieved and the method of calibrating the measurement equipment. This information shall be provided to the Commission prior to July 1, 1990 and each calendar year thereafter.

[50 FR 29400, July 19, 1985]

76.616 Operation near certain aeronautical and marine emergency radio frequencies

The transmission of carriers or other signal components capable of delivering peak power levels equal to or greater than 10^{-5} watts at any point in a cable television system is prohibited within 100 kHz of the frequency 121.5 MHz, and is prohibited within 50 kHz of the two frequencies 156.8 MHz and 243.0 MHz.

[50 FR 29401, July 19, 1985]

76.618 Grandfathering

Cable television systems are permitted to use aeronautical frequencies which were requested or granted for use by November 30, 1984, under Section 76.619 of the Rules until July 1, 1990.

[50 FR 29401, July 19, 1985]

76.619 Grandfathered Operation in the frequency bands 108 MHz to 136 MHz and 225 MHz to 400 MHz

All cable television systems operating in a grandfathered status under 76.618 of the Rules and transmitting carriers or other signal components capable of delivering peak power equal to or greater than 10^{-5} watts at any point in the cable system in the frequency bands 108 MHz to 136 MHz and 225 MHz to 400 MHz for any purpose are subject to the following requirements:

(a) The operator of the cable system shall notify the Commission annually of all signals carried in these bands, noting the type of information carried by the signal (television, aural, or pilot carrier and system control, etc.). The timely filing of FCC Form 325, Schedule 2, will meet this requirement.

(b) The operator of the cable system shall notify the Commission of the proposed extension of the system radius in these bands. Notification shall include carrier and subcarrier frequencies, types of modulation, the previously notified geographical coordinates, the new system radius and the maximum peak power occurring at any location in the cable distribution system. No system shall extend its radius in these bands without prior Commission authorization.

(c) The operator of the cable system shall maintain at its local office a current listing of all signals carried in these bands, noting carrier and subcarrier frequencies, types of modulation, and maximum peak power which occurs at any location within the cable distribution system.

(d) The operator of the system shall provide for regular monitoring of the cable system for signal leakage covering all portions of the cable system at least once each calendar year. Monitoring equipment and procedures shall be adequate to detect leakage sources which produce field strengths in these bands of 20 microvolts per meter at a distance of 3 meters. The operator shall maintain a log showing the date and

location of each leakage source identified, the date on which the leakage was eliminated, and the probable cause of the leakage. The log shall be kept on file for a period of two (2) years, and shall be made to authorized representatives of the Commission on request.

(e) All carrier signals or signal components capable of delivering peak power equal to or greater than 10^{-5} watts must be operated at frequencies offset from aeronautical radio services operated by Commission licensees or by the United States Government or its agencies within 111 km (60 nautical miles) of any portion of the cable system as given in paragraph (f) of this section. (The limit of 111 km may be increased by the Commission in cases of "extended service volumes" as defined by the Federal Aviation Administration or other federal government agency for low altitude radio navigation or communication services.) If an operator of a cable system is notified by the Commission that a change in operation of an aeronautical radio service will place the cable system in conflict with any of the offset criteria, the cable system operator is responsible for eliminating such conflict within 30 days of notification.

(f) A minimum frequency offset between the nominal carrier frequency of an aeronautical radio service qualifying under paragraph (d) of this Section and the nominal frequency of any cable system carrier or signal component capable of delivering peak power equal to or greater than 10^{-5} watts shall be maintained or exceeded at all times. The minimum frequency offsets are as follows:

Frequencies	Minimum frequency offsets
108-118 MHz	(50 + T) kHz.
328.6-335.4 MHz	
108-136 MHz	
225-328.6 MHz	(100 + T) kHz.
335.4-400 MHz	

In this table, T is the absolute value of the frequency tolerance of the cable television signal. The actual frequency tolerance will depend on the equipment and operating procedures of the cable system, but in no case shall the frequency tolerance T exceed ± 25 kHz in the bands 108 MHz to 136 MHz and 225 MHz to 400 MHz.

[50 FR 29401, July 19, 1985] ■

TOTAL LEAKAGE PROTECTION



INTRODUCING *SNIFFER III*TM

From signal leakage detection to easy CLI certification, the SNIFFER III now adds the power of microvolt display to the industry standard SNIFFER Leakage Detection System. The new microvolt display joins a host of other SNIFFER III features that will put you in total control of your signal leakage program. Get the details today. . .



COMSONICS[®], INC.

An Employee Owned Corporation

1350 Port Republic Road, P.O. Box 1106, Harrisonburg, VA 22801
Toll Free (800) 336-9681, In VA (703) 434-5965

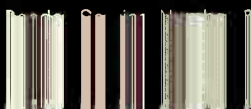

Aeronautical band access: the new regulations

The Federal Communications Commission began reviewing the access requirements for cable usage of channels in the aeronautical band in the mid-1970s by the issuance of docket 21006. The final Rules were adopted in 1985 and will fully come into effect July 1, 1990. Up until that time, cable operators will be able to operate under the previous Rules, which continue to be grandfathered until July 1, 1990. They cannot add new channels under the old Rules but must comply with the new regulations if they wish to add any channels in the aeronautical band. The regulations regarding use of the aeronautical bands begin in section 76.610 of the Code of Federal Regulations, Title 47, Telecommunications, Part 76, Cable Television Service.

It must be pointed out that the new regulations for aeronautical band usage do not in any way change the signal leakage requirements that a cable system must meet. This requirement, in 76.605 (a) (11), specifies that the radiation limit for cable systems is as follows: up to and including 54 MHz, 15 microvolts per meter, measured at 100 feet; over 54 MHz up to and including 216 MHz, 20 microvolts per meter, measured at a distance of 10 feet. Any signals over 216 MHz have a leakage limit of 15 microvolts per meter measured at 100 feet from the leakage source.

Cable system operators are required to maintain their systems within these very tight leakage limits in order to insure they do not cause interference to other users of the spectrum. It must be remembered that cable systems are allowed access to bands outside normal TV transmission on the assumption that they will not leak and, therefore, will not interfere with authorized users of those other bands.

Section 76.609 (h), specifies the measurement procedures to determine whether a system is in compliance.

Section 76.610

Section 76.610 is the beginning of

By Brian James, director of engineering, NCTA

the regulations regarding operation in the frequency bands 108 MHz to 137 MHz and 225 MHz to 400 MHz. These two bands constitute the aeronautical bands. The aeronautical band section of the Rules are applicable to all cable television systems with carriers having signal components operating at an average power level equal to or greater than 10^{-4} watts (38.75 dBmV) across a 25 kHz bandwidth in any 160 microsecond period at any point in the cable distribution system in the aeronautical bands.

If a cable operator is operating carriers in these bands at these levels then the system must comply with these Rules by July 1, 1990. Prior to that date the system will have had to have been authorized under the old Rules and the grandfathering procedures will cover the operation until July 1, 1990. The 136 MHz to 137 MHz band is excluded until July 1, 1990, however a cable operator should consider this portion to be included in this band for current operation and not procrastinate on including it.

Section 76.611

Section 76.611 covers the basic signal leakage performance criteria which applies to the aeronautical band. These special requirements are in addition to the general signal leakage requirement. They are specified to ensure that the cable system is operating in a manner which will not interfere with aircraft prior to turning on signals in the aeronautical band. Prior to July 1, 1990 or at anytime after that date but prior to inserting a new signal in the aeronautical band, the cable operator must insure compliance by either a ground-based measurement procedure or a flyover procedure.

These procedures provide a snapshot of the signal leakage condition of the cable system and must be performed once a year with no more than 12 months between tests. The ground-based measurements require the testing of at least 75 percent of the cable strand. This must include any portions of the cable system which are known to have or can reasonably be expected

to have less leakage integrity than the average of the system. The cable operator can either demonstrate compliance with a cumulative signal leakage index by showing either an I_{3000} equal to or less than -7 or an I_{∞} equal to or less than 64 using procedures and formulas set out in the regulations.

The alternative, which would normally be done by cable operators with larger systems, is to perform a flyover of the system. With this procedure the system is monitored by an aircraft at a height of 1,500 feet (450 meters) to determine whether or not at any point above the cable system the signal leakage creates a field in excess of 10 microvolts per meter at the test altitude. The test is performed using carriers in the 108 MHz to 137 MHz band or can be performed at other frequencies if the correlation between the measurements is shown to the FCC.

If a new section of cable plant is to be energized, the operator must show compliance with either the basic signal criteria by performing a ground-based measurement or an airspace measurement. If this is not feasible, then the operator can make a showing that indicates that no individual leak in the new section of plant exceeds 20 microvolts per meter at 3 meters. In order to perform these tests prior to energizing the plant a cable operator is allowed to put a test signal on the system at an approved offset frequency in the aeronautical band for the purpose of determining compliance with the regulations.

Section 76.612

Section 76.612 specifies the new offset requirements for operation in the aeronautical band. The FCC no longer allows a cable operator to request authorization for a specific nominal or offset frequency that is not in use within the aeronautical frequencies in the general area. These specific offset frequencies must be changed to the new offset frequencies as called for in section 612. The offsets have been selected to ensure minimal chance of interference from cable operations by placing any carriers from the cable plant

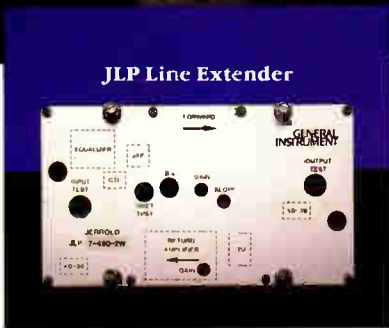
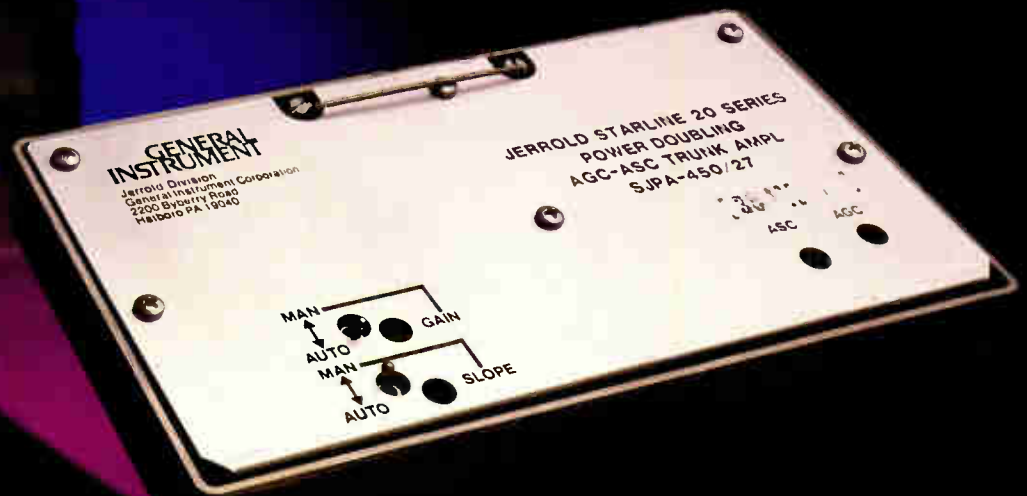

Double The Performance At Less Than Half The Cost.

Now you can double the performance of your Jerrold STARLINE 20 amplifiers—and dramatically increase channel-carrying capacity—without major rebuild costs or service disruption.

The SJA upgrade module is designed for easy drop-in installation so you can take the labor savings, time savings and hardware savings all the way to the bank. But that's not all . . .

You Can Bank On the SJA's:

- ability to expand your present system's channel capacity.
- 5-sided die-cast shell for outstanding heat dissipation.
- exceptionally high picture quality.
- flat or tilted transmission capabilities.

Jerrold's modular approach to upgrades extends all the way down the line: from our high gain, power doubling, JLP line extender modules to our "J" series FFT brass port taps. And this modular design gives you the advantage of backward compatibility, underscoring Jerrold's commitment to long-term customer support.

WHY BUY NEW HOUSINGS WHEN ALL YOU NEED IS MORE ROOM?

So why throw away money on a new housing when all you really need is more headroom? For more information about these or any Jerrold product, contact your local Jerrold account representative. Or call

or write: Jerrold Division, General Instrument Corporation, 2200 Byberry Road, Hatboro, PA 19040. (215) 674-4800



JERROLD

A Division of General Instrument Corporation

midway between the carrier frequencies of the communications and navigation signals. The cable signals will fall between assigned channels in the aeronautical band.

The aeronautical radio communication band is 108 MHz to 137 MHz, 225 MHz to 328.6 MHz and 336.4 MHz to 400 MHz. Within these bands, communication channels are channelized on a 25 kHz spacing. In order for cable channels to fall midway between these channels they must be offset by 12.5 kHz from any of the communications carriers. In addition to the offset a frequency tolerance of ± 5 kHz is allowed. Special consideration has been made for harmonically related carrier (HRC) systems. They are allowed to operate in the communication bands providing the comb generator has a fundamental frequency of 6.0003 MHz with a frequency tolerance of ± 1 Hz.

The aeronautical radio navigation bands are 108 MHz to 118 MHz and 328.6 MHz to 335.4 MHz. These radio navigation bands are channelized on a 50 kHz spacing. Cable signals must be offset by 25 kHz in order to fall midway between channels. Special review of the final frequencies for HRC and IRC operation must be made to insure that the resulting frequencies from their comb generators do, in fact, comply with the specified process for the navigation bands.

All cable operators must review their assigned frequencies now and with the new offsets to ensure that they will be operating at the new offset nominal frequency. Cable operators cannot use offset equipment which was designed for a frequency that falls close but not on the nominal offset frequency. For instance, if you are presently offset by 15 kHz you cannot operate this equipment under the new rules on the assumption that it is within the ± 5 kHz tolerance. The equipment must be designed to operate on the assigned frequency. All equipment in operation at other than the new offsets must be removed from service by July 1, 1990.

Section 76.613

Section 76.613 covers interference from a cable television system. Harmful interference is defined as any emission, radiation or induction which endangers the functioning of a radio navigation service or other safety services or seriously degrades, obstructs or repeatedly interrupts a radio communication service operating in accordance

with this chapter. If a cable television system causes harmful interference the operator shall promptly take appropriate measures to eliminate harmful interference.

If harmful interference to a radio communication involving safety of life and protection of property cannot promptly be eliminated by application of simple techniques, operation of the offending cable television system or appropriate elements thereof shall immediately be suspended upon notification of the FCC engineer in charge, i.e., if you can't fix it, you shut the channel off. The channel cannot be turned back on until the interference has been eliminated to the satisfaction of the FCC's engineer in charge.

In order to determine that this elimination has been accomplished, the engineer in charge may allow short test periods during which the cable operator can test his system to ensure that it is not leaking. The engineer in charge, of course, can request from the cable operator a detailed explanation of the cause of the interference and the corrective measures planned or taken in the efficacy of the remedial measures.

Section 76.614

This section specifies cable system regular monitoring. Under the old Rules, cable systems only had to be monitored once a year to ensure they were not leaking. The FCC believes this was not adequate so the new regulations require that systems be monitored once each quarter. The monitoring equipment and procedures must be adequate to detect a leakage source which produces a field of 20 microvolts per meter or greater at a distance of 3 meters from the leakage source in the mid-band aeronautical band.

Cable systems can either dedicate a person or persons to systematically patrol or monitor the system once each quarter or they can install monitoring equipment in a sufficient number of service vehicles so that over the period of three months, over 90 percent of the cable plant has been monitored by a monitoring device. Any leaks in excess of 20 microvolts per meter must be logged and corrected with a log maintained showing the date and location of each leakage source, the date the leak was repaired and a probable cause of the leak.

These logs must be kept on file for a period of two years and must be made available to authorized representatives

of the Commission upon request. When determining the procedures and equipment for monitoring, the cable operator must review normal plant location and truck driving monitoring habits to ensure that if they are trying to monitor plant that is located in the back yard the equipment is sensitive enough to detect a leak that would exceed the specification.

Section 76.615

This section specifies the notification requirements. The notification requirements must be complied with prior to the cable operator turning on signals in the aeronautical bands as specified in the new aeronautical band requirements. If a cable operator is changing the frequency offset from a grandfathered to a new aeronautical offset, the operator must inform the FCC prior to that change of frequency.

The cable operator must provide the Commission with the following information: each year the system must notify the Commission of all signals carried in the aeronautical radio frequency bands, noting the type of information carried by the signal (i.e., television, aural subcarrier, pilot carrier, etc.). FCC form 325, schedule 2 will meet this requirement. The cable operator shall also notify the Commission before transmitting any carrier or other signal component with an average power of 10^{-4} watts or greater (38.75 dBmV) at any point in the cable distribution system on any new frequency or frequencies in the aeronautical radio frequency bands.

This notification must include: the legal name and local address of the cable television operator; the names and FCC identifiers of the system communities affected; the names and telephone numbers of local system officials who are responsible for compliance with these sections of the rules and the carrier and sub-carrier frequencies and their tolerances; type of modulation of maximum average power levels of all carriers and sub-carriers occurring in any location in the cable distribution system; the geographical coordinates of a point near the center of the cable system together with the distance in kilometers from the designated point to the most remote point in the cable plant, existing or planned, which defines a circle closing the entire cable plant; a description of the routine monitoring procedure which will be used, including description of the monitoring equipment and its sensitivities;

and after July 1, 1990 a cumulative leakage index or airspace measurement test result, including a description of the method by which compliance with basic signal leakage criteria is achieved and the method of calibrating the measurement equipment.

This information must be provided to the Commission prior to July 1, 1990, and each calendar year thereafter. The FCC is now reviewing the exact details of the submissions they desire and will indicate in the near future what information they want and when they would like to begin receiving that information.

Section 76.616

Section 76.616 specifies the restriction regarding use of frequencies near certain aeronautical and marine emergency radio frequencies. Cable signals cannot exceed 10^{-5} watts at any point in the cable television system within 100 kHz of the frequency 121.5 MHz. In addition, it cannot have signals in excess of 10^{-5} watts within 50 kHz of the two frequencies 156.8 MHz and 243.0 MHz. These are all emergency radio frequencies used when aircraft or marine equipment has an emergency safety life situation. Cable systems must not cause interference on these bands and are, therefore, restricted to a lower maximum signal level and are not allowed to exceed that at any point in the cable system.

Section 76.617

Section 76.617 covers responsibility for interference and generally states that it is the cable operator's responsibility to ensure that devices attached to the cable system do not leak in excess of Part 15 of the rules. In those instances where these devices leak in excess of Part 15 regulations, the cable operator is only obliged to disconnect service to that device. Similarly for antennas and selector switches, it is the operator of the switch who is responsible for ensuring that the switch does not leak in excess of Part 15. However, if it does the cable operator is responsible for disconnecting service to that switch.

Sections 76.618 and 76.619

Section 76.618 and 76.619 cover the grandfathering provisions. These provisions allow cable operators to continue to operate on authorizations they had received prior to the conclusion of docket 21006. These grandfathering

conditions will expire on July 1, 1990. At that time, the cable operator must be in complete compliance with the new regulations. This means that frequencies and offsets, carrier information, etc. filed with the FCC, a cumulative leakage index test or flyover test successfully completed and filed with the FCC, monitoring procedures and equipment in place to ensure continued compliance with the regulations and offsetting of all carriers on the system

to the new offsetting frequencies.

If a system is not in compliance with all these requirements then the system does not have authorization to operate on the new frequencies. The operator must then stop carrying those signals on the system effective July 1, 1990. This can have a serious impact on channel availability. If a 54-channel, 400 MHz system, does not comply with the new regulations then it will, overnight, become a 20-channel system. ■

CLI PROOF OF SUCCESS: SNIFF-WARE™

ComSonics invented successful leakage detection with the SNIFFER family of detection equipment — now you can put that technology right into your IBM compatible system.

SNIFF-WARE brings you powerful X-Y Plot, System Gridding, leakage levels and $\mu\text{V}/\text{meter}$, dBmV. It's powerful, affordable and available!

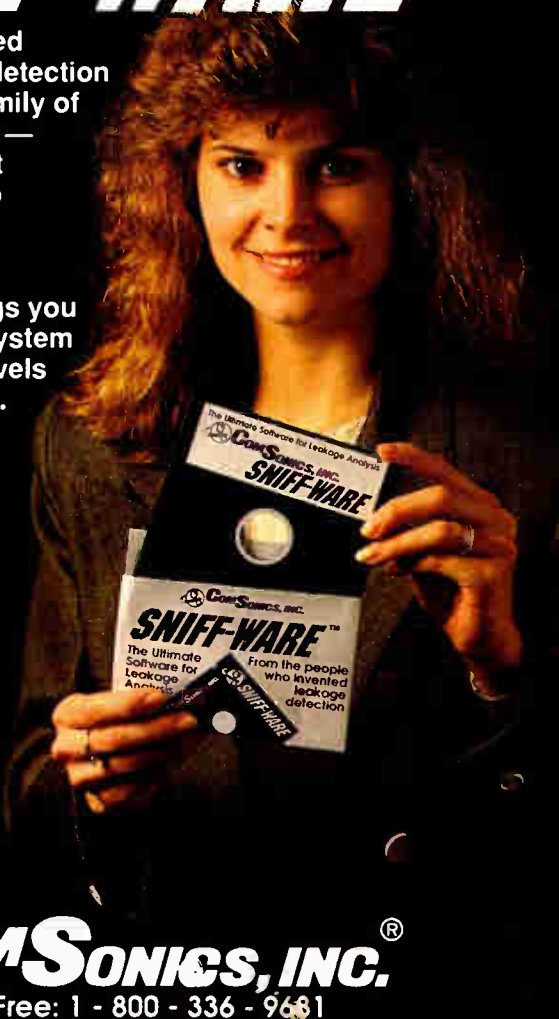

COMSONICS, INC.®

Call-Toll Free: 1 - 800 - 336 - 9681
In Virginia Collect: 1 - 703 - 434 - 5965

The history of signal leakage: An unauthorized autobiography

In the early days of cable, the signals carried on the cable were within the same portion of the spectrum as commercial VHF television (54 MHz to 72 MHz, 76 MHz to 88 MHz and 174 MHz to 216 MHz). The first motivation by cable operators to suppress cable leakage was to avoid giving the product away to non-subscribers. Whatever efforts the industry applied until the early '70s were driven by prevention of non-subscribers viewing the product and complaints of interference to over-the-air reception by non-subscribers within a system. When over-the-air signals are interfered with by cable signals, on or near the same frequency, a beat, co-channel effect or so called bar & ghost may occur, depending on the conversion technique and program source being used on the offending channel.

When cable grew beyond 12 channels, it also grew out of the historical spectrum for over-the-air television transmission; with the advent of push-pull amplifying stages which were suitable for cable amplifier use, a major stumbling block was removed for use of frequencies in the heretofore unused "midband."

Taking over the turf

The arrangement of the original 12 channels is no historical accident. They were chosen to minimize adverse radio properties that were difficult or impossible to manage with the hardware of the era. The spectrum 108 MHz to 176 MHz (which is the second harmonic of the lowband) represents a heavily populated portion of the radio spectrum. Most aviation communications and navigation, two-way radio and a very popular radio amateur band all are subsumed within this area.

Once the technological barrier of second-order beats was removed, cable moved right in and set up house. If this seems like a harsh characterization, it reflects equally on the author who turned on everything he could find as soon as the push-pull amps went up.

We were cable TV, which meant that

signal goes through the wire, right? Radio signals go through the sky and cable signals go through wire. So we started parceling out the new territory of 120 MHz to 126 MHz., let's call it channel A or 14 (depending on who you were talking to). You say airplanes use this band? That's OK, these are cable signals remember? And up the spectrum we marched, to channel E (or 18); 2-meter ham band? Channel F (or 19); VHF FM radio band? Only when you're in the sky, these megahertz in coax

The first motivation by cable operators to suppress cable leakage was to avoid giving the product away to non-subscribers.

belong to us! We simply saw this as a harmless way of offering more channels over our systems.

Storm clouds moved in

The first clouds came over the horizon in the early '70s when the IEEE formed a committee on the topic and asked that the Office of Telecommunications (OTP) look into any potential hazard created by cable's use of this "new" spectrum. In 1972 the FCC¹ felt it was a remote possibility, but lots of other things can also get into the "aeronautical" spectrum and we have no incidents of complaint. This was not a cavalier response in that the prevailing regulation, which remains in force today, provided for incidental emission from other sources (i.e. television receivers, etc. and FM radio stations); millions of times more than that which was ever permitted from a cable system.

While the FCC essentially said if it ain't broke don't fix it, they, as well as others, invited the predecessor of the NTIA (National Telecommunications and Information Administration) to

determine if cable TV could impinge on aeronautical navigation systems. These studies reported in 1974² and 1975³ said, "maybe."

Then came Harrisburg

In 1976, as we were painting fire plugs like little solders and thinking of the Bicentennial, it finally happened. In April 1976 signals from a cable system in Harrisburg, Pa. opened the squelch of a communications receiver aboard an aircraft.

In response to this incident, the FCC issued an interim rule⁴ to provide for the offset of cable signals in the aeronautical bands from the frequencies used by nearby aeronautical facilities. Speaking of interim, in 1958, a small transistorized AM-FM radio called a Grundig Transworld Jr. was used aboard a commercial aircraft⁵, resulting in a minor navigational malfunction. The FAA, "blind sided" by this, conducted an investigation, and in 1961 as an *interim* measure, banned personal radio receivers. This little guy was a miniature transmitter in that it produced 700 $\mu\text{V}/\text{m}$ at 115 MHz.

Shortly after Harrisburg, the Advisory Committee on Cable Signal Leakage was impaneled. This committee was chartered to advise the FCC on the issues of radio frequency interference from cable systems. The 21 members represented the FCC, FAA, and the cable industry. Cable had good representation, including Dick Shimp, Bob Luff and Bob Dickinson.

During the same timeframe, the FCC, through its Field Office Bureau (FOB), set about evaluating the radiation from 66 systems located across the country. They concluded that about one-half the leaks evaluated were less than 100 $\mu\text{V}/\text{m}$ at 10 feet and that the incidence of leakage was about one leak per seven miles of plant.

Table Mesa testing

The FOB purposefully examined systems of widely differing age and size to attempt to gain the greatest understanding of the circumstances more likely to be present in systems with high amounts of signal leakage. Also in this same approximate period, the

By Ted Hartson, vice president and chief engineer, Post-Newsweek Cable

Psssst...

Rumor has it
that the best
kept secret
for testing
Broadband
Networks is
OUT
of the
BAG!

The Calan 1776/1777 Sweep/Analyzer System

Unique in the industry, the Calan 1776/1777 is the only synchronized receiver/transmitter with a built-in spectrum analyzer that provides a true sweep response and non-interference to data or video.

In addition, it offers a portable, lightweight design and the reputation of being the **Most Reliable** sweep/analyzer system ever designed for broadband test and measurement requirements.

If you have a Broadband Network and don't have the Calan 1776/1777 Sweep/Analyzer System, you can **Pounce** on one by calling a Calan representative for a demonstration in your system.



The Calan logo consists of the word 'CALAN' in a bold, blue, sans-serif font. The letters are outlined, giving it a three-dimensional appearance. The logo is positioned to the right of the product image.

CABLE AND LOCAL AREA NETWORKS

CALAN, Inc.
R.R. 1, Box 86T
Dingmans Ferry, PA 18328
800-544-3392 • In PA: 717-828-2356

Reader Service Number 11

Office of Telecommunications conducted the so-called "Table Mesa tests," wherein attempts were made to characterize⁶ the fields about a "typical" broken cable. Elsewhere, theories emerged suggesting that maybe cable was a huge, tuned array and that all of its power would in some way project upward. (Pow, good-bye aircraft!)

The notion was called an "endfire radiation antenna pattern" or "phase addition."

The work of the Advisory Committee on cable signal leakage was finalized in a report dated November 1, 1979.⁷ This work is extremely comprehensive and should be reviewed by any serious student of the leakage issue. In summary, the ACCSL concluded that reasonably simple ground-based measurements could infer the cable leakage that one might reasonably expect in the airspace over a cable system. Further, that adherence to CLI limits would provide virtually no hazard to aeronautical communications receivers as they are operated in actual practice, and that navigation receivers should be offered *greater* protection through *frequency offset* (emphasis added).

Benefit of the doubt

Continuing, they also reported that of 13 systems tested, only two represented a potential hazard, both of which were old and in poor repair. They felt that systems built under modern conditions with current (1979) hardware, would with reasonable leakage monitoring, *not* be a probable hazard to aeronautical communications.

The committee further held that leakage sources less than 100 $\mu\text{V}/\text{m}$ at 3 meters did not "contribute significantly" to the prospective hazard of cable leakage. They also could not add credence to or duplicate the issue of "phase addition."

Before we enter the Eighties, one final point from the 1978 FOB report should be relayed. In 1978, all the animals were still in the forest, in that little if any leakage repair, except on a demand basis, was being performed. The FOB found the following average distribution of leaks:

Percentage	$\mu\text{V}/\text{m}$
51	100
24	250
17	350
12	500
4	1000
1	1500

Remember, the FOB also felt that

we had about one leak per seven miles of system. Based on the data we see coming across in 1989, one might infer that many systems perform today about like they did in 1978!

Interference and panic

In the summer of 1980, all hell broke loose. A system in Flint, Michigan was held to have repeatedly interfered with aircraft in the area attempting to communicate with a traffic control center operating on 133.25 MHz (channel C visual). A leak was found and no further aircraft interference was reported. In a follow-up, the FCC held however, that the frequency was not offset as required, more leaks were found and that the operator had failed to take appropriate action.

It would be easy to name companies because they are a matter of public record and you can look them up, but the real issue is that it could have happened to any one of us in 1980, 1989 or next year. Any system old or new, tight or loose has the potential of projecting fields in the tens of thousands of microvolts/meter at 10 feet.

In 1985, an unusual chap named Dr. Strangleak⁸ issued forth at the NCTA convention. In these calculations the good doctor suggested:

Consider a distribution line operation at +42 dBmV. The power at this point may be calculated:

$$+42 \text{ dBmV} = \text{Log} \left(\frac{42}{20} \right) / 1000 = .125 \text{ Volts}$$

$$P = \frac{E^2}{R} = \frac{.125^2}{75} = .0002 \text{ Watts}$$

Assume that one-half of this power is radiated isotropically from a leakage source resulting in a source power of 100 microwatts.

$$P = \frac{P_t}{4\pi(R)^2} = \frac{100 \times 10^{-6}}{12.56 \times (3)^2} = 884 \times 10^{-9} \text{ Watts}$$

$$E = \sqrt{WR} = \sqrt{884 \times 10^{-9} \times 377} = 18,000 \mu\text{V m}$$

Under these conditions a leakage field of 18,000 $\mu\text{V}/\text{m}$ would be present at 3 meters. That ain't hay!

Out with Docket 21006

Meanwhile, back at the District, good old docket 21006 was getting some play. More people were getting interested in leakage and filing periods were extended so that they might be heard. Docket 21006 was released in October 1984 and after a successful petition for reconsideration was released in final

form on June 21, 1985.

The most significant change brought about during the reconsideration process was a shift from a quarterly monitoring program that required a mandatory full ride-out four times a year, to an ongoing program that could be integrated into routine system activities.

In Docket 21006 the Commission said, "...Not only the danger involved in co-channel use of aeronautical frequencies, but the substantial risk presented by a major cable break in a cable system [have caused us to be] considerably less confident than we were...that cable operators will diligently control signal leakage...."

The game was now afoot, in that the events of the time caused the FCC to doubt the contention of the ACCSL that said we could operate safely without offsets. The FCC said, "we believe the record supports strengthening, not relaxing the present requirements...." but, don't stop there. It went on "[we don't think] that cable operators can be relied on to maintain their systems sufficiently free from leakage [to not be a risk]...."

As 21006 continued to unfold, the FCC felt that universal offsets, in that the frequencies permitted to cable would clear universally all aeronautical channels, were easier to manage than the older, so called "negotiated offsets," where you would request, and the Commission would permit a specific and unique offset, based only on services near your system.

Old versus new

How do you do that? Old aeronautical offsets were 50 kHz or 100 kHz from the protected channels. New offsets in the aeronautical communication spectrum are 12.5 kHz (navigation, 25 kHz.) The protection of all potential channels of aeronautical use actually resulted in many cable channels being moved *closer* to the protected channel. "Old aeronauticals" had rather relaxed frequency tolerance, new offsets require a stability of 5 kilohertz. Docket 21006 also affirmed the ACCSL's position on forecasting fields above a system through the use of ground-based measurements. The final rules called for demonstration of acceptable leakage management by:

- Ground-based measurements, CLI (Infinity): Limit 64.
- Ground-based measurements, CLI (3000): Limit -7.
- Flyover: 90 percent below 10 $\mu\text{V}/\text{m}$

HISTORY OF SIGNAL LEAKAGE

at 450 meters.

The notion of frequency separation is not likely to go away on M Street in Washington until we as an industry can restore the Commission's confidence in our ability to control leakage.

The recent history is less exciting, but not entirely without incident.

In 1986, a system using channel A (121.250 MHz visual), carried over an AML system drifted and leaked so that the a visual carrier was at 121.5 MHz (an international distress frequency) with sufficient strength that it was received by a special satellite intended to monitor distress transmissions. Cable's fascination with satellites is a long established record, but this probably is the first (and hopefully, last) transmission from a system to a satellite!

Solving the problem

This history of leakage covers a lot of territory. Ironically, the problems are the same now as then. When things get loose or broken, leakage occurs. With modern leakage detection programs and the new awareness of full compliance prior to July 1990, any system that is serious about leakage compliance can meet the requirements.

The FCC has kept the door open for cable to offer alternative testing and for that matter, redeem itself. What is most important is that we maintain our systems in such a way as to not create a hazard to any communications and strive to truly have cable be a "closed system."

As we leave the '80s, it would be a good time to leave leakage behind. We as an industry are under the microscope as to how, and if, we can meet the new rules. Successful compliance rests in the hands of every operator.

The actual rules and regulations governing signal leakage are found in the *Code of Federal Regulations*, Title 47, parts 76.610 through 76.619 (which are reprinted elsewhere in this Handbook). The FCC requires that every cable operator have a current copy of the rules. ■

References

1. Cable Television Report and Order, 36 FCC 2d, 143, (1972).

2. Electromagnetic compatibility simulated CATV signals and aircraft navigation receivers. OT Report 74-39, Harr and Haakinson.

3. Radiating aerial coaxial cable measurements, OT-75-73, Harr and Juroshek.

4. Report and Order, 65 FCC 2d 813, (1977).

5. FAA task 101-33S reported January 5, 1961.

6. Electromagnetic fields of a dielectric coated coaxial cable with an interrupted shield, Wait & Hill, Office of Telecommunications, OT 75-192 (1975).

7. The report was reproduced in its entirety by the Society of Cable TV Engineers in 1981.

8. *Dr. Strangeleak* NCTA Technical

Papers, 1985.

The information assembled here has been primarily derived from public documents bearing on the issue of signal leakage. The commentary and modest humor is my own. Whenever a decision is to be made regarding any issue where Commission regulation is involved, operators should consult their own management or counsel as appropriate.

THE FCC IS READY.



ARE YOU?

Does your system comply with FCC leakage regulations? Now is the time to find out. The simplest, most effective, least expensive method to test for signal leakage is CableTrac's CLASS (CATV Leakage Aerial Survey System) "flyover" service.

It's the least expensive because it uses state-of-the-art signal tracking technology developed by Dovetail Systems.

It's the most effective because it graphically identifies leakage "hot spots" going far beyond a simple pass/fail report.

It's simple because you can now test in a day what otherwise would take weeks — without disrupting the work schedule of your staff.

The CableTrac report is ready for FCC filing and gives you additional credibility with the regulators through our independent "third party" status.

CLASS service is ideal for gaining access to the areas hard to reach with a ground crew. And CLASS service is available virtually everywhere throughout North America.

Call CableTrac today for additional information. Before July 1, 1990 slips up on you.



CableTrac, Inc.
19011 36th Ave. W. Suite A
Lynnwood, WA 98036
(206) 774-2100

Reader Service Number 12

A service of Dovetail Systems and Alpha Technologies.

Scrutinizing CATV operators: The FCC gets tough

As the deadline for compliance with the cable leakage rules moves closer, the FCC will begin to actively review cable systems to ensure they're truly in compliance. We took some "typical" questions often asked by CATV operators to John Wong, engineering adviser at the Video Services Division of the FCC and asked him to respond.

John, when will the FCC begin accepting CLI filings?
January 1990.

Will the FCC step up its inspection program in 1990?

To insure rule compliance, of course we will step up our inspection program. However, this does not necessarily mean additional on-site inspections by FOB engineers. This step-up can come in the form of closer paperwork scrutiny by the staff of the cable branch.

So cable operators have to make sure their filings are in order.
That's correct.

What will those field inspectors be looking for when they inspect a system?

They will still continue to look for leaks on the most suspect portion of the cable plant—usually the oldest part of the plant. After that, they may go to the headend or the headquarters of the cable system and look for monitoring, the repair logs, and the associated aeronautical filings. Maybe a quick spot check on some of the monitoring equipment to see if it works, whether they have a dead battery or not, who is responsible for signal leakage monitoring, and any system-related filing that is necessary to be filed with the FCC.

At the same time, the inspector is going to sense what is happening with the operations of the system—whether it's in order or whether it is in a shambles. That determines what additional time they are going to spend at that system. That does come back in their report. Now, we will have certain in-house inspectors, whether they're engineers or examiners, at headquarters who would review systems for the lack of CLI filings, questionable CLI

filings and accuracy of those CLI reports. On-site inspections, those at the system, will continue to become complaint driven, with an anticipation of an increase in requests for inspections by the in-house team to replace some of the random inspections.

What documentation and/or reports will the inspectors ask to see from the system management?

That is fairly self explanatory if one goes through the aeronautical rules. Generally, we will look for the aeronautical frequency notification filings—what are the actual frequencies used on the system? We can compare that with the notification. From then on, we will ask for the monitoring and repair logs of the leaks. Again, after that, the inspector will use his or her common sense with regard to the overall operations of the system. They'll test for knowledge on monitoring now by asking questions. Roger, you went to that mock inspection session (held at the Texas Cable Show), you can see how well it may go, or how short it can be. At that point we leave it up to whether the inspector feels it is a nice, clean operating system.

With regard to some of the documentation (we'll be looking for), as long as they keep it at an easily accessible location at the headend or at the headquarters, it's fine by us. The critical thing is that they are able to produce that information in a short period of time. It's OK even to have it in the form of floppy disks—they can easily print that out off the office PC, that's fine, too.

I see. Now, where does ultimate CLI compliance responsibility lie? Is it at the system level, or with the MSO?

I believe that this compliance responsibility lies at all levels of cable operations. Remember, these rules are considered the industry's compromise with the FAA. It has to go through all levels.

How about any possible grace period? Will that be possible, or would any of these rules possibly

be delayed when FCC personnel changes?

As far as I'm concerned, the five-year delay in implementation of the rules was the grace period. We're in the middle of it now. With personnel changes, anything can happen. However, I have mentioned this before, I will personally crusade against any additional delay in this implementation because a delay in the implementation of these rules can only hurt the industry later on. Come five years down the road, when we will need at least five years worth of statistical data on how the industry is complying with aeronautical usage criteria, when the FAA can split their assignments in 1995. We need that as our negotiation tool for the future.

What are the levels of penalty operators may have to pay if they're found not to be in compliance?

The level of consequence will depend upon the severity of the rule violation. At all times, corrective actions to eliminate the interference will always come first. The fines will follow. We can target any and all the channels in aeronautical bands used by the cable operators to ensure this compliance.

As far as the fines go, what fine structure has been set up? What are the levels of fines that an operator could be forced to pay?

Fines, in general, are (issued) on a case-by-case basis because we want to hear out the operator who may feel that (his system isn't in terrible shape). However, at this time we can levy fines of up to \$20,000 per violation—that's per individual leak. We still have in Congress a proposal to significantly increase those fines, as I mentioned before, for certain telecommunications industries. It could go up to \$1 million, but those have not been approved by Congress yet.

Are those one-time fines, or are those per-day fines?

Those are the maximum fines per violation.

Now, when an inspector comes

At Integral, Fiber Optics is "Old Hat"!

Hard



When you're ready for fiber optic cable-in-conduit, look no further than Integral. While Fiber Optics may be new to the CATV industry, it's "Old Hat" to us. We've been manufacturing Cablecon® Fiber Optic Cable-in-Conduit for more than 3 years now, and it's already in use in CATV "backbone" and transportation trunk line applications.

Integral has been in business for nearly three decades. Our involvement in the CATV industry began in 1980 and for the last four years, we have been considered the leader in the industry. Our Cablecon Cable-in-Conduit and empty duct are used in

more CATV underground plant installations than any other polyethylene duct. We are one of the largest commercial purchasers of underground coaxial cable in the United States.

Integral's Cablecon Fiber Optic Cable-in-Conduit provides the optimum solution for your underground plant installation needs. Our tough polyethylene duct provides unmatched protection from the elements, rough terrain, aggressive environments, and people. And, Cablecon allows easy replacement of coax or fiber optic cables in the event

that it should become damaged and need repair or replacement.

Integral can provide Cablecon pre-assembled fiber optic cable in duct with cable purchased by you or Integral. It's readily available on standard 2KM or 3KM reels, and can even be purchased on reels up to 18,000'. Or, install Integral's empty duct with pre-installed pulling member and simplify your future cable installation. Either way, you'll save money, time, and tempers.

If you're ready for fiber optics, you're ready for Integral.

CALL 1-800-527-2168 TODAY

Now from Integral...

LUBADUK®

A slick solution
for cable pulling!

Marketed to the CATV industry
exclusively by
Channell Commercial Corporation
(818) 963-1694
(800) 423-1863
(except CA)
(800) 345-3624
(in CA)

 **Integral
Corporation**

P.O. Box 11269, Dallas, TX 75223-0269
(214) 826-0590

out and finds tremendous problems, does he have the ability to shut either channels or an entire system down if he finds it necessary?

The inspector cannot shut a system down. However, the local engineer in charge can if he determines that the cable operator is interfering with the safety of flight service.

And then, on the other hand, if that should happen, how does an operator go about getting that channel or channels turned back on?

Sell the system. (Laughter) No, eliminate the interference problem. They could lower the channel power levels or prove compliance with their leakage reparations and things like that. Show us how well you're fixing and eliminating the problem.

Does an operator have any legal recourse to any of these fines or to a system or channel shutdown?

All of the FCC's regulations provide avenues for legal recourses. These recourses are for the operators who feel the rules are unfair or they feel it's not their fault that they're in violation. However, whether or not they're successful in their petitions is a totally different matter.

Are operators responsible for leakage in MDUs and hotels and other multi-unit buildings and structures? What about rebuilds and newbuilds? What about newly-acquired systems?

Sticky question. Sticky problem. Operators who are serving these MDUs and similar structures, they are responsible for leakage in the internal wiring of these MDUs. The operators can always disconnect these MDUs if they feel that they are the cause of their leakage problems, especially since these facilities are physically connected to them. This is the best answer I have for MDUs and MATVs and similar structures.

For rebuilds, we can deal with rebuilds on a case-by-case basis if the operator shows diligence and they are indeed doing everything they can to comply with these rules. We have got to hear about (rebuilds) first, not after the fact.

On newbuilds, I have absolutely no sympathy if they can't meet signal leakage requirements on a newbuild. What happened?

On newly acquired systems, let the buyer beware.

All right. That says it all right there. Now, should systems that serve multiple communities be treated as one system or as multiple systems when operators are computing and filing their CLI numbers?

That depends on whether the system operator elects to do an individual CLI for each community—by CLI, I include flyover tests, I do not want to eliminate the option of doing either a ground-based CLI or flyover test for each community—or whether they elect to do it as one large system. Regardless, the filing of that CLI or flyover information must include all communities being served by that cable system. We are working on a filing system that will be based on the lowest denominator of each cable system which we perceive to be individual communities and the community codes assigned right now.

What information needs to be included in a CLI filing?

We are looking for minimal information right now. This may change, by the way. We are looking for the basic procedures used and the end result information on that filing. We are also working on a scenario where for the first couple of years we will be asking for certain specific filing information as well as a copy of their frequency offset notification. That will end after two or three years at which point we may just ask for a number—it can be as simple as a number incorporated with their Form 325, which is their annual filing required on the cable system registration form. We intend to issue a public notice as that filing date draws near as to what we want.

What frequency, in megahertz, should be used when operators do their CLI or flyover testing?

The rule says any frequency that's precisely offset and can be correlated back to the VHF aeronautical band. However, I recommend precisely offset frequencies within the band—from say 108 MHz through 140 MHz. That will be what our inspectors will be looking at to detect leaks.

Does passing the CLI number mean that you met the leakage standard as well?

No. CLI is just a test on how well you do on your monitoring. With regard to the individual leakage standard, it is the continuous monitoring and reparation of leaks that would do that. You

must meet both standards—that is the quarterly monitoring and annual CLI.

Which of the two CLI calculations, meaning CLI infinity or CLI 3000, should operators use?

Use the calculation that is more advantageous to your system. Both will meet our CLI requirement.

Is there one that maybe is more advantageous to a large system? Or is it difficult to say?

I believe the CLI 3000 is more advantageous to a larger system; however, it is also more difficult to calculate and more difficult to implement. But, again, this is just an annual snapshot, the CLI. By saying which one is easier, you still have another portion of the aeronautical leakage rules that you have to comply with, which is the monitoring. You shouldn't have any problem with either CLI infinity or CLI 3000 if you do your monitoring correctly.

How will the FCC inform operators that there is a problem with the system?

That depends on the urgency of the problem. It could be either by telephone, in person or by mail.

Over what time period must the CLI test be done?

For ground based measurements, we will allow up to a three-month period to perform those measurements. This is done so as to coincide the last quarterly monitoring function. But I really recommend not more than a month time frame for ground based measurements—and that's being conservative. For flyovers, I can't see it going beyond more than a two-week period.

In general, do you personally feel that cable operators are ready to meet this July deadline? Or is there still a lot of work yet to be done?

From what I see in terms of filings, and what I hear from the industry, the majority of the operators will not meet that deadline. That's as I see it today. But this industry has a knack of coming through in the final stretch on controversial issues. In that regard, I'm still optimistic.

OK, John, thanks very much. ■

The opinions represented here are those solely of Mr. Wong and do not necessarily represent the views and positions of the entire FCC.—Ed.



DROP IN, ANYTIME, ANYWHERE, ANYWAY

You are now invited to call on Trilogy
for all your drop cable needs.
Start outside with MC² trunk and feeder.
Move indoors with Trilogy foam drop.

Get Trilogy technology and quality
inside and out.
And picture the savings of one-stop
shopping in new installations.



Trilogy

COMMUNICATIONS INC.

Call or write for our free sample and brochure: TRILOGY COMMUNICATIONS INC., 2910 Highway 80 East, Pearl, Mississippi 39208
800-874-5649 • 601-932-4461 • 201-462-8700
Reader Service Number 14

Basics of Cumulative Leakage Index

The CLI formulas with which we are learning to live, originated from the work of the Advisory Committee on Cable Signal Leakage. This committee was convened by the FCC and FAA in 1978 to study the potential for interference to aeronautical radio services by cable signal leakage and to recommend measures for its control.

The ACCSL, which included representatives from the cable industry, studied the theoretical mechanisms of cable signal leakage and conducted a testing program under actual conditions to develop ground-based procedures for prediction of signal strengths in the airspace above a leaking cable system. The deliberations of this committee are well reported in the Final Report of the Advisory Committee on Cable Signal Leakage which was published in 1979.¹ Reprints of the report are available from the SCTE.

Committee goals

The primary goal of the committee was to recommend regulations which would assure protection of aeronautical radio communication and navigation services from interference by CATV leakage. Much effort was expended in the theoretical considerations and the determination of the susceptibility of aircraft radios to interference in terms of signal strength, frequency, and modulation. These efforts resulted in establishment of a threshold of interference which could be used as a criterion for evaluation of cable system integrity. The final determination was that signal intensities of 10 microvolts per meter or less in the airspace would not pose a threat to aeronautical radio services regardless of frequency or modulation format of the interfering signal.

To apply the criterion above, the direct method for qualifications of a given CATV system is simply to fly an aircraft over the cable system and make a continuous measurement of the leakage field strength and thereby demonstrate that the leakage does not

exceed the threshold. However, the committee recognized that flyover measurements would not be convenient or even appropriate in all cases and developed a method (CLI) for prediction of the airspace field intensity by means of ground measurements alone. As one might imagine this prediction is a very complex problem involving phase, polarization, and other parameters which affect the summation of energies from multiple sources (leaks) distributed throughout the cable system.²

Beginning the procedure

The first step to accomplish this goal was to formulate a relationship for summation of energies from multiple

...the committee...
developed a method
(CLI) for prediction of
the airspace field
intensity by means of
ground measurements
alone.

leaks of known magnitudes. Since the FCC Rules already had provisions for measurement of leaks on the ground (Sec. 76.609), the existing practice of using a resonant half-wave dipole at 3 meters (10 feet) from the leak, was retained. Certain basic assumptions were required, including definition of the addition of these energies in a "power" fashion.

The familiar model of combining the outputs of two antennas receiving energy from the same source can be used to illustrate the problems involved in making this assumption. If the two receiving antennas are at the same distance from the radiating source and oriented to maximize their reception they will receive equal amounts of

power. If they are located such as to produce outputs of identical phase, combination of these outputs will produce double the voltage of either one and if they are combined exactly out of phase there will be no resultant output. The assumption of "powerwise addition" produces results somewhere "in between" and can only be considered as a hopeful average.

In addition, the problem of polarization differences leaves another area of possible uncertainty. Consider two dipoles, one transmitting a signal and the other receiving this signal. If the two dipoles are perpendicular to the line connecting them and parallel, maximum signal transfer is achieved. If one dipole is rotated in the plane perpendicular to the connecting line, the signal decreases becoming zero at 90 degrees (or 270 degrees) displacement which is the situation known as "cross polarization."

The polarization of a cable leakage signal arriving at an observer over the system, is not always the same. At first glance it may appear that all radiation from the cable system must be horizontally polarized since the cable is generally horizontal. However, the cable is bonded to the power company's neutral, grounded at every so many poles, connected to drops, water pipes, power supplies and many other conductors which can carry electrical currents originating from leaks.

The system is very complex and therefore, in the general case, the polarization of the leakage energy is indeterminate. Even in the case where only horizontally polarized energy is present, a dipole below the observer oriented with its end toward the observer will present only a vertically polarized component to the observer.² It can be seen that polarization relations in three dimensions are very complex and further complicate the assumption of "powerwise addition."

Given the various complicating factors and assuming the presence of more, it can be seen that getting the desired "simple" formula is easier said than done. The major justification for this powerwise addition assumption is that with a large number of combining

By Robert V.C. Dickinson, Dovetail Systems Corporation



TFC-450 AND TFC-600



SEARCHER PLUS



FDM-4



C.L.I.C.S.



FDM-3



SEARCHER



FDM-5

**ARE YOU SEARCHING FOR CLI COMPLIANCE EQUIPMENT?
ONLY TRILITHIC HAS IT ALL!**

TRILITHIC is the only source for all your CLI compliance needs.

- The new SEARCHER PLUS provides vehicle mounted and handheld CLI measurement capability.
- The TFC-450 and TFC-600 frequency counters keep your carriers on frequency.
- The SEARCHER midband channel receiver and the FDM Series of dedicated carrier receivers offer affordable leakage monitoring.

- C.L.I.C.S. (Cumulative Leakage Index Computing Software) wraps it all up.

Search high and low — only TRILITHIC has everything you need for CLI compliance. You just supply the leaks.

For more information on TRILITHIC'S complete line of CLI instrumentation and accessories contact TRILITHIC or your authorized TRILITHIC representative.

HORIZON
1021-A Calle Ricardo
San Clemente, CA 92672
(714) 361-2011

Winfield Scott & Associates
P.O. Box 1149
Grapvine, Texas 76051
(817) 488-0029

CABLE PRODUCTS INC.
288 King Arthur Drive
Lawrenceville, Georgia 30245
404 962-8133

TFC SUPPLY COMPANY INC.
1746 E. Chocolate Ave
Hershey, PA 17033
(717) 533-4862, (800) 233-2147
In Pennsylvania: 800-482-2398

contact us at:

- ★ **TRILITHIC INC.**
3169 N. Shadeland Ave.
Indianapolis, Indiana 46226-6233
(317) 545-4196
Toll free outside Indiana: (800) 344-2412
TLX: 244-334 (RCA) FAX: (317) 547-2496

HOW TO COMPUTE CLI

leaks over the whole range of possible phases, polarizations, etc. the averaging effect will result in the "powerwise addition" which was assumed. To date,

basic leakage model. The cable system is illustrated by the area on the ground while the location of a generalized leak is at a radius r_i , from the center of the

$$\sum_{i=1}^6 X_i = X_1 + X_2 + X_3 + X_4 + X_5 + X_6$$

In this case all of the X terms to the right of the equal sign are to be summed. Since there are six terms $n=6$. The notation tells us that all values of X from the first to the sixth are to be added.

This provides a shorthand way of expressing the summation regardless of the number of terms. In the I_{3000} formula the squares of all of the leakage voltages divided by the squares of the respective distances are added. As you can see, this notation will apply whether you have one or ten or hundreds of leaks.

In addition to summing the terms containing the magnitudes and distances, the factor " ϕ " is added and is defined as the fraction of the system tested. As an illustration, if you surveyed only one half of the system your summation would give a smaller result than if you did it all. In an effort to compensate for this the partial result is multiplied by the reciprocal of the fraction tested. In the case of measuring only one half of the system it is reasonable to expect the result for the whole system to be twice as high. Therefore $1/\phi = 1 \div 0.5 = 2$ in the formula therefore gives the correct result.

So, here we have the calculation of an index of the predicted field in the airspace over the cable system at 3,000 meters altitude but it is only an index and not a real number in microvolts per meter since we have only considered proportionalities rather than doing a rigorous computation using all constants. The ACCSL decided not to require the rigorous computation but only that of the index which is simpler and provides the desired comparative information. To determine the proper limit they chose to go out and measure the values in real-life situations. They did just that over ten cable systems in various parts of the country. At the same time they measured the leakage in the same systems from the ground.

Through these measurements of ground and air signal strengths they were able to determine actual average factors and establish the appropriate index. This index is a very unwieldy number therefore the logarithm of the index was employed giving the familiar value of $10 \log I_{3000}$ equal to or less than -7 . Here you have the results of much labor and calculation rolled up into a simply expressed limit which

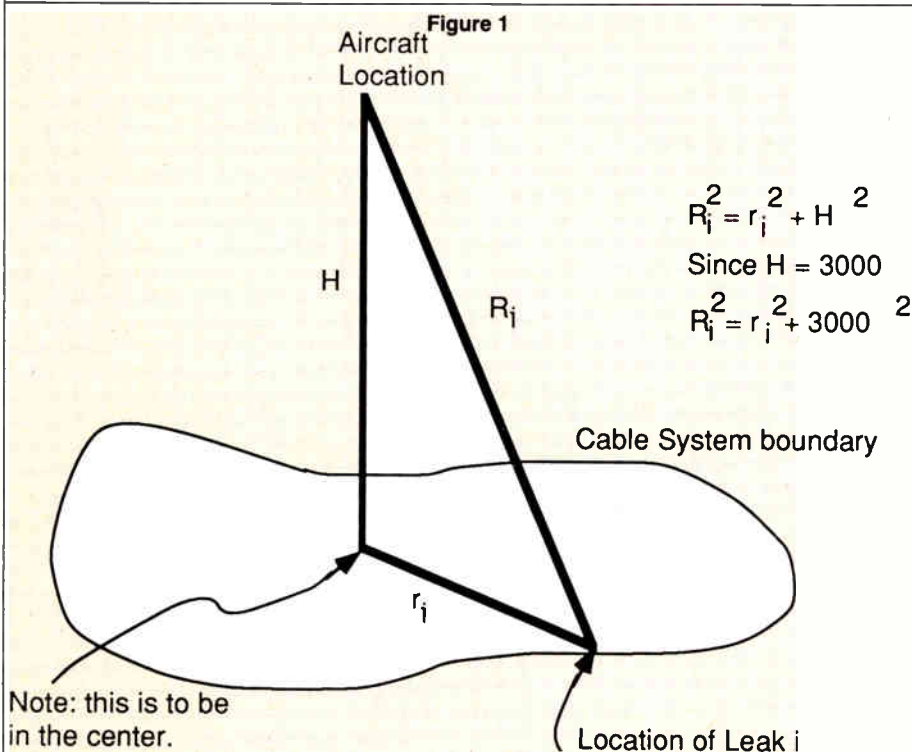

there has been no evidence that this assumption is incorrect.

What is CLI?

The computation of the summation of leakage signals in the airspace from ground-based measurements has been named the Cumulative Leakage Index. It is "cumulative" in that it attempts to "accumulate" the energy from all of the leaks. It is an "index" in that the ultimate formula does not determine the quantity of signal accumulated but only a relative number which is derived from the actual quantity in a way that simplifies its use in actual practice. It might be considered as a "figure of merit."

Referring to Figure 1, the model of the basic calculation of the Cumulative Leakage Index is illustrated. In the original considerations of the subject it was expected that the worst effects of the combined leakage would be encountered high above the cable system so that an altitude "H" of 3,000 meters was chosen. It was later determined by experiment that a better altitude for in-flight measurements was much lower, however, the 3,000 meter altitude was retained for the

system.

It can be seen that if a leak is not directly under the aircraft its energy must travel a longer distance to the aircraft and its contribution to the total leakage will be reduced in proportion to the distance traveled. To apply the "powerwise addition" assumption, we know that field strength decreases in direct proportion to distance from the leak and we know that power is proportional to the voltage squared (for instance $P = E^2/R$ in a resistive circuit.) From these we see that power addition in the airspace will be proportional to

Figure 2

$$I_{3000} = \frac{1}{\phi} \sum_{i=1}^n \frac{E_i^2}{R_i^2}$$

$$10 \log I_{3000} \leq -7$$

E^2/R_i^2 and that $R_i^2 = H^2 + r_i^2$ as seen in the I_{3000} formula (Figure 2.)

For those not familiar with the Greek letter capital Sigma used in the formula, its meaning is illustrated in the following equation:

SIGNAL SENSITIVE

The FCC has toughened their requirements regarding RF leakage. To meet the revised FCC codes, you need an RF leakage detection system that's sensitive. LRC's TR-1 can take equivalent readings of 10 $\mu\text{V}/\text{m}$ or less at a distance of 100 feet. That's sensitive.

BUDGET SENSITIVE

Our TR-1 won't break your budget. We sell the TR-1 as a package — what you see is what you get. All of it — at a competitive price. That's sensible.

USER SENSITIVE

The TR-1 is easy to use and easy

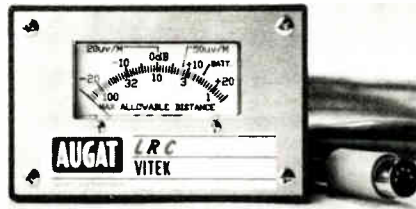

The TR-1 Remote Meter — easy to read, easy to use. With velcro strips to mount unit in a variety of locations convenient to the driver.*

**Is not included in basic package.*

to read. The meter face highlights both 50 $\mu\text{V}/\text{m}$ for CLI reporting and 20 $\mu\text{V}/\text{m}$ to indicate leaks which need repair.

Our NEW remote meter makes it even easier. The remote plugs right into the TR-1 and uses the same meter/light combination. Velcro strips allow the driver to place the remote meter where he wants it. That's sensational.

WHEN SENSITIVITY IS THE KEY — CALL AUGAT/LRC. 607-739-3844

Or write: Augat Communications Group/LRC Electronics, P.O. Box 111, Horseheads, NY 14845.

WE'RE SENSITIVE TO YOUR NEEDS



LRC TR-1 tracer package includes; tracer unit, probe adapters, strap, wall mount charger, cigarette lighter plug, dipole antenna with 10ft of cable, headphones, 8 and 20 dB pads, tuning tool, and mounting bracket with hardware.

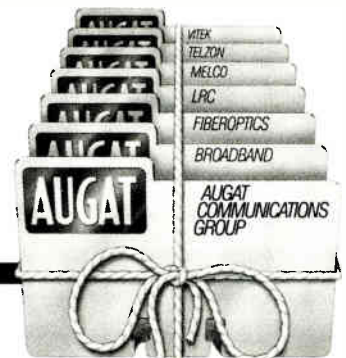

WE'RE AUGAT COMMUNICATIONS GROUP. WE TIE IT ALL TOGETHER. WITH EASE.

HOW TO COMPUTE CLI

Figure 3

$$I_{\infty} = \frac{1}{\beta} \sum_{i=1}^n E_i^2$$

$$10 \text{ Log } I_{\infty} \leq 64$$

incorporates the statistical compensation for real-life differences. Not bad, huh? The committee deserves a pat on the back for this accomplishment.

Using I_{∞}

Although I_{3000} is the basic index calculation, it is somewhat difficult to use due to the requirement that one must know the distance of each leak from the center of the system. The committee anticipated this reaction as well and developed I_{∞} to make the computations easier. As you review the I_{3000} diagram (Figure 2), you can readily see that leaks not directly under the aircraft contribute less to the total than those which are directly beneath. In the I_{∞} equation (Figure 3) the R_i term has been removed which causes all leaks to contribute equally and is, in effect, the same as considering all leaks to be directly under the

aircraft.

You can see immediately that this maneuver results in a higher value and therefore is harder to pass than I_{3000} . You can also appreciate that the calculation is more readily accomplished due to elimination of the requirement for knowledge of the distance of each leak from the system center. This is an accommodation for the cable operator, courtesy of the FCC. By the way, if you fail to pass I_{∞} you can try I_{3000} since it is the real test while I_{∞} is a shortcut providing a more conservative result.

The actual implementation of I_{3000} can be organized to make it less painful. For instance your cable system could be divided into a series of zones defined by concentric circles about the center. As long as these zones are not too broad, the FCC will probably accept this method where your technician need only specify the zone in which the leak was located and use a standard radius for any leak within the zone. This might also be implemented using strand map sheets, power supply sectors, etc. as long as the standard distances assigned do not substantially change the results when compared to an exact calculation. Be sure, when you

submit such information to the FCC, that you clearly explain your system and show that it is technically realistic.

The preceding has attempted to show the origin of the CLI formulas and a little about their application. Many operators have streamlined their data taking procedures to make the computation more expeditious. Computer programs are available from several sources not only to do the calculations, but to organize the information, generate forms, and generally make the whole leakage control system operate more efficiently. It appears that leakage control will be with us for a long time so it behooves us all to tune up the procedures and, at the same time, try to eliminate as many sources of cable leaks as possible. Rather than fight the same old problems for ever our new motto should be "Leak-Free Cable Systems." ■

References

1. Final Report of the Advisory Committee on Cable Signal Leakage to the Chief, Cable Television Bureau Federal Communications Commission.
2. Dickinson, Robert V.C. and Edwin L., CATV Leakage Aerial Surveys, 1988 NCTA Technical Papers.

CLI Equipment

FCC Compliance Made Easy

RD-1

Low noise, battery operated, pre-amplifier, tuneable Dipole, 16db gain, 50 to 250 MHz.

\$450.00*

CLR-4

High sensitivity, hand held leakage detector, scans 1-4 video carrier frequencies, locator tone varies with strength of signal detected.

\$450.00*

CLM-1000

Leakage field strength meter 50 to 550 MHz. Three meter equivalent measurements from 10 to 100 ft., audio alarm, non volatile storage (100 memories) & RS232 port.

\$2,495.00*

WAVETEK

Authorized Sales & Service Representatives for CA, AZ, OR, WA, ID, MT, NV, AK

CLIDE - Control Leakage Index Data Easily

Software program for an easy & inexpensive way to record the levels & location of signal leakage in ground based inspections. Repair & FCC logs simplified. IBM PC Compatible. \$695.00*



CATV
SERVICES

Inside California

Outside California

800/223-3152 800/227-1200

2211 Warm Springs Court, Fremont, CA 94538 • (415) 651-4331

* Prices subject to change • Add tax & shipping.

Reader Service Number 17

36 Signal Leakage Supplement June 1989

NEW! AVCOM PSA-37D

PORTABLE SPECTRUM ANALYZER

WITH DIGITAL FREQUENCY READOUT

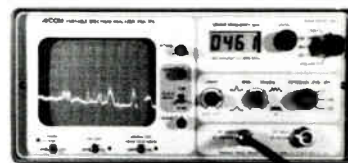

AVCOM INTRODUCES THE NEW PSA-37D PORTABLE SPECTRUM ANALYZER WITH DIGITAL FREQUENCY READOUT. AVCOM'S NEW PSA-37D Portable Spectrum Analyzer has a 4 digit front panel frequency readout controlled by a rotary frequency adjustment control. Frequency ranges that the PSA-37D cover are 0 to 500 MHz, 500 to 1000 MHz, 950 to 1450 MHz, 1250 to 1750 MHz and 3.7 to 4.2 GHz. The PSA-37D Portable Spectrum Analyzer is lightweight, portable, battery operated, ideal for field test situations. A built-in DC block with a +18 VDC powers LNAs and BDCs with the flip of a switch. All other performance characteristics and features are the same as the PSA-35A which has become an industry standard for satellite communications work. **\$2475**



COM-96T

The COM-96T Ku/C Band Receiver is compatible with all Ku and C Band LNAs and BDCs operating in the 950 to 1450 MHz range, providing complete 4 and 12 GHz performance in one system. Highly stable oscillators eliminate frequency drift in this fully agile receiver, and allow operation over wide temperature ranges. Special threshold extension circuitry enhances video quality. Threshold peaking and triple IF filters allow the COM-96T to receive international transmissions. This double-conversion, high performance receiver sells for \$939.

AVCOM

500 SOUTHLAKE BOULEVARD, RICHMOND, VA 23238
Tel. (804) 794-2500 FAX (804) 794-8284 Telex 701-545

Reader Service Number 18



More Power to You.

 **Lectro**[®]

More Efficiency.

In response to operators' concerns over skyrocketing utility costs, Lectro designed and delivered the first Super Efficient power supplies. Now, a complete line of Super Efficient products is available for you.

More Modularity.

Lectro features plug-in modularity so advanced, so simple that maintenance is a snap! Just ask the man in the bucket.

More Designs

Lectro has the most diversified product line in the business, ranging from 4 amp to 18 amp. You'll find products to meet every application.

More Service.

We've been powering cable systems for decades. We back up our service and warranties with field and factory support personnel. *A satisfied customer is our most important asset.*

CALL 1-800-551-3790.

In Georgia, call (404) 543-1904

 **Lectro**[®]

More power to you

Lectro Products, Inc.
420 Athena Dr.
Athens, GA 30601

Made in U.S.A.

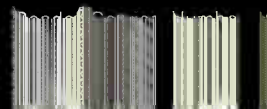
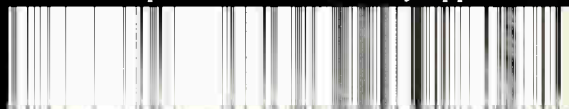

CLI. IF YOU DON'T KNOW



FEDERAL
COMMUNICATIONS
COMMISSION

Rules and Regulations

VOLUME VIII • SEPTEMBER 1987

Part 76—Cable Television Service

Part 78—Cable Television Relay Service

WHAT IT MEANS NOW, YOU WILL LATER.

It means Cumulative Leakage Index. And it means that by July, 1990, CLI could have a major impact on the operation of your system. But the time to react is now. And the people to help are at Comm/Scope.

You know you will have the best cable you can get from Comm/Scope. The entire Comm/Scope line, from QR to PIII, drop cables including CRD and APD to Optical Reach fiber optic cable, has been designed to give you the confidence you will need. Because we will never allow the integrity of your system to be compromised with inferior product.

If you have more questions about CLI or our fine cable products, contact your nearest Comm/Scope representative or call us at 800-982-1708 (800-222-6808 in NC).

Comm/Scope, Inc., P.O. Box 1729, Hickory, NC 28602. Phone 800/982-1708 (800/222-6808 in NC). Fax: 704/328-3400. Telex: 802-166.

Comm/Scope, Inc.
THE Cable in Cable TV.

Reader Service Number 20

Or you might consider a flyover

Part 76.611 of the FCC Rules and Regulations provides three choices of method for qualification under the signal leakage requirements. These are: use of I_{3000} ; use of I_{∞} and measurement of the leakage fields above the cable system by an overflight. The concept of an overflight is a departure from ground-based methods since it is a direct measurement of field strength rather than the estimation of an index as described in the accompanying article, "Basics of the Cumulative Leakage Index."

As one of the approved alternatives for cable system qualification, it is well to study various aspects of this technique and its performance. The basic idea is to directly measure the strength of the leakage fields where aircraft will fly and where protection of radio services should be provided. Before proceeding further, there is one point which cannot be too strongly made. *The goal of a flyover is not to find leaks* but to qualify the cable system for adequate leakage integrity.

When to do a flyover

Let us consider when it might be advantageous to employ a flyover rather than a ground-based CLI determination.

- A flyover offers a fairly short testing period so should be considered when time is of the essence or a better "snapshot" of the system leakage integrity is desired.

- A flyover usually takes a few hours to a few days depending on the system size, as compared with considerably longer times for most ground drive-outs.

- A flyover must be performed when less than 75 percent of the cable system is accessible for the ground driveout (76.611 (d)).

- A flyover is demanded when a direct measurement of the leakage fields is desired to confirm the ground-based estimation as well as the effectiveness of the leakage control pro-

gram.

- A flyover is one way to present a report to management on the overall leakage integrity without drawing off the rather large manpower required to do the drive-out. In medium to large systems a flyover is usually less expensive and therefore to be desired.

Regarding the specifics of flyovers, the FCC rules reflect the conclusions of the Advisory Committee on Cable Signal Leakage¹ which recommend that a maximum leakage field strength of 10 microvolts per meter be permitted in the airspace above the cable system. If the leakage fields are kept below this threshold serious interference will be avoided although occasional squelch breaks may occur on radios used for the aviation communications. Measurement of the leakage fields may be done with equipment similar to the aircraft radios employed by various aviation interests.

Part 76.611 specifies several aspects of the required equipment and the performance of the tests. Some of these requirements are discussed below.

- The aircraft should fly at an altitude of 450 meters (1,500 feet) above the average terrain. Obviously, care is necessary in very hilly regions and some variations in altitude must be employed to fit the situation. The FCC can be expected to accept such variations if accompanied by an engineering description of the technique and the compelling reasons for its use.

- A horizontally polarized receiving antenna is to be used on the aircraft as recommended by the ACCSL.

- The measuring system is to be calibrated at each test site. The matter of calibration is obviously important and deserves discussion. Calibration of the entire measuring system starts with calibration of the test receiver on the bench. By using a calibrated radio frequency generator, the entire operating range of levels can be calibrated and thereby relate input signal level to output level indication (AGC voltage or the like). This results in an input/output curve for all level conditions but does nothing in terms of calibrating the antenna system as mounted on the aircraft.

Calibrating antennas

Part 76.611 (a) (2) defines a method to be used to produce a $10 \mu\text{V/m}$ field at 450 meters above the ground. This involves the use of two orthogonal resonant dipoles mounted one quarter wavelength above a specified ground screen. Each dipole is then excited with a power level calculated to produce the $10 \mu\text{V/m}$ field at 450 meters. The RF excitations for the dipoles are to be 90 degrees offset in phase. The resulting field is then circularly polarized pointing straight up.

The reason for this configuration is that the circularly polarized field is the same at all approach angles when sensed by the linearly polarized antenna on the aircraft. The result then is that during the calibration run, exact angular alignment of the aircraft antenna is not required, making the calibration procedure less critical and the results more dependable. Once the received output level for the $10 \mu\text{V/m}$ calibration field is known, other levels may be accurately extrapolated on the receiver input/output curve, giving exact calibration over the entire range of the receiver.

- A readily identifiable test signal must be used. The reason for this is obvious. It is hardly necessary to say that you wouldn't want to allow any spurious signals to increase the apparent leakage from your system.

- The receiver bandwidth must be 25 kHz or a calibration factor must be used to correct the level information to that bandwidth. This requirement only becomes significant when measuring systems with high background noise levels which are seldom encountered. When a narrow band signal such as the test signal is being measured, receiver bandwidth is usually unimportant. When wideband noise is being measured, the output level is directly proportional to receiver bandwidth (the wider the bandwidth the more noise captured) so this bandwidth must be known.

Some recommendations

There are numerous other param-

By Robert V.C. Dickinson, Dovetail Systems Corporation

CLI FLYING SUCCESS

INTRODUCING FLYOVER PROTECTION FROM THE PEOPLE WHO INVENTED LEAKAGE DETECTION...

Avoid fines and loss of channels with ComSonics' exclusive SNIFFER FLYOVER PROGRAM

- Overall Area Detection
- Accurate Leak Accumulation Indexing
- Leak Location Coordinates
- Complies with FCC Specifications

This is the most cost effective technology and service available to the industry today!

Contact ComSonics today and go for SUCCESS NOW for 1990!



COMSONICS, INC.

Call Toll Free: 1 - 800 - 336 - 9681

In Virginia Collect: 1 - 703 - 434 - 5965

Reader Service Number 21



ters which must be specified but are not fixed by the FCC. These include:

- The pattern to be flown over the system to fully survey the appropriate ground area. The two general patterns are parallel passes and a full grid pattern. Since the object of the test is to survey leakage over the entire system, the basic requirement is to assure that the antenna coverage on the ground will receive energy from leaks at all possible locations without

undue attenuation. With a horizontal dipole antenna placed longitudinally beneath the aircraft this requirement is met with passes spaced about one-half statute mile. A full grid pattern will provide more data points but little additional information.

- The number of data samples to be taken per unit time is left up to the individual. This parameter is important with a digital measuring system although an analog system may also

be employed. It becomes a matter of getting enough data to adequately simulate the interference that would be experienced by an aircraft flying through the airspace. With a modest computer-based data collection system it should be possible to take in the order of 50 to 100 samples per second which is readily overkill. An aircraft flying through the airspace would not be sensitive to peaks of energy if they were not present long enough to charge the radio's AGC time constant, which is usually in the one second region. Therefore, rates of 10 or so samples per second are adequate. Analog data receives the same filtering effect and its output should not be further filtered by the display device.

- The speed of the measurement aircraft is not critical as long as it is fairly constant, since it is desirable to maintain the same density of data points throughout the run.

- There are other factors which one might question. In any case these are items to be governed by good engineering practice which is what the FCC wants to see exercised.

Selecting a test frequency

One very important consideration is selection of a test frequency. We have said before that the test should be run with an identifiable test signal so that responses can be identified as leakage signals and not spurious emissions which confuse the data. The object is to select a test frequency which is clear of spurious signals. This may be more difficult than it sounds since a frequency that is clear on the ground often is found to mysteriously sprout signals when monitored in the air. The problem is often the presence of distant radio transmitters which cannot be heard on the ground. Usually it is impossible to find a suitable channel in the FM band and often distant FAA signals are heard in the aeronautical bands.

Sometimes interference comes from harmonics or spurious emissions from broadcast or other transmitters. Even if there are no signals directly on the channel, a strong transmitter on a nearby channel can overload the receiver frontend causing intermod products or desensitization. The pilot's transmitter on the test aircraft is one that you may have to live with, but you can always note his transmissions and flag the data at that time. The bottom line in selecting a frequency is to choose one that is *very clear* since you are measur-

Prepare Now!

On July 1, 1990, the FCC's regulation on signal leakage goes into effect. Failure to comply with FCC standards may lead to stiff fines and a possible shutdown of your system. But that's nothing compared to the damage a major leak could cause if it interferes with air traffic control. If you're not sure how to meet

the FCC standards, CSS has an answer. Our engineering staff will survey your system, detect leaks, correct them and then update your personnel in the proper preventive maintenance so that your system will continue to meet compliance. July 1990 is right around the corner, so don't wait, give us a call today.



CATV Subscriber Services, Inc.
808 Summit Ave.
Greensboro, NC 27405
(919) 273-5553

Reader Service Number 22

SPECIFICS OF FLYOVERS

ing quite small signals which may be only a few dB above the noise floor.

Starting the tests

When all of the above details have been cared for, it is time to do the tests. First, make sure the frequency is clear in the air. Then fly your calibration run. At that time you will be ready to start the measurements. You must then fly your selected pattern (parallel passes, grid, etc.) and record the data. Your data should include time, signal level and location. Location is often the difficult one. Trying to record visual landmarks is sometimes confusing and usually not very accurate. The use of LORAN or some other automatic navigation system is recommended. Continually monitor the test frequency and flag any occasional interference. Frequent interference disqualifies your data and another frequency should be chosen.

The 90th percentile

After the test flight the data must be reduced and displayed. The rules allow use of the "ninetieth percentile" to determine pass or fail. This means that 90 percent of your data points (in a digital measurement) must be under the threshold value (10 $\mu\text{V/m}$). This can be easily determined from the data. Ideally, only points taken over the actual cable system should be counted. Passes beyond the cable system boundaries will probably supply extra good points and should not be counted since the extra points unfairly expand the allowable 10 percent above the limit. Although submitting the calculation of the 90th percentile seems to meet the letter of the law it is desirable to also submit a latitude/longitude plot of the flight path and the levels experienced along the way. You might even consider an overlay to your map scale for a clearer presentation of the leakage distribution. Incidentally, you should always keep a record of the conditions of your test such as equipment, levels, setup, anomalies, weather, etc.

There are several ways in which the report may be used. It certainly should be submitted to the FCC for qualification (after July 1990.) The major value is really for you and your management. This is the acid test of the effectiveness of your leakage control program. Management will probably want to see it to assess how well you are doing your job. They may not want to see it if it seems to demand a system rebuild.

If you fail the test, the first thing to do is fix the big leaks. After that, the course of action is not too clear. The FCC may want to see another test flight after the leaks are fixed.

The real challenge for the cable industry is to beat the FCC at its own game. The right way to do this is not to worry through annual test after annual test. It is much better to find out where these leaks are coming from and eliminate the sources. The sooner

we get to the bottom of these problems, the sooner we'll control our leaks. Then, the testing, etc. can be reduced or eliminated.... *Go to it and good luck!* ■

References

1. Final Report of the Advisory Committee on Cable Signal Leakage to the Chief, Cable Television Bureau Federal Communications Commission.

SUCCESS IN MY POCKET! THE SNIFFER JR.



The SNIFFER JR. can mean the difference between a successful installation and a problem one.

SNIFFER JR.

lets your installers
"IT RIGHT THE FIRST TIME!"

Leak-free installations mean no call-backs or needless sniffing later. SNIFFER JR. is powerful detection for SUCCESSFUL CLI compliance that is accurate and affordable!



Reader Service Number 23

COMSONICS, INC.®

Call Toll Free: 1 - 800 - 336 - 9681

In Virginia Collect: 1 - 703 - 434 - 5965

Managing leakage data and CLI reporting via software

Some people that I've spoken with think software is the only way to go and other people say, 'I'm going to stay as far away from software as I can,' " reports Greg Marx, director of sales and marketing, instrument products, for Texscan Trilithic. However, Trilithic is optimistic enough about the market for CLI software that it now offers a software program called CLICS (Cumulative Leakage Index Computing Software).

made the program more user-friendly, but at \$495, it remains the least expensive package on the market. When used in combination with Searcher Plus, the measurement and collection of signal leakage information is relatively straight forward.

The Searcher Plus unit, which weighs one pound and mounts neatly in a bracket in the truck, offers a readout in $\mu\text{V}/\text{m}$ at 10 feet and an audio tone that increases in pitch with signal

that would allow data entry directly into the CLICS program. Trilithic recommends using a small audio cassette recorder for creating a log during the drive out, verbally noting the address and reading of signal level. The tape can then be transcribed by a clerical person at the office upon return to base.

CLIDE

The optional hand-held Psion computer offered by Telecommunications Products Inc. (TPI) with its CLIDE software can be interfaced with the program for direct data entry. Of course, the technician doing the drive out must enter the data in the field using this method.

However, according to Tom Russell of TPI, one of the special advantages of CLIDE is the speed of data entry and output when creating the final reports. This is due to extensive use of machine software in the running of the program.

The CLIDE program is menu-driven for ease of operation and, in addition to one line on-screen "help" messages, the entire user manual is accessible from within the program. CLIDE requires the most memory of all the software available and the use of a hard disk drive. Fourteen different forms and reports can be created using CLIDE.

LES

Long Systems Inc.'s LES program is perhaps the most visually attractive program available. The presentation is a pop-up style with an on-screen calculator or an on-screen frequency chart each accessible by a function key at any time without leaving the screen the user is working with.

In its latest version, LES includes a "route table" which permits an easy calculation of I₃₀₀₀. The route table



Cablelogic Corporation's "mobile version of a flyover."

Trilithic, an independent firm which took over Texscan's instrument products division March 1, will be marketing this software program along with its new Searcher Plus leakage detection and CLI measurement instrument, CED has learned. Both products were shown at the NCTA's National Show in Dallas.

CLICS

Trilithic's CLICS was originally developed by a CATV engineer and is already reportedly in use in 56 systems. According to Marx, Trilithic has

level. A front panel analog meter has a five second peak-hold function. There is also a X10 control on the front panel that changes your scale from a maximum of 200 $\mu\text{V}/\text{m}$ to a maximum of 2,000 $\mu\text{V}/\text{m}$. When carried in the truck-mounted bracket, Searcher Plus derives its power from the truck and its signal input from an antenna mounted on the roof of the truck. When removed from the bracket and hand-held, power is supplied by an internal two hour nicad and the signal is obtained from an uncalibrated "rubber duck" antenna on the front panel.

Searcher Plus has no data-out port

WHEN TIME IS MONEY



If You Want Your CLI Testing Done On Time,
Call Cable Services... It's That Simple.

Cable Services Company/Inc.



2113 Marydale Ave • Williamsport, PA 17701 • 717-323-8518 • 800-233-8452 • In PA: 800-332-8545

Reader Service Number 24

includes the distance from the center of the system for each geographic coordinate of the system to be audited. The route table requires a one time set-up before the drive out.

According to Harry Long, president, "ATC headquarters, before it decided to recommend our program to all systems, said they would like our program to do an I₃₀₀₀ calculation. They said, 'All you have to do is add one additional field for the distance from the center of the system and you'll be fine.' I sat down and thought about it. What I came up with was the following: We already ask the user to put a route code in there which would be, for example, Map Number 12, Coordinate A-4 and, in the route table they put the average distance that that route coordinate is from the center of the system. So, when we do an I₃₀₀₀ calculation, we just take the route code for each leak, look it up in the route table, and use that to calculate the slant rate," Long says.

Regarding direct data input from detection hardware, LES is compatible with the new Wavetek CLM-1000 meter. The CLM-1000 outputs an ASCII text file that can be imported into the program. Other possibilities include interfaces using RS232 ports.

Contracting for CLI

One such service is Cablelogic Corporation's CLI-MATE service, based in Littleton, Colo. CLI-MATE is a mobile-based data acquisition service which is, according to Mike McNeill of Cablelogic, "a mobile version of the flyover." Cablelogic will bring in its fully equipped vans and perform the complete CLI project.

Tom Moe, McNeill's partner, explains: "On the truck there is a scanner. We can pre-tune to a channel that the system is using that we want to test. We have a dipole antenna on the top of the vehicles. It's all automated in that we have a person that drives the vehicle who can operate the three activation buttons from the dash that operates the entire process in the back of the van."

An on-board computer saves all data to a three-and-a-half-inch disk. It is voice activated in that anytime a leak is found, the computer comes on. The address is entered at that time. All the information on the disk is then downloaded for the creation of the CLI report.

Says Moe, "We have a base price of \$14 per mile and, if it's a smaller

Profile of commercially available CLI software

CLIDE (Control Leakage Index Data Easily):

DESCRIPTION: Signal leakage data management program, clean format, menu-driven, on-screen "help" plus entire user manual in program.

ON-SCREEN DISPLAYS: FCC CLI report, unrepaired leak report, repaired leak report, repaired leak statistics, log new leaks, record leak repairs, display unrepaired leaks, subsystem menu, convert measurement, and an extensive "help" menu.

REPORTS AND FORMS GENERATED: Unrepaired leaks by intensity, unrepaired leaks by number, new repaired leaks, all repaired leaks, statistics by area, all area statistics, maintenance report, FCC CLI report, "must fix" and "what-if" user account report, leak source code report, drive out form, subsystems report, purged leaks report, and repair work orders.

SPECIAL FEATURES: High-speed data entry and output, automatic conversion of any input to $\mu\text{V}/\text{m}$, interface with optional Psion hand-held computer (\$595) with optical range finder (\$42).

MAXIMUM DATA LOSS IN POWER FAILURE: Only the data being entered and not yet saved to disk.

REQUIREMENTS: A leakage detector, an IBM PC/XT/AT (or fully compatible) computer with 640K random access memory, DOS version 2.11 or higher, hard disk drive with a single floppy diskette slot, an 80 column printer or wider, can be networked optionally on Novell LAN.

NUMBER OF SYSTEMS CURRENTLY USING: (Proprietary information.)

SUPPLIER: Telecommunication Products Inc. (717) 267-3939.

COST: \$695 (quantity discounts available).

LES (Leakage Evaluation System):

DESCRIPTION: Signal leakage data management program, attractive pop-up style of format, menu-driven, the most user-friendly of all programs available.

ON-SCREEN DISPLAYS: Main menu, CLI report, leaks reported, leakage log, repair log, largest-to-smallest, leakage analysis, break-even analysis, cause table, pending repair work orders, file maintenance menu, pop-up conversion calculator, pop-up frequency chart, extensive "help" menu.

REPORTS AND FORMS GENERATED: FCC CLI report, leakage log, repair log, largest-to-smallest leak, leakage analysis report, break-even analysis, cause table, repair work orders, pending repair work orders, route table (average distance from center of system for I₃₀₀₀ calculation).

SPECIAL FEATURES: Automatic conversion of any input to $\mu\text{V}/\text{m}$, "break-even analysis," on-screen pop-up calculator, on-screen pop-up frequency chart, password protection, optional RDT1 handheld remote terminal for in-field data entry (\$895).

MAXIMUM DATA LOSS IN POWER FAILURE: Whatever is in DOS buffers (not yet saved to disk).

REQUIREMENTS: A leakage detector, IBM or 100 percent compatible (also Macintosh version requiring MacPlus or better available), DOS 2.0 or better, 512K memory (hard disk required when using RDT1), 80 column printer or wider.

NUMBER OF SYSTEMS CURRENTLY USING: Over 500.

SUPPLIER: Long Systems Inc. (619) 278-2700.

COST: \$595 (quantity discounts available).

CLICS (Cumulative Leakage Index Computing Software):

DESCRIPTION: A basic, no frills program for managing leakage detection data, calculations, and forms generation.

ON-SCREEN DISPLAYS: Leaks-per-mile, I₃₀₀₀, six leak level categories, six leak fix categories, and repair screen.

REPORTS AND FORMS GENERATED: Valid FCC log, CLI report, repair work sheets sorted from highest leak levels, repairs by management zones, current summary, program (data entry) activity log.

SPECIAL FEATURES: Optional Searcher Plus hand-held leakage detection and CLI measurement receiver (\$699).

MAXIMUM DATA LOSS IN POWER FAILURE: The last six entries.

REQUIREMENTS: A leak detector, an IBM compatible computer with 384K free memory, 80 column printer or wider.

NUMBER OF SYSTEMS CURRENTLY USING: 56

SUPPLIER: Texscan Trilithic, (800) 344-2412.

COST: \$495.

NaCom

**A Full Service Communications Contractor
Specialists in: Installation, Construction, LAN**



BUILDING COMMUNICATION SYSTEMS THROUGHOUT AMERICA

- Installations (including fiber optics)
- Converter Exchanges, PPV, Audits, Special Projects
- MDU, SMATV, & LAN Pre/Postwiring
- CLI Detection, Correction, & Documentation
- Strand Mapping Engineering
- Design (AutoCAD)
- Aerial/Underground Construction

NaCom

1900 E. Dublin-Granville Rd.
Columbus, Ohio 43229

614/895-1313 • 800/669-8765 • FAX 614/895-8942

system and they have to have us there quick, the cost may go up." The price applies mainly to systems of 500 to 1,000 miles of plant. "If it's 1,000 miles or more, or three or four customers in a geographical area and they are somewhat close, we can bring that cost down," Moe says.

While CLI-MATE will provide the system operator with complete detection and CLI reporting, another contractor, Bill Engle of Cable Communications Corp., provides all that plus the repair work (for an additional charge).

Engle's service is called CLI-TEC and is based in Ada, Okla. With CLI-TEC, the initial drive out costs \$26.40 per mile with a follow-up drive out costing \$20.80 per mile. According to Engle, "Chances are, once you do your initial audit, and you run into a major leak, say, in excess of 500 μ V/m, we will go in there and capture that big guy and get them (the system's repair crew) on it, because until you get the biggest leak in an area knocked out, you are not going to get anything else under that. It will mask (other leaks under that level)."

Engle says, "Our man can do 60 miles a day. He goes into an area and looks for (big leaks) and by the time he gets through doing that, they're pretty close to getting the repairs done in another area. Then he will proceed on. After they get done doing the repairs in one area, we have our follow-up driver go through the area and look for anything at or below 50 μ V/m just to satisfy everyone that the repairs were made and there weren't any other outstanding leaks."

In addition to this service, Engle has a stand-by crew that can do leak repair

if the system gets behind or otherwise can't do the repair work. "We turn in all the paperwork, all the forms and documentation, and let the cable operator determine whether they've got the people to go out and do the repairs." CLI-TEC uses the CLIDE software program. Once the repair work orders have been approved, Engle sends his people out to do the work.

In-house crews and hidden costs

"The CLI software in general is the least significant cost item that a system is going to have to purchase to perform CLI," says Russell of Telecommunications Products, "and, at the same time, it does the most for them in increasing their efficiency and effectiveness." But when cable operators budget for signal leakage detection and reporting, they often fail to identify the hidden costs of doing it all in-house.

"I know the expense of the trucks, the payroll and the taxes, the overtime, and the things that aren't getting done because they have to take people off what they are doing to do this," says Moe of CLI-MATE. "There are operators that want to do it in-house because they think contracting for this is too expensive. We don't have the time to go out there and educate them."

Engle of CLI-TEC reports, "I actually saw a crew here in Oklahoma doing detection and repair work on their own, and in an eight-hour day they covered three-and-a-half blocks with six vans and eight technicians. They are going to need a supervisor out there at one point or another." And there can be delays in performing new hook-ups since the crew is occupied

with CLI. "You might be postponing 30 people who want to get cable and you've got to look at the lost revenue."

Reaching management

Engle says, "A friend of mine is \$105,000 over budget and they gave him \$750,000 a year ago March to work on his CLI, and he's got less than one-third of his system done. There's no way he's going to have it done by July of next year." While the engineering community knows the need for action, it's not clear whether management has the full picture.

"We're saying to them," says Engle, "You made a couple of wrong decisions along the way." One system I know took on 45 more people, brought in 12 more trucks, bought \$125,000 worth of test equipment and it's like that old horse out there in the pasture. It's still costing them money because they have to feed it. When we're gone, all that you've got is proof that we were there. You can rest easy."

With only one year to go before the FCC starts levying fines, the industry is still slow to move on detecting and repairing leakage. "I've attended five seminars on CLI across the country," reports Moe, "and there are operators who say, 'Oh yeah, CLI, I've heard about that—what is it?'"

Moe believes most operators are trying to figure out their costs first before they go out and get a contractor to visit the system. He expects his telephone to be ringing often come the last quarter of 1989. "We will have to say, 'I'm sorry but we can't accommodate you now.'"

—George Sell

WE HELP PREVENT LEAKS!

When you plan your system, be sure to specify RMS Taps, Splitters, Directional Couplers, Power Inserter/Combiner, "Superfit" Connectors, and 'F' Connectors. We help keep signals fed into them to stay within the system—away from FCC and FAA detectors. Call your RMS Account Executive for details and prompt delivery.

RMS ELECTRONICS, INC. Over 40 years of experience

621 Route 46, Hasbrouck Heights, N.J. 07604
 CALL COLLECT: (201) 288-8833 - FAX: (201) 288-1625
 TOLL FREE: (800) 223-8312
 (Continental U.S.A., Puerto Rico, U.S. Virgin Islands)

If there's an RF signal leak in your system, you better get it before it gets you in trouble with the Fed's.

You've got to put an end to RF signal leaks before the government brings the heat down on you. If you don't, there'll be more than grief to pay. It's time you put your plan into action.

Call Power & Telephone Supply. We'll help you silence the leaks and put an end to the problem.

No job's too big or too small for us. With our inventory from manufacturers like Times Fiber, Pyramid, Antronix, Scientific Atlanta, Sigmaform and Gilbert on our shelves we can help put this RF signal leakage out of your misery.

Power & Telephone Supply - 13 locations. All with inventory ready for immediate shipment.



Reader Service Number 27



Power & Telephone Supply Company

Atlanta, GA · (800)241-9996 · Lexington, NC · (800)438-2914 · Memphis, TN · (800)238-7514 · Nashville, TN · (800)251-1700
Jackson, TN · (800)238-3979 · Reamstown, PA · (800)238-7514 · Fort Wayne, IN · (800)348-0883 · Des Moines, IA · (800)247-0042
Houston, TX · (800)392-5939 · San Antonio, TX · (800)221-5213 · Knoxville, TN · (800)367-6047 · Appleton, WI · (800)558-8448
The Norcom Agency, Canby, OR · (800)451-2162

Detection equipment buyers' guide

You can have the most dedicated staff of technicians, the best software on the market and an aggressive leak detection and reparation program and all of it could amount to wasted energy if you don't have the proper hardware to find cable system leakage. Investing in the proper gear isn't cheap—but then, it shouldn't be. Consider the consequence to non-compliance: by losing channels, you'll lose a lot more than you spend for equipment.

With that in mind, what should you buy? In many respects, that's a decision only you can make. No one but you knows how much money you want to spend or how many units you want or need to buy. The equipment is out there and available from more than one manufacturer, however.

Making sure you're buying the right equipment for the job is one of educa-

tion. The more you know about the equipment, the better your decision-making process will be. Talk to fellow operators, find out what they use. Talk to the manufacturers, find out what they offer. Then, bring in your techs and ask them what they've heard. Then test some of the equipment and get feedback from your techs concerning their likes and dislikes.

You'll probably have the most success from equipment that was specifically built to detect CATV system leakage. You can use signal level meters attached to dipole antennas, but not even the companies that manufacture those meters recommend this approach as your primary method of detection.

Essentially, there are two approaches manufacturers take when they build leakage detection equipment. One involves the use of a special carrier

generator that is installed in the headend and receivers which are used to detect the leaks. The other is a simple receiver that can be tuned to one of your carriers and makes an audible tone when that carrier is detected. Which is the best approach? That may depend on several considerations. For instance, is your system located contiguous to a neighboring system using the same carriers? Consider the over-the-air environment; is your system located in an area with a lot of broadcasters?

Regardless, today's CLI gear is getting smarter. Used to be that you, the operator, had to convert readings to microvolts or microvolts per meter. Now, however, some of the new equipment takes all the conversion hassles out of the equation and does it for you. That makes life a little easier, doesn't it?

Augat/LRC (607) 739-3844

TR-1 "Tracer"
Base price: \$1,095



The model TR-1 Tracer features a calibrated dual-scale meter that indicates relative field strength and maximum allowable distance. The maximum distance scale is calibrated to the FCC specifications for leakage from a CATV cable in the 54 MHz to 301 MHz region. The 0 dB point on the relative field strength scale indicates the maximum allowable leakage when measured at a distance of 10 feet from the cable. The Tracer is factory set to operate with any carrier up to 301 MHz. It requires only that the video carrier stay within ± 4 kHz of the buyer specified frequency. No special headend transmitter is required. A recognizable audio tone is emitted when leakage is detected. A crystal controlled local oscillator and a 800 Hz bandpass filter are employed. A "fine-tune" adjustment compensates for temperature induced drifts in the LO frequency. A magnetic based, tuned dipole antenna, headphones, AC charger/adaptor and cigarette lighter plug are included.

Long Systems Inc. (619) 278-2700

RDT1 Remote Data Terminal
Base price: \$895



The Long Systems RDT1 Remote Data Terminal is a hand-held computer designed for data entry of cable system leakage. The unit helps eliminate errors in data entry by removing the need for double entry. Fully self-contained, the RTD1 operates on a 9-volt battery and data is backed up with a 5-year battery. If you're using Long Systems' software, you can download data using RS-232 cable or over standard telephone lines. The one-pound unit features a liquid crystal display of two 16-character lines, 36-key keypad (including editing, cursor, alphabetic, numeric, mode and on/clear keys), a plug-in 32K Rampak to store data (with typical capacity of 250 records), and an automatic shut-off after 5 minutes of not being used.

ComSonics Inc. (800) 336-9681 (703) 434-5965 (In Va.)

Sniffer II
Base price: \$1,939



ComSonics' Model S-400 "Sniffer II" system provides a signal source which injects a carrier at the headend and a detector used in the field to detect that carrier. The signal source can be operated between 45 MHz and 360 MHz. Features include a high selectivity input preselector which allows detection in locations where high level off-air signals are concentrated; tone coded variable squelch to mute background noise; tone squelch sensitivity at audible threshold, which helps prevent missing small leaks; low battery warning and automatic cut-off. The signal source offers enhanced detection sensitivity, and actual squelch tone decoding is at near audible threshold, which allows users to mute background noise while maintaining high squelch decoding and audible sensitivity.

ONE KEEPS THE SUBSCRIBER IN THE PICTURE. THE OTHER KEEPS THE FCC OUT OF IT.

Twenty cents per subscriber – that's all it takes to

upgrade to Times drop cable with lifeTime®

protectant. And to avoid angry calls

from subscribers and the FCC.

With lifeTime, we intro-

duced the concept of adding aerial

flooding compound to drop cable – to give you

the extra protection you need against moisture

entering the cable and degrading the shielding.

When that happens, RF energy leaks into the

atmosphere. And with the new CLI rules soon

going into effect, that could lead to substantial

financial penalties – and even loss of channels.

Even if the FCC never calls, your subscribers

will – with picture quality complaints that trigger

expensive service calls.

For a few cents more, lifeTime can lower your

operating costs and eliminate penalty fees.

So make the move to the new

leader in drop cable. Call

1-800-TFC-CATV. Or write

Times Fiber Communications

at 358 Hall Avenue, Wallingford, CT 06492.



TFC

TIMES FIBER COMMUNICATIONS, INC.®
an LPL company

Where technology meets the bottom line.

DETECTION EQUIPMENT

Sniffer III Base price: \$2,299



The Model S-600 "Sniffer III" operates from 48 MHz to 330 MHz and offers a new meter face and new internal logging circuitry over the Sniffer II. Also, readouts are given in microvolts per meter (2 to 2,000) in addition to the standard green-yellow-red go/no go detection capabilities. The meter is self-shielding and accurate to 2 percent of full scale. Meter movement is permanently fixed to the back panel to resist the effects of vibration. A 9-pin sub-miniature D connector has been placed on the back of the unit to allow for the application of a recording device or other peripherals.

Sniffer Jr. Base price: \$229.95



A pocket-sized leakage detector, the Sniffer Jr. allows for installers to check for leakage when they complete an install and effectively increases the size of your signal leakage detection team. The 7-ounce unit is frequency tuned to midband video carrier (channels C, D or G) to avoid false leakage indications from broadcast sources. The self-contained dual purpose antenna allows for far field monitoring and near field locator. FM squelch prevents false alarms due to ignition and RF noise and prevents operator misuse and undetected leakage. Also, operators can specify the field strength sensitivity they want.

Sniffware

A new software package designed to help operators meet the July 1, 1990 deadline, Sniffware allows for the logging of leakage locations, strength of leaks in dBmV or microvolts per meter and performs all calculations needed to obtain a CLI figure for your system. Included in the package is a leakage report form used for the routine leakage maintenance of a CATV plant. The report includes fields for location of leak, date, grid location, suspected cause of leak, action taken and other pertinent data needed.

Window II Base price: \$2,295



ComSonics' "Window II" field strength meter builds on the success of Window I. The microprocessor-based meter relies on a chip that performs one million instructions per second and is built inside a rugged carrying case. The high contrast liquid crystal display provides a bar-graph type readout of all channels (up to 83) as well as an alphanumeric display of individual channel measurements as indicated by a movable cursor. The Window II has special features which include sweep, zoom and tune modes. Direct carrier-to-noise and hum measurements can be executed by a single keystroke. Thirty-five screens can be stored in memory and with the system management package, the screens can be either printed in graphic or chart form. Software for the unit, dubbed "Mini-Bridge," permits downloading to a PC for storage or later analysis.

Remote Window



The rack-mounted version of the Window II enables system and/or management personnel access to the output parameters of their headends by using their personal computer. The unit interfaces to the PC via a phone modem. Software allows the operator to choose any Remote Window headend location and link technical information to the PC, which displays real-time information.

Flyovers

Finally, ComSonics now offers CATV operators the option of doing a flyover to detect and measure system leakage. The service generates a statistical summary of the test data as well as indicating excessive leakage areas.

Trilithic/Texscan Instruments (800) 344-2412 (Outside Ind.) (317) 545-4196

FDM-3 Base price: \$289



The Beephound signal leakage receiver is a double conversion superheterodyne crystal controlled fixed frequency receiver designed to operate with a headend transmitter. Squelch circuits insure alarm indication only when leakage occurs. The 13-ounce receiver can be hand-held, belt-clipped or used in a vehicle. The flexible antenna is removable to facilitate connection to a vehicular antenna. A NiCad battery operates the unit for 8 hours and recharging can be done overnight.

FDM-4 Base price: \$359



The mobile version of the signal leakage receiver is designed to be powered by a vehicle power system and is used in conjunction with a headend transmitter. The unit's compact design allows for mounting in several locations. An in-line fuse protects the DC power interface between the FDM-4 and the vehicle system. The front panel of the unit provides for power on indication; power off-on/volume; and squelch off-on. The speaker is mounted on the bottom of the unit. A BNC receptacle is provided for antenna connection along with the DC power input cable.

WESTEC

Microwave

Manufacturing

Modification

Repair

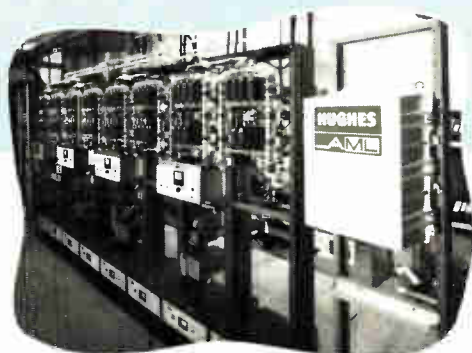

We have enlarged our AML Service operation to include all major AML system requirements at a reasonable cost. Since starting to refurbish solid state sources six years ago, we now provide the services shown below, and then some! Currently we are supplying all the modifications to convert AML systems to 450 MHz Bandwidth. Call Westec for responsive answers to your service problems.

*Bob O'Hara, President
Westec Communications, Inc.*

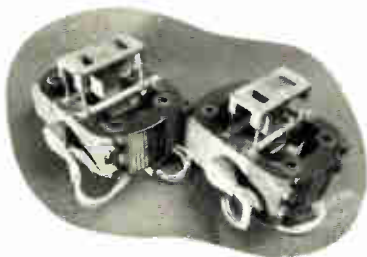

- SOLID STATE SOURCES
- UP CONVERTERS
- TRANSMITTERS
- RECEIVERS
- REBUILT KLYSTRONS
- KLYSTRON & OTHER POWER SUPPLIES



WESTEC COMMUNICATIONS, INC.

14405 N. Scottsdale Road, Scottsdale, Arizona 85254
(602) 948-4484 FAX: (602) 998-8701
Microwave Service (800) 666-4441

DETECTION EQUIPMENT

FDM-5
Base price: \$799



The headend transmitter designed to be used with the FDM-3 and FDM-4, this unit can be programmed to provide an output signal in the 88 MHz to 120 MHz range at 60 dBmV. It is frequency modulated by a 1 kHz tone to provide a signal which will cause an alarm in the receivers. Front panel provides for power off/on; power on indicator; output level adjust; and unlock (synthesizer fail safe alarm) indication. The RF synthesizer fail safe circuit removes the transmitter RF output if the phase locked loop should go into an unlock condition to assure output signal only on the programmed frequency.

Searcher
Base price: \$269



A portable, single frequency receiver, the Searcher peak detects a visual carrier leakage signal. The unit is factory adjusted to alarm at an RF input level of 1 microvolt. An alarm condition produces an audible tone with a pitch that increases as the receiver approaches the leak. A switch allows manual reduction of gain for close-in detection. The unit is available for channels 14, 15, 16, 17 or 18. Front panel indicators are provided for alarm, power on and low battery conditions.

Searcher Plus
Base price: \$699



A compact truck-mounted receiver that can be removed for hand-held use, the Searcher Plus is brand-new. A unique mounting bracket connects the external whip antenna and DC power from the truck for routine patrolling, yet when unplugged from the bracket, the unit becomes a hand-held receiver. The meter, calibrated in microvolts per meter, can be set to hold peak readings for 5 seconds, giving a busy driver time to check the meter scale. The audio alarm increases in pitch as the leak is approached. The unit operates in the 108 MHz to 157.25 MHz range. A fixed tuned dipole antenna is offered as an option.

TFC-450
Base price: \$2,999

TFC-600
Base price: \$3,499



Tuned Frequency Counters from Trilithic/Texscan Instruments can measure the entire headend for frequency accuracy of the video carriers and audio spacing in minutes. The TFC-600 (600 MHz frequency range) automatically strips the modulation from the video carrier, counts the video carrier frequency and counts the audio spacing. A temperature controlled quartz crystal time base gives 8 digit or 10 Hz resolution through a 10-second gate. The unit is also available in a 450 MHz version.

Wavetek RF Products
(317) 788-9351
(800) 622-5515

CLR-4
Base price: \$450



The CLR-4 is a hand-held leakage detection/location instrument used to scan four different cable video frequencies or to monitor those frequencies one at a time. When a leak is detected, the unit stops scanning and a tone is emitted. The tone varies in pitch according to signal strength. Sensitivity is listed as 1 microvolt; channels B, D and G will break squelch for 10 μ V/m at 3 meters. A sync buzz switch allows for audible video channel verification.

CLM-1000
Base price: \$2,495



A field-strength meter designed for leakage testing, this unit offers a wide tuning range (50 MHz to 550 MHz) with aeronautical bands preselected. In conjunction with an antenna, the CLM-1000 can be used to make precise measurements up to 100 feet. The unit automatically calculates the equivalent 3-meter measurement and the result is displayed on a LCD display in microvolts per meter. The alarm field strength trip point is user settable. The unit also provides data logging, level at 3 meters, frequency and repair required. Entries are made by a dual function 32-key keyboard. An RS-232 port allows interfacing with a PC.

ST-1
Base price: \$750

ST-1C
Base price: \$830

The ST-1 "Cuckoo" injects an FM signal into the cable plant for detection by receivers in the field (in this case, the advantage is that normal FM radios can be used to detect the injected signal). The ST-1C is similar but is crystal-controlled and is mated with a special receiver (no tuning is required). These units are designed for leakage monitoring.

RD-1
Base price: \$450

A tuned dipole-type antenna with a 16 dB gain battery operated amp, this antenna can be set for frequencies from 50 MHz to 250 MHz and can be used in conjunction with Wavetek signal level meters. A bandpass filter can be placed between the antenna and preamp to correct for strong local off-air signals. ■

—Roger Brown

YOU'RE WELCOME!

JONES INTERCABLE, INC.

February 22, 1989

RISER-BOND INSTRUMENTS
505 16th St. P.O. Box 188
Aurora, Nebraska 68818

To: Linda Fangman
Sales/Marketing Services

Re: RISER-BOND INSTRUMENTS Model 2901B+

In November 1988, JONES INTERCABLE of Madison, Wisconsin purchased a RISER-BOND Model 2901B+ TDR. We were a little skeptical of an instrument that sells for under \$800.00 that supposedly will do the same thing (locating faults in cable) as an instrument that sells for over \$6,900.00.

We at JONES INTERCABLE in Madison are impressed! The instrument totally surpassed our expectations. We have found the instrument to be invaluable. It is safe to say, IT HAS PAID FOR ITSELF FIVE TIMES OVER IN ONLY FOUR MONTHS.

Case #1: In an 800 ft. span of .500 cable, we were experiencing a higher than normal attenuation of RF, as well as a large loss in AC. A JONES technician put the 2901B+ to the test. He put .500 to F fittings on the cable and took readings from each end. He proceeded to dig-up the fault at the distance indicated by the TDR, found the problem, and restored full service in less than three hours!

Case #2: We had a similar situation with a 1300 ft. .750 trunk run. After pinpointing the fault with the 2901B+, we went in with a slit trencher and a back hoe. We were off by only 6 inches! The cost savings is multiplied when I explain that this was done in 24-30 inches of frost. This is a scenario where being off can cost \$100.00 per foot! With wind chills of 20-40 below zero, no one wants to be on a roadside any longer than necessary.

We have more examples, but so far, all have been happy endings thanks to the RISER-BOND INSTRUMENTS Model 2901B+.

Although the Model 2901B+ is simple to operate, we opted to purchase the instructional video tape for only \$35.00, again, some of the best money we ever spent. This gave our JONES technicians the confidence to trust the instrument, as well as giving them a good understanding of the principal of a TDR. Did we need the video tape? NO, but it did help.

For a very cost effective, easy to operate, dependable, highly accurate cable fault locator, you can't beat the RISER-BOND 2901B+!

Thank you.

Joe Browning
Joe Browning
Chief Engineer

2984 Triverton Pike Road, Madison, Wisconsin 53711-5897 / (608) 273-4800

505 16th STREET, P.O. BOX 188
AURORA, NEBRASKA 68818
402-694-5201



RISER-BOND
INSTRUMENTS

Reader Service Number 30

CLI: A total proven approach

Following you will read about a computer-aided program to effectively monitor, log, repair and file leaks. To this end, we gather important data as to the cause of the leak and the best method for repair, and we provide a preventative maintenance program to keep the levels acceptable.

MetroVision systems use a ground-based procedure to effectively monitor, log, repair and document leaks. We compile data showing the cause of the leak and method of repair. The procedures have been used in MetroVision's 1,100 miles of plant in the Detroit area systems since January 1, 1987. All MetroVision systems now utilize these procedures to control signal leakage.

Signal leakage is like lust; we all have it—just don't let the FCC catch you with it!

- Current FCC rules require leakage measurements to be taken 3 meters from the cable with a field strength meter of adequate accuracy and a horizontal dipole antenna. Systems operating in the frequency bands of 108 MHz to 137 MHz and 225 MHz to 400 MHz must be in compliance with a cumulative leak index by July 1, 1990.

- The Cumulative Leak Index (CLI) measurement technique was developed several years ago to assure cable television operators that leakage from their system would not present a hazard to the safety of aircraft operating overhead.

- Ground-based CLI is calculated using all leaks equal to or greater than 50 microvolts per meter. The value of each reportable leak found is squared. The squared values of all leaks are summed. This sum is multiplied by the result of total plant mileage derived by the driven mileage to compensate for partial drive-outs. CLI is equal to 10 times the log of this number. The maximum allowable legal limit is 64.

- All individual leaks found of 20 microvolts per meter or greater must be logged showing the date found, the location of the leak, the date of repair, and the cause of the leakage. The log must be kept on file for two years and be made available to authorized FCC representatives upon request.

- The current FCC regulations are that the entire cable system must be monitored once each calendar year. (Non-grandfathered status systems must monitor substantially all their plant every three months.) We use a large three-ring binder labeled "FCC Signal Leakage Records" for each drive-out. At the end of each drive-out the unrepaired leak file is purged and the repaired leak information is retained in the FCC public file for two years. The new Repaired Leak Report is added to the existing file and kept in the three-ring binder. The binder is used as a current reference should there be an inspection by the FCC.

- The cable operator shall annually notify the FCC of its calculated CLI on

By Victor B. Gates and Clayton A. Collins, MetroVision Inc.

©NCTA. Reprinted from 1988 NCTA Technical Papers

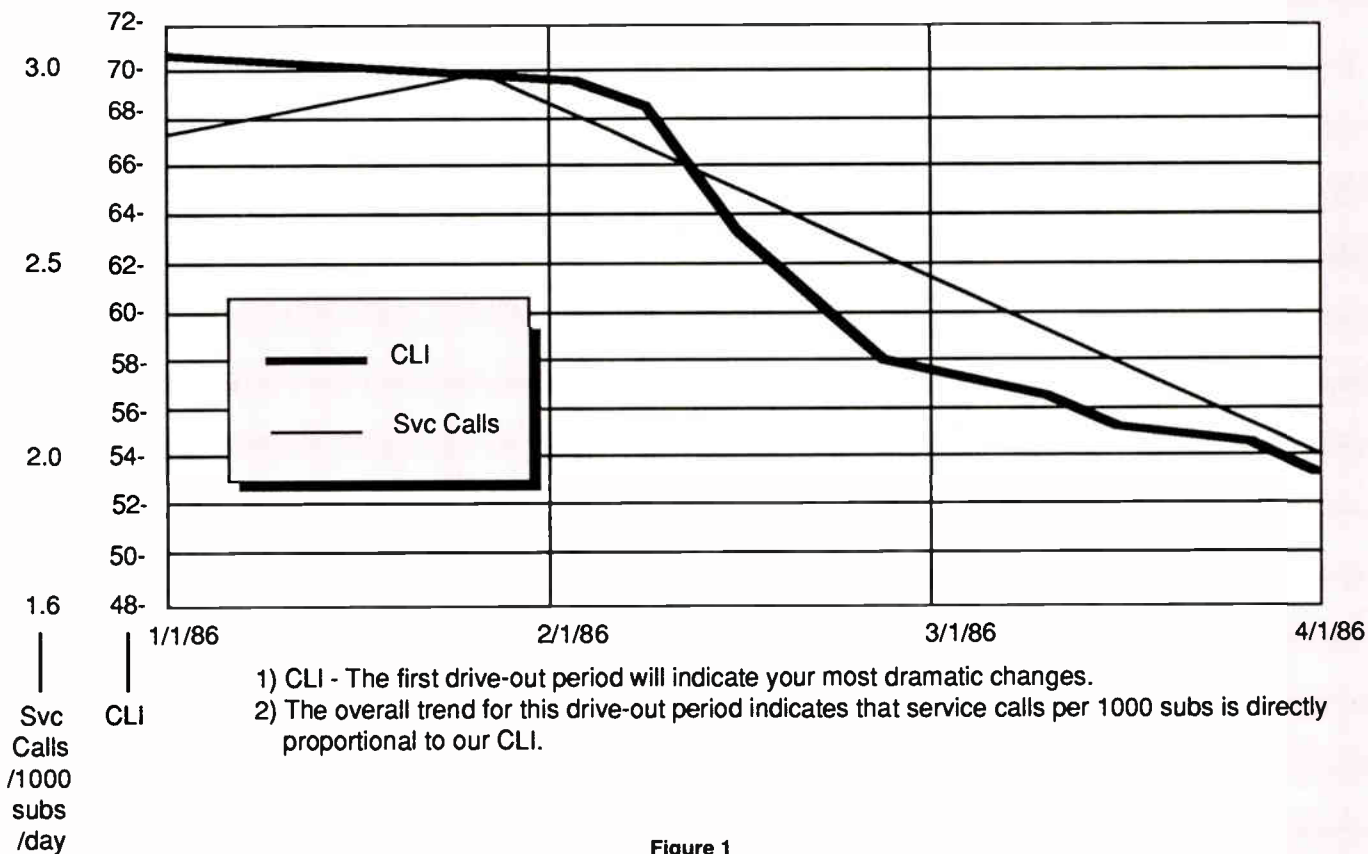
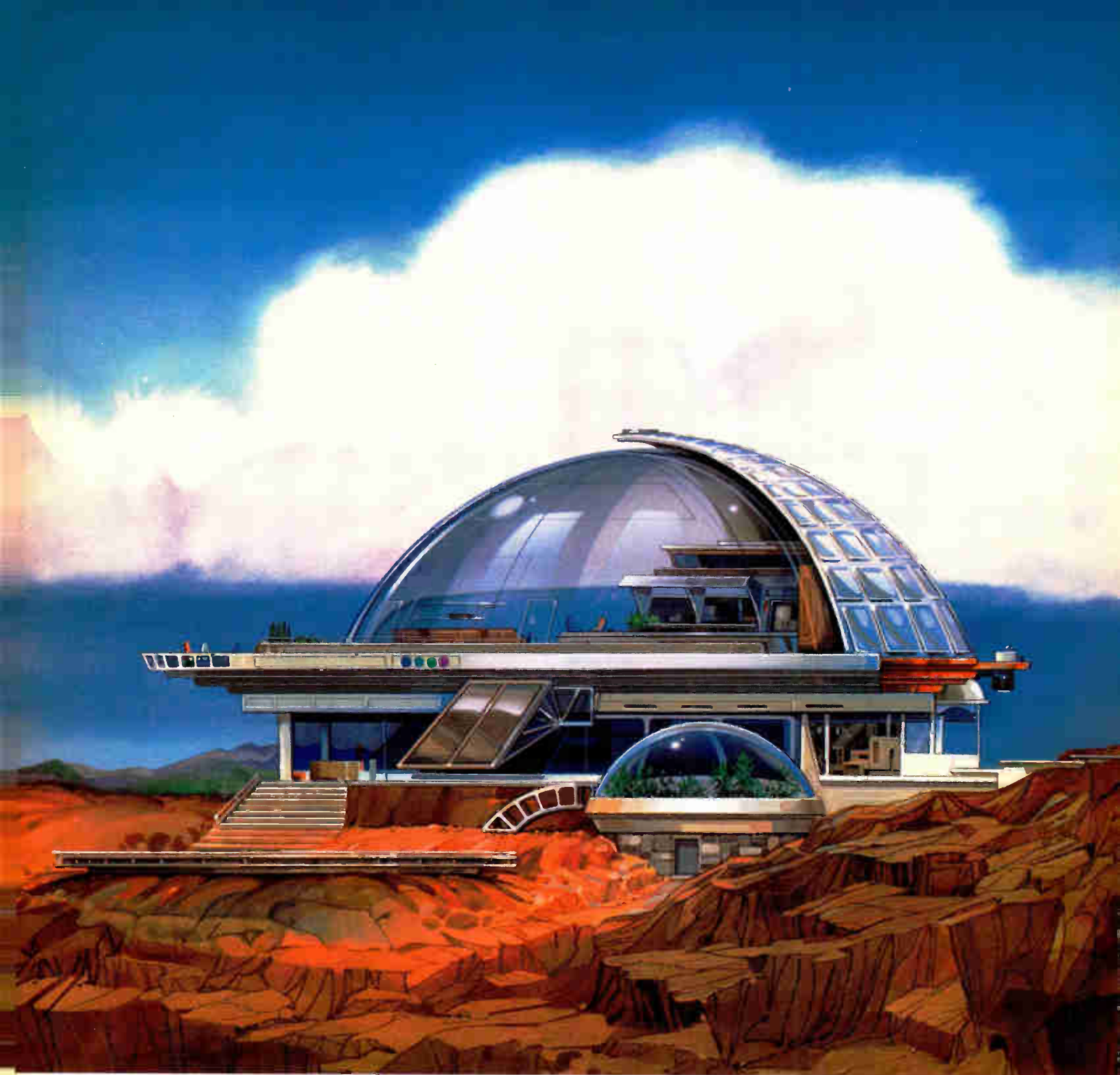

Figure 1



Wouldn't it be nice if C-COR rebuilt homes, too?

Like our cable system rebuilds, you'd have the technology of tomorrow, today. And if you preferred, we'd custom build it. Your warranty would be three times the industry standard. You could reach us 24 hours a day for personalized service and fast turnaround on repairs.

You'd have the best home on the block.

If this kind of innovative service, advanced product line and commitment to quality hits home, let us show you what we can do for your business. Call 1-800-233-2267. In PA, 1-800-356-5090. Or write: C-COR,

60 Decibel Road, State College, PA 16801.

But please. Limit your rebuild requests to cable systems. We don't do houses. Yet.

C-COR[®]
ELECTRONICS INC

We're Out To Give You
The Best Reception In The Industry.

Reader Service Number 31

Form 325.

In our program, we don't specifically measure each leak at 3 meters on a monitoring basis. We use the computer program to do the calculations based on an estimated footage from the leak and the direct reading of the meter. If we limited ourselves to a 3 meter measurement on each leak during the first drive-out, we wouldn't complete the first drive-out until June 30, 1990. But, as will be shown, we meet the 3 meter measurement requirement as the repairs are completed.

Getting started

The key to any good maintenance program is getting your schedules, tools, forms and people together.

- Personnel. We use existing per-

- Get system prints. We use size 11 by 17 prints in plastic covers. (These will be used for tracing the route while the drive-out is being performed.) The prints have to be updated as the plant grows or changes are made.

- Signal Leakage Logs. These logs are the most important source for field information and will have to be treated as such. Careful attention to detail is not only easy, but very important.

The drive-out

On the day of the drive-out, the coordinator puts the prints in groups of 48 miles per team. The technicians calibrate their meters to a known signal in the headend. They use non-permanent markers to follow their route and when a leak is detected, the

in the drive-out.

Seeing the results of the drive-out is clearly the most discouraging part of the process. However, in Figure 1 you'll see a graph that indicates our service call ratio before the introduction of this program and after the first drive out and repair period (CLI and service calls versus time.) Figure 2 shows our current CLI and service calls versus time graph after one year with this program.

Computer

We use an IBM PC/AT compatible computer and custom software to manipulate and sort all leakage data gathered during the drive-outs. The computer is equipped with a 20 megabyte hard disk and 640K of RAM memory and a dot-matrix printer. The software is entirely menu-driven and will provide all reports necessary to control and document leakage repairs and calculate CLI for all or part of a cable system.

Leak information is input into the computer in terms of the leakage detection meter reading and estimated footage from the leakage detection antenna to the probable leak location. The computer calculates the leak's intensity in microvolts per meter at 10 feet. The drive-out personnel need not be concerned with determining the field strength.

The computer software provides a listing of all leaks sorted by intensity for the entire system or a portion of the system. The software also provides CLI reports for the entire system or a portion of the system.

As repairs are completed, the repair data is stored with all information required to meet the FCC's rules for leakage logs. Printouts of all available reports are stored in a binder that is available for review by visiting FCC inspectors.

We keep the following reports in the public file for FCC inspection:

1. FCC CLI Report (correct CLI to lower than 64 (see Figure 3)).
2. Maintenance CLI Report. (See Figure 4).
3. Unrepaired Leak Report.
4. Repaired Leak Report.
5. Area Information file
6. Repaired Leak Statistics report.

Administration

The data entry person needs to dedicate time to CLI on a part-time basis; we use a CSR. Emphasis on this position *must* be the same as other

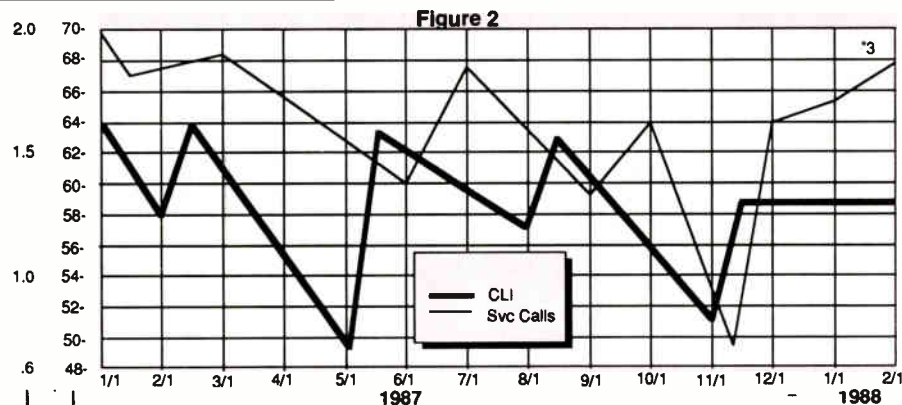

1) SERVICE CALLS PER 1000 SUBS - You'll see an overall down trend in service calls as CLI is maintained.
 2) CLI - You'll see a rise and fall as driveouts are completed. After service has been done, there is an overall decline in CLI to an average of 59.
 *3) Indicates an increase in service calls when no leaks have been repaired over a period of a month.

sonnel; a team of one CSR, salesperson or installer and one technician. The technician records the leaks while the other person drives.

- Time. Although this seems to be the only commodity impossible to make available, it can be done relatively quickly on a Saturday or in slow time. We have found a team can drive eight miles of plant per hour with a six-hour time limit due to fatigue.

- Set up a schedule. This has to be a practical schedule—one that can be attained and maintained.

- Get detection equipment. We use a detection meter with a cut dipole at 139.25 MHz (one meter per 68 miles of plant.) The antenna is on a magnetic base and mounted on the top of each vehicle. The meter is sensitive and should be used at a temperature as constant as possible. Calibration is absolutely necessary all through the day of the drive-out. When a leak is detected the meter has to be peaked.

technician instructs the driver to slow down from 10 miles per hour to 5 MPH. At the strongest indication on the meter, the driver stops to write down the level and estimate the footage to the cable plant (the leak level is calculated by the computer for the 3-meter intensity.) He then records the nearest address or the system print location on the Signal Leakage Log. He continues this until his 48 miles is complete.

At the end of each day, the coordinator gathers the log and system prints to verify that all assigned prints were driven out, the logs are legible and all blanks are filled in. This is done to ensure that the data entry person can enter accurate information. This also ensures that the equipment is working properly and that the drive-out team was paying attention. At this point, it's Miller time (refreshments.) We make sure there is plenty of pizza and other refreshments for everyone taking part

CLI-TEC

A Cable Communications Corporation

Your source for Signal Leakage Detection !

- CLI-TEC has over 65 years combined CATV experience
- All of CLI-TEC's technicians are SCTE certified
- CLI-TEC offers the following
Computer Generated Documentation:
 - Drive out Reports
 - Maintenance Reports
 - Repair Work Orders
 - Repaired & Unrepaired Leakage Reports
 - Priority Leakage Reports
 - Cumulative Leakage Index Reports

25% OFF

All systems through September 1, 1989

Repairs available
Call for a FREE estimate:
1-800-842-6071

In Oklahoma: 405/332-7513

FAX 405/332-9021

CLI-TEC, PO Box 158, Ada, OK 74820

more traditional CSR activities, such as balancing cash.

The CSR gets the drive-out information from the coordinator and then enters each leak individually. We have found we can enter approximately four leaks per minute.

After the leaks have been entered, an Unrepaired Leak Report is generated. This report may be retrieved either by leak intensity or by leak number. The Unrepaired Leak Report by leak number is used by dispatch to log the completion of repaired leaks as called in by the technicians. The Unrepaired Leak Report by leak intensity is used by the chief technician to assign work orders by leak intensity.

The CSR will also, at that time, print work orders based on intensity, picking the highest level leaks as well as the number of leaks that can feasibly be repaired in one week. A copy is given to the dispatch department and the original is given to the chief technician of each system. We review this at our weekly regional chief technician meeting.

Other reports printed at that time include the FCC CLI Report and the Maintenance CLI Report. The FCC CLI report only uses leaks above 50 $\mu\text{V/m}$ at three meters in its calculation and the Maintenance CLI Report uses all reported leaks. All of these reports are copied and given to the chief technician and filed in the FCC binder, with the exception of work orders.

The chief technician accesses the information for leaks above 150 $\mu\text{V/m}$ and these are repaired immediately. They are assigned from his Unrepaired Leak Report by intensity and technicians are given the original copy of the

repair work order. When these repairs are completed, he continues to hand out more repair work orders by intensity until all work orders are complete or until the next drive-out rolls around.

The technician repairs each leak and

All Areas FCC Report		
Mileage	178.650	
Miles Driven	178.650	
Percent Driven	100.0	
Total Leaks	27	
Leaks per Mile	0.15	
Largest Leak	203	$\mu\text{V/m}$ at 10 ft
Smallest Leak	51	$\mu\text{V/m}$ at 10 ft.
Leaks greater than 1500	$\mu\text{V/m}$ - 0	
Leaks between 1000-1500	$\mu\text{V/m}$ - 0	
Leaks between 500-1000	$\mu\text{V/m}$ - 0	
Leaks between 200-500	$\mu\text{V/m}$ - 1	
Leaks between 50-200	$\mu\text{V/m}$ - 26	
Cumulative Leak Index	51.8	(Pass)

Figure 3

All Areas Maintenance Report		
Mileage	178.650	
Miles Driven	178.650	
Percent Driven	100.0	
Total Leaks	150	
Leaks per Mile	0.84	
Largest Leak	203	$\mu\text{V/m}$ at 10 ft
Smallest Leak	11	$\mu\text{V/m}$ at 10 ft.
Leaks greater than 1500	$\mu\text{V/m}$ - 0	
Leaks between 1000-1500	$\mu\text{V/m}$ - 0	
Leaks between 500-1000	$\mu\text{V/m}$ - 0	
Leaks between 200-500	$\mu\text{V/m}$ - 1	
Leaks between 50-200	$\mu\text{V/m}$ - 26	
Leaks between 20-50	$\mu\text{V/m}$ - 112	
Leaks less than 20	$\mu\text{V/m}$ - 11	
Cumulative Leak Index	53.8	(Pass)

Figure 4

records it on his work order, being sure to record a measurement at three

meters or indicating "no leak measured." We've found that after a number of large leaks are fixed, there are no leaks where a minor leak was recorded. The technician then calls in the repair to dispatch with the fix code, date of repair and level at three meters. Dispatch records this on their copy of the work order. The technician, at the end of each day, turns in his copy of the work order to the chief technician.

Problems in the home

Sometimes, a technician is unable to complete an assigned work order because the leak is emanating from a subscriber's home. This can occasionally be quite a frustrating problem, especially when your subscriber works days with no one at home.

We alleviate this problem with a door-hanger and a series of letters that always resolve the problem. We place the door-hanger on the technicians' first attempt to correct the problem. If we get no response, we send a series of three letters resulting either in the repair of the leak or the disconnecting of the subscriber.

Weekly, the CLI CSR gathers the repaired work orders from the dispatch department and verifies the information against the chief technician's work order. The leak repairs are then logged in the computer and new reports are generated. At this point, the Repaired Leak Report and the Repaired Leak Statistics report are copied for the FCC file and the chief technician. We do not file the Repaired Leak work orders.

At the end of the drive-out period all reports are generated and the new drive-out information replaces it. ■

MIDWEST CABLE SERVICES

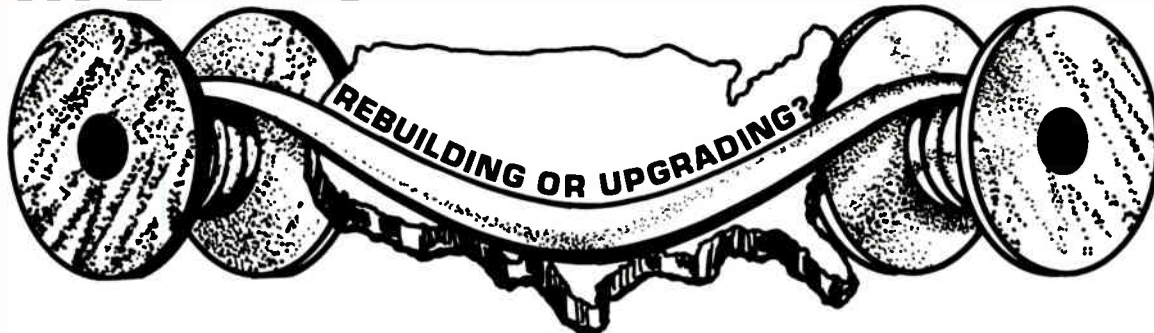

— **NATIONWIDE BUYERS** —
CATV SCRAP CABLE AND USED LINE GEAR

322 N. Michigan Street, Plymouth, IN 46563
 Phone (219) 936-2545 FAX (219) 936-5749

CLI measurements for large systems

The following paper reviews Cumulative Leakage Index requirements and considers leakage program organizational methods and procedures as they relate to large systems.

Both ground-based Cumulative Leakage Index formulas were analyzed revealing the lack of any system size allowances. Flyover advantages and limitations were compared with system leakage strategy. Its intent is to emphasize the need for immediate planning which will ease the ordeal of passing the FCC filing on July 1, 1990.

Large system considerations

Large cable systems have an inherent disadvantage when attempting to submit a passing annual Cumulative Leakage Index to the FCC.

There is no mileage adjustment factor included in any of the three methods for collecting and computing a CLI. That means, for example, that a 3,000-mile system cannot have any more leaks, which equal or exceed 50 microvolts per meter at a distance of 10 feet, than a 10-mile system can if any channels between 108 MHz and 136 (soon to be 137) MHz or 225 MHz to 400 MHz are used.

A review of the following considerations and their possible implementation into your leakage program may make the task of filing a passing annual CLI to the FCC more pleasant, and may reduce the anxiety of the July 1, 1990 deadline.

If you do not presently have an aggressive, routine quarterly monitoring and repair program in place, *don't expect to pass your first annual CLI.* The following list is an example of allowable leaks at various field strengths producing a CLI at the passing threshold:

# of leaks	level	CLI
1000	50 μ V/m	63.9
250	100 μ V/m	63.98

By Bob Saunders, Director of Engineering, Sammons Comm.

©NCTA. Reprinted with permission from the NCTA Technical Papers, 1989

100	150 μ V/m	63.52
1	1600 μ V/m	64.08 (failure)

The CLI calculations were derived from this formula:

$$I_{\infty} = \frac{1}{l} \sum_{i=1}^n E_i^2$$

ϕ is the fraction of the system cable length actually examined for leakage sources and is equal to the strand miles in the plant;

E_1 is the electric field strength in microvolts per meter (μ V/m) measured pursuant to Section 76.609 (h) 3 meters from the leak i ; and

n is the number of leaks found of field strength equal to or greater than 50 μ V/m pursuant to Section 76.609 (h).

where: $10 \log_{10} I_{\infty}$ must equal or be less than 64.

More simply stated:

$$CLI_{\infty} = 10 \log_{10} \left[\left(\frac{\text{plant miles}}{\text{miles monitored}} \right) \text{sum of } (leaks^2) \right]$$

As you can see from this formula, large systems have the same burden of a 1,000 leak maximum limit if all leaks discovered emit a field strength of 50 μ V/m. As the leak levels increase, the number of allowable leaks decreases exponentially. Therefore, the larger the system, the more advanced planning is required to avoid the last minute panic of how to deal with a system that can not produce a passing CLI.

Routine monitoring

What is an effective routine quarterly monitoring and repair program? Docket 21006, as adopted in Part 76 of the FCC Rules, states that a sufficient number of vehicles must be equipped with leakage receivers sensitive enough to detect leaks at a field strength of 20 microvolts per meter at a distance of 3 meters (10 feet) to ensure 100 percent system coverage every three months. Repairs must be made at all locations which meet or exceed the 20 μ V/m threshold and all objectionable leaks (an incident where complaints have been made, no matter what the level)

even though a minimum level of 50 μ V/m is used for CLI computation.

Assess the resources you presently have. The monitoring can and should be included in routine daily work activities.

Prevention is the only path to a passing CLI and an eventual "closed system," in my opinion. Until all appropriate staff are trained to understand the significance of all the tasks they perform on your coaxial cable plant and develop the necessary skills and professional ethics to deliver high quality work standards every time, your leakage repair backlog will remain an unmanageable problem. Properly preparing and tightening every trunk and feeder connector, as well as drop F-fittings, will show results quickly.

Multiple Dwelling Units are the single most common cause of excessive signal leakage in the majority of cable systems I have examined. Feeder cables usually present the greatest potential for high level leakage since the highest signal levels in a typical cable plant are present. Therefore, feeder cable in apartment houses, hotels, motels, etc. should be constructed with $\frac{5}{8}$ -inch by 24-thread ported amplifiers, aluminum cable and directional taps. Gain amplifiers (50 dB) with an F-fitting at the output port feeding residential splitters via a piece of single shielded RG 59U is an example of what should not be used. Typically, these bulk billed accounts are simply a result of attaching to an existing MATV system. The rules are clear. *If your signal is present on a cable or piece of equipment, it's your responsibility.* I recommend adopting the rule "aeronautical channel signal levels may not exceed 20 dBmV on any drop type cable," including short jumpers.

Effective receivers

Leakage receivers should be equipped with some type of meter which can be calibrated. The Rules do not require level measurements during quarterly monitoring, however, the benefits justify the cost (especially to larger systems.) Time spent during the locating

process is shortened since the direction-finding properties of the receiver are enhanced. Repair time is more productive toward CLI reduction because leaks can be sorted by level for priority.

S meters, LCD bar meters, and LCD light bars can be calibrated just as effectively as a meter which reads microvolts per meter directly. The development of a graph similar to the one in Figure 1 will establish the relationship between various signals in dBmV and the appropriate field strengths in microvolts per meter for the monitoring frequency of your receivers. The graph was produced from calculations derived from the formula:

$$\text{dBmV} = 20 \text{ Log}_{10} \left(\frac{E (\mu\text{V/m})}{1000} \right)$$

Where: f = frequency being measured

Example:

$$\text{dBmV} = 20 \text{ Log}_{10} \left(\frac{20}{1000} \right) = -43.95$$

The example above demonstrates that a signal of -44 dBmV will represent a field strength of 20 microvolts per meter when the frequency measured is 150 MHz. The graph illustrated in Figure 1 shows similar relationships for a 150 MHz receiver including field strengths from 20 $\mu\text{V/m}$ to 340 $\mu\text{V/m}$.

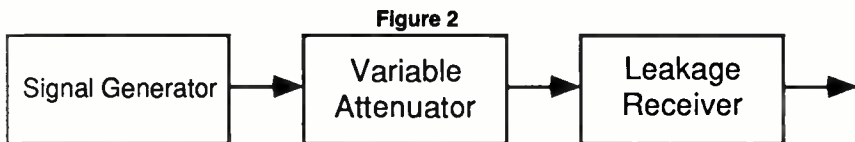

Figure 2
Test Setup to determine signal level

A test arrangement similar to the one presented in Figure 2 can be used for calibration purposes. A lab quality signal generator is not necessary. Calibration signals from a SAM 1 field strength meter were used for this example along with a 2 meter amateur receiver since both will operate at 150 MHz. We will then assume that channel F will be used for monitoring the hypothetical system. The signal from the generator is fed into a variable attenuator. I recommend that the output of the signal source be adjusted or attenuated to produce 0 dBmV. This will facilitate the readings since a direct relationship will exist between the variable attenuator settings and the negative signals being exposed to the receiver under test.

Since the formula is based on measurements collected from a half-wave dipole, a correlation must be established if an alternative antenna is used. Place an appropriate in-line pad in the test lead to compensate for any antenna loss exhibited when compared to a half-wave dipole. The signal generator output must be adjusted above 0 dBmV an amount equal to the gain factor of any antenna used to maintain the attenuator's direct relationship. Various receiver meter readings are recorded against the field strengths indicated from the graph to serve as a calibration table. Employee participation during this procedure and future routine confirmations will improve their development in learning the relationship between dBmV and $\mu\text{V/m}$. A sense of confidence with the new skills required develops when various leaks are quantified in $\mu\text{V/m}$ rather than pass/fail. The system's leakage program efficiency will improve parallel to the learning curve of its participants.

To confirm the proper operation of leakage receivers, build a "test zone" at some frequently visited location such as the company parking lot entrance. A typical example is the use of a half-wave dipole mounted on a pole fed by signals from your system and adjusted to produce a 20 $\mu\text{V/m}$ leak at a specific location painted on the parking lot pavement. Regular visits to that spot will develop operator confidence in the correct operation of their leakage receivers and save valuable monitoring

and repair time avoiding the use of faulty equipment.

Logging

Prior to the development of logging procedures, careful consideration to some aspects of these records may mean the difference between passing or failing your first CLI, even though you may have collected identical data.

It is advantageous to divide a system for leakage calculations whenever legally possible. John Wong of the FCC has stated at recent NCTA seminars on leakage that sections of cable systems fed by a separate headend, microwave signals, or fiber optic cables that are not connected by coaxial cable in any way may be considered as separate systems for the purpose of CLI computation. By no means am I giving permission to make divisions of your system based on any of these criteria, however, division is worth considera-

MAP • a • bil • ity

from USGS data
DIGITAL MAPS
for AutoCAD® users

ideal for:

- cable system design
- detecting terrestrial interference
- marketing strategy

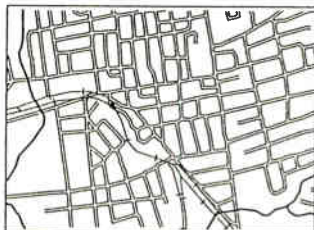

includes roads, highways, waterways, powerlines, railroads, landmarks, contours and terrain data.

Reader Service Number 34
AMERICAN DIGITAL CARTOGRAPHY™

715 W. Parkway, Suite A • Appleton, WI • 54914
414-733-6678



CABLE ENGINEERING, INC.
P.O. Box 4086, Louisville, KY 40204

- Sweep Balance
- Head End Proof
- Makeready Survey
- As Built
- Splicing
- C.L.I.
- Strand Mapping
- Makeready Survey
- Drafting, Design, LAN

Reader Service Number 35

(502) 426-9372
1-800-626-2715
502-589-2848

California License

LARGE SYSTEMS

tion with interpretation confirmation from the Cable Branch of the FCC if necessary.

contour band may provide a useful tool to ease collection of this information. Without proper logging of leakage

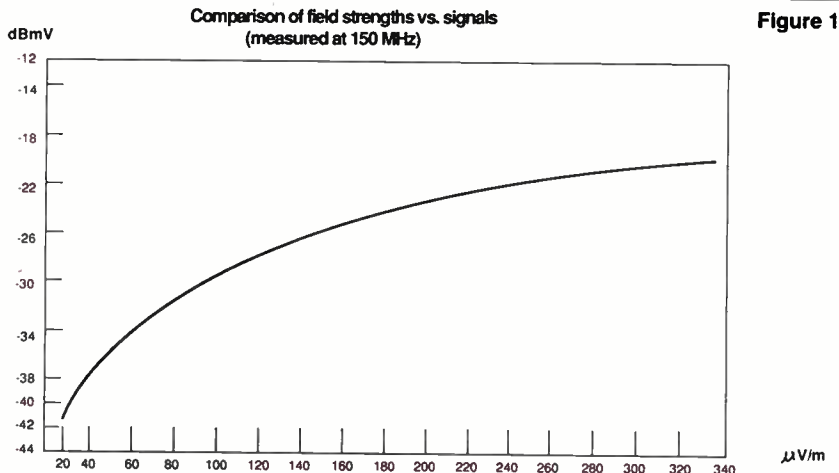

Computation based on the:

$$I_{3000} = \frac{1}{\beta} \sum_{i=1}^n \frac{E_i^2}{R_i^2}$$

where:

$$R_i^2 = r_i^2 + (3000)^2$$

r_1 is the distance (in meters) between the leakage source and the center of the cable television system;

β is the fraction of the system cable length actually examined for leakage sources and is equal to the strand miles of plant tested divided by the total strand miles in the plant;

R_1 is the slant height distance (in meters) from leakage source i to a point 3,000 meters above the center of the cable television system;

E_1 is the electric field strength in microvolts per meter $\mu\text{V}/\text{m}$ measured pursuant to Section 76.609 (h) 3 meters from the leak i ; and

n is the number of leaks found of field strength equal to or greater than 50 $\mu\text{V}/\text{m}$ pursuant to Section 76.609 (h).

may provide some relief since the slant height is used to determine the effect of individual leaks upon aircraft. Larger systems potentially offer greater advantages since the distance adjustment may be significant. In order to use this formula, distances from each leak to the theoretical center of the system must be added to the list of information collected while on leakage patrol. Distance averaging may be used as long as an advantage is not derived from its use. The advance development of distance contour lines about the system center and the use of a common distance for all leaks within each

monitoring and repair activities, all your efforts will have been wasted when faced with an FCC inspection. The responsibility of proper documentation is to ensure a "good faith effort" can be demonstrated.

Flyovers?

Finally, you must deal with the question, "do I use aircraft to determine system cumulative leakage?" Consideration of the following information may make that decision easier.

The FCC considers a CLI as a snapshot of your system to determine its total cumulative contribution to potential aircraft interference. Recent question-and-answer sessions have indicated that it would like the annual CLI pass of the system to take about two weeks with a four week maximum. System size coupled with available staff may make a flyover the only practical means to accomplish this task within that time frame.

Additionally, a ground-based CLI must cover a minimum of 75 percent of your system. Both the I_{3000} and the I_{3000} formulas contain correction for partial rideouts, therefore it may be a disadvantage to miss up to 25 percent of the plant. It is very important to remember that a system that cannot pass a ground-based CLI calculation, due to unrepaired quarterly monitoring backlogs, is unlikely to pass a flyover. Be sure the system is tight before spending time and money in aircraft. ■

References

1. FCC Rules, Part 76.



FORGET FIBER!

Without proper training you might as well.

Give us your crew and we'll give you a fiber-intensive, "hands-on experience" education

Class I

- Fusion Splicing
- Mechanical Splicing
- Enclosures
- OTDR's
- Construction

Class II

- Engineering
- Electronics
- Design
- Construction Practices

We utilize Sumitomo, Catel, Anritsu & Tamaqua.

Call for more information at:
1-800-937-3423/1-800-YES-FIBER
(203)871-6750

The Fiber Connection
PO Box 245,
Stafford Springs, CT 06076

CLI and its effect on aeronautical navigation

When the FCC released its Second Report and Order in Docket 21006, most operators did not realize its long range financial implications. As we approach July 1, 1990, the final deadline for the submission of a CLI index figure to the FCC, more and

Much has been written over the last few months about the "how to" of leakage monitoring and repair. This article will focus on three key issues: current aeronautical communication/navigation technologies; the effects of cable TV signal leakage on aircraft

is especially important that navigation channels be free from interference when aircraft are operating in congested areas, particularly around heavily used airports such as Chicago's O'Hare or Atlanta's Hartsfield, or when making an approach to a landing in

Figure 1

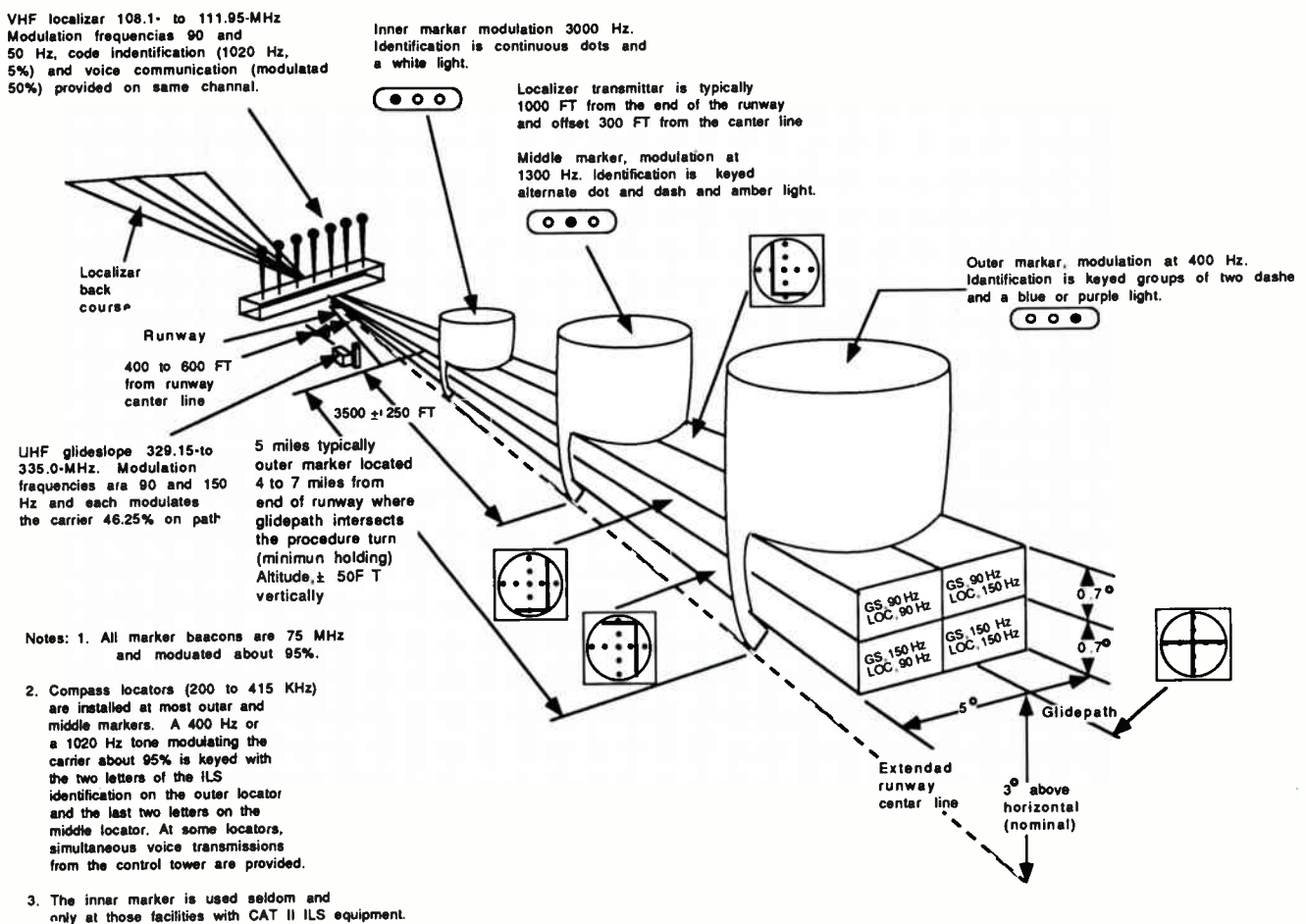

more operators are coming to grips with signal leakage problems and have implemented programs that will ensure their systems are capable of meeting the CLI threshold number by the end of 1989. These programs, in many cases, have been laborious, time consuming, and expensive, to say the least.

By Larry Warren, Regional Product Manager, Anixter Cable TV

communication/navigation equipment; and leakage sources and solutions.

Communication/navigation

There are basically two types of signals used by the aviation industry—communication signals and navigation signals. Among other things, navigation signals are used while making instrument approaches to airports. It

is especially important that navigation channels be free from interference when aircraft are operating in congested areas, particularly around heavily used airports such as Chicago's O'Hare or Atlanta's Hartsfield, or when making an approach to a landing in

inclement weather when visual contact with the earth's surface is not possible until close to touchdown. The Advisory Committee on Cable Signal Leakage decided that, in order to minimize interference from cable plants, one thing that should be required of these systems was a mandatory offset of those visual carriers being used in the aeronautical portion of the spectrum. In the 108 MHz to 118 MHz

range (the navigational portion of the VHF band) the aeronautical channel spacing is 50 kHz and the channel spacing for the 118 MHz to 136 MHz communication range is 25 kHz. The current offset requirements of 25 and 12.5 kHz put the visual carriers of CATV channels operating in this range directly between the aeronautical carriers.

Practically all major airports have ILS (Instrument Landing System) approaches. ILS systems consist of three distinct elements—the glideslope, the localizer and marker beacons. All of these can be used together by a pilot making an instrument approach to a runway. Figure 1 depicts the typical components of an ILS system. The localizer transmitter and antenna are located at the departure end of the runway, the glideslope transmitter at one side of the approach end of the runway, and the marker beacon transmitter and antenna along the approach course.

...signal leakage on any navigational frequencies can seriously endanger lives if it interferes with operation of the equipment guiding a pilot...

The localizer operates between 108 MHz and 112 MHz and is used to locate the center line of a runway. It is used in conjunction with a servo driven indicator that shows lateral deviation from an imaginary line that extends into space from the runway center. When a localizer frequency is selected, a corresponding glideslope frequency is also automatically selected in the 329.15 MHz to 335 MHz range. A localizer frequency of 108.10 MHz, for instance, is always paired with a glideslope frequency of 334.70 MHz.¹

The marker beacons operate at a frequency of 75 MHz, and they provide the pilot with information about his relative distance from the end of the runway along his approach course. The outer marker is typically four to seven miles from the end of the runway and

is modulated at 400 Hz. The middle marker is generally 0.6 of a mile from the runway end and is modulated at 1300 Hz and the inner marker is within a few hundred feet of the runway and is modulated at 3000 Hz. As the aircraft passes over these beacons while it is on an approach path to the runway, visual indicators illuminate on the instrument panel to show the pilot which beacon he is passing over.

Obviously, cable television signal

leakage on any of these navigational frequencies can seriously endanger lives if it interferes with operation of the equipment guiding a pilot to a safe landing.

Leakage effects on VOR

The Advisory Committee on Cable Signal Leakage also evaluated the effects of cable system leakage on another type of navigation instrument—

CLI PROOF OF SUCCESS: SNIFF-WARE™

ComSonics invented successful leakage detection with the SNIFFER family of detection equipment — now you can put that technology right into your IBM compatible system.

SNIFF-WARE brings you powerful X-Y Plot, System Gridding, leakage levels and $\mu\text{V}/\text{meter}$, dBmV. It's powerful, affordable and available!



COMSONICS, INC.®

Call Toll Free: 1 - 800 - 336 - 9681
In Virginia Collect: 1 - 703 - 434 - 5965



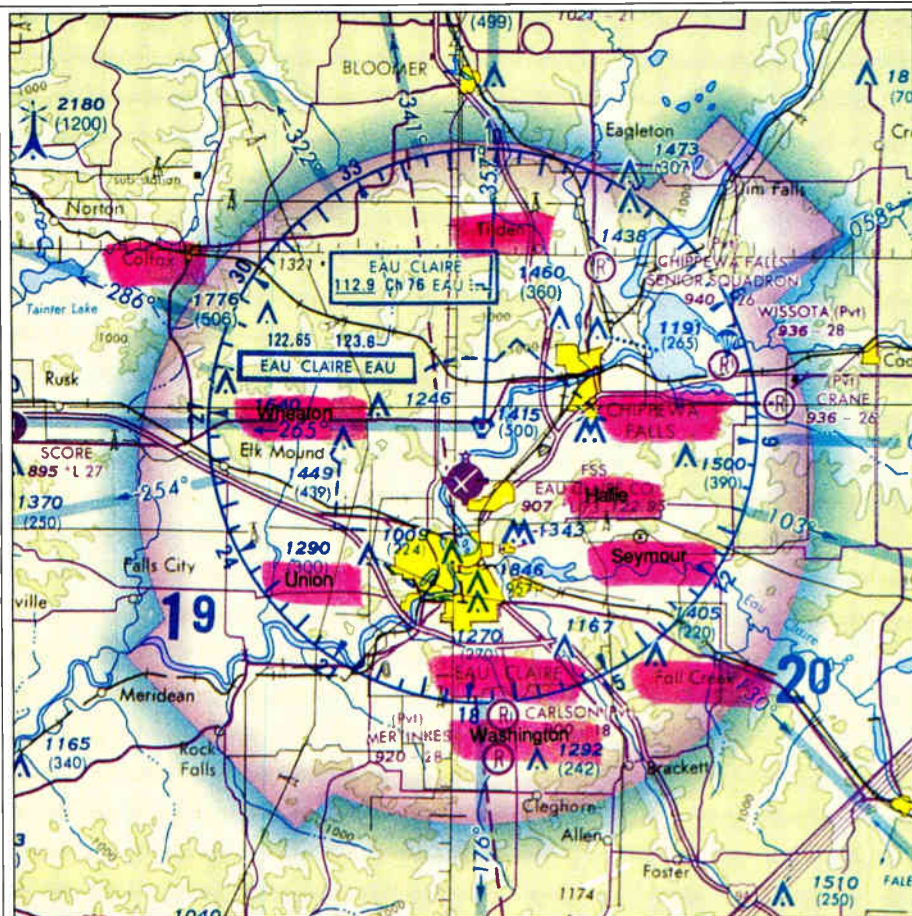

Figure 2

the VHF omni-directional range (VOR). This technology is used by a pilot to navigate from point A to point B as he flies cross country. The VOR station transmits a "compass rose" of radials. The VOR receiver can be tuned to the appropriate frequency (in the 108 MHz to 118 MHz range) and the pilot can select the particular radial he wants to track as he flies toward or away from the station. These VOR stations are strategically located around the country, many of them near or in large cities, where there exist the possibility of interference from leaky cable TV plant. A typical VOR compass rose is depicted in Figure 2 as it appears on a "sectional"—a map used by pilots as a navigation aid.

Communities served by cable systems within the compass rose area are marked; each of these systems poses a navigational hazard if CLI levels are excessive.

Effects on aircraft equipment

In the 1970s, a committee was formed to determine the relationship between cable television system signal leakage, as measured at ground level, and the

probability of harmful interference to aeronautical and other radio services. A rather exhaustive study was done by the committee and its final report was submitted to the FCC in November 1979. Also, in the late 1970s, several incidents occurred around the country that caused concern among FCC and FAA officials about the effects of cable

TV system leakage on aircraft communications and navigation. These incidents and the studies done by the Advisory Committee proved that co-channel interference from cable TV systems could pose serious hazards to air traffic.

In one incident to date, at least, the interference was so severe that the pilot had difficulties communicating with air traffic control. It is air traffic control's (ATC) responsibility to provide proper separation between aircraft operating in the same general vicinity, and to provide approach and departure sequencing. Imagine the confusion and anxiety of a flight crew unable to communicate with ATC while traveling into a congested area.

Interference is...

The report states, "In communications receivers the conditions that can exist are undesired audio (music or voices), beat frequencies (heterodynes), excessive levels of noise, and even random on-off action of the squelch circuit.

In navigation receivers, interference is manifested as erroneous course information, receiver flag operation (the flag indicates the operational status of the receivers), or audible interference to the voice channel used for station identification.

Even if the flag indicates that the VOR signal is present and audible, if the Morse Code identification of the navigation signal is off, blocked, or is unidentifiable because of audio interference, the pilot should not use the station for navigation."²

In one series of tests over a particu-

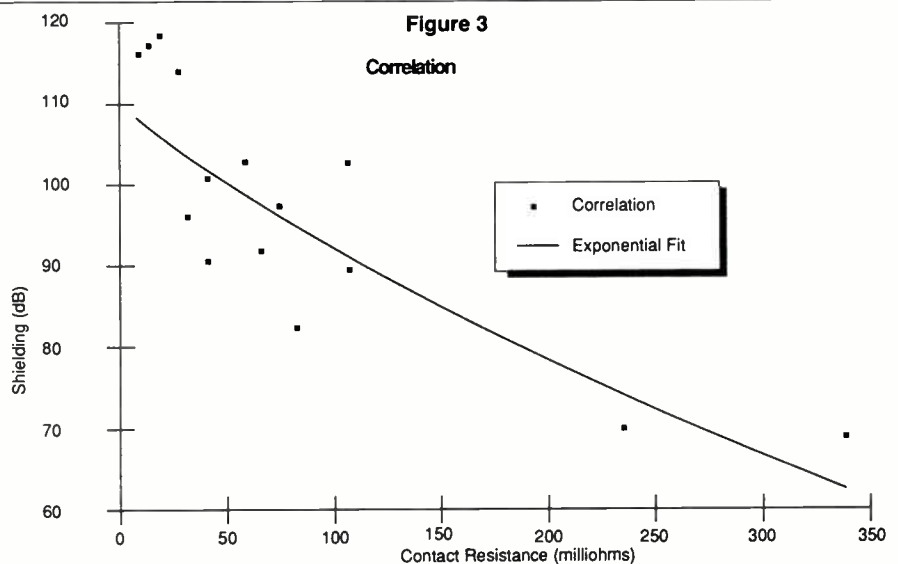

lar cable system which was operating a pilot carrier at a frequency of 112.5 MHz, an audio beat frequency was received on the VOR receiver at 450 meters and above all the way up to 3000 meters (10,000 feet) above the system. This heterodyne actually blocked the Morse Code identification of the VOR station 90 kilometers distant.²

Cable system leakage, without question, has the potential of posing hazards to air traffic that could result in consequences far more serious than fines or even system shut-down. Human lives are at risk when communications and navigation frequency interference impair operation of equipment pilots rely on.

Leakage sources and solutions

Connectors are by far the most offending culprits in signal leakage, responsible for 80 to 90 percent of leakage problems. Egress from hard

line connectors is a relatively infrequent problem, but at higher levels than leakage from F-connectors. The additive nature of CLI makes F-connector integrity the most important area to focus leakage clean-up efforts, with corrosion and improper installation the most frequent cause of the problem. In light of these facts, Raychem Corp. developed an F-connector with the following criteria in mind:

- It had to be resistant to moisture

intrusion.

- It had to exhibit high anti-corrosion properties.
- It had to be a universal connector—one size for all RG-59, one size for all RG-56, and one size for all RG-11 cables to eliminate wrong connector selection problems.
- It had to be simple to install so that proper installation would be easily repeatable.

The connector thus developed, the EZF, was designed to meet these criteria. It is not a new generation of hex connector, but a totally new concept in F-connector design. Figures 4 and 5 give a visual representation of hex and EZF connectors for comparison purposes. Figure 4 is a side view of a standard hex connector. Note that it can leak at three different junctures—water can ingress through the threads, at the swivel, or at the rear of the device. In the EZF

HEX Crimp Connector

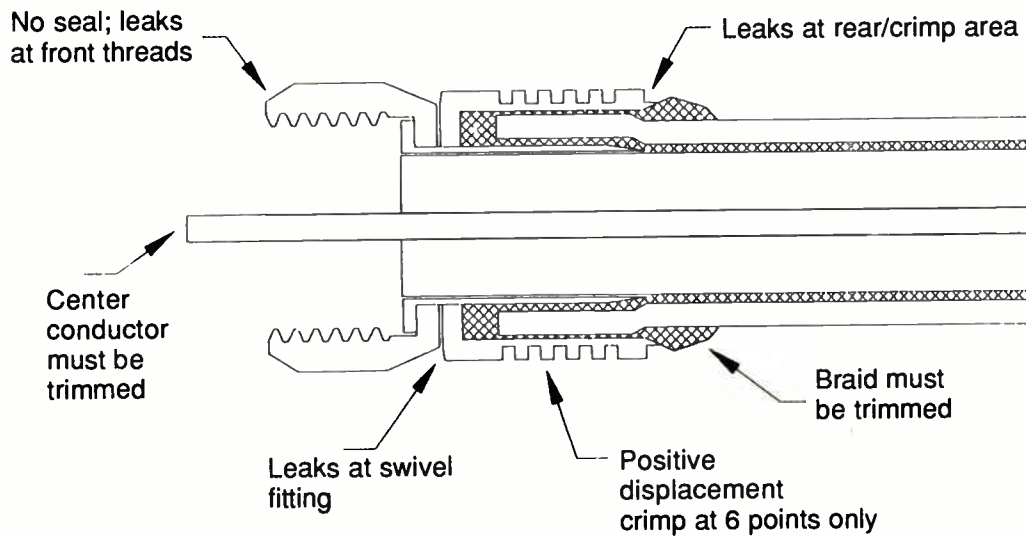

Figure 4

EZF Connector

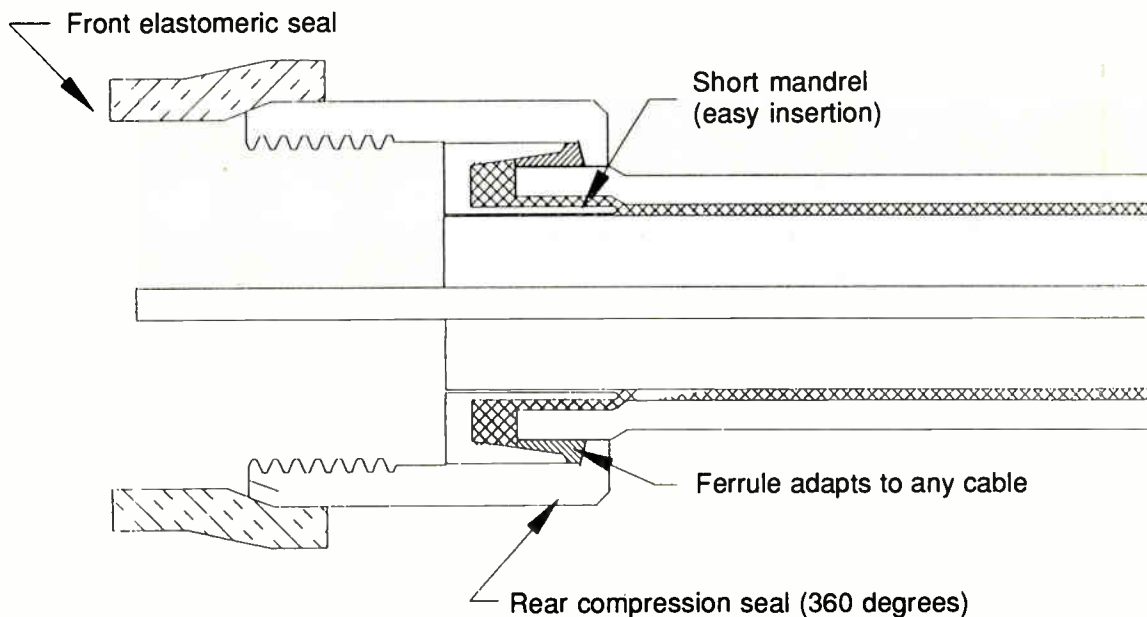

Figure 5

design in Figure 5, the rear seal and elastomeric boot are designed to prevent water ingress into the connector.

Once moisture enters a connector and lodges on the braid and connector/braid interface, a corrosion process sets up. When this corrosion has established itself on the interface, the contact resistance between the connector and braid begins to deteriorate. Figure 3 shows that there is a direct correlation between this contact resistance and the shielding integrity of the connector.

Evaluation of this product after long term exposure to ascetic acids in a chamber designed to emulate a coastal environment showed its corrosion resistance to be superior. Its ability to resist water ingress can also lengthen the life of the drop itself—since water migrating into the connector may travel several inches into the drop cable.

Another problem common with connectorization of coaxial cable is improper preparation of the cable itself. Many F-connector problems occur as a result of incorrect center conductor or braid lengths. System techs and installers should be trained on how to properly install connectors.

As stated in the beginning of this

article, many operators have found their leakage correction programs time consuming, laborious and expensive, but in the final analysis service calls will be reduced, call backs will be minimized, and cost savings will be realized as a result of these programs—

'Small' splitters play big part

How many house splitters do you have in your system? Hundreds? Thousands? Maybe you are not aware that house splitters can be a leakage source, and there are important differences in manufacturing techniques.

Some important points to consider while choosing splitters:

- Does the manufacturer even publish an RFI leakage specification for his device? If so, what is it?

- Was the back-plate put on by hand or machine? The back-plates of many splitters are simply put on manually and then epoxied to hold them in place. Shielding integrity is much greater if the back-plate is inserted with a press so that good metal-to-metal contact

not to mention the elimination of a very real potential risk to human life. ■

References

1. Collins Radio.
2. Final Report of Advisory Committee on Cable Signal Leakage.

exists between the back-plate and housing.

- Most manufacturers use aluminum back-plates. Stainless steel is more expensive, but exhibits better shielding integrity and greater strength.

- Most manufacturers do not go to the added expense of building their splitters so that the back-plate is seated into the housing by way of tongue and groove construction. The tongue and groove allows greater pressure to be applied to the back-plate while it is being seated into the housing, creating a more solid metal-to-metal contact interface.

- The larger the back-plate, the poorer the RFI shielding integrity of the devices. For example, a 4-way splitter of the same construction as a 2-way splitter will have poorer shielding integrity than the 2-way device.

By Larry Warren

Due to overwhelming demand, SCTE is reprinting its publication entitled "FCC Advisory Committee: Signal Leakage" (1980 edition - stock #TR-2)

"This work is extremely comprehensive...a must-read for anyone who wants to understand the issue of leakage..."

- Ted Hartson,
Post-Newsweek Cable

SCTE member cost - \$18.00

Non-member price - \$25.00

Now available from
the Society of Cable Television Engineers!

TO ORDER: All orders must be prepaid. Shipping and handling costs are included in the Continental U.S. All prices are in U.S. dollars. SCTE accepts MasterCard and Visa. To qualify for SCTE member prices, a valid SCTE Identification Number is required, or a complete membership application with dues payment must be included with this order.



Send orders to:
SCTE
669 Exton Commons
Exton, PA 19341

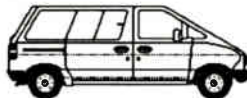
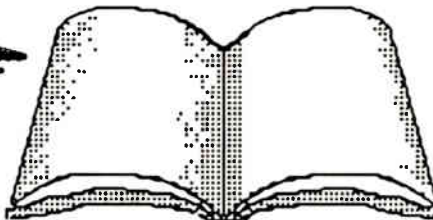

HEADEND EQUIPMENT REPAIRS!

- Receivers
- Processors
- Strip Amps
- Field Meters
- FCC Offset Modification
- LNC

All makes and models repaired.
10-15 working day turn around
complete repair reports
90 day warranty

800-346-3083

Call for quotes on distribution and S.A. addressable converter repairs.



Midwest
CATV Engineering

1818 N. Went Street, Mishawaka, IN 46545

Worried About July 1, 1990?

Get a head start on
signal leakage
with

Lindsay



“The FCC has mandated July 1st as the date for all cable systems, larger than 1000 subs, to comply with specific limits on the amount of signals leaking from a CATV system.”

The LINDSAY RTA-1 Field Strength Survey Antenna is specifically designed for leakage and radiation measurement of CATV system components.

The Lindsay RTA-1 Features:

- it's light weight of 5 pounds
- easy handling for off road metering
- adjustable dipole
- collapsible whips
- complete with vehicle mount
- 10 foot RG-59 cable
- waterproof zinc cast housing
- very reasonable price

For further information please contact:

LINDSAY SPECIALTY PRODUCTS
50 Mary Street, Lindsay, Ontario, Canada K9V4S7

Telephone:
(705)324-2196

Telex:
O-6962-86O

Fax:
705-324-5474

How to win the CLI game by finding and fixing leaks

Recently, the National Cable Television Association held a series of seminars on cable system leakage in several cities around the country. During the seminars, a lot of good, practical tips were given to operators who desire more information on how to detect and measure leakage (much of which is reproduced in this Handbook). During the seminar, Ted Hartson, vice president and chief engineer at Post-Newsweek Cable, and Bob Saunders of Sammons Communications gave the attendees some ideas of how to win the CLI game. Listed here are some of the "common sense" tips they gave.

- Complying with the FCC's leakage rules takes "emotional and financial commitment. Casual monitoring" of your system won't find and fix enough leaks for a system to comply. Operators who are really serious about compliance must have an "orderly program" to find and correct leakage.

- If you don't fix an average of one-half a leak per mile per day you have either a tight system or a lousy CLI detection and correction program. (Obviously, that number will be reduced over time as operators implement an effective leakage program).

- Get your technical staff used to detecting and measuring leak strength with a dipole antenna. Proper measurement is an art form that must be learned with repetition. If you make serious errors in quantifying the leaks in your system, your CLI computation will be skewed.

Keep it simple

- Make it easy for the technical staff to report signal leakage. Radio dispatch is an effective tool.

- Don't be discouraged if the number of leaks your staff finds goes up with time. As your techs get better at operating the equipment, it's only natural that more leaks will be found. Just don't get complacent about fixing the leaks, either.

- Fix the leaks you find in the trunk and distribution portions of your plant first, then work on the drops. "Get the

aluminum work done first," advises Hartson. Once you fix the big leaks, some of the little ones will simply go away.

- Take the time to characterize your system and show your staff exactly what they're looking for. Take out maps of your system that represent a 20-mile area. Divide the maps into four equal sections and give a section to teams of one or two persons (a total of four to eight people).

Have each team follow the maps and drive everywhere they possibly can—including the cul-de-sacs, back alleys, etc. Tell them to mark on the maps the place where they detect leakage and its relative intensity (small, medium or large). "Don't measure them, don't find them, just write them down," says Hartson.

After that's done, assemble your teams and then go out and measure the leaks. Practice using the dipole to get the highest reading. Fix the big leaks. "This allows you to normalize people's

behavior," says Hartson. "They'll all be looking for the same thing." Perform the CLI calculation if you have fewer than 20 leaks or so. "It's important everyone sees this success story."

- Consider doing a monthly review of your offset frequencies and logging them. Are they within the 5 kHz tolerance you are allowed? The more information you can keep in your logs, the better, especially if you're ever visited by an FCC inspector.

Reward accuracy

- Institute an awards program for who can find the most leaks and the biggest leaks. This will increase the number of leaks logged and repaired by the staff.

- Outfit all installers and technicians with detection equipment. The guys in the trenches visit large portions of the plant everyday, so give them the opportunity to ferret out leaks wherever they go. ■

First time? Don't worry...

Be happy!

Listening to Ted Hartson discuss leakage is akin to visiting a guru—you get a wealth of knowledge from someone who's been there before. In fact, Ted will tell you he's been battling leakage for years now. Consequently, he's got some great ideas for first-timers. In what he calls his CLI "first-aid" kit, people are given some helpful hints for operators who are implementing a leakage program for the first time. According to Hartson, it's important to remember:

- Big signal levels make big leaks, so look at your distribution plant first and eliminate any problems you have there before you move any "deeper" into your system.

- Get the detection skill level up among your personnel (go out and practice with the equipment), then go after the drops.

- Check the distribution connectors;

in areas where the signal level is high is where the majority of your final CLI number builds up.

- Conversely, the low-level drop connectors are largely inconsequential in the final CLI number.

- Your system can have as many as 1,004 50 $\mu\text{V}/\text{m}$ leaks and still pass CLI, but just one leak of 1,600 $\mu\text{V}/\text{m}$ will throw your system over the compliance threshold.

- Most often, the source of leakage problems are loose connectors, taps, etc. so go out and tighten up your plant.

- When you go out, "sneak" up on the leaks—they often tend to "hide" if they know you're coming.

- Get the equipment you need to do the job. You won't find the leaks unless your equipment can detect them.

- Don't patrol for leakage while it's raining. Water tends to absorb what you're looking for.

- The benefits associated with a good leakage detection and reparation program include fewer service calls.

- Most leaks that are found average an intensity of 70 $\mu\text{V}/\text{m}$.

Happy hunting!

—Roger Brown

A date to remember. (or one you'll never forget!)



This time next year, the FCC will be knocking on doors asking for two year's documentation of Cumulative Leakage Index logs.

Not prepared? Get ready to be slapped with a minimum \$10,000 penalty EACH DAY your system is in non-compliance. You might even risk having your Mid-band and Super-band channels shut off! That adds up to fines AND lost revenue.

CLI-MATE is a mobile signal leakage detection service. Our fully equipped vans and qualified technicians will generate the documentation needed for FCC compliance in 1990.

But why wait? Avoid the rush and the risks! Wouldn't you rather do it NOW and document that you DID take preventative measures?

CLI-MATE can offer you, for less than the

cost of a day's fine:

- A complete system drive out
- 90% accuracy of location and measurement of leaks
- Concise computer-generated reports and documentation to satisfy FCC Rules 76.611[1]
- Completion of CLI report
- Software compatible to your own computer system

You will have no additional equipment purchases. And no additional workload and overtime for your crews. Your crew can do what they do best.

With CLI-MATE, and documentation of repair, come July 1,

1990, all you will be left with is a system in compliance and a fond memory of a pleasant visit from the FCC.

For more information about CLI-MATE's service and a free cost analysis with no obligation, call today—**303/730-8885**.

CLI-MATE
MOBILE DETECTION & REPORTING SERVICE



What do you *really* know about CLI?

Ron Ramage, FCC Electronics Engineer in the Kansas City Field Operations Bureau, was a guest speaker at the February 1989 Heart of America SCTE Chapter meeting. Instead of the usual "facts, computations and equations" of CLI, Ramage pulled a pop quiz on those attending to judge their knowledge of this important issue.

Following is a copy of the quiz. We hope that after reading this special Signal Leakage Handbook, you'll have better success than the meeting attendees. Out of 59 completed tests, fewer than 40 percent were returned with correct responses in seven of the nine questions, 10 percent or below on three questions, and only one person came close to correctly answering the final question.

The quiz is reprinted below in order to offer you the same opportunity as

Reprinted with permission from the Mid-America Cable TV Association newsletter, March 31, 1989.

those who attended the chapter meeting. Test yourself. What do you *really* know about CLI?

CLI quiz

1. July 1, 1990 is fast approaching, a technician recommends that his system manager budget for both equipment and personnel to conduct CLI measurements beginning on that date. Is this person likely to be commended or fired for his recommendation?

2. At least percent of the cable strand must be sampled when compiling the CLI data.

3. When conducting the CLI measurements, the measurements must be completed within what amount of time?

4. All signal leakage above $\mu\text{V/m}$ must be included in CLI ground-based measurements.

5. All signal leakage above $\mu\text{V/m}$ must be included in the quarterly monitoring logs.

6. The logs kept during the quar-

terly monitoring must include what items?

7. After July 1, 1990, if my system has to pass a CLI or flyover annually, do I still need to perform quarterly monitoring?

8. Name the two aeronautical frequency (critical) bands in MHz.

9. Name the three emergency frequencies that your system must avoid.

- Answers:**
1. Fired. The system must be in compliance *before* this date.
 2. 75 percent.
 3. Shortest time frame possible.
 4. 50 $\mu\text{V/m}$.
 5. 20 $\mu\text{V/m}$.
 6. Date leak found, location, date fixed, probable cause of leak.
 7. Yes.
 8. 108 MHz to 137 MHz and 225 MHz to 400 MHz.
 9. 121.5 MHz, 156.8 MHz, and 243 MHz.

Ad Index

Reader Service #	Page #	Reader Service #	Page #
Alpha Technologies	4 11	Integral	13 29
American Digital Cartography	34 62	Lectro Products Inc.	19 37
Anixter Communications	43 76	Lindsay Specialty Products	40 71
Augat/LRC Electronics	16 35	Long Systems	3 6-7
Avcom of Virginia	18 36	Midwest CATV	5 13
C-COR Electronics	31 57	Midwest CATV Engineering	39 70
CATV Services Inc.	17 36	Midwest Cable Services	33 60
CATV Subscriber Services	22 42	Nacom	25 47
CLI Tec	32 59	Power & Telephone Supply	27 49
Cable Engineering	35 62	RMS Electronics	26 48
Cable Services	24 45	Riser-Bond	30 55
Cablelogic	41 73	Sachs Communication	42 75
CableTrac	12 27	Scientific-Atlanta	6, 7 14-15, 16-17
Calan	11 25	Telecommunication Products Corp.	2 5
Commscope	20 38-39	Times Fiber	28 51
Comsonics	21, 10, 23, 37, 42 19, 23, 43, 65, 41	Trilithic incl. Texscan Inst.	15 33
The Fiber Connection	36 63	Trilogy Communications	14 31
General Inst./Jerrold	9 21	Wavetek	1 2-3
		Westec	29 53

PROBLEM

Eliminate
radiation
~~C.L.I.~~

SOLUTION

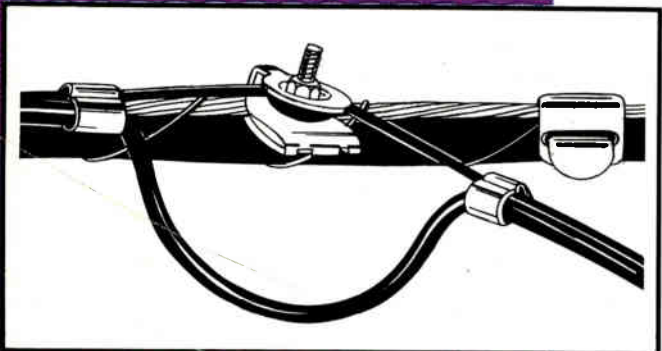
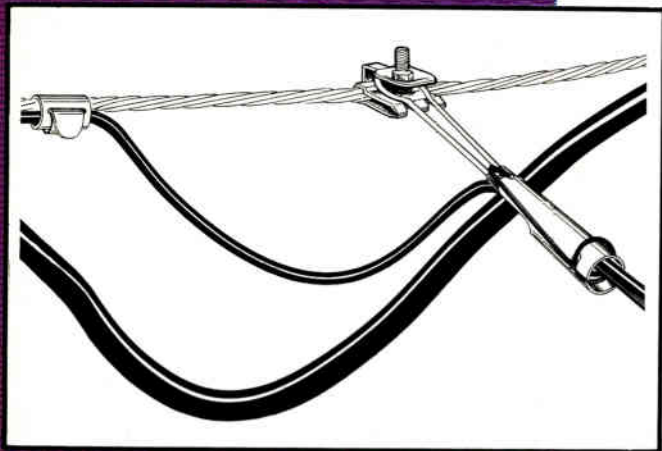
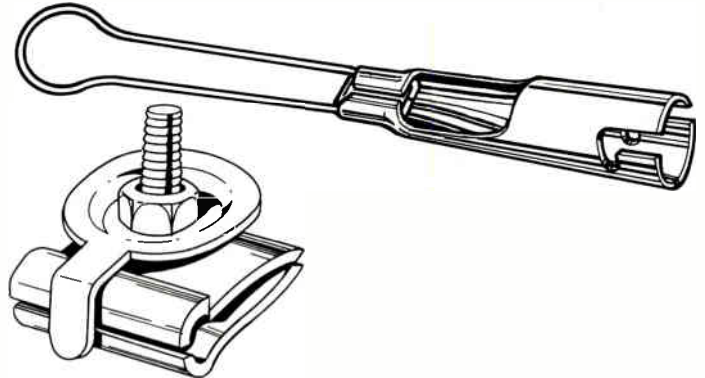

1. **PROBLEM** the old industry practice of wrapping steel messenger wire around the drop cable is time consuming and non-consistent. It increases sheath breakdown caused by drop movement resulting in ingress/egress within 6 months.

SOLUTION the SC02M supports the cable freely and secures the messenger wire. This method allows a gradual drip loop, which prevents sheath breakdown caused by drop movement, eliminating cable distortion and ingress/egress. The SC02M offers a quick and uniform installation.

2. **PROBLEM** the old industry practice of using a knife or a side cutter to separate the messenger wire from the drop cable at mid-span, in most cases will result in damaging the drop cable, causing cable distortion and ingress/egress. This method is time consuming and non-consistent.

SOLUTION the SC03E clamp has a unique retainer tab to separate the messenger wire from the drop cable, without the use of a knife or a side cutter, eliminating any chances of damaging the cable. This method offers easy installation and time savings.

3. **PROBLEM** the old industry practice of using plastic tie wraps to secure cable tightly along the strand and/or to prevent cable separation from the messenger, in most cases results in depressing or kinking the drop cable, damaging the sheath and generating ingress/egress.

SOLUTION the SC10 will prevent cable separation from the messenger wire without crushing the cable and it can be installed without a tool. The SC052 strap allows to bundle multiple drops without causing any damage to the cable, eliminating potential cable distortion and ingress/egress. Both products offer easy installation and time savings.

The time savings using the Sachs methods allows the installer/technician to be less pressured and more attentive in producing a quality drop installation.

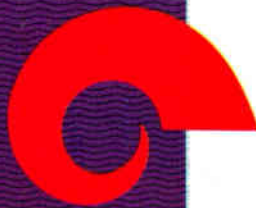

SACHS®

Sachs Communications Inc.
1885 West Dartmouth
Unit 1
Englewood, Colorado 80110
Tel: 303-761-6339
Fax: 303-761-4482

Sachs Canada Inc.
745 Avoca Avenue
Dorval, Quebec
H9P 1G4
Tel: 514-636-6560
Fax: 514-636-0794

Sachs Communications Inc.
30 West Service Road
Champlain, New York 12919-9703
Tel: 1-800-361-3685
Fax: 514-636-0794

Reader Service Number 42

Why have MSO's ordered over 40 million EZF Connectors?

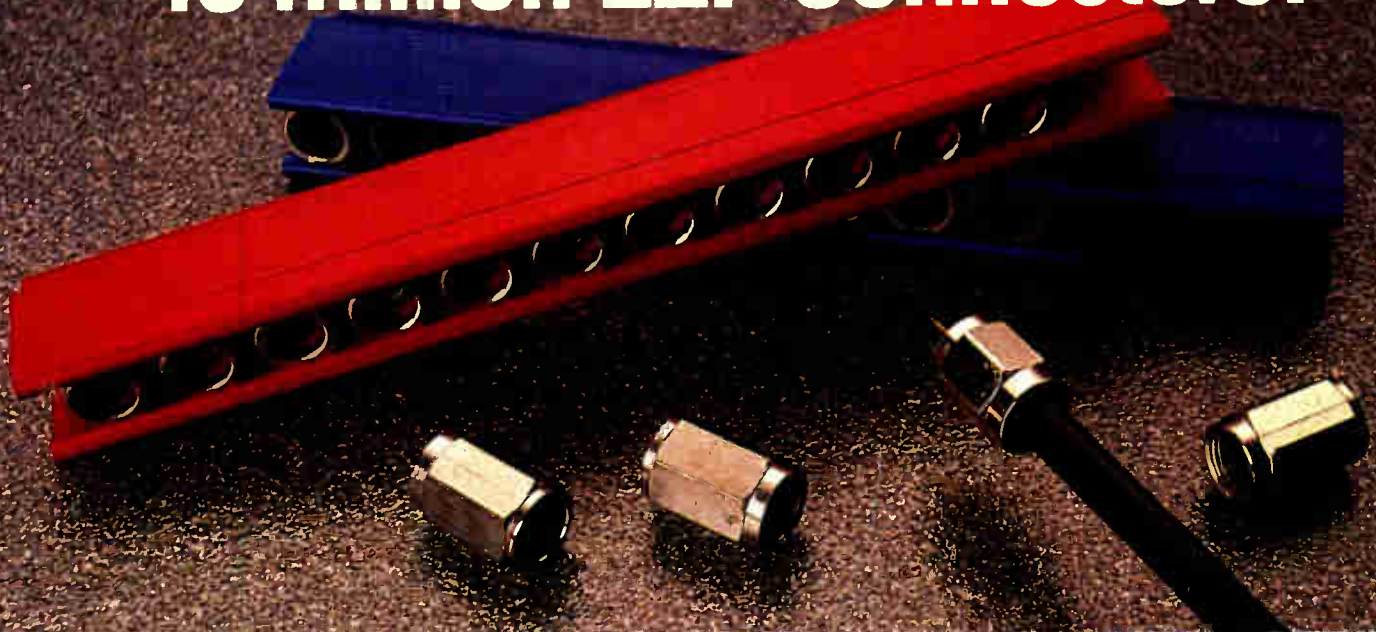

Lower Maintenance Costs and Improved Customer Satisfaction

In both new builds and rebuilds, users of the EZF connector system are experiencing a dramatic reduction in drop related service calls. RF leakage trouble calls resulting from improper connector installation and corrosion are no longer the single most problem in a CATV system when the EZF connector system is used.

PROVEN: Fewer problems occur during installation

- One color-coded connector for each cable size minimizes connector selection problems.
- The cable is prepared for installation the same way every time with the EZF cable preparation tool.
- Only a 7/16 inch wrench is needed for installation.
- Cassette packaging facilitates proper installation and reduces connector loss.

- Immediate inspection for proper installation by installers and QC inspectors.



PROVEN: Fewer problems occur during service life

- A circumferential, environmental seal is automatically made at the connector/cable interface during installation.
- The EZF sealing sleeve supplied with the connector prevents moisture penetration at the connector/port interface.
- Material compatibility and corrosion resistance are ensured by specially selected and tested materials and platings.
- Rugged connector design and consistent installation quality contribute to reduced RF leakage and reliable performance.

Raychem

ANIXTER

WEST-ANAHEIM: (714) 779-0500, (800) 854-0443; **DENVER:** (303) 373-9200, (800) 841-1531; **SEATTLE:** (206) 251-6760, (800) 426-7665; **MIDWEST-CHICAGO:** (312) 364-7000, (800) 544-5368; **CLEVELAND:** (216) 526-0919, (800) 321-8068; **DALLAS:** (214) 446-7337, (800) 231-5006; **IRON MOUNTAIN, MI:** (906) 774-4111, (800) 624-8358; **SKOKIE, IL HDQTRS:** (312) 677-2600; **EAST-ATLANTA:** (404) 995-5110, (800) 241-5790; **LONG ISLAND, NY:** (516) 293-7788, (800) 645-9510; **NEW JERSEY:** (201) 328-0980, (800) 631-9603; **TAMPA:** (813) 626-7115, (800) 282-9164; **CANADA-CALGARY:** (403) 250-9646; **MONTREAL:** (514) 636-3636; **TORONTO:** (416) 625-5110; **VANCOUVER:** (604) 321-5885.

In an emergency, weekends and holidays or after 5 P.M. call toll free 1 (800) 323-8166.
CORPORATE OFFICES, ANIXTER BROS., INC., 4711 Golf Road, Skokie, IL 60076, (312) 677-2600

©1989 ANIXTER BROS., INC.