

CED

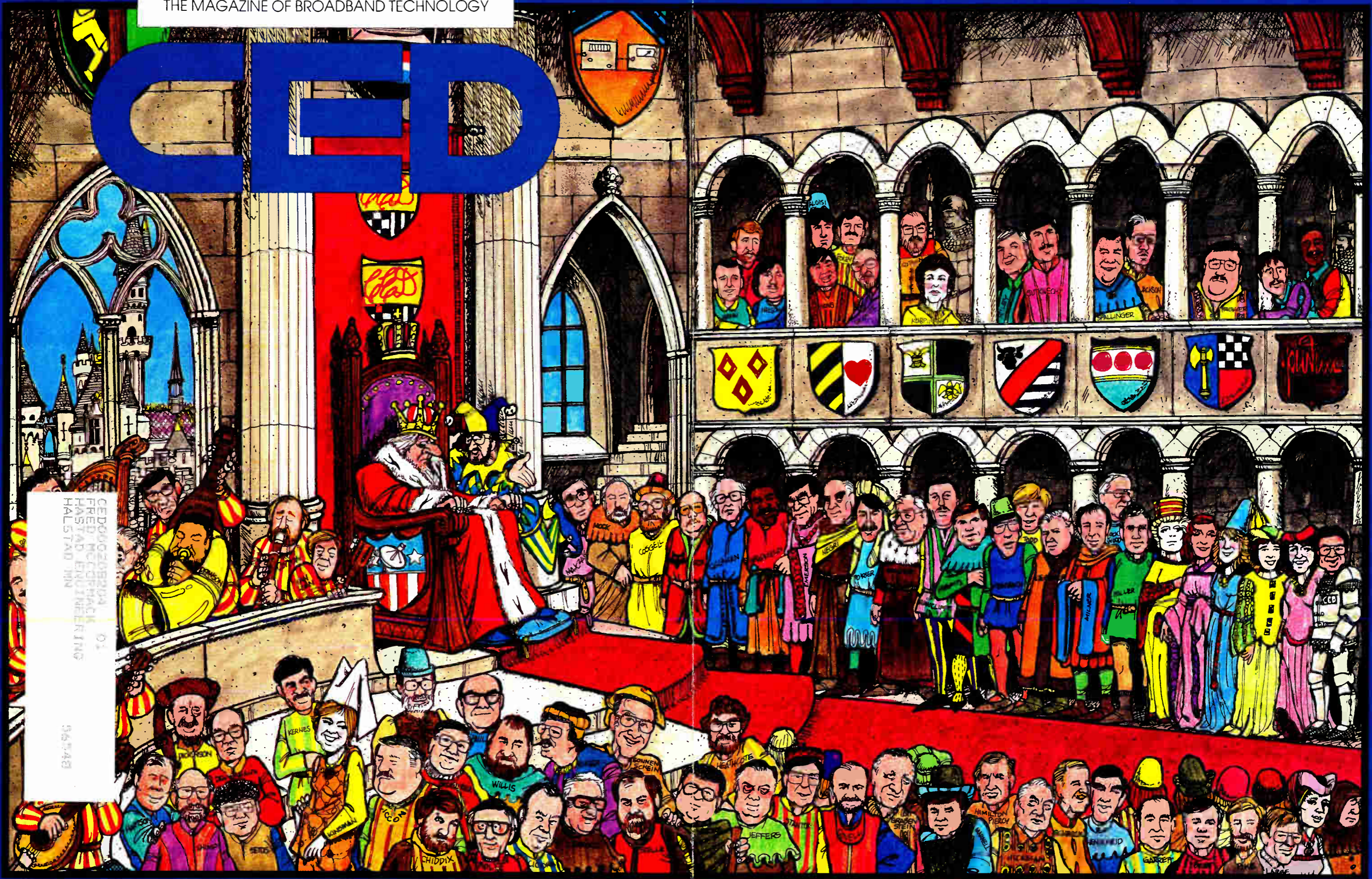

CEDEGEBERUA 01
FRED MC CORMACK
HASTAD ENDINERINO
HALSTAD INN
967748

Caricatures of various individuals are scattered throughout the scene, with names written on their clothing or near their heads. Visible names include: KERNES, CHIDIX, WILLIS, BONNER, SCHEIN, JEFFERS, HAMILTON, PIERCY, GARRETT, and others. Some names are written on shields or banners.

SCIENTIFIC-ATLANTA INNOVATION MEANS PROFITS YOU CAN DEPEND ON.

WE'RE ALREADY SOLVING TOMORROW'S PROBLEMS.
Nobody knows more about CATV equipment than the people who use it—day in and day out. That's why Scientific-Atlanta places a lot of stock in what people like you have to say. We never "improve" our equipment simply by adding fancy bells and whistles. We work closely with our customers to innovate new and practical

solutions to real problems. The result? Lower operating costs and a higher profit margin for you.

COMPATIBILITY DOWN THE LINE.
Obsolescence is a hidden cost that you don't need. So we make sure our new ideas apply to our earlier equipment as well. For example, the distribution amps we're building this very minute will fit in the first

amplifier housings we ever built. Invest in Scientific-Atlanta and you invest in the future.

ALWAYS TWO STEPS AHEAD.
To no one's surprise, Scientific-Atlanta was the first to offer C/Ku-Band antennas and receivers. And we were stereo ready before the first stereo TV was ever sold. That's why our customers weren't caught off guard by the sudden demand for stereo TV reception. The newest in our BTSC stereo compatible line is the 6380 stereo encoder. It's affordable, compact, and easy to install. And your ears won't believe what it can do.

We've simplified upgrades and maintenance by introducing hybrid feedforward gain blocks for greater on-line serviceability. Our modular amplifier design eliminates the need for a motherboard and improves heat dissipation for smooth, dependable performance. We're building converters that use advanced microprocessors to set new standards in reliability and profitability.

WE'VE ONLY JUST BEGUN.
Improvements like these are just the beginning. We're already working on tomorrow's solutions. Because an aggressive investment in research and development is an investment in our customers. No matter how unpredictable the future may seem, you can depend on Scientific-Atlanta. And depend on greater profits.

Call 1-800-722-2009

Scientific Atlanta

**Our Top Concern
Is Your Bottom Line.**



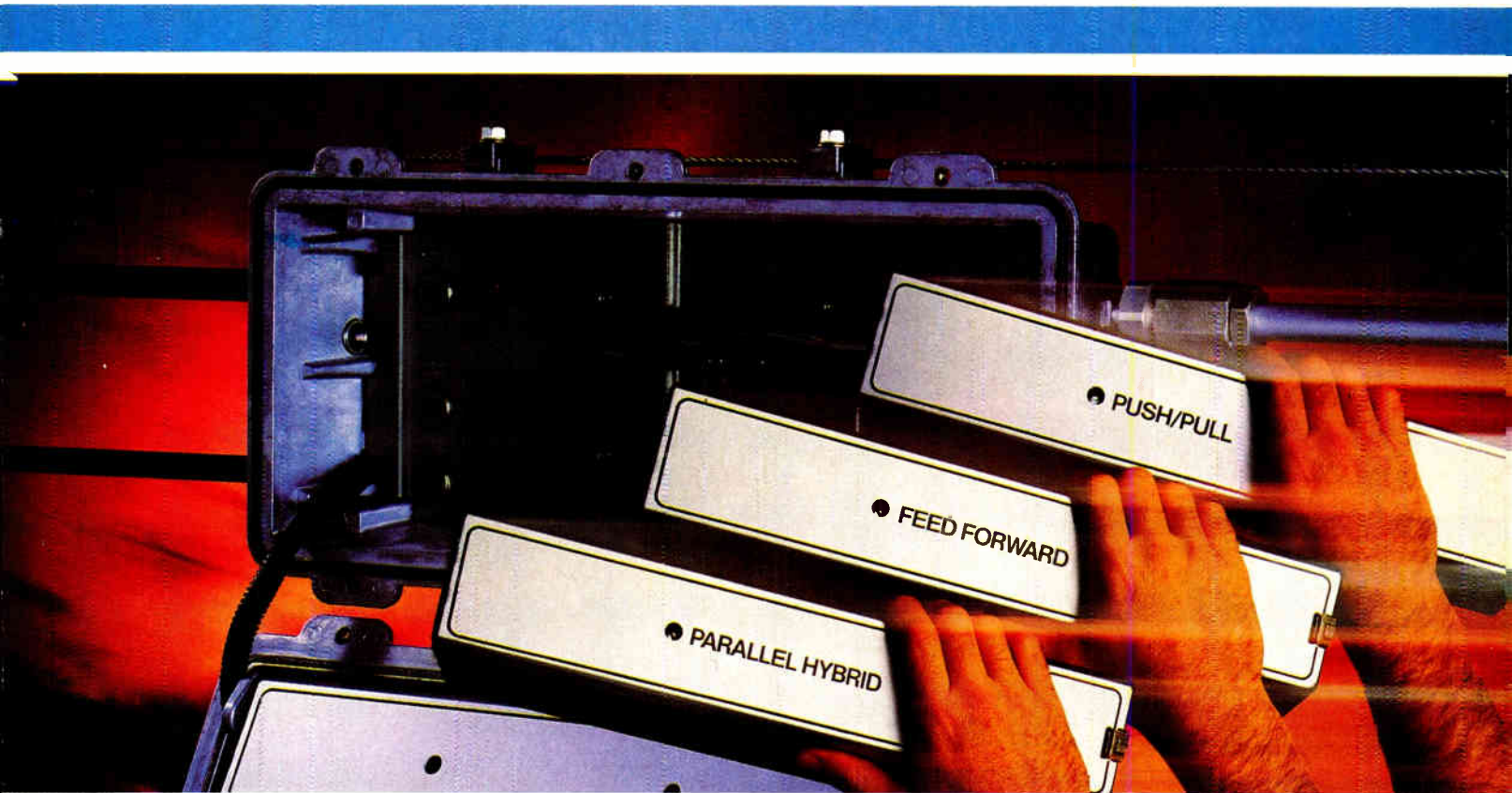

GROWING WITHOUT THE PAINS.

SCIENTIFIC-ATLANTA MAKES UPGRADES AND REBUILDS A SNAP.

Expanding your system's bandwidth with Scientific-Atlanta is as simple as snapping new modules into existing Scientific-Atlanta housings. Or dropping us in when the job calls for amp replacement or total rebuild.

Our upgrade/rebuild program includes system analysis of cascade performance, project engineering consultation, system evaluation and feasibility studies.

MODULAR COMPONENTS, MAXIMUM CHOICE.

Our modular distribution concept gives you flexibility others can't. Our full line of push/pull, parallel hybrid and feedforward amps are available immediately in the widest choice of bandwidths (300/400/450/550) and gains (22/26/30).

SINGLE-FUNCTION MODULES.

Modular components let you configure a system with exactly the right combination of performance and economy...right to the end of the cascade.

MINIMUM MAINTENANCE.

Our use of discrete slope and gain controls, ultra-stable AGC/ASC, surge-resistant power supplies and heat-dissipating amplifier housings assures a smooth-running, maintainable system under the most demanding conditions...yours.

PART OF A FULL-LINE PACKAGE.

In addition to our distribution amps, taps and passives, Scientific-Atlanta offers a complete line of compatible, upgradable CATV products. And they're all backed by a company with a reputation for quality, service and support.

So why not call us for more information about our painless upgrade/rebuild program? It sure can't hurt. Dial 1-800-722-2009 or write to: Scientific-Atlanta, Dept. AR, P.O. Box 105027, Atlanta, GA 30348.

Scientific Atlanta

EDITORIAL

Gary Y. Kim
 Publisher/Editor
Kathy Berlin
 Associate Publisher
Linda J. Johnson
 Production Editor
Roger Brown
 Technical Writer
Derrick Jackson
 Editorial Assistant

CONSULTING ENGINEERS

Chairman
Wendell H. Bailey, NCTA VP, Science and Technology

Members

Jim Chiddix, VP, Engineering and Technology, ATC
Ron Coffen, VP of Engineering, Daniels & Associates
Bob Daffner, VP, Technical Services, Media General Cable
John Dawson, VP of Engineering, Mile Hi Cablevision
Roy Ehman, VP of Engineering, Storer Cable Communications
Mark Elden, Director of Engineering, Showtime/The Movie Channel
Robert Luff, VP Technology, Jones Intercable
Steve Raimondi, Director of Eng. (East), United Artists Cablesystems
Graham Stubbs, Consulting Engineer
Sruki Switzer, Consulting Engineer
Joe Van Loan, Eng. VP, Viacom Cablevision

PRODUCTION

Jeff Knight, Production Director
Don Ruth, Art Director
Diane Krensky, CED Art Director
Debra Rensel, Typography, Traffic
Greg Packer, Circulation Director

ADVERTISING

Cathy Wilson, Sales Manager
Christina Panczyk, Classified Sales
Lesley Camino, Promotions

Patrick Keleher, President/CEO
David Carlton, Vice President, Financial & Administration
Janice L. Benesch, Controller

OFFICE

Denver 600 Grant Street, Suite 600, Denver, CO 80203 -or- P.O. Box 5208 T.A., Denver, CO 80217, (303) 860-0111.

ITCI

INTERNATIONAL THOMSON COMMUNICATIONS INC.

© 1986 by International Thomson Communications Inc. All rights reserved. CED, (USPS 300-510) (ISSN 0191-5428) is published monthly by International Thomson Communications Inc., 600 Grant St., Denver, CO 80203. © November 1986, Volume 12, Number 11. Subscriptions free to qualified industry readers. All other one-year subscriptions are \$26, prepaid in U.S. funds only. Second-class postage paid at Denver, CO, and additional mailing offices. CED is published on behalf of the cable television and broadband communications industries. POSTMASTER: Please send address changes to P.O. Box 5208 T.A., Denver, Colorado 80217. MEMBERS OF THE BPA.

SPOTLIGHT

The more things change. . .

The more they stay the same, says industry veteran Mike Jeffers.

8

MY TURN

"A stench in the ear. . ."

and other humorous asides.

10

CLASSICS

System testing

Here's the second half of Jerry Crusan's thoughtful piece on CATV distortion measurement.

14

Stumbling on the answer

Billing software has technical application, it turns out.

38

The cost of commercial insertion has fallen

Just keep in mind the trade-offs. You may want to spend more.

44

Audio separation and buzz: how does BTSC fare?

Quite well, a test at Scientific-Atlanta shows.

56

BTSC generators

Finding one isn't tough at all anymore.

60

Broadband LAN planning

Here are a few pointers from Tele-Engineering on large network design.

70

Choosing an A/B switch

Keep a few critical pointers in mind.

74

HRC, feedforward or both?

ATC's Walter Colquitt tells when to use each.

76

DEPARTMENTS

In Perspective 12

Classifieds 86

Ad Index 92

In the News 90

About the cover

Depicted are members and guests of the NCTA Engineering Committee; Society of Cable TV Engineers board members, chapter heads and officers; CED and CT editorial board members.



TRILOGY LEADS IN TECHNOLOGY:

Cable Size	MC ² 0.750" air dielectric	0.750" gas-injected	0.875" gas-injected	1.000" gas-injected
Attenuation (dB 100' @ 450 MHz)	.97	1.15	1.01	.92
Total loss (dB @ 10 miles)	512	607	533	486
# amplifiers @ 22 dB	23	27	24	22
Cable cost/1,000'	\$ 355	\$ 340	\$ 430	\$ 605
Total cable cost	\$18,744	\$17,952	\$22,704	\$31,944
Amplifier cost (\$800 each)	\$18,400	\$21,600	\$19,200	\$17,600
Total cost	\$37,144	\$39,552	\$41,904	\$49,544
Percent difference	Reference	+ 6.0	+ 11.3	+ 25

All prices for reference purposes only.

**STATE-OF-THE-ART
COST-EFFECTIVENESS**

**MC²
COAXIAL CABLES**

Unlike most technological advances, MC² reduces costs significantly, in a variety of ways.

The unique air dielectric—with 93% velocity of propagation—makes it possible to use MC² in one size smaller than you normally would with foamed cables. The advantage, is the accommodation of more cables per duct in an urban system.

The lower attenuation and stronger

signal also allow you to use about 20% fewer amplifiers.

MC² also provides relief from "suck out"—the air dielectric and the 100% bonded construction permits the inner and outer conductors to expand and contract at virtually the same rate. This provides you with quicker and simpler installations and maintenance.



Trilogy

COMMUNICATIONS INC.

Call or write for a free sample and brochure:

TRILOGY COMMUNICATIONS INC., 2910 Highway 80 East, Pearl, Mississippi 39208

601-932-4461

800-874-5649

Please see us at the Western Show, Booth #1154.

Reader Service Number 3



Mike Jeffers

Jeffers sees rebirth of two-way cable

Mike Jeffers' entire 36-year career in the cable industry has been spent at Jerrold, but don't be mistaken—his influence and expertise has been felt throughout the industry. Whether it's through the NCTA, SCTE, EIA, FCC, IEEE or a myriad of other industry boards and associations, Jeffers seems to be everywhere at once.

You'd think, then, that this pioneer of the industry would be most concerned about ways to squeeze more channels out of existing equipment or developing the first completely consumer-friendly converter. But actually, it's the age-old problem of picture quality that most concerns Jeffers.

"Even the better systems today are delivering a signal of too low a quality in terms of signal-to-noise ratio," says Jeffers. "I think there's a tendency for the industry to be scared to death of overload distortion and we run the systems too conservatively." Jerrold's expert on distribution equipment notes that the problem can often be easily overcome. "There's a lot that can be done (to correct the problems) in the old systems very, very simply because now there are better-performing integrated circuits."

Jeffers has seen some dramatic changes in the way CATV signals are distributed over his years in the indus-

try. As a graduate of the University of Pennsylvania in 1949 with a BSEE, Jeffers wound up where at least two of his classmates found employment—Jerrold. (One of those classmates was Frank Ragone, now the vice president of engineering for Comcast.)

Starting in late 1951 as a project engineer, Jeffers made quick progress climbing the corporate ladder. He was manager of engineering when General Instrument purchased Jerrold at the end of 1967, and in 1969 he was named vice president of engineering. By 1981, Jerrold had grown to such proportions that it was divided into subscriber and distribution, at which time Jeffers took the title of vice president, engineering, advanced development.

Interwoven among those years at Jerrold, Jeffers has offered his opinions and experience to the NCTA Engineering Advisory Committee, the joint NCTA/EIA committee, the FCC's Cable Television Technical Advisory Committee and the SCTE. He is also an NCTA subcommittee chairman and editor of *Recommended Practices*, the industry's definitive guide to good engineering practices.

In 1979 he won the prestigious NCTA Science and Technology Award for Development, an honor reserved only for those who have reached the pinnacle of influence and expertise. Jeffers points to his general contributions to the industry, which include his exhaustive studies of distortions and signal-to-noise ratios, as the reason he was given the award.

Over the years he's given papers to the NCTA and IEEE, but his discussions of the industry even transcend international borders. He's spoken about cable in the Soviet Union, Belgium, Switzerland, England and Japan.

Developing and keeping up with technological advances is Jeffers' job, but sometimes a great idea won't catch on in the marketplace. To wit: one that got away was a library of video games that was designed to be sent over cable, downloaded into electronic cartridges in the home and used by the sub for one monthly fee. "From an engineering design standpoint, it was extremely clever and it worked great," recalls Jeffers. But video games died a quick death, rendering the project unwanted

before it even got started.

But it's not always that way. Jerrold was one of the first vendors to offer a 400-MHz distribution system. Jeffers remembers that from the time he first heard about the possibility of a 400-MHz system until he was actually working on it was only "about three months." Up until that time, he thought the industry was sitting comfortably with all the channels it needed.

Sometimes, the industry is unable to keep pace with the demand for more and better technology. For instance, the interface problems between descrambling converters and cable-compatible TVs and VCRs remain a sore spot for supply-side engineers. "When you listen to what consumers or operators want, there are many things that will satisfy their demands, but at too high a price. So it's a tough, tough engineering job, especially when you look at IPPV."

So what's new out there? Everything, and yet, nothing, Jeffers says. With the coming demand for IPPV and home shopping services, he sees a resurgence of two-way technology, developed years ago but only now showing signs of being economically viable.

"I've never been a believer in a lot of the two-way services, but of all the ones I'm delighted to see coming about is home shopping," he says. "To be really effective, it requires a two-way system, which is something the suppliers have been able to do for years—it's the operators who could never see the advantage of putting it in."

Technological developments have brought the industry through the age of vacuum tubes and then resistors into integrated circuits. Likewise, power doubling, quadra power and feed-forward amplifiers have given system engineers more choices than ever before. "Important strides have been made toward the improvement of picture quality, even though they were mostly intended to provide more channels," says Jeffers. "But the two go hand-in-hand in a way—you have to get basic improvement in the performance and linearity of the devices to allow more channels. What I'm saying is that maybe we have enough channels so let's (now) get the additional improvements."

— Roger Brown

HOW TO TAKE THE RECALL OUT OF THE INSTALL



Belden's drop cable with DUOBOND PLUS™ shield helps you prevent costly call-backs. It's also the most shield-effective drop cable in the CATV industry.

Easier termination for maximum shielding integrity.

The DUOBOND PLUS shield features a foil/braid/foil construction with a shorting fold in the outermost foil which provides superior shielding effectiveness to typical 4-layer shield constructions. The transfer impedance graph demonstrates this effectiveness.

The added benefit is easier termination. This means less chance for error, resulting in greater shielding integrity and reliability. It also means fewer

call-backs, lower operating expenses and more satisfied subscribers.

Cables with the DUOBOND PLUS shield require only half the steps for termination than 4-shield cables. Because it's less bulky, more flexible and its outer foil is bonded to the jacket, stripping and connectorizing are much simpler tasks. You can minimize your connector inventory to one size connector and one crimp tool.

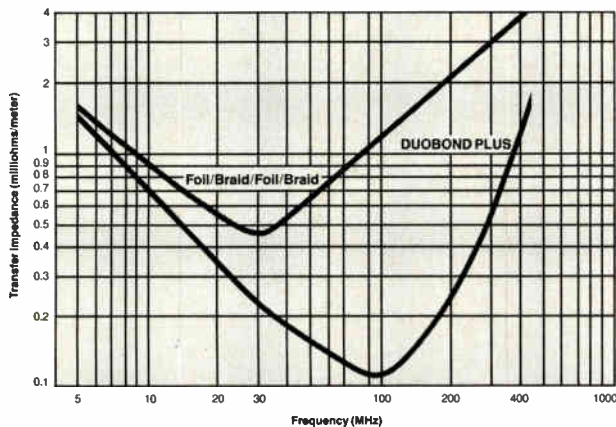

Belden's unique shield protection.

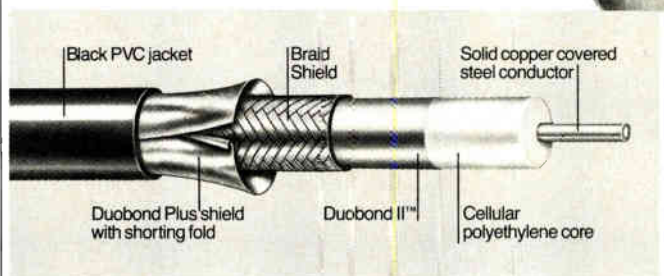

The inner foil of the DUOBOND PLUS shield is bonded *directly* to the core. Foil pushback and signal leakage problems are eliminated. Protection from shielding degradation is eliminated during installation—where most shielding problems occur.

The unique shorting fold in the outer foil of the DUOBOND PLUS shield provides metal-to-metal contact for improved isolation. Traditional overlapping foils fail to reduce slot radiation as effectively.



Belden's exclusive shorting fold

Drop cables with the DUOBOND PLUS shield are available in RG59, RG6 and RG11 constructions—messengered, non-messengered, dual and flooded versions. All cables are 100% sweep tested from 5 to 450 MHz with a minimum return loss of 23db for RG59 and 26db for RG6.

When it comes to shielding effectiveness and ease of termination, there is no equal to Belden in the CATV industry. Take the recall out of your install. Call Belden today for more information and a free CATV catalog. Belden Electronic Wire and Cable, P.O. Box 1980, Richmond, IN 47375. Phone: 1-800-BELDEN-4

There is no equal.

Reader Service Number 4



My Turn



The Lighter Side

While browsing around the science and technology reading room of the Library of Congress recently, I came across a 20-year-old article by Joseph Roizen, then of Ampex Corp., and a Fellow in the SMPTE, that displayed the lighter side of engineering. If you have saved your back issues of *IEEE Spectrum*, you will find the article on page 112 of the March 1967 issue. Just in case you can't find that issue in the stack of old magazines out in the garage, here are a few excerpts from the true history of color TV, according to Roizen, who is described by the *Spectrum* editor as "...One undisciplined representative of the electronics discipline (who, we hasten to add, has written a number of more esoteric articles on color television)." Now, Roizen speaks:

"...Within the scope of my own memory, I can recall the controversy over the three-color rotating filter proposed by one of our largest networks and the subsequent technical battle between the pure Electronic Knights and the dastardly Mechanical Monsters. In the United States, the FCC refereed the fight and, after a hurried decision for the MMs, they reversed themselves and ruled for the EKs.

By Archer S. Taylor, Senior Vice President, Engineering, Malarkey-Taylor Associates, Inc.

"We had glorious living color television and, like most modern things, it got labeled by its initials, to be known henceforth as NTSC.

"While NBC's peacock preened his flashy feathers, our European friends started having committee meetings about what kind of tinted television they were going to have. A few hardy members even dispatched to our shores intent upon assessing the impact and quality of NTSC. They must have disliked what they saw, because they went back to their colleagues with reports so detrimental that NTSC became synonymous with Never Twice the Same Color (oops, colour).

"The NIH* factor now took over. Suddenly it became imperative to invent a new system that would show those Americans a thing or two....

"The French started the ball rolling with a system that sequenced the color signal on a line-by-line basis, while a one-line delay memorized the last line and added it to the subsequent one.

"The Europeans learn fast; they may not like our technology, but they do dig initializing, so the Sequential (Colour) And Memory system became...SECAM.

"...While French engineers made demonstrations from Munich to Moscow, plenipotentiaries followed up with bids of a free system to Argentina and an offer to withdraw from NATO if the Soviet Union would adopt line sequential color TV. It was all done with such zeal that SECAM was soon paraphrased as 'Something Essentially Contrary to the American Method'....

"The Germans were not about to stand idly by. With Teutonic thoroughness, they re-examined NTSC to see what could be salvaged....Well, it happened; an American dance craze known as the twist hit Berlin (brought in by a Pan-Am stewardess, no doubt) and with a sudden inspirational flash of crystal clarity, a Telefunken scientist combined NTSC with the twist and got PAL.

"Just twist the phase of every alternate line 180 degrees and the hue errors will cancel themselves out. The PAL system was ready for the next meeting in Vienna and soon it would stand for 'Peace At Last'...."

Joe Roizen ends his "electronic fan-

tasia" on a creative note, sort of:

"As I sat contemplating engineer's inhumanity to engineers, I hit upon a solution, one that would transcend all national barriers, let no one lose face or fortune, and combine, out of all the systems, those elements of which their advocates are so proud. This system, in keeping with established practice, is called NUTSEQAMIR (National Universal Television Sequentically Encoded, Quadrature and Amplitude Modulated and Intermittently Reversed)...."

I will not bore you here with Roizen's description of NUTSEQAMIR, but you will find it in the March 1967 *IEEE Spectrum*, in full, and glorious detail.

Joseph Roizen's satire also brings to mind the "Light Traffic" section in the October 1986 issue *IEEE Communications Magazine*. In it, Professor Subbarayan Pasupathy of the University of Toronto (that is his real name!) provides some entertaining excerpts from the *Devil's Dictionary*, published between 1881 and 1911 by one Ambrose Bierce. As a starter, Professor Pasupathy reports that W.R. Bennett, a pioneer in communications, opened his textbook on *Electrical Noise* (McGraw-Hill, New York, 1960) by quoting Bierce's definition of Noise:

"Noise: A stench in the ear. Undomesticated music. The chief product and authenticating sign of civilization."

Or, how about these, quoted from Bierce:

"Phonograph: An irritating toy that restores life to dead music."

"Telephone: An invention of the devil which abrogates some of the advantages of making a disagreeable person keep his distance."

And these demoniacal quotations, also from Bierce:

"Harangue: A speech by an opponent who is known as a haragueoutang."

"Helpmate: A wife, or bitter half ('Now why is yer wife called helpmate, Pat? ...'For she helps to mate the expinses')."

So much for the *Delightful Dictionary of Mr. Devil*. Thank you Mr. Pasupathy for telling us about it. Now, back to work.

FOR THE LIFE OF A SYSTEM

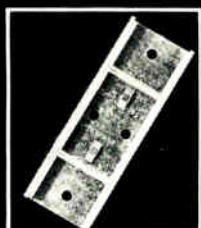
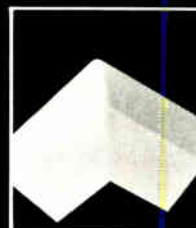

GUARDIAN Series Protective Molding

GALVANIZED STEEL with Custom Fittings
Backed by a ***15 Year Warranty***

- LABORATORY TESTED TO WITHSTAND SUN, SALT AIR AND EXTREME WEATHER
- VANDAL RESISTANT — PATENTED KEY ACCESS FOR FAST AND EASY UPGRADES
- SLASHES INSTALLATION TIME AND COST
- REQUIRES LESS THAN HALF THE ANCHORS OF LESS DURABLE MOLDING
- OFFERS GREATER CABLE CAPACITY
- AESTHETICALLY APPEALING

TO ORDER, CALL 1-(800) 222-2142

CABLEREADY INC.

6820 N. Broadway, Suite E,
Denver, CO 80221, (303) 428-9141

See us at the Western Show Booth #301

Reader Service Number 5



A riverboat gamble

The CATV and telephone industries have faced each other poker-faced before, playing for the right to wire U.S. homes for video. The government broke up the game and sent the CATV industry home with the chips. But the sheriff's looking the other way now, and the telcos are coming back to the table. And there's a technological wild card in the deck this time around—fiber optics. You can place your bets on who's going to carry the winnings home. You can bet on how long the game will last. You can even bet that fiber optics won't soon be a cost-effective competitor to coaxial cable as a medium for putting pictures into lots of homes. But don't bet the farm. That guy with the green eyeshade is holding different cards this time.

The regulatory climate has changed. Telcos are eyeing new businesses. And they still want to be the one wire into U.S. homes. Only this time it'll be fiber; capable of carrying video, voice and data. They've already ripped out copper and substituted fiber at breakneck pace on long-haul and trunk lines. The metropolitan feeders are next. House drops might follow, if certain technical and cost problems can be worked out. If you're a gambler, it's even money. Price drops continue. Connectors and splices aren't the huge barriers they once were. Transmission sources and receivers also are developing. Band-

widths and transmission speeds are increasing. Optical couplers and splitters still are a problem, to be sure. But the big question is how soon these issues will be resolved, not whether they can be resolved.

There seems little doubt that using current technology, at least one, and possibly four, video channels can be delivered to subscriber homes by fiber drops on a test-bed basis today. The debate, it seems, is over the cost, network configuration (star or tree-and-branch), transmission technique (analog or digital) and timing (are the components available off-the-shelf today).

A recent Fiber Optic Communications/Local Area Networks show panel chaired by NCTA Director of Engineering Brian James and a keynote address by CATV pioneer Irving Kahn raised the issues. Kahn's betting his money that fiber is the future of cable television. "I can't for the life of me believe that by the 1990s we will still be putting coax into the ground." He's also betting that the telcos will own the fiber drop into the home and run video services on some joint venture basis with CATV interests.

Panelist Gary Moore, a telecommunications consultant with Texas-based Peoples' Telephone, emphatically believes off-the-shelf components can deliver multiple channels on a fiber tree-and-branch system today. "Fiber isn't a technology that's over five years away, and CATV people are digging their own graves if they hold to that view." Gary never minces words.

The panel, which included James, Moore, John Prisco of PSF Fibernet (formerly with Warner Amex Cable), Jock Leconte of the European firm CLIO and Farouque Mesiya of American Lightwave Systems, discussed the future for fiber in CATV. Discussion didn't get vigorous until the issue of cost was raised. Moore clearly believes it's possible to build home terminals and complete systems at a cost far lower than the other panelists felt was reasonable today. Two to three years, maybe. But not today. How reasonable? Moore argues for a \$400 in-home terminal and a per-subscriber cost of about \$1,200 to provide both telephone and CATV services to homes on one fiber.

Moore argues for digitizing all channels. Some experts say analog is the way to go. The issues other panelists raise? Digital transmission requires huge bandwidth. Accurate decoding of packets is still a problem. Signal security isn't addressed and the component costs are too optimistic.

Still, it's important to note that the objections are over timing and cost, primarily. Another speaker estimated that a fiber-based local loop with 500 Mbps capacity, carrying four video signals, several channels of stereo and 10 voice channels into the home would cost between 2 and 10 times as much as the current telephone twisted pair local loop. As component costs drop, though, that premium diminishes. Another angle on costs is to roll capital investment for separate CATV and telco drops together.

Moore estimates a cost of \$500 per sub to provide conventional phone service, another \$800 per sub to hook up a CATV subscriber for 35 channels of TV. Roll the two together and total capital comes to \$1,300 per house. The point? You have higher costs, but also two or more revenue streams: telephone service, CATV and ancillary services.

Moore says fiber-delivered CATV is cost-effective today. James isn't so sure.

"Even with a \$400 terminal, you've still got taps and couplers in the \$80 to \$100 range." And he also questions whether digitizing 35 channels and reconstituting them in the subscriber home is really feasible on anything more than a test bed basis. At the point where couplers are in the \$10 range, James might change his mind. But even then, the NCTA veep prefers a star configuration to a tree-and-branch. "One of the reasons people don't think CATV is reliable is that every time we take an amplifier down we lose everything downstream. Your phone can be down for long periods of time before you notice it. That's not the case for CATV."

Without belittling the regulatory issues, it's clear that video services could be the driver for telco introduction of fiber drops to the home. As Kahn says: "Whoever gets that fiber drop into the home owns the home." We'll be watching. So should you.

— Gary Kim
Editor/Publisher

Satisfaction guaranteed.



Head-end

We stand solidly behind every piece of cable equipment we sell.



Test equipment

Head-end through drop materials, it performs the way we say, or we'll correct it — immediately.



Distributor

All items carry the manufacturer's full warranty.



Taps & connectors

We'll also compete with any distributor on price, selection, delivery, and service.



Aerial

We stock all major brands, and can tailor packages to your needs.



Underground

Items arrive when you need them, not sooner or later.



Cable

And our engineers and technicians can answer any questions you have about design, installation, or field performance.



Housedrop

Call Cable Services with your next order, or for a free catalog: **1-800-233-8452.** (In PA, call 1-800-332-8545)



Tools and safety



Cable Services Company/Inc.

2113 Marydale Avenue, Williamsport, PA 17701
Reader Service Number 6

CATV measurement techniques, part II

Cross modulation is the transfer or "crossing" of modulation from the interfering channel to the desired channel, resulting in a weak reproduction of the picture that the interfering channel has superimposed on the picture being viewed. This is because the receiver's horizontal scanning is synchronized with the wanted signal but usually not with the interfering one. The two horizontal frequencies usually differ slightly and the interfering picture moves back and forth across the screen reproducing slanting bars which give the windshield wiper effect.

Since it is difficult to measure cross-modulation on the wanted channel,

Cross-modulation is the subject of the second part of this classic article.

this measurement has usually been done with a CW signal substituted for the wanted picture signal. Where cross-modulation exists, it results in a variation in the peak voltage of an otherwise unmodulated signal substituted for the wanted carrier. Percent cross-modulation is defined as 100 times the ratio of this variation to the maximum peak voltage.

The equipment required to measure cross-modulation will consist of a transmitting and a receiving package. The most desirable transmitting package is a multi-carrier signal generator. Output frequencies corresponding to

the standard VHF channel assignments plus additional mid, sub and super-band frequencies. (This headend substitution transmitter must also contain individual modulators for each carrier and a two-position switch for choosing either CW or modulated carrier. It is also very desirable if the unit possess individual carrier level control.

If you desire to buy a transmitter, remember the old saying, "haste makes waste." Transmitters on the market today range from \$7,000 to \$14,000, and you should attempt to squeeze every ounce of return from your investment.

First of all consider the variety of testing you will be performing and which frequencies will be involved. Second order, channels 2, G, 13, T7, T8 and T9. Triple beat, channels 9, 10, 11,

Jerald S. Crusan, Mgr. CATV Field Engineering, Jerrold Electronics Corp.

FIGURE 8A

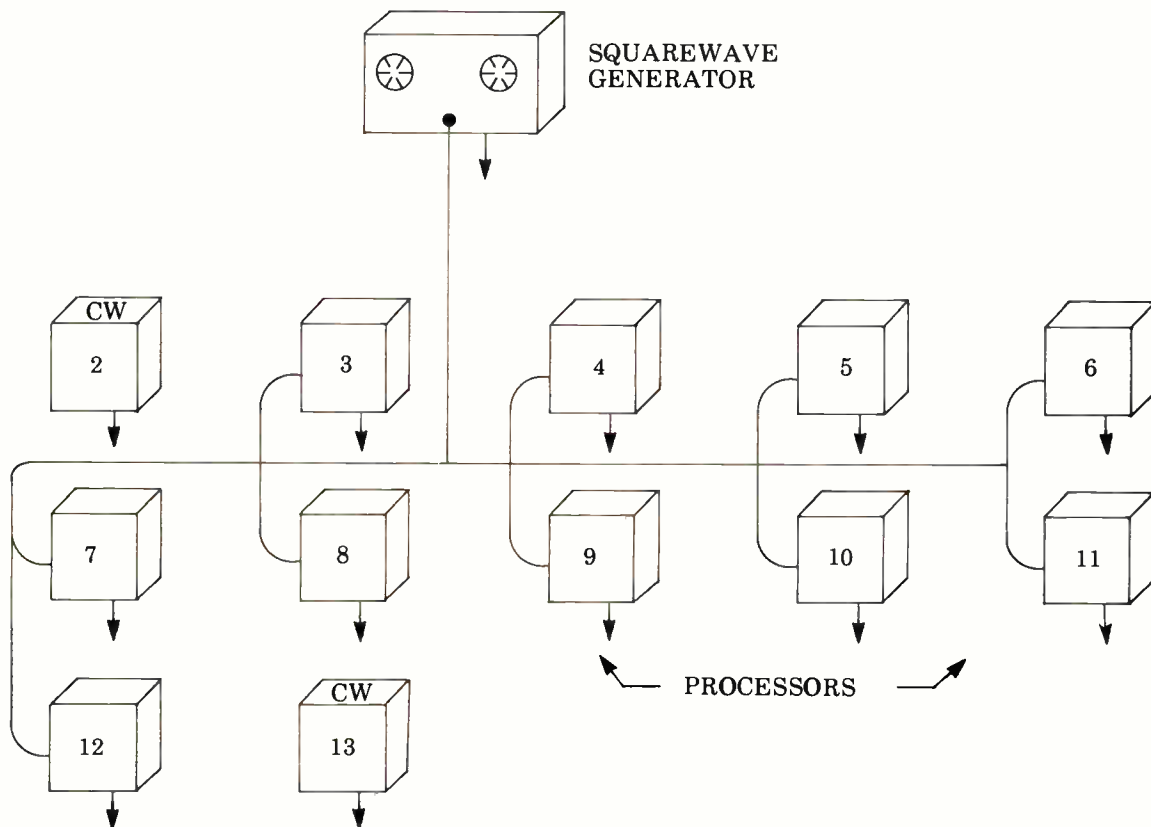

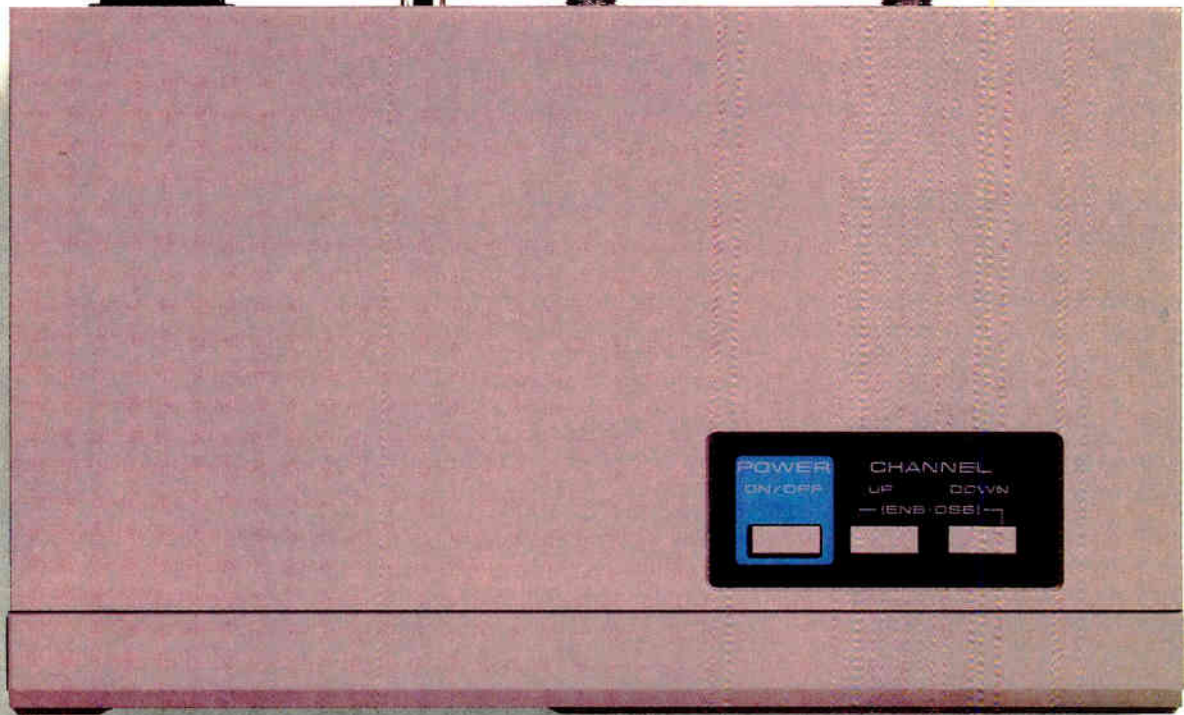

(The dotted line represents the proportional 40% reduction in space between our new BC-4500 and our previous model.)

MORE IS LESS!

Never before has so little been able to do so much. Introducing the new BC-4500, a standard converter that takes up 40% less space than our previous model, but still offers **more** features than ever before. More channel capacity. More subscriber convenience. And more operator flexibility.

Every BC-4500 is delivered with 550 MHz as a standard feature. That's 83 channels (20 more than our previous model) for your programming needs. The BC-4500 and its shipping container are even bar coded for quick and accurate converter inventory management.

Through our new custom hand-held transmitter, the Options Selector™, you can program the BC-4500 without opening the converter, or utilizing a PROM. Now you have a secure method to disable the remote control function from subscribers who decline remote rental — without hassling with internal modifications.

In seconds, the transmitter can also change spectrum allocations from HRC, IRC, and Standard. Or the transmitter can quickly remap the frequency tuned versus the channel displayed.

And just one more thing... the BC-4500 is still as economical as its predecessor. Call us today at 1-800-421-6450 for the big news on our littlest IR remote converter.



PIONEER®

PIONEER COMMUNICATIONS OF AMERICA, INC.
2200 Dividend Drive, Columbus, Ohio 43228 (614) 876-0771
Outside Ohio, 1-800-421-6450

© 1986, Pioneer Communications of America, Inc.

Reader Service Number 7

The initial cost of the transmitter is far outweighed by the advantages it offers.

12, T8, T9, T10 and a 30 MHz carrier. Carrier-to-noise channels 2, 13, 0, T7 and T10. Group delay, channels 2, 3, 13, T10 and 30 MHz. Automatic slope channels 4 and 11. AGC depends upon your system pilot carrier frequency.

The total channels in numerical order are T7, T8, T9, T10, 30 MHz, 2, 3, 4, pilot carrier, G, 9, 10, 11, 12, 13 and 0. Total number of channels is 16. Since the generators are usually built to order you can select the frequencies you desire. Remember that the measurement of second order with the wave analyzer requires that the beat falls within a few kc of the measurement carrier. Therefore, channel T7 should be 6 MHz, T8 12 MHz, T9 18 MHz, T10 24 MHz and channel G 156 MHz.

The initial cost of the transmitter is far outweighed by the advantages it offers. The following is a partial list:

1. Due to the fact that the system service must be interrupted for cross-mod testing, the available testing time

is limited to two or three hours of early morning work. Time then becomes a very important commodity and efficiency is the word of the day. The carrier generator will allow you to reduce the equipment set-up time in the head-end by a factor of 10, which allows you more time for system testing.

2. Since the headend remains basically intact do not run the risk of head-end equipment malfunction due to rearrangement of processor operating parameters and levels.

3. If you have ever desired to build an independent lab for evaluating products, this unit is definitely for you.

Figure 8.a. depicts the second method which requires a processor that has provisions for modulating the internal standby carrier. Some processors have terminal strips that will accept baseband information and produce an output that is modulated at the aforementioned baseband frequency. If your processor does not have this capability you may be able to

use an alternate method depending upon the availability of a 45.75 MHz IF tie point. The sequence is outlined by figure 8.b. and the following procedure:

An audio frequency generator with a 15,750 Hz square wave output is utilized to modulate a modulator at 100 percent. The frequency is relatively unimportant but it can serve as one of the modulated carriers. A sample output can serve as the input to a processor, whose output in turn would serve as the second modulated carrier. The processor IF module output then can be sampled with a directional coupler and the processor output level re-established with the coupler insertion loss in place.

The sample signal at the IF frequency is then divided equally and inserted at the input of the IF amplifier in each of the remaining channel processors. All of the outputs including the CW outputs which are established by the signal replacer of the desired

HIGH RESOLUTION COLOR CHARACTER GENERATOR

The CG-7000P; a new standard in simplicity and performance — \$1995.00

- Extremely simple to operate and easy to learn
- Very high resolution maintained on all four character sizes
- Genlocks to external video or generates its own background
- Will generate any NTSC color for characters or background
- Outperforms character generators costing much more
- Has a long, long list of useful and needed features

Write or phone us toll-free for additional information



ICM VIDEO
701 W. Sheridan
P.O. Box 26330
Oklahoma City, OK 73126
USA
800-426-9825 Toll-free
Phone (405) 232-5808;
Telex 747-147 CABLE INCRYSTAL
Reader Service Number 8

ICM VIDEO

Always make a reference cross-modulation measurement to assure good working order.

test channels should be operated at normal system levels.

Before leaving the headend you should always make a reference cross-modulation measurement to assure the receiving package is in good working order. Normally, the measurement will be very low and will be noise limited in the range of -90 to -100 dB.

Referring to figure 4 for receiving point test set-up the measurement is accomplished as follows:

A. Develop a 40 dB down reference reading on the wave analyzer by utilizing the calibrator in the manner outlined in the section of this paper titled Second Order Measurements. The calibration procedure for cross-modulation is slightly different than in the case of second order and triple beat. The attenuator should be adjusted for 44 dB of attenuation due to the differences of sine wave and square wave modulation. This amount of attenuation will develop a reference that is 40 dB down from carrier. When the calibration pro-

cedure is complete, continue with these outlined procedures.

B. Connect the system testpoint to the input of the bandpass filter that is tuned to the measurement channel. Connect the output of the bandpass filter to the input of the field strength meter. Tune the field strength meter to the desired measurement channel and increase the field strength meter gain until the voltmeter indicates +4 VDC.

C. Tune the wave analyzer frequency control to obtain maximum deflection at 15,750 Hz. (This may require the removal in steps of 10 until a useable scale indication is reached on the wave analyzer meter). The direct reading of cross-modulation, (in dB) imposed on the CW carrier by the presence of the modulated carriers will be equal to the sum of 40 dB reference, plus the attenuation removed from the wave analyzer attenuator, \pm the final deflection of the meter from reference setting.

D. Refer to the chart enclosed to translate this cross-modulation to the

system channel capability by adding or subtracting the indicated amount to the reading.

System radiation

System radiation shall be limited as follows:

Up to and including 54 MHz, 15 microvolts per meter at 100 feet; from 54 to 216 MHz, 20 microvolts per meter at 10 feet; and over 216 MHz, 15 microvolts per meter at 100 feet.

It is difficult to measure 20 microvolts per meter utilizing a tuned half wave dipole and the standard field strength meter.

To clarify the point, assume that the cable system is radiating 20 microvolts per meter at 10 feet on channel 12. If this is the case, the standard field strength meter connected to the output of the dipole antenna must be capable of measuring a -46 dBmV. This is not practical with the standard field strength meter. However, you may



A powerful new ally just joined your side

TELE-WIRE now distributes for Jerrold, General Instrument

We're two veterans who've joined forces to provide you with all the best in CATV equipment and supplies.

This means you can now get all your Jerrold distribution gear, headend electronics and system passives from TELE-WIRE Supply Corp.

And since we stock their products in our regional distribution centers, you won't have to wait for back orders. With *no minimum* order quantities!

Of course, we still distribute products from hundreds of other top manufacturers.

Start ordering all your Jerrold equipment from TELE-WIRE today. Call us toll free.

TELE-WIRE
SUPPLY CORPORATION

Reader Service Number 9

Corporate Headquarters:

7 Michael Ave. • E. Farmingdale, NY 11735

Northeast: Toll-free 800/645-9510; NY only 516/293-7788

Southeast: Toll-free 800/237-8203; FL only 800/282-8257

Southwest: Toll-free 800/527-1646; TX only 800/442-9926

Midwest: Toll-free 800/624-8358; MI only 800/523-9537

Low values can be measured if we use the spectrum analyzer.

FIGURE 8B

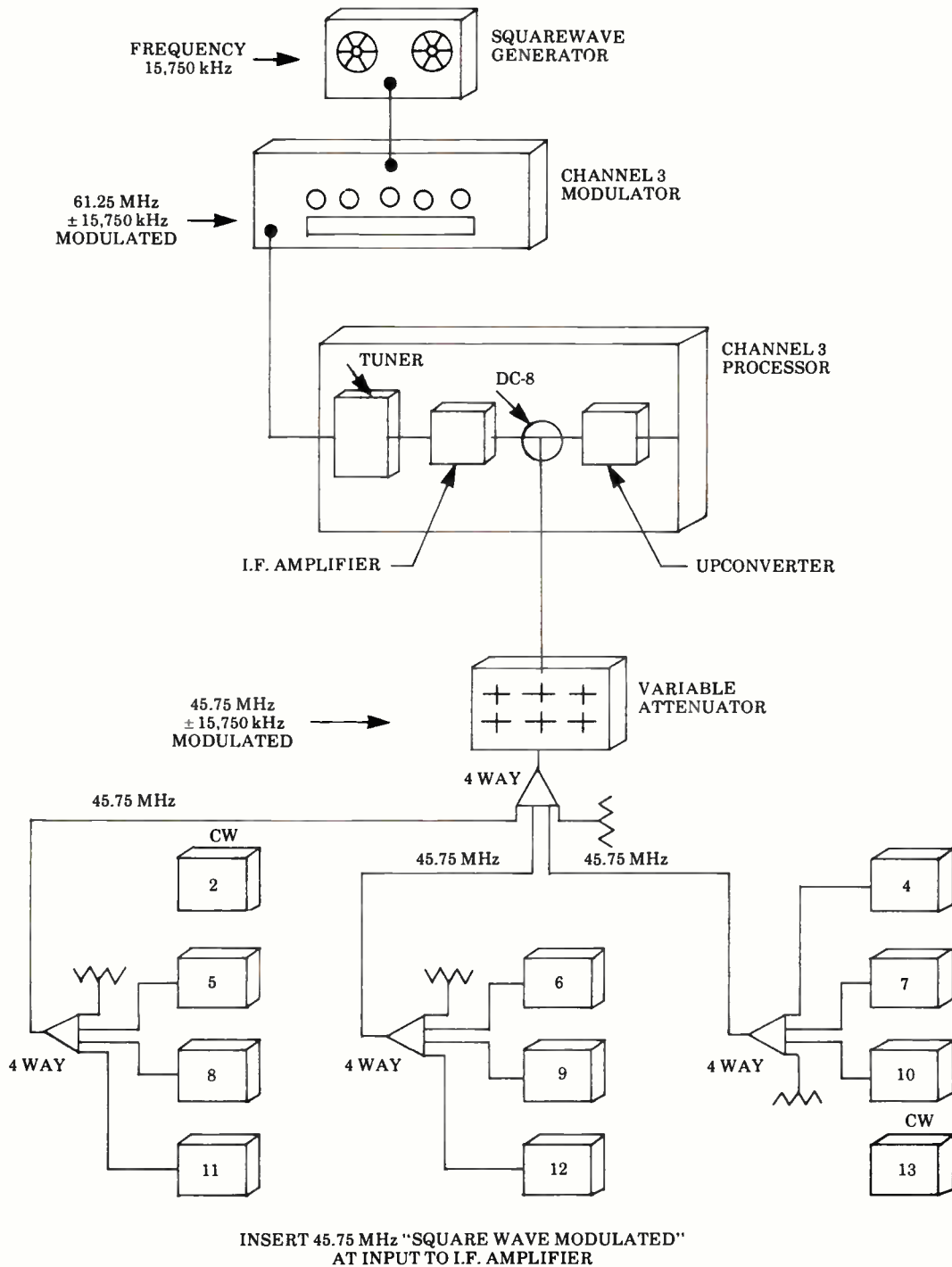



HOW TO TALK THE POWER COMPANY INTO LOWERING YOUR BILL 10%.

Introducing the first superferroresonant power supply—the new Lectro **Super Ferro**.

It's a radical improvement in power supply technology. It operates 10% more efficiently than most power supplies available until now.

For example, the **Super Ferro** is 93% efficient at normal load factor (see graph at right). Take that news to your power company, and you've got a powerful argument for a 10% saving in your power bill.

We've put together test results to help you prove the increased efficiency of the **Super Ferro** to even the most skeptical utility company.

Call 1-800-551-3790 or write today for complete details and test results. Because that 10% would look better on your bottom line than on your power line.

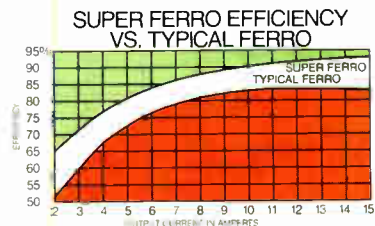

Super Ferro Outperforms The Average Power Supply At Every Load Factor.

THE NEW LECTRO SUPER FERRO BY LECTRO

One source of error is in the bandwidth of the average field strength meters: approximately .6 MHz.

FIGURE 9

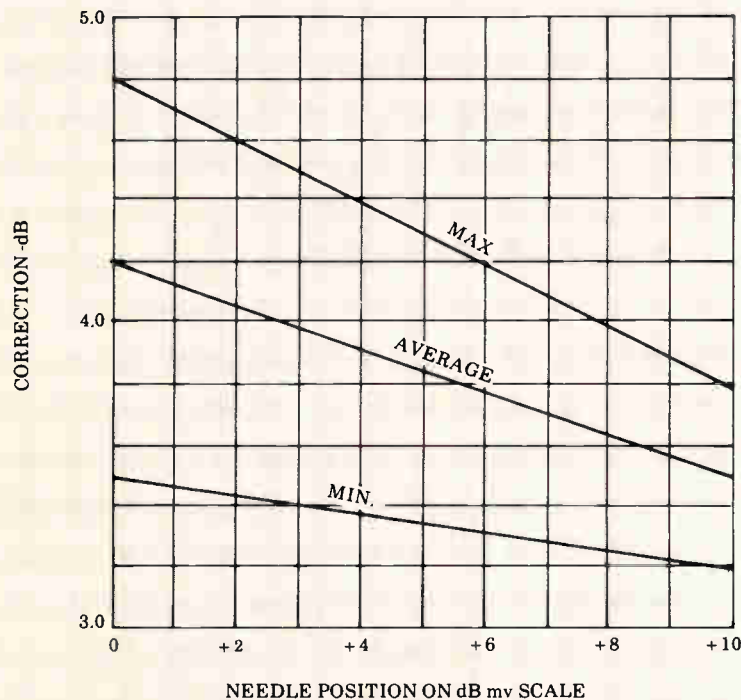

noise levels directly and both must be taken into account in the correction. One source of error is in the bandwidth of the average field strength meters which is approximately .6 MHz. Since noise power is proportional to bandwidth, the apparent noise will be reduced by a factor of 8.2 dB, which is the decibel equivalent of a power ratio of 4 MHz divided by .6 MHz. The second error occurs in the opposite direction. It is due to the fact that the average field strength meter utilizes a peak detector. Peak detectors will attempt to respond to the noise peak better than reading the RMS noise. Since noise has a higher peak-to-RMS ratio than the CW signals, the detected output reads high. As its output is reduced the efficiency of the detector is lowered and reads closer to RMS so more total correction is needed at the low end of the meter scale.

Figure 9 illustrates the maximum, average and minimum correction values dependent upon the needle position on the dBmV scale of the field strength meter. The appropriate correction corresponding to the needle position on the scale is then added to the measured level to obtain true noise level.

Test description

The carrier-to-noise ratio should be measured utilizing the lowest and highest carrier frequency transported by the transmission system. These frequencies should generally be considered to be the worst cases if the system frequency response is held within ± 3 dB. The carriers shall be generated by the headend processing equipment and the receiver package shall consist of one variable attenuator and one field strength meter. Previously mentioned field strength meter correction factors can be verified by measuring any known noise source, but this is usually not essential.

Test procedure

A. Connect a drop cable from the system testpoint to the input of variable attenuator.

B. Connect the output of the variable attenuator to a bandpass filter that is tuned to the measurement channel.

make the situation slightly more tolerable by adding a pre-amplifier between the dipole antenna and the field strength meter and the level will be within the sensitivity range.

The additional noise from the field strength meter due to the low input level will further obscure the reading when the measurement is attempted. At 300 MHz, expect the carrier-to-noise to degrade by an additional 3.3 dB. When the measurement is made at channel 2 expect the carrier-to-noise to improve by 11.3 dB.

In summation, the technique is useable for frequencies up to 100 MHz, but for frequencies higher than 100 MHz the results would be questionable. The aforementioned analysis is predicated on the assumption that the field intensity of cosmic noise, atmospheric noise and man-made noise is not excessive.

Unfortunately, the median value of both urban and suburban man-made noise is in excess of 10 microvolts per

meter when measured with a 600 kc bandwidth field strength meter. The facts at this point indicate that the field strength meter is not the receiving instrumentation necessary to measure such low values of radiation.

However, these low values can be measured if we utilize the spectrum analyzer. The spectrum analyzer can perform the measurement for two basic reasons. Increased sensitivity and the ability to reduce the receiver bandwidth to the point that noise is not objectionable.

Carrier-to-noise

The average field strength meter is designed to measure the voltage and the dBmV levels of CW, FM carriers and television signals in cable systems. Although it is not calibrated for noise levels, with suitable correction, a meter can be used for this purpose.

Two factors prevent it from reading

A few procedures must be followed to insure the measurements are accurate.

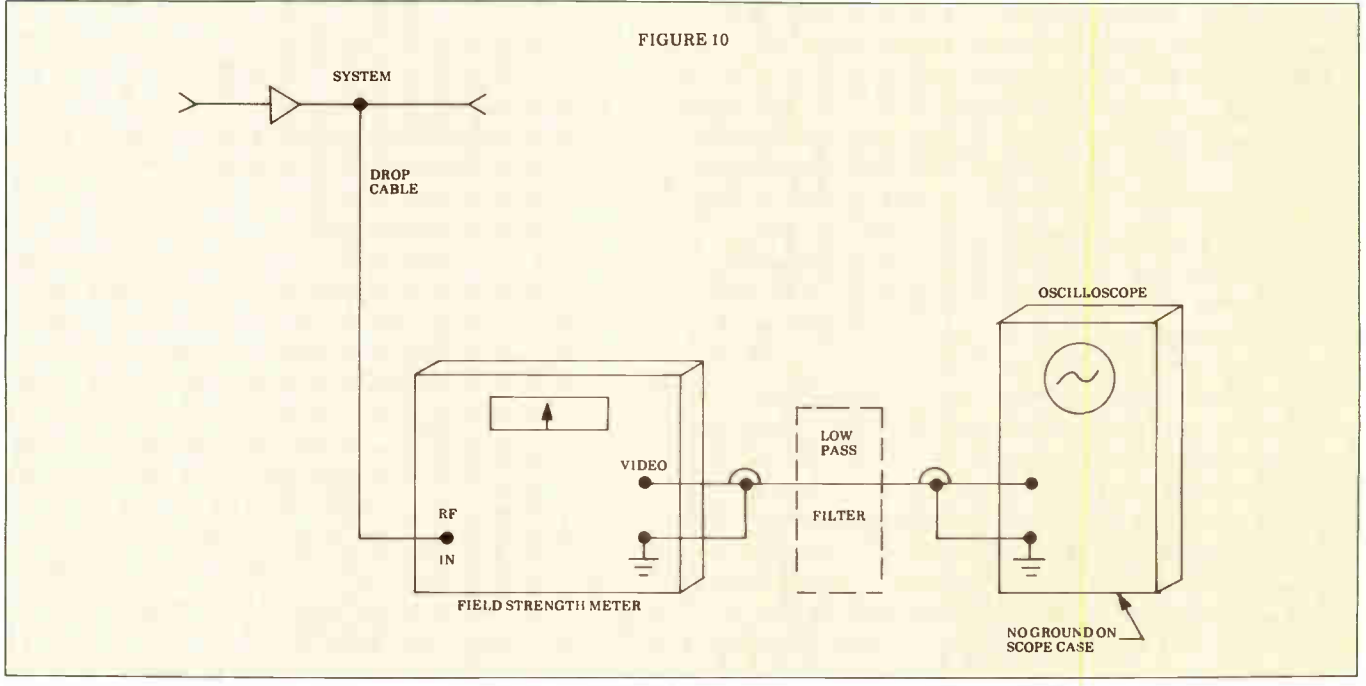

RMS GUARANTEES **-120 dB RFI!**



Only RMS guarantees -120 dB RFI in its CA-1000/M and CA-2000/M directional couplers, and CA-2000/SM silver plated two-way hybrid splitter. No one else comes close. These products are especially useful at the headend in systems in metropolitan areas and in LAN systems where RFI integrity is essential.

RMS - "Back to the technician in mind"

RMS ELECTRONICS, INC.

50 Antin Road, Bayside, N.Y., 11462 - CALL COLLECT: (212) 832-1000 (New York State)
TOLL FREE: (800) 223-8312 (Continental U.S.A., Puerto Rico, U.S. Virgin Islands)

It is necessary to test amplifiers and systems to insure that this effect isn't objectionable.

FIGURE 11

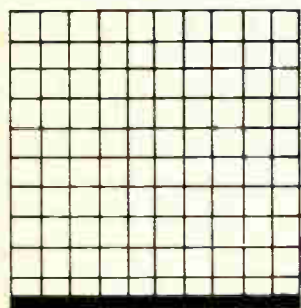

DISCONNECTED INPUT

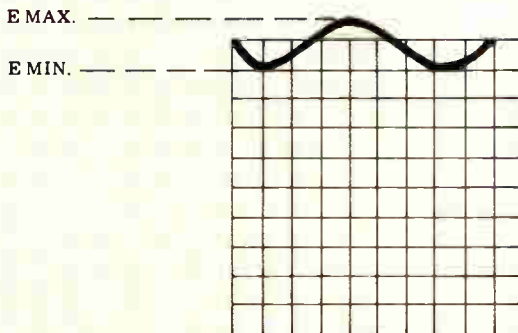

CONNECTED INPUT

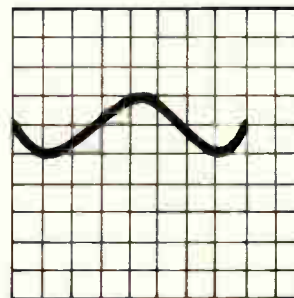

A-C COUPLED AND VERTICALLY CENTERED

SATELLITE RECEIVERS

EXCELLENCE **PRICES**

CRYSTAL SYNTHESIS BLOCK-RECEIVER ZXR-900

For More Information
Call 918-834-1229



- The ZXR-900 Satellite Receiver is current state of the art for low cost receivers, works with conventional, or most block systems.
- Stable block-down RF in frequency range between 900 and 1450 MHz.
- Descrambler compatible.
- Video Out — Keyed Clamp.
- We modify and service most commercial receivers.

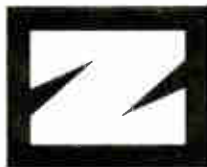

ZEPHYRUS
ELECTRONICS, LTD.
1550 N. 105th E. Ave.
Tulsa, Okla. 74116

Performance Counts! We perform. . . so you can!

Let's face it. Performance is the bottom line. If we don't perform, you don't either.

With a Control Technology standby power system, that just won't happen.

We're so confident our standby power designs out-perform the competition, we offer a no-strings FREE trial program, so you can test our performance for yourselves!

Remember, we guarantee our performance. . . so you can!

For more information,
call toll free

1-800-527-1263;
in TX 214-272-5544



1881 State Street, Garland, TX 75042

INNOVATION & INFORMATION Magnavox at its best



Magnavox leads the industry in advanced cable technologies. PowerDoubling™, Feedforward, and amplifier bandwidths to 550/600 MHz—you continue to look to Magnavox for innovations. Our transformerless power supply is cool, efficient, and cost-effective. It's the direction of the future.

We excel at making your system easy to install and maintain. Our reliable 600 MHz passives allow easy upgrades with interchangeable base assemblies. And our enhanced status-monitoring system underscores our dedication to reliable field operations.

Magnavox's commitment to you extends beyond the sale. Our exclusive Mobile Training Center sets the standards for training in the industry by providing hands-on experience. And our technical publications give you clear and complete instructions.

Put our innovations and information to work for your system. Talk to your Magnavox account executive, or call toll-free 800-448-5171 (in NY State 800-522-7464); Telex 937329; FAX 315-682-9006.



Magnavox CATV Systems, Inc.
A North American Philips Company
100 Fairgrounds Drive
Manlius, NY 13104

A low pass filter may be utilized between the field strength meter and the oscilloscope.

modulation will appear on the television receiver as horizontal bars that move up or down, so it is necessary to test amplifiers and systems to insure that this effect is not objectionable.

The test procedure for determining the percentage of hum modulation is as follows:

1. Assemble the test equipment as shown in figure 10.
2. Connect the system test point to the RF input of the field strength meter.
3. Tune the field strength meter to any CW signal present on the system including the pilot carrier. When the system utilizes automatic slope amplifiers that are tuned to a modulated carrier you will be required to introduce a hum free source of CW at the system origination point.
4. Sync the oscilloscope to the "line" at a frequency of 30 or 60 cycles.
5. Adjust the oscilloscope coupling to DC.
6. Set the field strength meter to

"Manual Gain" and adjust gain until the meter reads full scale. Now adjust scope gain and centering so that, with the signal source disconnected, or the vertical input grounded, the trace is on the bottom line of the oscilloscope, and with the source reconnected it goes to the 10th line. This adjustment sets the relation between oscilloscope deflection and CW level so that each division on the screen utilized represents a 10 percent change in level. Since hum modulation is usually symmetrical (varying both above and below the modulated level), percent modulation follows the rule

Percent Mod. =

$$100 \times \frac{E_{\max} - E_{\min}}{E_{\max} + E_{\min}}$$

Referring to Figure 11

7. For convenient measurement, switch the scope to an AC coupling and center the trace vertically. If the

percentage of modulation is so low that it cannot be measured, increase the scope gain 10 times and divide the final percentage hum modulation reading by 10.

A low pass filter may be utilized between the field strength meter and the oscilloscope if you desire to reduce the amount of system noise present during the measurement.

The low pass filter is usually not required unless you are attempting a measurement of 1 percent or less. An ordinary power combiner with the AC side connected to the oscilloscope will fill the bill.

Channel frequency response

The channel frequency response is a measurement of system gain at various frequencies within the 6 MHz bandwidth assigned to each standard television channel. The methods of measurement are related in concept to the approach taken in normal bench

R.T.G.* VERSALIFTS - Ready for You - Right Now!

When you need a lift in a hurry, call your **Versalift** Distributor. He has fast access to our R.T.G.* pool of complete, mounted **Versalifts**. No waiting because of long delivery on vehicles, manufacturing delays, or freight problems. Best of all, they're **Versalifts**, with job-proven reliability and industry-wide acceptance. And, since we're mounting them in quantity, the

prices are right, too. Truck or van mounted, telescopic or "elbow" models, with working heights up to 55 feet, all ready to go to work — Now!



***Ready To Go**
Mounted on current model chassis.

For the name of your **Versalift** Distributor, call:



P.O. Box 20368
Waco, TX 76702-0368
(817) 776-0900

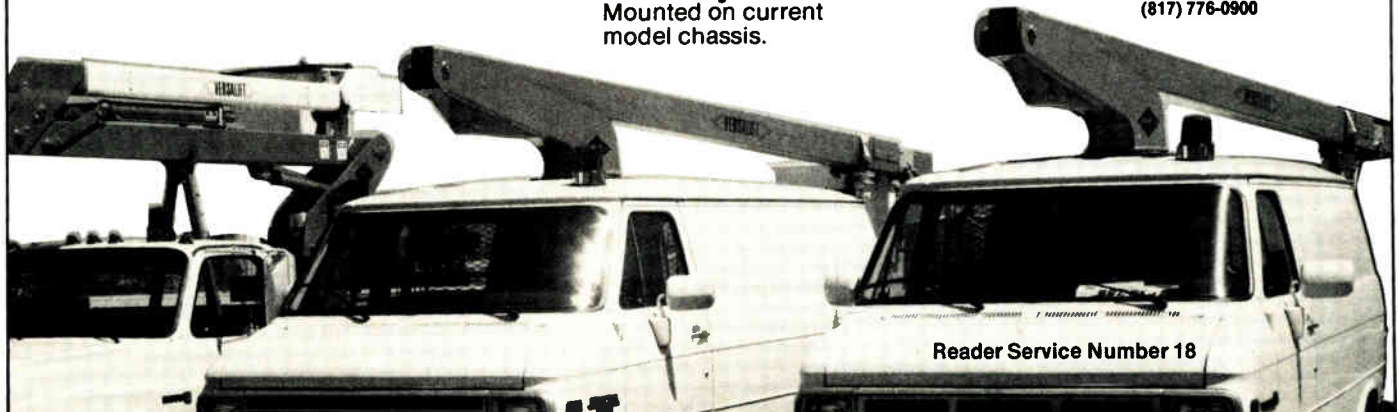

Reader Service Number 18

Agile Omni, the industry's most advanced receiver designed by the most relied upon name in the business... Standard.

With the new Agile Omni, you need no other receiver.

Standard designed it for cable TV operators, broadcasters, CATV, SMATV, and business and special teleconferencing networks — now and in the future.

An onboard microprocessor permits selection of any band available from domestic satellites, including the 32-channel ANIK C2. Channel tuning provides direct reading of the transponder-assigned channel number and a format control permits selection of six frequency band formats — 24-channel C-band, SBS/USAT and Spacenet already installed. Select channel and format, and the microprocessor controls frequency, channel spacing, transponder bandwidth, audio

frequency and bandwidth, and antenna and video polarity — automatically.

Omni's flexible design can handle up to three separate subcarriers including stereo programming or data. Omni also will accept descrambling modules — eliminating the need for expensive add-on descramblers.

For CATV and SMATV applications, severe microwave terrestrial interference is minimized by optional internal SAW notch filters, automatically programmed to switch in. A 30 MHz low DG/DP LC bandwidth filter is standard, and a second internally installed optional filter of 18, 22, 26, or 36 MHz bandwidth can be controlled by the microprocessor, or manually switched.

Standard's proven RF

loop-thru circuitry and blockdown conversion technology combine, with better image rejection and lower differential gain and phase, to provide excellent video performance. C/N threshold is an impressive 6.5 dB at the wide 30 MHz bandwidth.

Agile Omni is an affordable, flexible receiver designed to keep you in business, a commitment Standard backs with its unique 5-year warranty program. Contact us for further information.

Standard
Communications

P.O. Box 92151
Los Angeles, CA 90009-2151
Toll free 800/243-1357
(In Calif. 800/824-7766, ext. 275)
Reader Service Number 19

Engineered to a new Standard



Operating functions including MGC, AGC, AFC, level sets, normal/invert video, clamp/unclamp video, skew, subcarrier frequency selection, video and IF test points are conveniently located on the front panel. Meter reads C/N ratio, signal strength or center frequency.



Format control enable selections of desired satellite system. Direct-reading channel selector displays transponder-assigned channel. Second selectable subcarrier and space for optional third subcarrier or descrambler modules.



The low pass filter isn't required unless you are attempting a measurement of 1 percent or less.

FIGURE 12

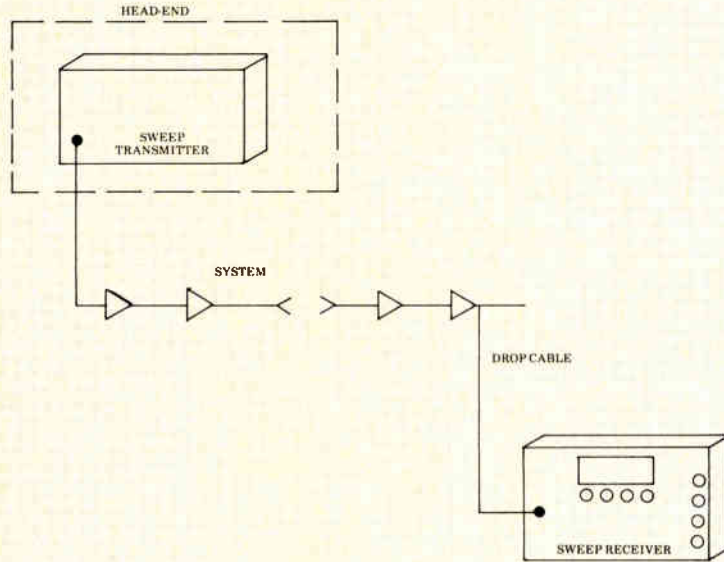

10 DAYS FACTORY REPAIR SERVICE

Send your Sadelco Meters direct to the factory for repair.

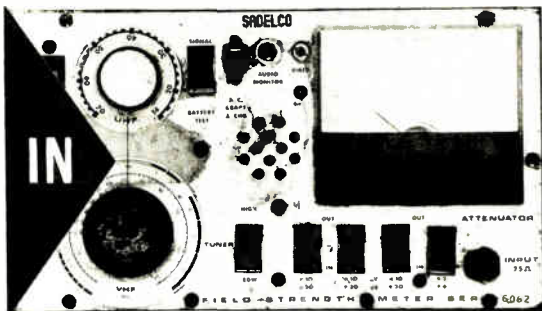

REPAIR
HOT-LINE
201
569-3323

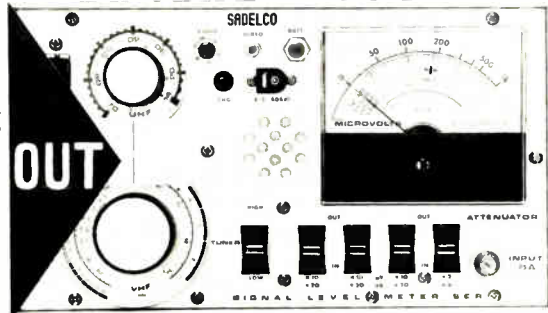

■ 10 work-days, in-out service

■ Repair cost-estimate on request

Repair Service includes updating your Sadelco SLM with all of the latest Sadelco modifications.

Trade-in any SLM, we'll allow a liberal discount towards the purchase of any new Sadelco Signal Level Meter.

Sadelco, Inc. 75 West Forest Avenue, Englewood, New Jersey 07631 201-569-3323

General Representative for Europe: Catec AG, Habsburgerstr 22, 6003 Luzern. Tel. 041/573636 Telex: 041/572796

Reader Service Number 20

THE SHOW STOPPER.



New Vitek canister traps stop premium show thefts.

Are your customers receiving your premium shows for nothing? Now you can stop these profit losses economically with our new Vitek VT-X Single Channel Rejection Traps.

Available for channels 2 through 6 and (A-2) through I, these traps are weather-resistant and stable in temperatures of -40°F to 140°F .

They feature a high quality, injection molded P.C. board, not foam or urethane-filled, so they

last. They are backed by an unbeatable warranty—two full years on parts and one year on labor.

Each model has superb R.F. shielding characteristics and is stamped with a product identification code. HRC, PRIME, IRC and other offsets are available.

For a free sample, just write or call LRC/VITEK Electronics. Stop their shows. Increase your profits.

AUGAT® **LRC**
VITEK

Quality and Innovation

LRC Electronics, Inc.
901 South Avenue, Box 111
Horseheads, New York 14845
Phone: 607/739-3844

Reader Service Number 21

Both approaches are the same: a carrier is swept from the lowest system frequency to the highest.

**TABLE 1
Theoretical conversion for cross-modulation distortion**

Test signal		System capability		Cross-mod conversion factor
No. of channels	Block tilt*	No. of channels	Block tilt*	
9	3 dB	12	3 dB	-3.8
9	3 dB	21	3 dB	-7.5
9	3 dB	27	3 dB	-10.8
12	3 dB	21	3 dB	-3.7
12	3 dB	27	3 dB	-7.0
21	3 dB	27	3 dB	-3.3
9	5 dB	12	5 dB	-4.4

* The tilted channels are the five low-band VHF channels and (if applicable) the nine mid-band TV channels.

sweep techniques with a few changes in procedure necessary to insure accurate results.

1. The continuous method.

a. Standard sweep generator located

at headend, operated at low sweep levels.

b. Produces severe interference on television receivers.

c. Requires traps at AGC carrier fre-

quencies to reduce sweep energy contribution, which alters AGC amplifier levels.

2. The simultaneous method.

a. Simultaneous sweep transmitter located at headend, operated at high sweep levels.

b. Produces unobjectionable interference on television receivers.

c. Increased equipment cost.

Both approaches are basically the same. A carrier is swept from the lowest system frequency to the highest. The effects of system gain at various frequencies within the system passband produce variations in the amplitude of the CW carrier as it travels through high and low gain points in the passband. The sweep receiver unit transforms the RF amplitude variations to DC variations. The DC variations are then displayed on an oscilloscope in the form of a trace. The high and low points of the trace can be frequency identified by mixing a known RF signal with the sweep prior to de-

**10% OFF
Equipment Repair**

COM-TEK

- Work Guaranteed
- Quick Turnaround
- Refurbished Equipment
- Hot Line

See us at the Western Show Booth #1218

(415) 785-4790

(816) 826-3011

Hayward, Calif. 94545 Sedalia, Missouri 65301

Reader Service Number 22

Expires 2-1-87

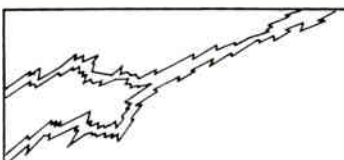

Prevention is the only protection

Lightning rods attract lightning—that's their function. The only sure protection is to prevent the lightning from striking the structure and damaging the installations inside. That's what the VERDA Lightning Deterrent does—it gives you protection from all lightning-associated problems by deflecting lightning. A positive corona is formed which deters positive lightning energy. The VERDA Lightning Deterrent can be applied in all situations requiring lightning protection—

- Communications systems—
- microwaves—two-way radio
- TV—FM—Nurad antennas
- boats—police and fire stations—ambulances—
- telephones—trucks—
- It's round-the-clock

protection against lightning. This system has been storm-tested on the highest structure in the world.



Lightning Deterrent Corp.

5321 South Kedzie Avenue
Chicago, Illinois 60632
(312) 434-7912

**The Proven
Lightning
Deterrent!**



Reader Service Number 23

TRAP YOUR PROFITS.



New! Economical canister traps from Vitek.

Stop security losses that lead to profit losses. And do it economically with our new Vitek VT-X Single Channel Rejection Traps.

Available for channels 2 through 6 and (A-2) through I, these traps are weather resistant and stable in temperatures of -40°F to 140°F .

They feature a high quality, injection molded P.C. board, not foam or urethane-filled, so they last. They are backed by an unbeatable warranty—two full years on parts and one year on labor.

Each model has superb R.F. shielding characteristics and is stamped with a product identification code. HRC, PRIME, IRC and other offsets are available.

We'll send you a free sample. Just write or call LRC/VITEK Electronics. Trap your signal. Trap your profits.

AUGAT® **LRC**
VITEK

Quality and Innovation

LRC Electronics, Inc.
901 South Avenue, Box 111
Horseheads, New York 14845
Phone: 607/739-3844

Reader Service Number 24

Panasonic found in or a 99.88% r Pleased wit

Panasonic CATV. For a number of good reasons.

Reliability has long been a Panasonic trademark. But the 99.88% success rate of our first CATV converter* is only one reason to choose Panasonic CATV components. Our performance, features and full line are equally good reasons.

The VCS-1 Switcher.

For your subscribers who want to get the most out of their video components, offer them the Panasonic® VCS-1 switcher.

The VCS-1 lets your subscribers



record a pay channel while they watch a basic channel. In fact, your subscribers can record any CATV channel while they watch any one of four video sources. Like a second VCR, a second converter/descrambler—even a video camera.

To get the VCS-1 message to your subscribers, Panasonic provides extensive marketing support. Like cooperative advertising funds, statement stuffers, point-of-purchase displays, create kits containing complete print ads—even a TV spot to run on your local avails.

The TZ-PC120 and TZ-PC150 converters.

Our Non-Addressable Remote Converter, the TZ-PC120, features

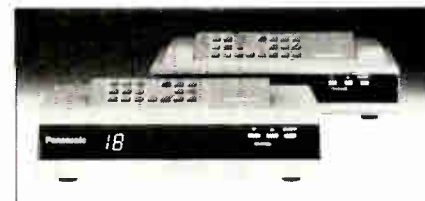

68-channel capability. Each channel is precisely controlled by phase-locked synthesized tuning, switchable between HRC and Standard/IRC offsets.

We didn't forget the favorite-channel memory. In fact, the TZ-PC120 can store up to 68 channels. It also features direct-access tuning, two-speed all-channel scan and last-channel recall. All this without an "Enter" button.

When it comes to our optional

Industrial e cable TV reliability fac h the result

parental control, the TZ-PC120 lets your subscribers lock out the sensitive channels they don't want their children to see, without affecting the remaining channels. And thanks to our innovative *Stored Charge Non-Volatile Memory*, parental control channels and other memory functions will not be affected by a power outage. There's also an 18-button infrared remote control. It's compact, controls every function and comes complete with Panasonic batteries.

For your subscribers who want even more, there's the TZ-PC150. It has all the features of the TZ-PC120 plus *volume control* and *mute*. Parental control and base-band audio and video outputs are optional.

The new addressable PC-200 converter.

When it comes to your headend, the new PC-200 addressable converter



can help give you a head start. Downloadable features include channel map, channel authorization, clear parental control, initial activation and emergency alert.

The PC-200 also features 68 channels, a full-function infrared remote control, electronic parental control, favorite-channel recall and

two-speed scan.

Pay-per-view capabilities include simultaneous events, multi-episode events and both inclusive and exclusive events.

Panasonic CATV components. The performance and features your subscribers want. The reliability you demand. *Based on in-warranty repairs as of 4/1/86 from all converters sold since 8/84

For more information, contact Panasonic Industrial Company, Video Communications Division, One Panasonic Way, Secaucus, NJ 07094. Or call:

East Coast: (201) 392-4109

West Coast: (415) 672-2592

Panasonic
Industrial Company

Ignoring delays in time due to signal propagation on group delay will aid in explaining the trace display.

FIGURE 13

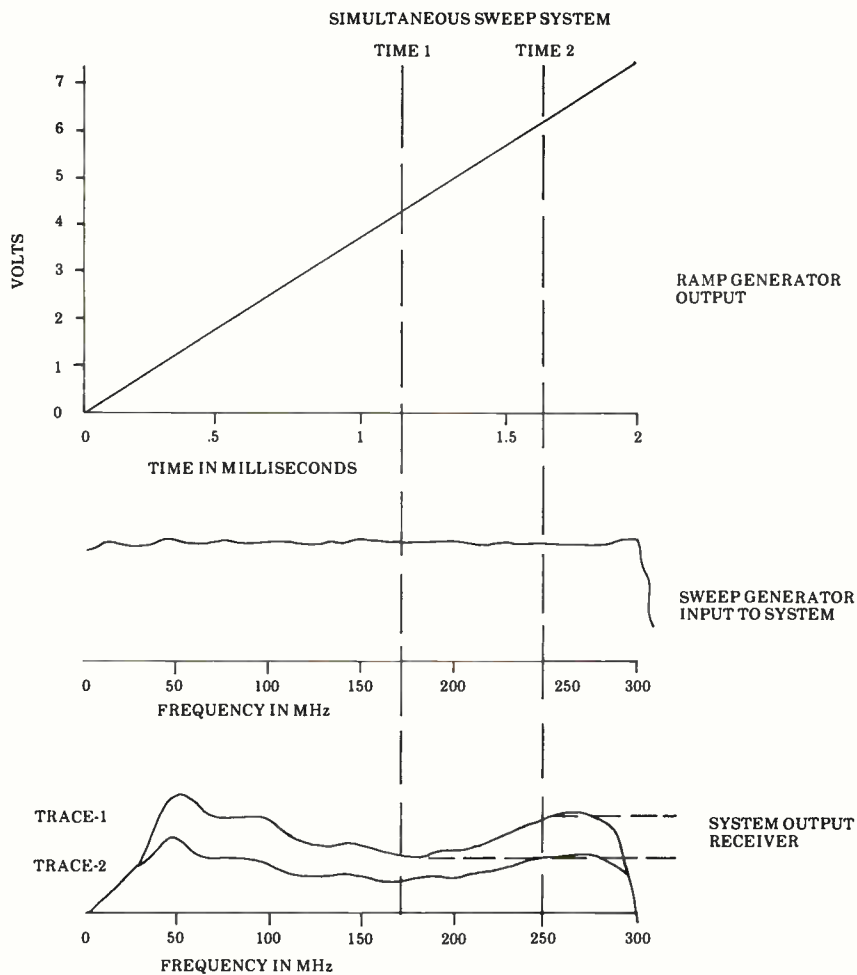

tection. This will cause a beat on the trace at the point the sweep frequency coincides with the known RF marker signal. The difference in system gain at different frequencies may now be determined by adding a variable attenuator prior to the sweep receiver and adding attenuation until the frequency with the highest amplitude rests at the same point on the oscilloscope as the frequency with the lowest amplitude occupied prior to the level decrease.

Figure 12 is an illustration of the simultaneous sweep system. The sequence is as follows for a 500 kc to 300 MHz sweep.

1. A variable rate generator in the transmitter triggers a ramp generator.

2. The ramp generator begins at 0 volts and increases in a linear fashion to 7 volts.

3. The ascending ramp voltage frequency modulates the sweep generator. When the ramp voltage increases the sweep generator output frequency increases.

4. The output of the sweep generator is passed through a "diode gate," and into the trunk system.

5. During the 2 millisecond sweep time the CW carrier has progressed from 500 kc to 300 MHz and the system non-uniformities in gain have acted on all the individual frequencies within the system passband.

6. The sweep receiver detects the sweep signal and displays the resultant information on a CRT.

Figure 13 indicates two time marks. Ignoring any delays in time due to signal propagation or group delay will aid in explaining the trace display.

Time 1 shows the ramp voltage at 4 volts. When the ramp input to the sweep generator is 4 volts, the sweep generator output is at 160 MHz and the system for this instant in time is amplifying a CW carrier at 160 MHz. The trace on the CRT indicates the amount of gain the system exhibits at 160 MHz.

Time 2 shows the same information, only this time at 240 MHz. Ramp voltage = 6.2 volts, frequency = 240 MHz. The trace indicates that 160 MHz is 3 dB lower in amplitude than 240 MHz. This may be due to lower amplifier gain at 160 MHz relative to 240 MHz, or excessive loss in a passive or passive devices at 240 MHz. ■

Micro-Beam™

The Cable Expansion Problem Solver

Channel Master® MICRO-BEAM™ is a flexible, cost-effective CARS-band microwave relay system designed to solve the cable expansion problem facing today's cable operators.



That's why some of the top MSO's like, United Cable, Newhouse Broadcasting, Centel Cable, Cable Entertainment, Sonic Communications and Telescripts, use MICRO-BEAM™ as an alternative to the more expensive systems on the market today.

Eliminates Additional Headends

MICRO-BEAM™ reaches isolated subscriber pockets and spans natural barriers without additional remote headends, adapting to your entire service including audio, video, data and addressability signals and commercial insertion capabilities. MICRO-BEAM™ also saves you that \$500 per-channel descrambling cost by allowing you to descramble each channel at the main headend. In fact, MICRO-BEAM™ is so compact, it allows you to transmit from a weatherproof unit that mounts behind the antenna. It can even be mounted on water towers, and can be placed anywhere in your system, not just at the headend.

Two Affordable Systems

MICRO-BEAM™ is available in two affordable systems that can be configured in many ways to meet your systems needs. A 36-channel 300 MHz system available in 1 and 5 watts, allows many more receive sites and offers cost savings in smaller systems for as low as \$46,965! The 1-watt system can transmit your signal fully loaded over 9 miles in each of four directions or 15 miles in each direction with the 5-watt system.

The 60-channel 450 MHz system also comes in 1 and 5 watts and provides the range and channel capacity larger systems demand.



For example, the 1-watt system can cover a path distance fully loaded up to 7 miles in four directions or 14 miles in one direction. The 5-watt system can carry 60-channels up to 20 miles and allows up to 4 separate receivers fully loaded up to 12 miles in each direction.

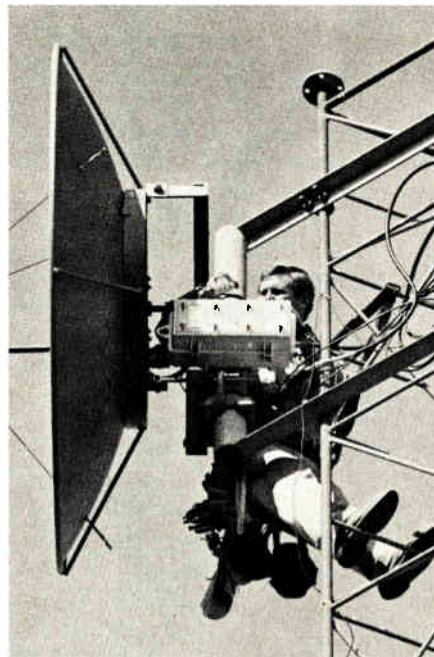

In addition to extra power, the 5-watt system utilizes GaAs FET amplification, highly stable microwave oscillator and redundancy of key components to insure reliable operation and reduce maintenance. A Status Monitor Panel, included with the 5-watt transmitter, allows remote monitoring of all system functions by bringing all test points to the headend or tower base.

The rugged transmitter unit is housed in a heavy-duty weatherproof housing designed for pressurization. The transmitter is cable powered, and operates in temperatures ranging from -50°C to +60°C, with humidities up to 100%.

Cost-Effective Expansion

With MICRO-BEAM™ you can expand your system cost-

effectively because there are no "hidden costs" for optional equipment and services, so you get more for your money!

Standard Equipment & Services

- 450 MHz Transmitter
- Microwave Receiver
- LNA/Image Rejection Filter/AGC
- Mounts, Waveguides, Connectors
- Feasibility Study
- Installation of MICRO-BEAM™ Electronics
- F.C.C. Application Assistance
- Alignment of Microwave Paths
- 1-Year Warranty on Parts and On-Site Service
- 24-Hour, 7-Days A Week, Technical and Warranty Service
(In Continental U.S. Only)

Because MICRO-BEAM™ is basically option free, the system you order is in stock, giving you the fastest lead time of any microwave product on the market.

See us at the Western Cable Show
Booth No. 1122 or:

CONTACT: Channel Master
Division of Avnet, Inc.
P.O. Box 1416
Smithfield, NC 27577
(919) 934-9711

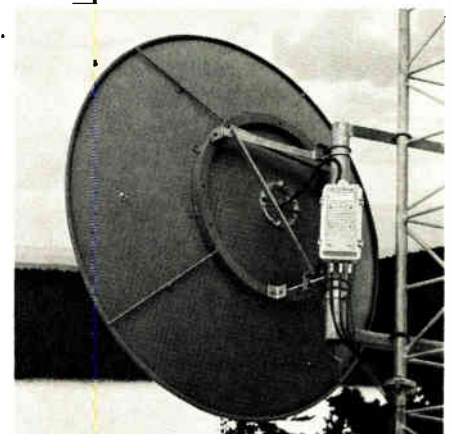

 **Channel Master®**

Division of Avnet, Inc.
Industrial Park Drive, Smithfield, N.C. 27577
Reader Service Number 26

Billing vendors focus on technical applications

It's no secret that an increasing number of MSO's are turning to more sophisticated billing software that allows a host of management information reports to be manipulated as they see fit. But what seems to be less obvious is that those same packages perform a variety of functions of interest to engineers and technical managers.

Whether you have in-house computer capability or are on-line to regional service bureaus, every billing vendor contacted for this story offers some form of management information targeted toward the technical end of a cable system's operation. Despite the fairly high level of sophistication, however, it seems that the technical community is just now stumbling upon uses for the information and is beginning to ask for even more.

And while each software package contains its own unique functions and features, some of them can be considered much more universal in nature. Most, if not all, of the companies contacted can replicate the following features, but because of space requirements, only one feature from each firm will be discussed in this article.

Tracking the performance of each technician and/or installer for ongoing staff evaluation can be done on a daily, weekly and monthly basis through CableData's on-line software. Because every install, restart, downgrade, upgrade, disconnect, service call or special request order has a technician/installer number tied to the job, management is able track jobs issued, completed, not done, rescheduled and cancelled for each technician, according to Diane Johnson, CableData's manager, sales software support.

Additionally, Johnson said that skills needed to complete or fix service call problems are summa-

MSO's are increasingly turning to more sophisticated billing software.

riated by work points and number of jobs for every tech. This allows the manager to get an accurate picture of the type of tasks each tech is carrying out.

Service call histories by location can be determined by using CMS' System 1 software. A complete report listing date and times for each call is supplied, along with who took the call, who responded to it, when it was dispatched, when it was completed, etc., said John Jonopulos, western regional manager. Each call report also has room for five unique problems and resolutions, along with a brief description of the problem.

Physical plant data, such as amplifier number, pole number, tag number, etc. can also be supplied to the database and used to identify each household by location to spot recurring problems by geographical area. If an amplifier is shown to be receiving a lot of attention, it can be replaced and brought in for service. As a preventive maintenance function, signal readings throughout the system can be uploaded, giving management another sign of impending problems.

Similarly, Great Lakes Data Systems' billing system has available three memo fields in each customer record which can be used to do sorts and/or selects, said Lon Rosado, vice president. Many operators use the fields for location codes, feed codes and service call histories. For instance, the feed code, created by entering the power supply, amplifier, line extender and tap number each sub is fed from, can be used to

identify all subs who are fed from a particular power supply or amp. After the subs are identified, labels can be generated and they can then be notified of any upcoming planned outage resulting from system service.

Business Systems Inc. software can track equipment placed throughout the system as an inventory control function. For example, as converters are placed in subscribers' homes, stored in the company warehouse, placed in installers' trucks or returned to the manufacturer for repair, the information is keyed into the system and their locations can be accessed immediately, said Bill Cox, vice president, sales.

Taking that function one step further, First Data Resources has a forced converter test option that allows the system operator to turn on parameters that would force all converters removed from the field (for testing or repairs, for example) to be placed into a test status before being reassigned to a technician or subscriber. This function forces all returned converters to be adequately tested before they are replaced into homes, said Stan Durey of FDR.

For areas characterized by high numbers of transients, a feature, dubbed "hot-to-cold tap disconnect" by FDR, prints work orders that call for simple disabling and removal of converters from the premises. The tap location is left "hot" for a specified period of time, during which remarketing information is automatically generated and used to remind the sales staff that the residence may need to be contacted for a reconnect inquiry. Where disconnects/reconnects are a common occurrence, this can be a real time saver, according to Durey.

In FDR's next software release, scheduled for the first quarter of '87, an "on-line bulletin board"

A·N·N·O·U·N·C·I·N·G

Cable **EXPRESS**

Get on board!

The cost of your ticket is based solely on your number of subscribers, with no initial investment.

That's right! State-of-the-art in-house system management and billing can be yours *today* for a monthly fee based on your subscriber count. Let us **EXPRESS** you to the leading edge of technology for less than 25¢ per subscriber!

All the features of proven comprehensive *in-house* control are yours:

- Immediate update of all subscriber data,
- Management and sales reports available upon demand—at *any* time,
- Fully integrated addressable interface to insure consistency of service and billing,
- Receipt and scheduling of all work

orders any time of the day or night, every day of the week,

- *And* the ability to consolidate multiple systems for reporting and analysis.

Now you can have the best of all worlds—a management system fully under your control with **no capital expenditure, no fear of outgrowing your computer system, and no maintenance costs**. As your subscriber count increases, we insure that you have the equipment, training and support to manage your business at a predictable, contracted monthly cost per subscriber.

Why wait? Everything you need for total control is here *today*.

Your ticket to board the Cable-EXPRESS is waiting for you. Don't delay—Don't be left at the station!

**Business
Systems
Inc**

BSI

1-800-424-0303

ONE MARCUS DRIVE, GREENVILLE, SC 29615
(803) 297-9290

Reader Service Number 27

CTEC
A COMPANY

It's apparent more attention will have to be paid to productivity and cost reduction schemes.

will be added, Durey said. With this feature, a dispatcher who receives outage information can place that information on the computer bulletin board and force all terminals to display the message

when a user signs on.

Information Systems Planners' Cabill software makes locating wanted information easy by using Informix-4GL, a fourth-generation language built around a relational

database and now available in English and Spanish languages. This computer language, described as "state of the art" by ISP's Snowden Bunch, allows for the location of a subscriber or group of subscribers by fragments of information.

Companion modules to the Cabill software can use the system's query capabilities to track subscriber complaints, do work order processing, scheduling and inventory, among other things, Bunch said. These add-on modules can perform many service-related functions and the relational database allows an operator to summarize and collect information.

So, as cable operations become more concerned with meeting bottom-line projections and look to in-house methods to achieve those goals, it's apparent that more attention will have to be paid to productivity and cost reduction schemes in the engineering and technical departments. But perhaps what is surprising is that the systems making strides in this area aren't always the urban systems.

"More emphasis is placed (on using the billing software to manage technicians) by the rural systems that aren't yet addressable," said Herb Lair of Computer Utilities of the Ozarks. "The urban systems are more financially oriented and use the information to increase penetration and gather information for marketing purposes."

"There is a tendency on the technical side for there not to be as much (effort paid to) efficiency control," said BSI's Cox. "Usually, it's the technical accomplishments that are centered upon."

However, there is ample evidence to suggest that the practice will catch on.

At United Cable, primarily a Cable-Data software user, the inventory ability and converter tracking is used heavily, said Pat McDonough, corporate chief engineer. United has been developing and refining its software for about two years and has been "going strong" with it for about six months, said McDonough.

DeJoy's joy.

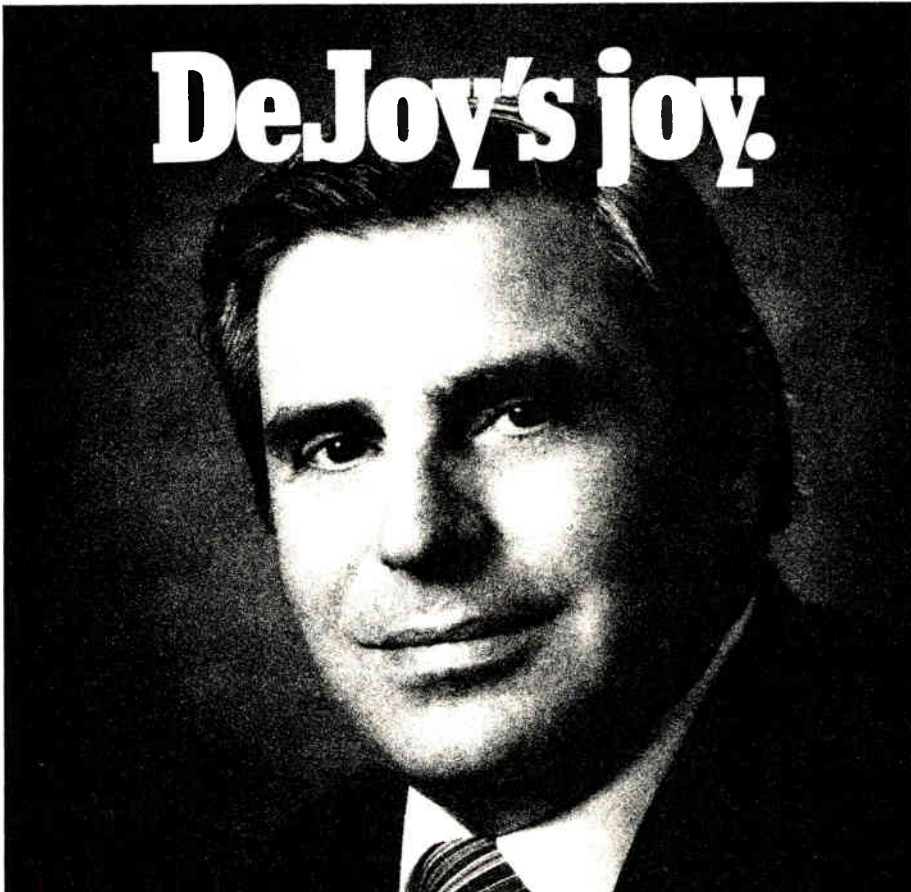

When they put you in charge of operations for a cable system of 185,000 subscribers, you're faced with a lot of tough decisions.

Frank DeJoy, Vice President of Operations of Suburban Cable in East Orange, New Jersey can testify to that. He and his staff took a year and a half to study all the problems and considerations of addressability for a system as large as Suburban's.

When they finally made their choice, it was Sigma. "It offers security we'll be able to rely on for the next ten years," DeJoy explains, "and technically, it is far superior to anything else we looked at."

But technology wasn't the only reason DeJoy chose Sigma. "I like the cooperation

and support of the Oak organization," and later added, "Oak engineers worked with us to develop an electronic second set relationship which allows the converter of the primary set to authorize the secondary set converter to function."

Oak solved a dilemma for Frank DeJoy and Suburban Cable. And in the process, developed a technology that is now a standard part of Oak's Sigma converter-decoder.

If you'd like more information concerning Sigma, call your nearest Oak representative or contact us directly at (619) 451-1500.

We'll save you a fortune on cable theft. And speaking from a Frank point of view, we'll also save you a year and a half of your time.

SIGMA
Here Today. Here Tomorrow.



Oak Communications Inc 16516 Via Esprilla Rancho Bernardo CA 92127 (619) 451-1500
© OAK COMMUNICATIONS INC

Reader Service Number 31

TAKE IT IN!

Don't send it out to Service Bureaus
anymore!

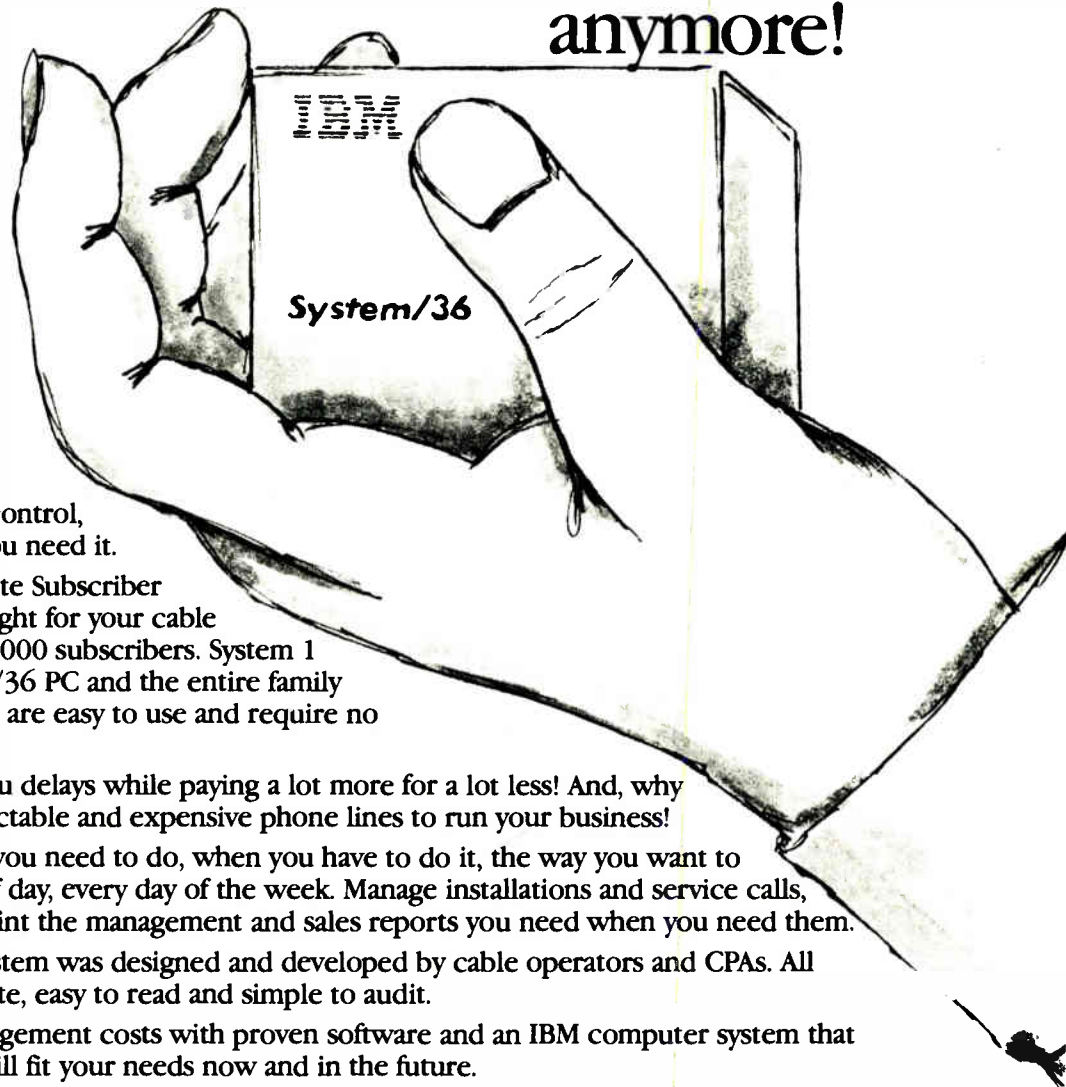

You can take it in...NOW...
take it in-house with IBM
and CMS!

It's easier.

It's more reliable.

It's more comprehensive.

It costs less.

And, it's always under your control,
working when and where you need it.

CMS System 1 is the Complete Subscriber
Management System that's right for your cable
company from 2,000 to 200,000 subscribers. System 1
operates on the IBM System/36 PC and the entire family
of System/36 processors. All are easy to use and require no
computer professionals.

So why accept service bureau delays while paying a lot more for a lot less! And, why
be dependent upon unpredictable and expensive phone lines to run your business!

With CMS you can do what you need to do, when you have to do it, the way you want to
do it. Take orders anytime of day, every day of the week. Manage installations and service calls,
on demand or scheduled. Print the management and sales reports you need when you need them.

And best of all, your CMS system was designed and developed by cable operators and CPAs. All
reports are balanced, accurate, easy to read and simple to audit.

Lower your subscriber management costs with proven software and an IBM computer system that
guarantees a solution that will fit your needs now and in the future.

Choosing the best and most complete subscriber management system is now easier than ever before.

TAKE IT IN WITH CMS!

*IBM and System/36 are trademarks of International Business Machines Corp.

CMS

Creative Management Systems, Inc.

An IBM Value Added Remarketer

Headquarters:
213 Washington Street
Toms River, NJ 08754
(201) 341-6165

Western Region:
1750 Montgomery Street
San Francisco, CA 94111
(415) 954-8550

Eastern Region:
Park 80 West, II, St. 200
Saddle Brook, NJ 07662
(201) 843-4889

Reader Service Number 30

There is ample evidence to suggest the practice will catch on.

And with the MSO already committed to a heavy rebuild and upgrade agenda where addressability will be included in all systems, a major feature of the software will become construction management, where purchasing, budgets and equipment consumption are tracked.

Others admit there's a long way to go, however. At Jones Intercable, a proprietary system tracking productivity and capital management has been in place for some time now, said Al Kernes, vice president of engineering. And, in many systems, CableData software and hardware will be added over the next 18 months. Still, Kernes believes technical management in this manner is an undeveloped resource.

"We're still lacking good feedback systems" that can be effectively taken and massaged by computer according to each user's wants and needs, said Kernes. "It would be nicer to be able to

get more concrete data. I'd like to accumulate that data and see how much time is spent in certain areas to streamline our operations. But the critical part is being able to analyze it, not just accumulate it," he added.

Kernes must have been reading the software developers' minds, because that's what they're concentrating on.

"Every aspect of the business gets focused upon once the other things get taken care of," BSI's Cox said, noting that PPV is presently the issue most MSOs are concentrating on.

At CableTEK, efforts are underway to develop new software that will improve the way technicians, materials and supplies as well as consumption of those materials and supplies, are tracked.

Present plans call for the company to demonstrate a hand-held terminal at the 1986 Western Show that would serve as a technician/installer's daily

diary. Using a series of codes (or perhaps bar codes supplied to the tech), the terminal would store information relating to who the technician is, what truck he was driving, how many and the location of service calls, type of service call, the amount of equipment supplies used and many other potential services.

Robert Noren, senior vice president, said the device "fills in the missing link" between the office and the activity in the field. "We've got good information (about the productivity) of people inside, but not for those outside the office." And while he admits the industry hasn't made extensive demands for technology this sophisticated, Noren said, "I find the MSOs are increasingly looking at the productivity numbers" and added that the device would be able to offer that information."

Roger Brown



Our **CABILL** Management System is a high tech solution for your business. It's written in a state of the art 4th generation relational database language. This system has indescribable power. Search for customer or subscriber information by any field in the database. Cross check subscribers by combinations of fields. You choose them.

CABILL operates on AT compatibles with hard disks as well as on AT&T 3B series minicomputers. MSOs can use **CABILL** on their smallest to largest systems—getting comparable reports from system to system—with communications back to the home office.

CABILL Management Systems start as low as \$4,000 for our software. We also sell the full line of AT&T computers. Interested in state of the art solutions, call isp.

Information Systems Planners, Inc.

6094 Apple Tree Suite 9

Memphis, TN 38115

901-795-8314



Hardware & Software for \$5,500

Cable/1 XT Compatible System

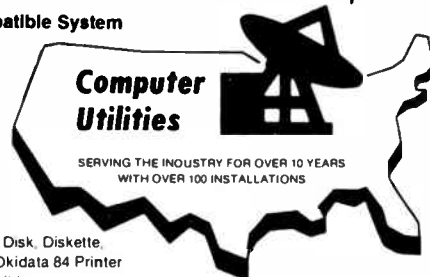

CABLE/1 Hardware:

256K RAM, 20MB Hard Disk, Diskette,
Monochrome Monitor, Okidata 84 Printer
fully IBM PC/XT compatible.
Recommended for up to 3,500 subscribers.

CABLE/1 Software:

Management Information and Accounting System
Complete In-house Accounts Receivable and Billing Software
Multi-user Capability Optional
One-Entry Addressable Interface Optional

Ideal for SMATV, MDS, as well as cost effective solutions for Independents and MSOs. System is also available on the PC/AT and IBM SERIES/1 Minicomputer for virtually unlimited growth.

Find out what others know about our In-House, On-Line Management Information and Accounting System for the IBM Series/1 and PC.

Computer Utilities

P.O. Box 1062, Harrison, Arkansas 72601-

(501) 741-1616

HERB LAIR, President

Now FDR's PC-based billing system gives you a real one-two punch.

We've enhanced our features and lowered our price.

To deliver a real One-Two Punch with our PC-based billing system, Micro Delivery Option (MDO), we updated and expanded MDO's capabilities. And now we've lowered the price to less than 22¢ per sub . . . including the hardware and hardware maintenance, for cable systems with more than 3,000 subscribers. That means even more punch for your system's bottom line.

Designed for small and medium size cable systems, MDO offers you the advantages of on-line, real-time billing information. Advantages like the most current subscriber information when you need it, not just twice a month, or at best, once a week like you get from a batch system. Or the advantage of having access to a variety of management information allowing for more efficient decision making. Also, you'll have more uses for your hardware investment. Because MDO operates on IBM compatible PC's, AT's and XT's, you can use readily available off-the-shelf software for your other business needs, plus enjoy the convenience of local service organizations.

Add to this the cost-saving benefit of centralized billing. First Data Resources (FDR), utilizing its sophisticated computer network and mail facility, will print, stuff and mail all of your statements with return envelopes for only pennies per subscriber. You can also add billing inserts, promotional messages, as well as



thirty, sixty and ninety day delinquency notices.

New enhancements to MDO make a great system even better. We looked at all the standard features of MDO and used our expertise to improve them. These updated improvements include an even more efficient Work Order System, easier control of Converter Inventory, simplified

Account File Listing, expanded Franchise Reporting and enhanced Lock Box Maintenance. All of these features will save you time and give you more control of your cable system.

Best of all, when we updated these features we made an even more unique business decision. We lowered the price! Now you can enjoy the benefits of Micro Delivery Option's expanded features for the lowest price ever. All of these capabilities and more for under 22¢ a subscriber.

Take advantage of FDR's One-Two Punch. Call us at 1-402-399-7035. That simple call could mean even more punch for your system's bottom line.



First Data Resources Inc.
Cable System Services Division

1-402-399-7035

Cable Marketing Dept.
7301 Pacific Street
Omaha, Nebraska 68114



Cutting local ad insertion costs

Much of the development activity in commercial insertion equipment this year has been focused on the needs of the lower-end user; the smaller cable system looking to get started in automated local ad sales. Where once it was a rule of thumb that a system needed at least 20,000 subs or so to get into local ads sales, that's not true anymore. Ad sales will now justify the costs of getting commercial insertion gear, depending on the local market, below 20,000 subs. And it's possible that, in some markets, channel reorganizations—taking broadcast affiliates out of the VHF band and moving them up in the spectrum—will increase the ratings, and hence the value to advertisers, of satellite-delivered basic services.

By and large, that effort has meant finding ways to cut costs for per-channel insertion capability, which have in the past ranged from \$4,000 to \$5,000 and up. It's also meant focusing on sequential, rather than random access; single-rather than four-channel capability; and shrinking the number of VCRs that are used with each channel. In a few cases, it's also meant designing a system that doesn't require the use of the de facto industry standard VCR, the Sony VP-5000. Modular and upgradable systems that offer basic sequential ad insertion, for example, without verification capability, yet can add this feature later, or even upgrade to random access, now are available.

Flexibility, in fact, may be one of the most important attributes of a system, whether it's a basic introductory system or a larger sophisticated system. "If we know anything based on our experience of the past 18 months, it's that the biggest consideration is not just the initial component cost, but what the gear does to leverage the investment," says Texscan MSI/

It can be done, but there are trade-offs

Compavid's Ken Lawson. Here's a typical scenario. "An operator may start with a low-cost system with one VCR and running sequential access. To get in, the operator wants it cheap," Lawson says. But a short time later, that may not be enough. "We find that about 60 percent of the time, the operator has upgraded within about an 18-month period," Lawson adds.

So keep modularity in mind. You may change your mind, perhaps sooner than you might think. You may eventually wish to upgrade to random sequential or full random access. You may wish to run four VCRs a channel instead of just one. And keep in mind that not every introductory system on the market today will necessarily allow upgrades. Texscan, for example, has gone out of its way to build modular upgrades into its line. "Lots of systems start with a sequential access system, looking at MTV and CNN, for example. Then they discover they want to run day-parts and need full random access and four VCRs a channel," Lawson says. "All of a sudden they need two new controllers and eight VCRs. And what they really need is to be able to share equipment." Also, it's nice when the equipment you've already bought doesn't need to be thrown out. That could happen in some cases though, with some equipment, if the need to control several VCRs on a single channel does arise.

In some respects, the strategy here is like that used by some dealers of Japanese cars. Get the first-time car buyer sold on good, basic, reliable transportation. As that customer gets older, he or she is going to upgrade; get a bigger car with more

features. And if that customer is happy with the bottom-of-the-line model, he or she might just continue to upgrade with the same company's cars. Adams-Russell, whose Arvis line plays Mercedes to the lower-end models, will be doing something like this in reverse. Long known as a vendor of top-of-the-line, broadcast-quality systems with all the bells and whistles, Adams-Russell is now working on an introductory system, priced lower than ever before, called the Grid System, according to Roger Strawbridge, company project director. Unlike most other introductory systems on the market, though, the Grid System will be a random access system. It will sell in the \$18,000 to \$20,000 range complete, and will be upgradeable to features found on the more expensive 7000 series Compact, 7100 series Basic and 7200 Standard lines. By way of comparison, the Basic line with a traffic station costs about \$40,000.

In brief, the 7000 series Compact system has lesser software capabilities than the higher-end series systems. "It does have contract entering and logging, but lacks the sophisticated accounting features found on the more expensive systems," Strawbridge says. The 7100 series Basic system has the same software capabilities as the 7200 Standard line and all the basic hardware. "What it doesn't have is the sophisticated hardware like power controls or time base correctors, for example," Strawbridge says. The top-of-the-line Standard system is a broadcast standard dual- or triple-rack system with TBCs, power controls, "everything you need to run a first-class system from day one," says Strawbridge.

Texscan believes in a minimum configuration any operator ought to have, no matter how small. "Even the smallest system needs accurate documentation on spot

BREAKTHROUGH

NEW random access ad insertion system will set standard for price and performance for years to come!

EAD CART 2+2 . . . by Channelmatic, of course.

We're whispering about a revolutionary new ad insertion system in hopes that you'll stop by our display at the Western Show.

It's *not* one of your run-of-the-mill, me-to, Johnny-come-lately copies of some existing system. In fact it is new from the bottom up, and it has virtually *every* worthwhile feature offered in any ad insertion system today. Add to that numerous all-new features, combined with a low, low price, and you get a system that will knock even the best competition right on their tails.

Come see it at the Western Show. But if you can't, then give us a call or drop us a line, and we'll wire you in. Don't even think about buying a competitor's system until you see the ***EAD CART 2+2***. Pass it by and your boss will hate you, or at the very least you will surely hate yourself; it will make your job easier.

CHANNELMATIC built the first automatic ad insertion system, and we have built most of them since. Now we have built a new industry standard. What else would you expect from the leader?

CHANNELMATIC . . . serving you now, serving you in the future.



CHANNELMATIC, INC
821 Tavern Road
Alpine, CA 92001
TOLL FREE 1-800-231-1618 or (619-445-2691)

**WESTERN
SHOW
BOOTH 942**

Reader Service Number 33



WESTERN SHOW PREVIEW

So keep in mind that costs have fallen; it's easier to get started in advertising.

insertions," Lawson argues. The solution? A \$575 terminal and \$300 printer. Not a full IBM workstation. That terminal solution provides a "midnight printing of a log

of the full day's work, ready to go straight into an advertiser field," Lawson says. "There's no tabulation needed." The idea: complete channel status reporting in real

time, all the time. Not just a record that a "roll tape" signal was sent; a report on whether the tape in the VCR was the right one, and whether the VCR in question actually was on line.

It's a building block approach. A dumb terminal at first. Intelligent workstations later. Midnight affidavit sorting at first; specific placements later. Maybe a single VCR per channel at first; multiple VCRs later. A single headend at first; multiple channels and headends later.

But Texscan also has come out with a basic introductory version of its controller. The Comserter 91 controller runs about \$2,595, and does almost everything the next unit in the line—the \$4,300 version—does. But there is a trade-off. The Comserter 91 only controls one VCR and that's all it is designed to do. The \$4,300 unit is configurable for as many as four VCRs.

So keep in mind that costs have fallen. It's easier to get started in local advertising than ever before. But remember that there's no magic involved. You're giving up features and flexibility to get the lower price tag.

Costs have fallen to the point where Tele-Engineering, for example, can offer a two-channel sequential Ad-Cue Jr. system for about \$2,090. That price would include a cue tone generator, option board, switch module and shelf. Of course, there are trade-offs. One of the ways the price of the gear has been dropped is to strip off options like verification and logging. That means manual tracking and billing. It also means more work in case an advertiser wants proof that a spot actually ran at the time claimed.

PRODUCT

CWY
electronics

BULLETIN

Omni-Rack Performs One Incredibly Neat Trick

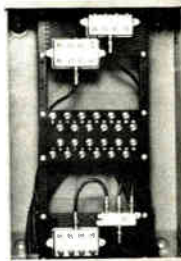

CWY's Omni-Rack™ system uses rails and panels similar to headend rack accessories to take the tangle out of multiple dwelling enclosures. This money- and time- saving system easily adapts to fit existing installations and is versatile enough to conform to your own design.

Omni-Rack 16-gauge perforated panels fasten to punched and threaded rails and accommodate all makes of splitters. To change subscriber status — change only the jumper cables between splitters and F81 D-type

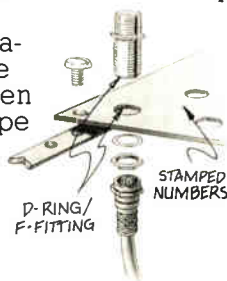

connectors on punched panels.

CWY also offers all-welded enclosures constructed of aluminumized steel—with the rust-resistance of aluminum and the toughness of steel, giving you longer service life for the money.

For more information about the Omni-Rack and CWY's complete line of products, write or call us toll-free. And as always, CATV and SMATV products by the industry's leading manufacturers are also available from CWY. Cable TV solutions are now just a phone call away.

**Not just supplies.
Solutions.**

CWY
electronics

P.O. Box 4519
Lafayette, IN 47903
317-448-1611
Call Toll-Free
1-800-428-7596
Indiana
1-800-382-7526

Reader Service Number 34

The flip side

In general, "you also have less flexibility with fewer VCRs or sequential access because you get run-of-station

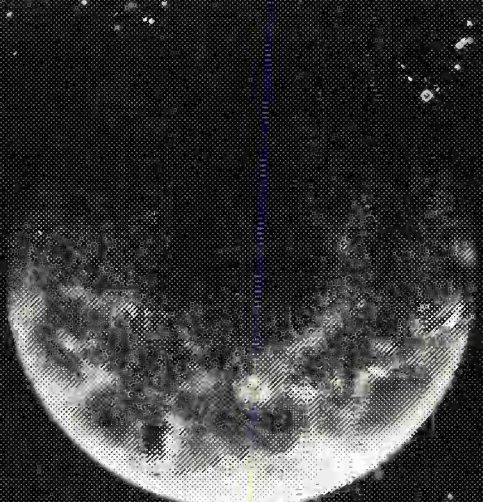

**From the beginning,
we planned on producing
the best, most versatile
ad sales automation
system in the business.**

WE'VE DONE IT!

Now it's up to you to buy the best...



Telecommunication Products Corporation

115 Spring Valley Road, P.O. Box 476, Chambersburg, PA 17201

(717) 264-1938

Reader Service Number 35

Sequential systems are cheaper than random access systems.

ads only," says Telecommunications Products Engineer Don Rice. Rice says a minimum configuration—an inserter only, no verification and one playback machine—isn't a lot of work. Still, it'll cost about \$4,000 for a single channel.

And he doesn't think prices can fall much more.

Another customer demand is single-channel insertion capability with the option for later expansion to four-channel. So upward-compatibility is a nice

feature. For example, both the Ad-Cue Jr. by Tele-Engineering and the Li'l Moneymaker by Channelmatic—single VCR, sequential system—are upward-compatibile with verification add-on units.

Channelmatic's Li'l Moneymaker takes another cost-reducing tack. The unit works with almost any industrial quality VCR, either half- or three-quarter inch. Since the Sony VP-5000 isn't cheap, this saves some money.

Weighing the options

In broad strokes, sequential systems are cheaper than random access systems and single-VCR systems are less expensive than multiple VCR systems. Time base correctors, which eliminate sync timing inconsistencies in the VCR output, will definitely add costs. But Bill Killion, president of Channelmatic, says Sony VP-5000 series VCRs can function nicely without them if needed. Systems with vertical interval switching, used to assure a clean transition from one signal source (a VCR, say) to another (the satellite signal, say), also will add cost, because the technique requires a time base corrector or some other way to synchronize the signal sources. Killion says a cheaper way to accomplish the same end is to remove the composite sync signal from satellite video, amplify it and apply it to the VCR sync input. It's almost \$8,000 cheaper, he says.

A monitoring system including color and monochrome monitors, switches and a waveform monitor are usually suggested, and also entail additional cost. Also desirable is a bypass switch that automatically returns primary program source to the satellite network in case of tape recorder or tape failure. Backup power supplies or line conditioners also are sometimes recommended.

Sequential or random

Whether a system edits its own tapes or contracts for this service can make a cost difference as well. Telecommunications Products, for example, sells an editing console for \$12,000 to \$15,000. Also, "the industry still needs a good software system to address low-end

**Increase Revenues
With a Reliable,
Economical Two-Way
Monitoring System.**

The Electronic Watchdog.

You can create new revenues with the built-in capabilities of your cable system! A reliable, economical, expandable two-way monitoring system from CableBus is a low-cost, high-income service on the cutting edge of technology.

For anyone who needs to know when it overheats, overflows, runs dry, shuts down, runs when it shouldn't or if someone is there who shouldn't be, a CableBus two-way monitoring system is the dependable, cost-effective solution.

Let CableBus show you how to unleash the power of your cable system.

Call today:
(503) 643-3329

CableBus
SYSTEMS CORPORATION
7869 S.W. Nimbus Avenue
Beaverton, OR 97005

CableBus products work on subsplit, CATV, MATV and SMATV systems with two-way capability.

Reader Service Number 36

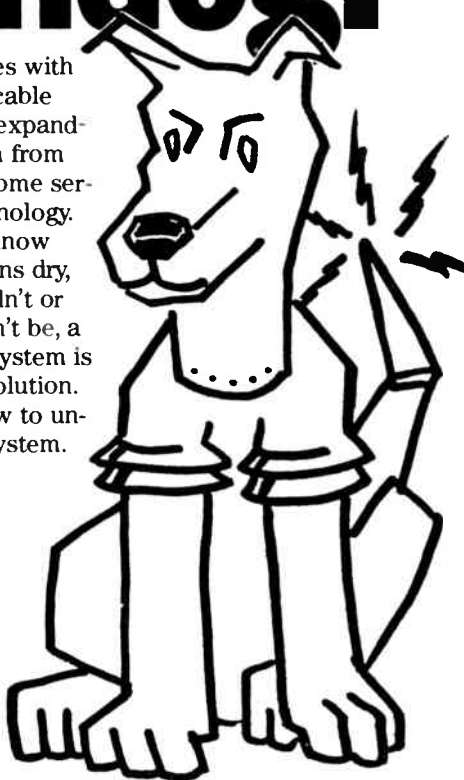

Affordable Commercial Insertion

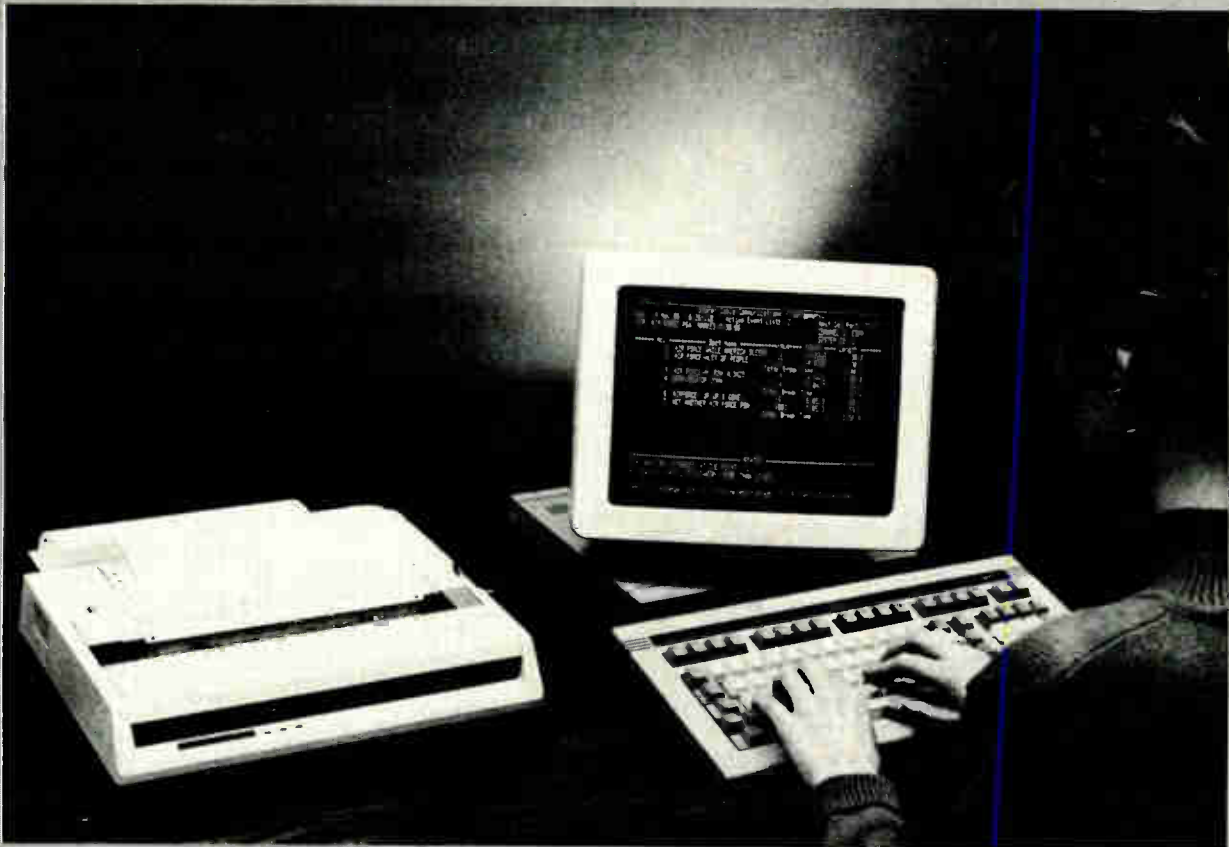

With all of the Frills!

INTRODUCING TEXSCAN'S ECONOMY MODEL COMSERTER 91

You can now own an affordable commercial insertion system without giving up these essentials:

- Computer Terminal Operation
- Single Channel Integrity
- Automatic Daily Sorted Affidavits
- ROS or Random Sequential Spot Selection
- Remote Telephone Control
- True Video Verification While Spots Run
- Upgradeable to Full Traffic and Billing
- Beta™ or U-Matic™ VCR's

For more information call 1-800-367-6011



Texscan

MSI COMPUTERS

TRADEMARKS OF THE SONY CORP. AND SONY AMERICA CORP. USA

3855 South 500 West, Suite S, Salt Lake City, Utah 84115, (801) 262-8475, 1-(800) 367-6011

Reader Service Number 37

The Biggest Success in Pay-Per-View History...



In the last year, SPRUCER's 2-way addressable system helped NYT Cable TV, Cherry Hill, NJ, record new milestones in cable- and pay-TV:

- Over 112,000 pay-per-view takes were ordered by an average of 13,719 SPRUCER-equipped subscribers in 1985.
- Astounding monthly take rates of 78% were achieved—with only two months falling below a 60% take rate.
- Using traditional "free preview" of the Disney Channel, NYT achieved a 30% lift, allowing subscribers to authorize their own service without any CSR intervention.

And in 1986, new records are expected as SPRUCER is installed throughout the entire 130,000-subscriber system.

Undoubtedly, NYT Cable TV and SPRUCER today represent the single biggest success in pay-per-view history.

...Just Got Smaller



Today, we're proud to introduce the SPRUCER 300—the new generation of addressable converters.

Smaller. Lighter. And better.

With all the features that made the original SPRUCER successful... and then some.

Such as an IPPV capacity that's been increased to *900 events per channel*.

And forced-automatic-select-tuning (FAST) that lets operators program what channel the subscriber will see when their set is tuned to "on".

Plus lots more... All designed to help you make pay-per-view and impulse-pay-per-view a profitable reality in your system. So call us. It will really pay off.

SPRUCER® Addressability that pays in profits.

BY **KG** KANEMATSU-GOSHO (USA) INC. 400 COTTONTAIL LANE, SOMERSET, NJ 08873 (201) 271-7544/TWX 710-991-0048/FAX (201) 271-7370

Reader Service Number 38

**System costs will increase
depending on the complexity
of the automation.**

billing, traffic and verification."

Automatic differences

And in general, the cost of a system will increase depending on the complexity of the automation method cho-

sen. Spot sequential systems, probably the most widely used in the industry today, involve recording all spots in the right order on a single tape of playback each time a satellite cue tone is received. After the last spot is

played, the VCR is rewound and the process repeats. This is the method being used on most of the really low-end systems out there today, and achieves the cost savings in large measure because it uses only one VCR. Tape preparation time and costs are a disadvantage with this type of system, though. A single-channel system might run \$4,600, Killion says. A four-channel system with monitors, switch and VCRs might cost \$25,000.

Sequential automation systems typically involve control of four VCRs, each of which is loaded with a different commercial, so that four 30-second spots can be played during each two-minute local avail. Because of the number of VCRs used for each channel, this method is more expensive. A single-channel system might cost about \$12,000; with monitoring, about \$22,000, Channelmatic says.

Greater flexibility

Random access systems are more flexible, use only one VCR per channel, and have a distinct advantage: the controller has the ability to find any given spot on the tape and play it when the right cue tone is received. That ability obviously saves on editing time, since the spots generally don't have to be recorded in any particular order, with a single exception. When there is, say, a two-minute avail to be filled by four 30-second spots, all four must be grouped together on the single tape. There isn't enough time to find, cue and playback the four spots if they're scattered all over the single tape. But the system is great when avails are of uniform length and the spots sold must run at particular times. It is probably too expensive in a situation where there are few advertisers and those advertisers only want run-of-station placement.

Sunk costs

This type of system also will cost considerably more for the first channel than for the following three, because the microprocessor cost is amortized over one channel, not four, for example. Typically, modules can be added on for the additional channels. A four-

**OVER ONE MILLION
A/B SWITCHES SOLD.**

Over one million reasons why our A/B switches
are the best in the CATV industry.

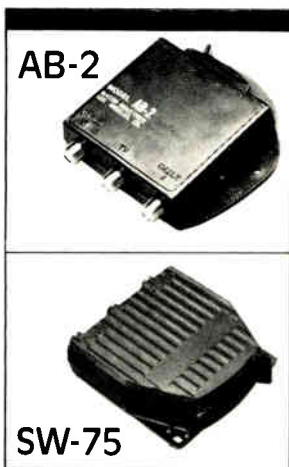

For the 8th straight year MACOM's A/B switch is still outselling and outperforming the competition.

No other A/B switch on the market can match our record of solid, reliable performance—thanks to MACOM's exclusive, patented design and heavy-duty construction.

Each one of our A/B switches is built for—

- high 90 dB isolation,
- superior shielding from RF, and
- unmatched CATV quality

So if you're not already using the industry leader, SWITCH TO MACOM. Go

with the Number 1 selling A/B switch in the CATV industry!

Choose reliability & reputation—Choose the #1 selling A/B switch!

PICO MACOM, INC.

PICO MACOM / OEM SALES

A subsidiary of Pico Products, Inc.
12500 Foothill Blvd. • Lakeview Terrace, CA 91342
Toll Free (800) 421-6511 • In California (818) 897-0028

Reader Service Number 39

At whatever trade-off between costs and features, reliability has to be an issue.

channel, single-VCR system with encoder and printer might run \$22,000. "A disadvantage of this type of system is the possibility of operator error in program sequence entry," Killion points out.

Of course, there are even nicer systems, with much higher price tags. Multiple-VCR random access systems almost eliminate the need for tape editing. Typically, four VCRs are used for each channel, and again, the micro-processor can access any spot on any tape when it gets the right satellite cue tones. Compared to the single-VCR random access system, no assembling of spots by duration is required. Basically, a master tape containing all the spots, back-to-back, is made and dubbed onto each of the four VCRs used for each channel. "This system is the simplest and most reliable," Killion says. It's not cheap, though. A single-channel system might run about \$26,500, and would almost require a verification and logging system. A complete turnkey system, including monitoring, time base corrector, tone generators, switcher, audio and wave-form monitors, a vectorscope, audio and test signal generators might cost a quarter of a million dollars, Killion says.

Reliability is an Issue

At whatever trade-off between cost and features, reliability has to be an issue. No system is cost-effective if it repeatedly requires "make-goods" to advertisers whose spots didn't run as planned, didn't run at the right times, were clipped, ran without audio tracks, or were aired with poor quality. Staff training also will be an issue, since few systems can afford to station full-time operators at the headend. The maintenance and product support agreements that may come with the system also can be important. Adams-Russell's Video Information Systems Division, manufacturers of the Arvis-7000 line of random access equipment, for example, is one of the companies that has attained a reputation for system reliability. Its equipment, admittedly pitched at the high-end of the market, allows unattended operation for a week or so on at least four channels,

comes equipped with verification, billing and traffic software, and runs between \$50,000 and \$100,000. The more expensive 7200/7550 version comes with six Sony VP-5000 VCRs, five monitors and time base correctors and

can access as many as 100 different 30-second spots.

Adams-Russell also has a good product support package. Six months free coverage is included in system purchase price. Monthly satellite program-



Our ground crew is now UL LISTED

100% GROUND SACHS HAS THE ONLY ALTERNATIVE

Now you can be sure of your grounding. The UL listing reaffirms our quality. Here are our special unique features:

SC-13

- Series Ground Strap:*
- Easy one tool installation
 - Positive contact (all copper)
 - Preformed to fit any size pipe
 - One piece construction.
 - No welding

SC-12

- Ground Block/Bracket:*
- Exceeds 280 hrs anti-corrosion Salt test per ASTM B117
 - Accepts single or dual F81 fittings.
 - Easy and positive attachment of grounding wire.
 - Additional subscriber lines can be accommodated using splitters without removing block/bracket
 - Accepts 2 way, 3-way, 4-way 5-way, etc... splitters.
 - Very low contact resistance; less than 1 ohm

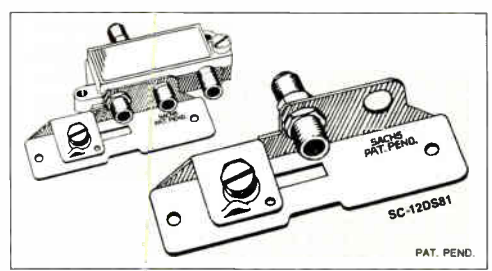
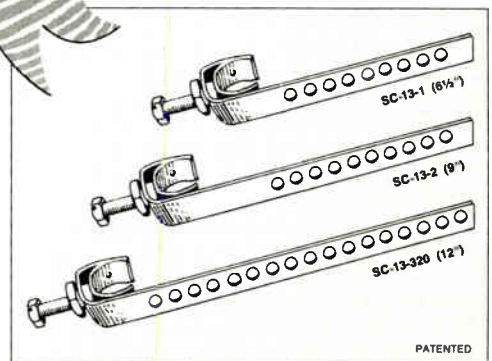

FREE SAMPLES SENT WITH EVERY INQUIRY



SACHS Communications Inc.,
30 West Service Road, Champlain, N.Y. 12919-9703
In Canada: 745 Avoca Avenue, Dorval, Qué. H9P 1G4

FOR MORE INFORMATION CALL TOLL FREE 800-361-3685
In Canada: Call (514) 636-6560

Reader Service Number 40

Nothing can replace certain operator-supplied maintenance services.

ming information on floppy disk, software support, service and parts for the remote and traffic units is included. Service agreements are available for the periods after the initial six months.

But nothing can replace certain operator-supplied maintenance services that must be done on a regular basis. Without question, it is the VCRs that will cause the most problems. Adams-Russell will emphasize that it is not responsible for maintenance of the Sony VCRs. Owners are expected to change tapes twice a month and clean the heads once a week before the new tapes are loaded. The company recommends that every six months the fast-forward rewind belt be replaced; the brakes adjusted; the threading mechanism be lubricated; the heads and pinch rollers inspected for possible replacement; and the tape rewind sensor position checked and the heads cleaned. Adams-Russell also recommends that

at least one spare VCR be available for use during repair and preventative maintenance on the decks.

Environmental conditions play a role. Relative humidity in the headend should run between 20 percent and 80 percent.

Static electricity also can be a problem, Killion says. "Don't put a system in on carpeted floors. And make sure the chassis-to-chassis and rack-to-rack grounding is proper."

It also isn't a good idea to add the insertion gear to available spaces in the RF racks, or even adjacent racks, unless there's shielding. Vented top panels will dissipate heat.

Sometimes, remote control of the insertion gear is required. This is true in an interconnect situation, for example, or where the insertion gear isn't located where the billing, traffic and verification computer is. That's when good error detection and correction is essen-

tial. New York's Metropolitan Transmission Center, for example, runs a hard interconnect between 10 different systems using H.A. Solutec smart switches and insertion equipment. "We might broadcast a 30-second spot to all 10 systems, but maybe only five are supposed to see and air it," says MTC's Bob McAlpine, operations manager. The way it's done is to "record an FSK signal identifier in front of each transmission that contains all the cueing parameters," adds Gilles Fortin, H.A. Solutec vice president, marketing.

Texscan MSI/Compuvid is also a company with lots of remote systems to its credit, and, not surprisingly, has spent quite a bit of time perfecting the software used to control remote systems. "More than half of our software development effort goes into the operator interface to the computers," says the company's Ken Lawson.

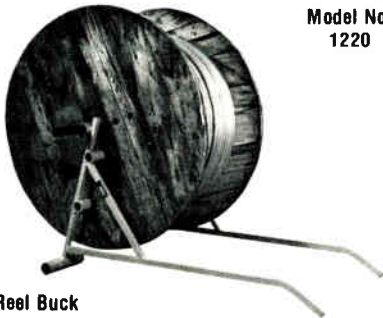

Model No.
1220

Reel Buck

Collapsible for easy storage. Use on ground, truck, or warehouse. Handles strand or cable — reel diameters to 54" (.750 trunk cable).

Cable Tools

A constantly expanding selection designed for cable system maintenance and construction.

- Aerial construction
- Underground construction
- Rebuilds
- Splicing
- Installations

Available from your nearest Lemco distributor. Call or write for a complete catalog.

Lemco Tool Corporation
R.D. 2, Box 330A
Cogan Station, PA 17728
In PA: 717-494-0620
Outside PA: 1-800-233-8713
All products American-made



Model No.
XA-85



Quick-Change Adapter

Put this on your 3/8" or larger drill chuck and go from one Corstrip tool diameter to another — in seconds.

Model No.
6354P



Trailers

7 models available, with choice of 3 hitch types. Standard equipment includes leaf springs, light group, safety chains, license plate bracket, reflectors. Up to 4-reel capacity, or designed to your specs.

NEW



Coring/Stripping Tool

Exclusive "Corstrip" features:

- adjustable center conductor stop
- tapered stripping blade creates smooth, clean chamfer to outer conductor ends. No burrs or sharp edges: clamp nuts slide on easily
- for use with Dielectric, MC², and Cableflex, in all cable sizes

Model No.
T-254



Cable Caddies

... can be carried to walk off cable, or stationary for cable pull-out. 3 models available to handle all size drop cable reels.

Let Di-Tech's Pace 2000 Simplify Your Local Origination, Remote And Multiple Headend Requirements With Real Time Automatic Control

Di-Tech's Pace 2000 is everything you want in an affordable weekly controller. Anyone on your staff can save you time and money and ensure you that every event (1500 on a weekly basis) will be executed on time everytime.

With the Pace 2000 in use throughout the country, Di-Tech invites you to ask our clients about it's reliability and simple operation. Call, write or telex DI-TECH for more information, or a list of satisfied PACE 2000 users, today!

Note: The PACE 2000 consists of a computer, terminal and battery back-up. All other units indicated are available from DI-TECH as an option. Call or write for more information or ask for our FREE catalog of A/V Routing Switchers, A/V Pulse Distribution Amplifiers, Audio Monitor Amplifiers, Video Presence Detectors, Touch Tone Systems and more!

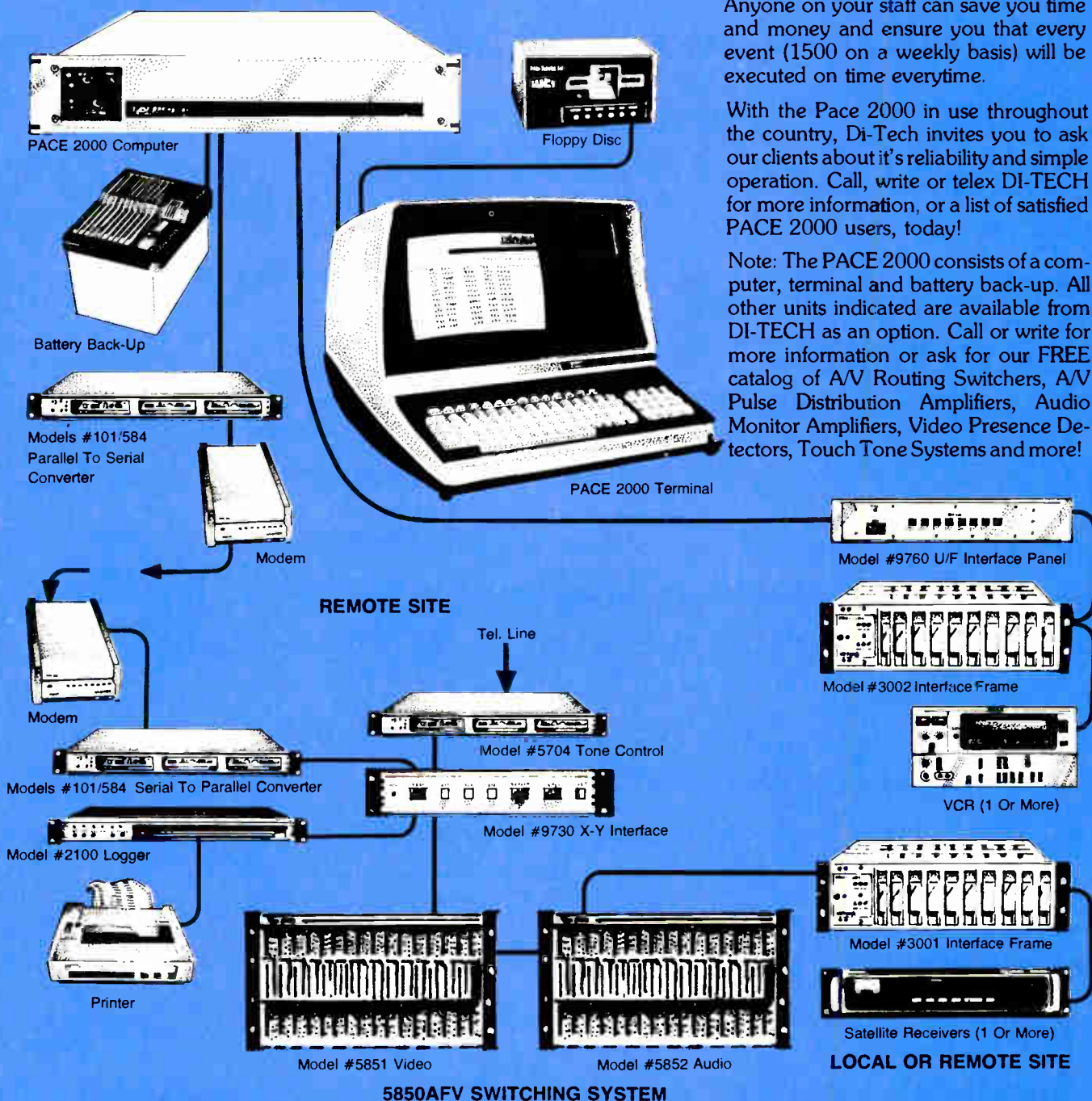

48 JEFYRN BOULEVARD DEER PARK, N.Y. 11729

TEL. #(516) 667-6300 TELEX #971806

Reader Service Number 42

A test of BTSC on the cable

Since the introduction of BTSC stereo, many articles have been published on the subject, some of which have specifically addressed topics of particular significance to the CATV industry. Gibson¹ has discussed the theory behind separation in long cascades. Bowick² has shown the importance of proper signal and modulation level adjustment to preserving separation in a CATV headend. Farmer³ has described the effects of scrambling on BTSC and vice-versa.

That the system works has been

*By Luis A. Rovira, Senior Engineer,
Broadband Communications Division,
Scientific-Atlanta Inc.*

Pressing questions about BTSC stereo remain; this paper attempts to answer those questions.

shown by Farmer et al.⁴ in a complex but non-quantitative system test. An earlier test published by Large⁵ was comprehensive and quantitative, but, as predicted in that paper, improvements in BTSC encoders have been made which call for new data. Today's better encoders are capable of inaudible distortion, broadcast-quality separation and frequency response that is

quite flat out to the full 15 kHz.

The most pressing questions remaining include: how well does this separation survive the system, and how much is signal to noise ratio degraded by buzz? The tests described in this paper attempt to quantify the answer to these questions for a typical headend and distribution system.

Description of system

The Scientific-Atlanta in-house headend and distribution systems were used in the test. The headend is a 400 MHz, HRC system. It uses Model 6601 and 6602 satellite receivers and 6350 modulators. One off-air channel is

FIGURE 1

Test distribution system

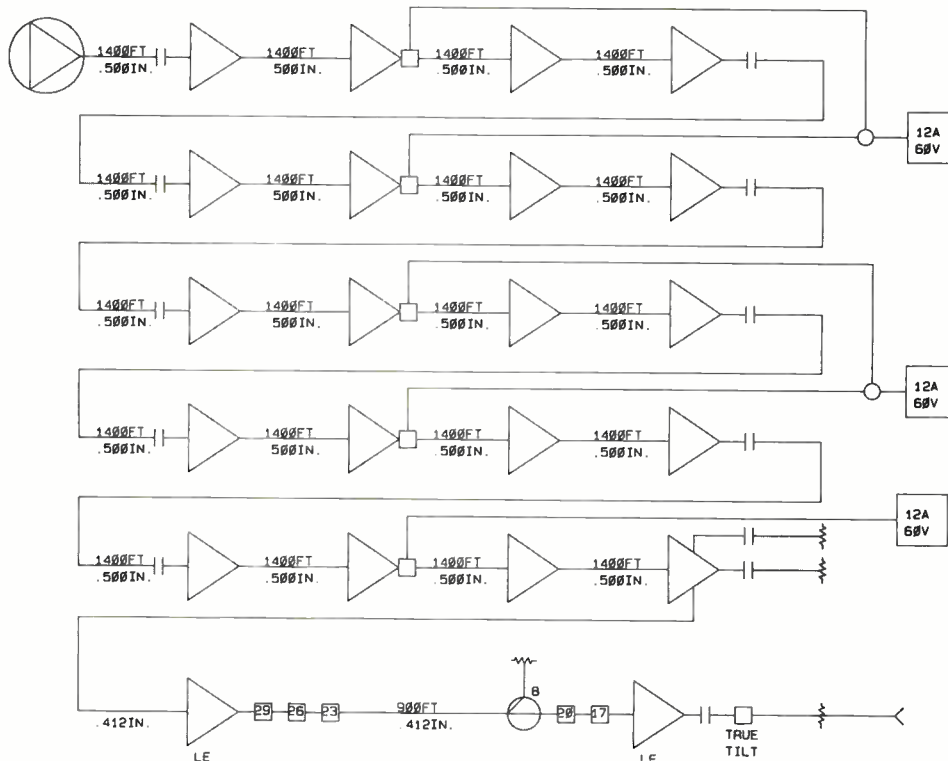

Introducing The NEXUS SD-5 Audio Subcarrier Demodulator

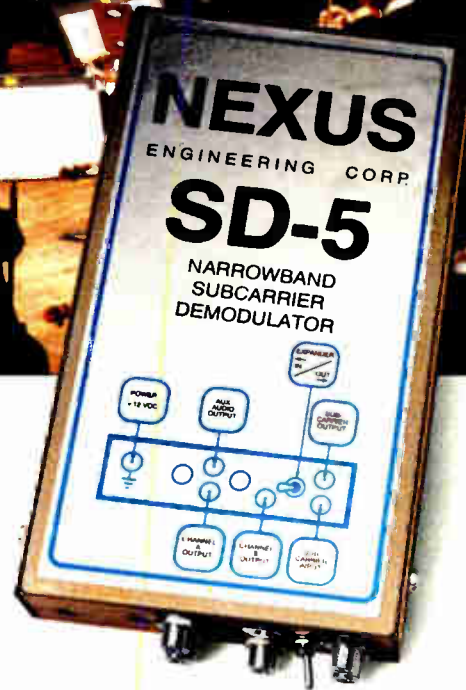

The Newest Performer In The Nexus Line Of Stereo Products.

The New SD-5 Subcarrier Demodulator: A Great Little Performer in the Nexus Tradition.

Whether it's the SD-5 wideband or narrowband model, your CATV or private cable system can now have the sound it deserves—at a price you can easily afford.

We Never Play Second Fiddle

The SD-5 demodulates all subcarrier audio signals. It introduces less than 1% total harmonic distortion and maintains a signal-to-noise ratio of greater than 60dB, assuring excellent sound quality.

Treble Benefit

While the SD-5 can solo with other makes of headend equipment, it really makes beautiful music with the other stars in the Nexus stereo line. Combined with the SG-5 stereo generator and FM-5 audio frequency modulator, popular stereo services can

be easily added on your FM band, giving your subs more choices—you more income.



Our three great performers fit into just one standard rack space!

The Grand Finale

You can buy the SD-5 for a song. Compare its price, performance and our 2 year limited warranty, and we know you'll be impressed.

Find out more about the Nexus line of audio products. Send in the coupon or call for our free product catalogue.

Reader Service Number 43

YES! Send me more on the Nexus line of audio products.

Name: _____
Title: _____
Company: _____
Address: _____ Tel: _____

12/86 CED SD86-1

TELEPHONE: (206) 644-2371
OR WRITE: 7000 Lougheed
Bellevue, Wash. Hwy.
(604) 420-5322 Burnaby, B.C.
Burnaby, B.C. V5A 4K4
FAX NO. (604) 420-5941

NEXUS
ENGINEERING CORP.
PERFORMANCE
YOU CAN SEE.

Hear

Calibration was accomplished using the calibration tone provided in the 6380 encoder.

handled using a 6150 signal processor and the rest are demodulated and re-modulated using 6250/6350's. Model 8556 scramblers are used on selected channels and recently, with the introduction of our Model 6380 encoder, stereo has been added to the system.

The distribution trunk consists of a cascade of 20 push-pull 400 MHz trunk amplifiers and 20 spools of half-inch cable with 22 dB of loss each at 400 MHz. This is terminated with a bridging amplifier. A feeder coming from the bridging amplifier is run through two push-pull line extenders with four taps, a splitter and 14 dB of cable between the line extenders. The output of the second line extender is brought out through a true tilt correction network, an attenuator and finally into a Scientific-Atlanta Series 8500 set-top terminal.

The performance of the distribution system to the output of the second line extender was known to be:

Carrier-to-noise ratio = 46.6 dB

Composite triple beat = -56.1 dBc
2nd order distortion = -67 dBc
Cross-modulation = -57.6 dBc
in the vicinity of the test channel frequency. A block diagram of the distribution system is shown in Figure 1.

The baseband output of the test 6380 encoder was connected to the main audio input of the channel R (converter channel 31) modulator. The modulator was an older unit, upgraded for stereo by replacing the audio module with a new broadband audio modulator. In the broadband audio module the jumpers were set to bypass preemphasis and to select the appropriate input level.

Calibration was accomplished using the calibration tone provided in the 6380 encoder. With the tone turned on, the front panel audio deviation control on the broadband audio modulator was adjusted until the LED was at the threshold of turning on. No other special adjustments were made.

Video from the satellite feed of The

Nashville Network was run through the test encoder, modulator and scrambler during the tests. Audio from the satellite feed of The Disney Channel was used for the SAP channel and was also run through the stereo encoder during the test.

Test equipment description

For separation measurements, test signals were provided by a HP 3577A network analyzer connected to the audio inputs of the test stereo encoder. The channel 3 output of the set-top terminal was input to a Tektronix 1450 television demodulator equipped with the broadband audio upgrade (used in the quasi-parallel mode). The baseband output of this was input to a Modulation Sciences SRD BTSC stereo reference decoder. The right and left outputs of this decoder were then fed to the inputs of the network analyzer to close the test loop.*

Calibration of the 1450/ decoder

An Ever Expanding Range

OPEN NETWORK CAPABILITY

Our 'Expanding Range' is more than just a headline. Because today there's only one modem designer in the U.S. with OPEN NETWORK CAPABILITY—RADYNE. In fact, we're the only one in the U.S. who can currently make this claim: RADYNE's DMD-1000 QPSK Modulators and Demodulators have been tested and approved for operation in the Open Network Mode (conforming to Intelsat's specification IESS 309). Now RADYNE modems are working together with GTE and Marconi, carrying international traffic between the U.S. and Europe.

There's more. Unsurpassed in performance, RADYNE's advanced modem design offers you push button control over power, frequency and mode of operation. And with a RS422 link and a simple CRT you get all these features available remotely, giving you outstanding network control, configuration and monitoring.

Talk to RADYNE... then talk to the world.

Radyne Corp.

"Watch Us Grow!"

170 Wilbur Place • Bohemia, New York 11716
(516) 567-8484 • TWX 4971029

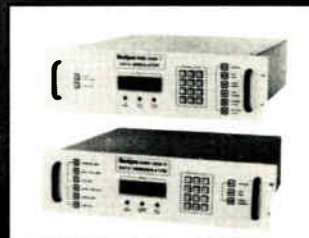

Be On The Lookout For:

- Modems with capabilities up to 2.048 Mbs (T1, E1) by early 1987
- 70/140 MHz I.F. Converter

**For separation
measurements, test signals
were provided by a HP 3577A
network analyzer.**

FIGURE 2

Test equipment and connections to system

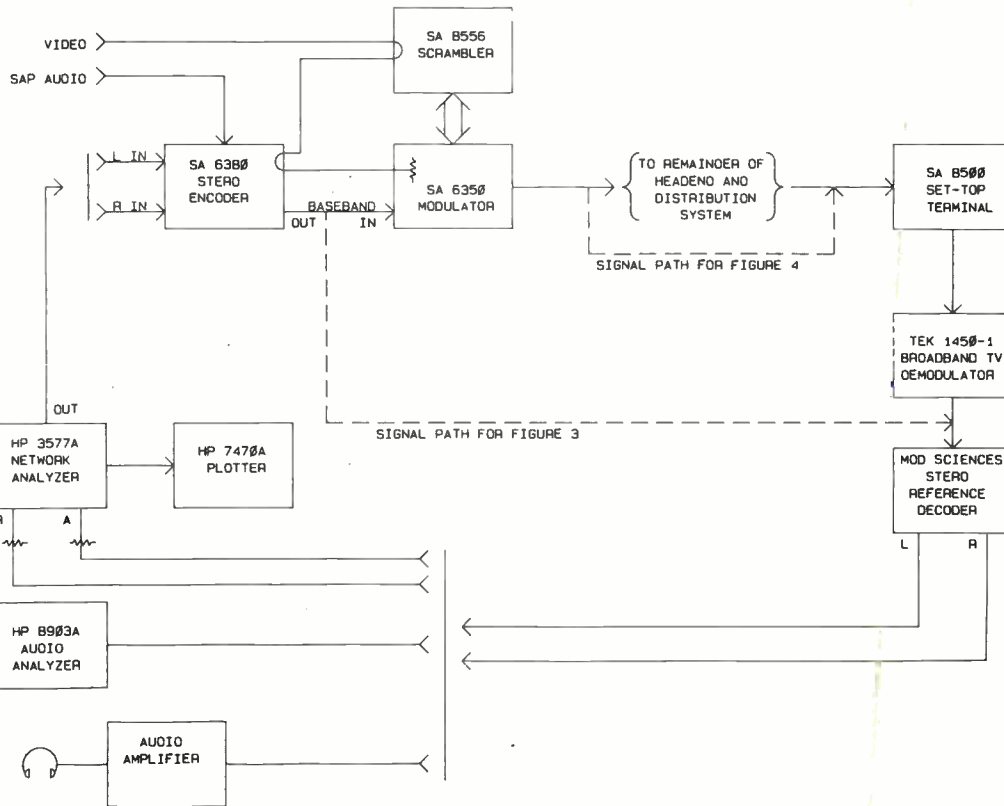

Continued on page 78



Get The Jump On Stereo TV Audio!

Upgrade Basic with Stereo for Greater Retention
Upgrade Premium with Stereo for Greater Penetration
With New & Improved FMT 633S

3877 So. Main
Santa Ana, CA 92707

FM SYSTEMS, INC.

714-979-3355
800-235-6960

Please see us at the Western Show, Booth #659.

Reader Service Number 45

Generators are easy to find

A year ago, it wasn't clear to many in the technical community that BTSC really would pass unhindered through RF converters. As Lu Rivera points out in this issue, that isn't a problem. One of the reasons for the confusion was that it was so hard to get your hands on a BTSC generator even to run tests. Fortunately, that isn't a problem any longer. If you want to run BTSC, you can. Generators are available from several vendors. The following profiles the vendors and their products.

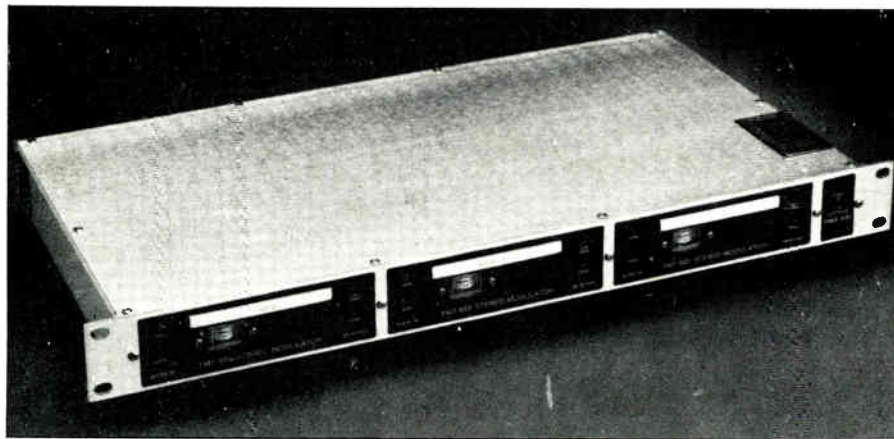

FM stereo's FMT stereo modulator

FM Systems

The FMT633S multiplexer-modulator from FM Systems converts baseband left and right stereo, or monaural audio, to a multiplexed MTS-compatible carrier at 4.5 MHz. The 4.5 MHz may be connected directly into a TV modulator equipped with a separate 4.5 MHz input port. TV modulators that require the 4.5 MHz audio signal to be combined with the video signal at the input to the modulator also will require the BEF45MTS combining filter.

The baseband audio signal is processed with the DNR (Dynamic Noise Reduction) system to improve the perceived TV audio signal-to-noise ratio. The FMT633S multiplexer derives the stereo signal by means of a proprietary process that is less sensitive to gain and phase misalignments in stereo TV receivers and cable equipment, while



CAN YOU IGNORE STEREO T.V. ?

The over-the-air broadcasters, TV set manufacturers, and (more important) the consumers have adopted the BTSC format as the de facto standard for stereophonic sound with television. In fact, more than three quarters of all homes are in the vicinity of one or more BTSC transmitting stations; and there are millions of TV sets and stereo VCR's already in service which are capable of receiving BTSC.

The Leaming **MTS-1** and **MTS-2** BTSC Stereo Generators, both utilizing dbx® companding, offer you a cost effective method of getting satellite delivered services through your cable system in the BTSC format.

THE BTSC SOLUTIONS FROM

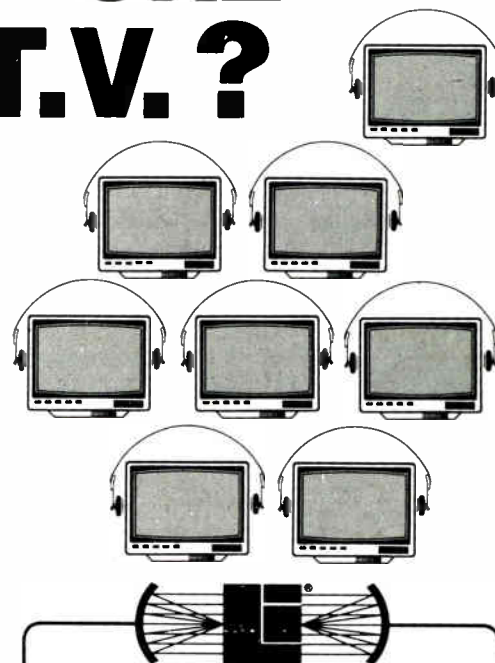

LEAMING INDUSTRIES

180 McCormick Avenue • Costa Mesa • CA 92626 • (714) 979-4511 TWX: 510 600 4362

PICO

Quality



Now Even More Affordable

These graphs clearly show the superior quality of PICO traps.

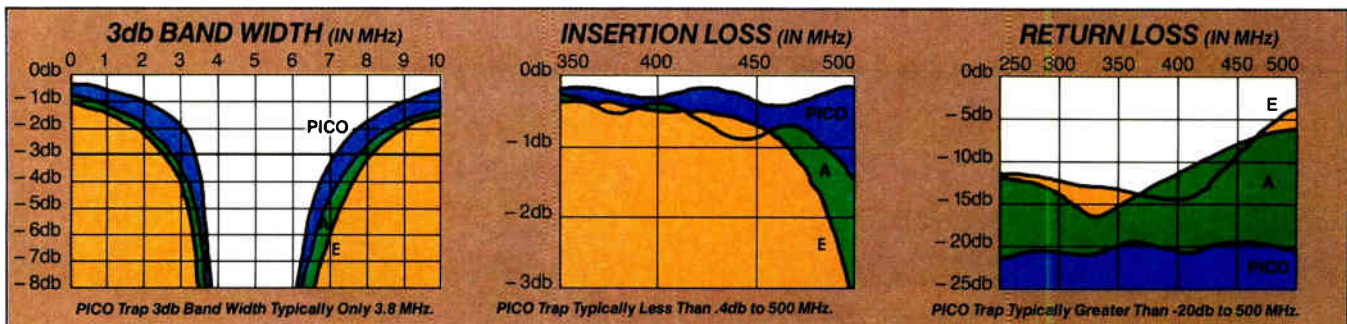

One phone call will prove our affordable pricing.

Call us for a quote!

EAST: Atlanta (404) 449-6533, (800) 241-5790
Cincinnati (513) 733-9100, (800) 543-0113
New Jersey (201) 328-0980, (800) 631-9603
Rochester (716) 426-3440, (800) 252-7516
Tampa (813) 626-7115, (800) 237-6466

MIDWEST: Chicago (312) 364-7000, (800) 544-5368
Dallas (214) 484-2933, (800) 231-5006
Skokie, IL (Headquarters) (312) 677-2600

ANIXTER
COMMUNICATIONS®

SERVICE IS OUR TECHNOLOGY

WEST: Anaheim (714) 778-4414, (800) 854-0443
Anchorage (907) 274-8525
Denver (303) 373-9200, (800) 841-1531
Seattle (206) 251-6760, (800) 426-7665

CANADA: Calgary (403) 250-9646
Montreal (514) 637-3511
Toronto (416) 625-5110

Anixter, America's No. 1 supply specialist for the Cable-TV industry, provides everything from head-end equipment to subscriber products for operating, maintaining, upgrading and constructing CATV systems. Anixter serves the industry from computerized distribution centers throughout the United States, Canada and the United Kingdom.

CORPORATE HEADQUARTERS: ANIXTER BROS., INC., 4711 Golf Road, Skokie, IL 60076 (312) 677-2600 — Telex 289464

Reader Service Number 47

© 1986 PICO PRODUCTS, INC.

The FMT 633s can also transmit a second audio program (SAP) channel.

compatible with standard MTS stereo television sets.

The FMT633S also can transmit a Second Audio Program (SAP channel) when connected to the FMT631SAP modulator.

Up to three FMT633S modulators may be placed in a single PMS600 mainframe, which measures 1.75 inches high.

For more information, contact FM Systems, (714) 979-3355.

Jerrold

The Commander, Model CMTS from Jerrold, allows a system operator to encode both stereo and secondary audio programming (SAP) for transmission. The unit includes dBx noise reduction circuitry to ensure a quality signal.

The Model CMTS encoder generates a linear, non-filtered composite spectrum for optimum stereo separation without requiring phase adjustment. This encoder/modulator transforms baseband stereo and SAP input (optional plug-in module) into BTSC multichannel sound, which is then modulated to both a 4.5 MHz subcarrier output and a 41.25 MHz IF output.

The integral precision 4.5 MHz crystal phase locked voltage-to-frequency converter included in the CMTS encoder provides unmatched linearity and minimum phase noise, while the 41.25 MHz



Jerrold's MTS encoder

BTSC STEREO GENERATOR

**FULLY DBX® COMPANDED
INTERNAL 4.5 MHz MODULATOR
DEVIATION CALIBRATION TEST TONE
EXCEEDS ALL OST60/BS15 REQUIREMENTS
LOW PROFILE 19" RACK MOUNTING**

FOR YOUR FREE COPY OF "IMPLEMENTING STEREO TV" CALL OR WRITE TODAY!

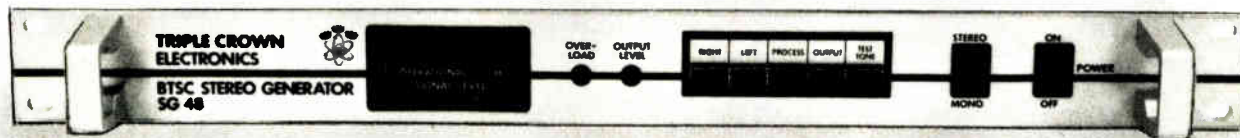

TRIPLE CROWN ELECTRONICS

4560 Fieldgate Drive,
Mississauga, Ontario L4W 3W6
(416) 629-1111
800-387-3205 (U.S. Only)

601 Fairway Drive,
Deerfield Beach, Florida 33442
(305) 429-0870
Inwats 800-824-4332

Reader Service Number 48

An offer you can't afford to pass up.

In 1965, a handful of engineers set out to offer the RF instrumentation industry something different than what anyone else was offering: a company called Texscan.

In 1972, the same handful of engineers also set out to offer the CATV industry something different than what anyone else was offering: the most comprehensive line of CATV test equipment available.

Over the past 21 years, Texscan learned that the most important benefit a company can offer an industry is something different than what anyone else is offering.

So in 1987, a new handful of professionals will offer you something different than what anyone else will offer:

an ear.

Why? Because we want to understand your problems, and solve them. And because we want to understand your needs . . . and meet them.

Call Us, 1-800-344-2412

3169 N. Shadeland Ave.
Indianapolis, IN 46226

Texscan
INSTRUMENTS

Our time has come.

Reader Service Number 49

crystal upconverter is provided for interfacing with non-stereo compatible modulators.

The CMTS is a rack-mounted unit with a 1.75-inch high chassis. It features front panel access to all audio input level controls and includes bargraph indicators on the front panel for left, right and SAP channels. The bargraph indicators provide a true peak deviation metering of incoming audio signals, helping ensure that subscri-

ers are receiving a high-quality audio signal.

In addition, the Jerrold CMTS encoder includes automatic non-clipping over-modulation protection on all channels, a video lock indicator and remote-controllable A/B input for automatic commercial insertion.

For more information, contact Jim Barthold at the Jerrold Division of General Instrument Corp., (215) 674-4800, Ext. 4180.

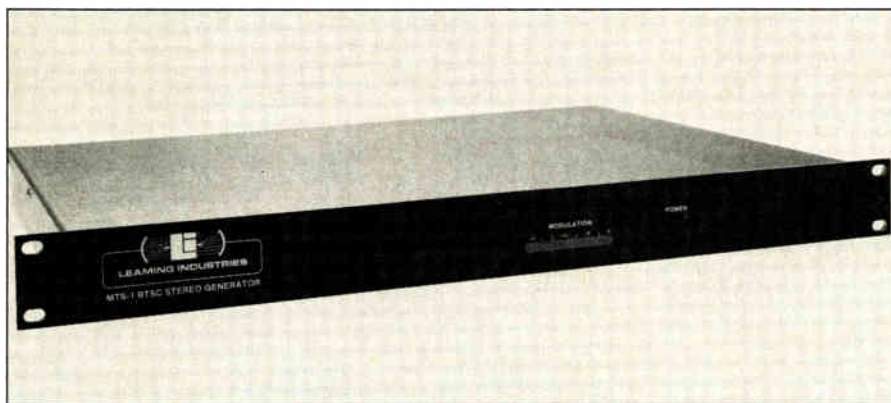

Leaming

Leaming Industries' MTS-1 generates a BTSC stereo baseband aural composite signal from left and right

baseband audio inputs. The unit produces a composite baseband signal consisting of a left plus right signal, a double sideband suppressed carrier (DSBSC) left minus right signal centered at twice the video horizontal sync

frequency and a pilot tone phase locked to the video horizontal. The left minus right channel is companded using a dBx 525CH compressor. Inputs may come from a subcarrier receiver, a decryption device or a local source.

Also from Leaming, the MTS-2 generates a sync-locked pilot signal and a BTSC stereo composite signal from left and right baseband audio inputs. The left minus right channel is companded, again using a dBx 525CH compressor.

The MTS-2 has both a composite stereo output and a 4.5 MHz subcarrier output with separable video and 4.5 MHz loop-throughs. A built-in test-tone generator is included for ease and accuracy of setting the deviation.

The MTS-2 features separate left and right level meters with LED peak indicators, dual stereo level controls on the front panel, a built-in stereo synthesizer for mono services and pilot-sync relative phase control. The unit also offers switching for local ad insertion and is rack mountable at 1.75 inches high.

For more information, contact Leaming Industries, (714) 979-4511.

Nexus

The Nexus SG-1/TV stereo generator is a high-performance BTSC encoder which allows for the addition of

Subscribers Demand Stereo—Wegener Delivers Now

BTSC Stereo demand is growing. Cable operators are hearing from their subscribers and they want their MTV...and their HBO...and their Showtime...and all of their programming on their new Stereo Televisions in Stereo. And now you can give it to them. Because Wegener Communications, the leader in audio equipment for the cable industry makes it easy for you to add BTSC Stereo to your system.

When you plug a Wegener Series 1791 BTSC Modulator into a Wegener Mainframe—one for each of your satellite networks offered in stereo—stereo indicators will illuminate on stereo televisions across your system.



Subscribers will get what they want and you'll get what you need—dependable, maintenance-free performance from the people who have already delivered hundreds of BTSC encoders. Wegener has lowered the price and is offering incentives when you add multiple channels in BTSC. So don't hesitate...listen to your subscribers! Give them their stereo today.

Delivering On Our Sound Promises

WEGENER COMMUNICATIONS
150 TECHNOLOGY PARK/ATLANTA
NORCROSS, GEORGIA 30092
(404) 448-7288 TELEX 54-3634

Reader Service Number 50

TWO AND A HALF YEARS TO DESIGN.

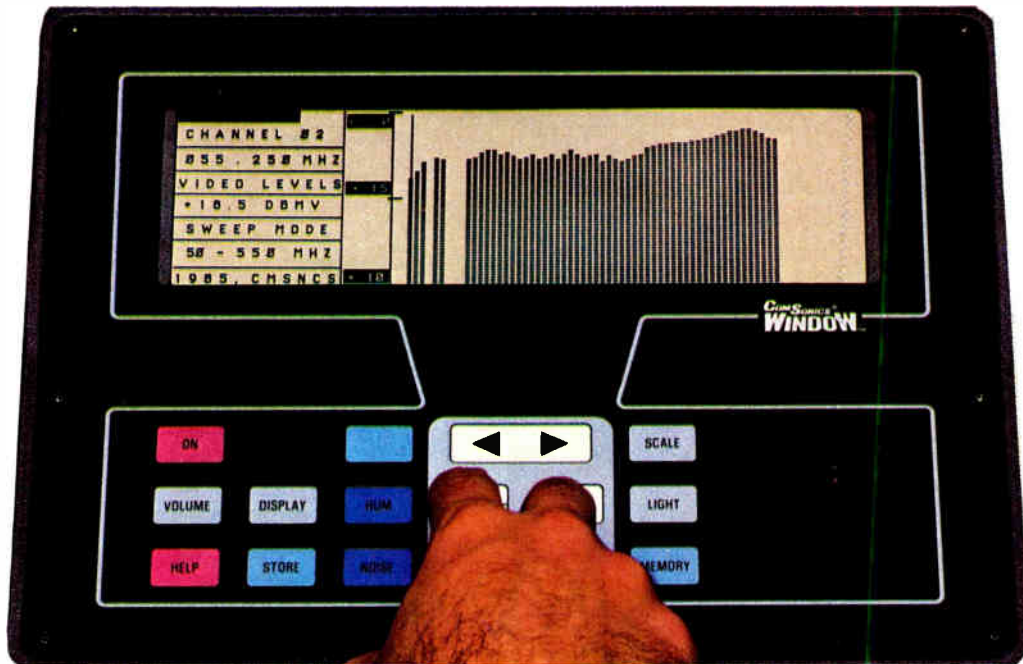

TWO HOURS TO LEARN.

If you've been monitoring your system using a FSM, you can easily operate the WINDOW. Two and a half years of research and development and marketing made this sophisticated piece of test equipment simple to learn to operate.

The WINDOW's 3 diagnostic ranges plus 9 memory locations replace half a dozen pieces of expensive equipment. Need we say more?

Find out about WINDOW today, it will open a whole new world of powerful capabilities for your field techs, even the rookies.



COMSONICS[®] INC.
AN EMPLOYEE OWNED CORPORATION

CALL TOLL FREE 1-800-336-9681 IN VIRGINIA CALL COLLECT 1-703-434-5965

See us at the Western Cable Show, Booth #1068

Reader Service Number 51

CABLE LINK INC.

**The cable
operators
converter store
and a whole lot
more.**



**280 Cozzins St., Suite 2-A
Columbus, OH 43215
(614) 221-3131**

**Let us add you to our long
list of satisfied customers.
Just to mention a few:**

- Buckeye Cablevision
Toledo, OH
- Consolidated TV Cable
Frankfort, KY
- Tri-County Communications
New Richmond, IN
- Continental of Ohio
Findlay, OH
- Monroe Cablevision
Monroe, MI
- Centel of Iowa
Burlington, IA
- Telecable Broadcasting of
Jefferson Township
Dayton, OH
- Gulfstream Cablevision
Dunedin, FL
Pasco, FL
- Heritage Communications Inc.
Des Moines, IA

Reader Service Number 52

stereo TV signals to any cable system. The SG-1/TV combines signals from any stereo audio source into a BTSC-composite stereo signal. Audio level indicators are calibrated to the internal 4.5 MHz modulator, eliminating field set-up errors and measuring equipment.

The SG-1/TV requires only 1.75 inches of rack space. All units are fully tested and burned in before shipment.

For more information, contact Nexus Engineering Corp., (604) 420-5322.

Scientific-Atlanta

The Model 6380 from Scientific-Atlanta encodes stereo audio signals into the BTSC multichannel television sound format for cable transmission of stereo in the same manner as off-air stereo broadcasts. The encoder utilizes the dBx β noise reduction system on both the stereo difference and SAP channels as required by BTSC standards.

All major controls and indicators are located on the front panel of the encoder to facilitate set-up monitoring. Factory preset levels for critical subcarrier modulation eliminates field setup errors.

Several options are available for a variety of system applications. With

the second audio program channel option, bilingual or other program, related audio may be transmitted. A dual audio demodulator option is available to receive most of the popular stereo satellite subcarrier formats directly from an earth station receiver. A 4.5 MHz subcarrier modulator option interfaces the encoder with modulators or microwave systems that can only accept the BTSC signal as a modulated subcarrier.

For more information, contact Scientific-Atlanta, (404) 925-5000.

Triple Crown

The Triple Crown Electronics Model SG48 stereo generator provides BTSC audio signal encoding for cable TV or broadcast applications, utilizing the dBX noise reduction system. Encoding of discrete right and left baseband channels into the BTSC subcarrier is performed via direct linear multiplication. The unit incorporates high-quality passive eleventh order 15 kHz filters for maximum amplitude and phase linearity.

To ensure optimum stereo performance, all critical internal levels are factory set. A built-in test tone generator is provided.

continued on page 68

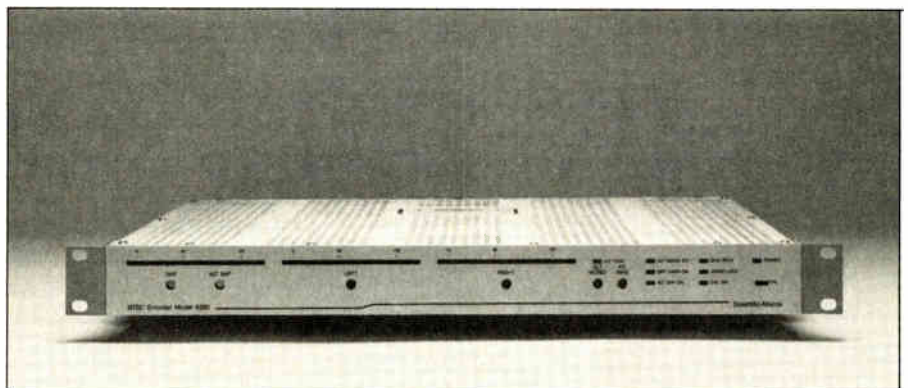

Scientific-Atlanta's model 6380 BTSC encoder.

New products

If you have a new product you would like listed in *CED Magazine* let us know. Send it to; Linda Johnson, Production Editor, P.O. Box 5208 T.A., Denver, CO 80217.

Harris Quality Midwest Pricing and Delivery



\$1,295.⁰⁰

*Model 5115-AZ includes AZ/EL mount
and dual polarity feed.*

The Harris 3-meter C-Band Delta Gain™ Antenna gives you more than an impressive 41 dB gain. It's also rugged enough to withstand 120 MPH winds. Plus, it's easy to install and available with either an Az-El Mount or a Polar Mount with optional motorization.

The Harris 6529-2 Frequency Agile Receiver is the updated version of the popular 6529. It is a 4 GHz input receiver, so if you have an older system you can get the excellent picture quality of the 6529-2 without the added cost of installing an external down converter or new plumbing. Plus you get one of the best warranties in the industry – two years on parts, labor and workmanship.

As one of the world's largest stocking distributors of Harris equipment, Midwest has these, and other Harris products, on hand and ready to ship – instantly. Midwest provides complete systems or individual components for either C or Ku-Band, fixed or mobile, Up-link or TVRO.

For the best prices and fastest delivery in the industry, contact Midwest at 800-543-1584.

\$695.⁰⁰

Model 6529-2



MIDWEST

Communications Corp.

One Sperti Drive
Edgewood, KY 41017

800-543-1584
(In KY 606-331-8990)

Reader Service Number 53

The SG-48 provides basebands output for broadcast applications.

continued from page 66

The SG48 provides baseband output for broadcast applications as well as 4.5 MHz subcarrier output for CATV application. The 4.5 MHz aural subcarrier modulator assures factory-set optimum

stereo performance with TV modulators having a 4.5 MHz input capability. Use of this option is also recommended where a TV modulator lacks the required audio bandwidth and/or distortion characteristics at the required

additional deviation for proper BTSC operation.

The automatic stereo-mono transfer circuit causes the mono mode to be automatically selected, should loss of synch or video lock occur.

For more information, contact Triple Crown Electronics, (416) 629-1111 or (800) 824-4332.

Looking into the 1000 series

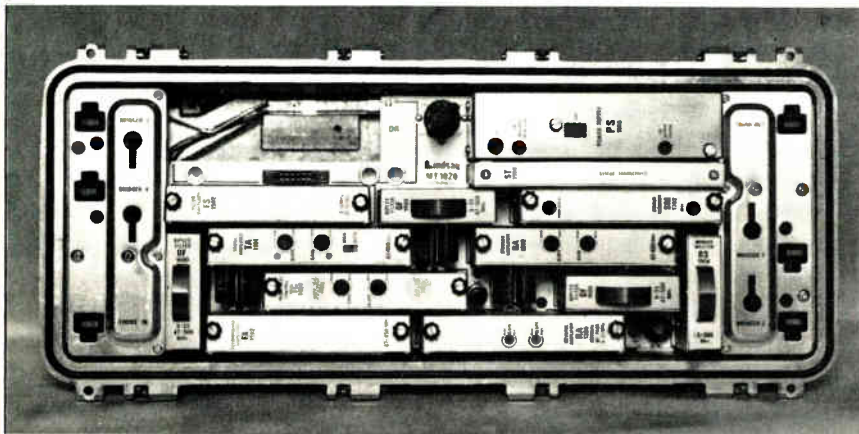

IS LIKE LOOKING INTO THE FUTURE!

WITH THE LINDSAY 1000 SERIES TRUNK, YOU CAN START WITH AN OPEN RETURN SYSTEM & MULTIPLEX WHEN YOUR SUBSCRIBER BASE HAS EXPANDED, BY SIMPLY ADDING MODULES. BY MULTIPLEXING, THE LINDSAY 1000 SERIES CAN ACCOMMODATE UP TO 400 CONTINUOUSLY TRANSMITTING HOME TERMINAL UNITS, PER BRIDGER STATION. THE SYSTEM ALSO FEATURES FAILSAFE FORWARD & REVERSE STATION BYPASS, POWER DOUBLING & FEED FORWARD, AS WELL AS DIAGNOSTIC CAPABILITIES.

Lindsay

SPECIALTY PRODUCTS LIMITED

50 MARY ST. W.
LINDSAY, ONTARIO
CANADA K9V 4S7
TEL: 705-324-2196

CAL: TELEWIRE SUPPLY	415-939-9243
COL: ADVANCED COMM.	303-596-4464
FL: TELEWIRE SUPPLY	800-237-8203
NY: TELEWIRE SUPPLY	800-645-9510
OH: THE HEAD END	614-766-0874
PA: TONER CABLE EQUIP	215-675-2053
TX: TELEWIRE SUPPLY	800-527-1646

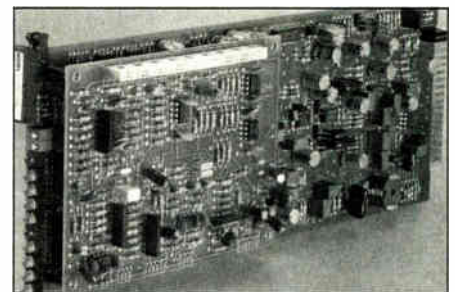

Wegener's model 1791-01

Wegener

Wegener Communications manufactures the Model 1791-01 TV broadcast standard (BTSC) stereo modulator. The model 1791-01 is the second generation BTSC modulator produced by Wegener. It consists of two circuit cards which can be installed in any channel of the more than 5,000 Model 1601 four-channel mainframes currently in place at cable systems across the U.S.

The Model 1791-01 offers two separate stereo audio inputs and both an encoded baseband audio and a 4.5 MHz modulated output. Dual five-step LED indicators and front panel potentiometers allow precise main left and right channel input level adjustment and monitoring without need for test equipment. An auxiliary stereo input is available for local commercial insertion or other applications.

The level of the 4.5 MHz output is adjustable over a wide range with a front panel potentiometer. Encoded baseband audio is available for external modulation, if required. If SAP is used, the modulated SAP channel can be input to the Model 1791-01 and summed into the MTS output. Current list price for the unit is \$1,995. MSO discounts may apply.

For more information, contact Wegener Communications, (404) 448-7288.

Lesley Camino

This Entire Ad Is Your Official Entry Coupon

ENTER The GREAT CLOSURE EXPOSURE CONTEST

If you can't spot all 10 of Reliable's new
low-profile CATV closures, that's good.

If you can...that's even better!

Win a Panasonic Technics Remote Control Hi-Fi Component Rack System or one of 100 other low-profile prizes in Reliable Electric's GREAT CLOSURE EXPOSURE Contest.

Reliable Electric announces a new and complete line of low-profile CATV pedestals and closures, designed to act tough while looking good.

Heavy gauge, corrosion-resistant steel construction, expansive interior space, flow-thru ventilation, and simplified, vandal-resistant access are just a few of the features we've included in sculptured closures less than 17" tall.

The GREAT CLOSURE EXPOSURE Contest

Circle the 10 hidden CATV closures in the photo, fill-in this entry form and mail this advertisement to: The GREAT CLOSURE EXPOSURE Contest, 11333 Addison St., Franklin Park, IL 60131. Attn: Advertising Dept.

name _____ title _____

company _____

street address _____

city _____ state _____ zip _____

phone _____ ext. _____

No purchase necessary. You may enter as often as you wish. All entries become the property of Reliable Electric/Utility Products. Contest entries must be received by midnight, February 20, 1987. Chances of winning dependent upon number of entries. Complete rules and details available upon written request.

High quality. Low-profile. An unbeatable combination from Reliable. And, a chance for you to win a fabulous stereo system worth more than \$1,500 or, any of 100 other prizes. Enter our GREAT CLOSURE EXPOSURE Contest, now!

Correct entries will go into a sweepstakes drawing to be held March 1, 1987. Winners will be notified by mail. Void where prohibited by law.

Reliable Electric/Utility Products

RELIANCE
COMM/TEC
Reader Service Number 55

©1986 RE/UP

The GREAT CLOSURE EXPOSURE Coupon

Planning a broadband LAN

Proper planning of a broadband system includes the following subject areas:

- Determination of inter-building carrier facilities;
- Locating the headend;
- Determination of port density;
- Spectrum considerations;
- System architecture; and
- Special installation instructions.

Inter-building carrier facilities can be steam tunnels, steam ducts, underground conduit systems or aerial poles.

The broadband system does not require much space, but it should be relatively free from third-party interference.

If the conduits carry heavy telephone cables, be careful about damage during the installation phase.

Steam ducts are ideal from the point of view of third-party interference, but they are also difficult to measure and operate in when the steam is turned on.

Collect recent blueprints that show all details of the layout of the steam tunnels, steam ducts, manholes, conduit occupancy and conduit routing.

Locating the headend

For data communication, the headend location can be anywhere. Whether point-to-point, collision detection and token passing systems, the headend is simply a turnaround point. The turnaround function is usually provided by a frequency translator.

Port densities

Broadband multi-taps can be provided with 2, 4 and 8 ports. The service area of a port of multi-taps depends on the number of devices that ultimately will be connected to the network.

*By Ernest O. Tunman,
President, Tele-
Engineering Corp.*

The broadband system should be free from third party interference.

Devices can be:

- Data channels;
- Computers;
- TV monitors;
- Security modems;
- Energy management modems;
- Teleconferencing cameras; and
- Telephones.

In collision detection and token-passing systems, multiple bus interface units (BIU) can serve up to 24 terminals. So, the number of terminals or devices in an area does not necessarily coincide with the number of ports.

A port serving a 100-square-foot area will satisfy a very dense device population. Using 8-port taps, each tap will serve 800 square feet, or an area of about 28×28 feet.

A port serving a 200-square-foot area will satisfy medium dense device populations. Using 8-port taps, an area of about 1,600 square feet, or 40×40 feet can be served.

A port serving a 300-square-foot area will satisfy low-density areas such as dormitories. Using 4-port taps, an area of 1,200 square feet could be served. Using 8-port taps, the drop wire connection to the outlets may exceed the desirable length of 75 feet.

Spectrum considerations

Unless a full spectrum of 54-450 MHz or 66 video channel assignments are required in each direction (dual cable), a high-split or mid-split system using a single coaxial cable should be sufficient for many years of growth.

System architecture

It is desirable to locate the headend somewhere in the geographic center of the building complex. This permits the development of two, three or four separate tree and branch systems in a star arrangement.

For data, this kind of architecture is not important and all loops are simply

cross-connected at the headend.

For both video and telephony, the multi-loop topology is very important as it would permit the re-use of identical frequencies in each loop.

Let us assume, for instance, that 10 two-way 6-MHz channel assignments have been set aside for teleconferencing. It would now be possible to conduct 30 simultaneous teleconferences on a 3-loop system.

Each video return is demodulated at the headend and forwarded as baseband to the programmable matrix switch which will select the right path to the selected modulator for downstream transmission.

This expansion is possible using TE's programmable PVS-100 switching equipment. By doing so, we have made a star out of three tree-and-branch bus systems.

Survey and design

Broadband LAN systems require careful survey and design, because inaccurate or incomplete survey information can lead to defective system design, level and equalization problems.

At TE, survey and design is a four-step activity including pre-engineering activities; base maps and preliminary routing considerations; field survey; and system design and bill of materials.

At completion of the survey and design phase, the LAN system is minutely defined in terms of cable routing, device placement, amplifier mounting, cable footages, forward and return performance data and is ready for implementation.

Pre-engineering consists of review of: building and floor plans; manhole plans; underground or steam duct routing; high-, medium- and low-density areas; areas not initially included, but desired for; future expansion of the system; and the building plans to determine the headend space requirement and powering of the system.

Base maps and preliminary routing plans follow. Included are: manhole plans, underground conduit routes; building entry location; and riser diagrams and floor plans.

MyIars indicate the desired port density, future expansion requirements,

Is strange data leaking in2to you)r LAN?

No matter how well it's maintained, every Local Area Network is susceptible to leakage. Yours included.

It's a subtle problem. Often unnoticed. Or unnoticeable. Perhaps even overlooked.

But leakage is serious, nonetheless. With equally serious consequences.

Ingress, in. Egress, out.

The causes are simple. The diagnosis, however, isn't.

Leakage occurs because of a breakdown at any of the vulnerable points. A loose cable. A corroded fitting. A nick in the cable. Usually, something minor enough that won't take the system down.

Which is precisely why leakage goes undetected.

LAN leakage comes in two forms.

Ingress, where data seeps into your system from outside. Or *egress*, where your system is, in effect, broadcasting data that may interfere with airborne or other frequencies.

Big Brother is watching.

Egress leakage has the potential to be the more severe because it often affects off-air, shared frequency services.

Your data leaking out threatens airline communications. It threatens military communications. It threatens emergency communications.

The problem is real. Leakage is a very sensitive issue. One that is attracting more than casual attention from the likes of the FCC and FAA.

Already, the FCC has formulated rules to address CATV leak-

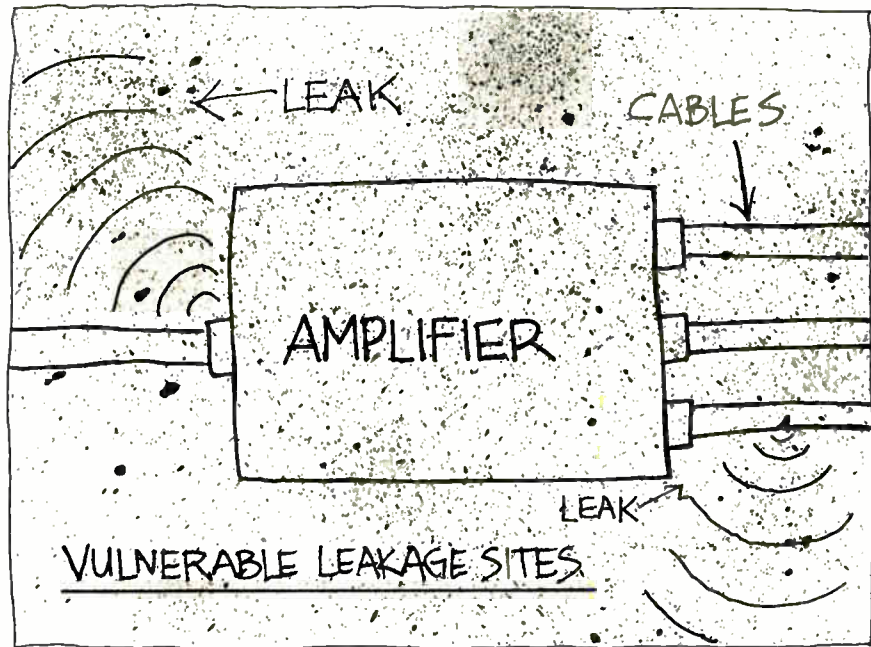

age. Can LAN be far behind?

If LAN operators don't police themselves now, they'll face potentially severe government regulations and fines. Both very costly.

The threat is real, too.

Good in, garbage out.

Ingress leakage, while not as potentially dangerous as egress, can be costly in its own right.

It threatens the integrity of the system you were hired to maintain. RF energy from outside sources, such as CB radios or other high level sources, seeps into your spectrum. It doesn't belong. It's unwanted. It messes things up.

Transmission error rate increases. System reliability decreases.

User complaints soar.

All of a sudden you've got a problem for which, because of its subtlety, you can't quickly get to

the source and correct.

The cure: routine testing.

The best way to prevent leakage is to adopt a program of routine leakage testing.

Wavetek can help.

We can determine the scope of your current leakage problem. Recommend solutions. Help establish maintenance programs.

And we can supply you with the proper leakage testing instruments for the particular make-up of your LAN.

Don't ignore leakage. It won't go away.

For more information on leakage or other broadband LAN performance testing, and for our free booklet, Testing LAN Performance, write Wavetek Indiana, Inc., 5808 Churchman, P.O. Box 190, Beech Grove, Indiana 46107.

Or call toll free 1 800 622-5515. In Indiana, 317 788-5965.

A clear definition of responsibilities is an important consideration.

headend location and loop segmentation.

Each floor plan then is analyzed to determine the optimum routing for the coaxial cable. Tap locations are identified to satisfy the port density requirements in each area.

Finally, a preliminary routing plan of the entire system is prepared, which indicates desirable multi-tap locations, amplifier mounting points and cable routing information.

Field survey

The field survey team uses blue-prints of the base maps to conduct a detailed survey and to verify that the pre-selected routing is feasible from an installation point of view.

All conduits are rodded, measured and equipped with pull-lines in preparation for the installation. Steam tunnels and ducts are measured. Building entry points and amplifier mounting locations are approved and determined.

The headend location is measured for initial rack placement and future expansion needs. All building risers are investigated and special installation methods determined.

The cable routing in each floor of each building is verified and carefully measured between any device location. Notations, relative to the installation method to be used, are made.

Special conditions such as obstructions, borings and device mounting details are noted on the drawings. The base maps, with updated routes, installation notations and measurements, are then returned to the design department.

System design

The designer evaluates the field notes, adjusts the routing information and produces a single-thread routing diagram with measurements, commonly referred to as the strand map.

Another drawing contains all routing, installation and special condition information. Port or tap levels for both forward and return direction are determined by computer. The design determines trunk and feeder requirements, amplifier gain and system equalization.

The design also verifies drop wire length to outlets and notes the actual outlet levels in both forward and return direction.

A completed bill of materials also is produced, creating an accurate cost baseline.

The design activity is complete after all design information is inked on mylar, complete with data, power supply details and forward and return port levels at every multi-tap.

Implementation

A clear definition of responsibilities is an important consideration at the outset of the implementation program.

A pre-construction meeting should be held to ensure close coordination between contractor and owner.

TE's past experience with turnkey implementation projects shows that accessibility to buildings and classrooms has been a major cause for delays. Other delay-causing activities by the owner can be new underground sections, building entry bores, obstructed steam ducts and conduits, etc.

It is recommended that both the owner and the contractor set aside a full-time LAN project engineer, so that daily coordination of activities can proceed expeditiously.

The LAN test plan should include the following:

- Amplifier alignment - forward;
- Amplifier alignment - return;
- Multi-tap level tests;
- Line end level tests;
- Sweep testing - forward;
- Return testing;
- Carrier-to-noise test;
- Spurious response testing; and
- Radiation testing.

The forward path amplifier alignment consists of the determination of gain and equalization of the forward passband. Signal generators for the lowest and highest video channel in the passband should be installed in the headend for this purpose.

The amplifier alignment record should include input level, output level, pad value and equalizer value.

Amplifier alignment in the return direction is done in a similar manner; however, in practice it becomes more complicated. This is caused by the tree

topology of the system. Return levels have to be matched at branch points, which requires the set-up of signal generators at every last amplifier.

Again the amplifier alignment record should show measurements at both the lowest and highest video channel of the return passband and include input level, output level, pad value and equalizer value.

The design drawings will show the forward output levels at highest and lowest passband frequency. It will also show the return transmit level at highest and lowest passband frequency.

A practical method of testing has been developed by TE to prove out the design value.

By placing a return generator at the output of each amplifier, the tap level will be measured in the forward direction. This method checks the return attenuation and proves forward transmission at the same time.

The Line End Level Tests prove that there is continuity throughout the system. This test is conducted in the forward direction using the high/low signal generators at the headend.

The tests are conducted at the last tap in every branch. The test record should indicate highest and lowest passband levels at the tap port.

System sweep

The forward passband is more critical because of the much higher frequencies it uses. A sweep generator, set-up at the headend, can be used to provide a graphical display of the response over the entire frequency range.

Polaroid pictures should be taken of the oscilloscope display at key amplifiers and at every last amplifier. Flatness in a typical LAN system with many branches can be expected to follow the formula $F = 4 + N/10$ in which N is the number of amplifiers in cascade.

As mentioned before, it is required to match levels at each branch point. If I wanted to know what the level difference is at the headend from transmissions at the last tap of each branch, then I would need to set up a signal generator at every last tap. This is, of course, impractical.

continued on page 89

FROM SMALL TOWN TO DOWNTOWN— HUGHES HAS THE RIGHT SYSTEM FOR YOUR APPLICATION

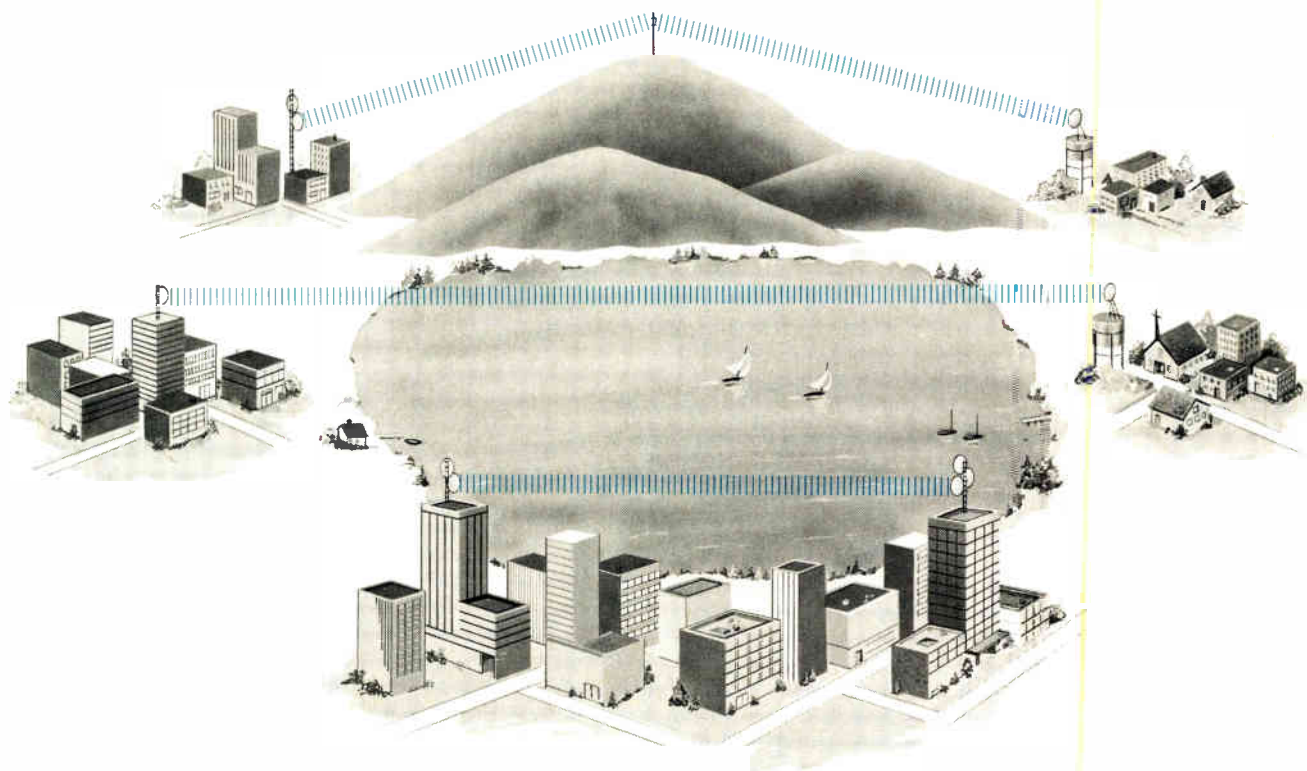

No one microwave system is intended to fit every application. And that's why Hughes Aircraft Company offers you a choice. Whether you're serving a rural community or a metropolitan area, you can now get a microwave video distribution system suited to your specific application... as well as your pocketbook.

Low Power. This low-cost, solid state OLE-111 transmitter is pole mountable, will handle 1-60 TV channels, and allows you to rapidly and inexpensively extend your cable plant from the end of a cascade to new subscriber pockets.

Medium Power. The most widely used Hughes AML® transmitter, the MTX-132, is easily expandable to accommodate cable systems up to 550 MHz, and is ideal for providing local distribution of a large number of television signals from headend to hubs.

High Power. The STX-141 offers the ultimate in high power microwave video distribution. It is intended for use where large num-

bers of hubs are served, or where long microwave paths may be encountered.

Beam Bender. This low-cost, on-frequency, active repeater is solid state, requires little power, and is designed for outdoor mounting. The MWB-122 is used to redirect a microwave signal when the path is blocked by a man-made or natural obstacle.

These transmitters deliver AM or FM signals, and, like all Hughes AML products, are backed by a comprehensive support program. So contact Hughes today and let us help you select the right system for your microwave application. Hughes Microwave Communications Products, Bldg. 245, P. O. Box 2940, Torrance, CA 90509-2940, or call toll free (800) 227-7359, Ext. 6233. In California: (213) 517-6233. In Canada: COMLINK Systems Inc., 1420 Bayly Street, Unit 5, Pickering, Ontario L1W 3R4, (416) 831-8282.



Understanding A-B RF switches

In recent years, switches for RF applications, commonly referred to as A-B switches by the cable industry, have become popular due to the increasing need to share services such as cable, off-air, MDS and VCR programming on one television set. The requirement to electrically attach multiple systems without degradation or interference have focused attention on the A-B switch features such as isolation, frequency range, matching and the ability to withstand repetitive use. The latter is of the ultimate importance due to the potential of costly service calls.

RF switch function

To understand the difference between switches, it is necessary to discuss an RF switch's basic functions. In its common configuration, the A-B switch is a single-pole double-throw (SPDT) switch. See Figure 1. The CATV converter or television to be switched is connected to a center pin and switched between two incoming signal sources. The most important characteristic of the switch is its abil-

*By Michael Holland, President,
Pico Macom Inc.*

A-B switches have become popular due to the increasing need to share services.

ity to prevent the signal on the unwanted port from radiating into the output port going toward the TV, or to the other source line input which could be an antenna or cable system.

If the signal radiates into the TV port, allowing the TV to see two signals, the results would be a degraded picture. This can occur with an undesired signal -50 dB down from the desired one. If the signal were allowed to radiate into the other source input line, at a high enough level, it would be possible to cause intermodulation or radiation problems, especially if that source was a high gain antenna or cable system.

This important characteristic, called isolation, varies with the frequency present on the incoming cable. The higher the frequency, the lower the isolation. A computer game switch with a nominal 60 dB isolation typically exhibits 65 dB isolation from TV chan-

nels 2 to 6, dropping to as low as perhaps 55 dB in the superbands and to 40 dB at UHF (see Figure 2).

As a rule of thumb, a television set tuned to the desired signal will show visual signs of interference if the level of the unwanted signal on the same frequency is within 50 dB of the desired signal's level. Remember strong UHF signals may possibly mix with cable frequencies and cause beats within the cable spectrum if allowed to reach certain nonlinear components.

For this reason, acceptable isolations are usually 60 dB minimum at all frequencies used. The FCC also requires this much isolation for video games and other devices connected to a TV through a switch as stated on FCC Part 15. One area of misconception is that these switches, though they provide acceptable isolation from channels 2 to 13, would also provide this much isolation at 500 MHz. This is not the case. Standard isolation switches are intended to prevent cable, converter, computer, VCR, MDS or STV signals on channels 3 and 4 from being coupled to the antenna cable. These switches are available with a variety of input and output configurations. See Figure 3.

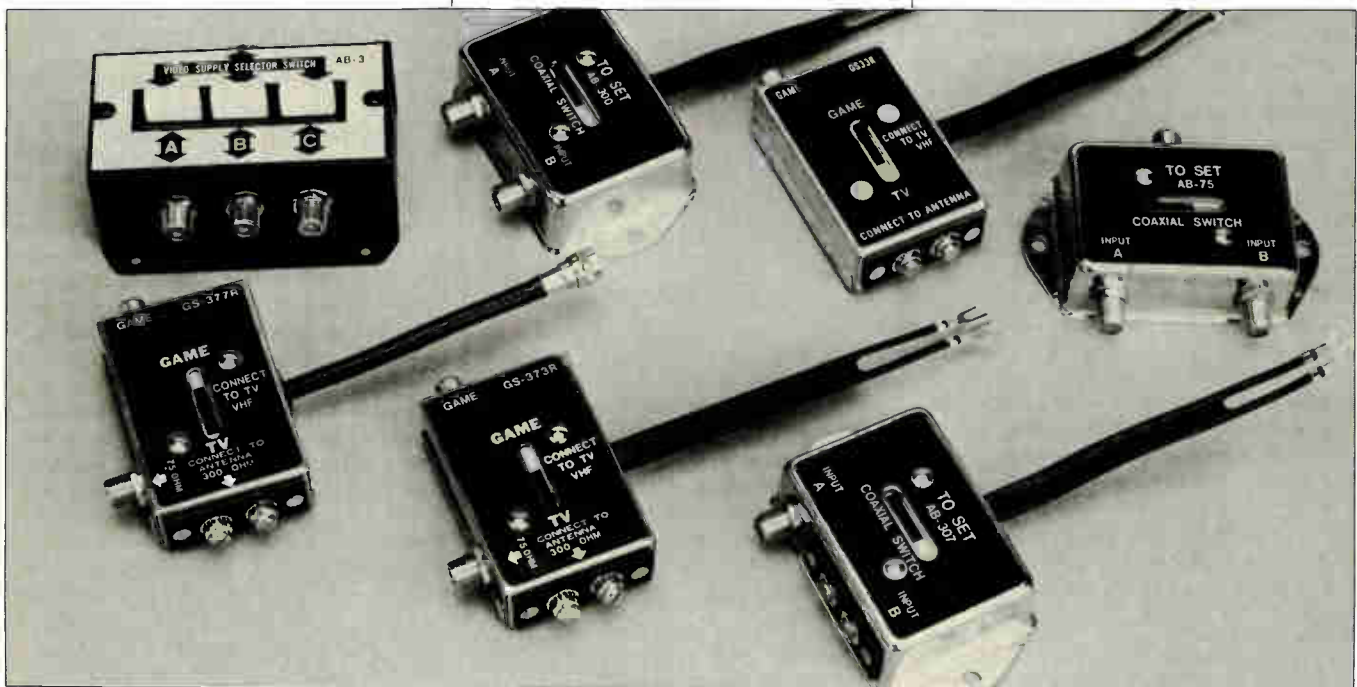

Many different A-B switches are available and most provide 60 dB isolation up to channel 13.

A Direct Line To Excellence

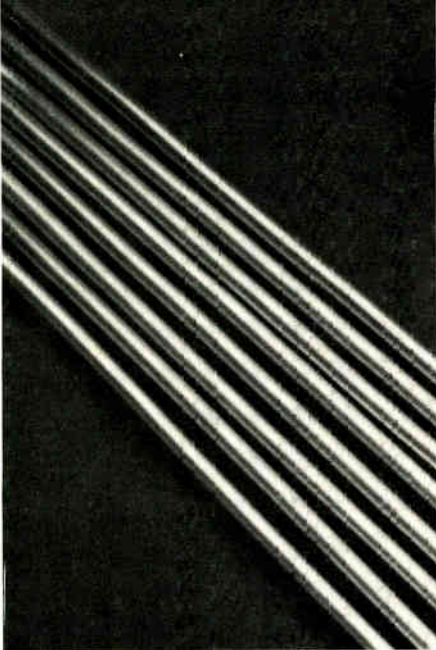

These low-quality switches typically use audio multi-pole switches to assure their isolation. All switching is done at 75 ohms; 300 ohm inputs simply have a transformer for the 300 ohm to 75 ohm conversion. One factor to be noted is that these switches do not provide 75 ohm termination of the unused port. This can cause signal radiation and interference down the line due to direct pick-up in the cable. Though this is not critical in game/VCR switching, it does become an important consideration in more complex systems such as cable, where matching is required.

The most common type of high-isolation switch is the rocker/slide switch type (presently known as the AB-2) developed and patented by the Arvin Diamond Co. specifically for the CATV market. It provides over 90 dB isolation (low frequency) and terminates the unused port with 75 ohms at a return loss above 16 dB at all frequencies.

In order to provide the needed isolation at high frequencies, the high isolation switches have a good die-cast case with molded RF tuned chambers between switching retention, and plastic integrity have provided a good proven reliability factor for the approximate 2 million AB-2 type switches presently in CATV use.

Testing

Testing of CATV switches can be made in many ways, each having slightly different results. The important thing to remember is to not get caught up in comparing test methods

In Products And Services

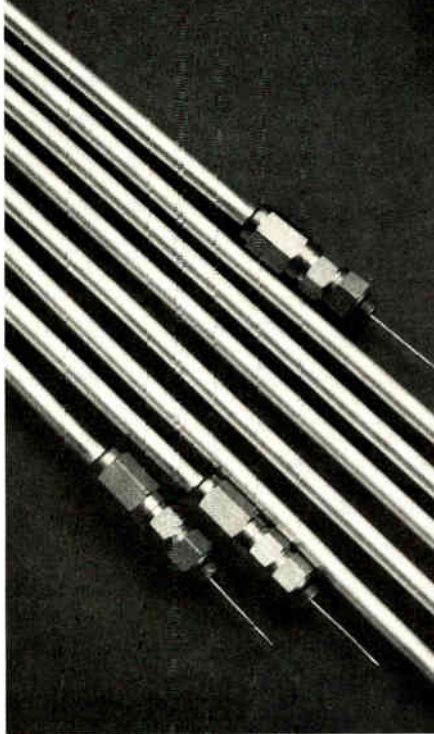

but to select the right switch. If you test one way, then clarify the manufacturer or distributors' methods and test the same or ask for a specification made to your CATV system's test method.

Any passive device may be tested with a continuous wave (CW) signal or swept method.

The CW method consists of providing a fixed signal at each frequency to be tested. This can even be your cable signal itself. To measure isolation, you simply read the level on a good spectrum analyst at a slow speed. A field strength meter, though reading a peak

Testing of CATV switches can be made in many ways, with different results.

and average composite signal level, is okay for comparisons. This method requires the drawing of a curve in that each frequency is tested one by one.

Sweep

The complete sweep method, using a spectrum analyst and tracking generator, provides a nice picture of the entire response but can have distortion caused by the tracking filter's bandwidth giving a false reading at low signal levels and fast sweep rates. This has always been a classic problem in measurement of CATV channel trap depth and an ongoing subject of controversy.

Selecting switches involves evaluating all requirements such as frequency range, return loss, termination of unused port and especially mechanical integrity. Your long-term cost will rely on this physical integrity to avoid costly service calls. ■

- Dependable service
- Large inventories
- Quality products
- Prompt delivery
- Quick response



We Make The Connection

**2 Wrigley
Irvine, CA • 92718
714/586-3196**

Western Show Booth #345

Reader Service Number 58

HRC, feedforward or both?

In the early days of cable television, the system designer had to make only a few choices in selecting which type of distribution equipment to use, and what levels to operate it at. Lower system limits were determined by signal-to-noise ratios; upper limits by cross-modulation.

As channel capacities expanded from 12 to 21, to 35 and eventually to 50 or more, both amplifier design and headend technology changed to provide solutions to the signal degradation problems that followed. Push-pull, feed forward, and, most recently, power doubling, and parallel power doubling (quad powering) amplifiers were introduced to reduce second- and third-order distortion. Harmonically Related Carrier (HRC) frequency assignments and synchronous headends were used to effectively mask the detrimental effects of carrying multiple channels over long cascades.

As is the case with other technologies, many of the solutions created their own set of problems; in some cases, the cure was worse than the disease. This article will examine two of the more popular state-of-the-art approaches for solving the problems inherent in today's high channel capacity systems, HRC and feed forward, and will offer some arguments why they should or should not be used together.

Cable distribution systems are designed to keep three distortion parameters within acceptable limits; these factors are (1) signal-to-noise (S/N) ratio, (2) second-order and, (3) third order distortion. S/N ratios are determined solely by amplifier input levels, noise figure of each amplifier and the number of amplifiers in cascade; these ratios do not change as channel capacity increases (input levels may be de-

The early days of few choices for system designers are gone.

creased as block tilt and slope techniques are employed).

Second-order distortion has been effectively reduced to acceptable levels by the use of push-pull amplifiers in the distribution equipment; these levels remain marginally below third-order distortion levels in feed forward systems.

Third-order distortions include both cross-modulation and triple beat. Cross-modulation is when the modulation from one (or more) signal carrier modulates another signal carrier. Third-order intermodulation—triple beat—is the beating of one signal carrier with the second harmonic of another signal carrier ($2F_1 \pm F_2$) or the beating of three signal carriers together ($F_1 + F_2 \pm F_3$).

Third-order products are a major factor in the design of a high-level, broadband, distribution system because the third-order levels increase 2 dB for every 1 dB increase in carrier output level. Likewise, third-order levels increase 6 dB every time the number of amplifiers in cascade are doubled; cross-modulation levels also increase 6 dB every time the number of channels are doubled. These levels become even greater when more than 60 channels are carried, because the amplifiers are operated above the threshold of compression. Third-order products can be significantly reduced by employing block tilt and slope techniques, that is, operating the lower channels at progressively lower levels than the higher channels to equalize for cable attenuation. They can also be reduced some-

what by the use of power doubling or parallel amplifiers.

While the levels of individual triple beats are not affected by an increase in the number of channels, the total number of triple beats produced increases exponentially; these beats are "stacked" across the entire system spectrum in a bell-shaped fashion, with the maximum number of beats falling within the pass band of the center channel.

These accumulated beats add randomly to produce "wiggly" lines, or "worms," across the television screen. The distortion caused by the random addition of triple beats falling within the pass band of a single television channel is called Composite Triple Beat (CTB).

The use of HRC frequency assignments first became popular when system capacities began to exceed 35 channels. At that time, CTB replaced cross-modulation as the dominant distortion factor for determining the maximum amplifier output levels and cascadability. Instead of spacing the channels at odd intervals, HRC systems phase lock the video carriers to the output of a 6 MHz "comb generator."

The use of HRC frequency assignments effectively eliminates the effects of composite triple beat by causing all triple beats to "zero-beat" against the 6 MHz-spaced video carrier frequencies; this restores cross-modulation as the predominant third-order factor in the design of distribution systems, an improvement of three or more db depending on the number of channels being carried.

While the use of HRC provides significant improvements in subjective distortion levels, it also causes many other system problems. An HRC channel cannot be phase locked to the carrier frequency of a strong off-air broadcast channel; the resulting 1.25 MHz beat can be very noticeable and objectionable.

Continued in January 1987 edition.

By Walter Colquitt, Director of New Technology, ATC.

Hi-tech deserves Hi-tech.

Watchman® II. Superior stand-by power battery.

Watchman® II is the technological leader in stand-by battery power, designed especially for CATV and other stand-by power applications. Watchman II is made of Duratrex™. This same tough material is used in GNB heavy-duty batteries which virtually eliminates breakage in the field. The bottom line is, it's the top of the line.

No maintenance.

Watchman II's Absolyte® sealed lead acid technology means no maintenance, and no maintenance cost. Watchman II never needs watering, there's no acid spillage or corrosive fumes to damage expensive electronics. And because Watchman II is sealed, you can use it in any position, no matter how remote, even freezing will not damage it.

Premium performance.

Compatible with float service, and unlike most stand-by batteries, Watchman II can be cycled over 250 times. Give your Hi-tech equipment all the power it deserves. Watchman II stand-by power battery.

For more information, contact Jim Trenter, Technical Applications Manager, GNB Incorporated, P.O. Box 64140, St. Paul, MN, 55164. (612) 681-5000.



Watchman II and Absolyte are registered trademarks and Duratrex is a trademark of GNB Incorporated



GNB Incorporated

Signal-to-noise measurements were run using a HP 8903A audio analyzer.

Continued from page 59

combination was done using the calibration tone built into the 6380 encoder. The cal tone was turned on and the input level control of the reference decoder was adjusted to illuminate the green LED, but not the red.

Signal-to-noise measurements were run using a HP 8903A audio analyzer. The 6380 cal tone was used as the reference (0 dB) level. The Tek 1450 was used in the intercarrier and direct modes as well as the quasi-parallel mode for these tests.

A block diagram of the test equipment, including connections to the headend is shown in Figure 2.

* The validity of swept sinusoid test signals (as opposed to noise input) for BTSC stereo separation tests has in the past been questioned. In our lab, we have run both types of tests and find excellent correlation between the results when using the 6380 stereo encoder.

Test results

Swept tests of separation were run by driving the left channel of the output of the network analyzer and measuring the response at the right output of the reference decoder relative to the left output in dB (thin trace). The right channel was then driven and the procedure was repeated with the network analyzer inputs reversed (heavy trace). The results are shown in the following plots. Frequencies are in hertz as indicated on the horizontal axes, and the vertical scales represent stereo separation in dB. Figure 3 shows the separation performance of the test encoder and reference decoder connected di-

rectly to each other. This represents the baseline for the system.

In Figure 4, the 6350 modulator and set-top converter were included in the test loop, but the rest of the headend and distribution system were left out. Note that the semi-random variations in gain and phase between sum and difference paths act to both degrade and improve separation at the various frequencies in the audio range. Below 100 Hz, some degradation of separation (to a low of about 27 dB) is evident due to AC coupling capacitors in the audio

modulator module. This effect is negligible due to the fact that the human ear is quite insensitive to directional information at such low frequencies.

Figure 5 shows separation measured through the entire system. As expected, the distribution system tends to have little effect on stereo separation. This is due to the broadband nature of the components, as well as the more random nature of gain and phase variations.

Figure 6 shows the effect of Scientific-Atlanta's sync suppression

FIGURE 3

Stereo separation baseline-encoder to decoder

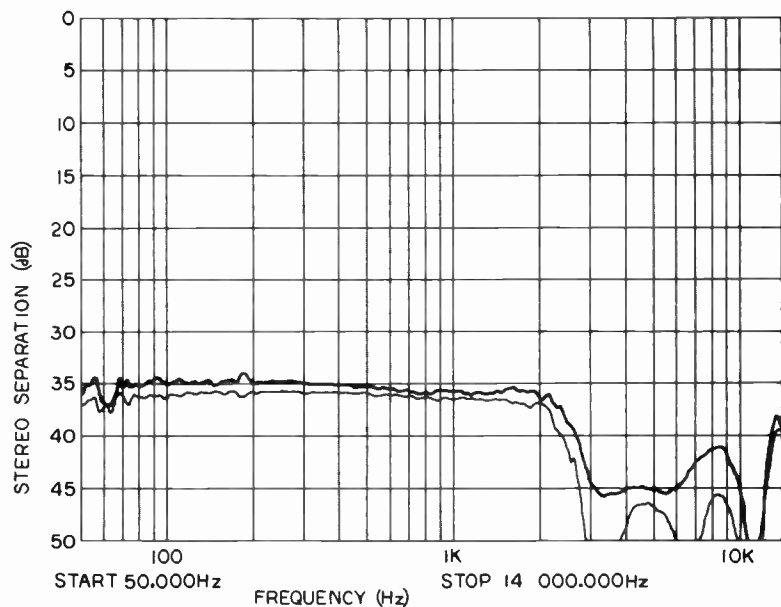

TABLE 1

Effect of scrambling on stereo s/n

TEK 1450 W/MOD SCIENCES DECODER SOURCE	DISTRIBUTION SYSTEM BYPASSED		THROUGH DISTRIBUTION SYSTEM	
	SCRAMBLING ON	SCRAMBLING OFF	SCRAMBLING ON	SCRAMBLING OFF
QUASI-PARALLEL	55dB	60dB	56dB	58dB
INTERCARRIER	54dB	58dB	53dB	57dB
DIRECT	31dB	33dB	33dB	33dB



You're invited



Dear Colleagues:

The NCTA Science & Technology department is developing a technical program - ten sessions and a conference proceedings text - for NCTA's 36th annual convention to be held in Las Vegas this coming May.

I am chairing the paper selection subcommittee and I urge you to send in, for the subcommittee's review, summaries of one or more technical papers you want to deliver at a Cable '87 technical session and to write for the 1987 NCTA Technical Papers volume.

Send me a 250 word outline or summary of the cable-related engineering paper you'd like to present to your peers [e.g., improvements and/or problem-solving treatments in system operations or equipment design] by December 19th -- include your name, title, address and phone number. The subcommittee will judge all proposals in January and, if yours is selected, you will have eight weeks to complete the paper as a camera-ready manuscript using the author's kit we provide. Oral presentations based on the paper will have 15 to 20 minutes on the technical session agenda. If you think that you may not be able to present the paper in May, there's still a chance that the subcommittee will accept your abstract and invite you to complete a paper for the conference proceedings [1987 NCTA Technical Papers].

Take a chance! Authors get industry acclaim, their company's gratitude and a free copy of the \$40 book.

PAPER PROPOSAL DEADLINE

DECEMBER 19

Good luck and best regards,

Wendell H. Bailey, Jr.
VP, Science & Technology Dept.
National Cable Television Association
1724 Massachusetts Ave., NW
Washington, D.C. 20036
telecopier-(202)775-3604

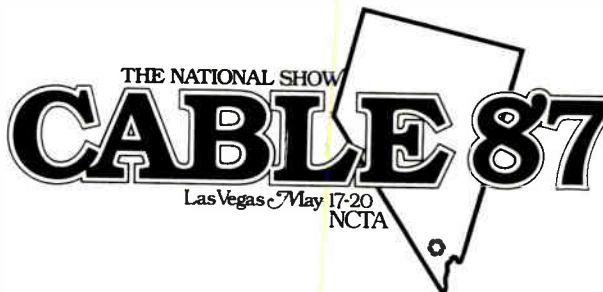

The Inside Story Behind the PTS/Katek Acquisition.

Bloomington, IN—Why did the two leaders in converter repair agree to an acquisition?

"Frankly, we've been chasing Katek since we entered the cable market in 1981," says Jeff Hamilton,



Jeffrey A. Hamilton

PTS Vice President of Marketing. "Katek was the first company to emerge as a national contender. More important, they have maintained a technological edge especially

in addressable repair."

Ron Katz, founder of Katek says, "PTS was unlike any competitor we had faced. On their first day of cable operation, they had hundreds of technicians in Servicenters nationwide.

They were flexing the muscle they had built as the largest independent repair company for T.V. service dealers and manufacturers."



Ronald L. Katz

In 1984 Katek merged with RT Construction. "It was a good move at the time. But this new alignment with PTS—a company dedicated to repair will put us in a much stronger position," explains Katz.

These two multimillion dollar companies have joined to form the largest cable equipment repair company: PTS/Katek. Ron Katz directs operations as Executive Vice President, "We're in a strong position to serve cable companies. MSO's and independent operators can expect faster service, consistent quality and continued technological leadership."

"The inside story is that Katek did not fit in with RT/Katek's direction," explains Katz. "PTS/Katek creates a synergy that will set the standard in the repair industry."

PTS/Katek
Cable Services Division

Corporate Headquarters
P.O. Box 272 Bloomington, IN 47402
(812) 824-9331
(800) 441-2371

Reader Service Number 60

The network analyzer does not respond to discrete interfering tones in a calibrated fashion.

FIGURE 4

Separation including modular and set top terminal

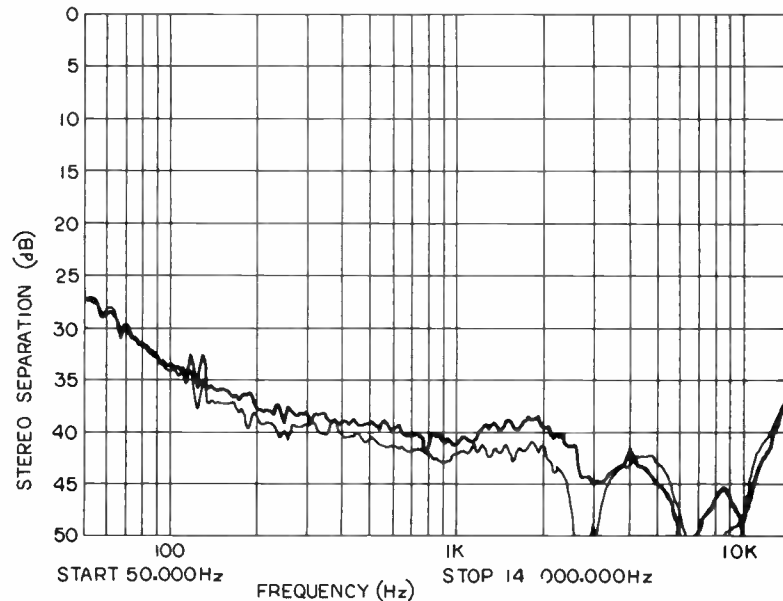

scrambling. Again, little change in the overall separation curve is evident. The key features of this plot, however, are the discrete spikes at multiples of 60 Hz. This buzz is due to amplitude modulation of the aural carrier by the scrambler and subsequent AM to PM conversion in the signal path and receiver. This effect can also be caused by inadequate AM rejection in the aural carrier FM demodulator or by incidental visual carrier phase modulation (ICPM) in the modulator, though neither is the case here due to the pulse count demodulator in the Tek 1450 and the absence of the spikes in figures 4 and 5.

The network analyzer does not respond to discrete interfering tones in a calibrated fashion. To better quantify the buzz, signal-to-noise ratio measurements were performed. Measurements were made with and without the distribution system, and with scrambling both on and off. The Tek 1450 was used in all three aural detection modes: quasi-parallel, intercarrier and direct. Results are shown in Table 1.

The quasi-parallel mode of operation performed slightly better than the intercarrier mode in the Tek 1450. The direct inability to reject phase noise introduced by the set-top terminal. Such phase noise is common to both the vis-

System performance is far in excess of the capabilities of the consumer decoders.

FIGURE 5

Separation through distribution system

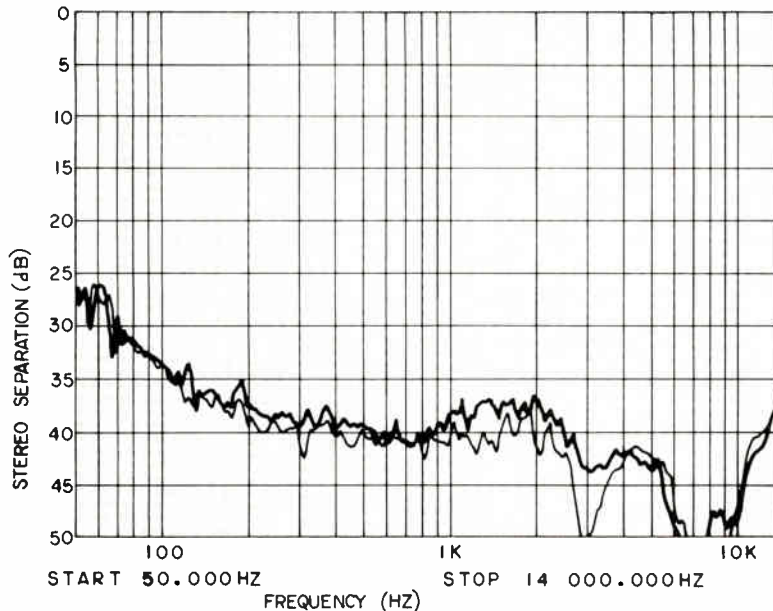

ual and aural carriers and so is rejected by the intercarrier or quasi-parallel detection methods. Quasi-parallel detection is most common in stereo compatible consumer receivers.

Tests of buzz rejection on consumer receivers have shown great variability and so are not reported here. Both poorer and better buzz rejection has been seen, although sometimes at the expense of other parameters.

Conclusion

There has been much discussion among CATV engineers about budgeting stereo separation within a system.

Although the data is not presented here, the separation performance of a number of consumer-grade BTSC stereo decoders has been tested in this laboratory. In all cases, the system performance shown here is far in excess of the capabilities of the consumer decoders.

Though it would be fair to question the generality of separation tests run on one particular stereo encoder and RF modulator, experience shows these results to be quite typical. Both of these were production units which received no special adjustments. The test of the distribution system is more statistically significant. The number of

Eagle
TRAPS



The Great Trap Test!

Compare these features with the competition:

FEATURES	MANUFACTURERS		
	EAGLE	A	B
100% Urethane filled (Weather Resistant)	■		
Single Board Construction (Improved Grounding)	■		■
Dual "D" Rings (Weather Resistant)	■	■	■
Blocking Capacitor (Reduced Theft)	■		
Metal Shields Available (Reduced Theft)	■		
Made in USA	■	■	
Special Design Multichannel Traps	■	■	
Metal-Stamped Channel I.D.	■		■

**(800)
448-7474**



4562 Waterhouse Road
Clay, NY 13041
(315) 622-3402

Reader Service Number 61

**The degree to which buzz
due to scrambling is rejected
depends on the receiver
used.**

FIGURE 6

Separation of system with scrambling

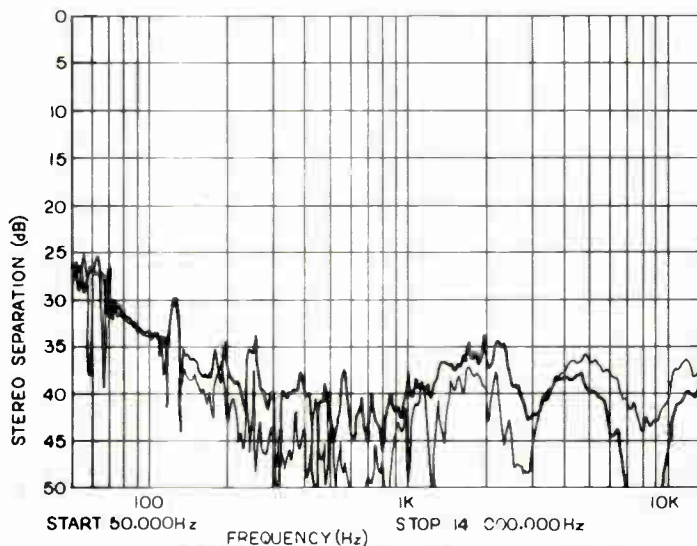

**Tower
cable clips
for proven quality
and economy**

**Tower-leaders
in the industry**

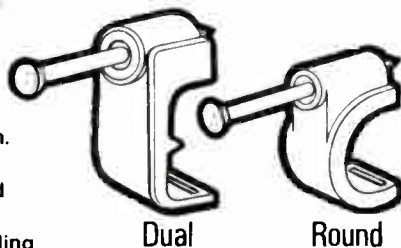

- Sure-fit for quick simple installation.
- Plated, hardened, flat-headed Steel masonry nails, pre-assembled ready for use.
- Sizes to fit all coaxial cables, including quad and double shielded, both single and dual systems. Available in black, white and grey.
- Sold by most leading distributors — Ask for Tower by name.
- Write today for samples, literature and a copy of Tower Cable Clips test results as required by the British Telephone Company, giving name of your supplier.

WELDONE TRADING CO. INC.
1401 Legendre Street W.
Suite 106,
Montreal, Québec H4N 2S2
(514) 381-8861

**EXCLUSIVE UNITED STATES
IMPORTERS**

components in cascade tends to rule out a chance selection of any particular characteristic.

The degree to which buzz due to scrambling is rejected will depend greatly on the receiver used. The CATV system, however, is capable of delivering a quality signal to the customer. ■

References

1. Gibson, J.J. *Accumulation of Stereo Separation Errors in Cascades of Subsystems Conveying L+R and L-R Over Different Paths*, publication of RCA Laboratories.
2. Bowick, C. *The Importance of Setting and Maintaining Correct Signal and Modulation Levels in a CATV System Carrying BTSC Stereo Signals*, presented at the 1986 NCTA convention.
3. Farmer, J. *RF and Stereo, CED*, December 1985.
4. Farmer, J., Sedacca, D., Williams, T., Jones, H., *Practical Experience with Stereo Cablecasting, CED*, June 1986.
5. Large, D.J., *The Gillcable Stereo Television Tests*, presented at the 1986 NCTA convention.

5 Star General

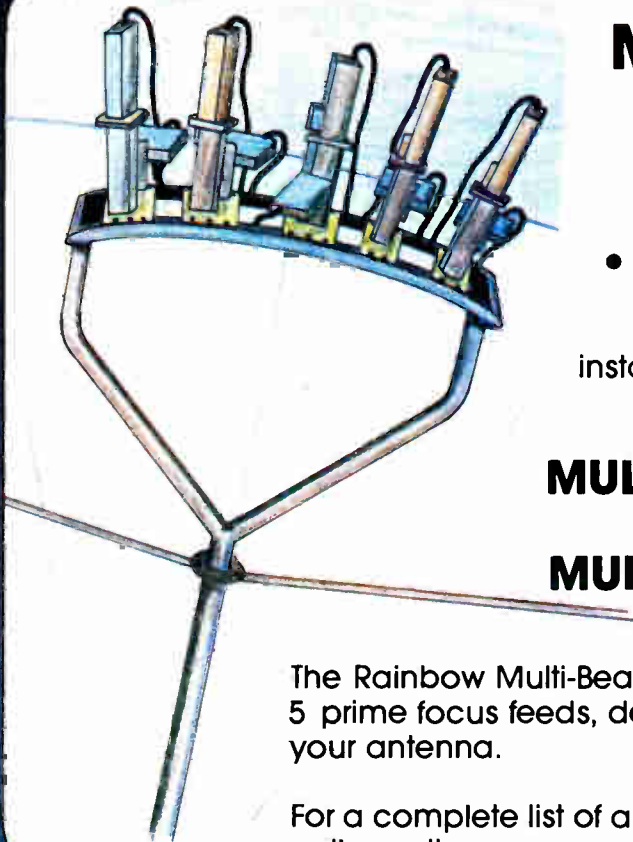

MULTI-BEAM FEEDS

- Maximize your programming capability, by receiving Galaxy I, Satcom III R, Telstar 303, Westar 5 and Spacenet with the use of one dish.
- Add to system revenues, through tier expansion.
- Eliminate additional land acquisition and the installation costs of multiple dishes, while increasing your earth station investment.

MULTI-DISH? OR MULTI-FEED?

The Rainbow Multi-Beam Feed allows you up to 5 prime focus feeds, depending on the size of your antenna.

For a complete list of antennas that can be retrofitted call or write:

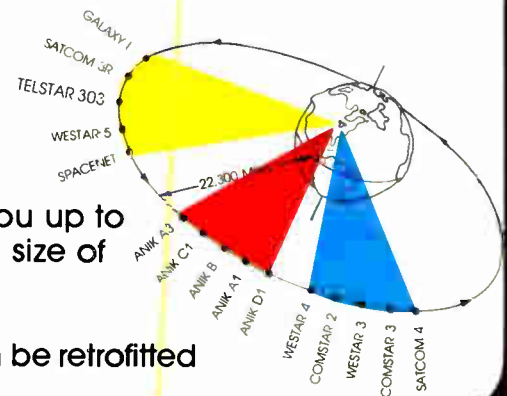

RAINBOW SATELLITE COMMUNICATIONS

Attn: Brian Wilkes
P.O. Box 395 Leesburg, FL 32748
(904) 326-8030

Distributed by
Tele-wire Supply
7 Michael Ave.
E. Farmingdale, NY 11735
800-645-9510

classifieds

EMPLOYMENT OPPORTUNITIES/HELP WANTED

CATV PROJECT ENGINEER/ CATV PROJECT MANAGER

A growing development company in the cable television Home Shopping Service Industry is seeking CATV engineering professionals to work on an exciting new concept.

To qualify, candidates must have at least 5 years experience in cable television systems with 10,000+ subscribers. Microwave and addressable cable system experience is a must. Familiarity with CATV design and good communication skills are also required. Fiber Optics budgeting knowledge and supervisory experience are desired. B.S.E.E. also a plus.

Both positions offer a unique opportunity, salary commensurate with experience, excellent benefit package and professional challenge with leading edge technology. Suburban Chicago location. EOE M/F.

To apply, send resume and salary history in confidence to:

CED: 1201-01

Baker Scott & Co. EXECUTIVE SEARCH

1259 Route 46 Parsippany, NJ 07054 201 263-3355

**Specialists in the COMMUNICATIONS
INDUSTRY**

CABLE TV BROADCAST TELECOMMUNICATIONS
DIVISION DIVISION

POSITIONS AVAILABLE AT ALL LEVELS OF
MANAGEMENT. COAST TO COAST

Call or write in CONFIDENCE

FEE PAID

"WE DON'T TALK CABLE, WE KNOW CABLE"
PRINCIPALS DAVID ALLEN & JUDY BOUER

INSTALLATION SUPERVISOR

Supervise 13 in-house and 12+ contractor personnel. Budget and work order processing experience a plus. Send resume with salary history and requirements to:

Storer Cable Communications
403 South Street
P.O. Box 598
Eatontown, N.J. 07724

Cable Engineering, Inc. IMMEDIATE OPENINGS ENGINEERING PERSONNEL

Growing cable company has full-time positions available for strand mapping, as built and makeready survey, rough balance and sweep personnel. In 14 states totaling 12,000-15,000 miles.

Call 1-800-334-9684 or send resume to:

Cable Engineering, Inc.
1615 Mellwood Avenue
Louisville, Ky. 40206

CABLE TV CONSTRUCTION

Experienced pole climbers, splicers and foremen needed for long term jobs throughout New England. We offer long term employment, excellent wages and benefits and year round work. Call: (603) 736-8163.

How to respond to a blind box ad:

Box CED (Box Number) c/o CED Magazine,
P.O. Box 5208 T.A., Denver, CO 80217.

BUSINESS DIRECTORY

**Harold Bigham, Pres. Two Fully Staffed
(904) 932-6869 Office Locations**

Bigham

Cable Construction, Inc.

Complete CATV Construction

P.O. Box 903 Gulf Breeze, FL 32561
738 Renfro St., Burleson, TX 76028

**Specializes Warren "Herb" Biddle, V.P.
in Rebuilds (817) 447-1960**



THE INSTALL PEOPLE.

Serving the industry
since 1974

**ENGLISH
ENTERPRIZES**
P.O. Box 6494
Orlando, Florida 32853

·305-898-7134

- Aerial Installs
- Underground Installs
- Drop Transfer
- Commercial Development
- Design

CONTRACT INSTALLERS

HOUSE INSTALLERS • APT. INSTALLERS
• TAP AUDITS

P.O. Box 1564
Appleton, WI 54913
phone (414) 582-7087

*Lenny
Fricker*



**THE BEST QUALITY ENGINEERING
AND CONSULTING FOR THE LOW-
EST PRICES.** Are you buying or selling? New Builds. Re-builds. System Evaluations. Feasibility Studies. Strand Mapping. Make-Ready. As-Built. System Design. Twenty-five years of experience. Call Wayne Stevens (904) 761-CATV.

Cable Television Services
120 Erbbe N.E.
Albuquerque, NM 87213
(505) 292-7766



—Converter Repairs—
Jerrold Specialists
Quality Workmanship
Fast Turnaround
Two week normal

CASH IN!



Even small cable operators can profitably insert ads on ESPN, CNN, CBN and other satellite channels using our low cost ad insertion system. A complete package (character generator, firmware and DTMF channel controller) for only \$975! Money back guarantee!

**Abiqua International - P.O. Box 100
Silverton, Oregon 97381
Phone (503) 873-4181**

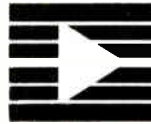

CABLE SYSTEM SURVEY CO.

MAPPING • DESIGN • AS-BUILTS
COMPLETE DRAFTING SERVICES

**Planning a project this year or next year?
Call us for more information.**

17 Peddler's Row
Newark, DE 19702

Tom Tetreault
(302) 368-2436



TechNeTronics Inc.

192 Route 9W • New Windsor, N.Y. 12550

**CONSTRUCTION (MDU, Aerial,
Underground, LAN) ★ AUDITING
MAPPING ★ ENGINEERING**

CALL ANDREW HEALEY at (914) 561-7880

As always, the results of our work as well as the workmanship itself are fully 100% guaranteed by TechNeTronics-the name you can depend on.



Western Catv DISTRIBUTORS, INC.

YOUR TOTAL SUPPLY CENTER

Provides a complete selection of products and equipment for CATV, MATV, TVRO



Western Services
Technical and Repair

CATV/MATV Repairs Converter Repair

Magnavox factory authorized in and out of warranty repairs. Repair and alignment of Headend Equipment and Satellite Receivers.

3430 Fujita Avenue
Torrance, CA 90505

In CA: 800 641-2288
Outside CA: 800 551-2288

**You can advertise your
product or service in the
only technical classified in
the cable marketplace.**

Man of the Year issue: January 1, 1987
Deadline for ad copy: December 8, 1986

For more information, contact Christina Panczyk (303) 860-0111

P.O. Box 5208 T.A.
Denver, Co. 80217



- INSTALLS
- AUDITS
- HOMES PASSED AUDITS
- CHANGE OUTS
- APARTMENT WIRING

Four K Cable Service

P.O. Box 1532
IDAHO FALLS, IDAHO 83403-1534
(208) 525-1998

Glen J. Everson

Kevin B. Logan



FOR SALE SPECIAL LOW LOW RATES

		Regular Prices	Special Low Prices
CONVERTERS	M-35	20.00	15.00
	RSX	12.50	10.00
	SX	10.00	8.00
	Gammets	8.00	6.00
	JRX	16.50	12.00

JERROLD TRUNK AMPS
JN 300 MHZ All With Housings.

	Regular Prices	Special Low Prices
STATIONS		
1# AGC Trunk w/dist.	350.00	315.00
2# MGC Trunk w/dist.	310.00	270.00
3# AGC Trunk only	290.00	245.00
4# MGC Trunk only	230.00	200.00
5# High Gain dist.	310.00	270.00

Taps - 300 MHZ, FFT, EFT RMS \$3.50 \$2.50

"VOLUME DISCOUNTS AVAILABLE"
All equipment is in workable condition. Don't miss out on these super low prices.

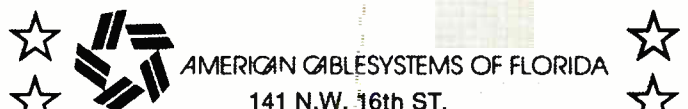

AMERICAN CABLE SYSTEMS OF FLORIDA

141 N.W. 16th ST.
Pompano Beach, FL 33061
(305) 946-0099

Contact: Kurt Kerrigan



BUSINESS DIRECTORY / EQUIPMENT FOR SALE

THE SOURCE

- SALES: Converters, CATV Equipment and Parts
- SERVICE: Converters and CATV Equipment
- JERROLD Qualified Warranty Service Centers

WE BUY USED AND EXCESS EQUIPMENT

1-800-382-BRAD
IN NY 1-518-382-8000



Cherokee, N.C. 28719
Schenectady, NY 12301
Tampa, FL 33610 Fife, WA 98424

CATV EQUIPMENT REPAIRS

- Line & Distr. Amplifiers
- Field Strength Meters
- Headend & CCTV Gear
- Fast Turnaround
- Quality Workmanship
- Reasonable Rates

VideoTech Service Inc.
CATV • MATV • CCTV

All repairs unconditionally guaranteed.
For more information call collect

VIDEO TECH SERVICES, Inc.
4505 D W ROSENCRANS AVENUE
HAWTHORNE, CALIFORNIA 90250
213-970-9012

★ ★ ★ ★ SALE ★ ★ ★ ★

UNDERGROUND EQUIPMENT

- 1 Ford F350 Dumptruck
- 2 Port-a-mole-Boring machines
- 2 Burkeen B-30 Plows w/PTO & attach. with trencher and trailer
- 5 Line Wards Vibratory Plows w/ramps & attach.
- 1 Wacker Rammer w/4" shoes and ext.

For information, call Bob or Dave (312) 226-0533.

NEMAL TAP SALE

\$2.49 Ea. (1000 Lot)

2/4 Port • While Supply Lasts!
ASSTD. VALUES — MOST 400 MHZ

25 Pcs. @ \$4.29 ea. 500 Pcs. @ \$2.99 ea.
100 Pcs. @ \$3.79 ea. 1000 Pcs. @ \$2.49 ea.

— ALSO IN STOCK —

- Trunk/Drop Cable
- Splitters
- Connectors
- BT Modulators

ORDER TOLL FREE:
U.S.: 1-800-327-5999
FL: 1-800-52-CABLE

NEMAL

ELECTRONICS INTERNATIONAL, INC.
12240 N.E. 14 Ave., North Miami, FL 33161
(305) 893-3924 • Telex: 6975377

Bucket Trucks — Used

Telsta, Versa-Lift, Digger Derricks—10 in Stock. 30 other Utility Construction Trucks.

"We Buy and Sell"

Opdyke, Inc. (Philadelphia Area)
3123 Bethlehem Pike (215) 721-4444
Hatfield, Pa. 19440

SATELLITE RECEIVING ANTENNA

Model 8010 PF 7 meter SA prime focus antenna. Brand new-still in crate located in Alaska. For information, call Jan Rearick (605) 352-4014.

DID YOU KNOW THAT. . .

According to Harvey Research, CED classifieds are the third most read section of the magazine?

For more information, contact Christina Panczyk (303) 860-0111 or write: CED Magazine, P.O. Box 5208 T.A., Denver, Co. 80217.

Reprints Reprints

Reprints are a convenient, cost effective communication tool: designed to give your company high visibility in the marketplace. They are ideal for announcing new products and events to customers, suppliers and staff.

For more information contact the Classified Department, International Thomson Communications Inc., P.O. Box 5208 T.A., Denver, Colorado 80217 or call (303) 860-0111.

MAILING LISTS AVAILABLE

For more information, call Christina Panczyk at (303) 860-0111

FOR SALE

WAVETEK 1865 CATV Sweep Analyzer
★ NEW ★ w/camera and charger \$5,000. TEXSCAN 7272 ★ LIKE NEW ★ \$800. JERROLD 727 ★ Good-working order ★ \$300. GENERAL Lasher C w/ case ★ Good condition ★ \$500. Lasher J w/case \$800. CD Spinner Lasher w/ case \$500. Call (703) 772-0267

Licensed

AUTOMATION TECHNIQUES INC.

GLR 500 CH New Commercial Satellite Receiver

Crystal Stability Affordable Price \$329.⁰⁰

★ Descrambler Ready ★ Crystal Synthesized ★ Made in USA ★ Quality Video with Crystal Stability

1839 North 105th East Avenue • Tulsa, OK 74116 • (918) 836-2584

This test proves the signal qualities of the system.

BROADBAND (HIGH)-SPLIT LAN SYSTEM TRUNK & FEEDER CONFIGURATION

OUTBOUND FREQUENCY 222-450 MHz TYPICAL
INBOUND FREQUENCY 5-186 MHz TYPICAL

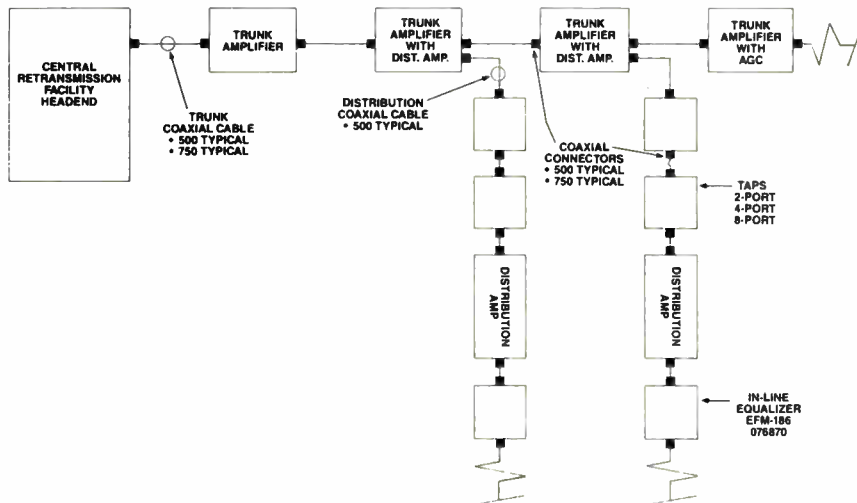

Broadband 8

continued from page 72

Similar results

But we can achieve the same result by taking the amplifier alignment—return data and the multi-tap level test data together. Compilation will show the entire range of return transmission points and their receive levels at the headend.

The return flatness is a direct function of the number of branches and can be expected in the range of the design value +/- 4 dB.

This test proves the signal qualities of the system. In the forward direction, it is desirable to conduct the test at one test point per loop.

A spectrum analyzer is used to measure the carrier peak level over the white noise level of the amplifiers. Carrier-to-noise ratios of better than 60 dB should be attainable.

In the return direction, the return carrier generator level can be measured at the headend and should provide similar results.

Spectrum analyzer

Using the spectrum analyzer at the

headend for the return band and at each loop test point for the forward band, all spurious and external sources can be measured.

The test is conducted by simply tuning through the passband. There shall not be any discreet carriers or spurious products found that offer less than a 40 dB carrier to spurious signal. Even a local FM station shall meet this criteria.

Leakage tests are performed concurrent with activation of the system. The testing equipment consists of a modulated signal generator that is connected at the headend.

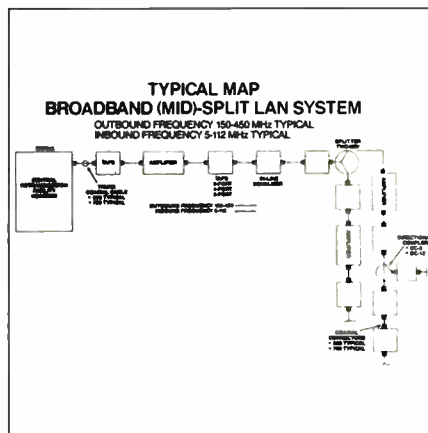

The hand-held receiving equipment will indicate audible tones when energy escapes out of the system.

Open housings, loose connectors or un-terminated lines will cause this condition, which can seriously affect the performance of the system in both directions.

The test should be conducted along every foot of the completed system as it proves the workmanship of the installation.

Upon completion of all testing, the LAN system is now ready to accept the vendor hardware.

Whether you employ collision detection equipment, token passing, video modulators, T1 point to point modems, digital telephones, security and/or status monitoring equipment, the LAN has been optimized across the passband to provide satisfactory performance.

Future expansion, even the addition of new buildings, should be possible without rearrangement of the initial system.

Also, terminals, bus interface units and other devices can be disconnected from one port and reconnected at another port without any re-wiring.

Properly designed and certified, the LAN broadband transmission system will provide years of reliable service.

Business is up

Without question, the best news from the Atlantic Cable Show, at least for equipment suppliers and contractors, is that business is up. Over the past few months, orders for headend and distribution equipment, in particular, have been strong. At least one distributor reports setting a new record, in fact, for business over the last quarter. Traps are moving strongly; converters present a more mixed picture. There doesn't seem to be any single propelling force. Rate deregulation may have spurred some operators to make investments in channel capacity: hence the strong business in modulators, receivers and headend gear. Some operators may have reached the point where rebuilds simply couldn't be postponed any longer; new system owners may be upgrading newly acquired properties; or services like pay-per-view or home shopping necessitating equipment additions. Whatever the reasons, business is up.

Panasonic addressables

Some people questioned the wisdom of Panasonic's entry into the plain vanilla converter market under its own label in 1984. Doubtless, some will question the company's recent decision to add addressable, Jerrold-compatibles to its product line. But the company appears firmly committed to the CATV market, for strategic, not tactical reasons. Matsushita, remember, is the third largest electronics manufacturer in the world. The fastest growing division at Matsushita is consumer appliances.

And the company has been a strong backer of "home of the future" projects like the Electronic Industry Association's Home Bus project. In sum, the company wants a "wire into the home," says Video Communications Division head Dick Strable. An odd statement for a home appliances manufacturer? Not really. The company's definitely positioning itself for the future; for a time when devices of all sorts possess intelligence and share communication pathways.

Still, the company's CATV business makes sense on its own. The boxes

themselves have earned a reputation for reliability, and Panasonic just doesn't think the future of the terminal business lies in plain vanillas. The firm also believes cable will keep growing and is realistic about the level of business it can attract. It's moved up on the list of plain vanilla suppliers and expects to get a share of the addressable market as well. Panasonic also believes PPV will be nearly universal some day, and so has three impulse PPV converter models on the drawing boards now. Contact: Panasonic Industrial Co., (201) 392-4708.

IS-15

Two TV set manufacturers, we understand, will feature IS-15 plugs during the first quarter of 1987, Panasonic being one of the manufacturers. Sony, we'd guess, will do so as well. By 1988, at least four receiver manufacturers will have made the commitment to IS-15 on at least top-of-the-line sets.

IS-6

IS-6, the EIA interim channelization standard for CATV, should be moving closer to adoption as a full standard in the near future. The interim plan was released in May 1983 and review to date has centered on the FM band (88 to 108 MHz). Some TV set manufacturers install FM traps in their tuners to limit distortion products caused by local FM transmitters. Consequently, the sets won't tune CATV channels in the FM band. The issue: should it be a recommended practice to assign CATV channel numbers to the FM band?

The pros: 35-channel systems can buy a little time—say two to three years—by using the FM band until a rebuild/upgrade. Suburban Cable of New Jersey, for example, runs pay services in the FM band. On the other hand, it's not a terribly widespread practice.

The cons: it can cause subscriber confusion when a cable-compatible receiver with FM traps tries to tune the 88 to 108 MHz frequencies. After vigorous discussion, the NCTA Engineering Committee has recommended that the channelization plan include the FM band, but suggests that these three

channels not be used.

IEEE 802.7

The IEEE 802 local area network standards committee has been looking at broadband LANs recently with the aim of setting accepted practices for 75-ohm networks. Archer Taylor and Larry Lockwood have been following the issue closely, and recently met with the 802.7 subcommittee to clear up some misunderstandings the group had about current CATV state-of-the-art. No references were made to NCTA's "Recommended Practices" text, for example, nor were many good 1980s papers, books and articles cited.

There were also some common terminological confusions as well. "Tilt" and "slope" were used interchangeably. "Slope" is the gain/loss vs. frequency characteristic of cable, amplifiers and other devices. "Tilt" is the relative level of multiplexed carriers compared to a reference carrier. The definition of dBmV inconsistently mentioned that zero dBmV is 1 millivolt referenced across 75 ohms. The latest version of the FCC's 21006 and NEC and NESC rules also needed to be referenced. It now appears that all the substantive issues have been worked into the proposed final document.

S-A converters

Scientific-Atlanta's model 8550 converter now features a smaller footprint. In addition, S-A has a new learning remote, the model 8550-375, to match. A programmable version, the 8550-275 also is available. It's compatible with all 8500 series converters.

The company also was showing its programmable model 8535 converter/descrambler, which is compatible with Jerrold, Hamlin, Regency, Sylvania and Eagle scrambling techniques. The new S-A model 8580 addressable terminal has an integral, four-event, 14-day VCR timer and time-of-day clock. It also has the smaller footprint and was scheduled for November 1986 shipping. Contact: Scientific-Atlanta, (404) 441-4000.

Smart remote

Pioneer is introducing a new smart

New products specially adapted for the LAN market are showing up.

remote with eight programmable keys, with quantity production set for the first quarter of 1987. It will primarily be pitched to existing customers. Introduction is scheduled for the Western Show. Contact: Pioneer Communications, (614) 876-0771.

New LAN products

As has been the case all year, new products specially adapted for the LAN market are showing up. Augat LRC, for example, has a new 1 dB incremental tap that will sell for \$35 in quantity. What's so special about it? An RF bypass plate, so if the plate is pulled for adjustment, the network doesn't go down; just the one tap. Samples are available now.

Interfering sweeps are tolerable in a CATV environment; not always so in a LAN environment. CaLan, a new firm headed by former Wavetek personnel Syd Fluck and William Le Doux, offers the first totally non-interfering sweep and analyzer, the model 1776/1777. It's a combination spectrum analyzer and 5 to 600 MHz sweep. The high resolution device automatically scans the band, verifies the location of all carriers and sets up guard bands around the center frequencies. The guard band width is operator-controllable.

For data carriers, 1 MHz ought to do; for video, 5 MHz. As a stand-alone receiver, the device sells for about \$10,400 in single quantities. The transmitter costs \$5,500. Le Doux says the company's working on a version without a video display, designed for automatic, remote monitoring. That version ought to shave \$1,000 or more off the cost of each unit. Delivery is about 45 days and 90 days ARO. Contact: CaLan, (717) 828-2356.

AM Cable's Network Technologies Division reports it is in advanced Beta testing of its technical monitoring and control system, the TMC-8000. The TMC-8000 is the first offering in a planned line of LAN products designed to meet the fault isolation needs of broadband LAN users, says the company's Phil Verruto. Unlike some traditional status monitoring systems, the TMC transponders—as many as 250 per controller—do not have to be placed in amplifier housings. Also, the TMC is frequency agile: it can poll any

frequency from 40 to 400 MHz in 50 kHz steps; not just high and low pilots. In the works: an intelligent A-B switch to move network traffic to a backup cable in case of primary cable failure; interfaces to three popular makes of

amplifiers and possibly a LAN version of Tier-Guard—the company's off-premises addressable system—that would offer remote drop control. Contact: Network Technologies, (215) 536-1354.

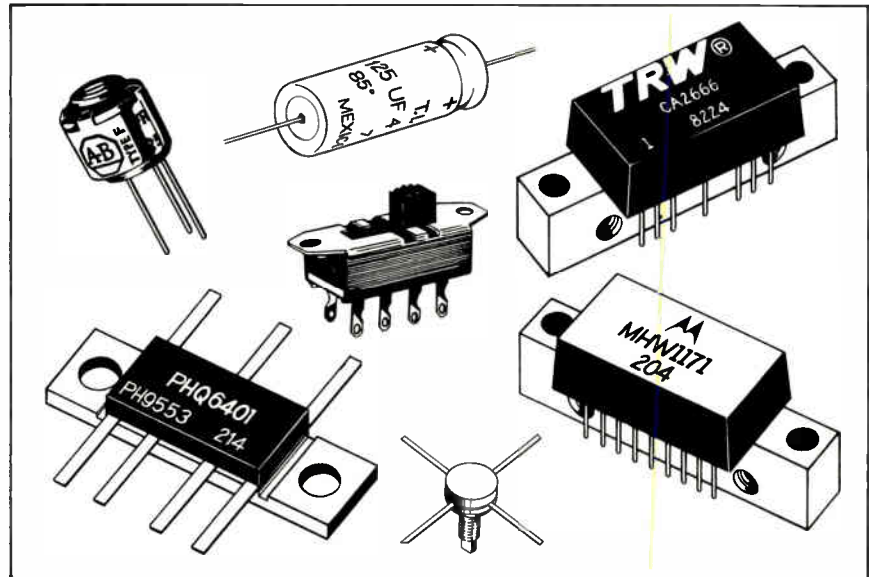

Broadband: For fast delivery of replacement components

Broadband is the largest independent supplier of replacement components in the CATV industry. We got that way by providing quality replacement components when you need them at a fair price.

Broadband stocks over 1,000,000 parts with one working day service on

most orders. That means faster repair in your shop and less down time for your equipment.

For more information, call Broadband Engineering at 800-327-6690 (in Florida 305-747-5000) or write us at 1311 Commerce Lane, Jupiter, Florida 33458.

For quality, performance and service, call Broadband



Reader Service Number 64

The LAN market will spur the development of two-way products anyway.

Cable Communications Scientific has developed a system which it calls P-CAM, offering a non-interfering system for doing LAN alignment and allowing daily adjustments to gain and slope settings. The company also has developed a more precise LAN test lead using 140 dB shielded cable and a 110 dB shielded, industrial quality connector. Contact: CCS, (317) 326-2601.

Joe Preschutti's new company, Broadband Networks, will start shipping its new split-band tap in January 1987. It lets LAN designers lay out the forward path at one set of tap values, then engineer the reverse path using a different set of tap values.

"If you've ever tried to design a two-way system, you probably ran into the problem of incorrect values on the return path, forcing a shrinking of total system reach," Preschutti says. The new tap takes care of that. The tap uses a set of duplexing filters and one dB-step attenuators in both the for-

ward and reverse paths. The taps can be factory set for either high- or mid-split systems. Interestingly enough, the sorts of additional devices Preschutti's company will be looking at are the sorts of things CATV might have gotten earlier had two-way really taken off. Now it appears the LAN market will spur the development of those products anyway. Contact: Broadband Networks, (814) 237-4073.

Off-premises

AM Cable's TGT system, meanwhile, will soon get a pilot test at a top-five MSO site in the Southwest. The company's pitching its off-premises system as a good rebuild or newbuild solution in high density areas, especially where it's important to coexist with trapping. The TGT oscillators can be factory set to avoid as many as six channels where pay channels are run. AM's Verruto says TGT offers an addressable passing in an MDU environ-

ment for under \$50. Also, as far as the old argument about subscriber modules—do you put them all in at once or add them on as subs are turned on?—TGT drops all modules in at once. That makes convenient new sub promotion, such as program sampling, possible. Since the modules are all in place, all you have to do is activate the sample channels from the headend. Also, the system transmits in the clear and inserts jamming carriers at the MDU box. That offers a couple of advantages. There's no scrambling for subscribers to defeat and the full band is passed to the house, so VCR taping is pretty simple. Contact: AM Cable, (215) 536-1354.

Commercial insertion

Falcone International has developed a version of its single-channel Autosserter that can do ad insertion on two channels using one tape player. The ASI 2X offers two-channel insertion

Advertisers' Index

Reader Service #	Page #	Reader Service #	Page #
Alpha Technologies	14	Nexus Engineering	43
Anixter Communications	47, 68	Northern CATV	69
Belden Corp.	4	Oak Communications	31
Broadband Engineering	64, 65	PTS Electronics	60
Burnup & Sims Lectro.	10	Panasonic	25
Business Systems Inc.	27	Pico/Macom	39
CMS Corp.	30	Pioneer Comm.	7
CWY Electronics	31	Power Guard	66
CableBus Systems	36	RMS Electronics	11
Cable-Link	52	Radyne Corp.	44
CableReady	5	Rainbow Satellite	63
Cable Services Co.	6	Reliable Electric	55
Channel Master	26	Riser-Bond	13
Channematic Inc.	33	Sachs Comm.	40
Computer Utilities of the Ozarks	29	Sadelco	20
Comsonics	51	Scientific-Atlanta	1
Com-Tek	22	Signal Vision	58
Control Technology	16	Standard Comm.	19
Di-Tech	42	Telecommunications Products	35
Eagle Comtronics	61	Telecrafter	12
FM Systems	45	Telewire	9
First Data Resources	32	Texscan	49
GNB Batteries	59	Texscan MSI-Compuvid	37
Hughes Microwave	57	Time Manufacturing	18
ICM Video	8	Times Fiber	67
Information Systems Planners	28	Trilogy Communications	3
Kanematsu-Gosho	38	Triple Crown	48
Leaming Industries	46	Vitek	21
Lemco Tool Corp.	41	Vitek/LRC	24
Lightening Deterrent Corp.	23	Wavetek	56
Lindsay Specialty Prod.	54	Wegener Comm.	50
Magnavox	17	Weldone Trading Co.	62
Midwest Comm. Corp.	53	Zephyrus Electronics	15
			26

Most vendors at the Atlantic Cable Show were selling; Resource Recovery Systems was buying.

capability at \$2,600. In essence, the processor takes advantage of the fact that some networks offer ad avails at relatively more predictable times and lengths while some networks offer a bit more variation. The ASI 2X is programmed to watch a relatively less predictable network, ESPN for example, and then switch over to a relatively more predictable network like CNN.

The company also is working on a new, IBM-driven, eight-channel, random access ad inserter. It's ABC-100 automated break compiler can cut tape editing time from "eight to three hours," says Falcone's Allen Kirby. Contact: Falcone International, (404) 427-9496.

Scrap?

Most vendors at the Atlantic Cable Show were selling. Resource Recovery Systems was buying. The company is a national buyer of wreckout cable, and offers a chance to turn five or more miles of wrecked out cable into revenue. The company provides the local labor to handle the cable and a local processor to bundle it. Generally speaking, a minimum of five miles of wreckout cable is required before RRS can take the job. Contact: Tom Woods Jr., (713) 493-5158.

New Tocom software

Release V3.0 software for Tocom's Micro-ACS Addressable Control System is now available to all Tocom customers, having finished its Beta testing. Designed to be more user-friendly, its new enhancements include easier access to the subscriber data base, dynamic control of channels and the headend video processor. Preprogramming of parental ratings and tagging is possible. Subscriber records can now be accessed by name, account, phone or converter serial number and in-the-field initialization of 5503-VIP converters also is possible with the new software. Contact: Tocom, (214) 438-7691.

SCTE senior members

Four new senior members of the Society of Cable Television Engineers were recently named. They are: Mi-

chael Aloisi, regional engineer for Showtime/TMC and president of the Chattahoochie Chapter, Atlanta; David Randolph, vice president, engineering, Group W Cable, Grapevine, Texas; Roger Seefeldt, fund director of

engineering, Jones Intercable, Denver; and Lynn Watson, regional engineer, Showtime/TMC, Dallas. Senior membership requires at least 10 years experience in the industry and is the highest professional grade for which the

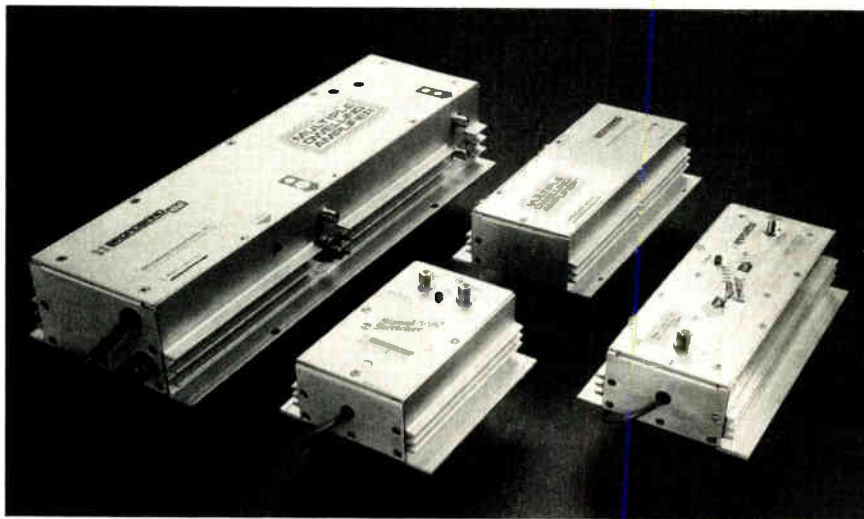

Broadband: For the best in distribution amplifiers

Broadband Engineering has a distribution amplifier for every application from the lowest cost to the highest performance CATV, MATV and SMATV installation.

Flexibility to meet demanding system requirements is our goal with:

- Bandwidths up to 550 MHz
- Gains from 14 to 50 dB
- One and two-way operation
- Sub, mid and high-split options
- Standard or power doubler hybrids
- Line, cable and class II powering

Extruded aluminum housings insure excellent heat transfer from active devices for long life and reliable service.

And we don't forget maintenance either. Our hybrids are installed in sockets so that replacement is quick and easy and down time short.

We don't cut corners in design, we engineer the best.

For more information on specifications, call Broadband Engineering at 800-327-6690 (305-747-5000 in Florida) or write us at 1311 Commerce Lane, Jupiter, Florida 33458.

For quality, performance and service, call Broadband



Reader Service Number 65



CABLE POWER FOR ALL SEASONS

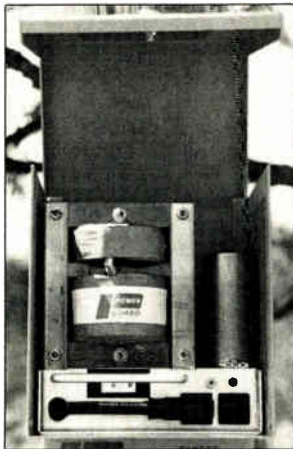

**MODEL NS-6015-0
FERRORESONANT
POWER SUPPLY**

The Model NS-6015-0 is rated at 15 amps/60 VAC... All active components are located in the plug-in module, which allows for easy installation and servicing in the compact (8"W x 8"D x 11"H) housing. Various options available.

The Power Guard NSM-6015 is available with a retrofit plate for use in other power supply and standby power supply housings!



**MODEL SB-6012-24-0
STANDBY POWER SUPPLY
FEATURES**

Temperature compensated battery charger, Totally modularized electronics, All active components on plug-in modules, Automatic switch over when either module removed, Simple/fast installation, security locks, Built-in short circuit and overload protection, Under voltage protection, Approved quick disconnect, Large battery compartments. Various options available.

THREE YEAR WARRANTY

POWER GUARD is able to give a limited three-year warranty on the POWER GUARD power supply due to the "kool" operation created in the design of the proprietary transformer and the packaging of the unit. Tests indicate a 20 (plus) year projected life.



MADE
IN
USA



P.O. Box 549 • Hull, Georgia 30646
(404) 354-8129

Reader Service Number 66

SCTE accepts applications. There are 550 senior members in total.

Cable pioneers

Kip Fletcher and Cay Cooley, two of the first Jerrold engineers, were honored at a Pennsylvania Cable TV Association banquet Oct. 27. Also recognized that evening were Frank Brophy, George Uritis, William Dimmerling, Joseph Gans, George Gardner and Peter Walsonavich, all early shapers of the CATV industry.

Moving up and on

Mike Hayashi has assumed marketing responsibilities for Pioneer Communications, replacing Jennifer Miller, who has become the account executive for Pioneer at the ad agency of Leff and Squicciarini.

Steve Dozier, meanwhile, is now western regional sales manager for Hughes Aircraft Co.'s microwave communications products. Steve is moving to Denver and will market the AML line of products.

Ralph Patterson has joined Alpha Technologies as western regional sales manager. He'll be based in Southern California.



Kathy Miller

Kathy Miller is new southeastern sales rep for GI's Network Cable Division.

At Pico Macom's OEM Sales Division, Glenn O'Connell has been promoted to sales manager, with responsi-

THE ARCOM FAMILY

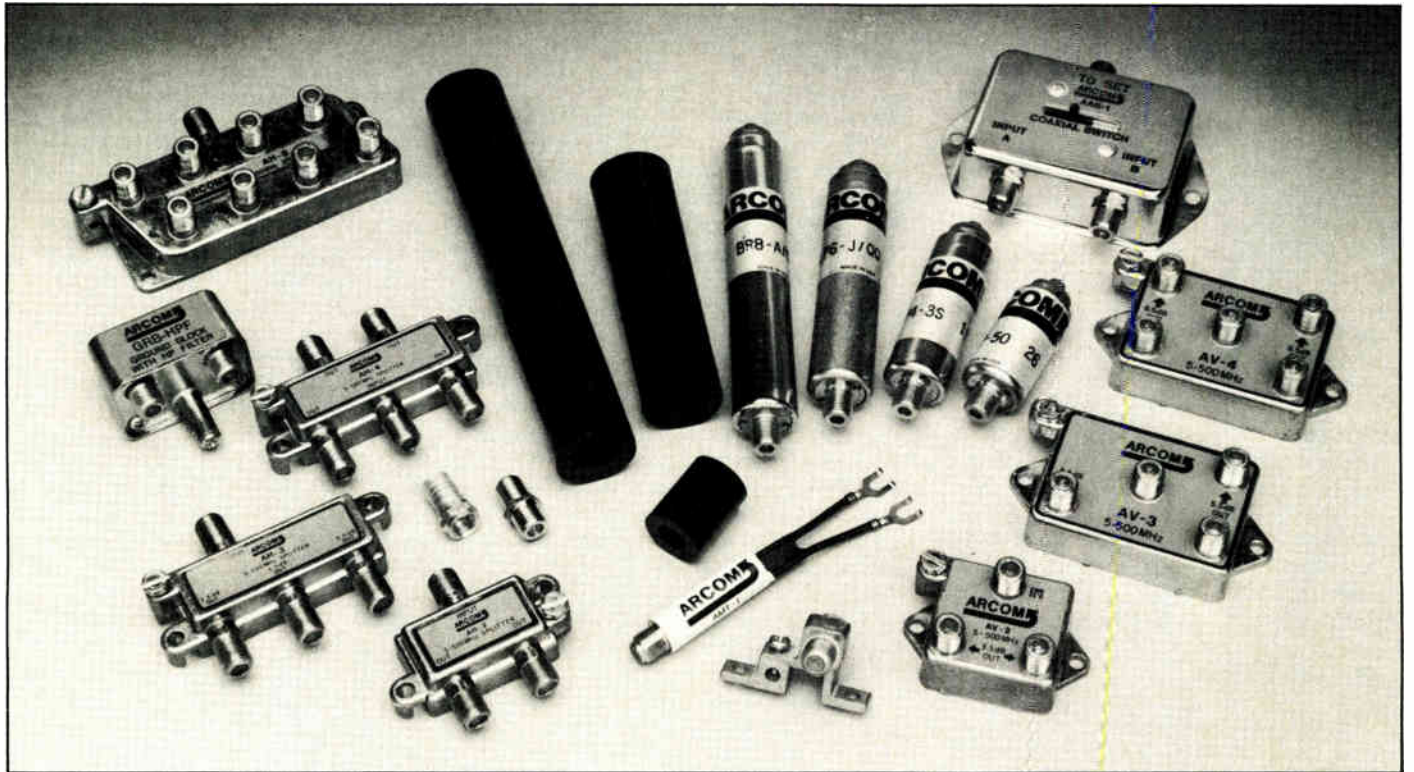

If our quality doesn't sell you,
our service will.

ARCOM traps are the #1 quality traps in the industry. So, what would you expect from the rest of the ARCOM family? Quality, of course. But, what good is great quality, if you can't get it when you need it. And, that's where our extraordinary service comes in.

Because we're dedicated to growing, we're

Give us a call for
full specs and pricing.

Call Toll Free
(800) 448-1655

In N.Y. State Call
(315) 463-8433

dedicated to giving our customers the best service in the industry. That means more hustle. More friendly, informed personnel. *And* faster deliveries.

If top quality products and top quality service are what you need for your system, why not get to know the ARCOM family of fine CATV products.

 **Northern**
catv sales, inc.

Sytek's recovered from the hangover it got from IBM and the IBM PC Network.

bility for CATV product development as well. At Pico's Home Satellite western division, Jesse Rusmisl has been promoted to sales supervisor. Sam Tagliavore is new company sales rep for the Pacific Northwest.

At Nacom Construction Corp., David Miller is new director of operations.

CMS has added three software support reps: Charmain Tyler, Mary Towne and Carol McNamara, all based out of headquarters.

And James Taglia, a CATV veteran who recently retired as Hughes Aircraft Co.'s microwave division southeastern regional sales manager, died of a heart attack in Atlanta, Ga., on Sept. 22 at the age of 62. Taglia had worked for Hughes Microwave and its predecessors for 20 years and had also worked for Jerrold and the NCTA.

Lost diagrams?

In the October issue of *CED*, we ran an article on BTSC by Chris Bowick. In editing the article to fit, we had to delete two diagrams mentioned on page 18 (diagrams 2 and 3). If you want them, contact Linda Johnson, (303) 860-0111. She'll send them to you.

New gear

Tele-Engineering has announced an add-on Auto-Mate interface that retrieves and stores spot logs for as many as six channels run on the Ad-Log commercial insertion system. The battery backed-up RAM stores as many as 6,000 logs. It sells for \$1,595. Contact: Tele-Engineering Corp., (617) 875-3137.

Hewlett-Packard has a new 50 kHz to 22 GHz model HP 71201A spectrum analyzer, designed for test, bench and manufacturing applications. It sells for \$45,000 with delivery 12 weeks ARO. Contact the local Hewlett-Packard sales office listed in the telephone directory for further information.

Tektronix has a new generation 2710 spectrum analyzer covering the 10 kHz to 1.8 GHz band. The portable device weighs less than 20 pounds, has a 5 MHz IF bandwidth filter, 10^{-5} accuracy and four-trace storage. It sells for \$8,250. Contact: Tektronix, (503) 627-

2228.

New controllers

Jerrold has introduced a new addressable controller, the model AH-4E and a new data signal generator, the model DSG II 106.5. The new controller adapts to one- or two-way impulse PPV ordering using the company's Starfone or Starvue sidecar ordering systems. The new controller is smaller than its predecessor, the AH-4, and costs about 10 percent less. The new data generator is used with Jerrold addressable control systems, uses fewer components than earlier models and, hence, should be more reliable. Both products are immediately available. Contact: Jerrold, (215) 674-4800.

Also, NCS Industries is now stocking Jerrold repair parts and subassemblies for line extenders, headend gear and amplifiers.

LRC/Vitek Electronics has introduced a new VT-X single-channel cylinder rejection trap, available for channels 2 through 6. HRC, Prime, IRC and other offsets are available. Each trap has a two-year warranty on parts and one year on labor. Contact: LRC, (607) 739-3603.

Wavetek Corp. has bought the Matrix Test Equipment Inc. line of signal sources and measurement products and will be adding the acquired firm's line of carrier generators and analyzers to Wavetek's existing line of test products. Contact: Wavetek, (317) 788-5968.

Also in the test area, Sadelco has introduced the Super 600 Special and Super 900 Special, two new low cost 600 and 900 MHz signal level meters. Contact: (201) 569-3323.

Applied Instruments, meanwhile, has named Cable Communications Scientific as its distributor for North America. Applied Instruments makes a line of test and switching equipment for the local area network and I-net markets. Contact: (317) 782-4331.

Cable Services Co. now is distributing Great Lakes Data billing systems. Contact: Cable Services, (800) 332-8545.

Deepening its distribution network, Anixter has opened four new service centers in Jacksonville, Fla.; Portland, Ore.; Sacramento, Calif.; and Colum-

bus, Ohio. The company further plans to open centers in Wichita and Kansas City, Kan., in January 1987. Other locations will be added as the year progresses. Contact: (312) 677-2600.

And Midwest Communications Corp. now has its first West Coast office with the acquisition of Bennett Engineering of Seattle, Wash. Contact: Midwest, (606) 331-8990.

Klein Tools, meanwhile, has added five new parts storage boxes to its line of containers. The metal boxes measure 18 by 12 by 3 inches. Contact: Klein (312) 677-9500.

Also new: the model CS-27 cable jacket stripper from Lemco Tool Corp. One size fits cable ranging from .375 to one inch thick. The device costs \$16. Contact: Lemco, (717) 494-0620.

Sytek PC LAN

Sytek's recovered from the hangover it got from IBM and the IBM PC Network. Sytek was the authorized supplier of PC Network communication boards. Unfortunately, Sytek got tied up with the demands IBM placed on it and got stuck when orders never materialized and IBM dropped it as a supplier. Sytek's new System 6000 PC LAN, which accommodates as many as 1,000 IBM PCs, uses similar technology but has price advantages over other PC LANs. The System 6000 is based on standard NETBIOS, making it compatible with IBM token ring and PC Network software and hardware.

The company also has added products to its System 2000 family LAN: a modern board supporting the Manufacturing Automation Protocol; a network bridge connecting any channel to other channels on the same or remote networks, a statistical monitor; a DES standard encryption system; and interfaces allowing synchronous and asynchronous devices to be connected to the LAN. Contact: Sytek, (415) 966-7300.

TRW/Chipcom

Chipcom Corp., the Ethernet-over-broadband specialist, is now supplying TRW's Information Networks Division with Ethermodem products. Contact: Chipcom, (617) 890-6844.

—Gary Kim

THE ANATOMY OF A SUPER CABLE

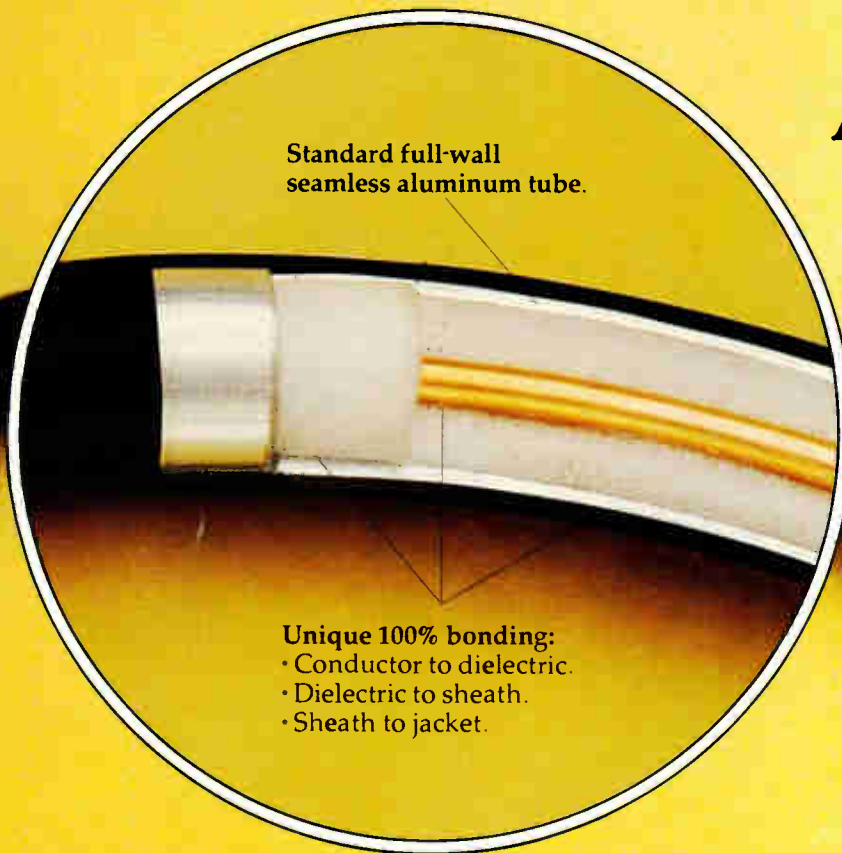

Standard full-wall seamless aluminum tube.

Unique 100% bonding:
• Conductor to dielectric.
• Dielectric to sheath.
• Sheath to jacket.

Bend radius as tight as 4" with 1/2" cable.

INTRODUCING T4 PLUS™ TOUGHER AND TAMER FOR EXTRA PERFORMANCE WITHOUT COMPROMISE.

THE STANDARD IS NOW THE SUPER-STANDARD

Standard connectors and cable preparation tools. No additional parts inventory or special training required.

Temperature-stable electrical and mechanical performance, to withstand broad temperature swings and years of winter/summer extremes.



Jacket bonded to sheath for additional handling ease and increased corrosion protection. Peels away easily, leaving no adhesive residue. Continuous conductor-through-jacket bonding greatly increases sidewall and pull strength. Extra-rugged LLDPE* jacket dramatically increases abrasion resistance and reduces pulling friction.

*Linear Low Density Polyethylene is an extra-tough polymer that still can be readily cut for cold weather connectorization.



Easy coring with standard tools. Resistant to abuse. No objectionable residue left on aluminum surface.



For a sample of this remarkable new cable, contact TFC today at P.O. Box 384, Wallingford, CT 06492, (203) 265-8482 or (800) 243-6904.

TFC

TIMES FIBER COMMUNICATIONS, INC.
an L P L company

Visit us at the Atlantic Cable Show
Booth #311-313
Reader Service Number 67

CABLE TV'S GREAT NEW REVENUE PRODUCERS



HEADEND VIDEOCIPHER (VC2C)

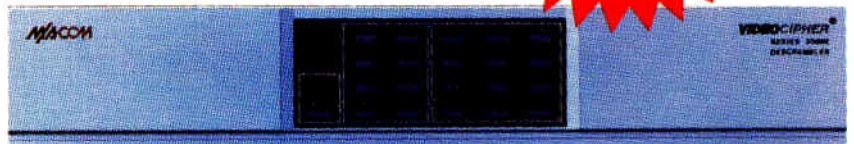

VIDEOCIPHER II TVRO MODEL 2000E

M/A COM's VideoCipher II, the revolutionary descrambler, accepted for use in demanding high quality satellite program distribution environments, is now available through Anixter's nationwide distribution network.

This new system produces a descrambled signal that is indistinguishable from the original, even at low C/N.

VideoCipher II descramblers are rack-mounted and interface easily to commercial satellite receivers.

VideoCipher II can control up to 56 independent tiers of programming, and its security system assures that a descrambler can only receive programming in tiers for which it has been authorized.

And, when planning to order your **VideoCipher II** descramblers, remember it's good business practice to have a couple of spare descramblers to serve as common back-ups.

Now you can help TVRO customers in your franchised areas to stay tuned to their favorite programming with the **VideoCipher II TVRO Model 2000E**.

TVRO owners have invested heavily in their satellite systems. And now some of their favorite programming is scrambled or about to become scrambled.

With more than a million and a half people with TVRO systems, and thousands buying new systems every month, the start of scrambling opens up a whole new world of incremental sales for Cable-TV System Operators. Act now! Order your M/A-Com **VideoCipher II TVRO Model 2000E** from Anixter today.



CORPORATE HEADQUARTERS: ANIXTER BROS., INC.
4711 Golf Road, Skokie, IL 60076 (312) 677-2600 — Telex 289464

* VideoCipher is a Registered Trademark of M/A COM, Inc.

©1986 Anixter Bros., Inc.

Reader Service Number 68

Mail To: **ANIXTER COMMUNICATIONS** 4711 Golf Rd., Skokie, IL 60076

Please send me M/A COM'S VIDEOCIPHER II Technical bulletin.
 Please send me M/A COM'S VIDEOCIPHER II 2000E Technical bulletin.

Name _____
Title _____
Company _____
Address _____
City _____ State _____ Zip _____
Phone _____

12/86 CED

Please see us at the Western Show, Booth #235.