

MAY 1986

COMMUNICATIONS ENGINEERING AND DESIGN
THE MAGAZINE OF BROADBAND TECHNOLOGY

CEED

**Converter
compatibility
trend grows**

**More action on
MAP; more
players in
broadband
LANs**

**TVRO slump will
pass, many
smaller
operators say**

**THE NEXT 12
MONTHS:
WHAT'S
AHEAD?**



CEED000208204 01
FRED MCCORMACK
HASTAD ENGINEERING
448
56548
HALSTAD MN

If you've had to bear the expense of replacing your entire mainstation every time you needed to add new features, that's too bad.

Too bad you didn't choose Magnavox originally. We've understood the economics of upgradability ever since we built our first mainstation. We designed it to set-up fast, easy and economically; and inserted compatible, plug-in modular components ever since.

Today, cable operators using Magnavox look very smart because our new Power Doubling™ and Feedforward fit into the original housing to do wonders to reduce noise and distortion. Our new Parallel Power Doubling™ retrofits nicely so it can push profitable signals into more subs homes, too.

The point being, it's never too late to begin with, or rebuild with, Magnavox.

For more cost-effective data please call our Marketing Department toll-free for our upgrade update.



A NORTH AMERICAN PHILIPS COMPANY
100 FAIRGROUNDS DR., MANLIUS, N.Y. 13104
TOLL-FREE 800-448-5171 (IN NY, 800-522-7464)

Our mainstation has held its own since 1972. How's yours doing?

1972

"TH" housing. Durable and still in use today.

1976

System Sentry Status Monitoring

1980

Bridger & Trunk Switching. 6 dB switchable pads for ingress localization.

1980

440/450 MHz technology. A Magnavox first.

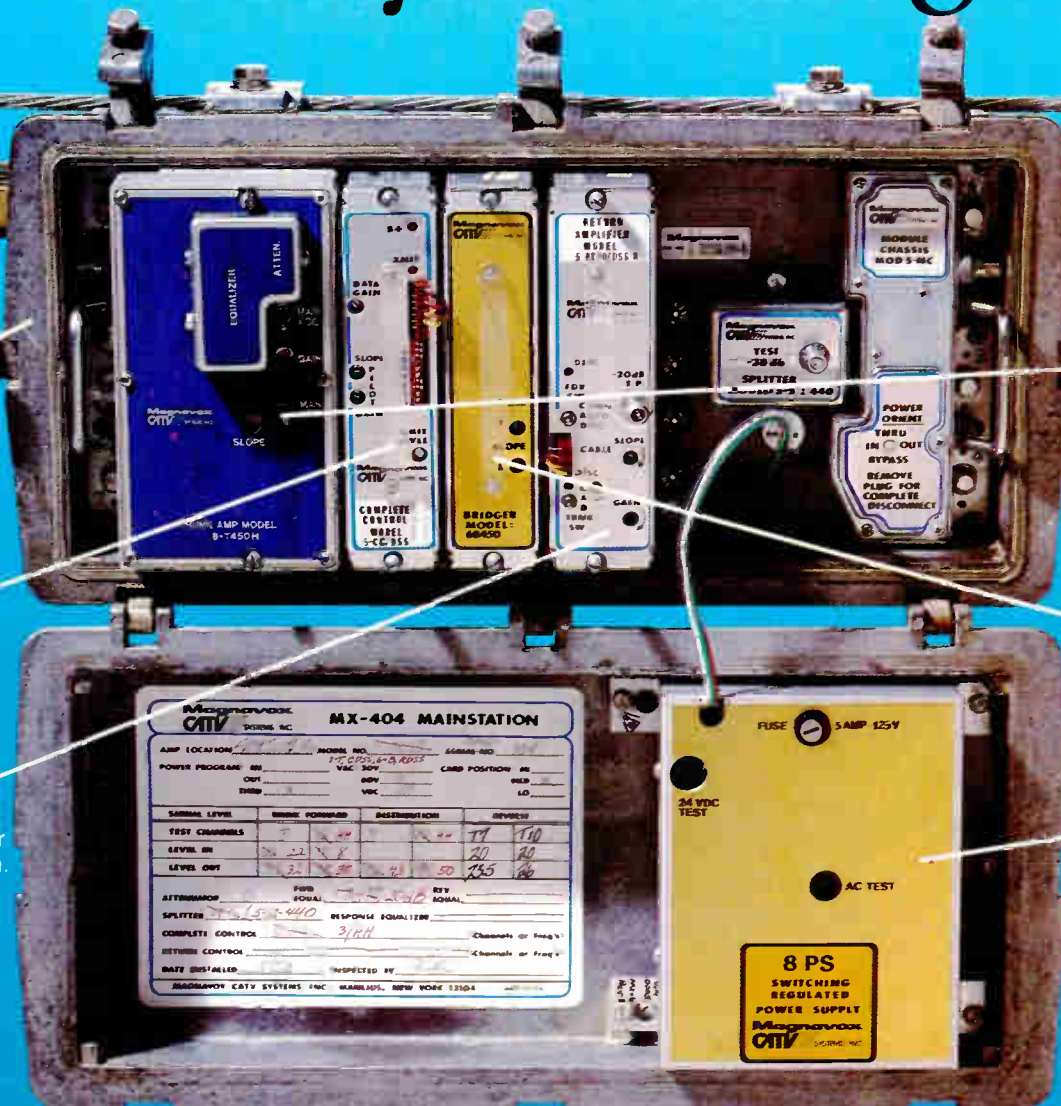

1984

Feed-forward with Power Doubling™. We're first again.

1983

Single chip Power Doubling™. Another Magnavox first.

1983

Switching Regulated Power Supply Increases efficiency at least 25%.

TRIOLOGY LEADS IN TECHNOLOGY:



AIR
THE PERFECT
DIELECTRIC

ONLY

MC²
COAXIAL CABLES
HARN²SSED IT

That unique achievement resulted in the only coaxial cable with 93% velocity of propagation. Which means the lowest attenuation over the longest distances. It means fewer amplifiers in new installations, and stronger signals with less noise in rebuilds and upgrades. Cost-effectiveness in

all situations is significant.

And the polyethylene sleeve—totally bonded to sheath and disc spacers—assures superior handling characteristics. With MC², you don't have to trade off signal strength for tight bends and ruggedness.



Reader Service Number 2

Call or write for a free sample and brochure:

TRIOLOGY COMMUNICATIONS INC. • 2910 Highway 80 East, Pearl, Mississippi 39208

Trilogy

COMMUNICATIONS INC.

800-874-5649
601-932-4461

EDITORIAL

Gary Y. Kim
 Publisher/Editor
Kathy Berlin
 Associate Publisher
Lesley Camino
 Production Editor

CONSULTING ENGINEERS

Chairman
Wendell H. Bailey, NCTA Vice President, Science and Technology Members
Ron Coffen, Vice President of Engineering, Daniels & Associates
Bob Dattner, Vice President, Media General Cable
John Dawson, Director of Engineering, Mile Hi Cablevision
Roy Ehman, Vice President of Engineering, Storer Cable Communications
Mark Elden, Director of Engineering, Showtime/The Movie Channel
Robert Luft, Senior Vice President of Engineering, United Artists Cablesystems
Steve Raimondi, Director of Engineering (East), United Artists Cablesystems
Graham Stubbs, Vice President, Science and Technology, Oak Communications
Sruki Switzer, Consulting Engineer
Joe Van Loan, Engineering Vice President, Viacom Cablevision

PRODUCTION

Jeff Knight, Production Director
Brad Hamilton, Art Director
Diane Krensky, CED Art Director
Debra Rensel, Typography
Diana Fuehrer, Circulation Director
Tanya Golden, DP Manager

ADVERTISING

Cathy Wilson, National Sales Manager
Christina Panczyk, Classified Sales
Lesley Camino, Promotions Coordinator
Sandi Benke, Division Secretary

Patrick Keleher, President/CEO
David Carlton, Vice President/
 Financial & Administration

OFFICES

Denver International Thomson Communications Inc., 600 Grant Street, Suite 600, Denver, CO 80203 - or - P.O. Box 5208 T.A., Denver, CO 80217, (303) 860-0111.

Washington Bureau 1625 I Street, Suite 615, Washington, D.C. 20006, (202) 835-0900.

New York Bureau 432 Park Avenue South, Suite 1109, New York, N.Y. 10016, (212) 213-3110.



INTERNATIONAL THOMSON COMMUNICATIONS INC.

©1986 by International Thomson Communications Inc. All rights reserved. CED, (USPS 300-510) (ISSN 0191-5428) is published monthly by International Thomson Communications Inc., 600 Grant St., Denver, CO 80203. © May 1986, Volume 12, Number 5. Subscriptions free to qualified industry readers. All other one-year subscriptions are \$26, prepaid in U.S. funds only. Second-class postage paid at Denver, CO. CED is published on behalf of the cable television and broadband communications industries. POSTMASTER: Please send address changes to P.O. Box 5208 T.A., Denver, Colorado 80217. MEMBERS OF THE BPA.

SPOTLIGHT

John Kurpinski

Today's technicians need better training says Kurpinski.

6

MY TURN

The state of the art

MSOs need to get more involved in R&D efforts.

8

CLASSICS

The next 12 months: what's ahead?

New NCTA Engineering Committee Chairman Walt Ciciora sums up major technical issues facing the CATV industry in the year ahead.

16

So what's a Bode equalizer?

It's an adjustable equalizer used in the telephone industry since the late 1930s and imported to CATV. This paper by Donald Groff explains how it works.

18

TVRO slump will pass. . .

. . . just as soon as everybody scrambles, say many independent small MSO operators widely scattered throughout rural areas of the country.

30

Converter compatibility a growing trend

New boxes on the market are designed to work with multiple scrambling modes.

38

More players in broadband LANs

Viacom and Zenith are two of the newest entrants.

45

What's good for General Motors. . .

. . . might just be good for lots of companies selling CATV-type hardware and services.

51

Keep looking over your shoulder

Fiber optic cable is starting to migrate from the long-distance and trunk markets to the local loop and LAN market.

62

PRODUCT PROFILES

Pedestals 57

DEPARTMENTS

Return Path 12

In Perspective 14

Classifieds 63

Ad Index 64

About the cover

Walt Ciciora, vice president, new technologies, at ATC, is the new chairman of the NCTA Engineering Committee.

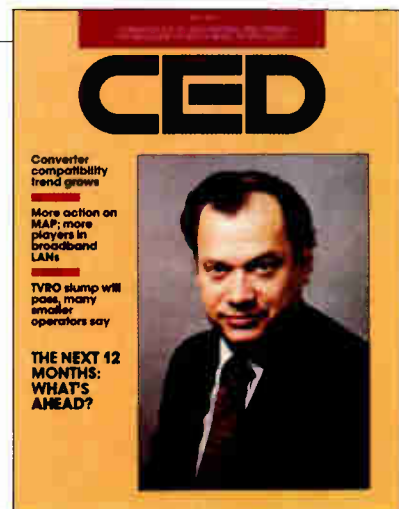

Scientific
Atlanta

IMMEDIATE
AVAILABILITY

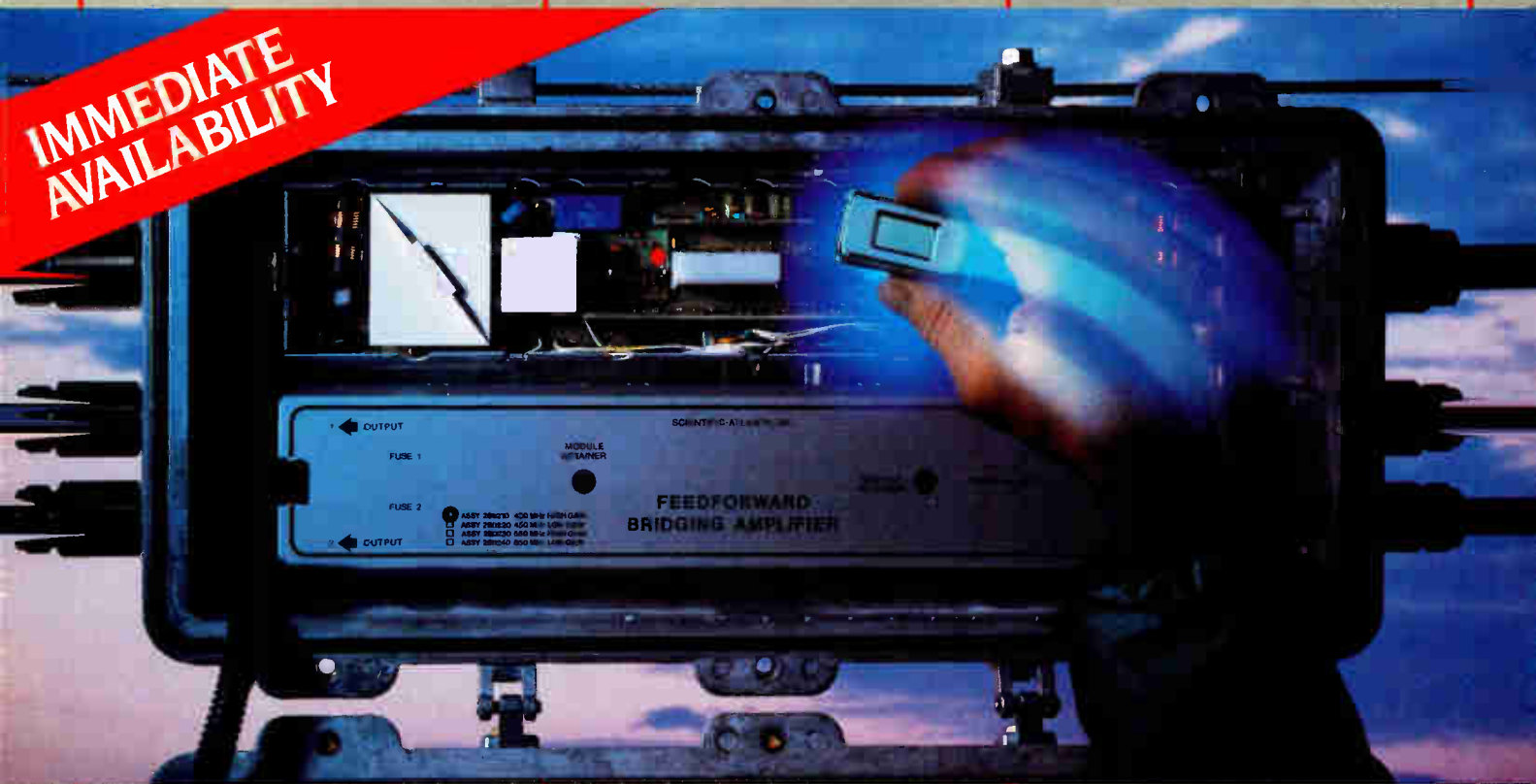

FEEDFORWARD AMPS BY SCIENTIFIC-ATLANTA. ON-LINE SERVICEABILITY, IN A SNAP.

FEEDFORWARD GAIN BLOCKS MAKE BACK-TO-THE-FACTORY SERVICE OBSOLETE.

Which feedforward amplifier is easier to service—the one that must be removed from the line, brought back to the bench, tested, and probably sent back to the factory? Or the amplifier that can be tested on-line, and, if necessary, simply opened, serviced with a snap-in replacement module and closed.

More importantly, which feedforward amplifier will cost you less to operate?

Scientific-Atlanta answers those questions with a new line of trunk, bridge, and line extender amplifiers which combine feedforward performance with push-pull simplicity.

**SIMPLE IS BETTER...AND
LESS EXPENSIVE.**

By using a single Feedforward Gain

Block instead of the collection of components currently used in feedforward amplifiers, Scientific-Atlanta has taken a major step forward. All discrete feedforward hybrids and circuitry have been removed from the amplifier circuit board and enclosed within a single, easily replaceable gain block. Nothing to match, nothing to align or misalign—just dependable feedforward performance.

The Scientific-Atlanta feedforward test set verifies the on-line performance of each Feedforward Gain Block and can be effectively used by even the novice technician—no factory service personnel needed.

THERE'S MORE TO THE STORY. Feedforward Gain Block isn't the whole story, either. Our feedforward amps are more than just unmatched modularity and serviceability. You'll find superior heat dissipation and resulting longer operating life, plus highly effective lightning and

surge protection, ultra-stable AGC and dependable stepped pads and equalizers.

With Scientific-Atlanta, you will get the most out of your distribution electronics.

For more information about Scientific-Atlanta's feedforward distribution amplifiers, clip the coupon or call Pat Miller at (404) 925-5462.

Please send me more information on Scientific-Atlanta's new feedforward amplifiers. **5/86 CED**

Name _____

Title _____

Company _____

Address _____

City _____ State _____

Zip _____ Phone (_____) _____

Mail to: Scientific-Atlanta, Dept. AR,
3845 Pleasantdale Road, Atlanta, GA 30340.

Reader Service Number 3

**FREE FEEDFORWARD TEST SET WITH ORDER
OF 20 FEEDFORWARD AMPLIFIERS**



John Kurpinski: Stressing training for the future

"You'd be surprised at the number of techs who don't have the background, the basic knowledge needed to perform in day-to-day operations," says John Kurpinski, director of sales and marketing for Cable Services Company Inc. "There were a couple of surveys done last year in the trade publications on problems facing operators," Kurpinski says. "And the number one problem, the biggest headache, was getting and keeping qualified people."

CATV is a complex technology. That's part of the problem. Also, "I don't know of any college or learning institution in the country that you can go into and walk out four years later with a degree in cable television," says Kurpinski. "The industry right now is a hybrid of RF, digital and audio technology. It's tough to go to a school where you can learn all the technologies in one swoop."

This lack of training is what motivated Kurpinski to start a meeting group of the Society of Cable Television Engineers (SCTE). "I noticed there weren't too many technical people coming to the shows. Mostly high level engineers were attending the technical sessions, and they aren't the ones who need training—it's the grass roots, day-to-day technician who needs

the information." So Kurpinski founded a group in the Philadelphia area which later became the Delaware Valley Chapter of the SCTE.

A member of the SCTE since 1974, Kurpinski was elected SCTE Member of the Year for 1983. He is past president of the Delaware Valley Chapter of SCTE and currently serves as the chapter's secretary/treasurer. Kurpinski also heads the chapter development committee and has served on the Broadband Communications Technician/Broadband Communications Engineer (BCT/BCE) and relocation committees. He is the author of *Guide to Chapter Development* and, as associate director of the Atlantic Cable show, is responsible for the technical programs. Kurpinski was part owner of a small cable system in upstate New York and served on the board of directors of the New York Chapter TV Association for five years.

Currently an at-large-director, and eastern vice president of the SCTE, Kurpinski sees his role as "sort of giving a helping hand to the regional directors. I help meeting groups and chapters get started and help with their technical programs and problems. I also try to encourage membership at the national level."

"One thing we can't figure out," Kurpinski says, "is why, when the industry needs so much training, is there so little involvement in the SCTE? There are approximately 30,000 technicians and engineers in CATV and only 3,000 are members of the SCTE. The lack of training causes a snowball effect in the industry. Instead of going right to the problem, an unqualified tech spends time looking for what's wrong. Then the subscribers get irate because it's not quick enough and it reflects back on the entire operation."

"A cable operator," he adds, "will gladly spend \$5,000-\$10,000 on a marketing effort to get more subscribers. But ask him to pay that same amount for test equipment to do a better job, and he'll balk." As systems are rebuilt to 450-550 MHz and more sophisticated services are introduced, better training and higher qualifications are a must.

Some 23 years ago, when he first got into cable, Kurpinski was working with 12 channels and transistor type

equipment. But there's always something new: 550 MHz, hybrid circuits and sophisticated programming." It's unbelievable," he says.

But Kurpinski feels there's room for even more growth and expansion. "Look what's happened with pay-per-view—they're the glory people in the industry. There's only so much revenue you can get out of a subscriber, and the way to get more income per subscriber is PPV. You just can't hammer them year after year with rate increases in basic. I think cable operators will realize more money on a PPV basis, than if they were to sell an additional pay to the subscriber."

Another area Kurpinski sees as a good revenue source for cable is in selling data services, although he feels many cable operators are mom-and-pop operations and scared of the data technology. "But to run data you need a good cable system," Kurpinski says. "It has to have a good maintenance program and be very reliable."

In his present position with Cable Services, he is responsible for complete turnkey system sales: from strand mapping and design, purchasing of equipment, sales, marketing, advertising and inventory control. "I guess over the years I've gotten away from the real in-depth engineering, more into administration and sales. But I've always been involved with the technical end of sales."

"A problem we face," he notes ironically, "is communication. For an industry that bases its whole technology on communications, we don't communicate. There are many groups that have problems and just as many organizations trying to solve those problems—but everyone's working on different levels. The NCTA is an effective organization but doesn't represent the entire industry in a rule-making capacity. The FCC makes a decision, and we have a number of different groups all fighting to solve it but not as a total group."

"We've come a long way in cable, and we're starting to turn the corner as far as training goes. But we still have work to do. The more sophisticated our services become, the better we have to make our basic systems—and our industry."

—Kathy Berlin

Agile Omni, the industry's most advanced receiver designed by the most relied upon name in the business... Standard.

With the new Agile Omni, you need no other receiver. Standard designed it for cable TV operators, broadcasters, CATV, SMATV, and business and special teleconferencing networks—now and in the future.

An onboard microprocessor permits selection of any band available from domestic satellites, including the 32-channel ANIK C2. Channel tuning provides direct reading of the transponder-assigned channel number and a format control permits selection of six frequency band formats—24-channel C-band, SBS/USAT and Spacenet already installed. Select channel and format, and the microprocessor controls frequency, channel spacing, transponder bandwidth, audio

frequency and bandwidth, and antenna and video polarity—automatically.

Omni's flexible design can handle up to three separate subcarriers including stereo programming or data. Omni also will accept descrambling modules—eliminating the need for expensive add-on descramblers.

For CATV and SMATV applications, severe microwave terrestrial interference is minimized by optional internal SAW notch filters, automatically programmed to switch in. A 30 MHz low DG/DP LC bandwidth filter is standard, and a second internally installed optional filter of 18, 22, 26, or 36 MHz bandwidth can be controlled by the microprocessor, or manually switched.

Standard's proven RF

loop-thru circuitry and blockdown conversion technology combine, with better image rejection and lower differential gain and phase, to provide excellent video performance. C/N threshold is an impressive 6.5 dB at the wide 30 MHz bandwidth.

Agile Omni is an affordable, flexible receiver designed to keep you in business, a commitment Standard backs with its unique 5-year warranty program. Contact us for further information.

Standard
Communications

P.O. Box 92151
Los Angeles, CA 90009-2151
Toll free 800/243-1357
(In Calif. 800/824-7766, ext. 275)
Reader Service Number 4

Engineered to a new Standard



Operating functions including MGC, AGC, AFC, level sets, normal/invert video, clamp/unclamp video, skew, subcarrier frequency selection, video and IF test points are conveniently located on the front panel. Meter reads C/N ratio, signal strength or center-tune.



Format control enable selections of desired satellite system. Direct-reading channel selector displays transponder-assigned channel. Second selectable subcarrier and space for optional third subcarrier or descrambler modules.



The state of the art

Engineers can do anything (almost), if they have strong enough motivation and an adequate supply of time and money. We learned to fly, not quite as freely as the birds, but faster and farther. We have learned to use machines to magnify our limited muscular and sensing capabilities and to perform incredibly complex mental exercises with enormous speed and precision. Only 50 years ago, the very idea of flying to the moon was so preposterous as to be entertained only by poets, writers of fiction and dreamers. The engineers did it, at great cost, motivated in much the same way as George Mallory who wanted to climb Mount Everest—simply “because it is there.”

It has been written that “disinterested intellectual curiosity is the lifeblood of real civilization.” And so it is, with the scholars, astronomers and scientists in the great universities, observatories and laboratories of the world, whose motivation derives more from insatiable curiosity than the prospect that serendipity may yield practical results. Without the study of the behavior of electrons in quartz crystals or the development of the esoteric mathematical theory of numbers, the computer revolution could not have happened.

Entrepreneurial engineers, which most of us are, do not have the liberty to pursue “disinterested intellectual curiosity.” Innovation in entrepreneurial enterprise is necessarily motivated almost exclusively by the bottom line. Innovation in this arena is necessarily intended to improve the product (or its perception), reduce costs or generate new or enhanced revenue. New ideas may grow slowly out of trial and error or they may explode in brilliant flashes of inspiration. Sooner or later, however, new ideas have to be tested against the bottom line of the P&L statement.

Development is the process of con-

verting an innovative idea into state-of-the-art technology. Research is the gathering together of information and knowledge which may or may not lead to the development of a useful idea. Both R&D are essential contributors to the state-of-the-art.

Most of us have promised at one time or another to build state-of-the-art cable TV systems. Probably a good many of us claim, and truly believe, we have done just that.

Just what does “state-of-the-art” mean? To a researcher studying plasma physics, the term is likely to mean the threshold of knowledge or, perhaps, the limit of what can and has been accomplished in the laboratory, at least once. Cost is not part of the definition, although lack of adequate funds certainly can inhibit accomplishment. In space travel or nuclear power generation, safety is, or should be, a necessary criterion, while cost is given much lower priority. In the laboratory, in space or in nuclear power plants, ready availability of components “off the shelf” is of virtually no concern, so long as what is needed can be fabricated or custom built. In the automotive industry, is the state-of-the-art represented by the futuristic, twenty-first century sketches in the popular magazines?

If the state-of-the-art is what people want, why is it that so many cars are sold with ordinary, old-fashioned, skid-prone braking systems, idiot-light dash boards and ordinary carburetors without fuel injection? Could cost have something to do with it?

The state-of-the-art truly is a moving target. What was experimental yesterday may be state-of-the-art today and obsolete tomorrow. Ten years ago, 35 channels (300 MHz) was the state-of-the-art. Five years ago, 55 channels (400 MHz) met the criteria, soon followed by 63 channels (450 MHz). If 80 channel technology (550 MHz) is not yet considered state-of-the-art, it probably soon will be.

It is quite interesting to note, however, that there is increasing demand for 46 channel (350 MHz) equipment—apparently for upgrades. Like the demand for cars without state-of-the-art features, consumer demand for cable service requires an adequate choice of programming and reliable service, but

not necessarily today's version of the state-of-the-art.

Qualifications & suggestions

To qualify as the state-of-the-art in cable television, I believe new systems, new hardware or new software should meet the following criteria:

- Production models should be readily available with reasonable delivery schedules (not more than a few months from placement of the order), preferably from more than one supplier.
- Capability to perform the intended functions effectively and reliably should have been demonstrated in the field under actual operating conditions.
- The effective net cost to subscribers should be acceptable in the consumer marketplace.

Ideally, engineers would prefer to field test new technology under actual operating conditions long enough to not only detect the effect of weather and temperature but also to pick up subtle and often overlooked operational defects. In the real world, such luxury may not be affordable. Innovation for us is something like a crap shoot. The odds depend on engineering evaluation of hardware, operational evaluation of concepts and manufacturing quality control. If a new idea is successful, the inventor is a certified hero. Otherwise, the roof may fall in on him. We need something better.

The MSOs, no one of which claims as much as 10 percent of the total subscriber count, cannot be expected to individually support an R&D effort anywhere near the scale of the Bell Labs. On the other hand, if there is a legally acceptable way to do it, why not a joint R&D effort by operators, although on a much smaller scale than Bell Labs? Competition among operators for franchises is in substantial decline. All operators could benefit, to the detriment of none. Let the suppliers compete to produce, or improve upon, the innovations developed by the operators.

Six hundred years ago, Chaucer wrote: “For he that naught n'assaieth, naught n'acheveth.” Nothing ventured, nothing won.

Why not develop our own state-of-the-art? Engineers can do it, you know. ■

By Archer Taylor, Senior Vice President, Engineering, Malarkey-Taylor Associates Inc.

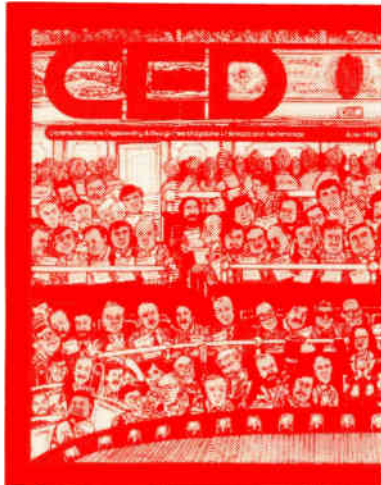
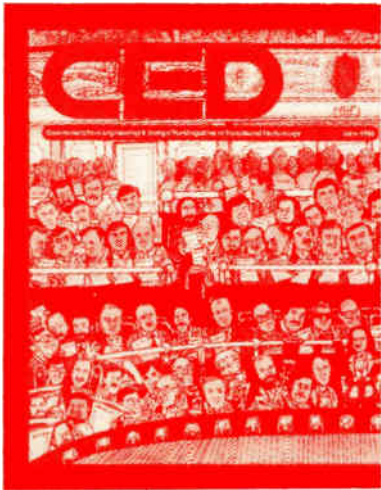

CED

Reader Service

on the products

Name _____

Title _____ Company _____

Address _____

City/State _____

Zip _____ Phone _____

Signature _____

In the performance of my job, I authorize, specify or purchase products and/or services.

Yes No

Reader Service Information
(circle these numbers for prompt reply)

Advertising

1	11	21	31	41	51	61	71
2	12	22	32	42	52	62	72
3	13	23	33	43	53	63	73
4	14	24	34	44	54	64	74
5	15	25	35	45	55	65	75
6	16	26	36	46	56	66	76
7	17	27	37	47	57	67	77
8	18	28	38	48	58	68	78
9	19	29	39	49	59	69	79
10	20	30	40	50	60	70	80

Please circle the category that best describes your firm's primary business (please circle one).

- CABLE SYSTEM OPERATORS
 A INDEPENDENT CABLE TV SYSTEM
 B MSO (TWO OR MORE CABLE TV SYSTEMS)
 C CABLE TV CONTRACTOR
 D CABLE TV PROGRAM NETWORK
 E SMATV or DBS NETWORK
 F MDS, STV or LPTV OPERATOR
 G MICROWAVE or TELEPHONE COMPANY
 H COMMERCIAL TELEVISION BROADCASTER

- I CABLE TV COMPONENT MANUFACTURER
 J CABLE TV INVESTOR
 K FINANCIAL INSTITUTION, BROKER or CONSULTANT
 L LAW FIRM or GOVERNMENT AGENCY
 M PROGRAM PRODUCER or DISTRIBUTOR
 N ADVERTISING AGENCY
 O EDUCATIONAL TV STATION
 P SCHOOL or LIBRARY
 V OTHER

(Please describe)

16E1



**NO POSTAGE
NECESSARY
IF MAILED
IN THE
UNITED STATES**

BUSINESS REPLY CARD

FIRST CLASS PERMIT NO. 162 DENVER, CO

POSTAGE WILL BE PAID BY ADDRESSEE

International Thomson Communications Inc.

P.O. Box 5208 T.A.
 Denver, Colorado 80217-5208

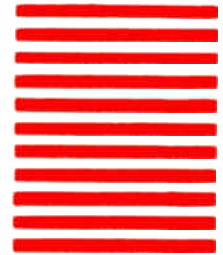

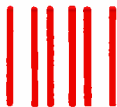

**NO POSTAGE
NECESSARY
IF MAILED
IN THE
UNITED STATES**

BUSINESS REPLY CARD

FIRST CLASS PERMIT NO. 162 DENVER, CO

POSTAGE WILL BE PAID BY ADDRESSEE

International Thomson Communications Inc.

P.O. Box 5208 T.A.
Denver, Colorado 80217-5208

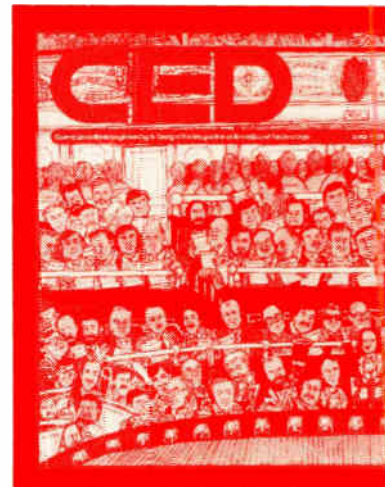

CED

I would like to receive a complimentary subscription to **CED**.

Name _____

Title _____ Company _____

Address _____

City/State _____

Zip _____ Phone _____

Signature _____

No. I'm sorry. I can't take advantage of the offer. —

In the performance of my job, I authorize, specify or purchase products and/or services.

Yes No

16E1

Please circle the category that best describes your firm's primary business (please circle one).

- CABLE SYSTEM OPERATORS
 - A INDEPENDENT CABLE TV SYSTEM
 - B MSO (TWO OR MORE CABLE TV SYSTEMS)
- C CABLE TV CONTRACTOR
- D CABLE TV PROGRAM NETWORK
- E SMATV or DBS NETWORK
- F MDS, STV or LPTV OPERATOR
- G MICROWAVE or TELEPHONE COMPANY
- H COMMERCIAL TELEVISION BROADCASTER
- I CABLE TV COMPONENT MANUFACTURER
- J CABLE TV INVESTOR
- K FINANCIAL INSTITUTION, BROKER or CONSULTANT
- L LAW FIRM or GOVERNMENT AGENCY
- M PROGRAM PRODUCER or DISTRIBUTOR
- N ADVERTISING AGENCY
- O EDUCATIONAL TV STATION, SCHOOL or LIBRARY
- V OTHER

(Please describe) _____

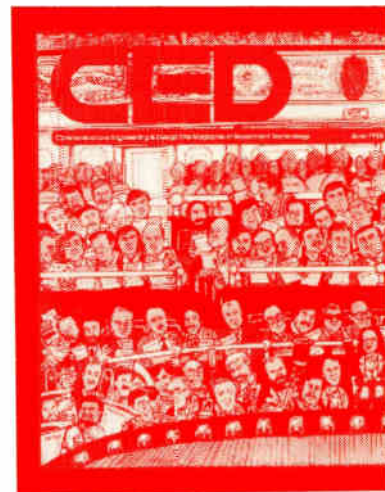

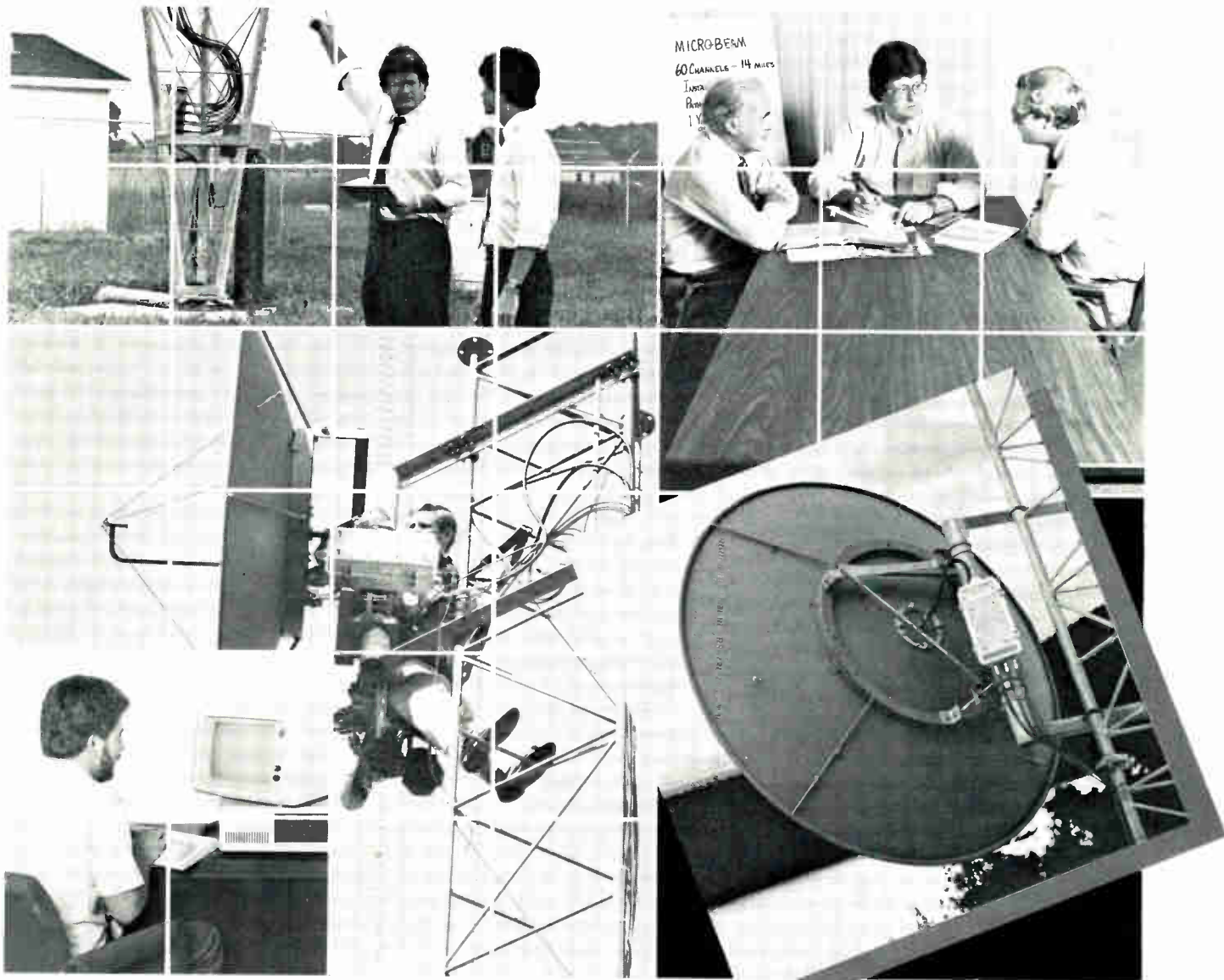

Micro-Beam™ solves the profit puzzle

Total Customer Service:

- | | |
|---|------------------|
| • 1 Year Parts/Labor Warranty | NO CHARGE |
| • Installation of Micro-Beam™ Equipment | NO CHARGE |
| • Path Alignment | NO CHARGE |
| • F.C.C. Application Help | NO CHARGE |
| • Feasibility Study | NO CHARGE |

The Puzzle: How to generate more revenue while minimizing capital expenditures, and still ensure subscriber satisfaction.

The Solution: Cost-effective plant expansion using Micro-Beam™ broadband microwave relay systems from Channel Master®.

Channel Master® makes CARS-band microwave technology affordable AND SIMPLE for systems of any size. Micro-Beam™ specialists offer more customer services at no charge than anyone in the business.

Compare Micro-Beam™: the SIMPLE choice in CARS-band microwave.

Channel Master®

Division of Avnet, Inc. P.O. Box 1416, Industrial Park Drive, Smithfield, N.C. 27577 • (919) 934-9711

Reader Service Number 5

return path

Dunbar's article discussed

The March *CED* was particularly interesting, not only because of the excellent coverage of the status of broadband LANs, but also the article by R. Dunbar on the calculation of system noise figure. The latter subject is an area that I investigated in considerable detail a few years ago. Although Mr. Dunbar's paper presents modified equation 1 above, F_c would actually be slightly less than 2 (3 dB) because of not, as he claims, the correct analytical description of the noise figure for a cascade.

Equation 8 in the article is not an exact equation for the network under consideration. Rather than M devices in cascade, as noted by the author, there are actually $2M$ devices since each amplifier is followed by a cable with a specific attenuation. Although the cable is a passive device, it too has a noise figure, i.e. the cable is a source of noise due to its attenuation. The noise figure of a cable with attenuation $1/L$ is exactly equal to L as derived in a paper presented at a previous NCTA convention.¹ (In the more conventional notation, the attenuation in dB would be $-10 \log L$.)

A section of the network, shown in Figure 1, consists of an amplifier with power gain G and noise factor F in series with a cable with an attenuation $1/L$. The exact expression for noise factor F_c for the two devices in tandem is:

$$F_c = F + \frac{L-1}{G} \quad (1)$$

The units of F , L and G are in absolute value—not in dB. Equation 8 in Mr. Dunbar's article assumes that the noise factor is equal to F (the noise factor of the amplifier alone). The assumption is valid in practical cable networks, where the second term in equation 1 is usually much smaller than F . For example, with $L >> 1$, $L = G$ at unity gain, $F_c = F + 1 \cong F$ for $F >> 1$.

The concept of a noise factor for a

passive component does become important when low noise amplifiers are encountered—as in satellite receivers. For tutorial purposes, it is interesting to consider the case in which the amplifier is noiseless, i.e. $F = 1$ and $G >> 1$. According to Mr. Dunbar's equation, the noise factor of the unity gain network in Figure 1 would be equal to one, or i.e. 0 dB. However, as shown in equations for a cascade of amplifiers and cables, his initial formulation is the noise contributed by the lossy cable. See referenced papers 1 and 2 for more detail.

The derivation of Mr. Dunbar's equation 19 appears unnecessarily complicated. The output noise power N_o of an amplifier with a noise factor F and gain G is:

$$N_o = N_i FG \quad (2)$$

when N_i is the input thermal noise power at a given reference temperature.

The contribution to the output noise power caused by N_i , the input noise power, is:

$$N_i G \quad (3)$$

Therefore, the difference between equations 2 and 3 is the noise power caused by the amplifier:

$$N_o = (F-1) N_i G \quad (4)$$

Equation 4 becomes Mr. Dunbar's equation 19 when it is expressed in logarithmic terms. It should be noted that equation 4 is also the expression for the noise added by a cable with $G = 1/L$ and $F = L$.

I hope that these comments will be of value to *CED* readers and, perhaps, generate further discussion on this topic.

Dr. H. W. Katz,
Program Director,
Communications Technologies,
Trintex

Dunbar replies

Dr. Katz does not identify the errors correctly. The first error is that the cascade picture on page 72 (March *CED*) should have the cable length be-

fore and not after the amplifier. Dr. Katz assumes that the picture is correct and proceeds on that basis, which is not the case. The "devices" are the cable plus amplifier sections and, therefore, there are M , not $2M$, sections.

The second error is that nf is defined in the article as the amplifier noise factor, which is incorrect. It should have been defined as the section noise factor (cable plus amplifier). For calculation purposes, nf on page 72 should be replaced with $g(nf_c)$ where nf_c is the amplifier noise figure.

Equations (12) and (14) are noise figures and must be added to N (-59 dBmV) to get the values in Table 1. Although the equations included the noise factor of the cable, the calculation on Table 1 did not. I apologize for the errors.

Dr. Katz's derivation of equation (19) is indeed a better approach. I had been attempting to use an arbitrary input noise level, in which case his equation (2) would be:

$$N_o = N_i FG \frac{1 + T_o/T_s}{1 + T_o/T_o}$$

where T_o is the temperature at which F was measured.

When $T_s = T_o$, then this reduces to his equation (2) and the rest of his analysis follows. Since the amplifier noise contribution is independent of the input noise level, there is no loss of generality by making $T_s = T_o$. It just never occurred to me that this generality was not lost.

Dr. Katz's equation (4) differs from equation (19) by a factor of G . This is because he has chosen a different, but equivalent, model of the device.

All variables are in linear units. p is the noise power (in watts) in a small band df , g is the gain and nf is the noise factor of the device ($p_{T_o} = kT_o df$).

ARTICLE MODEL:

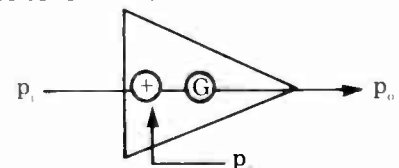

Continued on page 66

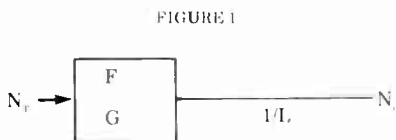

QUICK,...WHAT DO JERROLD, OAK, AND HAMLIN ALL HAVE IN COMMON?



The Pioneer BA-5000.

In the past 12 years, you had only one opportunity to choose converter hardware and an effective scrambling method for your cable system. And once your decision was made, it was final. There was no turning back.

But today, with Pioneer's multi-vendor compatible converter, you have the freedom to integrate a more reliable, consumer-friendly converter into your system without immediately changing out your entire subscriber base. It's that simple.

If you plan to upgrade to addressability, the BA-5000 means you will never again be locked into one source of supply. And, you can periodically switch

between the various scrambling modes — an excellent defense against potential service piracy.

Or, if you're dissatisfied with your system's performance, simply integrate the BA-5000 into any compatible system. You get the immediate benefit of upgrading your system to Pioneer security and reliability, without inconveniencing subscribers or disrupting your system.

Call Pioneer toll-free at 1-800-421-6450 and we'll explain why the BA-5000 is the best choice to enhance the reliability and profitability of your addressable system.

Multi-vendor compatibility...you asked for an alternative and now you've got one.

 **PIONEER®**
PIONEER COMMUNICATIONS OF AMERICA, INC.

More stringent plenum/riser cable rules on the way

Sometime this fall, it appears, new provisions of the National Electric Code will mandate tougher standards for CATV cables used in risers and plenums: vertical airshafts and horizontal air conditioning ducts in high-rise and commercial structures. Although the proposed new regulations won't be unveiled until the May 19-22 convention of the National Fire Protection Association in Atlanta, it's expected that they will require the use of Teflon-coated or similar flame- and fume-resistant jacketing by July 1, 1988, in all commercial buildings wired for CATV or local area networks using 75-ohm coax.

The details aren't cast in stone yet, and some vociferous opposition has to be expected at the May meeting and afterward, according to Jim Stilwell of

TeleServices R&D. But he has no doubt the rules will stick. Stilwell is the official NCTA representative to code panel 15, which has responsibility for weighing changes to section 820 of the NEC, dealing with CATV. The new rules would apply only to cables not enclosed in conduit, Stilwell says. "In-nets and MDUs will be most affected, although the in-home portions of subscriber drop cables also are covered by the new rules."

And although the telephone industry will have to comply with the new rules as soon as they're published, in July or so of this year, both the data communications industry and the CATV industry likely will get a longer transition period. Computer room wiring running at low voltage won't have to be switched over to the new stan-

dard until July 1, 1988. The CATV industry will have the same deadline.

Lively discussion

Stilwell says there was "lively" discussion about the proposed new rules at the December panel meeting. At issue is the quality of cables that may be installed by telephone, data and CATV contractors in the wake of the AT&T system breakup. The immediate trigger for the new rules was a switchboard fire at a Bell operating company office in New Jersey recently. Firemen there were injured by fumes caused by burning cables. The larger backdrop, though, is a recent flood of cheap wire and cable into Canada, many of them having "horrible" smoke and flame properties, Stilwell says. There's some concern these cables might migrate to the United States.

Although the primary impetus to stop the installation of such cables

COMMAND PERFORMANCE

- Hinged lid
- Easy access battery location
- Spill-guard battery trays (available)
- Insulated shelf for battery protection
- Modular construction
- Lightning arrestor
- Bottom indicator lights and entries

- 15 OPTIONS** including
- Remote Status Monitor
 - Automatic Performance Monitor
 - Vandal and corrosion resistant galvanized steel pedestal enclosure

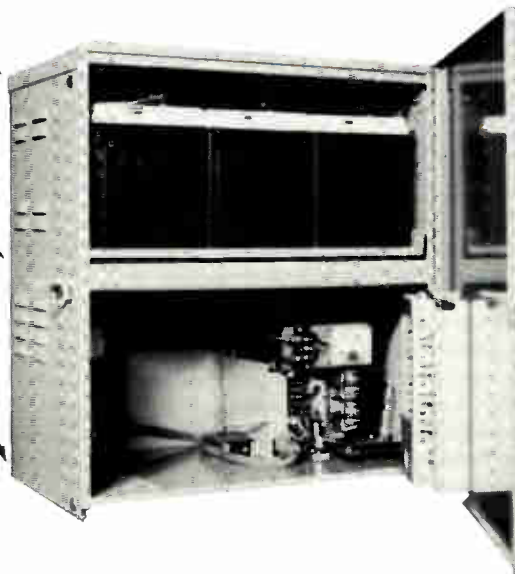

STANDBY POWER SUPPLY
Model CL 737XL
UL LISTED
FIELD PROVEN RELIABILITY

Factory and Customer Service:
 14860 N.E. 95th
 Redmond, WA 98052
 (206) 882-2304

Service:
 Redmond, WA
 (206) 882-2304
 Deerfield Beach, FL
 (305) 429-0870
 Ontario, CANADA
 (416) 629-1111

Reader Service Number 7

CABLE POWER INC.

A Triple Crown  Corporation

Opposition expected over economic consequences of plenum/riser cable rules.

probably comes from the insurance industry, which sponsors the NFPA and would bear the brunt of liability arising from the use of flammable and toxic cables, AT&T representatives also made clear their view that deregulation could possibly lead to less-careful installation procedures. "It's largely true that AT&T did an honorable job of self-policing when they had a monopoly," Stilwell says.

There are some differences in the rules governing CATV and telephone cables. "Telephone companies can't use cables with greater than one-quarter inch diameter," Stilwell says. "CATV, because it needs the higher frequencies, can go up to three-eighths of an inch. One-half inch would have been nice, but we couldn't get it."

Squawking expected

"A lot of people are going to raise hell about the economic consequences,

but the cost factor per foot of cable shouldn't be measurable," Stilwell argues. "We'll simply have to inventory a few new types of listed cables, tested for compliance with the new standard by some independent testing agency, like Underwriters Laboratories. In fact, we should have an evolution to the new standards by suppliers long before the mandatory deadline of compliance."

The rules for plenum cables are the most stringent; the rules for drop cable, the least stringent, Stilwell says. Riser cables and plain cables in walls fall in between. "Drop cables, in fact, are hardly affected by the new rules," Stilwell adds. "Once you're in the house, there's a limitation on the distance you can run polyethylene or PVC, depending on whether it's in conduit or not. Generally, you'll have to terminate the drop as near as possible to the point of entry into the house." Still, he thinks the cost differential

should be negligible for residential homes. The real impact could come if a series of MDU or commercial units with non-rated cables is acquired by a new owner. It's possible the old cable bundles would have to be pulled and replaced.

In any case, it's an issue to watch because there doesn't seem to be any likelihood of stopping the new rules.

The code panel sees safety as paramount, and it's not likely the new rules would be abandoned just because they're a bit inconvenient or add a little to the cost of construction. And, remember, Stilwell doesn't think the changes really will amount to much on the cost side.



\$495⁰⁰

For a limited time you can order M/A-COM's CSR-T1001 receiver from TELE-WIRE and pay just \$495.

Where else can you get a commercial quality, 24 channel tunable satellite receiver for such a low price? The CSR-T1001 features synthesized tuning, dual IF inputs, dual independently tunable audio modulators, LNB conversion, and comes with a one-year warranty. And of course it's VideoCipher® compatible.

Take advantage of this special price. Order one receiver or a hundred and one — but do it now. This is a one-time offer that won't be repeated. (Companion block downconverter also available.)

To Order: call 800/645-9510 (in NY 516/293-7788)

Ask For Department 'B'

TELE-WIRE® SUPPLY CORPORATION

Corporate Headquarters: 7 Michael Avenue • E. Farmingdale, NY 11735

New NCTA chair examines cable issues

As the new Chairman of the NCTA Engineering Committee, I would like to take this opportunity to review some of the technical issues facing the cable industry and enlist your support in the efforts to work toward solutions. This discussion is not intended to be comprehensive. Rather, selected important topics are explored. Other significant topics are left for another forum, another time.

The technical issues facing the cable industry can be viewed in three broad categories: short term, for instance BTSC stereo sound; longer term, which includes the state of R&D in the industry and High Definition Television (HDTV); and continuous issues such as FCC liaison and professional affairs. The continuous issues have been with us for as long as anyone can remember and will continue as long as cable exists.

In the short term, by far the most important technical issue is the consumer electronics interface. There has been more difficulty, debate and frustration over this issue in the last few years than any other topic. The essence of this problem is the subscribers' frustration over the loss of functionality and convenience when cable employs certain kinds of program protection techniques. The reason for the importance of this issue is simply that cable subscribers enjoy nearly all of their cable services through personally owned consumer electronics devices. These devices have shown two important trends: they are increasing in number and in variety. Whatever the solution(s) may be, it must be applied in many places in the home and accommodate many different features. The frustration of those working on this problem is that there have been no simple, universally applicable solutions. Nearly every proposed approach applies to only a small segment of the market, has some disadvantage—such as substantial expense—or will take a long time to implement.

One of the most promising solutions, the Decoder Interface Standard (IS-15) will take awhile to achieve its full impact. This Electronic Industries Asso-

Consumer electronics interface biggest short-term technical issue.

ciation (EIA) interim standard spells out the technical details for facilitating the plugging in of a descrambler module into the back of a TV receiver or VCR. Several years of effort went into achieving this standard. When the work started, this was a long-term technical issue. Over time, it has become a short-term priority.

To harvest the benefits of this work, the cable industry must motivate the manufacturers of consumer electronics equipment and decoders to make available equipment with the proper plugs and internal circuits. This will require the manufacturers to make a substantial investment in design, tooling and marketing. Cable must help these manufacturers appreciate the value of these efforts to their future businesses.

Two related standards are the EIA/NCTA RF Cable Interface interim standard (IS-23) and the EIA/NCTA Recommended Cable Television Channel Identification Plan (IS-6). The RF Cable Interface standard defines the requirements for successful technical operation of consumer electronics devices in a cable system. The most important and difficult topic has been the device's immunity to direct pick-up. IS-6 defines the relationship between channel numbers and frequencies. It is up for transition from an interim standard to a permanent standard. There are a few issues to be resolved before it can be promoted. Each of us must become a soldier in the struggle to promote the realization of the standards which will make our cable services more consumer friendly.

The EIA Home Bus committee's principal potential impact on cable will be the expected creation of industry standards for infra-red remote controls and standards for hard wire and wireless communication between devices such as residential security modules.

A related consumer electronics interface technical issue, which deserves separate attention, is multi-channel television sound (MTS), as defined by the Broadcast Television Sound Com-

mittee (BTSC) of the EIA. At one time it appeared that BTSC would be an unmitigated disaster; it was feared that the subscriber's new stereo sound TV receiver would yield annoying and unacceptable noises and distortions when connected to cable. This was particularly troublesome when the specter of a must-carry situation was upon us. Now we appreciate that what we have is a difficult, expensive problem, but not an impossible task. Significant implementation and clarification work lies ahead. One of the strongest needs is for standard, cost-effective, user-friendly equipment. Another priority is affordable, reliable encoding equipment so our satellite-delivered signals will play through the subscriber's new MTS TV receiver.

We must make our industry and our industry association, the NCTA, more technology aware. The pace of technology's advance is accelerating. It is difficult for technologists to comprehend the consequences, let alone communicate them to the non-technical decision maker. But we must increase our sensitivity to the threats and opportunities offered by advanced technology. When cable fails to take advantage of an opportunity which others grasp, cable loses two ways: first, cable misses an opportunity to become stronger; secondly, a potential competitor gains additional strength.

There is a need for increased technical cooperation between cable companies. Much can be gained from a sharing of experience and learning.

At least four new business opportunities have strong technological components: pay-per-view, commercial communications services audio services, and residential security. In all cases, technology exists to make a start at the businesses possible. But cost-effectiveness, reliability and user-friendliness need improvement.

Potentially competitive technologies include DBS, MMDS and VCRs. The customer isn't buying technology; she is buying programming and convenient access to that programming. It would be a mistake not to realize that the competitor is not a technology, but rather better signal quality, more convenience or more cost-effectiveness. Better signal quality involves not only

Continued on page 16

By Walter Ciciora, Ph.D., Vice President, New Technologies, American Television and Communications

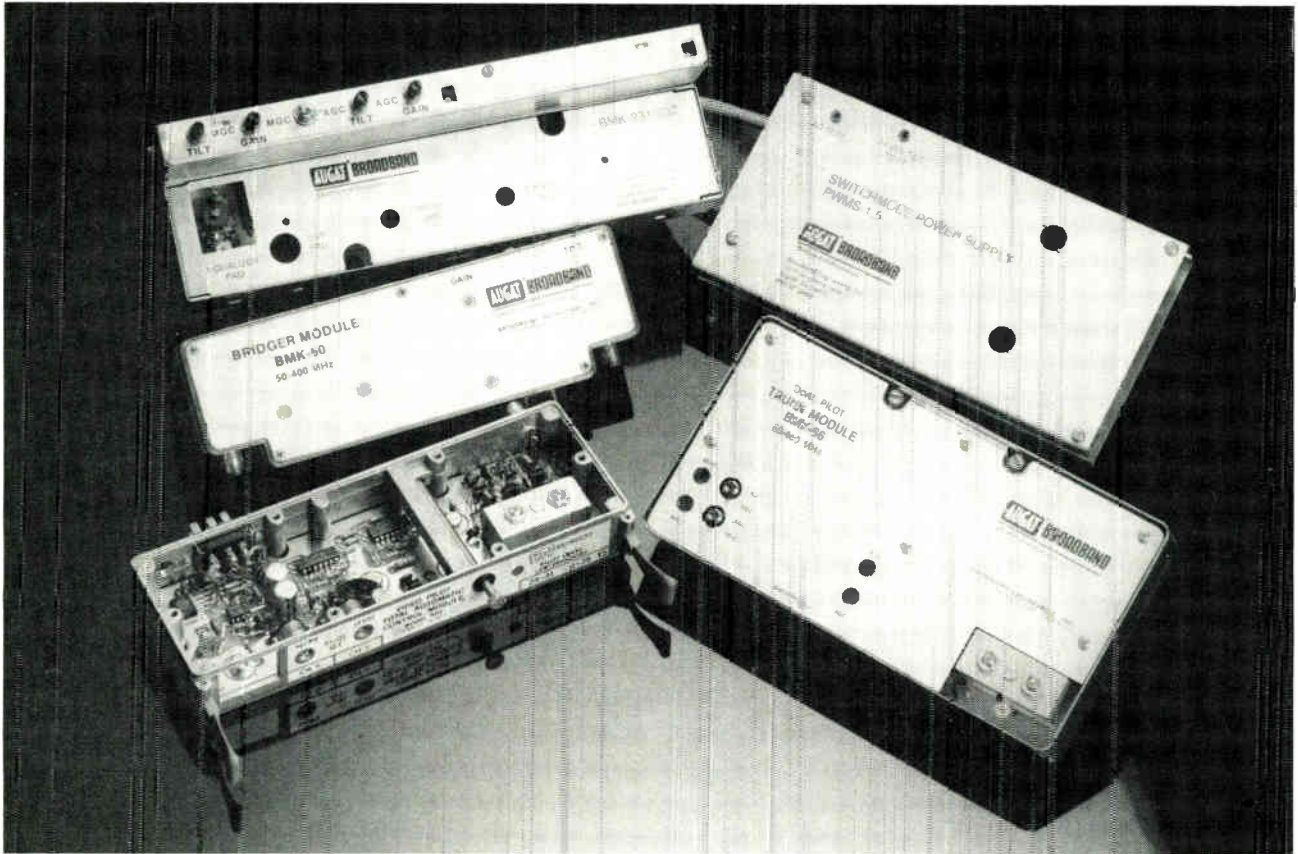

Broadband: The leader in upgrade electronics

Upgrading rather than rebuilding has been the cost effective way of extending the life of cable systems by many years thus adding profits to the bottom line.

Broadband originated the concept of upgrading almost 9 years ago and we have continued our leadership ever since.

You can feel confident with the technical superiority and reliability that we have always been known for.

We don't look for quick fixes, we engineer long term solutions to your upgrading problems.

The result is electronics better than the original equipment that you are upgrading.

We stand behind our product too. Our upgrades have a one-year warranty and we are always there to discuss any immediate problems by phone.

For more information call Broadband Engineering at 800-327-6690 (in Florida 305-747-5000) or write us at 1311 Commerce Ln., Jupiter, Florida 33458.

For quality, performance and service, call Broadband

AUGAT[®] BROADBAND
Quality and Innovation

Reader Service Number 9

Bode's variable equalizer

The Bode equalizer, an adjustable equalizer circuit long used in the telephone industry at voice carrier frequencies, is finding its way into the cable industry at VHF frequencies. This type of circuit provides superior cable tracking accuracy and ease of adjustment compared to circuits used in the past. The design of these equalizers can be accomplished by a straightforward bench procedure or by computer aided design techniques. The theory, design and application of the Bode equalizer are discussed in this paper, and a sample CAD program used in its design is presented.

The CATV industry has borrowed terminology as well as technology from a number of other fields. One obvious source is the telephone industry, especially carrier telephony. This paper will discuss one recent acquisition.

In the April 1938, *Bell System Technical Journal*, H. W. Bode described a type of variable equalizer circuit which has come to be known as the Bode equalizer. (Bode's name is familiar to engineers through his many other contributions to electrical engineering.) The original application was for telephone carrier systems, with top frequencies of a few Megahertz or so. A number of articles have appeared in print on the subject over the years, usually related to the same frequency range. The technique is readily adaptable to the VHF range for CATV purposes, and this has been done in recent years.

Equalization

In any cable-repeater amplifier system, equalization of the cable attenuation is a fundamental requirement. For the frequencies and transmission lines of interest in CATV, the decibel attenuation is very nearly proportional to the square root of the frequency. In order to maintain uniform signal levels over a long cascade of cable spans and repeater amplifiers, unity gain must be preserved. The repeater amplifier must

Bridged-T equalizers have been used in cable equipment for many years, but did you know that other forms of equalizers also have been used? Do you know that it is possible to make an adjustable equalizer with only one or two controls? Or that an equalizer can be designed to compensate for bow and sag in frequency response?

complement the cable loss, i.e. the amplifier must have high gain at high frequencies and low gain at low frequencies. This can be done by arranging the active devices themselves to have the desired gain-versus-frequency characteristics. But the more common pattern, nowadays, is to use a more or less flat broadband amplifier with a separate passive equalizer. This equalizer usually is a bridged-T circuit, and may have any number of adjustments available to achieve system flatness.

The major concern of this article is the need for variable equalization. The need arises because, as the cable temperature changes, its attenuation changes in a fashion also proportional to frequency. The normal rule of thumb is that attenuation changes by 0.2 percent per degree C (0.11 percent per degree F), at any frequency. A 22 dB span of cable at 20°C will be a 23 dB span at 43°C and a 21 dB span at -3°C. To preserve unity gain, the corresponding amplifier must change its gain by +1 dB or -1 dB at the top frequency and by lesser amounts at lower frequencies with the same frequency characteristic. This needs to be done automatically, simply and reliably.

The usual passive equalizer is designed with minimum loss at the top frequency and a variety of controls for the loss at lower frequencies. It does not lend itself well to the thermal compensation problem described above. A

variety of "handles" is desirable for setting-up a system, but a simple and reliable control system for automatic operation of a number of controls is difficult to conceive.

What is needed then is a separate network to perform the gain adjustment function. It should have a single control point and be capable of precise gain-versus-frequency control. The Bode equalizer fills this need.

Bridged-T networks

First, a brief review of some pertinent network theory. The bridged-T network is a familiar circuit in CATV. Frequently used for equalizers and attenuators, it has the property of showing a purely resistive input impedance of R_0 ohms if the series network and the shunt network are duals of each other and the network is properly terminated. Referring to Figure 1(a), this means that the product of the series network impedance and the shunt network impedance must equal R_0^2 , and the network must be terminated with R_0 . Another way of saying this is: if the

Cable Classics

Cable attenuation is (in addition to the physical parameter of the cable material and construction) a function of frequency—and temperature. Equalizers, which automatically and accurately compensate for the variation of attenuation with temperature, are a particular challenge to the equipment designer.

Bridged-T equalizers have been used in cable equipment for many years, but did you know that other forms of equalizers also have been used? Did you ever hear of the "Bode Equalizer"? Do you know that it is possible to make an adjustable equalizer with only one or two controls? Or that an equalizer can be designed to compensate for bow and sag in frequency response?

This paper by Donald E. Groff describes a form of equalizer offering superior tracking accuracy and ease of adjustment compared to circuits used previously.

**Graham Stubbs,
Vice President,
Science & Technology,
Oak Communications**

*By Donald E. Groff, Senior Development Engineer, Flam & Russell Inc.
Reprinted, with permission, from the 1976 NCTA Technical Papers.*

The Converter System That Can Take You Wherever The Market Goes.

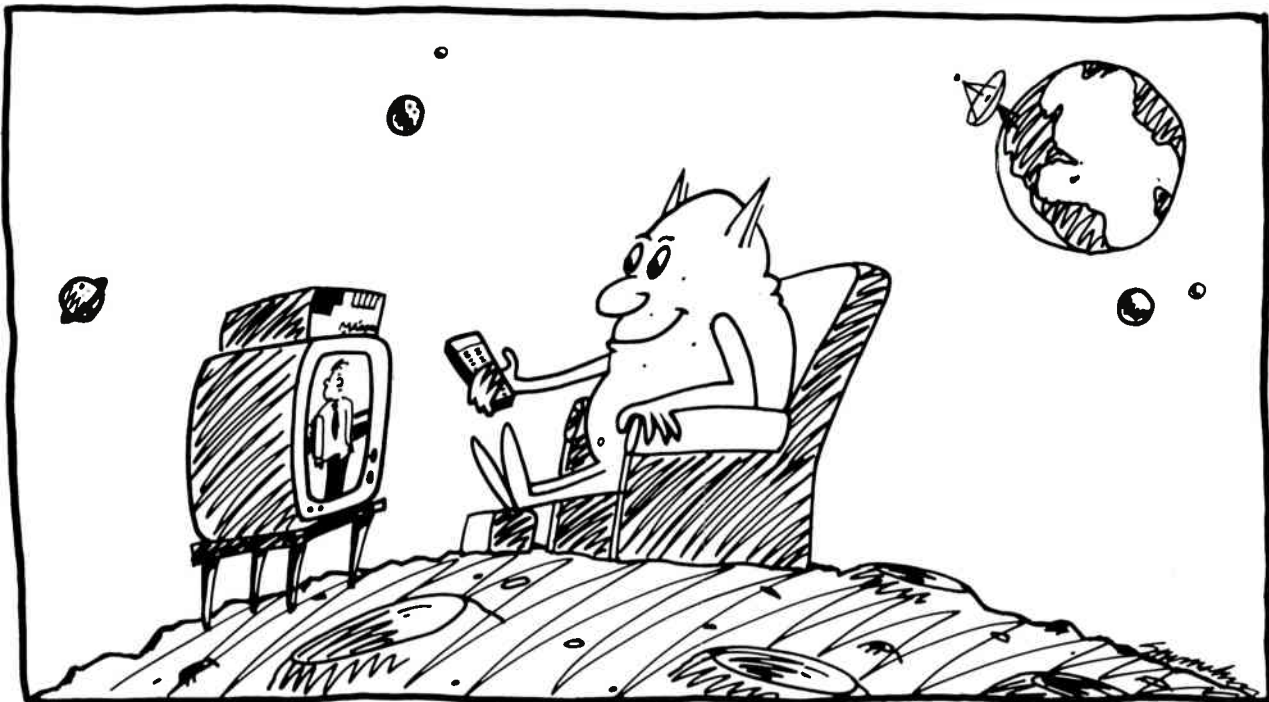

Most cable system operators have no more idea where the market will be ten years from now than the man on the moon.

Some forecasters predict that system automation will be the thing of the future. Some vote for stereo or want VCR compatibility. Others think pay-per-view is the salvation of struggling MSO's.

One thing is for sure. Put ten experts in a room and they're never able to agree on a thing. That's why M/A-COM's software driven converter systems are so important. Because nowadays, built in features often mean built in obsolescence.

A M/A-COM system is as flexible as you can get. If you have 128 channels, you have 128 favorite channels. Or 128 parental control channels. 128 channels to do whatever you need to do to attract subscribers and enhance revenues.

In short, it's a system that can grow with you, and go with you, wherever the market takes you.

So if you've got stars in your eyes call M/A-COM at 1 (800) 346-2266. We'll show you how things are looking up for cable system operators.



M/A-COM

M/A-COM Addressable Converters
10737 Gateway West, Suite 350
El Paso, Texas 79935 1 (915) 593-2250

Bode equalizer fills need of a separate network to perform gain adjustment function.

series network impedance is Z_0 , then the shunt network impedance must be R_0^2/Z_0 . For the usual case of $R_0 = 75\Omega$, this might be as simple as a 68Ω resistor for Z_0 and an 82Ω resistor for R_0^2/Z_0 , in which case you would have a 5.6 dB flat pad. Figure 1(b) shows a simple kind of equalizer circuit. The parallel RC network in the series leg and the series RL network in the shunt leg are duals.

Sometimes it is stated that the series network controls the response of the entire bridged-T network. This is true and can be carried even further: the series network of a bridged-T network in an R_0 ohm system can be lifted out and placed in series in an $R_0/2$ system to yield exactly the same insertion loss characteristic. Moreover, the shunt network likewise can be taken out and placed in shunt in a $2 R_0$ ohm system, also with the same insertion loss.

Of course, the new networks will not

FIGURE 1
Bridged-T networks

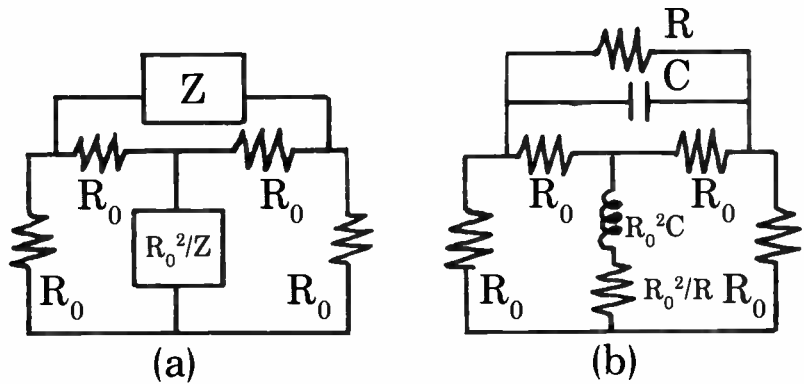

System Spectrum Calibrator

±0.25 dB Accuracy 4.5-450 MHz

A very economical signal source, compared to an expensive sweep summation system, which can be used . . .

- To measure gain, loss and response of active or passive devices
- To calibrate signal level meters
- To determine the location of opens and shorts
- As an accurate standard signal source
- As a white noise generator ● In the field or lab

Special Offer:

Yes, I want to know more about how I can use the Sadelco, SC 450 Spectrum Calibrator.

- Send me a copy of the technical paper describing various applications.
- Have the nearest distributor contact me.

Contact _____ Position _____

Company _____ Phone _____

Address _____ 5/86 CED



Sadelco, Inc. 75 West Forest Avenue, Englewood, New Jersey 07631 201-569-3323
 General Representative for Europe: Catec AG, Habsburgerstr 22, 6003 Luzern. Tel. 041/573636 Telex: 041/572796

What's The One Standby Power Source That's Efficient, Modular And Easy to Maintain?

Lectro Power!



Like every great idea, it's remarkably simple. Lectro Sentry II has the fewest components of any comparable standby power unit—so it's no surprise that Sentry II consistently delivers the longest mean time between failures. That's reliability.

Sentry II simplicity also means that maintenance takes only minutes. Because Sentry II is the only standby power source with modular plug-in design, the only service tool you need is a key to open the cabinet, then slide one module out and simply plug a new module in. So it not only reduces service costs, but helps to ensure customer satisfaction and subscriber retention.

No wonder more cable systems use Lectro for standby power than any other source. It pays off on the power line. And it pays off on your bottom line. Call Lectro at (404) 543-1904, or toll free (800) 551-3790. Now in stock at all Anixter distribution centers.



LECTRO 
A Burnup & Sims Cable Products Group Company

If bridged-T network isn't terminated correctly, its input impedance will not be equal to R_o .

be matched; they will not have the R_o input impedance of the bridged-T circuit. But the notion is very useful for analysis and discussion and, with due caution, for bench testing.

Another point to mention is that if the bridged-T network is not terminated in its characteristic impedance, its input impedance will not, in general, even be resistive, let alone equal to R_o .

The Bode equalizer

The curves of Figure 3 represent a sweep system display of an equalized length of cable at three different temperatures. The coordinates are chosen to correspond to a conventional scope display. The idea here is that the cable has been perfectly equalized by a passive network at a nominal temperature. For low temperature, the loss decreases in a manner proportional to $\sqrt{\text{frequency}}$; for high temperatures, the

loss increases in a similar fashion.

We now look for a network capable of keeping the transmission flat across the band by some simple control. Figure 4 shows what kind of characteristics this network must have, considering only series attenuator networks, as

discussed earlier. For low temperatures, a series RL network of 4(a) will attenuate the high frequencies more than the low—in effect simulating cable, because of the increasing reactance of the inductor with frequency. At midrange, the resistor of 4(b) causes

FIGURE 2
Three networks with the same insertion loss

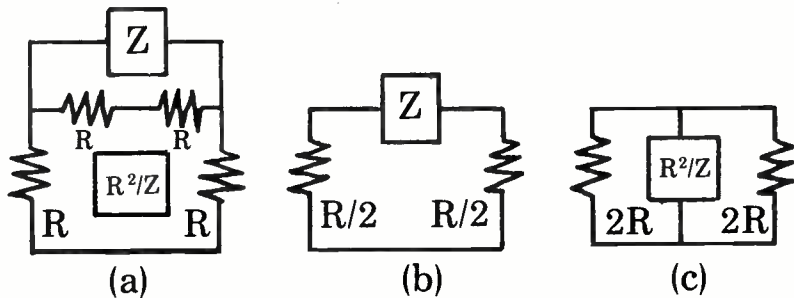

Performance Counts! We perform . . . so you can!

Let's face it. Performance is the bottom line. If we don't perform, you don't either.

With a Control Technology standby power system, that just won't happen.

We're so confident our standby power designs out-perform the competition, we offer a no-strings FREE trial program, so you can test our performance for yourselves!

Remember, we guarantee our performance . . . so you can!

For more information, call toll-free

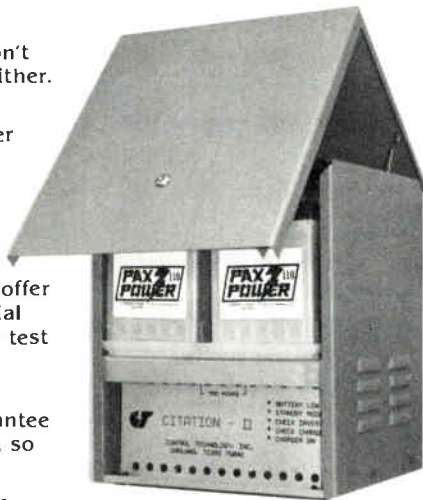

Reader Service Number 13

1-800-527-1263; in Tx. 214-272-5544

 **Control
Technology**
1881 State Street Garland, Tx 75042

6 GOOD REASONS! Why You Should Phone for Our Free Catalog

1. NEW & USED EQUIPMENT

— We buy & sell most makes and models

2. FREE DELIVERY

— No hidden costs

3. REPAIR FACILITY

— Quick & complete

4. CREATIVE PRICES

— Trade-ins considered

5. SATISFACTION GUARANTEED

— 90 day unconditional guarantee

6. TOLL FREE



"DISTRIBUTION AT IT'S BEST"

Outside California
800/227-1200

Inside California
800/223-3152

Reader Service Number 14

3270 Seldon Court, Suite 5 Fremont, California 94539

RMS GUARANTEES **-120 dB RFI!**

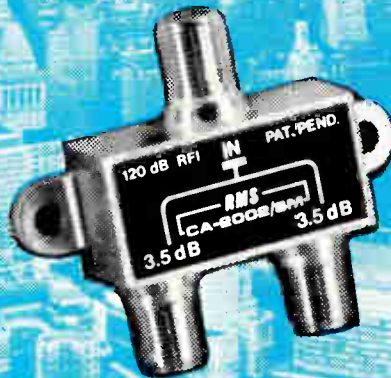
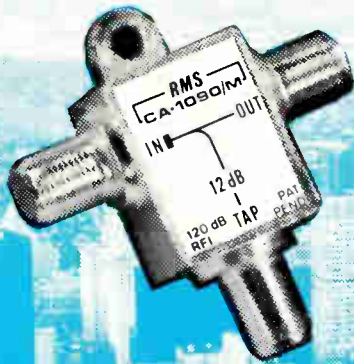

Only RMS guarantees -120 dB RFI in its CA-1090/M and CA-2090/M directional couplers, and CA-2002/SM silver plated two-way hybrid splitter. No one else comes close. These products are especially useful at the headend, in systems in metropolitan areas, and in LAN systems where RF integrity is essential.

RMS - *"Built with the technician in mind"*

RMS ELECTRONICS, INC.
50 Antin Place, Bronx, N.Y., 10462
CALL COLLECT: (212) 892-1000 (New York State)
TOLL FREE: (800) 223-8312 (Continental U.S.A., Puerto Rico, U.S. Virgin Islands)

Reader Service Number 15

Bode equalizer simplifies task of choosing the reactances to yield desired equalization.

$(R_x + R_2)$ which determines what fraction of the total range of the equalizer is brought into play. Figure 6 indicates the behavior of a Bode equalizer for various terminations.

A proof that the statements of the previous paragraph are true was performed and indicates how R_1 and R_2 are to be chosen; but if one accepts on

faith the symmetry property, it is not difficult to see how to pick R_1 and R_2 .

Design procedure

The starting point is the desired flat loss of the network, called α on Figure 6. This usually will be somewhat more than half the total range of control de-

sired. Going back to Figure 5, the equalizer will be flat when $R_x = R_2$. The input impedance to the R_2 bridged-T network will be R_2 ohms, and this will be in parallel with R_1 . This establishes that R_2 in parallel with R_1 is the resistance which determines the flat loss of the Bode equalizer.

Also from Figure 5, notice that for $R_x = \infty$, at very high frequencies, the series inductor takes everything out of the picture except R_1 . Now back to Figure 6 and the realization that, for that situation, the symmetry condition requires that R_1 be associated with 2α , twice the flat loss. In other words, if this circuit is to be symmetrical about a flat loss of α dB, then its two extremes have to be 0 dB and 2α dB.

To sum it up, pick R_1 to yield twice the desired flat loss, and pick R_2 such that $R_2 \parallel R_1$ yields the desired flat loss.

The more difficult part lies ahead: how to choose the reactances to yield the desired equalization. But the theory of the Bode equalizer simplifies this task enormously. With R_x set to zero, you design an equalizer by your favorite method: "tweaking" at the bench, calculating breakpoints or computer programs. Once the equalizer is designed on a Bode basis, one can be confident that varying R_x will produce the desired symmetrical behavior.

The Appendix is an example of a CAD program used to design a Bode equalizer. Of course, if we are dealing with broadband VHF, the accuracy of the final result will depend on how well the stray impedances are dealt with. And that is a significant qualification.

The equalizer based on a parallel RC described above is about as simple as possible. The need for wider bandwidth, increased precision or wider range may require a more complex network to start with, e.g. two parallel RCs in series or a series LC.

The Bode equalizer is by no means limited to the specific usage described above. Any variable gain versus frequency characteristic which is symmetrical about a flat loss can be accomplished this way. Figure 7 shows some of the possibilities. Figure 7(a) shows what is usually called a slope control, normally used to interpolate between fixed values of main equalizer for set-up purposes. Another conceivable version is shown in 7(b), which is an ad-

FIGURE 4
Desired variable equalizer characteristics

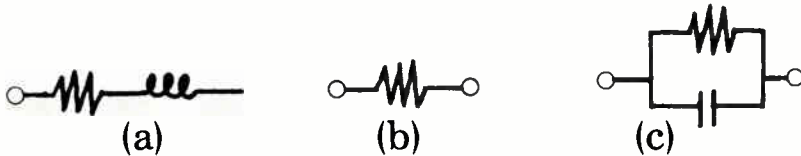

FIGURE 5
Bode equalizer—series version

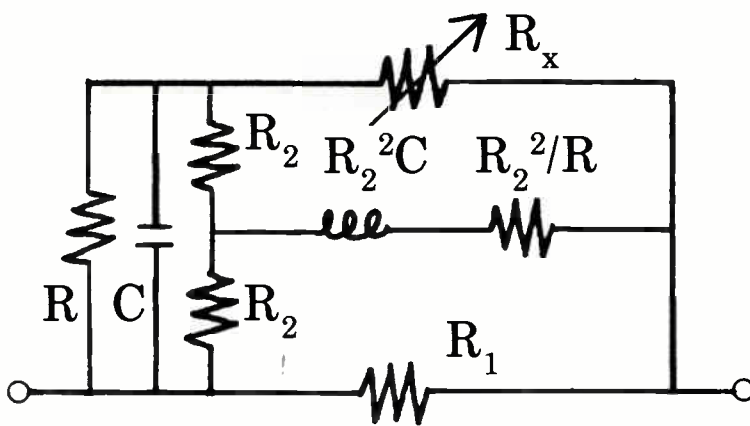
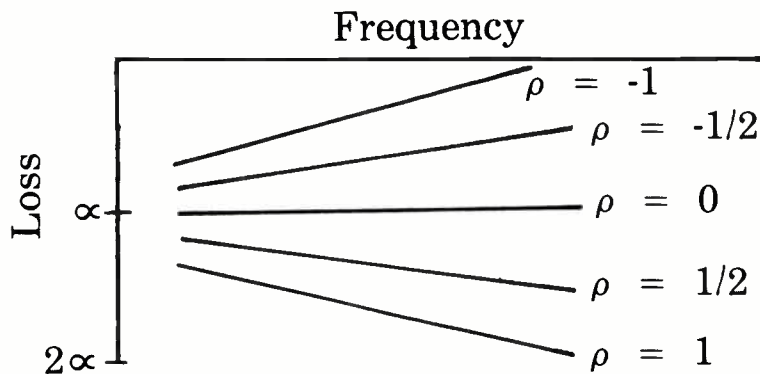

FIGURE 6
Loss of a Bode equalizer





Our
ground
crew
is now
UL
approved

100% GROUND SACHS HAS THE ONLY ALTERNATIVE

Now you can be sure of your grounding. The UL approval reaffirms our quality. Here are our special unique features;

SC-13

Series Ground Strap:

- Easy one tool installation
- Positive contact (all copper)
- Preformed to fit any size pipe
- One piece construction.
- No welding

SC-12

Ground Block/Bracket:

- Exceeds 280 hrs anti-corrosion Salt test per ASTM B117
- Accepts single or dual f81 fittings.
- Easy and positive attachment of grounding wire.
- Additional subscriber lines can be accommodated using splitters without removing block/bracket
- Accepts 2 way, 3-way, 4-way 5-way, etc... splitters.
- Very low contact resistance; less than 1 ohm

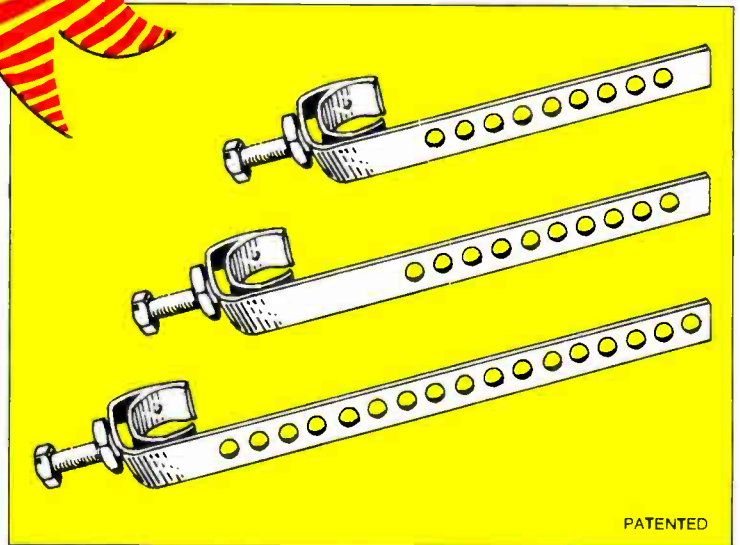

PATENTED

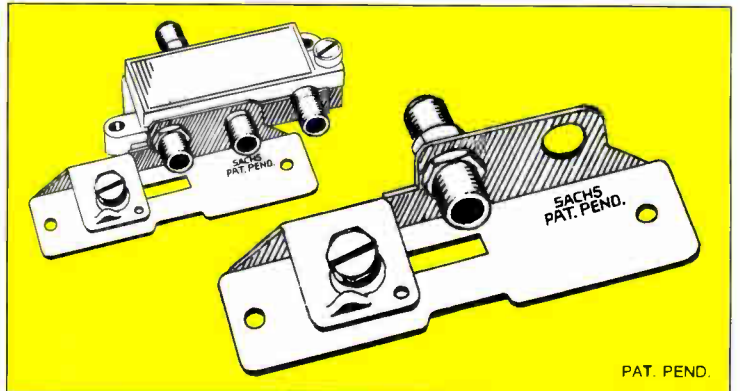

PAT. PEND.

FREE SAMPLES SENT WITH EVERY INQUIRY



SACHS Communications Inc.,

30 West Service Road, Champlain, N.Y. 12919-9703
In Canada: 2095 Chartier Avenue, Dorval, Que. H9P 1H3
Reader Service Number 18

**FOR MORE INFORMATION
CALL TOLL FREE**

800-361-3685

In Canada: Call (514) 636-6560

To be useful in CATV, Bode equalizer must be used in impedance matched version.

justable bow or sag.

To be useful in CATV, the Bode equalizer must be used in an impedance matched version. This is accomplished by providing the 75 Ω dual in the shunt position of a 75 Ω T. The dual of a bridged-T network is itself a bridged-T network. The dual of the terminating resistor must also be provided. Figure 8 shows a full dual ver-

sion of the circuit in Figure 5.

In a fully matched Bode equalizer, the terminating resistor also must be provided dually. There are a variety of ways of doing this. Dual potentiometers are available but are not suitable for automatic control. PIN diodes and thermistors are candidates for R_x . The PIN diodes may be controlled by an AGC loop or perhaps by a thermistor.

To achieve the full range of the Bode equalizer, R_x must vary very widely—from a short to an open circuit. ■

Bibliography

- Brading, W.A.; Exact Design Method for Adjustable Equalizers, *Electrical Communication*, March 1972.
- Bode, H.W.; Variable Equalizers, *Bell System Technical Journal*, April 1938.
- Haas, W.; Theory and Design of an Adjustable Equalizer, *Electrical Communication*, February 1965.
- Hakim, S.S.; Bode's Variable Equalizer, *Electronic Technology*, June 1961.

Appendix

This is a CAD program used for designing a Bode equalizer. It is written for COMPACT, a network analysis and optimization program available on UCS timesharing and elsewhere. This equalizer uses two parallel RC networks in series. They are assigned in lines 100-120. In line 190 the terminating resistance is set to 10 ohms. Line 250 puts 4.5 dB of cable in series with the equalizer, and lines 290 and 320 instruct the program to look at 5 to 115 MHz and make the total loss 5.7 dB.

```

00100 PRC AA SE -75 -100
00110 PRC BB SE -33 -240
00120 CAS AA BB
00130 RES BB PA 204
00140 RES CC SE 110
00150 INV DD AA 110
00160 RES EE SE 110
00170 CAX BB EE
00180 PAR AA BB
00190 SBR AA AA 10
00200 RES BB SE 75
00210 INV CC AA 75
00220 RES DD SE 75
00230 CAX BB DD
00240 PAR AA BB
00250 CAB BB SE 4.5 .05 .0007
00260 CAS AA BB
00270 PRI AA S1 75
00280 END
00290 5 115 10
00300 END
00310 0.1
00320 0 0 10 -5.7
00330 END
    
```

FIGURE 7

Other Bode type equalizers

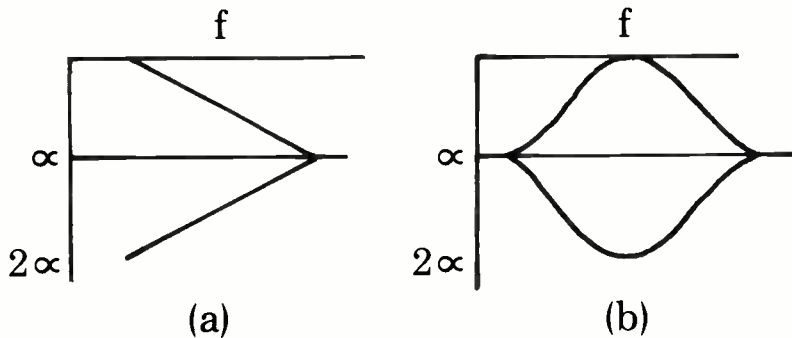
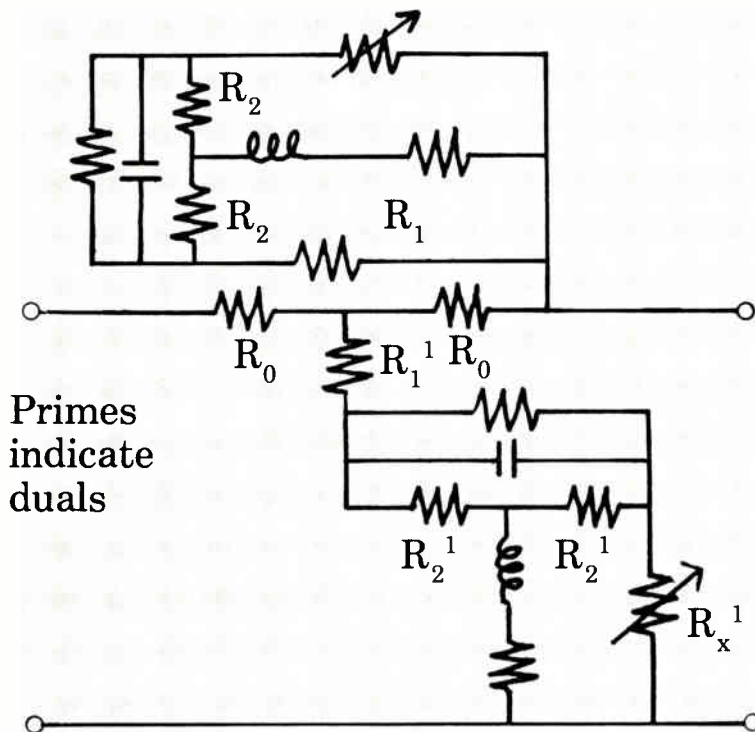

FIGURE 8

Full dual Bode equalizer



Your next trencher.

Here's what you'll miss if it isn't a *new* Case 760.

Exclusive four-wheel maneuverability.

Rigid-frame design and unique Case Four-Wheel Selective Steering give you extraordinary

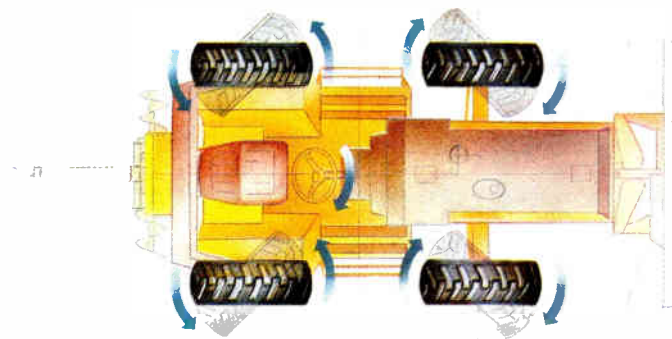

maneuverability, with precision handling and excellent traction in three different steering modes. Front-wheel steering is perfect for trenching and roading. Crab steering puts each tire in a separate track for more gripping power on slopes. And our exclusive coordinated steering mode gives you tight, full-power turning. The steering wheel controls both front and rear wheel direction. When changing from coordinated to front-steer, the rear wheels automatically return to the straight-ahead position.

Minimal maintenance.

Only Case offers a trencher with *no* daily lubrication requirements. Just check the easy-to-read hydraulic oil sight gauge and engine oil level and you're ready to go. To further reduce maintenance needs, the planetary trencher drive is sealed in oil — another Case exclusive.

Easy operation.

A single-lever control raises, lowers, tilts and angles the backfill blade. The operator's platform is isolated from the mainframe to reduce vibration. And there's a comfortable, adjustable swivel seat. These are just a few of the ways the 760 can increase operator efficiency, with features available *only* from Case.

Greater maneuverability. Reduced maintenance. Easy operation. Three of the many good reasons to see your Case dealer soon and get the competitive edge in trenching.

J I Case
A Tenneco Company

700 State Street Racine, WI 53404 U.S.A.

Building On Quality™



Home TVRO slump will pass. . .

Home TVRO sales have been in a steep tailspin since the confusion over scrambling intensified early this year, undoubtedly causing second thoughts among some CATV operators who might have been looking at getting into the business. Larger MSOs with major urban franchises seem particularly hesitant. But out in the cornfields of Iowa, the hills of Tennessee and pine forests of Georgia and Mississippi, many small system operators believe the slump will pass, a *CED* survey indicates. They may not be pushing sales very hard, and present sales volumes are small, but they haven't put their plans on hold.

Charles Vaccaro, for example, manager of Clover Cable Systems in Port Norris, N.J., is a new entrant into TVRO. He recently ordered 20 Channel Master systems. He's got two orders on hand. Marshall Martin, owner of Luverne TV Cable Service, Luverne, Ala., on the other hand, has been in the

. . . say many independent CATV operators and smaller MSOs scattered widely throughout the more rural areas of the country, a recent *CED* survey finds.

business since 1980 or so. His business was "pretty good until scrambling." He's still carrying and installing systems, but isn't pushing it right now. Neither is Ted Derby, manager of Preston Cable TV of Preston, Minn. He got started in 1983 and still sells "a few" dishes to customers outside the franchise area.

Neither do many operators seem to be moving descramblers or making any money at it. And some don't want to sell descramblers. Opal Chadwell,

for example, has been selling Winegard and Channel Master systems for a year and a half. But only to people who really understand the scrambling issue and can get their own descramblers. Neil Webster, co-owner of Guttenberg TV Cable System in Guttenberg, Iowa, plans to keep only one VideoCipher unit on display. He'd rather refer buyers to two TVRO retailers in town and stick more to the programming and financing ends of the business.

Business to increase

But all seem to agree that—once the major programmers scramble, packages and prices are set and the air clears—sales will pick up again, possibly in early summer. Some indicate sales already are turning back up, and a few say they never experienced a real downturn. Take John Jackson, for example. He's manager of Jackson Cable Systems in Eaton, Ohio. There are

THE PICO TEN STEREO SATELLITE SYSTEM GIVES YOU EXTRAORDINARY RECEPTION.

Here's Our Best!

Enjoy the best home entertainment system ever: over 100 channels of TV variety, over 50 audio choices, many in full frequency stereo, all accessed from your easy chair by remote control. The Pico Ten system delivers crystal clear reception. It is our top of the line, yet the Pico Ten has a price that will pleasantly surprise you.

Call for more information on the Pico Ten System and the complete line of quality Pico products.



PICO PRODUCTS, INC.

103 Commerce Blvd.
Liverpool, NY 13088

CALL TOLL FREE:
1-800-822-7420
IN N.Y.S. 315-451-7700



Reader Service Number 22



PERMA-CAST SYSTEMS Headend Buildings

Precast concrete headend and earth station structures. Secure, fire and vandal resistant, maintenance free. Same day occupancy. Standard 10 x 10 and customs designs available.

Specializing in communications industries

For information call Chris Miller at 215-926-5336

Reader Service Number 21

Expand your profit WITHOUT expanding your plant.

Satellite TVRO Marketing: The Opportunity is Now.

Channel Master® would like to introduce an idea that helps you reach new subscribers within and beyond your current service area **without plant expansion**: satellite TVRO marketing.

The sale of satellite TV programming subscriptions and receiving hardware promises to be a profitable enterprise for the cable industry—but only for those operators and MSOs who move decisively in the immediate future.

The Channel Master® Cable Products Group brings the strength, resources and satellite TV marketing experience of Channel Master® directly to your system. We're the one partner you need to take full advantage of your market's potential.

Find out how Channel Master® Cable Products Group can help make the transition to TVRO marketing simple and profitable for your system. Mail the coupon below to get the facts from Channel Master®: The **POWER** in TVRO Marketing.

See us at the W. Virginia Cable Show, May 6 - 8.





Industrial Park Drive, Smithfield, N.C., 27577

YOUR NAME _____

COMPANY NAME _____

ADDRESS _____

CITY _____

STATE _____ ZIP _____ PHONE _____

Send me more information on TVRO Marketing

Owner Manager Engineer

MSO Independent

Return To: David Waddington, National Sales Manager
Cable Products Group

CED56

Reader Service Number 20

Channel Master Division of Avnet, Inc.
P.O. Box 1416, Industrial Park Drive, Smithfield, N.C. 27577 • (919) 934-9711

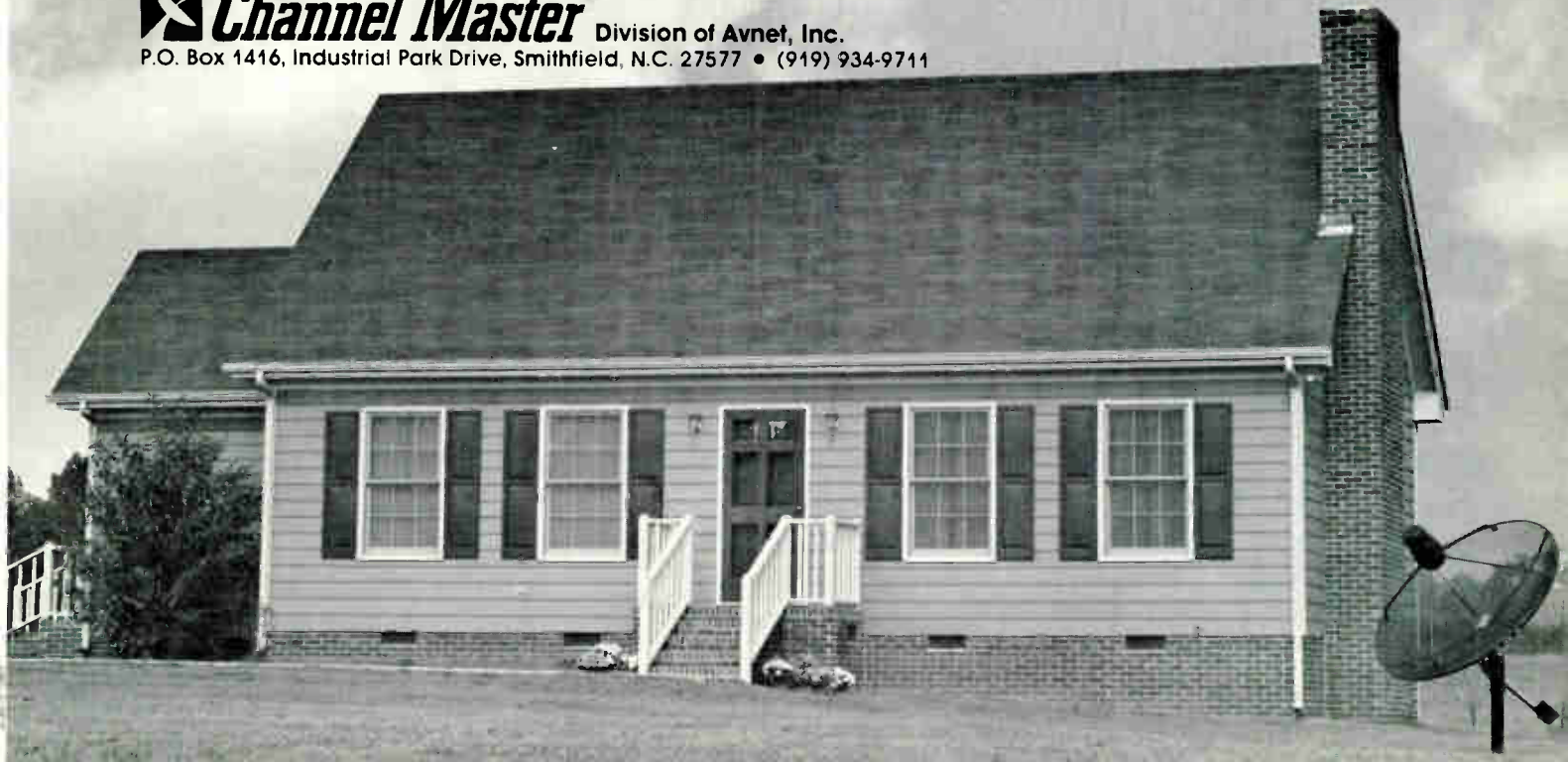

A few operators have been burned by buying gear from companies that have gotten out of the business.

about 75,000 homes in his areas, but only 24,000 lie within his franchise. He's been in business about a year, and by the second month was putting in 20 to 25 systems every 30 days. After scrambling? "I'm still selling about

two a day," he says. What he thinks has happened, though, is that his growth rate is nil.

Likewise, two months after Rolla Cable in Rolla, Mo., got started selling TVRO systems, sales dropped off.

"But things are already picking back up, especially on the rental side of the business," says manager Doris Barton. And Scott Witcher, owner of Evant TV Cable in Evant, Texas, says his own desire to wait until the scrambling picture clears up is the cause of the slowdown in his sales. "I'm just holding off pushing it until everything's settled," he says.

Howard Lock, owner of seven rural Wisconsin systems also expects sales to rise. He sells 99 percent of his systems outside the actual franchise areas and really saw his sales fall off in January of this year. He was selling a system a day in November 1985. He sold a total of 10 systems in December and only one in January of this year. But his April numbers should reach eight or so.

Slump or not, more small and rural system operators say they'll be getting into the business by early summer. Ed Blewett, manager of the Cortez, Colo., system, is looking at early May. He says he's still getting lots of inquiries about systems from people outside his franchise area and plans to limit his initial sales there. Between now and May, he wants to make sure the technical staff is trained on dish assembly and installation.

And whether they're already in business or plan to be, almost all are a bit restive about selling programming. Most think they ought to be able to sell programming outside their franchise areas, since in most, but not all cases, that's where the hardware is going. But some operators, like Southwest Missouri Cable, are selling even inside their franchise areas.

The timetable for basic service scrambling also may have an impact. Jerry Kittelson, manager of the Spirit Lake, Iowa, system, says, "Everybody's kind of waiting. I've talked to 14 people, and they're waiting to see what Congress does," referring to a possible scrambling moratorium some interests have asked for. "If nothing like that happens as a result of the Tim Worth hearings this spring, we'll get going this summer."

He's still waiting for the basic programmers to announce terms, rates and conditions for basic packages. "So far I've only heard from CNN."

A few have gotten burned by buying

YOU BUY EQUIPMENT TO WORK. VERSALIFT® DOES.

Down-Time is a bad word in any working fleet. It's expensive. It wastes time. That's why we build Versalifts to work. And work efficiently.

More than 14,000 Versalifts have been built over the years. Most of them are still out there in the field. Working. The most complete line of aerial devices on the market, with the best in-service records and lowest operating and maintenance costs. That's Versalift. Your local Versalift distributor will be glad to work with you to choose the model and size best suited to meet your aerial work requirements.

Versalift is a service proven product of Time Manufacturing Company.



Reader Service Number 28

Once the major programmers scramble, sales will pick up again—possibly in early summer.

gear from companies that have gotten out of the business, and most are sticking with names they know: Channel Master, M/A-COM and Scientific-Atlanta. Drake, Uniden and Chaparral also seem favored. Lock, for example, had Automation Techniques gear, but AT has closed its TVRO business. Jackson started out with Wilson receivers but is switching to Scientific-Atlanta. He doesn't know whether Wilson will be around for the long haul. Thomasson used Amplica gear, but they're out of this end of the business.

Retailers fleeing market

The slump already has driven many retailers from the market, and that could leave CATV operators in stronger positions once the slump ends. Gary Wright, manager of the Village of Marlboro, Mo., system, near St. Louis, says, "Most of the dealers in the St. Louis area are out of business. It behooves me to keep pushing TVRO because, when it does come back, we could be the largest dealer in St. Louis. The question is whether the other guys can hold on until the market picks up. We can."

Likewise, when Ron Thomasson, manager at Coast Communications, Ocean Shores, Wash., started selling home systems 18 months ago, "Some local distributors were saying scrambling would never happen." Today, Thomasson is "the only one left" selling in his small town environment.

Telling the truth also helped TeleCable, of Borrego Springs, Calif., put in about 100 dishes since November 1985. "We had a local guy selling home systems, and he wasn't giving the straight story. We did," says Dorothy Barnett, sales manager.

By way of contrast, John Watkins, manager of the Blue Rapids, Kan., system, has almost no competition. On the other hand, he's only been selling dishes for about three months and has but a few sales to date. Of course, he's not really pushing them very hard. "I got in because I was sort of curious about how many people out there really wanted them," he says.

And the relationship with local TVRO dealers isn't necessarily competitive. Greg Curry, director, marketing, for North American Cable System

in Hector, Minn., is giving cash incentives to TVRO dealers when they refer customers who want programming packages. Webster has excellent relations with the two local TVRO retailers; both used to work for him.

Few changes reported

Surprisingly few systems reported major changes in the way they do business as they moved into TVRO. Aside from training for the technical staff



THE S.G. SERIES BTSC STEREO GENERATORS

Broadcast Quality Exceeding FCC-OST 60
Discrete, Matrix or Composite Inputs
Ultra Linear High Order Matched Filters
Fully DBX® Companded
Over Deviation Protection
Complete Level Monitoring
Low Profile 19" Rack Mount

To discover stereo television, just call us or write for a free copy of "Implementing Stereo TV".

TRIPLE CROWN  ELECTRONICS

4560 Fieldgate Drive
Mississauga, Ontario L4W 3W6
(416) 629-1111

700 West Hillsboro Blvd.
Deerfield Beach, Florida 33441
Reader Service Number 24 (305) 429-0870

The Biggest Success in Pay-Per-View History...

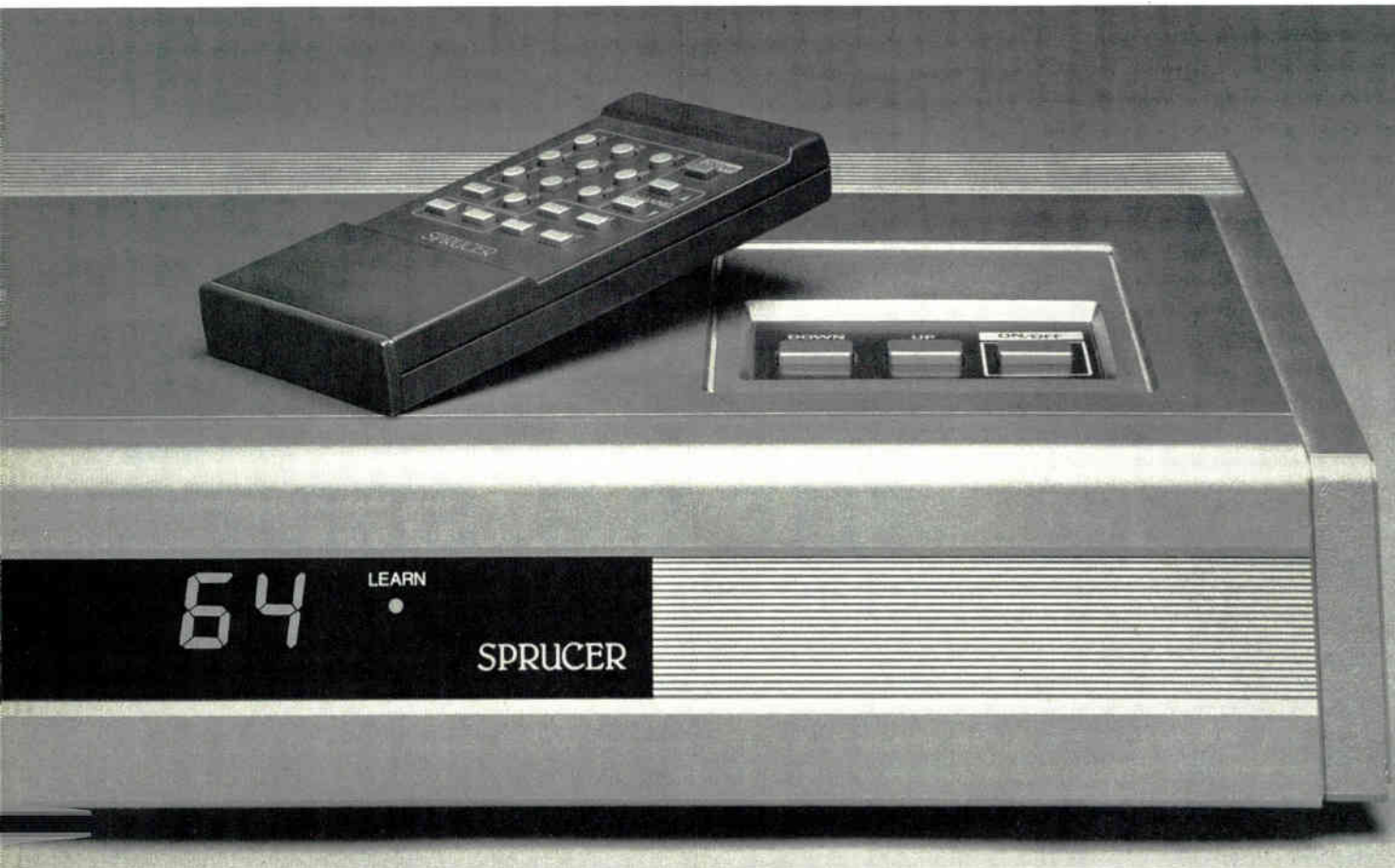

In the last year, SPRUCER's 2-way addressable system helped NYT Cable TV, Cherry Hill, NJ, record new milestones in cable- and pay-TV:

- Over 112,000 pay-per-view takes were ordered by an average of 13,719 SPRUCER-equipped subscribers in 1985.
- Astounding monthly take rates of 78% were achieved—with only two months falling below a 60% take rate.
- Using traditional "free preview" of the Disney Channel, NYT achieved a 30% lift, allowing subscribers to authorize their own service without any CSR intervention.

And in 1986, new records are expected as SPRUCER is installed throughout the entire 130,000-subscriber system.

Undoubtedly, NYT Cable TV and SPRUCER today represent the single biggest success in pay-per-view history.

...Just Got Smaller



Today, we're proud to introduce the SPRUCER 300—the new generation of addressable converters.

Smaller. Lighter. And better.

With all the features that made the original SPRUCER successful... and then some.

Such as an IPPV capacity that's been increased to *900 events per channel*.

And forced-automatic-select-tuning (FAST) that lets operators program what channel the subscriber will see when their set is tuned to "on".

Plus lots more... All designed to help you make pay-per-view and impulse-pay-per-view a profitable reality in your system. So call us. It will really pay off.

SPRUCER® Addressability that pays in profits.

BY  KANEMATSU-GOSHO (USA) INC. 400 COTTONTAIL LANE, SOMERSET, NJ 08873 (201) 271-7544/TWX 710-991-0048/FAX (201) 271-7370

Reader Service Number 25

Few systems reported major changes in the way they do business as they move into TVRO.

and CSRs, few mentioned starting separate retail businesses, opening new offices or adding staff. Some did remodel their offices, like Charlotte Dalton, manager of Twin Valley Cablevision of Germantown, Ohio. Steven

Guest, manager of the Davenport, Okla., system, was one of the few who actually set up a new company to handle the retail end of the TVRO business. Cable Brazil, in Brazil, Ind., and Tele-Media, of Hillsboro, Ohio, were

two systems that did hire additional staff to sell, install and maintain TVRO gear.

Maybe business isn't booming the way it was. But when the dust has settled on the scrambling issue, many smaller cable operators in rural areas are going to find themselves well positioned for programming and hardware sales to a home TVRO market.

*By Gary Kim
and Kathy Berlin*



**The Signal
Stops Here.**

LRC ELECTRONICS INTRODUCES SELF-TERMINATING CABLE CONNECTORS

LRC's self-terminating coaxial cable connector is designed for the automatic termination of a 75 ohm coaxial transmission line in a coaxial cable system when a cable/connector interface is interrupted.

FEATURES:

- 1) Automatic termination when interface is disconnected.
- 2) Quality workmanship and material, insuring long life and unlimited disconnects.
- 3) Components completely contained in housing to insure highest RF integrity.
- 4) Elimination of ingress and egress problems from un-terminated ports.
- 5) Compact design for compatibility in any application.
- 6) Compatible with RG 59U and RG 6U connectors for both PVC and plenum cables.
- 7) Eliminates chains and loose terminators which are misplaced or not re-connected.

- 8) "D" flat installation to prevent rotation.

SPECIFICATIONS:

1) Structural Return Loss	18 db 0-450 MHz
2) Insertion loss	.2 db
3) RF shielding effectiveness	<-60 db (reduces signal 1/millionth of the voltage)
4) Material (main body)	Brass
5) Plating (main body)	Bright nickel
6) Contacts	Silver-Plated

AUGAT[®] LRC

Quality and Innovation

LRC Electronics, Inc.
901 South Avenue
Box 111, Horseheads, NY 14845
(607) 739-3844

Reader Service Number 26

Where to find them

Opal Chadwell
Blanco Cablevision
Blanco, Texas
(512) 833-4886

John Watkins
Blue Water Cable
Blue Rapids, Kan.
(913) 226-7678

Edward Blewett
Cable TV Investors
Cortez, Colo.
(303) 565-4031

Wanda Schraedley
Cable Brazil
Brazil, Ind.
(812) 448-8308

Charles Vaccaro
Clover Cable Systems
Port Norris, N.J.
(609) 785-0072

Ron Thomasson
Coast Communications
Ocean Shores, Wash.
(206) 289-2750

Scott Witcher
Evant TV Cable
Lampasas, Texas
(512) 556-6673

Neil Webster
Guttenberg TV Cable
Guttenberg, Iowa
(319) 252-1343

Gary Wright
Heritage Cablevision
St. Louis, Mo.
(314) 962-8600

John Jackson
Jackson Cable Systems
Eaton, Ohio
(513) 456-1183

Marshall Martin
Luverne TV Cable Service

Luverne, Ala.
(205) 335-5059

Howard Lock
North Cable Co.
Marinette, Wisc.
(715) 735-9532

Greg Curry
North American Cable
Hector, Minn.
(612) 848-6231

Ted Derby
Preston Cable TV
Preston, Minn.
(507) 765-2712

Doris Barton
Rolla Cable System
Rolla, Mo.
(314) 364-5206

Ruth Kolpin
Southwest Missouri Cable
Carthage, Mo.
(417) 358-2063

Jerry Kittelson
Spirit Lake Cable TV
Spirit Lake, Iowa
(712) 336-5151

Dorothy Barnett
Tele-Cable
Borrego Springs, Calif.
(619) 767-5607

Margaret Stroumer
Tele-Media of Tri County
Hillsboro, Ohio
(513) 393-2936

Charlotte Dalton
Twin Valley Cablevision
Germantown, Ohio
(513) 855-3559

Steven Guest
Vi-Tel
Davenport, Okla.
(918) 377-2347

TO BE RELIABLE, YOU HAVE TO HAVE THE GUTS.

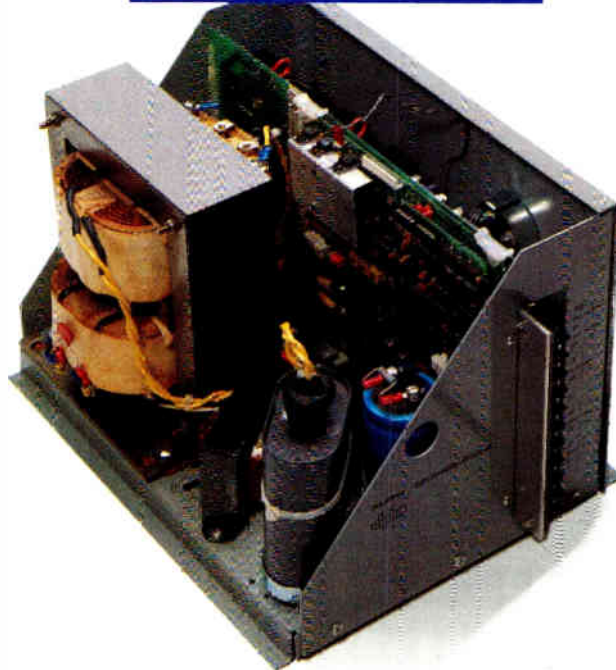

Pull off our cover and you'll see why Alpha is the CATV Standby Power Supply leader. Sure, we could have designed a system using two transformers like most manufacturers, but no, we decided that a single ferro-transformer would be more reliable. It was gutsy, it was innovative, and it works.

Some customers wanted to check the power supplies by just driving by. So we built-in **Automatic Performance Monitoring**. Other customers didn't want to leave their office. What did we do? We designed and built the first stand alone status monitoring system — another innovation from Alpha.

Our guts reflect our sincere desire to give you the standby power supply features you want because serving our customers is as important to us as serving your customers is to you. The way we see it, if we take care of you, you can take care of them.

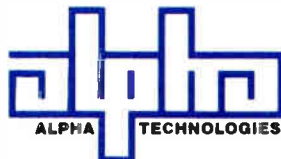

We're here to back you up.

3767 Alpha Way Bellingham, WA 98225 206-647-2360
7033 Antrim Ave. Burnaby, B.C. V5J 4M5 604-430-1476 TELEX: 04-356760

Reader Service Number 27

Multi-vendor compatible converters: a new approach

Multi-vendor compatibility (MVC) is a new term in the industry, used to describe a converter's ability to descramble more than one vendor's scrambling method. The basis of the technology lies in the converter's descrambling module, which consists of separate descrambling circuits for each compatible type of scrambling. While this technique is new to the industry, large MSOs such as Group W, Times Mirror and Storer already have analyzed the benefits of an MVC converter and, early this year, began integrating them into specific systems.

But the importance of the multi-vendor concept cannot be fully realized without some brief background. For the past 12 years, an operator has had one opportunity to choose an effective converter and scrambling method to secure his cable system. And once this decision was made and his system dedicated, the operator was locked into that converter and its particular scrambling technique.

Today, MVC converters mean an op-

*By Jennifer Miller,
Marketing Manager, Pioneer
Communications of America*

Multi-vendor compatibility offers operators second source availability in converter decision.

erator can integrate, for example, a Pioneer brand converter into a system currently using Jerrold converters and Jerrold's Tri-mode scrambling. A relatively simple concept, but one that has just recently been aggressively applied to the cable industry.

The MVC converters became essential because of three main factors. First, all-descrambling and PROM boxes had become extremely susceptible to theft-of-service, and operators were looking for a way to thwart cheaters without immediately changing out the system's entire subscriber base.

Second, high failure rates among some converters created a need for operators to integrate a more reliable converter—again, without immediately changing out all converters in the field or even changing scrambling methods.

And finally, operators wanted a way

to slowly integrate converters into their system which had enhanced functions such as remote control, VCR timers and other consumer-friendly features.

Among the hardware manufacturers that have jumped on the MVC bandwagon are Pioneer Communications, Regency, Zenith, Scientific-Atlanta and Jerrold. Each hardware manufacturer differs in the competitive scrambling technique(s) with which they are compatible. Also, some converters are compatible only with certain scrambling techniques of a particular vendor.

The descrambling process

Figure 1 depicts the sequence in which MVC converters read and process the scrambling information. First, the operator must download the system parameters which include the scrambling method or methods the operator wants to utilize. (The converter's logic is told which scrambling methods are available for descrambling.) In this case, the converter has been downloaded to accept Pioneer VCS™ scrambling, Oak A-mode and Jerrold Tri-mode scrambling.

As the scrambled signal is received by the converter, the converter's logic uses its decision-making process to determine if that particular scrambling method has been authorized by the operator. If the signal has been authorized, the logic tells the descrambling module to switch to the corresponding descrambling circuit, thereby providing the subscriber with a clear, descrambled picture.

In this example, the converter would descramble either Oak A-mode and Pioneer VCS™, or Jerrold Tri-mode and Pioneer VCS™. Any other scrambled signal would be denied, protecting against potential subscriber piracy.

Although the theory of operation for an MVC converter is simple, in practice, an MVC converter design must take into account numerous variations of similar scrambling systems. To illustrate this point, let us focus on sync-suppression type scrambling. An MVC converter, as illustrated in Figure 2, first determines whether the selected channel is scrambled or not. For most RF type scrambling, this is determined by the presence of the descram-

FIGURE 1
Multi-vendor compatible converter

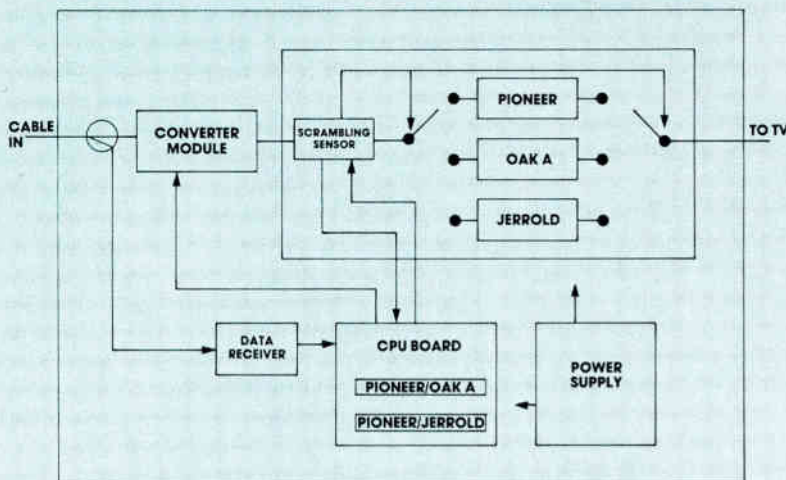

Figure 1 depicts the process in which an MVC converter reads and processes scrambling information. In this example, the converter is compatible to Oak A-mode, Jerrold Tri-mode and Pioneer VCS scrambling.

Satisfaction guaranteed.

Head-end

We stand solidly behind every piece of cable equipment we sell.

Test equipment

Head-end through drop materials, it performs the way we say, or we'll correct it — immediately.

Distribution

All items carry the manufacturer's full warranty.

Taps & connectors

We'll also compete with any distributor on price, selection, delivery, and service.

Aerial

We stock all major brands, and can tailor packages to your needs.

Underground

Items arrive when you need them, not sooner or later.

Cable

And our engineers and technicians can answer any questions you have about design, installation, or field performance.

Housedrop

Call Cable Services with your next order, or for a free catalog: **1-800-233-8452.** (In PA, call 1-800-332-8545)

Tools and safety



Cable Services Company/Inc.

2113 Marydale Avenue, Williamsport, PA 17701
Reader Service Number 28

An appropriate billing interface is needed to complete the integration process.

bling key signal on the aural carrier.

The second decision will be what type of sync suppression should be used. Today, two basic forms of sync-suppression scrambling are available: sine-wave sync suppression (SSS) and gated sync suppression (GSS). The two fundamentally differ in the basic scrambling waveform. For this reason, regeneration circuits are different, although a certain degree of sharing is possible.

The next step, which is probably the most complicated, is the detection of subtle differences within GSS (or SSS). Variations such as depth of sync suppression, vertical suppression and timing of sync suppression separate one vendor's scrambling from another. Thus, an MVC converter system must be able to activate the correct scrambling combination. Typically, a custom LSI, which incorporates all the variations, is used to eliminate extensive increase in discrete circuits.

The final step, which is common to all addressable converters, is the confirmation by the converter as to whether the particular subscriber is authorized to receive this channel.

An economical phase-in

Multi-vendor compatible converters are especially beneficial to an operator who is dissatisfied with his current converter or scrambling mode. Without removing any existing converters, an MVC converter can be phased into a system which uses a scrambling method compatible with the converter.

Take for example, an operator who is using Brand X and is dissatisfied with its security (See Figure 2). He can take Brand Y, which is multi-vendor compatible, and begin to integrate it into his system. The operator continues to use his existing scrambling method and encoders during the phase-in procedure. Once Brand Y is completely

phased in, the operator can replace the scrambling method in the headend to Brand Y's and render useless any unauthorized converters trying to defeat the system.

Any Brand X converters that were effectively pirating service can no longer descramble Brand Y's scrambling method. Plus, the operator now has given his subscribers a state-of-the-art converter with improvements such as SAW filters, SAW resonators and phase lock loop technology.

In most cases, the operator does not need to purchase new encoders to phase in the MVC converter, nor does he have to run duplicate channels of scrambled programming for each converter type.

For an existing addressable system, a new addressable controller must be purchased prior to the phase-in. But the integration process would not be complete without an appropriate billing interface. Brand X and Brand Y

The converter specialists.™



Are you suffering from weak inventories? Are your converters calling in sick? Call in the converter specialists for sales and service.

Sales specialists can quickly fill your order or bring your inventory to full strength. New Jerrold converters are in stock. Plus we can match your type with all

makes/all models in our rebuilt converter bank.

And service specialists can quickly diagnose and repair the most serious converter ailments. Nationwide operating rooms are fast and efficient.

Keep your system profits healthy. Call in the specialists.

**PTS EXPRESS
CONVERTER
SERVICE
AND SALES**

Contact Corporate Headquarters at:
PTS CORPORATION
P.O. Box 272
Bloomington, IN 47402
(812) 824-9331

for the Servicenter nearest you.

Reader Service Number 29

CAN YOU SPOT 15 IMPROVEMENTS?

Model 2901B

NEW!

Still only **\$695** complete.



Made in USA

DIGITAL TDR • CABLE FAULT LOCATOR

- Liquid Crystal Display
- $\pm 1\%$ Accuracy
- Feet or Meters Readout
- 11,000 Feet Readability
- Variable Sensitivity
- Compact, Rugged Packaging
- LCD Annunciators
- Pocket-Size Manual
- Low Battery Indicator
- Auto Zero
- Powered Cable Warning
- Improved Resolution
- Longer Battery Life
- Lightweight (only 3 lbs.)
- Padded Carrying Case
- One Year Full Warranty

manufactured by Riser-Bond Instruments



Western Catv

3430 Fujita Avenue
Torrance, California 90505-4078
(213) 539-8030
In Calif. (800)641-2288
Outside Calif. (800)551-2288

ANSWERS: 1.) Variable Sensitivity Control 2.) 11,000 feet readability 3.) Front Panel Charging Socket 4.) Low Battery Indicator 5.) Powered Cable Warning 6.) Readout in feet or meters 7.) Auto-Zero function 8.) Increased battery life 9.) Padded Carrying Case 10.) Improved On/Off Control 11.) LCD Annunciators 12.) Increased Accuracy 13.) Pocket-Size Manual 14.) Better Resolution 15.) One Year Full Warranty

Reader Service Number 30

THE SOURCE!



SALES: Approved Sales Center
for JERROLD's JRX-A/
JSX-A Addressable Products

SERVICE: 3 JERROLD
Authorized Warranty
Service Centers (Nationwide)

PLUS
WE SERVICE

- ★ All Major Brands of Converters
- ★ Distribution Equipment
- ★ Test Equipment
- ★ Head-End Equipment

1-800-382-BRAD
IN NY 1-518-382-8000

9 customer service
representatives
available to serve you



THE
CONVERTER
MARKETPLACE™

5906 Breckenridge Pkwy.
Suite I
Tampa, FL 33610
(813) 623-1721

Corporate Headquarters
1023 State Street
Schenectady, NY 12301
(518) 382-8000

4630 Pacific Hwy. East
Suite B-7
Fife, WA 98424
(206) 922-9011

ADDRESSABILITY FOR \$1.00 A MONTH



Why pay \$100 up front for a single addressable remote control when you can lease both for \$1 a month? Now, with Phoenix Cable/Lease, you can get into—or expand—a profitable Pay Per View business with no money down.

The Phoenix Cable/Lease 1-2-3 Addressability offer on a typical \$100 converter works like this: over a five year lease, you pay \$1 a month for the first year, \$2 a month for the second year and \$3 a month for the remaining 3 years.

With Phoenix Cable/Lease, for \$100 a month you can lease 100 addressable converters and remote control units, and increase your revenue per subscriber. Addressability also provides you with operating and anti-piracy benefits. This offer applies to practically any converter. Similar terms are available for the associated head end computer equipment.

Call **Ron Demer** at Phoenix Leasing today, (404) 872-2406. It's as easy as \$1, \$2, \$3.



PHOENIX CABLE/LEASE
We Stand Alone in Cable Leasing

A division of Phoenix Leasing Incorporated
100 Colony Square, Atlanta, GA 30361, (404) 872-2406

Reader Service Number 32

Benefits of compatibility go beyond flexibility.

addressable controllers must both be tied directly to the billing host. This is a relatively simple procedure whereby the appropriate communication interface is added to the billing host by the billing company.

The time and degree with which the MVC converters are phased into an existing system is the operator's choice. Experienced operators have done the phase-in on a new install basis or even as replacements for converters brought in for repair. The replacement procedure can be completed as quickly as several months, or an operator may choose to stretch it out for several years—depending on the magnitude and urgency of the operator's system problems.

The benefits

But the benefits of multi-vendor compatibility go beyond flexibility. Operators purchasing these converters stress that MVC gives them the benefit of second source availability. Prior to MVC, the operator was locked into only one supply source, even though the converter purchase is traditionally his biggest capital expense.

Additionally, multiple types of scrambling schemes provide a moving target for subscribers who are attempting to cheat the system. Operators have the option to periodically switch between the compatible modes. Finally, the operator will, in many cases, experience an improvement in the subscriber's picture quality and reliability due to the technological improvements discussed earlier.

System operators who are managing more than one system will discover that MVC creates inventory and operational consolidation among his different systems. Take for example Pioneer's multi-vendor addressable converter, the BA-5000. If an operator utilizes Jerrold Tri-mode scrambling in one system and Hamlin in another, the BA-5000 can serve as a second source to consolidate both systems.

Even operators planning to upgrade to addressability should strongly consider a converter with MVC. Problems such as idle inventory and theft-of-service mean today's cable operators simply cannot afford the expense and headache of being locked into one con-

Converter Compatibility Chart

Manufacturer	Model	HAMLIN	JERROLD			M/A-COM	MAGNAVOX	OAK			PANASONIC	PIONEER	REGENCY	SCIENTIFIC-ATLANTA	SYLVANIA	TEXSCAN	W&S SYSTEMS	ZENITH
			6 dB	10 dB	Trimode			A	B	Clear								
Jerrold		•	•	•	•	3020 RF	6400				TZ-PC 200	BA-5000	LC32R RC32R	8550 8555		4040	VM 2000	
M/A-COM	3025 Baseband 3020 RF		•					•	•									
Magnavox	6400		•										6 dB		•			
Oak	Sigma								•	•								ZTAC Version
Panasonic	TZ-PC 200 Series Avail. June/July		•	•														
Pioneer	BA-5000	•		•	•			•	•	•								
Regency	LC32R RC32R		•	•	•													
Scientific-Atlanta	8550 and 8555	•	•	•										•				
Telease	MAAST	Compatible with any inverted sync mode with software, compatible with sync modification systems																
Texscan	4040		•															
W&S Systems	VM2000		•	•	•													
Zenith	ST5000 Series									TC 56 earlier series TC 35 unit								

* Single bold line represents blocks where manufacturers are compatible with themselves.

**CABLE
LINK
INC.**

**The cable
operators
converter
store and a
whole lot
more.**



280 Cozzins St., Suite 2-A
Columbus, OH 43215
(614) 221-3131

Let us add you to our
long list of satisfied
customers. Just to
mention a few:

- Buckeye Cablevision
Toledo, OH
- Consolidated TV Cable
Frankfort, KY
- Tri-County
Communications
Richmond, IN

Reader Service Number 33

**MVCs give purchasing
control back to the operator
—exactly where it belongs.**

FIGURE 2
**MVC descrambling flow chart for a
converter which is Jerrold, Oak and
Pioneer compatible**

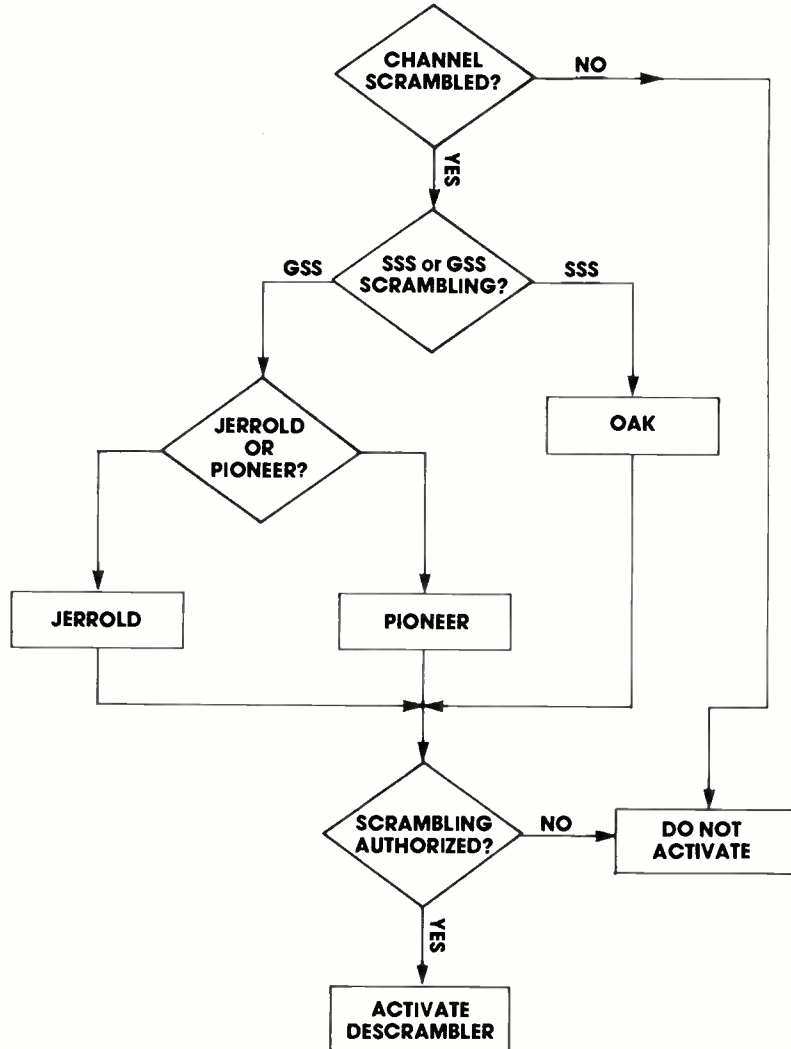

verter. MVC also means that, for the first time, operators can purchase the best converter for their dollars instead of the one mandated by their scrambling method.

Perhaps MVC's most important benefit is that it gives purchasing control back to the operator—exactly where it belongs. The cable operator is trying to

give his subscribers good programming with reliable service and a quality picture. He should have the flexibility to pick and choose the technology that best suits his needs. Multi-vendor compatibility can improve reliability and security, without inconveniencing subscribers or disrupting an entire system. ■

Interface '86

If there were few blockbuster announcements involving broadband local area networks at Interface '86, a major data communications show held March 24-27 in Atlanta, that's understandable. Those cannons would have been shot at Communications Networks '86, a trade show held in January. But a few salvos were fired, and a couple of "first-time-ever" appearances by CATV vendors showed people are expecting some hits in LANs.

Two new players sharing booth number 2355 were notable. **Viacom Telecommunications**, a subsidiary of Viacom International, is now prepared to build, test and certify local area networks—75-ohm coaxial cable and fiber optic, as well as microwave nets. What the company's doing is leveraging existing assets: it's ability to buy CATV equipment and cable in vast bulk, a "point-of-presence" in many parts of the country (CATV systems, broadcast TV stations, MTV networks and Showtime/The Movie Channel offices); installation and maintenance experience with over 13,000 miles of broadband plant, 15 regional microwave nets, fiber and DTS links. Of Viacom's 2,500 employees, 25 percent are technical.

Says General Manager Dave Archer, "We've been dabbling in data for a long time—on and off since 1978—hoping to get into the 'data over cable' business. But the Cox-Omaha decision wasn't as clean as we wanted. There's still too much room for state regulation."

Here Archer is referring to the 1985 FCC decision that gave a go-ahead for Cox Cable's Comline service, offering voice and data services to business customers in Omaha, Neb. The state public utility commission has tried to assert jurisdiction over the service as a common carrier, but the FCC disagreed. The decision was hedged a bit, since the commission declined to extend the ruling in blanket fashion to every other similar service.

But it was a major victory, nonetheless. For the first time, the FCC ruled that cable companies could provide communication services without the burden of PUC regulation, so long as portions of the traffic were destined for out-of-state carriage. The decision even

Interest in broadband LANs continues to grow. Zenith Electronics and Viacom Telecommunications get into the act.

okayed data and voice traffic intrastate, so long as the intent to expand to interstate service was there.

But it wasn't enough to soothe Viacom's nerves. Fortunately, the LAN business isn't regulated. And, luckily, Viacom never dismembered its new business development unit, which had data communications experience. The move into LANs was logical.

And here's a switch: Viacom Telecommunications has a distributor relationship with **Zenith Electronics**, nearly finalized, under terms of which Viacom installs the new Zenith Z-LAN 500, a local area network system that supports as many as 10,000 users at 10 Mbps. Z-LAN subdivides each of five 6-MHz channels into four 500-kbps sub-channels. Capable of supporting nodes over a 30-mile distance, Z-LAN uses the CSMA/CD signaling technique. Remote diagnostics and network management are built right into the system software, as is frequency selection.

The new system can operate over a single or dual cable system, with sub-, mid- or high-split frequencies. Compared to many other products on the market, Z-LAN features "much lower C/N ratios," according to Semir Sirazi, director of communications products for Zenith. "It's also suitable for operation over existing CATV I-nets or existing sub-split broadband networks," he adds.

In the works for about two years, Z-LAN is another example of leveraging existing assets. "It's based on our experience with Z-View, teletext and two-way communication," Sirazi says. That's given the company extensive experience with remote diagnostics. Another outgrowth of Zenith's work with Z-View: the need for automatic adjustment of power levels, which can vary widely on CATV systems. "The system has power level adjustment automatically built in," Sirazi says. "There are 16 steps of 1.5 dB each."

The system also appears to be positioned as a very low cost broadband alternative. The Z-LAN-500D, a dual-port network communication unit, with asynchronous RS-232C interfaces, is priced at \$795—offering a per-port connection cost considerably less than comparable gear on the market today. Eight and 16-port versions are on the way, and they'll offer a significantly lower price, Sirazi says. In es-



Today, General Motors has about 40,000 programmable controllers in its plants. By 1990, it will have 400-500 percent more. CATV-type networks will tie them together on a plant-wide basis.

HERE'S YOUR QUICK-REFERENCE BROADBAND MODEM CATALOG.

General Instrument has many unique modems to fit your needs!

At General Instrument we've created a family of different point-to-point RF modems for use on your broadband local area network. With special features to meet your special needs. Surprisingly low in cost. And with that General Instrument reliability you've come to expect.

Plus, we supply *everything* needed to implement the

distribution backbone of a high-performance broadband LAN. Redundant and conventional amplifiers, status monitoring systems, taps, splitters and power supplies.

For full facts on our expanding line of modem, distribution and headend products, send for our new broadband LAN catalog today.

MODEL 1000

- M-1000 Broadband Data Modem
- Frequency-agile point-to-point modem
 - 16 data rates: from 110 Bps to 19.2 Kbps
 - 50 KHz per data channel
 - Sensitivity of $-16 \text{ dBmV} \pm 10 \text{ dB}$
 - Synchronous or asynchronous
 - Rackmount or desktop available



MODEL 1600

- M-1600 Broadband T-1 Modem
- T-1 point-to-point modem
 - Voice trunking applications
 - High speed data communication
 - Sensitivity of $0 \text{ dBmV} \pm 10 \text{ dB}$
 - Synchronous



MODEL 8000

- M-8000 RF Frequency Transverter
- Six MHz Block Translation
 - Compatible with sub-split, mid-split, high-split and dual cable systems
 - Compatible with all broadband modems
 - Compact unit designed for rack-mounting



MODEL 1700

- M-1700 T-1 Data Modem
- Frequency agile T-1 (1.544 Mbps)
 - 1 MHz spacing
 - Remote loopback capability
 - Reverse frequency option
 - Switched or constant carrier



MODEL 9000

- M-9000 Transverter Redundancy Switch
- Automatic or manual transverter switching
 - Compatible with sub-split, mid-split, high-split and dual cable systems
 - Built-in visual alarm indicators
 - Contacts for external alarm indicators
 - Compact unit designed for rack-mounting



MODEL 1200

- M-1200 56/64 Kbps Modem
- Switchable data rates of 56 and 64 Kbps
 - Optional data rates from 38.4 Kbps to 76.8 Kbps
 - Frequency agile
 - 150 KHz channel spacing



Yes, I'd like your broadband LAN catalog. Please send it to:

Name _____ Company _____

Address _____

City _____ State _____ Zip _____

5/86 CED



Reader Service Number 34

GENERAL INSTRUMENT

Local Area Networks
General Instrument Corporation
2200 Byberry Road
Hatboro, PA 19040
(215) 674-4800

Multi-vendor sourcing is needed to give the customer what works best in each situation, at the best price possible.

sence, it's now possible to get broadband capabilities at about the cost of baseband connections. Limited shipments should begin in June, and quantity production should occur by the third quarter of this year.

The system also uses the Z-LAN-06FTR, a frequency translator priced at \$1,995; and the Z-LAN-500BRG, a bridge priced at \$9,900. What the bridge does is connect different NCUs operating on different frequencies, so the network is totally user-transparent in terms of channelization. All devices on the network communicate as though they were sharing a single frequency.

Viacom Telecommunications, by the way, has firmly decided against exclusive distribution agreements with Zenith or any other vendors. Viacom wants the freedom to give the customer what works best in each situation, at the best price possible. That means multi-vendor sourcing.

More interfacing

C-COR Electronics was at Interface. Cliff Schrock wasn't. It seems he left the company about a week or so before the show. We wish him the best. Among the products C-COR was showing were its new intelligent A-B switch, which allows forced or automatic switching of RF signals in systems that require redundant cable paths. For the IBM PC Network, there's the model 5141 translator, a low-cost way to support 72 modes. For larger nets, the 5200 series is also available. The newer 7800 series of high-speed, synchronous modems are available for T-1 applications (both voice and data). The 7100 series offers analog audio, asynchronous data up to 19.2 Kbps or synchronous data up to 19.2 Kbps. C-COR also has a camera control system designed to monitor as many as 255 cameras on one to five video channels. That's possible because there's a dedicated telemetry link.

Bob Dickinson, by the way, has decided to strike out on his own again. Founder of E-Com and most recently with the Network Technologies Division of AM Cable, you can be sure he won't be sitting still. My guess: his next project could well be a switching

system for voice over broadband LANs. That would knock a linchpin out of the argument that a PBX network is better than a LAN, since it can handle voice switching and data traffic. Network Technologies division

was one of the broadband vendors exhibiting at the show.

LanTel, the Norcross, Ga.-based supplier of broadband frequency translator, data and voice modems, said it would be introducing a synchronous,

PRODUCT

CWY
electronics

BULLETIN

A pedestal built for you!

CWY constructs cable TV pedestals from T2 aluminized steel. Which is why CWY pedestals have outstanding resistance to rust. Heavy 16 and 18-gauge steel with a hot-dip coating of aluminum gives CWY stainless steel riveted pedestals the maintenance-free surface quality of aluminum, with the superior strength of steel. In tests, T2 aluminized steel outlasts unpainted galvanized steel at least five-to-one.

The rectangular design gives you maximum work space, and for easy accessibility—the front cover and top lift off as one unit.

Other features: multiple knockouts for ease of mounting, interior lid guides and an innovative stake lock that keeps the pedestal where you plant it. All for a competitive price.

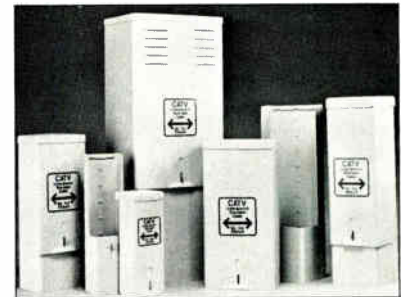

CWY carries a complete line of CATV and SMATV products from the industry's leading manufacturers. Write or call toll-free today for application assistance or our complete inventory catalog of CATV products.

CWY Pedestal Boxes

Model Number	Dimensions						Knockouts	Knockout Spacing	Material* Gauge	Price
	Exterior Dimensions			Lid Dimensions						
	Width	Height	Depth	Width	Height	Depth				
PED-45	5"	17 ³ / ₄ "	4 ¹ / ₂ "	5"	12 ¹⁵ / ₁₆ "	3 ³ / ₁₆ "	5	2 ¹ / ₈ "	18	\$11.20
PED-58	8"	19 ³ / ₄ "	5 ¹ / ₈ "	7 ¹³ / ₁₆ "	13"	3 ³ / ₈ "	5	2 ¹ / ₈ "	18	\$14.96
PED-69	9 ⁷ / ₁₆ "	23 ³ / ₄ "	6 ¹ / ₄ "	9 ⁵ / ₁₆ "	19"	4 ⁵ / ₈ "	8	2 ¹ / ₈ "	16	\$17.40
PED-77	7 ¹ / ₁₆ "	23 ³ / ₄ "	7 ¹ / ₁₆ "	6 ¹⁵ / ₁₆ "	19"	4 ⁷ / ₈ "	8	2 ¹ / ₈ "	16	\$16.84
PED-1014	14"	35 ³ / ₄ "	9 ¹ / ₂ "	13 ⁷ / ₈ "	23"	9 ³ / ₈ "	33	2 ¹ / ₈ "	16	\$37.36

***T-2 aluminized steel with 4-stage washing/phosphatizing; baked vinyl wash primer; and electrostatically applied and baked on enamel.**

Custom sizes also available; call with specifications.

Reader Service Number 35

Not just supplies. Solutions.

CWY
electronics

P.O. Box 4519
Lafayette, IN 47903
317-448-1611
Call Toll-Free:
1-800-428-7596
Indiana:
1-800-382-7526

Manufacturing Automation Protocol products were prominent at the show as many companies committed to the MAP marketplace.

19.2 Kbps point-to-point modem in May, rounding out its existing six-product line, which includes two frequency translators: the model 168, designed for the IBM PC Network; and the model 156 for other general pur-

pose LANs. LanTel also has two voice modems: the model 500T, which connects two telephone circuits point-to-point; and the model 500DC, which provides telephone-to-PBX connections. The modem line includes the

500A asynchronous data modem, transmitting up to 9600 bps; and the 500S asynchronous modem, transmitting up to 19.2 Kbps.

Magnavox CATV Systems was attending Interface for the first time this year and, like many of the companies, was showing its amplifiers and status monitoring systems.

Manufacturing Automation Protocol products also were prominent. Concord Data Systems was showing its Token/Net line of MAP-compatible products, including a headend remodulator, MAPserver network interface modules, Terminal Server for synchronous device attachment to MAP networks and Token/Scope network analyzer. The company also was showing its broadband and carrierband modems and MAPware, a set of modular hardware and software designed for connecting OEM products to a MAP network.

Scientific-Atlanta, which also is committed to the MAP marketplace, was emphasizing its general purpose and IBM PC Network line, showing the PC Network translator, 6402 modem, 6822 distribution amp, taps, passives and cable.

Ungermann-Bass likewise was putting the emphasis on other products than MAP compatibles, among them the company's micro-to-mainframe software and token ring system.

Veteran exhibitor Zeta Labs was showing its point-to-point line of modems and suggested its ZT 1 modem would be out this summer. The company doesn't seem to be hurting for business and clearly expects dramatic price drops in modems over the next year or two.

Allied Data Communications has a solution for smaller companies and buyers who want to test an actual broadband system but don't want to commit lots of money to the effort. Allied's solution is a mini-headend selling under the name of Mod-LAN. The model on display at the show was a high-split version with six ports and designed for about 100 feet of cable. The rack includes combiner, amplifiers and a test panel and lists at \$2,995. Martin Marietta and Lockheed plants in Georgia already have versions of the Mod-LAN, which Allied ships in pre-certified form: sort of a plug-and-go

DeJoy's joy.

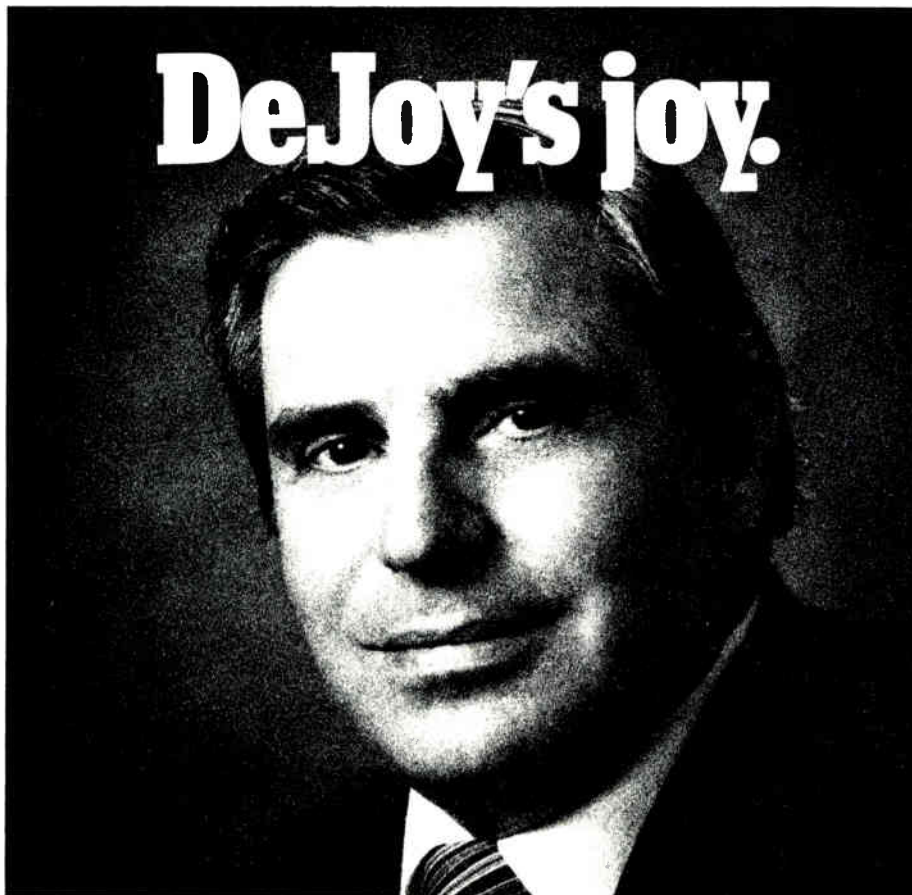

When they put you in charge of operations for a cable system of 185,000 subscribers, you're faced with a lot of tough decisions.

Frank DeJoy, Vice President of Operations of Suburban Cable in East Orange, New Jersey can testify to that. He and his staff took a year and a half to study all the problems and considerations of addressability for a system as large as Suburban's.

When they finally made their choice, it was Sigma. "It offers security we'll be able to rely on for the next ten years," DeJoy explains, "and technically, it is far superior to anything else we looked at."

But technology wasn't the only reason DeJoy chose Sigma. "I like the cooperation

and support of the Oak organization," and later added, "Oak engineers worked with us to develop an electronic second set relationship which allows the converter of the primary set to authorize the secondary set converter to function."

Oak solved a dilemma for Frank DeJoy and Suburban Cable. And in the process, developed a technology that is now a standard part of Oak's Sigma converter-decoder.

If you'd like more information concerning Sigma, call your nearest Oak representative or contact us directly at (619) 451-1500.

We'll save you a fortune on cable theft. And speaking from a Frank point of view, we'll also save you a year and a half of your time.

SIGMA
Here Today. Here Tomorrow.



Oak Communications Inc. 16516 Via Esprilla Rancho Bernardo, CA 92127 (619) 451-1500
© OAK COMMUNICATIONS INC.

Reader Service Number 36

Products that allow Ethernet signaling over broadband networks also were shown by several companies.

package. Full IEEE 802 compatibility is guaranteed.

General Instrument's RF Systems Division had one of the larger displays of actual distribution gear and, apparently, learned something from the last show it attended: display the mainstations with the housing open, not closed. Cosmetically, CATV amplifiers still look somewhat out of place at a data communications show, but showing the electronics helps. In addition to its point-to-point modems, RF Systems was showing mid- and high-split amplifiers, line extenders, power inserters, splitters, an internal distribution amp, taps, splitters, status monitoring gear and equalizers.

Allen-Bradley Co. was showing both its MAP network, the VistaMAP, and its general purpose net, the VistaLAN/1. The company also has an IBM PC Network-compatible network called the VistaLAN/PC.

Fairchild Data Corp. also supports MAP and was showing its M8024 Map-Link modem, as well as general purpose, frequency agile modems. The M505 is agile from 5 to 400 MHz, while the M505(M) is agile over the 1 to 20 MHz band.

Products that allow Ethernet signaling over broadband networks also were shown by several companies. Needham, Mass.-based Chipcom introduced its Ethermodem Repeater, which connects a baseband Ethernet system to a broadband Ethernet network. A maximum of two repeaters can be placed in a path between two Ethernet nodes. The unit is priced at \$6,250 and June delivery is promised.

Bridge Communications of Mountain View, Calif., introduced the GS/6 Gateway Server, an internetwork router that connects Ethernet subnets over a broadband trunk. As many as 255 subnets can be supported on a 6 MHz channel. The GS/6 is the first of a family of RF products that will probably be introduced in the third quarter of this year. It's expected that the line will mirror the company's existing stable of Ethernet gateways and servers. And although MAP products aren't expected this year, token ring products are. The broadband gear will use CSMA/CD access control protocols.

Also showing Ethernet over broadband products was Communication

Machinery Corp. of Santa Barbara, Calif. Its family of EtherCast modems come in single- and dual-cable versions, with two and eight ports. Also available for shipment now is the EtherCast 10 Frequency Translator. Prices for

the modems begin at \$5,525. The translator costs \$5,850.

Irvine, Calif.-based AST Research was showing its new AST-SNA/BSC gateway, linking IBM mainframes and PC networks running NETBIOS.

PRODUCT



BULLETIN

Now you can judge a box by its cover.

CWY constructs apartment boxes from 16-gauge aluminized steel—sheet steel with a hot-dip coating of aluminum. This gives you maintenance free enclosures without sacrificing the durability and security of steel. You can't buy any other metal apartment box with the rust resistance of CWY apartment boxes.

For extra protection, our boxes have welded security stops, a hingeless cover removal system, knockouts for cam locks, and 11-gauge replaceable hasps. Plus, CWY enclosures are pre-drilled to accommodate the CWY Omni-Rack™ system for organizing enclosures.

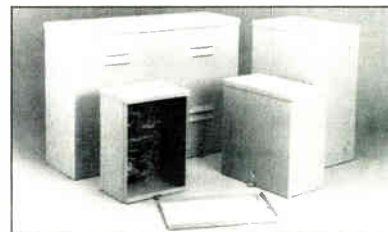

You can order leading manufacturers' CATV and MATV products from CWY's catalog. Write or call us toll-free today for application assistance or our complete inventory catalog of CATV products.

CWY Apartment Boxes

Model Number	Dimensions						Knockouts	Material*	Price
	Exterior Dimensions			Lid Dimensions					
	Width	Height	Depth	Width	Height	Depth			
APB-812	8 1/8"	12"	6 1/8"	8"	12"	19/32"	2 Bottom	16	\$17.80
APB-1212	12 1/8"	12"	6 1/8"	12"	12"	19/32"	3 Bottom	16	\$22.88
APB-1218	12 1/8"	18"	8 1/8"	12"	18"	19/32"	3 Bottom 1 Each Side	16	\$34.48
APB-1824	18 1/8"	24"	8 1/8"	18"	24"	19/32"	3 Bottom 2 Each Side	16	\$48.24

*Polyester baked enamel on aluminized steel.

Model Nos. 1824 and 1218 are predrilled for Omni-Rack™ mounting. Model No. 1824 includes AC outlet area and welded aluminum screens inside vents.

Reader Service Number 37

**Not just supplies.
Solutions.**



P.O. Box 4519
Lafayette, IN 47903
317-448-1611
Call Toll-Free:
1-800-428-7596
Indiana:
1-800-382-7526

Almost 20 companies attended Interface '86 to show latest equipment.

Zyplex of Concord, Mass., displayed a broadband version of its DEC VAX compatible switching system for PC or terminal communications with a host computer. The system also can access IBM mainframes or allow IBM PCs to access an IBM host.

—Gary Kim

Where to find them

Allen-Bradley Co.
Industrial Computer Group
C Division
3920 Varsity Drive
Ann Arbor, Mich. 48104
(313) 973-1500

Allied Data Communications Group
5375 Oakbrook Parkway
Norcross, Ga. 30093
(404) 923-4866

AST Research
2121 Alton Ave.

Irvine, Calif. 92714
(714) 863-1333

Bridge Communications
1345 Shorebird Way
Mountain View, Calif. 94043
(415) 969-4400

C-COR Electronics
60 Decibel Road
State College, Pa. 16801
(800) 233-2267

Chipcom
31 Thorpe Road
Needham, Mass. 02194
(617) 449-7666

Communication Machinery Corp.
1421 State St.
Santa Barbara, Calif. 93101
(805) 963-9471

Concord Data Systems
397 Williams St.

Marlborough, Mass. 01752
(617) 460-0808

Fairchild Data Corp.
350 N. Hayden Road
Scottsdale, Az. 85257

General Instrument
RF Systems
2200 Byberry Road
Hatboro, Pa. 19040
(215) 674-4800

LanTel Corp.
3100 Northwoods Place
Norcross, Ga. 30071
(404) 446-6000

Magnavox CATV systems
100 Fairgrounds Drive
Manlius, N.Y. 13104
(315) 682-9105

Network Technologies Division
of AM Cable TV Industries
1 AM Drive
P.O. Box 505
Germantown, Pa. 18951
(215) 536-1354

Scientific Atlantic
3845 Pleasantdale Road
Atlanta, Ga. 30340
(404) 449-2274

Ungermann-Bass Inc.
2560 Mission College Blvd.
Santa Clara, Calif. 95052
(408) 496-0111

Viacom Telecommunications Inc.
5924 Stoneridge Drive
Pleasanton, Calif. 94566
(415) 463-0870

Xyplex Inc.
100 Domino Drive
Concord, Mass. 01742
(617) 371-1400

Zenith Electronics Corp.
1000 Milwaukee Ave.
Glenview, Ill. 60025
(312) 391-8181

Zeta Laboratories Inc.
3265 Scott Blvd.
Santa Clara, Calif. 95054
(408) 727-6001

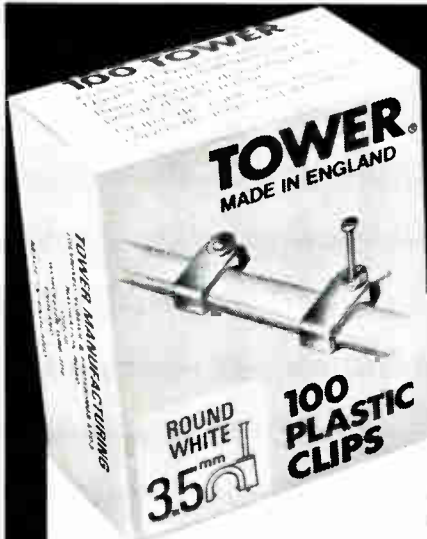

Tower cable clips

for proven quality and economy

Tower-leaders in the industry

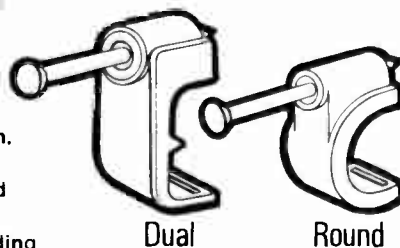

- Sure-fit for quick simple installation.
- Plated, hardened, flat-headed Steel masonry nails, pre-assembled ready for use.
- Sizes to fit all coaxial cables, including quad and double shielded, both single and dual systems. Available in black, white and grey.
- Sold by most leading distributors — Ask for Tower by name.
- Write today for samples, literature and a copy of Tower Cable Clips test results as required by the British Telephone Company, giving name of your supplier.

WELDONE TRADING CO. INC.
1401 Legendre Street W.
Suite 106.
Montréal, Québec H4N 2S2
(514) 381-8861

EXCLUSIVE UNITED STATES IMPORTERS

“What’s good for GM is good for the country”?

Let’s hope so. If the company’s MAP effort succeeds, broadband notches a big, big win. Vendors are scrambling to comply with the standard, but obstacles remain.

Somewhat prophetically, Charles E. Wilson told the Senate Armed Forces Committee in 1952 that “What is good for the country is good for General Motors, and what’s good for General Motors is good for the country.” Hopefully, that’s true for MAP, the company’s major standards-setting effort. Because if the Manufacturing Automation Protocol becomes a commercial success, the broadband community gets a big financial shot in the arm. And there’s reason to think it might. MAP has some awfully big guns behind it: GM, Boeing, Deere & Co., DuPont, Eastman Kodak, Ford, the U.S. Air Force, Inland Steel, McDonnell Douglas, Proctor & Gamble, TRW and perhaps 50 other sizable end-users. And vendors of all sorts have been scrambling to proclaim their support for the standard. Some products are already on the market, and the trickle looks to become a flood later this year.

But the enormity of the undertaking isn’t to be taken lightly. MAP seeks nothing less than an open architecture for broadband local area networks in the factory environment: plug-in compatibility between modems, network interface units, headend remodulators and other devices on the network. It hasn’t been easy to achieve, even at the lowest physical levels. Furthermore, the development effort has required a major cultural shift in the way companies do business.

Kevin Hughes, manager of MAP product marketing for Allen-Bradley, a major player in factory automation, recalls that at the very early MAP meetings, engineers from competing companies didn’t even sit in the same room. Messages were shuttled back and forth between them. Today, companies cooperate in ways that would

have seemed unthinkable back then. They have to. GM has made absolutely clear its intention to purchase only network products that conform to MAP specifications. So companies must demonstrate interoperability of their

devices at increasingly higher levels of functionality.

Potential dangers

And, there’s potential danger lurk-

PRODUCT

CWY
electronics

BULLETIN

Omni-Rack Performs One Incredibly Neat Trick

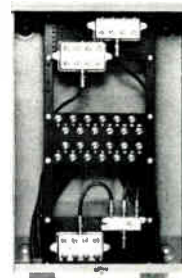

CWY's Omni-Rack™ system uses rails and panels similar to headend rack accessories to take the tangle out of multiple dwelling enclosures. This money- and time-saving system easily adapts to fit existing installations and is versatile enough to conform to your own design.

Omni-Rack 16-gauge perforated panels fasten to punched and threaded rails and accommodate all makes of splitters. To change subscriber status — change only the jumper cables between splitters and F81 D-type

connectors on punched panels. CWY also offers all-welded enclosures constructed of aluminumized steel—with the rust-resistance of aluminum and the toughness of steel, giving you longer service life for the money.

For more information about the Omni-Rack and CWY's complete line of products, write or call us toll-free. And as always, CATV and SMATV products by the industry's leading manufacturers are also available from CWY. Cable TV solutions are now just a phone call away.

Reader Service Number 38

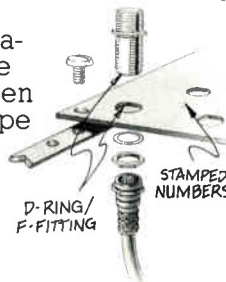

**Not just supplies.
Solutions.**

CWY
electronics

P.O. Box 4519
Lafayette, IN 47903
317-448-1611
Call Toll-Free:
1-800-428-7596
Indiana
1-800-382-7526

Big guns behind MAP may help lead to its commercial success.

ISO/OSI reference model

Application
(Layer 7)
Presentation
(Layer 6)
Session
(Layer 5)
Transport
(Layer 4)
Network
(Layer 3)
Data Link
(Layer 2)
Physical
(Layer 1)

Map layer functions

Program-to-program
Communications
Format Translation

Connection Establishment
and Maintenance
End Node-to-End Node
Error Checking
Internetwork
Message Routing
Intranetwork
Error Checking
Signaling and Physical
Connection to Media

ISO OPEN SYSTEMS INTERCONNECT REFERENCE MODEL

ing behind the MAP effort. It isn't just that communication between different devices consumes processing time as the various protocol layers are addressed. It's not that the effort to do so requires prodigious investments of time and resources, although perhaps 10 companies have each committed \$10 million to the MAP research and development effort. A few of the companies may have ponied up twice to three times that amount.

No, the real problem is that MAP has been a moving target so far. MAP has evolved over the past few years, and newer versions are coming. Version 2.2 is scheduled for release in the third quarter of this year, with a 3.0 version slated for first quarter 1987 introduction. That's because the standard began at the physical level and has been progressively refined at higher and higher levels of the Open Systems Interconnection model of the International Standards Organization. The OSI is a seven-layer reference model governing data communications.

And, without question, an undertaking of this sort takes time. It can't emerge full-blown overnight. But here's the economic problem. How many vendors can afford to invest heavily in MAP-compatibility at one spec, only to watch the spec change before they've had time to sell product and recover their costs? That's happened already. To date, GM has only promised to buy products at certain specs for two years or so. That may not be enough time.

Also, even when companies have time to put out compatible versions of MAP gear, those versions need to be out on the market at roughly the same time. Otherwise, there's the real possibility that various "MAP-compatible" or "MAP-compliant" devices won't talk to each other because each is using a different version of MAP. How many end-users are going to have confidence in MAP if the devices won't communicate? That could jeopardize the entire project and, with it, broadband's chances for serious market inroads in the local area network market.

MAP was the word

But MAP was the word on every-

Cable Prep[®] Stripping/Coring Tools

The performance
you need today
and the
dependability
you need
tomorrow.

For more information
contact your distributor.

BEN HUGHES
COMMUNICATION PRODUCTS CO.

207 MIDDLESEX AVENUE, P.O. BOX 373,
CHESTER, CT 06412 (203) 526-2291

Reader Service Number 39

MAP was the word on everyone's lips at Internat'l Programming Convention.

body's lips at the International Programmable Controllers convention, held April 8-10 in Detroit. MAP clearly was the glamour topic there, and the roll-out of MAP-compatible products continued. Just as clearly, the question on vendor minds was "when?" When will MAP products begin moving in serious quantities?

There seems to be no clear answers to the question now. Not a surprising situation, perhaps, considering that production quantities of MAP-compliant gear won't be on the market until later in the year. Allen-Bradley's VistaMAP LAN modems, for example, have successfully demonstrated interoperability with a Concord Data System headend remodulator. The A-B modulator also has been successfully tested with Scientific-Atlanta and Fairchild Data Corp. modems.

But the VistaMAP headend remodulator and terminal server units still are in beta testing. Production quantities won't be shipped until the end of July or so. By September, A-B hopes to be shipping a four-port version, in addition to the initial eight-port version. Other companies announcing MAP-compliant gear at the controller show are in similar situations.

Still, Allen-Bradley, for example, clearly is planning to move ahead aggressively. MAP products currently represent only about 5 percent of the Communications Division's sales. But in five years that figure could be 50 percent. The present staffing of the division is about 100 people. But that should grow to about 200 or so this year. And it may triple in the next several years.

Carrierband is next

For many of the vendors at the show, including Allen-Bradley, carrierband sub-networks attached to a broadband MAP backbone make a lot of sense. Known as "Mini Map," carrierband sub-networks use a less expensive signaling technique: 5 Mbps single-channel FM. The idea is to lower cost and lessen the chance of a catastrophic failure of the system. Since carrierband is a baseband technique, it doesn't need the more complex broadband modems. Also, the system provides some protection against total

system failure. If a sub-net goes down, the broadband net would still be functional.

Carrierband also suits the particular requirements of factory-based communication. Speaker Wendy Gibbons, senior systems engineer with A-B, pointed out that a variety of needs exist. Distributed control messages are sent frequently, usually need a rapid response and are limited in message length. Typically, communication between different programmable controllers is involved.

Factory monitoring, on the other hand, isn't as dependent on response time—except for alarms. Generally, data collection can be done in non-real time. Data acquisition, likewise, only needs to be done a couple of times per shift.

Supervisory control messages might only have to be downloaded once every few weeks, while program support and factory management also involve large

blocks of data transmitted in loosely coupled fashion.

Broadband is well-suited to some of these applications, said Susan Baumann, communications product specialist with General Electric Co. Supervisory transmissions involving lengthy messages sent out to many hundreds of devices are well served by the MAP broadband format. Programmable controllers at the sub-net level, by way of contrast, must have real-time communication, but generally only exchange short messages. So a carrierband sub-net is ideally suited to cells of about 20 devices, communicating frequently and briefly. "Mini AP is the level of MAP standard to which vendors of programmable controllers will conform," said Keith LeFebvre, product marketing manager with Gould Electronics.

Square D, for example, although showing a MAP-compliant gateway called Sy/Gate, also was very inter-

LIFE INSURANCE

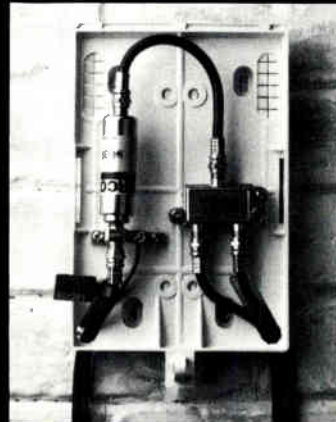

Insure the life of your drop components with the rugged, compact Drop Control Box. You'll appreciate the solid protection it gives to your drop installations. Your purchasing department will appreciate its immediate delivery, low cost and great durability. Your subscribers will appreciate its clean-lined, professional appearance.

For more information on the toughest drop enclosure in the business, or any of our other products, call 800 548-7243.



Telecrafter Products
CORPORATION

Products creatively designed for the cable industry.

THE ARCOM FAMILY

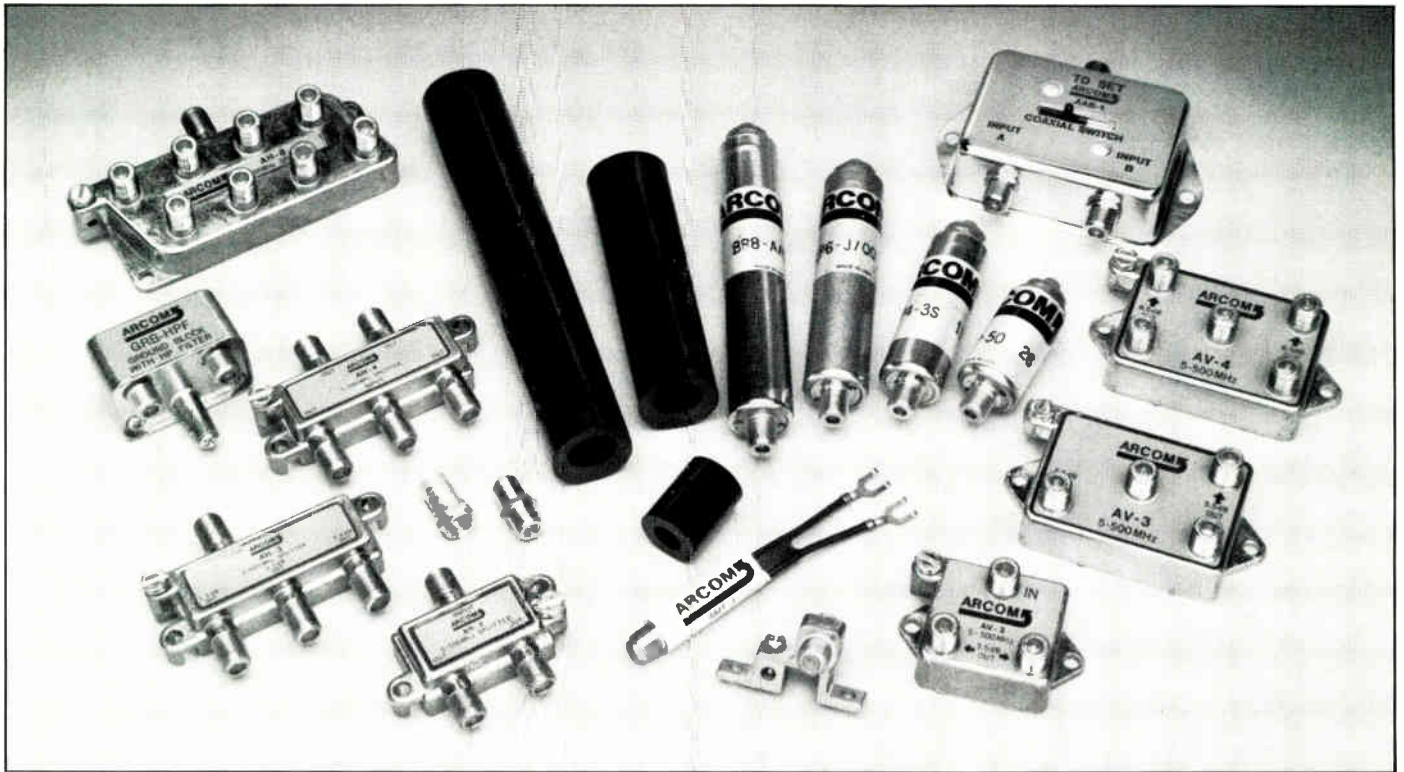

If our quality doesn't sell you,
our service will.

ARCOM traps are the #1 quality traps in the industry. So, what would you expect from the rest of the ARCOM family? Quality, of course. But, what good is great quality, if you can't get it when you need it. And, that's where our extraordinary service comes in.

Because we're dedicated to growing, we're

Give us a call for
full specs and pricing.

Call Toll Free
(800) 448-1655

In N.Y. State Call
(315) 463-8433

dedicated to giving our customers the best service in the industry. That means more hustle. More friendly, informed personnel. *And* faster deliveries.

If top quality products and top quality service are what you need for your system, why not get to know the ARCOM family of fine CATV products.

 **Northern**
catv sales, inc.

Carrierband sub-networks use less expensive signaling techniques than regular broadband MAPs.

ested in carrierband standards, since so much of the company's work is at the cell level: a group of automated machines that must be closely coordinated in real time to function properly.

Compatible with MAP version 2.1, Sy/Gate actually incorporates three functions into a single unit. It acts as a cell controller for up to eight devices, is a MAP gateway and also can serve as a network interface unit for factory floor equipment.

General Electric was demonstrating its new MAP-compliant GENet factory LAN. The 10 Mbps token bus system includes a bus interface unit, headend remodulator, a network management console and software packages for device attachment. In essence, GE has added software to Industrial Networking Inc. components. INI is a joint venture between Ungermann-Bass and GE. Beta testing begins in May, with full production expected in July. The remodulator will be priced at about \$5,800; the interface unit will sell for \$4,500-\$5,000 in a two-part configuration supporting eight controllers from each port. Like other vendors at the show, GE is interested in carrierband, and the company's next announcements will be for carrierband products.

Gould Electronics was showing its NW 0200 MAP Gateway, operating at MAP 2.1. Orders will be taken in June. The company also was showing its Modbus II interface module, a MAP-compliant device allowing attachment of Gould 984 controllers to a MAP network. Beta testing begins in July, with production on a full scale in September. Later, an interface for IBM PCs will be rolled out. The new interface is compatible with Mini-MAP, 802.2, 802.4 and 5 Mbps phase coherent carrierband standards.

Universal Computer Applications announced its offering of MAP training courses and design consulting.

Motorola was showing several of its MAP products: the MAP Network Developer's Kit, the VME module MAP network interface and the MC68824 token passing bus controller. The Developer's Kit includes a headend remodulator, drop cables, return cables, diplex filter, connector adaptors, 75-ohm terminator and two-way tap. The VME module connects a MAP net and a VMEbus. The

MC68824 is a chip-level device that provides media access control functions for devices to be attached to a MAP network.

—Gary Kim

Where to find them

Allen-Bradley
Industrial Computer Group
C Division
3920 Varsity Drive
Ann Arbor, Mich. 48104
(313) 973-1500

General Electric Co.
Automation Controls Operations
P.O. Box 8106
Charlottesville, Va. 22906
(804) 978-6922

Gould Electronics
Programmable Control Division
P.O. Box 3083

Andover, Mass. 01810
(617) 475-4700

MAP/TOP Users' Group
Society of Manufacturing Engineers
One SME Drive
P.O. Box 930
Dearborn, Michigan 48121
(313) 271-1500 ext. 521

Motorola Literature Distribution
P.O. Box 20912
Phoenix, Ariz. 85036

Square D Co.
P.O. Box 472
Milwaukee, Wis. 53201-0472
(414) 332-2000

Universal Computer Applications
30362 Southfield Road
Southfield, Mich. 48076
(313) 642-4792

SPARE ROOM

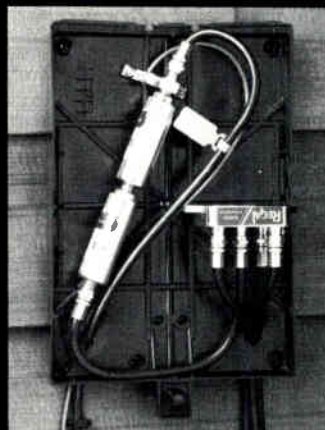

232 cubic inches! Plenty of room for several traps, a ground block, a splitter and a few extra feet of cable. And there's more!

With the spacious Audit Control Box, thefts of service are reduced by providing visual evidence of tampering. Field costs are reduced by placing customer service and tap audits at ground level. Equipment costs are reduced by protecting drop components from the weather. For more information, call 800 548-7243.



Telecrafter Products
CORPORATION

Products creatively designed for the cable industry.



Technology Above the Rest

Product design and technology are often copied but seldom duplicated.
At Utility Products, we advance the state-of-the-art by designing better pedestals.

We are thinking of the future when taps, couplers, and amplifiers
may require a more compact designed closure.

Also, the environment is changing; acid rain, pollutants,
and coastal salt contaminants promote corrosion
so we've improved our already long-lasting finish.

In addition, all our closures feature increased mounting capacity
and variety through improved bracketry.
It is this attention to detail that keeps Utility Products above the rest.
Your future is assured with Utility Products.
Phone or write us at the address below.

Reliable Electric/Utility Products 11333 Addison Street/Franklin Park, Illinois 60131/312-455-8010

Reader Service Number 43

RELIANCE
COMM/TEC

product profile

Pedestals

CWY Electronics

Designed exclusively for the cable industry, the pedestal line from CWY Electronics is constructed from 18-gauge T2 aluminized steel followed by a four-stage process including: washing, phosphatizing, baked vinyl wash primer, and electrostatic application of baked-on polyester enamel. The rectangular design of CWY's pedestals allows for maximum use of interior space. Each unit features a fully replaceable 11-gauge hasp, a hingeless front cover and top removal system for full exposure of interior and is flush-mountable directly to buildings. Multiple equipment mounting knockouts, hipped lid and interior lid guides, and an optional cam lock knockout are also included features in CWY's PED line.

The Omni-Rack™ system from CWY simplifies connections, disconnections and changes in subscriber status in multiple dwelling enclosures. The Omni-Rack rails are punched and threaded, thereby eliminating the need for plywood. Universal 16-gauge perforated panels accept No. 6 self-tapping screws and are designed to accommodate all makes of splitters. Once leads are connected to the underside of Omni-Rack's punched panels, connecting, disconnecting or changing subscriber status involves changing only the jumper cables between splitters and F81 D-type connectors on the punched panels. The Omni-Rack apartment box is available in two sizes: 12 x 18 x 18 inches and 18 x 24 x 8 inches.

The APB line of apartment security boxes from CWY is constructed of 16-gauge aluminized steel and features a hingeless lid removal system with security stops welded inside the front cover to deter unauthorized entry.

For more information on CWY's complete enclosure line, contact (800) 428-7596, in Indiana (800) 382-7526.

Channell Commercial

Channell Commercial Corp. is a privately held company that has been developing and manufacturing CATV pedestals for over 20 years. The materials used by Channell in its CATV products were developed in the 1960s

for use in the "Minuteman Missile" project through extensive government-funded laboratory research and testing.

In addition, Channell's pedestal line is designed with a rounded lid to reduce the need for increased material quantities and to ensure durability. The round design also appears smaller than a square design of the same size, company spokesman Bill Channell Jr. states. All Channell pedestals are injection molded with a TV identification symbol on the cover, eliminating the need for stickers that may peel over time.

Constructed of acrylonitrile-butadiene-styrene plastic (ABS), Channell's enclosures are flame retardant and capable of withstanding high-impact blows, according to the company.

The metal components of Channell's pedestal products are hot dip galvanized after fabrication, and all pedestal products are shipped pre-assembled

with factory-installed stakes, brackets and locking accessories. These features can reduce the contractor's installation cost.

Suitable for all single- and dual-plant underground CATV projects, the CPH and DCPH enclosures from Channell are available in a variety of sizes.

For more information, contact Channell, (800) 423-1863 or (818) 963-1694.

Coil

The PEDLOCK series of closures from Coil Sales & Manufacturing Co. is constructed of specially formulated rigid polyvinyl chloride (PVC), which resists deterioration from chemicals, fertilizers, ground acids and salt conditions. Special additives in the PVC material provide high impactibility and shield against ultra-violet light degradation.

All PEDLOCK closures are available with an optional integral stake base, which eliminates the need for

NO TROUBLE

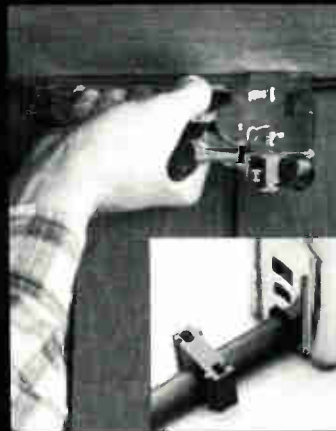

It's easy to use. The Fastac Clip Gun and its companion RB-2 Cable Clips will install drop cable on any wooden surface solidly, quickly, and flawlessly. It's error free. Installations proceed smoothly and trouble calls resulting from cable damage are eliminated.

Because the cable will be installed correctly, service will be clear and continue to be clear. For more information on the trouble-free Fastac Clip Gun, call 800 548-7243.



Telecrafter Products
CORPORATION

Products creatively designed for the cable industry.

Reader Service Number 44

Communications Engineering and Design May 1986 57

Coil's PEDLOCK series, steel enclosures from ComPedCo and Diamond's fiber glass pedestals. . .

separate metal stake and mounting hardware.

The PEDLOCK line is available in five sizes (4-, 6-, 8- and two 10-inch). All standard closures feature dual security for protection against unauthorized

entry. This security system includes a 7/16-inch hex bolt and 1/4-inch hasp. Locking systems are optional.

A 2-inch overlapping area created by the dome and base of all PEDLOCK closures keeps out environmental

problems. The overlap is designed with an air space which, working in tandem with a series of small openings at the top of the dome, provides proper air circulation.

Also from Coil are apartment house boxes—available in heavy-gauge galvanized steel, aluminum or stainless steel. Each apartment box comes with two 2-inch knock-outs at the bottom for cable entry and a removable, treated plywood backboard for mounting of components. The baked-enamel finish is available in beige, brown, green and grey. High-security and standard styles are offered in six sizes.

Coil's line of closures also includes two models designed to house and protect large amplifiers and auxiliary equipment. The 10- and 14-inch amplifier closures feature screened, louvered openings in the dome for additional air circulation.

For more information, contact Coil Sales & Manufacturing Co. at (312) 398-6774.

ComPedCo

A subsidiary of Milbank, ComPedCo Inc. has been fabricating sheet metal enclosures for over 50 years. Its CATV pedestal line is made from heavy-gauge zinc-coated steel finished with a hybrid polyester epoxy powder, electrostatically spray applied 1.5 to 2 mm. thick. These enclosures consist of a backplate/lower front cover assembly and an upper cover/cap assembly. Each unit features a knock-out provision for cylinder lock and/or padlock hasp. Accessory mounting brackets may be installed on the back plate.

The ComPedCo series of pedestals is available in five sizes, two of which feature screened louvers for ventilation.

Apartment boxes and a line of mounting accessories also are available from ComPedCo.

For more information, contact ComPedCo Inc., (816) 483-5314.

Diamond

The Pedestal and Closure Division of Diamond Communications Products Inc. manufactures CATV pedestals of pultruded fiber glass. Strand and mat glass fibers are fed into a bath of specially formulated resin that has been mixed with pigments, fire retardants

Diamond Communication Products, Inc.

A CLOSER LOOK AT DIAMOND'S REINFORCED PEDESTAL
—Now Competitively Priced and Superior to Steel—

Multiple Layers. . .

Multiple Advantages. . .

- NON-CORROSIVE—Fiberglass cannot rust and is favored in coastal, tropical, and alkaline soil areas. Reduce maintenance costs by not having to replace unsightly, rusted-shut or structurally-affected pedestals.
- SHAPE MEMORY—Fiberglass is impact resistant and will not dent. Always remains easy to open and close.
- LOW PROFILE—Less obtrusive in field. Diamond pedestals can be custom-made to your height requirements.
- EXCELLENT INSULATOR—Decreases the chance of shorting circuitry or signal interference.
- HEAT RESISTANT—Fiberglass will chemically extinguish flames. Fiberglass dissipates heat and, unlike steel's oven effect, fiberglass maintains a lower inside pedestal temperature.
- LIGHTER WEIGHT—Reduces shipping costs, and installers prefer our lightweight pedestals which reduce fatigue and increase productivity.
- UNIQUE PATENTED INTERLOCKING DESIGN—Seals out weather and insects, while allowing easy entry.
- STRENGTH—Pound for pound, fiberglass is stronger than steel. Fiberglass is used in boats, refinery tanks, stairways, ladders, and more.



UNIQUE INTERLOCK DESIGN

provides environmental protection but permits instant cover removal. Loosen one bolt and the cover lifts off. Close-tolerance construction shuts out dust, dirt, rain, snow, and insects.

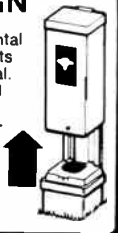

Fiberglass vs. Steel—there's no comparison. Call your local distributor or contact us directly for additional information.

Diamond's Fiberglass Reinforced Pedestal. . . Extra advantages without extra cost.

Reader Service Number 45



DIAMOND COMMUNICATION PRODUCTS, INC.
500 NORTH AVENUE, GARWOOD, N.J. 07027 • (201) 789-1400

We must make our industry, and the NCTA, more technology aware.

Continued from page 16

better pictures and sound but, perhaps more importantly, better availability. We can argue all day whether the subscriber can see an improvement in picture quality, but there is no debate about the observability of an outage. Since DBS has much fewer electronics between the program source and the viewer, it can have an outage advantage. Convenience includes not only the consumer electronics interface issue but also ease of use, availability, variety and an ability to appreciate what is available. We must ensure that alternate methods of delivery don't gain or retain a competitive advantage over cable.

The continuous issues include FCC & legislative affairs, professional affairs, inter-industry relations and standards. FCC issues include signal leakage, frequency usage and must-carry. The legislative branch of government is currently pursuing satellite scrambling, copyright and compulsory license. Professional affairs include conferences, technical literature, training and technician certification support. We are affected by several other industries, among them: consumer electronics, broadcast, telephone and power. These important issues will continue to demand time and effort in order to win new ground and defend previous gains.

The cable industry doesn't have a tradition of dealing with its future because for most of its existence it *was* the future. This may no longer be the case. Our industry has always had such an all-consuming present that there have been little or no resources left to apply to the future. This, in itself, is the most important long term technical issue. Cable must become more technologically strategic. It is hard to cite another industry of similar size and technological dependence that has less R&D. We have no strong university ties. There is no college with a graduate research program in cable technology. MSO investment in R&D has been limited. Cable has traditionally left R&D to its vendors. The depressed economic state of the industry's vendors has drastically reduced development and essentially eliminated research. Unless this is changed, there will be few technological choices

from which to build our future. Others, particularly the telephone industry, are not similarly at risk; they are investing in advanced technology and strategic planning on a comparatively grand scale. This cannot fail to yield them advantages.

HDTV and its related approaches, such as enhanced television techniques, would appear to be natural opportunities for a relatively bandwidth-rich medium such as cable. But cable's bandwidth has certain technical restrictions which could work to our disadvantage if we don't actively participate in the standards setting process. Onerous standards could result in the need for another \$100 ugly box on top of the "standard" HDTV receiver to accommodate the special needs of cable transmission.

Program protection technology is yet another important long-term issue. It is not possible to predict the ultimate solution(s). Two candidates answer the consumer electronics interface issue: off-premises interdiction and an advanced IS-15 compatible scrambling standard. In the latter case, the desire is for a method so secure that the hardware can be owned by the subscriber. The cable industry would be better off with standardization. An industry standard would allow vendors to compete on features, service and price. If, in addition, the standard could accommodate VCR recording in the scrambled mode, only viewing devices would require a decoder.

Two way capability could become the salient difference between cable and many of its would-be competitors. Two way communication is the key to a future home information business. Cable must invest in ways to realize this advantage and make it practical.

Productivity improving technology, such as Expert System software, needs to be encouraged if cable is to maintain its operational advantages.

There are certainly more technical issues to consider. This short review clearly indicates that we have our work cut out for us. I look forward to working with you over the next year in the NCTA Engineering Committee and hope we will have the satisfaction of achieving significant progress in these issues. ■

Eagle TRAPS



The Great Trap Test!

Compare these features with the competition:

FEATURES	MANUFACTURERS		
	EAGLE	A	B
100% Urethane filled (Weather Resistant)	■		
Single Board Construction (Improved Grounding)	■		■
Dual "O" Rings (Weather Resistant)	■	■	■
Blocking Capacitor (Reduced Theft)	■		
Metal Shields Available (Reduced Theft)	■		
Made in USA	■	■	
Special Design Multichannel Traps	■	■	
Metal-Stamped Channel I.D.	■		■

**(800)
448-7474**



4562 Waterhouse Road
Clay, NY 13041
(315) 622-3402

POLYPED from Federal Telecom, steel enclosures from Pyramid, Reliable & Superior.

and ultra violet absorbents. This mixture is pulled through a die, and the specified shape emerges. The parts then are cut to length. As a result of this process, Diamond pedestals will not rust or deteriorate and will maintain their shape indefinitely, according to a company spokesman. And because the color is molded in, the units never need painting. All models are electrically non-conductive and fire resistant.

Diamond enclosure products are subjected to a series of tests including: salt spray resistance, freeze/thaw, splashproofness, impact testing, fire-arms testing, temperature storage, humidity, thermal shock and flame resistance.

New from Diamond is the OP-TIPED, a round fiberglass closure for fiber optic splices mounted on a concrete vault. The splice case with a fiber optic splice inside is mounted on brackets which allow the case to hang vertically with the in and out cables coming through the bottom of the case.

For more information, contact the Pedestal and Closure Division of Diamond Communication Products Inc., (201) 789-1400.

Federal Telecom

The POLYPED series of housings from Federal Telecom is manufactured in five sizes (4-, 6-, 8-, 10- and amplifier) of polyethylene using the company's No. 7420 resin. The POLYPED line is available with internal brackets, stakes, labels and airvents—all offered as accessories. Brackets and stakes are mounted on common centers, with the stakes mounted from the inside of the unit—eliminating outside obstructions.

POLYPED's removable cover permits 360-degree working access. This cover, when in place, results in a snug fit to the base with a 3-inch (5-inch in the amplifier housing) overlap that eliminates dust, water, insect and ultra-violet penetration. In addition, a molded-in hex head lock and hasp provide security protection against unauthorized entry.

The POLYPED family of closures is non-corrosive, non-conductive, nonporous, fire and thermal resistant and provides flood protection in high water areas because of its bell jar effect.

For more information, contact Federal Telecom Inc., (312) 381-8700.

Pyramid

Pyramid Industries manufactures a complete line of above- and below-ground cable television enclosures. Constructed of heavy-gauge steel with mill-galvanized coating, the Pyramid line is finished with phosphatizing and baked-on enamel. A wide variety of sizes are available, some featuring louvered covers for free-flow ventilation and 360-degree access to electronic components.

Most units are furnished with anchor posts and mounting hardware. Pole mounting kits and a complete selection of mounting plates, brackets, and accessories are also available.

For more information, contact Pyramid Industries Inc., (602) 269-6431.

Reliable Electric/Utility Products

Reliable Electric/Utility Products manufactures over 19 different sizes and styles of CATV enclosures. Each closure features the company's five-step finishing process to guard against corrosion and weathering. This process starts with mill-galvanized steel which is bathed in an alkaline wash, then phosphatized and acid washed to create a bondable surface. This is followed with heavy-duty primer vinyl and polyester top coats, which are separately dipped and baked.

Many Reliable Electric/Utility Products' closures include screened louvers to guard against the environment, and each closure features a security locking system which includes temper-resistant bolts, padlock hasps and three-point locks.

Also from Reliable Electric/Utility Products is the Super SAFE, a multiple-dwelling enclosure designed to prevent cable theft. Made of 14-gauge mill-galvanized steel, SAFE features welded corners, an interlocking cap, no bolts or rivets, knockouts on the bottom of the unit, inner-tite barrel locks and a plywood backboard. SAFE is available in 10 sizes.

For more information, contact Reliable Electric/Utility Products, (312) 455-8010.

Superior

Cable television enclosures manufactured by Superior Metal Products are constructed of zinc-coated 10-, 12-, 14-, 16- and 18-gauge galvanized steel. In a four-step finishing process, the surface of the steel first is cleaned in a solvent bath. The surface then is treated in phosphoric solution to etch and prepare it for coating adhesion, then prime coated with a high-acid zinc-rich primer and finished with a coating of plasticized, chlorinated rubber paint.

Available in a variety of sizes, Superior enclosures are offered with a high-security tubular lock which uses a circular key. Enclosures are shipped without keys, which are forwarded to an authorized system agent designated to have key control. Keys are issued only to that individual and shipped via certified mail with a return receipt. Each cable system or MSO is assigned a unique lock and key code which is not duplicated with any other company.

For more information, contact Superior Metal Products Inc., (206) 455-9159.

CableData's "PEP" talk

While researching the article on voice response, "Let Your Computer do the Talking," for the March issue, CED was informed that CableData's PEP unit was not used for voice response applications. We have since learned that the PEP unit may, in fact, be used for voice response and that CableData also offers a Programmable Auto Dialer (PAD).

The PEP unit uses a voice synthesizer to let subscribers communicate directly with the on-line computer. Each PEP unit is microprocessor-based, accommodates up to 16 phone lines and uses two Tandem ports. PEP interfaces with CableData's on-line DDP software and works with all CableData addressable interfaces.

PAD is a telecomputer that interfaces with CableData's DDP software to place customer calls. PAD delivers messages and records selected responses.

For more information about PEP and PAD, contact CableData, (916) 636-5800. ■

classifieds

EMPLOYMENT OPPORTUNITIES/HELP WANTED

State-of-the-Art Broadband System Engineer

Stanford University seeks a qualified CATV/broadband system engineer to design and supervise installation of two-way, interactive broadband distribution networks throughout the Stanford Campus; an 8000 acre site with hundreds of buildings and about 10,000 residents. The Stanford system is a state-of-the-art, two-way interactive system supporting low and high speed data as well as television video and experimental research.

Responsibilities include: engineering analyses of broadband network devices; developing maintenance programs for network equipment; determining inventory requirements; troubleshooting broadband network malfunctions and analyzing failure patterns. You'll also select, construct/adapt, install & debug interfaces for a wide range of computers and signal sources. In addition, you'll train and supervise technicians and student assistants; evaluate monitoring and test equipment; provide users with training and technician advice on acquisition and applications of networking equipment and interfaces.

The position requires a BSEE or equivalent, along with at least 3 years experience in CATV/broadband communication system design, development, operation and maintenance. Knowledge of a wide range of network interfaces and test equipment is required. Must be well-organized and able to independently manage resources and carry out projects on schedule.

Send resume and cover history highlighting qualifications to: Kathy DeMoulin, #40223, Old Pavilion, Stanford University, Stanford, CA 94305. An equal opportunity employer through Affirmative Action.

VIDEO/PRODUCTION TECHNICIAN

Needed in Mississippi.
Call Mickey (601) 844-6700

**Baker Scott
& Co. EXECUTIVE SEARCH**
1259 Route 46 Parsippany, NJ 07054 201 263-3355
**Specialists in the COMMUNICATIONS
INDUSTRY**
CABLE TV BROADCAST TELECOMMUNICATIONS
DIVISION DIVISION
POSITIONS AVAILABLE AT ALL LEVELS OF
MANAGEMENT. COAST TO COAST
Call or write in CONFIDENCE FEE PAID
"WE DON'T TALK CABLE, WE KNOW CABLE"
PRINCIPALS DAVID ALLEN & JUDY BOUER

**"Leader in the
Placement of Cable
Television Professionals"**
Nationwide Service
**JIM YOUNG &
ASSOCIATES**
One Young Plaza
1235 Ranger Highway
Weatherford, TX 76086
(800) 433-2160
(817) 599-7623

**RF PRODUCT DESIGN
ENGINEER/RF SYSTEMS
DESIGN ENGINEER**
Well established and still growing manufacturer of Cable & Networking products looking for EXPERIENCED people who want to grow along with us. Must be willing to relocate. Competitive salary, benefits + more. For information call Cynthia Brown, (800) 645-7600. In NY (516) 921-7080.

BUSINESS DIRECTORY

CATV EQUIPMENT REPAIRS

- Line & Distr. Amplifiers
- Field Strength Meters
- Headend & CCTV Gear
- Fast Turnaround
- Quality Workmanship
- Reasonable Rates

**VideoTech
Service Inc.**
CATV • MATV • CCTV

All repairs unconditionally guaranteed.
For more information call collect
VIDEO TECH SERVICES, Inc.
4505 D W ROSENCRANS AVENUE
HAWTHORNE, CALIFORNIA 90250
213-970-9012

NEMAL STOCKS:

- SPLITTERS • SWITCHES
- TRANSFORMERS
- ADAPTERS • CONVERTERS

Immediate Delivery!!!

- TRUNK CABLE
- DROP CABLE • AMPLIFIERS
- SATELLITE CABLE

Call or write for
Cable Systems Pricing
WE EXPORT WORLDWIDE

**NEMAL
ELECTRONICS, INC.**
12240 N.E. 14th Avenue
North Miami, FL 33161
(305) 893-3924

**THE
SOURCE**

- SALES: Converters, CATV Equipment and Parts
- SERVICE: Converters and CATV Equipment
- JERROLD Authorized Warranty Service Centers

WE BUY USED AND
EXCESS EQUIPMENT
1-800-382-BRAD
IN NY 1-518-382-8000

BRAD THE CONVERTER MANUFACTURER

Schenectady, NY 12301
Tampa, FL 33610 Fife, WA 98424

TRIPLE 'C' COMMUNICATIONS
CABLEVISION CONTRACTOR

INSTALLATIONS — UNDERGROUND DROPS
APARTMENT WIRING

RR 1 BOX 199 NORWALK, IOWA 50211
BOB COUCHMAN, OWNER (515) 287-2215

SCTE

Society of Cable Television Engineers

Registration Package

for

CABLE-TEC EXPO[®]'86

- 100% Technical Orientation
- Hands-On Breakout workshops
- Non-Commercial Exhibit Area Featuring Industry Hardware Vendors
- Tours of Manufacturing Facilities
- Administration of BCT/E Certification Program Examinations

Phoenix Hyatt Offers
Special Room Rates

- Single — \$50.00
- Double — \$59.00

Shared Double Rooms For The
Unbeatable Rate of \$29.50 Per
Night Each

For more information contact:
SCTE National Headquarters
(215) 363-6888

June 12-15, 1986

Phoenix Convention Center
Phoenix, Arizona

Cable-Tec Expo '86 will be the only cable industry trade-show to increase its exhibit space over its 1985 show.

PRELIMINARY PROGRAM

Engineering Conference

- Increasing Communications Between Engineering and Management, Part II
- Lightning and Grounding
- Pay-Per-View Revisited
- Developing Technical Management Skills
- Keynote Speaker—James P. Mooney—President, NCTA

Expo Workshops

- Developing An Effective Preventative Maintenance Program
- Video and Audio Signals and Systems (BCT/E Prep Course)
- CPR and Industrial First Aid
- Basic Electronics and Electricity
- Implementing Stereo Headend Equipment
- Field Intensity and RF Field Strength
- System Sweep and Analysis
- New Technologies In Power Supplies
- Commercial Insertion Equipment Update

Advertiser's Index

Reader Service #	Page #	Reader Service #	Page #
Alpha Technology.....	27.....37	Northern CATV.....	41.....54
Anixter Communications.....	50.....68	Oak Communications.....	36.....48
Ben Hughes.....	39.....52	Permacast.....	21.....30
Brad Cable.....	31.....41	Phoenix Leasing.....	32.....42
Broadband Engineering.....	9.....17	Pico Satellite.....	22.....30
Burnup & Sims.....	12.....21	Pioneer Communications.....	6.....13
Cable Link.....	33.....44	PTS Electronics.....	29.....40
Cable Power.....	7.....14	Reliable Electric.....	43.....56
Cable Services Co. Inc.....	28.....39	Riser-Bond.....	30.....40
CATV Services.....	14.....22	RMS Electronics.....	15.....23
Channel Master.....	5, 20.....11, 31	Sachs Communications.....	18.....27
Control Technology.....	13.....22	Sadelco.....	11.....20
CWY Electronics.....	35, 37, 38, 47, 49, 51	Scientific Atlanta.....	3.....5
Diamond Comm. Prod. Inc.....	45.....58	Sitco Antenna.....	48.....66
Eagle Comtronics.....	46.....61	Standard Communications.....	4.....7
General Instrument.....	34.....46	Telecrafter.....	40, 42, 44, 53, 55, 57
Hughes Microwave.....	16.....24	Telewire Supply.....	8.....15
J.I. Case Co.....	19.....29	Time Manufacturing.....	23.....32
Kanematsu-Gosho.....	25.....34-35	Times Fiber.....	49.....67
Line-Ward.....	17.....25	Trilogy.....	2.....3
LRC Electronics.....	26.....36	Triple Crown.....	24.....33
M/A-COM Cable.....	10.....19	Weldone.....	47.....50
Magnavox CATV.....	1.....2		

When you need every advantage:

Count on Sitco's top Performance, Price, Delivery, Research & Development.



You'll get the best high tech antenna ever.

For 30 years SITCO has designed arrays to withstand severe weather and give top performance throughout the world. All arrays are cut to channel and include installation materials for mast or tower mounting. Phone or write and give us your requirements. We'll give you our latest top performers.

VHF & UHF tower mounted arrays available in cantilevered, single bays, vertical stacks or stagger stacked quads.

Reader Service Number 48



Continued from page 12

$$p_o = g(p_i + p_a)$$

$$\text{where } p_a = (nf-1)p_{T_o}$$

$$\text{so, } p_o = g[p_i + (nf-1)p_{T_o}]$$

DR. KATZ MODEL:

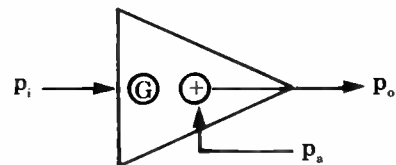

$$p_o = gp_i + p_a$$

$$\text{where } p_a = g(nf-1)p_{T_o}$$

$$\text{so, } p_o = g[p_i + (nf-1)p_{T_o}]$$

Thus the models give identical total output noise powers but the device contribution differs by a factor of g depending on the model configuration.

Dr. Katz's comments lead me to realize that the analysis differs depending on whether the model has the cable length before or after the amplifier. However, the primary purpose of the article was to present the model, equation (20), which is correct as stated.

In addition, the following "errors" occurred because of the ambiguity of my PC printer:

In equation (2), the original manuscript was ambiguous because of the limitations of my PC printer. The correct expression is:

$$V_T^2 = V_1^2 + V_2^2 \quad (2)$$

Equation (7) is missing a circle and should appear:

$$\text{dBm}V_T = \text{dBm}V_1 \oplus \text{dBm}V_2 \quad (7)$$

The "m" in $(nf_m - 1)$ should be capitalized in equation (8).

In the amplifier model figure, change N_i to N_1 for consistency and delete the two arrows pointing downwards.

Richard N. Dunbar

Ed: A revised Table 1 and supplemental equations are available from CED.

VIDEOCIPHER II / VIDEOCIPHER II 2000E

CABLE TV'S GREAT NEW REVENUE PRODUCERS

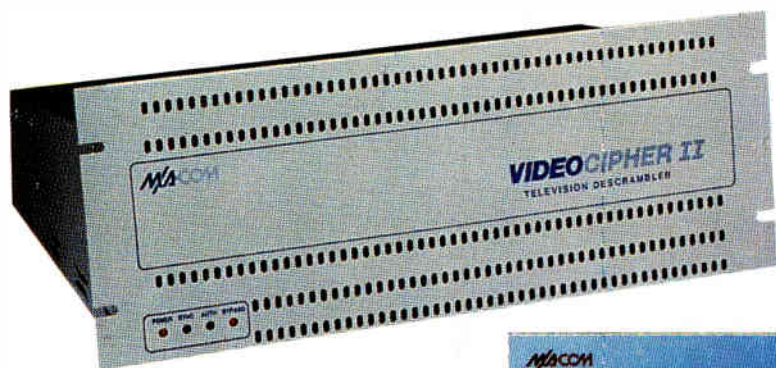

HEADEND VIDEOCIPHER (VC2C)

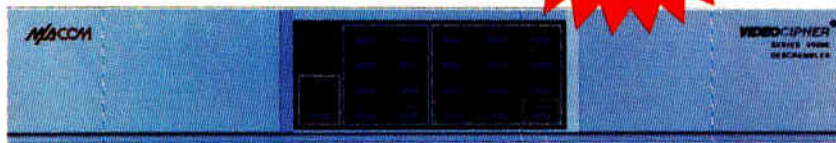

VIDEOCIPHER II TVRO MODEL 2000E

M/A COM's VideoCipher II, the revolutionary descrambler, accepted for use in demanding high quality satellite program distribution environments, is now available through Anixter's nationwide distribution network.

This new system produces a descrambled signal that is indistinguishable from the original, even at low C/N.

VideoCipher II descramblers are rack-mounted and interface easily to commercial satellite receivers.

VideoCipher II can control up to 56 independent tiers of programming, and its security system assures that a descrambler can only receive programming in tiers for which it has been authorized.

And, when planning to order your VideoCipher II descramblers, remember it's good business practice to have a couple of spare descramblers to serve as common back-ups.

Now you can help TVRO customers in your franchised areas to stay tuned to their favorite programming with the **VideoCipher II TVRO Model 2000E**.

TVRO owners have invested heavily in their satellite systems. And now some of their favorite programming is scrambled or about to become scrambled.

With more than a million and a half people with TVRO systems, and thousands buying new systems every month, the start of scrambling opens up a whole new world of incremental sales for Cable-TV System Operators. Act now! Order your M/A-Com **VideoCipher II TVRO Model 2000E** from Anixter today.

ANIXTER
COMMUNICATIONS

CORPORATE HEADQUARTERS: ANIXTER BROS., INC.
4711 Golf Road, Skokie, IL 60076 (312) 677-2600 — Telex 289464

©VideoCipher is a Registered Trademark of M/A COM, Inc.

©1986 Anixter Bros., Inc.

Mail To:

ANIXTER
COMMUNICATIONS

4711 Golf Rd.,
Skokie, IL 60076

- Please send me M/A COM'S VIDEOCIPHER II Technical bulletin.
 Please send me M/A COM'S VIDEOCIPHER II 2000E Technical bulletin.

Name _____

Title _____

Company _____

Address _____

City _____ State _____ Zip _____

Phone _____

CED 51

THE ANATOMY OF A SUPER CABLE

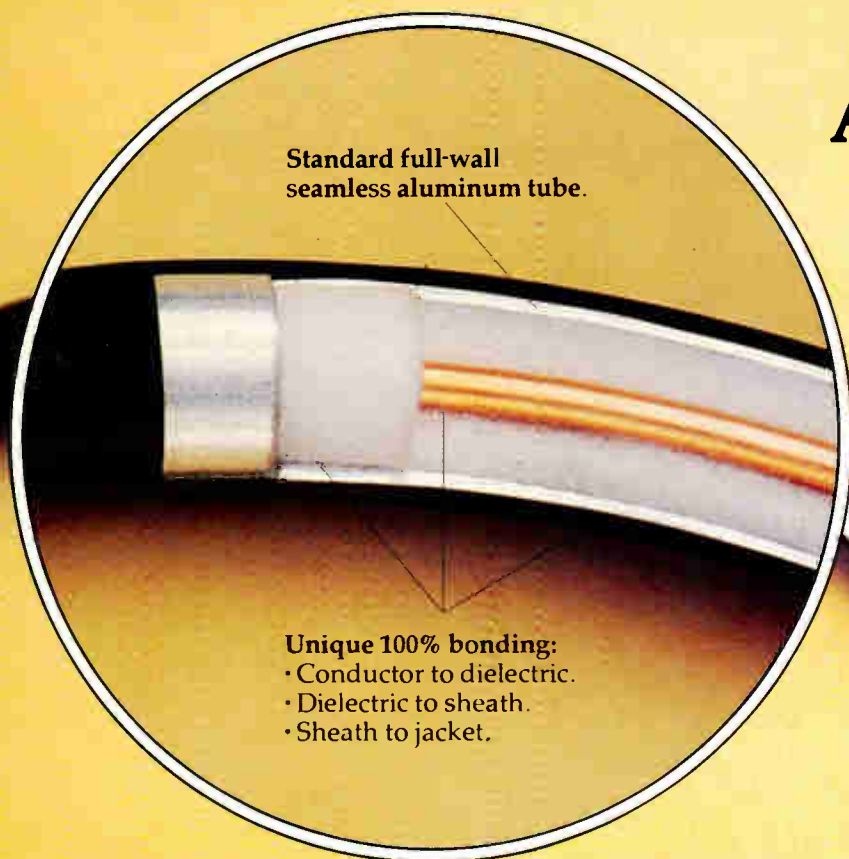

Standard full-wall seamless aluminum tube.

Unique 100% bonding:
• Conductor to dielectric.
• Dielectric to sheath.
• Sheath to jacket.

Bend radius as tight as 4" with 1/2" cable.

INTRODUCING T4 PLUS™ TOUGHER AND TAMER FOR EXTRA PERFORMANCE WITHOUT COMPROMISE.



THE STANDARD IS NOW THE SUPER-STANDARD

Standard connectors and cable preparation tools. No additional parts inventory or special training required.

Temperature-stable electrical and mechanical performance, to withstand broad temperature swings and years of winter/summer extremes.



Jacket bonded to sheath for additional handling ease and increased corrosion protection. Peels away easily, leaving no adhesive residue. Continuous conductor-through-jacket bonding greatly increases sidewall and pull strength. Extra-rugged LLDPE* jacket dramatically increases abrasion resistance and reduces pulling friction.

*Linear Low Density Polyethylene is an extra-tough polymer that still can be readily cut for cold weather connectorization.



Easy coring with standard tools. Resistant to abuse. No objectionable residue left on aluminum surface.

For a sample of this remarkable new cable, contact TFC today at P.O. Box 384, Wallingford, CT 06492, (203) 265-8482 or (800) 243-6904.

TFC

TIMES FIBER COMMUNICATIONS, INC.
CABLE TELEVISION DIVISION

Reader Service Number 49