

BYTE

THE SMALL SYSTEMS JOURNAL®

APRIL 1986 VOL. 11, NO. 4

\$3.50 IN UNITED STATES
\$4.25 IN CANADA / £2.10 IN U.K.
A MCGRAW-HILL PUBLICATION
0360-5280

Number Crunching

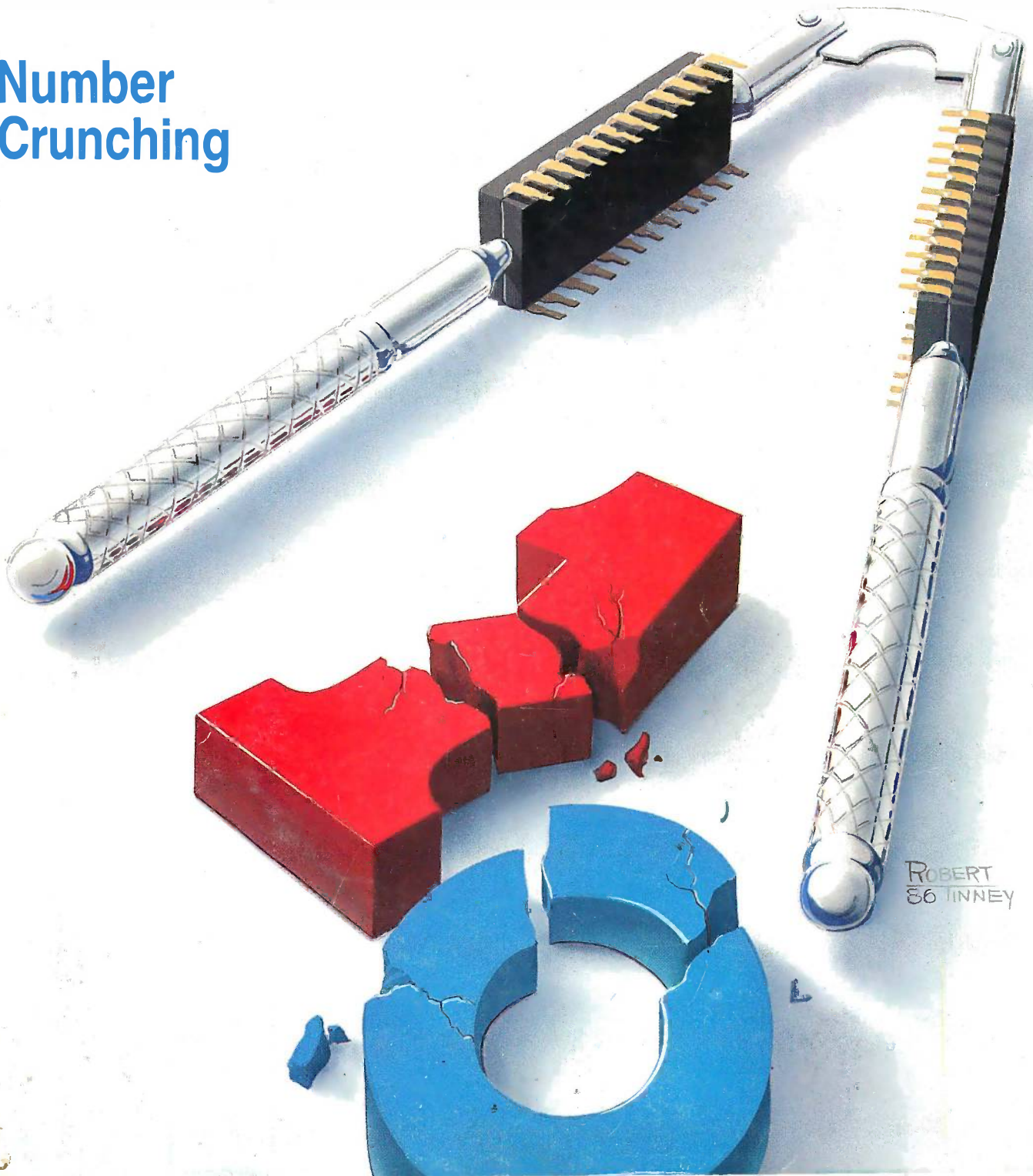

A single company has revolutionized the business of language, the language of business, and created the exciting new world of electronic reference works—Borland!

Which isn't bad for a 3-year-old. Turbo Pascal,® our first product, now has more than half a million users, and has become a world-wide standard. And that was just the beginning.

Since then, the Turbo Pascal family has grown to a family of 9, and today we're announcing our second language, Turbo Prolog,™ the natural language of Artificial Intelligence.

We've also introduced amazing business productivity tools like SideKick,® Traveling SideKick,™ Reflex, The Analyst,™ and SuperKey.®

We broke new ground in 1985 with Turbo Lightning.™ It includes the Random House® dictionary and thesaurus Turbo Lightning is the forerunner of a complete electronic reference library, newly joined by the Word Wizard,™ which solves the unsolvable twists, and boggles and challenges your mind. Word Wizard

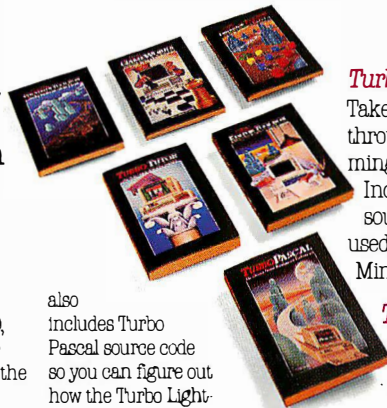

also includes Turbo Pascal source code so you can figure out how the Turbo Lightning access system works.

And here is a brief synopsis of current offerings from the Borland library of history-making software . . .

Turbo Pascal® 3.0

The fastest Pascal compiler, plus an integrated programming environment. Includes a free MicroCalc™ spreadsheet, and 1,200 lines of annotated source code, ready to compile and run. Minimum memory: 128K.

Turbo Tutor®

Takes you from basic right through advanced programming concepts and techniques. Includes 300-page tutorial and source code for every example used in the reference manual. Minimum memory: 128K.

Turbo Graphix Toolbox™

Lets you create high-resolution graphics. Includes tools for complex business graphics, easy windowing, and storing screen images to memory. Complete with source code on disk, ready to compile. Minimum memory: 128K.

Turbo Database Toolbox™

Perfect complement to Turbo Pascal. Contains complete library of Pascal procedures that allows you to search and sort data and build powerful database applications. Minimum memory: 128K.

Turbo Editor Toolbox™ **NEW!**

It's all you need to build your own text editor or word processor. Provides all the routines—you decide which features you want. Source code included. Also includes the MicroStar™ text editor with pull-down menus and windowing. Interfaces directly with Turbo Lightning to let you spell-check your MicroStar files. Minimum memory: 192K.

Turbo GameWorks™ **NEW!**

Reveals the secrets and strategies of game theory. Includes source code so you can write your own games. Gives you ready-to-play Chess, Bridge, and Go-Moku, an ancient Japanese game that will provide hours of fascinating diversion. Even if you don't want to write your own games, it's a terrific value. Minimum memory: 192K.

NEW! NEW! NEW!



Turbo Prolog™

The natural language of Artificial Intelligence, Turbo Prolog is our second language and the latest product in the

Borland software library. Turbo Prolog is a fifth-generation language, and probably the most powerful programming language ever conceived. Includes a 200-page reference manual and free GeoBase,™ a natural query language database with commented source code on disk, ready to compile. It's all you need to know about Artificial Intelligence at a Humanly Intelligent price. Minimum memory: 384K.

NEW!



Word Wizard™

Intriguing new addition to the Turbo Lightning Library.™ Solves unsolvable

crosswords, and challenges your word skills and ability to break codes and ciphers. Scrambles, twists, turns, and boggles your mind. Includes Turbo Pascal source code and all the technical information you'll need to figure out the "nuts and bolts" of the Turbo Lightning access system. Minimum memory: 256K.



SideKick®

Powerful desktop management program. #1 best-seller for the IBM® PC. Includes notepad, calculator, appointment scheduler, telephone directory and autodialer, and ASCII table. RAM-resident, it's always there to help, and stays in the background while you run other programs. One keystroke activates it. Minimum memory: 128K.



Reflex, The Analyst™

Unique, easy-to-use database management and analysis. Shows your spreadsheet data from 1-2-3® dBase,® and others in five graphic forms—including bar charts, pie charts, scatter plots, line graphs, and stacked bar charts. Answers What If? questions. Minimum memory: 384K.



Turbo Lightning™

An electronic reference library which includes the 80,000-word Random House Concise Dictionary and the 50,000-word Random House Thesaurus. Checks your spelling as you type. Gives you instant synonyms. Leads the revolutionary way in electronic publishing. Minimum memory: 256K.



SuperKey®

Amazing keyboard enhancer for your IBM PC. With easy-to-write macros that can turn 1,000 keystrokes into 1.

Also includes powerful encryption technology that keeps confidential files confidential; locks your keyboard with secret password protection. (Because of encryption technology, SuperKey is under a US Government export ban.) Minimum memory: 128K.



Traveling SideKick™ **NEW!**

BinderWare® that includes an organizer, a binder, a software program, and a report generator that picks

your SideKick's electronic brain, then prints out your appointments, daily/weekly/monthly/yearly calendar, phone lists, mailing labels, or whatever else you need when you're away from your desk. It's the smart new way to take your computer with you without taking your computer with you. Minimum memory: 256K.

Special Prices!

You can save even more through September 1, 1986:

- Turbo Jumbo Pack—six Turbo products for only \$245.00: Turbo Pascal, Turbo Tutor, Turbo Graphix, Turbo Database Toolbox, Turbo Editor Toolbox, and Turbo GameWorks
- SideKick and Traveling SideKick for only \$126.00.
- SideKick and Traveling SideKick and SuperKey, for only \$176.00.
- Turbo Lightning and Word Wizard for only \$149.95.

Step-by-step tutorial, demo programs with source code included!

And now Borland introduces Turbo Prolog™, the natural language of Artificial Intelligence.

Prolog is probably the most powerful computer programming language ever conceived, which is why we've made it our *second* language—and "turbocharged" it to create Turbo Prolog.™

Our new Turbo Prolog brings supercomputer power to your IBM® PC and introduces you step-by-step to the fascinating new world of Artificial Intelligence. And does all this for an astounding \$99.95.

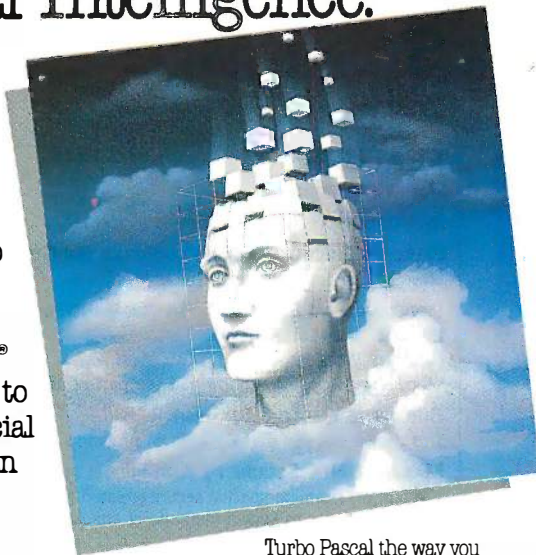

Turbo Prolog is to Prolog what Turbo Pascal® is to Pascal!

Our Turbo Pascal astonished everyone who thought of Pascal as "just another language." We changed all that—and now Turbo Pascal is the de facto worldwide standard, with hundreds of thousands of enthusiasts and users in universities, research centers, schools, and with professional programmers, students, and hobbyists.

You can expect at least the same impact from Turbo Prolog, because while Turbo Prolog is the most revolutionary and natural programming language, it is also a complete development environment—just like Turbo Pascal.

Turbo Prolog radically alters and dramatically improves the brave new world of artificial intelligence—and invites you into that fascinating universe for a humanly intelligent \$99.95.

Inquiry 35 for End-Users.
Inquiry 36 for DEALERS ONLY.

Even if you've never programmed before, our free tutorial will get you started right away

You'll get started right away because we have included a complete step-by-step tutorial as part of the 200-page Turbo Prolog Reference Manual. Our tutorial will take you by the hand and teach you everything you're likely to need to know about Turbo Prolog and artificial intelligence.

For example: once you've completed the tutorial, you'll be able to design your own expert systems utilizing Turbo Prolog's powerful problem-solving capabilities.

Think of Turbo Prolog as a high-speed electronic detective. First you feed it information and teach it rules. Then Turbo Prolog "thinks" the problem through and comes up with all the reasonable answers—almost instantly.

If you think that this is amazing, you just need to remember that Turbo Prolog is a 5th-generation language—and the kind of language that 21st century computers will use routinely. In fact, you can compare Turbo Prolog to

Turbo Pascal the way you could compare Turbo Pascal to machine language.

You get the complete Turbo Prolog programming system for only \$99.95

You get a complete Turbo Prolog development system including:

- The lightning-fast Turbo Prolog incremental compiler and the interactive Turbo Prolog editor.
- The 200-page reference manual which includes the step-by-step Turbo Prolog tutorial.
- The free GeoBase™ natural query language database including commented source code on disk—ready to compile. GeoBase is a complete database designed and developed around U.S. geography. It includes cities, mountains, rivers, and highways, and comes complete with natural query language. Use GeoBase immediately "as is," or modify it to fit your own interests.

So don't delay—don't waste a second—get Turbo Prolog now. \$99.95 is an amazingly small price to pay to become an immediate authority—an instant expert on artificial intelligence! The 21st century is only one phone call away.

YES!

Rush me Turbo Prolog Today

\$99.⁹⁵

To order by phone, or for a dealer nearest you, call (800) 255-8008; in CA call (800) 742-1133

Copies	Product	Price	Totals
—	Turbo Pascal 3.0	\$69.95	\$
—	Turbo Pascal w/BOB7	\$109.90	\$
—	Turbo Pascal w/BCD	\$109.90	\$
—	Turbo Pascal w/BOB7, BCD	\$124.95	\$
—	Turbo Database Toolbox	\$54.95	\$
—	Turbo Graphix Toolbox	\$54.95	\$
—	Turbo Tutor	\$34.95	\$
—	Turbo Editor Toolbox	\$69.95	\$
—	Turbo GameWorks	\$69.95	\$
—	Turbo Lighting	\$99.95	\$
—	Turbo Prolog	\$99.95	\$
—	Word Wizard	\$69.95	\$
—	Rellex, The Analyst	\$99.95	\$
—	SideKick	\$84.95	\$
—	Traveling SideKick	\$69.95	\$
—	SuperKey	\$69.95	\$
—	Turbo Lighting Word Wizard	\$149.95	\$
—	SideKick, Traveling SideKick	\$125.00	\$
—	SideKick, SuperKey	\$175.00	\$
—	Traveling SideKick	\$175.00	\$
—	Turbo Jumbo Pack	\$245.00	\$

Outside USA add \$10 per copy
CA and MA res. add sales tax \$

Amount enclosed \$

Prices include shipping to all US cities.

Carefully describe your computer system:

Mine is: 8-bit 16-bit

I use: PC-DOS MS-DOS

CP/M-80 CP/M 86

My computer's name and model is: _____

The disk size I use is: 3 1/2" 5 1/4" 8"

Payment: VISA MC Bank Draft Check

Credit card expiration date: ___/___/___

Card # _____



4585 SCOTTS VALLEY DRIVE
SCOTTS VALLEY, CA 95066
(408) 438-8400 TELEX: 172373

Other Borland Products include Turbo Pascal, Turbo Tutor, Turbo Lighting, Turbo Database Toolbox, Turbo Graphix Toolbox, Turbo Editor Toolbox, Turbo GameWorks, SuperKey, SideKick, The Macintosh Office Manager, Rellex, The Analyst, and Traveling SideKick—all of which are registered trademarks or trademarks of Borland International, Inc. or Borland/Analytics, Inc. Turbo Prolog and GeoBase are trademarks and Turbo Pascal is a registered trademark of Borland International Inc. IBM and AT are registered trademarks of International Business Machine Corp. Copyright 1988 Borland International.

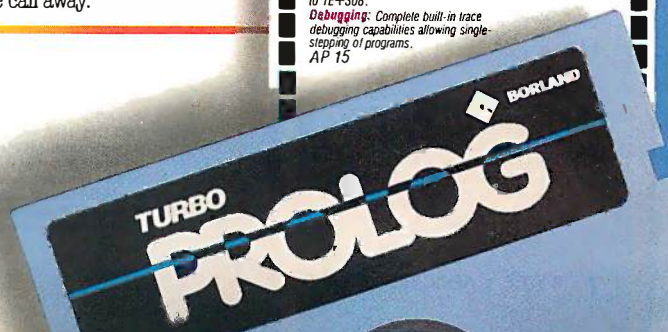

C·O·N·T·E·N·T·S



82

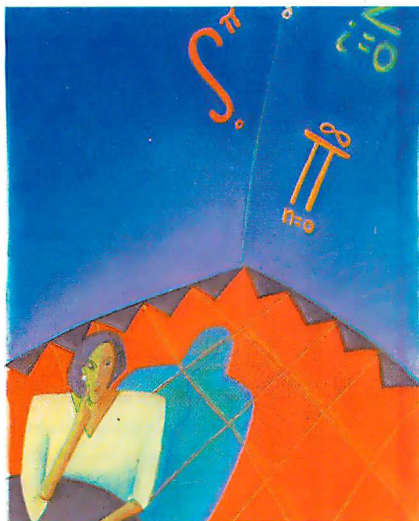

142

FEATURES

INTRODUCTION	82
CIARCIA'S CIRCUIT CELLAR: COMPUTER ON GUARD! by Steve Ciarcia	84
Steve has an adventure in the moonlight.	
PROGRAMMING PROJECT: A SIMPLE WINDOWING SYSTEM, PART 2: IMPLEMENTATION by Bruce Webster	96
Learn how to close a window and see part of an actual implementation.	
BUILD THE EMULO-8 by Stuart R. Ball	105
This device lets you develop EPROM programs in RAM.	
MAKING UNIX SECURE by Alan Filipski and James Hanko	113
The authors examine specific security-related features of UNIX and discuss countermeasures to known methods of attack by crackers.	
DATA DESIGN by Leonard Shapiro	129
The structure of data files is almost as important as their contents.	
PROGRAMMING INSIGHT: DRAGON by Bruce R. Land	137
Using MacFORTH, this program produces a recursive drawing of a dragon curve on the Macintosh.	

THEME: NUMBER CRUNCHING

INTRODUCTION	142
A MICRO-BASED SUPERCOMPUTER by Norman H. Christ and Anthony E. Terrano	145
A unique combination of microcomputer parts yields supercomputer processing power.	
COMPUTER APPROXIMATIONS by Stephen L. Moshier	161
Optimize speed and precision in your computations.	
THE INVERSION OF LARGE MATRICES by Thomas E. Phipps Jr.	181
The Pan and Reif approach removes all limits except those set by available time and RAM.	
THE RUNGE-KUTTA METHODS by Benku Thomas	191
The author shows us ways to approximate solutions to ordinary differential equations.	
THE ATOMCC TOOLBOX by Y. F. Chang	215
ATOMCC uses Taylor series to solve ordinary differential equations.	

REVIEWS

INTRODUCTION	226
REVIEWER'S NOTEBOOK by Glenn Hartwig	229
THE PANASONIC EXEC. PARTNER by Rich Malloy	231
A transportable featuring a high-speed processor, an integral printer, and a gas-plasma display.	
KAMAS by Albert S. Woodhull	241
An outline processor and programming language for document organization and preparation.	

BYTE (ISSN 0360-5280) is published monthly with one extra issue per year by McGraw-Hill Inc. Founder: James H. McGraw (1860-1948). Executive, editorial, circulation, and advertising offices: 70 Main St., Peterborough, NH 03458, phone (603) 924-9281. Office hours: Mon-Thur 8:30 AM - 4:30 PM, Friday 8:30 AM - 1:00 PM, Eastern Time. Address subscriptions to BYTE Subscriptions, POB 590, Martinsville, NJ 08836. Postmaster: send address changes, USPS Form 3579, undeliverable copies, and fulfillment questions to BYTE Subscriptions, POB 596, Martinsville, NJ 08836. Second-class postage paid at Peterborough, NH 03458 and additional mailing offices. Postage paid at Winnipeg, Manitoba. Registration number 9321. Subscriptions are \$21 for one year, \$38 for two years, and \$55 for three years in the USA and its possessions. In Canada and Mexico, \$23 for one year, \$42 for two years, \$61 for three years. \$69 for one year air delivery to Europe, 17,100 yen for one year surface delivery to Japan. \$37 surface delivery elsewhere. Air delivery to selected areas at additional rates upon request. Single copy price is \$3.50 in the USA and its possessions, \$4.25 in Canada and Mexico, \$4.90 in Europe, and \$5 elsewhere. Foreign subscriptions and sales should be remitted in United States funds drawn on a U.S. bank. Please allow six to eight weeks for delivery of first issue. Printed in the United States of America.

PROFESSIONAL DEBUG FACILITY AND ADVANCED FULLSCREEN DEBUG <i>by Jack C. Carden</i>	249
A comparison of two debuggers.	
MICROTSP <i>by Paul Davenport</i>	257
A microcomputer version of the original TSP time-series regression program.	
PCTEX AND MICROTEX <i>by Hal R. Varian</i>	267
Two typesetting programs for MS-DOS machines.	
REVIEW FEEDBACK	273
Readers respond to previous reviews.	

KERNEL

INTRODUCTION	276
COMPUTING AT CHAOS MANOR: JERRY'S BEST OF 1985 AWARDS <i>by Jerry Pournelle</i>	279
Winners—and losers—are announced this month.	
CHAOS MANOR MAIL <i>conducted by Jerry Pournelle</i>	302
Jerry's readers write, and he replies.	
BYTE U.K.: XENOPHILIA <i>by Dick Pountain</i>	305
Dick looks at the XEN, Apricot's answer to the IBM PC AT.	
ACCORDING TO WEBSTER: CLEARING THE BACKLOG <i>by Bruce Webster</i>	315
Bruce looks at software for the Macintosh, the Amiga, and the Atari 520ST.	
APPLICATIONS ONLY: A COUPLE OF WINNERS <i>by Ezra Shapiro</i>	329
Ezra talks about Mirror, a Crosstalk XVI clone, and Framework II.	
CIRCUIT CELLAR FEEDBACK <i>conducted by Steve Ciarcia</i>	336
Steve answers project-related queries from readers.	

BEST OF BIX

AMIGA	349
ATARI ST	366
IBM	371
MACINTOSH	376
EDITORIAL:	
MICROBYTES DAILY, WHAT'S NEW, AND SPECIAL EVENTS	6
MICROBYTES	9
LETTERS	14
FIXES AND UPDATES	33
WHAT'S NEW	37, 384
ASK BYTE	44
CLUBS AND NEWSLETTERS	54
BOOK REVIEWS	57
EVENT QUEUE	78
DISKS AND DOWNLOADS	346
UNCLASSIFIED ADS	445
BYTE'S ONGOING MONITOR BOX, BOMB RESULTS	446
READER SERVICE	447

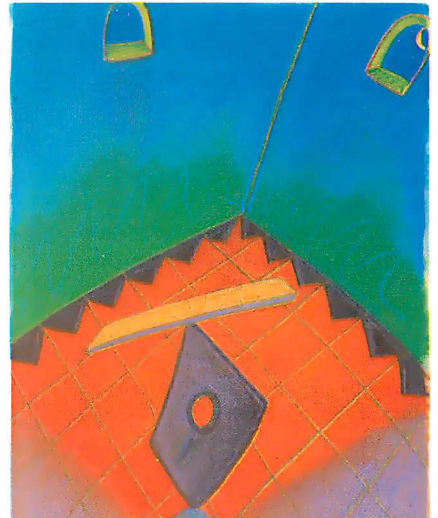

226

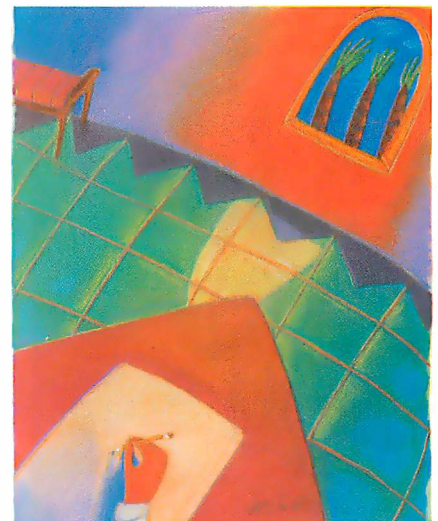

276

Address all editorial correspondence to the Editor, BYTE, POB 372, Hancock, NH 03449. Unacceptable manuscripts will be returned if accompanied by sufficient first-class postage. Not responsible for lost manuscripts or photos. Opinions expressed by the authors are not necessarily those of BYTE. Copyright © 1986 by McGraw-Hill Inc. All rights reserved. Trademark registered in the United States Patent and Trademark Office. Where necessary, permission is granted by the copyright owner for libraries and others registered with the Copyright Clearance Center (CCC) to photocopy any article herein for the flat fee of \$1.50 per copy of the article or any part thereof. Correspondence and payment should be sent directly to the CCC, 29 Congress St., Salem, MA 01970. Specify ISSN 0360-5280/83 \$1.50. Copying done for other than personal or internal reference use without the permission of McGraw-Hill Inc. is prohibited. Requests for special permission or bulk orders should be addressed to the publisher. BYTE is available in microform from University Microfilms International, 300 North Zeeb Rd., Dept. PR, Ann Arbor, MI 48106 or 18 Bedford Row, Dept. PR, London WC1R 4EJ England.



Subscription questions or problems should be addressed to: BYTE Subscriber Service, POB 328, Hancock, NH 03449

The Electric Sponge: EnGarde™

EnGarde™ is the only surge suppressor with the added protection of an anti-static touch pad that safely absorbs harmful static charges from your body. It protects computer memory and data from disruptions, while shielding your system from static charges that degrade delicate microcircuitry.

A multi-peripheral master switch and an LED grounded outlet indicator are also built into the total protection of EnGarde™.

EnGarde™ also protects your computer from power surges caused by changes in electrical loads and other electrical disturbances. It includes a limited five-year warranty.

EnGarde™ is a product of Systems Control, manufacturer of power protection systems for the nation's utility companies.

Ask your dealer for the total protection of EnGarde™. Or call toll free 1-800-451-6866 to order (in Michigan call collect 906/774-0440). If unsatisfied, return EnGarde™ within 30 days for a full refund.



EnGarde™

A product of Systems Control, a division of M.J. Electric, Inc.

BYTE

EDITOR IN CHIEF

PHILIP LEMMONS

MANAGING EDITOR, PRINT

GENE SMARTE

MANAGING EDITOR,

ELECTRONIC PUBLISHING AND COMMUNICATIONS

GEORGE BOND

CONSULTING EDITORS

STEVE CIARCIA

JERRY POURNELLE

BRUCE WEBSTER

SENIOR TECHNICAL EDITORS

G. MICHAEL VOSE, *Themes*

GREGG WILLIAMS

TECHNICAL EDITORS

DENNIS ALLEN

THOMAS R. CLUNE

ION R. EDWARDS, *Reviews*

RICHARD GREHAN

GLENN HARTWIG

KEN SHELDON

JANE MORRILL TAZELAAR

TOM THOMPSON

CHARLES D. WESTON

EVA WHITE

STANLEY WSZOLA

ASSOCIATE TECHNICAL EDITORS

MARGARET COOK GURNEY, *Book Reviews*

DONNA OSGOOD, *San Francisco*

NEWS AND TECHNOLOGY

EZRA SHAPIRO, *Bureau Chief, San Francisco*

RICH MALLOY, *Senior Technical Editor, New York*

PHILLIP ROBINSON, *Senior Technical Editor, Palo Alto*

TONY LOCKWOOD, *Senior News Editor, Peterborough*

ASSOCIATE NEWS EDITORS

DENNIS BARKER, *Peterborough*

CATHRYN BASKIN, *Peterborough*

BRENDA McLAUGHLIN, *San Francisco*

LYNNE M. NADEAU, *Peterborough*

CONTRIBUTING EDITORS

JONATHAN AMSTERDAM, *programming projects*

DAVID BETZ, *programming*

MARK HAAS, *at large*

RIK JADRNICKEK, *CAD, graphics, spreadsheets*

ROBERT T. KUROSAKA, *mathematical recreations*

PHIL LOPICCOLO, *computers in medicine*

ALASTAIR J. W. MAYER, *software*

ALAN MILLER, *languages and engineering*

DICK POUNTAIN, *U.K.*

WILLIAM M. RAIKE, *Japan*

COPY EDITORS

BUD SADLER, *Chief*

ELIZABETH COOPER

FAITH HANSON

NANCY HAYES

CATHY KINGERY

ANNE FISCHER LENT

PAULA NOONAN

JOAN VIGNEAU ROY

WARREN WILLIAMSON

ASSISTANTS

PEGGY DUNHAM, *Office Manager*

MARTHA HICKS

JUNE N. SHELDON

JUDY WINKLER

ART

ROSSLYN A. FRICK, *Art Director*

NANCY RICE, *Associate Art Director*

JAN MULLER, *Art Assistant*

ALAN EASTON, *Drafting*

PRODUCTION

DAVID R. ANDERSON, *Production Director*

DENISE CHARTRAND

MICHAEL J. LONSKY

VIRGINIA REARDON

TYPOGRAPHY

SHERRY MCCARTHY, *Chief Typographer*

LEN LORETTE

DONNA SWEENEY

SENIOR VICE PRESIDENT/PUBLISHER

HARRY L. BROWN

PUBLISHER'S ASSISTANT

BEVERLY JACKSON

CIRCULATION (800-258-5485)

GREGORY SPITZFADEN, *Director*

ANDREW JACKSON, *Subscriptions Manager*

LAURIE SEAMANS, *Assistant Manager*

SUSAN BOYD

PHIL DECHERT

MARY EMERSON

LOUISE MENEGUS

AGNES E. PERRY

JENNIFER PRICE

JAMES BINGHAM, *Single-Copy Sales Manager*

CATHY A. RUTHERFORD, *Assistant Manager*

CLAUDETTE CARSWELL

KAREN DESROCHES

ADVERTISING SALES

DENNIS J. RILEY, *Director of Sales and Marketing*

SANDRA FOSTER, *Administrative Assistant*

ADVERTISING/PRODUCTION (603-924-6448)

LISA WOZMAK, *Supervisor*

ROBERT D. HANNINGS, *Senior Account Coordinator*

MARION CARLSON

KAREN CILLEY

LYDA CLARK

MICHELE JACKSON

DENISE PROCTOR

WAI CHIU LI, *Quality Control Manager*

JULIE MURPHREE, *Advertising/Production Coordinator*

MARKETING COMMUNICATIONS

HORACE T. HOWLAND, *Director (603-924-3424)*

VICKI REYNOLDS, *Marketing Production Manager*

LISA JO STEINER, *Marketing Assistant*

STEPHANIE WARNESKY, *Marketing Art Director*

SHARON PRICE, *Assistant Art Director*

DOUG WEBSTER, *Director of Public Relations (603-924-9027)*

WILBUR S. WATSON, *Operations Manager, Exhibits*

RESEARCH

PATRICIA AKERLEY, *Research Manager*

JULIE PERRON, *Market Research Analyst*

CYNTHIA DAMATO SANDS, *Reader Service Coordinator*

FINANCIAL SERVICES

PHILIP L. PENNY, *Director of Finance and Services*

KENNETH A. KING, *Business Manager*

CHRISTINE LEE, *Assistant*

VICKI WESTON, *Accounting Manager*

LINDA SHORT, *D/P Manager*

EDSON WARE, *Credit*

MARILYN HAIGH

DIANE HENRY

VERN ROCKWELL

JOANN WALTER

PLANNING AND DEVELOPMENT

MICHELE P. VERVILLE, *Manager*

FAITH KLUNTZ, *Copyrights Coordinator*

PERSONNEL

CHERYL HURD, *Office Manager*

PATRICIA BURKE, *Personnel Coordinator*

BUILDING SERVICES/TRAFFIC

ANTHONY BENNETT, *Building Services Manager*

BRIAN HIGGINS

MARK MONKTON

RECEPTIONIST

L. RYAN McCOMBS



Officers of McGraw-Hill Information Systems Company: President: Richard B. Miller. Executive Vice Presidents: Frederick P. Jannott. Construction Information Group: Russell C. White. Computers and Communications Information Group: J. Thomas Ryan. Marketing and International. Senior Vice Presidents: Francis A. Shinal, Controller: Robert C. Violette. Manufacturing and Technology. Senior Vice Presidents and Publishers: Laurence Altman, Electronics Week: Harry L. Brown. BYTE: David J. McGrath. Construction Publications Group Vice President: Peter B. McCuen, Communications Information. Vice President: Fred O. Jensen. Planning and Development.

Officers of McGraw-Hill, Inc.: Harold W. McGraw, Jr., Chairman; Joseph Dionne, President and Chief Executive Officer; Robert N. Landes, Executive Vice President and Secretary; Walter D. Serwatka, Executive Vice President and Chief Financial Officer; Shel F. Asen, Senior Vice President, Manufacturing; Robert J. Bahash, Senior Vice President, Finance and Manufacturing; Ralph R. Schulz, Senior Vice President, Editorial; George R. Elsinger, Vice President, Circulation; Ralph J. Webb, Vice President and Treasurer.

Editorial and Business Office: 70 Main Street, Peterborough, New Hampshire 03458. (603) 924-9281.

West Coast Office: McGraw-Hill, 425 Battery St., San Francisco, CA 94111. (415) 362-4600.

McGraw-Hill, 1000 Ellwell Court, Palo Alto, CA 94303. (415) 964-0624.

New York Editorial Office: 1221 Avenue of the Americas, New York, NY 10020. (212) 512-2000.

Circuit-Board-Artwork Software for the Design Engineer in a Hurry

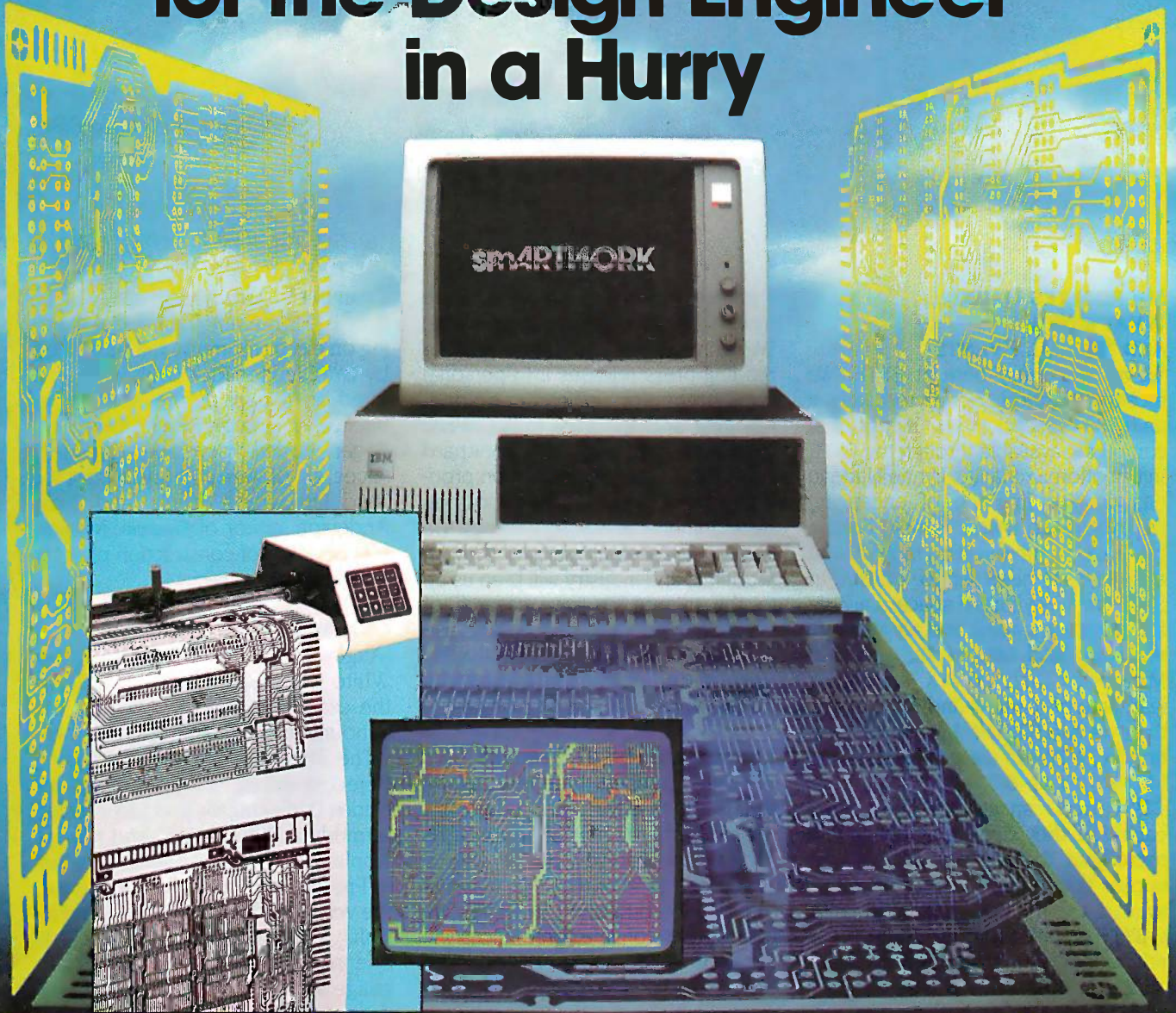

For only \$895, smARTWORK® lets the design engineer create and revise printed-circuit-board artwork on the IBM Personal Computer. You keep complete control over your circuit-board artwork — from start to finish.

Forget the tedium of taping it yourself or waiting for a technician, draftsman, or the CAD department to get to your project.

smARTWORK® is the only low-cost printed-circuit-board artwork editor with all these advantages:

- Complete interactive control over placement and routing
- Quick correction and revision
- Production-quality 2X artwork from a pen-and-ink plotter
- Prototype-quality 2X artwork from a dot-matrix printer

- Easy to learn and operate, yet capable of sophisticated layouts
- Single-sided and double-sided printed circuit boards up to 10 x 16 inches
- Multicolor or black-and-white display

System Requirements:

- IBM Personal Computer, XT, or AT with 256K RAM, 2 disk drives, and DOS Version 2.0 or later
- IBM Color/Graphics Adapter with RGB color or black-and-white monitor
- IBM Graphics Printer or Epson FX/MX/RX series dot-matrix printer
- Houston Instrument DMP-41 pen-and-ink plotter
- Optional Microsoft Mouse

The Smart Buy

At \$895, smARTWORK® is proven, convenient, fast, and a sound value. Call us today. And put it to work for yourself next week.



Wintek Corporation Inquiry 367
1801 South Street
Lafayette, IN 47904-2993
Telephone: (317) 742-8428
Telex: 70-9079 WINTEK CORP UD

In Europe contact: RIVA Terminals Limited,
Woking, Surrey GU21 5JY ENGLAND,
Telephone: 04862-71001, Telex: 859502

"smARTWORK," "Wintek" and the Wintek logo are registered trademarks of Wintek Corporation.

MICROBYTES DAILY, WHAT'S NEW, AND SPECIAL EVENTS

We've been busy here at BYTE. We recently founded Microbytes Daily, a daily news service about personal computing available through the BYTE Information Exchange. Lynne Nadeau has done a fine job of enhancing Microbytes so that it is now both a two-page monthly section in BYTE and a larger daily news service on BIX. In BYTE, we have limited space available for quick news items and an absolute minimum lead time of six weeks. In Microbytes Daily on BIX, we have a lead time of minutes and more space than we can fill. The Microbytes section in BYTE is now a subset of the Microbytes on BIX.

BIX users can get the latest news each time they sign on by typing `join microbytes`. To make Microbytes always appear first in the queue of materials to read, use the BIX order command.

BYTE receives 2400 to 3000 press releases each month, most of them announcing products. We try to select from all these releases those that will be of greatest interest to most BYTE readers. Thanks to the extra efforts of Dennis Barker and Cathy Baskin, who regularly edit What's New, we now have much greater scope: the "whats.new.hard" and "whats.new.soft" conferences on BIX. By joining those two conferences, BIX users can see a large selection of product announcements divided into hardware and software. Topics in the conferences provide subdivisions such as software for specific machines. You can also use the BIX search command to look for announcements that contain specific terms of interest to you. The familiar What's New will continue to appear in BYTE as before. Now the print What's New will be a subset of the on-line whats.new.hard and whats.new.soft.

In time, we hope to make the on-line news services truly comprehensive. We're investigating OCR devices for reading press releases into personal computers for efficient editing, rewriting, and uploading to BIX. While whats.new.soft and whats.new.hard will continue to concentrate on products, Microbytes Daily will focus on developments in new technology. We hope that research centers in both academia and industry will keep us up to the minute on any research of potential interest to people who use computers so that we can quickly pass along such information via Microbytes Daily and Microbytes.

EVENTS AND ISSUE THEMES

We have arranged three month-long events on BIX for April, which are related to the themes of future BYTE issues and involve special guests. These events may result in material that will be published in BYTE. We believe these on-line conferences will enhance BYTE's coverage of issue themes and that through BIX we can learn more about what BYTE readers want in the way of theme coverage. We will use some upcoming articles to stimulate discussion in conferences on BIX.

The relationship of the BIX special events to BYTE issue themes is indicated in parentheses.

OPTICAL STORAGE

(May BYTE theme is mass storage.) BYTE editor Ken Sheldon will be moderating this special event. Check the system.news conference on BIX for the exact title and location. Some of the experts invited to discuss CD-ROMs are William Zoellick, manager of Software Research for TMS Inc.; William Casey, president of Advanced Storage Concepts; and Tim Oren of Activenture.

COMPUTERS AND MUSIC

(July BYTE theme) The special meeting on electronic music will be chaired by BYTE editor Rick Grehan and offered as a part of the Music conference. Among the experts invited are Roger Powell, developer of MIDI squeezer software and keyboardist for Todd Rundgren's Utopia, and Craig Anderson, editor of *Electronic Musician* and designer of construction projects for electronic musicians.

OBJECT-ORIENTED LANGUAGES

(August BYTE theme) BYTE's Eva White will moderate this event. For the exact title and location, see the announcement in BIX system.news.

The lineup of experts discussing object-oriented programming includes Daniel Ingalls and Larry Tesler, formerly at Xerox PARC and now at Apple; Brad Cox and Kurt Schmucker of Productivity Products International, the vendor of Objective-C; Charles B. Duff, author of Neon, an object-oriented extension to the FORTH language for the Macintosh, and president of the Whitewater Group; Jeremy Jones of Coral Software and one of the designers of Object Logo; Bjarne Stroustrup of Bell Labs and designer of C++; and Jim Anderson, president of Digitalk, which developed Methods, a Smalltalk development environment for the IBM PC.

We hope to see you on line for these events and the more than 100 other conferences on BIX. If you prefer not to participate in telecommunications, however, we still expect that you'll benefit from BIX events and conferences because direct interaction with readers and technical experts will help the BYTE staff plan and prepare better issues.

—Phil Lemmons
Editor in Chief

Maxell Corp. of America, 60 Oxford Drive, Moonachie, NJ 07074



maxell[®]
FLOPPY DISKS
THE GOLD STANDARD
Inquiry 208

Before you invest in a DEC*VT240 terminal, consider the software alternative.

Stop and think about what you really need: A text terminal. Tektronix* graphics. ReGIS* graphics. File transfer capabilities. Communications.

Purchasing a state-of-the-art terminal may be one option, but Persoft has a smarter solution—**SmarTerm® 240**, the ultimate in terminal emulation software.

SmarTerm can do everything the state-of-the-art terminal can do—and more. That's why we call it **state-of-the-smart**.

With SmarTerm 240, the emulation is so exact you'll forget you're using a PC. It features superior text emulation, ReGIS graphics, Tektronix graphics, outstanding communications and file transfer capabilities.

You also get on-line help screens, remappable keyboard layouts and programmable softkeys which can simplify your most frequently performed tasks. You can even customize your own menus!

And because SmarTerm runs on your PC, you've always got a wealth of computing power right at your fingertips.

All SmarTerm products are backed by Persoft's strong technical support network. It's a service you expect from the industry leader in terminal emulation software.

No matter which terminal you're currently using—Data General Dasher* D400, Tektronix 4010/4014, DEC VT100, VT125, VT220 or even the new VT240,



SmarTerm has a state-of-the-smart solution for you.

To find out more about the SmarTerm family of terminal emulation software, see your local dealer. Or contact: Persoft, Inc.
2740 Ski Lane
Madison, WI 53713
(608) 273-6000 – Telex 759491

STATE OF THE ART

VS

STATE OF THE SMART

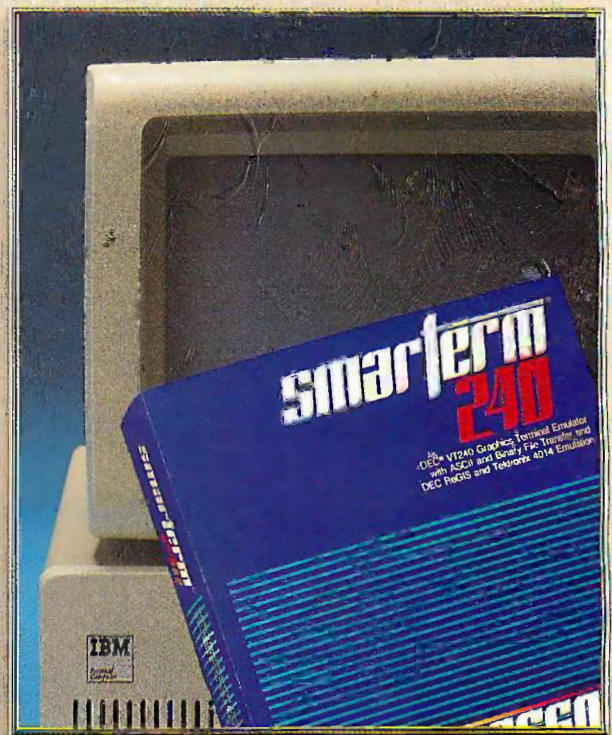
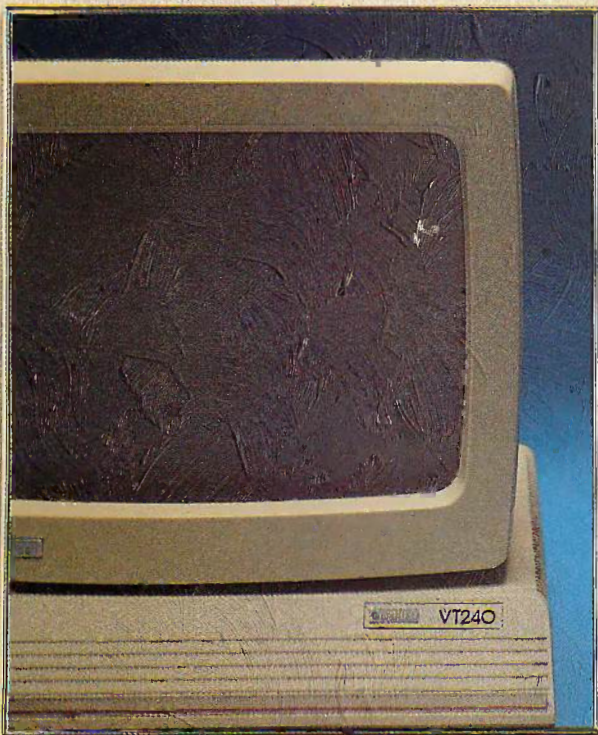

*SmarTerm is a registered trademark of Persoft, Inc. *DEC, VT and ReGIS, are trademarks of Digital Equipment Corp.
*DASHER is a registered trademark of Data General Corp. *Tektronix is a registered trademark of Tektronix, Inc.
© Persoft, Inc., 1986. All rights reserved.

persoft

Inquiry 260

Visi On Is Back On

Remember Visi On, the highly touted integrated program for the IBM PC? Control Data Corporation purchased the program from the now-defunct VisiCorp about a year and a half ago. CDC has been busy retooling the product and now is almost ready to rerelease it, according to a spokeswoman at the firm's Business Information Services division in Minneapolis, MN.

"What we've done is enhance the applications manager [the central controlling component of Visi On] and the individual applications," said the CDC spokeswoman. "We recognize people have favorite DOS packages, so we're positioning [Visi On] as a value-added package." Each Visi On application will be priced at \$150, as will the applications manager. The minimum suggested configuration to run Visi On is an IBM PC with a hard disk and 512K bytes of RAM. Visi On came out at a time when most PC users were still adjusting to the idea of hard disks and 256K RAM. CDC hopes that Visi On will get a better reception than it did earlier now that more powerful PCs are the norm.

Customers will be able to purchase Visi On directly through a still-unannounced 800 number and various value-added retail channels.

Intel Controller for 8/16-bit Programmable Bus

Intel Corporation of Santa Clara, CA, announced what it calls the first 16-bit microcontroller that lets a system's external data bus be programmed at 8 bits, 16 bits, or both. The first implementation of this controller is an EPROM chip called the 8796BH, which is designed for prototypes and low-volume production where software is not yet complete. The 8796BH is priced at \$75 in quantities of 1000. A ROM version of the chip, called the 8396BH, will sell for \$9.96 in 25,000-unit quantities. The chips will be available in the second quarter and second half, respectively, of 1986.

Demonstration of Project Andrew for 3M Computers

Carnegie-Mellon University of Pittsburgh, PA, has given the first hands-on demonstration of its nascent Project Andrew educational-software system. Andrew is expected to run on so-called 3M computers. The 3M specification refers to a computer with a minimum of 1 megabyte of RAM, processor speed of 1 million machine instructions per second, and screen resolution of 1000 by 1000 pixels. (However, Andrew does run on the IBM RT PC, which has a screen resolution of 1024 by 750 pixels.)

The Project Andrew system runs on top of UNIX 4.2 and is designed so that applications written for it will be transportable across different hardware systems. Although Project Andrew will not be completed for another year, a Carnegie-Mellon official said that at least one major hardware vendor (and perhaps several) is expected to announce 3M computers within the next 12 months.

A number of vendors (IBM and DEC chief among them) have contributed to the CMU project. Apple Computer has stated that it plans to participate in the 3M market. That market has also been targeted by Next Inc., a start-up firm headed by former Apple chairman Steven Jobs.

Intel and Interactive Systems Will Port UNIX V to 80286/80386

Intel Corporation of Santa Clara, CA, and Interactive Systems Corporation of Santa Monica, CA, have agreed to port AT&T's latest version of UNIX System V to the 80286 and 80386 microprocessors. According to George Alexy, Product Marketing Manager of Intel's

(continued)

Microprocessor Division, "The inherent ability of the 80386 means that, when combined with UNIX System V, the system will support the current base of MS-DOS applications." Interactive had previously ported its UNIX System V product, IN/ix, to the entire iAPX86 line of microprocessors.

Borland's Modula-2 for the Apple II and Turbo Pascal for the Mac

At the MacWorld Exposition in San Francisco, Borland International of Scotts Valley, CA, demonstrated its new Turbo Modula-2 on an Apple IIe with a Z80 coprocessor card running CP/M. The language is scheduled to ship during the second quarter of this year. It won't be available just to Apple owners; Borland plans to support it for all the same CP/M (2.2 or higher) computers that are already served by Turbo Pascal. And the firm claims that it will sell an MS-DOS version in the second half of the year.

Turbo Modula-2 includes a WordStar-style editor similar to that of Turbo Pascal. The main menu lets you choose to compile directly to native code or to interpreted m-code. Another menu selection lets you either accept Borland's extensions to Modula-2 or stick with the Wirth definition of the language.

Borland also announced that it will begin shipping Turbo Pascal for the Macintosh in the second quarter of 1986. The language was not demonstrated at the exposition.

ADAPSO Pushes Software-Protection Scheme

Eight hundred million dollars. That's about how much money software vendors lost last year to illegal copying of programs according to ADAPSO (Association of Data Processing Services Organization), a computer-industry group representing software and service firms. ADAPSO, based in Arlington, VA, is sponsoring a lock-and-key system standard for computers to prevent illegal duplication of programs. The device connects to a computer's RS-232C port and limits use of duly protected software to the specific computer for which it was bought. Although negative consumer reaction has discouraged widespread endorsement by software firms, ADAPSO continues to push for adoption of the device, which it says costs about \$25.

Nanobytes

NEC Electronics Inc. of Mountain View, CA, has introduced a 64K by 4-bit (256K) DRAM with an access time of 100 nanoseconds. The page-mode organization of the μ PD41464 chip can help in designing memory in small segments: 64K bytes can be constructed of two chips instead of the eight required with standard 64K by 1-bit chips. . . . The **Massachusetts Microelectronic Center** is a \$48 million educational center funded by high-technology industry and the Massachusetts state government. It will provide advance training and research opportunities in microelectronics and semiconductor technologies for students, scientists, and engineers. . . . **Symbolic Control** of Palo Alto, CA, has developed the 4thCPU-40 chip, which directly runs FORTH instructions at a rate of 8 million per second. Designed in 2-micron CMOS and sitting inside a 68-pin PLCC (plastic leaded chip carrier), the 4thCPU-40 can directly access 12 gigabytes and has a 20-MHz DMA coprocessor interface. In volume, the chip costs approximately \$70. . . . **Western Union** has announced a new convenience for subscribers to its EasyLink on-line information service that lets users create and distribute customized business forms electronically via computer. The \$100 package is called Instant Forms Plus. . . . **Advanced Micro Devices** of Sunnyvale, CA, has aimed its new Am2130 dual-port 8K static RAM at multiprocessor systems that need independent read/write access to a single memory. The 48-pin chip has separate I/O ports, addresses, and controls to let two devices read or write to memory at the same time. The 70-nanosecond version costs \$44.80. . . . **Lotus Development Corporation** of Cambridge, MA, and **Living Videotext** of Mountain View, CA, have separately announced agreements with **Microsoft** of Bellevue, WA. Both companies will be developing applications that support the Microsoft Windows environment. . . . **Oki Semiconductor** of Sunnyvale, CA, is offering fast CMOS versions of the 8086 and 8088 microprocessors. The MSM80C86-2 and MSM80C88-2 run at 8 MHz, have a maximum power consumption of 275 milliwatts, and cost \$20 in lots of 100. . . . Computer-terminal manufacturer **Wyse Technology** of San Jose, CA, announced plans to buy **Amdek Corporation**, the Chicago-based computer-monitor manufacturer. The acquisition involves about 650,000 shares of Wyse stock and is subject to approval by Amdek shareholders.

Meet the disk-based Tandy 600.



A breakthrough in portable computing power and versatility.

Get a portable that matches the performance of a desktop computer. The amazing Tandy 600 features a 16-bit microprocessor, an 80-character by 16-line display, a built-in 3 1/2" disk drive that stores 360K of data and 32K RAM (expandable to 224K*).

Five resident applications

With Tandy 600's larger display and memory, Multiplan spreadsheet analysis can hold more information. Word processing is as easy as using MS-Word. You'll have quicker access to documents and better storage with the built-in disk drive. File is an electronic data base for names and addresses, expenses, client billing, inventory and more. And you can keep a large number of different files on the pocket size diskettes. With Telecom and the Tandy 600's built-in modem, you're able

to communicate with other computers over phone lines. Telecom will even dial the phone number of anyone listed in the File program. Calendar helps you keep track of daily tasks and activities.

The easy-to-learn resident System Manager lets you run each application, exchange information between applications and manage the files created. You can even set it to turn itself on for unattended operations. And you can add BASIC language ROM (26-3904, \$129.95) to write your own programs.

Tandy...Clearly Superior™

If you've been looking at portable computers, compare them with the Tandy 600 (26-3901, \$1599). You'll be amazed at what it can do! Visit a Radio Shack Computer Center today.

Available at over 1200 Radio Shack Computer Centers and at participating Radio Shack stores and dealers.

Radio Shack
COMPUTER CENTERS

A DIVISION OF TANDY CORPORATION

Send Me a Free Tandy 600 Brochure.

RadioShack, Dept. 86-A-896
300 One Tandy Center
Fort Worth, TX 76102

Name _____

Company _____

Address _____

City _____

State _____

Zip _____

Phone _____

*RAM upgrades are in banks of 96K (26-3910, \$399.95 each). Prices apply at Radio Shack Computer Centers and participating stores and dealers. Multiplan and MS-Word/TM Microsoft Corp.

Your first color good enough

NEC introduces the only color monitor you need. Superb resolution plus MultiSync for across-the-board compatibility with all three PC graphics boards made by IBM® for business graphics, CAD/CAM, computer art, and text.



Now there's one high resolution color monitor that does things your way. The MultiSync™ monitor from NEC.

It gives you the best color resolution available at the price.

- Compatibility with the IBM Professional Graphics Adapter, the IBM Enhanced Graphics Adapter, and the IBM Color Graphics Adapter.

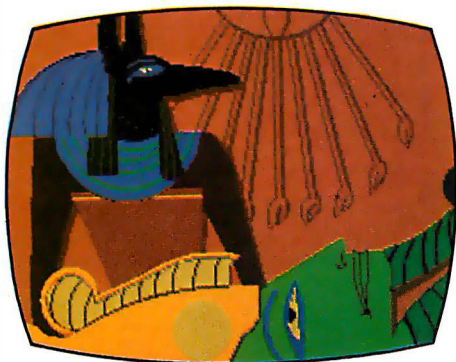

Compatibility with the IBM® Enhanced Graphics Adapter Board

- MultiSync, the NEC feature that automatically adjusts to color adapter board scanning frequencies from 15.75 KHz to 35 KHz—suggesting the possibility that the MultiSync monitor might be compatible with *all* color graphics boards that are fully compatible with the IBM PC, PC/XT, and PC/AT, now and in the future.

- Full implementation of high resolution graphics software for business and other applications, now and in the future.

- And color capability limited only by the board being used.



See Things Our Way

Until now, you had to choose different color monitors for compatibility with all three PC color graphics boards made by IBM. With so many board and monitor configurations, folks

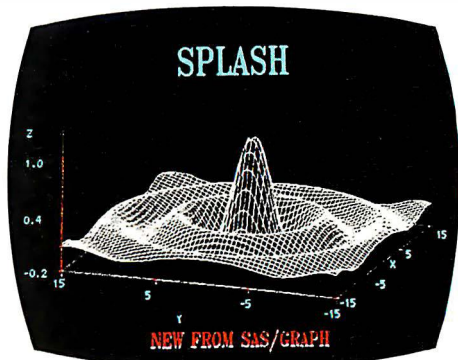

Compatibility with the IBM® Professional Graphics Adapter Board

didn't know which way to look.

The new MultiSync color monitor gives you unique compatibility. As well as TTL and analog color. With 7 switchable text colors. And resolution up to maximum 800 horizontal dots and maximum 560 vertical lines, on a large, 13" diagonal viewing area.

All that, priced at just \$799. All from NEC, a name respected around the world for advanced,

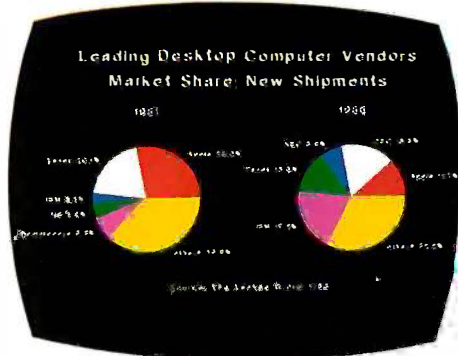

Compatibility with the IBM® Color Graphics Adapter

monitor should be to be your last

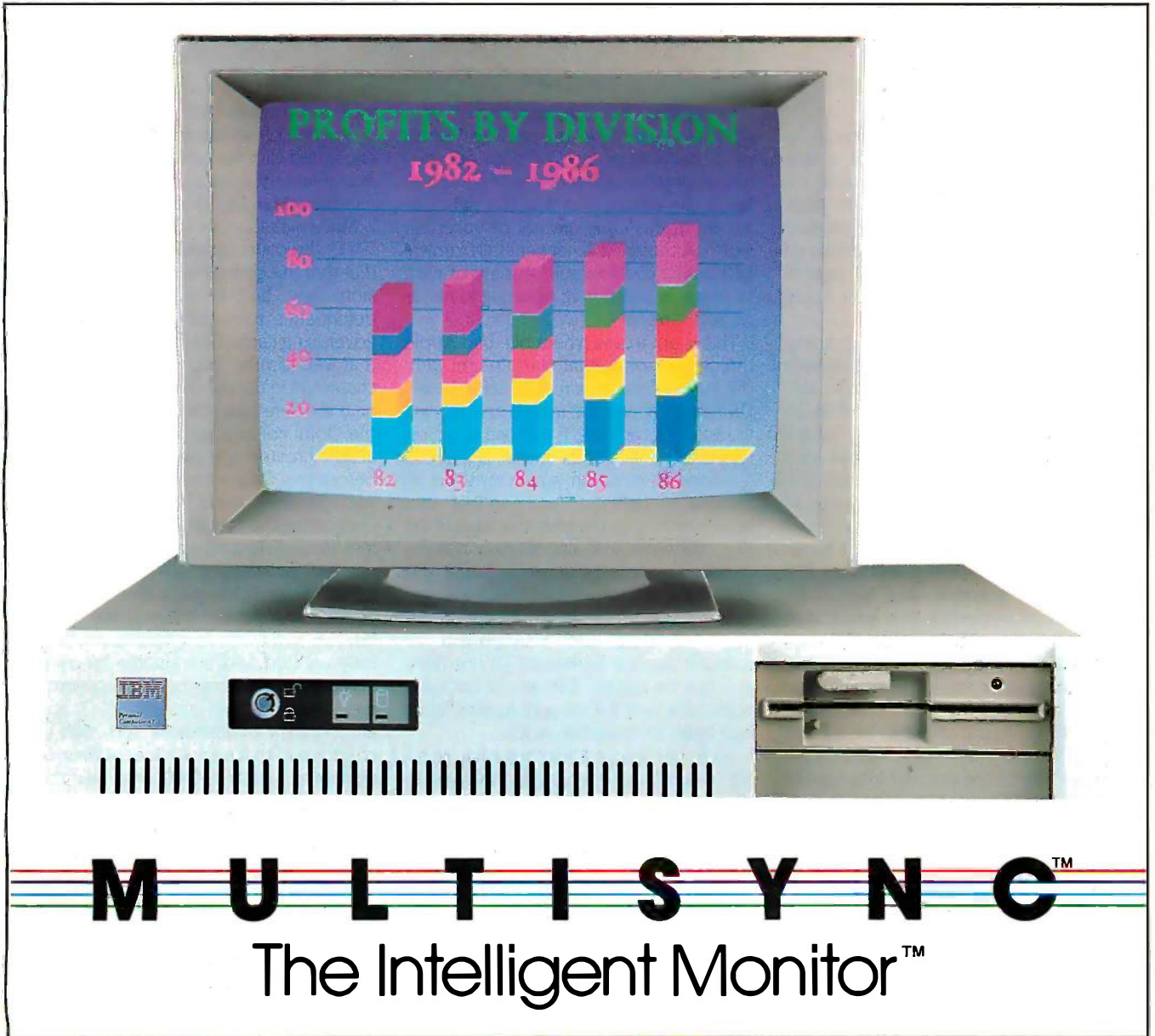

reliable products
backed by nationwide
service.

It's the one color
monitor that does
everything your way.

But why talk more
about it? Visit your

nearest dealer and see
a graphic demonstra-
tion of the new NEC
MultiSync monitor's
capabilities. Then draw
your own conclusions.

For information dial
1-800-447-4700

NEC HOME ELECTRONICS (U.S.A.) Inc.
Personal Computer Division
1401 Estes Avenue
Elk Grove Village, IL 60007

NEC

VISUAL COPYRIGHTS

I applaud Gregg Williams's editorial regarding Apple's unconscionable action against Digital Research Inc. for GEM ("A Threat to Future Software," January, page 6). We at Batteries Included, a software publisher producing GEM applications on both the IBM PC and the Atari ST, experienced considerable dismay when Apple flexed its corporate legal muscle.

Unfortunately for the entire industry, Apple decided to pick on the company least able to defend itself. For its part, DRI clearly chose discretion over valor in acquiescing to Apple's pressure. What's most ironic is that GEM's most awkward feature, menus that drop automatically, was almost certainly originally created to avoid Apple's wrath.

At the time of the "settlement," I spoke with folks at both Microsoft and Atari. The former, when asked if they were concerned about Apple possibly going after them for Windows, simply laughed. Atari's comment was that they hoped Apple would come after them, they could use the free publicity.

Regrettably, Apple chose to be a bully. Can you imagine AT&T's response if Apple had gone after it for the user interface of the UNIX PC?

Your editorial stance is to be commended. Rarely do mass-market journals have the gumption to take a principled position against an advertiser. Apple deserves the ire of the microcomputer community. Our common goal should be to foster the development of a user interface, not the divisiveness of nonconstructive legal harassment.

MICHAEL H. REICHMANN
Richmond Hill, Ontario, Canada

It was with some dismay that I read your January editorial. Perhaps the most frustrating part of this is that we seemingly both want the same thing for the industry but come out on opposite sides of each issue. I trust you will forgive the length of this letter, but I have a number of points to make that will inevitably take considerable space and time to read. I have also listed a number of legal citations in case you should care to conduct further research on this matter.

I must begin by taking exception to your comment regarding "the uncertain worth of a 'visual copyright.'" As an attorney whose practice is in the area of computer law, I can assure you that the rights involved in this issue are not of uncertain worth. Although it is not generally known, DRI paid a considerable amount of cash to Apple in addition to agreeing to revise its software.

This is not a case where big, bad Apple threatened some small start-up firm without the financial resources to defend itself. DRI certainly had the means and the will to defend its actions, if it chose to do so. However, the fact of the matter is that DRI assessed its situation, which involved infringing not only the "look and feel" (the legal terminology covering this area) of the Mac software but also certain nondisclosure agreements between Apple and DRI and came to the conclusion that defending itself would be an inappropriate use of financial and management resources; thus the settlement. Of one thing you can be certain, DRI would not have settled the case if it thought Apple's rights had been of uncertain worth.

Some background here regarding copyright law would undoubtedly help you in understanding the situation. The copyright law protects computer programs in both source- and object-code forms [17 U.S.C. §§ 101,117] and declares anyone who violates the exclusive rights of the copyright holder to be an infringer of the copyright [17 U.S.C. §501(a)].

Further, the copyright laws grant the copyright owner the exclusive right to reproduce the work, to prepare derivative works based upon the copyrighted work, and to distribute the work [17 U.S.C. §106]. A work done for hire is protected for 75 years [17 U.S.C. §302].

The question that arose when the courts unequivocally upheld the rights of copyright owners in source and object codes and application and operating-system software was what would be the scope of protection for both the look and feel of the protected software.

In order to place this protection into context, you must remember that copyright law originally evolved to protect the works of authors in their writings (which

included painters in their paintings). This protection of written and visual work was expanded with the advent of movies and, subsequently, television.

In *Sid & Marty Krofft Television Products Inc. v. McDonald's Corp.* 562 F.2d 1157 (9th Cir. 1977), the court upheld a lower-court verdict that the plaintiff's copyrighted television show had been infringed by the defendant's advertising campaign. This advertising campaign included characters that were similar, but not identical, to the characters in the plaintiff's show. The court held the defendant had infringed by using the "total concept and feel" of the characters created by plaintiff. Thus, even before this issue came to the fore in the software area, there was good case law supporting the protection of the look and feel in copyrighted material.

In *SAS Institute Inc. v. S&H Computer Systems Inc.* 605 F. Supp. 816 (M.D. Tenn. 1985), the plaintiff brought suit alleging that the defendant had taken its software, which ran only on IBM and compatible hardware, and infringed its copyright by converting the software to run under the VAX operating-system environment. Although the court found that only 44 lines of code out of approximately 180,000 had been plagiarized from the SAS code, it found substantial modular similarity and a copying of the user-interface dialogue. In finding for the plaintiff, the court held that there had been an "extensive taking of the structure and topical sequence" of the SAS software.

In *Whelan Associates Inc. v. Jaslow Dental Laboratory Inc.* 609 F. Supp. 1307 (E. D. Penn. 1985), the court held that "the 'expression of an idea' in a software program is the

(continued)

LETTERS POLICY: *To be considered for publication, a letter must be typed double-spaced on one side of the paper and must include your name and address. Comments and ideas should be expressed as clearly and concisely as possible. Listings and tables may be printed along with a letter if they are short and legible.*

Because BYTE receives hundreds of letters each month, not all of them can be published. Letters will not be returned to authors. Generally, it takes four months from the time BYTE receives a letter until it is published.

This Little Fella Means Business.

The Mouse by Maynard Electronics makes your favorite programs faster, easier, and smarter!

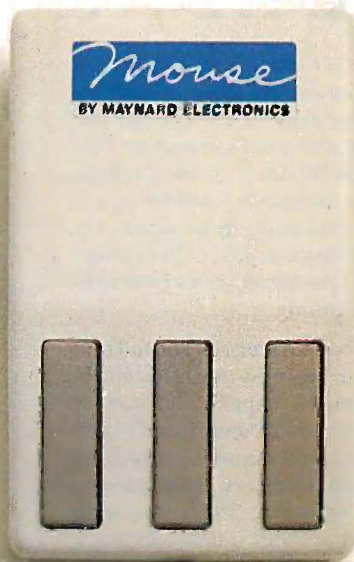

Teach The Mouse To Type.

A single Mouse click will instantly produce the character, sentence, paragraph, or anything else you've selected. **Click:** you call up the CustomKey menu. **Click:** your file is saved. **Click:** a commonly used paragraph appears in place. No other mouse gives you such power and versatility.

At last, an "intelligent" mouse! Now you can add command power to your programs, when you want, the way you want — instantly! The Mouse by Maynard Electronics comes with our CustomKey™ software which lets you assign and reassign commands while using your favorite programs — even those without mouse utilities. Fly through programs like Symphony,* Lotus 1-2-3,* Framework,* MultiMate,* and others with undreamed of speed! And of course, it's fully compatible with all programs written for a mouse, too.

A Tale Of Three Mice . . .

Compare our Mouse with the others running around and you'll see, there's no comparison! Here are just a few features across the board:

FEATURES	Maynard Mouse	Micro-soft	Mouse Systems
# of Button Combinations	7	3	5
Button Auto Repeat	Yes	No	No
Diagnostics	Yes	No	Yes
Dynamic Scaling	Yes	No	No
Cursor Overshoot Control	Yes	No	No
Adjustable Cursor Speed/Up, Dn (while running application)	Yes	No	No
Adjustable Cursor Speed/Rt, Lft (while running application)	Yes	No	No
Buttons-Definable (while running application)	Yes	No	No
Macros-Definable (while running application)	Yes	No	No
User-Definable Alternate Cursor Movement	Yes	No	No

Free Drawing!

Purchase The Mouse now and receive the popular paint program Telepoint* at no additional cost — a \$149 value!



*Symphony and Lotus 1-2-3 are trademarks of Lotus Development Corporation. Framework is a trademark of Ashton-Tate. MultiMate is a trademark of SoftWord Systems Inc. Telepoint is a trademark of LCS/Telegraphics.

Maynard Electronics
Shaping tomorrow's technology.

460 E. Semoran, Casselberry, FL 32707 • 305/331-6402

Available at the finest computer stores. Contact your local dealer or write to us today for product information.

Why you should ignore 95% of the news

Because NewsNet automatically finds the 5% you need. From our database of authoritative, up-to-date business news, you get just the stories you want, delivered instantly to your microcomputer. You choose your own, unique keywords, and NewsNet saves—just for you—every new article containing those words. Or, you can find that critical 5% on your own, with NewsNet's powerful keyword searching and text scanning.

Just what's in NewsNet's database? The full text of over 300 valuable business newsletters. In-depth news, written by experts, filled with analysis and interpretation. News from 34 different industries and professions—everything from Computers to Investments, from Management to Telecommunications. Plus extras such as wire services, online stock quotes, air fares, and business credit reports.

Computer News: Your Specialty is our Specialty. Here are just a few of the 25 Electronics and Computers newsletters on NewsNet:

The Artificial Intelligence Report
The Business Computer
The Computer Cookbook
Consumer Electronics
Data Base Informer
Electronic Mail News
Outlook on IBM
Japan High Tech Review
Micro Moonlighter

Mini/Micro Bulletin
Personal Computers Today
Robotronics Age
Newsletter
Semiconductor Industry & Business Survey
The Seybold Report on Professional Computing
Stanley Klein Newsletter on Computer Graphics

**ONLINE
BUSINESS
NEWS**

NewsNet

Call Today!
We'll send all you need to subscribe.

**(800)
345-1301**

(in PA 215-527-8030)

NewsNet Inc. 945 Hilyerford Road, Bryn Mawr, PA 19010

manner in which the program operates, controls and regulates the computer in receiving, assembling, calculating, retaining, correlating, and producing useful information either on a screen, printout, or by audio communication." The court continued in stating that "the expression of the idea embodied in the computer program is protected by the copyright laws..." On the basis of substantial similarity, the court found infringement on the part of the defendant.

In essence, what the courts are saying is that copyright in software extends beyond the code itself and also includes the organization and user dialogue, i.e., the look and feel. While this viewpoint might seem revolutionary to laymen or even attorneys who are unfamiliar with intellectual-property law, it is not a broad, new interpretation of the copyright law.

For instance, the copying of the internal structure and organization of a textbook (the table of contents) has been held to be an infringement of the copyrighted work (*Meredith Corp. v. Harper & Row Publishers Inc.*, 500 F. 2d 1221 [2d Cir. 1974]). And, in *Roth Greeting Cards v. United Card Co.* 429 F. 2d 1106 (9th Cir. 1970), the court held the sale of greeting cards that copied the total concept and feel of the plaintiff's copyrighted cards to be an infringement. Given this background, the protection of the look and feel in software is in compliance with long-held case law.

I feel compelled to add, lest you adopt the somewhat unique argument of the current U.S. Attorney General regarding case decisions that go beyond the intent of the legislators who drafted the laws, that Congress made two substantial revisions to the copyright laws, in 1976 and 1980. If Congress had felt that the courts' rulings in *Harper & Row* and *Roth* were a misapplication of the law, there was more than ample opportunity to correct the problem in the 1976 and 1980 revisions. That Congress did not revise the copyright laws to overrule the courts' decisions is a definite indication that it did not see any problem with the rulings.

Although the legal analysis of the courts in *SAS* and *Jaslow* is based upon interpretation of the copyright laws, the underlying rationale is really based upon ethical and economic arguments.

In both *Jaslow* and *SAS* the infringing defendants took software that had been successful in one operating environment (IBM Series/1 and IBM mainframes, respectively) and made clones operating under another environment (IBM PC and

(continued)

New! Windows-Compatible In·a·Vision 1.1

FREE Microsoft® Windows!
Limited Offer
Microsoft® Windows!

Complex Drawing Made Easy

We created In·a·Vision just for you. The engineer who needs more productive drafting support. The designer who needs versatility for alternate ideas or quick revisions. The architect who needs to manage a variety of working drawings. And the businessman who needs first-class presentation materials as well as detailed flow charts and organization charts.

Point. Click. Draw.

Now all you do to create complex technical drawings, systems designs, blueprints, diagrams, illustrations, and proposals is point, click and draw. With In·a·Vision's mouse support, windowing, icons,

and pull-down menus, you produce drawings more quickly, accurately and efficiently than ever before. In·a·Vision's advanced technology includes many features not found on comparable systems costing thousands more. For example, you can pan around in a user-definable drawing space up to 68" x 68" and zoom in on specific areas for



greater detail. Scale, rotate and dimension symbols, fill an area with your choices of pre-defined colors and patterns, as well as draw lines with multiple styles and widths. Other features include overlays, predefined and user-definable page sizes, rulers, grids, and templates to speed popular applications.

Multi-tasking in a PC-based CAD system.

In·a·Vision uses multi-tasking to enable you to continue drawing while printing hard copies or edit multiple drawings simultaneously.

FREE Microsoft® Windows from MICROGRAFX!®

If you purchase In·a·Vision directly from MICROGRAFX, we'll give you a free retail copy of Microsoft Windows so you can use In·a·Vision as part of a fully integrated working environment. Move instantly from In·a·Vision to other applications and back... cut and paste text and drawings

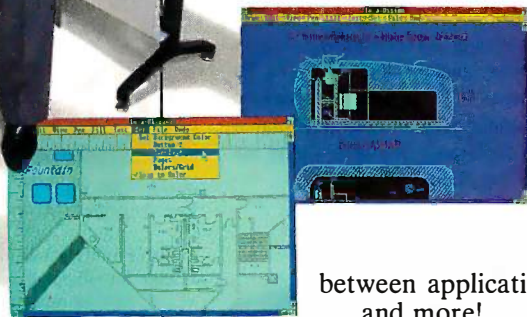

between applications... and more!

We're confident you'll agree — In·a·Vision will make your complex drawing tasks simple and make you more productive. Satisfaction guaranteed.

TO ORDER CALL:
800-272-3729

Demo disk* or brochure available to qualified customers. In Texas or for customer support, call (214) 234-1769.

MICROGRAFX, Inc., 1820 North Greenville Avenue, Richardson, Texas 75081.



MICROGRAFX®
The Picture of Success.

(Most popular graphics cards, plotters, and printers supported.)
Microsoft Windows-compatible. Call for specific operating environment requirements.

* Demo requires MS Windows. Full demonstration system for users without Windows available for \$49.00.

Escape the Programmer's Prison

Do you feel imprisoned by your IBM PC? Do you spend too much time wrestling with a rigid, unyielding programming language? Are you tired of clumsy programming tools that straight-jacket your creativity instead of liberating it?

If so, you're ready for Methods—a Smalltalk, object-oriented programming system for the IBM-PC and compatibles that sets you free from the constraints of other languages. Until you program with Methods, you don't know just how quick and creative programming can be on the IBM PC.

Methods is . . .

. . . high-performance object-oriented programming. A powerful, language-compatible subset of Smalltalk-80™.

. . . a toolkit of over 100 classes—easily-customized software building-blocks for rapid, incremental development of real-world applications.

. . . an open-ended, window environment that encourages exploration while allowing recovery from any error.



. . . extensively documented in a four-part manual for everyone from beginners to experienced programmers—the perfect introduction to Smalltalk programming.

. . . ideal for software prototyping, simulation, databases, advanced user interfaces, and numerous AI applications.

Methods also offers easy access to DOS, a powerful directory/file browser system, remote UNIX™ access, an object-oriented shell for DOS programs, and much more.

Methods requires DOS and 512K RAM on IBM PC's (including AT) or "compatibles," and can be used with or without a mouse.

digitalk inc.

5200 West Century Boulevard
Los Angeles, CA 90045 (213) 645-1082

Available from Digitalk for \$250. Outside U.S. add \$15.00 for shipping and handling.

California residents add sales tax.

Educational and dealer discounts available.

Inquiry 111

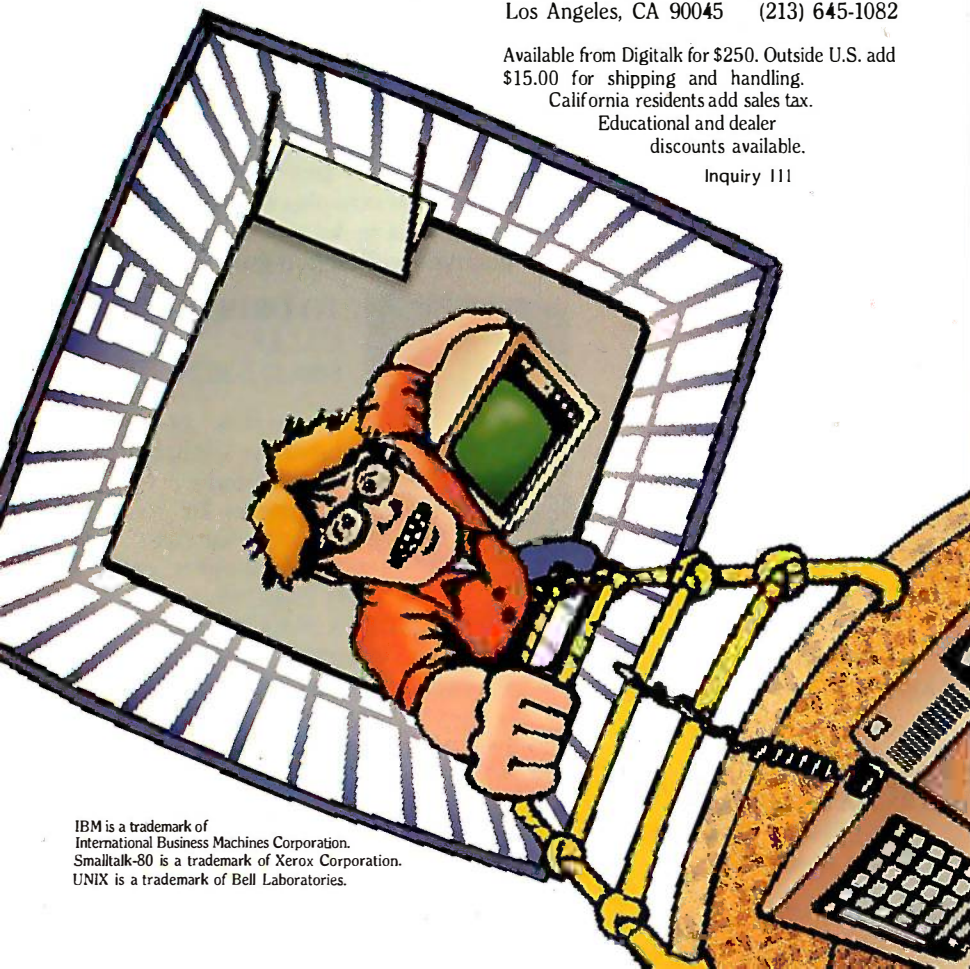

IBM is a trademark of International Business Machines Corporation.
Smalltalk-80 is a trademark of Xerox Corporation.
UNIX is a trademark of Bell Laboratories.

LETTERS

DEC VAX, respectively). Was this done from some altruistic sense of providing computing power to the people? Of course not; it was done to make money.

These programs were not selected at random. The defendants selected these programs because they had proved successful in their initial operating environments. So, what the defendants decided to do was to take the successful, creative work of the authors and then port it to another environment in order to make themselves money.

The truth of the matter is that programming per se is not a creative act. The creative act is in the design and organization of the software. And, when we look at the marketplace, the ease of operation by the user is a considerable factor in whether the design and organization of a software product is successful. (If you doubt this, ask yourself if WordStar would be a success or a flop if initially released today.)

To put it bluntly, what the defendants in *Whelan*, *SAS*, and *DRI* did was to rip off a successful look and feel from its rightful author. Once you have that, the coding is merely grunt work.

What the courts are really saying in these cases is that to deprive the authors of the fruits of their creative efforts is unethical and that it won't be tolerated in American commerce. It will be a very sad time indeed, Mr. Williams, if the standard of business in this country becomes such that it is considered unethical to deprive the rip-off artists of their "right" to pirate someone else's creativity.

Your argument regarding standardization in the computer industry is fine as far as it goes. But it misses the point regarding how a standard is attained. Standards don't become standards merely because the issuing party says that this is now the standard. Alas, there are some notable failures attempting to do just that in the not too distant past. Standards become standards because the publisher wants it to become a standard *and* the public (users in this context) decide that something is useful to them, and it becomes the standard by popular election.

However, carrying your argument to its logical conclusion would make the public's (or some portion thereof) desire to make some piece of software a standard amount to a taking of the intellectual property inherent in the software by eminent domain, with the compensation to the developer for such condemnation being an increase in revenues from some other

(continued)

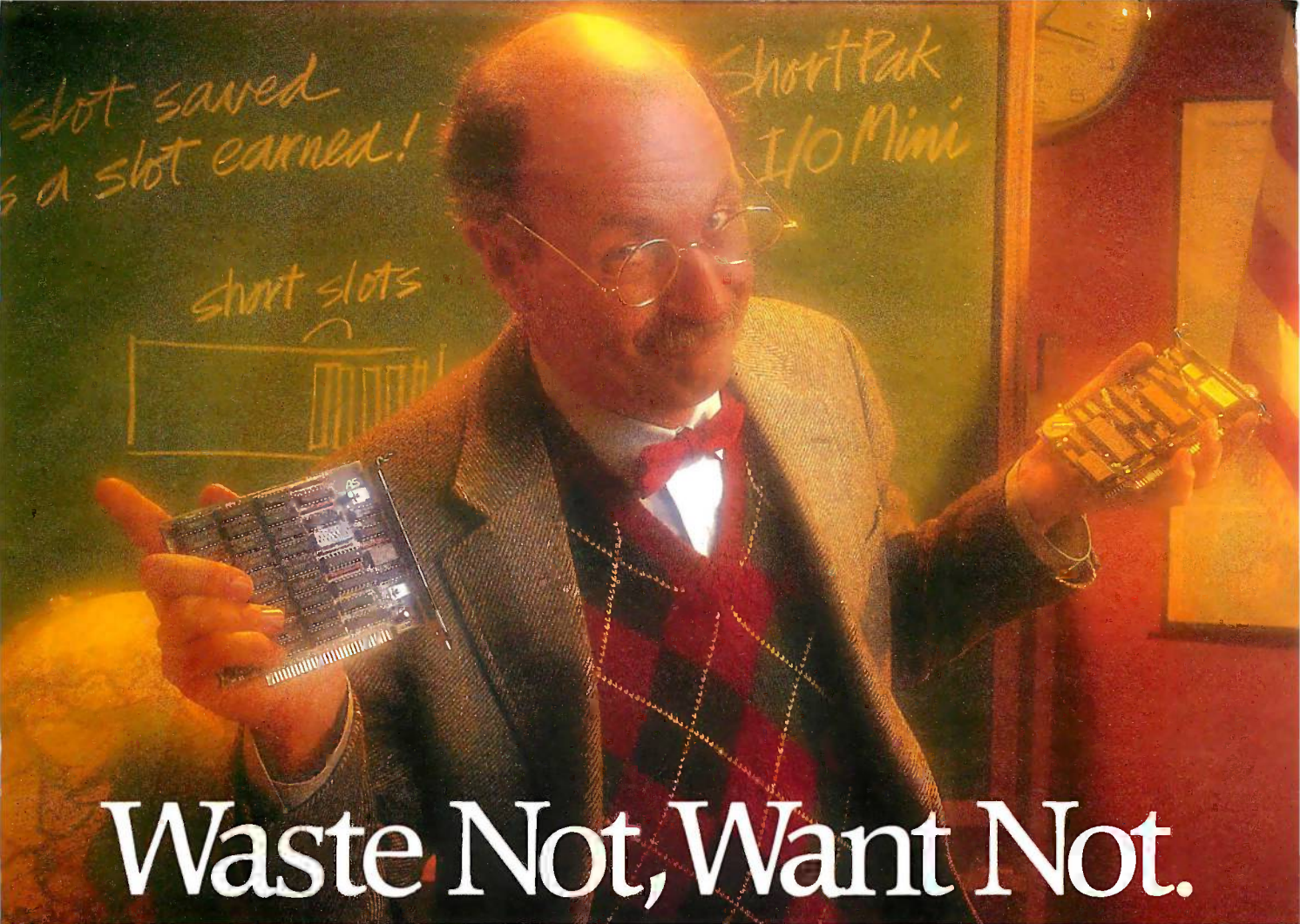

Waste Not, Want Not.

AST's ShortPak™ and I/O Mini™ Offer the Powerful Memory and Input/Output Capabilities of Full-Size Boards on Convenient Half-Size Cards.

Waste Not. Don't waste valuable, full-size, system-expansion slots on memory or I/O cards. AST Research offers the space savers—short-board solutions for adding memory and input/output to your IBM® PC-XT, 3270 PC or Portable. And users of new, basic IBM PCs, check your system chassis. You may have short slots, too.

Of course, ShortPak and I/O Mini work just fine in long slots also.

Small Size, Big Memory With AST's ShortPak. Now you can boost your PC's memory with up to 576 Kilobytes (Kb) in a single, short slot. Using both 64Kb and 256Kb chips, this versatile short card rounds out virtually any system's memory to the DOS 640Kb limit.

And with every ShortPak board, you'll get SuperPak™ utility software including SuperDrive™, SuperSpool™ and, AST's new fASTdisk™ electronic hard disk. Both SuperDrive and fASTdisk let you create lightning-fast, electronic RAM disks and SuperSpool lets you spool files to the printer while you continue to enter and process data on your system.

Powerful Connections With I/O Mini. This short card offers all the

input/output ports you may ever require. With up to two serial ports, a parallel port and battery-backed clock/calendar, this five-inch board connects to printers, plotters, mice, modems and more. In addition, SuperPak software is included.

Want Not. When you install ShortPak and I/O Mini in your PC's short slots you get the added memory you need to run today's memory-intensive software and the vital serial and parallel ports needed to make peripheral connections.

Plus you save your long slots for other expansion products—like AST's RAMpage!® expanded memory board, offering up to 2.0 megabytes of memory; ColorGraphPlus™, our 16-color IBM compatible color graphics card; and, our complete line of networking and micro to mini/mainframe cards.

By the way, there'll be a test covering this material on Thursday morning. Please be prepared. For tutoring contact your local Authorized AST Dealer or call AST's Customer Information Center (714) 863-1333. Or write, AST Research, Inc., 2121 Alton Avenue, Irvine, California 92714. TWX: 753699 ASTR UR.

Don't wait until Wednesday night.

ShortPak Features

- Offers up to 576Kb memory on a single board (no piggyback required)
- Rounds out system memory to 640Kb on single board
- Fits short and long slots*
- Uses 64Kb and/or 256Kb DRAMs
- Includes SuperPak utility software
- Two-year warranty

I/O Mini Features

- Standard serial port
- Standard battery-backed clock/calendar
- Fits short and long slots
- Optional: second serial port and parallel port
- Includes SuperPak utility software
- Two-year warranty



AST
RESEARCH INC.

Inquiry 2 for End-Users.
Inquiry 3 for DEALERS ONLY

TABLE 1
COMPARISON CHART
RELATIVE RANK OF WP PACKAGES

FEATURE	WORDSTAR 2000 PLUS REL. 2	MICROSOFT WORD VERS. 2.0	WORD PERFECT VERS. 4.1	MULTIMATE ADVANTAGE VERS. 3.5	DISPLAY- WRITE 3 VERS. 1.0
Installation	1	2	3	1	4
Documentation	1	2	2	2	3
Ease of Learning	1	2	3	1	4
Functionality	1	2	2	3	2
Performance	2	3	1	3	3
Document Control	1	3	2	4	1
Text Control	1	3	2	4	2
Page Control	2	1	3	2	3
Micro Editing	2	1	3	3	3
Global Control	1	1	2	2	3
Page Layout	2	3	1	3	1
Printing	3	2	3	2	4
Advanced Features	1	3	2	3	3
Writing Aids	3	1	3	2	4
Printers/Fonts Supported	1	3	1	3	2
Connectability	1	4	3	3	5

Note: The comparison numbers represent the relative ranking of each package compared to the others. The package with the highest ranking is given a 1. If packages rank equally, they are assigned the same ranking number.

Source: InfoCorp

SINK YOUR TEETH INTO THIS.

Introducing WordStar® 2000 Plus Release 2, the new and improved software that topped InfoCorp's chart of word processing packages.

We could make all kinds of claims about our new WordStar 2000 Plus Release 2.

About its commonsense commands. Tutorials for easy training. Direct Lotus® file input. Extensive printer support. DCA connectivity. LANs and site licensing options.

That would be easy to do.

But we decided to let the experts do the talking.

In a comparative report—the report containing the chart to the left—Robert Lefkowitz of InfoCorp said:

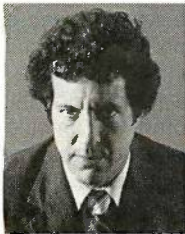

"WS 2000+ emerges as a clear winner in overall applicability. InfoCorp believes WS 2000+ would appeal to the largest number and widest variety of users. Its layered functionality, ease of learning, and excellent

communications features make it ideal for corporate users, ranging from secretaries to clerks to managers to executives."

And, after reviewing WordStar 2000 Plus Release 2 alongside MultiMate™ Advantage™ and IBM®'s

DisplayWrite® 3, International Data Corporation's Jim Chapman concluded:

"WordStar 2000 is our favorite—for ease of learning, ease of use... and for well-conceived and helpful documentation."



Now we don't expect you to take these opinions as gospel.

Because when it comes to knowing your company's word processing needs, you're the expert who really matters.

So evaluate our product yourself.

See your local MicroPro dealer today. Or call 800-227-6703 (800-632-7979 in California) for the dealer nearest you. Put WordStar 2000 Plus Release 2 to the test and see how it measures up to the advance reviews.

We believe it'll be time well spent. For you and your company.

If you'd like the complete InfoCorp and IDC reports, we'll be happy to send them to you. Just fill out the coupon below and mail it to us, or call 800-443-0100 x. 547.

MicroPro®

WORDSTAR
2000
RELEASE 2

Powerful word processing has never been easier.™

MicroPro International, Industry Analyst Reports
P.O. Box 57135, Hayward, CA 94545

Yes, I'd like copies of the InfoCorp and IDC Reports on WordStar 2000 Plus Release 2. Please send them to me right away.

Name _____
Title _____
Company _____
Address _____
State _____ Zip _____
Phone (____) _____ B

Lotus and IBM DisplayWrite 3 are registered trademarks of Lotus Development Corporation and IBM Corporation, respectively. MultiMate and Advantage are trademarks of MultiMate Corporation. Current WordStar 2000 owners can update to WordStar 2000 Release 2 by calling MicroPro Customer Update: 800-443-0100 x. 265. 8805M 2/85

3M
diskettes

Everything that goes into a 3M diskette is manufactured and/or controlled by specifications set by 3M.

From unique substrates and oxides, to hole punching and jacket fabrication, 3M does it all and does it well. With confidence in your complete satisfaction, 3M diskettes are certified to be error free and have an unlimited warranty against defects in workmanship or materials. Day in and day out 3M gives you one less thing to worry about.



What separates us from our competition? Simply a combination of the best service in the industry, highly competitive pricing, and an ever widening range of products. Above all we care about our reputation and we are willing to work on a lower margin while delivering what others only claim—and we do it all on a day-in day-out basis.

Early in 1986 every subscriber to **Byte Magazine** will receive our New 1986 First Edition Catalog with 16 additional pages and dramatically lower pricing. We want to be your source for computer supplies & accessories.

Lyben Computer Systems

WATCH FOR OUR NEW 1986 CATALOG

1050 E. MAPLE RD. • TROY, MI 48083
(313) 589-3440

DataSaver⁴⁰⁰ Standby UPS

Power protection for the most powerful micro-computer systems with peripherals is here, now, with the 400 Watt DataSaver. Protect your investment in application software and hardware with reliable, continuous power. 90 and 200 Watt capacities and international models are also available.



Cuesta Systems Corporation
3440 Roberto Court
San Luis Obispo, CA 93401
TLX: 4949381 CUESTA

©1985, Made in U.S.A.

Write or call 805/541-4160
Dealer, O.E.M. inquiries invited

LETTERS

portion of the business (in Apple's case, hardware).

The problem arises when the author of the so-called standard doesn't want it to become the standard, as is the case with Apple and the Mac software look and feel. In this case the desire of the public (assuming it exists in this matter) must take a back seat to the rights of the author. It is the author's privilege to make the use he or she sees fit of such personal-property rights.

Finally, I believe that your economic analysis of this situation is in error. If you look at the entire history of software development, you find that improvements, particularly in the user interface/dialogue, came from having to compete in the marketplace. In the late sixties and early seventies, the little interactive mainframe software in existence was decidedly user-unfriendly. Then along came the minis, and software written for them was much more user-friendly (although crude by today's standards), and suddenly, mainframe software, both commercial packages and in-house developed, went through substantial revisions in order to meet the new expectations of what the user interface/dialogue was supposed to be.

In the late seventies and early eighties came the micro revolution. How did the software authors compete in the office environment against much more powerful hardware/software combinations? They made the software even more user-friendly. Thus accountants, financial analysts, attorneys, and middle managers began to bring computing power to their own desks instead of relying upon data-processing professionals with their rules, regulations, buzzwords, and priorities. It can fairly be said that the dawn of user-friendly micro software ended the monolithic power structure of the data-processing organizations in business.

This user-friendly environment has created its own synergy in the industry. In the same manner that sophisticated mini software forced change upon new and existing mainframe software, now the micro software has forced change upon new and existing mini and mainframe software. With the advent of such packages as Symphony and Framework heralding the beginning of very sophisticated, integrated packages, this trend will continue into the foreseeable future. Or will it?

I believe that, if your arguments are followed, it will not. The reason is that it will not make economic sense for software developers to expend vast amounts of

(continued)

THE PC PENS

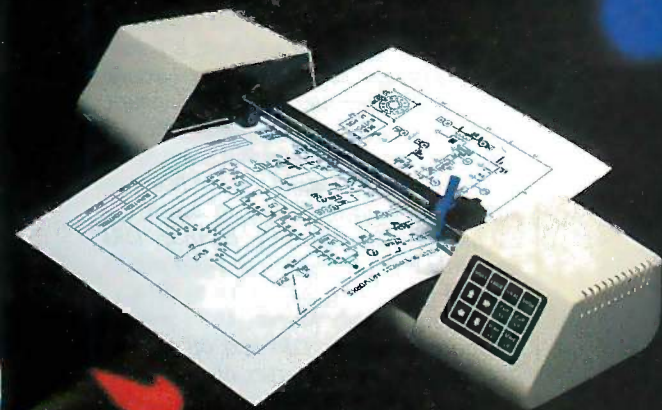
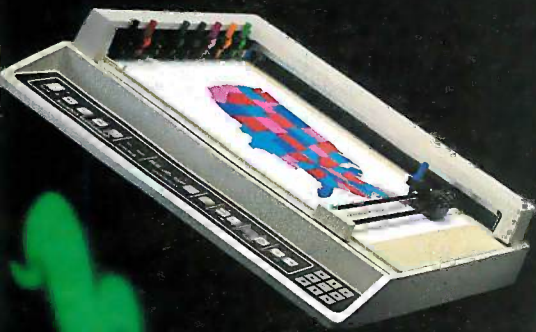

Discover new dimensions in PC graphics with Houston Instrument's "PC Pens"—a family of desktop plotters that allow you to add brilliant color and clarity to your presentations.

Starting at \$699,* these compact plotters produce professional graphics that dot-matrix printers simply can't match. With sharp resolution, HI's PC Pens give you countless graphic choices—a variety of pen types (felt tip, hard nib, and drafting), plotting media (paper, vellum, and transparencies), and special firmware.

Whether you're producing sales graphs, creating CAD drawings,

or charting household finances, these plotters complete the picture on 8½ × 11 or 11 × 17 inch formats.

Choose from Houston Instrument's single-pen DMP-40, the four-pen PC Plotter series, or the impressive eight-pen DMP-29. Each features a standard RS-232-C compatible interface and Houston Instrument's built-in DM/PL™ language, making each one immediately compatible with most microcomputers and hundreds of software packages. And each is remarkably reliable and simple to use.

For more information and the name of the distributor nearest you, call Houston Instrument at 1-800-531-5205

(512-835-0900 if in Texas) or write Houston Instrument, 8500 Cameron Road, Austin, Texas 78753. In Europe, contact Houston Instrument, Belgium NV., Rochesterlaan 6, 8240 Gistel, Belgium. Tel.: 32-(0)59-277445, Tlx.: 846-81339.

*U.S. suggested retail price for PC595 model plotter. Pricing subject to change. DM/PL is a trademark of Houston Instrument.

Inquiry 157

houston instrument

A Division of **AMETEK**

resources—time, effort, and money—to create the extensive user-friendly interface/dialogue necessary to make these systems work efficiently, if the result of that work cannot be protected. Allowing the look and feel of software to be co-opted by anyone who feels like it will be a universal disincentive to software developers.

The marketplace will become stagnant because the price for success will be im-

itation by other software developers, with the resulting loss of uniqueness and revenue. It is only by securing the authors' absolute right to exploit the economic advantage made possible by their creations, that the present trends in software development will continue.

It wasn't that long ago—May 1981—when BYTE devoted a whole issue to software protection. At that time, you took a

stand that needed to be taken and, perhaps more importantly, raised the consciousness of many people regarding the ethics of illicit copying of software. Thus my dismay at reading your editorial. While the issues are somewhat more subtle, the principles are the same.

I can only hope that this letter may cause you to reconsider your editorial and return the BYTE philosophy to whence it came in 1981.

JAMES E. BRANSFIELD
Toluca Lake, CA

Talk is Secure

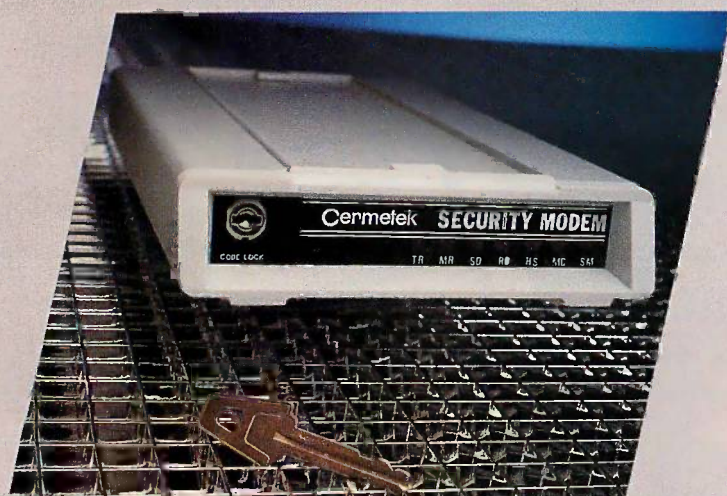

You want the capabilities of a 1200 or 2400 bps modem for collecting and transferring information over the phone line. You need to protect your business files from unauthorized users. Expect both in the Security Modems from Cermetek Microelectronics.

Safe not Sorry!

Cermetek Security Modems provide a secure method for protecting your private data files. It's called BARRIOR SECURITY. The intruder is stopped before he accesses your computer. Up to four levels of security are available for

you to choose from with Cermetek's security call-back and password features. Built-in audit trail capabilities allow you to monitor who is accessing your valuable files. BARRIOR SECURITY is built into both originate and answer modes.

Protection Plus!

In addition to advanced security features, Cermetek Security Modems include Hayes® compatibility, auto dial and answer, auto speed and parity selection, call progress monitoring via speaker or quiet screen messages, and a modem warranty. Available now in both 1200 or 2400 bps operation (national and international standards).

Be Safe! Take this ad to the dealer nearest you for more information on the Security Modems from Cermetek.



Cermetek Microelectronics, Inc.

1308 Borregas Avenue Sunnyvale, CA 94088-3565 408/752-5000

Hayes is a registered trademark of Hayes Microcomputer Products, Inc.

Gregg Williams replies:

Thank you for your authoritative letter, which includes one case I had heard of and several that I had not. I think you've clearly indicated the legal context that supports the idea of "visual copyrights."

Despite the legal defensibility of the "visual copyright" concept, my opinion concerning it remains (as it was in the editorial) threefold. First, I think that, even though the concept is legal, perhaps its legality should be reconsidered; in my opinion, its use will have a harmful effect on the industry. Second, I would rather see Apple vindicate the concept in court instead of pressuring a company to settle. Third, I maintain that, even if this concept remains legally valid, it is not in Apple's long-term interest to use it.

I have to disagree with you that "DRI certainly had the means and the will to defend its actions, if it chose to do so." According to Judy Mervis, DRI's public-relations manager, DRI laid off "about 100 people, or a quarter of our workforce, worldwide" in mid-July 1985, which is exactly the time at which Apple was negotiating the settlement (which was finalized September 30) with them. I'd guess that DRI was financially strapped at the time and could not afford a legal battle.

Another factor that forced DRI to acquiesce was its fear that Apple could get an injunction that would prohibit it from selling its GEM products until the case was settled (which would take years). According to Ms. Mervis, DRI couldn't afford to put GEM, one of its major income-producing products, into "suspended animation." "It wasn't just the money [that we couldn't afford]," she said, "but, most of all, the time. There's a window of opportunity for GEM, and it's now, not two years from now."

Finally, I have to restate my belief that Apple's self-protective actions will, in fact, stunt the growth of the microcomputer

(continued)

THE F-15 JET FIGHTER. IF THE COMPUTER GOES DOWN SO DOES THE PLANE

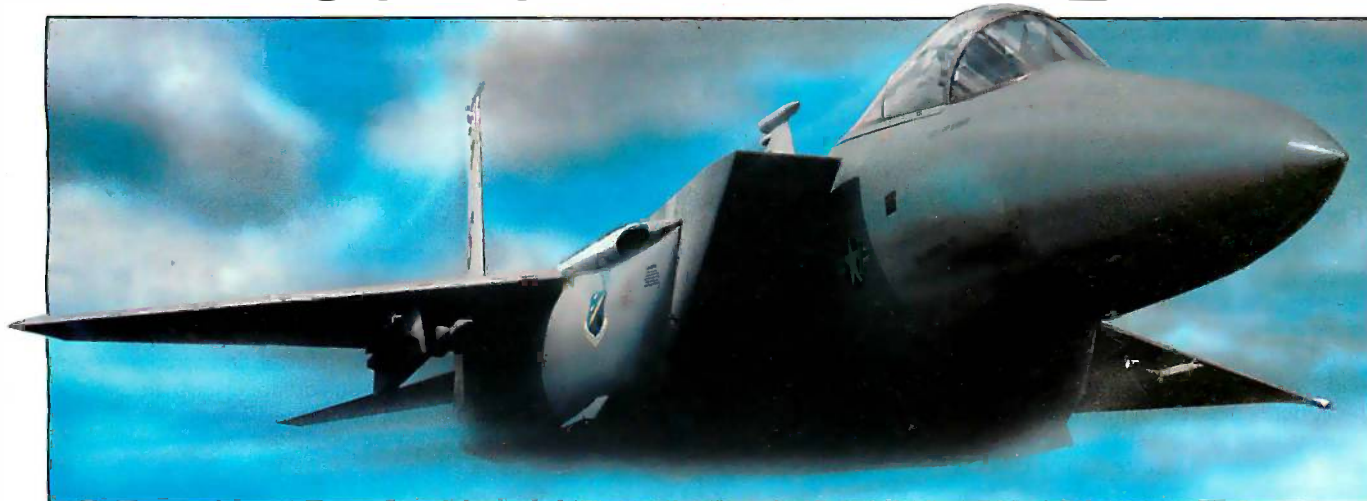

The F-15 served as a test bed for a flight control system written in the Ada language. Ada was designed to meet today's demands for a standard computer language, producing efficient, reliable and maintainable code.

Does your compiler deliver?

Even if your programs don't do loops in mid air, and won't make a boom if they crash, you need a powerful programming language. It has to be easy to learn, structured yet flexible, compact and fast. Your programs should reflect the latest advances in hardware and software and be portable.

Get your software off the ground!

Meet Ada. The DoD's new language of the future. Now you can run Ada on your MS-DOS or PC-DOS computer. Artek Ada is the most advanced Ada compiler for PCs.

A new standard in software engineering

We invite you to learn, explore and use the most powerful general-purpose programming language ever, — with Artek Ada. Artek has approached the tradeoffs of Ada compiler design in a novel way. Modern software engineering techniques are applied to produce a state-of-the-art compiler.

Artek Ada is available now

You can order the Artek Ada compiler now for only \$ 895.00 including a debugger and a screen editor. Outside the U.S.A. add \$ 20.00.

For orders or information call toll free: 1-800-PC-ARTEK, in New Jersey or outside the continental U.S.A. call (201)-867-2900, or write to our address.

VISA, MC and AMEX accepted.

New Jersey residents add 6% sales tax. Please pay with credit card or a bank draft in U.S. dollars drawn on a U.S. bank.

Dealer and distributor inquiries welcome.

Inquiry 24

Artek Ada specifications

Artek Ada implements the Department of Defense 1983 Ada standard, including generics, derived types, overloading, packages, separate compilation, dynamic arrays, standard I/O, string handling, array and record aggregates and much more. The only major feature of Ada not implemented is tasking. Minimum hardware requirements are: IBM PC or a compatible computer, running MS-DOS or PC-DOS (2.0 or later version) with 384 Kb RAM and one double-sided floppy-disk drive. Artek Ada works with the IBM PC network. For further information see our information kit.

A demo diskette is available for \$ 29.95 (including p&p anywhere in the world).

Ask for our free information brochure.

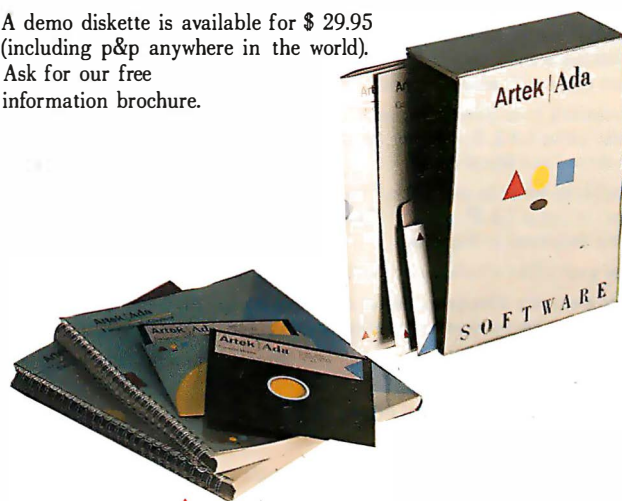

A r t e k

Artek Corporation 100 Seaview Drive Secaucus
NJ 07094

industry and cause the company to lose even more of its market share to the IBM world. Software protection—actually, software piracy—is a separate issue that BYTE disapproved of in 1981 and disapproves of today, but that's unrelated to the Apple/DRI dispute. You and I must then present the facts but disagree on their implications; we at BYTE still believe that Apple's actions against DRI are neither fair nor advisable.

FROM INSECTS TO ROBOTICS

I found your January issue on Robotics interesting. The cover was super! Sooner or later people will teach machines how to move and accomplish objectives in a real-world environment. The question is, when and by what paths will we discover the procedures needed by the machines?

I would like to suggest a path that at first glance may seem bizarre. I think that the complete dissection and mapping of the nervous system of an insect (via the electron microscope) will provide us with the necessary procedures. Why do I say this? Simply because these creatures exist and

thrive in a real-world environment and they do this by processing information about the world in biological time (nervous-system interaction), which is a good deal slower than digital. Reading "Multiple Robotic Manipulators" by J. Scott Hawker et al. (page 203) reminded me of watching a fly clean itself. So the code already exists, in flies and other creatures, including man.

There are many insects that are very small. True, they are large in the microscopic sense, but other, larger creatures are for all practical purposes infinite. I think that the complete mapping of an insect's nervous system is possible. Without question we will discover inputs that we don't understand, but all we will need to know is how the input interfaces to the system. The input's influence on the system can then be derived.

This concept is based on the belief that an insect's actions are a result of nervous-system (hardware) processing of sensory input. It is my guess that the map could be produced by three people in two years. There may be a very simple reason that

invalidates this concept, but I have yet to hear it.

ROBERT HESTER
Toulouse, France

ZBASIC BENCHMARK

After reading Bruce Webster's comments on benchmarking ("According to Webster: Benchmarking," January, page 371), I thought you might be interested in my recent experience, an example even more dramatic than those he gave.

I have a Plain Jane Morrow MD3. The Sieve runs in 152 seconds using the bundled MBASIC, or it can run in 2.4 seconds using ZBasic just purchased from Zedcor. To get a reasonably accurate measure of that short an interval, and without system time, I put an additional loop around the program so it does 10 iterations. It takes a short 24 seconds.

Another way to dramatize the difference is to put in a print statement. That slows ZBasic down to 21 seconds. With MBASIC, 21 seconds is the same time it takes for the first integer, 3, to print. Printing only

(continued)

DREAMER®
An intelligent function keyboard
FOR USE WITH 1-2-3™, WordStar™, MultiMate™, DisplayWrite 3™
Symphony™, WordStar 2000™, WordPerfect™

NO MORE MEMORIZING FOR SOFTWARE COMMANDS

The Dreamer is an intelligent function keyboard. It is pre-programmed with over 550 software commands which it sends to the IBM PC at the touch of a single key.

The Dreamer's descriptive keys simplify the use of seven sophisticated business program: Lotus 1-2-3, Symphony, WordStar, WordStar 2000, MultiMate, DisplayWrite3 and WordPerfect.

Wouldn't it be easier to press a key "Bar" instead of typing "/ G T B V" to display bar chart in Lotus 1-2-3? or a key "Save File" instead of searching for "Ctrl K-S" to save a document in WordStar.

Increase your office efficiency by putting a Dreamer next to your PC system.

Dreamer is entirely a hardware device it will not occupy PC memory. It requires no memory-resident programs and there are no pre-boot disk necessary.

OEMs and VARs: Our professional engineers can re-program the Dreamer to fit your special application.

The Dreamer is available for IBM PC, XT, AT.

DREAMER FEATURES:

- * 20-key numeric pad with separate cursor controls.
 - * Lotus 1-2-3 100 commands MultiMate 58 commands
 - Symphony 191 commands DisplayWrite 3 58 commands
 - WordStar 58 commands WordPerfect 58 commands
 - WordStar 2000 58 commands
 - * Template included for alternate command pages
 - * Easy selection between command pages
 - * Easy installation
 - * Full 90-day warranty
- * Suggested retail price \$259



T.S. MICROTECH INC. (213) 644-0859 12565 Crenshaw Blvd. Hawthorne, CA 90250

Registered Trademarks: IBM, IBM PC, XT, AT, DisplayWrite 3-International Business Machines Corp. 1-2-3, Symphony-Lotus Development Corp. WordStar, WordStar 2000-MicroPro International. MultiMate-MultiMate International, WordPerfect-SSI

Inquiry 392 for End-Users.
Inquiry 393 for DEALERS ONLY.

Ven-Tel's Half Card™ modem is in all the best computers. Here's why...

Ven-Tel gives you lots of reasons to buy our Half Card™ modem for your IBM PC or compatible. The Half Card™ is a complete system that lets you communicate with other PCs, mainframes, and databases effortlessly. It includes Crosstalk-XVI® software. It's reliable. It's got all of the features you want. And it's a good value.

Do You Own One of These Computers?

Chances are you do. And if you're thinking of buying a modem, consider the Half Card™. Because of its small size, the Half Card™ fits in more computers, including all of the models we've listed here. The Half Card™ is small, so it fits in short slots or long. That means you can save your long slots for other expansion uses.

Effortless Communication

Each Half Card™ comes with Crosstalk-XVI® communications software, by Microstuf. It's the easiest to use, whether you're a beginner or an old hand, and the most powerful. A full on-line help menu makes using Crosstalk® for the first time a snap. It can turn your PC into a terminal on a mainframe computer with its powerful terminal emulation feature. It will even operate your PC when you're not there. You can call into an information service such as The Source or Dow Jones News Retrieval, or transfer files and electronic mail, all at the touch of a button. The Half Card™ connects your computer to the world. Effortlessly.

More Modem for Your Money

When you buy the Half Card™, you don't need anything else. The Half Card™ is a complete communications package that includes a full-featured modem and the best known software on the market. Complete easy-to-understand instructions with full technical support on installation and use. And a very competitive price. The Half Card™ with Crosstalk-XVI® software, retails for only \$549.

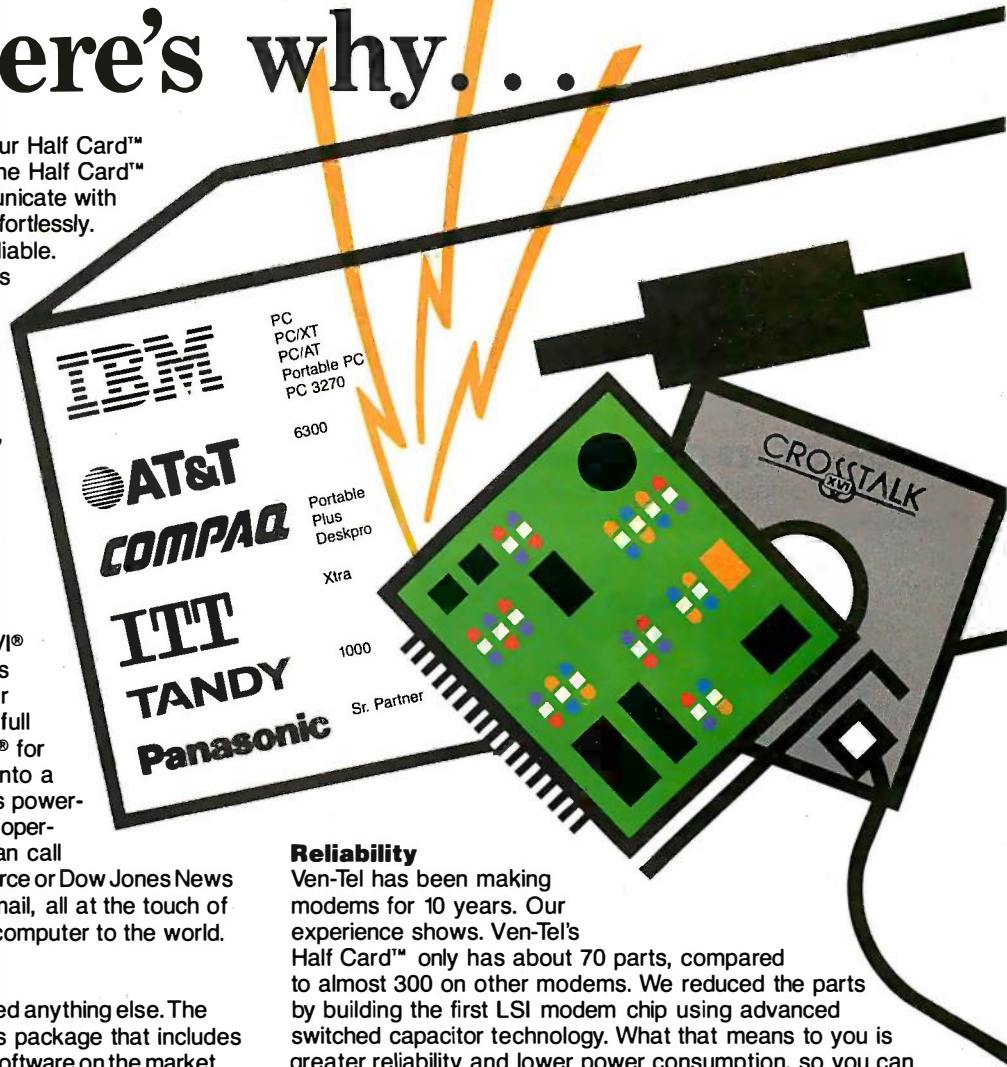

Reliability

Ven-Tel has been making modems for 10 years. Our experience shows. Ven-Tel's Half Card™ only has about 70 parts, compared to almost 300 on other modems. We reduced the parts by building the first LSI modem chip using advanced switched capacitor technology. What that means to you is greater reliability and lower power consumption, so you can load up your PC with expansion boards and not worry about heat or power problems. And we back the Half Card™ with a full two-year warranty on parts and labor.

You Can Buy the Half Card™ Anywhere

You can get the Half Card™ at ComputerLand, Businessland, the Genra Group, Entré Computer Centers, Macy's Computer Stores and other fine dealers nationwide. Also from Ven-Tel: the 1200 Plus™, an external modem and the PC Modem 1200™, an IBM internal with V.22 international capability.

Features

- 1200/300 baud auto-dial, auto-answer.
- Uses the industry standard "AT" command set.
- Runs with virtually all communications software, including Smartcom II and PC Talk III and integrated packages such as Symphony and Framework.
- Includes Crosstalk-XVI® software.
- On-board speaker and extra phone jack for easy switching from voice to data mode.
- Selective tone or pulse dialing; full or half duplex.
- Automatic answer on any ring.
- True ring or busy signal detection.

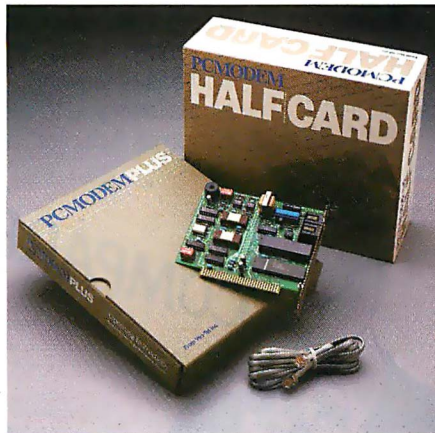

Effortless Communication

Ven-Tel Inc.

2342 Walsh Avenue
Santa Clara, CA 95051
(408) 727-5721

Princeton Gra In a class ab

When you put Princeton Graphic Systems Monitors to work with IBM's new graphics cards, you step up to a new class of performance. Exciting RGB color, sharp, crisp graphics and text and Princeton's quality and dependability...all at a great price!

Our full line of monitors clearly demonstrates why Princeton is an industry leader in high-resolution technology.

Princeton SR-12P Color Monitor

The first IBM compatible monitor available for the IBM Professional Graphics Controller.*

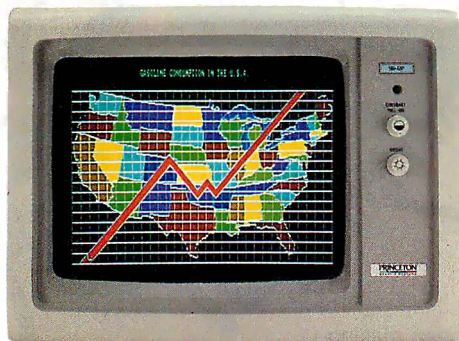

Princeton HX-12E Color Monitor

The superior choice for use with IBM's Enhanced Graphics Adapter.*

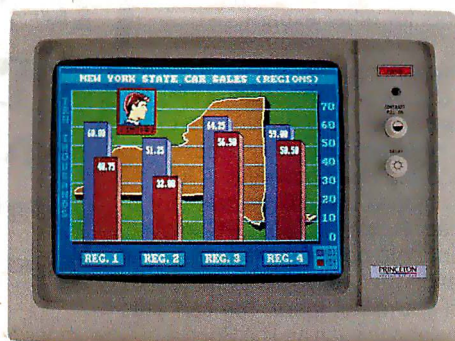

COMPARE:	Princeton SR-12P	IBM 5175
Dot Pitch (The lower, the better.)	.26 mm	.31 mm
Sugg. Retail Price (The lower, the better too!)	\$999	\$1295
Warranty	1 Year	90 Days

Designed for demanding professionals who won't settle for anything less than the finest color graphic capabilities. Displays more than 4,000 brilliant colors... features an anti-reflective coated black matrix tube for less fatigue and eye strain. You get the sharpest graphics and text... at a substantial savings!

COMPARE:	Princeton HX-12E	IBM 5154
Dot Pitch	.28 mm	.31 mm
Sugg. Retail Price	\$785	\$849
Tinted Black Matrix Tube	Yes	No
Warranty	1 Year	90 Days

Ideal for most computing applications, the HX-12E offers 64 high-resolution colors and easy-to-read text. It gives you sharp colors, crisp characters... for less eye strain and easier viewing, hour after hour. Built-in versatility also allows you to display 16 colors with the IBM Color Graphics Adapter* automatically.



phic Systems ove the rest

Princeton HX-9 Series

For more performance in less space, the Princeton HX-9 series is in a class by itself.

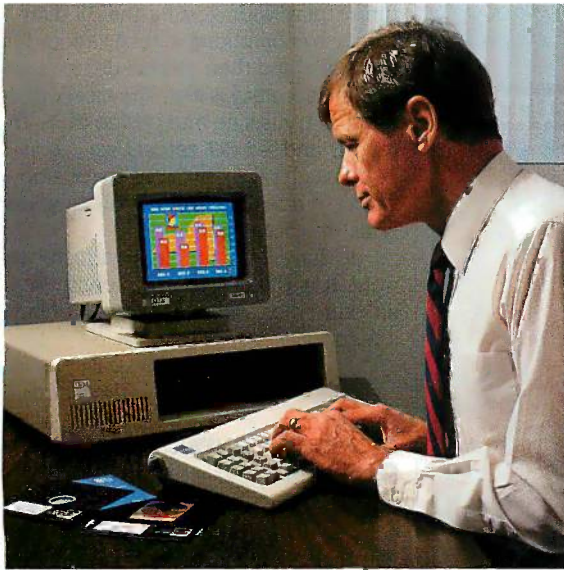

Nobody else—not even IBM—offers a 9", high-resolution RGB color display. The HX-9 and HX-9E feature a super-sharp .28mm dot pitch tube for crisp, clear text and graphics. Nonglare screens for less eye strain. The built-in tilt-and-swivel base allows you to adjust the screen to a comfortable viewing angle. Select green or amber display modes with built-in green/amber switch.

Full IBM compatibility enables you to use the HX-9 or HX-9E with the IBM Color Graphics Adapter.* The HX-9E gives you added flexibility of full compatibility with the IBM Enhanced Graphics Adapter.*

Our other monitors also give you full IBM compatibility:

Princeton SR-12 Color Monitor—boasts twice the vertical resolution of the IBM Color Display... when used with graphics adapter cards such as the Sigma Designs Color 400.

Princeton MAX-12 Amber Monochrome Monitor—ergonomically designed to give you up to 15** shades of high-resolution amber... plus high-resolution text and graphics when used with a monochrome card.



1984 and 1985 winner of the PC World "World Class PC Competition"!

Princeton HX-12 Color Monitor—16 sharp, clear colors and superb character definition make the HX-12 the winning choice among monitor users...



Princeton HX-12



IBM 5153

COMPARE:	Princeton HX-12	IBM 5153
Dot Pitch	.31 mm	.43 mm
Nonglare Screen	Yes	No
Warranty	1 Year	90 Days

See the clearly superior Princeton Monitors at your Authorized Princeton Graphic Systems Dealer. For the dealer nearest you, please call: **800-221-1490 (Extension 1604)**, 609-683-1660 (NJ only), Telex: 821402 PGS PRIN.

Princeton Graphic Systems, 601 Ewing Street, Bldg. A, Princeton, NJ 08540.

* Or equivalents.

** When used with IBM Color Graphics Adapter or equivalent.

IBM is a registered trademark of International Business Machines Corporation. Sigma Designs Color 400 is a registered trademark of Sigma Designs, Inc.

PRINCETON™

GRAPHIC SYSTEMS
AN INTELLIGENT SYSTEMS COMPANY

Inquiry 264

MEGA-16 BAR CODE READER

BAR CODE READER WITH KEYBOARD EMULATOR FOR IBM PC/XT, AT

Your PC will become a BAR CODE SYSTEM by using our "MEGA-16" bar code reader. With Built-in "KEYBOARD EMULATOR" in our "MEGA-16", it can read the bar code data directly WITHOUT adding any software or hardware. All you have to do is just plug in the "MEGA-16" bar code reader to your PC instead of PC's keyboard plug.

ONLY \$395.00



APPLICATIONS:

- INVENTORY CONTROL
- ASSET MANAGEMENT
- FILE OR DOCUMENT TRACKING
- ORDER ENTRY
- WORK-IN-PROCESS
- RETAIL POINT OF SALE

FEATURES:

- IBM PC, PC/XT, PC/AT PLUG-IN COMPATIBLE
- WITH KEYBOARD EMULATOR, NO EXTRA SOFTWARE OR HARDWARE IS NEEDED
- READ THE MOST OF CURRENT CODES
- BIDIRECTIONAL SCANNING
- AUDIBLE "BI" FOR CORRECT READING
- COMPACT SIZE, LIGHT WEIGHT, AND NO EXTRA POWER SUPPLY IS NEEDED
- VISIBLE INDICATOR
- EASY TO INSTALL AND EASY TO OPERATE
- NO CARD SLOT REQUIRED/SIMPLE INTERCONNECT
- READ HIGH, MED & LOW DENSITY LABELS
- HIGH FIRST READ RATE
- SWITCH SELECTABLE OPTIONS
- SELF-TEST DIAGNOSTICS
- CAN READ 6 KINDS OF BAR CODES—UPC, EAN, IAN, 2 OF 5, 3 OF 9 & CODE BAR

LETTERS

slows MBASIC down by 10 seconds to 162.

The real reason for getting ZBasic was my frustration with only single precision for MBASIC functions. To get added precision with the MBASIC compiler was \$400. ZBasic was \$90. Not only is it fast, it is precise. It can be configured for from 2 to 54 digits of accuracy. Certainly there is no need here for that accuracy, but since this is a hobby, too, it's nice to have and fun to play with. Testing the 54-digit accuracy by computing π , then various functions of π and their inverse demonstrates that the accuracy is real. The most obvious thing to try is sine and cosine of π . They read 0 and $-1.(52 \text{ zeros})3$.

Although the extreme precision is slower, it does not increase run time nearly as much as expected.

I do have one problem with the software. It is difficult to use parentheses in an expression without the result being an integer.

BILL E. JOHNSON
Portland, OR

MORE ON CONFERENCING SYSTEMS

Your December 1985 theme signaled the coming of age of a new industry, which you called "computer conferencing." That phrase tends to underestimate powerful "electronic organization" and pervasive "electronic culture" that are already making "electronic mail" and "computer conferencing" seem like relics. Some day, using 20/20 hindsight, we will see the eighties as this industry's horseless-carriage stage.

E-mail gave us distance independence and time independence. Electronic bulletin boards moved us from one-to-one to topic-oriented, one-to-many communication. Early computer conferencing gave us dynamic user records that allowed few-to-few communication within relatively fixed conferences. Such systems kept track, by each participant, of what had been read versus what was new in that particular topic. Many-to-many communication did not appear until this decade's introduction of topic branching to allow "many"—meaning thousands—to easily and spontaneously form separate interest groups. Computer conferencing today allows networking in human terms on an unprecedented scale.

The most advanced conferencing software now adds sufficient access controls to topic branching to be able to be molded to various organizations. These

(continued)

MEGA AT COMPUTER

\$1745⁰⁰
ONLY



- 6 or 8 mHz 80286 Microprocessor Socket for 80287 Math Co-Processor
- 640K Standard Memory, Expandable to 1MB on board
- 8 I/O Expansion Slots
- One 1.2MB Floppy Drive
- Western Digital Hard & Floppy Drive Controller
- 192 Watt Power Supply
- AT Style Keyboard
- Color Graphic Card
- Operation Manual & System Box
- One Year Warranty

CALL FOR MEGA TURBO AT SYSTEM!!!

- 6 or 8 mHz Switchable with Zero Wait State

AT ADD-ON

Enhanced Color Graphic	\$449
Short Card, 256K Graphic Memory	
Seagate 225 with WD Controller	\$549
Seagate 4026 (20MB, 30ms)	\$799
Seagate 4038 (40MB, 30ms)	\$899
20MB Streaming Tape Backup System	\$649
AT Serial & Parallel Card	\$ 99
AT 3 MB Multi-Function (OK)	\$239
AT 2.5 MB memory Expansion Card (OK)	\$199

MEGA XT COMPUTER

\$699⁰⁰
ONLY



- IBM PC/XT Fully Compatible Mother Board with 640K on Board
- Color Graphic Card
- One Floppy Disk Controller Card
- One DS/DD Slim Drive
- Flip Top Metal Case with Speaker
- 135W Power Supply
- Keyboard
- Operation Manual & System Box
- One Year Warranty

CALL FOR SPECIAL PRICE OF XT ADD-ON CARDS

POWER SUPPLY

FOR PC/XT AND AT



135 Watts
XT Power Supply
OEM PRICE: \$69⁰⁰



200 Watts
AT Power Supply
OEM PRICE: \$99⁰⁰

(QTY. 10 PRICE)

KEYBOARD

To Be Used On **Both PC/XT and AT**

BTC 5060 AT



NO SWITCH, AUTOMATIC SELECTION!
OEM PRICE: \$65⁰⁰
(QTY. 10 PRICE)

CASE



XT OPEN-TOP CASE
OEM PRICE: \$39⁰⁰

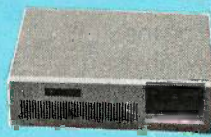

AT CASE
OEM PRICE: \$79⁰⁰

(QTY. 10 PRICE)



C.J. COMPUTERS CORPORATION

(Manufacturer & Distributor)

2424 W. Ball Rd., Suite A&B, Anaheim, CA 92804

ORDER AND INQUIRY HOT LINE (714) 821-8922 (5 LINES)

TLX: 3720117 JC COMPTR - FAX: (714) 821-8941

IMMEDIATE DELIVERY!

*90 days warranty on parts and labor.

IBM is the trademark of International Business Machines Corporation.

PC Paintbrush.™

Because life is too short for monochrome pie charts.

Fun is the best thing to have.

With PC Paintbrush, you can add color, flair, dimension and creativity to a chart, a presentation, or an otherwise dull day. From charts and graphs to serious computer art, our newest generation 3.0 PC Paintbrush will cheer you on with features no other graphics package can match.

Best of all, it's easy to use. You don't have to learn up to sixty commands, like you do with some products. If you can understand icons as simple as scissors, paintbrush, spray can and paint roller, you're ready to start using PC Paintbrush.

The pen is mightier than the keyboard.

None of history's great artists drew with a keyboard, and you shouldn't have to either. So PC Paintbrush is now available with a Summasketch MM™ Series drawing tablet, to give you complete freedom of expression. Of course, it also supports regular mice, joysticks, graphics tablets, and is compatible with most graphics cards.

PC Paintbrush also has a beautiful way with words. The text icon lets you write in any of eleven fonts, in nine sizes, with italics, outline, shadow and boldface variations.

What's more, with the new 3.0 PC Paintbrush, you can draw rounded boxes, rubber band curves and circles, and edit pictures many times larger than the screen.

Are we making fun of 1-2-3®? Why not?

For Lotus™ users, PC Paintbrush's new PIC

Go on, live a little.

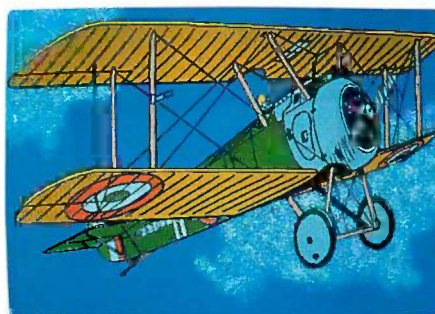
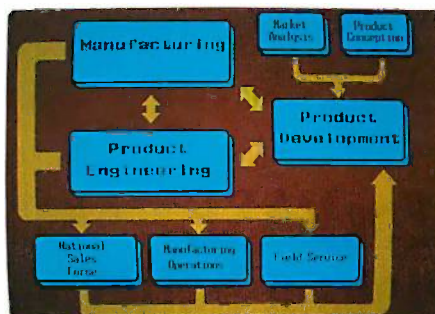

interpreter loads 1-2-3™ and Symphony™ charts and graphs at your equipment's best resolution, from an IBM EGA™ (640 X 350 X 16 colors) to a Number Nine Revolution™ (512 X 512 X 256 colors).

With our FRIEZE™ frame grabber you can pull graphics created by any program right off the screen into PC Paintbrush. So you can take your Paintbrush and palette anywhere, improving the looks of things as you go. And having a lot of fun on the way. In addition, our optional slide show package, PC PRESENTATION, allows you to program your graphics into a first class presentation with fades, zooms, quick cuts and animation.

PC Paintbrush supports 19 video graphics cards and 30 printers and plotters.

For more information on PC Paintbrush, call or write us at the address below, or ask your computer dealer for a demonstration.



Z-SOFT
PC Paintbrush

See us at
COMDEX/Spring '86
April 28-May 1, 1986
Georgia World Congress Center
Atlanta, GA

Ask about our
PC Paintbrush &
Summasketch™ drawing
tablet special

Corporate Headquarters:

ZSoft Corporation, 1950 Spectrum Circle, Suite A 495, Marietta, GA 30067, 404/980-1950

PC Paintbrush is a trademark of ZSoft Corporation. Lotus, 1-2-3, and Symphony are registered trademarks of Lotus Development Corporation. IBM and Enhance Graphics Adapter are registered trademarks of International Business Machines, Corp. Number Nine Revolution is a trademark of Number Nine Computer Corp. Summasketch is a registered trademark of Summagraphics Corp.

systems can be configured so that they are no longer perceived by their users to be generic communication systems but rather as more specialized management tools. "Electronic organization" deals with how these systems are designed and used to address specific business problems. Business problems currently being solved via this medium include project coordination for the organization and implementation

of plans, specifications, tasks, and sub-tasks; sales management for the tracking of leads, prospects, customers, and competitors; and customer service for the answering of inquiries, complaints, and suggestions.

"Electronic culture" deals with how electronic communication systems need to be organized in order to be integrated with more established forms of communica-

tion. Electronic communication systems must mirror the organizational culture or they have a high chance of failure.

Brock N. Meeks, in his article titled "An Overview of Conferencing Systems" (page 169), did not show how the fixed conference structures of the early days differ from "many-to-many communication" aspects introduced in the eighties or from concepts of "electronic organization" and "electronic culture," which could dominate the industry by the end of this decade. An even more serious lack for those using his article for systems assessment is that the article confused the roles and importance of software functionality, information content, and on-line culture associated with each implementation he reviewed.

For example, he described PARTICIPATE in terms of the public systems he has used. We are glad that individuals are being entertained and educated on these public systems. However, these public systems represent less than 10 percent of all PARTICIPATE installations. More important, the information content and the on-line cultures associated with the more numerous corporate installations of PARTICIPATE are as different as the number of installations we have. On-line cultural differences stem not only from differing purposes to which computer conferencing systems can be put but also from the information content of the business applications and from the existing communications culture of the organizations making use of the medium. This interplay of software functionality, information content, and culture was not made explicit by Mr. Meeks. Yet it is this complete picture that determines the success or failure of the medium.

CHANDLER HARRISON STEVENS
Participation Systems Inc.
 Winchester, MA

Congratulations for the extensive and well-written articles regarding computer conferencing (December 1985). Brock Meeks did a fine job of researching and reviewing the technology and many of the participants in this growing industry. As the creator of CONFER II, I appreciate having our product so favorably reviewed. I am especially pleased that BYTE was able to increase awareness of this communication and decision enhancing tool.

I would like to correct a few minor inaccuracies in Mr. Meeks's comments about CONFER II: (1) The product is actually registered as CONFER II, not CONFER, and is owned by Advertel Communication

(continued on page 340)

Why buy 3 packages to get a complete multi-user dBASE* System?

FoxBASE™ does it better. For less.



for the widest variety of machines and operating systems.

In addition, FoxBASE is interactive and 100% dBASE compatible (including full macro usage). The only thing you won't get is all those annoying dBASE bugs!

Best of all, FoxBASE costs less than half the other packages.

So call (419) 874-0162 now, and ask for a copy of our comparative analysis (including benchmarks). After all...

Nothing Runs Like a Fox.

FOXBASE™ 

Fox Software, Inc.
 27475 Holiday Lane, Perrysburg, OH 43551
 (419) 874-0162

After all, FoxBASE is a compiler, an interpreter and a multi-user dBASE system all in one. That means single vendor support and no problems with product incompatibility.

Not only that, FoxBASE actually outperforms dBASE and other dBASE compiler products: its program execution speed is far superior to the competition and its compiler runs up to 60 times faster than other compilers. And FoxBASE is available

*dBase is a registered trademark of Ashton-Tate FoxBASE is a trademark of Fox Software, Inc. Clipper™ is a trademark of Nantucket

Microsoft
Introduces
Power
Windows.

It's going to open your eyes.

Microsoft® Windows has arrived.

For anyone who uses a computer in earnest, that is extremely good news.

Windows gives you a practical way to integrate programs. It radically decreases the time it takes to move from one application to another. Dramatically simplifies the means of consolidating data from many different programs.

And, as a graphical extension of the MS-DOS® operating system, it gives you a highly visual way to work and to organize your work.

In short, Windows brings efficiency to all those processes of personal computing which have till now been awkward, unwieldy, inconvenient.

The joys of job hopping.

With the advent of Windows, you can work with multiple applications. And switch from program to program with ease.

Start up with one application, then another, and another. Leap back and forth between applications as your work routine dictates. Then pick up right where you left off.

The ability of Windows to change quickly from program to program logically and naturally magnifies the utility and productivity of the personal computer. And is a

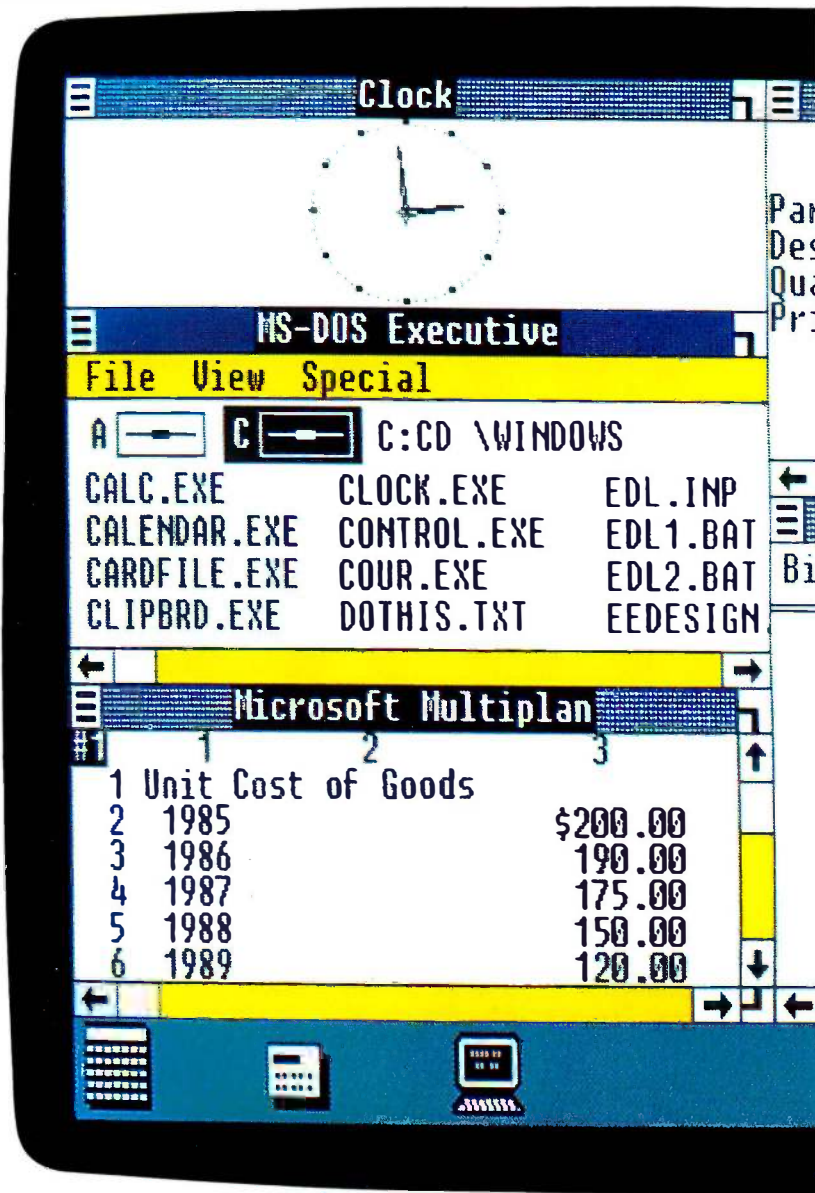

recognition of the way people who exploit the power of PCs really do their jobs.

Breaking the 640K barrier.

Just like you, Microsoft Windows can handle several projects at the same time. Juggle assignments. Deal with frequent interruptions.

And Windows will ignore the 640K limit of your PC, especially if you have a hard disk, the Intel® Above™ Board, or expanded memory. It will execute the rather neat trick of working with more programs than memory can hold at one time.

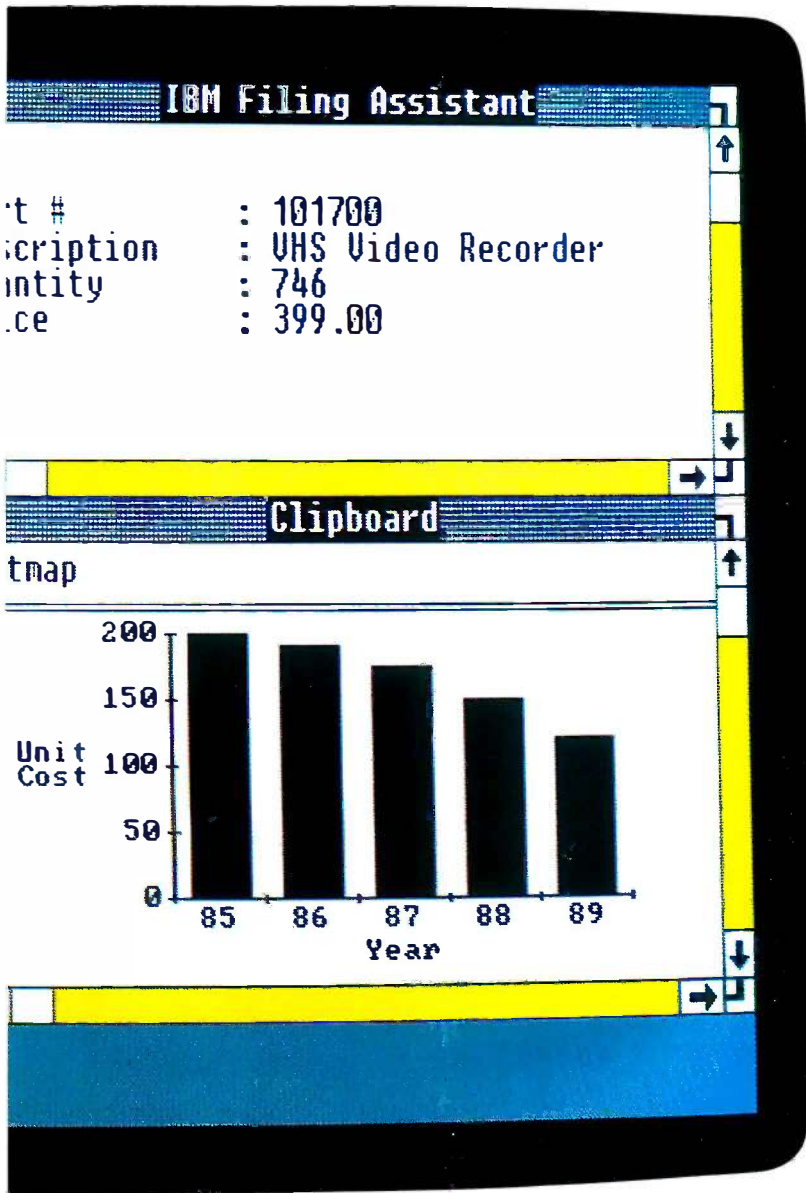

Spreading knowledge.

Another great service Windows performs is accelerating the movement of information from one program to another.

Collecting and combining that information is as simple as taking a "snapshot" of data in one program. Editing it. Then consolidating it with data from other programs.

With Windows, you can enjoy the advantages of conventional integrated programs without their compromises. Because Windows lets you put together the applications that you know, and that get a job

done for you.

Choose your best word processor, spreadsheet, database — you name it. They're all there for you at a keystroke.

Common ground.

Finally, Windows is not only an immensely powerful tool for today, it's also a solid base for a new generation of Windows applications.

As an introductory offer, two of these — Microsoft Windows Write and Paint — are included in the package. Along with more than a dozen other programs.

In Windows applications you have a common interface which includes drop-down menus, dialog boxes, icons. Along

with a richer environment that allows you to mix pictures and text. And to summon different type faces and styles at a keystroke.

Windows is a bridge between today's applications and the graphics based software now evolving. A way to work interchangeably with today's programs. And tomorrow's.

If you're someone who uses personal computing as a natural part of your work life, who capitalizes on the productive powers of sophisticated applications, look into Windows, a new vision of what a computer can do.

Windows breaks down walls.

Windows lets you freely combine information from all your applications. And gives you the means to organize, compose, format and print it.

The staging areas for this consolidation are Windows Write and Windows Paint. Two

graphics based programs which are bundled with the Windows package.

Here you highlight, expand, and compose text, charts, and illustrations drawn from a variety of programs. Then polish it all for printing.

Five-Year Digital Audio Market Analysis		
Unit Sales To Dealers		Revenues
Compact Disc Players		
1983	35,000	\$13,965,000
1984	200,000	82,992,000
1985	600,000	239,400,000
1986	900,000	359,100,000
1987	1,100,000	430,500,000
Total	2,843,000	\$1,134,357,000
Compact Disc Cleaners		
1983	26,250	\$393,750
1984	156,000	2,340,000
1985	450,000	6,750,000
1986	675,000	10,125,000
1987	825,000	12,375,000
Total	2,132,250	\$31,983,750

Audio Distribution Contacts		
Stanley Lake R/O Systems Inc. 13424 NE Blonsdale Blvd. Wichita KS 67204	Thomas Wayne Audio Inc. 1800 W. Montgomery Atlanta GA 30310	
Mark Renn Audio Networks 656 U. Palm Drive Miami FL 33186	Clifford Swain Central Audio/Video 2202 U. Market Street Chapel Hill NC 27514	
Beverly Adams Future Videos Inc. 818 LaVista Phoenix AZ 85022	Walter Jacobson Greater Metropolitan Audio 7117 W. Melrose Los Angeles CA 90029	
Kevin Williams New England Audio 707 Campus Blvd W. Boston MA 02160	Jennifer Castle Video Distribution 10053 U. Franklin Blvd San Francisco CA 94100	

Spreadsheet information from Lotus® 1-2-3® can be captured. And then transferred to Windows Write, our graphic word processing program for consolidating, editing, and formatting.

Data from dBase II® can also be copied and transferred to Write.

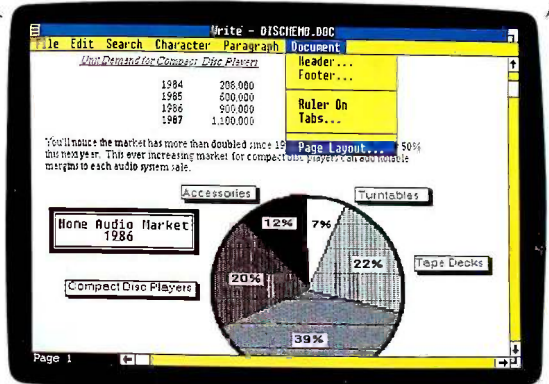
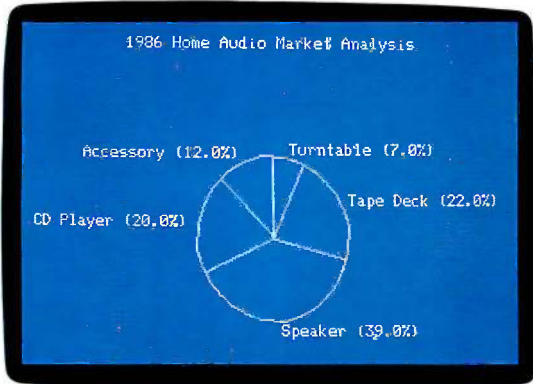

Using your spreadsheet data, build a Lotus chart. Then capture it from the screen. And paste it into Windows Paint.

Windows Write is a straightforward and able word processor. It serves as the "great integrator" in Windows. The place where text and graphics from all your other programs are organized and formatted for presentation. What you see on the screen is what you'll get on the printout.

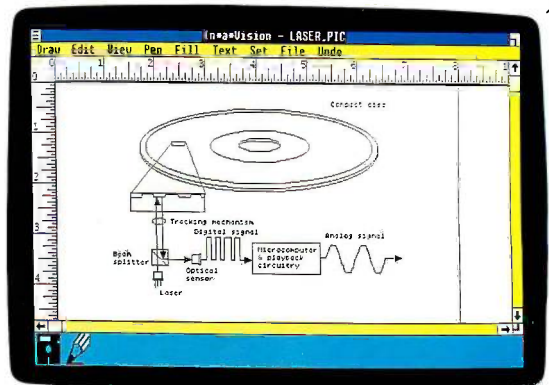
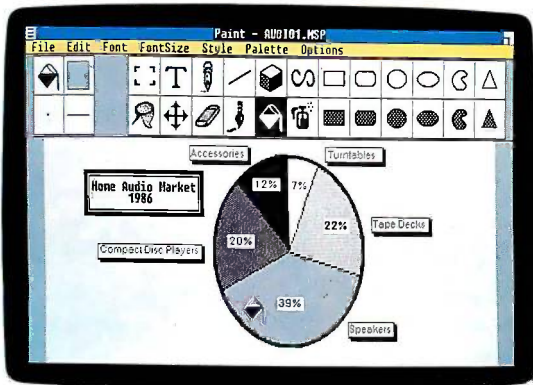

Windows Paint is an illustrator's studio. A palette of graphic tools. Use Paint to create drawings and diagrams. Or, in this case, to enhance a 1-2-3 chart to emphasize your point.

In-a-Vision, a Windows application by Micrografx, Inc., is a computer-aided design program. Its highly detailed technical illustrations are easily transferred to other Windows applications.

**Consumer Audio Incorporated
11705 Wellington Parkway
Morristown, New Jersey 07960**

Clifford Swain
Central Audio/Video
2202 W. Market Street
Chapel Hill, NC 27514

Dear Mr. Swain:

As a major supplier of compact disc players in the audio market, it is my pleasure to introduce you to **Consumer Audio**. Our product line includes all major brands of audio equipment and accessories including the latest in compact disc technology.

Compact discs have revolutionized the art of sound reproduction. Their acceptance as a universal standard for home-use audio has made way for numerous business opportunities in selling related equipment and accessories.

As shown in the table below, the unit demand for compact disc players is rapidly increasing. **Consumer Audio** is committed to supporting you in every possible way to capitalize on this tremendous opportunity.

<u>Unit Demand for Compact Disc Players</u>		<u>Estimated Revenues</u>
1984	208,000	\$ 82,992,000
1985	600,000	239,400,000
1986	900,000	359,100,000
1987	1,100,000	438,900,000

You'll notice the market has more than doubled since 1984 and is expected to grow 50% this next year. This ever increasing market for compact disc players can add notable margins to each audio system sale.

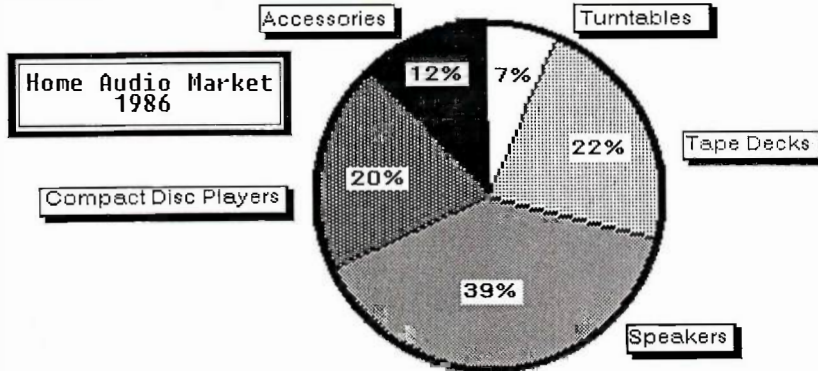

The chart above indicates projected market share of the major segments of the home audio market for 1986. The compact disc segment is a marked increase from 1985.

This is Windows' finished product. And it's highly finished, indeed. An exact representation of what you produced on-screen. The better your printer (in this case a laser) the better the results.

Spend a day with us. You'll

One of the great beauties of Windows is that in the here and now you enjoy the benefits of computing's future path—graphically oriented software. Without giving up any of the applications you're happy with today.

In addition to Windows Write and Paint, the Windows package includes a collection of desktop applications you can use to manage your day-to-day activities. A calendar, cardfile, notepad, calculator, and telecom-

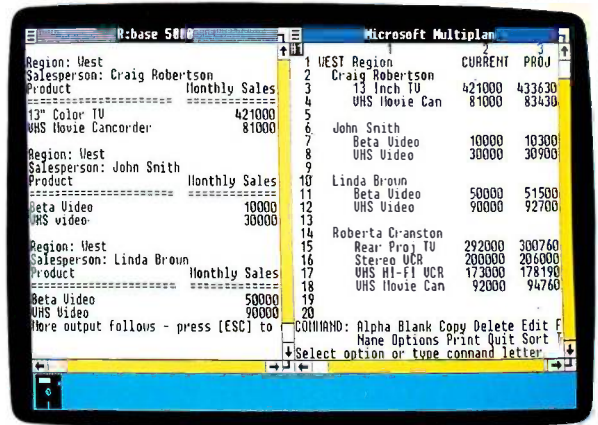
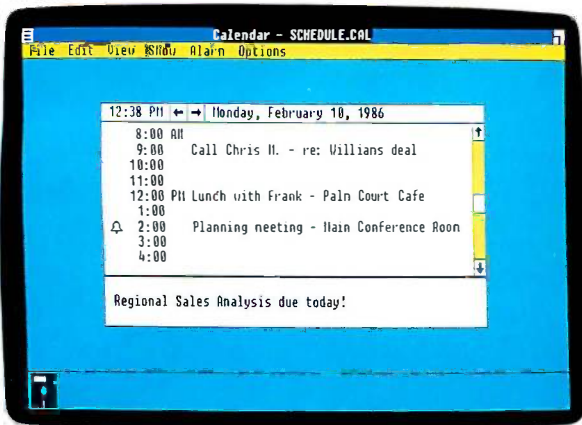

7:45 AM. Early as usual. Opening Windows lands you in the MS-DOS Executive, the Windows command center and file directory. Run the Windows Calendar program and see what's up for the day.

7:55 AM. You've got a report due by the end of the day. A comprehensive sales analysis. Bring up Multiplan® and R:BASE 5000®. Copy regional sales data from R:BASE into Multiplan.

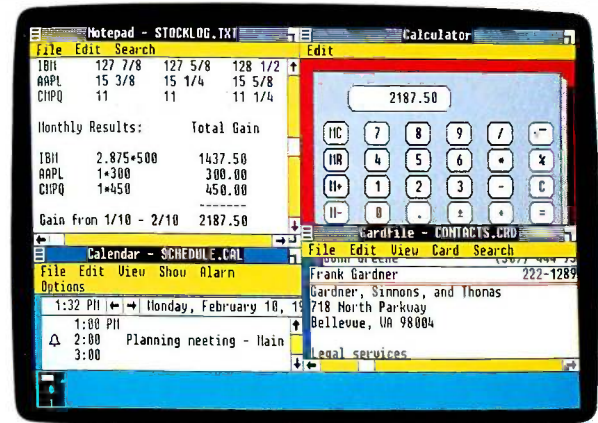
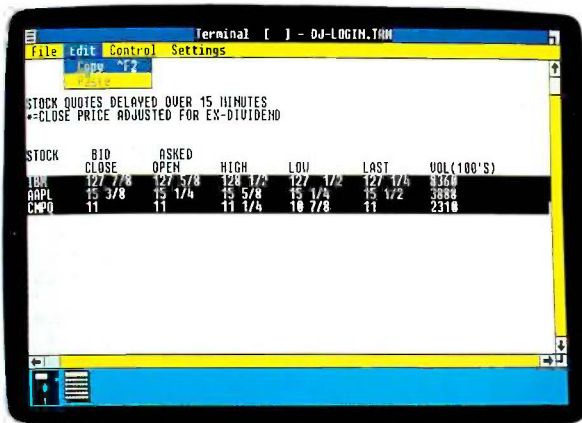

1:30 PM. Market's closed. How'd you do? Open Terminal to dial Dow Jones News/Retrieval® and check the final quotes. Copy and paste them into Notepad.

1:45 PM. You did pretty well today. So use the Windows Calculator to figure your gains. Which you duly note in Notepad. Your good luck, however, requires a call to your tax attorney. A quick click brings up his listing in Windows Cardfile. Another click dials him automatically on your modem.

never give up a Windows office.

munications program, just to name a few. Used together with your standard applications, they can handle an impressive list of office routines.

And because Windows runs standard

DOS applications, you can look forward to the future.

But you don't have to wait on it.

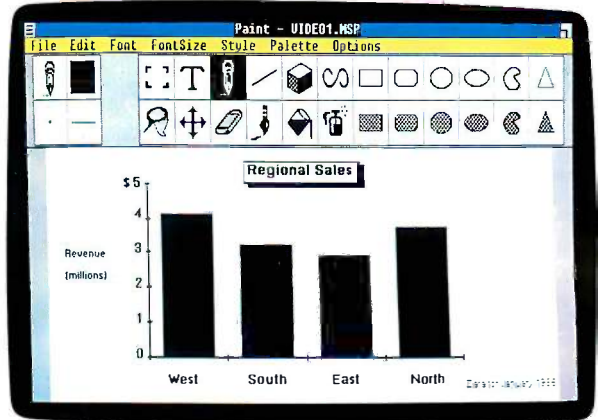
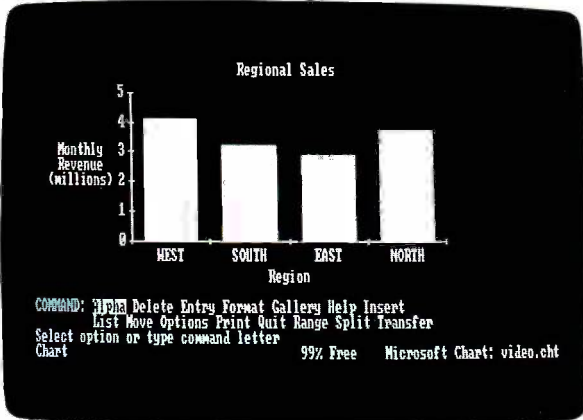

10:30 AM. You've squeezed everything you can out of the numbers. Now open up Microsoft Chart. And let the pictures tell the story. When you've made a chart fit for presentation, capture it from the screen.

11:00 AM. Paste your finished chart into Windows Paint. Add borders, highlights and illustrative detail. Not only more appealing, but more effective.

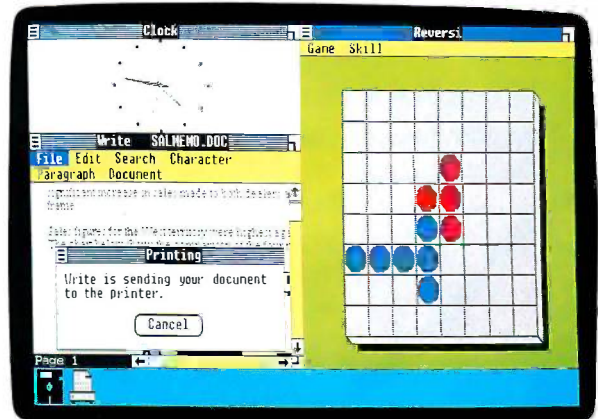
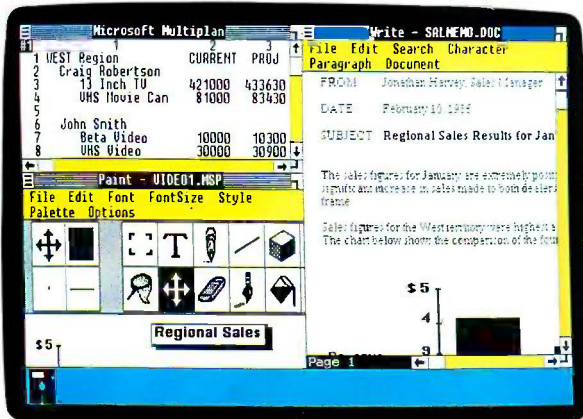

1:55 PM. No sooner do you hang up, than your Calendar alarm sounds. Checking the calendar, you find you've got a meeting at 2.

3:00 PM. The meeting went on forever. About time you got back to that report.

Copy the chart from Paint, and paste it into Write. It looks brilliant. Now write it so it *sounds* brilliant.

4:48 PM. Everything on screen is looking good. You're ready to print. Open Clock to confirm time. That's right, it's tight. Choose the Print command and send the document off to the printer. Open Reversi for a quick game while you wait. While you beat the clock you can try beating the computer.

5:00 PM. Report printed impeccably. Turn it in and shut down for the day. After all, you were in fifteen minutes early.

The first reviews are in. Here's what they see in Windows.

Prominent reviewers and industry experts have been eagerly awaiting the arrival of Microsoft Windows.

Now they've had a good look. And we're pleased to record their responses to what they saw.

"I'll bet on Microsoft Windows."

Jonathan Sacks, West Coast editor of *Popular Computing* magazine.

"You've got a clear winner..."

Stewart Alsop, editor and publisher of *P.C. Letter*.

"... Windows looks very good..."

Peter Norton in his column in *PC WEEK* 9/24/85.

Of course, all this is going to cost you: \$99.

A price that makes Windows the most startling value ever offered in software.

A comparable collection of programs—a switching program, a graphic interface, desktop applications, a word processor, a drawing program—could easily cost hundreds of dollars more.

Windows will instantly deliver you a more productive present. And a leap into the future.

A future which, frankly, we have no interest in keeping exclusive. At this price,* it looks to be arriving in a rush.

Check out the view.

We invite you to visit your Microsoft Dealer and get a screenful of Microsoft Windows. What you see will confirm what others have said, Windows is clearly a winner.

*Price valid only in the U.S.A.

You can run Windows with either keyboard commands or by a mouse and keyboard together. Windows admirably exploits the mouse's speed, mobility, and simplicity.

Microsoft® Windows

The High Performance Software™

Integration features:

- Work with multiple applications and switch between them.
- Run more applications than fit in memory at one time.
- Consolidate information from standard DOS and Windows applications.

Applications included:

- MS-DOS Executive—DOS file management program. Run programs; format disks; copy, rename, delete files.
- Calendar—Set appointments with optional alarm reminders; daily or monthly view.
- Cardfile—Filing program; cards can include text or graphics, autodial capability.*
- Notepad—Text scratch pad/editor; time/date stamp option.
- Terminal—Telecommunications program; copy session data to other programs or capture to file; autodial capability.*
- Calculator—Common arithmetic operations, plus square root, percent, and memory.
- Clock—Can be displayed anywhere on the screen.
- Reversi—Strategy game; four levels of play.
- Control Panel—Set time, date, communication ports, colors, add/delete printers.
- Program Information File (PIF) Editor—Create or edit PIF files for standard applications.
- Print Spooler—Print files from Windows applications while running other programs.
- Clipboard—View information copied from applications.
- RAMDrive—Setup memory expansion cards as a RAM disk.

Introductory offer also includes:

- Windows Write—Graphics based word processor.
- Windows Paint—A full-featured drawing program.

System Requirements:

- IBM or COMPAQ* Personal Computer 256K memory, DOS 2.0 or higher, two double-sided disk drives, graphics adapter card (IBM Color/Graphics Monitor Adapter, IBM Enhanced Graphics Adapter, Hercules Graphics Card, COMPAQ Personal Computer Graphics Display Adapter, or compatible).

Note:

- 512K memory and a hard disk are recommended when using multiple applications or DOS 3.0 or higher.

*requires a Hayes compatible modem

International Offices

Microsoft Corporation Bellevue, Washington USA	Microsoft Ltd. Reading ENGLAND	
Microsoft GmbH München DEUTSCHLAND	Microsoft Canada Inc. Toronto CANADA	
Microsoft Pty Sydney NSW AUSTRALIA	Microsoft AB Stockholm SWEDEN	
Microsoft SARL Paris FRANCE	Microsoft Far East Tokyo JAPAN	QNIX Microsoft Seoul KOREA

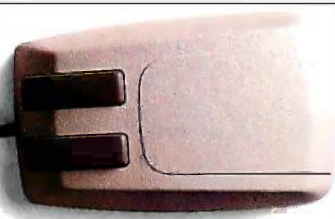

NOTE: Photos show color and resolution obtained on an IBM PC equipped with IBM Enhanced Graphics Adapter. Monochrome display is generated when an IBM Color/Graphics Adapter or compatible graphics adapter card is used.

For the name of your nearest Microsoft dealer, call (800) 426-9400. In Washington State and Alaska, (206) 828-8088. In Canada, call (800) 387-6616.

Microsoft, Multiplan and MS-DOS are registered trademarks and The High Performance Software is a trademark of Microsoft Corporation.

The names of the people and companies used in this piece are fictitious. Any resemblance to actual people or companies is purely coincidental and unintentional.

F·I·X·E·S A·N·D U·P·D·A·T·E·S

UPDATES

Conferencing Contacts

Brock N. Meeks's "An Overview of Conferencing Systems" in our December 1985 issue (page 169) described a variety of computer conferencing systems. However, the article did not include

addresses or telephone numbers of the companies mentioned. Here now is that information. (For more on conferencing systems, see Letters, page 30.)

System	Availability	System	Availability
PARTICIPATE Participation Systems Inc. 50 Cross St. Winchester, MA 01890 (617) 729-1976	Various information networks; may be licensed	EIES Electronic Information Exchange System New Jersey Institute of Technology 323 High St. Newark, NJ 07102 (201) 420-5111	Telenet, Uninet, or direct dial
GENIE Data Dynamics Inc. POB 2728 Portland, OR 97208 (503) 626-4635	No subscription service; may be licensed or rented	eForum Network Technologies International 315 West Huron Ann Arbor, MI 48103 (313) 994-4030	GESICO; may be licensed
NOTEPAD Infomedia 801 Trager Ave., Suite 275 San Bruno, CA 94066 (415) 952-4487	Tymnet; may be licensed	CONFER Advertel Communication Systems 2067 Ascot Ann Arbor, MI 48103 (313) 665-2612	Telenet
AUGMENT Tymshare 20705 Valley Green Dr. Superior, CA 95061 (408) 446-6000	Tymnet; may be licensed	CoSy Institute of Computer Science University of Guelph Guelph, Ontario N1G 2W1 Canada (519) 824-4120 ext. 3712	BYTE Information Exchange; Tymnet
COM Swedish National Defense Research Institute Stockholm University Computing Center Box 27322 S-102 54 Stockholm, Sweden Telephone: 46 8 679280	Tymnet; no subscription service; may be licensed		

BYTE'S BITS

Free FORTH Reference Card

This little card from the FORTH Interest Group (FIG) is a useful aid for programming. The FORTH reference card lists the required commands of the FORTH-83 standard. Commands are grouped by function, such as stack manipulation, comparison, strings, numeric conversion, compiler and interpreter words, and vocabularies.

FIG is a nonprofit organization with more than 5000 members. It costs \$20 to join, which includes a subscription to the group's bimonthly publication, *FORTH Dimensions*. The reference card is free to anyone. Just contact FIG at POB 8231, San Jose, CA 95155, or phone the FIG Hot Line at (408) 277-0668.

BYTE'S BUGS

Changes in Ciarcia's Cellar

A few changes to Ciarcia's Circuit Cellar in the March issue. On page 118, the telephone number for Dallas Semiconductor should be (214) 450-0449. In figure 6 on that same page, the two capacitor symbols should be battery symbols. And on page 119, last paragraph, chip model DS1224 should read DS1221.

The personal computer that raised high performance to new heights.

If you work with high volumes of information,
you need answers fast.

You need a personal computer that's up to the task.

Which is why IBM created the Personal Computer AT® system. It's changed a lot of ideas about business computing.

The idea of "fast" has become much faster. The idea of "data capacity" has become far greater.

There are new definitions of "power" in a stand-alone PC. While phrases like "sharing files" and "multi-user systems" are being heard more often.

And surprisingly, words like "affordable" and "state-of-the-art" are being used *together*.

Clearly, the Personal Computer AT is different from anything that came before. And what sets it apart can be neatly summed up in two words.

Advanced Technology.

If you've ever used a personal computer before, you'll notice the advances right away.

To begin with, the Personal Computer AT is extraordinarily fast. That's something you'll appreciate every time you recalculate a spreadsheet. Or search through a data base.

It can store mountains of information — literally thousands of pages' worth — with a single "hard file" (fixed disk). And now you can customize your system to store up to

30,000 pages with the addition of a *second* hard file.

The Personal Computer AT runs many of the thousands of programs written for the IBM PC family. Like IBM's TopView, the program that lets you run and "window" several other programs at once.

Perhaps best of all, it works well with both the IBM PC and PC/XT. Which is welcome news if you've already made an investment in computers.

You can connect a Personal Computer AT to the IBM PC Network, to share files, printers and other peripherals with other IBM PCs.

You can also use a Personal Computer AT as the centerpiece of a three-user system, with your existing IBM PCs as workstations.

Most important, only the Personal Computer AT offers these capabilities *and* IBM's commitment to quality, service and support. (A combination that can't be cloned.)

If you'd like to learn more about the IBM Personal Computer AT, see your Authorized IBM PC Dealer, IBM Product Center or IBM marketing representative. For a store near you, call 1-800-447-4700 (in Alaska, call 1-800-447-0890).

The IBM Personal Computer AT, for Advanced Technology.



IBM[®]

We've Earned The Right To Be #1 By Being First So Often

When it comes to being **FIRST** with technology-leading products **Advanced Digital** wears its #1 button with pride. We were **FIRST** to introduce an 8-Bit, single board S-100 computer... We were **FIRST** to introduce a 6MHz, 128KByte single board computer... We were **FIRST** to introduce a 6MHz, 128KByte Slave Processor board. Our record of **FIRSTS** continues with...

- The introduction of **MULTI SLAVE** - a 3 USER, 8MHz SLAVE card for the S-100 Bus systems running Turbo-Dos™ or NETWORK/OS.™
- The introduction of **HDC-2001**, the all new hard disk controller for the S-100 BUS.
- The introduction of **SUPER 16**, a 16-Bit, S-100 Slave card for use with Turbo-Dos or NETWORK O/S.
- The introduction of our new **SUPER 186** - the **FIRST** 16-Bit, single board S-100 computer that performs at twice the speed of older technologies. Loaded with features such as on-board floppy disk controller and up to 1MByte of RAM, the SUPER 186 is designed to function as a bus Slave or Master. Advanced Digital's SUPER 186 permits you to take advantage of vast libraries of sophisticated applications software.

Again, we were #1 with...

- The introduction of **PC-SLAVE**, an IBM PC Multiuser card with 8088 (8MHz) CPU and 256-768K RAM on board.

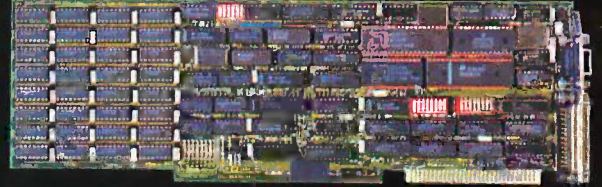

When it comes to selecting your S-100 boards, go with Advanced Digital - the recognized industry leader.

See your local computer dealer or contact Advanced Digital today for more information on the new PC-SLAVE, and the complete line of S-100 single board computers and multiuser systems.

ADVANCED DIGITAL CORPORATION *Leading the Microcomputer Technology*

Advanced Digital • 5432nd Production Drive, Huntington Beach, CA 92649 • Tel. (714) 891-4004 • Telex 183210 ADVANCED HTBH
Advanced Digital U.K. Ltd. • 27 Princes St., Hanover Square • London W1R8NQ • United Kingdom • (01) 409-0077 • (01) 409-3351 • Telex 265840 FINEST
Toll Free (1-800) 251-1801
(Outside California)

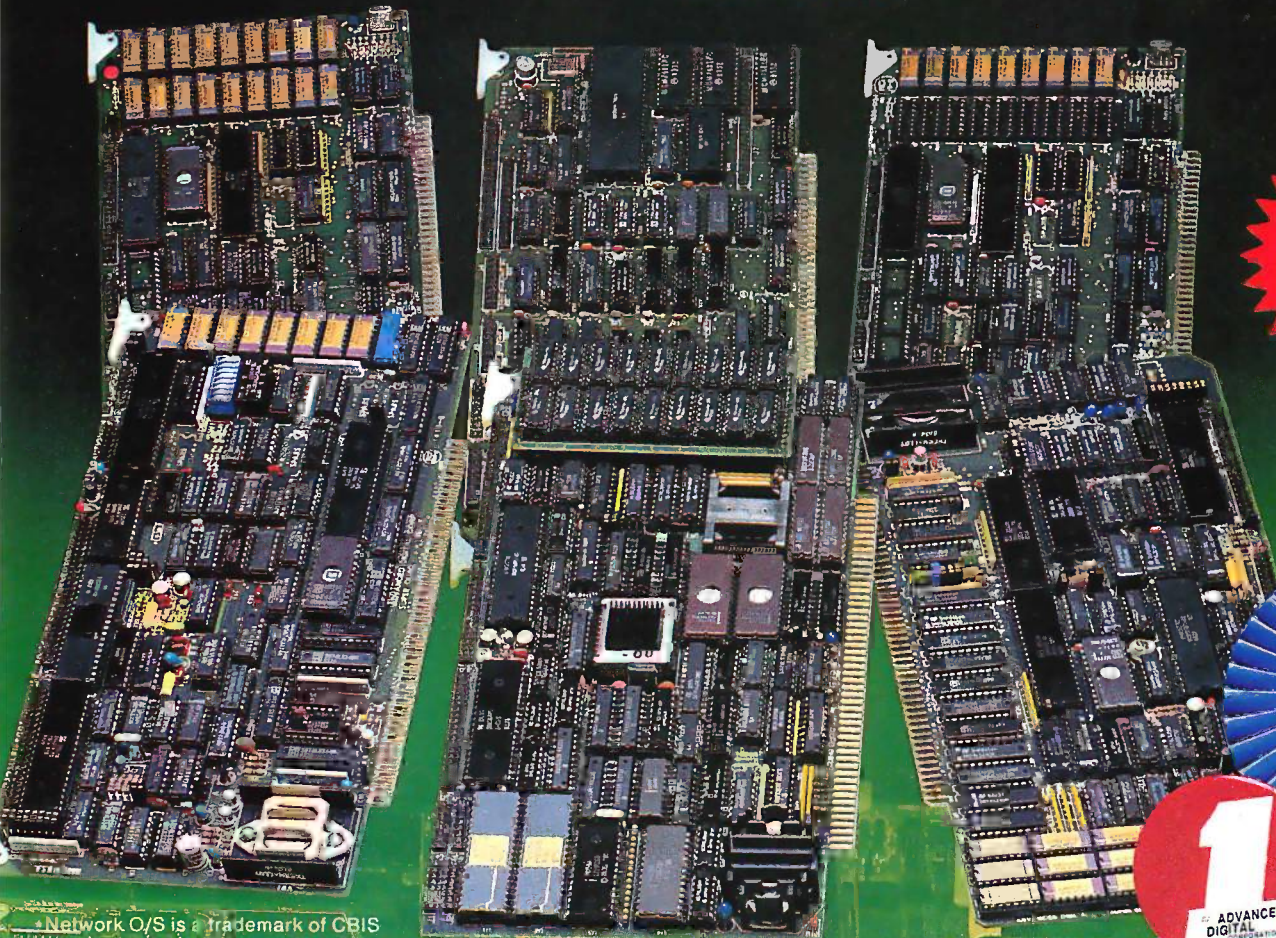

SEE US AT ATLANTA COMDEX '86



* Network O/S is a trademark of CBIS
* CPM is a trademark of Digital Research
* TurboDOS is a trademark of Software 2000

Hi-Res Color Workstation Runs Two UNIX Standards

Apollo Computer's Domain Series 3000 Personal Workstation combines 32-bit computing, high-resolution color graphics, and integrated networking capabilities. The workstation comes with Apollo's Domain/IX software, which is based on AT&T's UNIX System V and enables that UNIX and Berkeley 4.2 to run as coresident operating systems.

The Series 3000 uses the 68020 processor and 68881 floating-point chip. Memory capacity ranges from 2 to 4 megabytes, and large-program capability is provided by 64 megabytes of virtual address space per process (for as many as 24 processes).

Equipped with an external bus that's compatible with the IBM PC AT, the workstation has six 16-bit slots and two 8-bit slots. Apollo says it has in the works a co-processor for running IBM PC applications.

The color versions of the Series 3000 offer resolution of 1024 by 800 pixels on a 15-inch monitor; the basic model, with 2 megabytes of main memory, costs \$14,900. The monochrome models offer resolution of 1280 by 1024 pixels on a 19-inch monitor; the basic version, with 2 megabytes of main memory, costs \$9900. For more information, contact Apollo Computer Inc., 330 Billerica Rd., Chelmsford, MA 01824, (617) 256-6600. Inquiry 550.



Apollo's Domain Series 3000 Personal Workstation.

CD-ROM Hardware with Encyclopedia Disk

Activenture's Personal Information Package consists of a CD-ROM player, a controller card and connecting cable, the Grolier Electronic Encyclopedia on a compact disk, and software that lets you search for and retrieve information. The system works with IBM PCs and compatibles having at least 256K bytes of memory.

With the Knowledge Retrieval System (KRS) software, you can search—by

word, name, phrase, or topic—the disk version of the 21 volumes of Grolier's Academic American Encyclopedia. According to Activenture, locations of any word (there are more than 9 million of them) in the encyclopedia can be found in seconds through KRS.

The ROMulus CD-ROM drive has a data capacity of 540 megabytes per disk and can be connected to any IBM PC, XT, AT, or compatible through a controller card that fits in an open expansion slot.

The complete hardware/software package sells for \$995, but you can buy just the CD-ROM player and controller for \$849 and the

encyclopedia disk/KRS software for \$199. Contact Activenture Corp., POB 51125, Pacific Grove, CA 93950, (408) 375-2638. Inquiry 551.

PC Board Designer for Atari ST

Abacus Software has a program for designing printed circuit boards with an Atari 520ST or 1040ST. PCBoard Designer, developed by Data Becker GmbH of West Germany, features an automatic routing capability. Traces are drawn automatically on the screen, and if you change your design, the trace can be immediately redrawn. Options allow for 45- or 90-degree angle traces, different widths, routing from pin to pin, from pin to bus, bus to bus, and two-sided boards.

You first define the components that are part of the board and enter the information at the keyboard. Next, you define the connections. Using the mouse, you then place the components on the screen. You can change or reposition the components or connections at any time.

PCBoard Designer prints the layout to any Epson or compatible dot-matrix printer. According to Abacus, printouts are suitable for photoetching. You can also print the component layout and a list of components and connections.

(continued)

Suggested retail price of PCBoard Designer is \$395. Contact Abacus Software, 2201 Kalamazoo SE, POB 7211, Grand Rapids, MI 49510, (616) 241-5510. Inquiry 552.

Presentation Graphics Program

Harvard Presentation Graphics, the initial offering in Software Publishing's Harvard software line, lets you combine text, graphs, and charts in one image and create a slide show on the computer screen. The package has 13 kerned fonts, a selection of 16 colors, and formatting and layout options that include three-dimensional graphs and large text. An editor lets you incorporate text and symbols in charts.

The program reads Lotus spreadsheet data and graphs directly. It also reads pfs:Graph and ASCII files and can export files to pfs:Write.

Harvard Presentation Graphics runs on MS-DOS computers and requires 256K bytes of memory. It works with the Enhanced Graphics Adapter card and a variety of printers, plotters, and film recorders. Retail price is \$395. Contact Software Publishing Corp., 1901 Landings Dr., Mountain View, CA 94043, (415) 962-8910. Inquiry 553.

Genigraphics has also released a program for generating presentation-style graphics. Graftime uses preformatted business graphics and a "forms-fill menu interface"; you select a predefined format for your graph or chart and then enter the information you want to convey. Graphics

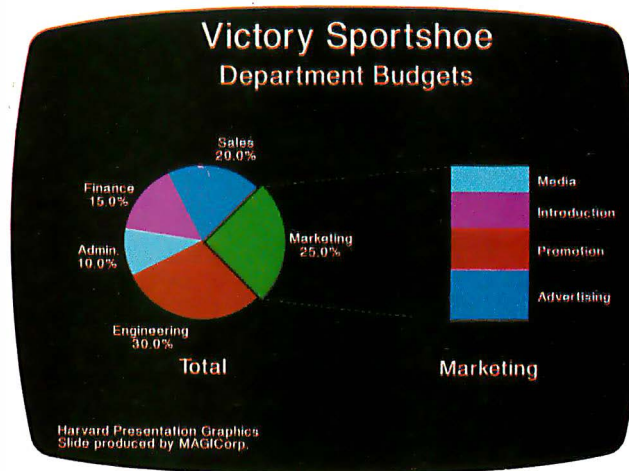
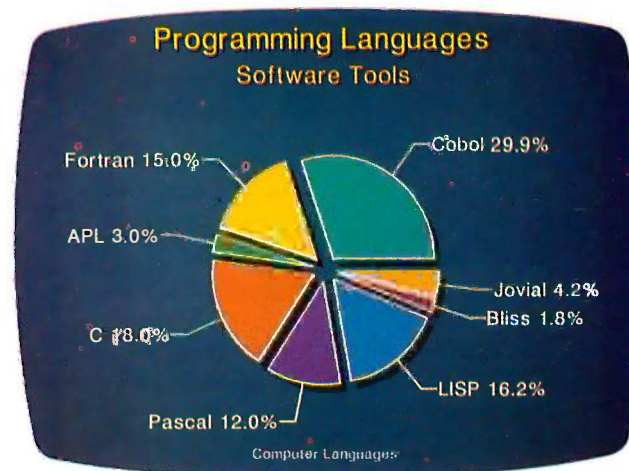

Image created with Harvard Presentation Graphics.



Pie chart and text generated with Graftime.

can be output as printed copy, overhead transparency, or 35mm slide.

Graftime offers 14 types of charts, five color palettes, and eight choices for handling attributes. For constructing sequenced slides, the package has an automatic build function.

The software costs \$395 and runs on the IBM PC line and compatibles with at least 448K bytes of memory and DOS 2.0 or later. To use the program's previewing

option, you need a graphics card. Contact Genigraphics Corp., POB 591, Liverpool, NY 13088, (315) 451-6600. Inquiry 554.

Animation System for the Macintosh

MacMovies, a high-resolution animation package from Beck-Tech that runs on the Apple Macintosh and Macintosh Plus, accepts hand-drawn, prestored, or digitized (with a camera or tablet) images, compresses and stores them on

a floppy or hard disk, and plays them back as animated sequences. Playback rate is adjustable from 1 to 30 frames per second. If your Mac has a 1- or 2-megabyte memory board inside for picture storage and you've set the playback speed at 10 fps, MacMovies can show as much as 30 seconds of continuous animation if the images are complex and as much as 90 seconds of footage if the images are simple. With a hard disk, you can link sequences and make a longer movie.

You can create cartoons using MacDraw or MacPaint and cel animation techniques (a cel is a single image of a sequence, and cel-by-cel animation involves rapidly changing these individual images). MacMovies can provide full-motion pictures with multiple moving objects and moving backgrounds.

MacMovies requires at least 512K bytes. Suggested retail price is \$99. Disks of premade flicks are available for \$29.95 in monochrome and \$39.95 in color: "Have a Heart" shows the operation of the human heart; "The Moving Motor" demonstrates the workings of an internal-combustion engine.

Beck-Tech is also selling MacAnimation Station, a turnkey animation system that packages a Macintosh with 1 megabyte of memory, MacMovies, MacPaint, Click-Art images, and a pen-based digitizer tablet for \$4995. Options include the company's Chromatron converter for color display, 10- or 20-megabyte hard disk, and 2-megabyte memory. Contact Beck-Tech Corp., 41 Tunnel Rd., Berkeley, CA 94705, (415) 548-4054. Inquiry 555.

(continued)

Using Lotus 1-2-3[®] without Reflex is like driving at night without lights

If you use Lotus 1-2-3 you need Reflex, the Analyst[™] because it shows you what 1-2-3 either hides in the dark or can't show you at all. Reflex shows you relationships and inter-relationships in your data that you can't afford to miss.

Reflex includes the best Report Generator for Lotus 1-2-3.

Reflex includes the Report Generator that 1-2-3 should have included — but didn't. With Reflex, you can generate reports, graphs, charts and diagrams from your 1-2-3 worksheets that are impossible to generate with 1-2-3.

You can do sales reports, letters, memos, invoices and mailing labels — to name a few — and you can see a few of them on this page.



Reflex is the best database for 1-2-3 users and it's also the easiest to use.

Reflex is the first database that separates the trees from the forest. The first database that understands that what you see depends on how you look at it.

The first database that probes relationships — then shows them to you in various graphic forms — scatter, line, bar, stacked bar and pie charts. The first database to break the bonds of traditional database management and give a dramatic visual turn to data analysis.

Reflex makes graphic leaps far beyond 1-2-3. With Reflex, when you look, you see.

Reflex gives you five new and different views of what's hidden in your 1-2-3 worksheets.

Form View, List View, Graph View, CrossTab and Report View.

Form View lets you create your database. List View shows you your data in tabular list form, just like a spreadsheet. Graph View gives you instant interactive graphic representations; CrossTab View gives you amazing "cross-referenced" pictures of the links and relationships hidden in your data. Report View allows you to use information from 1-2-3, and then print out reports in all sorts of different formats.

The commands for all five Views are consistent — so you're not stuck learning five different ways to get something done. And because Reflex uses advanced windowing techniques, you can see several views on the screen at the same time — without having to switch back and forth. You get the picture, and the pictures, all at once.

Whether you're a 1-2-3 user or not, Reflex answers all your "What Ifs?" and leads you to the right conclusions.

With Reflex when you modify a number all your Views — List, Form and Graph — are immediately updated, on-screen.

Let's say you're analyzing "Traveling Expenses by Salesperson" and you ask, "What if they stayed at a Motel 5 1/4 instead of the Presidential Suite of the Hotel Chic?" "Show me." So Reflex shows you.

"What if they could no longer order \$100 wines, but had to stick to the stuff that matures in the truck?" "Show me." So Reflex shows you. Instant answers. Instant pictures. Instant analysis. Instant understanding.

Of course Reflex can do all of the above with or without 1-2-3. Reflex is a complete database management and analytical tool that stands on its own feet and helps you stay on yours because it's only \$99.95!

Borland's \$99.95 Reflex could be the best business investment you'll ever make.

Buying 1-2-3 was a good idea. Reflex is an even better idea because now you can see what you're doing, what you've done, and what you need to do.

Think of Reflex as an "automatic product," a "standard" that every up-to-speed PC owner should have on hand. It's only \$99.95, and you get our 60-day money-back guarantee.

We don't believe in copy-protection, but we do believe in quality, performance and reasonable software prices. So keep driving your old 1-2-3, but get Reflex today, because then you can see where you're going.

“Everyone agrees that Reflex is the best-looking database they've ever seen

Adam B. Green,
InfoWorld

The next generation of software has officially arrived

Peter Norton,
PC Week

YES! Rush Reflex to me.

Send me _____ copies at:

\$99.95

This price includes shipping to all U.S. cities.

**60-DAY MONEY-BACK GUARANTEE
NOT COPY-PROTECTED**

To order by credit card call (800) 255-8008, CA (800) 742-1133. Available at better dealers nationwide.

Name: _____

Shipping Address: _____

City: _____

State: _____ Zip: _____

Telephone: _____

Subtotal _____

Outside USA add \$10 per copy
CA res. add \$6 tax per copy

Amount Enclosed _____

Payment: VISA MC Bank Draft Check

Credit Card Exp Date _____ / _____

Card # _____

System requirements:
IBM® PC, XT, AT, or compatibles. 384K RAM minimum. IBM Color Graphics Adapter®, Hercules Monochrome Graphics Card™, or equivalent. PC DOS® 2.0 or greater. Hard disk and mouse optional.

CODs and Purchase Orders WILL NOT be accepted by Borland. California residents add 6% sales tax. Outside USA add \$10 per copy and make payment by bank draft payable in US dollars drawn on a US bank.

Inquiry 37 for End-Users. Inquiry 38 for DEALERS ONLY.



4585 SCOTTS VALLEY DRIVE
SCOTTS VALLEY, CA 95066
(408) 438-8400 TELEX: 172373

Reflex is a trademark of Borland/Analytica Inc. 1-2-3 is a registered trademark of Lotus Development Corporation. IBM and PC DOS are registered trademarks and PC, XT, AT, and Color Graphics Adapter are trademarks of International Business Machines Corporation. Hercules Graphics Card is a trademark of Hercules Computer Tech. Copyright 1988 Borland International. BI-1031.



CAD Software for IBM PCs, Compatibles

Foresight Resources has released a package for two-dimensional drafting and designing with an IBM PC, XT, or AT and most compatibles. Called Drafix I, it sells for \$295 alone, \$395 with a mouse, and \$585 with a 12- by 12-inch plotter.

Input techniques for lines, arcs, circles, fillets, and chamfers include grid and angle locks, snap locks to item endpoints, midpoints, intersections, and tangents. Copy and move operations let you translate, rotate, scale, and mirror. Flexible numeric input, combined with the program's calculation capabilities, provides you with areas, perimeters, angles, coordinates, and other drawing information.

Among additional drawing attributes are 16 pen colors, 256 layers, 8 line types, and 12 text fonts. Resetting, zooming, and panning capabilities let you control the view.

The visual interface makes extensive use of icons, and a menu of drawing and program options is on the screen at all times.

Although Drafix I can stand alone, Foresight Resources has developed a utility that enables a Drafix-generated drawing to be used on an AutoCAD workstation (from Autodesk Inc.). The AutoCAD File Exchange Utility costs \$95.

Written in Lattice C, Drafix I runs under PC-DOS 2.1 or later and requires at least 512K bytes; Foresight recommends at least 640K bytes and a math coprocessor. Other requirements are an RS-232C port and a mouse or digitizer. The software works with a variety of graphics cards, printers, and plotters (up to "C" size). For



Drafix I, a drafting package from Foresight Resources.

more information, contact Foresight Resources Corp., 932 Massachusetts St., Lawrence, KS 66044, (800) 231-8574; in Kansas (913) 841-1121.

Inquiry 556.

Outline Processor for CP/M Machines

KAMASOFT has taken the programming language out of KAMAS (see review on page 241), its outline tool for CP/M computers, added some features, enhanced the interface, and packaged it as Out-Think. This full-screen outline editor has collapse and expand capabilities and comes with a text editor for working with prose in the outline.

The outline processor allows a maximum topic size of 8 megabytes; there's no limit, other than disk space, to the number of items per file, items per level, or levels

per file. You can jump from topic to topic and copy branches within and between topics. The maximum number of topics you can access at one time is 16.

With the program's retrieval capabilities, you can search for information by keywords or by similar-sounding keywords. Six methods are provided for querying accessible text. You can read and write text files compatible with most well-known word processors and print an outline with more than 20 formatting parameters. The package automatically generates a table of contents. Among other features are a file manager, date and time stamping, and password security.

Out-Think can run on most computers equipped with CP/M version 2.2 or later, including machines with 8080, 8085, and Z80 processors. It needs at least 48K bytes of RAM and an 80-column by 24-line screen. Suggested retail price is \$49.95.

KAMAS owners can get Out-Think by sending in their master disk and \$25. Contact KAMASOFT Inc., 2525 Southwest 224th Ave., Aloha, OR 97006, (503) 649-3765.

Inquiry 557.

MIDI Sequencer for Apple II+, IIe

Synthesia, a MIDI sequencer and controller program for the Apple II+ and IIe, brings a complete MIDI system under the control of one synthesizer keyboard. Each key on the MIDI-equipped master unit can be independently assigned to any voice of any synthesizer in the system. You can control as many as 16 keyboards, drum machines, expanders, or other MIDI devices from one keyboard.

The sequencer supports 100 sequences with 16 tracks each. You can assign any key to start, stop, loop, and sync any sequence or combination of sequences. This capability enables you to play one-finger chords and special effects. Other features include 100 definable patches for matching presets to MIDI channels, independent key transposition, loading and saving to disk, and unlimited keyboard splitting, doubling, tripling, and echoing.

To use Synthesia with an Apple, you need at least 64K bytes, one disk drive, one monitor, one MIDI interface card (Decillionix, Passport, Syntech, Yamaha, or equivalent), and at least one MIDI-equipped keyboard. The price is \$120. Contact Decillionix, POB 70985, Sunnyvale, CA 94086, (408) 732-7758.

Inquiry 558.

(continued)



The C for Microcomputers

PC-DOS, MS-DOS, CP/M-86, Macintosh, Amiga, Apple II, CP/M-80, Radio Shack, Commodore, XENIX, ROM, and Cross Development systems

MS-DOS, PC-DOS, CP/M-86, XENIX, 8086/80x86 ROM

Manx Aztec C86

"A compiler that has many strengths... quite valuable for serious work"

Computer Language review, February 1985

Great Code: Manx Aztec C86 generates fast executing compact code. The benchmark results below are from a study conducted by Manx. The Dhystone benchmark (CACM 10/84 27:10 p1018) measures performance for a systems software instruction mix. The results are without register variables. With register variables, Manx, Microsoft, and Mark Williams run proportionately faster, Lattice and Computer Innovations show no improvement.

	Execution Time	Code Size	Compile/Link Time
Dhystone Benchmark			
Manx Aztec C86 3.3	34 secs	5,760	93 secs
Microsoft C 3.0	34 secs	7,146	119 secs
Optimized C86 2.20J	53 secs	11,009	172 secs
Mark Williams 2.0	56 secs	12,980	113 secs
Lattice 2.14	89 secs	20,404	117 secs

Great Features: Manx Aztec C86 is bundled with a powerful array of well documented productivity tools, library routines and features.

Optimized C compiler	Symbolic Debugger
AS86 Macro Assembler	LN86 Overlay Linker
80186/80286 Support	Librarian
8087/80287 Sensing Lib	Profiler
Extensive UNIX Library	DOS, Screen, & Graphics Lib
Large Memory Model	Intel Object Option
Z (vi) Source Editor -c	CP/M-86 Library -c
ROM Support Package -c	INTEL HEX Utility -c
Library Source Code -c	Mixed memory models -c
MAKE, DIFF, and GREP -c	Source Debugger -c
One year of updates -c	CP/M-86 Library -c

Manx offers two commercial development systems, Aztec C86-c and Aztec C86-d. Items marked -c are special features of the Aztec C86-c system.

Aztec C86-c Commercial System	\$499
Aztec C86-d Developer's System	\$299
Aztec C86-p Personal System	\$199
Aztec C86-a Apprentice System	\$49.

All systems are upgradable by paying the difference in price plus \$10.

Third Party Software: There are a number of high quality support packages for Manx Aztec C86 for screen management, graphics, database management, and software development.

C-tree \$395	Greenleaf \$185
PHACT \$250	PC-lint \$98
HALO \$250	Amber Windows \$59
PRE-C \$395	Windows for C \$195
WindScreen \$149	FirstTime \$295
SunScreen \$99	C Util Lib \$185
PANEL \$295	Plink-86 \$395

MACINTOSH, AMIGA, XENIX, CP/M-68K, 68k ROM

Manx Aztec C68k

"Library handling is very flexible... documentation is excellent... the shell a pleasure to work in... blows away the competition for pure compile speed... an excellent effort."

Computer Language review, April 1985

Aztec C68k is the most widely used commercial C compiler for the Macintosh. Its quality, performance, and completeness place Manx Aztec C68k in a position beyond comparison. It is available in several upgradable versions.

Optimized C Macro Assembler Overlay Linker Resource Compiler Debuggers Librarian Source Editor MacRam Disk -c Library Source -c	Creates Clickable Applications Mouse Enhanced SHELL Easy Access to Mac Toolbox UNIX Library Functions Terminal Emulator (Source) Clear Detailed Documentation C-Stuff Library UniTools (vi,make,diff,grep) -c One Year of Updates -c
---	--

Items marked -c are available only in the Manx Aztec C86-c system. Other features are in both the Aztec C86-d and Aztec C86-c systems.

Aztec C68k-c Commercial System	\$499
Aztec C68d-d Developer's System	\$299
Aztec C68k-p Personal System	\$199
C-tree database (source)	\$399

AMIGA, CP/M-68k, 68k UNIX call

Apple II, Commodore, 65xx, 65C02 ROM

Manx Aztec C65

"The AZTEC C system is one of the finest software packages I have seen"

NIBBLE review, July 1984

A vast amount of business, consumer, and educational software is implemented in Manx Aztec C65. The quality and comprehensiveness of this system is competitive with 16 bit C systems. The system includes a full optimized C compiler, 6502 assembler, linkage editor, UNIX library, screen and graphics libraries, shell, and much more. The Apple II version runs under DOS 3.3, and proDOS, Cross versions are available.

The Aztec C65-c/128 Commodore system runs under the C128 CP/M environment and generates programs for the C64, C128, and CP/M environments. Call for prices and availability of Apprentice, Personal and Developer versions for the Commodore 64 and 128 machines.

Aztec C65-c ProDOS & DOS 3.3	\$399
Aztec C65-d Apple DOS 3.3	\$199
Aztec C65-p Apple Personal system	\$99
Aztec C65-a for learning C	\$49
Aztec C65-c/128 C64, C128, CP/M	\$399

Distribution of Manx Aztec C

In the USA, Manx Software Systems is the sole and exclusive distributor of Aztec C. Any telephone or mail order sales other than through Manx are unauthorized.

Manx Cross Development Systems

Cross developed programs are edited, compiled, assembled, and linked on one machine (the HOST) and transferred to another machine (the TARGET) for execution. This method is useful where the target machine is slower or more limited than the HOST. Manx cross compilers are used heavily to develop software for business, consumer, scientific, industrial, research, and educational applications.

HOSTS: VAX UNIX (\$3000), PDP-11 UNIX (\$2000), MS-DOS (\$750), CP/M (\$750), MACINTOSH (\$750), CP/M-68k (\$750), XENIX (\$750).

TARGETS: MS-DOS, CP/M-86, Macintosh, CP/M-68k, CP/M-80, TRS-80 3 & 4, Apple II, Commodore C64, 8086/80x86 ROM, 68xxx ROM, 8080/8085/Z80 ROM, 65xx ROM.

The first TARGET is included in the price of the HOST system. Additional TARGETS are \$300 to \$500 (non VAX) or \$1000 (VAX).

Call Manx for information on cross development to the 68000, 65816, Amiga, C128, CP/M-68k, VRTX, and others.

CP/M, Radio Shack, 8080/8085/Z80 ROM

Manx Aztec CII

"I've had a lot of experience with different C compilers, but the Aztec C80 Compiler and Professional Development System is the best I've seen."

80-Micro, December, 1984, John B. Harrell III

Aztec C II-c (CP/M & ROM)	\$349
Aztec C II-d (CP/M)	\$199
C-tree database (source)	\$399
Aztec C80-c (TRS-80 3 & 4)	\$299
Aztec C80-d (TRS-80 3 & 4)	\$199

How To Become an Aztec C User

To become an Aztec C user call 1-800-221-0440 or call 1-800-832-9273 (800TEC WARE). In NJ or outside the USA call 201-530-7997. Orders can also be telexed to 4995812.

Payment can be by check, COD, American Express, VISA, Master Card, or Net 30 to qualified customers.

Orders can also be mailed to Manx Software Systems, Box 55, Shrewsbury, NJ 07701.

How To Get More Information

To get more information on Manx Aztec C and related products, call 1-800-221-0440, or 201-530-7997, or write to Manx Software Systems.

30 Day Guarantee

Any Manx Aztec C development system can be returned within 30 days for a refund if it fails to meet your needs. The only restrictions are that the original purchase must be directly from Manx, shipped within the USA, and the package must be in resalable condition. Returned items must be received by Manx within 30 days. A small restocking fee may be required.

Discounts

There are special discounts available to professors, students, and consultants. A discount is also available on a "trade in" basis for users of competing systems. Call for information.

Inquiry 201

MANX

To order or for information call:

800-221-0440

IBM RT PC Based on RISC Architecture

IBM's RT PC workstation is the company's first product incorporating its RISC (reduced instruction set computer) architecture, based on research begun at Big Blue in the 1970s. The machine's advanced functions are implemented on two IBM-developed NMOS chips: a 32-bit RISC processor and the system's memory management unit. The processor can execute 118 instructions, 84 of them in a single machine cycle, or pulse. In the RT PC, this pulse is approximately 170 nanoseconds. Instead of instructions that can take several cycles, software for the RT allows complex tasks to be assembled from a set of simple instructions. The instruction set also lets software use general-purpose registers to minimize the processor's need to access memory for data.

IBM says that a data path between the MMU and the 32-bit chip, which can handle multiple requests for data and instructions, makes access to memory more efficient. Traffic between the processor and memory can be pipelined; hence, multiple requests shouldn't cause delays.

The RT's microprocessor refers to memory about 3 to 4 million times per second. According to IBM, this can be done efficiently because of two proprietary developments: a two-stage "memory-mapping" facility and an "inverted page table" (which essentially keeps only real memory addresses). These features reportedly raise addressing capability to 40 bits and let the processor address as many as 1 trillion bytes of virtual storage.

The series runs under an operating system called Ad-



IBM's RT PC 6151 model 10 with color display.

vanced Interactive Executive (AIX), which is similar to UNIX System V.

The line begins with a desktop unit called the RT PC 6151 model 10, about the size of a PC and packaged with 1 megabyte of memory (expandable to 3 megabytes) and 40 megabytes of fixed-disk capacity. Prices begin at \$11,700. Three floor-standing models are also available; their prices run in the range of \$14,000 to \$20,000. All RTs have an AT-compatible 16-bit I/O bus. For more information, contact your local IBM marketing representative (listed in the telephone book).

Inquiry 559.

RGB Card Beefs Up Apple IIe

Checkmate Technology's MultiRam RGB card fits into the auxiliary slot on the Apple IIe motherboard, replacing the standard 64K-byte 80-column card, and supplies color output, additional RAM, and provision for battery-backed RAM. The card comes with 64K bytes and can be expanded to 1 megabyte of memory; you

can add an optional 2 megabytes of static RAM, and with the company's MultiRam +, which plugs into the RGB card, you can add 3 more megabytes.

With the card, AppleWorks and other applications can be loaded entirely into RAM. Software supplied with the card lets you designate how much memory is to be used by programs. The hardware works with Apple ProDOS and DOS 3.3.

Checkmate points out that the card is compatible with exported IIe computers.

MultiRam sells for \$199.95. Contact Checkmate Technology, 509 South Rockford Dr., Tempe, AZ 85281, (800) 325-7347; in Arizona (602) 966-5902.

Inquiry 560.

Motherboard Upgrades XT to AT

CSS Laboratories has developed a motherboard that replaces the one in the IBM PC XT and upgrades that machine's memory, clock speed, and other functions to levels comparable to those of the PC AT. The XT-286, priced at \$995, has a 16-bit 80286 processor, 512K bytes of

memory (expandable to 4 megabytes with a card), 64K bytes of ROM, seven-channel direct memory access, and a real-time clock. The board also has a speaker.

Standard clock speed of the XT-286 is switch-selectable up to 8 MHz. The motherboard can be used with IBM PC-compatible peripherals and add-ons; it has three 8-bit slots and three 16-bit slots.

The XT-286 comes with a limited one-year warranty. For more information, contact CSS Laboratories Inc., 2134 South Ritchey St., Santa Ana, CA 92705, (714) 540-4141. **Inquiry 561.**

Utility Captures Screen Data for Use As Input

Your Move!, a memory-resident utility for IBM PCs and true compatibles, lets you take data directly from the screen for use as keyboard input. You can designate areas on the screen in which data is to be captured and kept in a RAM buffer or stored on disk for later. After invoking Your Move!, you can run your applications software; hitting a function key allows the captured data to be used as input in that program. A macro facility lets you store a sequence of Your Move! commands and execute them with one keystroke.

The utility carries a price tag of \$59.95. For more information, contact Goldata Computer Services Inc., 2 Bryn Mawr Ave., Bryn Mawr, PA 19010, (800) 432-3267; in Pennsylvania, (215) 525-1036. **Inquiry 562.**

(continued on page 384)

EVEREX EVER FOR EXCELLENCE



LOTUS 1-2-3 132 COLUMNS



PC PAINT



PC PAINTBRUSH 720x348

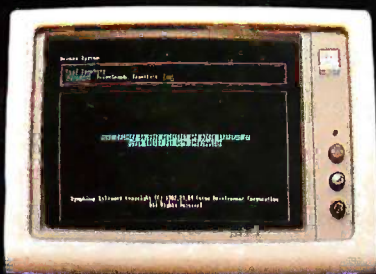

SYMPHONY HIGH RESOLUTION



PC PAINT



16 COLORS, 320x200

The Edge



The Plain Facts:

The EVEREX EDGE	The EVEREX EDGE	Paradise Modular Card	Genoa Spectrum	STB Chaufeur	Hercules Graphics Card	Tseng Labs Ultrapak
Runs an IBM or Compatible Color Monitor	✓	✓	✓			
IBM Monochrome Compatible and High Resolution, 720x348 graphics	✓		✓		✓	✓
Runs Color Software on a Monochrome Monitor, Full Screen:	✓	✓	✓	✓		
—in 16 shades of green on the IBM Monochrome monitor	✓	✓	✓	✓		
—Runs Flight Simulator, PC Paintbrush, IBM BASICA commands and more	✓	✓	✓	✓		✓
—No patches or modifications needed	✓	✓	✓	✓		✓
—Displayed in the IBM standard 9x14 character set	✓	✓	✓	✓		✓
Extended Text Modes:	✓		✓			✓
—132 columns by 25 rows in monochrome	✓		✓			✓
—132 columns by 44 rows in monochrome	✓		✓			✓
—132 columns by 25 rows in color	✓		✓			✓
Runs Lotus 1-2-3™ and Symphony™ in high resolution monochrome graphics:	✓		✓		✓	✓
—in 132 columns by 25 rows	✓		✓			✓
—in 132 columns by 44 rows	✓		✓			✓
Runs Lotus 1-2-3™ and Symphony™ in High Resolution color:	✓		✓			✓
—16 colors, 320x200	✓		✓			✓
— 4 colors, 640x200	✓		✓			✓
Software switchable for all display modes and monitors	✓		✓			
Software switchable display memory, 16K, 32K and 64K	✓		✓			
Disable Screen Memory	✓					
Printer Port (standard)	✓		✓	✓	✓	✓
Light Pen Connector (standard)	✓	✓	✓		✓	
Works in any PC-AT slot	✓	✓	✓	✓	✓	
List Price	\$399	\$395	\$459	\$395	\$499	\$680*

*Includes one serial port and clock/calendar.

Excellence is the standard at Everex—it's in our name, our products, in everything we do. When you look for the best for your computer—you'll find Everex products.

Visit your local Everex dealer today and ask to see Everex products in action. For the name of your nearest Everex dealer, please call (415) 498-1111. TELEX: 5101000590 EVEREX FAX: 415-651-0728

Dealer Hotline: (800) 821-0806 In CA (800) 821-0807

Everex Far East, Ltd., Hong Kong TLX: 36810 WKKL HX
 Everex International, Ltd., Middlesex England TLX: 268744 EVEREX G
 Feeder Paris, France TLX: 4413241 FEEDER
 Automated Office Systems Hout Bay, South Africa 2721-70-8091
 Servex, 1027 Speers Road, Oakville, Ontario Canada L6L-2X5; 416-842-6093
 Pride Computers, 102-8167 Main Street, Vancouver,
 British Columbia, V5X 3L2, 604-321-5690

Registered Trademarks: Paradise Modular Graphics Card—Paradise Systems, Inc.; Hercules Graphics Card—Hercules Computer Technology; Lotus 1-2-3—Lotus Development Corporation; PC Paint—Mouse Systems Corporation; Teemar Graphics Master—Teemar Inc.; Perysyl B&B—Perysyl Products; Ultra Pak—Tseng Labs; The Edge—Everex Systems Inc.; IBM, PC Tutorial—International Business Machines Corporation; Flight Simulator—Microsoft Corporation.

EVEREX

EVER for EXcellence

48431 Milmont Drive, Fremont, CA 94539 (415) 498-1111

Conducted by Steve Ciarcia

MIRACULOUS MEMORY

Dear Steve,

While looking for memory to expand my TI-58 to 128K bytes, I came across a new type of chip called an EERPPROM. Can you explain to me how this memory device works?

PAUL JOHNSON
Knoxville, TN

The EERPPROM, which stands for electrically erasable retrievable past programmable read-only memory, is the newest development in memory. Not only can you write and erase the memory, you can also recover data that was erased up to one year before. This is accomplished by an internal comparator circuit that compares the stored charged level with an ideal logic 1 or 0, and by determining whether it is higher or lower, is able to find its previous logic state.
—Steve

RETURN OF ONE JEDI

Dear Steve,

I had feared you were killed along with the rest of the COUNCIL when ALDERAN was destroyed. It is good to learn that most of the GUARDIANS of the OLD REPUBLIC have evaded the EMPIRE'S grasp and are continuing to educate the REBELS in the use of high technology for the good of all.

You have referred to LASERS in many of your past articles. Unfortunately, during my last duel my Model 91Q LIGHT SABER was slightly damaged. As you probably suspect, a LIGHT SABER's beam can create havoc if not restricted. Help me, Steve, you are my only hope. May The Force Be With You.

LUKE S.
A Galaxy Relatively Near

This was a common occurrence in 91Q LIGHT SABERS manufactured before the CLONE WARS. First a little background. The MICROSONIC TRANSDUCERS used in this model set up a standing wave at an adjustable distance from the LASER'S APERTURE. This causes the beam to be reflected back upon itself, restricting its length.

Due to the unbalanced nature of the DILITHIUM CRYSTALS used in the power source, the maximum differential input limits of the standing-wave exciters can be exceeded during high-use conditions like battle. Replacement of the TRANSDUCERS is mandatory unless peace is imminent. I also recommend that TRANSORBS (use TD50s) be Xeiallarded across the TRANSDUCERS to prevent recurrent failure.—Steve

OCCUPANCY DETECTION

Dear Steve,

I am a computer hacker interested in home-control systems. The problem I am having deals with developing a system for controlling lighting and heating based on room occupancy. I have tried many approaches, but all seem limited. Motion detectors can't see me in my favorite wingback chair. Infrared and heat detectors cannot pick up my wife, who has a slightly lower than normal body temperature. Acoustic sensors fail in my study, where I commonly relax by listening to music while wearing headphones (in order to avoid disturbing other household members).

The radio-transmitter pendant or amulet idea requires frequent battery changes,

and they are still too big to wear as everyday casual attire. Have you come up against this? Is there any way to solve the problem without having to resort to multiple approaches?

CHARLES RENKIN
Enrico, AZ

The main factor in the design of an occupancy-detection system is that it detect a physical phenomenon that is discrete enough to avoid false triggering yet require no special attention on the part of the person(s) in the room. Developers at Brookhaven Labs have come up with a unique way of tagging people and objects that satisfies both criteria. They employ radioactivity.

The system is quite simple. Persons, pets, or other objects you wish to have monitored are exposed to high but non-lethal doses of radiation from a radioactive source. Scintillation counters mounted in the various rooms detect the radioactive objects anytime they are in proximity.

The system's sensitivity can be improved by applying a few coats of lead-based paint to ceiling and walls, so as to shield various rooms from each other. The scintillation counters can be pur-
(continued)

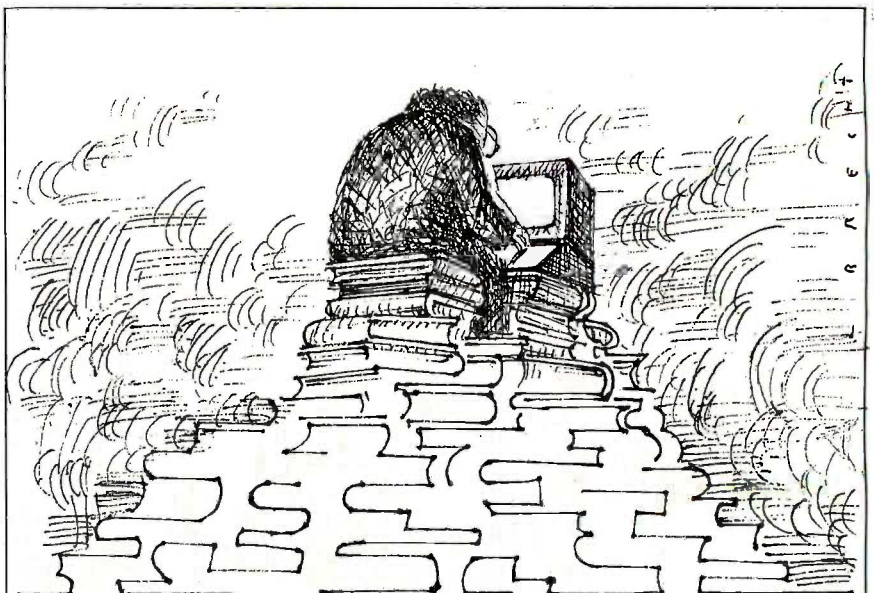

ILLUSTRATED BY MACIEK ALBRECHT



Clipper gives dBASE III™ users more time to do more. Or less.

Clipper™ allows you to run all dBASE III™ programs 2 to 20 times faster than they do with the standard dBASE interpreter.

That frees up extra time you're wasting if you're running dBASE III programs without Clipper.

Extra time to think. To create. To produce. To use as you choose.

You see, Clipper is the first true compiler for dBASE III. Clipper eliminates the time-consuming translation which the dBASE interpreter performs line after line whenever a program is run.

With Clipper, once you've debugged your source code, it's compiled into more efficient machine code.

And Clipper compiles all your dBASE III programs. The ones you have today. The ones you'll have tomorrow. But don't wait until tomorrow to order Clipper.

Today, Clipper has already been purchased to speed up dBASE run time at 3M and Touche Ross. At Exxon and NASA. In

the Harvard Physics Department. For the State of Arizona and TRW.

And that's just a few of the installations worldwide. From Greece to Venezuela to Canada to Europe.

So stop wasting time. Call our toll-free 800 number and get Clipper.

You'll spend less time running dBASE III and more time running the rest of your life.

 **Nantucket**™

Inquiry 233 for End-Users. Inquiry 234 for DEALERS ONLY.

5995 S. Sepulveda Blvd., Culver City, CA 90230 (800)251-8438 In California (213)390-7923

dBASE III is a registered trademark of Ashton Tate

3.5" DISK COMPATIBILITY FOR YOUR PC™

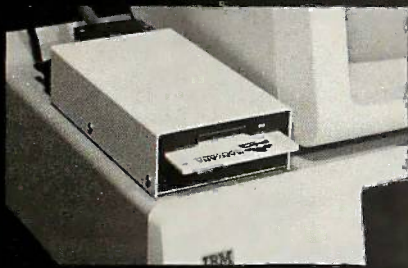

**MANZANA'S 3.5" ADD-ON
DISK DRIVE FOR THE IBM PC
(AND MANY COMPATIBLES)**

COMPATIBILITY with the new generation of lap-top computers using 3.5" disk drives.

CONVENIENCE of rugged 3.5" disk media.

CAPACITY of 730K additional storage for your PC.

DIRECT ACCESS on your PC to files generated on DG/One, TI Pro-Lite, GRiD Case, HP 110&150, Toshiba T-1100, and Atari 520ST via our flexible, powerful software device driver.

*Built-in voltage spike protection
FCC-approved*

*UL-listed plug-in AC transformer
Limited 6-month factory warranty*

MDP3 3.5" drive with an MAP3-PC accessory package forms a complete add-on package for the IBM PC or XT. Absolutely no tools needed for installation. Runs off standard IBM floppy controller.

Accessory packages for IBM AT, PC-compatibles & AT-compatibles available soon. Also coming: dual external drive, internal 3.5" kit.

For more information, contact your dealer or call direct.



MANZANA™

935 Camino del Sur
Isla Vista, CA 93117
(805) 968-1387

ASK BYTE

chased as cold war surplus items. A doorway dosing unit for family and friends can be made from a lead-coated coffee can with a solenoid for opening the lid. The trigger for the solenoid can be run in parallel with your doorbell. A separate unit for each door is recommended for maximum efficiency.

Adding a computer to the system and using isotopes with differing specific levels of radiation would let you detect individual family members or pets as they move about the house.

The radioactive source can be obtained by contacting any mail-order scientific supply store, but some of the materials, especially the radium compounds, are expensive. An equally viable but more economical source is our interstate highway system, where you can follow trucks marked RADIOACTIVE WASTE and collect chunks of the material that fall or drip off.—Steve

A TRUE HOME COMPUTER

Dear Steve,

I picked up a Cray-IS at a tag sale. It looked like it was in pretty good shape, but when I got it home and plugged it in, it didn't work. I think there must be a loose wire or something. This model was apparently an early prototype because there are almost no printed-circuit boards in it, just point-to-point wiring and a lot of funny-looking cubes with connectors on them. I have looked through all the back issues of BYTE and can't find anything on the Cray. Please send me any information you have as soon as possible. My wife says it is taking up too much space in the living room and has threatened to use it as a bench around the tree outside.

RAY C.
Boston, MA

One of the reasons it has become difficult to obtain information on the Cray-IS is that, like the VIC-20 and the Atari 400, it has been made obsolete by improved versions. For this reason, you won't see much software or many peripherals for it.

Many large corporations make information available to the general public and the KGB through a filing system called Dempster Dumpmaster. In most cases, those desiring information must do the research themselves at the facility, but 24-hour service is usually available for those for whom acquiring such information during normal business hours is inconvenient. You should be able to find a Dempster Dumpmaster file about the

Cray-IS behind Cray's facilities in Minneapolis.—Steve

MXSFX. MODEM

Dear Seve,

I am usXng my modem .o send .hXs le.er .o .he Ask BYTE bulle.Xn board. As you can see, .here Xs a problem Xn my modem Xn.erface. Do you have any Xdeas on wha. seps I mXgh. .ake .o debug .he problem?

S.AN SMX.H
Har.land, New BrunswXck, Canada

It looks like your modem is crossing the "i"s and dotting the "t"s.—Steve

ARCTIC LIFE

Dear Steve,

I have computerized my igloo using ideas from many of your articles ("Computerize a Home," "Computerize a Wood Stove," etc.) but have encountered several insurmountable, even very difficult, problems. The big problem is the heat. I added a steam pipe to my igloo, extending from the floor through the roof. This is a trick I saw my cousin use when I visited him. He lives in the Bronx (New York, of course). When it's too cold and you want more heat, you bang on the pipe.

Using information and ideas from your articles, I was easily able to rig a computer-controlled pipe banger, but there's still no heat. I've tried everything I can think of, but the system in my igloo doesn't function at all. Your assistance is greatly appreciated.

VLADIMIR GROSSPIGGIAN
Nome, AK

Your best bet is to move in with your cousin. And take the computerized pipe banger with you—your cousin will love it.—Steve

[Editor's note: The following letter is a historic document. It was received by Steve in April 1975. I wonder what ever happened to these guys?]

A SHOESTRING OPERATION

Dear Steve,

My friend and I are technicians for Hewlett-Packard and Atari and are very interested in designing a computer system. Although we have designed some stuff (blue boxes, etc.), we have never tackled a project as ambitious as this. We decided to use the 6502 processor because we got one pretty cheaply and just can't afford

(continued)

Dac-Easy Accounting "Best Software Value"

InfoWorld
1985 "Product of the Year" Awards



Dac-Easy "Accounting Product of the Year"

PC World
December, 1985

70,000 and more every day. That's how many smart buyers have already streamlined their accounting with the fastest-selling, most highly praised accounting package ever introduced.

Dac-Easy offers seven full feature accounting modules in a perfectly integrated package, with instant access to:

- General Ledger
- Accounts Receivable
- Accounts Payable
- Forecasting
- Inventory
- Purchase Order
- Billing

You can generate over 300 reports from 80 different routines. And best of all, Dac-Easy Accounting can be used to manage either service- or product-based businesses.

Dac-Easy Accounting is non copy-protected, and comes in a handsome package with easy-to-follow documentation.

Read what the experts have to say. Compare Dac-Easy with packages sold module by module for *thousands* more. Then join more than 70,000 people who have said "Yes!" to Dac-Easy Accounting.

30-day money back guarantee

Dac Software offers an unconditional guarantee on Dac-Easy Accounting (less postage and handling). There is a \$10 restocking fee if the disk envelope is opened.

Minimum Hardware Requirements:
IBM (PC); PC, XT or AT¹ or other compatibles. (Also available for Apricot and Victor 9000.) 128K memory, one DSDD disk drive, 132 column printer in compressed mode, 80X24, CRT, MS-DOS², PC DOS² 2.0 or later.

¹Trademarks of International Business Machines Corp.
²Trademark of Microsoft Corp.

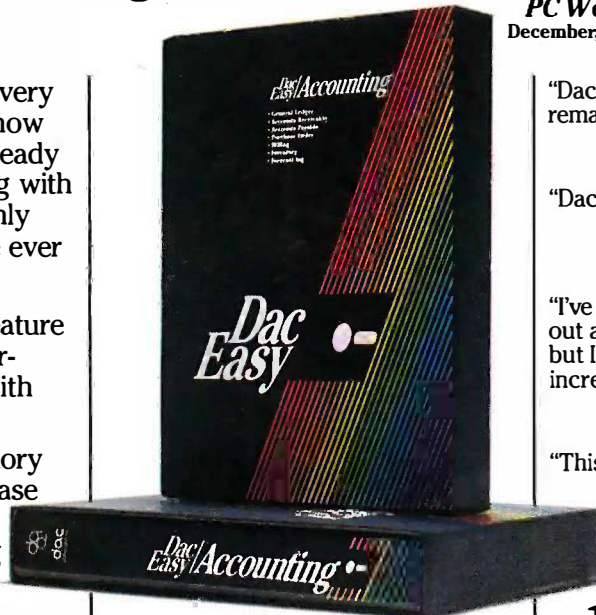

\$69.95

NEW!

Dac Easy Payroll™

ONLY

\$49.95

Dac-Easy Payroll was designed to solve all your personnel and payroll management problems, outperforming systems costing thousands more. And it can either stand alone or integrate perfectly with Dac-Easy Accounting to form a comprehensive business management program. Features include:

- Built-in 1986 federal and state tax tables (all 50 states).
- Automatic federal, state and city withholding calculations.
- FICA and user-defined deductions like union, insurance, etc.
- Prints continuous form checks and W-2s.
- Up to 99 departments, with earning and deduction codes per department.
- Manages hire dates, raises, reviews, terminations, vacations and sick time.
- Generates complete range of management reports.
- Supports hourly and salaried employees, four different payroll periods, tips, piece-rate and after-the-fact payroll, and much, much more!

All for only \$49.95...with the same money back guarantee!

*Hardware requirements — same as Dac-Easy Accounting, except two DSDD floppy disks required.

"Dac-Easy has done something truly remarkable."

InfoWorld Editorial,
December 2, 1985

"Dac-Easy is a genuinely amazing deal!"
PC Magazine,
October 15, 1985
"Editor's Choice"

"I've never before in a review come right out and told readers to buy a product, but I'm doing it now. Dac-Easy is an incredible value."

PC Week,
August 27, 1985

"This is an incredibly good value!"
InfoWorld,
September 23, 1985

Call toll free or
return coupon below today

1-800-992-7779

Ask for operator #826

In Texas or
for more information call
214-458-0038

☼ dac software, inc.
4801 Spring Valley Rd., Building 110-B
Dallas, TX 75244

Please rush me _____ copies of Dac-Easy Accounting at \$69.95 per copy and _____ copies of Dac-Easy Payroll at \$49.95 per copy. I've enclosed \$7.50 postage and handling. In Texas, add 6½% sales tax (\$4.28 for each Accounting, \$3.06 for each Payroll). U.S. prices only. Please indicate computer brand _____

- Check Money Order
 AMEX VISA MASTERCARD

Expires _____

Account Number _____

Name _____

Company Name _____

Street Address _____

City _____

State _____ Zip _____

Phone _____

Signature _____

CALL 1-800-992-7779 FOR
IMMEDIATE RESPONSE

Dac Series™

#826

Here's Feather

No Cords Attached

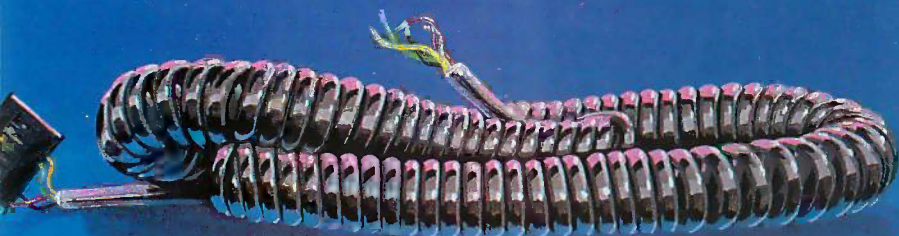

HEI's Revolutionary Cordless Pen Offers Greater Reliability and the Weight of a Feather.

When it comes to input devices, nothing's as light as Feather.

At half the weight of a light pen, Feather reduces operator fatigue. And because it's cordless, operators can work faster, with less restriction.

Using an infra-red communications link, powered by commonly available batteries, Feather utilizes leading-edge technology. Being fully plug compatible, it can replace almost any existing light pen.

Feather is easy to use, and easy to maintain. By eliminating the cord, we've eliminated the major reason for failures.

Feather has the same quality and reliability found in the over 50,000 light pens already designed and manufactured by Light Sensing Products Division of HEI, inc.



Feather

It weighs less
... but there
is nothing lightweight
about its performance.

PATENT PENDING

Call now to order...\$195 each.
1-800-328-8322 ext. 638

OEM pricing available.

Light Sensing Products, a division of HEI, inc.
Victoria, MN 55386 (612) 443-2500

Inquiry 379

ASK BYTE

a good processor like a Z80 on our salaries! What we had in mind was an S-100 card with the 6502 and 16K bytes of RAM, all on one card! Pretty neat idea, huh? We figure that no one will ever need more than 16K bytes of memory—what would you do with it? We thought that we'd include some sort of ROM monitor function, too. Then you just add a serial port for a standard video terminal and maybe a Tarbell cassette interface.

Do you have any suggestions for us?

STEVE J. AND STEVE W.
Applegate, CA

You guys are heading in the right direction by wanting to include multiple functions on one card, but why not take the idea "to the max," as you say in California. Why not put the processor, memory, I/O, and mass-storage interface all on one board? I bet you could add some circuitry to use a TV set for video I/O. Make it a color set while you're at it; the bandwidth will be limited, but you could limit it to uppercase and just 40 characters per line, and you could add a separate color-graphics mode, too. I could see a single-board computer packaged in a neat little case with a high-efficiency switching power supply and keyboard built in; the TV monitor could sit on top, with your cassette recorder right beside it.

But whatever you do, please make sure it has some sort of expansion capabilities. Why not bring out seven or eight expansion slots in the rear with the address lines already decoded? And 16K bytes of RAM may seem like a lot, but eventually even 64K bytes won't be enough. And though they are expensive now, I'd be willing to wager that people will want to add floppy disks for true random-access storage. (I was just suggesting to Al Shugart last week that he should make something more compact than those 8-inch drives of his.)

And don't forget software. ROM monitors may be okay for us hackers, but if you are going to get more people interested in this machine of yours, you will have to supply them with a higher-level language like BASIC.

If you guys play your cards right, you could turn your little computer into a true home "appliance." But if you ever hope to sell more than a few hundred, you will have to make it real easy to use. And do it now, before the Japanese decide to do it. In the near future, a home computer should be as American as mom's apple pie.

(continued)

Your modem should be this good

The most dependable 2400-bps modem on the market...
USRobotics' Courier 2400

Your personal computer or terminal becomes a data communications powerhouse with USRobotics' Courier 2400 modem.

Whatever your application—file transfer, electronic mail, mainframe access, electronic bulletin boards, public databases—Courier 2400 gets it done. Error-free, simply and FAST—up to 240 characters a second.

If you don't think you need that kind of speed, think again. Compared with a 1200-bps modem, the Courier 2400 can slash your datacom phone bills while it boosts your productivity.

Most public databases and bulletin board systems now offer 2400-bps service. In fact, more than a thousand bulletin board operators have chosen our Courier 2400—a demanding application that has proven the Courier's reliability and efficiency.

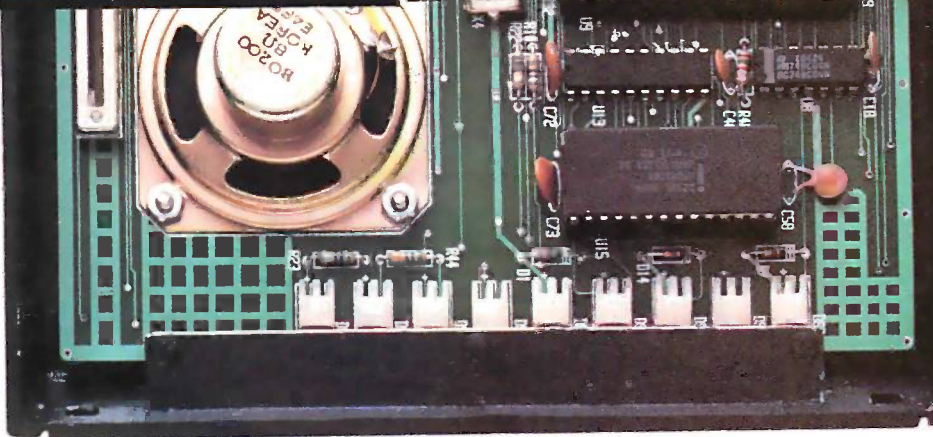
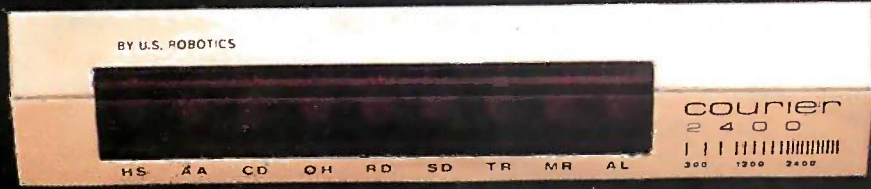

Lawrence and Lee, playwrights ("Inherit the Wind," "Auntie Mame," "First Monday in October," and many other Broadway hits, motion pictures and teleplays) and educators (professors of Advanced Playwriting at UCLA and USC).

"Our Courier 2400 modems give us instant access to each other's minds across town or across the country. Collaborating on play scripts, exchanging and polishing our words at such dynamic speed is a powerful aid to the creative process. There's never an error, sending or receiving data. And they're as easy as they're fast. As its name implies, the Courier 2400 modem is a swift and dependable messenger. Bravo, Courier!"



The Intelligent Choice in Data Communications

8100 McCormick Blvd. Skokie, Illinois 60076
 phone toll free: **1(800)DIAL USR**

Why Courier 2400? In a word—quality. Less than one percent of all Courier 2400s have come back to us for warranty service. We challenge the industry to match this record. The auto-dial, auto-answer Courier includes all the features you'd expect in a first-class modem, and then some—like "help screens" and a printed operations summary on the back panel. You can find a modem for more money, but you can't find more modem for your money than Courier 2400.

To learn more, send for our **FREE booklet, "24 Questions and Answers on 2400-BPS Modems."**

America's business communicates on USRobotics Modems

Please send my **FREE** copy of "24 Questions and Answers on 2400-BPS Modems."



NAME _____
 ADDRESS _____
 CITY _____ STATE _____ ZIP _____
 COMPANY _____
 TITLE _____
 PERSONAL USE BUSINESS USE

Attention all FX80, FX100, JX, & RX owners:
**You already own half of
 a great printer**

**Now
 Only
 \$79.95**



Now for \$79.95 you can own the rest. You see, today's new dot matrix printers offer a lot more.

Like an NLQ mode that makes their letters print almost as sharp as a daisy wheel. And font switching at the touch of a button —

in over 160 styles. But now, a Dots-Perfect upgrade kit can make your printer work like the new models in minutes. At a fraction of their cost.

Call now and use your Visa or Master Card. Don't replace your printer, upgrade it!

1-800-368-7737

In California: 1-800-831-9772

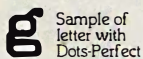

Dots-Perfect

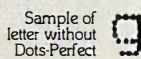

Dresselhaus

837 E. Alosta Ave., Glendora, CA 91740 Tel: (818) 914-5831

An upgrade kit for EPSON FX, JX and RX printers



EPSON is a trademark of EPSON America, Inc.

PORTABLE PRINTER

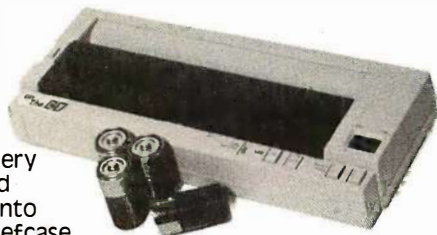

**JUST 149.95
 THE PERFECT
 PARTNER FOR
 YOUR PORTABLE
 COMPUTER**

Drop this battery powered printer into your briefcase next to your portable computer and you have an office on the road. It's just 11 1/4"x4 1/2"x1 3/4" and less than 2.5 pounds. The thermal print mechanism means quiet, reliable, 40 character per second printing for two hours on batteries.

On-The-Go has full-sized performance: normal sized, enlarged double width, and condensed characters - uses standard 8 1/2" width thermal paper - 5x7 character matrix with true lowercase descenders - shadow printing - underlining Epson MX-80 graphics - industry standard parallel interface. On-The-Go comes complete with 4 "C" batteries, 90 day limited warranty.

DEALER INQUIRIES INVITED - Please give Visa or Mastercard number and expiration date. Or if you prefer, mail certified check or chargecard authorization for full amount. Include 4% for UPS shipping and insurance. California residents add 6% sales tax.

**CALIFORNIA TOLL FREE
 805 482-9699 800 LAP-TOPP**



Laptop Systems - Dept. 80 515 Calle San Pablo, Camarillo, CA 93010

ASK BYTE

Good luck with your project. Let me know how it turns out.—Steve

[Editor's note: The truth is stranger than fiction it is said, and this last letter for the April column is one actually received by Steve Ciarcia.]

EXOCHRONIC INSTABILITY

Dear Steve,

I read with interest your response to Sean F. McCartney in the September 1985 Ask BYTE in which you suggest an endochronic transmission line to solve time-delay problems in Mr. McCartney's starship. You cited the Good Doctor's seminal work with thiotimoline but curiously failed to mention the fact that many semiconducting materials in common use today exhibit temporal instability. Anyone who has tried to debug a VLSI chip will have many tales of signals that arrive at point B before having left point A. The trouble with temporal instability is that it's, ah, unstable. This is especially true of endochronic instability. Frequently, the signal that arrives at B isn't the same shape as the one that left (will have left!) A. Once we understand endochronic instability, we'll be on the way to such goodies as sensors that detect events that haven't happened and laser cannons that shoot intruders who aren't there.

What we need is a beginning point for our research. I suggest exochronic instability as that beginning point. Exochronic instability is often far more stable than endochronic instability. It's relatively easy to build circuits in which a signal leaves A and is never seen again. This can be done with ordinary conductors, as well as with semiconductors, and at scales far larger than VLSI. Can you explain why this important topic is not already a national priority?

BOB BROWN ■

IN ASK BYTE, Steve Ciarcia answers questions on any area of microcomputing. The most representative questions received each month will be answered and published. Do you have a nagging problem? Send your inquiry to

Ask BYTE
 do Steve Ciarcia
 POB 582
 Glastonbury, CT 06033

Due to the high volume of inquiries, personal replies cannot be given. All letters and photographs become the property of Steve Ciarcia and cannot be returned. Be sure to include "Ask BYTE" in the address.

The Ask BYTE staff includes manager Harv Weiner and researchers Larry Bregoli, Bill Curlew, Jeannette Dojan, Jon Elson, Roger James, Frank Kuechmann, Edward Nisley, Dick Sawyer, Andy Siska, and Robert Stek.

A \$1495 PC/AT?

Is This a Joke?

A★Hoax?

A★Trick?

A★Put-On?

A★Spoof?

A★Flimflam?

No, it's an **A★Star™**! And, unlike most of its would be competitors, it's none of the above. What it *is* will astonish you! At \$1495*, **A★Star** is by far the lowest priced PC/AT compatible on the market. But, it's not just another clone, it's better!

A★Star™ runs 30% faster than most AT's, has twice the memory and eight *available* expansion slots; theirs has only seven. Plus, **A★Star** is so "compatible" it's backed by an exclusive money back guarantee. Better yet, **A★Star** is the only "network ready" AT you can buy...at *any* price.

But that's not all. **A★Star™** is also the only PC/AT compatible made in America by an American Stock Exchange manufacturer. And that's real peace of mind when you consider the unknown origin and quality of many of the cheap, import imitations.

A★Star™ It's about time! And...it's from Wells American.



Wells American

Inquiry 359

3243 Sunset Boulevard • West Columbia, South Carolina 29169 • (803) 796-7800 TWX 510-601-2645

*Second unit price. Call us for first unit pricing and guarantee details. You'll be amazed!

Call for latest prices.

FREE SHIPPING

in the Continental United States via UPS Ground.

NO SURCHARGE FOR



OR



Seagate HD □ Western Digital Controller

20 MEG Hard Disk System for PC™

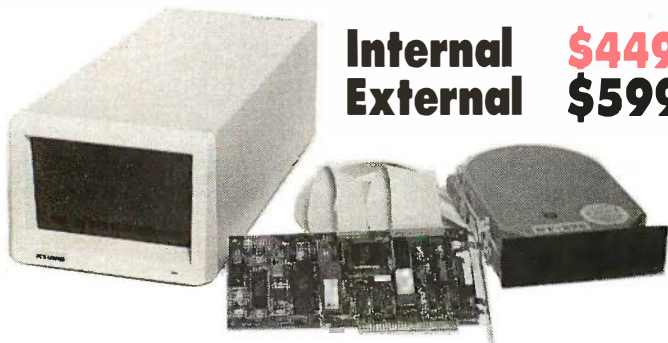

Internal \$449
External \$599

For Xebec 1220 Combined Floppy/Hard Disk Controller add \$75.

Includes Seagate Hard Disk, Western Digital Controller, Cables, Manual, Software, and Mounting Hardware.

Boots From Hard Disk 65 MS Access Time One Year Warranty

Our Hard Disk Systems are compatible with the latest versions of the following Computers: IBM PC, IBM XT, AT&T 6300, Compaq Deskpro, Tandy 1000, Tandy 1200, PC's Limited Turbo PC, Zenith 150, Zenith 151, Leading Edge PC (Both Models), Sperry PC, Wyse PC, Televideo PC, Faraday Mother Boards, Corona PC, Eagle PC, ITT PC, and most other Compatibles.

PLEASE SPECIFY YOUR COMPUTER TYPE WHEN ORDERING.

Seagate

20 and 30 MEG High Speed 40 MS Access Time Hard Drives for AT™

Uses Linear
Voice Coil
Activator.

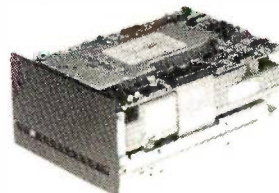

Heads park automatically
at power down.

20 MEG \$579
30 MEG \$699

Includes Seagate Full Height Hard Disk,
Cable, and Mounting Rails.
Boots from Hard Disk. One Year Warranty.

64K RAM \$10 per set
Set of 9 chips, 200 or 150 Nanoseconds

256K RAM \$29 Set of 9 chips
150 Nanoseconds

300/1200 Baud Hayes Compatible Modem Fits in Short Slot

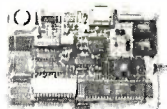

\$159

PC'S LIMITED Six Function Card

- Upgradable to 384K
- Clock/Calendar
- Includes Software
- Parallel Port
- Serial Port
- Game Port



Two Year Warranty **w/OK \$99 w/384K \$129**

PC's Limited AT Multifunction Card

- Expandable To 3 Meg (1.5 on Board/1.5 on Piggy Back Board)
- Supports 64 or 256K Rams
- Parallel Port
- Serial Port (2nd Serial Optional)

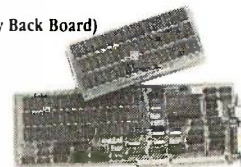

\$199 w/OK

Piggy Back Board \$59 w/OK

PC's Limited PC-576 RAM Board W/OK

- Expandable to 576K
- Supports 64K or 256K RAMS
- Fits in Short Slot



\$69

SOLVE YOUR POWER PROBLEM. XT™ POWER 135W

\$89



Directly replaces power supply in PC.™
Fully XT™ compatible. One Year Warranty

PRICES AND MACHINES THAT OUTRUN THE COMPETITION.

**PC'S LIMITED TURBO
PC™**

High Performance Competitive Price

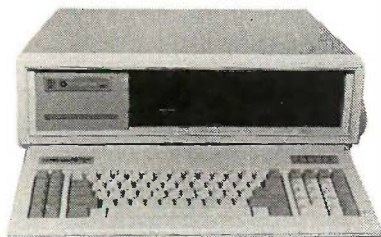

\$795

One year warranty.*

Includes: System Unit, 640K on Mother Board,
360K Floppy Drive, AT Keyboard, 135W Power Supply.

Runs all Major Software written for the IBM PC™ and PC XT™, 40% faster, without modifications.
(Processor) 16-bit 8088-2, 4.77 or 6.66MHZ Clock Speed. (Expansion Slots) :8; 7 are available in above configuration.

GW Basic \$95 • IBM DOS 3.1 \$85 • 8087-2 \$149

PC'S LIMITED AT™

High Performance Competitive Price



"Editor's Choice"
—Feb. 25, 1986

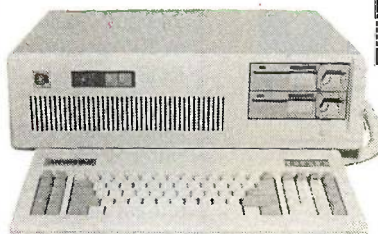

\$1995

One Year Warranty.*

**8MHZ Option included
at no extra charge.**

Includes: 80286-based System Unit, 1024K on
Mother Board, 1.2 Meg Floppy Drive, Combined Floppy
and Hard Disk Controller Card, AT Keyboard, 192W
Power Supply, 2 Serials and 1 Parallel Port, and
Clock/Calendar with Battery Backup.

Runs all Major Software written for the IBM PC™, PC XT™, and PC AT™. (Processor) Intel 80286 running at 6MHZ.
(Expansion Slots) :8. Same Bus Configuration as IBM PC AT™.

GW Basic \$95 • IBM DOS 3.1 \$85 • 80287 \$195

PC's Limited Mini I/O

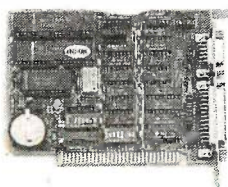

\$99

- Serial Port
- Parallel Port
- Clock
- Software
- Fits In Short Slot

PC's Limited Monochrome Graphics Fully Hercules Compatible

- Text Mode 80 X 25
- Graphics Mode 720 X 348 Pixels
- One Parallel Printer Port

\$159



**PC'S LIMITED
MONO-1 MONITOR \$169**



- 12-inch Screen
- Amber
- Compatible with monochrome
or color graphics cards

**PC'S LIMITED
RGB-1 MONITOR \$459**



- 31MM dotpitch
- RGB Input
- 12-Inch screen
- 690x240 resolution
- 16 colors

Floppy Disk Drive



\$109

Also available for AT™
in Gray Color.

**MITSUBISHI
ELECTRONICS**
Half-Height, DS/DD

TEAC
55-B, Half-Height, DS/DD

PANASONIC
Half-Height, DS/DD

PC's Limited Universal Video Adapter



\$259

- Replaces numerous cards, including IBM,
Hercules, Plantronics.
- Provides 132 column text—color or mono
- Supports all parallel printers and plotters
- Emulates color software on monochrome
monitor in 16 shades

*Terms: Due to our low prices and assurance
that all merchandise is new, unused product, all
sales are final. Call technical support for return
authorization number on all warranty repairs.
Any unauthorized return subject to a 10%
restocking fee. Prepaid checks, money orders,
VISA, MasterCard, American Express, or ap-
proved company purchase orders are accepted.
Prices reflect 3% cash, VISA, and MasterCard
discount. American Express not subject to
discount.

Some quantities may be limited. PC's Limited
reserves the right to substitute equivalent
items. All prices are subject to change without
notice.

We are an independent sales organization.

*Limited Warranty



PC'S LIMITED™

SALES CALLS OUTSIDE TEXAS, 1-800-426-5150
1611 Headway Circle, Building 3, Austin, Texas 78754
Sales Calls from anywhere in country, (512) 339-6962

Technical Support Calls, (512) 339-6963 Customer Service Calls, (512) 339-6964

Telex No 9103808386 PCLTD FAX (512) 339-6721

Panasonic, TEAC, Mitsubishi, Intel, IBM,
Hercules, Plantronics, Xebec, Seagate, Western
Digital, AT&T, Compaq, Tandy, Leading Edge,
Sperry, Wyse, TeleVideo, Faraday, Corona,
Eagle, ITT, and Zenith are registered trade-
marks of their respective companies. IBM PC,
IBM XT, IBM AT, are trademarks of IBM Cor-
poration. LeadingEdge PC, Sperry PC, Wyse PC,
Compaq Desktop, Zenith 150, Zenith 151,
TeleVideo PC, Corona PC, Eagle PC, AT&T
6300, Tandy 1000 and Tandy 1200 are trade-
marks of their respective companies.



Ad Number 404/86

UNIXTM**Multi-Link**TMThe
BOSS
BOARDTM

High Performance

**MULTI-USER
UPGRADE KIT**

for

PC DOS Programs

- IBM PC, XT,
AT Compatible
- Up to 16 Megabytes of
RAM
- Unlimited Users
- Supports Most Popular
Terminals

**Gabe Tech.** Ltd.

P.O. Box 41223
Brecksville, Ohio 44141-0223
(216) 237-4900

Excellent VAR/ISO Programs

Full Line of Support Products
Terminals, Cables,
Memory Boards,
Serial Port Boards,
and Multi-user Application Programs.

IBM PC[®] & PC DOS[®] are trademarks of IBM Corp.
Multi-Link[®] is a trademark of The Software Link, Inc.
UNIX[®] is a trademark of AT & T. Bell Labs

**C.L.U.B.S A.N.D
N.E.W.S.L.E.T.T.E.R.S**

CUL-DE-SAC BBS, 377 University Ave., Westwood, MA 01746, Attn: Pete White. 24-hour, 7-day BBS running TBBS software at 300 or 1200 bps at (617) 429-1784. MS-DOS oriented.

AMIGA USERS GROUP, Tony Preston, Computer Sciences Corp., 304 West 38th St., Moorestown, NJ 08057. Send SASE. \$12 annual dues includes newsletter.

THE QUARTERLY BYTE, Production Editor, 430 North Michigan Ave., Chicago, IL 60611-4088, (312) 329-8520. \$30 for four annual issues. Data exchange for realtors on real-estate-related software and more.

KAYPRO USERS' ASSOCIATION, Mr. M. Lawrence, 69 Pound Lane, Upper Beeding, West Sussex, England. Users group for Kaypro owners.

POLYFORTH USER'S GROUP, FORTH Inc., 2309 Pacific Coast Highway, Hermosa Beach, CA 90254, (213) 372-8493. Two national meetings; regional meetings scheduled. Users share many applications.

THE BLUE MOUNTAINS HOMEBREW COMPUTER CLUB, Eric Lindsay, 6 Hillcrest Ave., Faulconbridge, New South Wales 2776, Australia; telephone: (047) 512258. For computer enthusiasts and homebrewers.

TANDY BUSINESS USERS GROUP, 1701 Carmen Dr., Elk Grove Village, IL 60007, (312) 956-7000. Monthly newsletter and meetings, \$35 annual dues. Nonmember newsletter subscription: \$15 annually.

SMUG OF MONTREAL, 443 Blvd. Roche, Vaudreuil, Quebec J7V 2N4, Canada, (514) 455-4705. Spectravideo and MSX users group. Monthly meetings and newsletter; bilingual. Fees vary.

THE PENINSULA APPLE USERS GROUP, 1092 Hewitt Dr., San Carlos, CA 94070, (415) 591-9124. Monthly meetings and newsletter, \$10 annual subscription.

NATIONAL MACFORTH USERS' GROUP, 3081 Westville Station, New Haven, CT 06515. Bimonthly newsletter, public-domain programs, \$25 annual dues.

PHILADELPHIA AREA CPA COMPUTER USER'S GROUP (CPA CUG), Mike Levinson, 1 Breyer Office Parke, Suite 200, Elkins Park, PA 19117, (215) 248-0200. Accountants using computers wish information exchange. Monthly newsletter and meetings. Annual dues: \$15.

MAC1, Ward Hammond, POB 17678, Greenville, SC 29606. Monthly newsletter and meetings, library, \$25 annually.

ANTELOPE VALLEY CP/M USER GROUP, POB 1752, Lancaster, CA 93539. Monthly meetings and public-domain library.

COMPRESS QUARTERLY, POB 102, Wentworth, NH 03282. Seasonal newsletter covering educational software issues.

HIGH SIERRA ATARI USER'S GROUP (HiSUG), POB 2152, Sparks, NV 89432. Monthly newsletter and meetings.

THE 128 SOCIETY, David Haynes, 109 Blackbird Way #17, Lewisburg, WV 24901. For Commodore 128 users. Plans for newsletter, BBS, and other services.

THE NATIONAL XENIX USERS GROUP, Martin Steiner, POB 34043, San Diego, CA 92103. Monthly newsletter planned.

THE MULTISSET USERS GROUP (MUG), Carl Paquette, c/o Aldus Type Studio, 741 South La Brea Ave., Suite 201, Los Angeles, CA 90036, (213) 934-1179. For users of typesetting equipment linking up with PCs. Meetings require registration and fee. \$125 annual dues includes three publications.

AKRON-CANTON PC USERS GROUP, POB 334, 1570 Wooster Ave., Akron, OH 44320, (216) 745-5981. Public-domain software library, monthly meetings and newsletter. \$12 annual dues includes file, catalogue, and library disks. ■

CLUBS AND NEWSLETTERS is an acknowledgment of new clubs and newsletters received at BYTE. Please allow at least four months for your club's mention to appear. Send information to BYTE, Clubs and Newsletters, POB 372, Hancock, NH 03449.

The future... a little sooner than you expected.™



**ACHIEVE THE POWER
AND SPEED OF TOMORROW'S
TECHNOLOGY. TODAY.**

**INTRODUCING
THE EXEC. PARTNER™ FROM
PANASONIC®.**

The Panasonic Exec. Partner. What makes it an executive? The 7.16 MHz 8086-2 microprocessor for high-speed processing. So you can do more in less time.

What makes it your partner? Like all ambitious achievers the Panasonic Exec. Partner gets along with others. Namely, IBM hardware and software.

You'll also accomplish more with the new high-resolution plasma display. It lasts four times longer, offers clearer definition and is easier to read than an ordinary screen.

The Exec. Partner's built-in dual mode printer will help

you make a good impression. From silent, draft-quality mode to correspondence quality.

The 256K internal memory has built-in expandability to 640K. So the Exec. Partner will run the most sophisticated data base management programs. And its expansion slot allows you to fulfill the needs of specific applications like telecommunications and Local Area Networks.

Tomorrow's technology for today's executives. The new Panasonic Exec. Partner.

**Panasonic
Industrial Company**

For the location of your nearest dealer, call 1-800-PIC-8086.

IBM is the registered trademark of International Business Machines, Inc.



NOTHING DOWN.

Even the best of personal computers can have a bad day. Blackouts happen. Usually at the worst possible time.

But power interruptions don't need to be business interruptions. And lost power shouldn't result in lost data. Not with the POWERMAKER® Micro UPS from Topaz.

Designed specifically for hard disc and critical-use business systems, Powermaker Micro UPS ensures a continuous supply of smooth sine wave power even during

a total blackout.

And there's more. Powermaker Micro UPS also removes spikes and other error-producing transients from incoming power, protecting your PC's sensitive circuitry.

So, if your PC needs a little help once in a while, give it Powermaker Micro UPS protection. For nothing down. Call us today at (619) 279-0831, or contact your local Square D distributor.

TOPAZ[®]
SQUARE D COMPANY

**THE FFT:
FUNDAMENTALS
AND CONCEPTS**
Robert W. Ramirez
Prentice-Hall
Englewood Cliffs, NJ: 1985
178 pages, \$28.95

**DESIGNING DIGITAL
FILTERS**
Charles S. Williams
Prentice-Hall
Englewood Cliffs, NJ: 1986
349 pages, \$36.95

**MACINTOSH REVEALED,
VOLUME TWO:
PROGRAMMING WITH
THE TOOLBOX**
Stephen Chernicoff
Hayden Book Co.
Hasbrouck Heights, NJ: 1985
626 pages, \$29.95

**EXPLORING THE PICK
OPERATING SYSTEM**
Jonathan E. Sisk and
Steve VanArsdale
Hayden Book Co.
Hasbrouck Heights, NJ: 1985
238 pages, \$29.95

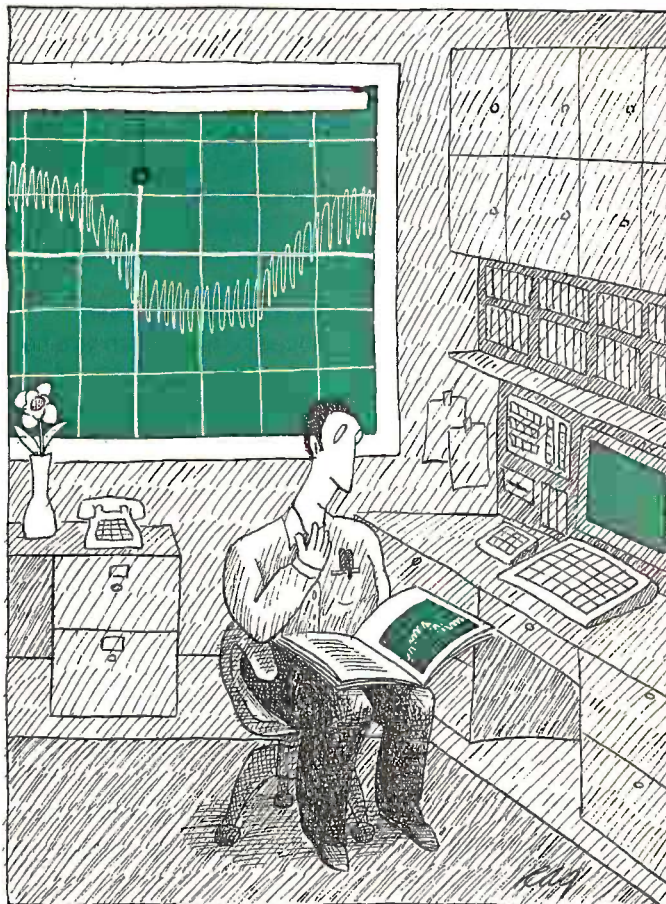

customer support with technicians, engineers, and scientists. Ramirez does not belabor what is "theoretically interesting" but concentrates on what is practically important.

The book is divided into three parts: a general introduction to Fourier analysis, a specific discussion of the FFT and how to use it, and a presentation of the Sande-Tukey algorithm (decimation in frequency) and a BASIC program to implement it.

The first part is closest in style and content to the usual books on the Fourier transform. It presents a (thankfully, nonrigorous) derivation of the Fourier integral from the series, discusses interpretation of polar and rectangular forms of a transform, explains the effects of scaling and shifting in one domain on the transformed spectra, and introduces the notions of

even, odd, and mixed functions of time.

Although the treatment of these topics is as clear and conceptually appealing as such material is likely to get, I would not have been offended if the treatment had been shortened by a factor of four. In truth, I would have been perfectly content for the book to begin with the discrete Fourier transform (DFT). Depending on your needs and interests, you may want to just scan the first three chapters and begin reading in earnest at chapter 4.

THE DFT

Part 2 begins by introducing the DFT and includes a simple, slow BASIC program to implement it. The main virtue of the program Ramirez presents here is that it is clear. Anyone with any hope of understanding a DFT should be

(continued)

THE FFT: FUNDAMENTALS AND CONCEPTS

Reviewed by Thomas R. Clune

The fast Fourier transform (FFT) has become ubiquitous in scientific and engineering instrumentation. As a result, many more people have to work with it than have to program FFT routines. Most books that cover the FFT discuss its derivation and alternate ways of implementing the algorithm. What we need is a discussion of the practicalities of working with FFT instrumentation. Robert W. Ramirez's fine little book, *The FFT: Fundamentals and Concepts*, is just such a volume.

Ramirez is an employee of Tektronix Inc., the oscilloscope company, and it shows. The book reads like it was written by someone who has spent a lot of time in

DISCOVER THE LANGUAGE OF ARTIFICIAL INTELLIGENCE

PROLOG V

Interpreter for MS-DOS/PC-DOS

Not Copy
Protected



At last! A Prolog with enough muscle to handle real-world applications for UNDER \$100! Discover why Japan has chosen Prolog as the vehicle for their "Fifth Generation Machine" project to design intelligent computers.

CHOOSE FROM TWO GREAT VERSIONS:

PROLOG V-Plus \$99.95

- More Than 100 Predefined Predicates
- Large Memory Model (to 640K)
- Floating Point Arithmetic
- 150-Page User's Manual and Tutorial plus Advanced Programming Documentation
- Co-Resident Program Editor
- Calls to Co-Resident Programs
- Text and Graphic Screen Manipulation

PROLOG V \$69.95

- 70 Predefined Predicates
- Small Memory Model
- Integer Arithmetic
- 122-Page User's Manual and Tutorial

STANDARD FEATURES ON BOTH:

- Clocksin & Mellish-Standard Edinburgh Syntax.
- Extensive Interactive Debugging Facilities
- Dynamic Memory Management (*garbage collection*)
- Custom-Designed Binder and Slipcase

UNBELIEVABLE UPGRADE POLICY
Tough decision? Buy PROLOG V and upgrade to PROLOG V-Plus within 60 days for only the difference in price plus a handling charge.

NO RISK OFFER
Examine the documentation at our risk for 30 days. If not fully satisfied, return with disk still sealed for full refund.



**CHALCEDONY
SOFTWARE, INC.**

5580 LA JOLLA BLVD.
SUITE 126 B
LA JOLLA, CA
92037
(619) 483-8513

THE CHOICE OF UNIVERSITIES

Generous university site licenses and an excellent teaching tutorial and reference guide have made PROLOG V the choice of universities nationwide. Call for details.

PHONE ORDERS: 1-800-621-0852 EXT 468

<input type="checkbox"/> PAYMENT ENCLOSED \$ _____	PROLOG V-Plus \$99.95
CA residents add 6% sales tax	PROLOG V 69.95
<input type="checkbox"/> CHARGE MY: <input type="checkbox"/> MasterCard <input type="checkbox"/> Visa	UPGRADE ONLY 40.00
Card No. _____ Exp. Date _____	Return factory diskette and \$30 plus \$10 Handling
Signature _____	SHIPPING:
Mr./Mrs./Ms. _____	\$ 5.00 U.S.
(please print full name)	7.50 Canada
Address _____	10.00 Caribbean,
City/State/Zip _____	Hawaii Air
	20.00 Overseas Air
	COD Orders Not Accepted
	15 day check clearance

BOOK REVIEWS

able to figure it out from the eight lines of code that implement the algorithm. The program also allows the author to introduce the topic of data output formats for DFTs and FFTs.

Since an FFT is just a DFT that executes quickly, Ramirez uses the DFT as the basic introduction to the FFT. In part 3, he returns to the FFT and provides a detailed look at how it works, but he is wise not to bog down his discussion of working with the FFT with unnecessary implementation details.

One of the most appealing aspects of this book is that it is peppered with photographs of oscilloscopic displays of waveforms and their transforms in either real/imaginary format, magnitude/continuous-phase format, or magnitude/phase modulo 2π format. The value of this approach is that you begin to acquire experience in interpreting FFT information. Given a series of waveform displays and transform displays, you can begin forming expectations of what the transform of a waveform should look like.

WHAT'S IMPORTANT

Once he has shown you how to read a transform, Ramirez discusses the reality of even and odd harmonics by examining transforms of real square waves. The photographs in figure 6-1 of the book make it very plain that easily overlooked differences in DC offset can have very pronounced effects on the appearance of the transform. This is important to know if you're going to work with FFTs, and it's just the kind of information you usually have to pick up the hard way. Ramirez continues with a discussion of noise, both that in the signal and that introduced by the conversion instrumentation, and what you can do about it. He then discusses leakage. While there is nothing revelatory in his treatment of these topics, they are important and should be covered. And in keeping with Ramirez's emphasis on what is important rather than what is interesting, he is not above explicitly pointing out that the assumed periodicity of the FFT refers to the sampling window, not the waveform.

ALIASING

The discussion of windowing and sampling leads naturally into aliasing. Ramirez begins by stating the Nyquist theorem, without proof (thank you). He then goes on to show what oscilloscopic displays of the frequency-magnitude transform look like as you approach the Nyquist limit, and he suggests, reasonably enough, that you try to use a sampling rate at least three times the frequency of the fastest component of your data. Beyond the pictures, there is little in this that exceeds a usual competent treatment of aliasing. However, Ramirez continues on from here. He discusses what the frequency transform looks like when you exceed the Nyquist limit and why. The treatment is divided into two parts: what aliasing looks like when you exceed the Nyquist limit by only a little, and what happens with massive aliasing. This is important. If

(continued)

MARK WILLIAMS' CSD

Those who insist on C compiler performance
are very big on Mark Williams.

And the compiler is just part of our total C Programming System.

NEW 3.0 ENHANCEMENTS

These and other powerful utilities now *included* in the C Programming System:

- make: compiles only what's necessary from multiple modules, a powerful programming discipline
- diff: identifies differences between two files
- m4: macroprocessor expression editing and substitution
- egrep: extended pattern search
- MicroEMACS: full screen editor with source

COMPILER FEATURES

- Runs under MS-DOS
- Full Kernighan & Ritchie C with recent extensions including void and enum
- Register variables for fast, compact code
- Full UNIX™ compatibility and complete libraries
- Large and small memory models
- MS-DOS linker compatibility
- 8087 Support
- One-step compiling
- English error messages
- ROMable code
- Linker, assembler, archiver
- Extensive third party library support

csd C SOURCE DEBUGGER

- Debugs at C source level without assembly language
- Separate evaluation, source, program and history windows
- Can execute any C expression
- Capabilities of a C interpreter, but runs in real time
- Set trace points on any statement or variable

Mark Williams' C compiler has earned a place in some very big companies for some very good reasons: it proves the benchmarks right with the speed, code density, consistent performance and expert support required in professional development environments.

But a total development tool shouldn't stop with compiling. Or go on and on with extras that add up and up.

Only Mark Williams' C Programming Systems *includes* the csd C Source Debugger with true source level debugging to speed your programming job.

And only Mark Williams' new 3.0 version *includes* utilities like "make" to make quick work of even the largest projects.

From source code to final product, only one takes you all the way: Mark Williams' C Programming System. All for only \$495. **Ask about our 60-day money back guarantee when you call**

1-800-692-1700 to order today.*

You'll be big on the total C Programming system from Mark Williams, too.



1430 West Wrightwood
Chicago, Illinois 60614

IBM XT 512K FLOPPY	\$1988	ZENITH 148	\$1098
IBM XT 512K 20 MEG HD	\$2488	ZENITH 158	\$1598
IBM AT 512K FLOPPY	\$3288	ZENITH 177	\$1988
IBM AT 512K FLOPPY 20 MEG HD	\$3788	ZENITH 200 AT	\$2888
512K [OK] MEMORY CARD	\$ 48	20 MEG SEAGATE HD	\$ 488
384K [OK] XT MLTIFCT CARD	\$ 98	10 MEG TAPE BACK-UP	\$ 468

MONITORS

AMDEK COLOR 600	\$388
SONY IBM HI RES COLOR	\$488
TAXAN IBM HI RES COLOR	\$395
ZENITH AMBER TTL	\$159
RF MODULATOR IBM OR APPLE	\$9.99
COLOR GRAPHICS CARD RGB	\$ 78

PRINTERS

CITIZEN MSP10	\$248
EPSON FX85	\$368
OKIDATA 182	\$216
IBM PRINTER CABLE (HI QUALITY)	\$ 15
APPLE 21 or 2e CABLE	\$ 15
OTHER PRICES	CALL

INTRODUCING THE NEW SUPER SPC XT PORTABLE

FITS ANY IBM PC, XT OR APPLE II+, IIe OR (AT - CALL) COMPATIBLE MOTHER BOARDS
KIT INCLUDES: • TTL or COMPOSITE (AMBER GREEN) ASSEMBLED AND TESTED
 3 DISK DRIVE SLOTS • HARDWARE RESET • SPC XT 256K FLOPPY, MONO \$ 999
 • KEYED POWER SWITCH • AUTOMATIC BRIGHTNESS CONTROL • SPC XT 256K FLOPPY, 10 MEG HD \$1499
 • EASY TO ASSEMBLE • SPC XT 256K FLOPPY, 10 MEG HD \$1999
 INCLUDES: • 9" HIGH RES MONITOR
 • 135 W SWITCHING POWER SUPPLY
 • KEYBOARD
 • ABS CASE ACCESSORIES MOUNTING HARDWARE ASSEMBLY MANUAL UP TO 6 EXPANSION SLOTS

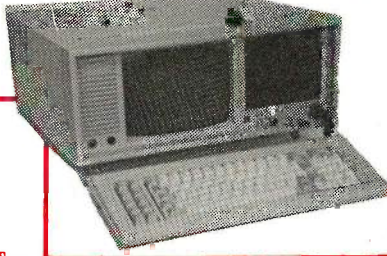

\$695



NEW SHORT COLOR & MONOCHROME GRAPHICS CARD

COMPOSITE OUTPUT PORT - TTL OUTPUT PORT - MONOCHROME GRAPHICS TO COLOR GRAPHICS - COLOR GRAPHICS TO MONOCHROME GRAPHICS - VLSI PROCESSOR - MANUAL AND SOFTWARE INCLUDED \$158

SUPER SPC AT

TOTALLY IBM AT HARDWARE & SOFTWARE COMPATIBLE

MOTHER BOARD	• SUPER AT KEYBOARD	\$ 89
80286 MICROPROCESSOR	• SUPER AT CASE	\$ 89
80287 COPROCESSOR (OPTIONAL)	• SUPER AT 200 WATT POWER SUPPLY	\$149
512K STANDARD MEMORY	• 2.5M MULTI-FUNCTION CARD (OKI)	\$229
8 I/O EXPANSION SLOTS		
ONLY (OKI)		\$999

SUPER COMPATIBLE PC/XT

TOTALLY IBM XT HARDWARE & SOFTWARE COMPATIBLE!

• 256K MOTHER BOARD (OKI)	\$149	SPECIAL THIS MONTH ONLY!
• MONOCHROME GRAPHIC PRINTER CARD	\$ 88	5150 KEYBOARD (HIGH QUALITY)
• MULTI-I/O CARD	\$128	\$48.00
• PARALLEL PRINTER CARD	\$ 28	XT CASE (FLIP TOP)
• SERIAL CARD	\$ 38	\$47.00
• GAME PORT ADAPTER	\$ 28	135 WATT XT POWER SUPPLY
• EPROM WRITER CARD	\$109	\$78.00

APPLE COMPATIBLE PRODUCTS

• S SERIAL CARD	\$68	• APL II+ COMPATIBLE MOTHER BOARD	\$189
• APL II+ COMPATIBLE MOTHER BOARD	\$238	• APL II+ REPLACEMENT CASE	\$30
• APL II+ COMPATIBLE 80 COLUMN CARD	\$150	• APL II+ REPLACEMENT KEYBOARD	\$50
• W/84K MEMORY	\$48	• APL II+ FUNCTION & NUM KEYBOARD	\$59
• APL II+ REPLACEMENT KEYBOARD	\$58	• APL II+ FUNCTION, NUMERICAL KEYPAD & CASE	\$68
• APL II+ REPLACEMENT CASE	\$58	• APL II+ DETACHABLE KEYBOARD	\$78
• POWER SUPPLY (REPLACEMENT II+ or IIe)	\$38	• EPROM WRITER CARD	\$58
• APL II+ DETACHABLE KEYBOARD	\$99	• Z-80 CF/M CARD	\$58
• W/KEYPAD	\$99	• GRAPPLER COMPATIBLE PRINTER CARD	\$38
		• PRINTER CABLES	\$13
		• 80 COLUMN CARD FOR II+	\$42
		• DISK CONTROLLER CARD II+ or IIe	\$38
		• 18K MEMORY/LANGUAGE CARD	\$29
		• JOYSTICK II+ or IIe	\$15
		• FANCY JOYSTICK II+ or IIe	\$18
		• HALF HEIGHT DISK DRIVES (II+ or IIe)	\$118
		• IC DRIVES	\$138
		• SUPER COOLING FANS II+ or IIe	\$24

2e CASE & KEYBOARD w/KEYPAD

2e EXTERNAL KEYBOARD

MAIL TO BTE Computers, Inc.

P.O. BOX 30705C • PHOENIX, AZ 85046-0705 • PHONE (602) 867-8962

MASTER CHARGE, VISA, ARE WELCOME. \$5.00 MINIMUM SHIPPING & HANDLING NOT RESPONSIBLE FOR TYPOGRAPHICAL ERRORS. ALL PRODUCTS SUBJECT TO AVAILABILITY OR STOCK ON HAND. ALL PRICES ARE SUBJECT TO CHANGE WITHOUT NOTICE!

ALL SALES ARE CASH DISCOUNT PRICES! REFUNDS ARE CREDITED ONLY.

BOOK REVIEWS

you are going to analyze transformed data successfully, you have to be able to recognize aliasing when you see it—and you will see it. Ramirez's treatment of this topic is by far the most useful I have seen.

After examining potential problems with FFTs, Ramirez offers guidelines for improving FFT results. His discussion includes signal averaging, subtracting DC bias, pointing out that phase components are meaningful only where frequency components exist, discussing phase delay, the trade-off between time-domain resolution and frequency-domain resolution in selecting sampling rates, and the shape, roll-off, bandwidth, and effects on frequency-domain magnitude of different windows. This last topic is presented especially well and includes oscilloscopic displays of the results of using different windows on an almost periodic waveform.

SOME APPLICATIONS

Ramirez closes part 2 with a very brief look at FFT applications. Included are distortion analysis, signature analysis, transfer functions, convolution and deconvolution, and correlation analysis. The author's discussion of each is so brief that it includes little more than a definition of terms. I would have preferred to have this chapter expanded by the factor of four that part 1 could have been pruned by. Nonetheless, the discussion is useful in providing some idea of what you can get out of Fourier analysis.

Part 3 of the book is devoted to a clear discussion of the Sande-Tukey algorithm. It includes a BASIC program that implements the algorithm and lacks only input and output routines to use. Though the book ends with a bibliography for further study, don't expect the referenced books to be as clear and informative as this one.

The FFT: *Fundamentals and Concepts* was written for people who work for a living. If you are about to acquire an FFT instrument or have to bring new employees up to speed on working with FFT instrumentation, you will want to have this book around.

DESIGNING DIGITAL FILTERS

Reviewed by Thomas R. Clune

Designing Digital Filters is an undergraduate textbook in digital filtering. It assumes that the reader neither knows what a filter is nor how to make one. Anyone who believes that it is desirable not to make assumptions will be cured of that view by reading this book.

The author begins by asking the question, "What is a filter?" The answer: "In the most general terms, a filter is a black box with a set of inputs and a set of outputs. The box contains some form of processing that generates the outputs from the inputs." In case anyone fails to recognize that this definition can encompass anything from a bowling alley to a notch filter, the author follows it with an example showing that a cash register is a filter.

(continued)

Mark Williams

Now the biggest name
in C compilers comes in a size
everybody can afford.

Let's C.[™]
\$75

Introducing Mark Williams' \$75 C compiler: Want to explore C programming for the first time? Or just on your own time? Now you can do it in a big way without spending that way. With Let's C.

This is no little beginner's model. Let's C is a powerful programming tool, packed with all the essentials of the famous Mark Williams C Programming System. The one chosen by Intel, DEC, Wang and thousands of professional programmers. The one that wins the benchmarks and the reviewers' praise:

Mark Williams Let's C

- For the IBM-PC and MS-DOS
- Fast compact code plus register variables
- Full Kernighan & Ritchie C and extensions
- Full UNIX[™] compatibility and complete libraries
- Small memory model
- Many powerful utilities including linker, assembler, archiver, cc one-step compiling, egrep, pr, tail, wc
- MicroEMACS full screen editor with source
- Supported by dozens of third party libraries
- Upgradeable to C Programming System for large scale applications development

Let's C Benchmark Done on an IBM-PC/XT, no 8087. Program: Floating Point from BYTE, August, 1983.

Exec Time in Seconds

Let's C	134.20
MS 3.0	347.45

"(This compiler) has the most professional feel of any package we tested..."—BYTE
"Of all the compilers reviewed, (it) would be my first choice for product development."—David W. Smith, PC WORLD

And now for more big news. Get our revolutionary csd C Source Debugger for just \$75, too. You can breeze through debugging at the C source level ignoring clunky assembler code.

Affordable, powerful, debuggable. Mark Williams Let's C is the big name C compiler at a price you can handle. Get your hands on it now.

Use this coupon or charge by calling toll-free:
1-800-MWC-1700. In Ill. call 312-472-6659.

ORDER NOW! 60-DAY MONEY BACK GUARANTEE!

Mark Williams Let's C

Please send me:

_____ copies of Let's C and _____ copies of csd (C Source Debugger) at \$75 each. (Ill. residents add 7% sales tax.)

Check Money Order Visa, MasterCard or American Express

Name _____

Address _____

City _____ State _____ Zip _____

Card # _____ Exp. Date _____

Signature _____



**Mark
Williams
Company**

1430 West Wrightwood
Chicago, Illinois 60614

Inquiry 205

DRIVE INN

Enclosure &
power supplies
for
**FLOPPY,
WINCHESTER,
TAPE DRIVES,
SINGLE BOARD
COMPUTERS
& S-100 SYSTEMS**

8 inch
5 inch
3 inch

Call or write
for free
catalogs &
application
assistance

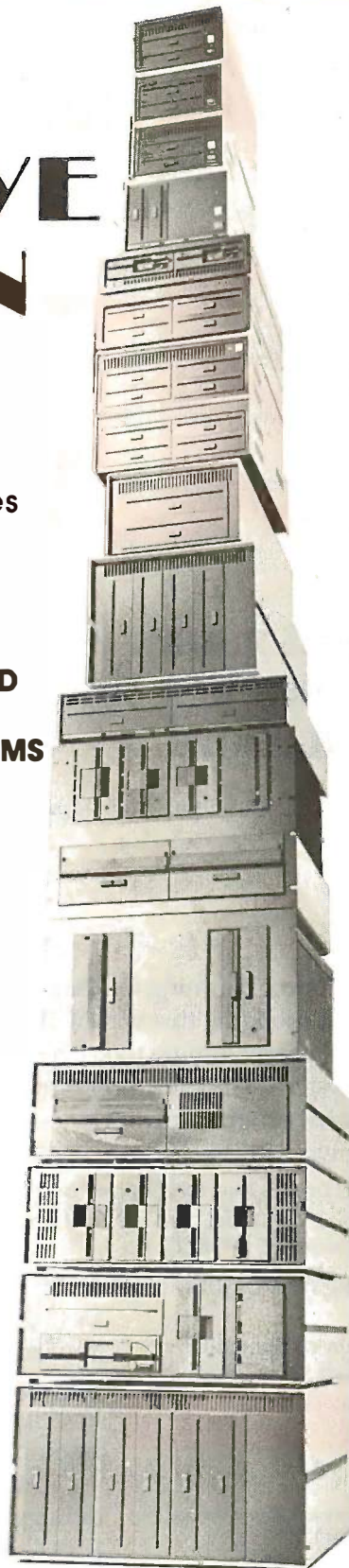

INTEGRAND
RESEARCH CORPORATION

8620 Roosevelt Ave. • Visalia, CA 93291
209/651-1203

We accept BankAmericard/Visa
and MasterCharge

BOOK REVIEWS

Early on in his exposition, Charles Williams presents a noisy EKG as an example of data needing filtering, then provides (without explanation) a simple weighted moving-average filter to improve the output. He then notes, "For reasons probably unknown to you, this filter attenuates the muscle noise without greatly affecting the EKG signal." In not much more space than that, he could have offered some insight into what is going on. But the full thrust of this book is to place mathematical rigor above insight.

In keeping with this theoretical emphasis, Williams derives the Nyquist limit before getting out of the first chapter. He then notes that, for any signal that is represented as the weighted sum of sines and cosines, exceeding the Nyquist limit will result in aliasing. This kind of exposition bothers me for several reasons. First, most people would be better served by the more insightful treatment of aliasing provided by Ramirez in *The FFT* (see the preceding review). Second, it is very easy for neophytes to gloss over the "weighted sums of sines and cosines" part of his point. Most smoothing techniques used on data are more likely to produce garbage than aliasing if pushed too far. Further, most will produce garbage long before the Nyquist limit is reached. Consider, for example, a moving-average smoothing algorithm. This criticism may seem unfair. But most popular articles I have seen (including some in *BYTE*) hold up the Nyquist limit as some universally applicable speed limit for sampling rates without regard to the method of analysis. This is just the sort of confusion that a course in filtering should set to rest, but this book makes it all too easy for students to be reinforced in their ignorance. Finally, the hardest question to answer with respect to the Nyquist limit concerns the highest frequency component important to a given data set. Unless you are dealing only with pure sine waves, the answer to this question is very obscure. But you will get little help from this book in analyzing your data to determine its filtering requirements.

The author's discussion of convolution and windowing is rather well done, but it could benefit from a more thoroughly graphic presentation. Nonetheless, his treatment of Hamming windows and Kaiser windows is one of the best parts of the book. Similarly, when he returns to this topic while discussing the discrete Fourier transform, his exposition of the trade-offs between narrowing the main lobe and attenuating the side lobes for a window is clear and useful. His illustration of the effects of uniform and Hamming windows on the same data and his warning that you must know the window to know how to interpret the transform are well done and cogent. For me, however, these passages only served to highlight the lack of such cogency in the rest of the text.

The discussion of polynomial modeling of digital signals, for example, does not maintain the quality of exposition Williams attained with windowing. After presenting the general equations for fitting polynomials of a given order to a set of points, Williams discusses estimating missing

(continued)

Why look like the average manager?

At last there is software that puts you ahead of the pack.

SuperProject Plus.™ The management advantage.

We have refined the effective techniques of project management into an unprecedented tool for complete management control.

From planning an audit, scheduling a new product, budgeting an ad campaign to managing the production of a Broadway musical.

At a level any manager can understand. From beginner to expert.

SuperProject Plus is the first micro software that lets you see how *all* the elements you manage – your people, projects, budgets, schedules and resources – relate to and affect each other.

SuperProject Plus can improve performance on any level.

So you can plan ahead with confidence. Identify potential problem areas and take corrective action *before* it's

too late. Compare your actual performance against your plans. And never be surprised by a deadline again.

Now you'll have the ammunition you need to make better decisions.

SuperProject Plus will help you optimize resources. Take on greater challenges. Manage more intelligently.

In short, be a better manager.

You can even directly transfer your information into SuperCalc®3 Release 2, Lotus® 1-2-3®, dBase™ and other leading software for more detailed financial analysis and business reports.

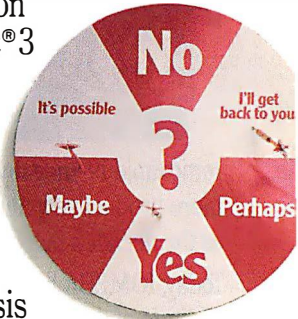

SuperProject Plus. From Computer Associates, the world's most experienced business software maker. With a list of satisfied

customers that includes over 80% of the Fortune 1000.

For the whole story on SuperProject Plus for the IBM PC, call Terry Smith at 1-800-645-3003.

Or see your dealer. You'll wonder how you ever managed without it.

COMPUTER ASSOCIATES
Software superior by design.

Inquiry 77

The way is CA.

© 1985 Computer Associates International, Inc. SuperCalc is a registered trademark, and SuperProject a trademark of Computer Associates International, Inc. Lotus and 1-2-3 are registered trademarks of Lotus Development Corp. dBASE is a trademark of Ashton-Tate. Computer Associates productivity software: SuperCalc®3 Release 2; SuperProject™; EasyWriter II® System; EasyPlanner™; EasyFiler™; EasySales Pro™; EasyBusiness Systems™ accounting software: EasyPlus™; EasyPlus™ Network Manager; General Ledger and Financial Reporter; Accounts Payable; Accounts Receivable; Inventory Control and Analysis; Order Entry; Payroll; Retail Invoicing; Time, Billing, and Client Receivables; Job Costing.

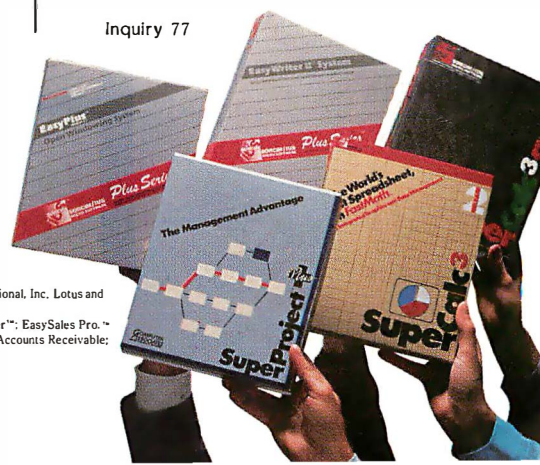

DATA INDEPENDENCE MUCH SMALLER

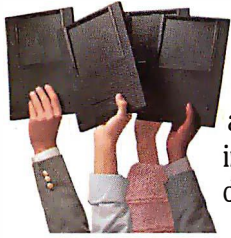

The Age of Data Independence™ dawned about two years ago when IOMEGA introduced a revolutionary mass storage device called The Bernoulli Box®. Featuring a unique technology that uses rugged,

removable 10-megabyte cartridges, it freed companies to work more productively and economically—and was soon recognized as the decade's biggest step forward in business data storage.

Today, IOMEGA has taken another giant step. With the addition of the compact 20-megabyte-per-cartridge Bernoulli Boxes, in single- and dual-drive versions, the Data Independence family gets simultaneously bigger and smaller. The new Bernoulli Boxes double on-line capacity to up to 40 megabytes and cut the space required to carry and store data cartridges. They also boast a footprint that is literally half that of the previous version, freeing just that much more valuable desk space.

But what makes the new Bernoulli Box so exciting are the same features that made it the new standard in data management to begin with.



TRANSPORTABILITY.

The Bernoulli Box cartridges are completely interchangeable. You're free to take the cartridge from one and use it in another with complete confidence. Take it across the hall or mail it across the continent.

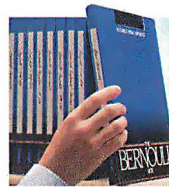

EXPANDABILITY.

Free yourself from the limitations of system capacity. If you need more, you expand by buying slim, inexpensive cartridges, not bulky and costly hardware.

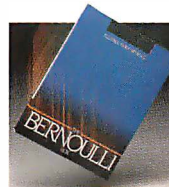

RELIABILITY.

Incredible resistance to shock and vibration combined with a rugged cartridge format frees you from concerns about equipment failure, head crash, or data loss.

BERNOULLI

THE

BO

™ : MORE GIANT STEPS. ER FOOTPRINTS.



SECURITY.

Free your sensitive files, such as payroll and personnel, from unauthorized scrutiny and free yourself from unnecessary anxiety. Put them on a Bernoulli Box cartridge, and put the cartridge where you *know* it will be safe.



Check out the latest Bernoulli Box family members today. More giant steps towards the complete data independence of businesses using the IBM PC, XT, AT, most compatibles, and the Macintosh:™ Giant steps with very small footprints.

For the dealer nearest you, call 1-800-556-1234, ext. 215. In California, call 1-800-441-2345, ext. 215.

PERFORMANCE.

The amazing speed of The Bernoulli Box—with access times and transfer rates that rival and often surpass the best hard disk drives—translates into the best freedom of all: the freedom of time. And now The Bernoulli Box offers users the option of booting from The Bernoulli Box cartridge with any of the IBM PC or compatible computers.



*The Bernoulli Box for Macintosh is available in a 5-megabyte single-drive version and a 20-megabyte dual-drive version for AppleTalk.™

The Bernoulli Box is a registered trademark of IOMEGA Corporation. Data Independence is a trademark of IOMEGA Corporation. Macintosh is a trademark licensed to Apple Computer, Inc. AppleTalk is a trademark of Apple Computer, Inc.

HE OULLI OX®

IOMEGA®

IOMEGA Corporation
1821 West 4000 South
Roy, Utah 84067

Inquiry 167

COST SAVING CONNECTIONS

RS232 INTERFACE PROBLEM SOLVERS...FROM WESTERN TELEMATIC INC.

END DATA SWITCHING PROBLEMS



Is switching data cables becoming a pain in the ASCII? Automatically switch between computers, printers, instruments—just about any RS232 device.

Economically expand computer ports, access multiple computers or remote peripherals.

From simple AB switches to intelligent 196 port code activated switching systems, our reliable, easy to use, interface switches will help end your interconnect problems.

EFFICIENT PRINTER SHARING

It's time to make more efficient use of your expensive printers. Share a single plotter, daisy wheel, dot matrix or laser printer with up to 8 computers, word processors or CAD systems. Ideal for the automated office, school or engineering lab.

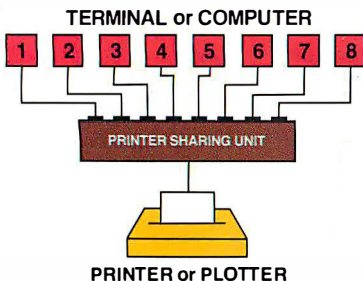

Our 4 or 8 port Printer Sharing Units work automatically. No cable switching or knobs to turn. Software changes are usually unnecessary since they use standard Ready/Busy or XON/XOFF handshaking.

AFFORDABLE RS232 NETWORKING

Create your own local network with our Any-port to Any-port Smart Switches. Available in either 8 or 16 port versions, the Smart Switch is ideal for computer port expansion, computer sharing, engineering work clusters and much more.

Each port has its own spooling buffer. So any baud rate can communicate with any other baud rate and parity anywhere in the system.

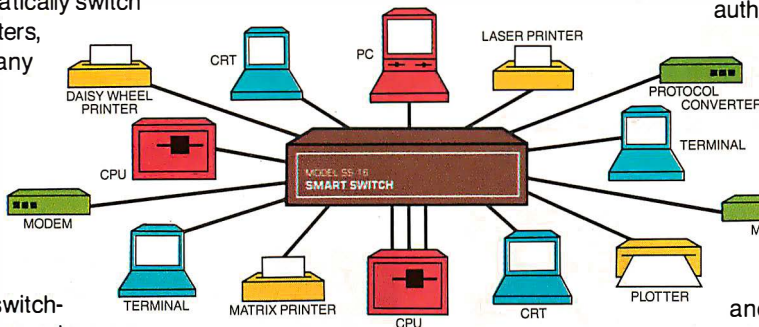

A special supervisory port lets you monitor activity on any other port, connect ports together, broadcast messages or designate the supervisory power to other ports.

The Smart Switch is easy to use. User friendly commands allow you to select ports, disconnect and display port activity. A push button defines each port for either DCE or DTE. So if you need an intelligent, affordable way to link your RS232 system, you're ready for the Smart Switch.

CONCERNED ABOUT DATA SECURITY?

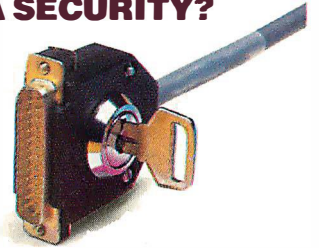

Prevent unauthorized access to your computer system. Our Dial-back Security Unit prevents outsiders from peeking at, destroying or tampering with your data. Only users entering authorized passwords and dial-back numbers stored in the 200 number battery backed directory will be allowed access.

An auxiliary command port is used to set-up the directory and security levels as well as log each password attempt and duration of each call.

Simply connect the DSU between your computer and modem and feel secure about who's using your data.

QUALITY PRODUCTS

Every WTI product is designed and manufactured with quality and reliability as a major requirement. We're so confident you'll like our products that we offer a 30 day return policy. Compare our features, quality, customer support and prices with any other manufacturer and you'll know why WTI is a recognized leader in the Data Communications industry.

IT'S ALL IN THE BOOK...IT'S FREE

Descriptions, diagrams, specifications and prices for the above products, plus many more, are in our colorful new catalog. It's your cost saving connection...just ask for it!

Call toll free: **1-800-854-7226**
(in California 714/979-0363)

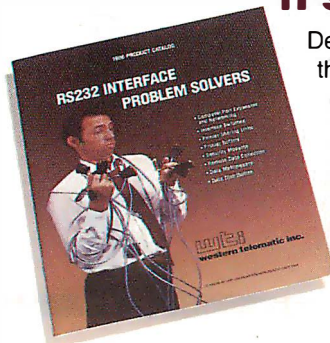

wte western telematic inc.

2435 S. Anne St., Santa Ana, CA 92704 • Telex 467741

Inquiry 363 for End-Users. Inquiry 364 for DEALERS ONLY.

data points as follows: "Most of us would just 'eyeball' the data so that the estimates 'look right.' However, polynomial modeling provides us with a formal, rigorous approach to data estimation." I shudder to imagine how many students draw the conclusion that "formal, rigorous" fitting of data offers an improvement over eyeballing. Indeed, the entire treatment of polynomial fitting gives very short shrift to overfitting data. While Williams does indicate that real data contains noise, he acts as though a least-squares approach will deal with the problem. In fact, selecting an appropriate order polynomial for a given data set is a very difficult problem. It requires having some understanding of the basic form of the data or some appreciation of the level of precision that can be associated with a given data set. It is most certainly not a mechanical process, and your surest guide to avoiding rigorous foolishness is "eyeballing." But this is just another way of saying that you can't teach people with no understanding of what they are trying to do how to do it.

The book ends with a couple of surprisingly good appendixes and a list of references. I only wish that the spirit that guided the writing of the appendixes had guided the writing of the book itself.

Before coming to BYTE, Thomas R. Clune was the Physical Chemistry Laboratory Coordinator at Brandeis University, where he taught computerized data acquisition for chemistry and computer science students. He can be reached at BYTE, POB 372, Hancock, NH 03449.

MACINTOSH REVEALED, VOLUME TWO: PROGRAMMING WITH THE TOOLBOX
Reviewed by Bonnie L. Walker

Programming with the Toolbox picks up where *Volume One: Unlocking the Toolbox* left off, as Stephen Chernicoff continues his effort to unravel the mysteries of the Macintosh's powerful user interface, the Toolbox (for a review of *Volume One*, see November 1985, page 57). The two-volume *Macintosh Revealed* is intended for serious programmers who plan to develop applications using either a Pascal compiler or 68000 assembly language. Chernicoff assumes a fairly high level of programming experience but assumes very little background with a Macintosh. Examples throughout both volumes are in Lisa Pascal and 68000 assembly language. From time to time this approach results in an uneven style, as the author goes into detail about Mac philosophy on one hand and skims over highly technical points related to programming in these languages on the other.

MINIEDIT: A SAMPLE PROGRAM

The most important feature of *Unlocking the Toolbox* is the sample program MiniEdit, which was developed using Lisa Pascal. MiniEdit is a simple interactive text editor that demonstrates many of the features of the Toolbox and

(continued)

Expansion Chassis/ Sub-System

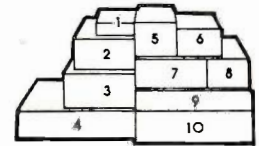

Specification

Model No.	No. of Slot	Half Height Drive	Power Supply	Dimension D x W x H (cm)	Price
M-1*	0	1	A or B	30 x 15 x 6.5	\$149
M-2	3	3	C	42 x 25 x 16	\$299
M-3	5	3	C	39 x 30 x 15	\$259
M-4	12	2	D	40 x 39 x 14	\$299
M-5	0	2	E	39 x 18 x 15	\$149
M-6	0	1	A or B	26.5 x 18 x 13.5	\$169
M-7	5	2	C	38.5 x 30 x 13.5	\$299
M-8	0	2	E	39.5 x 18 x 13.5	\$149
M-9	0	2	F	38.5 x 49 x 9	\$249
M-10	8	4	G or H	43 x 49 x 14	\$259

* Extra space for a stand alone controller

EXT and RCV Adapters

- Connecting master expansion chassis to PC, XT or AT
- Fully buffered address, data and control signals.
- 3 feet shielded flat cable.

Price \$159

Power Supply

	Watt	+5V	+12V	-12V	-5V
A	50	5.0	2.5		
B	50	1.8	3.5		
C	100	8.0	5.0	0.3	
D	100	10	3.5	0.5	0.5
E	45	4.0	2.0		
F	60	5.0	3.0		
G	135	15	4.2	0.3	0.3
H	150	15	6.0	0.3	0.3

ORDER TOLL FREE: (800) 826-0267
In California Call (415) 651-3355

DEALER INQUIRIES INVITED

SOURCE ELECTRONICS CORP.

45277 Fremont Blvd., Unit 6

Fremont, CA 94538

Telex: 279366

FAX: (415) 791-0935

THE PRICE LEADERS!!!

BUILD YOUR OWN PC!

IBM COMPATIBLE



COMPLETE SYSTEM

IBM PC-XT TYPE CASE #90180	\$ 39.00
150 WATT POWER SUPPLY #90155	\$ 79.00
5150 IBM-TYPE KEYBOARD #90130	\$ 49.00
MOTHER BOARD EXPANDABLE TO 640K WITH 128K INSTALLED #SPCL01	\$135.00
MONOCHROME GRAPHIC PRINTER BOARD #90010	\$ 85.00
FLOPPY CONTROLLER BOARD #92260	\$ 35.00
2-FLOPPY DISC DRIVES @\$85 EACH #93140	\$170.00
12" TTL HIGH RESOLUTION MONITOR #96710	\$ 97.00
COMPLETE WITH INSTRUCTION & ASSEMBLY MANUALS.	

YOUR COST **\$689.00**

Any of these components may be purchased separately.

All boards guaranteed for 1 year. IBM, PC/XT are trademarks of International Business Machines, Inc.

SmarTeam Modem



103/212A -
Operates at 300
Baud & 1200 Baud
• Hayes
Compatible
• Auto Answer,
Dial & Redial

Uses RS 232-C Connector
#91990 **\$165.00**

Magnovox Color Monitor



• RGB High Resolution • 14" diagonal
• 64 Dots/H-240 lines/V-2000 characters
• Built-in Tilt Stand
#97890 **\$350.00**

Key Boards



5151 IBM Type Key Board
Caps and Num Lock
#51515 **\$79.00**
K-150M AT IBM Type Key Board Over
size shift and return key.
#99020 **\$59.00**

Brother® Printer



Dot Matrix Printer
#96220 **\$75.00**

ADD ON BOARDS IBM COMPATIBLE

Monochrome Graphic Printer Board

• Built in Parallel Printer Port
• Text: 25 line x 80 column
• Graphics: 720 x 348 resolution
• TTL High Resolution Output
#92270 **\$85.00**

Multi I/O Card

• Built-in Floppy Controller that can drive
2 floppy drives • Two RS 232 Serial
Adapters • Timer Port • Parallel Printer
Port • Joystick Adapter
#96770 **\$88.00**

Multifunction Board

• Expandable to 384K RAM
• Serial Port, Game Port
• Parallel Printer Port
• Clock Calendar w/ Battery Backup
• Software, Manuals and Cables
#92290 **\$89.00**

RS 232 Serial Board

• 1 Serial Port
• 2nd Port optional
#92310 **\$29.00**

Color Graphics Board

• RGB and Composite Port
• Light Pen Interface
• Graphics: 320 x 200(color);
640 x 200(BW)
• Text: 25 x 80
#92280 **\$72.00**

Parallel Printer Card

• Also may be used as I/O Port
#92700 **\$29.00**

Floppy Disk Controller

• Drives 2 internal drives
• Includes cable
• IBM PC compatible
#92260 **\$35.00**

Plus A Huge Selection of Cables & Accessories!

THE WHOLESALE OUTLET

Dept. BY, 1 Interstate Avenue, Albany NY 12205. To order call
1-800-344-4387 (Non-NYS Res.) or 518-459-7883 (NYS Res.)
Personal and company checks accepted (on mail in orders.) Customer pays
freight & handling FOB Albany, NY. Non-credit card order shipped UPS. C.O.D.
Minimum order \$25. Dealer and large quantity
orders call 518-459-7883. Ask for Computer Dept.



BOOK REVIEWS

provides a framework for developing your own application program. Throughout the book small sections of MiniEdit are presented and explained. MiniEdit includes Toolbox routines that control events, windows, menus, controls (buttons, dials, scroll bars), cut-and-paste text editing, alert and dialog boxes, and disk I/O. (The complete source code, which is 45 pages long, is included as an appendix. It is also available from the Hayden Book Company for \$19.95 plus \$2.50 postage and handling.)

In Volume Two, Chernicoff has attempted to write a tutorial about the Toolbox for people who are already experienced with Pascal or 68000 assembly language. While the focus is on the technical knowledge needed to access the built-in routines that make a Macintosh program unique, the text is interwoven with Macintosh philosophy. For instance, the author points out that the Macintosh is dedicated to the principle that the user, not the computer, should be in control. On a Macintosh, a user controls the program by clicking the mouse or typing on the keyboard. Each user action is an "event" to which the program must respond.

Each chapter addresses one aspect of the Toolbox, illustrated by parts of MiniEdit and then explained in depth. A reference section after each chapter restates the procedures in both Pascal and assembly language.

Ordinarily in books of this type, sample programs are given so that they can be entered at a computer, run, and modified as learning experiences. This is not the case with the example procedures throughout this book. Due to the nature of Pascal and the complexity of MiniEdit, the examples are "shells" that are presented as a focus for the tutorials, to be studied and understood as "tools" for developing an actual program.

PASCAL COMPILER FOR THE MACINTOSH

In Volume One, Chernicoff warned that since MiniEdit was compiled on a Lisa, a few changes might be required when the program was used with the Macintosh Pascal compiler. Unfortunately, a Macintosh Pascal compiler was not available from Apple as I reviewed this book. Since MiniEdit is a major component of Volume Two, the book is far less useful than it could be. Translating MiniEdit so that it will run on the interpreted version of Macintosh Pascal is impractical because of this particular implementation's limitations. (I should mention that Chernicoff does not refer to the interpreted Macintosh Pascal in the book. Perhaps he assumed that either a Macintosh Pascal compiler would be available or that the reader would be using a Lisa or Macintosh XL.) A UCSD Pascal compiler and development system for the Macintosh are available from SofTech Microsystems (San Diego, CA).

TEXTEDIT REVEALED

Programming with the Toolbox provides a great deal of information about TextEdit, the text-editing facilities in the Toolbox that are comparable to QuickDraw, the graphics

(continued)

Europe's top-selling integrated software makes it easy to choose.

Top-of-the-line: **Open Access**® \$395*.

For starters: **Entry** \$195*.

OPEN ACCESS Comparison Chart	Database	Form Query	Report Generator	Query Processor	Relational Database	Graphics	3-D Graphics	Spreadsheet	Goal Seeking	Word Processor	Communications	Time Management	Price
Lotus 1-2-3	✓				✓	✓							495 ⁰⁰
Symphony	✓	✓			✓	✓		✓	✓				695 ⁰⁰
Framework	✓	✓	✓		✓	✓		✓	✓				695 ⁰⁰
Open Access	✓	✓	✓	✓	✓	✓	✓	✓	✓	✓	✓	✓	395^{00*}

*U.S. version only

ENTRY Comparison Chart	Database	Form Query	Report Generator	Query Processor	Word Processor	Mail Merge	Spreadsheet	Goal Seeking	Time Management	Mail Merge / Print Management	Price
pfs: file & report	✓	✓	✓								265 ⁰⁰
Q & A	✓	✓	✓	✓	✓						299 ⁹⁵
Multiplan						✓					195 ⁰⁰
Open Access Entry	✓	✓	✓	✓	✓	✓	✓	✓	✓	✓	195^{00*}

*U.S. version only

Open Access has sold almost 50,000 copies overseas. With one of the most powerful Relational Databases around, and just about all the additional features you could want, it's no wonder. Just take a look at the screens below and see all you get in this sophisticated business program. (We're even written in 11 languages with exact file transfer.) And now we offer it in the United States at a reduced price so you can find out what made it Europe's top-seller.

Or, to make it even easier, we offer you *Open Access Entry*™, for those who don't need all that *Open Access* has to offer. Yet. You get four programs plus all the documentation for the complete *Open Access* package so that updating will be a snap—for you and us. We make it easy. Just call today.

Available at better dealers nationwide. For your nearest dealer or distributor, call (619) 450-1526.



Relational Database

Spreadsheet

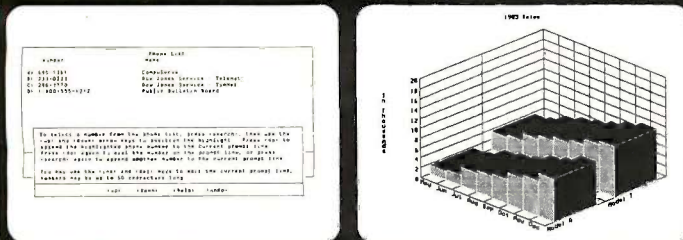

Communications

Graphics



Database

Spreadsheet

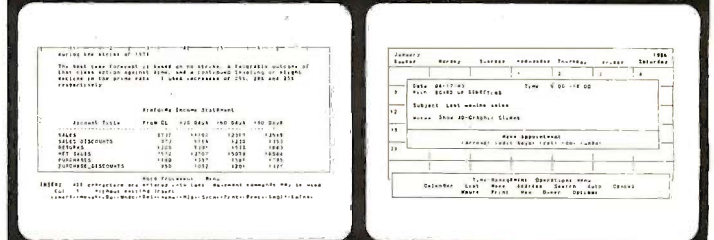

Word Processing

Time Management



Word Processing

Time Management

The product's exceptional. The price extraordinary. Can you really afford to compromise any longer?



SOFTWARE PRODUCTS INTERNATIONAL

10240 Sorrento Valley Rd. • San Diego, CA 92121 • (619) 450-1526 • Telex 499-0919

Open Access and SPI are registered trademarks of Software Products International, Inc.; Lotus, 1-2-3 and Symphony are registered trademarks of Lotus Development Corp.; Multiplan is a registered trademark of Microsoft; Q & A is a trademark of Symantec; Framework is a trademark of Ashton-Tate.

Inquiry 310 for End-Users. Inquiry 311 for DEALERS ONLY.

APRIL 1986 • BYTE 69

TOTAL CONTROL with LMI FORTH™

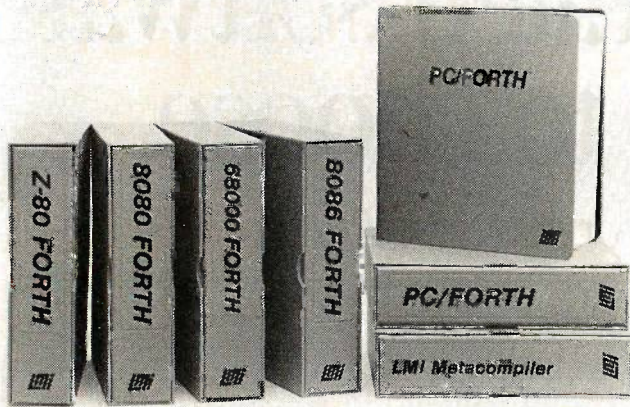

For Programming Professionals: an expanding family of compatible, high-performance, Forth-83 Standard compilers for microcomputers

For Development:

Interactive Forth-83 Interpreter/Compilers

- 16-bit and 32-bit implementations
- Full screen editor and assembler
- Uses standard operating system files
- 400 page manual written in plain English
- Options include software floating point, arithmetic coprocessor support, symbolic debugger, native code compilers, and graphics support

For Applications: Forth-83 Metacompiler

- Unique table-driven multi-pass Forth compiler
- Compiles compact ROMable or disk-based applications
- Excellent error handling
- Produces headerless code, compiles from intermediate states, and performs conditional compilation
- Cross-compiles to 8080, Z-80, 8086, 68000, and 6502
- No license fee or royalty for compiled applications

Support Services for registered users:

- Technical Assistance Hotline
- Periodic newsletters and low-cost updates
- Bulletin Board System

**Call or write for detailed product information
and prices. Consulting and Educational Services
available by special arrangement.**

LMI Laboratory Microsystems Incorporated
Post Office Box 10430, Marina del Rey, CA 90295
Phone credit card orders to: (213) 306-7412

Overseas Distributors.

Germany: Forth-Systeme Angelika Flesch, D-7820 Titisee-Neustadt
UK: System Science Ltd., London EC1A 9JX
France: Micro-Sigma S.A.R.L., 75008 Paris
Japan: Southern Pacific Ltd., Yokohama 220
Australia: Wave-onic Associates, 6107 Wilson, W.A.

BOOK REVIEWS

facilities. For example, TextEdit provides automatic word wrap, with any sequence of non-space characters defined as a word. Text is automatically wrapped after a cut, paste, or type-in. There are built-in routines for all standard cut-and-paste editing. Chernicoff also identifies some of the features that are *not* built in, such as Undo and automatic scrolling. MiniEdit includes the code for automatic scrolling, but you'll have to figure out Undo for yourself, since MiniEdit does not include procedures for that feature.

MAC FILE MANAGEMENT

The discussion of file management (I/O) provides some information applicable in day-to-day use of the Mac. A great deal of information is included about the Macintosh's built-in disk drive and how to create and use files. Chernicoff also explains how to use two of the standard packages in the system resource file, the Standard File Package (MiniFinder) and the Disk Initialization Package.

NOT THE BASIC REFERENCE

Macintosh Revealed, Volume Two: Programming with the Toolbox provides a combination tutorial and reference for developing a Macintosh application program. Unfortunately, despite its length (well over 1000 pages in the combined volumes), you'll still need the basic Macintosh reference, Apple's *Inside Macintosh*. *Programming with the Toolbox* does not include routines for using the printer and in many cases refers the reader to *Inside Macintosh* for more information. Of course, you will also need either Pascal or 68000 assembly-language reference books (and expertise) as well.

Bonnie L. Walker is Project Director of JWK International (7617 Little River Turnpike, Annandale, VA 22003), a systems analyst/programmer, and a technical writer.

EXPLORING THE PICK OPERATING SYSTEM

Reviewed by Larry Allen Heberlein

Exploring the Pick Operating System by Jonathan Sisk and Steve VanArsdale may well be the first book on the Pick operating system, even though Pick has been in use by businesses for a decade. A multiuser system for managing databases, it's available on a score of machines, including half a dozen implementations on the Motorola 68000. Recent releases of versions for the IBM PC XT and AT and the warm reception of the Pick clone Revelation have helped it along. (For an overview, see Parts I and 2 of Rick Cook and John Brandon's "The Pick Operating System," October and November 1984 BYTE. For a review of the PC version, see "Pick, Coherent, and THEOS" by Marc J. Rochkind, BYTE's *Inside the IBM PCs*, Fall 1985.)

TECHNIQUES

Unfortunately, this book is a disappointment. Stingy with examples but filled with unnecessary detail, lacking

(continued)

THE PROFESSIONAL'S CHOICE

Lotus 1-2-3 \$319	Lotus Symphony \$449	dBase III Plus \$369	FrameWork NEW II \$369	MultiMate \$219	Word Perfect 4.1 \$209
--------------------------------	-----------------------------------	-----------------------------------	-------------------------------------	---------------------------	-------------------------------------

Software

Word Processing Editors

FANCY FONT	\$139
FINAL WORD II	\$219
MICROSOFT WORD	\$239
MULTIMATE	\$219
MULTIMATE ADVANTAGE	\$269
OFFICE WRITER/ SPELLER	\$239
PFS: WRITE	\$ 89
SAMNA WORD III	\$259
THINK TANK	\$109
TURBO LIGHTNING	\$ 59
VOLKSWRITER 3	\$159
VOLKSWRITER SCIENTIFIC	\$269
WORD PERFECT 4.1	\$209
WORDSTAR 2000	\$249
WORDSTAR 2000+	\$289
WORDSTAR PRO	\$259
XYWRITE III	\$249

Database Systems

ALPHA DATA BASE MANAGER II	\$179
CLIPPER	\$359
CONDOR III	\$339
CORNERSTONE	\$259
DBASE III PLUS	\$369
KMAN 2	\$319
PARADOX	\$549
PFS: FILE/PFS: REPORT	\$169
POWERBASE	\$219
Q & A	\$199
QUICKCODE III	\$159
QUICKREPORT	\$159
R BASE 5000	\$359
REFLEX	\$59
REVELATION	\$559

Spreadsheets/Integrated Packages

ENABLE	\$349
FRAMEWORK II	\$369
JAVELIN	\$549
LOTUS 1-2-3	\$319
MULTIPLAN	\$135
OPEN ACCESS	\$259
SMART SYSTEM SPREADSHEET	\$529
AUDITOR	\$109
SUPERCALC 3	\$209
SYMPHONY	\$449

Graphics

CHARTMASTER	\$219
DIAGRAM MASTER	\$215
EXECUVISION	\$249
ENERGRAPHICS	\$189
FREELANCE	\$219
GEM DRAW	\$159
GRAPHWRITER COMBO	\$329
IN-A-VISION	\$289
MS CHART NEW OVERHEAD	\$189
PC DRAW	\$239
PC PRINTBRUSH	\$ 89
PFS: GRAPH	\$ 59
SIGNMASTER	\$159

Project Management

HARVARD TOTAL	\$279
PROJECT MANAGER	\$249
MICROSOFT PROJECT-NEW	\$249
PROJECT SCHEDULER NETWORK	\$339
SUPERPROJECT	\$209
TIMELINE 2.0	\$259

Desktop Environments

DESK ORGANIZER	\$ 69
GEM DESKTOP	\$ 39
SIDEKICK	\$ 39

Communications/Productivity Tools

CROSSTALK	\$ 99
PROKEY	\$ 89
KEYWORKS	\$ 59
RELAY GOLD	\$149
REMOTE	\$119
SMARTERM	\$Call
SMARTCOM II	\$ 99
SUPERKEY	\$ 55

Statistics

SPSS/PC	\$575
STATPAC-NWA	\$329
STATPAC-WALONICK	\$349
SYSTAT	\$419

Network Applications

DBASE III LAN PAK	\$569
KMAN 2	\$1195
OPEN SYSTEMS	\$459
R BASE 5000	\$839
REVELATION	\$999
WORD PERFECT	\$495

Languages/Utilities

CONCURRENT OOS	\$189
C86 C COMPILER	\$299
DR FORTRAN 77	\$219
FASTBACK	\$119
LATTICE C COMPILER	\$289
MARK WILLIAMS C	\$319
MICROSOFT C COMPILER	\$249
MS BASIC COMPILER	\$249
MS FORTRAN	\$229
NORTON UTILITIES	\$ 59
QUICK BASIC	\$ 79
TURBO PASCAL	\$ 49
XENIX	\$Call

Accounting

BPI	\$299
GREAT PLAINS	\$479
IUS EASYBUSINESS	\$319
ONE WRITE PLUS	\$179
OPEN SYSTEMS	\$359
PEACHTREE	\$299
REAL WORLD	\$399
STAR ACCOUNTING PARTNER II	\$529

Hardware *

Multifunction Boards

AST ADVANTAGE (128K)	\$359
AST 8 PAK PLUS (64K)	\$229
AST 8 PAK PLUS (384K)	\$259
AST RAMPAGE PC	\$299
AST RAMPAGE AT	\$429
GOLD QUADBOARD (0K)	\$419
INTEL ABOVEBOARD PS (64K)	\$339
ORCHID CONQUEST (0K)	\$279
ORCHID BLOSSOM (384K)	\$249
ORCHID PC TURBO W/ DTRBOARD (256K)	\$889
PERSYST TIME SPECTRUM (384K)	\$249
QUADBOARD (384K)	\$219
SILVER QUADBOARD (0K)	\$219
TECMAR CAPTAIN (384K)	\$229
TECMAR WAVE (64K)	\$209
J RAM-3	\$Call

Display Boards

EVEREX EDGE	\$299
EVEREX GRAPHICS	\$299
EDGE	\$299
HERCULES GRAPHICS CARD	\$299
HERCULES COLOR CARD	\$159
PARADISE COLOR/MONO	\$169
PARADISE MODULAR GRAPHICS	\$275
QUADRAM EGA+	\$379
SIGMA COLOR 400	\$489
STB EGA PLUS	\$399
TECMAR GRAPHICS MASTER	\$489
TSENG ULTRA PAK	\$429
TSENG ULTRA PAK-S	\$369

Emulation Boards

AST 5251-11	\$589
AST 5251-12	\$499
AST BSC	\$489
AST SNA	\$599
CXI 3278/9 Plus	\$959
IRMA	\$799
IRMALINE	\$999

Modems

AST REACH 1200	\$389
HAYES 1200	\$389
HAYES 1200B	\$349
HAYES 2400	\$579
TRANSET 1000	\$279
VENTEL 1200	\$389
HALF CARD	\$319
WATSON	\$319

Mass Storage/Backup

EXCEL STREAM 60 TAPE (INT)	\$899
OMEGA BERNOULLI BOX-IOHO	\$2399
IRWIN 310A 10MB TAPE (EXT)	\$850
IRWIN 110D 10MB TAPE (INT)	\$479
MAYNSTREAM 60MB TAPE (INT)	\$1199
MOUNTAIN DRIVECARD 20MB	\$949
PRIAM 42MB AT	\$1295
SYSCEN SMART IMAGE 20 MB (INT)	\$825
TALLGRASS	\$Call
TECMAR QIC-80AT TAPE (INT)	\$1199

Monitors

AMDEK 310A	\$169
AMDEK 600	\$379
AMDEK 710	\$439
AMDEK 722	\$499
PRINCETON HX-12	\$449
PRINCETON MAX-12E	\$179
PRINCETON SR-12	\$579
PRINCETON HX-12E	\$539
PRINCETON HX-9	\$329
TAXAN 122 AMBER	\$159
TAXAN 830/640	\$469/539

Networks

AST PC NET	\$Call
ORCHID PC NET	\$Call
3 COM	\$Call

Printers/Plotters

BROTHER TWINWRITER	\$939
DIABLO	\$Call
EPSON FX-85	\$359
EPSON FX-286	\$539
EPSON LQ-1000	\$799
EPSON HI-80	\$399
EPSON DX-10/20/35	\$Call
HP 7475A	\$Call
JUKI 6300	\$699
NEC 3550	\$889
OKIDATA 192	\$399
OKIDATA 193	\$519
TI 955	\$799
TOSHIBA P321	\$Call
TOSHIBA P341	\$Call
TOSHIBA P351	\$1069

Input Devices

KEYTRONIC 5151	\$179
KOALA	\$109
MICROSOFT MOUSE	\$129
PC MOUSE W/ PAINTPLUS	\$139

Accessories

CURTIS SURGE PROTECTORS	\$Call
DATASHIELD BACKUP POWER	\$Call
GILTRONIX SWITCHES	\$Call
MASTERPIECE PLUS	\$135
MICROFAZER INLINE BUFFERS	\$Call
TRIPLITE BACKUP POWER	\$Call
256K RAM SET	\$ 39
8087 MATH CHIP	\$135
80287 MATH CHIP	\$199

Hercules Graphics Card \$299	Mountain Drivecard 20 NEW \$949	Quadram NEW EGA \$379	Princeton HX-12E \$539	Smartmodem NEW 2400B \$549	IRMA Board \$799
---	--	------------------------------------	-------------------------------------	---	-------------------------------

*CALL FOR SHIPPING COSTS



LOWEST PRICE GUARANTEE!!

We will match current nationally advertised prices on most products. Call and compare.

free!

Diskette Library Case with your order



1-800-221-1260

In New York State call (718) 438-6057

TERMS:

Checks—allow 14 days to clear. Credit processing—add 3%. COD orders—cash, M.O or certified check—add \$5.00. Shipping and handling UPS surface—add \$3.00 per item (UPS Blue \$8.00 per item). NY State Residents—add applicable sales tax. All prices subject to change.



MON.-THURS. 9:00AM-8:00PM
SUN. & FRI. 9:00AM-4:00PM

Softline

Softline Corporation
P.O. Box 729, Brooklyn, N.Y. 11230
TELEX: 421047 ATLN UI
FAX: 718-972-8346

When you think of Xerox what do you think of?

It's almost instinctive to think of copiers whenever the name Xerox is mentioned. After all, 25 years ago we invented the category. And since that time we've become the gold standard for dependable and diverse desktop, mid and high volume copiers.

But just for the record, in the last 8 months we've introduced 30 new office systems and business solutions. **From Xerography To Lasography.** All of these new systems and solutions are designed to help you create, preserve and share documents of unsurpassed quality. And all are backed by Team Xerox. The people who provide a service and support organization second to none.

Most of these new systems are the direct results of harnessing the power of the laser. What we call

Lasography. You see, ten years ago Xerox believed the best way to print text and graphics from simple memos to complex reports would be through lasography. So, we began work on a new generation of office systems.

For instance, the Documenter System you see here gives office professionals a personal lasographic system right at their fingertips. A desktop system that lets them create and print documents of incredible clarity.

The Documenter consists of the Xerox 6085 Professional Computer System and the Xerox 4045 Laser CP. The 6085 offers a unique 19 inch bit map screen with multiple windows that allow you to spread out all of your work right in front of you.

The Xerox Documenter System.

In fact, its windows allow you to work on many things at once. Using either our ViewPoint® or MS-DOS® software.

And when you're ready to print documents, you can use the Xerox 4045 Laser CP shown here or one of the latest Xerox Diablo printers.

XEROX® and the identifying names and numbers are registered trademarks of XEROX CORPORATION. MS-DOS® is a registered trademark of Microsoft Corporation. IBM is a registered trademark of the International Business Machines Corporation. ViewPoint® is a registered trademark of XEROX CORPORATION.

The Xerox 4050 Laser Printing System featured here is the newest lasographic printer from Xerox. It offers the power and capabilities of the Xerox 9700 and 8700 in a medium speed laser printer.

We're also introducing the Xerox XPS 701. A low cost, full function, turnkey publishing system. The entry level XPS 701 enables you to create and manage text and graphic input. It's especially designed for large illustrated documents that require frequent revision, fast production turn-around and relatively small print runs.

The Xerox 4050 Laser Printing System.

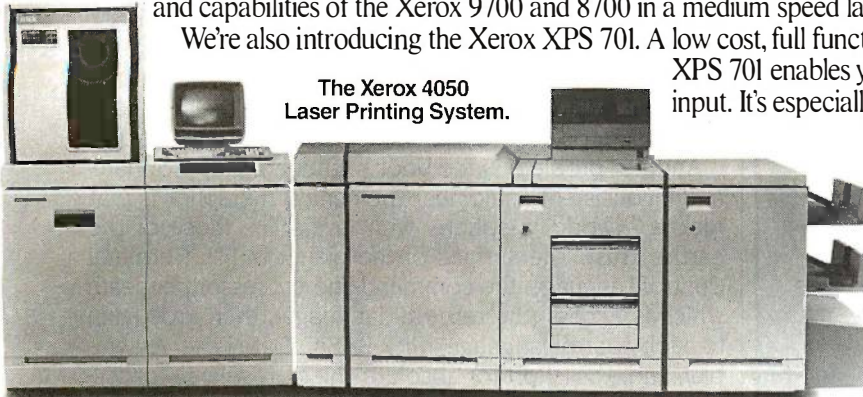

And for those who want more than a line printer but less than a laser printer, there's the Xerox 4060 Computer Printing System. Using Ion Deposition Technology, the advanced 4060 is ideal for the IBM data center.

Yet another exciting capabilities story revolves around networks and software.

The Most Complete Family Of Networks.

Xerox now offers the most comprehensive networking capabilities in the industry.

The new XC22 twisted pair network, is low cost and simple to install and takes advantage of existing telephone wires. The XC22 allows work groups to share information and resources such as laser printers and rigid disks.

The XC24 System uses a coaxial cable that can easily run along the base of office walls or in ceilings. And it's an entry-level option utilizing the same industry standard MS-DOS® operating system as does the XC22. The XC24 is also user installable, easy to learn and use.

Finally there's the XC80 network family using Ethernet. Fully configured networks, with virtually unlimited work stations, printers, storage, main frame communications and internetworking applications. The key to all of these networking capabilities is that we can design business solutions that enable small work groups or full departments to easily share information. Two examples are the new Xerox Integrated Financial Management and Purchasing Management Solutions. Both

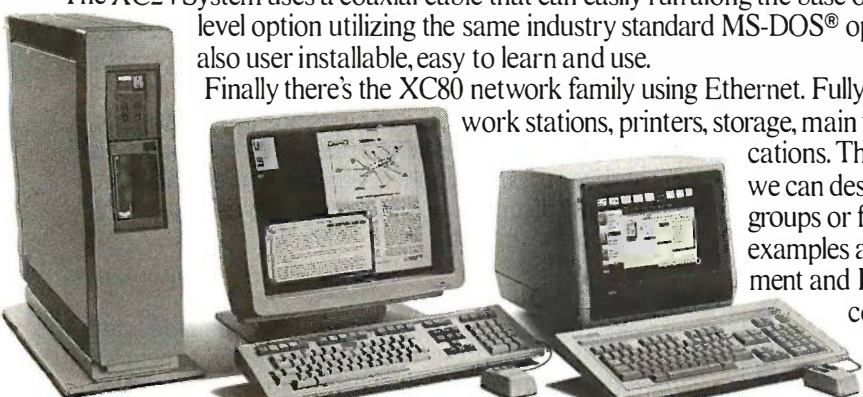

The Xerox XPS 701.

contain powerful departmental processing options such as sophisticated relational

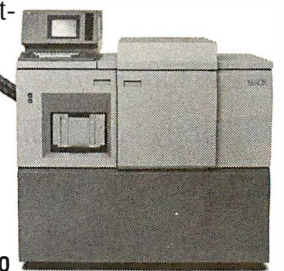

The Xerox 4060 Computer Printing System.

data-base management, host program access, electronic mail and high capacity file, disk and print services which enable each application to fulfill complete purchasing or financial needs. Xerox is also introducing the 4020 Color Ink Jet Printer, which is also network compatible. The 4020 can produce up to 4000 shades of seven primary colors. And finally Xerox is introducing

the Telecopier 7010. A portable digital facsimile transceiver that can transmit a hand written or typed page in just 25 seconds. Before we leave we'd like to remind you of Team Xerox. A unified support structure that includes people, products and services. All here to help you every step of the way.

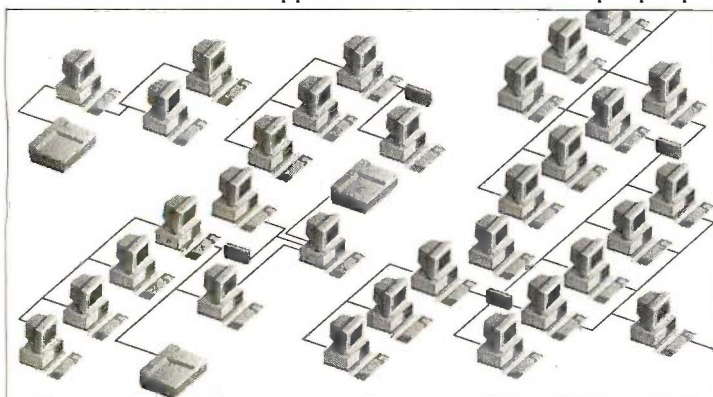

Xerox Networks.

So the next time you hear the name Xerox, we hope you'll think of more than just the world's most dependable copiers.

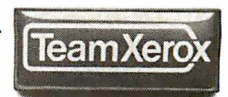

For more information, call your local Xerox sales office or:
1-800-TEAM XRX, ext. 213
 (1-800-832-6979, ext. 213)

Yes, I'm interested in learning more about the newest Xerox office systems and business solutions.

Send this coupon to: Xerox Corporation, P.O. Box 24, Rochester, NY 14692.

- | | |
|--|---|
| <input type="checkbox"/> The Documenter System | <input type="checkbox"/> The Xerox XPS 701 System |
| <input type="checkbox"/> The 4045 Laser CP | <input type="checkbox"/> The Xerox 7010 Telecopier |
| <input type="checkbox"/> The 4060 Computer Printing System | <input type="checkbox"/> The 4050 Laser Printing System |
| <input type="checkbox"/> Xerox Networks and Software | <input type="checkbox"/> The 4020 Color Ink Jet Printer |
| <input type="checkbox"/> Please have a sales representative call me. | |

STATE _____ TITLE _____
 COMPANY _____
 ADDRESS _____ CITY _____
 STATE _____ ZIP _____ PHONE _____

If you can't wait, call
1-800-TEAM-XRX, ext. 213
 (1-800-832-6979, ext. 213)

213

192 4/86

Compatibility without Compromise!!

50% FASTER

All included **\$1995**



Made in JAPAN

- CPU INTEL 80286 6/8MHz
- RAM 512KB on Mother Board
- 2 X 1.2MB Floppy Drives
- Floppy and Hard Disk Controller Card
- Turbo Display Color/Monochrome Card
- 1 Serial and 1 Parallel Card
- AT Keyboard
- Monochrome Display Monitor

OEM Acceptable

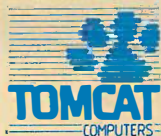

TOMCAT CORPORATION

Suite 304 3820 Del Amo Blvd., Torrance, CA 90503

TEL:(213)542-6646

TOMCAT COMPUTER Inc.

Yaguchi Bldg., 3-6-4 Nishiwaseda Shinjuku-ku, TOKYO

TEL:(03)208-2511 TELEX:J28984 FAX:(03)208-2662



BOOK REVIEWS

technical meat but replete with insider jargon, the book seems to have been put together without any clear conception of its audience. On one page the authors assume you have never touched a keyboard, and on the next page you're supposed to understand hexadecimal notation.

Another problem is the book's strained, inappropriate, and inconsistent analogies. The central metaphor is that Pick is a world, a sphere, with layers like those of the earth's crust. The surface of the planet is TCL (Terminal Cont of Language, the command-line processor), beneath which is Access (the retrieval language), then Proc (akin to a job control language), Pick BASIC, Data Base, Assembler, and Abs (short for absolute, the storage area for systems programs). These categories aren't even parallel. Most of the "levels" are languages. Data Base is all the files on the computer, and Abs is just a place where some things are kept.

The metaphor itself is inaccurate. The processors listed do *not* form a hierarchy. Proc, for example, does not have to go through BASIC to get to the database, nor does Access have to go through Proc. It is one of the strengths of the system that the languages use the same system routines. File updates or data conversions in Access, Proc, BASIC, or even Assembler all execute the same code. This integration contributes to Pick's thrifty use of hardware resources and distinguishes Pick from just about everything else on the market.

WHAT'S LEFT OUT

For reasons that escape me, Sisk and VanArsdale decided not to describe Pick BASIC—not even enough to write a program that will print "Hello." The standard that holds Pick implementations—and Pick clones—together is Pick BASIC, a language with a rich set of functions for manipulating the Pick database.

The book lacks a sense of balance. The bias of the authors is that the Pick operating system is revolutionary, a breakthrough, a window into a new era; that its users are sophisticated, artistic, gaining in productivity "while acquiring a new zeal and enthusiasm." Nowhere do the authors attempt to appraise Pick critically.

One advantage of the system is its use of dictionaries to describe the structure of a file. On the simplest level, I can use a dictionary to name a field in all the records in a file (e.g., the third field of all employee records will be named "Salary") and access the fields by name in a remarkably conversational retrieval language ("Sort Personnel by Salary").

More significantly, my dictionary can specify conversions to be performed as data is being retrieved. I can specify concatenation, extraction, range checking, or formatting. I can use the field as a search key for translation through another file. I can request that all sorts of math be done on the field before or after sorting it. For example, my dictionary could define "Take.Home.Pay" as weekly pay minus deductions and even explain how to figure the deductions,

(continued)

THUNDERSTONE ARTIFICIAL INTELLIGENCE

Consolidated Diesel, CDC, Cullinet, Crown Zellerbach, David Sarnoff Research Center, RCA Labs, Dunn & Bradstreet Computing Services, Inc., EG&G Washington, Riverview Hospital, General Electric.

PC MAGAZINE said our first AI product, **LOGIC-LINE 1™**, "... comes closer to achieving its lofty aims than most other PC programs that claim to possess intelligence.* We're pleased to announce our new company name, and two spectacular new products for your portfolio of data-manipulation assets.

QUESTION: IS AI "STILL CRAZY AFTER ALL THESE YEARS?"

We used to be *Clarity Software*. In our first advertising ever, we asked, "Would you buy a pacemaker from Mattel?" We asserted that, compared to **LOGIC-LINE 1** artificial intelligence software, competitive products were toys by comparison. *PC MAGAZINE* agreed. So did satisfied customers around the world, a few of whom are around this ad.

Our success has effectively stomped the mortal spit out of the brain-damaged geeks whose rancid cells have been polluting the gene pool of legitimate AI professionals.

Our aggressive ad also got a rise out of another *Clarity Software*, a Texas firm. Relax, *Clarity*. You had the name first, so we cloned Joshua, of Jericho fame, long enough to give us a new corporate name: **Thunderstone** (he had his own hunch about artificial intelligence - *JOSHUA 24:27* - suggesting that an ordinary stone can be made to remember events).

It's not too big a leap of logic to name a company "Thunderstone," especially if that company is trying to turn a bucket of sand (which is all a computer really is) into something even *artificially* intelligent.

So, now we're **Thunderstone**. Still railing at those trendy marketing wizards who figure that calling their product "AI" is enough reality (since they're into science fiction so seriously, we suggest they do something really creative, like starting their own religion). And we respectfully submit three **Thunderstone** products for your review: Our meteoric success, **LOGIC-LINE 1**, and two new rock-solid products, **LOGIC-LINE 2™** and **COMPREHENSION™**.

LOGIC-LINE 1: \$250 TRUE AI! CLONE THE WORLD'S GREAT MINDS ON YOUR PC.

LOGIC-LINE 1, a major breakthrough in sub-cognitive mathematics, distills the DNA/RNA-like analog to any writer's thought processes. It allows you to search any textbase for actual concepts and inference patterns unique to that writer.

LOGIC-LINE 1 lets you take advantage of the best minds the world has produced. Not only can you learn from history, but you can perpetuate the intellectual *essence* of the great thinkers. You can apply their thought processes to today's problems.

In other words, even though Einstein may never have had a single thought about ecology,

you can apply his thinking patterns to solving ecological problems! Or you can clone your own best thinking, again and again.

LOGIC-LINE 1 was produced by a couple of learning-cyberneticists and the physicist who developed one of the first DNA/RNA-tracking systems (Yes, boopie, the *RNA-of-thought* assertion is more than an advertising creation).

Can a PC simulate the thinking of great writers? We're sticking a money-back guarantee on our products, and to any so-called AI competition.

LOGIC-LINE 2: \$400 EXTENDING LOGIC-LINE 1 TO NUMERIC AND MATHEMATICAL CONCEPTS

What **LOGIC-LINE 1** is to textual data, **LOGIC-LINE 2** is to numeric and symbolic data.

At its lowest level, you can do pattern recognition on financial data, algebraic and chemical formulae, tax laws, manpower-allocation statistics and all the other data that makes the financial world go around. (Too bad Malcolm Forbes is already using the slogan "*Capitalist Tool*.")

And at its highest level? You just might use **Thunderstone** tools to save the free world, again.

That's right: *Again!* **LOGIC-LINE 2** began with the mathematics of *possibilistic analysis and recursion* (developed by men like Alan Turing and Norbert Wiener) that directly led the Wellington College team to breaking the German naval codes in World War II (if you're involved with SDI, there's a special federal/DOD-phone number below).

For customers who already own LOGIC-LINE 1, we will upgrade you to LOGIC-LINE 2 for the difference in price between the two packages: \$150.

COMPREHENSION: \$75 AN EXPERT SYSTEM THAT HELPS YOU DEBUG YOUR OWN THINKING/LEARNING PROCESS

Given our insights in analyzing the thinking process, it's only natural that we'd produce an *expert system* that helps you debug your own thinking and learning. **COMPREHENSION** is designed as a trouble-shooting companion for students or executives.

When it's 2:00 AM, and you have a 9:00AM exam or project deadline, your computer can now debug *you*. Through conditional branching structures, **COMPREHENSION** allows you to subjectively diagnose information-skill weaknesses and improves your overall intelligence/performance.

WAKING UP FROM THE BOOLEAN DREAM

It's time to make a major departure from "if-then" thinking. Human thought processes are much more versatile. **Thunderstone** has taken a major departure from boolean AI approaches. Ours are *sub-cognitive* tools, as opposed to *cognitive* tools (such as those from expert-system builders like *Teknowledge* in Palo Alto, one of the few reputable AI companies anywhere).

COMPREHENSION and the **LOGIC-LINE** series are intended to amplify the man-machine loop. Does **LOGIC-LINE** make the computer *think* like a man? No. As Frank Herbert (*DUNE*) says: "The human intellect is cast in the crucible of survival, not in the play of symbols." Nevertheless, **Thunderstone** products explore the mathematics of the human thought process as described by Pulitzer Prize-winning author Douglas Hofstadter (*METAMAGICAL THEMAS*): "The brain itself does not 'manipulate symbols'; the brain is the medium in which the symbols are floating and in which they manipulate each other."

The genius, then, of a particular mind, is evidenced by the DNA/RNA-like patterns of what Hofstadter calls *neural firings*. The product of that process is words. Words which can be analyzed by **LOGIC-LINE** to simulate further inference from your own best thinking, or from the long-dead, but still-great minds.

WHAT DO YOU THINK?

You may return any purchases, for any reason whatsoever, within 30 days for a full refund. We think you'll love **Thunderstone** software (We also think you're too smart to be fooled with \$249.95 or \$399.95 price tags): **COMPREHENSION** is \$75; **LOGIC-LINE 1** is \$250; **LOGIC-LINE 2** is \$400.

To find out more about **LOGIC-LINE 1**, **LOGIC-LINE 2** or **COMPREHENSION**, call 216/729-1132. To order by phone, call 800/621-5839 (or in Illinois, call 800/972-5855). If you are with the US government or one of the intelligence *spook shops*, **Thunderstone** software is available to federal/DOD buyers through IBIS Corporation, 131 Eldon Street, Herndon, VA 22070 (call 800/532-3344 or 703/478-0300). Please add \$5 shipping per order, and Ohio residents add 5% sales tax.

THUNDERSTONE CORPORATION

*AI from anyone else is like buying
a pacemaker from Mattel*

PO Box 839 • Chesterland, OH 44026 • USA
216/729-1132

AT LAST: Professional Typesetting Capability For PC Users

With **PC_TEXTM** — the best-selling full implementation of Professor Don Knuth's revolutionary typesetting program **T_EX**.

FINEST Typeset Quality Printing From:

dot matrix laser phototypesetter

$$\sum_{i=1}^{\infty} \frac{1}{i} \begin{pmatrix} a_{11} & \dots & a_{1n} \\ a_{21} & \dots & a_{2n} \\ \vdots & \ddots & \vdots \\ a_{m1} & \dots & a_{mn} \end{pmatrix} \int_{-\infty}^{\infty} e^{-x^2} dx$$

WIDEST Range Of Output Device Drivers:

- Epson FX, LQ
- HP LaserJet*
- Toshiba
- Apple LaserWriter
- Corona LP-300*
- APS-5 phototypesetter
- Screen preview, with EGA or Hercules card

MOST COMPLETE Product Offering:

PC **T_EX** (not copy protected) includes the following:

- Our specially written *PC_TEX Manual*, which enables you to start using **T_EX** right away.
- Custom "macro packages" that provide formats for letters, manuals, technical documents, etc.
- The **L_AT_EX** document preparation system, a full-featured macro package for preparing articles, books, reports, etc., and **L_AT_EX User's Manual**.
- **A_MS-T_EX**, developed by the *Amer. Math. Society* for professional mathematical typesetting.

Site licenses, volume discounts, and interfaces to PC Paintbrush, PC Palette, FancyFont and Fontrix are also available.

PRICED FROM ONLY \$249.00!

(Printer drivers and interfaces additional.)

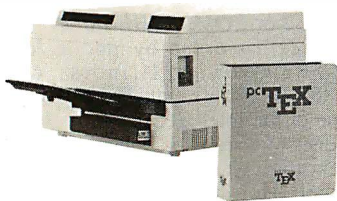

**Laser printer,
fonts & software
from \$295.00**

For IBM PC/XT, AT or compatible, DOS 2.0 or higher, and 512K RAM. Hard disk required for printer drivers and fonts.
*HP LaserJet and Corona require additional interface boards.

**For more information call or write:
Personal T_EX, Inc.**

20 Sunnyside, Suite H, Mill Valley, CA 94941 (415) 388-8853

This ad, with space for the photograph, produced by PC **T_EX**. Typeset on the Epson FX80, the Corona LP-300 laser printer, and the Autologic APS-5 phototypesetter.

T_EX is a trademark of the American Mathematical Society. Manufacturers' product names are trademarks of individual manufacturers.

BOOK REVIEWS

looking up my tax bracket in another file. The advantage here is the concept of virtual data—from the command line a user can list and sort data that doesn't exist until it's asked for. The authors explain the physical format of a dictionary item, but they don't communicate a sense of the power of dictionaries. Nor do they convey a sense of how the system's features could actually be used. The examples are not only sparse but also lifeless and abstract.

Unfortunately, the authors didn't take the time to compare Pick to more conventional and more familiar systems, either by way of explaining Pick or to help potential users decide what might be appropriate for their needs. (A comparison shopper might, for example, like to know how Pick and other systems handle the problem of multiple users trying to update the same record at the same time; this topic isn't mentioned.)

And they don't compare Pick systems with each other. Pick systems are not all alike. Some will let you execute TCL commands from inside a BASIC program. Some will let you retrieve and edit previous TCL commands. Various implementations call things by different names. In fact, the original implementation and the biggest seller calls things by different names than those used here, and the things act differently than described here.

THE GOOD POINTS

The index is copious and accurate. There is an excellent glossary of Pick terms. The typography and layout are well done, and the book is remarkably free of grammatical and typographical errors.

The authors know whereof they speak. The senior author is head of a large Pick training agency and author of the pocket reference guides Pick Systems publishes. Although the explanations might occasionally confuse (such as a sentence that appears to imply that a group is the same thing as a frame), if you can understand what is being said, you can be sure that it is technically accurate.

CONCLUSION

Pick is justly praised for its ease of use. Applications are easy to create in the programming environment, and the database is easy to access. User magazines are full of testimonials from executives that "at my last company, if I wanted a report I'd have to wait weeks until the data processing department could generate it; with Pick, I can get it myself in minutes." But ease of use is relative, and "Pick" isn't short for "point and click." It's a command-line environment, and to use it you have to learn the commands. Anyone who can master the command line of CP/M or MS-DOS could master Pick quickly. A book of this length could easily be produced that would teach novices everything they need to know in a few sessions. That book would serve a wide market, but this isn't that book. ■

A software engineer at CDI Information Systems, Larry Allen Heberlein (4132 Corliss N, Seattle, WA 98103) maintains the Pick operating system on the IBM Series/1.

EXPERIENCE THE FUTURE:

2500AD SOFTWARE INC

SERIES 4.0
ASSEMBLERS / CROSS ASSEMBLERS

2500AD Software Inc. is a company which specializes in developing assemblers and cross assemblers for the world's most popular microprocessors (listed below).

FEATURES:

- Series 4.0 has all in memory assembly and linking (FAST!). Series 3.0 buffers overflow to disk
- No limit to: program size, number of symbols, macros and user defined registers
- Powerful macros Conditional assembly Built in cross reference
- Assembly time calculation using 80-bit arithmetic Supports manufacturers mnemonics
- Built in floating point support for equating symbols and declaring storage locations
- Full listing format controls Linker included (One linker supports all microprocessors)
- Links 256 files, with 256 section names, to specific address or stacked in successive order
- Linker generates the most used file formats: Executable, Intel Hex, Extended Intel Hex, Tektronics Hex and Motorola S19, S28 and S37 formats
- Linker runs in either; Prompt Mode, Command Line Mode, or Data File Mode
- Assembler and Linker has a Quiet Mode option (great for use with compilers!!)
- 8086 Assembler has optional output in Microsoft relocatable format

In addition to our Assembler product line, please call or write for information concerning our new line of SIMULATORS for Single Chip Microcomputers. (Simulators for the 8051 and 8748 are available now!!)

TO ORDER: Simply circle the product you want (Price is listed under each product column for desired O/S)

<table style="width: 100%; border-collapse: collapse;"> <tr> <td style="padding: 2px;">Z8</td><td style="padding: 2px;">8080</td><td style="padding: 2px;">80186</td><td style="padding: 2px;">8086/88Δ</td><td style="padding: 2px;">8400</td><td style="padding: 2px;">84C00</td><td style="padding: 2px;">6501/11</td><td style="padding: 2px;">NSC800</td><td style="padding: 2px;">6800/02/08</td><td style="padding: 2px;">Z8000</td><td style="padding: 2px;">Z80.000◊</td> </tr> <tr> <td style="padding: 2px;">Z80▽</td><td style="padding: 2px;">8085</td><td style="padding: 2px;">80286</td><td style="padding: 2px;">8044/51</td><td style="padding: 2px;">8748</td><td style="padding: 2px;">64180</td><td style="padding: 2px;">83C351</td><td style="padding: 2px;">COPS400□</td><td style="padding: 2px;">6804 6805</td><td style="padding: 2px;">68000/08/10</td><td style="padding: 2px;">68020+◊</td> </tr> <tr> <td style="padding: 2px;">6301</td><td style="padding: 2px;">8096</td><td style="padding: 2px;">68C11</td><td style="padding: 2px;">6801/03</td><td style="padding: 2px;">6502</td><td style="padding: 2px;">65C02</td><td style="padding: 2px;">F8/3870□</td><td style="padding: 2px;">NEC7500□</td><td style="padding: 2px;">6809 1802□</td><td style="padding: 2px;">65C816◊</td><td style="padding: 2px;">32000</td> </tr> <tr> <td colspan="10" style="padding: 2px; text-align: center;">Super8◊</td><td style="padding: 2px;">NCR/32□</td> </tr> </table>	Z8	8080	80186	8086/88Δ	8400	84C00	6501/11	NSC800	6800/02/08	Z8000	Z80.000◊	Z80▽	8085	80286	8044/51	8748	64180	83C351	COPS400□	6804 6805	68000/08/10	68020+◊	6301	8096	68C11	6801/03	6502	65C02	F8/3870□	NEC7500□	6809 1802□	65C816◊	32000	Super8◊										NCR/32□			
Z8	8080	80186	8086/88Δ	8400	84C00	6501/11	NSC800	6800/02/08	Z8000	Z80.000◊																																					
Z80▽	8085	80286	8044/51	8748	64180	83C351	COPS400□	6804 6805	68000/08/10	68020+◊																																					
6301	8096	68C11	6801/03	6502	65C02	F8/3870□	NEC7500□	6809 1802□	65C816◊	32000																																					
Super8◊										NCR/32□																																					
MSDOS, CP/M 86, Z80 CP/M, XENIX, UNIX (ATT 7300)	\$ 199.50	\$ 299.50	\$ 399.50																																												
VMS, UNIX, ZEUS	\$ 995.00	\$1250.00	\$1500.00																																												
Δ \$99.50 under MSDOS ▽ \$99.50 under Z80 CP/M + Not available on Z80 CP/M □ Processors are not supported on Series 4.0 ◊ Processors are not supported on Series 3.0 NOTE: Series 4.0 is not available on Z80 CP/M and CP/M 86 Prices for Series 3.0 and 4.0 are the same Series 4.0 requires at least 512K of memory	TOTALS	\$	\$																																												
Name _____ Company _____ Address _____ City _____ State _____ Zip _____ Phone _____ Computer System _____ <input type="checkbox"/> COD (2500AD pays COD charges) <input type="checkbox"/> VISA or MasterCard # _____ Exp. Date _____	Select One: <input type="checkbox"/> Series 3.0 <input type="checkbox"/> Series 4.0	Check One: <input type="checkbox"/> 8" Single <input type="checkbox"/> Osborne <input type="checkbox"/> IBM PC <input type="checkbox"/> Cartridge Tape <input type="checkbox"/> Apple (Softcard) <input type="checkbox"/> Kaypro DSDD Other formats are available, please call:	TOTAL \$ _____ Shipping UPS Blue Label, no charge. For International shipments, \$20.00 per unit. \$ _____ \$ _____ 1/86 Signature TOTAL ORDER																																												

2500AD SOFTWARE INC

17200 E. Ohio Drive, Aurora, CO 80017 (303) 369-5001

E·V·E·N·T Q·U·E·U·E

April 1986

SECOND ANNUAL COMPUTER ART CONTEST FOR KIDS: COMPUTERS AND THE FUTURE. For an official entry blank, contact West Educational Publishing, 201 Castro St., 4th Floor, Mountain View, CA 94041, (800) 532-9378; in California, (415) 969-1283. Entries must be postmarked by May 1.

COMDEX/WINTER '86, Los Angeles Convention Center, Los Angeles, CA. The Interface Group Inc., 300 First Ave., Needham, MA 02194, (617) 449-6600. April 1-3

ELEVENTH WEST COAST COMPUTER FAIRE, Moscone Center, San Francisco, CA. Computer Faire Inc., 181 Wells Ave., Newton, MA 02159, (617) 965-8350. April 3-6

FEDERAL OFFICE SYSTEMS EXPO (FOSE '86), Washington Convention Center, Washington, DC. National Trade Productions Inc., 2111 Eisenhower Ave., Suite 400, Alexandria, VA 22314. April 7-10

IEEE INFOCOM-86, Miami, FL. IEEE Computer Society, 1109 Spring St., Suite 300, Silver Spring, MD 20901, (301) 589-8142. April 7-10

1986 IEEE INTERNATIONAL CONFERENCE ON ROBOTICS AND AUTOMATION, San Francisco, CA. Robotics and Automation, c/o Harry Hayman, 738 Whitaker Terrace, Silver Spring, MD 20901, (301) 434-1990. April 7-10

1986 TEST & MEASUREMENT WORLD EXPO, San Jose Convention Center, San Jose,

CA. Meg Bowen, Test & Measurement World Expo, 199 Wells Ave., Newton, MA 02159, (617) 964-8900. April 8-10

WESTERN REGIONAL COMPUTER TECHNOLOGY FOR THE HANDICAPPED, Los Angeles Convention Center, Los Angeles, CA. Closing the Gap, POB 68, Henderson, MN 56044, (612) 248-3294 or (507) 345-8233. April 9-13

ALASKA ASSOCIATION FOR COMPUTERS IN EDUCATION '86: FORGING THE LINK BETWEEN COMPUTERS AND CURRICULUM, Anchorage, AK. Dennis Daggett, Kenai Peninsula Borough School District, 148 North Binkley, Soldotna, AK 99669, (907) 262-5846. April 10-12

INTERVENTION STRATEGIES FOR THE NONSPEAKING, Children's Hospital of Philadelphia, Philadelphia, PA. Ann Campbell, Children's Seashore House, Communication Technology Center, 4100 Atlantic Ave., Atlantic City, NJ 08404, (609) 345-5191. April 11-12

NINETEENTH ANNUAL SMALL COLLEGE COMPUTING SYMPOSIUM, Rapid City, SD. Dale Rognlie, Mathematics and Computer Science Department, South Dakota School of Mines and Technology, Rapid City, SD 57701, (605) 394-2470. April 11-12

CHI '86: CONFERENCE ON HUMAN FACTORS IN COM-

PUTING SYSTEMS, Boston, MA. ACM Conference Management, 11 West 42nd St., New York, NY 10036, (212) 869-7440. April 13-17

AIM FIFTH ANNUAL CONFERENCE: INFORMATION MANAGEMENT IS EVERYBODY'S BUSINESS, Boston, MA. Associated Information Managers, 1776 East Jefferson St., 4th Floor, Rockville, MD 20852, (301) 231-7447. April 15-16

COMPUTER GRAPHICS NEW YORK '86, New York, NY. Andy Montgomery and Associates, 8300 Greensboro Dr., Suite 690, McLean, VA 22102, (703) 893-4545. April 15-17

WHAT CURRICULUM FOR THE INFORMATION AGE? New York, NY. Office of Continuing Education, Box 132, Teachers College, Columbia University, New York, NY 10027, (212) 678-3064. April 17

MICROCOMPUTER JUNGLE: IMPACT ON HEALTH CARE, Overland Park, KS. Carole Rosen, University of Kansas Medical Center, Office of Continuing Education, 39th and Rainbow Blvd., Kansas City, KS 66103, (913) 588-4480. April 17-18

ELEVENTH ANNUAL TRENTON COMPUTER FESTIVAL, Trenton, NJ. TCF-86, Trenton State College, Department of Electronics Engineering Technology, Hillwood Lakes CN 550, Trenton, NJ 08625,

(609) 771-2487. April 19-20

CONFERENCE ON EXPERT SYSTEMS AND ARTIFICIAL INTELLIGENCE IN PUBLIC POLICY, Syracuse, NY. Dr. Stuart Bretschneider, Technology and Information Management Program, The Maxwell School of Citizenship and Public Affairs, Syracuse University, Syracuse, NY 13210, (315) 423-1890. April 21-22

ROBOTS '86 CONFERENCE AND EXPOSITION: ROBOT APPLICATIONS FOR INTEGRATED MANUFACTURING, McCormick Place, Chicago, IL. Jeff Burnstein, Robotic Industries Association, POB 1366, Dearborn, MI 48121, (313) 271-7800. April 21-24

FOURTH ANNUAL CONFERENCE ON INTELLIGENT SYSTEMS AND MACHINES, Rochester, MI. Dr. Nan Loh, Center for Robotics and Advanced Automation, Oakland University, Rochester, MI 48063, (313) 370-2233. April 28-30

COMDEX/SPRING '86, Georgia World Congress Center, Atlanta, GA. The Interface Group Inc., 300 First Ave., Needham, MA 02194, (617) 449-6600. April 28-May 1

AI 1986: ARTIFICIAL INTELLIGENCE AND ADVANCED COMPUTER TECHNOLOGY CONFERENCE AND EXHIBITION, Long Beach Convention Center, Long Beach, CA. Tower Conference Management Co., 331 West Wesley St., Wheaton, IL 60187, (312) 668-8100. April 29-May 1 ■

IF YOU WANT your organization's public activities listed in BYTE's Event Queue, we need to know about them at least four months in advance. Send information about computer conferences, seminars, workshops, and courses to BYTE, Event Queue, POB 372, Hancock, NH 03449.

PC NETWORK GOES TO THE

O R I E N T D I R E C T

How do you suppose most manufacturers of personal computer products get started?

They go to the Orient... taking either their designs or simply their ideas to one or more of the major electronics manufacturing concerns, getting bids for making these devices under contract to the creators. Multifunction Cards, Video Cards, Disk Controllers, Modems and I/O Boards all begin their life in this way.

This relationship between the manufacturing capabilities of the East and the design and marketing talents of the U.S. has resulted in the incredible selection of enhancement products for the IBM and Apple computer markets.

Well, with 100,000 members and growing strong, The Network sent its buyers east to visit some of these manufacturing

concerns to check out the feasibility of directly importing these products in the necessary volumes to *save our members money!* What they came back with was astounding.

Now, we always figured that there were some pretty substantial markups as these boards came into the country and got fancy boxes and marketing promotions under any one of a number of well known brand names in the peripheral add-on markets *but we had no idea they were so large!*

To prove our point, consider what they brought back. Each board is constructed to the same precise standards, on similar machinery to their name-brand duplicates. The difference? *As a Network member, you pay only 8% over our unusually low wholesale price...and you get our full 1 year warranty!*

Hercules™ Smarter Brother

A Monochrome Graphics Card with Printer Port...100% compatible with Hercules™ product...

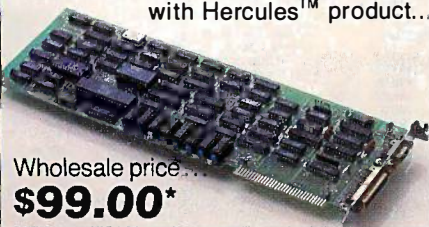

Wholesale price...
\$99.00*

Graphics Printer Interface

If all you want is a printer, this is the card for you. Supports all text and graphics printer features.

Wholesale price... **\$29.00***



The Multi-384 Board

A clone of the AST's SixPakPlus™ includes up to 384Kb of expansion memory, 1 serial, 1 parallel, 1 game port, a clock/calendar and software standard.

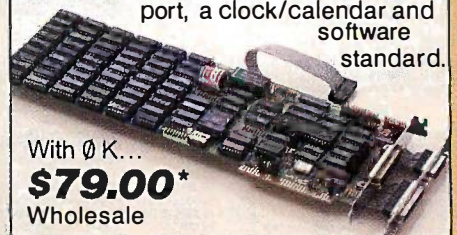

With 0 K...
\$79.00*
Wholesale

IBM Color Card

100% compatible with the IBM offering. The wholesale price?

A mere **\$69.00***

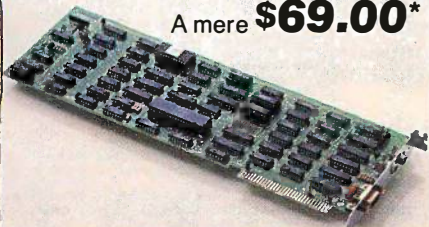

I/O Multifunction Card

Identical I/O board to the AST's I/O+™ with 2 serial, (1 standard) 1 parallel, 1 game port and clock/calendar with software.

Wholesale price...
\$65.00*

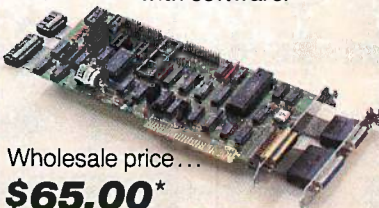

512 K Memory

The least expensive way to add memory to your current system. With 0 K installed.

Wholesale priced at only...

\$59.00*



™Six Pak, I/O Plus and AST are all registered trademarks of AST Research Inc. Hercules is a registered trademark of Hercules Computer Technology Inc.

*PC NETWORK Members pay just 8% above this wholesale price, plus shipping. All prices reflect a 3% cash discount. Minimum shipping \$2.50 per order. International orders call for shipping & handling charges. Personal checks: please allow 10 working days to clear.

CALL TOLL-FREE 1-800-621-SAVE In Illinois Call (312) 280-0002

PC NETWORK

GET THE NETWORK ADVANTAGE!!!

PC NETWORK

BUY HARDWARE AND SOFTWARE AT WHOLESALE + 8%, AND GET 14-30 DAY SOFTWARE RENTALS†...

Listed below are just a few of the over 30,000 products available at our EVERYDAY LOW PRICES! The Network carries products for Apple, IBM, CP/M and most other popular computer families.

GAMES & EDUCATIONAL SOFTWARE FOR YOUR APPLE II & MACINTOSH

(Please add \$1 shipping and handling for each title ordered from below.)

Wholesale	Wholesale
Axtons Home Accountant-Mac Only \$65.00*	Miles Computing Mac Attack-Mac Only \$23.00*
Arlyl Portillo's & Card Shoppe 31.00*	Palatir Mac Type-Mac Only 23.50*
Bluechip Baron/Millionaire/Tycoon 26.00*	Penguin Graphics Majestix 28.97*
Broderbund Loadrunner 19.75*	Penguin Pensator Xyphus 20.00*
Broderbund Chaplitter 19.00*	Penguin Transylvania-Mac Only 20.00*
Broderbund Phil Shop 28.75*	Professional Software Trivia Fever 19.00*
Broderbund Dazzle/Draw 31.97*	Priority Software Forbidden Quest 21.00*
CBS Mastering the GRE 53.50*	Scarborough Master Type 26.50*
CBS Murder by the Dozen 20.97*	Scarborough Fun for the Money 26.00*
CBS Goren Bridge Made Easy 45.00*	Simon & Schuster Typing Tutor III 28.25*
Counterpoint The News Room 26.97*	Sir-Tech Wizardry 26.97*
Davidson Speed Reader II 36.50*	Sir-Tech Knight of Diamonds 18.97*
Davidson Math Blaster 26.50*	Sir-Tech Rescue Raiders 18.97*
Davidson Word Attack! 26.50*	Sublogic Night Mission Pinball 20.00*
1st Byte Smooth Talker-Mac Only 47.00*	Sublogic Flight Simulator II 27.25*
Hayden Davinci-House/Interiors/Landscapes 24.75*	▶ Spinnaker Alphabet Zoo, Face Maker, 24.75*
Hayden Sargon III 25.75*	▶ Spinnaker Alpha, Hey Diddle Diddle, 25.75*
Infocom Deadline or Suspend? 24.00*	Rhymes & Riddles, Story Machine 20.77*
Infocom Enchanter: Planet/I 20.00*	▶ Spinnaker The Most Amazing Thing 24.97*
▶ Cuthroats, Witness or Zork I 20.00*	▶ Spinnaker Delta Drawing 25.00*
Infocom Hitchhiker's Guide or Seastraker 22.00*	T/Maker Click Art-Mac Only 19.77*
Infocom Suspect, Sorcerer or Infidel 22.00*	Warner Desk Organizer 65.00*
Infocom Zork II or III 22.00*	Videx Fun Pack-Mac Only 19.77*
Layered Front Desk-Mac Only 65.00*	Videx Mac Checkers & Reversal 25.17*
Mirage Concepts Trivia 11.00*	Virtual Combinatics Micro Cookbook 21.00*

BUSINESS SOFTWARE FOR YOUR APPLE II & MACINTOSH

(Please add \$2.50 shipping and handling for each title ordered from below.)

Wholesale	Wholesale
▶ Apple Apple Works \$160.00*	▶ Microsoft Word for Macintosh \$102.00*
▶ Borland International Turbo Pascal 30.00*	▶ Microsoft File for Macintosh 102.00*
BPI GL, AP, AP, or HW 20.00*	▶ Microsoft Instruments for Macintosh 102.00*
Broderbund Bank Street Writer 40.00*	Microsoft Basic for Macintosh 79.00*
Central Point Copy II Plus or Copy II Mac 66.00*	Microsoft Chart for Macintosh 66.00*
Funk Software Sideways 32.00*	Monogram Dollars & Sense for Apple II 55.00*
Funsoft Macasm 60.00*	Monogram Dollars & Sense for Macintosh 70.00*
Haba Habadex 40.00*	Odesia Helix for Macintosh/Regis 512K 135.00*
Haba Quaver! 97.00*	Prove Oversee-Mac Only 67.50*
Harvard Mac Manager 29.95*	Sendable Software Sensible Speller IV 125.00*
Human Edge Mind Prober 24.00*	Softcraft Fancy Fonts 37.00*
▶ Human Edge Sales Edge 110.00*	Softech Microsystems UCSD Pascal 37.00*
Human Edge Communication Edge 98.00*	Software Arts TK Solver for Mac 134.00*
▶ Living Videotext Think-Thank-Mac Tool 65.00*	Software Publishing PFS: File, Write, or Graph 68.00*
▶ Main Street File-Mac Only 67.00*	Stoneware DB Master-Mac Tool 85.00*
▶ MECA Managing your Money 87.50*	Telos Filevision for Mac 87.50*

HARDWARE FOR YOUR APPLE II & MACINTOSH

(Please add shipping and handling charges found in italics next to price.)

DISK DRIVES

Wholesale	Wholesale
Alps AP-100A Dual Apple Drives in One Case \$309.00* (7.00)	Hayes Micromodem II w/Smartcom \$125.00* (2.50)
Apple MAC 400KB External Drive 349.95* (7.50)	Noves Microemul Call! 174.45* (3.50)
Corvus 5.5MB Hard Drive 939.00* (20.28)	Prometheus 1200A 276.00* (6.00)
▶ Omega Macquint 5.5MG Removable Drive for Macintosh 1,250.00* (27.00)	Low Cost 1200 Baud Internal Modem for Apple II 299.00* (6.00)
Micro SciA2 145KB Drive 150.00* (5.00)	Prometheus Promodem 1200 w/MacPack 95.00* (2.50)
Micro SciA2 160KB Drive 150.00* (5.00)	Zodius Modem II 95.00* (2.50)
Micro Sci Floppy Controller 55.00* (2.50)	Zodius Modem II Micromodem Compatible-Free Dow Jones 95.00* (2.50)
▶ Paradise Mac 10MB Hard Drive 750.00* (16.20)	
Subsystem	
▶ Paradise Mac 20MB Hard Drive 950.00* (20.52)	
Subsystem	
▶ PC Network 140K External Drive for Apple II 95.00* (2.50)	
Rana Elite! 163K Drive 225.00* (5.00)	
Tecmar 5MB Removable Drive for MAC 999.00* (21.58)	
Tecmar 10MB MAC Drive 999.00* (21.58)	
Tecmar 5MB MAC Drive Upgrade 1,235.00* (26.68)	

BOARDS AND BUFFERS

Wholesale	Wholesale
ALS Z-Engine \$115.00* (2.50)	Amdek Video 300G Composite Green \$110.00* (3.00)
AST Multi I/O-2 serial/Clock 155.00* (2.50)	Amdek Video 300A Composite Amber 120.00* (3.00)
Microsoft Premium Softcard II 243.67* (2.50)	Amdek Video 310 A1BM Type Amber 130.00* (3.00)
Microtek Dumping/GX 55.00* (2.50)	Amdek Color 300 NEW Composite 215.00* (4.68)
Orange Micro Grappler+ 66.00* (2.50)	Amdek Color 300 NEW High Res RGB 365.00* (7.89)
Orange Micro Serial Grappler 66.00* (2.50)	Amdek Color 700 NEW Ultra High Res 495.00* (8.83)
PC Network Z80 Card 35.00* (2.50)	Amdek Color 710 NEW! 700 w/Non Glare 475.00* (10.48)
Quadram APIC/G Graphics Interface 62.00* (2.50)	Long Phosphor 399.00* (8.62)
Quadram e-RAM-60 88.00* (2.50)	Princeton MAX-12e 159.00* (5.00)
Quadram Multicore-1 Parallel/1 Serial/Clock Expandable to 256K 140.00* (2.50)	Work with Color/Mono Card! 289.00* (6.24)
Thunderware Thundercock 104.00* (2.50)	Quadram Quadchrome II New! 640X200 RGB w/14" Screen/Black Phosphor Mask/IBM Case 85.00* (5.00)

MEMORY CHIPS

(All Memory Chips Guaranteed for Life!)

Wholesale	Wholesale
▶ 64K Memory Upgrade Kits (9 Chips) \$9.00* (1.00)	Amdek Video 300G Composite Green \$110.00* (3.00)
Quantity Discounts Available!	Amdek Video 300A Composite Amber 120.00* (3.00)
▶ 64K Dynamic Ram Chips (Each) 1.00* (1.00)	Amdek Video 310 A1BM Type Amber 130.00* (3.00)
▶ 256K Dynamic Ram Chips (Each) 2.25* (1.00)	Amdek Color 300 NEW Composite 215.00* (4.68)
▶ 128K IBM AT Piggback Chips (Each) 5.50* (1.00)	Amdek Color 300 NEW High Res RGB 365.00* (7.89)
	Amdek Color 700 NEW! Ultra High Res 495.00* (8.83)
	Amdek Color 710 NEW! 700 w/Non Glare 475.00* (10.48)

EXTERNAL MODEMS

Wholesale	Wholesale
Anchor Signalman Express \$205.00* (5.00)	Amdek Video 300G Composite Green \$110.00* (3.00)
Hayes Smartmodem 300 125.00* (5.00)	Amdek Video 300A Composite Amber 120.00* (3.00)
Hayes Smartmodem 1200 340.00* (5.00)	Amdek Video 310 A1BM Type Amber 130.00* (3.00)
Hayes Smartmodem 1200B with new Smartcom II V1100 Emulator 317.00* (2.50)	Amdek Color 300 NEW Composite 215.00* (4.68)
Hayes Smartmodem 1200B Alone 265.00* (2.50)	Amdek Color 300 NEW High Res RGB 365.00* (7.89)
Hayes Smartmodem 2400 335.00* (2.50)	Amdek Color 700 NEW! Ultra High Res 495.00* (8.83)
Prometheus Promodem 1200 276.00* (6.00)	Amdek Color 710 NEW! 700 w/Non Glare 475.00* (10.48)
External 100% Hayes Compatible	Long Phosphor 399.00* (8.62)
▶ U.S. Robotics Courier 2400BPS Modem 395.00* (5.00)	Princeton MAX-12e 159.00* (5.00)
▶ U.S. Robotics Passport 195.00* (4.00)	Work with Color/Mono Card! 289.00* (6.24)
LOWEST PRICE 1200BPS Modem!	Quadram Quadchrome II New! 640X200 RGB w/14" Screen/Black Phosphor Mask/IBM Case 85.00* (5.00)

TERMS & CONDITIONS

*PC NETWORK—Members pay just 8% above the wholesale price. All prices reflect a 3% cash discount. Minimum shipping \$2.50 per order. International orders call for shipping & handling charges. Money orders, personal and company checks please allow 10 working days to clear. All prices subject to change without notice!

†RENT BEFORE YOU BUY—Members are eligible to join the NETWORK'S Business and Game software Rental Libraries and evaluate products for a full 14 (Regular) or 30 (VIP) days to see if it meets your needs. And the NETWORK'S rental charges are far less than other software rental services—Just 20% OF THE MEMBER WHOLESALE PRICE. Rental titles available in IBM/Apple/MAC and CP/M Formats. Hardware prices highlighted by * reflect recent major price reductions.

GAMES & EDUCATIONAL SOFTWARE FOR YOUR IBM

(Please add \$1 shipping and handling for each title ordered from below.)

Wholesale	Wholesale
ATI Intro to PC DOS Vol 1 & II \$23.00*	▶ Infocom Deadline, or Suspend? \$24.00*
ATI Intro to BASIC 23.00*	Microsoft Flight Simulator 27.00*
Bluebus Chess (Your Toughest Opponent) 34.25*	Mouse Systems PC Paint—Turn your PC into a Color Macintosh! 59.95*
Bluechip Millionaire/Oil Baron or Tycoon 28.00*	Scarborough Master Type 26.50*
Broderbund Lode Runner 19.75*	Sierra On-Line King's Quest II 27.00*
CBS Goren Bridge Made Easy 40.00*	Sierra On-Line Crossfire 18.00*
CBS Mastering the SAT 50.00*	▶ Spinnaker Alphabet Zoo, Kinder Comp, 32.25*
CDEX Training for Word Star 37.00*	▶ Spinnaker Alpha, Hey Diddle, Diddle, 25.75*
Comprehensive Intro to Personal Computing 32.00*	Rhymes & Riddles 24.97*
Davidson Math Blaster, Word Attack! 26.50*	▶ Spinnaker Most Amazing Thing 20.77*
Davidson Speed Reader II 36.50*	Sublogic Night Mission Pinball 20.00*
Hayden Sargon III 25.75*	Virtual Combinatics Micro Cookbook 21.00*
Individual Professor DOS 32.50*	
Individual The Instructor 24.50*	
▶ Infocom Zork I or Witness 20.00*	

BUSINESS SOFTWARE FOR YOUR IBM

(Please add \$2.50 shipping and handling for each title ordered from below.)

Wholesale	Wholesale
▶ Ashton-Tate DBase II \$365.00*	MicroPro Wordstar 2000 \$219.00*
▶ Ashton-Tate Framework II 365.00*	MicroPro Wordstar 2000+ 262.00*
Borland Turbo Pascal 25.75*	MicroRM RBASE 5000 300.00*
Borland Sidekick (Protected) 26.00*	Microsoft C Compiler 220.00*
Borland Superkey 32.00*	Microsoft Word—Latest Version 2.0 202.00*
BPI GL, AIR or AP 305.00*	Microsoft Multiplan 101.00*
BPI Aura 265.00*	Microsoft Mouse 107.00*
BPI Personal Accounting 48.00*	Monogram Dollars & Sense 95.00*
Breakthrough Timeline 230.00*	▶ Multimedia, Multimedia II (Latest Version) 190.00*
▶ Central Point Copy II/PC 20.00*	Norton Norton Utilities 3.0 46.00*
Conceptual Instruments Desk Organizer 157.00*	Oasis The Word Plus 75.00*
Digital Research DR Logo 75.00*	Open Systems P/O Sales A/R/INVTGL A/P Team Mgr. ea. 275.00*
Digital Research Gen Desktop 26.00*	Power Base Power Base 197.00*
Digital Research Gem Draw 73.00*	Real World GL, A/P A/R or OE/INVT ea. 275.00*
Enertronics Energraphics 155.00*	Rosesoft Prokey Version 3 65.00*
Funk Software Sideways 32.00*	Ryan McFarland RM COBOL (Dev. System) 52.00*
▶ Harvard Harvard Project Manager 175.00*	▶ Samna Samna III Word Processor 227.00*
▶ Harvard Total Project Manager 225.00*	▶ Samna Samna IV 320.00*
▶ Hayes Smartcom II—New V1100 Emulator 86.00*	▶ Satek Software Word Perfect 190.00*
▶ Human Edge The Management Edge 137.50*	Softcraft Fancy Fonts 125.00*
▶ Human Edge The Sales Edge 110.00*	Softcraft Arts TKI Solver 200.00*
▶ Human Edge Mind Prober 24.00*	Software Publishing PFS: File, Write, Graph 68.00*
Infocom Cornerstone 242.00*	Software Publishing PFS: Report 64.00*
Lifefree Volkswriter III 135.00*	Sorcim SuperCalc III 169.00*
▶ Lotus Development Lotus 1-2-3 285.00*	Xanaro Ability 247.50*
MDBS KnowledgeM2 239.00*	

HARDWARE FOR YOUR IBM

(Please add shipping and handling charges found in italics next to price.)

DISK DRIVES

Wholesale	Wholesale
▶ Omega Beroulli Box Dual 10MB Drives \$2,149.00* (46.42)	Everex Evercom II w/Bitcom Software \$119.00* (2.50)
▶ PC Network 10MB INTERNAL Height Autoloop Drive New lower price 340.00* (7.34)	Low Cost Short Shell Hayes Compatible 1200 BPS Modem 262.00*
PC Network 10MB Tape Backup 395.00* (8.94)	Hayes Smartmodem 1200B with New Smartcom II/V1100 Emulator 312.00* (2.50)
Same unit used in Compaq's DeskPro	Hayes Smartmodem 1200B Alone 265.00* (2.50)
PC Network AT 42MB Internal Hard Disk 1,155.00* (24.95)	Prometheus Promodem 1200B Internal 225.00* (2.50)
35MS Access Time—Comes Complete	
PC Network 20MG Tape Backup 495.00* (10.69)	
Half Height Internal w/Controller	
PC Network 20MB Internal w/ Micro Science 400.00* (8.64)	
PC Network Drives by Seagate or High Science 59.00* (1.27)	
▶ Tandem TM 100-2 Full Height DS/DD Drives 93.00* (2.20)	

VIDEO CARDS

Wholesale	Wholesale
Hercules Color Card w/Parallel Port \$142.00* (2.50)	▶ Hercules Monochrome Graphics Card 263.00* (2.50)
▶ Hercules Monochrome Graphics Card 263.00* (2.50)	Paradise Modular Graphics Card 219.00* (2.50)
▶ Paradise Modular Graphics Card 219.00* (2.50)	▶ PC Network Hercules Mono Card Clone 99.00* (2.50)
▶ PC Network Hercules Mono Card Clone 99.00* (2.50)	100% Hercules Compatible!
▶ PC Network Color Card 69.00* (2.50)	▶ PC Network Ultra High Res Color 299.00* (2.50)
▶ PC Network Quad EGA + Enhanc'd Graphics Adapter 340.00*	
▶ STB Graphix Plus II 199.00* (2.50)	

MULTIFUNCTION CARDS

Wholesale	Wholesale
Apparat AT Ram Expansion Card \$139.00* (2.50)	▶ Brand Name DS/DD Disks 88.95* (1.00)
▶ AST SixPakPlus™ With 64K 195.00* (2.50)	Guaranteed for Life! Not Generic!
AST™ I/O Plus II™ 120.00* (2.50)	▶ DS/DD Bulk Rate Special .59¢ ea.
AST™ Advantage for AT™ 355.00* (2.50)	Packaged in 50 with sleeves and labels
▶ AST Advantage Card/64K 160.00* (2.50)	Guaranteed for Life!
▶ PC Network 512K Memory Board w/OK PC Network The Multi-384 Board 59.00* (1.10)	▶ PC Network Replacement 130 Watt 7000* (2.70)
A clone of the AST's™ SixPakPlus.™ Includes up to 384K of expansion memory, 1 serial, 1 parallel, 1 game port, a clock/calendar and software standard.	IBM PC/AT Base System—12MB Floppy/256K 2,795.00* (60.37)
▶ PC Network I/O Plus II Clone 65.00* (2.50)	IBM AT Professional System CALL
▶ PC Network I/O Plus II Clone 65.00* (2.50)	1.2MB Floppy/20MB Hard Disk I Ser/1 Par/512K
Quadram Improved Quadboard w/OK 170.00* (2.50)	
Quadram Quad Sprint Turbo Board 360.00* (2.50)	
Tecmar Captain Multifunction Card w/OK 146.00* (2.50)	

ACCESSORIES

Wholesale	Wholesale
▶ Brand Name DS/DD Disks 88.95* (1.00)	Guaranteed for Life! Not Generic!
▶ DS/DD Bulk Rate Special .59¢ ea.	Packaged in 50 with sleeves and labels
Guaranteed for Life!	▶ PC Network Replacement 130 Watt 7000* (2.70)
▶ PC Network Replacement 130 Watt 7000* (2.70)	IBM PC/AT Base System—12MB Floppy/256K 2,795.00* (60.37)
IBM PC/AT Base System—12MB Floppy/256K 2,795.00* (60.37)	IBM AT Professional System CALL
IBM AT Professional System CALL	1.2MB Floppy/20MB Hard Disk I Ser/1 Par/512K

COMPLETE SYSTEMS

Wholesale	Wholesale
Apple Macintosh Base Systems CALL	▶ COMPAQ Hard Disk Portable CALL
AT&T 6300 PC CPU2 \$1,575.00* (34.02)	10MB Hard Disk/Floppy/256K
128K/2 CPU1 1 Serial/1 Parallel	▶ IBM PC Base System 20SDDD/FDD/256K \$1,325.00* (30.78)
AT&T 7300 Unix PC 3,699.00* (79.90)	▶ IBM PC Professional Hard Disk 1,685.00* (36.91)
10MB Hard Disk/1 Floppy/512K	▶ IBM PC/AT Base System—12MB Floppy/256K 2,795.00* (60.37)
COMPAQ DeskPro/Teke Backup System w/640K/1 Floppy/10MB Hard Disk/10MB Tape Drive/Monitor 2,446.00* (63.70)	

PRINTERS

Wholesale	Wholesale
▶ Citizen MSP-10 NEW! \$265.00* (5.72)	▶ NEC 3530 33CPS LQ Parallel \$ 888.00* (19.18)
160CPS/80CPL/Fric + Trac	▶ NEC 3550 33CPS Letter Quality Printer 920.00* (17.87)
▶ Citizen MSP-15 NEW! 350.00* (7.56)	▶ NEC 8850 55CPS Printer 1,330.00* (28.73)
160CPS/132CPL/Fric + Trac	▶ NEC Pmwinter 2 New Color Dot Matrix 599.00* (12.94)
▶ Citizen MSP-20 NEW! 350.00* (7.56)	Okidata ML 182 New 120CPS/LQ Model/Fric/IBM Graphics + more CALL
200CPS/80CPL/Fric + Trac	Okidata ML 192 New Steek Design/160CPS/LQ Model/Fric/IBM Graphics CALL
▶ Citizen MSP-25 NEW! 499.00* (10.76)	Okidata Color 20 80CPS/100 + Colors/LQ Model/IBM Graphics + More (Requires Interface) CALL
200CPS/132CPL/Fric + Trac	Okidata IBM Interface for Okimate CALL
▶ Citizen Premier 35 NEW! 385.00* (8.32)	Okimate 20 350CPS/132CPL CALL
35CPS Daisywheel/132CPL/Fric + Trac	Okidata ML84P 200CPS/132CPL CALL
▶ Epson LX-80 100CPS/80CPL LQ Model! 199.00* (4.30)	Okidata ML93P 160CPS Wide Platen CALL
▶ Epson FX-85 299.00* (6.46)	Okidata 210P Pwemark 350CPL CALL
▶ Epson FX-286 NEW! 459.00* (9.91)	Qume Sprint III 400CPS/Letter Quality 1,155.00* (24.00)
Epson L10100 NEW! 180 CPS/60 CPS LQ CALL	Star Microscans Power type 18CPS 300.00* (6.48)
Epson 602000 NEW! Inkjet Printer 1,359.00* (29.35)	Toshiba P1340 80CPL/144CPS 430.00* (9.29)
100CPS LQ Model/176CPS Draft/132CPL	Toshiba P341 New! 210CPS/132CPL 699.00* (15.09)
Epson DX-35 35CPS Letter Quality Printer 569.00* (12.29)	Toshiba P351 New! 288CPS/132CPL 975.00* (21.06)
▶ NEC 2030 20CPS LQ Parallel 605.00* (13.00)	
▶ NEC 2050 20CPS Letter Quality Printer 605.00* (13.00)	

Reason #1
You've made us the biggest, with your belief in our marketing and product selection, with your faith in our customer support programs, and you've demonstrated all this by joining the PC Network.

We're #1 In The World

with the Number One Buy of the Month
Hayes™ Smartmodem 1200B
IBM™ PC, XT, AT Compatible
Modem From the Industry Leader.



\$305.00*
Wholesale Price
with Smartcom II™

Hayes

Smartcom II™ ver. 2.1
for the IBM™ PC
Wholesale Price **\$68.00***

*PC Network members pay 8% above this wholesale price plus shipping.



NO POSTAGE
NECESSARY
IF MAILED
IN THE
UNITED STATES



BUSINESS REPLY CARD

First Class Permit No. 14823 Chicago, IL

POSTAGE WILL BE PAID BY ADDRESSEE

PC NETWORK
320 West Ohio
Chicago, Illinois 60610

COMPLETE SYSTEMS

(Optional local warranty service available in most major metro areas)

IBM PC BASE SYSTEM

IBM PC w/256K
Floppy Drive Controller
2 Double Sided Double
Density Disk Drives
Mix and Match with
your Favorite Monitor
and Printer!

\$1,325.00*

CALL FOR
LATEST IBM
ANNOUNCEMENTS

New Lower Prices!

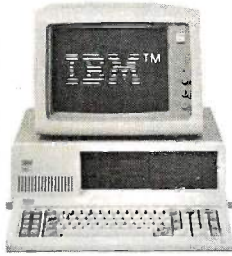

IBM PC HARD DISK SYSTEM

IBM PC w/256K
Floppy Drive Controller
1 Double Sided Double
Density Disk Drive
Half Height 10MB
Disk Subsystem

\$1,685.00*

CUSTOM
CONFIGURATIONS
WELCOME

COMPAQ™

PORTABLE HARD DISK SYSTEM

w/256K/1 Floppy/10MB Hard Disk



\$2,269.00*

w/20MB
Call for 10MB

DESKPRO SYSTEM WITH TAPE BACKUP

640K CPU/1 Floppy/10MB Hard Disk
10MB Tape Drive/Monitor



\$2,446.00*

w/10MB
\$2,596.00* w/20MB

APPLE IIc



APPLE IIe



MACINTOSH SYSTEMS



64K IBM PC MEMORY EXPANSION KITS

Quantity Discounts Available.
Guaranteed for Life!



Set of
9 Chips **\$9.00***

DISKETTES

Guaranteed for Life!
Brand name diskettes
available in boxes of 10
or in bulk packs of 50

5 1/4" DS/DD
\$8.95*
Bx. 10 Bx. 50
ea. **.59***

5 1/4" SS/DD
\$7.95*
Bx. 10 Bx. 50
ea. **.47***

3 1/2" SS/DD
Bx. 10
\$15.95*
Free Flip
& File Case

1/2 HEIGHT DS/DD DISK DRIVES

The Network buys direct
and makes fantastic deals
with manufacturers like MPI/
Tandon/CDC/Shugart/Qume/
TEAC and others to bring you
fantastic prices on Name
Brand drives for your PC/AT/
XT/jr/or Compatible.

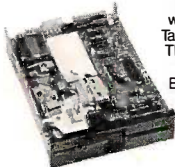

\$85.00*
Quantity Discounts Available

INTERNAL PC HARD DISK

Low Power/Automatic Boot. Works on standard PC's
and Compatibles. Includes drive/controller/cables/
mounting hardware and instructions.

Full one year warranty!

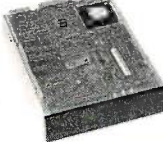

10MB
\$340.00*
20MB
\$400.00*
Quantity Discount Available



\$285.00*



\$190.00* ea.

PC NETWORK

GET THE NETWORK ADVANTAGE!!!

SEE WHY OVER 100,000 HAVE JOINED
MAKING US THE NATION'S #1 SOURCE
FOR EVERYTHING IN COMPUTING...

- **Our 600 Page Wholesale Catalog**
Over 30,000 products priced at Wholesale + 8%. Anything
you will ever need at a Consistent low price...
- **Quarterly Catalog Updates**
Your Catalog is never obsolete! Keep on top of the newest
products and latest price changes.
- **The Printout**
Our newsletter gives you fantastic specials along with
unbiased analysis of new products and industry trends.
- **10 Day Returns on any Hardware!!**
If you don't like any hardware product—for any reason
—return it for a refund.
- **1000 + Title Rental Library**
14 to 30 day rentals on over 1000 different titles.
Try before you buy!!
- **Size-Strength and Stability**
The Network has over 100 employees, 40,000 square feet
of office and warehouse, inventory valued in excess of
\$15,000,000 and is ranked the largest computer product
supplier in the Nation!! Our commitment is to serve our
customers and our 90% repeat business rate is proof!!

CALL TOLL FREE
1-800-621-S-A-V-E

(Orders—Membership and Advice!)
In Illinois call (312) 280-0002

Your Membership Validation Number **B346**

You can validate your membership number and, if you wish,
place your first money-saving order over the phone by using
your VISA, MASTERCARD or AMERICAN EXPRESS. Our
knowledgeable sales consultants are on duty Mon.-Fri. 8:00
AM to 7:00 PM, SAT. 9:00 AM to 5:00 PM CST.

PERSONAL COMPUTER NETWORK
320 West Ohio
Chicago, Illinois 60610

Call now...Join the PC NETWORK and start saving today!
Customer Service and Order Status (312) 280-1567
8:30AM to 4:30 PM, Mon.-Fri. CST



PC NETWORK • MEMBERSHIP APPLICATION

YES! Please enroll me as a member in the PC NETWORK™ and rush my
catalog featuring thousands of computer products, all at just 8% above
DEALER WHOLESALE PRICES. I will also periodically receive "THE
PRINTOUT", a special up-date on merchandise at prices BELOW even those
in my wholesale catalog, and all the other exclusive, money-saving services
available to Members.

B346

I am under no obligation to buy anything. My complete satisfaction is
guaranteed. Please check (✓) all boxes that apply:

- | | |
|---|--|
| <p>Basic Membership
With 14 Days Rental</p> <p><input type="checkbox"/> One-year membership for \$8</p> <p><input type="checkbox"/> Two-year membership for
\$15 (SAVE \$1)</p> <p><input type="checkbox"/> Business Software Rental
Library for \$25 add'l. per
year—with 14 day rentals</p> <p><input type="checkbox"/> Games Software Rental
Library for \$10 add'l. per year</p> | <p>Special V.I.P. Membership*
With 30 Days Rental.</p> <p><input type="checkbox"/> One-year membership for \$15</p> <p><input type="checkbox"/> Two-year membership for \$25
(SAVE \$5)</p> <p><input type="checkbox"/> BOTH Business and Game
Software Rental Libraries for \$30
add'l. per year—with 30 day rentals</p> <p>*VIP members receive advance
notice on limited quantity
merchandise specials</p> |
|---|--|
- Bill my credit card: VISA MasterCard American Express

Account Number:

Exp. Date mo. year

Check or money order enclosed for \$ _____

Name
Address Apt. No.
City State Zip

Telephone ()
My computer(s) is: IBM PC IBM-XT IBM-AT Apple II
 Macintosh Other

Signature
(Signature required to validate membership)

*Members pay 8% above this wholesale price plus shipping.

CALL TOLL FREE 1-800-621-S-A-V-E (orders and memberships)

In Illinois call (312) 280-0002 Validation code: B346

Customer Service and Order Status (312) 280-1567

TM & R—Registered trademarks of IBM/COMPAQ/APPLE/AST Research/LOTUS/MultiMate Int'l./OMEGA. Inquiry 255

Copyright © 1985. PC NETWORK INC.



Features

**CIARCIA'S CIRCUIT CELLAR:
COMPUTER ON GUARD!**
by Steve Ciarcia 84

**PROGRAMMING PROJECT:
A SIMPLE WINDOWING SYSTEM,
PART 2: IMPLEMENTATION**
by Bruce Webster 96

BUILD THE EMULO-8
by Stuart R. Ball 105

MAKING UNIX SECURE
by Alan Filipski and James Hanko 113

DATA DESIGN
by Leonard Shapiro 129

**PROGRAMMING INSIGHT:
DRAGON**
by Bruce R. Land 137

WITHOUT A SHADOW OF A DOUBT, this month's Circuit Cellar is a genuine departure for Steve. You won't learn how to build anything this time. Instead, Steve recounts an evening when things got very dicey for him... locked out of the Circuit Cellar, a monster security system facing him, the possibility of destruction descending on his neighborhood. Enlisting the aid of a doubting but helpful neighbor, Steve prepared to storm the Circuit Cellar. Did they succeed in preventing disaster? We're not about to tell you here.

This month's Programming Project is the final part of Bruce Webster's article on windows. He shows you how to close a window, describes pseudocode versions of the necessary routines, and gives code fragments from an implementation on an Apple II. Noting that many older microcomputers don't have windowing routines built in, Bruce hopes that his article will help you get started.

If you are tired of continually programming and erasing EPROMs as you develop software for your projects, you may be wise to construct the Emulo-8. Its creator, Stuart Ball, says that it's an ideal program-development tool on several counts and gives you all the details in "Build the Emulo-8."

Addressing themselves to system administrators, Alan Filipski and James Hanko examine some specific security-related features of the UNIX operating system, discuss methods of attack employed by crackers, and outline countermeasures that are effective against would-be invaders. The authors believe that administrators who are aware of potential problems can maintain their systems to provide sufficient privacy and protection for most applications.

Just as you should apply principles of structured programming to your programs, you should apply principles of data design to your database. In "Data Design" Leonard Shapiro offers valuable techniques for achieving this goal.

This month's Programming Insight, from Bruce Land, focuses on the recursive drawing of a dragon curve on the Macintosh. The Mac's high-resolution display and the rapid execution rate of MacFORTH produce the interesting image shown on page 137.



COMPUTER ON GUARD!

BY STEVE CIARCIA

*A tale of overzealous
computer security*



Editor's note: Steve Ciarcia has been working with and writing about home-control systems for many years. This month's Circuit Cellar shows what could happen when a sophisticated system runs amok.

"Merrill, you gotta help me!"

The feeling of panic was coming over me as I beat on Merrill's back door. I needed help, and Merrill was the only person I could trust—the only person that would understand that I wasn't crazy. As I knocked on the door, I glanced over either side of my shoulders to make sure no one else was around.

"Merrill, you gotta help me!"

I stood next to the door in a shadow that the moonlight failed to illuminate. It was a cool spring evening. While the stars shown brilliantly in their quiet elegance, I couldn't help but fear that this would be the last quiet moment of the evening if I failed.

"Steve? What are you trying to do? Can't you just ring the bell and wait 30 seconds like everyone else?"

Merrill wasn't really mad, just startled at my wild-eyed look and disheveled appearance. I often visited him but usually announced myself by some means other than beating down his back door. He waited a few seconds. He realized that this wasn't a

social call and changed his tone to one of concern.

"What's wrong? You look terrible!"

"I locked myself out!"

For any other person in the world, that would not be a catastrophic occurrence. In fact, the words sounded a bit absurd as I said them. I only hoped that Merrill valued our friendship enough to listen to me.

"You locked yourself out? Didn't you once give me a key to hold just in case this ever happened?" Merrill was becoming increasingly curious as to why I should be so distraught. I should have known he had a key.

I nervously glanced at my watch and answered, "That was when one needed a key to get in my house." Such a statement obviously would lead to all kinds of conjecture, but I didn't have time to explain.

"What do you mean, no key? How do you get into your house? Whistle?" Merrill seemed a bit disturbed that I was playing guessing games.

"I don't use a key anymore. I use a digital code. I really don't have time to explain.

(continued)

Steve Ciarcia (pronounced "see-ARE-see-ah") is an electronics engineer and computer consultant with experience in process control, digital design, nuclear instrumentation, and product development. He is the author of several books about electronics. You can write to him at POB 582, Glastonbury, CT 06033.

Please, just put on some dark clothes and help me."

His help-thy-neighbor attitude took five giant steps back when I mentioned the necessity for dark clothes. Glancing at my watch once again to see how much time we had left, I determined that a portion of it had to be allocated for explanation. I stepped into the doorway and moved past Merrill.

"You see, Merrill, I've locked myself out of the house, and I have a soufflé in the oven."

Merrill looked at me like I was some kind of nut. He walked over to the kitchen sink and opened the cabinet doors beneath it, revealing a toolbox. "Look, we'll zip over and pull the hinges on one of the doors. It's a cinch."

Before he could pass me any tools, I interrupted him. "Merrill, it's not that easy. You don't understand. Let me explain."

The expression "Please do" was painted all over his face and needed no verbalization. As he sat down in the overstuffed chair, he extended and crossed his legs on the footstool and stroked his gray beard nervously. The little bit of fuzz on the top of his balding head seemed to bristle like a cat. To further the impression that he was ready for a real fish story, he took out a briar pipe and nonchalantly started to clean it. Between the sounds of tapping the pipe on the ashtray and blowing through the stem to clear it, he extended his hand toward me and said, "Do begin, please."

The delay was excruciating. It was critical to act soon. The soufflé was irrelevant. It was the chain of events that could be accidentally touched off that I was worried about. My *only* hope was to talk fast.

"Merrill, my house doesn't use a house key anymore because it has a computerized environmental and security control system!"

He puffed on the pipe and interjected, "Fair enough. But what's that got to do with the soufflé?"

"This isn't just any home-control and security system. I designed it! An advanced sensor system tied directly into my computer makes it about the most sophisticated home burglar alarm in the world. I got thinking one night that I needed a burglar alarm. Since practically all the lights and appliances were already connected to the control system, I just extended its capability a little. But I got a little carried away on the engineering, and I'm not sure I know how to get in without setting it off."

Merrill was amused. Every time he and I had spoken lately, it had something to do with computers. He no longer thought I was completely crazy, just a little. There was still that one burning question, "What has that got to do with the soufflé?"

"There's a soufflé in the oven, and let's see . . . it should be done in 30 minutes. But the oven timer only buzzes. It doesn't shut the oven off. I know you're only an engineer and not Betty Crocker, but even you can guess that it wouldn't be more than another 20 to 30 minutes before it starts to burn."

I spoke rapidly. We were eating up precious seconds. "When the smoke from the burning soufflé hits the smoke detectors on my alarm system, all hell is going to break loose on this street."

"Wow! What does it do, call the police?"

Most people are familiar with the standard smoke and burglar alarms that automatically dial the fire department. While the end result was the same, my method was quite different. The so-

phistication of my home-control computer was unmatched by anything that commercial companies had to offer. That, in combination with the mind of your average, everyday mad scientist, can produce startling results.

"Well," I started rather sheepishly. It isn't often one has to explain the limits of his paranoia. "It isn't every day you have a fire in your house. When you do, you want action fast so you can reduce the damage and get people out in time. This system is predicated on everyone acting fast. When a fire or smoke is detected, it first sets off the alarm horns mounted outside next to the garage. I've never tried them, but they're war surplus air-raid sirens.

"Mathematically, the sound level coming out ought to be high enough to break about half the windows on the street. Mrs. Picker, who lives directly across from my house, will probably have her whole house moved back about two feet when they go off.

"Secondly, there are four xenon strobe aircraft-landing lights mounted on the corners of the house that will start flashing with about 2 million candlepower each. That was just in case the fire trucks had trouble finding the house.

"Then come the automatic telephone calls out on the three telephone lines. Remember, Merrill, my computer has a voice synthesizer, so I don't need a tape recorder. It definitely doesn't sound like a recording, so it should



"Merrill, you gotta help me!"

prompt immediate action. The first call is to the fire department. It also is simultaneously transmitted on CB channel 9. Then a whole bunch more. The end result is more cars and trucks than we can fit on this street."

The pipe in Merrill's mouth drooped lower and lower as I conveyed the consequences of my alarm going off. It was hanging down to his chin when he muttered, "Why don't you add me to the list of calls in case I miss the initial shock wave?"

"Don't worry, Merrill! You're the ninth call!" Merrill definitely had a concerned expression. As I expanded upon the next step, it turned to terror.

"Merrill, you gotta help me break into my house and shut the alarm off before the soufflé burns."

The pipe fell out of his mouth, and the ashes formed a line down the front of his shirt. He barely noticed them as he exclaimed, "Are you crazy? Break into your own house?"

"Look, Merrill, I designed that system to prove I could do it. Now that I can count the seconds before I know it's going to go off, I recognize it as pure overkill. I'll replace it later with something more sane, like six Doberman pinschers and a minefield. But right now we have to stop it! Will you help me?"

Merrill brushed the ashes off his lap and jumped up.

"Do I need dark clothes?"

"Yes. I'll explain later. And wear a dark sweatshirt with a hood or something to cover your head."

The evening newspaper fell to the floor as it was sucked off the table by the vacuum created as Merrill ran to change. I could detect a cold sweat forming as I checked my watch repeatedly. It was only 10 minutes since we had first started talking, but now it was only 20 minutes before the soufflé would be done.

I could picture in my mind the progression of events that would follow. First, the soufflé would blacken and crack. Then, as it shriveled, some of the exterior sections would have dried enough to be combustible. The first whiffs of smoke would go unnoticed, but eventually a billowing cloud would spew forth from the oven. When it reached the smoke detectors, the computer would go into action. Our only hope was to get inside in time to stop the computer. If we failed, we had better make sure we were not standing next to one of those sirens when it blew. Further thoughts were interrupted as Merrill burst into the

room fully dressed for action.

"I'm ready. Let's go."

Merrill looked like a cat burglar. The solid-black sweatshirt had a hood that completely covered his balding head, and, while his gray beard still showed, it aided the camouflage. His pants were equally dark and skintight. All

reflective surfaces like belt buckles and key chains were carefully omitted. Black track shoes completed the outfit. I only hoped we didn't have to do too much running with all the rope, and as we jogged up the street toward my house, Merrill turned and asked, "You sure you know how to get in?"

The details of the computer alarm design flashed through my mind. I knew every wire, every sensor. Yes, I knew what the components of the system were. But the computer had far greater speed than I at analyzing the data received from them. A pressure switch activated in the wrong sequence, a heat sensor detecting human presence, any number of things could activate the alarm. I had let my inventive

genius run "open loop." The tiny credit card that now lay on the coffee table in the living room had been my only control over the potential Frankenstein I had created. True, it would foil a burglar or call the fire department, but the ends to which I had gone in devising the system were aimed more at instant incineration of any perpetrator than protection of property.

To fully answer Merrill's question was impossible. I didn't know whether I could beat myself at my own game. "I don't know, Merrill. I hope so."

We stopped in front of my house. Almost magically a floodlight switched on to illuminate the area before us. Music could be heard from inside. A light in one room switched off, and another turned on. I didn't wait for Merrill to ask since I knew he was curious.

"Most of the AC outlets in the house are remote-controlled. The computer can control almost any light or appliance in the house, except the stove. The computer knows that something or someone is out here from microwave motion sensors planted in front of the house. No one is in the house, but it is simulating habitation by playing music and making it appear as though people are moving from room to room. Just for good measure, it turned the floodlight on to tell you that it knows you're here too."

(continued)



"But what's that got to do with the soufflé?"

Merrill started toward the front walk. I grabbed his arm to stop him.

"Forget it. The only way into the house is through some window that doesn't have any sensors attached. They're in the back of the house. Possibly one of the bathroom windows would be the best to try."

"Hey, Steve, before I lay my life on the line to save your soufflé, do you mind telling what happens if we set off the burglar alarm while trying to break in. You already told me about the fire alarm."

My reputation had preceded me. The fire alarm was only part of the system. The burglar alarm was equally devastating.

"Well, there's a bunch of stuff I'll explain as we go along. It's too complicated to explain in detail. But the end result is that the computer determines the location of the perpetrator and then tries to lock him in the area where he has been detected and calls the police."

"If that's all, you can explain the accidental phone call to the police. They often get false alarms from automatic dialers."

"Wait, you didn't let me finish. Then, it sets off all the sirens and lights, just for good measure. And, oh yeah, there's a very loud noise source inside the house that's triggered, which is supposed to temporarily disable the perpetrator. Then it does all the same telephone calls, explaining there is a break-in instead of a fire."

Merrill looked at me in amazement. The adventurer in him wanted to go full speed ahead and tackle the Mount Everest of electronic obstacle courses, while the quiet engineering instinct suggested that he go home and check his medical insurance first. He shook his head as he said facetiously, "Why didn't you just use tear gas?"

"Oh, I considered it. It's just too hard to get the smell out of the Oriental rugs."

This unexpected response was too much for Merrill. As we stood there in the moonlight, I could see the sweat forming above his brow.

To this point, he had been aiding an eccentric neighbor. Though it had taken a long time and not through any direct explanation, Merrill was ready to admit that this computer alarm had to be stopped. There was no animosity that I had created it, just a realization of the full consequences of its being.

He, too, looked at his watch and sensed the seconds

ticking away. No longer was he along for the ride. Now he was a committed participant. "Let's go."

I knelt down next to a sandy area at the corner of the lot. Merrill looked over my shoulder. Grabbing a short stick to draw in the soft soil, I started to lay out the attack plan. "Here's the house, the property line, and key obstacles.



"Mathematically . . ."

There's only one way to approach the house from the rear and not be detected. We have to go over the side-yard fence, along through the brush to the pine trees behind the house, and then across the back lot. Have you done any pole-vaulting recently?"

"Pole-vaulting? Are you kidding? I just about have enough energy to go from the couch to the refrigerator for another beer. What are you talking about?"

His eyes opened wide and projected a common expletive. The general translation was, "Hey man, I agreed to break in a house with you, but I ain't pole-vaulting over no fence."

That was the easiest way, but I had to agree with Merrill. The years in the cellar being a mad inventor rather

than a tennis pro had taken their toll. I wasn't about to pole-vault over any fence either.

"We've got to find a way over the fence without actually climbing on it. There are vibration sensors in the vertical supports that are meant to detect anyone climbing over it. Tripping it won't set the whole alarm off, but it will start a timer where the computer treats perimeter events more seriously. If during that period the computer senses too many motion and vibration inputs, it will treat it as a threat and react accordingly." I didn't elaborate on the latter.

We stood next to the fence. It was constructed of heavy wire mesh attached to metal supports. Trying to vault over such a fence and missing would be like putting your body into a cheese grater. It was only about 5 feet high though, so there had to be an easy way over it.

Merrill looked at the situation. I could see his engineering mind going to work. Pictures of levers, fulcrums, balances, and pulleys were flashing through his mind. Walking over to the tree adjacent to the fence, he started coiling a length of rope in one hand. With one mighty swing, he threw the coil of rope over a 20-foot-high tree limb hanging directly over and parallel to the fence. Now the rope hung down and touched the top of the fence.

"Come here, Steve," he said.

I was still a little puzzled, even as he looped the rope around under my arms and tied a knot at my chest. Only when he pulled on the other end and hoisted me off the ground did I realize how he intended to get us over the fence.

"Gee, Steve, why don't you lose a little weight for the next break-in?"

I felt like a side of beef hanging on a rope 6 feet off the ground. When he started swinging me from side to side, I thought I was going to get seasick. The amplitude of the swing got longer and longer until the arc carried me over the fence to the other side. The realization of what the next part of the sequence would be came a fraction too late for me to protest. As the arc carried me over the fence, Merrill let go of his end of the rope. Logically, I should have expected that this was the only way, but the experience of being swung on the end of that rope hadn't any semblance of logical reasoning on my part. My far-too-late protest started something like a "whoop" and concluded with the tonal equivalent of Tarzan merrily swinging through the jungle and suddenly missing the last vine.

The fall was only 6 feet, but it felt like a hundred stories. I thought that if that was a sample of things to come, maybe I should take my chances with the alarm. It didn't help matters when I landed sitting down. The ground was quite moist, and my clothing sucked up the water like a sponge. When I put my hand down to reorient my position, I felt the cold spring mud ooze between my fingers. The totality of my situation and the immediate sensations at hand were summed up with the single word, "Yech!"

As I turned to check on Merrill, I caught a glimpse of him sailing through the air. Rather than be hoisted, he had secured one end of the rope and tied large knots in the other to aid climbing. Once at the 6-foot level, he swung out over the fence as I had and let go. Even though he came down feet first, the momentum was too great for the terrain. It took only a fraction of a second for two skid marks to form behind his heels, and Merrill came crashing down in the same sitting position next to me. His first word was, "Yech!"

I glanced at my watch and realized there were only 10 minutes left on the oven timer. I said, "Come on, Merrill, we can't sit here like two idiots. There's not much time left. We have to head for the brush on the right and then crawl

toward the pine trees."

"Crawl? Why do we have to crawl?"

"I'll explain when we get there. Right now, pull your hood up over your head like this. Whatever you do, don't look at the house as you run past the brush into the pines, or the computer will see you."



"Gee, Steve, why don't you lose a little weight for the next break-in?"

"What is this, a science-fiction movie or something? What do you mean see us?" Merrill's nervousness was evident by the shrillness of his voice. He should have believed me when I said it was the most sophisticated alarm installed in a home.

"Just that. See that small box on the corner of the porch roof?" I pointed to a small black rectangular enclosure suspended below the corner of the roof line. About every 10 seconds a small red light flashed, giving it the appearance of being activated.

"There's a digital television camera in that box that scans this section of the yard between a height of 3 and 7 feet. When that light flashes, it starts a scan and looks for changes in light patterns

from one scan to the next. With our dark clothes, by running just ahead of the scan we should go unnoticed."

The 30 seconds it took while we watched the blinking light until we could anticipate the next scan seemed like an eternity. When the precise moment came, I yelled, "Head for the pines. Go!"

Running with both hands in our pockets to shield our skin from detection made trying to run at full speed rather awkward. It was more like a high-speed waddle than the statuesque gait of a long-distance runner. We had 5 seconds to make it to the pines before the camera would start to retrace its path and compare the new image to that of the preceding scan. It was barely 120 feet, but it took all our effort to achieve it in time.

As I was about to dive under the first pine for concealment, I remembered something vitally important. I crouched under instead. "Merrill, watch out where you walk. There is where my dogs . . . Oh, I see you just found out. Sorry about that, Merrill."

Merrill was apparently just mentally chalking it up on his list of reasons to strangle me when the escapade was over—which it wasn't. Standing out there in no-man's-land was not accomplishing the task. Pointing to his watch, he said, "We have 5 minutes. What's this about crawling?"

(continued)

"Don't worry about it, just crawl. Remember, we have to stay below 3 feet high. Don't stand up or we're dead. Ready? Go!"

Merrill still didn't understand why he was on all fours, crawling toward my house at ten o'clock at night. Life used to be so much simpler.

We were neck-and-neck about halfway across the yard when the computer spotted us. Two bright floodlights came on, illuminating the area where we lay. Merrill, exercising reflex actions learned from years in the Marines, instinctively dove into a prone position, as though he anticipated an imminent artillery barrage. At the same time the lights came on, the tumultuous roar of many vicious, snarling dogs filled the yard.

Frozen in his position, Merrill yelled, "What have you got, a pack of hungry timber wolves in the basement? What do you need an alarm for?"

"Don't talk. Just bark!"

"Bark?" Merrill looked at me and shook his head.

"Bark," I said. "Like this. Arf! Arf! Arf!"

Soon we were both barking and woofing up a storm. My two Scotties would be proud of us. We kept it up for about 25 seconds, until the lights and the ferocious dogs stopped as miraculously as they had started.

Speaking very softly and not waiting for questions, I said, "Hey, you can stop barking. There's a laser perimeter intrusion detector in this corner of the yard. It sensed our presence below the 3-foot level. It turned on the floodlights and the recorded sounds of barking dogs to see what it was or try to scare it off."

"Now, here's what the computer is great for. After all that was triggered, the computer turned on a microphone to listen out here at the same time. When it heard us barking the same as any real dog would do upon hearing the recording, it shut off the alarm sequence. You see, Merrill, the computer thinks we are just a dog that wandered through the yard and not an intruder. A real burglar, smart enough to see the different sensors and trying to crawl as we have been doing, wouldn't know enough to bark back at the computer. Neat, huh? Now we can finish crawling to the house. It won't bother us again."

Merrill rolled his eyes and put his muddy palm to his sweat-laden forehead. As straight-faced as one could be, all things considered, he said, "Steve, you're crazy."

Not wishing to argue, since time was running out, I merely responded, "Genius is never appreciated until it's too late."

"Steve, tell me why I'm going through all this. What do you have in your house that is so valuable that you installed a system designed to counter an invasion?"

"Well, if I really think about it, I guess the computer control system and all the alarm sensors are probably worth the most."

Merrill didn't know how to respond to that information. We computer hackers design things sometimes just for the challenge. Unfortunately, this particular challenge was getting out of hand, and time was very short.

The remaining distance across the lawn was far less wasteful than the first. We encountered no land mines, bear traps, or quicksand. We finally found ourselves resting against the house just below the bathroom window. Reaching the next objective was not as bad as the preceding events. The window lock was easily pried open with a pinch bar. I warned



"Bark," I said. "Like this. Arf! Arf! Arf!"

Merrill not to make any noise once he was inside the house. Then I hoisted him up to the window. Grabbing the top of the window frame for support, he lifted himself off my shoulders and knelt on the window ledge. Next, trying to be as graceful as he could in such an awkward position, Merrill swung his body around so that he now sat on the sill, with the trunk of his body hanging outside the window and his legs projecting inside. Once in that position, it was easy to swing into the bathroom and land squarely on the floor.

In a gymnasium, Merrill would have executed it perfectly. A small bathroom was quite another story. One foot came down squarely on the carpeted floor, as it should have. The other foot came down squarely into the open toilet, as it shouldn't have. Remembering that I had warned of excessive noise, he cursed very quietly as he extracted his foot from the toilet.

As he leaned out the window to help pull me up, he said, "Hey, Steve, I hear some kind of buzzer in the house."

I quickly glanced at my watch and responded, "That's the oven timer. It's running a little faster than I thought. Now the soufflé is overcooking. Help me up. We haven't got much time."

Merrill leaned out the window and grabbed the shoulders of my sweatshirt as I jumped up to the window

ledge. My entrance was far less graceful than his. I had no alternative but to go through the window head first. I'd swear that Merrill directed my flight toward the toilet on purpose, but I have no proof. At the last instant, I was able to extend an arm and apply a force opposite to that of my trajectory. The result was a dull, rolling thud on the bathroom floor.

Our totally disheveled appearances lent no levity to the situation. But we were inside the house, and the stove was just 20 feet away. If we could get to the soufflé in time to stop it from burning, we would have all the time in the world to shut off the rest of the alarm. "Merrill, don't say anything louder than a whisper. There are mikes planted around the house, and the computer is listening for loud noises." I extended a forefinger against my lips to dramatize what I had said.

"Steve, I just saw something outside. Outside near the fence in the backyard!" Merrill was looking out the window, and after a few moments he excitedly pointed over my shoulder toward a dining room window, visible from the bathroom even though it was on the other side of the house. "There it is again!"

I jerked around in time to detect motion from an unknown object. "What do you think it is, Merrill?"

Before he had time to answer, a human form stood for a second in front of the window. Extending from an arm was a long, slender object. For a moment, Merrill and I just stood with our mouths open watching the proceedings. The figure turned suddenly. The slender object exhibited a metallic gleam in the moonlight. Then the figure was gone, as quickly as it had appeared.

We looked at each other. Our eyes were wide open as we whispered in unison, "I think that was a gun!"

"I think we have a real prowler, Steve. What are we going to do? He has a gun, too!"

"Don't ask me! Remember, I'm stuck here, too!"

"Suppose. Now just suppose he was able to get by all the alarms and got into the house. And just further suppose he fills his pillowcase and is about to leave when he decides to go to the bathroom. Voilà, us two looking down the barrel of that gun!"

"Shhh, Merrill. Don't be an alarmist. Nobody can get through my alarm system."

Simultaneously, as Merrill spoke them, I thought of the exact same words, "But we did!"

The situation presented a problem. Should I leave the oven on and purposely trigger the alarm to bring help and catch the prowler? Or should we still try to finish what we had started and then hope the perpetrator wasn't smart enough to make it through my alarm?

I looked at my watch. The soufflé had to have been over-cooking about 10 minutes. The stove timer was buzzing relentlessly in the background. I sniffed the air. What had previously smelled freshly baked now had the scent of being overdone. It would still take a few minutes before smoke would be produced that the computer could smell. We were in a real dilemma. We were caught between our protector and the prowler.

"Steve, look again!" Merrill pointed toward the dining room window. "It's a woman!"

The figure was in full moonlight in front of the window. The features were easily discernible, and I recognized the person immediately. The metallic glint previously thought to be a gun was the stainless-steel tip of a walking

cane. I grabbed Merrill's arm tightly and said, "That's no woman. That's Mrs. Picker from across the street."

"Is that bad?" Merrill had little experience with Mrs. Picker. He could not fully comprehend the grave position we were now in.

"That's worse than any prowler with 10 guns. She probably saw us and thinks we are the prowlers."

"Boy, that must really take guts to confront two prowlers single-handedly." Merrill still didn't understand what I was trying to tell him.

"That feisty old lady might be 80, but I wouldn't put it past her to climb over the fence after us if she discovered the rope. What I'm really worried about is that while she's looking for us, she'll probably set the alarm off. When the law arrives, guess who is wearing the cat-burglar costumes and covered with mud?"

Merrill looked down at his clothes and back up at me. His eyes pleaded with me to act fast. We were in the worst possible combination of circumstances to be caught in. The only solution was to try to turn off the system before Mrs. Picker triggered it.

"Let's go," I said. "We still have to turn the oven off." Merrill agreed. We had no other choice. Extra time to shut off the system was gone. First, we had to get to the

(continued)



I'd swear that Merrill directed my flight toward the toilet on purpose, but I have no proof.

stove. Motioning to Merrill that he should follow in my exact footsteps and mimic my every motion, like a childhood game, we started the ordeal.

"Merrill, see those two holes on either side of the door molding? Those are photosensors. The computer can tell if we pass through the door and in what direction we are going. Fortunately, they are only 18 inches off the floor."

At the doorway of the bathroom, I lifted my right leg very high and extended it out over the other side. Shifting my weight to the now firmly planted foot outside the bathroom, I retracted the other leg by reversing the process. Merrill followed suit. We stood in the back hallway outside the bathroom.

"Every doorway we go through, we will have to follow the same procedure. Got it?" Merrill nodded affirmatively as I continued to whisper. "Now step over this area and these other two. There are pressure switches under the rug that will go off if you step on them. Try not to make too much noise jumping. Remember the mikes!"

Ordinarily, all these sensors and switches caused the computer to turn on lights and direct the stereo system to the appropriate rooms as I walked through the house, all in the name of convenience. Now, however, the feeling we had was like being in combat. We were in the middle of a minefield directing those behind to follow in our footprints. While the sensation of stepping on a mine could not be exactly equaled by my computer, the heart attack following the first sound of that air-raid siren could be just as lethal. We silently high-stepped and hopscotched our way through the house until we reached the stove.

As I extended an arm to turn the oven off, I could see the blackened soufflé through the oven door's window. It was very disconcerting to see a creation of one's hand and mind shriveled and destroyed. But the realization that we were still at the mercy of another such creation prompted a fast exit. We had not gotten to the stove too soon. Inside it was filled with smoke. While not so dense as to obscure total view, I dared not open the oven door. The smell was of burned baked goods, but it was not dense enough for the computer to get excited about—yet.

Our final objective was the cellar, where the computer was headquartered. It was quicker to go there than try to find and insert the digital card in the reset mechanism

in the front hallway. The motion sensors in that area of the house were not as easily overcome as the simpler variety that we had thus far defeated. The cellar door was but 5 feet and one pressure switch from the stove. We made it to this objective as easily as we had the others. There was no sensor on the door. I opened it slowly so

that the squeaking of hinges would not reach an appreciable volume level.

When we opened the door, my two Scotties looked up at us. "No time to play now, guys," I said.

I went bounding down the stairs with Merrill in close pursuit. "When the alarm is activated, the dogs are kept in the cellar. So there are just a few sensors down here. We're home free now!"

Merrill and I stood in front of the computer control system. This computer did not have the usual panel full of flashing lights. That was old hat. The new stuff all had cathode-ray-tube displays. The monitor attached to the control system displayed a matrix of control parameters and on/off state. Peripheral sensors, not directly used to

determine specific alarm conditions and still experimental, scanned the grounds like radar and displayed their activity around an outline of the house on another monitor. A dot flashed on the screen next to the outline. It slowly moved around the periphery of the house.

"That's Mrs. Picker," I pointed out to Merrill. "The computer knows she's out there. It has turned on the lights, but it will ignore her unless she goes over the fence into the backyard. See, she's moving in that direction now. I'll need about 3 minutes to enter the disarm commands."

Merrill looked around the cellar at all the equipment. Spying a refrigerator, he started to walk toward it. "Hey, Steve, why can't you just pull the plug on the computer?"

"That wouldn't do anything. In case of a power failure, the computer has battery backup and all kinds of redundancy."

I started to type in the first abort code. Merrill, who finally felt relaxed again, stood at the refrigerator and said, "Boy, all this work has really made me thirsty. Do you have any beer in here?"

He opened the refrigerator door. The fact that the refrigerator contained refreshment became immediately irrelevant. Suddenly a small speaker next to the computer started to emit a loud, repetitive sound: beep. . . beep. . . beep. . . beep.



Mrs. Picker

"Merrill! You triggered the alarm! It's going to go off in 10 seconds!"

My mind raced with the thoughts of things that were about to happen. Everyone but the National Guard would be here in 10 minutes. Large jetliners approaching the nearby airport would be distracted by the brilliant flashing lights and start to circle the house instead. They would find Merrill and me in a state of partial rigor mortis from the loud horns that would now go off inside the house. The computer had sensed an intruder. Finally, and most important, there was Mrs. Picker. If she was standing next to one of those sirens when it started, it would be curtains!

Merrill's eyes bulged with terror. Internally, he screamed, how could this be happening? Vocally, he yelled, "I thought you said that there were very few sensors down here because of the dogs! Why did it go off?"

Simple, yet true. We were done for, but he still had to know. "Dogs don't open refrigerator doors. That's why."

The 10 seconds had almost elapsed. My final words were, "Hit the deck! Cover your ears!" That was exactly what we did. It was a hard-tiled cement floor, but we dove under one of my workbenches and covered our heads with our arms. Almost immediately the beeping stopped. Then, silence...and more silence...and more silence. After about 15 seconds I peeked out. At 30 seconds we got up and walked over to the computer.

"I don't understand," I said. "It should have gone off. At the end of the beeping, it should have started the sirens and lights and everything. I don't understand."

I walked over to the console and started to list the program on the display. "There must be a program bug or a loose wire in the back here someplace. Otherwise, it would have gone off." I busily typed on the keyboard as I spoke. "Gee, Merrill, that's a lousy demonstration of my talents. I'm a better programmer than that."

"Merrill, wait a few minutes, and let me see if I can fix it. Don't think this was all a waste of your time. I want you to know that this thing really works. Give me a minute or two to fix it, and I'll show you that the sirens really do go off."

Merrill didn't wait. He gave me a fierce glance and took off up the staircase. I yelled, "Where are you going? Don't you believe this will work?"

Merrill yelled down the stairs. "I'll be right back. I'm just going to borrow Mrs. Picker's cane!"

CIRCUIT CELLAR FEEDBACK

This month's feedback is on page 336.

NEXT MONTH

Adding SCSI expansion to the SBI80. ■

This story was adapted from the chapter called "Computer ON Guard" in "Take My Computer... Please!" by Steve Ciarcia and is reprinted by permission of Scelbi Publishing.

Autographed copies of my hardbound book "Take My Computer... Please!" can be obtained for \$10 including shipping (add \$6 outside continental U.S., \$4 for Canada). Send check or money order directly to me at POB 582, Glastonbury, CT 06033.

There is an on-line Circuit Cellar bulletin-board system that supports past and present projects. You are invited

to call and exchange ideas and comments with other Circuit Cellar supporters. The 300/1200-bps BBS is on line 24 hours a day at (203) 871-1988.

Due to an overwhelming response and increased production rate for the SBI80, as described in the September and October 1985 Circuit Cellars, the assembled and tested SBI80-1-20 "BYTE Readers' Special" price of \$499 has been extended indefinitely by Micromint.

To be included on the Circuit Cellar mailing list and receive periodic project updates and support materials, please circle 100 on the reader-service inquiry card at the back of the magazine.

Editor's Note: Steve often refers to previous Circuit Cellar articles. Most of these past articles are available in book form from BYTE Books, McGraw-Hill Book Company, POB 400, Hightstown, NJ 08250.

Ciarcia's Circuit Cellar. Volume I covers articles in BYTE from September 1977 through November 1978. *Volume II* covers December 1978 through June 1980. *Volume III* covers July 1980 through December 1981. *Volume IV* covers January 1982 through June 1983. *Volume V* covers July 1983 through December 1984.



"Give me a minute or two to fix it, and I'll show you that the sirens really do go off."

When You Get Tired Of

IBM HARDWARE

	List	Ours
AST		
SixPak Plus 64K	\$395	\$239
SixPak Plus, 384K, S/P/CC	\$895	\$269
Advantage Multif Brd for AT	\$595	\$425
Rampage 256K for PC	\$495	\$395
Rampage 128K for AT	\$745	\$495
CENTRAL POINT		
PC Option Board	\$ 95	\$ 81
COMX		
130 Watt Power Supply	\$179	\$ 93
CORE Hard Disks for AT		
ATplus 20 meg for AT	\$1595	\$1355
ATplus 30 meg for AT	\$1995	\$1695
ATplus 56 meg for AT	\$3595	\$3195
HAUPPAGE (HCW)		
8087 Chip	\$175	\$119
8087-2 Chip	\$225	\$175
80287 Fast-5 Chip	\$295	\$229
HERCULES		
Color Card with Parallel Port	\$245	\$159
Mono Graphics Card	\$499	\$319
INTEL		
Above Board 64K for PC	\$395	\$299
Above Board 128K for AT	\$595	\$449
KENSINGTON		
Masterpiece Plus	\$180	\$129
KEYTRONIC Keyboards		
KB5151 or KB5151 Jr.	\$255	\$189
MICROSOFT		
Mouse	\$195	\$125
MOUSE SYSTEMS		
PC Mouse with Paint	\$220	\$145
Mouse with Software (Jr)	\$220	\$138
PERSYST		
PC Mono Board w/Par Port	\$250	\$159
Color Board	\$210	\$139
QUADRAM		
Quadboard no RAM to 384K	\$295	\$189
Quadboard 384K S/P/CC/G	\$795	\$235
EGA+ Board	\$595	\$425
RACORE		
Expansion Chassis Plus (Jr)	\$675	\$459
256K Expansion Board (Jr)	\$275	\$179
TALLTREE		
JRAM II board	\$219	\$159
JRAM III 256K Board	\$399	\$309
TITAN		
PC Accelerator 128K	\$795	\$595
VIDEO 7		
Mono Graphics Card	\$250	\$179
MGC with Parallel Port	\$300	\$215
VEGA Board IBM EGA Comp.	\$599	\$429

IBM SOFTWARE

ASHTON-TATE		
Framework II	\$695	\$415
dBase III+	\$695	\$389
dBase II (req. PC DOS & 128K)	\$495	\$305
BOURBAKI		
I dir	\$ 95	\$ 62
CENTRAL POINT		
Copy II PC	\$ 40	\$ 22
PC Tools	\$ 40	\$ 22
CHIP SOFT		
Turbo Tax	\$ 65	\$ 45
CYGNET		
The Little Black Book	\$ 50	\$ 39
DAC		
Easy Accounting	\$ 70	\$ 55
DOW JONES		
Market Analyzer	\$349	\$229
FIFTH GENERATION		
Fastback	\$179	\$109
FUNK SOFTWARE		
Sideways	\$ 60	\$ 42

	List	Ours
HOWARD SOFT		
1986 Tax Preparer	\$295	\$199
HUMAN EDGE		
Mind Prober	\$ 50	\$ 29
LIVING VIDEOTEXT		
Think Tank	\$195	\$109
Ready	\$100	\$ 60
LOTUS		
1-2-3 NEW VERSION	\$495	\$329
Symphony	\$695	\$449
MAGNUM COMPUTER		
Fastrak, RAMdisk & Print Spooler	\$ 50	\$ 39
MICROPRO		
Easy	\$150	\$ 99
WordStar	\$350	\$189
WordStar 2000 Plus	\$595	\$295
MICRORIM		
R:Base 5000	\$695	\$385
R:Base Clout	\$249	\$133
Program Interface	\$395	\$225
MICROSOFT		
Flight Simulator	\$ 50	\$ 33
Windows	\$ 95	\$ 63
QuickBASIC	\$ 99	\$ 69
Macro Assembler	\$150	\$ 99
Multiplan	\$195	\$124
Access	\$250	\$169
Word	\$375	\$239
MICROSTUF		
Crosstalk XVI	\$190	\$110
Remote	\$195	\$110
MULTIMATE		
Multimate	\$495	\$229
Advantage requires 384K	\$595	\$295
PAPERBACK		
VP Planner	\$100	\$ 65
PETER NORTON		
Norton Utilities	\$100	\$ 56
POLYTRON		
Polywindows (copiable)	\$ 85	\$ 45
ROSESOFT		
Prokey	\$130	\$ 80
SATELLITE (SSI)		
WordPerfect NEW VERSION!	\$495	\$229
SIMON & SCHUSTER		
Star Trek	\$ 40	\$ 27
SOFTWARE PUBLISHING		
PFS: Write, File or Graph	\$140	\$ 84
SYMATEC		
Q & A	\$299	\$219
UNISON		
Print Master	\$ 60	\$ 38

DISKETTES

CONROY-LAPOINTE DISKETTES		
10 ea SS/SD 35 trk (Apple)	\$ 13	
100/1000 ea SS/SD, 35 trk	\$ 99/669	
10 ea SS/DD 3.5" (Mac)	\$ 25	
50/100 ea SS/DD 3.5"	\$115/235	
10 ea DS/DD 40 trk (IBM)	\$ 16	
100/1000 ea DS/DD 40 trk	\$119/799	
10 ea DS/HD 96 TPI (IBM-AT)	\$ 29	
100 ea DS/HD 96 TPI (IBM-AT)	\$269	
GENERIC		
10/100 SS/SD 35 TRK (Apple)	\$ 8 / 75	
10/100 DS/DD 40 trk (IBM)	\$ 10/ 79	
10/100 DS/HD 96 TPI (AT)	\$ 27/249	

MODEMS

HAYES		
Micromodem IIe (Apple)	\$199	\$149
Transet 1000 Comm. Buffer	\$399	\$309
Smartmodem 1200B (IBM Int.)	\$549	\$379
Smartmodem 1200 (External)	\$599	\$419
2400 Modem (External)	\$899	\$595
VENTEL		
PC Halfcard (IBM Internal)	\$549	\$389

APPLE HARDWARE

	List	Ours
CCS		
7711 or 7710-A Ser. Card	\$115	\$ 95
CPS/EASTSIDE		
Wild Card II Copier	\$140	\$ 79
COMX		
16K RAM Card (1 Yr Ltd Wty)	\$119	\$ 39
KENSINGTON		
System Saver Fan	\$ 90	\$ 65
KOALA		
Muppet Keys	\$ 80	\$ 44
Touch Tablet	\$130	\$ 75
MICRO-SCI		
80 Col.+64K Card IIe	\$179	\$ 79
Full or Half Ht Drive II+,e	\$269	\$139
MICROSOFT		
Z80 Softcard II, 64K	\$425	\$295
ORANGE MICRO		
Grappler Plus (Par.Card)	\$145	\$ 72
Hot Link S-P Cable IIc	\$ 70	\$ 44
TEAC		
T40 Half Ht Disk Drive	\$249	\$149
TITAN		
Accelerator IIe	\$319	\$229
128K RAM Card	\$329	\$149
VIDEO 7		
V Color Enhanced IIc	\$130	\$ 89
V Color Enhanced IIe	\$250	\$169

APPLE SOFTWARE

ADVANCED LOGIC SYS. (ALS)		
Word or List Handler	\$ 80	\$ 36
ASHTON-TATE		
dBase II (req. CP/M)	\$495	\$305
BEAGLE BROTHERS		
Big U or D Code	\$ 40	\$ 25
Fat Cat or Pro Byter	\$ 50	\$ 27
BORLAND		
Turbo Pascal (req. CP/M)	\$ 70	\$ 36
Turbo Toolbox	\$ 55	\$ 30
BRODERBUND		
Karateka	\$ 35	\$ 25
The Print Shop	\$ 50	\$ 31
Print Shop w/Refill	\$ 65	\$ 39
CENTRAL POINT		
Copy II Plus	\$ 40	\$ 22
FUNK		
Sideways	\$ 60	\$ 37
INFOCOM		
Zork I, II, or III	\$ 40	\$ 29
LIVING VIDEOTEXT		
Think Tank	\$145	\$ 89
MICROPRO		
WordStar w/Starcard	\$495	\$265
WordStar Professional	\$495	\$265
MICROSOFT		
Typing Tutor II	\$ 25	\$ 17
MICROSTUF		
Crosstalk	\$195	\$109
MONOGRAM		
Dollars & Sense II+,e	\$100	\$ 59
Dollars & Sense 128K	\$120	\$ 69
ORIGIN		
Ultima III	\$ 60	\$ 39
Ultima IV	\$ 64	\$ 44

SATELLITE (SSI)

	List	Ours
WordPerfect NEW!	\$179	\$115
SIMON & SCHUSTER		
Typing Tutor III	\$ 50	\$ 33
SOFTWARE PUBLISHING PFS Series		
File, Write, Graph or Report	\$125	\$ 79
SPECTRUM HOLOBYTE		
GATO (req. 128K)	\$ 40	\$ 25
SUBLOGIC		
Flight Simulator II	\$ 50	\$ 30
TIMEWORKS		
Swiftax	\$ 70	\$ 49

MACINTOSH

AEGIS		
Challenger or Pyramid	\$ 50	\$ 37
ASSIMILATION		
Numeric Turbo	CALL	
Mac Port Adaptor	\$ 79	\$ 59
BORLAND		
Sidkick (copiable)	\$ 85	\$ 45
CENTRAL POINT		
Copy II Mac	\$ 40	\$ 22
HABA SYSTEMS		
800K DS/DD Disk Drive	\$599	\$299
LIVING VIDEOTEXT		
Think Tank	\$145	\$ 89
LOTUS		
Jazz	\$595	\$389
MICROSOFT		
Multiplan, Word or File	\$195	\$125
Fortran	\$295	\$199
Excel	\$395	\$259
Business Pak	\$595	\$395

MONITORS

AMDEK		
300G 12" Green Composite	\$179	\$119
300A 12" Amber Composite	\$199	\$129
310A 12" Amber TTL (IBM)	\$230	\$159
PRINCETON		
MAX-12 12" Amber TTL (IBM)	\$249	\$179
HX-12 12" Color RGB	\$795	\$445
HX-12e RGB for IBM-EGA	\$785	\$545
ZENITH		
ZVM-1220 12" Amber Comp.	\$159	\$109
ZVM-1230 12" Green Comp.	\$159	\$109
ZVM-1240 & ZVM-135	SAVE	

PRINTERS

BROTHER		
HR25 Daisywheel	\$695	\$555
EPSON		
LX80 100 cps, 16 cps NLQ	\$299	\$249
FX286 200 cps, 40 NLQ	\$749	\$609
LQ800 180 cps, 60 LQ	\$799	\$649
LQ1000 180 cps, 60 LQ, 15"	\$995	\$795
LQ1500 200 cps, 67 LQ, 15"	\$1295	\$995
OKIDATA		
Okimate 20, 182, 84	LOW	
92, 192,193, 2410 Pacemark	PRICES	
PANASONIC		
P1092 180 cps	\$599	\$349
P1093 180 cps 15"	\$699	\$469
P3151 22 cps Daisywheel	\$659	\$439
STAR MICRONICS		
SG10 120 cps, 30 cps NLQ	\$299	\$249
SD10 120 cps, 40 cps NLQ, 10"	\$449	\$379

We carry thousands more products than are listed here. If you don't see what you are looking for, call!



"We'll give you the best service anywhere"

ORDERING INFORMATION & TERMS

Mail to: 12060 S. W. Garden Place, Portland OR 97223 • Include telephone number • We immediately honor cashiers checks, money orders, Fortune 1000, and Government checks • Personal and other company checks allow 20 days to clear • Advertised prices reflect a 3% discount for Conroy-Lapointe credit card or cash, so add 3% for other credit card purchases • We ship Federal Express Standard Air • U.S. and Puerto Rico add 3% (\$5 minimum) • Canada add 12% (\$15 min) • Foreign add 18% (\$25 min) • APO, FPO and other U.S. Territories add 6% (\$10 min) • Call for rates on monitors, printers, and systems • All prices, availability and specifications subject to change without notice • All sales final • We do not guarantee compatibility • You must call for R. A. number to return defective goods.



CONROY-LAPOINTE COMPUTER STORES 3 Locations. Retail Sales Only. Store Prices May Vary.
San Francisco, CA • 415-982-6212 • Across From The Pyramid On Washington St. Near Montgomery
Portland, OR • 503-620-5595 • Business Park 217 In Tigard, At Intersection of Hwys 217 & 99W
Seattle, WA • 206-455-0206 • Belgate Plaza In Bellevue, 2 Blocks North Of Bellevue Square

The Runaround, Call Us.

Internal Hard Drives

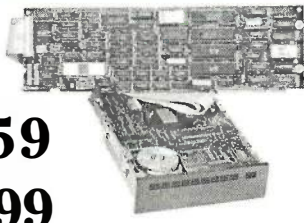

10 meg List \$745 **\$459**
with controller

20 meg List \$895 **\$499**
with controller

Fast access time beats the standard IBM drive by 30%. 90 day limited warranty.

64K RAM 100+ sets **\$10**
9 each, 4164 200 ns chips 1-99 sets \$12

256K RAM 100+ sets **\$32**
9 each, 4256 150 ns chips 1-99 sets \$34

128K RAM 100+ sets **\$37**
9 each, 4128 150 ns chips 1-99 sets \$39

All prices subject to change without notice. 90 day limited warranty.



COMX/IRWIN Tape Backup Kit

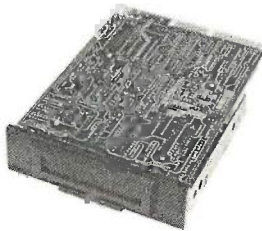

10 meg List \$795 **\$495**

Kit List \$895 **\$549**
with Tape, Cable & Software
90 day limited warranty.

CDC 360K Floppy Drives

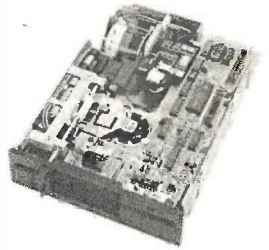

Half Ht. List \$195 **\$89**

Full Ht. List \$195 **\$119**

Call for quantity prices. 30 day limited warranty.

BORLAND Award Winning Software at Bargain Prices



- Turbo Toolbox \$30
- Superkeys \$36
- Turbo Pascal \$36
- Traveling Sidekick . . . \$39
- Editor Toolbox or GameWorks \$40
- Sidekick (copiable) . . \$45
- Turbo New Pack \$50
- Turbo Lightning \$52
- Reflex: The Analyst . . \$59
- Turbo Holiday Pack . . \$69
- Superkey/Sidekick Package \$75
- Turbo Jumbo Pack . . \$130

MAGNUM PCMasterCard™

More Features Than SixPak or Quadboard



- Expandable to 1.5 MB
- 1 Serial RS-232C Port
- Parallel Printer Port
- Clock/Calendar & Battery
- Game Port
- SiliconBullet Software: Printer Spooler, RAMdisk, and Bank Switching Driver
- 1 Year Limited Warranty

384 KB List \$199 **\$179**

1.5 MB List \$399 **\$329**

For IBM PC, PCXT or Compatibles.

Hard Disk Cards

A screwdriver and your two hands are the only tools necessary to install 10 or 20 megabyte hard disk power in your PC. These new hard disk cards make it unnecessary to discard a floppy drive to make room for a hard disk, or replace your power supply to run it. All you need to do is take the cover off your PC, plug the hard disk card in an empty slot, and put the cover back on! All your excuses for not upgrading to a hard disk have just vanished.

WESTERN DIGITAL

FileCard list \$895 **\$695**
• 10 Megabytes Formatted Capacity
• Only Requires 8 Watts

MOUNTAIN

Drivecard list \$1195 **\$945**
• 20 Megabytes Formatted Capacity
• Low Power Requirement

MAGNUM

XT/Mark 2 640K, 2 360K Floppy Drives list \$1195 **\$995**

Prices exclude video card and monitor.

- Fully IBM PC/XT Compatible
- Dual Speed 4.77 and 8 MHz 8088-2
- RAM Expandable to 640K On Motherboard
- 360K Floppy Disk Drives
- 135 Watt Power Supply
- IBM Selectric AT Style Keyboard (84 Keys)
- 5 Expansion Slots
- 2 Serial RS-232C Ports Built-In
- Parallel Printer Interface Built-In
- Clock/Calendar Built-In
- Floppy Disk Controller Built-In
- Tape Backup Interface Built-In
- MS-DOS Operating System
- Complete User Operating Manual
- Reset Button Switch Built-In
- 8087-2 Co-Processor (optional)
- RAMdisk & Printer Spooler
- 1 Year Parts 90 Day Labor Limited Warranty



Our References

- First Interstate Bank (503) 643-4678
- Portland Chamber of Commerce (503) 228-9411
- Direct Marketing Association
- Dun and Bradstreet
- Others On Request



1•800•547•1289

Oregon Toll Free 1•800•451•5151 Telex 910 380 3980
Foreign. Local (503) 620-9878 hours 6-6 (Pacific) Mon-Fri, 8-4 Sat
Customer Service (503) 620-9877 hours 8-5 (Pacific) Mon-Fri

The World's Largest Computer Mail Order Firm

Conroy•LaPointeSM

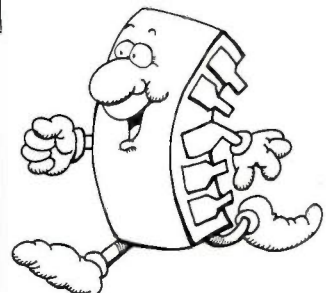



A SIMPLE WINDOWING SYSTEM

PART 2: IMPLEMENTATION

BY BRUCE WEBSTER

*This final part includes code fragments
from an actual implementation*

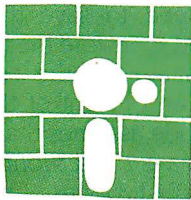

Last month, I talked about the basic ideas underlying windows and outlined a simple windowing system based on the following assumptions: (1) a bit-mapped graphics or byte-mapped text display; (2) an existing library of graphics or screen routines providing a few specific capabilities; (3) byte-aligned windows; (4) only one active (last-opened) window at a time; and (5) automatic restoration of background on window closing.

I also discussed the issues and problems behind opening a window and made additional decisions about how this system would work, most of which aimed toward keeping the system as simple as possible.

This month, I'll show you how to close a window. You'll then see a pseudocode implementation of the `OpenWindow` and `CloseWindow` routines. Following that, you'll be able to look at code fragments from an actual implementation on the Apple II.

CLOSING A WINDOW

Closing a window is, for the most part, simpler than opening it. The first step is to retrieve the window information: location, size, and screen data. By screen data I mean the screen information that was covered

when the window was open. I've been using a last-opened/first-closed approach; the most recently opened window is the one you close first. The information for that window is still sitting in the window buffer in RAM, so that's where you look.

Using the window information, copy the screen data back over where the window is, making the window disappear. This is a simple reversal of the routine that copied the screen data into the window buffer in the first place. If no more windows are open, set the viewport to encompass the entire screen. The window is now closed.

If other windows are still open, the next most recent one must have its information copied to the RAM buffer. This information may be stored out on disk, or (given sufficient RAM) it may be sitting in memory. In either case, you must move it to the window buffer and note the change in mass storage. Finally, retrieve the values for location and size to set the viewport (or clipping region) for the newly restored window.

PSEUDOCODE VERSION

Having made the various design decisions concerning your windows, you can now develop pseudocode versions of the nec-

(continued)

Bruce Webster is a consulting editor for BYTE. He can be contacted c/o BYTE, POB 1910, Orem, UT 84057, or on BIX as bwebster.

*By writing your
routines in
pseudocode, you can
then convert them
to the language
you are working in.*

essary routines. Pseudocode is just an English-like programming "language" that has two goals: readability and ease of translation into actual programming languages. By writing your routines in pseudocode, you can then convert them to whatever language you happen to be working in. You also avoid the problem of remembering the syntax and peculiarities of a particular language.

Listing 1 shows the global declarations needed for the routines. The constants are all system-specific values; PPB, the pixels per byte value, is needed only if a graphics display is involved. You could declare two of

the three variables—BufAddr and BufSize—as constants if the window buffer's address and size are known at compilation time and never change. BufUsed is a flag signaling whether anything is currently stored in the buffer; it should be set to False at the start of the program.

StoreBuf and FetchBuf are user-written routines that allow multiple windows to be opened. StoreBuf copies the current buffer contents to some other location—typically a disk—while FetchBuf copies the most recently saved buffer back to the buffer area. (If you have lots of memory, you'll probably want to take a different approach and dynamically create a new buffer of the appropriate size for each window you open.) ScrAddr is a function that returns the memory address of the location (x,y) on the screen. Viewport, ClearScreen, and DrawBox should all exist in your graphics/screen library in some form. If they don't, you can easily write them from routines that do exist.

Listing 2 shows a pseudocode version of the OpenWindow procedure. The parameters passed to OpenWindow are those chosen last month: the coordinates of the upper left corner

and the width and height of the window. OpenWindow returns an error code indicating whether or not the window was successfully opened and, if not, why not. The X1 and Width parameters are in bytes, not pixels. This is to simplify placing the window and saving its contents to a buffer.

The first step in OpenWindow is to initialize some variables, then detect any error conditions. Four possible errors are checked for: the window is too big for the buffer; the upper left coordinates are off the screen; the window is too wide or tall to fit on the screen; or there is no room to store the data already in the buffer. If any of these situations occur, the parameter Error gets the appropriate value, and OpenWindow ends.

The next major step is to save in the buffer that portion of the screen that the window will cover. First, though, you need to save the information needed to restore the buffer later: the coordinates of the corner and the width and height of the area saved. This code assumes that each of those values are 2 bytes long and thus take up the first 8 bytes of the buffer area. (The notation BufAddr[i..j] indicates the range of bytes from BufAddr + i to BufAddr + j, inclusive.)

The following loop then calculates the starting address of each line in the window's area and copies that line into the buffer. This code assumes that each line consists of contiguous bytes and that the Width parameter represents the true width in bytes. These assumptions are not universal. For example, the Amiga uses a multiple-plane bit-map approach, which spreads the bits for each pixel throughout memory, while the IBM PC uses 2 bytes per character on its text display, requiring adjustments for either Width or X2. You'll need to make the appropriate changes for your environment. Also note that the flag BufUsed is set to True, indicating that the buffer now contains screen data.

Having saved that portion of the screen out to the buffer, you can now draw the window. A simple (and sys-

(continued)

Listing 1: Global declarations used in OpenWindow and CloseWindow.

```

global constants
  XMin    = lowest allowed X value (bytes)
  YMin    = lowest allowed Y value (lines)
  XMax    = highest allowed X value (bytes)
  YMax    = highest allowed Y value (lines)
  PPB     = pixels per byte;
           used to convert coordinates for window

global variables
  BufAddr = address of window buffer
  BufSize = size (in bytes) of window buffer
  BufUsed = flag indicating that buffer has window in it

global procedures
  StoreBuf = routine to copy buffer to backup area
            (other buffer, disk, etc.)
  FetchBuf = routine to read buffer from backup area
  ScrAddr  = function that returns memory
            address of location (X,Y)
  Viewport = routine to set up viewport
  ClearScreen = clears current viewport
  DrawBox   = draws box using upper left,
            lower right corners

```

PROGRAMMING PROJECT

Listing 2: Pseudocode version of OpenWindow.

```
procedure OpenWindow(X1,Y1,Width,Height,Error);
parameters
  X1      = coordinate (byte) of upper left corner
  Y1      = coordinate (line) of upper left corner
  Width   = width (in bytes) of window
  Height  = height (in lines) of window
  Error   = returns error code, if any

local variables
  Size    = size (in bytes) of window to be opened
  X2      = coordinate (byte) of lower right corner
  Y2      = coordinate (line) of lower right corner
  Line    = current line being copied to buffer
  Addr    = starting address of that line
  BStart  = starting address in buffer for that line

start code for OpenWindow
// initialize variables
-- set Error = 'no error'
-- set Size = 8 + Width*Height
-- set X2 = X1 + Width - 1
-- set Y2 = Y1 + Height - 1

// do error checking
-- if Size > BufferSize then
  Error = 'Too big'
  exit OpenWindow
-- if X1 not in XMin..XMax or Y1 not in YMin..YMax then
  Error = 'Bad coordinates'
  exit OpenWindow
-- if X2 not in XMin..XMax or Y2 not in YMin..YMax then
  Error = 'Window too large'
  exit OpenWindow
-- if BufUsed = True then
  call StoreBuf(Error) // save buffer out to disk //
  if Error <> 'no error' then
    exit OpenWindow

// copy underlying screen area out to buffer
-- store X1 at BufAddr[0..1]
-- store Y1 at BufAddr[2..3]
-- store Width at BufAddr[4..5]
-- store Height at BufAddr[6..7]
-- set BStart = 8
-- for Line = Y1 to Y2 by 1 do
  set Addr = ScrAddr(X1,Line)
  copy Addr[0..Width-1] to
    BufAddr[BStart..BStart+Width-1]
  set BStart = BStart + Width
-- set BufUsed = True

// set up window on screen
-- if graphics display then
  set X1 = X1 * PPB
  set X2 = X2 * PPB
-- call Viewport(X1,Y1,X2,Y2)
-- call ClearScreen
-- call DrawBox(X1,Y1,X2,Y2)
-- call Viewport(X1+1,Y1+1,X2-1,Y2-1)
end code for OpenWindow
```

LOOKING FOR AT PERFORMANCE FROM YOUR PC?



EARTH HAS IT FOR LESS THAN \$1,000!

YOUR SEARCH IS OVER!! EARTH COMPUTERS' exciting new high-speed, 80286 accelerator card, TurboACCEL-286™, is just what you've been looking for. The TurboACCEL-286 will boost your PC performance up to Five times...its completely software transparent...and its only \$995! TurboACCEL-286 will function with most operating systems and application programs (unlike other so-called accelerator boards).



The TurboACCEL-286 features a high-speed, 8MHz, 80286 processor, 512Kbytes of RAM (expandable to 1Mbytes), a switch for 8088 operation, and facilities for an 80287 math co-processor. It occupies one expansion slot, is completely compatible with most PCs and is software transparent. End your search for AT performance. Order the TurboACCEL-286 today! Call or write:



EARTH COMPUTERS

P.O. Box 8067, Fountain Valley, CA 92728
TELEX: 910 997 6120 EARTH FV

(714) 964-5784

Ask about EARTH COMPUTERS' other fine PC and S-100 compatible products.

tem-dependent) calculation is made to convert byte values to pixel values, if you are using a graphics display. You then set up a viewport for the entire area, clear it, draw the border, then reset the viewport to just within the border. OpenWindow is now done.

Listing 3 shows the pseudocode version of CloseWindow. CloseWindow first makes sure there is a window to be closed; that is, the buffer contains screen data. If not, it exits with an error; otherwise, it continues by retrieving the location and size values from the buffer. Having done that, it can then copy the screen data to the screen itself, erasing the window by restoring what was underneath. CloseWindow must now see if other windows are open. It does this by calling FetchBuf, which copies (from disk, presumably) the data for the next most recently opened window. If successful, FetchBuf sets BufUsed to True; otherwise, it sets BufUsed to False. CloseWindow checks BufUsed and, if it is True, extracts from the buffer the information needed to set up the viewport for the now-active window. If BufUsed is False, the viewport is set up to cover the entire screen. CloseWindow is now done.

A SPECIFIC IMPLEMENTATION

I've implemented a few windowing systems on different microcomputers. For example, I wrote a graphics-based Pascal version on the Apple II. The version made no disk access at all. Instead, it used RAM to hold all window buffers; you can continue to open windows as long as you have enough memory left. Listing 4 shows some excerpts from that program. You should notice a few things. First, the variant record type, BufRec, is designed to let you create an array anywhere in memory, so you can copy data from the screen to the buffer and back without much trouble. Second, the function ScrAddr returns the starting memory address of each line on the screen, according to the rather bizarre memory-mapping scheme on the Apple II. Third, the procedure DoXfer handles the grunt work of the actual copying of what lies behind a win-

Listing 3: Pseudocode version of CloseWindow.

```

procedure CloseWindow(Error)
parameters
  Error = returns error code, if any
local variables
  X1 = coordinate (byte) of upper left corner
  Y1 = coordinate (line) of upper left corner
  Width = width (in bytes) of window
  Height = height (in lines) of window
  X2 = coordinate (byte) of lower right corner
  Y2 = coordinate (byte) of lower right corner
  Line = current line being copied to buffer
  Addr = starting address of that line
  BStart = starting address in buffer for that line

start code for CloseWindow
// check for window to close
-- set Error = 'no error'
-- if BufUsed = False then
  set Error = 'no window to close'
  exit CloseWindow

// get X1,Y1,Height,Width
-- get X1 from BufAddr[0..1]
-- get Y1 from BufAddr[2..3]
-- get Width from BufAddr[4..5]
-- get Height from BufAddr[6..7]

// copy buffer back to screen
-- set BStart = 8
-- set Y2 = Y1 + Height - 1
-- for Line = Y1 to Y2 by 1 do
  set Addr = ScrAddr(X1,Line)
  copy BufAddr[BStart..BStart+Width-1] to
    Addr[0..Width-1]
  set BStart = BStart + Width

// set up underlying window, if any
-- call FetchBuf
-- if BufUsed = True then
  get X1 from BufAddr[0..1]
  get Y1 from BufAddr[2..3]
  get Width from BufAddr[4..5]
  get Height from BufAddr[6..7]
  set X2 = X1 + Width - 1
  set Y2 = Y1 + Height - 1
  if graphics display then
    set X1 = X1 * PPB
    set X2 = X2 * PPB
    Viewport(X1+1,Y1+1,X2-1,Y2-1)
  else
    Viewport(XMin,YMin,XMax,YMax)

end code for CloseWindow

```

Listing 4: Excerpts from the Apple II Pascal version.

```

const
  XMin   = 0;
  XMax   = 39;
  YMin   = 0;
  YMax   = 191;
  PPB    = 7;
  BufAddr = 16384;
  BufSize = 16383;

type
  Byte      = 0..255;
  Direction = (Save,Restore);
  ByteBuffer = packed array[0..BufSize] of Byte;
  BufRec    =
    record
      case Boolean of
        False : (Addr   : Integer);
        True  : (BBuf   : ^ByteBuffer);
      end;

var
  BufUsed   : Boolean;
  Buffer     : BufRec;
  Offset,OldOff: Integer;

function ScrAddr(Line : Integer) : Integer;
var
  Addr,Temp : Integer;
begin
  Line := 191 - Line;
  Addr := 8192 + 1024 * (Line mod 8);
  Temp := (Line div 8) mod 8;
  Line := Line div 64;
  ScrAddr := Addr + 128 * Temp + 40 * Line
end; { of func ScrAddr }

function DoXfer(Dir : Direction; var Buffer : BufRec);
var
  X1,Y1,Y2,Width,Height,BStart,Line : Integer;
  TBuf : BufRec;
begin
  with Buffer do begin
    X1 := BBuf^[Offset];
    Y1 := BBuf^[Offset+1];
    Width := BBuf^[Offset+2];
    Height := BBuf^[Offset+3];
    BStart := Offset + 4;
    Y2 := Y1 + Height - 1;
    for Line := Y1 to Y2 do begin
      TBuf.Addr := ScrAddr(Line);
      if Dir = Save
      then MoveLeft(TBuf.BBuf^[X1],BBuf^[BStart],Width)
      else MoveLeft(BBuf^[BStart],TBuf.BBuf^[X1],Width);
      BStart := BStart + Width
    end
  end
end; { of proc DoXfer }

procedure OpenWindow(X1,Y1,Width,Height : Integer;
                    var Error : Integer);
var
  Size,X2,Y2 : Integer;

```

(continued)

dow either to or from the buffer. Fourth, since the values X1, Y1, Width, and Height are all limited to 8-bit values (0..255), they use up only a single byte each in the window buffer, rather than two (as indicated in the pseudocode).

Be warned that this version is not very fast. The turtle-graphics unit used for the graphics sets no speed records, and, as you can see, all the windowing code is done in Pascal. Speed will improve significantly if you turn DoXfer into an assembly-language routine, especially if you use lookup tables to compute each line's address. You can improve things even more by throwing out turtle graphics and writing your own graphics library, which I've already done... but that's a topic for another article.

POSSIBLE EXTENSIONS

As I said from the outset, this is a simple windowing system. Many things it doesn't do could be added with varying amounts of effort. For example, you might want to let windows exist on pixel boundaries, instead of just byte boundaries. It isn't too difficult to do, really. You still save out entire bytes, but you must now create and save in the buffer a mask for each edge of the window. When you restore the underlying data to the screen, you then use the mask at the beginning and end of each line to preserve those leftmost and rightmost pixels that should not be overwritten.

If you have enough RAM, you can keep all window buffers in memory and dynamically allocate new buffers as needed. This has many advantages. First, you can open and close windows faster since there is no disk access. Second, you don't have to worry about window size versus buffer size unless you are running out of memory completely. Third, there is little (if any) wasted space since each buffer is exactly the size needed. Again, the changes necessary are minor.

Another possible extension would let you move a window around. This isn't too difficult, assuming that you're moving the topmost (active) window.

(continued)

```

begin
  Size := 6 + Width*Height;
  X2 := X1 + Width - 1;
  Y2 := Y1 + Height - 1;
  (* error checking goes here -- removed for space *)
  with Buffer do begin
    BBuf^[Offset] := X1;
    BBuf^[Offset+1] := Y1;
    BBuf^[Offset+2] := Width;
    BBuf^[Offset+3] := Height;
    DoXfer(Save,Buffer);
    OldOff := Offset;
    Offset := Offset + Size;
    BBuf^[Offset-1] := OldOff div 256;
    BBuf^[Offset-2] := OldOff mod 256;
    BufUsed := True
  end;
  X1 := X1 * PPB; X2 := X2 * PPB;
  Viewport(X1,X2,Y1,Y2);
  FillScreen(White);
  ViewPort(X1+2,X2-2,Y1+1,Y2-1);
  FillScreen(Black)
end; { of proc OpenWindow }

procedure CloseWindow(var Error : Integer);
var
  X1,X2,Y1,Y2,Width,Height : Integer;
begin
  (* error checking again omitted for space *)
  Offset := OldOff;
  DoXfer(Restore,Buffer);
  If Offset = 0
  then BufUsed := False
  else with Buffer do
    OldOff := 256*BBuf^[Offset-1] + BBuf^[Offset-2];
    if BufUsed then with Buffer do begin
      X1 := BBuf^[OldOff] * PPB;
      Y1 := BBuf^[OldOff+1];
      Width := BBuf^[OldOff+2];
      Height := BBuf^[OldOff+3];
      X2 := X1 + PPB*Width - 1;
      Y2 := Y1 + Height - 1;
      ViewPort(X1+2,X2-2,Y1+1,Y2-1)
    end
  else ViewPort(0,279,0,191)
end; { of proc CloseWindow }

procedure Initialize;
begin
  InitTurtle;
  Offset := 0; OldOff := 0;
  BufUsed := False
end; { of proc Initialize }

```

My first windowing system, which was for an Apple II, was easy to write and worked well.

Once you've determined the new location for the window, you do the following:

1. Copy the window's contents out to a special buffer.
2. Copy the contents of the regular buffer out to the current location on the screen.
3. Copy the screen data at the new location to the regular buffer.
4. Copy the contents of the special buffer to the new location on the screen.

Two popular window functions are resizing (changing the size of the window) and reordering (bringing hidden windows up to the top). You can handle these functions easily if you are willing to force the programmer to redraw the contents of the window. If you want to maintain the current approach, though, these functions are difficult to implement. Resizing is probably the easier of the two, requiring you to modify just the data in the current window buffer. Reordering, though, can force you to make changes throughout all the buffers, changes that are tedious to calculate and implement. This is another of those exercises left to the reader.

CONCLUSION

I wrote my first windowing system for a 48K-byte Apple II some years back. I was surprised how easy it was to write and pleased with how well it worked. While the newer breed of microcomputers (Macintosh, Atari 520ST, Amiga) have windowing routines built in, there are still several million older micros out there for you to play with. I hope this article helps you get started. ■

Actually, we give you two things free.
Our source code. And your freedom.

Just buy part or all of our excellent integrated
business accounting system, the SBT Database
Accounting Library.

We'll give you our source code absolutely free.

Which, in turn, gives you the freedom to
customize our software to fit your business needs.

Say, for instance, you want to change the
way a management report is formatted. Our free
source code enables you to change it.

What's more, the change will be quick and
simple because our software is written in easy-to-
use dBASE.

In fact, the entire SBT Database Accounting
Library runs with dBASE III or dBASE II,* so you
get the power and flexibility of those best-selling
programs. Plus the freedom to use any computer
that runs dBASE.

The SBT Database Accounting Library.
Great software and freedom. All in the same box.

Call today for our demo disk and brochure.
(415) 331-9900.

THE SBT DATABASE ACCOUNTING LIBRARY.

dProfessional	Time & Billing	\$395
dOrder	Sales Order processing	\$195
dInvoice	Billing/Inventory Control	\$195
dStatement	Accounts Receivable	\$ 95
dPurchase	Purchase Order	\$195
dPayable	Accounts Payable	\$295
dPayroll	Payroll/Labor	\$395
dLedger	General Ledger/Finance	\$395
dAssets	Asset/Depreciation	\$295
dProject	Project/Job Accounting	\$395
dBackup	Menu/Backup	\$ 65



Three Harbor Drive
Sausalito, CA 94965
(415) 331-9900

Call today for the name of the SBT consultant
in your area.

Free source code in every box.

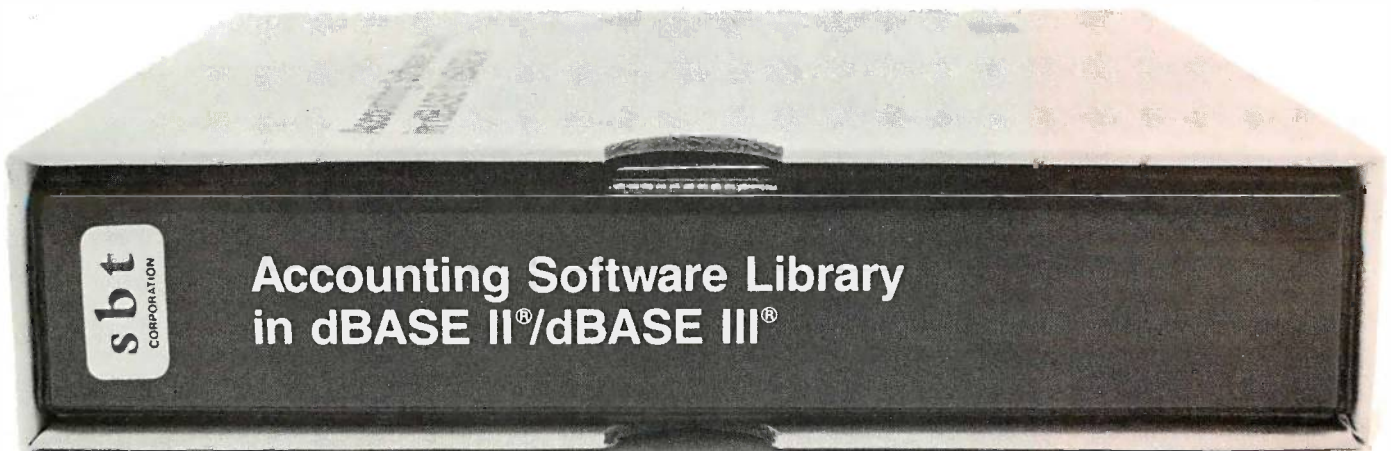

HI, HONEY!

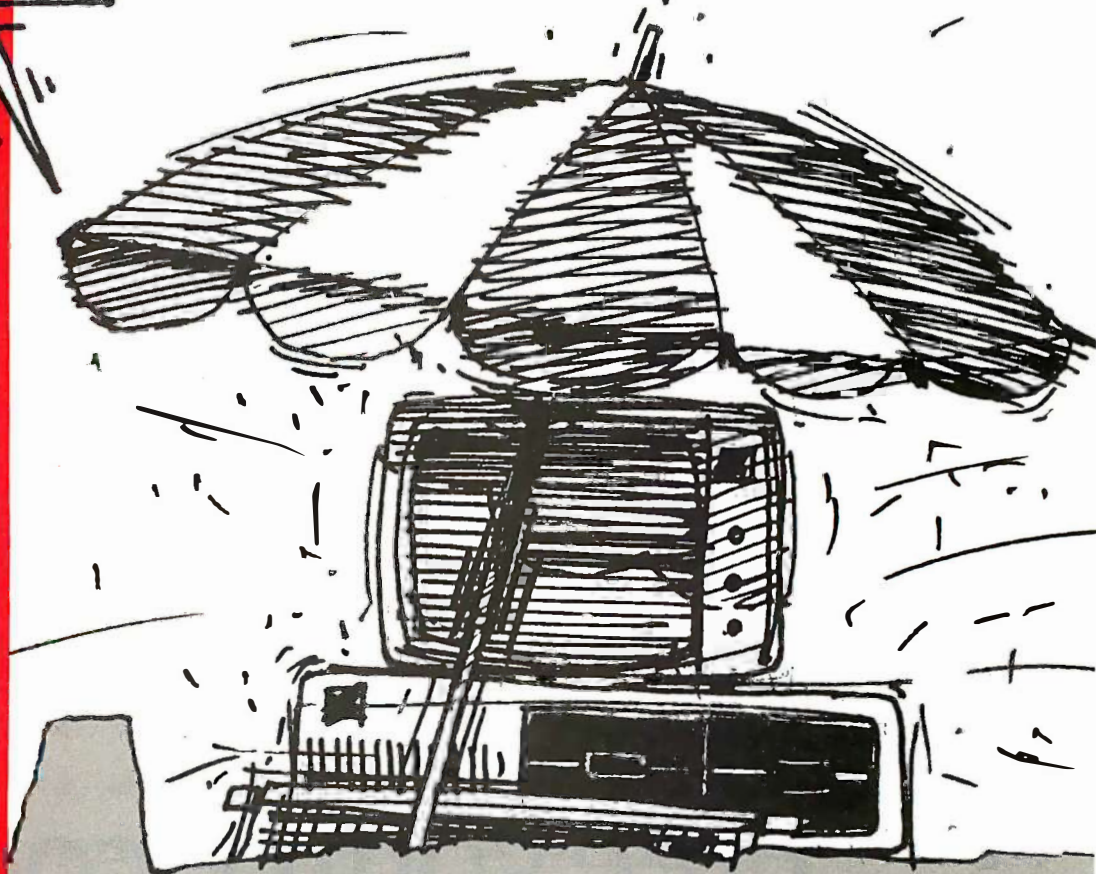

Honeywell synchronous
VIP emulation and file
transfer (FTF an option).
Compatible with Topview.
Honeywell VIP
asynchronous emulation
and file transfer.
Compatible with Topview.

ASYNCHRONOUS \$399
SYNCHRONOUS \$499

TO ORDER PHONE TOLL FREE
1-800-826-7839

TDT

GROUP INC.

Rivergate Plaza, 444 Brickell Ave
Suite 902, Miami Florida 33131
Telephone 305/372-9332, Telex 4947306

Connections IBM PC—Honeywell mainframe.

DPS 4, 6, 7, 8, LEVEL 6, 66, ETC. Inquiry 335

BUILD THE EMULO-8

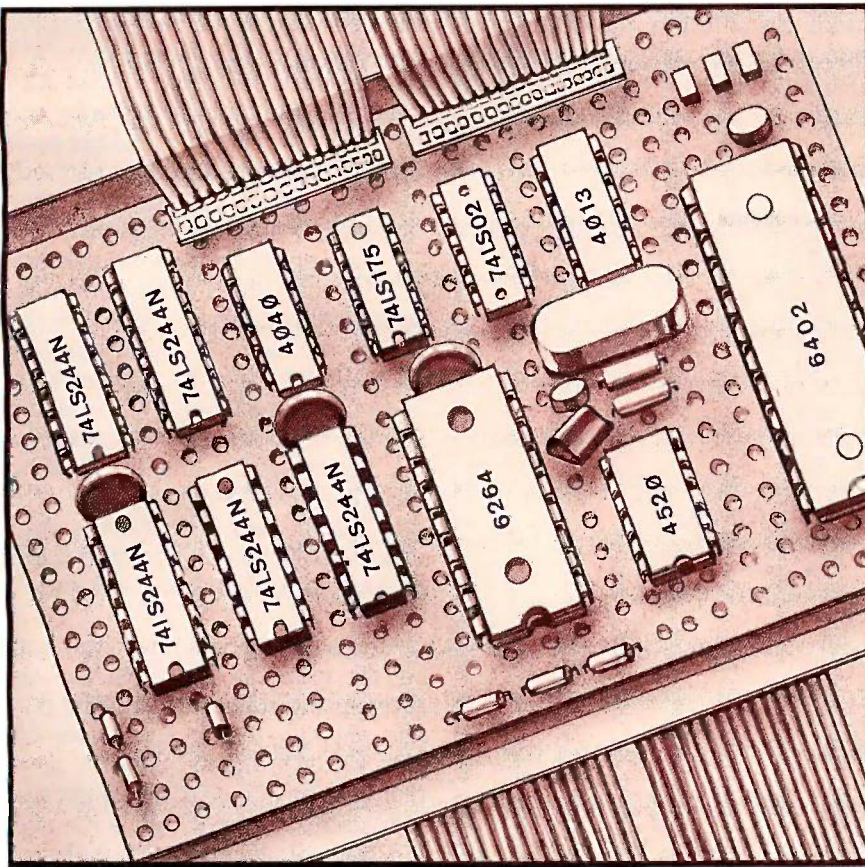

*A device that lets you
develop EPROM
programs in RAM*

Are you tired of continually programming and erasing EPROMs as you develop software for your projects? How many EPROMs have you thrown away because they were programmed one too many times? The

Emulo-8 solves these difficulties. The Emulo-8 is an EPROM emulator that interfaces to any computer that has an RS-232C serial interface. Software loaded into the Emulo-8 is executed in your target system as if it were in an EPROM. The Emulo-8, which can emulate 2716, 2732, or 2764 EPROM chips, is ideal for anyone who develops software for embedded microprocessors, especially if EPROM programming and erasing resources are limited. Firmware developed with the Emulo-8 needs to be programmed into an EPROM only once, after it has been completely debugged.

The normal method of debugging EPROM-based software is to erase and program a new EPROM each time a problem is corrected. This is tedious and time-consuming. It is possible to add enough RAM to a system to store the code, but this approach requires a ROM-based program to download the software and this also uses valuable printed circuit board space. Additionally, any time you run a program from system RAM, it is possible for a programming error to creep in and modify the RAM itself. The code will not work when it is programmed into an EPROM, although it works perfectly in RAM.

The ideal program-development tool, then, would use RAM that cannot be modified by the target system processor. It would have a simple interface to the host computer where

(continued)

Stuart R. Ball (741 Okie Ridge, Yukon, OK 73099) is a senior design engineer at BTI Systems. He has a B.S.E.E. from the University of Missouri at Columbia. His hobbies are tinkering with electronics and bicycling.

BUILD THE EMULO-8

the software is developed and plug into an existing EPROM socket to save space. The Emulo-8 meets all these requirements.

The Emulo-8 consists of an RS-232C interface, an internal 8K-byte by 8-bit RAM, and two DIP headers (24- and 28-pin). Data received from the host computer is stored in the RAM. The DIP headers plug directly into an EPROM socket on the target system. The address and data lines to the RAM are buffered by TTL gates that isolate the RAM from direct connection to the target system. The Emulo-8

has a self-contained power supply and does not need to be turned off while you make hardware modifications to the target system. (See table 1 for the parts needed to build the Emulo-8.)

HOW THE EMULO-8 WORKS

To load data into the Emulo-8, you switch it on and connect the RS-232C cable. Connect the appropriate DIP header to the target system. Place the mode switch (S1) in the LOAD position. In the LOAD position (see figure 1), tristate buffers IC4, IC5, and IC8 are

disabled, and IC6 and IC7 are enabled. Set the address switches (S2 and S3) for the EPROM to be emulated and press the reset switch (S4) to reset the UART (IC10) and the RAM address counter (IC2). The Emulo-8 can now accept serial data via the UART. This data is loaded into the 8K-byte RAM (IC1). Data is sent to the Emulo-8 in binary format. The first byte received will be stored in location 0000, and each subsequent byte will be stored in the next successive address. The LED labeled A0 will blink as the data is downloaded. IC11 generates the timing for storing the data, as shown in figure 2. After each byte of data is received and stored, the RAM address counter increments, pointing to the next location.

If you set the address switches for a 2716, the data is contained in absolute RAM addresses 1800-1FFF. For a 2732, the data is stored in locations 1000-1FFF. Setting the switches for a 2764 uses the entire RAM. The actual storage locations are transparent to the target system and the loading logic. If you set the switches for a 2716 or 2732, the data is read and stored exactly as if the emulator had a 2K- or 4K-byte RAM starting at location 0000.

After all of the data is received, you set the mode switch to READ. This reverses the state of the tristate buffers, enabling the ones that were off (IC4, IC5, IC8) and disabling the ones that were on (IC6, IC7). The target system addresses the RAM via IC4 and IC5. Data is buffered via IC8. Both sets of buffers are disabled if the mode switch is in the center position, which allows both the host computer and the target system to be switched on and off without corrupting the data in the RAM or driving the bus of the target system. After placing the mode switch in the READ position, start the target system, and it will access the Emulo-8 in the same way it would an EPROM.

CONSTRUCTING THE EMULO-8

The circuitry, except for the power supply, is mounted on a single 3½-by

(continued)

Table 1: The parts list for constructing the Emulo-8.

Qty	Description	Comments
1	6264 8K-byte by 8-bit CMOS RAM	IC1
1	4040 12-bit CMOS counter	IC2
1	74LS02	IC3
5	74LS244	IC4, IC5, IC6, IC7, IC8
1	4013 CMOS 'D' FF	IC9
1	6402 CMOS UART	IC10
1	74LS175	IC11
1	4520 dual CMOS counter	IC12
1	7805 5-V regulator	IC13
1	SPDT toggle switch, ON-NONE-ON	S1 LOAD/READ
3	SPST slide switch	S2, S3, S5
1	SPDT momentary switch	S4, reset
13	10-kΩ, ¼-W resistor	
1	1-kΩ, ¼-W resistor	
2	2.7-kΩ, ¼-W resistor	
1	470-Ω, ¼-W resistor	
1	6.8-kΩ, ¼-W resistor	
2	33-kΩ, ¼-W resistor	
1	47-pF capacitor	
1	100-pF capacitor	
1	500-μf, 35-V capacitor	
1	100-μf, 16-V capacitor	
5	0.01 to 0.1-μF capacitor	Bypass capacitors
4	1N914 or 1N4454 diode	
1	1N4002 rectifier diode	Just about any > 1-A rectifier will work
1	2N2222A transistor	
2	LED	Just about anything will work
1	1.8432-MHz crystal	
1	DB-25S connector	
1	12.6-V transformer	Radio Shack #273-1385

Misc: fuse, fuse holder, sockets, perfboard, wire, enclosure.

We have over 1000 Software and hardware items in stock. Shipments on almost all items within 24 hours!



FREE SOFTWARE!
With over \$100 purchase you will receive a free diskette for your IBM PC with label maker, checker game and banner programs.

Call for programs not listed

Technical & Other Info. (602) 246-2222

TOLL-FREE ORDER LINE 1-800-421-3135

SOFTWARE

---DATA BASE MANAGERS---

Clipper	\$345
Clout 2	129
Condor III	310
Fox and Geller Quickcode	145
Fox and Geller Quickreport	145
Knowledgeman	225
Knowledgeman II	299
K Paint	60
K Graph	135
K Text	105
K Report	135
Nutshell	55
PFS: File	78
Power Base 2.1	199
RBase 5000	Call
Think Tank	93
Tim IV	169

---WORD-PROCESSING---

Easy (Micro Pro)	89
Leading Edge w/Merge/Spell	130
Microsoft Word 2.01	230
Multimate 3.31	205
Multimate Advantage	255
Oasis Word Plus	85
Peachtext 5000	145
PFS: Write	78
Random House Spell Checker	36
Samna III 3.0	265
Volkwriter 3	Call
Word Perfect 4.1	199
Wordstar	170
Wordstar Propac	238
Wordstar 2000	238
Wordstar 2000+	285

---SPREADSHEETS---

Microsoft Multiplan	115
PFS: Plan	78
Supercalc III 2.1	Call
Twin	79

---ACCOUNTING---

BPI Accounts Payable	299
BPI Account Receivable	299
BPI General Accounting	299
BPI Payroll	299
Cyma	Call
Dollars and Sense	95
MBSI	Call
Tobias Managing Your Money	94

TCS. Big Four equivalent of Peachtree Series 4 - Specially augmented and customized for your IBM PC Terminal and Printer - GL, AR, PA, AP, CP/M-80, CP/M-86 for PC XT, DOS 1.1, 2.0. Each Module \$65 For All Four \$249

---INTEGRATED---

Enable	Call
Smart Software	Call

---TRANSFER PROGRAMS---

Crosstalk XVI	89
Hayes Smartcom II	88
Microsoft Access	149
Move-It	79
Remote	89

---GRAPHICS---

Chartmaster	215
Dr. Halo II	99
Energraphics w/o Plotter	170
Energraphics w/Plotter	220
Fancy Font	129
Fontrix	99
Freelance	199
Graphwriter/Combo	310
Microsoft Flight Simulator	30
PC Paint Brush	62

PFS Graph	78
Signmaster	135

INCREDIBLE VALUE!

Nationally advertised boards for IBM PC and most compatibles at giveaway prices.

1 year warranty

5151 Equivalent Keyboards	\$89
Monochrome Board w/Printer Port	\$79
Hercules Graphic Board Equivalent with Parallel Port	\$95
Expansion Board 0 to 576K	\$49
AST Six Pack Equivalent plus game port	\$99
Four Drive Floppy Controller	\$45
Color Card without printer port	\$79
Color Card with printer port	\$89
IBM PC CLONE 256K, 2 drives 7 expansion slots with Amber Monitor	\$850

---LANGUAGES---

Lattice C Compiler 3.0	Call
Run C Professional	169
Microsoft C Compiler	239
Microsoft Fortran	209
Microsoft Macro Assembler	89
Microsoft Pascal Compiler	178
Microsoft Quick Basic	65
Multi Halo	140

---UTILITIES---

Desqview	59
Copy II PC	19
Copy II PC Board	79
Copyright	45
Fastback	95
Norton Utilities 3.1	52
PC Tools	22
Prokey 4.0	75
Superkey	35

---PROJECT MANAGEMENT---

Harvard Project Manager	199
Microsoft Project	Call
Super Project	182

HARDWARE

---HARD DRIVES---

Bernoulli 20 MB 1/2 ht.	2439
Seagate 20 MB Internal w/Controller	499
Turbo 10 internal	529

---MODEMS---

Anchor Express	235
Hayes 1200	Call
Hayes 1200B w/Software	Call
Hayes 2400	599
U.S. Robotics Courier 2400	Call
U.S. Robotics Password 1200	Call

---RAM---

64K 150NS Chips (Japan - Set of 9)	9.50
256K Ram Chips (Set of 9)	27

---BOARDS---

AST Advantage	359
---------------	-----

HARDWARE

AST Sixpack (384K)	Call
Hercules Color Card	145
Hercules Graphics Card	289
J RAM III	Call
J RAM III AT	Call
Paradise Five Pak	119
Paradise Modular Graphics Card	249
Quadram Board with Par/Ser and Game Port	199
Quadcolor I	185
Sigma Maximizer Multifunction	149
STB Chauffeur Board	249
STB EGA Plus	320
STB Mono Board	155
AB Parallel Print Switch w/cables	75
Mini Micro Parallel Print Buffer	69
IBM 120 Watt Power Supply	83

---COMPUTERS---

Corona PC	Call
-----------	------

Sperry PC Mono 256K Dual Drive Serial Port, Clock, MS/DOS 2.11 \$1650

ITT Computers PC Compatible 256K Dual Drive, Mono, MS/DOS	Call
---	------

ITT XP 80286 IBM/PC Compatible, 512K, 10 MB Winchester, 3 times faster than an XT. 30% faster than an AT Call

Sharp Portable	Call
----------------	------

---PRINTERS---

FAST! ALL NEW PRINT SELECT PROGRAM VERS. 2.0
Written in assembly language for most MS-DOS computers. With purchase of any printer you will receive at no charge this menu driven program to set print characteristics or to make your computer function as a correcting typewriter. Retail value \$35.

CITIZEN	
MSP-10	255
MSP-15	355
MSP-20	329
Citizen 120D	169
Premiere 35 Daisywheel	415
EPSON - Call on all models	
JUKI	
Juki 6100	349
Juki 6300	685
NEC	
3550	989
8850	1349
P5 Parallel	995
Elf 360	398

OKIDATA - Call on all models	
PANASONIC	
1091	239
1092	320
1093	429
KXP3151	410
STAR MICRONICS - Call for prices	
TOSHIBA	
1340	460
P351	1049
P341	799

---MONITORS---

AMDEK	Call for price
Taxan 121 Green	Call
Taxan 122 Amber	Call
Princeton Max 12	169

TERMS: Prices include 3% cash discount. Add 3% for charge and C.O.D. orders. Shipping on most software is \$5.00. AZ orders +6% sales tax. Personal check - allow ten (10) days to clear. Prices are subject to change. We accept purchase orders from authorized companies.

TOLL-FREE ORDER LINE 1-800-421-3135

WAREHOUSE DATA PRODUCTS

2701 West Glendale Ave. • Phoenix, AZ 85051



Inquiry 357

BUILD THE EMULO-8

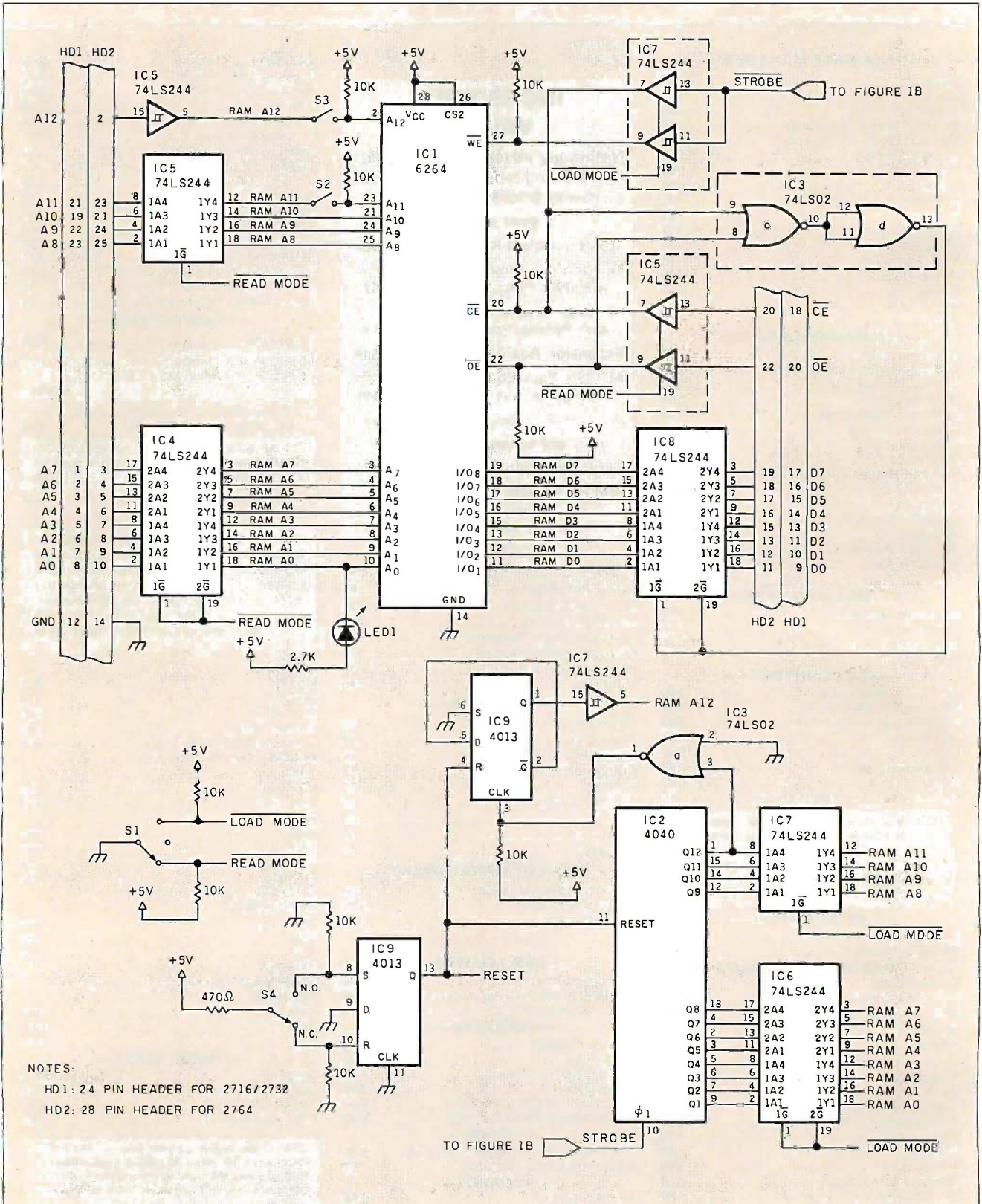

Figure 1a: A schematic diagram of the Emulo-8.

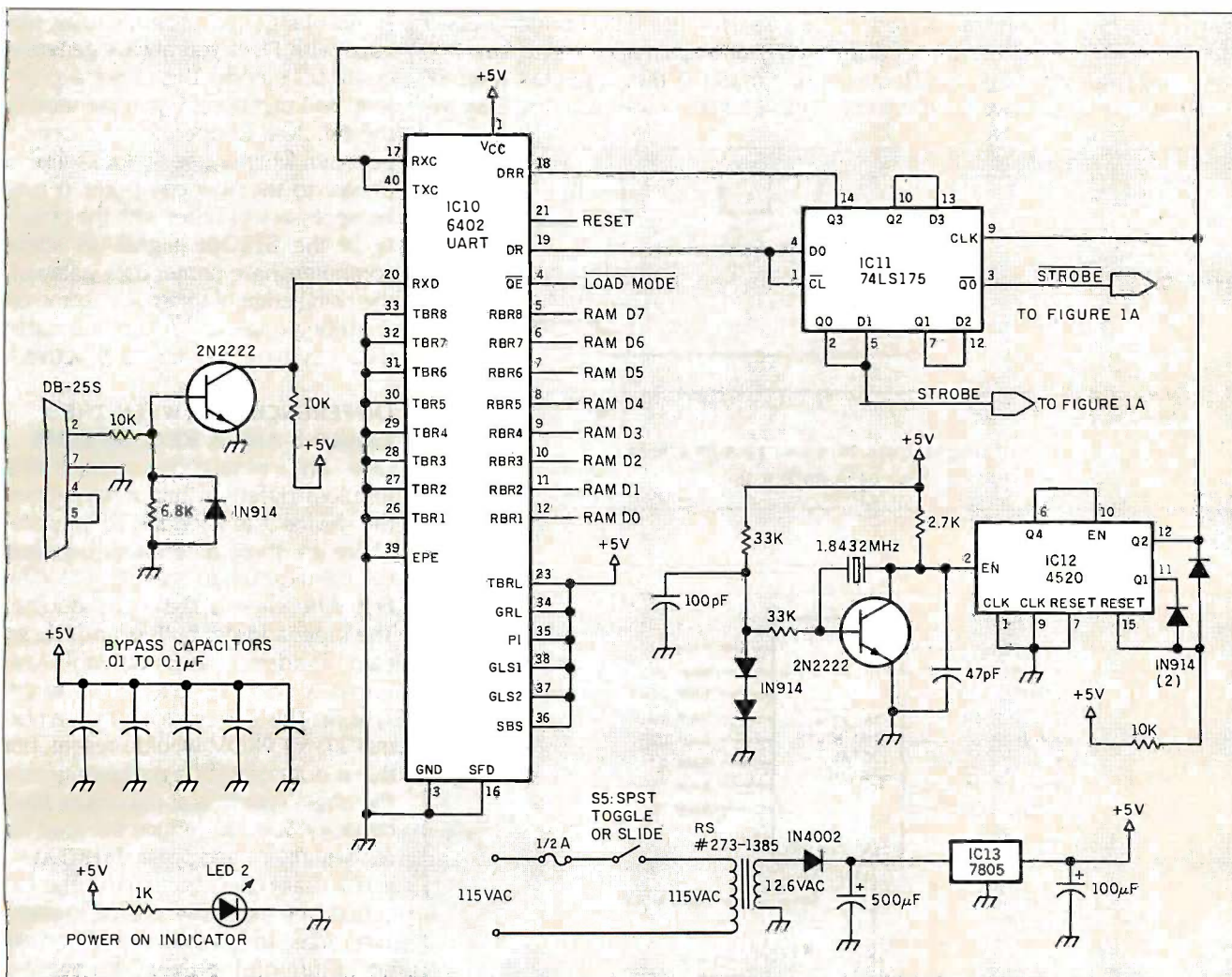

Figure 1b: Serial interface circuitry and power supply schematic for the Emulo-8.

5-inch perfboard. The circuit requires about 200 milliamperes of current at +5 volts. If you use the power supply shown, be sure to provide a good heatsink for the 7805 regulator. It is regulating 5 V from a 12-V transformer, so it dissipates more power than the rest of the circuit. You could substitute a 6.3-V transformer for the one shown, but the size of the filter capacitor must be increased. You can also substitute another power supply for the one shown.

The bypass capacitors shown on the schematic are essential, and you should distribute them evenly over the circuit board.

The 4520 counter (IC12) and the 1.8432-MHz oscillator generate the

baud-rate clock for the UART. The connections shown allow operation at 2400 baud. You can generate other baud rates by changing the divide ratio. Use a metal can 2N2222A for the oscillator. Or you can replace IC12 and the oscillator with a baud-rate generator IC such as the MC14411.

The 6402 UART is connected for 8 data bits, 2 stop bits, no parity. To operate properly, the UART must be connected for 8 data bits. The number of stop bits and the parity can be adjusted to match your computer.

The DIP headers that connect the Emulo-8 to the target system are attached with ribbon cable. To avoid crosstalk, make every other wire in the ribbon cable a ground wire. If you

have trouble locating 24- and 28-pin headers, you can build them. Do this by slicing a pair of 14- or 16-pin headers down the middle, cut off the extra pins, and mount them on a perfboard with plated-through holes.

If you do not have an 8-bit serial port on your computer, you can use the Emulo-8 with a (Centronics-type) parallel printer port. Replace the UART with a 74LS374 to latch the data, and use a 74LS74 to capture the strobe and return the BUSY signal (see figure 3).

INTERFACING THE EMULO-8

The Emulo-8 is intended to interface to an RS-232 port capable of transmit-

(continued)

ting 8 data bits. Data is transferred to the Emulo-8 in absolute binary format, and data gaps must be filled in. For example, if you have a file in Intel

format that has data from address 0 to F0, and again from 100 to, say, 1FF, you must fill the space between F1 and FF with something. I use an as-

sembly-language program that fills gaps with FF. If you always generate continuous code, this is not a problem. As I mentioned, you can modify the Emulo-8 to operate via a printer port, in which case it looks like a printer to the host computer. It may be necessary to tinker with the polarity of the STROBE signal, as some computers have printer data stable on the rising edge of the strobe, some on the falling edge, and some have stable data any time the strobe is active.

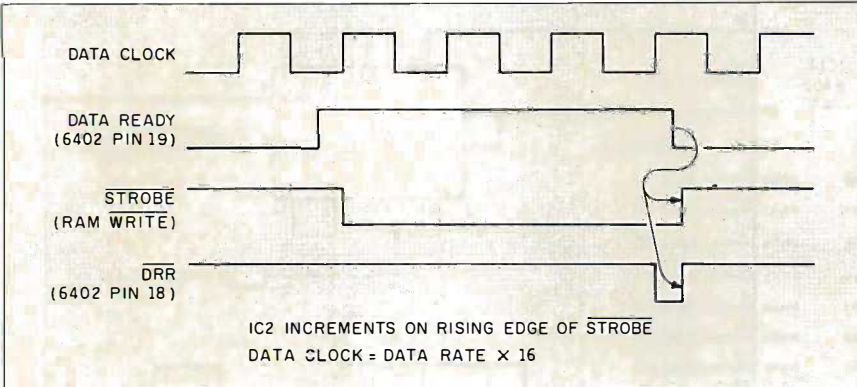

Figure 2: RAM load timing.

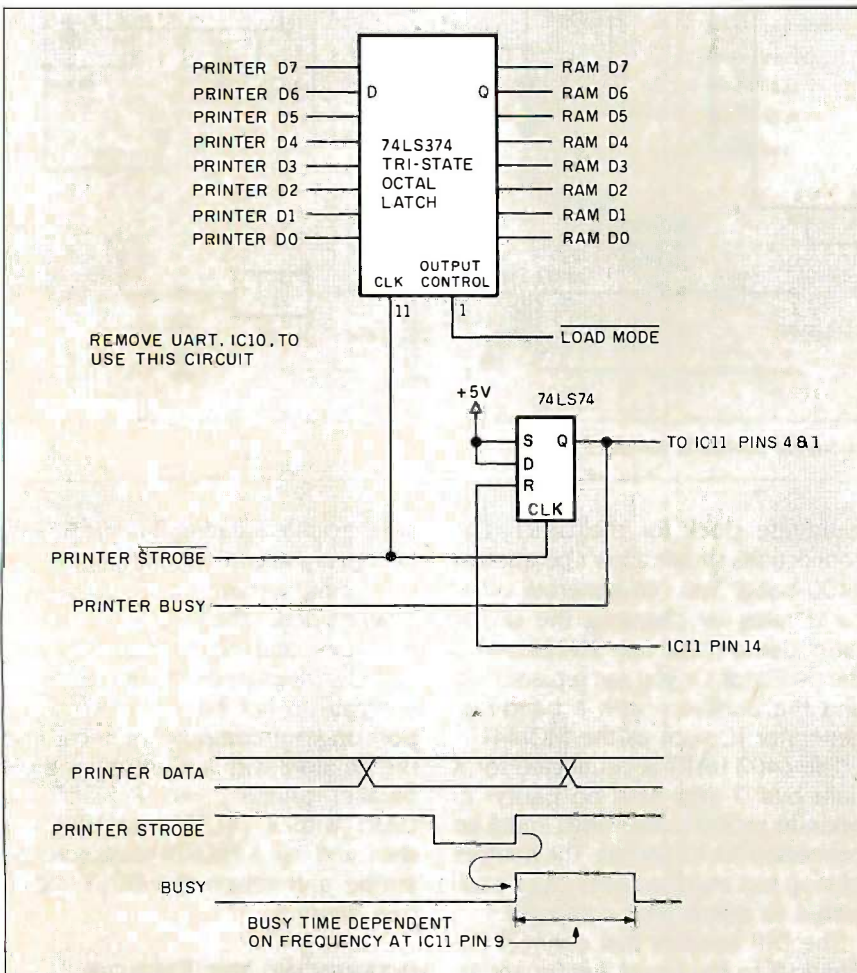

Figure 3: Schematic for interfacing the Emulo-8 to a printer port with the load timing using the printer interface.

DIFFERENCES BETWEEN THE EMULO-8 AND A REAL EPROM

Like any emulation circuit, the Emulo-8 differs in minor ways from the device it is intended to emulate. There are three differences between the Emulo-8 and a real PROM. The first difference is the input loading. The input address buffers are TTL, so each address and control line presents one TTL load to the target system. This is more load than a normal 27xx EPROM would present, but this is not normally a problem unless the target system is at maximum load capacity. You can reduce the load by replacing ICs 4 and 5 with 74HCT244s. If you make this substitution, the circuit will be more susceptible to static discharge. In addition, you should never turn off the Emulo-8 while the target system is turned on, or the HCT244s may latch up.

The second difference is the drive capability. The Emulo-8 data buffer, IC8, is a 74LS244, which has considerably more drive than a 27xx EPROM. The only consequence of this is that a heavily loaded circuit might work with the Emulo-8 but not with an EPROM.

The third difference is the access time. Most 8K-byte static RAMs that are available access much faster than a comparable EPROM. If the target system is designed around the access time of the Emulo-8 instead of the EPROM that will eventually be used, the circuit may not work when the real EPROM is installed. To avoid this, always design around the worst-case access time of the actual EPROM that will be used in the circuit. ■

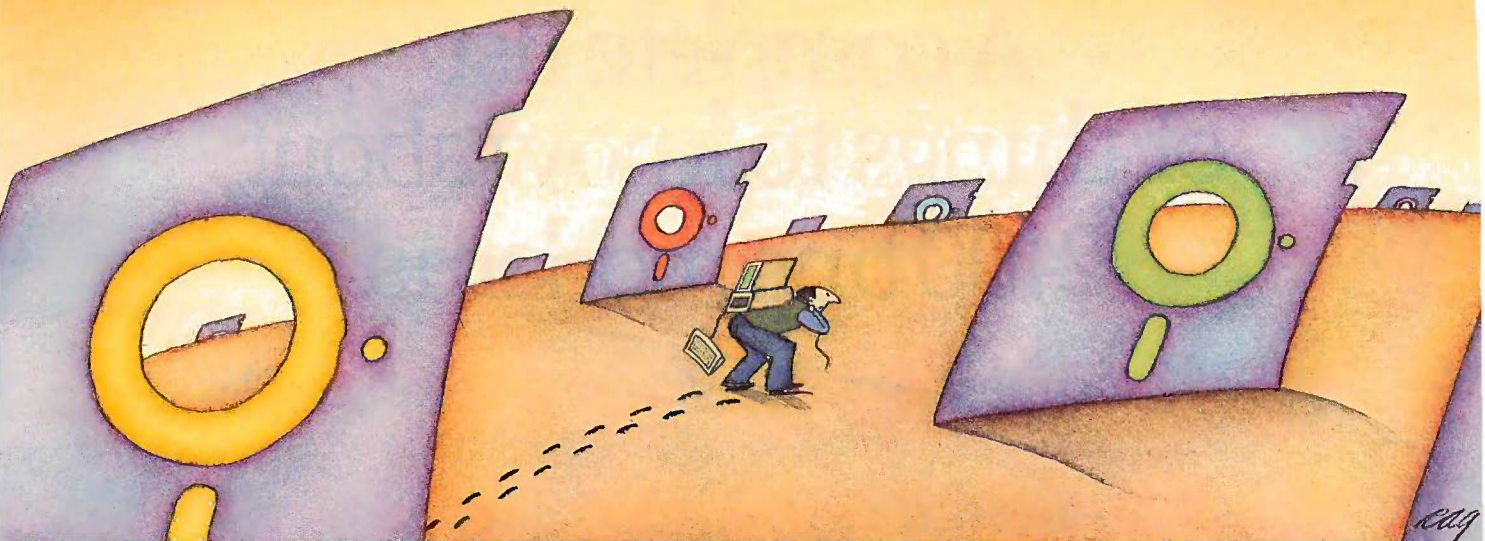

PROBLEM: There's just no easy way to move from one software program to another.

THE SOFTLOGIC SOLUTION: Software Carousel

Now you can keep up to 10 programs loaded and ready to run.

Hard to believe, but some people are happy with just one kind of PC software. Well, this is not a product for them.

But if you're someone who depends on many packages, all the time—someone who'd use several programs at once if you could, well now you can. With Software Carousel.

Why call it "Software Carousel"?

In some ways, Software Carousel works like the slide projector you're used to. You load a handful of pictures, view one at a time, then quickly switch to another. A simple idea, with powerful possibilities for computing.

Here's how it works. When you start Software Carousel, just tell it how much memory you have, load your software and go to work.

Need to crunch numbers? Switch to your spreadsheet. Need your word processor? Don't bother saving your spreadsheet file. Just whip over to your document and do your work. Snap back to your spreadsheet, and it's just like you left it.

With up to ten different programs at your fingertips, you'll have instant access to your database, communications, spelling checker, spreadsheet, word processor, RAM resident utilities, languages, anything you like.

Reach deep into expanded memory.

This could be the best reason ever for owning an expanded memory card, like the Intel Above Board, ASTRAMpage, or any

card compatible with the L/1/M Extended Memory Standard.

Software Carousel puts programs into this "high-end" memory for temporary storage when they're not in use. And

switches them back out when you want them. It's fast, efficient, and easy.

If you want, Software Carousel will even use your hard drive for swapping. Just allocate a portion for storage, and go to work.

Sidekick, Superkey and Ready. All at the same time.

You know what happens if you try loading two or more RAM resident utilities at once. You get crashed keyboards, frozen screens, all kinds of interference between programs fighting for control.

With Software Carousel, you can have as many accessories and utilities on-tap as you want. Just load different ones in different Carousel partitions. Since they can't see each other, they can't fight.

The easy way to maximize PC power.

With all this power, you might think Software Carousel is complicated and

difficult to use. Not so. Set it up once, and it will remember forever. Better still, Carousel will look for the programs you use most often, and optimize them for the quickest access.

You can spend a lot more money, and still not get the convenience and productivity increase of Software Carousel.

The way we see it, there are certain things you have the right to expect from your computer. Access to your software is one of them. At just \$49.95 a copy, Software Carousel is the best way to get it. Order today at 1-800-272-9900 (1-603-9900 in NH) or send the coupon below.

Special combination pricing is available for the purchase of Software Carousel and other SoftLogic products, including DoubleDOS and Disk Optimizer.

1-800-272-9900

	4X	8X	12X	16X
Word Star	■	■		
1-2-3	■	■	■	
BPI	■	■	■	■

With Software Carousel running in RAM, you can load a program and retrieve a file up to 15 times faster. Test conducted on an IBM XT

Software Carousel \$49^{95*}

YES!

Please send me _____ copies of Software Carousel today.

Name _____

Company _____

Address _____

City _____ State/Zip _____

Check Enclosed VISA MC AMEX

Card # _____ Exp. Date _____

Signature _____

SoftLogic Solutions, Inc.
530 Chestnut St.,
Manchester, NH 03101

*plus \$5.00 shipping and handling.

**SOFTLOGIC
SOLUTIONS**

A complete list of things to know about 2400 bps modems.

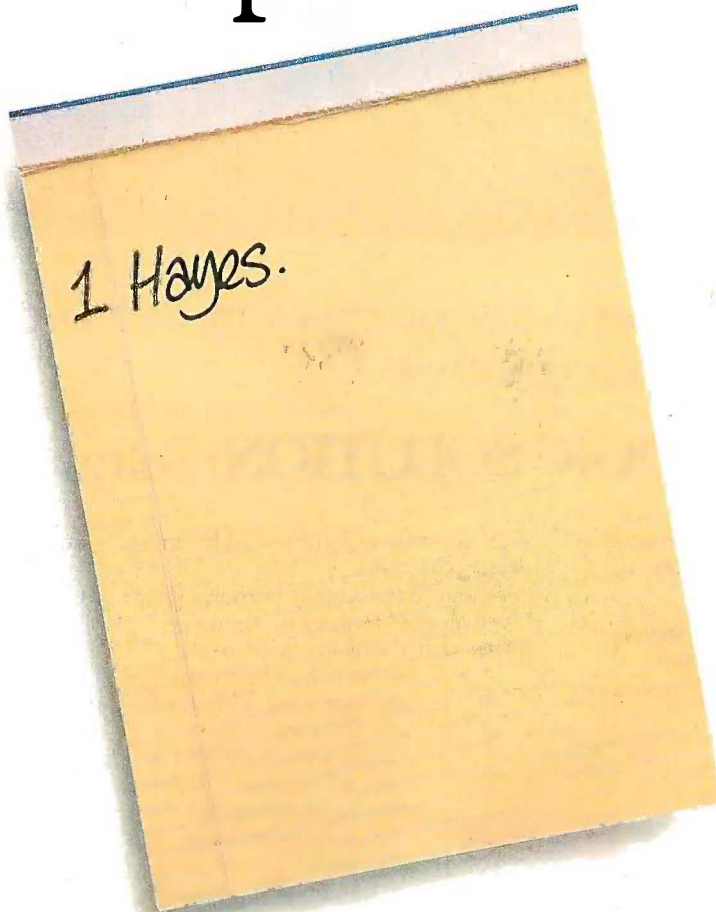

Now that you've memorized that, here's a partial list of why a Hayes® Smartmodem 2400™ is best for you.

1. The Hayes Smartmodem 2400 allows you to communicate with the vast installed-base of 300,1200 and 2400 bps "Hayes-compatible" modems. The Hayes Standard "AT" Command Set allows you to use Smartcom II® and other software that communicates.

2. Through synchronous/asynchronous technologies, the Smartmodem 2400 permits your PC to access mainframes, minis, and on-line services previously inaccessible through asynchronous-only modems.

3. The Hayes Smartmodem 2400 is efficient...it pays for

itself in just 4 hours of annual use over long distance.

4. The technology of the Smartmodem 2400 allows you to transfer volumes of files with confidence across the city or

across the ocean using Bell and CCITT standards.

5. The new Smartmodem 2400B™—a plug-in board for the IBM PC and compatibles—allows synchronous and asynchronous communication through the same Com port.

6. You will also get the Hayes standard 2-year limited warranty and the opportunity to extend the warranty to 4 years.

Best of all...you get Hayes. And that's all you ever really have to know!

For more information or technical specs, contact your authorized Hayes dealer. Or Hayes directly at (404) 441-1617.

Hayes Microcomputer Products, Inc., P.O. Box 105203, Atlanta, Georgia 30348.



Hayes®

Say yes to the future with Hayes.

MAKING UNIX SECURE

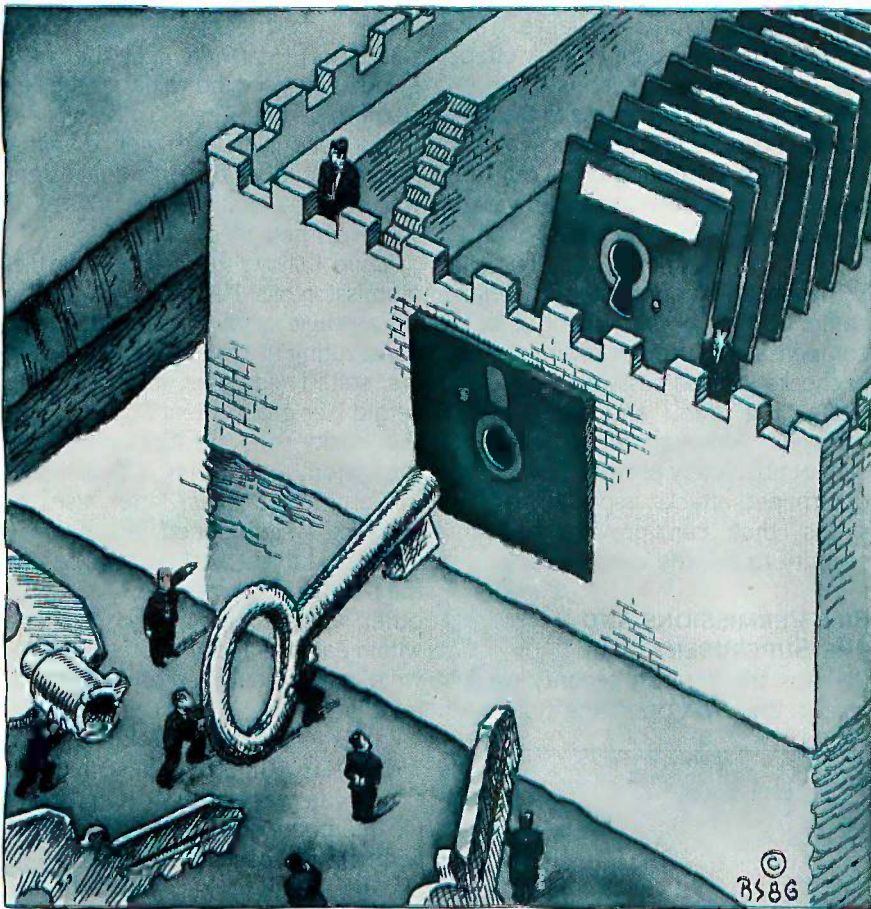

Countermeasures to known methods of attack

UNIX evolved as a powerful operating system at Bell Laboratories, where it was used primarily by a few research programmers. Much experience in using UNIX also came

from universities, particularly the University of California at Berkeley. These environments provided an army of competent and dedicated hackers to test UNIX system security. UNIX operating system security has always been an "open book."

R. Morris and K. Thompson wrote the following in "Password Security: A Case History" (from the programmer's manual for UNIX System III, volume II).

We did not attempt to hide the security aspects of the operating system, thereby playing the customary make-believe game in which weaknesses of the system are not discussed no matter how apparent. Rather, we advertised the password algorithm and invited attack in the belief that this approach would minimize future trouble. The approach has been successful.

In this article, we examine some specific security-related features of the UNIX operating system and discuss known methods of attack along with countermeasures and their associated costs. We make no claim of completeness; it is axiomatic that someone will always build a better

(continued)

Alan Filipski has a Ph.D. in computer science from Michigan State University. He has taught at Central Michigan University and Arizona State University and is currently a principal staff engineer at Motorola Microsystems, working on UNIX System V.

James Hanko has M.S. and B.S. degrees in computer science from Pennsylvania State University. He works at Edge Computer Corp., Scottsdale, Arizona, and is currently a senior software design engineer working on porting UNIX System V.

Both authors can be reached at Mail Drop DW160, 2900 South Diablo Way, Tempe, AZ 85282.

mousetrap (or Trojan horse).

We provide this information in a way that, we hope, is interesting and useful yet stops short of being a "cookbook for crackers." We have often intentionally omitted details. Admittedly, we are treading a thin line. However, it is the consensus of most system administrators that wider dissemination of such information is ultimately beneficial to the security of UNIX installations.

DEFINITION OF SECURITY

The level of "security" of computer systems can be measured by the amount of difficulty users would have accessing the system data or resources in a way unauthorized by the system administrator. The word "users" here includes legitimate users who modify or read data they are supposed to be excluded from, unauthorized persons who break into the system for the purpose of falsifying data or using system resources, or people who "decrypt" information they are supposed to read only in encrypted form.

We will not discuss protecting the user or administrator from his or her own carelessness or ignorance. If you are troubled by this kind of "insecurity" in a particular environment, you can write shell scripts or new shells to coddle the user to any degree re-

quired. Performing regular disk backups also effectively serves to limit the damage incurred in this way.

PHYSICAL VERSUS SOFTWARE SECURITY

There are two approaches to securing a computer system. You can put the system in a windowless electromagnetically shielded room with no data lines leading out and hire a guard to stand at the door and check persons who enter and leave. This type of physical security is very effective. Unauthorized persons are prevented from gaining access to the system and even legitimate users can be stopped from carrying tapes out the door. Of course, this approach greatly reduces the usefulness of the system.

The second approach is to relax some of this physical control and compensate by using software security checks, such as passwords, permissions, log files, and encryption schemes. Although these schemes cannot absolutely prevent clever and determined attacks, especially by insiders, they can provide enough security to foil the casual snooper.

FILE PERMISSIONS AND THE SUPERUSER

Perhaps the greatest security weakness of the UNIX operating system is

the power of the superuser. There is no effective system of checks and balances against him or her.

Within the UNIX operating system, each file has an owner and group associated with it and a set of switch values that control the way it may be accessed by different types of users. By default, the owner of a file is its creator, and the group associated with a file is the group its owner belongs to.

Only the owner of a file, or root (the superuser), can change the file's owner, group, or the values of the file-permission bits. The permissions are useful not only to the system administrator, but also to individual users who want to enhance the privacy of some of their files.

Figure 1 shows the format of the file-permission bits. They are organized as a four-digit octal number. The bits constituting the most significant digit are *setuid* (set user identification), *setgid* (set group identification), and the "sticky" bit. The sticky bit causes the system to preserve a core image (of often-used files) after use, to enhance system speed.

The next three octal digits represent the permissions for owner, group, and other users, respectively. The bits within each octal digit represent read, write, and execute/search permission for that group.

For example, a permission of octal 750 = 111 101 000 means that the owner can read, write, or execute the file; members of the group associated with the file can read or execute it; and others can neither read, write, nor execute it. A default set of values for these bits is used when a new file is created. Often this default is 644, meaning that only the file owner can write to and read the file, and everyone else can only read it.

In a work environment where people frequently need to share information, this is reasonable. But if security is a concern, the default should be changed to something more restrictive (such as 640 or even 600) and then weakened for selective files as necessary. UNIX's Bourne shell pro-

(continued)

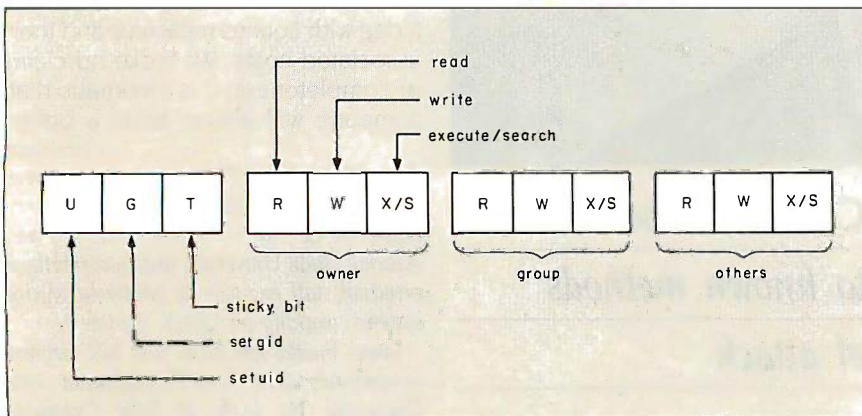
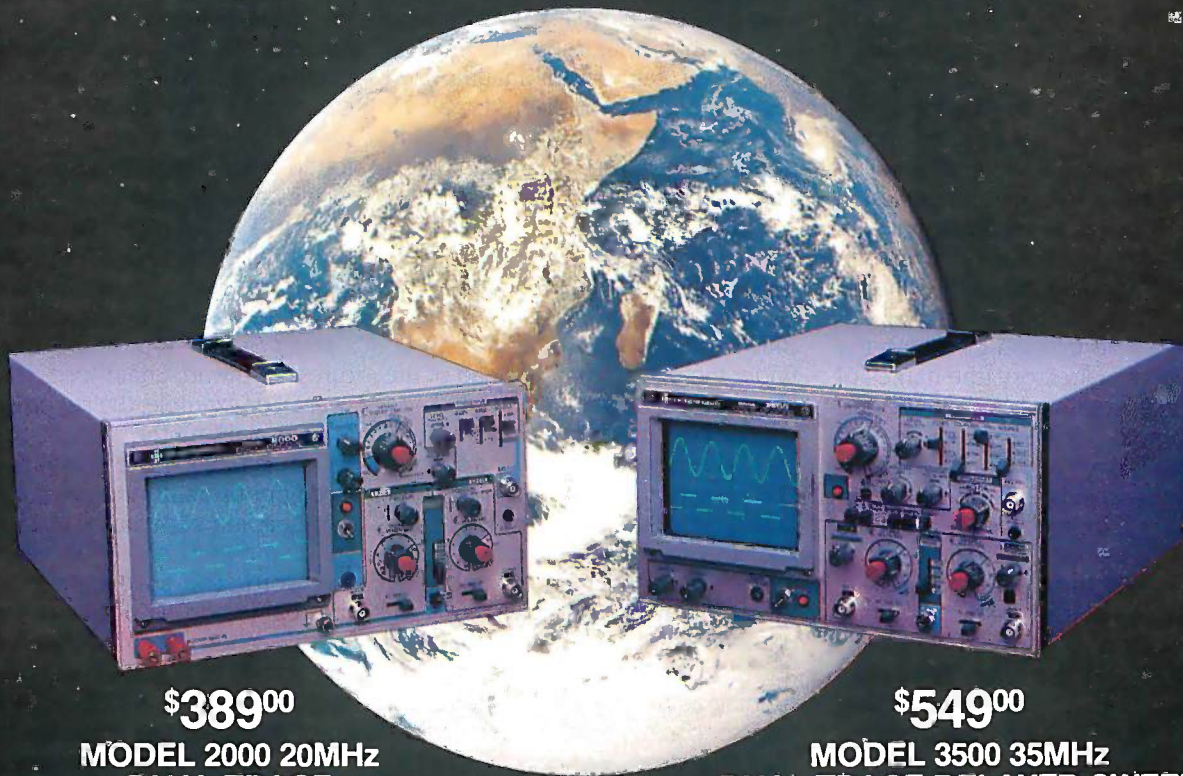

Figure 1: UNIX file permissions. Under the UNIX operating system, a user's ability to access a particular file is governed by the setting of 12 bits (four octal digits) associated with that file. The high-order 3 bits are the *setuid*, *setgid*, and "sticky" bits, respectively. The remaining 9 bits represent read, write, and execute/search permissions for owner, group, and others, respectively.

PERFORMANCE

THAT IS OUT OF THIS WORLD...



\$389⁰⁰

**MODEL 2000 20MHz
DUAL TRACE**

\$549⁰⁰

**MODEL 3500 35MHz
DUAL TRACE DELAYED SWEEP**

...AT A DOWN TO EARTH PRICE

At last! Truly affordable test equipment with no compromise in design, and features you would expect to find only on oscilloscopes costing hundreds of dollars more! JDR Instruments presents two, new, high-performance models backed by a two year warranty and technical support which is only a phone call away. Perfect for the technician or advanced hobbyist, both models feature Dual Trace capability and a variety of operating and triggering modes, including CH-B Subtract and X-Y operation.

MODEL 2000 has a 20 MHz bandwidth and 20 calibrated sweeps ranging from .2s to .2 μ s. A convenient built-in component tester provides additional diagnostic power.



INCLUDES TWO HIGH QUALITY
1x, 10x TEST PROBES

MODEL 3500 features a 35 MHz bandwidth and exceptional 1mV/DIV sensitivity. Delayed sweep and variable holdoff allow stable viewing of complex waveforms.

ORDER TOLL FREE
800-538-5000
800-662-6279 (CA)

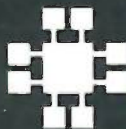

JDR INSTRUMENTS
1224 South Bascom Avenue
San Jose, California 95128 (408) 995-5430

vides an umask function to change this default.

Since directories are a special kind of file within the UNIX operating system, the same 9 permission bits apply to them. However, the execute bit has a special meaning here, and it is called the search bit. The search permission bit in a directory is required to access any file with that directory in its path. This is distinct and independent from read permission in a directory.

The read permission bit allows the contents of a directory (the names of files) to be examined or displayed as, for example, by ls. This distinction provides some additional security. You can let someone execute, read, or write to one of your files without letting him or her list the contents of the directory that the file is in. Therefore, the user can access the file only if he or she knows its name.

Some claim that the three-level (owner, group, other) file-protection system of the UNIX operating system is inferior to the scheme in which an explicit access list of users must be given for each file. Actually, you can simulate this other file-protection scheme on UNIX in several ways.

For example, you can form a group that defines any given subset of users, and you can give the desired permission to the group. More flexibly, a setuid program can be written to check the log-on ID of the user who invokes it and allow access to files based on a list of IDs. The UNIX SCCS (Source Code Control System) utilities do something like this.

Two additional file-protection bits, setuid and setgid, are very important to the security of the UNIX operating system. The setuid bit on an executable program allows it to run with the effective file-accessing power of the program's owner rather than with that of the user (the usual case). Likewise, the setgid bit on an executable program allows it to run with the effective file-accessing power of the group of the program file.

These features, when used with care, can be powerful tools for implementing application software. For instance, you can implement an elec-

tronic mail facility wherein a fictitious user group, e.g., "mail," is associated with all files that represent mail in transit. You can prevent unauthorized reading of the undelivered mail by preventing those users not running under the group "mail" from accessing the files.

This presents a dilemma: How does a user not ordinarily in group "mail" send mail to another? The setgid bit resolves this by allowing the program that sends mail to temporarily run under the group "mail" instead of the user's real group.

If not used carefully, this feature can compromise the security of a system. For example, the mkdir or df programs, which are owned by the superuser and have the setuid bit on, might inadvertently be made writable by others. Then any user could copy another program over the original mkdir and do whatever he or she desired, running as the superuser. Afterward, the user could copy the original mkdir back in to (partially) cover his or her tracks.

TRAPDOORS

The goal of nearly every UNIX system break-in scheme is to allow the cracker to become superuser (root) even for a few moments. The cracker creates a setuid shell that he or she can execute. He or she then becomes root whenever he or she wants to.

Administrators take note: A setuid root program in a user directory is an advertisement of a security hole.

If source is available on the system, the cracker can be more sophisticated. To cover his or her tracks the user creates a doctored version of, say, mkdir or df, and installs it in place of the real one. This version behaves exactly like the real one except that when given a special option, such as mkdir -xyzy, it transforms itself into a shell via an exec system call. Since the original utility was setuid to root, the shell will be setuid root also.

The cracker now becomes superuser whenever he or she wishes, even if the superuser password is changed and the cracker leaves no incriminating programs in his or her working

directory. The only trace left is that the doctored utility is now perhaps different in size and its modification date updated. But even these tracks can be covered. A little clever surgery can make the utility the same size, and touch can be used to reset its modification times.

Such a subverted utility is sometimes called a trapdoor because it gives those who know how to use it secret access to the operating system.

UNIX System V provides some features to thwart unauthorized superusers. For example, the superuser can log on only at the system console, which is subject to physical security. Ordinary users at ordinary terminals can become superusers through the su command and the superuser password. The su command enters the real log-on ID of the user into a log file when executed, but this log should not be relied upon as a deterrent because, like any other file, it may be changed by the superuser.

Because superuser privileges are required for many administrative operations, superuser passwords should be guarded with great care, and should never be given to anyone unless absolutely necessary.

THE crypt UTILITY

Many versions of the UNIX operating system provide a utility called crypt. This utility implements a single-rotor encryption machine that is a simplified version of the German World War II "Enigma" machine. Using the utility is simple—to encrypt an ASCII file plain to produce an encrypted file cipher, you only have to type

```
crypt [password] <plain> cipher
```

where password is a character string that serves as an encryption key. The crypt utility provides its own inverse, so that to decrypt the file, you type

```
crypt [password] <cipher> plain
```

using the same string for password.

Recent studies indicate that crypt may not be as secure as previously thought and that the files produced

(continued)

SEIZE POWER.

LOGIMOUSE[®] C7

Become twice as productive with half the effort and three times the fun. Whether you're using AutoCAD, Lotus 1-2-3, PC Paintbrush or Reflex. LOGIMOUSE is the productivity demon that gets you there faster.

At a powerful \$99 price.

HARDWARE SUPERIOR LOGIMOUSE has always been hardware superior. Which is why it's the consistent choice of professional users.

- HIGH resolution—twice as high as most other mice
- NO pad, NO external power supply—FREE of the optical mouse jumble of pads, wires, and plugs
- IBM PC, XT, AT compatible directly into any serial port

SOFTWARE SUPERIOR LOGIMOUSE software is still a generation ahead in bringing the mouse to its full power within your application.

- Fully compatible with AutoCAD, GEM, Lotus 1-2-3, MS Windows, all Microsoft compatible programs, PC Paintbrush, Reflex and many, many more
- LOGIMOUSE Software Disk FREE with every mouse, including:
 - Universal Mouse Driver with easy Mouse Setting File TAG, the Text-And-Graphics editor
 - LOGIMOUSE INTERFACE for 1-2-3

LOGIMOUSE INTERFACE FOR LOTUS **FREE**

The all new LOGIMOUSE INTERFACE for Lotus 1-2-3 sets a new industry standard for making 1-2-3 work faster and easier. LOGIMOUSE is not just a replacement for keyboard key-strokes. It's a 1-2-3 liberator that makes Lotus more fun to use.

OFFERED FREE for a limited time on every LOGIMOUSE Software Disk.

LOGIPAIN SET **\$149**

LOGIMOUSE C7 plus PC Paintbrush 3.0 is the most advanced paint set available for the PC. Use LOGIPAIN for designing a logo, creating a cartoon, or drawing a picture of a product you're developing. You won't believe its power with either free hand drawing or graphics.

To place a credit card order call our special toll free number:

800-231-7717

In California:

800-552-8885

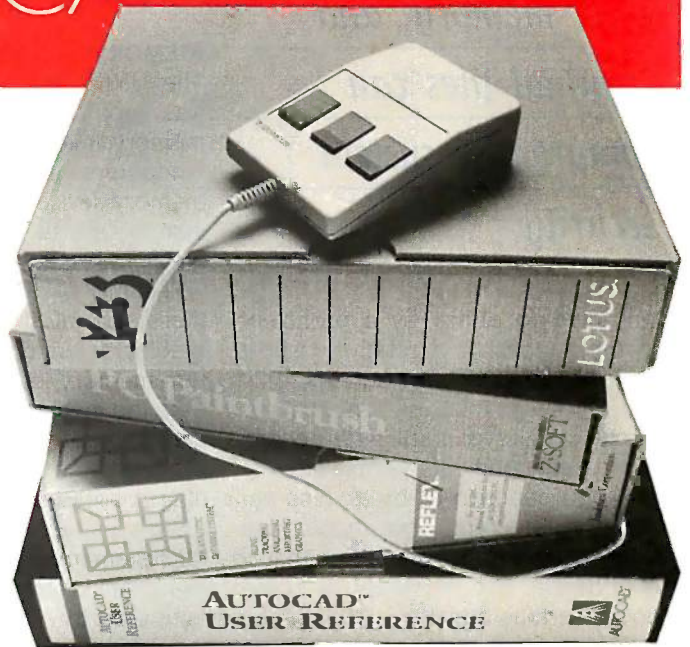

YES! I want to seize the LOGIMOUSE Power!
Please send me:

- LOGIMOUSE C7 with the Universal Mouse Driver, TAG and the LOGIMOUSE INTERFACE for 1-2-3. **\$99***
- LOGIPAIN SET—LOGIMOUSE C7 with the Universal Mouse Driver, TAG, the LOGIMOUSE INTERFACE for 1-2-3, PLUS PC Paintbrush 3.0. **\$149***

*Add \$5 for shipping and handling.

- VISA MASTERCARD CHECK ENCLOSED

Card Number _____ Expiration Date _____

SIGNATURE _____

NAME _____

ADDRESS _____

CITY, STATE _____

ZIP _____ PHONE _____



LOGITECH

LOGITECH, Inc.
805 Veterans Blvd., Redwood City, CA 94063, USA
Telephone: (415) 365-9852

LOGIMOUSE is a registered trademark of LOGITECH Inc. AutoCAD is a trademark of Autodesk Inc. GEM is a trademark of Digital Research Inc. Lotus and 1-2-3 are trademarks of Lotus Development Corp. MS Windows is a trademark of Microsoft. PC Paintbrush is a trademark of ZSoft Corp. Reflex is a trademark of Borland/Analytica Corp.

*Device-special
disk, memory, and
terminal files can
compromise system
security.*

will yield to attack by a proficient cryptographer in a relatively short time. However, if you encrypt only short files with relatively long (but different) keys, crypt is still fairly secure. In most environments, people lack the skill and patience to break files encoded with crypt. You should use crypt for encoding information that is confidential but not likely to come under serious attack.

Unfortunately, some versions of the UNIX operating system being produced today, particularly those designated for export, do not have a crypt utility. If your UNIX system does not have one, obtain a similar utility to provide a certain amount of security against casual attacks.

SPECIAL /dev FILES

Within the UNIX operating system, devices such as disks, terminals, etc., are treated as special files. These files appear in the directory /dev. For example, /dev/tty00 might represent a terminal and /dev/dk10 might represent one of the disks. Like any other file, each special file has an owner, a group, and a set of permission bits associated with it. If permitted, a user may perform read and write operations on it.

Internally, a special file is represented by a pair of numbers—the major device number (an index to a particular device driver) and the minor device number (one of the devices controlled by that driver).

Special files simplify the user interface to devices by allowing one mechanism to handle access to both devices and regular files. However, the use of three types of device-special

files can compromise system security. The devices in question are memory, disks, and terminals.

MEMORY

The UNIX operating system kernel was kept small and simple due to memory limitations of circa-1970 mini-computers. Therefore, UNIX uses memory device-special files instead of system calls to report status of running processes.

Reading or writing a location in these special files has the effect of reading or writing the associated system memory location. The ps utility uses the memory device-special files to read the information in the system's process table and report about running processes.

Such a structure may be appealing for system implementation, but it is a nightmare in terms of maintaining system security. The memory device-special files provide a window into the running system through which any user's proprietary programs or data can be observed. Even worse, this window allows access to critical variables in the kernel itself. Ordinary users should never have read or write permissions on the memory device-special files.

DISKS

Disk device-special files provide a convenient method for system administrators to specify particular disks to be mounted, backed up, etc. Reading the information from such a file would reveal the disk data in "raw" form; i.e., blocks concerned with maintaining directory structures and raw data blocks would be mixed in a seemingly random manner. However, a sophisticated user with knowledge of the file-system structure could follow the disk pointers and read or write any information without regard to the permissions recorded for files. Again, care must be taken to assure that ordinary users do not have access to the disk device-special files.

TERMINALS

Terminal device-special files pose a special security problem in UNIX sys-

tems. Ordinary users need read and write permission on these files while they are logged on to the associated terminal, to allow them to use the write utility to send real-time messages to each other.

The problem is that users should not be allowed read permissions for terminals that they are not logged on to. Such access allows them to intercept data that is entered at the keyboard, including passwords.

Most UNIX implementations check access permissions on open calls only. Therefore, user 1 can start a background process that opens user 1's terminal for reading while he or she is logged on to it. User 1 can then log off, allowing user 2 to log on. At any time, the background process can issue a read and thereby intercept input from the terminal.

Although such an attack is hard to defend, it is easy to detect. The telltale symptom is that the background process, not the system, receives user 2's input, and it appears that the input line of data is lost. If the system indicates that user 2's password is incorrect but user 2 is fairly certain it was entered correctly, that password may have been intercepted. If this occurs, it is a good idea for user 2 to log on to another terminal and quickly change his or her password.

DIAL-UP LINES

Dial-up lines pose additional problems. For example, the UNIX System V user's manual advises you to terminate a session simply by hanging up the phone. This is a bad idea; the next user who dials in may be able to resume your session.

Call-back modems offer improved security but should not be relied upon absolutely. Persons knowledgeable about the workings of the phone system may be able to foil these.

THE UNIX PASSWORD SYSTEM

Most time-sharing systems' passwords are kept in secret restricted files that ordinary users cannot read. The UNIX operating system takes a different approach. All passwords are stored in

(continued)

New from Logitech.

MODULA-2/86 VERSION 2.0

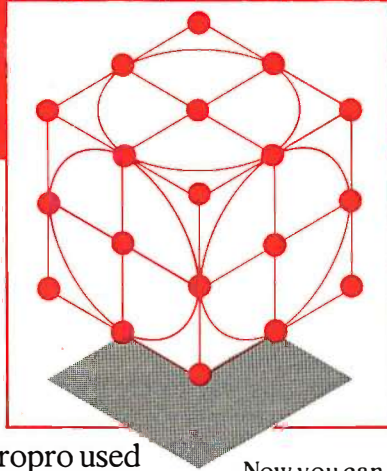

Professional Modula-2 for \$89.

Now the same powerful tools Micropro used to develop its latest word processing system is available to you at a new \$89.00 price.

Building Blocks for Tomorrow's Technology

Universities are switching to LOGITECH MODULA-2. Innovative programmers now develop applications and products with LOGITECH MODULA-2. The most productive teams at major companies depend on LOGITECH MODULA-2.

Now you can create your professional software development system using the proven technical sophistication of LOGITECH MODULA-2/86.

Systems to Fit Your Needs.

Base Language System \$89

- Compiler and Linker
- Module Library

Base Language System/8087 \$129

- Inline 8087 code.

Base Language System/512K \$189

- Full 8087 support.
- Uses RAM to increase speed by 40 to 50 percent.
- 80186 and 80286 support.

Run-Time Debugger \$69

- Monitors the execution of a program with user-defined breakpoints or by stepping through the program.
- Symbolically displays the source code, data, procedure call chain, and raw memory.

MODULA-2 Editor \$59

- Fast on-line Modula-2 syntax check.
- Can run compiler and linker from the editor.
- User definable templates for Modula-2 syntax constructs.

Utilities Package \$49

- Decoders: Disassemble link and load files.
- Version: Administrate different versions of one program.
- Post-Mortem Debugger: Debugs a program after abnormal termination.
- Cross Reference: Produces a cross-reference listing of a Modula-2 program.

Sources \$179

- Sources to customize your system.
- Run-Time System sources.
- Some library module sources.

Not Copy Protected

INTRODUCTORY OFFER:

Through the end of April you get the new MODULA-2 Editor for free with any purchase of the Base Language System.

To place an order call our special toll free number:

800-231-7717

In California:

800-552-8885

YES, I want to create my professional software development system. Please send me the following building blocks:

- BLS \$89 BLS/8087 \$129 BLS/512K \$189
 RTD \$69* EDITOR \$59*
 UTILITIES \$49* SOURCES \$179*

*\$10 less with the purchase of any Base Language System. Please add \$5 for shipping and handling.

- VISA MASTERCARD CHECK ENCLOSED

CARD NUMBER _____ EXPIRATION DATE _____

SIGNATURE _____

NAME _____

ADDRESS _____

CITY _____

STATE _____ ZIP _____ PHONE (____) _____



LOGITECH

LOGITECH, Inc.

805 Veterans Blvd., Redwood City, CA 94063, USA

Telephone: (415) 365-9852

LOGITECH SA

Box 32, CH-1143 Apples, Switzerland

Telephone: 41 (21) 774545

encrypted form in the file `/etc/passwd`, along with other information in plain form, such as log-on IDs, home directories, users' names, etc.

All users can read this file. This is the only place on the system where passwords are kept. Passwords are never stored anywhere in plain unencrypted form. However, the exception to this rule is the `uucp` file (`L.sys`, which we will discuss later), which contains passwords for restricted access to other systems.

No means are provided for decrypting the passwords in `/etc/passwd`, even by the superuser. If you forget your password, you cannot have the superuser find out what it is; you can only ask him or her to change it for you.

THE `/etc/passwd` FILE

Figure 2 shows a typical `/etc/passwd` file entry and defines the individual data fields within it. The system administrator can add new entries simply by editing the `/etc/passwd` file.

System administrators, please take note: Never set up log-on IDs with null passwords. This is sometimes done at universities where student accounts are set up without a password entry in `/etc/passwd`. The intention is that the student can supply it the first time he or she logs on. Anyone can peruse the `/etc/passwd` file looking for accounts with null passwords and commandeer those accounts.

ATTACKS VIA THE `/etc/passwd` FILE

One obvious way to break into the system is to try many passwords until you find one that works. You can do this by trying to log on many times with passwords generated combinatorially or read from a dictionary or list of proper names. A disadvantage to this method is that log-on programs are often intentionally slow and sometimes record a log of unsuccessful log-on attempts.

In a variation of this approach you encrypt trial passwords and compare

the resulting strings with the encrypted strings in the publicly readable `/etc/passwd` file.

A number of UNIX security features make this type of search impractical. First, UNIX uses an iterated version of the DES (Data Encryption Standard) algorithm that is unavoidably slow when implemented in software. The password encryption library routine `crypt()` (no relation to the utility `crypt`) requires about 1.29 seconds of VAX-11/780 processor time to encrypt a single password. This is fast enough so that a legitimate log-on sequence does not take an inordinate amount of time, but an exploratory key search would.

To prevent you from using commercially available hardware (e.g., DES chips) to perform a key search on a password file, the UNIX software uses a DES version with some minor modifications. Figure 3 and figure 4 illustrate the use of the modified DES algorithm for password encryption and verification, as adapted to the UNIX operating system.

salt

Another security feature that makes a key search impractical is the use of salt during password encryption. The new password utility obtains a random two-character string (the salt string) from the environment. Actually, this string is a function of the current time and process ID number (PID).

Twelve bits of this salt string are then used to modify, in one of 4096 different ways, the DES algorithm that encrypts the password string given by the user. The salt is stored in the `/etc/passwd` file along with the encrypted password. When a user enters a password at log-on time, the salt string from his or her entry in the `/etc/passwd` file encrypts his or her password.

Use of the salt string enhances password security in several ways. First, even if two users happen to choose the same password, their `/etc/passwd` entries will almost always look completely different. This prevents a user

(continued)

The fields within the entry are separated by colons.						
al	: davRP5LxxmSP,90/A	: 112	: 20	: AD446-3570-AIFilipski(2000)	: /a/a1	:
1	2	3	4	5	6	7
<p>Field 1 is the log-on name of the user.</p> <p>Field 2 is the password field: The first 11 characters, <code>davRP5LxxmS</code> are the encrypted password. The next two characters, <code>P,</code> are the salt. The comma is a subfield separator. The 9 and 0 following the comma mean that the password must be changed no less often than every 9 weeks and no more often than every 0 weeks. The <code>/A</code> is an encoded count of when the password was last changed, in weeks, since the beginning of 1970.</p> <p>Field 3 is the numerical user ID.</p> <p>Field 4 is the numerical group ID. It is a key into the field <code>/etc/group</code>.</p> <p>Field 5 is a comment field and can contain administrative information.</p> <p>Field 6 is the user's home directory.</p> <p>Field 7 is the null last field. It indicates that the user's default log-on shell is <code>/bin/sh</code>.</p>						

Figure 2: A typical `/etc/passwd` file entry. The fields within the entry are separated by colons.

FARSIGHT "SHOCKS" THE INDUSTRY WITH \$1000 WORTH OF SOFTWARE FOR \$99.95. DON'T BELIEVE US?



JUST ASK THE FRANKLINS.

SPREADSHEET, WORD PROCESSOR, WINDOWS: \$99.95. Introducing Farsight. The first truly integrated spreadsheet, word processor and window manager priced to put a jolt into the competition. Because \$99.95 delivers a 1-2-3® like spreadsheet, a high-end/full-featured word-processing system and an expandable window manager. Systems that purchased separately would easily cost \$1,000.00.

LIKE 1-2-3. ONLY BETTER. Farsight's Spreadsheet is everything you've loved about 1-2-3 plus some new high-voltage features. And you can move up to Farsight today without any down-time. Your existing 1-2-3 data files are read directly, plus keyboard and menu-driven macros are fully supported. You won't even have to re-learn your commands. So your investment in 1-2-3 data and procedures is not lost. Easy enough.

WORD PROCESSING + SPREADSHEET. TOGETHER AT LAST. Farsight's Word Processor combines all the features contained in the leading high-end products with the ease of use typically found in entry-

level systems. But the real spark in your word processing productivity comes from Farsight's multiple user-defined windows. You can virtually open as many document or spreadsheet windows as you wish and cut 'n paste text from one to another. With as little as six keystrokes.

BANK SOME BENS WITH FARSIGHT. Ben Franklins, that is. About nine of them. And that's just the value built into Farsight. Feature-rich software that's going to change the way the industry conjures up its inflated prices. So order today. We'll ship you Farsight and our 500-page manual within three days of your phone order. And if you don't agree that Farsight is the best value on the market, we'll send you your money back.

**NON COPY-PROTECTED.
MONEY-BACK GUARANTEE.**

 **FARSIGHT**
from Interface Technologies Corp.
3336 Richmond, Suite 200, Houston, TX 77098

1-800-922-9049

(In Texas, call 713/523-8422) Telex: 322127
In Europe call ITC at: Switzerland 41 (1) 700-3037;
Netherlands 31 (20) 106922; U.K. 44 (1) 656-7333

IBM is a registered trademark of International Business Machines Corporation. 1-2-3 is a registered trademark of Lotus Development Corp.

Not available through dealers in U.S. Hardware requirements: IBM PC family or 100% compatible, with at least 256K memory, dual floppy or hard disk, PC/DOS 2.0 or higher.

PARTIAL FEATURES LIST

Farsight's Spreadsheet/Data Manager

- All spreadsheet/data manager features of 1-2-3 Rel. 1A
- 1-2-3 macros, templates fully supported
- 1-2-3 data file read directly, no tedious importing
- Speeds comparable to or better than 1-2-3 Rel. 1A
- Pop-down menu user interface
- Sparse matrix technology like 1-2-3 Rel. 2.0
- Can search for values and labels
- 2048 rows by 256 columns

Farsight's Word Processor

- Full editing with insert or strikeover modes
- Multiple ruler layouts within a document
- Decimal tabs
- Search and replace backward or forward
- Mail Merge
- Continuous reformatting, underlining, boldfacing, italics, page breaks indicated on screen
- Proportional and micro-spacing supported
- Undo feature restores text deletions
- Can move columns
- Multiline headers and footers
- Soft hyphenation

Farsight's Window Manager

- Allows any combination of spreadsheet and word processor windows with full cut 'n paste integration
- On-line context sensitive help
- Filer supports subdirectories, file copy, move, rename, delete and search
- Supports over 40 popular printers
- Background printing
- Can have multiple printers on one machine
- Can add new Farsight applications as they become available
- User assignable keys for all applications
- Can record macros from the keyboard

Yes, rush me _____ copies of Farsight. I've enclosed \$99.95 for each copy plus \$7.00 shipping and handling. In Texas, add \$6.13 sales tax. U.S. prices only. No purchase orders accepted.

Check Money Order
 AMEX VISA MASTERCARD

Credit Card # _____

Expiration Date _____

Signature _____

Name _____
please print

Shipping Address _____

City _____

State/Zip _____

Day Phone _____

International orders add \$30 shipping/handling. If paying by check, check or draft must be in U.S. dollars drawn on a U.S. bank.

INTERFACE TECHNOLOGIES CORPORATION
3336 Richmond, Suite 200, Houston, TX 77098
(713) 523-8422

BYT

from making efficient sequential searches of the `/etc/passwd` file to see whether anyone is using a particular password. Determining if any of 100 people have the password `23skidoo`, for example, requires 100 separate applications of the encryption algorithm.

Finally, the UNIX operating system imposes many restrictions on the length and composition of the passwords. For example (under UNIX System V, release 2), passwords cannot be either entirely numeric or entirely

alphabetic. This discourages the use of strings that can be easily guessed, such as people's names. A password aging system is also implemented so that users can be automatically forced to change their passwords periodically. This feature should be used!

System V also provides the option of specifying a *minimum* length of time a password must exist before it can be changed. This feature is of questionable value. We recommend that it be set to 0 but that users be educated about the foolishness of using this to

maintain the same password perpetually.

THE TROJAN-HORSE PRINCIPLE

The cracker's Trojan-horse principle consists of getting a legitimate user to unwittingly execute or utilize program code set up by the intruder. Sometimes the planted code looks like an ordinary system utility. If the duped user happens to be a superuser, the security game is effectively over because it takes an intruder only a few instructions (as superuser) to set things up so that he or she can effectively become the superuser whenever he or she wishes.

For example, the intruder can quickly install a modified version of the `su` utility that bypasses the password check and log-file entry when a certain argument is given. Here are some of the more common ploys based on the Trojan-horse principle and some possible countermeasures for each.

FISHING FOR PASSWORDS

One technique uses a program that simulates the log-on sequence of the system. The intruder leaves this program running on a terminal that appears to be unused. When another user attempts to log on, the program easily dupes him or her into revealing his or her password. The password is then written into a file owned by the intruder, the password program kills itself, and a real log-on sequence is initiated.

A fishing program can be made sophisticated enough that users never know their passwords have been compromised. However, one feature of these programs arouses suspicion. After the fishing program obtains a password and writes it to a file, it must make a graceful transition to the real sequence for logging on.

The giveaway is that the user has already given his or her password correctly once yet must enter it again for the benefit of the "real" log-on program, which requires that the password be entered from a terminal. The fishing program usually tries to disguise this requirement by claiming

(continued)

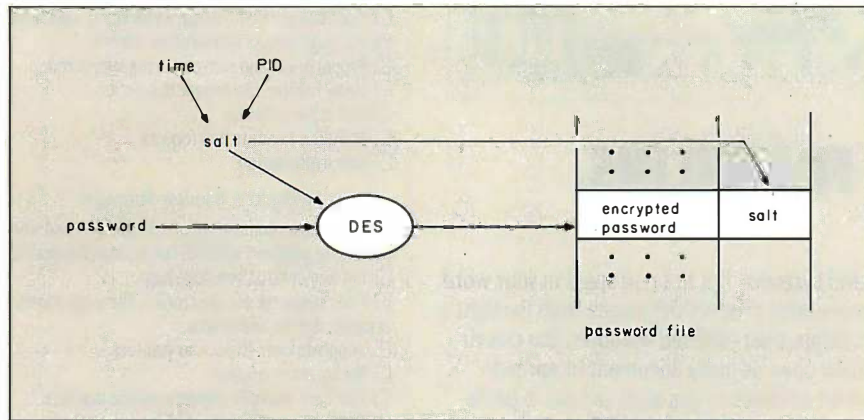

Figure 3: UNIX password encryption. When the user enters a new password, it is encoded by a variant of the DES algorithm. The algorithm is modified in one of 4096 different ways by a random quantity called the salt, which is then stored in the file `/etc/passwd` along with the encrypted password.

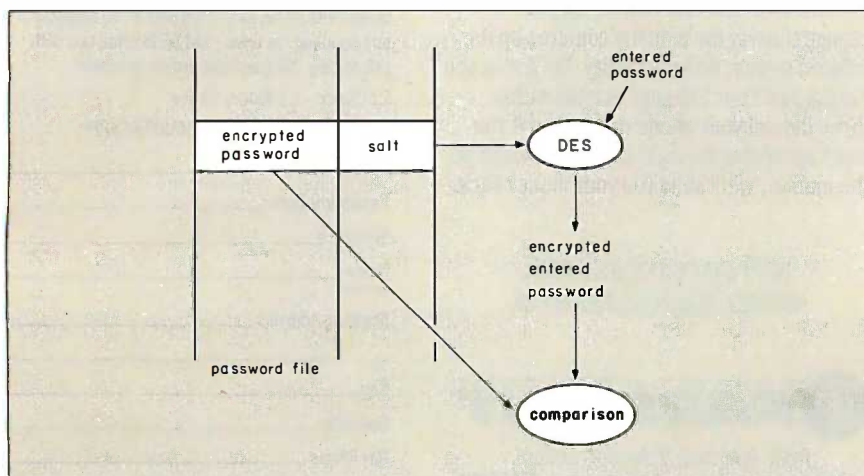
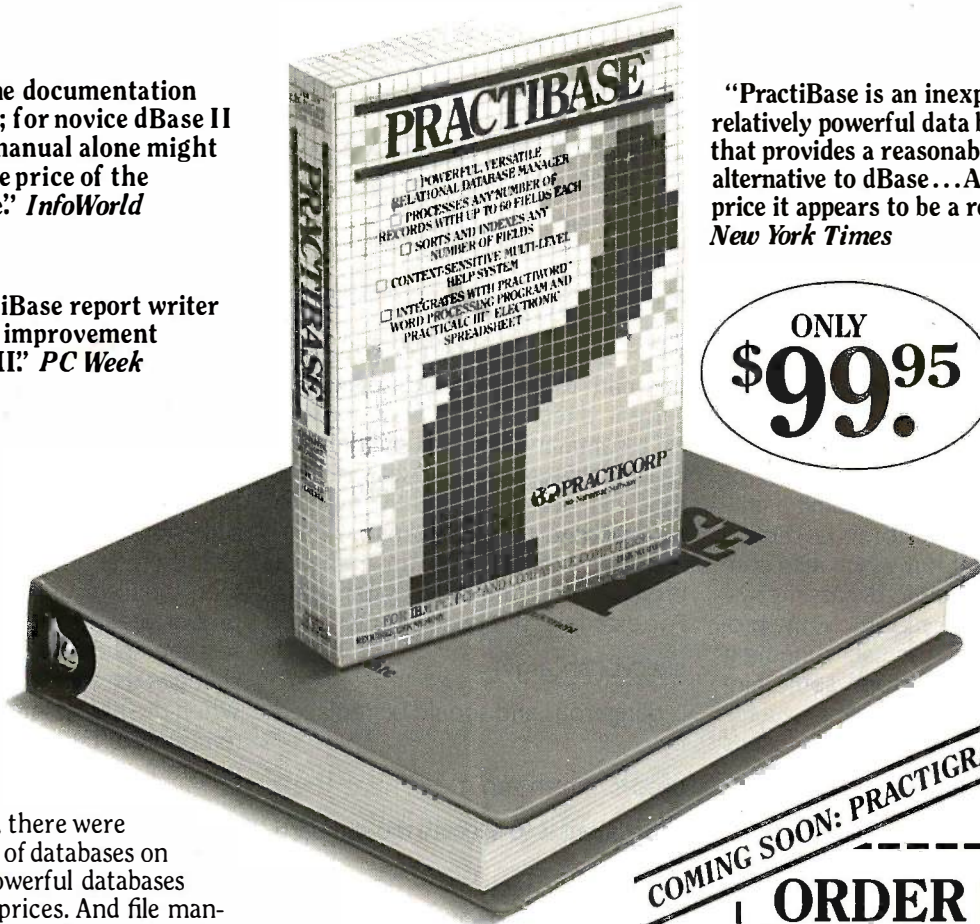

Figure 4: UNIX password verification. The entered password is encrypted by a variant of the DES algorithm using the salt string readout of the `/etc/passwd` file entry for that user. The resulting encrypted password is compared to the encrypted password in the file. If they are the same, the password is accepted. Note that the password in the file is never "decrypted."

dPOWER without dPRICE.

"We rate the documentation as excellent; for novice dBase II users, the manual alone might be worth the price of the full package." *InfoWorld*

"The PractiBase report writer is a decided improvement over dBase II." *PC Week*



"PractiBase is an inexpensive but relatively powerful data base manager that provides a reasonably attractive alternative to dBase... And at the \$99 price it appears to be a real bargain." *New York Times*

ONLY
\$99.95

COMING SOON: PRACTIGRAPH!™

ORDER NOW!

To order by mail: Complete this coupon and return to PractiCorp International, The Silk Mill, 44 Oak Street, Newton Upper Falls, MA 02164

To order by phone: Call TOLL FREE 1-800-858-2727 or call 617-965-9870

Yes! Rush PractiBase to me:

Quantity	Price
_____ PractiBase @ \$99.95 each	\$ _____
_____ PractiWord @ \$99.95 each	_____
_____ PractiBase/PractiWord bundle @ \$149.95 each	_____

Subtotal _____

MA residents add 5% sales tax _____

Shipping and handling \$5.00

TOTAL \$ _____

Payment: Check Visa MasterCard

Card No. _____

Expiration Date _____

Signature _____

Name _____

Shipping address _____

City _____ State _____ Zip _____

Phone no. (____) _____

Allow four weeks for delivery. Outside U.S.A., add \$10 and make payment by bank draft in U.S. dollars only.

B486

Until now, there were only two kinds of databases on the market. Powerful databases with powerful prices. And file managers that cost very little—and gave you very little in return.

Now you can get the power you want at the price you want to pay. With PractiBase®. The first inexpensive database that truly compares with *any* base at *any* price—especially at its low price of \$99.95.

Skeptical? We don't blame you. But consider some of PractiBase's features:

- A powerful relational database management system, including memo writer, forms generator, entry forms and page report generator
- Advanced dBase II*-compatible programming language—including JOIN, UPDATE and TOTAL commands
- Reads and writes dBase II files
- Runs dBase II programs! (.PRG and .FMT files)
- Sorts on multiple keys in a single operation
- Handles up to three data files at one time
- Menu- or command-driven (you never have to stare at a dot!)
- Includes time-saving abbreviation macros

- Context-sensitive, multi-level HELP
- Includes 200-page manual, case study and command summary card
- NOT copy-protected
- For the IBM PC, XT, AT* and compatibles
- Requires 256K minimum (hard disk optional)

Whether you're a first-time user or a power user, we believe you'll find PractiBase the equal of databases costing up to *ten times* its price.

You can buy PractiBase alone. Or save even more by buying it with PractiWord®—our full-featured word processor that gives you all the power of WordStar*—for a combined price of only \$149.95.

Either way, you'll get dPower you need. Without dStroying your budget.

PRACTICORP™
No-Nonsense Software™

The Silk Mill, 44 Oak Street, Newton Upper Falls, MA 02164 (617) 965-9870

*The following are registered trademarks of the respective companies indicated: dBase and dBase II, Ashton-Tate; WordStar, Micro-Pro International; IBM, PC, XT and AT, International Business Machines Corp. PractiCorp, PractiBase and PractiWord are registered trademarks of PractiCorp International Inc.

that the password given is "incorrect." Therefore, whenever you are fairly sure that you have entered your password correctly but the system says that it is incorrect, it is a good idea to log on to another terminal and change your password immediately.

FAKE UTILITIES

Many installations have a directory where locally produced utilities can be placed. Often, users will include this directory in their path variable, which indicates where to search for commands. A user may submit a utility program that performs a service many users want but which also contains code designed to bypass the system protections. For example, the program can check if the user running it is root and, if so, perform some hidden operation, such as changing a file to setuid root, without the user's knowledge.

In a simpler method, the user places a program in his or her directory with the same name as a commonly used system command, such as ls. If another user, including root, executes this program instead of the real ls utility, the user will be at the mercy of the fake utility program.

The system administrator can limit his or her vulnerability to these attacks by keeping the current directory

and any local utility directories out of the path for root.

The utility su should take care to set root's path to

```
PATH = /bin:/etc:/usr/bin
```

rather than

```
PATH = :/bin:/etc:/usr/bin
```

The colon at the beginning of the second path tells the shell to search the current directory first when looking for a command typed in by the user. Leaving this colon off makes sure that root will not inadvertently execute nonstandard utility programs.

This problem can also arise when a program uses the exec system call. For example, the code segment

```
execvp("sh",argv)
```

is dangerous and should be replaced by

```
execv("/bin/sh",argv)
```

if the intent is to execute the standard shell.

FAKE DISTRIBUTIONS

A remarkably simple and bold way of installing a Trojan horse in a system is to mail a doctored distribution tape to the system administrator with the return address of the source of the distribution tapes on it. The intruder

wants the administrator to believe that the tape is an ordinary update and install it on the system. Therefore, the perpetrator of this ruse must know a considerable amount of inside information. The security-conscious administrator should be aware of this possibility.

MOUNTING A DOCTORED FILE SYSTEM

The UNIX operating system accepts the contents of a mounted file system as being completely accurate. However, it is possible for a user to create a file system on removable media. The user then, at another location, "doctors" the file system. By writing to the proper area on the media, the user sets the setuid bit on a program and changes its ownership to superuser. When the file system is subsequently remounted, the user runs his or her program as the superuser. The most effective control of this is to restrict physical access to the machine and media.

OTHER TECHNIQUES

Another technique involving user terminals is terminal page-mode buffering (see figure 5). Most moderately intelligent terminals have what is known as a page mode of operation. When the terminal is put into this mode (by certain escape sequences), it does not send information to the host but merely buffers it in screen memory. When the terminal receives certain other escape sequences, it sends the contents of its buffer to the host computer.

All of these operations can be performed by sending escape sequences (from the host) instead of typing them in at the keyboard. The cracker makes the system believe that commands he or she writes to the victim's terminal were really entered by the victim. (Under the UNIX operating system, a terminal is simply a special file and you can usually write to it for the purpose of real-time communication via the write command.) Any processes the commands invoke therefore run under the victim's user ID. The efficacy of this method depends on the ter-

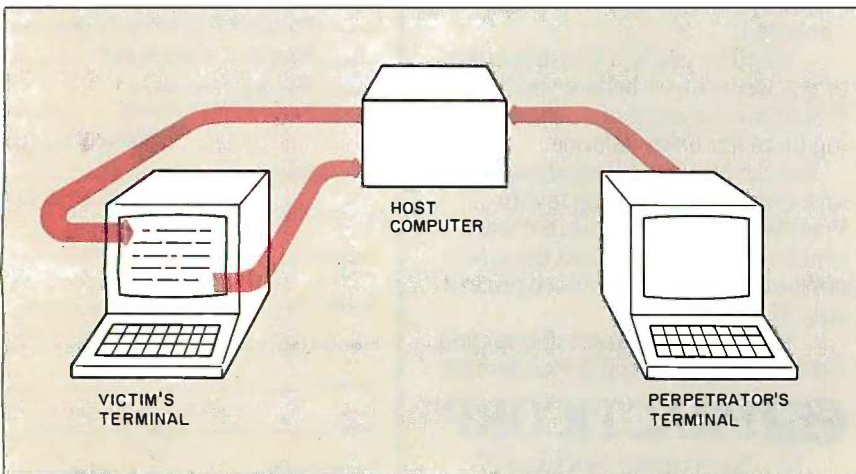

Figure 5: Terminal page-mode buffering. The colored path indicates how the perpetrator can send his or her own commands to the victim's terminal and then to the host, where they are interpreted as commands entered by the victim. Terminals with this feature should not have write permission for "other" enabled.

MAKING UNIX SECURE

minal used; there may be some visible effect, such as a flash at the victim's terminal.

How can this type of attack be guarded against? Terminals should be provided without the page-mode feature or at least with the option of turning it off. Making your terminal non-writable to others is easy—just type `mesg -n`. However, this does not provide certain protection against this trick, since mail or other means may be used to manipulate your terminal.

ATTACKS BY HOGGING RESOURCES

The UNIX operating system evolved in a nonhostile environment and is relatively liberal in its granting of resources to a user. Typically, a user is allowed to run 25 concurrent processes, and each process can have 20 files open simultaneously.

These limits, in isolation, will not cause the system trouble and are generally more than enough for any legitimate use. However, in order to limit the amount of memory the kernel occupies, installations often limit the number of files open (system-wide) to around 250. This is also generally enough for even a heavily used system.

A problem arises, however, when a malicious user spawns 25 concurrent processes that each attempt to open 20 different files. The user quickly takes all available slots in the file table and essentially makes the system unusable by others. UNIX installations that might encounter such antisocial users should be adjusted to prevent any single user from causing such problems.

Another area of concern is disk-storage space. Although the size of a user's files is usually limited to 1 megabyte, typically there is no limit to the number of files a user can produce. (Or if there is, it is often only enforced at the time of logging on or off.) Therefore, it is possible for a user to allocate all the free blocks of a file system to himself or herself, resulting in irate users and possible damage to the file system. However, the damage

(continued)

COMPUTERS - PRINTERS - MONITORS	
ATARI	
Atari 130-XE	119.99
Atari 1050-DD	129.99
1027 PTR	99.99
INDUS DD	189.99
COMMODORE	CALL
Comm. 128	215.00
Comm. 1571	289.99
1902	219.99
MPS-1000 Print.	212.99
Indus DD	CALL
TYPEDRIVERS	
BROTHER	359.99
CE-70	CALL
EM-711	CALL
EM-811	CALL
IBM	CALL
Wheelwriter 3	288.99
Wheelwriter 5	CALL
Compact-II	CALL
OLYMPIA	288.99
AMDEK	
Amdek 300-A	108.00
Amdek 300-G	103.00
Amdek 310-A	134.99
Amdek 300-Color	154.99
Amdek 500-Color	CALL
Amdek 500-Color	363.00
Amdek 700-Color	375.00
Amdek 722-Color	445.00
Amdek 722-Color	469.00
PGS HX 12E	CALL
PGS MAX 12	CALL
MODEMS	
Hayes 300	124.99
Hayes 1200B	322.00
Hayes 1200	347.00
Hayes 2400B	479.00
Micro Modem 2E	125.00
Paradise Mon.-Col. Comb.	140.00
Hercules Mono	149.00
Hercules Color	275.00
Persyst Mono	129.00
AST-6 Pak GAK Sidekick	199.99
Teomar Captain	148.00

IBM AT, PC, & XT
- All Configurations
CALL

GUARANTEED LOWEST PRICES
COMPUTER: 1-800-874-1235
VIDEO: 1-800-223-6779
TOLL FREE OUT OF N.Y.
IN N.Y. CALL (718) 237-2828
S'nW ELECTRONICS & APPLIANCES
633 Bedford Ave, Bklyn, NY 11211
HOURS: Mon-Thurs. 9-6
Fri. 9-2, Sun. 10-5, Sat. Closed
C.O.D. Accepted
Credit Cards Accounts charged at time of order
Add shipping, handling, insurance
Prices subject to change without notice
Not responsible for typographical errors

DO YOU KNOW WHERE YOUR PROGRAM HAS BEEN?

If you know where your program is spending its time, you can improve its performance.

The Watcher makes it easy.

The Watcher collects data from one or more runs of your program. You can then instruct it to display as a histogram the percentage of time spent in different parts of your program and in DOS functions.

The Watcher uses symbolic information from the link map, including line numbers, or information you provide to relate the data to your source program.

THE WATCHER KNOWS!



\$39⁹⁵

Stony Brook Software
Forest Road, P.O. Box 107
Wilton, New Hampshire 03086
MC or Visa orders: (603) 654-2525

For any .COM or .EXE on PC, XT, AT or compatibles DOS 2.X or 3.X. Not for use with Basic or other interpreters.

is usually minimal and easily repaired.

ATTACKS VIA UUCP

The uucp family of utilities facilitates file transfer between different UNIX sites and also provides the capability for remote command execution. The uucp utilities provide a good set of

security features to restrict the set of files and commands the remote user has access to, but they make up a complex system with many nooks and crannies and must be administered properly. The following security points must be observed carefully when setting up uucp utilities.

The uucp family allows the ad-

ministrator to give a different log-on ID and password to each authorized remote-user system. Do this. Under no circumstances make this log-on ID the same as that of the uucp system administrator. Put all remote users in a single group that is used for nothing else. This information should be included in the `/etc/passwd` file.

Make sure that uucp log-ons do not get the standard shell. They should get the program `uucico`, which implements all the security restrictions of the uucp system. Also, their home directory should be `/usr/spool/uucpublic`. This log-on shell and directory are also included in the `/etc/passwd` entries for the remote users.

There is a file called `/usr/lib/uucp/USERFILE` that allows the administrator to specify, for each remote user, which UNIX subdirectories he or she will be allowed to copy files to and from. This check is in addition to the normal file-permission scheme, so that even if a file can be read by others, if it is not in one of the proper subdirectories, the remote user will not be allowed to uucp it. It is a good idea to prevent all uucp access to directories other than `/usr/spool/uucpublic`.

The uucp utilities provide a file that the administrator uses to specify which commands can be executed from a remote system. Do not put commands in here without a reason. For example, `rmail` (not `mail`) probably should be in here, while `chmod` probably should not.

Use the sequence-check feature, which keeps a sequence count of conversations with particular systems. If the sequence number given by the calling system is not what the called system expects, the conversation is disallowed. This prevents someone from masquerading as a particular remote system even if he or she knows the log-on ID and password assigned to it.

Use the call-back feature where appropriate. When this facility is set up in uucp, incoming calls are told: "OK, now I know you want to talk; I'll call you right back." This requires the

(continued)



**One
Star
Always Shines
Brightest.**

**Display Telecommunications Corporation
announces
a complete family of IBM® compatibles.**

MEGA-BOARD-AT™
80286 CPU •
Our own Mega-BIOS-AT™

*"...masterpiece of IBM
imitation...minor
masterpiece of the cir-
cuit designer's art."
Winn L. Rosch, Cloning
Your Own PC, PC Maga-
zine, July 10, 1984.*

AT-BIOS licensing.

MEGA-BOARD-XT™
The industry standard with
our Mega-BIOS

**QEM QUANTITY PRICING
AVAILABLE ON REQUEST**

XT Bare Board	59.95
XT Assembled 256K	299.95
Mega-Case	69.95
Mega-Kit	750.00
Mega BIOS ROM	29.95
Power Supply	89.95

MEGA-NET™
Token-passing ring LAN •
IBM NETBIOS Compatible

*"The most compatible
IBM clone I've ever
worked with." Lee
Konowe, American Soft-
ware Club, Ridgefield, Ct.*

IBM is a registered trademark of International Business Machines Corporation.

XT-BIOS licensing.

8445 Freeport Parkway • Suite 445 • Irving, TX 75063
1-800-227-8383 • For Technical Calls Only: 1-214-607-1382
TELEX 5106000176 DTC UD

We've Earned Our Reputation. Let Us Help You Earn Yours.

You can't judge a scope by its cover.

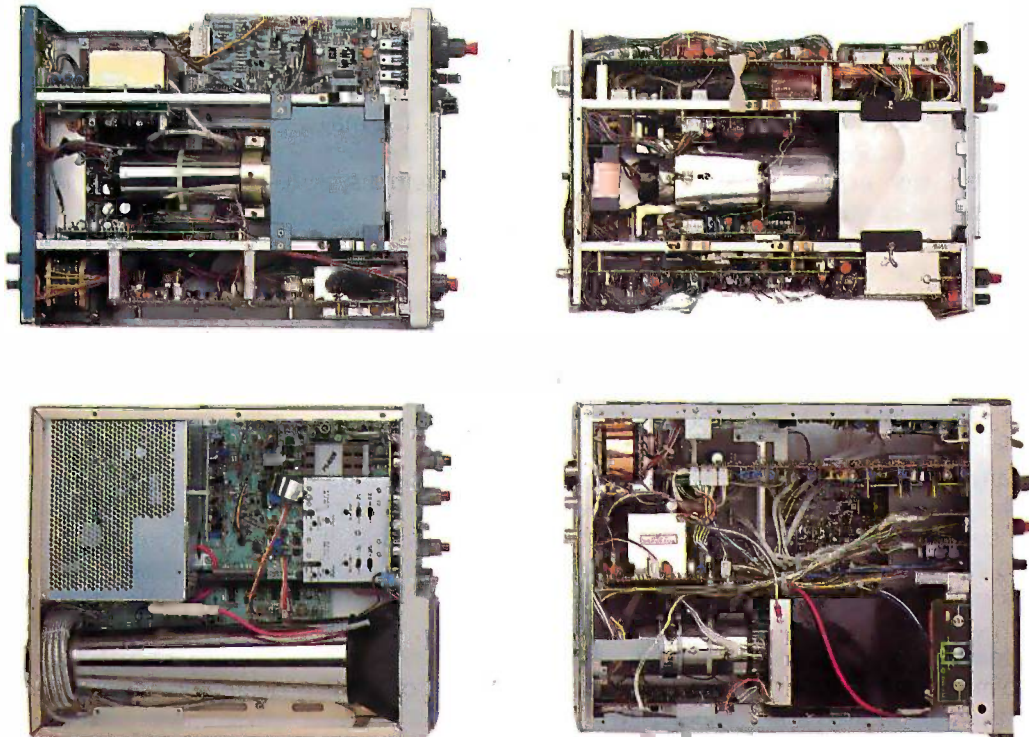

When you look at our simplified, practical internal design, you see why the Tek 2200 Series delivers unparalleled high performance and reliability in the field. You get quality that's unmistakably Tektronix in scopes so advanced, they cost you less to buy and own.

Through an innovative new concept in scope design we reduced the number of mechanical parts by 65%. Reduced cabling by 90%. Virtually eliminated board electrical connectors. And eliminated the need for a cooling fan.

The result: a scope with designed-in simplicity that increases reliability as it cuts downtime and repair costs. All of which means outstanding value in

a compact, lightweight package that your service technicians will appreciate.

Plus, you get a selection of performance to precisely match your needs. There are the 60 MHz single time base delay 2213A at \$1275* and the 60 MHz dual time base 2215A at \$1525*. And at 100 MHz, the dual time base 2235 at \$1750* and the 2236 with an integrated counter/timer/multimeter at \$2650*.

The industry's first three-year warranty† is testimony to 2200 Series dependability. Adding value to value are a variety of optional service plans that can economically extend this coverage to five years.

Consider what you're paying

now in downtime, in service, in back-up scopes. On the bottom line, a Tek 2200 Series scope will save you money, time and trouble now and in the years to come.

Contact your Tek Sales Engineer for a demo today. Or call 1-800-426-2200, Ext. 201.

In Oregon, call collect: (503) 627-9000, Ext. 201.



Tektronix®
COMMITTED TO EXCELLENCE

Inquiry 340

*Prices F.O.B. Beaverton, Oregon
†3-year warranty includes CRT and applies to 2200 family oscilloscopes purchased after 1/1/83. Scopes are UL listed, CSA and VDE approved.

Copyright © 1985, Tektronix, Inc. All rights reserved. TTA-517-1
Prices subject to change.

caller to be at the phone number that the called system knows as his or hers. The call-back feature may be specified for a remote system by setting a flag in that system's entry in the file `/usr/lib/uucp/USERFILE`.

Finally, make sure that permissions are set up properly on all the uucp administrative files. For example, the file `/usr/lib/uucp/L.sys` contains numbers and passwords for other systems and obviously must be unreadable by anyone but the uucp administrator. In general, it is necessary to set the permissions of the uucp files with extreme care.

If the above precautions are taken, uucp should not present any substantial security hole in a UNIX installation. However, any outside line to a computer slightly decreases the security of the system. An intruder who breaks into the remote system can now have some access to yours as well.

The security features of uucp are well designed to minimize this threat. However, uucp is a complicated system that no doubt contains security holes that have not yet been discovered or plugged. For example, ways have been suggested to induce uucp to create files whose owner is the uucp administrator but whose content is determined by some other user. Such a file may then be executed to gain access to sensitive information in `/usr/lib/uucp`. The uucp facilities provide a favorite hunting ground for crackers, and the security-conscious administrator would be well advised to keep an eye on it.

ATTACKS VIA MAIL

To facilitate communication among users, the UNIX mail system is set up as belonging to a mail administration group, with `/bin/mail` a setgid program. The text of all mail sent is kept in a central location (the directory `/usr/mail` in System V) and can be read and written to by anyone in the group mail.

As with any setuid or setgid program, mail must be carefully administered. Clearly, it would be disastrous to allow a user to create his

or her own setgid mail program, for example, by writing over `/bin/mail`. Such a program could be used to read or forge mail.

Some common versions of the mail utility allow a user to easily forge a false signature on mail sent by him. This is a very serious defect. The mail program should determine the identity of the sender via the getuid system call and not rely on other (possibly faked) means of identification.

PREVENTING THE DAMAGE

The greatest security weakness of the UNIX operating system is the power inherent in root. Therefore, an important overall principle is to *minimize the use of root*.

This may be done in several ways. First, use specialized log-on IDs instead of root whenever possible. If user ID bin or nuucp suffices to do a job, don't use root.

Second, make judicious use of setuid programs in lieu of giving out root. For example, if a user occasionally needs to mount a particular file system, having a program that is setuid to root is preferable to giving out the root password and is more convenient than having the user request that the system administrator provide this service.

Finally, and perhaps obviously, change the root password frequently.

UNDOING THE DAMAGE

What can a system administrator do if he or she suspects that someone has broken root? There are several kinds of traces that an inept or casual cracker may have left behind. The utility `su` maintains a log of uses or attempted uses. Programs that are setuid to root can easily be discovered using the `find` utility.

For example, the following command prints out the path names of all files on the system that are owned by root and have the setuid bit set:

```
find / -perm -0004000 -user root -print
```

(On some systems, the `ncheck` utility may be used for the same purpose.) Finally, if the perpetrator has avoided these means of detection, it is pos-

sible to modify the kernel to print out a secret log of superuser activity to a file or to the console.

Ridding the system of all effects of a hostile superuser is a big job. Essentially, the system needs to be generated again from known secure sources. Special attention needs to be paid to all setuid programs.

COSTS AND REQUIREMENTS

There are many steps an administrator can take to prevent attacks. Many of these precautions are free. However, some security measures cost money, efficiency, or ease of use of the system. You must make an intelligent evaluation of the real security requirements of a particular installation before you establish a security program.

CONCLUSION

Some people claim that the UNIX operating system provides no security. While it is true that UNIX is inadequate for some types of classified government projects, so are most other operating systems.

We have outlined some security threats to the UNIX system and their related countermeasures. An administrator who is aware of these methods can maintain a UNIX system installation that provides a sufficient degree of privacy and protection for most applications. ■

BIBLIOGRAPHY

- Grampp, F. T., and R. H. Morris. "UNIX Operating System Security," *AT&T Bell Laboratories Technical Journal*, volume 63, number 8, part 2, October 1984, pages 1649-1672.
- Morris, R., and K. Thompson. "Password Security: A Case History," *Programmers Manual for UNIX System III Volume II. Supplementary Documents*, Western Electric Corporation, October 1981.
- Reeds, J. A., and P. J. Weinberger. "File Security and the UNIX System CRYPT Command," *AT&T Bell Laboratories Technical Journal*, volume 63, number 8, part 2, October 1984, pages 1673-1684.
- Ritchie, D. M. "On the Security of UNIX," *Programmers Manual for UNIX System III Volume II. Supplementary Documents*, Western Electric Corporation, October 1981.

THE DIRECT BENEFITS OF BUYING SOFTWARE & HARDWARE DIRECT FROM LOGICSOFT.

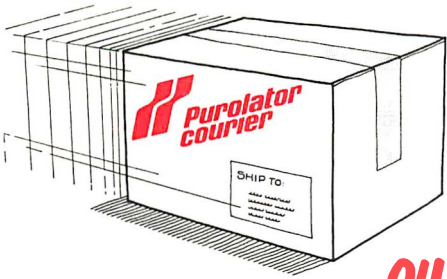

FREE OVERNIGHT DELIVERY.

Buy it today . . . use it tomorrow! At Logicsoft, we know you want your new product as fast as possible. That's why only Logicsoft ships your order the same day via Purolator Overnight Courier* . . . at no additional cost to you! You not only save money, you save valuable time, too.

OUR LOWEST PRICE GUARANTEE.

We're so confident about our low prices that if you can find a lower price we'll beat it by \$10! This offer includes any legitimate advertised price or quote on any of the hundreds of products we stock. And we stock only the latest versions. All factory sealed with the manufacturer's warranty. Our Corporate Accounts Program also offers attractive volume discounts. And we accept purchase orders from qualified institutions.

They're two more reasons why Logicsoft has become the major supplier of hardware and software to more than 50,000 companies worldwide, including over 90% of the Fortune 1000.



TOLL-FREE CUSTOMER SERVICE.

Customer service and technical support is only a toll-free call away before *and* after the sale. Our customer service representatives can instantly recall your ordering information from our on-line terminals. So they can answer your questions quickly and efficiently. Our technical people are standing by to help answer questions on any product we carry. Logicsoft gives you much more than great prices and fast delivery. We give you peace of mind as well.

*Applies to order totaling over \$100. Shipped UPS—free if under \$100 (within Cont. U.S.). Due to weight restrictions, systems, printers and monitors are also shipped UPS—free. †This offer does not apply to items under \$100, American Express or Terms orders. In these instances, we will meet any lower price. (Subject to discretion of sales agent.)

To order or receive technical assistance, call our National Hotline: **1-800-645-3491** NY State: **1-800-23 LOGIC** (235-6442)
Customer Service: 1-800-431-9037

Circle #400 on reader service card.

FREE 90-DAY, ON-SITE SERVICE ON ALL SYSTEMS.

On all systems listed below, Logicsoft offers something no other direct distributor does: a free-90 day, on-site system hardware service contract. If a problem arises with your system, SORBUS®, a Bell Atlantic™ company, provides your free service AT YOUR FACILITY in most metropolitan areas. SORBUS® is one of the nation's largest and most respected independent computer maintenance firms, servicing over 315,000 computer systems. With SORBUS®, expert computer maintenance is only a phone call away.

IBM-PC DELUXE—\$2,229

- 256Kb Ram Memory • Two DSD 360K Floppy Disk Drives • Half Height 10Mb Internal Hard Disk • Hard Disk Controller • Five Expansion Slots • IBM-PC Keyboard • 90-Day, On-Site Sorbus Service Contract • Color Or Monochrome Monitor Available As Option

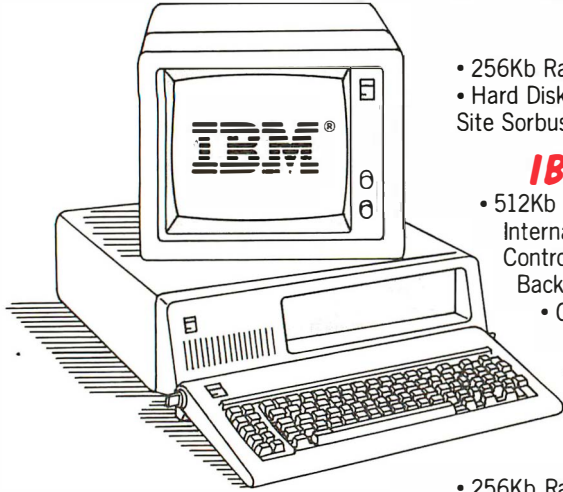

IBM PC/XT—\$2,349

- 256Kb Ram Memory • DSD 360K Floppy Disk Drive • 10Mb Internal Hard Disk • Hard Disk Controller • Eight Expansion Slots • IBM PC/XT Keyboard • 90-Day, On-Site Sorbus Service Contract • Color Or Monochrome Monitor Available As Option

IBM PC/AT ENHANCED—\$3,895

- 512Kb Ram Memory (Exp. to 3Mb) • 1.2Mb Floppy Disk Drive • 20Mb Internal Hard Disk (Optional 30Mb) • Eight Expansion Slots • Hard Disk Controller • IBM 84 Key AT Keyboard • Optional 20Mb Stream Tape Back-up • 90-Day, On-Site Sorbus Service Contract • Color Or Monochrome Monitor Available As Option

COMPAQ PORTABLE HARD DISK SYSTEM—\$2,495

- 256Kb Ram Memory • DSD 360K Floppy Disk Drive • 10Mb Internal Hard Disk • Hard Disk Controller • 90-Day, On-Site Sorbus Service Contract • 9" Text/Graphics Monitor Included

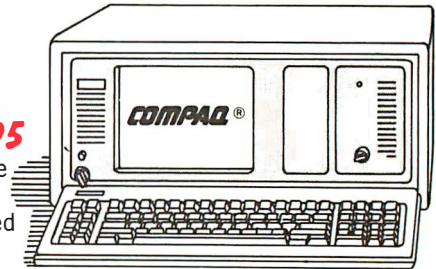

COMPAQ PORTABLE 286 MODEL 2—\$4,249

- 640K Ram Memory • 1.2Mb Floppy Disk Drive • 20Mb Internal Hard Disk Drive • 80286 Based CPU • 9" Text/Graphics Monitor Included • 90-Day, On-Site Sorbus Service Contract

COMPAQ PORTABLE DUAL DISK SYSTEMS—\$2,239

- 256Kb Ram Memory • Two DSD 360K Floppy Disk Drives • 9" High Resolution Text/Graphics Monitor Included • 90-Day, On-Site Sorbus Service Contract

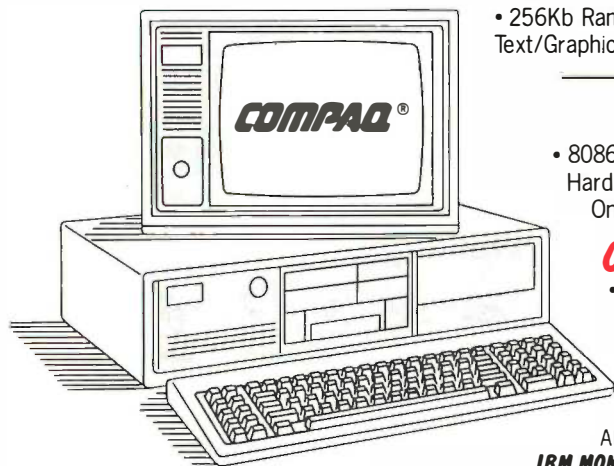

COMPAQ DESKPRO—\$2,549

- 8086 Board CPU • 256K Ram Memory • 360K Floppy Disk Drive • 10 Mb Hard Disk • Hard Disk Controller • COMPAQ Dual Mode Monitor • 90-Day, On-Site Sorbus Service Contract

COMPAQ 286 DESKPRO—\$4,349

- 80286 Based CPU • 640K Ram Memory • 1.2 Ms Floppy Disk Drive • 20 Mb Hard Disk • Hard Disk Controller • COMPAQ Dual Mode Monitor • 90-Day, On-Site Sorbus Service Contract

IBM MONOCHROME OPTION 1—\$249 Monochrome Graphics Display Card. AMDEK 310A Monitor. Parallel Port.

IBM MONOCHROME OPTION 2—\$349 Monochrome Graphics Display Card. IBM Monochrome Monitor. Parallel Port.

IBM COLOR OPTION 1—\$559 Color Graphics Display Card. Princeton RGB HX-12 Monitor. Parallel Port.

IBM COLOR OPTION 2—\$659 Color Graphics Card. IBM Color Monitor. Parallel Port.

AT&T 6300 SERIES AVAILABLE.



• No surcharge for MasterCard, VISA, American Express, C.O.D., money order or check • P.O.s accepted . . . no surcharge (please call for price verification)
 • No sales tax on orders shipped outside N.Y. State • Please add 2% for insurance and handling (Int'l orders add'l) • We do not bill until we ship.
 All products covered by mfg's warranty. Defective merchandise may be returned for repair or exchange only. We do not guarantee compatibility. Any goods returned for credit are subject to a 15% restocking charge.

IBM PC™, AT™, and PC/XT™ are trademarks and IBM® is a registered trademark of International Business Machines Corporation. COMPAQ® is a registered trademark of Compaq Computer Corporation.

Circle #400 on reader service card.

SOFTWARE FOR VIRTUALLY EVERY IBM-PC APPLICATION.

FREE OVERNIGHT DELIVERY. LOWEST PRICE GUARANTEE. TOLL-FREE CUSTOMER SERVICE.

WORD PROCESSING		ENERGRAPHICS		JUNIOR CORNER			
Wordstar	\$205	pfs: file & pfs: rept	\$239	Lotus 1-2-3 Junior	\$319		
Wordstar 2000	259	REVELATION	219	MISC. UTILITIES			
WORDSTAR 2000 PLUS	305	Revelation Network (1-4)	95	FANCY FONT	\$145		
Wordstar Pro Pac	255	Powerbase	199	Wordplus (Oasis)	119		
WORD PERFECT		PARADOX	529	pfs: proof	65		
(New Release)	219	Reflex	59	Punctuation & Style	99		
Microsoft Word	249	INTEGRATED/SPREADSHEETS		Quickcode III	149		
Multimate	245	LOTUS 1-2-3 (v2.0)	\$319	Quick Report	159		
MULTIMATE ADVANTAGE	275	Enable (New Version)	355	D Graph III	149		
Volkswriter III	159	Ability	315	D Util III	65		
Easywriter II/Speller/ Mailer	199	FRAMEWORK II	415	SPREADSHEET			
EASY	99	Electric Desk	209	AUDITOR	109		
Finalword	209	SYMPHONY	439	K Graph	175		
Samna III	279	Supercalc 3	185	K Paint	85		
Xy Write II Plus	239	Multiplan	129	K Text	109		
Think Tank	119	pfs: plan	85	Clout 2	149		
Pfs: Write	85	FINANCIAL		Extended Report Writer	119		
DATA BASE MANAGEMENT		Dollars And Sense	\$115	Sideways	45		
KNOWLEDGEMAN/2	\$329	MANAGING YOUR MONEY	115	PROKEY 4.0	89		
CORNERSTONE	275	Howard Tax Preparer '86	Low Price—Call!	Norton Utilities (New Release)	59		
Tim IV	199	GRAPHICS		SIDEKICK (unprotected)	55		
d Base II	295	CHARTMASTER	\$239	CROSSTALK XVI			
R:BASE 5000	355	Signmaster	185	(New Release)	109		
R: BASE 5000 (Runtime)	255	pfs: graph	85	Remote	109		
d BASE III PLUS	415	GRAPHWRITER COMBO		Turbo Lightning	59		
CLIPPER (d Base III Compiler)	385	PAK	305	Smartcom II	109		
Data Base Manager II (alpha)	169	DIAGRAM MASTER	195	Easy Plus	75		
Friday	179	Microsoft Chart	179	SUPERKEY	39		
		ACCOUNTING SYSTEMS		Copy II PC	39		
		Computer Associates (Formerly IUS)	Open Systems	Great Plains	39		
				Versa Business	65		
				State of The Art			
				Realworld (MBSI)			
				BPI			
Accounts Payable	\$299	\$359	\$459	\$79	\$479	\$359	\$345
Accounts Receivable	299	359	459	79	479	359	345
Fixed Assets	—	359	—	—	—	—	—
General Ledger	299	359	459	119	479	359	345
Inventory	299	359	459	79	479	359	345
Job Costing	—	359	459	—	—	—	345
Timekeeping/Billing	845	—	—	—	679	—	—
Order Entry/Processing	299	359	—	—	479	359	—
Payroll	365	359	459	79	479	359	345
Report Writer	—	359	—	—	—	—	—
Sales Invoicing	—	359	—	—	479	—	—
Purchase Order Entry	—	359	—	—	—	—	—
TCS Client Ledger System	\$1195						
GNP CPA + (Requires 1 2 3)	\$379						

All prices and policies subject to change without notice.

CAN'T FIND IT? ASK FOR OUR SPECIAL ORDER DEPT.

If you can't find the product you want here or you think it's not available through the mail, ask for our Special Order Department. There's a good chance we do carry the product (we're adding new ones every day). Or, we can get it for you from one of our suppliers—still at our low direct-to-you prices.



To order or receive technical assistance, call our National Hotline:

1-800-645-3491

NY STATE: 1-800-23 LOGIC (235-6442)

Customer Service: 1-800-431-9037

Circle #400 on reader service card.

110 Bi-County Blvd., Dept. 543
Farmingdale, NY 11735

CANADA: 416-283-2354

Domestic/Int'l Telex

286905 SoftUR

EUROPE: 020-83.48.64

Telex: 10759 Logic NL

Mail orders to:

LOGICSOFT EUROPE BV

pb 9460, 1006 AL Amsterdam, Holland

PERIPHERALS TO EXPAND YOUR SYSTEMS & CAPABILITIES.

FREE OVERNIGHT DELIVERY. LOWEST PRICE GUARANTEE. TOLL-FREE CUSTOMER SERVICE.

PRINTERS*	MULTI-FUNCTION BOARDS	QUADRAM	CORVUS
EPSON	AST RESEARCH	Quadmodem Series	The Bank 100 Mb \$1,729
LQ1500** \$879	Six Pak Plus (384k) \$259	Low Price—Call!	EVEREX
LQ1500 Sheet Feeder (Cut) 395	Six Pak Plus (64k) 239	RACAL-VADIC	Excel Stream 20 Mb Int. . . \$639
JX-80 499	Mega Plus II (64k) 275	2400 PC \$635	Excel Stream 60 Mb Int. . . 929
LX-80 229	Mega Pak (256k) 369	VEN-TEL	Excel Stream 60 Mb Ext. . . 989
LX-80 Tractor/Feeder 30	Advantage (128k) 409	PC Modem Half Card \$375	IRWIN
RX-100 399	I/O Plus II 129	1200 Plus 399	Irwin 110 10 Mb Int. \$595
FX-85 349	EVEREX	MOUSE INPUT DEVICES	KAMMERMAN LABS
FX-286 Low Price—Call!	Magic Card II (64k) \$175	MOUSE SYSTEMS	The Flight Tape Series
JUKI	STB	PC Mouse w/DR Halo II . . . \$135	60 Mb \$1,675
6100 \$365	Chauffeur \$255	MICROSOFT	The Flight Tape Series
6300 689	TECMAR	Microsoft Mouse (Serial) . . \$135	10 Mb 1,195
NEC	Captain (64k) \$189	Microsoft Mouse (Buss) . . . 135	MAYNARD ELECTRONICS
8850 \$1,459	Captain (384k) 199	SURGE PROTECTORS	Maynstream 20 Ext. \$1,139
Pinwriter P2 559	QUADRAM	KENSINGTON MICROWAVE	Maynstream At-20 Int. 949
Pinwriter P3 895	Quadboard (384K) \$255	Masterpiece \$95	SYSGEN
MANNESMAN TALLY	Goldboard Low Price—Call!	CURTIS	External 10 Mb \$845
MT-86 Low Price—Call!	Silverboard Low Price—Call!	Diamond \$39	TALLGRASS TECHNOLOGIES
OKIDATA	COMMUNICATIONS BOARDS	Emerald 49	Tg 4060 w/controller
182 Plug & Play \$219	AST	Sapphire 59	card \$1,495
192 Plug & Play 349	AST-5251-11 \$695	Ruby 69	TECMAR
193 Plug & Play 555	DCA	KEYBOARDS	Qic 60 At \$1,275
2410 Plug & Play 1,749	IRMA Board \$839	KEYTRONIC	HARD DISK TAPE
SILVER REED	QUADRAM	5150 \$159	BACK-UP SUBSYSTEM
770 \$699	Quadlink \$339	5151 (Deluxe) 169	ALLOY
PANASONIC	GRAPHICS BOARDS	JUNIOR CORNER	PC Qicstor 30/60 \$3,495
KX 1091 \$265	AST	Keytronic 5149 \$49	Microstor 20/20 2,275
TOSHIBA	Monograph plus \$425	Keytronic Junior 5151 169	KAMMERMAN LABS
P351 Tractor \$175	Preview 249	MEMORY STORAGE	Masterflight 10/10 \$1,795
P351 999	EVEREX	IOMEGA	Masterflight 60/60 3,849
1340 459	Graphics Edge \$269	Bernoulli Box (20mb) \$2,389	SIGMA
CITIZEN	The Edge 249	HARD DISK DRIVES	Stand Alone Winchester:
MSP10 \$279	HERCULES	EVEREX	Tape 20/45 \$2,675
MSP15 385	Graphics Card \$299	Everdisk 10 Mb Int. \$525	SYSGEN INDUSTRIES
MSP25 519	Color Card 155	Everdisk 20 Mb Int. 575	Sysgen Plus \$2,875
MONITORS*	PARADISE SYSTEMS	MAYNARD ELECTRONICS	LOGICSOFT PRODUCTS
AMDEK	Multi-Display Card \$209	Pci 10 Mb Int. \$539	Logicboard (six pak &
Color 300 \$219	Modular Graphics Card . . . 255	Ati 20 Mb Int. 775	equiv) \$129
Color 600 389	QUADRAM	MICROSCIENCE	Logicboard AT (Advantage
Color 710 559	Quadcolor I \$195	10 Mb Int. \$495	equiv) \$279
12" Green 300G 119	SIGMA	20 Mb Int. 525	Logicmodem 1200B (Hayes
12" Amber 300A 129	Color 400 (Princeton) . . . \$499	MOUNTAIN COMPUTER	equiv) \$195
12" Amber 310A 149	STB	CORP.	FLOPPY DISK DRIVES
PRINCETON GRAPHICS	Graphics Plus II \$259	Dynamic Disk 10 Mb Ext. \$1,475	Tandon TM-100 360 K . . \$109
RGB HX-12 \$429	TECMAR	PRIAM CORP.	Toshiba 360 K 1/2 Ht . . . 109
RGB SR-12 569	Graphics Master \$445	Innerspace Id 40 Ext. . . \$1,250	CDC 360 K 1/2 Ht 109
Scan Doubler Board	MODEMS	SIGMA	BACK UP POWER SUPPLIES
(for SR-12) 185	HAYES	Hard Disk Kit 10 Mb Int. . . \$725	DATA SHIELD
Amber Max-12E 159	Smartmodem 300 \$145	TALLGRASS TECHNOLOGY	200 Wt. (PC) \$249
QUADRAM	Smartmodem 1200 389	Tc 5525i 25 Mb Int. \$849	300 Wt. (XT) 359
Amberchrome 12" 155	Smartmodem 1200B	SEAGATE	500 Wt. (AT) 559
TAXAN	w/Smartcom II 359	10 Mb 1/2 Ht. Int. \$475	GRIZZLY
122 139	Smartmodem 2400 609	20 Mb 1/2 Ht. Int. 495	200 Wt. (PC) \$475
620 Call for Price	PROMETHEUS	CARRIDGE TAPE BACK-UP	300 Wt. (XT) 495
640 Call for Price	Pro-modem 1200 \$299	ALLOY	500 Wt. (AT) 695
	Pro-Modem 1200B 259	PC Qictape Ext. 70 Mb . \$1,749	
		PC Back Up Ext. 20 Mb . 1,649	

*Due to weight restrictions, Printers and Monitors are shipped UPS—free.

**Parallel interface req. Ask sales agent.

All prices and policies subject to change without notice.



To order or receive technical assistance, call our National Hotline:

1-800-645-3491

NY STATE: 1-800-23 LOGIC (235-6442)

Customer Service: 1-800-431-9037

Circle #400 on reader service card.

110 Bi-County Blvd., Dept. 543
Farmingdale, NY 11735
CANADA: 416-283-2354
Domestic/Int'l Telex
286905 SoftUR

EUROPE: 020-83.48.64
Telex: 10759 Logic NL
Mail orders to:
LOGICSOFT EUROPE BV
pb 9460, 1006 AL Amsterdam, Holland

DATA DESIGN

The structure of data files is almost as important as their contents

You bought a database system. It was dBASE II, or pfs:File, or whatever. You loved it. You were able to write more reports faster, and you could access specific information much more readily. You thought of more things to do with your database, and you added more and more information to it. Other people wanted to use it. You thought of more applications. You added more files and more information to each file.

Now you are beginning to lose track of just what is in your database files. The same information seems to be in several different places. When you change one program or database file, other programs or files are affected. When you want to add a new application, it's not clear what files should be enlarged or whether a new file should be built. Your data needs some structure. You should apply principles of *data design* to your database, just as you should apply principles of structured programming to your programs.

Before structured programming

techniques, all of us who wrote large programs complained incessantly about long, unwieldy programs. The principles of structured programming told us to build small program modules, using a few small constructs (WHILE, IF, etc.), and promised us that our programs would be vastly more understandable. It worked. Structured programs were easier to debug and to maintain. In fact, structured programming principles became so widely accepted that "languages" such as dBASE II include a few of them implicitly by omitting

GOTO statements and including structured programming constructs.

Data design is a set of principles and analytic tools that brings to the design of your data the same kind of organization that structured programming brings to your programs. Data design is relatively unknown in the microcomputer community but has been known by other names to the mainframe community for years. Dif-

(continued)

Dr. Leonard Shapiro is a professor of computer science at North Dakota State University (Fargo, ND 58105).

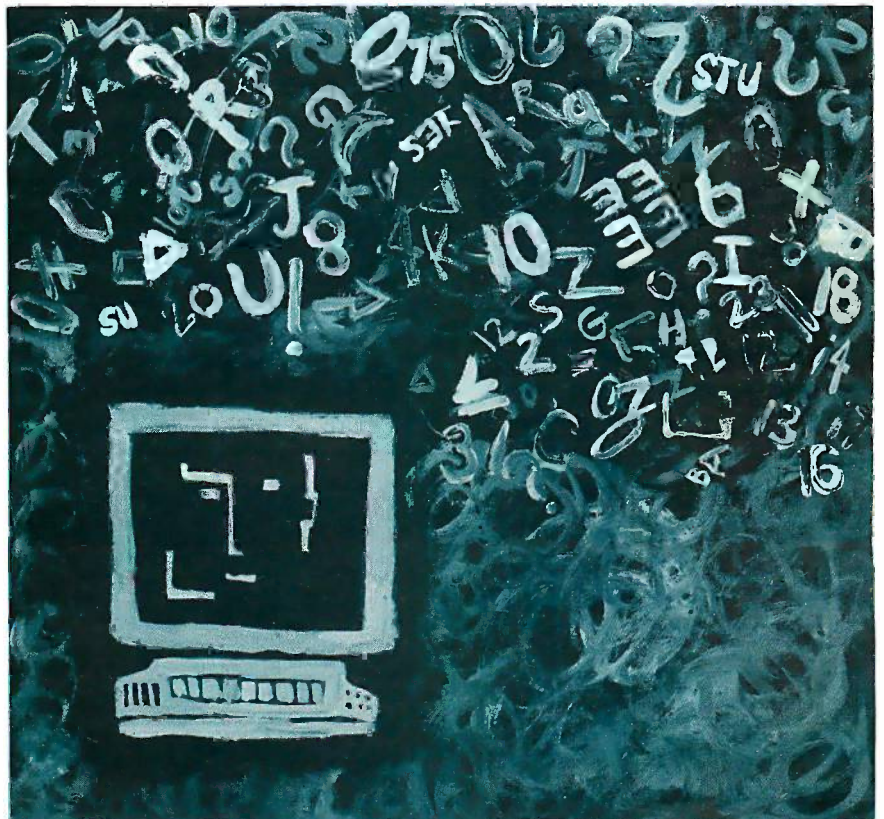

Switches to make your PCs powerful.

Reliable and affordable port expansion without memorizing complicated software commands. Switch your PC between peripherals with the push of a button. Is MFJ good? Joe Campbell in his book, *The RS-232 Solution* said, "Switch boxes are sold by many suppliers, but by far the two best values are from MFJ Enterprises." Below are just some of those values.

When you need to switch between two peripherals ... or you need to have two computers share the same peripheral ... MFJ-1240/\$79.95



The 1240 has a built-in transmit/receive switch that allows 2-way information flow. LEDs monitor data lines while built-in surge protectors guard them. Can be used as a null modem. MFJ's No. 1 seller!



When you need 1-to-4 computers to share one peripheral or 1-to-4 peripherals to share a common computer ... MFJ-1243/\$119.95

The perfect office switch. Save money. Don't buy extra printers or modems.

Connect 1-to-4 computers to a single printer or let a PC share up to four peripherals. LEDs monitor data lines; surge protectors guard them. Two-way communication is allowed.

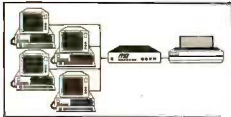

When you need to interconnect four computers and four peripherals at one time! The MFJ-1294 gives you a computer system ... MFJ-1294/\$299.95

With the MFJ-1294 you can create a mini-network of computers and peripherals. All eight devices can be working simultaneously! Think of the production you'll get with the MFJ-1294's 16 possible combinations.

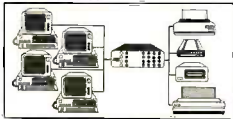

Seven additional models to choose from including MFJ's IBM and Centronics Parallel Switches. All RS-232 switches have RS-232 connectors, LEDs to monitor data lines, MOV surge protectors and transmit/receive buttons that allow 2-way communication.

And Power Strips to make them safe.

Your fine computer and peripheral equipment can be damaged by electrical surges much smaller than you've been led to believe. Save them and your valuable data with an MFJ Power Center. Multi-filters isolate equipment, eliminating noise/hash/inter-action; MOVs suppress spikes

and surges. These are heavy-duty, commercial quality Power Strips.

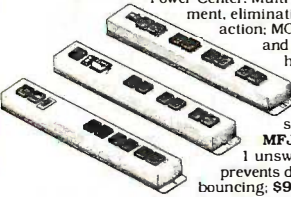

MFJ-1107 - 8 sockets, 2 unswitched; \$79.95

MFJ-1108 - 7 sockets; 1 unswitched. Drop-out relay prevents disk drive head from bouncing; \$99.95

MFJ-1109 - like 1107 but intelligent (switch on the device that's plugged into the control socket and everything else comes on); \$129.95

There are other Switches, Power Centers and Computer Peripheral Products available from MFJ. Call and talk with us about all your computing needs. When you do, ask for our latest catalog. Both the call and catalog are free.

1-800-647-1800

For technical/repair information, or in Mississippi, or outside the Continental United States, please telephone...

1-(601) 323-5869 or telex 53-4590 MFJSTKV

All MFJ products come with a double guarantee we think is unmatched. Order from MFJ and try any product for 30 days. If it doesn't satisfy your needs, just return it for a full refund less shipping. If you keep it you can be assured of continued service and our One Year Unconditional Guarantee.

Call toll-free 1-800-647-1800 and charge the products you need to your VISA or MasterCard, or send a check or money order, plus \$5.00 shipping, and our shipping department will promptly have your computer peripheral on its way to you.



MFJ Enterprises, Inc.
921 Louisville Road
Starkville, MS 39759

DATA DESIGN

ferent aspects of data design are called database design theory, normalization, or data modeling.

In this article I will discuss three important principles of data design: (1) your data is as important as your programs, (2) the structure of your data files is almost as important as their contents, and (3) some file designs are dangerous.

BAD DATA AND BAD STRUCTURES

You are the software guru in your business. Everyone comes to you for help. You have designed a database file called Help containing information about software contacts (see figure 1). Each record in Help contains three fields: the name of the software product, the name of someone to contact for help with that product, and a phone number where that person can be reached.

You have written a program called Findhelp to extract this information from the Help database. With Findhelp, you enter the name of a software product, and Findhelp displays the name of one person who can provide assistance and the number to call. You make the program available,

and many people use it, especially for help with Procword, a popular word-processing program in your firm. Your program refers people to Elayne for help with Procword, but she is sometimes busy. Joseph discovers that Dan is always accessible, although he is not as helpful as Elayne. He adds Dan's name to the Help database (see figure 2).

Now you have a problem. You wrote the Findhelp program assuming that just one contact was available for each piece of software in the Help file. Now the program is giving only Dan's name when someone wants information about Procword. Elayne, the most helpful contact, is never called.

This example illustrates the first two principles of data design. By adding Dan's name to the Help file, Joseph made the Findhelp program much less useful, almost as if he had introduced a bug in the Findhelp program itself. Thus, poor data can do as much damage as poor programs.

The second principle has to do with the importance of the structure of your data files. Notice that the damage in this example was done even though Joseph did not delete

(continued)

HELP		
Product	Contact	Phone
Spread	Carla	568-6588
Procword	Elayne	237-8194
Comm	Steven	485-0898
Procmail	Elayne	237-8194
Procbase	Elayne	237-8194

Figure 1: Help, a database file of software contacts.

HELP		
Product	Contact	Phone
Procword	Dan	263-2900
Spread	Carla	568-6588
Procword	Elayne	237-8194
Comm	Steven	485-0898
Procmail	Elayne	237-8194
Procbase	Elayne	237-8194

Figure 2: Help, with a new contact, Dan, added.

Turbo, who?

Do you have to give up power and advanced potential to get ease of use and affordability? Not anymore. Because now, you can have **UCSD Pascal** for only \$79.95!

If you're making your move into programming, there's no better way to go than Pascal. And starting now, you *don't* have to settle for a stripped-down version of Pascal in order to get a price that's right. Instead, you can choose UCSD Pascal—the recognized Pascal programming standard in colleges and universities throughout the country—at the incredibly low introductory price of \$79.95 for your PC-DOS, MS-DOS, or other popular computer.

Start with the standard

With an *entry-level* system, you spend a lot of valuable time learning a *non-standard* form of Pascal. And you don't get all the capabilities a true Pascal system is supposed to deliver—unless you buy a lot of add-on utilities—which can send the cost of your system sky-high! Worst of all, when you're ready to tackle anything more than short, simple programs—you have no choice but to move up to a more sophisticated system (like UCSD Pascal). And at that point, you also have to *relearn* standard Pascal.

UCSD Pascal has everything you need

With UCSD Pascal, you get a

full-featured, professional programming tool that's being used right now in the development of major scientific and business applications. The system comes with an outstanding text editor, a complete on-line tutorial, 8087 math coprocessor support and BCD (decimal arithmetic) *included* in the package at no extra cost. In fact, UCSD Pascal contains virtually everything you need—as standard equipment—for developing the simplest to the most

sophisticated programs.

UCSD Pascal is available for MS-DOS, PC-DOS, UNIX, VMS, MSX and many other operating systems. You can use UCSD Pascal to write programs of any size on virtually any computer, and port them to any other computer. And if speed is what you're after, the latest native code version of UCSD Pascal actually benchmarks favorably with Turbo Pascal® in execution time!

Programming that's easy ...and fun!

At Pecan Software Systems, we strongly believe programming should be as *easy* as possible. UCSD Pascal was originally designed for teaching programming skills, so it's extremely easy to learn and to use. With UCSD Pascal, you'll be developing programs right from the start that are easy to write, easy to understand, and easy to maintain. We also believe that programming should be *fun*. So we've made UCSD Pascal as enjoyable to use as it is powerful.

The right tool at the right price

When the fun gets serious, you'll have a comprehensive programming system right at your fingertips with UCSD Pascal—a system that will help you develop those big-league programs you may eventually want to write—at a price you can readily afford.

Put UCSD Pascal programming power on your PC now for only \$79.95! **Order by mail today or phone now 1-800-63-PECAN.** UCSD Pascal—the original standard of Pascal programming excellence. The new leader in Pascal price/performance.

PECAN™

The UCSD Pascal Company
Pecan Software Systems, Inc.
1410 39th Street, Brooklyn, NY 11218
718-851-3100

UCSD Pascal™

UCSD Pascal \$79.95 (for PC-DOS, MS-DOS, AMIGA, APPLE, ATARI 520, MACINTOSH, RAINBOW, TANDY, as well as most popular 8/16/32-bit systems).
Price includes 8087 support and BCD.
Please send me _____ copies of UCSD Pascal for my _____ (Operating system)
_____ which runs under _____
(Name and model of computer)

My disk size is 3 1/2" _____ 5 1/4" _____ 8"
Total amount (NYS add appropriate tax)
Payment by VISA MC US Bank Check Bank Draft
Card Number: _____
Credit Card Expiration Date: _____

UCSD Pascal is a registered trademark of The Regents of University of California

UCSD Pascal
Not copy protected
60-day money-back guarantee

Mail to: Pecan Software Systems, Inc.
1410 39th Street
Brooklyn, NY 11218
ITT Telex No. 494 8910
CompuServe Code 76703, 500

CREDIT CARD ORDERS
CALL TOLL-FREE
1-800-63-PECAN
(NYS) 1-800-45-PECAN

Name _____
Shipping Address _____ State _____ Zip _____
City _____
Telephone _____

Call or write for UNIX, VAX or other UCSD Pascal versions—and ask about our powerful Pascal add-ons, too. **SCHOOLS:** Contact us for our special educational discounts!
Call toll-free or enclose a check with this coupon to place an order. Please add \$2.50 for shipping within the US. Foreign orders add \$10 and make payment by bank draft payable in US dollars on US bank. New York State residents add appropriate sales tax.

AMIGA is a trademark of Commodore Electronics LTD.

APPLE & MACINTOSH are trademarks of Apple Computer.

ATARI 520 is a trademark of Atari Corporation.

RAINBOW is a trademark of Digital Equipment Corporation.

TANDY is a trademark of Radio Shack.

Turbo Pascal is a registered trademark of Borland International.

anything from the file. Joseph violated a *dependency*, namely, that only one contact per software product could be listed. You assumed this dependency when you wrote the Findhelp program, but when you explained the structure of the Help file to Joseph, you explained only the contents of each of the three fields in the file. You did not explain the structure of the file itself, including the dependency of the Contact field on the Product field.

The notation "Product => Contact" refers to such a dependency. It means that one and only one value in the field Contact corresponds to each value in the field Product. In figure 2, the dependency Product => Contact does not hold, since two Contact values, Dan and Elayne, are associated with the Product value Procword. Another way to describe the dependency Product => Contact is to say that the Product field *determines* the Contact field.

Dependencies like Product =>

Contact are perhaps the most important kind of structure that exists in databases. For example, in a database of customers that includes customer identification numbers, usually the ID number depends on the name of the customer, in that only one ID number is assigned to a given customer name. Those who modify the customer file must know whether it has programs assuming that dependency, so that whenever a new customer is added they will first check to see that no other customers have the same name.

DAINGEROUS FILE DESIGN

Dependencies are also fundamental to understanding the third principle, that some designs are dangerous. I will illustrate this with another example.

You receive a call from Elayne that her phone number has changed. You dutifully look up the record for Procword and make the change. But you

forgot that she is also your contact for help with the programs Procmail and Procbase. Your database now looks like figure 3. Someone using your database to contact Elayne has a 67 percent chance of getting her old, incorrect number.

Your file design has other problems. Suppose Carla is a tremendously helpful contact for the product Spread, and you've managed to get her personal phone number. One week you find out that Spread has been recalled because it is faulty, so you remove its record from the database. The next week someone tells you that Carla is also a tremendous help with the product Comm, but now, unfortunately, you've lost her personal phone number. One last potential problem: If Elayne is your contact for 100 products, you are wasting a lot of space in your database by recording her phone number 100 times.

Of course, all this difficulty could have been avoided if you had foreseen that your database would be used as a phone directory. You could have made it in two pieces: one for the contacts and one for the phone directory.

Data design includes analytic tools that will help you create appropriate file structures without the need for foresight. These tools will prevent the problems described above, even when the files are large and complex, with many interrelated fields.

To avoid dangerous file designs you must have a clear understanding of the dependencies in your file. I will demonstrate the connection between dependencies and dangerous file structures by showing that the dependencies in Help give off clear warning signals to anyone familiar with data design.

Suppose that figure 4 lists all the dependencies in your Help file. Notice the *transitive dependency* from Product to Contact to Phone. A transitive dependency occurs when the fields A, B, and C have two dependencies, A => B and B => C (in figure 2 these dependencies are Product => Contact

(continued)

HELP		
Product	Contact	Phone
Procword	Dan	263-2900
Spread	Carla	568-6588
Procword	Elayne	548-5206
Comm	Steven	485-0898
Procmail	Elayne	237-8194
Procbase	Elayne	237-8194

Figure 3: Help, with inconsistent phone numbers for a contact, Elayne.

<p>Dependency Product => Contact</p> <p>Meaning There is only one contact in the database for each product. (This dependency does not hold in the example of figure 2, because more than one contact is shown for the product Procword.)</p>
<p>Dependency Contact => Phone</p> <p>Meaning Given a contact in the database, only one phone number in the database is associated with that contact. (This dependency holds in the example of figure 1, but not in figure 3.)</p>

Figure 4: Possible dependencies in Help.

FORTRAN, C, and BASIC Programmers...

Programming just got easier with Scientific Subroutine Libraries from Wiley Professional Software.

You need to quickly generate dependable, accurate and error-free code. Whatever language you use, Wiley Professional Software has a powerful Scientific Subroutine Library that can save you considerable programming time and development money.

Each library consists of more than 100 pretested and precompiled mathematical and statistical subroutines, supplied on disk as a linkable library and as source code. Each package includes 400-plus pages of documentation, providing you with extensive reference material, a listing of the subroutine's source code, complete test programs and the results of running each test. The Subroutines cover formulas for:

- ◆ General statistics
- ◆ Probability
- ◆ Analysis of variance
- ◆ Regressions
- ◆ Matrices
- ◆ Interpolations
- ◆ Fourier analysis
- ◆ Cross tabulations
- ◆ Differential equations
- ◆ Roots of biquadratic equations
- ◆ Function evaluations
- ◆ Systems of equations
- ◆ Solution of equations
- ◆ Times series analysis
- ◆ and more

Just out, Professional FORTRAN! Coming Soon, MORE FORTRAN!

And now all the subroutines are available to those of you programming in Professional FORTRAN. All that's required is IBM Professional FORTRAN or Ryan McFarland FORTRAN.

On the way is MORE FORTRAN, which includes subroutines covering such areas as:

Analytical Geometry ◆ Vector Algebra ◆ Utility (including complex matrix manipulation) ◆ Numerical Analysis (including fast Fourier transforms, and solution to systems of non-linear equations) ◆ Assembler Service Routines—FORTRAN CALLS

LIBRARY	PRICE	REQUIREMENTS
FORTRAN Library	\$175	Microsoft FORTRAN ver. 3.13 or later, or IBM 2.0
C Language Library	\$175	Lattice C Compiler ver. 2.12 or later
BASICA Library	\$125	BASICA
Professional FORTRAN Library	\$175	IBM Professional FORTRAN: Ryan McFarland FORTRAN
MORE FORTRAN Library	Call for Price	Microsoft FORTRAN ver. 3.2 or later: IBM Professional FORTRAN: PC DOS 2.0 or better

Developed by Peerless Engineering Service

To order, or for free literature, call: 212-850-6788

Or write: Wiley Professional Software
John Wiley & Sons, Inc.
Leslie Bixel,
605 Third Avenue, New York, NY 10158



**Dealer Inquiries Invited.
Educational site licenses available.**

wiley™
PROFESSIONAL
SOFTWARE

THE TECHNICAL SOFTWARE SOURCE

and Contact => Phone) and no dependency B => A.

Any transitive dependency indicates a dangerous file structure. Just as Elayne's phone number was repeated unnecessarily in the Help file, a transitive dependency A => B => C will always invite repetition of values of B paired with values of C for different

values of A. This repetition in turn can lead to inconsistent information if you change your database, as with Elayne's phone number being listed incorrectly. It also can lead to wasted space, as is the case with Elayne's phone number being repeated 100 times.

Transitive dependencies are a fre-

quent cause of structural problems in the design of files. If you watch out for them, you are more likely to avoid the kind of difficulties I have described above.

WHAT TO DO?

I hope this article motivates you to look over your database files and chart the dependencies in them, then to look for transitive dependencies. But don't get carried away. Just as structured programming allows the use of GOTO statements when appropriate, data design theory should be interpreted as only a set of warnings to the designer. As dangerous as I have claimed the Help file design to be, several reasons might justify leaving it alone. For example, the usual way to eliminate a transitive dependency in a file is to split the file into two new files. Your database system may not support access to two files at once, or it may do so only at a great cost in processing time. Therefore, if you do find a transitive or embedded dependency in your files, consider all the ramifications before changing the file structure.

At least two important questions remain: If you find a transitive or embedded dependency, how do you correct it? And how do you design databases from the start so that they don't contain such dependencies? The answers involve a deeper understanding of the "join" operation in database systems and of the structure of information as "entities" and "relationships." A study of the books listed below should provide you with the knowledge you'll need to answer these questions on your own. ■

BIBLIOGRAPHY

- Date, Chris J. *Database: A User's Guide*. Reading, MA: Addison-Wesley (Microcomputer Books), 1983.
- DeMarco, Tom. *Structured Analysis and Systems Specification*. New York: Yourdon, 1979.
- Martin, James. *An End User's Guide to Data Base*. Englewood Cliffs, NJ: Prentice-Hall, 1981.
- Page-Jones, Meilir. *The Practical Guide to Structured Systems Design*. New York: Yourdon, 1980.

FLAMINGO
M I C R O

America's leading discounter
of micro computers and their associated hard- and software.

*Our prices are laid back
a Day Back*

IBM® hardware available upon request; call for current pricing. Volume discounts are given.

IBM® AT clone, 1 meg Ram, 2 360 K floppies, 192 watt power supply, keyboard \$1795.

Internal 300 / 1200 baud, Hayes compatible modem. \$189.

Hard disk, 20 megabyte sub-system \$469.

IBM® XT clone 256 K, 360 K floppy, 135 watt power supply, keyboard \$600.

Add \$50 for 640 K.

5151 Style keyboard available for AT or XT - Add \$25.

Herdon printer letter quality daisy wheel, 18 cps, warranted by Qume for one year. Regular retail \$599, now just \$275.

ABOVE PRICES AT 3% CASH DISCOUNT

Call Toll Free 1-800-231-1214
In Florida 904-837-3995

Write for catalogue: P.O. Box 1491 Destin, Florida 32541-1491
Prices subject to change without notice

PC 3780 FILE TRANSFERS STAY ON THE TRACK

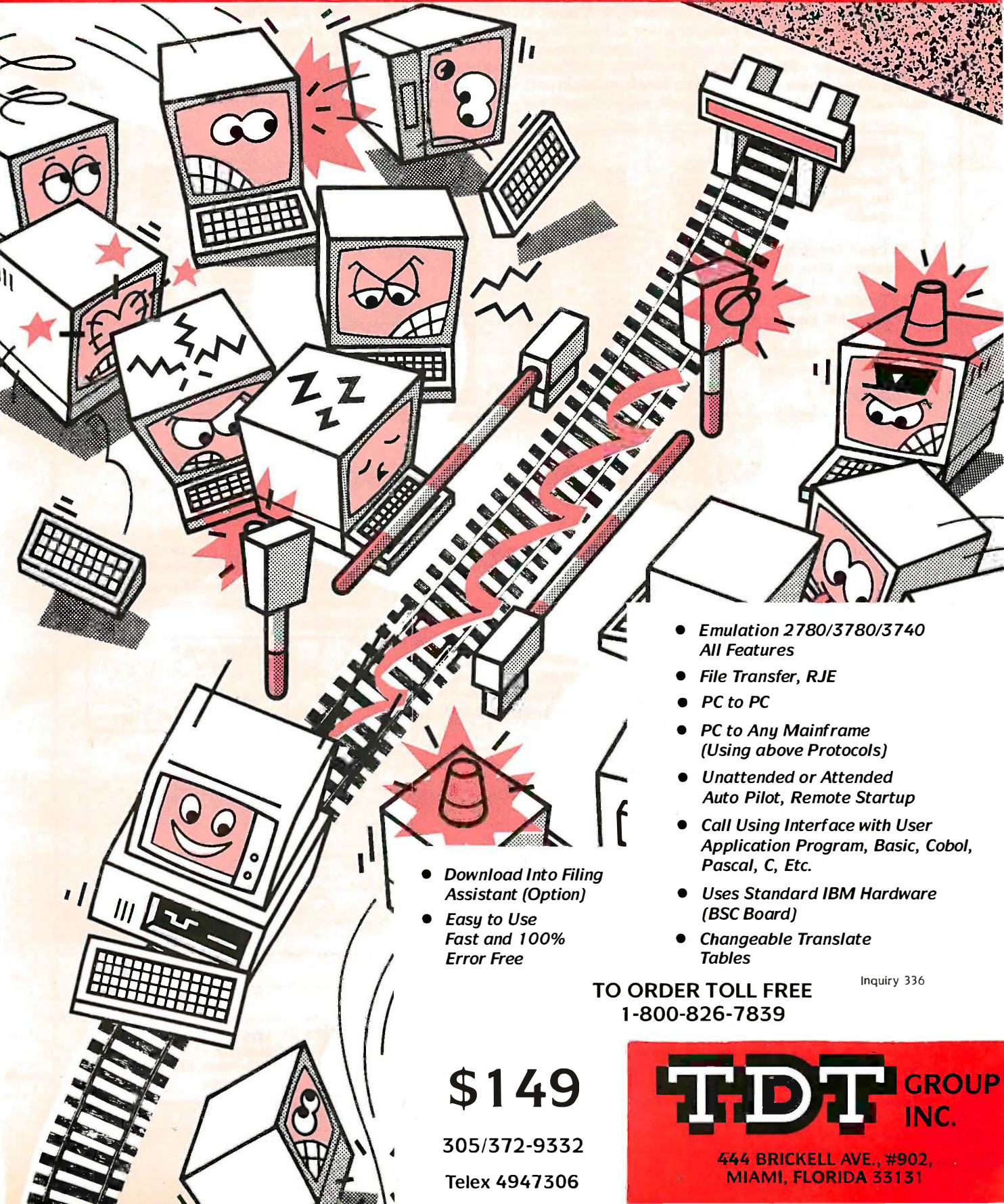

- Download Into Filing Assistant (Option)
- Easy to Use
Fast and 100%
Error Free

- Emulation 2780/3780/3740
All Features
- File Transfer, RJE
- PC to PC
- PC to Any Mainframe
(Using above Protocols)
- Unattended or Attended
Auto Pilot, Remote Startup
- Call Using Interface with User
Application Program, Basic, Cobol,
Pascal, C, Etc.
- Uses Standard IBM Hardware
(BSC Board)
- Changeable Translate
Tables

TO ORDER TOLL FREE
1-800-826-7839

Inquiry 336

\$149

305/372-9332

Telex 4947306

TDT GROUP
INC.

444 BRICKELL AVE., #902,
MIAMI, FLORIDA 33131

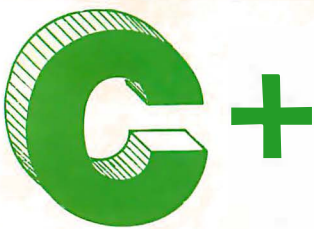

The Best C Book A Powerful C Compiler One Great C Value **\$39.95**

A good C book just isn't complete without a good C compiler to go with it. That's why we give you both. You get a comprehensive 450 page book and a full feature standard K&R C compiler with the Unix V7 Extensions. The Book is loaded with examples that teach you how to program in C. And our fast one pass C compiler comes with an equally fast

linker so you don't waste a lot of time watching your disk drives spin. You also get a Unix compatible function library that contains more than 150 functions (C source code included). And if all that isn't enough, we offer you a 30 day money back guarantee. So what are you waiting for? The exciting world of C is just one free phone call away.

Language Features

- Data Types: char, short, int, unsigned, long, float, double
- Data Classes: auto, extern, static, register
- Typedef, Struct, Union, Bit Fields, Enumerations
- Structure Assignment, Passing/Returning Structures

abs
asm
asmx
atan
atoi
atol
atol
bdos
bdosx
bios
biosx
calloc
ceil
cfree
chain
character
chdir
chmod
clearerr
close
clrscr
cmpstr

conbuf
conc
cos
cpostr
creat
cursblk
cursln
curscol
cursrow
cursoff
curson
delete
drand
exec
execl
execv
exit
exitmsg
exp
fabs
fclose
fdopen

feof
ferror
flush
fgetc
fgetno
filetrap
find
floor
fopen
fprintf
fputs
fread
free
freopen
fscanf
hypot
ftell
fwrite
getc
getch
putch
getchar

Functions

getcseg
getdseg
getd
putd
getdate
gettime
geti
puti
getkey
getmode
setmode
gets
getw
heapsiz
heaptrap
hypot
index
inp
insert
iofilter
isalnum
isalpha

iscntrl
isdigit
islower
isprint
ispunct
isspace
isupper
itoa
keypress
left\$
len
log
log10
longjmp
lseek
malloc
mathtrap
mid\$
mkdir
modf

movmem
open
outp
peek
perror
poke
poskurs
pow
printf
putc
putchar
puts
putw
rand
read
readatr
reach
writech
readdot
writedot
realloc
rename

replace
repmem
rewind
right\$
rindex
rmdir
scanf
setbuf
setbufsiz
setcolor
setdate
settime
setjmp
setmem
sin
sound
sprintf
sqrt
srand
scanf
stacksiz
str\$

strcat
strcmp
strcpy
strlen
strcat
strncmp
strncpy
strsave
system
tolower
toupper
ungetc
ungetch
unlink
write
writechs
xmembeg
xmemend
xmemget
xmemput
xmovmem
_exit

MIX Editor \$29.95

When you're programming in a high level language you need a high powered editor. That's why we created a programmable full/split screen text processor. It lets you split the screen horizontally or vertically and edit two files at once. You can move text back and forth between two windows. You can also create your own macro commands from an assortment of over

100 predefined commands. The editor comes configured so that it works just like Wordstar but you can change it if you prefer a different keyboard layout. The editor is a great companion to our C compiler. Because they work so well together we want you to have both. To make sure you do, we're offering the editor for just \$15 when purchased with the C compiler.

ASM Utility \$10

The ASM utility disk allows you to link object files created by Microsoft's MASM or M80 assemblers. Lots of useful assembly language functions are included as examples.

ORDERS ONLY
1-800-523-9520
IN TEXAS
1-800-622-4070

Canadian Distributor
Saraguay Software: 416-923-1500

NOT COPY PROTECTED

Editor	\$ _____ (29.95)	<input type="checkbox"/> PC DOS/MSDOS (2.0 or later)	Name _____
C	\$ _____ (39.95)	<input type="checkbox"/> IBM PC Single Side	Street _____
C & Editor	\$ _____ (54.95)	<input type="checkbox"/> IBM PC Double Side	City _____
ASM Utility	\$ _____ (10.00)	<input type="checkbox"/> Tandy 2000	State _____
TX Residents	\$ _____ (6.125% sales tax)	<input type="checkbox"/> 8 Inch	Zip _____
Shipping	\$ _____ (see below)	<input type="checkbox"/> Other _____	Country _____
Total	\$ _____	<input type="checkbox"/> CPM 80 (2.2 or later)	Phone _____
<input type="checkbox"/> Check <input type="checkbox"/> Money Order		<input type="checkbox"/> 8 Inch	
<input type="checkbox"/> MC/Visa* _____ Exp _____		<input type="checkbox"/> Kaypro II	
Shipping Charges: (No charge for ASM Utility)		<input type="checkbox"/> Kaypro 4	
USA: \$5/Order		<input type="checkbox"/> Apple (Z80)	
Canada: \$10/Order		<input type="checkbox"/> Osborne I SD	
Overseas: \$10/Editor • \$20/C • \$30/C & Editor		<input type="checkbox"/> Osborne I DD	
		<input type="checkbox"/> Morrow MD II	
		<input type="checkbox"/> Other _____	

MDX software
2116 E. Arapaho
Suite 363
Richardson, TX 75081
(214) 783-6001

Ask about our volume discounts. **B**

DRAGON

BY BRUCE R. LAND

Recursive drawing of a dragon curve on the Macintosh

THIS PROGRAM uses the high-resolution Macintosh display and the rapid execution rate of MacFORTH (Creative Solutions Inc.) to produce a recursive drawing of the so-called Harter-Hightway Dragon (described in reference 1). The resulting curve (see figure 1) is interesting to look at because it has features on many different length scales, from the very smallest kinks to the major "body" segments.

The curve is constructed by successive fragmentation of line segments into ever-smaller right angles. This construction lends itself to implementation by recursion.

Recursion is a process by which a task is broken up into smaller tasks that are similar except for, perhaps, a count of how many times the smaller task has been performed. The unique feature of recursion is that a recursive procedure calls *itself* before it finishes execution, so that intermediate results pile up, to be resolved later when an end condition (for instance a count) indicates that the recursion is complete.

To perform recursion in FORTH you

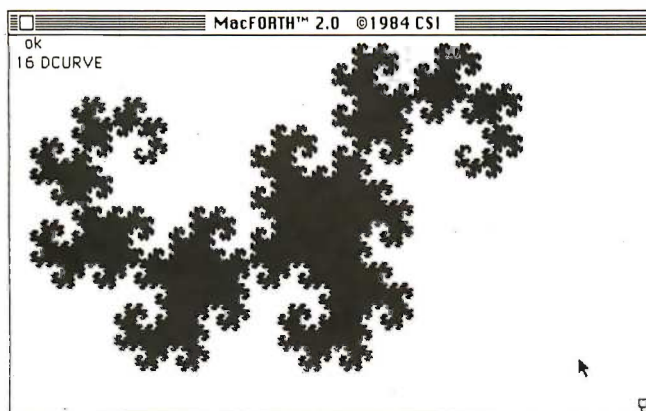

Figure 1: A 16th-order dragon drawn by the FORTH program DRAGON.

must consider two things. The first is that all local variables of the recursive routine must be on the stack, because when a routine calls itself, FORTH (unlike Pascal) does not make copies of variables for each invocation. The second is that FORTH normally assumes that no one would ever want to invoke a verb whose definition is not complete, so a recursive call within a definition is considered an error. This problem is easily handled by defining a verb called RECURS (reference 2) in listing 1 that temporarily tricks the compiler into considering the definition complete. As

you can note in listing 1, this verb must always be used in pairs or strange things will happen.

FORTH is a bottom-up programming language in which you start with the primitive operations and build up complex ones. After defining the RECURS verb, the program defines four variables to locate a "drawing turtle." I used a turtle-graphic approach because the code was translated from Apple UCSD Pascal (reference 3).

MacFORTH does not have turtle operations, but it is easy to produce the turtle operations TURN and MOVE. TURN accepts an angle (in degrees) on the stack and updates the turtle direction. MOVE causes the turtle to take one step forward in the direction it is facing.

The main work is done by DRAGON, which is the recursively called routine. Each time you enter DRAGON it calls itself twice until a value on the stack, called "level" in

(continued)

Bruce R. Land, Ph.D. (Box 73, RD #1, Trumansburg, NY 14886), is a senior lecturer at Cornell University.

Listing 1: *The FORTH blocks for the DRAGON program.*

```

Screen #1
( begin Dragon curve )
CREATE CURVE ( a FORGETable name)

CARTESIAN OFF

: RECURS SMUDGE ; IMMEDIATE ( trick verb for recursion)

VARIABLE ANGLE
VARIABLE XCOORD
VARIABLE YCOORD
VARIABLE STEPSIZE

: TURN ( deltangle-- | turn sign*delta)
  ANGLE +! ;

2 4 THRU

Screen #2
: MOVE ( -- | takes a step in present turtle direction)
  STEPSIZE @ DUP
  ANGLE @ COS * 10000 / ( r* cos of theta) XCOORD @ +
  DUP ( newX) XCOORD ! ( update X)
  SWAP
  ANGLE @ SIN * 10000 / ( r* sine theta ) YCOORD @ +
  DUP ( newY) YCOORD ! ( update Y)
  DRAW.TO ;

Screen #3
: DRAGON ( sign level-- | )
  DUP ( level) 0=
  IF ( at bottom of recursion)
    DROP ( level) DROP ( sign) MOVE ( by stepsize)
  ELSE
    OVER 45 * TURN ( getsign and turn)
    1 ( newsign)
    OVER 1- ( level=level-1)
    RECURS DRAGON RECURS

    OVER -90 * TURN ( getsign & turn)
    -1 ( newsign) ( edit to +1 for diff curve)
    OVER 1- ( level=level-1)
    RECURS DRAGON RECURS
  DROP ( input level) 45 * TURN ( getsign and turn)
  THEN ;

Screen #4
: DCURVE ( level --| )
  ( init pen position)
  PAGE 100 XCOORD ! 90 YCOORD ! 360 6 * ANGLE !
  WHITE PENPAT XCOORD @ YCOORD @ MOVE.TO

  PEN.NORMAL
  1 STEPSIZE !
  1 SWAP ( level) DRAGON

  WHITE PENPAT 4 10 MOVE.TO PEN.NORMAL ;

```

*With this MacFORTH
program, you can
draw a 16th-order
dragon curve
in 4½ minutes.*

the commands, reaches zero. At that point a step is drawn. A 16th-level dragon curve (the biggest that will fit on the screen) results in 2^{16} separate calls to DRAGON.

The final routine DCURVE initializes the pen position, sets up the stack for DRAGON, invokes DRAGON, and finally moves the pen away from the end of the curve. The program will draw a 16th-order dragon curve in 4½ minutes.

The program has a few limitations. The MacFORTH sine and cosine routines carry only four-place accuracy, so the program runs correctly only for even orders. An odd order causes the turtle to wander off the screen.

To run DRAGON, type N DCURVE, where N is the order desired. At one place in the program listing you'll see a notation that editing will produce an interesting variant. In particular, note that a 16th-order curve will not fit on the screen unless the STEPSIZE constant is unity. ■

[Editor's note: The source code for DRAGON is available for downloading from BYTEnet Listings. The number is (617) 861-9764. It is also available on disk. See page 346 for details. You will need MacFORTH to run the program.]

REFERENCES

1. Mandelbrot, B. B. *The Fractal Geometry of Nature*. San Francisco: Freeman, 1982, page 66ff.
2. Smith, A. J. "Another Recursion." *FORTH Dimensions*, vol. 3, no. 6, 1982, page 179.
3. Luehrmann, A., and H. Peckham. *Apple Pascal: A Hands-on Approach*. New York: McGraw-Hill, 1981, pages 335-344.

AW...

WHAT THE HECK!

ProDesign II The Easy to Use CAD System!

ProDesign II is one of the most advanced CAD packages available for microcomputers. We think it's absolutely the easiest to use. With competitive CAD systems priced at \$1500 to \$2500, we were posed with the problem of setting our price.

ProDesign II works a wide variety of digitizers and mouse devices. It works with nearly any plotter or printer available for the IBM PC. ProDesign II can produce plotter quality drawings on ordinary dot matrix printers - a feature found exclusively on ProDesign II. ProDesign II utilizes a virtual screen 4 times the size of the physical screen to make it practical to produce drawings on a normal resolution IBM monitor. ProDesign II is truly an outstanding CAD package for the IBM PC and compatibles. The question we had to answer was: Even though we had a better product, should we price it higher than the other CAD systems on the market?

We did market studies and calculations. We consulted with experts. We drew charts and graphs. We used the finest spreadsheet programs money could buy. When it came right down to it, we still didn't know what to sell ProDesign II for: \$2995? \$2495? \$1995? We even considered \$995.

Then, in the great American tradition, we said, "AW...WHAT THE HECK! Let's see the other guys beat this price!" ProDesign II costs \$299. At that price, you can't go wrong!

AW...WHAT THE HECK!
\$299.95

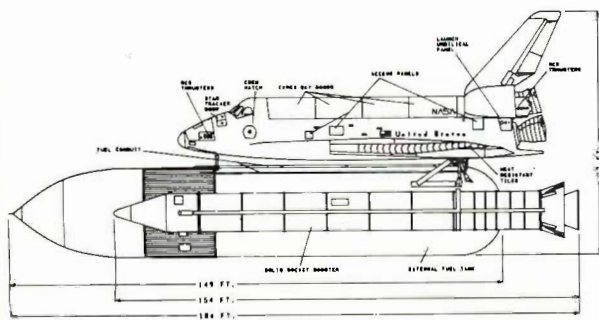

THE SPACE SHUTTLE DISCOVERY

American Small Business Computers

118 South Mill

Pryor, Oklahoma 74361

918/825-4844

B1 BOMBER

THIS DRAWING WAS PRINTED ON AN
EPSON RX-80 DOT MATRIX PRINTER.
RESOLUTION IS .005" -
MORE THAN 4 MILLION DOTS!
BETTER THAN MANY PLOTTERS!

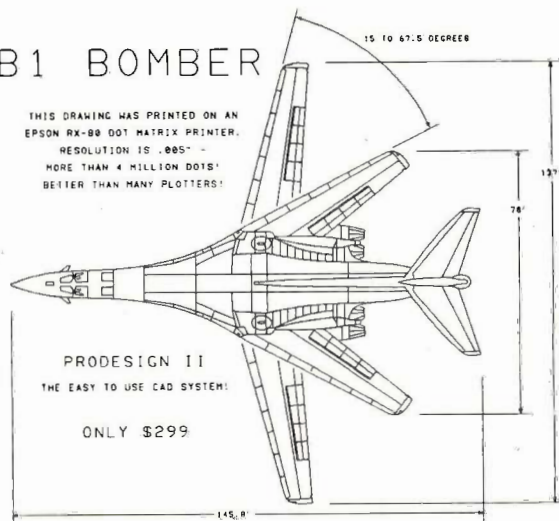

PRODESIGN II
THE EASY TO USE CAD SYSTEM!
ONLY \$299

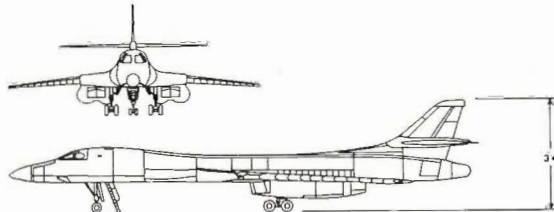

Why should you get ProDesign II? Four simple reasons:

1. ProDesign II is easy to use. You won't have to spend weeks learning simple functions.
2. ProDesign II works with the hardware YOU own. ProDesign II supports most printers and plotters available for the IBM PC, as well as a wide variety of digitizers and mouse devices.
3. ProDesign II can produce plotter quality output on ordinary dot matrix printers. (The B1 Bomber above was printed on an Epson RX-80.)
4. ProDesign II is priced 70% to 80% below competitive products!

What do you need to run ProDesign II? An IBM PC or compatible with 512K RAM and graphics capability.

How do you get ProDesign II? See your local computer dealer or contact us.

ProDesign II - The Easy to Use CAD System!

Inquiry 18

How to put the power of a Mainframe, Network and

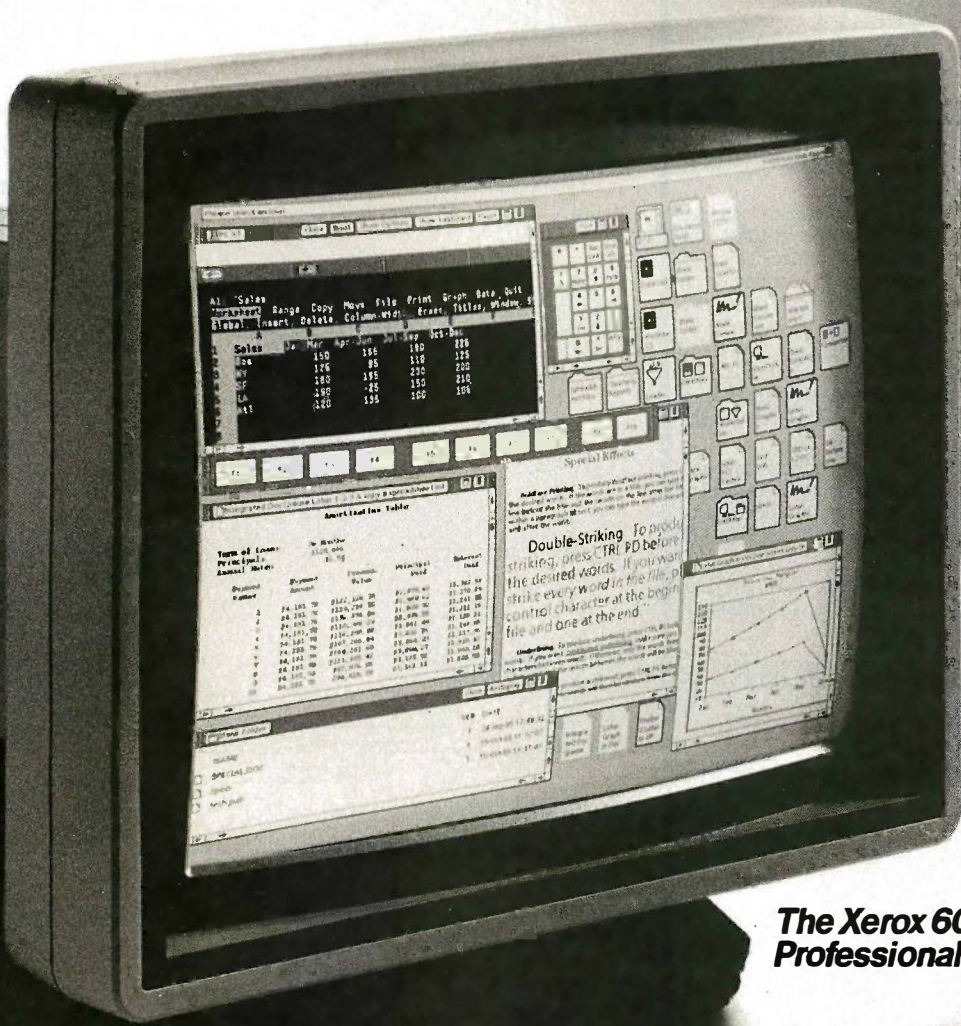

**The Xerox 6085
Professional Computer System.**

Mac, IBM PC, Word Processor, Laser Printer on your desk.

It's the first professional workstation and personal computer and communications terminal—in one. It's the first workstation ever with an enormous 19 inch bit map screen. With multiple windows that let you neatly display and process what used to clutter up your desk. Windows that can be stretched the entire width of the screen so you can see your work. And let you conduct numerous operations at the same time. Like running PC programs, running mainframe programs or downloading selected data from host computers. And, integrating the results. Even copying or moving host data into PC spreadsheets, or PC spreadsheets into Xerox' special ViewPoint Document Editor. True integration. Any window to and from any window!



You can compose documents made up of all these elements, with a huge variety of typefonts and sizes, multiple columns, labels and page numbering. Including data driven business graphics—and structured and free-hand drawings.

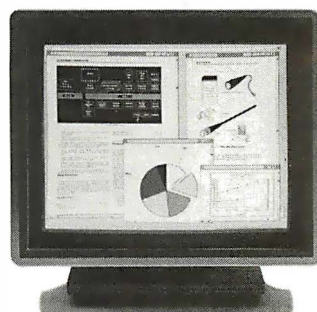

All this in virtually any foreign language. Or mix of languages. With resolution so refined your work is displayed on the screen precisely as you would receive it on a printed page. And the mouse and icons make it easy.



The 6085 Professional Computer System is compatible with industry standards including MS-DOS®, IBM 3270®, DEC VT100®, and others. And since the Xerox 6085 is brought to you by the people who invented Lasography, naturally it connects with local area and remote networks, as well as a variety of laser printers, including the desktop Xerox Laser Printer, matrix and character printers.



You can also print on just about any facsimile machine around the world. Of course the 6085 is part of Team Xerox, people, products, software and services working all together to meet your information needs.

So if what you've read amazes you, we've got more. Call us at 1-800-TEAM-XRX, ext. 294, or call your local Xerox sales office for a demonstration, or fill out and send in the coupon.

Because this remarkable machine will do remarkable things for your office. For information call Team Xerox, your local Xerox sales office or: **1-800-TEAM XRX, ext. 294.**

(1-800-832-6979, ext. 294)

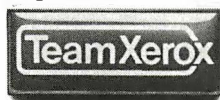

Yes, I'm interested in learning more about the Xerox 6085 Professional Workstation.

Send to: Xerox Corporation, P.O. Box 24, Rochester, NY 14692

Please have a sales representative contact me.

Please send me more information.

NAME _____

COMPANY _____ TITLE _____

ADDRESS _____

CITY _____ STATE _____

ZIP _____ PHONE _____

If you can't wait, call 1-800-TEAM-XRX, ext. 294

294 (1-800-832-6979, ext. 294) 192 4/86

XEROX® and the identifying names and numbers are registered trademarks of XEROX CORPORATION. MS-DOS® is a registered trademark of Microsoft Corporation. IBM 3270® is a registered trademark of the International Business Machines Corporation. DEC VT100® is a registered trademark of Digital Equipment Corporation.

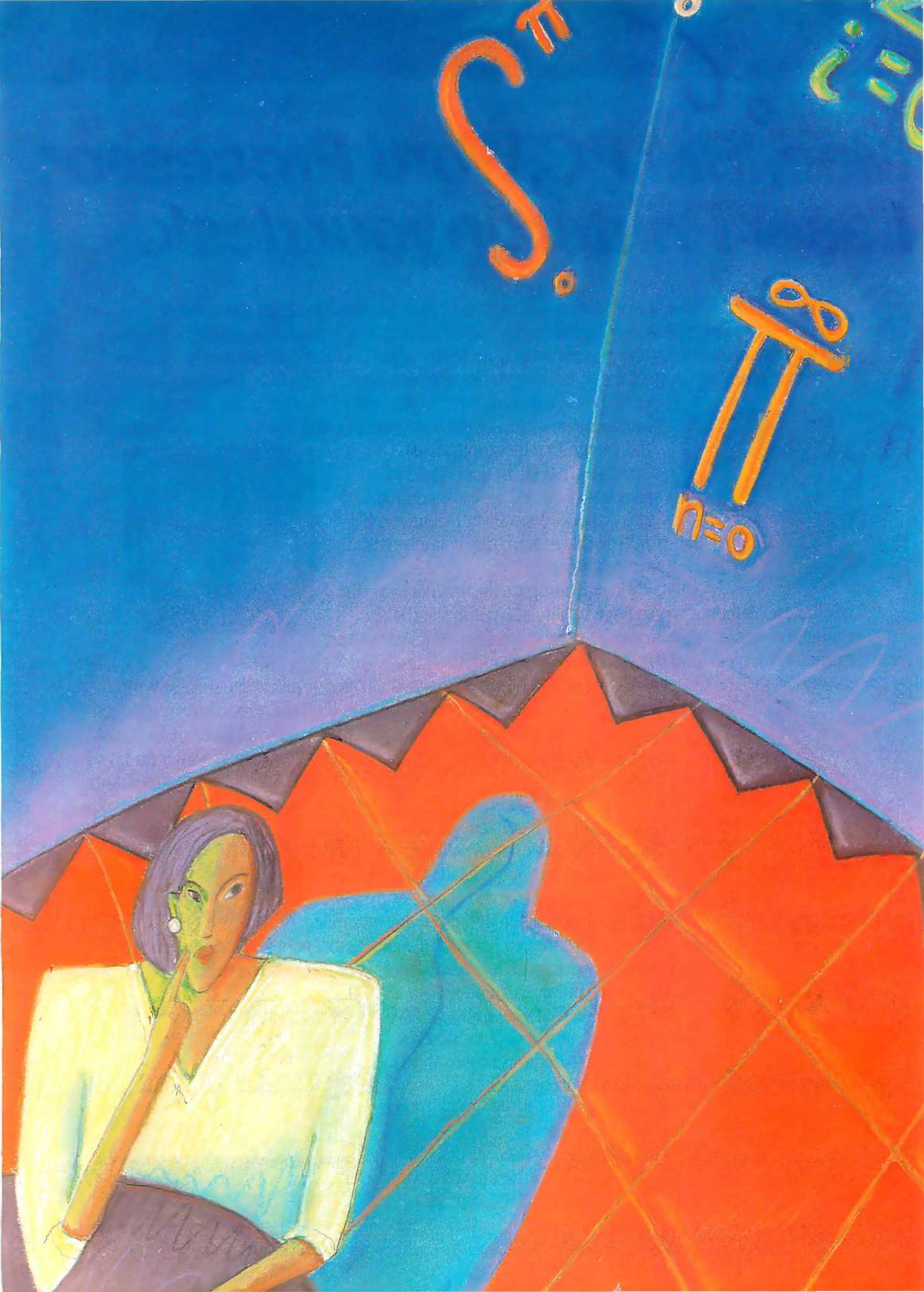

Number Crunching

A MICRO-BASED SUPERCOMPUTER <i>by Norman H. Christ and Anthony E. Terrano</i>	145
COMPUTER APPROXIMATIONS <i>by Stephen L. Moshier</i>	161
THE INVERSION OF LARGE MATRICES <i>by Thomas E. Phipps Jr.</i>	181
THE RUNGE-KUTTA METHODS <i>by Benku Thomas</i>	191
THE ATOMCC TOOLBOX <i>by Y. F. Chang</i>	215

NUMBER CRUNCHING IS TO COMPUTING what speaking prose is to talking: We all do it and tend to take it for granted. So for this theme I wanted articles that rekindled the sense of amazement we all felt when we ran our first FORTRAN Fibonacci sequence program. Unlike that first program, however, these articles are important and useful. But more than that, they make number crunching seem new and exciting.

We start off with a remarkable hardware piece by Norman H. Christ and Anthony E. Terrano of Columbia University. They have made a parallel-processing micro monster that is twice as fast as a Cray-1! The muscles of this beast are 16 (so far) 80286/80287/TRW vector-processor nodes slung onto a Multibus skeleton.

The rest of the theme is devoted to software issues. We lead off the software discussion with Stephen L. Moshier's discourse on numerical precision and rates of convergence in computer approximations. Mr. Moshier structures his discussion around writing an exponential-function routine, but his insights are applicable to all numerical calculations.

Many of us have written matrix-inverting routines. But how about routines to invert 50 by 50 or larger matrices? Thomas E. Phipps Jr. shows us the new Pan and Reif algorithm for inverting matrices as large as your computer can hold.

Next, Benku Thomas discusses the various flavors of Runge-Kutta algorithms for approximating solutions to systems of differential equations. Oddly, BYTE has never had an article on this classic technique. Among the many treasures in Mr. Thomas's piece is a FORTRAN routine for determining the machine epsilon (numerical resolution) of your computer. In the accompanying text box, David Leo presents a fourth-order Runge-Kutta routine in BASIC for solving spring-mass-damper systems.

Finally, Y. F. Chang presents one of the most awesome programs I have ever seen—a FORTRAN program that writes FORTRAN programs to solve systems of ordinary differential equations (ODEs) using Taylor series expansion through the first 30 terms. If you keep in mind that an *N*th-order RK *approximates* the first *N* terms of a Taylor series, and it is almost unheard of to do a Runge-Kutta larger than seventh order, you get some feel for what Mr. Chang is offering. The real virtue of his ODE solver is the ease with which this very-high-order solver dissolves stiffness.

I also want to direct your attention to a couple of related articles in other sections of the magazine. In the text box to his review of microTSP (page 257), Paul Davenport presents a brief introduction to time-series analysis. Time-series analysis is an alternative to Fourier analysis that is becoming increasingly popular in scientific as well as economic applications. And on page 57 I review an excellent new book on the fast Fourier transform.

—Tom Clune, Technical Editor

**NOW
COMES
WITH FREE
PRINTER CABLE!**

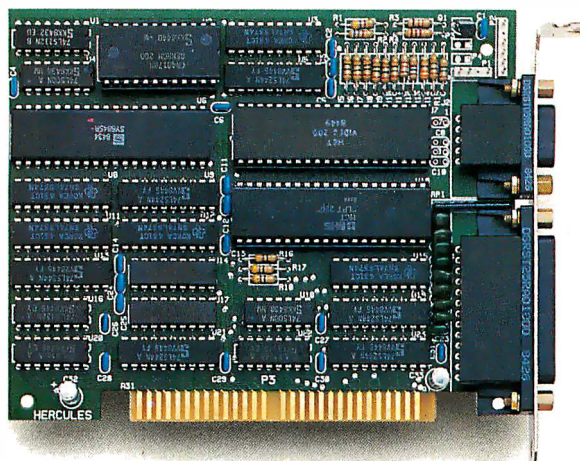

Why the Hercules Color Card is better for your XT than IBM's.

Did you know that there's a color graphics card specially designed for the XT™? It's called the Hercules™ Color Card. We think that it's better for your XT than the IBM® Color Graphics Adapter. Here's why.

The XT comes with an empty short slot. IBM's card is too long to fit in it, so you're forced to sacrifice a valuable long slot, while your XT's short slot goes unused.

The Hercules Color Card is designed to fit in this short slot. It's the smartest way to maximize the usable slots in an XT and provide for your future expansion needs.

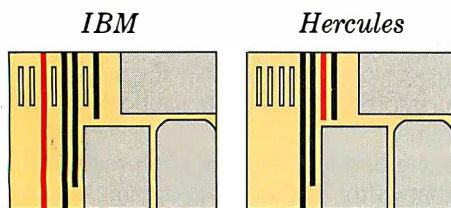

Notice how much more efficiently Hercules makes use of the XT's slots.

Our efficient use of an XT's slots is not the only reason to buy a Hercules Color Card instead of IBM's. We give you a parallel printer port at no extra cost. (IBM charges extra and takes up another slot.)

A lot of people wonder how Hercules can do everything that IBM can in a card less than half the size. We do it by designing our own graphics microchips. Just one of our chips packs the punch of dozens of IBM's, reducing by more than 50% the number of components that can fail.

And we'll do just about anything to make our products the most reliable you can buy.

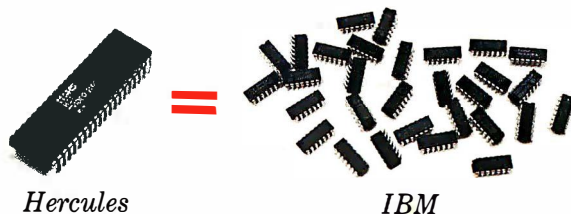

Of course, you *will* have to give up something when you buy a Hercules Color Card. You'll have to give up software incompatibility. With Hercules, there is none. Every program that runs on the IBM color card will run on the Hercules Color Card.

You'll have to give up IBM's ninety day warranty. Ours is two years.

Compare warranties	
IBM	3 months
Hercules	2 years

And you'll have to give up a dollar. The Hercules Color Card is \$245—IBM's is \$244.

Look into the Hercules Color Card for the XT, PC or AT™. Find out why the readers of *PC World* voted the Hercules Color Card 1985's best color graphics card—ahead of IBM's. Call 1 800 532-0600 Ext.432 for the name of the dealer nearest you and we'll rush you our free info kit.

Hercules.

We're strong on graphics.

Inquiry 153

A MICRO-BASED SUPERCOMPUTER

BY NORMAN H. CHRIST AND ANTHONY E. TERRANO

A unique combination of microcomputer parts yields supercomputer processing power

IN THIS ARTICLE we will describe a relatively simple parallel computer being built in the Physics Department at Columbia University. Although each node of the computer is quite similar to a microcomputer in complexity, the combination of many nodes is capable of speeds comparable to those obtained on today's fastest mainframe supercomputers. The device is pictured in photo 1.

Microprocessors are used in experimental university research for monitoring and controlling apparatus and performing data analysis. However, for the large-scale simulations common in theoretical science, the power of micros is simply inadequate. The arrival of Intel's 8087 (and now 80287) arithmetic coprocessors did not alter this situation. The speed of 100,000 floating-point operations per second, typical of an 8086/8087-based microcomputer, is still 1000 times slower than a Cray-1 supercomputer.

This state of affairs has been completely transformed by the manufacture of special arithmetic chips capable of up to 10 million floating-point operations per second (or 10 megaflops). It is now extremely attractive



Photo 1: Columbia University's parallel computer.

for theoretical scientists (especially those with limited university computing budgets) to harness these chips to microprocessors and, exploiting parallelism, build supercomputer-class machines. The project described here is an example of this approach.

These blindingly fast floating-point adders and multipliers are currently sold by Weitek, TRW, Advanced Micro Devices, and Analog Devices for prices in the range of \$200 to \$1000 each. Of course, these chips by themselves do not make up a complete arithmetic coprocessor. First, you need external storage registers to provide an interface to a standard 16-bit bus, and second, you must vary a number of input control signals to generate the desired sequence of arithmetic operations. About a dozen integrated circuits are needed in addition to the floating-point adder and multiplier chips for a working circuit. We refer to the resulting arithmetic unit as a "vector processor" because of its ability to execute a sequence of similar operations on a string (or vector) of data elements. Such a vector processor has the speed and programming characteristics of a com-

(continued)

Norman H. Christ holds B.A. and Ph.D. degrees in physics from Columbia University. Anthony E. Terrano holds a B.A. in mathematics from the University of Chicago and a Ph.D. in physics from Caltech. Both authors can be reached at the Department of Physics, Columbia University, New York, NY 10027.

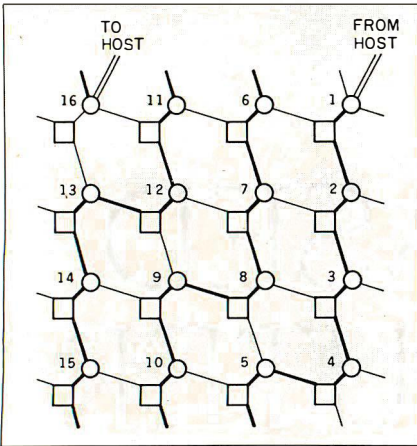

Figure 1: The interconnection scheme for 16 nodes. The squares represent data memories, and the circles represent processors.

mercial array processor.

This arithmetic unit is not as general-purpose as an 8087 or 80287 coprocessor. Since it is pipelined, full speed is obtained only when a sequence of similar operations can be executed consecutively. Also, the fastest of these chips work with 22-bit or 32-bit data (single precision), which is significantly less than the 80-bit data used internally in the 8087. However, for those applications that can tolerate these constraints, a single such unit can be added as a peripheral to a personal computer to boost performance as much as a hundred-fold.

To achieve supercomputer speeds, however, one must join many of these units together. We interconnected

these units in a two-dimensional mesh as shown in figure 1. The individual processors operate with full independence. They communicate by synchronously reading from or writing to their neighbor's memory. This sort of connection is very simple to implement in hardware and very fast. It is well suited to calculations performed on spatially homogeneous systems where at each stage the data (forces, particles, velocities, etc.) need only be passed between neighboring processors.

SINGLE-PROCESSOR ARCHITECTURE

The components of one of our computer's nodes are shown in figure 2. They are arranged on a single 12-by-18-inch board as shown in photo 2. The combination of the 80286/80287, the 32K bytes of RAM, and the 16K bytes of ROM joined to the Intel Multi-bus are typical of a high-end personal computer. The RAM (16 Inmos IM1400 static memories) and the ROM (two Intel 2764 EPROMs) are connected directly to the data lines on the 80286 to form a "local" data bus. They are enabled by standard address-decoding circuitry (three 74LS139 chips).

The bidirectional Y bus is the backbone (and bottleneck) for our system. Because it has ports connected to the four neighboring nodes, it can be used by the 80286 and the vector processor for off-board communication. In addition, it allows access to two banks of data memory. These banks, labeled A and B in figure 2, are each made of 32 static memory chips of 16K bits each. Again Inmos IM1400 parts are used, with 45-nanosecond access times. This memory appears to the 80286 as 128K bytes of additional fast RAM. However, it can also be addressed by the vector processor and each bank can supply a 16-bit word every 125 ns during a sequence of pipelined, vector-processor operations.

The final element appearing in figure 2 is the "X bus" which provides a second, unidirectional path from the

(continued)

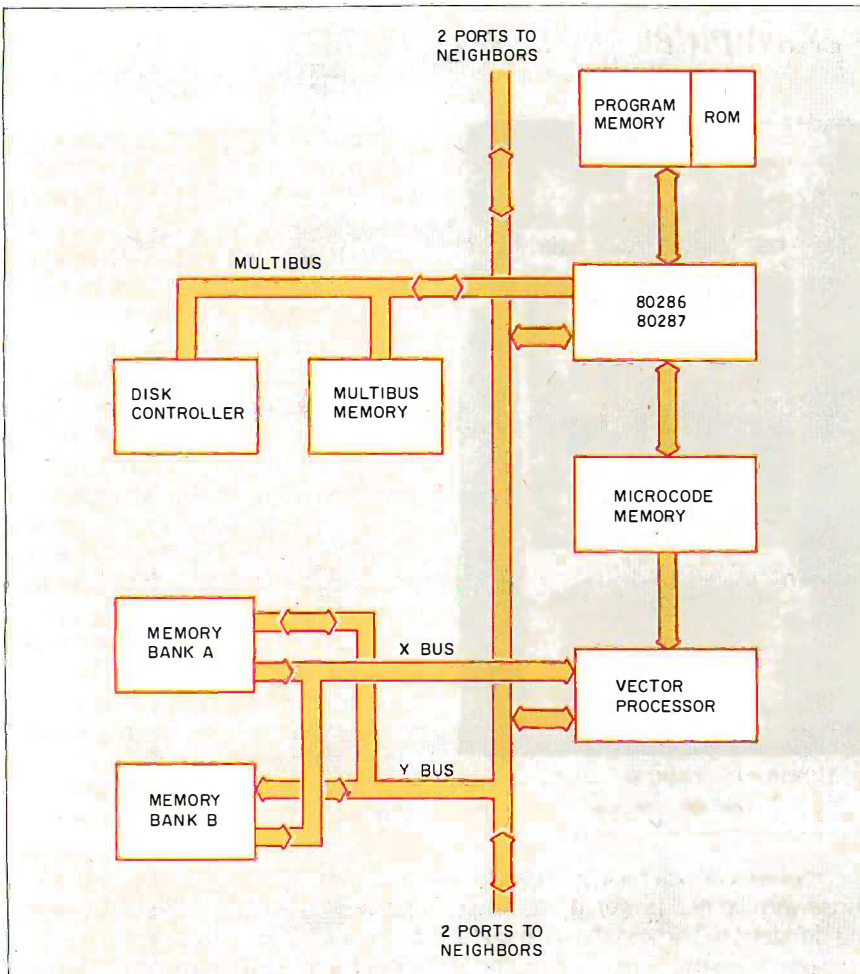

Figure 2: The architecture of a single node of our machine. Only the major elements of the design are shown.

WHEN IT COMES DOWN TO THE NUMBERS STEP UP TO BMDP™

From the Simple . . .

- complete descriptive statistics
- frequencies and percents
- chi square
- scatterplots and histograms
- t-tests
- analysis of variance and covariance
- nonparametric statistics
- linear regression
- cluster analysis
- missing value analysis
- planned and post hoc comparisons

You can use BMDP to analyze your data even if you are not a statistician or a computer expert. The BMDP/PC programs use logical, easy-to-learn instructions, and thorough documentation.

With BMDP/PC you can plot and describe data with simple statistics. Compare groups and contrast cases. Estimate missing values and explain results. Predict outcomes and forecast trends.

You can pick and choose any combination of BMDP/PC programs that suits your needs. Order some now, and others later, when you are ready to step up to more advanced analyses.

To the Sophisticated.

- stepwise logistic regression
- nonlinear regression
- all possible subsets regression
- repeated measures ANOVA
- factor analysis
- stepwise discriminant analysis
- log-linear modeling
- canonical correlation
- life tables & survival analysis
- spectral analysis
- time series (Box-Jenkins)

BMDP is especially appealing to the experienced data analyst. Many researchers learned "the old BMD" programs back in college or graduate school. That's because BMDP has been leading the way through the numbers maze since 1961. Ongoing R&D keeps BMDP ahead with the latest statistical techniques and convenience features.

The newest generation of BMDP is available for the IBM PC™ XT, AT, and compatible hard disk systems. (Mainframes and mini's, too.) Quantity discounts, site licenses, and our flexible "pick and choose" policy make BMDP/PC affordable for all research budgets.

Whether your data analysis needs are simple or sophisticated, BMDP/PC is the right choice.

For More Information, Contact:

BMDP STATISTICAL SOFTWARE, INC.
1964 Westwood Boulevard, Suite 202
Los Angeles, California 90025
(213) 475-5700

In Europe:

STATISTICAL SOFTWARE, LTD.
Cork Farm Centre, Dennehy's Cross
Cork, Ireland
+353 21 42722

BMDP and IBM PC are registered trademarks of BMDP Statistical Software, Inc. and International Business Machines Corporation, respectively.

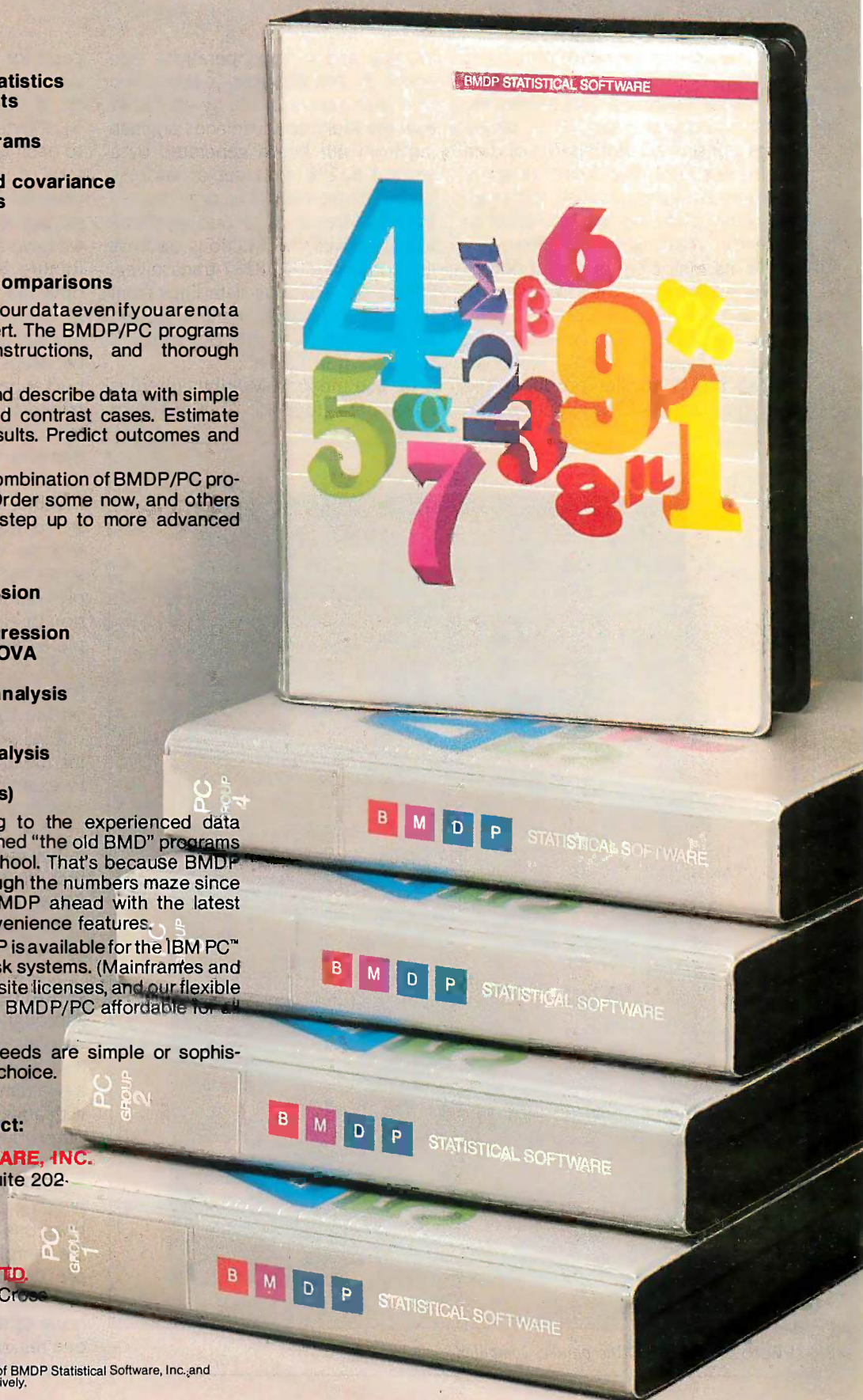

data memory to the vector processor. By using both buses independently, the vector processor can access the data memory at a rate of 32 megabytes per second. Both banks of data memories and the local program memory are parity-checked. Although this error checking was included to identify malfunctioning memory chips, its major benefit has been to reveal software bugs and faulty execution in the vector processor.

An Intel 82284 chip generates the clock and ready signals while an 82288 bus controller produces the command signals for on-board 80286

reading and writing operations (see figure 3). The Multibus is controlled in a multimaster mode by an 82289 with the Multibus commands originating from our board generated by a second 82288. One set of address latches (three 74LS373s) provides on-board addresses, a second set (three 8283s) drives the Multibus address lines. Likewise two 8287 transceivers isolate the Multibus data lines from those of the 80286, while a second set joins this local data bus to the Y bus shown in figure 2.

We use the local Multibus (there is a separate, four-slot Multibus card

cage for each node) to provide for easy expansion of the storage capacity of the machine. At present, two 512K-byte memory boards are added to each Multibus card cage, adding a total of 16 megabytes of memory. As our calculations proceeded, this large storage space became inadequate, so we have attached a disk controller (a Rimfire 50) and 470-megabyte disk drive (a Fujitsu Eagle) to the Multibus of every fourth processor. The disk-managing software then operates in two steps: First the data is transferred, bucket-brigade style, to the processor connected to the disk where it is written to a reserved area in the Multibus memory; second, the controller is activated and copies the data from the Multibus memory to the disk. Reading a file from the disk works in the reverse order. Note that all these steps are usually carried out in multiples of four, with simultaneous operation of all four disk drives. For example, a data file made up of data stored in all 16 nodes will be divided into four parts and written simultaneously on the four disks.

A very concrete way of understanding the arrangement just described is to examine the memory map of the system as seen by the 80286 outlined in table I. Only the Multibus and the initial startup address lie above the first megabyte of the 16-megabyte 80286 address space. Thus, the bulk of our programs operate in the fast, real-address mode.

PARALLEL ARCHITECTURE

Although each node in our machine consists of a processor and memory, it is useful to think of the system as a two-dimensional array of memories, with adjacent nodes joined to one another by the processing elements (figure 1). For a two-dimensional problem with physical interactions only between points that are nearest neighbors, this architecture is clearly ideal: We simply divide the plane of the problem into 16 identical regions, with each region corresponding to a node of the machine. Calculations in one region only require data from the adjacent regions. In each case there

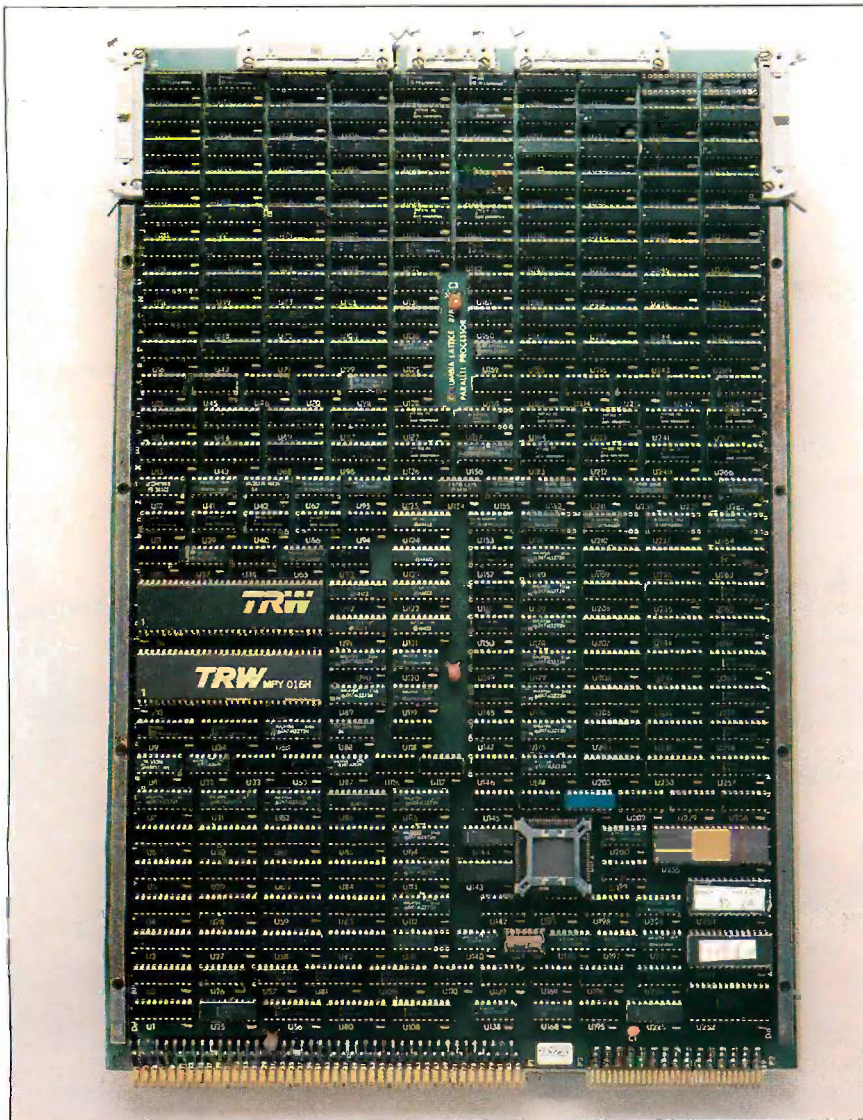

Photo 2: A node of the parallel computer.

is a unique processor with access to the two regions. Typically, that processor performs the calculation directly, with no data-copying operations.

For similarly local higher-dimensional problems, an identical strategy can be used. For example, a three-dimensional system with points labeled by three coordinates x,y,z would be divided into regions using only the two-dimensional x and y coordinates. Points with a given value of x and y but any value of z are assigned to the same memory.

Of course, the edges of the mesh should not be left unconnected. We separately join together the top and bottom and the right and left of the mesh shown in figure 1 to form a torus. This connection of the edges allows simple implementation of "periodic" boundary conditions. In order to avoid the long wires that would be necessary to join these distant edges, we actually fold the arrangement in figure 1 twice, first laying the left half over the right half so the left and right edges are adjacent, and then folding the top half over the bottom. The processors are physically arranged in a two-dimensional plane with the boards corresponding to the above folds interleaved. This procedure can be followed for an arbitrarily large mesh without increasing the length of the interconnecting cables (18 inches, in our case).

Superimposed on this two-dimensional mesh architecture is a "radial" connection of each processor to a very simple central controller as shown in figure 4. This controller provides a small amount of global coordination between the processors and all of the communication between the machine and the outside world. It is built on a single 7- by 14-inch wire-wrap board and is connected to each processor with a ribbon cable carrying eight signals. These include common clock, reset, and interrupt signals that are broadcast to each node. In the other direction, the controller receives "finished," "error," and "request for synchronization" signals from each board.

In addition to these identical connections to each processor, the controller is joined by 16-bit data lines to the Multibus of the first and last processors (the double lines to processors 1 and 16 in figures 1 and 4). The controller contains an 8K-byte buffer memory that can be accessed by the host computer. In an I/O operation, processor 1 reads a packet from this buffer memory. The data is passed daisy-chain style between the processors along a path specified in ROM (the heavy lines in figure 1), and finally processor 16 writes the packet back to the buffer memory.

We run the machine as a peripheral attached to a host VAX-11/780 computer, with a 1-megabyte data-transfer link to the controller. The host computer provides a convenient, multi-user environment to develop and run the programs for our machine. However, any means of providing support for the terminals, editors, and compilers, as well as a tape drive for data storage (such as a microcomputer or a slightly enhanced version of one of our boards) would suffice.

With the interconnection scheme shown in figure 1, each processor has

(continued)

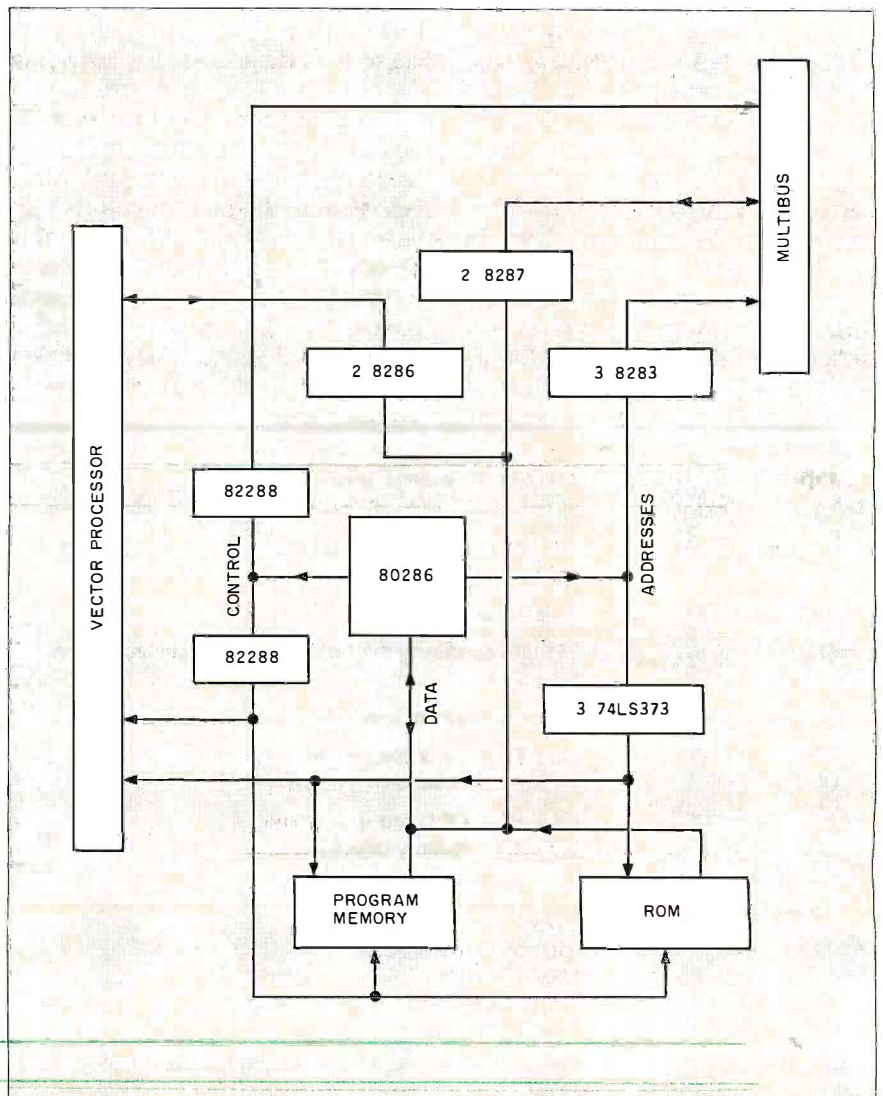

Figure 3: The configuration of the 80286, its program memory, and the Multibus interface.

access to the memory at three different nodes. This is accomplished by simply including all three of these memories in the processor's address space (see table 1). Each processor has unrestricted access to a single, contiguous 384K-byte memory. This implies that there are three different processors that have equal rights to read and write data to a given memory element. Clearly, some provision has to be made to restrict simultaneous references to a given memory element by two or more processors. The mechanism that we use to avoid contention rests on the simple observation that contention cannot occur if all of the processors are executing the same program in lockstep. Thus, if the processor at node 8 in figure 1 is using data in node 9, then the processor at node 9 will be using memory at node 14, and so on.

Such synchronization can be achieved at the hardware level by driving all the 82284 clock generators with the same external frequency (12 MHz) coming from the central controller. Likewise, a common 8-MHz signal provides the clock for the vec-

tor-processor sequencer discussed below. Synchronization of the processors is accomplished by releasing the reset line in phase with the oscillator. All of the clock generators will start on the same rising edge in the oscillator signal, and all of the microprocessors will start in phase. They will remain precisely synchronized for as long as they execute the same instructions on the same data.

The requirement that the processors be executing identical programs is obviously too restrictive. In order to see how we can relax this constraint, it is useful to change our perspective on the global architecture. Rather than considering the processors as democratically providing connections between the memories, we envision each of the processors as being more tightly connected to one of the memories to which it has access than to the other two, as is suggested by the layout of figure 1. This preferential coupling corresponds to the fact that each of our circuit boards contains both a processor and a memory, as described above. We refer to this preferred memory as the *local*

memory and to the remote memories as the *x* or *y* memories, depending on their direction from the local memory.

From this perspective, we see that only the parts of the program that require nonlocal-memory references must be identical and synchronous. Those parts of the calculation that involve only local-memory references can be asynchronous. In fact, since each processor has its own code memory, these local, asynchronous parts of the program can be completely different on different processors. The programmer must separate each program into a number of nonlocal, identical, and synchronous subroutines, and a number of local, possibly inhomogeneous and asynchronous subroutines. Prior to executing a synchronous subroutine, each processor copies the starting address of the subroutine into a location that is read by the bootstrap program and raises its "request for synchronization" line to the controller. When all of the processors have requested synchronization, the controller issues the synchronous reset signal described

(continued)

Table 1: Arrangement of the 80286 address space.

FC0000 - FFFFFFFF	EPROM containing the bootstrap and resynchronization programs.
F40000 - FBFFFF	Multibus address.
FC000 - FFFFFF	EPROM containing the bootstrap and resynchronization programs.
E0000 - FFFFFF	Decoded address lines used for control signals.
D0000 - DFFFFF	bank B Local data memory.
C0000 - CFFFFF	bank A Local data memory.
B0000 - BFFFFF	bank B Off-board data memory
A0000 - AFFFFF	bank A in the y direction.
90000 - 9FFFFF	bank B Off-board data memory
80000 - 8FFFFF	bank A in the x direction.
66000 - 66FFFF	Microcode bits 30-37
64000 - 65FFFF	Microcode bits 20-2F
62000 - 63FFFF	Microcode bits 10-1F
60000 - 61FFFF	Microcode bits 0-F
24000 - 25FFFF	Vector processor startup signal and transfer address.
20000 - 23FFFF	Decoded address lines used for control signals.
0 - 7FFF	Microprocessor program memory.

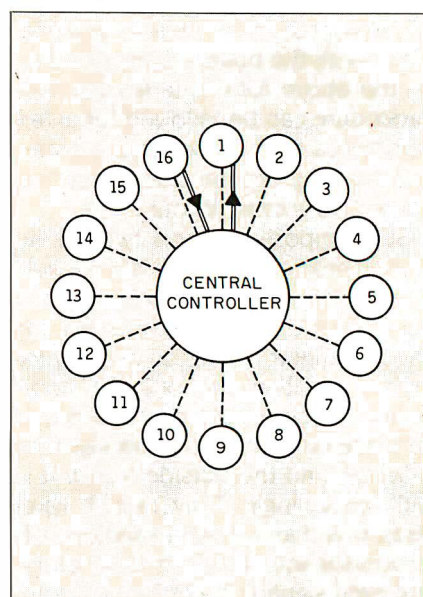

Figure 4: The radial connection between the central controller and the parallel nodes. The doubled lines refer to the data paths between the controller and the first and last nodes of the I/O bucket brigade.

News about the Microsoft Language Family

Structured Programming in Microsoft® QuickBASIC—Part 2—Modules

Easy modular programming is possible with Microsoft QuickBASIC by using separately compiled modules. This means that BASIC programs no longer have to be developed as one monolithic program. They can be written as separate, functionally grouped sets of subroutines that can be used in other programs. A module consists of an optional "main program" and a set of subroutines and functions. Data can be passed between modules by using subroutine parameters or named COMMON blocks. The named COMMON statement allows variables and arrays to be shared among the various modules in a single program. Additionally, the standard COMMON statement can be used to pass information between programs. An example of a common block named GRAF3D is shown below.

```
DIM TRANSFORM3D(3,3) 'static array passed in COMMON
COMMON/GRAF3D/CURX, CURY, CURZ, TRANSFORM3D()
```

Subroutines, separate compilation, COMMON blocks, and program CHAINing make Microsoft QuickBASIC an ideal language for developing large application systems.

Network and Multitasking File Support in Microsoft Languages

All of the Microsoft high-level languages have been extended to support file sharing and record locking. These features work with both MS-DOS® 3.1 networking and XENIX® multitasking systems. A distributed ISAM for the IBM® PC Network is now shipping with Microsoft COBOL 2.1 for MS-DOS.

List of Third-Party Libraries and Utilities Is Now Available

Microsoft has put together a list of names and addresses of vendors that offer libraries and utilities that work with our languages. There are math, statistics, graphics, and ISAM libraries, as well as utilities such as profilers and context sensitive editors. If you would like to receive a copy of this list, please contact Microsoft and ask for the Languages Library List. If you or your company provides libraries or utilities that work with Microsoft languages, then give us a call to find out about our Library Vendor Support Program.

Microsoft Has Simplified the Language Runtime License Agreement

Microsoft now offers a new runtime license agreement for our language compilers. We have simplified or removed many of the restrictions from the old agreement. The new agreement still allows you to distribute your programs on a royalty-free basis. If you are interested in receiving a copy of this agreement, please contact us.

Write to: Microsoft Languages Newsletter
 16011 NE 36th Way, Box 97017
 Redmond, WA 98073-9717 for product update information.
Or phone:
 (800) 426-9400. In Washington State and Alaska,
 call (206) 882-8088. In Canada, call (800) 387-6616.

Latest DOS Versions:

Microsoft C	3.00
Microsoft COBOL	2.10
Microsoft FORTRAN	3.31
Microsoft Macro Assembler	4.00
Microsoft Pascal	3.31
Microsoft QuickBASIC	1.02

above, and the processors begin executing the desired synchronous subroutine.

The principle virtue of this procedure for avoiding memory contention is its simplicity: No special hardware for detecting and arbitrating conflicting accesses is required. In addition, since the off-board memory references occur only when the processors are executing identical programs, the internode buses need carry only data. Rather than having to export addresses as well, each processor can address its own local memory, with the data being read or

written by the appropriate neighboring processor. Furthermore, there is no communication overhead for nearest-neighbor off-board memory references; the data is simply accessible to the processor that needs it, and no explicit transfer operation is required. Some overhead is incurred if a remote processor needs the data. However, each interprocessor bus has a bandwidth of 16 megabytes per second, so transfer times can be kept small.

THE VECTOR PROCESSOR

The throughput of an arithmetic unit can be dramatically increased by the

use of pipelining. A very high degree of parallelism can be achieved by breaking each operation into a number of stages of equal length and carrying out each stage in a separate processor. For example, a unit with 10 stages can work on as many as 10 operations at one time, calculating 10 answers in the time that an unpipelined processor takes to produce just one. We achieve the full speedup only if we can start an operation in every cycle. Our programs must be organized to keep the pipeline full as much as possible.

The vector processor is organized as a pipelined multiplier/accumulator, as is shown in figure 5. The floating-point adder is the TRW 1022, which performs a number of operations—add, subtract, accumulate, normalize, and denormalize—on 22-bit floating-point numbers. The integer multiplier is the TRW 16MPYHJ, which, combined with the exponent adder (two 74F382s), performs 22-bit floating-point multiplication.

The actual operation of this design can best be understood by viewing it as a pipeline with seven stages, each taking a single 125-ns clock cycle to complete. The first consists of clocking a significant into either or both of the two input latches of the integer multiplier. In the second stage, the exponents are clocked into the exponent adder latch, and the integer product of the significands from stage 1 is clocked out of the multiplier. During the third stage, the sum of the exponents of the factors and the significand of the product are clocked into an intermediate 22-bit latch, while overflow and underflow are detected. Since this stage follows the multiplication, it can be used to detect and correct the multiplication rule $-1 \times -1 = -1$ resulting from an overflow of fixed-point multiplication.

In the fourth stage, the correct floating-point product is clocked into one of the parallel 22-bit input latches in the adder. The adder itself contains a three-stage pipeline, and the fifth stage consists of the intermediate adder stage. The 22-bit sum is clocked

(continued)

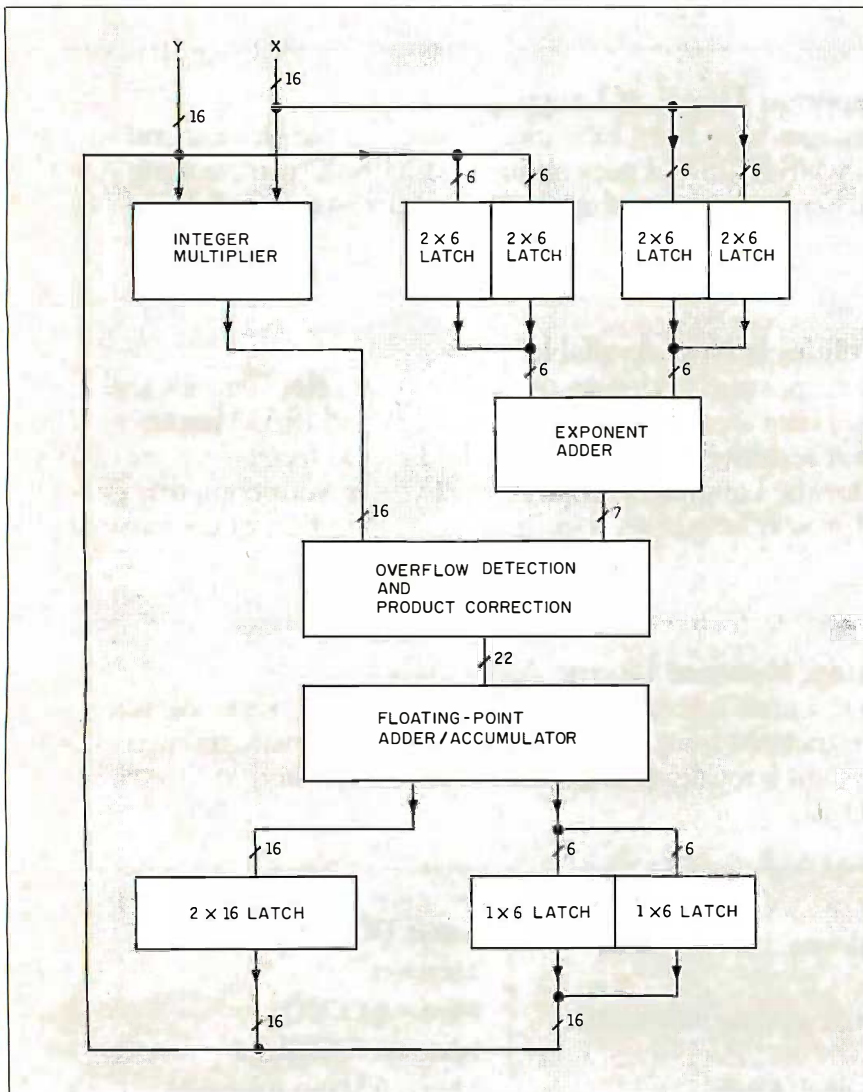

Figure 5: The configuration of adder, multiplier, and latches making up a vector processor.

MICRO CAP and MICRO LOGIC put your engineers on line... not in line.



MY OWN WORKSTATION



How many long unproductive hours have you spent "in line" for your simulation? Well, no more. MICROCAP and MICROLOGIC can put you on line by turning your PC into a productive and cost-effective engineering workstation.

Both of these sophisticated engineering tools provide you with quick and efficient solutions to your simulation problems. And here's how.

MICROCAP: Your Analog Solution

MICROCAP is an interactive analog circuit drawing and simulation system. It allows you to sketch a circuit diagram right on the CRT screen, then run an AC, DC, or Transient analysis. While providing you with libraries for defined models of bipolar and MOS devices, Opamps, transformers, diodes, and much more, MICROCAP also includes features not even found in SPICE.

MICROCAP II lets you be even more productive. As an advanced version, it employs sparse matrix techniques for faster simulation speed and larger net-

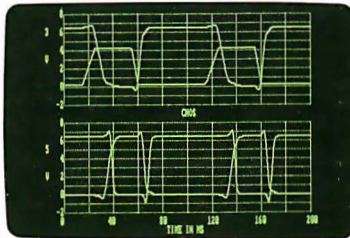

"Typical MICROCAP Transient Analysis"

works. In addition, you get even more advanced device models, worst case capabilities, temperature stepping, Fourier analysis, and macro capability.

MICROLOGIC: Your Digital Solution

MICROLOGIC provides you with a similar interactive drawing and analysis environment for digital work. Using standard PC hardware, you can create logic diagrams of up to 9 pages with each containing up to 200 gates. The system automatically creates the netlist required for a timing simulation and will handle networks of up to 1800 gates. It provides you with libraries for 36 user-defined basic gate types, 36 data channels of 256 bits each, 10 user-defined clock waveforms, and up to 50 macros in each network. MICROLOGIC produces high-resolution timing diagrams showing selected waveforms and associated delays, glitches, and spikes—just like the real thing.

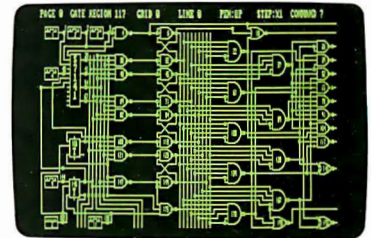

"Typical MICROLOGIC Diagram"

Reviewers Love These Solutions

Regarding MICROCAP... "A highly recommended analog design program" (PC Tech Journal 3/84). "A valuable tool for circuit designers" (Personal Software Magazine 11/83).

Regarding MICROLOGIC... "An efficient design system that does what it is supposed to do at a reasonable price" (Byte 4/84).

MICROCAP and MICROLOGIC are available for the Apple II (64k), IBM PC (128k), and HP-150 computers and priced at \$475 and \$450 respectively. Demo versions are available for \$75.

MICROCAP II is available for the Macintosh, IBM PC (256k), and HP-150 systems and is priced at \$895. Demo versions are available for \$100.

Demo prices are credited to the purchase price of the actual system.

Now, to get on line, call or write today!

Spectrum Software

1021 S. Wolfe Road, Dept. B
Sunnyvale, CA 94087
(408) 738-4387

Inquiry 321

The pipelined arithmetic unit requires the generation of a large number of properly timed control signals.

out of the adder in the sixth stage. In the seventh stage, the significand is clocked into one of two 16-bit latches and the exponent into half of another 16-bit latch. The outputs of each of the latches are connected together and joined to the bidirectional Y port. With this procedure, a full 6-byte complex number coming out of the adder can be packed into three 16-bit words and is ready to be stored in memory. Since the adder has two stages, it is possible to accumulate both the real and imaginary parts of a complex number at the same time.

Obviously, controlling such a pipe-

lined arithmetic unit requires the generation of a large number of properly timed control signals. The most flexible way to supply these signals is through the use of microcode. In a microcoded processor, each of the control signals is provided by a single bit of a word stored in ordinary memory; the output of the memory chip is directly connected to the appropriate pin of the component that is to be controlled. A sequence of operations then corresponds to a particular sequence of bits stored in the control, or microcode, memory. The operations can then be performed by "reading" the appropriate sequence of microcode words. Our microcode memory consists of four thousand 56-bit words.

The program sequencer for this microcode memory is a simple counter under the control of the 80286. Vector-processor execution begins when the 80286 presets this counter to the beginning address of that portion of the microcode to be executed. The counter simply incre-

ments the microcode address at 8 MHz until a microcode stop bit becomes true. All of the decision making, looping, and branching are performed by the microprocessor. A single addressing mode is provided; an 8-bit offset stored in the microcode program is added to a 16-bit base address supplied by the 80286. This is done for both the A and B banks of the memory. The box enclosed by dotted lines in figure 6 shows the elements of the vector-processor controller.

Before a vector-processor subroutine can be started, a memory-processor interconnection configuration must be specified. Either the local A or local B memory may be assigned to the X bus of the processor. If, for example, the A memory is chosen, then one of the B memories—local, *x*, or *y*—may be assigned to the Y bus. Different configurations can be specified for reading and writing operations. The specified configuration remains in force for the entire time the vector processor is running. The assignment is made by loading address bits 16 to 19 into the switch configuration latch. A complete 20-bit memory address is then determined by combining the 16 bits calculated above with the 4 bits in the switch configuration latch.

A typical compute-bound program consists of a large number of floating-point arithmetic operations that are carried out by the vector processor, combined with a small number of integer and Boolean operations, plus jumps and subroutine calls, performed by the microprocessor. To keep the vector-processor pipeline full, we organize our program so that most of the floating-point operations are grouped together into subroutines that can be performed without intervention by the 80286.

Each of these subroutines must be a linear series of multiply/accumulates, possibly arising from expanding the inner DO loops in a program for a conventional, unpipelined computer. These subroutines are converted into microcode programs that

(continued)

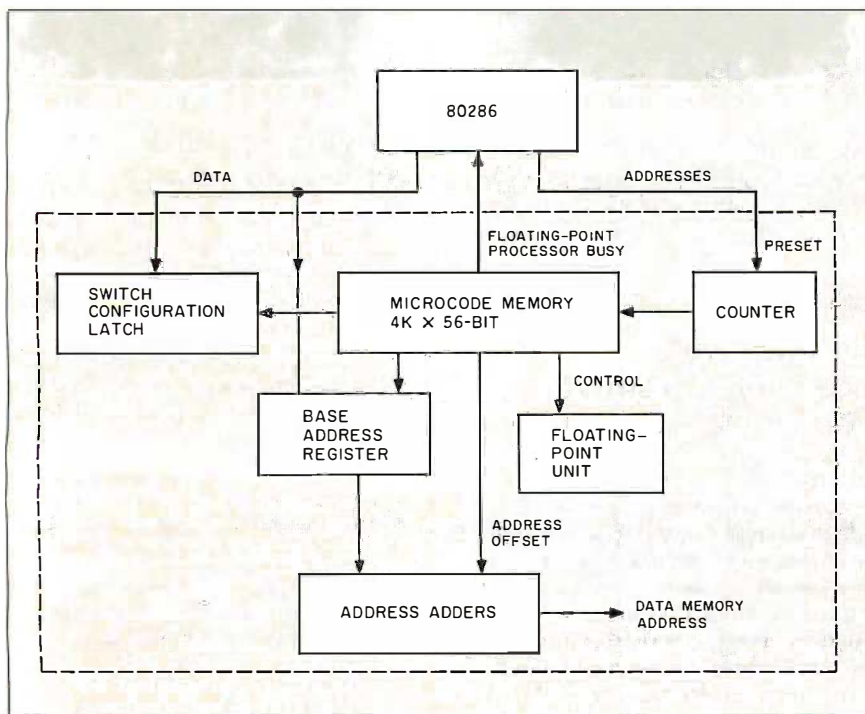

Figure 6: The arrangement of the control system for the floating-point unit. That portion inside the dashed box makes up the elementary microcode control that can operate concurrently with the 80286.

Powerful MS-DOS™ Software.

For the IBM®-PC, XT, AT & others with generic MS-DOS/PC-DOS 2.0 or higher.

Not copy
protected!

Only **\$3995** Each!

UTAH

COBOL™

Whether student, teacher or professional programmer, this is the one you've heard so much about.

- It's easy to use. Compiles 5000 statements on a 128K machine.
- 170 clear error messages, i.e. DATA-NAME IS MISSING OR MISSPELLED.
- Distribute your object code programs royalty free.
- Small object code programs conserve disk space.
- Fast compile times to increase programmer productivity. Over 25 times faster than one compiler costing \$995!
- You get a diskette and 213-page manual with lots of examples and 16 complete COBOL source code programs. **\$39.95.**

Also available: COBOL Application Packages, Book 1 **\$9.95.**

UTAH

PASCAL™

- 14-digit precision, BCD math, no round-off errors with decimal arithmetic for business and floating point +63 -64 for scientific.
- A very nice TRACE style debugging.
- Arrays up to 8 dimensions and 64K strings.
- External procedures and functions with dynamic auto-loading.
- One-step compile, no assembly or link required.
- You get a 132-page manual and diskette. **\$39.95**

UTAH

PILOT™

- Perfect for industrial training, office training, drill and testing, virtually all programmed instruction, word puzzle games, and data entry facilitated by prompts.
- John Starkweather, Ph.D., the inventor of the PILOT language, has added a built-in full-screen text editor, and much more.
- Meets all PILOT-73 standards for full compatibility with older versions.
- You get a diskette, 125-page manual and ten useful sample programs. **\$39.95.**

Also still available for 8-bit machines with CPM® is our world famous Nevada Software Series used by 50,000 customers in 40 countries. These include Nevada COBOL, Nevada FORTRAN, Nevada PASCAL, Nevada PILOT, Nevada BASIC and Nevada EDIT. **\$39.95** each.

Satisfaction guaranteed. If for any reason you're not completely satisfied, just return the package within 15 days in good condition, and we'll refund your money.

IBM is a registered trademark of International Business Machines Corp. CPM is a registered trademark of Digital Research. MS is a trademark of Microsoft Corp. © 1985 Ellis Computing, Inc.

UTAH

FORTRAN™

- FORTRAN IV based upon ANSI-66 standards.
- Very fast compile times and easy to use.
- IF . . THEN . . ELSE constructs.
- Chaining with blank and named common.
- Copy statement.
- ENCODE and DECODE.
- Free-format input and output.
- A very nice TRACE style debugging.
- 150 English language error messages.
- You get a diskette, and 223-page manual. **\$39.95**

UTAH

EDIT™

- A character-oriented full-screen video display text editor designed specifically to create COBOL, FORTRAN and PASCAL programs.
- Only requires 15K disk space so it can fit on the same disk as your compilers.
- Completely customizable tab stops, default file type, keyboard control key layout and CRT by menu selection.
- Diskette comes with easy to read 58-page manual. **\$39.95.**

UTAH

BASIC™

- This interpreter has a built-in full-screen editor.
- Single- and Multi-line user definable functions.
- BCD Math- no round-off errors.
- Full Matrix operations.
- You get 220-page manual and diskette. **\$39.95.**

Handling/Shipping: No shipping charge within US. Overseas add \$10 for first package, \$5 each additional. Checks must be in US Dollars, drawn on a US bank.

Utah Software requires 128K RAM and PC-DOS or MS-DOS 2.0 or higher.

HOW TO ORDER. Send check or money order to Ellis Computing, Inc. with VISA or MASTERCARD order by phone. Sorry no COD's.



Ellis Computing, Inc.
5655 Riggins Court, Suite 10
Reno, Nevada 89502
Phone (702) 827-3030

SINCE 1977



ELLIS COMPUTING™

can be called as needed in the main program. Once loaded into the vector processor's program memory, these subroutines effectively become extensions of the 80286's instruction set in much the same way that the 80287 adds floating-point operations to the instructions available.

Rather than having to write the microcode cycle by cycle, explicitly specifying each concurrent pipelined operation, it is possible to design an assembler that can generate the microcode needed for this restricted class of subroutines. The input to the assembler consists of the specification of a series of arithmetic operations to be performed. In particular, since the vector processor is a hard-wired multiplier/accumulator, each opcode specifies a multiplication followed by an addition.

Having restricted the class of subroutines that will be microprogrammed, only a few sequences of

operations to be performed on a pair of numbers can arise. This makes it possible to assign a single assembler instruction to the entire time sequence of operations. For a given opcode, the assembler generates a template, specifying the sequence of address offsets, latch enables, strobes, and control instructions with the proper timing relations needed to perform the desired arithmetic operations. The problem of keeping the pipeline full is then reduced to that of fitting together the templates as closely as possible without actually overlapping. This can be done by hand, by specifying delays between the operations, or it can be done automatically by the assembler. Both the FORTRAN and assembler versions of a program to calculate the product of two 2 by 2 complex matrices are shown in listing 1.

The full functionality of the vector processor is available for operations

on real numbers. Any of the floating-point-adder hardware instructions can be specified when the output of the multiplier is clocked into the adder. For complex numbers, the operations are restricted to loading the complex product of two numbers into the adder or adding the product to a number previously loaded into the adder. Either instruction can also specify that the result is to be stored in a memory location. In addition, the complex instructions can be specified to act on the complex conjugate of either or both operands.

Two data types, REAL*3 and COMPLEX*6, are provided for. The real format is determined by the design of the floating-point adder and consists of a 16-bit significand, including the sign bit, coupled with a 6-bit exponent. A REAL*3 number is stored in three consecutive bytes, with the significand in the first two bytes and the exponent in the third. The COMPLEX*6 format combines two real numbers packed into three words: the real significand is stored in the first word, the exponents in the second, and the imaginary significand in the third. The assembler can interpret both single variables and one-dimensional arrays, with all offset calculations being performed automatically.

THE VECTOR-PROCESSOR INTERFACE

The interconnection between the microprocessor and the vector processor is shown outside the dotted box in figure 6. As was described above, control is passed from the microprocessor to the vector processor by presetting a counter and loading a number of latches. Since the entire microprocessor program is stored in an independent program memory, the 80286 can run concurrently with the vector processor. The interface between the two processing elements is designed to allow the 80286 to prepare to start the next microcode program before the one presently executing has finished and then start this next routine as quickly as possible.

Listing 1: A program to multiply two 2 by 2 complex matrices. Versions written in FORTRAN and in microcode assembly language are shown.

```

subroutine mtm(m1, m2, ans)
  complex m1(2,2), m2(2,2), ans(2,2)
  ans(1,1) = m1(1,1)*m2(1,1)+m1(1,2)*m2(2,1)
  ans(1,2) = m1(1,1)*m2(1,2)+m1(1,2)*m2(2,2)
  ans(2,1) = m1(2,1)*m2(1,1)+m1(2,2)*m2(2,1)
  ans(2,2) = m1(2,1)*m2(1,2)+m1(2,2)*m2(2,2)
  return
end

var m1 complex a 0      ;declare complex array
                        ;m1, in memory a
var m2 complex b 0      ;declare complex array
                        ;m2, in memory b
var ans complex a 0     ;declare complex array
                        ;ans, in memory a
xpi m1 0 m2 0           ;initialize pipe and
                        ;multiply m1(0) by m2(0)
xpf m1 1 m2 2           ;accumulate m1(1)*m2(2)
                        ;and flush pipe
xs ans 0                ;store result in ans(0)
xpi m1 0 m2 0
xpf m1 1 m2 2
xs ans 1
xpi m1 0 m2 0
xpf m1 1 m2 2
xs ans 2
xpi m1 0 m2 0
xpf m1 1 m2 2
xs ans 3
end

```

(continued)

HALF PRICE

Introductory Subscription Offer

If you're a technically-inclined micro user, subscribe to BYTE and cut your cost right in half. At 50% of the newsstand price, every BYTE issue will bring you stimulating, timely articles on new technology, innovative pc applications, previews, reviews, and appraisals of major new hardware and software products. If your first trial issue of BYTE isn't everything you expected, just write "cancel" on the invoice and return it. Your first issue is FREE to keep with our thanks for trying. . . .

BYTE

THE SMALL SYSTEMS JOURNAL

4746

- Bill me (North America only)
- Charge Visa
- Charge Master Card
- Check enclosed (US. only)

- US 1 yr. \$21.00
(12 issues)
- Canada or Mexico
1 yr. \$23.00 U.S.
(12 issues)
- Europe 1 yr. (air)
\$69.00 U.S.
- Foreign Surface
Delivery (1 yr.)
\$37.00 U.S.

Name _____

Address _____

City _____

State/Providence/Country _____

Code _____

Signature _____

Card # _____

Expires _____

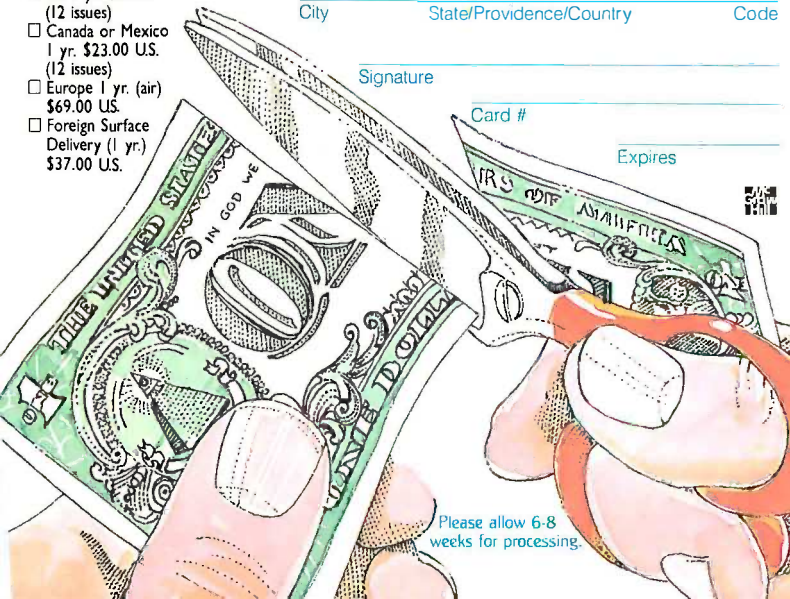

Please allow 6-8 weeks for processing.



NO POSTAGE
NECESSARY
IF MAILED
IN THE
UNITED STATES



BUSINESS REPLY MAIL
FIRST CLASS PERMIT NO. 39 MARTINSVILLE, NJ

POSTAGE WILL PAID BY ADDRESSEE

BYTE
THE SMALL SYSTEMS JOURNAL

Subscription Dept.
P.O. Box 597
Martinsville, NJ 08836-9956

In the tradition of Samuel Morse's telegraph, we've created an easier way to dash off messages on your computer.

In 1844 Morse tapped out a series of dots and dashes on his new telegraph, and the message "What hath God wrought?" traveled instantly between Washington D.C. and Baltimore. Telecommunications was born. Today, we've teamed our new 1200 bps modem with Microsoft's® Access software, and telecommunications has come of age.

Making information easier to send and receive was the reason we designed the Kyocera modem for the IBM PC, AT, XT* and compatibles. That's why we gave it 8K of intelligence for a variety of time and money-saving functions. Like unattended operation, busy and dial tone detection, 11 result codes, and help menus.

Then we teamed it with today's most advanced communications software. Access by Microsoft.

Access is the communications program with X.PC, the amazing protocol that allows you to open 15 live connections over a single line while actually viewing 8 of them simultaneously through "windows" on your screen. At the same time, it automatically checks for data errors during transmission. In addition, Access has built-in interfaces for the information services you need, like CompuServe® and Dow Jones News/Retrieval®. And the Access Learn command turns long command sequences into one-stroke functions that quickly get you on your way to solving problems and doing business.

So get the communications package that makes it easier to get the business information you need. The bundle includes modem, Access software, all accessories, and even the RS-232C cable (for IBM PC, XT and compatibles).

It's a system even Sam Morse would be proud of.

 **KYOCERA Modems**
A tradition of innovation.

For your nearest Kyocera dealer, call toll-free (800) 235-1222 or (408) 257-8000.

©1985 Kyocera International, Inc., Valley Park, 10050 N. Wolfe Rd., Suite 266, Cupertino, CA 95014. Microsoft is a registered trademark of Microsoft Corporation. CompuServe is a registered trademark of CompuServe, Inc. Dow Jones News/Retrieval is a registered trademark of Dow Jones, Inc. IBM PC, AT, XT are registered trademarks of IBM Corporation.

Inquiry 403 for End-Users. Inquiry 404 for DEALERS ONLY.



The 1844 Morse telegraph. With it, Samuel Morse revolutionized telecommunications.



Microsoft Access with X.PC allows multiple live connections.

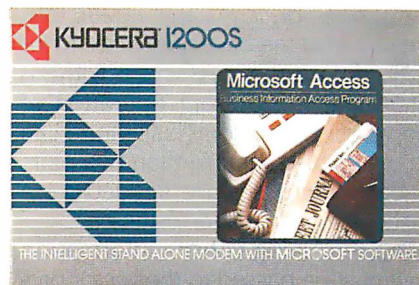

*Running the machine
at maximum efficiency
requires that
the microcode programs
be organized so that
they contain at least
200 operations.*

Calling a microcode subroutine from the master program is functionally identical to a FORTRAN subroutine call, with the arguments passed by reference. However, a special subroutine linkage is needed, since the microprocessor is handing off the control of the execution of the program. The addresses of the operands are written into the address latches, located at fixed memory locations rather than copied onto the stack. Similarly, transferring program control to the microcode subroutine requires writing the address of the initial instruction of the subroutine into the sequencer rather than saving and loading the program counter.

The base address registers used by the vector processor allow simultaneous reading and writing. These operations do not interfere with each other provided different registers are being accessed. We connect the least significant bit of the reading address to that of the writing address through an inverter and drive the writing address bit with a flip-flop whose state is toggled with each start of the vector processor. Thus the 80286 can directly load the base addresses to be used during the next cycle without disturbing the present operation of the vector processor. This feature can be overridden if more than two pairs of base addresses are needed for a particular microcode routine.

The remaining control information that must be passed to the vector processor is organized so that it can be

transferred in the single write operation that starts the microcode execution. A microcode routine is initiated by writing to a reserved address range (table 1). The segment portion of that address is decoded to start the vector processor. The offset is directly preset into the microcode address counter, determining the address of the microcode routine to be started. The data being written during this operation determines the interconnection configuration to be used by the microcode routine and is clocked into the switch configuration latch shown in figure 6.

The time required to set up the vector-processor control registers depends on the number of arguments being passed. For example, the time required to start the program shown in listing 1 is approximately 12 microseconds. The vector processor can carry out nearly 200 operations in this amount of time. Thus, running the machine at maximum efficiency requires that the microcode programs be organized so that they each contain at least this many operations.

Provision must be made to delay the next start-up instruction until the current vector-processor program has completed. A continuous sequence of microprocessor wait states is generated if the 80286 writes to a reserved address (VWAIT) while the vector processor is busy. Thus, before starting the next microcode routine, the 80286 writes to VWAIT. This operation is extended indefinitely by wait states until the microcode execution has completed. When the current microcode program finishes, the 80286 is released from the wait state and executes its next instruction, normally the "write" described above that restarts the vector processor. With this technique, only 700 ns need typically elapse between the end of one vector-processor operation and the beginning of the next.

Achieving this speed requires that the order of the microprocessor's instructions be adjusted so that the instruction queue is filled prior to executing the write instruction to VWAIT. By prefetching the instruction

that will restart the vector processor before entering the wait state, the microprocessor will be able to decode the instruction while the vector processor is still running. Typically, this requirement can be met by performing a register-to-register operation immediately before executing the wait instruction, freeing the bus for prefetch use. Listing 2 contains the 80286 assembly language that loads the required registers and initiates the multiplication of two matrices by the vector processor, using the microcode program in listing 1.

The microprocessor programs are generated using Intel cross-compilers (FORTRAN and PL/M) and an Intel assembler running on the VAX-11/780 host computer. The output from the microcode assembler is a standard, Intel format, relocatable object module. The microcode is stored in four initialized arrays corresponding to the four 16-bit words that make up an individual microcode instruction. Each of the arrays is assigned to a separate segment. The modules containing the microcode are then linked together using the Intel link editor, and the segments can be assigned the appropriate addresses in the microcode memory when the absolute load module is produced. In addition, the initial instruction is declared to be a public variable, making the starting address of the microcode subroutine conveniently available to the microprocessor programs. The microcode module can then be linked in the usual fashion with the program modules produced by the compiler for the microprocessor.

CONCLUSION

When we set out to build this machine we had two goals in mind. First, we hoped that by interconnecting a very large number of simple processors we would achieve number-crunching speeds well beyond those possible on commercially available supercomputers. Second, by coupling state-of-the-art VLSI floating-point chips with very fast microprocessors we believed we had a design sufficiently simple

(continued)

TATUNG

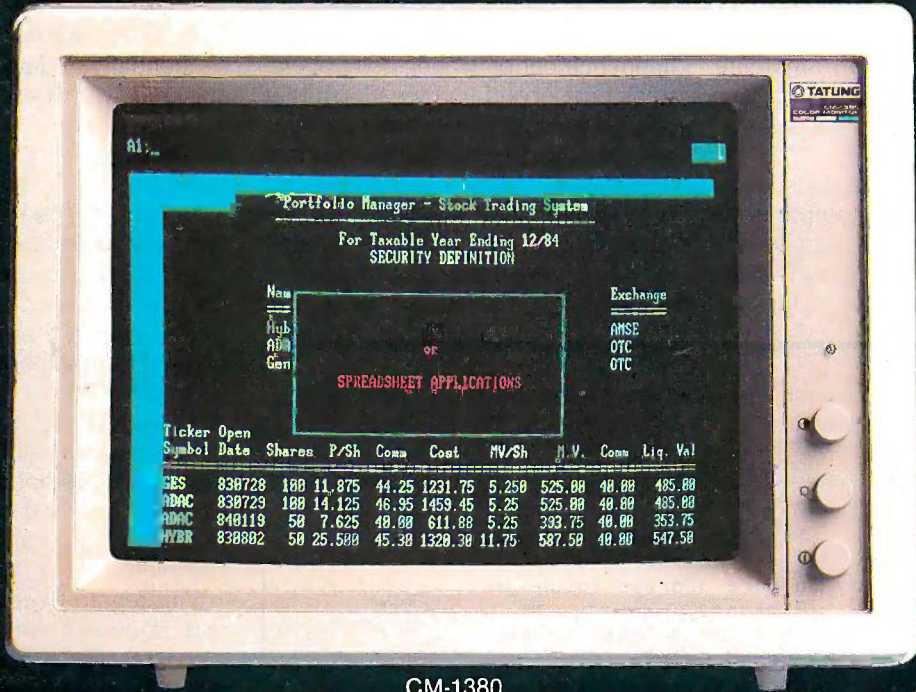

CM-1380

13" RrGgBbl Super High Resolution, 22KHz/15KHz dual frequency, 64 color display with 640 x 350 line resolution.



CM-1370
13" RGBI
Super High Resolution
16 color display
with 720 x 400
line resolution.



CM-1360
13" RGBI
High Resolution
16 color display
with 640 x 200
line resolution,
color/amber/green
selectable.



CM-1322
13" RGBI
High Resolution
16 color display
with 640 x 200
line resolution.



MM-1222
12" High Quality
Monochrome display
with 800 x 350
line resolution,
amber/green.

PICTURES PERFECT.

Tatung monitors. What you get is more than what you see. What you see is a picture of startling clarity. A picture that's sharp, clear, and crisp... whether color or monochromatic.

The kind of picture you can sit in front of for hours.

A Tatung picture.

What you can't see,



TATUNG

but will feel, is Tatung value. Dollar for dollar, feature for feature, you'll look a long time for a better, more capable, IBM compatible monitor... regardless of what kind of system you'll use it with. For more information and specifications, call or write for our brochure.

For complete information call (213) 979-7055.
TATUNG COMPANY OF AMERICA, INC. 2850 El Presidio Street, Long Beach, California 90810
In Northern California, call (408) 435-0140.
TATUNG SCIENCE & TECHNOLOGY, INC. 780 Charcot Ave., San Jose, California 95131.
Tatung Company of America, Inc. is a subsidiary of Tatung Company, Taipei, R.O.C.

that it could be built and programmed by a group of dedicated amateurs, thereby reducing construction and operating costs by at least a factor of 100. How have we done?

Let us first address the question of performance. Table 2 compares an IBM PC (with an 8087 installed), a VAX-11/780, and two Cray-1 computers with our machine. The first col-

umn refers to raw speed—the maximum number of floating-point operations per second (in megaflops) that can be executed. A more important comparison uses the speed for a real application program. In our case this is a Monte Carlo simulation of the laws of force obeyed by the “quarks” making up the neutrons and protons out of which the atomic nucleus is

built. In this statistical simulation you sequentially update the variables associated with the links of a four-dimensional lattice in space-time. It is this link-update time that is listed in table 2.

As can be seen from table 2, we have not yet met our first goal. The Cray XMP-4 outperforms us by a factor of 4. However, that goal may not be far away. We are now more than halfway through the construction of a 64-node machine equal in power to the Cray XMP-4. This machine should be operational within the next few months. A 256-node version is under construction, and it should require less than a year and a half to complete.

With regard to economy, the situation is already very clear. We can fabricate one of our nodes for less than \$3000. The cost of the 16-node machine—including the disk drives, controllers, and Multibus memory—is under \$150,000, well below the multimillion dollar price tag for a comparable supercomputer. The savings in operating costs are even greater. The group of faculty and students who built the machine and wrote the operating system and application programs can quite easily maintain it. (So far we have averaged one failure every three months.) Thus the major operating expense is electricity.

The machine described in this article is inferior in many respects to a commercial supercomputer. The configuration of the floating-point hardware is much less versatile, the arithmetic is less precise, the highly parallel operation is seriously constraining, and the programming environment is far from user-friendly. Nevertheless, our efforts demonstrate that by focusing on a particular class of applications and forgoing some of the conveniences associated with a commercial product, you can build a flexible and very competitive supercomputer-class machine. ■

ACKNOWLEDGMENT

The authors would like to thank the Department of Energy and Intel Corporation for their support.

Listing 2: The 80286 assembly-language program that initiates the execution of the program shown in listing 1.

```
mtm:

mov  si,[bx+2]    ;load the pointer to the
mov  ax,lind[si]  ;first matrix into ball,
mov  ball,ax      ;a base address latch for
                  ;B memory.

mov  ax,[bx+4]    ;load the pointer to the
mov  aal1,ax      ;second matrix into
                  ;aal1, a base address
                  ;latch for A memory.

mov  ax,[bx+6]    ;load the pointer to the
mov  aal3,ax      ;destination matrix into
                  ;aal3, a base address
                  ;latch for A memory.

mov  ax,0d0c0h   ;load the intended
                  ;contents of the memory
                  ;control latch into ax.

add  bx,8         ;set bx to point to the
                  ;next routine.

mov  vwait,ax    ;wait until the vector
                  ;processor has finished
                  ;the previous operation.

mov  svp+mumtm,ax ;load the memory control
                  ;latch (at address svp)
                  ;and start the vector
                  ;processor. The lower
                  ;bits of the address
                  ;(mumtm) determine the
                  ;microcode program being
                  ;started.

jmp  tab[bx]     ;jump to the next portion
                  ;of code selected by bx
                  ;which starts up the next
                  ;microcode program.
```

Table 2: A comparison of both peak speed and execution time for the basic element of an application program.

Computer	Peak Speed (megaflops)	Link-Update Time (microseconds)
IBM PC	0.1	200,000
VAX-11/780	1	20,000
Cray-1	160	80
Cray XMP-4	1000	15
16-node machine	256	65

Well Known Compatibility...Unheard of Price!!

IBM® Compatible Computing At An Affordable Price. Why Pay More?

STANDARD
BRAND PRODUCTS

PC/XT

- Intel 8088-3 (4.77 MHz)
- Half-Height Floppy Disk Drive
- 640K Ram
- 135 Watt Power Supply
- 8 Total Slots
- Keyboard



\$629

1 Year Warranty!

New!

Turbo XT

- 40% Faster Processing Speed
- Intel 8088-2 (4.77 or 6.66 MHz)
- Keyboard Selectable
- Standard PC/XT Configuration

\$729

Thousands Of Compatible Business And Other Application Software Packages Available Including Such Benchmarks As Lotus® 1-2-3® And Flight Simulator®

- ✓ Non-Infringing BIOS Copyright
- ✓ Extended Burn-In Testing
- ✓ 100 Page Illustrated Users Guide

"Runs All Major Software Written For The IBM® PC & XT"

PC
SOURCE

12303-G Technology
Austin, TX. 78727

Call Toll Free 1-800-626-4027
Within Texas 512-331-6700

Compare & Save

Compare & Save

Compare & Save

Compare & Save

Setting The Import Standard

Our Factory-Direct Volume Buying Saves You Money...Quality Assured With Our STANDARD 2 Year Warranty

STANDARD BRAND PRODUCTS

Enhancement Products For The IBM PC Market.

STANDARD MFC w/384K



- 384K Ram
- Clock/Calendar
- Serial Port
- Parallel Port
- Game Port
- Software

\$129

Memory Chips

64K **\$10**
9 Per Set, 1 Year Warranty

256K **\$29**
9 Per Set, 1 Year Warranty

STANDARD Monographic Card



Hercules Compatible Monochrome Graphics Card w/Parallel Port.

- Text Mode 80X85 Characters
- Graphics Mode 720X348 Pixels

\$119

STANDARD AT-MFC



w/OK

\$189



Speed-Up Your PC With Genuine Intel Math Co-Processors

8087-3 **\$119**
8087-2 **\$159**
80287 **\$219**

AT 360K Floppy Drive

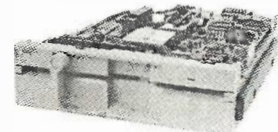

- Half-Height
- Color Coordinated

\$109

FDC



Controls Up to 4 Floppy Disk
Includes:
Internal Cables

\$49

ColorCard



Color Graphic Card w/Parallel Port For RGB Monitors

\$99

I/O



Clock/Calendar Serial & Parallel Port Card For IBM PC

\$99

MonoCard

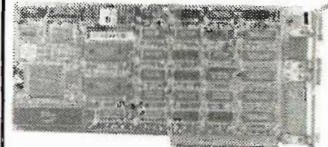

Monochrome Display Card w/Parallel Port

\$99

5151 Keyboard



With Separate Numeric And Cursor Keypad

\$99

PowerMaster AC Center And Monitor Stand

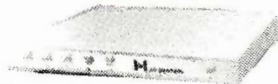

- Power Director
- Surge Suppressor
- Swivel Base

\$89

150 Watt Replacement Power Supply



\$85

With Four Power Connections

No Charge For UPS Ground Shipping. No Surcharge For MasterCard or VISA. Fortune 1000 Purchase Order Welcome. All Warranty Work Must Have A Return Authorization Number. IBM logo is a registered trademark of Hercules Computer Technology, Inc.

PC SOURCE

Outside Texas
800-626-4027

Inside Texas
512-331-6700

12303-G Technology Austin, TX. 78727



COMPUTER APPROXIMATIONS

BY STEPHEN L. MOSHIER

Optimizing speed and precision in computations

OFTEN, THE RESULTS of computer arithmetic are not exact. For example, we know what $Y = 2/3$ means, but a computer that employs base 10 or base 2 arithmetic has no number that is exactly equal to $2/3$.

In the case of transcendental functions, such as $Y = \exp(2)$, not even we humans have a number for Y . We may remember from a math course that the exponential (or antilogarithm) function can be defined as the given summation of an infinite series of terms. (See figure 1, equation 1. All equations are in figure 1 and will be referenced by an equation number appearing in parentheses to the left of the equation.) We can get only an approximate value by adding up a finite number of the terms in this series. To obtain a fairly accurate result, we have to include a large number of terms. Moreover, each term must be calculated to a correspondingly large number of decimal places.

Before computers and desk calculators, the preparation of a numerical table for functions such as logarithms or exponentials was a major undertaking. Mathematicians therefore devoted considerable thought to cal-

culational methods that are both fast and accurate. To mention just one example, the mathematician Gauss made use of a fast Fourier transform algorithm as long ago as the year 1803. A rich legacy of tricks for manual computation provides us today with many efficient algorithms for computer routines.

The objective of computer approximation is to calculate the value of a function to a given accuracy while expending as little computational energy as possible. Because of the various tricks that can be brought into play, this short article cannot present a cut-and-dried design technique. However, there is a small set of problems that have to be addressed in writing any numerical function routine. Each of these problems will be discussed here in relation to a specific programming example. The main connecting theme, or plot, will be to design a program to compute the exponential function. We shall see that this leads us into several interesting subplots.

ROUND-OFF ERROR

Let's review the way in which computers represent numbers. In order to

handle a large range of numbers, from very small to very large, computers use a "floating-point" representation. This is exemplified by the so-called scientific notation for numbers, such as $0.987654E3$, which means 987.654. Floating-point numbers contain a part called the "exponent," which in the above example is the 3, and a "mantissa," which in the above is 0.987654. The number of significant figures permitted in a computer number is usually fixed; this limits the precision of arithmetic operations. If, as in the example, a number can have six significant decimal figures, then its relative precision, or resolution, is at best 1 part in 999,999 or about $1E-6$. Although some computers (such as pocket calculators) operate directly with decimal arithmetic, typically both the exponent and the mantissa are represented by binary numbers.

Most of the computers in use today have one or more of the following for-

(continued)

Stephen L. Moshier is an independent consultant on speech recognition and signal processors and was a founder and former technical director of Verbex Corporation. He can be contacted at 30 Frost St., Cambridge, MA 02140.

mats for floating-point numbers:

1. Single-precision (32-bit): 8-bit exponent, 24-bit mantissa; resolution = 5.96E-8.
2. Double-precision (64-bit) IBM/DEC style: 8-bit exponent, 56-bit mantissa; resolution = 1.38E-17.
3. Double-precision (64-bit) IEEE style: 11-bit exponent, 53-bit mantissa; resolution = 1.11E-16.

The figures given as "resolution" indicate the smallest number that, when added to the number 1.0, yields a

computed result different from 1.0. The values shown are approximate. The relative error of the computer representation of a given number can vary from 0 up to the indicated amount. The term "relative error" is used in a percentage sense: It refers to the error divided by the correct value. "Absolute error" means simply the magnitude of the error itself.

"Round-off error" is the difference between an infinitely precise value and its representation in the finite-length computer-number format. This

is the irreducible limit to accuracy in a given computer arithmetic.

In a chain of calculations, the maximum total relative round-off error is estimated conservatively by counting the total number of arithmetic operations and multiplying by the "resolution" figure given above.

This is *not* the maximum possible error of the result, because in addition to round-off there are other purely numerical sources of error. In fact, as we shall see, round-off error is sometimes the least of our worries.

Listing 1: An inefficient power routine.

```
double power( x, N )
double x;
int N;
{
int i;
double y;
y = 1.0;
for( i=0; i<N; i=i+1 )
    y = y * x;
return( y );
}
```

ALGORITHM SPEED

The exponential function exp(x) involves finding the xth power of a special number e (2.71828...). Both x and e are floating-point numbers. To warm up to this problem, let's first design a program called "power(x,N)" that will find the Nth power of a number x. N can be any positive 16-bit integer, while x is a real number represented in floating point.

This looks trivial. We can immediately write down the computer code for an algorithm that simply multiplies x by itself N times. (See listing 1. All programs are written in C language, but some of the less obvious C constructions are avoided.) This program can take a relatively long time to execute. If N = 10,000, the for loop will have to be done 10,000 times.

There is a much faster algorithm than this. It can be understood by looking at the binary representation of N, equation 2.

Since adding in the exponent is equivalent to multiplying in the base, we can factor the product of 10,000 x's into equation 3. Are these 2-to-the-nth powers of x easy to compute? Yes, they are. To get them, we just successively square x, square the square of x, and so forth. Using this insight, the program can be revised to look like listing 2.

On each loop, the next binary bit of N is tested. If it is a 1, then the current value of z is one of the factors needed in the expression for the power. To prepare for the next loop, z is squared. Also, the next higher bit

(continued)

- (1) $e^x = 1 + x + \frac{x^2}{2} + \frac{x^3}{6} + \dots$
- (2) $N = 10,000 = 0010\ 0111\ 0001\ 0000$
 $= 2^4 + 2^8 + 2^9 + 2^{10} + 2^{13}$
- (3) $x^{10,000} = x^{2^4} * x^{2^8} * x^{2^9} * x^{2^{10}} * x^{2^{13}}$
- (4) $2^{x \log_2 e} = (2^{\log_2 e})^x = e^x$
- (5.1) $a_0 + a_1 x_1 + a_2 x_1^2 + d = f(x_1)$
- (5.2) $a_0 + a_1 x_2 + a_2 x_2^2 - d = f(x_2)$
- (5.3) $a_0 + a_1 x_3 + a_2 x_3^2 + d = f(x_3)$
- (5.4) $a_0 + a_1 x_4 + a_2 x_4^2 - d = f(x_4)$
- (6.1) $a_0 + a_1 x_1 - b_0 (f(x_1) + d) = x_1 (f(x_1) + d)$
- (6.2) $a_0 + a_1 x_2 - b_0 (f(x_2) - d) = x_2 (f(x_2) - d)$
- (6.3) $a_0 + a_1 x_3 - b_1 (f(x_3) + d) = x_3 (f(x_3) + d)$
- (7) $\frac{Q(x^2) + x P(x^2)}{Q(x^2) - x P(x^2)}$

Figure 1: The equations used in this article.

AMERICAN MICRO TECHNOLOGY
presents



STARRING

XT-PLUS

AMT 286

and
Introducing

AT jr



XT-PLUS

IBM PC XT Compatible, 4.77MHz Clock, 640K Mother Board, 8088 Intel Chip, Keyboard, 135 watt Power Supply, Floppy Disk Controller, Printer Port, Serial Port, Game Port, Clock w/Battery Back-up, Two Disk Drives \$699.

Specials *

- Floppy Disc Controller \$29.
- Monochrome Graphics Card/PP 79.
- Disk I/O Card FDC, PP/SP, Game, Battery Clock 79.
- 1200 Baud Modem (1/2 size) . . 159
- XT-Mother Board "O"K expandable to 640K 99.
- Mother Board for AT 650.
- Keyboard AT 65.
- 20MB Drive with Controller . . 425.
- Power Supply 135 watts 65.
- Power Supply 200 watts . . . 129.
- XT Chassis 31.
- AT Chassis 89.
- 8MHz IBM PC XT Compatible Mother Board "O"K 175.
- 30MB Drive with Controller . . 590.
- EGA Card 275.



AMT 286

IBM PC AT Compatible Computer (STM Board) 6 MHz, 640K Memory, Keyboard, Clock & Battery on Board, Floppy & Hard Disk Controller, 1.2MB Floppy, 192 watts Power Supply \$1499.*

AMT 286-e

IBM PC AT Compatible Computer (Atronics Mother Board), 8 MHz Clock (enhanced version), 640KB Memory expandable to 1MB, AT layout Keyboard, Floppy & Hard Disk Controller by Western Digital, 192 watts Power Supply, 1.2MB Floppy, 20MB Hard Disk, Socket for 80287 \$1999.

"O" Wait State Option \$300.

**PLEASE DON'T CALL
TICKETRON . . .
FOR FAST SERVICE
CALL US**

(714) 972-2945
TWX 5106003265



AT jr

IBM PC Compatible, 2 to 5 times faster than IBM PC, Zero Wait State, Eight Slots, 135 watts Power Supply, 8 MHz & 4.77 MHz Clock (Dual Speed Hardware & Software switchable), 640KB on Mother Board, V-20 or 8088-2 Processor, AT layout Keyboard, Floppy Disk Controller, Two Drives 360KB each, Runs Lotus 123, Wordstar, dBase II & III, Flight Simulator and more \$699.*

*Prices for quantity purchases only
Registered trademark of IBM Corporation

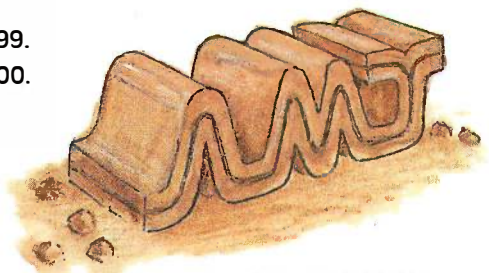

AMT AMERICAN
MICRO
TECHNOLOGY
1322 E. EDINGER SANTA ANA, CA 92705

Prices and Availability subject to change without notice.

of N is shifted down into the ones position, ready for testing by ANDing it with the number 1.

The revised algorithm reduces the number of passes through the loop from 10,000 to only 14. In general the number of passes is on the order of $\log_2(N)$. In addition to being much faster, the smaller number of operations means that this implementation is less subject to the effect of round-off error.

Of course, if N is small, then the original version of the program may be faster. A complete program might test the value of N and then choose one or the other method.

RANGE REDUCTION

Approximating functions often can be used for only a small range of argument values. For example, you might have a table of logarithms that covers arguments from 1 to 10. Outside this range, you must do something that

reduces the argument to the tabulated range, then do an inverse something on the tabulated function value in order to get the desired answer.

Let's use the trick described in the previous section to perform range reduction for the exponential function. Suppose there is available a formula for $\exp(x)$ for x between 0.0 and 1.0; say we have already written a function called $\text{formula}(x)$ to do this. We will split x into an integer part N and a fractional part f in such a way that $x = N + f$, with f between 0.0 and 1.0. The program code for this would be simply $N = x; f = x - N$; since the needed integer truncation function is invoked automatically by the language compiler. The first expression truncates x to the nearest integer smaller than x ; then the second finds the fraction by subtracting off the integer part. Having split x into the sum of its integer and fractional parts, we

can write $\exp(x) = \exp(N+f) = \exp(N) * \exp(f)$. We have the subroutine $\text{formula}()$ (listing 4) for $\exp(f)$, so we have only to find $\exp(N)$. But this is merely the N th power of the number $e = 2.71828\dots$, or $\text{power}(e,N)$. So the solution is immediate: $\exp(x) = \text{power}(e,N) * \text{formula}(f)$.

For a frequently used computer routine we would modify $\text{power}()$ to avoid having to calculate the squares of squares of e every time the function is called. Since these numbers are constants, we could simply write out a table of the possible values of z in $\text{power}()$. There would be one table entry for each of the possible bits (16 of them) in an integer. An additional advantage of incorporating a table is that the tabulated values would not be subject to accumulated round-off error but would have full machine accuracy.

CANCELLATION ERROR

In the above example, we were lucky that a computer number can be split into integer and fractional parts without losing accuracy. The fractional part of x , expressed in more general terms, is x modulo 1. If the modulus of the modulo function were not 1 but a number that cannot be represented exactly in the computer, then we would have been in some trouble.

This problem arises in trigonometry functions such as sines and tangents. Suppose we have $\sin(x)$ tabulated for x ranging from 0 to 2π (6.28318...). To compute $\sin(1000)$ we simply find 1000 modulo 2π and look up the answer directly in the table. However, this is not as easy as it seems because of the limited precision of the modulo function.

A typical program that computes x modulo m is presented in listing 3. The program divides x by the modulus and truncates the quotient to an integer n . This n is the largest whole number for which $m * n$ is less than x . (And so, $m * (n+1)$ would be greater than x .) Hence the answer sought is $x - (m * n)$.

Now to illustrate the problem, assume the computer uses six-place

(continued)

Listing 2: An efficient way of obtaining powers of x .

```
double power( x, N )
    double x;
    int N;
    {
    double y, z;
    y = 1.0;
    z = x;
    while( N != 0 )
        {
        if( (N & 1) != 0 )
            y = y * z;
        z = z * z;
        N = N >> 1;
        }
    return( y );
    }
```

Listing 3: A typical program to compute x modulo m .

```
double mod( x, m )
    double x, m;
    {
    long n;
    double f;
    f = x/m;
    n = f;
    return( x - n * m );
    }
```

THERE'S A NEW SOLUTION.

For years resellers did not have to be sophisticated because their customers were not sophisticated. Times have changed! Today's customers know what they want. And what they want is software that fits their business, supplied by professionals who understand their business.

This revolutionary attitude has created a new breed of computer professional, the Value Added Reseller (VAR). We understand the needs unique to a VAR. We ought to, years

ago we started out as one. We know long development cycles and the need to tailor applications for your client today and tomorrow can bleed your profits dry.

This knowledge was the stimulus behind the creation of The SENSIBLE SOLUTION Database Language. For years The SENSIBLE SOLUTION has been helping VARs all over the world profitably develop professional applications that fit their customers' needs.

NOW O'HANLON ANNOUNCES A NEW SERIES OF POWERFUL SOLUTIONS TO THE DEMANDING WORLD OF THE VAR.

The O'Hanlon DATABASE SOLUTION 3.0 development language opens new horizons in customized application development. This full-featured multi-user language removes virtually all limitations typical of a database development tool. All the power of The SENSIBLE SOLUTION is still there, plus a host of added highlights which include:

- Full Color
- Structured Programming Commands
- Data Exporting
- Alien Language Calls
- Batch File Execution
- On-Line Debugger

The O'Hanlon MANAGEMENT SOLUTIONS are a series of proven, pre-packaged business accounting applications. These applications, which are available with source code, can be used as is or tailored to fit your vertical market needs.

Applications include:

- General Accounting—General Ledger; Accounts Receivable; Accounts Payable
- Whole Distribution—Inventory Control; Sales Order; Purchase Order
- Law Office Management—General Ledger; Accounts Payable; Law Office Management and Billing

The O'Hanlon VAR Program focuses on the needs of application developers and value added resellers. Members of this select O'Hanlon group receive support, development tools and pricing which enhance profitability.

Benefits include:

- Private Label Ability
- Professional Programming Utilities
- Reduced Application and Run-Time Pricing
- Advanced Technical Support
- Shared Marketing Resources

Inquiry 243 for End-Users.
Inquiry 244 for DEALERS ONLY.

For further information call or write today! Better yet, redeem this coupon for a special limited introductory rate on the new O'Hanlon DATABASE SOLUTION 3.0.



O'HANLON
COMPUTER SYSTEMS

11058 MAIN STREET SUITE 110
BELLEVUE, WASHINGTON 98004 (206) 454-5350 Ext. 379
Development Software for Computer Professionals.....

- Yes I'm interested, please have a representative call me.
- Yes I'm interested, please send full descriptive literature.
- Yes I'm interested, please send an evaluation system in the following format:
Single-user ___ Multi-user ___ 8" ___ 5 1/4 ___
DOS ___ MP/M ___ CP/M ___ Other _____

NAME _____

TITLE _____

COMPANY _____

ADDRESS _____

CITY _____

STATE _____

ZIP _____

PHONE _____

PHONE EXT _____

Tell us about yourself:

VAR ___ OEM ___ MIS ___ Dealer ___ Distributor ___ End-user ___

decimal arithmetic to find the sine of 1000. Then 2π is represented as 6.28319. The computer finds $1000/6.28319 = 159.154$, so $n = 159$. Hence $\text{mod}(1000, 2\pi) = 1000 - 159 * 6.28319 = 0.967611$. The correct answer is 0.973536; the answer produced by $\text{mod}()$ is in error by nearly 1 percent. This is far from six-decimal accuracy!

The problem with the modulo function is an example of "cancellation error," which is a loss of relative precision on subtracting two floating-point numbers that are nearly equal. This error can be extremely severe. As the two numbers approach each other and become exactly equal so far as the computer is concerned, all relative

precision in the arithmetic difference is completely lost.

To improve the situation we could use extended-precision arithmetic in the modulo function. This can sometimes be done without writing a whole new set of arithmetic routines. Illustrating again by a numerical example, let the number 2π (6.283185307179586...) be represented as the sum of three special numbers: $2\pi = p_1 + p_2 + p_3 = 6.28000E0 + 3.18000E-3 + 5.30718...E-6$. The first two of these numbers are exactly represented in the (decimal) computer. Instead of calculating $x-n * m$, the program $\text{mod}()$ will calculate $x-n * (p_1 + p_2 + p_3)$ working from left to right in the form $x-n * p_1 - n * p_2 - n * p_3$. In other words, the computer will find successively $1000 - 159 * 6.28E0 = 1.48$, then $1.48 - 159 * 3.18E-3 = 0.97438$, and finally $0.97438 - 159 * 5.30718E-6 = 0.973536$.

Because this is only an incomplete implementation of a higher-precision arithmetic, its range is limited. The computer can multiply p_1 by any integer up to $999,999/628 = 1592$ and the result will be exact. If x is greater than $1592 * 2\pi$ (this is entirely possible, since the numbers are floating point), then the trick won't work; we would have to split 2π into more parts, each having fewer significant figures.

ERROR AMPLIFICATION

In the example of range reduction for the exponential function, there might have been significant cancellation error except for the fact that we were lucky in choosing a modulus that preserves full accuracy. A closely related, though separate, accuracy problem called "error amplification" can be illustrated by doing the range reduction in a slightly different way.

Many commercial library routines for $\exp(x)$ actually compute equation 4. This method theoretically produces the same result. It converts the original argument x into an equivalent exponent of 2. The program then splits that exponent into an integer

(continued)

UNLOCK™ Removes Copy Protection

RUNS YOUR SOFTWARE ON ANY HARD DISK

Currently supports only programs listed below:

UNlock ALBUM "A"
\$49.95 Plus \$4 ship/handling

- LOTUS 1-2-3™ (1.A, 1.A', 2.0)
- dBASE III™ (1.0, 1.1 & 1.2)
- FRAMEWORK™ (1.0, 1.1, II)
- SYSTAT™ (1.3 & 2.0)
- SPOTLIGHT™ (1.0 & 1.1)
- GRAPHWRITER™ (4.3 & 4.31)
- REALIA COBOL™ (1.2, 2.0)

UNlock ALBUM "B"
\$49.95 Plus \$4 ship/handling

- SYMPHONY™ (1.0 & 1.1)
- CLIPPER™ (Winter 84, Summer 85)
- ELECTRIC DESK™ (1.04)
- DOUBLEDOS™
- MANAGING YOUR MONEY™ (1.5 & 1.51)
- smARTWORK™ (1.0 REV 8, REV 9)
- DATA BASE MANAGER II™ (2.0, 2.02)

UNlock ALBUM "C"
\$49.95 Plus \$4 ship/handling

- MICROSOFT WORD™ (1.5, 2.0, 2.01)
- MULTILINK ADVANCE™ (3.02)
- IBM WRITING ASSISTANT™ (1.01)
- LOTUS 1-2-3 REPORT WRITER™ (1.0)
- PARADOX™ (1.0)
- PFS ACCESS™ (1984 Edition)
- THINKTANK™ (2.0)

- Produce non-protected DOS copies from popular software programs.
- For IBM® PC, XT, AT, compatibles

TranSec UNlock is a unique software copying disk that removes copy protection, providing standard non-protected DOS copies. UNlock runs on IBM® PC, XT, AT, and compatibles with 256K or more, DOS 2.0 or higher.

BACKUP COPIES. UNlock safely and easily makes backup copies.

RUN ON HARD DISK. Programs load faster, use less disk space and work with any hard disk, including Bernoulli Boxes. No longer do you need the original in drive "A".

RUN ON RAM DISK. UNlock is the only software that can run copy protected software on a RAM disk or micro-floppy.

EASY TO USE. 1) Type UNlock. 2) Select program destination. 3) Insert program disk.

SAFE ORIGINAL. UNlock does not alter your original distribution disk. UNlock works by creating a copy of your distribution disk on a hard or floppy disk. It then removes copy protection from the copy!

Recommended by the editors of:

PERSONAL COMPUTING

"The Best Software Utilities For Under \$100"

ORDER TODAY BY TELEPHONE!
1-305-474-7548

TRANSEC™



TranSec Systems, Inc., 1802-200 North University Drive, Plantation, FL 33322
 Trademarks are the sole property of their respective owners. • UNlock is For Use Only to Improve the Useability of Legally Acquired and Operated Software.



PROGRAMMED FOR PROFIT.

NOW THE PANASONIC® SOFTWARE DEVELOPMENT TOOL MAKES IT EASY TO CREATE CUSTOM SOFTWARE—AND CUSTOMERS—FOR OUR NEW HAND-HELD COMPUTER.

Introducing the Panasonic Software Development Tool (SDT) for our new 16-bit hand-held computer, the Panasonic® Personal Partner™.

Designed to help you create new customers by providing them with custom software, the SDT provides you with a programming environment which allows you to design, develop and de-bug custom ROM-based software on the Panasonic® Exec. Partner™, Sr. Partner™ and other IBM-PC* compatible computers.

You'll be writing software for our one-of-a-kind Personal Partner. It's the two-pound computer with the power of a desk-top, an 8-line by 80-character display



and the option of expanding up to 128K memory. The Personal Partner even has an optional 1200/300 baud modem for mainframe communication (available 2nd half 1986).

The Personal Partner provides your clients with the on-site answers they need. And the optional 80-column battery-operated printer makes it possible for them to create professional, computerized presentations wherever they are.

When you develop software for the Personal Partner with the Panasonic SDT, you know you're programmed for profit.

Send for more information on the SDT, or call:

1(201)392-4645

Name _____

Company _____

Address _____

City _____ State _____ Zip _____

Panasonic Computer Products Division
333 Meadowlands Pkwy.
Secaucus, NJ 07094



*IBM is a registered trademark of International Business Machines, Inc.

and fractional part. The number 2 raised to an integer power is computed easily by integer arithmetic on the exponent; this is one reason for converting x to an exponent of 2.

The problem with this is that the conversion factor $\log_2 e$ is not exactly represented in the computer. Therefore the computed exponent of 2 will be in error by a small relative amount. Let's see what trouble this leads to by performing an "error propagation" analysis. Call the above error "epsilon" (ϵ). Instead of calculating $\exp(x)$, the routine is really calculating $\exp(x * (1 + \epsilon)) = \exp(x) * \exp(x * \epsilon) = \exp(x) * (1 + x * \epsilon + \dots)$. The last expression consists of the first two terms of the infinite series for $\exp(x)$ given earlier. The analysis shows that by the time the final result is computed, the error ϵ , which crept into the base-conversion step of the computation, will have been amplified by the factor x . In a typical computer where $\epsilon = 1.4E-17$ and where x can be as high as 88 before overflow sets in, this design tactic increases the relative error from a few parts in 10^{17} to more than one part in 10^{15} .

APPROXIMATION FUNCTIONS

We now have all the pieces for an exponential function program except a formula for $\exp(x)$ when x is between 0.0 and 1.0. To start with, let's examine the infinite-series expansion

shown in the introduction and attempt to use it directly for this purpose.

Series expansions are very important, even though they are used only occasionally in finished library routines. The basic method of expressing and evaluating transcendental functions is in terms of infinite series (sometimes involving sequential multiplications or divisions as well as summation). To find an approximate expression for computation, it is necessary to have some accurate values of the function in order to design and test the approximation. These accurate values are found by reverting to a series expansion computed in high-precision arithmetic.

Let's now write a program to sum the infinite series for $\exp(x)$. The particular series shown for the exponential function (known as a Taylor series) contains in its n th term the n th power of x in the numerator and the factorial of n in the denominator. Having arrived at a given term in the series, we will have already calculated both items in the previous term but with n reduced to $n-1$. The factorial is easily calculated by multiplying the factorial of $n-1$, found in the previous term, by n . Similarly, the n th power of x is just x times the $(n-1)$ th power of x , also found in the previous term. For $n = 0$ the factorial is 1. The 0th power of x is also 1. Hence the series

expansion can be evaluated by a simple loop (listing 4). The loop may certainly be terminated at the point where term is so small compared to sum that adding it in the computer will not change the value of sum. The error of the result will usually be larger than TINY, though, due to round-off error in accumulating the sum. In this example cancellation error is not dominant because all the terms are positive; there is no chance of subtracting two nearly equal numbers. Table 1 shows the value of n (i.e., the number of items added up) at termination and the relative error of the sum for several values of x . For comparison, the error of a library routine for $\exp(x)$ is also shown. In this experiment the arithmetic employed IBM/DEC-format numbers, which have a resolution of $1.38E-17$. All of the indicated errors are relative to the output of a high-precision "check routine" that in this experiment was accurate to about 43 decimal places. In the interval between 0 and 1, the maximum error of our program `formula()` appears to be about twice that of the library routine. In fact, the approximation used in the library routine requires only about half as many operations as `formula()`, so it has correspondingly less round-off error.

You must realize that table 1 shows only a very few samples of the error, and the result for some value of x not shown might have considerably higher error. A better experimental test would be to evaluate the error at a large number of pseudorandom arguments. This test was carried out at 1000 arguments for both approximations; the maximum error found between 0 and 1 for `formula()` was $9.6E-17$ and for the library routine, $4.0E-17$.

Table 1 illustrates several important and general points. First, the error of `formula()` increases as the range of arguments to be handled becomes large. Second, there is a point (0 in this case) where convergence is rapid; however, the amount of computation time increases as the argument

(continued)

Listing 4: A Taylor-series expansion for finding $\exp(x)$.

```
#define TINY 1.38E-17
double formula(x)
  double x;
  {
  double n, sum, term;
  n = 0.0;
  sum = 1.0;
  term = 1.0;
  do
    {
    n = n + 1.0;
    term = term * (x / n);
    sum = sum + term;
    }
  while( (term / sum) > TINY );
  return( sum );
}
```

CITIBANK DIRECT ACCESS INTRODUCES AN UPLIFTING NEW FEATURE: DOWNLOADING.

Citibank Direct AccessSM is the first personal computer banking service compatible with popular financial software like Lotus 1.2.3, Visicalc, Appleworks and Dollars and Sense. Direct Access saves you time by downloading your account information automatically without tedious data entry. So it's quick and easy to use the leading financial software to organize and manage your finances.

Direct Access—up-to-the-minute control over your finances.

With Citibank Direct Access you can pay bills to anyone on your personal computer with the touch of a button. And put the drudgery of check writing, envelope addressing and postage behind you. Direct Access gives you an on-line relationship with Citibank. So you have up-to-the-minute information on all your accounts. Direct Access also lets you transfer funds between accounts, open new accounts, open CD's and even access the resources of Dow Jones News/Retrieval.[®]

Direct Access—compatible with the most popular personal computers.

Direct Access works with more than forty personal computers, including IBM, Apple, Macintosh, Kaypro, Commodore and Atari.

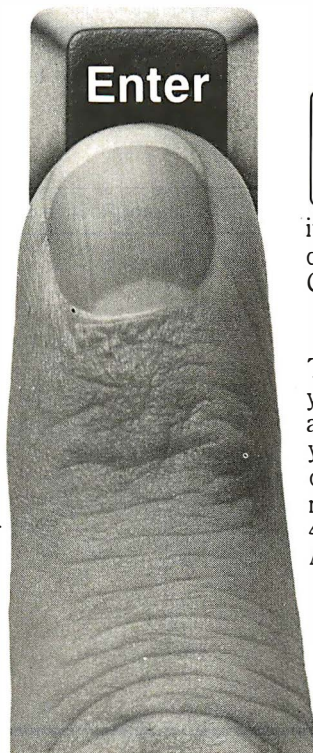

The Citibank Citicard and Direct Access—perfect partners for 24-hour banking.



Not even Citibank can accept deposits or send you cash through your computer. That's what the Citicard is for. You can use it to get cash or make deposits at any of hundreds of conveniently located 24-hour Citicard Banking Centers.

Get Direct Access free for two months—no risk, no obligation.

The best place to see a demonstration is on your own personal computer. If you decide after two months that Direct Access isn't for you, we won't charge you a cent. And if you don't have a Citibank checking account, we'll make opening one a snap. So call 1-800-248-4472, ext. 7003 today for more information. And start banking a whole new way.

IT'S YOUR CITISM
CITIBANK

A CITICORP COMPANY
© Citibank N.A. 1986 Member FDIC

Inquiry 56

Direct Access is a Service mark of Citicorp. Dow Jones News Retrieval is a registered Service mark of Dow Jones & Co., Inc.

moves away from that point. These are good reasons for performing range reduction on the argument.

Third, the errors are seemingly random and are within the bounds predicted by round-off analysis. Both programs have theoretical error: The series summation was truncated after a certain number of terms, and the algebraic polynomial formula used in the library routine has an error that can be computed analytically. In each case, the typical actual error is greater than the theoretical error, due to the effects of limited arithmetic precision.

In formula () we used an exact defining power series for the exponential function. The library routine employs an algebraic function that is only an approximation to the exact analytic function $\exp(x)$. Yet the library routine is both faster and more accurate than the series-summation method. This fact supplies the motivation for using and thinking about special approximating functions in numerical routines.

POLYNOMIAL APPROXIMATIONS

A basic function available for computer approximation is the polynomial of degree N (where N is the

highest power of the argument x in the polynomial). If the infinite series for $\exp(x)$ were stopped at, say, the term in x to the 19th power, the series would be just a polynomial of degree 19. However, this is not the best polynomial of degree 19 that we could use. Our objective will now be to adjust the $N+1$ coefficients of the polynomial so as to achieve the best fit to a given function. If "best" means that the worst-case deviation is made as small as possible, then the following conditions, discovered by Chebyshev, apply: For a general (continuous) function $f(x)$ in a given range of x , a particular polynomial of degree N can be found such that (1) the function and the polynomial agree exactly for at least $N+1$ values of x , (2) it can be arranged that the graph of the polynomial oscillates back and forth over the graph of the function, being first greater, then less, than the function (there will be at least $N+2$ values of x where the error, or deviation, is a local maximum), and (3) it can be arranged that all of the $N+2$ locally maximum deviations have exactly the same magnitude.

A polynomial having all three of these characteristics is a "least max-

imum" approximation to the function. The worst-case deviation will be as small as it can possibly be for a polynomial of that degree.

Such a polynomial can be found by an iterative procedure that eventually converges to the desired result. The procedure depends on our being able to set up and solve a set of equations that assume that the above three properties are true.

Equations 5.1 through 5.4 are the equations for a polynomial of degree 2 that is to approximate the function $f(x)$. The polynomial has three coefficients, denoted by a with a subscript ranging from 0 up to the degree 2 of the polynomial. If we evaluate the polynomial at some point x , then $f(x)$ equals the value of the polynomial plus or minus the deviation (labeled d in the equations). For a polynomial of degree 2, there are four ($N+2$) such values of x where the deviations are all equal, so we can set up four of these equations. In two cases the deviation is positive, while in the other two it is negative.

According to the third property stated above, the deviation at all four places should be a local maximum. The equations do not reflect this property, which is the reason for the technique being iterative.

Although we don't know where the extreme deviations will occur, we will put in four trial guesses for the four values of x . These should all be in the interval over which we want the approximation to be accurate. The unknowns in the equations are then the polynomial coefficients, labeled a , and the deviation d . The equations are linear, since only the first power of the unknowns occurs, and there are no cross terms. Therefore, we have a set of linear simultaneous equations in four unknowns to solve.

I have provided a program to solve systems of linear equations. [Editor's note: All programs discussed or listed in this article are available in C source code on disk in a variety of formats as explained on page 346. They are also obtainable by downloading from BYTEnet Listings at (617) 861-9764.] Limited space prevents a digression

(continued)

Table 1: Exponential-function approximation errors for listing 4 compared to a library routine's errors.

Exponential Function Approximations

x	n	Series Sum Error	Library Routine Error
0.0	1	0.0E-17	0.0E-17
0.1	11	2.9	2.9
0.2	12	0.6	1.6
0.3	14	3.6	1.5
0.4	15	3.7	1.9
0.5	16	0.5	1.2
0.6	16	0.7	2.2
0.7	17	5.2	2.8
0.8	18	0.7	1.8
0.9	18	0.9	1.4
1.0	19	4.9	2.9
2.0	24	2.4	2.4
4.0	31	4.5	2.9
8.0	43	4.7	0.9
16.0	61	4.5	1.9
32.0	91	7.6	2.7
64.0	143	15.4	2.2

TAS™

the "Hard-nosed" Relational Database

\$199.

the Database + Integrated Accounting

\$349.

If You Liked DBase III, You'll Flip Over TAS™

Hard-nosed business owners have been asking for the power of DBase III™ and RBase 5000™ but without the high price. That's why Business Tools, Inc. created TAS™

Compare TAS with DBase III and RBase 5000. You'll see why we think TAS is the best "Hard-nosed" value around. TAS includes a data dictionary. TAS includes a true procedural language. TAS includes a run-time compiler. Plus TAS can be upgraded to multi-user for \$100.

TAS lets you develop your own professional menu-driven business applications. And not just simple ones either. TAS applications can hold up to 17 million records. And because TAS compiles them, they run fast.

Get TAS Accounting Software for \$349

But why stop with just a database? For just \$349, you get TAS Relational Database/Language plus General Ledger, Accounts Receivable and Accounts Payable. And for \$499 you get all the above plus Inventory, Sales Order Entry, Purchase Order Entry, and Payroll.

Source code is included FREE! So you can even modify the accounting to fit your business.

	TAS™	DBASE III	RBASE 5000
Multi-User	\$100	No	\$1400
Data Dictionary	Yes	No	Yes
Procedural Language	Yes	Yes	Yes
Compiler	Yes	No	Yes
Records Per File	Unlimited	Unlimited	Unlimited
Files Open	16	10	40
Fields Per File	Unlimited	128	400
File Size	Unlimited	Unlimited	Unlimited
Record Size	10,254	4,000	1,530
Field Size	254	254	1,530
Prices	\$199	\$696	\$700

And TAS is no new comer. TAS was written by Phil Mickelson, the same "Hard-nosed" business person who created The Sensible Solution™ (relational database) in 1982.

TAS comes with a 30 day money back guarantee (less handling fee of \$15 Level 1, \$30 Level 2, \$45 Level 3 and \$10 Multi-User). TAS is available for the IBM PC/XT/AT™, Compaq™, AT&T 6300™, Tandy 1000, 1200, 2000™ and most MS-DOS™, CP/M™ and MP/M™ systems. Multi-user and LAN versions also available.

Call Today 1-800-648-6258
Ask for operator 11

Call our Toll-Free Hotline. Use your VISA or MasterCard to order today. Outside Washington call 1-800-648-6258. Washington residents call 1-206-644-2015.

Dealer Inquiries Welcome.

BUSINESS TOOLS INC.



4038-B 128th Ave. SE
Suite 266
Bellevue, WA 98006

Inquiry 43

In West Germany contact:
IC: Intacom GmbH
Friedrich List Straße 32
7022 L. Echterdingen 2
Tel: 0711/797043
Telex: 7255746(VSC D)

In United Kingdom contact:
Newtons Laboratories
111-113 Wandsworth High St.
London SW184JB
Tel: 01-8746511
Telex: 21768 (NewtonG)

The following are registered trademarks of these companies: TAS, Accounting Solution, Business Tools Inc, RBase 5000, Microim Inc, DBase III, Ashton-Tate Inc, CP/M and MP/M, Digital Research Inc, IBM PC/XT/AT, International Business Machines Corp, Compaq, Compaq Computer Corp, AT&T 6300, AT&T Information Systems Inc, Tandy 1000, 1200, 2000, Tandy Corp, MS-DOS, Microsoft Corp. The Sensible Solution trademark rights are claimed by O'Hanlon Computer Systems Inc.

©Copyright 1985 Business Tools Inc.

TAS™

"Affordable Software For Your Business Needs"

NOT COPY-PROTECTED

Describe your computer system:

8 bit 16 bit
MS-DOS
PC-DOS

CP/M, MP/M
TurboDOS

Disk size is:

5 1/4" 8"

Computer name/model is: _____

Name: _____

Street: _____

City: _____

State: _____

Zip: _____

Phone: _____

4038-B 128th Ave. SE
Suite 266
Bellevue, WA 98006

Quantity:

___ TAS Database/Language-\$199
___ Level 2 Accounting (TAS, GL, AR, AP)-\$349
___ Level 3 Accounting (Level 2, SO, PO, INV, PAY)-\$499
___ Multi-user upgrade-\$100
Subtotal (WA add 7.8% tax) _____
Shipping (USA-\$5.00 ea.) _____
(Foreign-\$20.00 ea.) _____

Total Enclosed: _____

Payment: VISA MC Cashier's Check
(All amounts are payable in U.S. funds only.)

Credit Card Expiration Date: _____

Card Number: _____

Name on card: _____

Signature: _____



into this interesting topic, so let's just use the program and not worry about how it works.

Having solved the equations, we can evaluate the polynomial, using the coefficients found by the equation solver, at various values of x in the range over which we want the approximation to be optimum. We should find that the deviation at the four trial values of x is equal to d , as returned by the equation solver.

However, we will find that there are places where the deviation is greater than d . This can happen because there is nothing in the equations to say that d is the maximum of anything. Looking at a chart of the deviation, we find the values of x at which the deviation actually is locally maximum. These values are used as the next trial guesses for insertion into the set of equations.

If the initial guesses are sufficiently close, the procedure will converge in a very few iterations to a condition in which the extreme deviations actually do occur at the values of x that we have guessed, and there are no deviations greater than d . The resulting coefficients a are those of the least maximum polynomial approximation to $f(x)$, for a polynomial of the given degree N . This overall procedure is known as the second algorithm of Remes.

There is a way of making initial guesses that are often extremely

close to the optimum trial values of x . If the start of the approximation interval is at $x = s$ and the width of the approximation interval is w , then the magic values are $x_i = s + 0.5w (1 - \cos(i\pi / N + 1))$ where i takes on the $N + 2$ values $0, 1, \dots, N + 1$. These guesses are frequently so good that "for engineering purposes," as the saying goes, there is little need to continue with another iteration. The indicated values of x are the points at which the Chebyshev polynomial (see the text box entitled "Chebyshev Approximations" on page 174) of degree $N + 1$ takes on its extreme values. The error curve for a best-fitting polynomial of degree N frequently looks like the Chebyshev polynomial of degree $N + 1$, which is why these are good values to try.

An interactive program to implement the Remes algorithm is available as specified above. Using it to approximate the exponential function with a polynomial of degree 2, we get the results shown in the figures. Figure 2 shows $\exp(x)$ for x ranging from 0 to 1. Also shown in the same figure is the best-fitting polynomial of degree 2. The error is less than 0.01, so the drawing shows at best a slight thickening of the line in several places.

Figure 3 illustrates the approximation error, greatly magnified for visibility. For comparison, figure 4 shows the Chebyshev polynomial of degree 3. You can see that the curves

are very similar in shape, except for the sign reversal.

RATIONAL APPROXIMATIONS

We are now in a position to design the most commonly used computer approximations, called "rational functions." A rational function is the ratio of two polynomials. For a given amount of calculation, rational functions tend to produce closer theoretical approximations than polynomials. (Sometimes the theoretical advantage is lost due to numerical instability.)

If $P(x)$ and $Q(x)$ are two polynomials, the equation for approximating $f(x)$ by their ratio is $P(x)/Q(x) = f(x) + d$, or $P(x) - (f(x) + d)Q(x) = 0$. Again, d is the deviation between $f(x)$ and the approximation $P(x)/Q(x)$. Reasoning as before, we can form a set of simultaneous equations to be solved for the coefficients of the two polynomials.

The equations when both $P(x)$ and $Q(x)$ are first-degree polynomials are shown in equations 6.1 to 6.3. The coefficients of the numerator polynomial $P(x)$ are labeled a with a subscript. The coefficients of the denominator polynomial $Q(x)$ are labeled b with a subscript. Since we can multiply both sides of the equation by a constant without affecting the equality, the leading coefficient of $Q(x)$ (i.e., its coefficient of x to the highest power) may be set equal to 1 without affecting either d or $f(x)$. This

(continued)

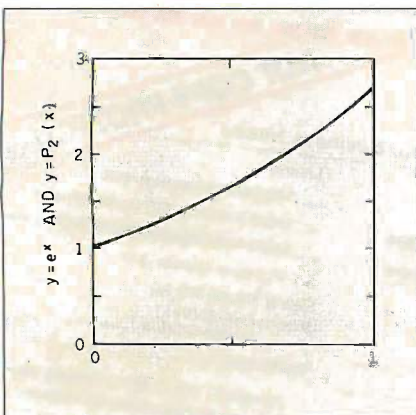

Figure 2: A graph of $\exp(x)$ for $x=0$ to 1. Included is the best-fitting polynomial of degree 2.

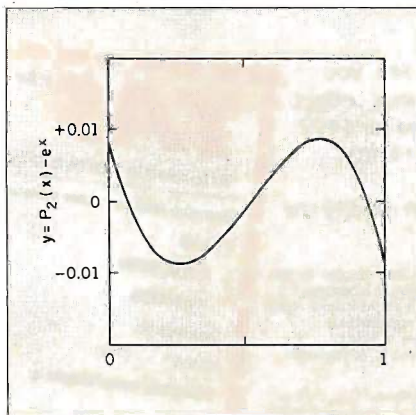

Figure 3: The approximation error in figure 2, magnified greatly for visibility.

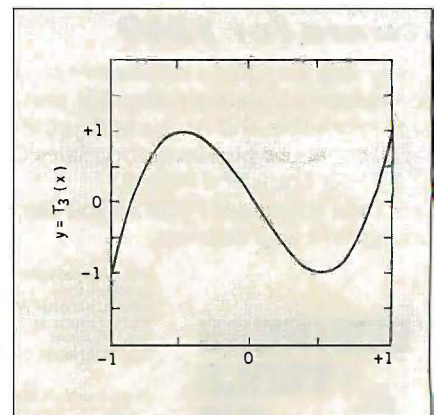

Figure 4: A graph of the Chebyshev polynomial of degree 3.



IBM COMPATIBILITY

... at a not so IBM price

TECH TURBO PC/AT \$2299

PRICE INCLUDES:

- 6 TO 8 MHZ 80286 CPU
- 512K
- ONE, 1.2 MB FLOPPY DRIVE
- 8 EXPANSION SLOTS
- 195 WATT POWER SUPPLY
- COMPLETE MS DOS, PC DOS, XENIX COMPATIBILITY
- RUNS LOTUS 123, DBASE III FRAMEWORK AND ALL OTHER POPULAR AT SOFTWARE
- ONE YEAR WARRANTY!!

OPTIONS:

TECH TURBO PC/AT WITH 20MB HARD DISK **\$2699**

TECH TURBO PC/AT WITH 20MB HARD DISK, MONOCHROME MONITOR, HERCULES® COMPATIBLE MONO/GRAPHICS CARD **\$2899**

ALSO AVAILABLE WITH TAPE BACKUPS, MODEMS, LARGER HARD DISKS, AND NETWORKING SYSTEMS.

TECH PC/AT \$1999

PRICE INCLUDES:

- 6MHZ 80286 CPU
- 512K
- ONE, 1.2 MB FLOPPY DRIVE
- 8 EXPANSION SLOTS
- 195 WATT POWER SUPPLY
- COMPLETE MS DOS, PC DOS, XENIX COMPATIBILITY
- RUNS LOTUS 123, DBASE III FRAMEWORK AND ALL OTHER POPULAR AT SOFTWARE.
- ONE YEAR WARRANTY!!

OPTIONS:

TECH PC/AT WITH 20 MB HARD DISK **\$2399**

TECH PC/AT WITH 20MB HARD DISK, MONOCHROME MONITOR, HERCULES® COMPATIBLE MONO/GRAPHICS CARD **\$2599**

ALSO AVAILABLE WITH TAPE BACKUPS, MODEMS, LARGER HARD DISKS, AND NETWORKING SYSTEMS.

TECH TURBO PC/XT \$1099

PRICE INCLUDES:

- 4 TO 7 MHZ SOFTWARE SWITCHABLE CPU
- 640K
- TWO 360K DS/DD FLOPPY DISK DRIVES
- 8 EXPANSION SLOTS
- 135 WATT POWER SUPPLY
- ONE YEAR WARRANTY!!

OPTIONS:

TECH TURBO PC/XT WITH 20MB HARD DISK **\$1599**

TECH TURBO PC/XT WITH 20MB HARD DISK, MONOCHROME MONITOR AND HERCULES COMPATIBLE MONO/GRAPHICS CARD **\$1799**

ALSO AVAILABLE WITH TAPE BACKUPS, MODEMS, LARGER HARD DISKS, AND NETWORKING SYSTEMS.

TECH PC/XT \$799

PRICE INCLUDES:

- 4.77 MHZ CPU
- 256K
- TWO, 360K DS/DD FLOPPY DRIVES
- 8 EXPANSION SLOTS
- 135 WATT POWER SUPPLY
- ONE YEAR WARRANTY!!

OPTIONS:

TECH PC/XT WITH 20MB HARD DISK **\$1299**

TECH PC/XT WITH 20MB HARD DISK, MONOCHROME MONITOR, HERCULES COMPATIBLE MONO/GRAPHICS CARD **\$1499**

ALSO AVAILABLE WITH TAPE BACKUPS, MODEMS, LARGER HARD DISKS, AND NETWORKING SYSTEMS.

HI-TEK PGS AVT TAXAN IBM AMDEK HERCULES GENOA PARADISE TEAC TOSHIBA HARDWARE/SOFTWARE NETWORKING HAYS AST JRAM HI-TEK PGS AVT TAXAN AMDEK HERCULES GENOA PARADISE TEAC TOSHIBA
PLEASE ALLOW ONE WEEK FOR SHIPPING **VISA, MASTERCHARGE** **TELEX: 272006 Answer Back-TECH FAX: 714/556-8325**

TECH PC

TECH PERSONAL COMPUTERS
2131 South Hathaway, Santa Ana, California 92705

714/754-1170

©1985 TECH PC *IBM, IBM PC, XT, and AT are registered trademarks of International Business Machines Corp *Hercules is a registered trademark of Hercules Computer Technology

Inquiry 338 for End-Users. Inquiry 339 for DEALERS ONLY.

CHEBYSHEV APPROXIMATIONS

Three conditions satisfied by a least maximum polynomial approximation were stated in the main text on page 170. If a polynomial satisfies all but the third condition, it is called a "nearly least maximum" approximation. Typically, error leveling carried out on such a polynomial accomplishes only a slight improvement in accuracy. Chebyshev polynomials yield a nearly least maximum approximation under most circumstances. Thus they are useful in such optimization situations as the design of digital and analog filters. Chebyshev expansions also tend to be numerically stable, in the sense that they do not suffer from cancellation-error problems. For this reason they may be found in actual library routines in cases where other forms of

approximation are less stable.

Chebyshev expansions bear a somewhat magical relation to Fourier-series expansions. In fact, to compute the coefficients of the Chebyshev expansion, we will evaluate the Fourier series of the function $f(x)$ using values of x that are not evenly spaced.

The family of Chebyshev polynomials is defined by equations a, b, and c (all equations designated by letters appear in figure A) and the general term can be found by the recurrence in equation d. Figures 4 and 7 in the main text show two of these polynomials. The argument x is considered to range between -1 and $+1$. Other desired intervals can be mapped into this range by a linear transformation of the input argument x .

Each of these polynomials crosses the x axis n times and has $n+1$ local extrema, all of which occur at the same value of deviation from the x axis. These are just the conditions for the error curve of a best approximation of degree $n-1$.

Suppose the coefficients of a Chebyshev polynomial expansion decrease fairly rapidly with n , so that the error after $n-1$ terms can be approximated by the n th term (i.e., ignoring the contribution of later terms). Then, the error has close to the least maximum properties, and the approximation to $n-1$ terms is close to a least maximum approximation.

To expand a function $f(x)$ in terms of Chebyshev polynomials, we want to find the coefficients in the formula given in equation e. By a shorthand convention, the prime ($'$) over the summation sign indicates that the first term is to be divided by 2 (this is done to make the formulas a little more compact). If we stop the summation at $k=n$, the result is a polynomial of degree n .

The Chebyshev coefficients of the function $f(x)$ may be found from the formula in equation f. The double prime ($''$) over the summation sign indicates that the first and last terms are to be divided by 2. This formula is the same as the Fourier cosine transform of the function $f(x)$, except that $f(x)$ is evaluated at the points $\cos(j\pi/N)$, which are not evenly spaced.

The "real" Chebyshev coefficients are obtained by letting N increase to infinity in equation f, so that the sum becomes an integral. This is analogous to the relation between the discrete and continuous Fourier transforms. In our situation, we cannot say that $f(x)$ is a spectrally band-limited function, so the behavior of the function between the sampled values of x cannot be disregarded so readily. For the error to be negligibly small, N should be considerably larger than the desired degree n of the approximation polynomial.

Since $f(\cos(j\pi/N))$ and the Chebyshev coefficients are a Fourier transform pair, the expression of $f(x)$ in terms of Chebyshev polynomials must be the in-

(a)	$T_0(x) = 1$
(b)	$T_1(x) = x$
(c)	$T_2(x) = 2x^2 - 1$
(d)	$T_{n+1}(x) = 2 * T_n(x) - T_{n-1}(x)$
(e)	$f(x) = \sum_{k=0}^{\infty} ' a_k T_k(x)$
(f)	$a_k = \frac{2}{\pi} \sum_{j=0}^N '' f(\cos(j\pi/N)) \cos(jk\pi/N)$
(g)	$T_k(x) = \cos(kj\pi/N)$
(h)	$T_n(x) = \cos(n \arccos(x))$
(i)	$T_n(x) = \cos(nz)$
(j)	$\cos((n+1)z) = 2 \cos(z) \cos(nz) - \cos((n-1)z)$
(k)	$\cos(A+B) = \cos A \cos B - \sin A \sin B$
(l)	$f(x) = \sum_{k=0}^M ' a_k T_k(x)$

Figure A: The equations used in the text box.

verse of this Fourier transform. Therefore, it must be true that when $x = \cos(j\pi/N)$, then equation g. We could then be tempted to substitute $j\pi/N = \arccos(x)$. As N increases to infinity, the equation would indeed be valid for any x . In fact, an alternate definition of the n th Chebyshev polynomial is equation h. It is not obvious that this expression is even a polynomial! However, putting $n=0$ yields $\cos(0)=1$, and $n=1$ yields $\cos(\arccos(x)) = x$. To see that this definition is equivalent to the original one, substitute $z = \arccos(x)$. Then we have equation i, and for the recurrence formula for the polynomials to be true, we want equation j to be a trigonometric identity. Using the identity equation k, you can show that this is correct. Thus the Fourier series for the

Chebyshev coefficients leads to the expression for $f(x)$ in terms of Chebyshev polynomials, with the proviso that N be sufficiently large.

I have provided a C program, as explained in the main text, that will evaluate the Chebyshev polynomial expansion coefficients for a given function $f(x)$. Once the coefficients have been found, they may be substituted into equation l to obtain an approximation for $f(x)$. Summation of the series stops at the M th term, where M is whatever we choose. If all the terms were rearranged and collected by powers of x , the result would be a straightforward polynomial of degree M . The summation can also be carried out directly from the expansion coefficients by using the listing A program.

Listing A: A subroutine to evaluate a Chebyshev polynomial expansion up to the M th-order term.

```

/*
This subroutine evaluates a Chebyshev polynomial
expansion up to the Mth-order term, given the
argument "x" and an array "array[M+1]"
containing the Chebyshev expansion coefficients.
To achieve maximum execution speed, the routine
is designed so the coefficients must be stored
in reverse order, with the Mth order coming
first and the 0th order last.
*/

double chbev1( x, array, M )
double x;
double array[];
int M;
{
double b0, b1, b2, *p;
int i;
p = array;
b0 = *p++;
b1 = 0.0;
x *= 2.0;
i = M - 1;
do
{
b2 = b1;
b1 = b0;
b0 = x * b1 - b2 + *p++;
}
while( --i );
return( 0.5*(b0-b2) );
}

```

The number of equations to be solved is equal to $N+D+1$.

term, multiplied by $f(x) + d$, has been moved over to the right side of the equations since it will be treated as constant.

Although there are four unknowns (two a 's, one b , and the deviation d), only three equations are shown. The reason is that all of the b 's are multiplied by a factor that includes d ; the product of b times d is a nonlinear term. Therefore the equations would not be linear if we considered d to be an unknown. So, to make the equations easy to solve, we are going to have to guess not only the three values of x , but also a value for d .

Suppose $P(x)$ is a polynomial of degree N (for "numerator"), and $Q(x)$ is a polynomial of degree D (for "denominator"). The number of equations to be solved is equal to $N+D+1$.

In the previous section it was noted that the error curve for approximation by a polynomial of degree N is often similar in appearance to the Chebyshev polynomial of degree $N+1$. In the present situation we can again make the job of guessing trial values easier, this time by making use of the Chebyshev polynomial of degree $N+D+1$.

While the Chebyshev polynomial may have the right shape, its extreme values are just $+1$ or -1 . This gives us no help in guessing the extreme values of d for our particular deviation function. However, there is a way out. We could just as well set $d = 0$ in the equations and use for x the points at which the Chebyshev polynomial is equal to 0! This will leave the actual extreme deviation somewhat uncontrolled, but we will at least have a starting point for the iterative procedure.

For this situation the magic values

(continued)

of x , the "zeros" of the Chebyshev polynomial of degree $N+D+1$, are at $x_i = s + 0.5w (1 - \cos(2(i-1) \pi / 2(N+D+1)))$, where i takes on the values $1, 2, \dots, N+D+1$. The iterative procedure begins by substituting these values of x , along with the value $d=0$, and solving the set of linear equations. This gives us the coefficients (the a 's and b 's) of the numerator and denominator polynomials of the rational approxima-

tion. As in the previous situation, the result is frequently so close to the final optimum that there is little point in going on with a second iteration.

If we do decide to continue, there are two basic strategies for leveling the error extrema: (1) adjust the points at which the error is 0 and continue to set $d=0$, and (2) use $N+D+1$ of the $N+D+2$ points where the error is locally maximum and, by looking at the error data, guess a value for the

You can sometimes

subtract away

a function's difficult

behavior around

critical values.

maximum error d . Each of these strategies has its adherents.

TAKING ADVANTAGE OF ANALYTICAL BEHAVIOR

Sometimes it is possible to find a trick that will reduce the degrees N and D of the rational approximation that satisfies a given error condition. The trick may be in the behavior of the function or in the rational approximation itself.

Many functions are very unpolynomial-like near critical values of the argument such as 0 or infinity. This may make it difficult to achieve a good rational approximation. In such cases it is wise to try factoring out or subtracting away the difficult behavior by searching for a simple expression that represents the function's limiting or asymptotic behavior. For example, a function $f(x)$ that behaves like a square root near $x=0$ might be approximated as $\sqrt{x} * P(x)$. In that case, the function that the polynomial $P(x)$ would be asked to approximate is $f(x)/\sqrt{x}$.

The exponential function has the interesting property that $\exp(-x) = 1/\exp(x)$. This suggests that some kind of antisymmetry might appear if we were to take the interval of approximation to be symmetrical around $x=0$. Figure 5 shows in detail what happens when we make the interval go from -0.5 to $+0.5$ and solve for a rational approximation with $N = D = 4$. The coefficients of the numerator and denominator polynomials become the same, except for a difference in the signs! A few moments' study of this situation will show that

(continued)

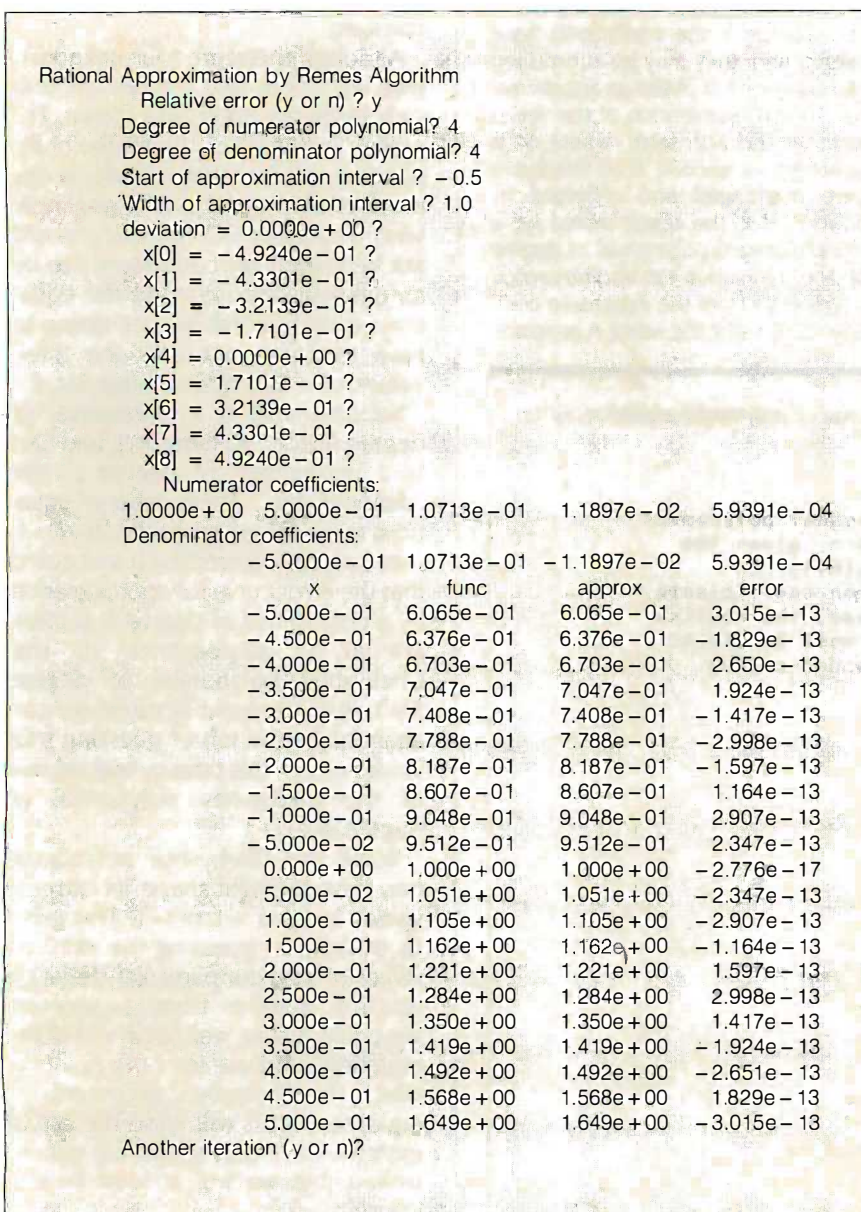

Figure 5: An interactive session with the author's Remes program. The approximation is for the exponential function.

PERFORMANCE

In a multi-user system, performance is the most important ingredient.

That's why we build performance into every aspect of our multi-user systems.

The **CompuPro 286/40™** offers more performance for the money than any competing system; a powerful 8 MHz 80286 processor, 768K of memory, 40 megabyte hard disk, 9 serial ports, floppy and tape backup drives, Concurrent DOS 816™ multi-user, multi-tasking operating system and applications including NewWord™ and SuperCalc 2™.

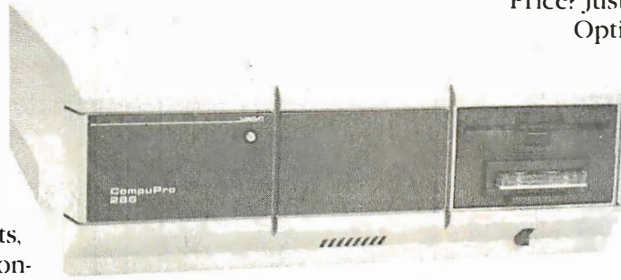

Price? Just \$9995. Now that's performance!

Options? How about memory expansion to a megabyte, 80 megabyte hard disks, slave processors, networking, graphics and more.

To find out how the **CompuPro 286/40** (or any of our other multi-user systems) can give your business the performance it needs, contact a distributor listed below for the name of your local CompuPro dealer.

PERFORMANCE ACCELERATORS

CompuPro's high performance S-100/IEEE 696 board products are the heart of our high performance systems. If you're looking to boost your system's performance or you're choosing boards to build new systems, you can't buy better boards than ours. Here are some of the highlights:

CPU 286™: 8 MHz, no wait state 80286 processor will really boost your system's performance. **\$895.**

SPUZ™: 8 MHz Z80H slave processor for concurrent 8-bit task processing reduces workload of host processor. 64K (one task) version: **\$295.** 256K (four task) version: **\$395.**

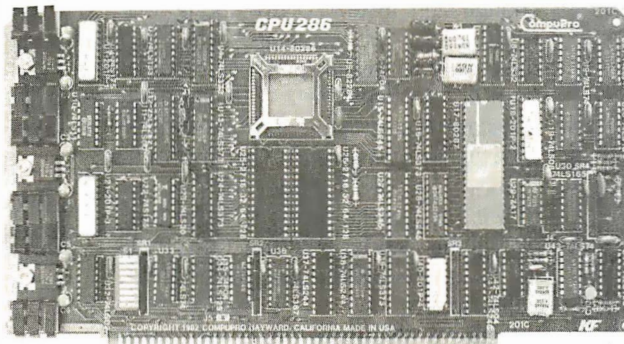

now be used as a hard disk cache under Concurrent DOS 816 version 4.1. 512K version: **\$495.** 2 Megabyte version: **\$1095.**

Fast Static RAM: Low power, high speed static RAM eliminates the wait states needed with dynamic RAMs. **RAM 22™** (256K): **\$595.** **RAM 24™** (1 Mbyte on a single card): **\$2995.**

NET 100™: Local Area Network board features high speed (2.5 MBPS) transfers using standard coax cable. Network multiple systems (even PCs) together for resource sharing and to increase performance in larger installations. **\$395.**

M-Drive/H™: RAM disk can increase system throughput by as much as 3500% and can

AT COMPUPRO, PERFORMANCE IS NOT JUST ANOTHER BUZZWORD.

Call the Distributor Near You For The Name Of Your Local Dealer:

Canada—Tri-M Systems (604) 438-0028

Hawaii—Viaduct (808) 242-9113

Illinois—Tek-Aids Industries Inc. (312) 870-7400

North Carolina—General Semantics (919) 378-1500

Ohio—QDP Computer Systems Inc. (216) 526-0838

Pennsylvania—Tek-Aids Industries Inc. (215) 337-3220

Texas—Business Systems (214) 785-0041

West of the Rockies (except Hawaii)

Call CompuPro direct for the name of your local dealer.

CompuPro™

Viasyn Corporation 26538 Danti Court, Hayward, CA 94545-3999 (415) 786-0909

CompuPro, CompuPro 286/40, CPU 286, SPUZ, Net 100, M-Drive/H, RAM 22 and RAM 24 are trademarks of Viasyn Corporation. Concurrent DOS 816 is a compound trademark of Digital Research Inc. and Viasyn Corporation. NewWord is a trademark of NewStar Software, Inc. SuperCalc 2 is a trademark of Computer Associates International Inc.

CopyWrite

BACKS UP IBM PC SOFTWARE

Hundreds of the most popular copy-protected programs are copied readily. CopyWrite needs no complicated parameters. It needs an IBM Personal Computer, or an XT or an AT, 128k bytes of memory, and one diskette drive. CopyWrite will run faster with more memory or another drive.

CopyWrite is revised monthly to keep up with the latest in copy-protection. You may get a new edition at any time for a \$15 trade in fee.

CopyWrite makes back up copies to protect you against accidental loss of your software. It is not for producing copies for sale or trade, or for any other use that deprives the author of payment for his work.

To order CopyWrite, send a check for \$50 U.S., or call us with your credit card. We will ship the software within a day.



Quaid Software Limited

45 Charles Street East
Third Floor
Toronto, Ontario M4Y 1S2
(416) 961-8243

Ask about ZeroDisk to run copy-protected software from a hard disk without floppies.

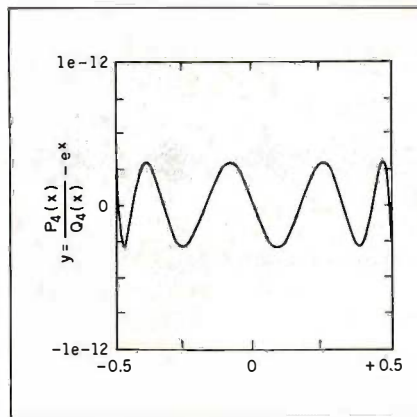

Figure 6: The error curve for the approximation solved in figure 4.

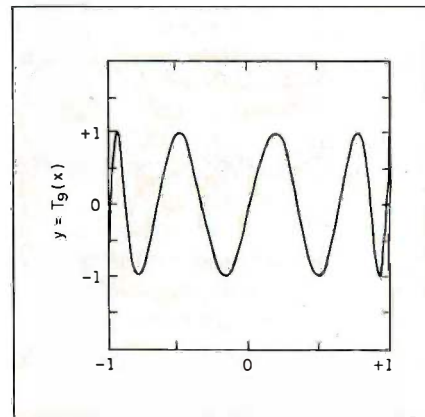

Figure 7: The Chebyshev polynomial of degree 9.

this approximation can be rearranged to have the form shown in equation 7, where $P(x)$ consists of the terms originally having minus signs in the denominator polynomial, and $Q(x)$ comprises the terms that did not change sign. Instead of evaluating two fourth-order polynomials, we now have only to evaluate $P(x)$ of degree 1 and $Q(x)$ of degree 2. This yields a substantial saving in computation for exactly the same result. This approximation is called a Pade form. Note that it has just the property we noted about the exponential function, that its value at $-x$ is the reciprocal of its value at $+x$.

Figure 6 illustrates the error curve for the approximation solved in figure 4. Again for comparison, Figure 7 shows the Chebyshev polynomial of degree 9.

IMPLEMENTATION ISSUES

We have now touched on all the theoretical design problems of computer approximation. Some additional problems arise in the environment of practical application. These are important to a programmer who is trying to get the function routines to work. However, since each machine and each compiler has its own peculiarities, there is little advice that can be offered in the abstract.

Good workmanship demands that any numerical routine be carefully tested and checked for possible arithmetic overflow and underflow condi-

tions that might render the answer meaningless. Alarm exits for these conditions must be programmed for the particular system in use.

A final note of warning: To achieve maximum accuracy, both the expansion coefficients and the test values of a function should be calculated using arithmetic having greater precision than the arithmetic of the intended routine. ■

BIBLIOGRAPHY

- Abramowitz, Milton, and Irene A. Stegun, eds. *Handbook of Mathematical Functions*. National Bureau of Standards Applied Mathematics Series #55; U.S. Government Printing Office, 1968. A large compendium of formulas and tables for functions ranging from elementary to very advanced.
- Clenshaw, C. W. "Chebyshev Series for Mathematical Functions." In *Mathematical Tables*, volume 5, The British National Physical Laboratory; British Stationery Office, 1962. Exposition of Chebyshev polynomials, with tables of coefficients.
- Forsythe, George E., and Cleve B. Moler. *Computer Solution of Linear Algebraic Systems*. Englewood Cliffs, NJ: Prentice-Hall, 1967. Contains a detailed exposition of the algorithm used in the simultaneous equation solver `simq()`.
- Hart, John F., et al. *Computer Approximations*. New York: John Wiley & Sons, 1968. Presents theory and technique, with extensive tables of coefficients for commonly used math functions.
- Hastings, Cecil, Jr. *Approximations for Digital Computers*. Princeton, NJ: Princeton University Press, 1955. A classic exposition with lots of pictures.

5 MEGA-BYTES
of software
FREE

PC HARD DISK KITS
10 MEGABYTES \$475
20 MEGABYTES \$545
30 MEGABYTES \$675
5 MEGABYTES OF FREE SOFTWARE



AT HARD DISK KITS
20 MEGABYTES \$545
33 MEGABYTES \$750



HIGH CAPACITY AT & XT HARD DISK KITS
70 MEGABYTES \$2695
120 MEGABYTES \$4995



TAPE BACKUP
10 MEG PORTABLE MT10P \$525
10 MEG INTERNAL MT10 \$385



TAPEBACKUP
40 MEG INTERNAL MT40 \$595
40 MEG PORTABLE MT40P \$695



TAPE BACKUP
60 MEG INTERNAL MT60 \$795
60 MEG EXTERNAL MT60E \$895



TANDY 1000 MULTI-FUNCTION CARD
SERIAL PORT / DMA CONTR / UPTO 512K RAM
TMF-1 \$255



PC/AT OR TANDY 1000 HARD DISK CARD
21 MEG HARD DISK
FREE SCSI PORT
THC-21 \$995
PCHC-21 \$995



MASTER MEMORY SYSTEM
HARD DISKS:
30 MEG FIXED
15 MEG REMOVABLE
POWER DISTRIBUTION
"THE LOW LINE"
\$2295



SCSI HOST ADAPTER CARD
CONNECTS YOUR PC TO 7 OTHER DEVICES
SCSI-1 \$190

NEW!!!

IN THE
WORLD OF PC UPGRADES

THE 21 MEGABYTE HARD DISK CARD

for your
PC, AT or TANDY 1000



only \$995

IMAGINE!!! MDI'S 21 MEGABYTE HARD DISK CARD simply plugs into your system and is ready to run!!!

The hard disk card also contains the **"PORT TO THE FUTURE":**

A **SCSI** port which allows you to tie (daisy chain) up to seven external (peripheral) devices to your computer.



TANDY 1000
HARD DISK CARD
21 MEG HARD DISK
FREE SCSI PORT

**NOW IN
OUR
8TH YEAR**

ORDER LINE **800-228-0891**
305-677-8333



1 YEAR WARRANTY, 30 DAY MONEY BACK GUARANTEE

Micro Design International, Inc.



6566 University Boulevard, Winter Park, Florida 32792

305-677-8333 telex 332559 MDII ORL UD

15,000 SAVED FROM CRASH.

No hysteria. No panic. No reports of data loss. No wonder more than 15,000 Alpha Micro users have chosen our Videotrax™ backup technology over streamer tape or floppies.

The best news is it's now available for the IBM® PC-AT, XT and true compatibles.

BETTER TO BE FAIL-SAFE THAN SORRY.

Exhaustive testing and long term use of Videotrax technology prove it more reliable than any other backup



High-tech. Open your PC and slide the controller board into any expansion slot. Low tech. Hook up VCR to computer with standard connector cables.

option available. Even more reliable than the hard disk you're backing up.

At the heart of the system is a patented video tape controller board that employs a standard video cassette recorder for copying data. Which means Videotrax offers the sophisticated technology of today's VCRs. And the depend-

ability of a durable consumer good.

EASY DOES IT.

If you own a VCR, you already own half the system. And you already know how to use it. Or you might opt for the complete subsystem (controller board plus enhanced VCR) and experience the

Your basic video cassettes. Reliable, cheap, easy to find



joy of its automatic, unattended backup capabilities.

Either way, our menu driven software, clear documentation and wide range of backup modes keep it simple: Insert a blank video cassette tape and follow the directions that appear on your screen.

You can copy or restore your entire hard disk, specific files, or only files modified since the last backup, while the system busily self-monitors for proper functioning.

And for the price of taping your favorite TV shows, you can record your most valued computer data. Up to 80MB can be stored on a single cas-

sette at less than a third of the cost of streamer tape.

Of course, if you ever require service, your authorized Alpha Micro dealer and our world-wide network of factory service centers will provide all the support you need.

For more information on how Videotrax can keep you off the crash course, call your local dealer or Alpha Micro at 1-800-992-9779 (in California call 1-800-821-0612).

VIDEOTRAX™
DATA BACKUP FROM
ALPHA MICRO.



THE INVERSION OF LARGE MATRICES

BY THOMAS E. PHIPPS JR.

The Pan and Reif algorithm provides a solution

A NEW METHOD for inverting matrices was recently discovered by Victor Pan of the Computer Science Department of the State University of New York at Albany and John Reif of the Aiken Computation Laboratory at Harvard (see references 1 and 2). Their main concern was with parallel processing, but the mathematical algorithms they propose work perfectly well with serial processing; all you need is time. Whatever computer you have on your shelf will do very well for testing the method. Using what was on my own shelf, I have inverted several dense (all entries nonzero) random-number-entry matrices of maximum dimension 60 by 60 in total times varying from 15 to 24 hours.

The matrix size limitation $n = 60$ is imposed solely by an artificiality of the particular BASIC language I use: My Toshiba T300 computer (8088 processor, 6-MHz clock, no coprocessor) came from the mail-order discounter bundled with a dialect known as TBASIC that arbitrarily limits me to about 60K bytes of RAM, even though the machine was never sold with less than 192K bytes and accom-

modates 256K bytes on the motherboard. If you are lucky enough not to be "software-bound" or can write your own assembly- or machine-language programs, the sky is the limit on what you can do in this era of cheap memory chips.

Large-matrix inversion is very RAM-demanding, but nothing fancy in the way of either hardware or software is needed to test the present approach, since the algorithm I shall describe is numerically stable—that is, "self-healing"—and works fine in single precision.

Let's begin at the beginning. A *matrix* A is a two-dimensional array of real or complex numbers, known as its "elements," $A(I,J)$; $I = 1, 2, \dots, n$; $J = 1, 2, \dots, n$. If a matrix is square (that is, of dimensions n by n) and nonsingular (that is, not in some sense equivalent to zero), it possesses an inverse matrix A^{-1} such that $A^{-1}A = AA^{-1} = I$, where I is the n by n "unit matrix" having ones on its main (upper left to lower right) diagonal and zeros elsewhere. The problem is: Given A , what is A^{-1} ? If the dimension n of A is small, this problem is easy.

But if n gets even as large as 10, classical methods become very cumbersome. If n becomes as large as 50 or so, home computers tend to poop out.

The Pan and Reif approach removes all limits except those set by available time and RAM. The underlying mathematical idea of their method involves iteration: Suppose, given the nonsingular n by n matrix A , that we approximate its inverse by a similar matrix B , $A^{-1} \approx B$, and define an "error matrix" of the form shown in figure 1, equation 1. (All equations not in the text are in figure 1. They will be identified by equation numbers appearing in parentheses to the left of the equations.)

By the rules of matrix multiplication we have the identity shown in equation 2. If $E(B)$ were a number x of magnitude $x < 1$, we know by the binomial theorem that we could write

(continued)

Thomas E. Phipps Jr. (908 South Busey Ave., Urbana, IL 61801) is retired from operations research/systems analysis for the U.S. Navy. He received his Ph.D. in nuclear physics from Harvard University.

equation 3. It happens that a "norm" q can be defined for a matrix that is analogous to the magnitude of our number x (see reference 1). So, if the matrix B is in some sense a "good enough" approximation to A^{-1} , the

norm q of the error matrix $E(B)$ will be less than unity and we can write equation 4 by analogy with equation 3.

Using this device of formal expansion as a guide and introducing an iterative index h ($h = 1, 2, \dots$), we

have for iteration h an error matrix (equation 5) by analogy with equation 1. Since B_0, B_1, B_2, \dots is a sequence of matrices that approximate increasingly well (we hope) to A^{-1} as iteration proceeds, we can replace A^{-1} on the left side of equation 4 by the refined approximation B_h , and we can interpret the B appearing on the right side as the less-refined approximation B_{h-1} . Thus equation 4 yields equation 6.

Finally, on entering properly into the spirit of rough approximation, we note that the higher powers of E_h (for $q < 1$), being smaller than the first power, can be dropped, yielding equation 7.

This form is known as *Newton's iteration* (gets around, doesn't he?). For 50 years numerical analysts have shunned it because, to make it work, one needs a "good enough" initial approximation matrix B_0 so that $q < 1$ from the start. Otherwise, the iterative process is prone to diverge. Since no way was known of evaluating B_0 , the method was of limited practical value.

The Pan-Reif breakthrough consists of the discovery of a simple and reliable way of evaluating B_0 , the initial approximation to A^{-1} , which can safely be used for starting Newton's iteration or variants of it. Readers interested in a derivation can consult the references. I give here merely one example of the results. Let me denote the "Hermitian transpose" of A by A^H . That is, if $A(I, J)$ is the element in the I th row and J th column of the A matrix, then $A^*(J, I)$ is the element at the corresponding position in the matrix A^H . Here the star denotes complex conjugate (i.e., if an element is $x + iy$, where x and y are real numbers, then the complex conjugate of that element is $x - iy$). If, as is the case to which I have limited all my own calculations, the elements of A are all real, then A^H is just the transposed matrix A^T of A (wherein elements are interchanged or "reflected" with respect to the main diagonal).

We now introduce a number t , defined by equation 8. In words: We consider the *magnitudes* of the various elements $A(I, J)$ of the given A matrix that is to be inverted. (In the case of

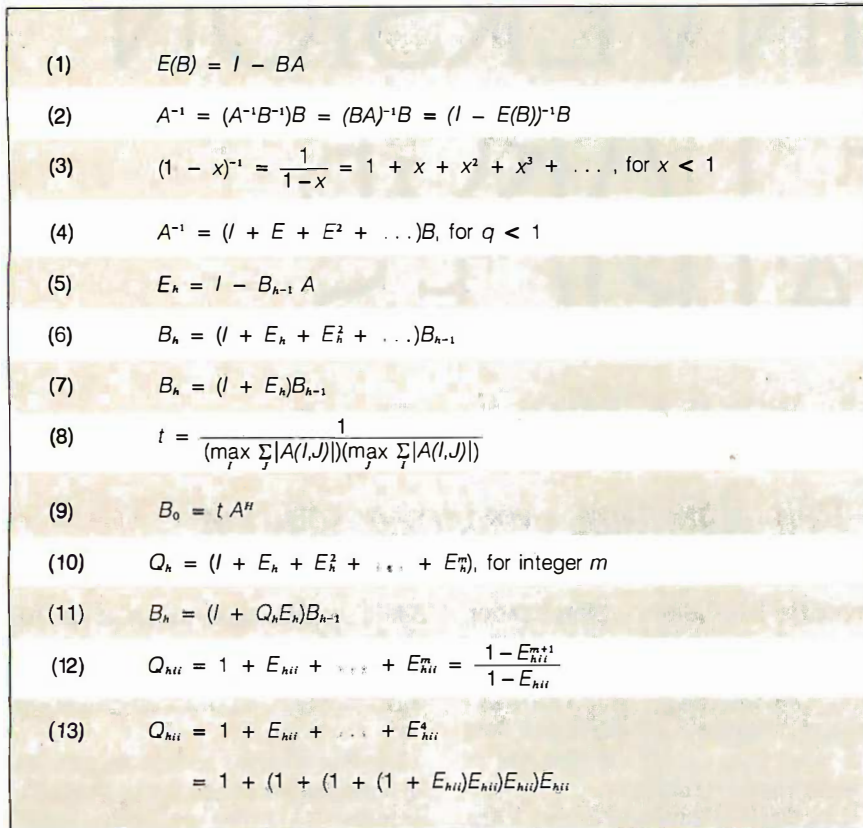

Figure 1: Equations used in the article.

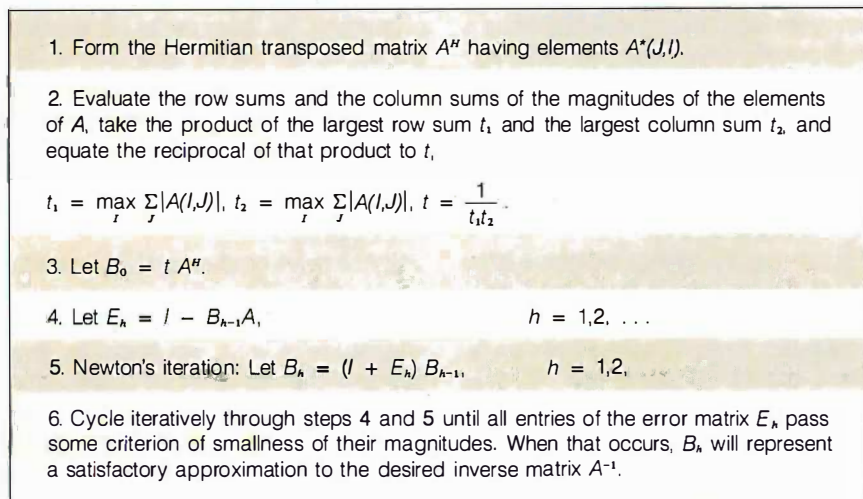

Figure 2: An outline of the Pan and Reif method discussed in the article.

a complex element $x + iy$, its magnitude is $\sqrt{x^2 + y^2}$. In the case of a real element, it is just its unsigned or absolute value.) We add up the magnitudes of the elements in a given row and record the sum. We do the same for the remaining rows and then compare the sums thus obtained. The largest of these row sums—just a number—is designated $\max_i \sum_j |A(i,j)|$. We do the same for the column sums and take the product of these two maxima, designating its reciprocal as the real number t . Finally, we define our initial approximate inverse matrix B_0 as shown in equation 9.

That is, the number t multiplies every element of the Hermitian transpose of the A matrix. Pan and Reif give alternative forms, but this will do. And that's all there is to it.

Figure 2 summarizes the algorithm for inverting a nonsingular square matrix A having given elements $A(i,j)$.

The form of the Pan-Reif procedure presented in figure 2 uses Newton's iteration. The references cited give other forms and iterations, but this one is simple and effective. I found it worthwhile, however, to experiment a bit with refinements to step 5 in the figure 2 iteration. For example, referring back to equation 6 and defining Q_h as in equation 10, we see that an iteration of greater accuracy might take a form such as that of equation 11. For $m \geq 1$ in equation 10, this reduces the number of iterations required for convergence, but because all the extra matrix multiplication increases the time per iteration disproportionately, the net result is a slower inversion algorithm. However, there is a trick of rough approximation to Q_h in equation 10 that does give some speed improvement over the raw Newton's iteration—not a great deal, but worth exploiting and

easy to program. No doubt the reader can play with this sort of thing and discover further improvements.

My refinement rests on the observation that the initial error matrix E_h , defined by equation 5 is typically not far different from a unit matrix; that is, it has entries on the main diagonal that are slightly less than unity and off-diagonal entries that are quite small with respect to unity. That being the case, a big improvement in initial convergence rate can be achieved by treating the off-diagonal elements of E_h as zero, in approximating the matrix Q_h . Such approximation is a relatively quick and easy calculation because only the n diagonal elements of E_h and powers of those elements are involved. Thus, instead of an extra n by n storage matrix to hold the information in Q_h , we need only one n -element array. This need not be ad-

(continued)

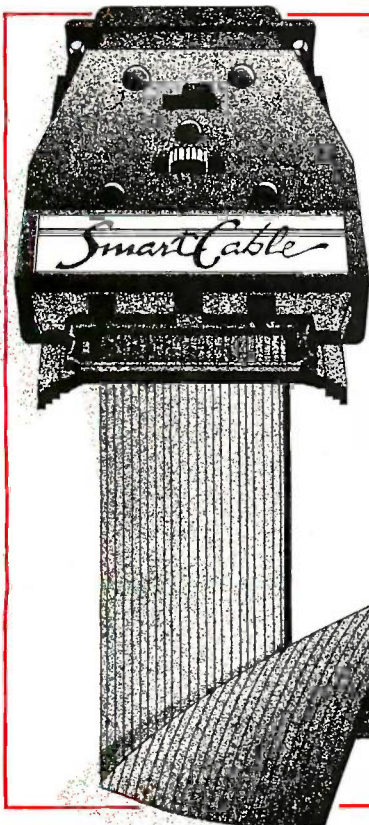

SMART CABLE

Universal RS-232 connections — Just \$49.95!

Here's the one cable to connect virtually any computer to nearly any serial peripheral. No more custom cables. It's easy! It's the Smart Cable SC 817 from IQ Technologies. Just plug it in, flip a switch, and its ingenious electronics do the rest. Instantly. Automatically.

"Another heaven-sent accessory." —PC Week

"A marvel of ingenuity."

—Microcomputing Magazine

"The answer to a costly problem."

—PC Magazine

Just \$49.95, plus shipping

InfoWorld				
Report Card				
Smart Cable				
	Poor	Fair	Good	Excellent
Setup				✓
Ease of use				✓
Performance				✓
Serviceability				✓

CALL SEATTLE DATA SYSTEMS

1-800-232-0817 MASTER CARD, VISA ACCEPTED

IN EUROPE, CALL (31)-0 2280-16049

ditional to the basic n by n matrices A , B , E , and X required for Newton's iteration. (The extra storage matrix X is needed to hold temporarily the product on the right side of equation 11 until it can be loaded back into B , it being generally impermissible in BASIC to write a matrix equation, $B = E * B$, in which the same matrix B appears on both sides of the equals sign. Any row or column of the X matrix will do to store the extra n pieces of data just mentioned.)

We have thus agreed, as an approx-

imation, to diagonalize Q_h and the matrices E_h from which it is formed. This means, if we designate the i th diagonal element of Q_h as Q_{hii} and of E_h as E_{hii} , that we can manipulate these numbers just as in school algebra to get equation 12.

Consequently, the only nonvanishing entries of our approximate Q_h matrix are the n numbers given by equation 12 for $i = 1, 2, \dots, n$. The Q factor gives enough refinement of the Newton iteration to speed initial convergence without significantly

penalizing later convergence (when all elements of the error matrix E_h become small and of comparable magnitudes, so that all higher powers of E_h become comparatively negligible). The choice of m must be handled with some delicacy. If m is too large (say, greater than 10), the initial rate of reduction of the diagonal elements of the error matrix is excessive, the attendant increase of off-diagonal errors is also too rapid, and the resulting instability can cause divergence of the subsequent iterative process. Empirically, I find values $m = 4$ or 5 generally give best results, and for simplicity I have written my present sample program (listing 1) with $m = 4$. Rewriting equation 10 for this case yields equation 13. [Editor's note: The BASIC program is available on disk as explained on page 346 or may be downloaded from BYTEnet Listings at (617) 861-9764.] A more versatile program can be written with m an adjustable input parameter and Q_{hii} given by equation 12.

The Pan-Reif algorithm, with the Q -factor modification just described, as programmed in Microsoft BASIC, is shown in listing 1. For convenience of numerical experimentation and to avoid having to input great amounts of made-up data, I have at line 140 generated a random-entry A matrix, to be inverted, the entries of which are real numbers between 0 and 1. At step 150 a randomly chosen algebraic sign is assigned to each entry, with equal probability of plus or minus. (Any real-number matrix can be expressed in this fractional-element form by dividing all elements by the magnitude of the largest element.) The program is readily modified to allow user input of A -matrix entries.

At lines 190 through 210 the row and column sums of absolute values of the A -matrix entries are calculated and temporarily stored in row matrices $X(1..I)$ and $E(1..I)$. These "lists" are then sorted for entry size at lines 220 through 230 and the maxima, $T1$ and $T2$, are used at line 240 to evaluate T —the quantity t in our above discussion. The initial matrix B_0 is evaluated at line 260, and the main iteration comprising lines 280 through

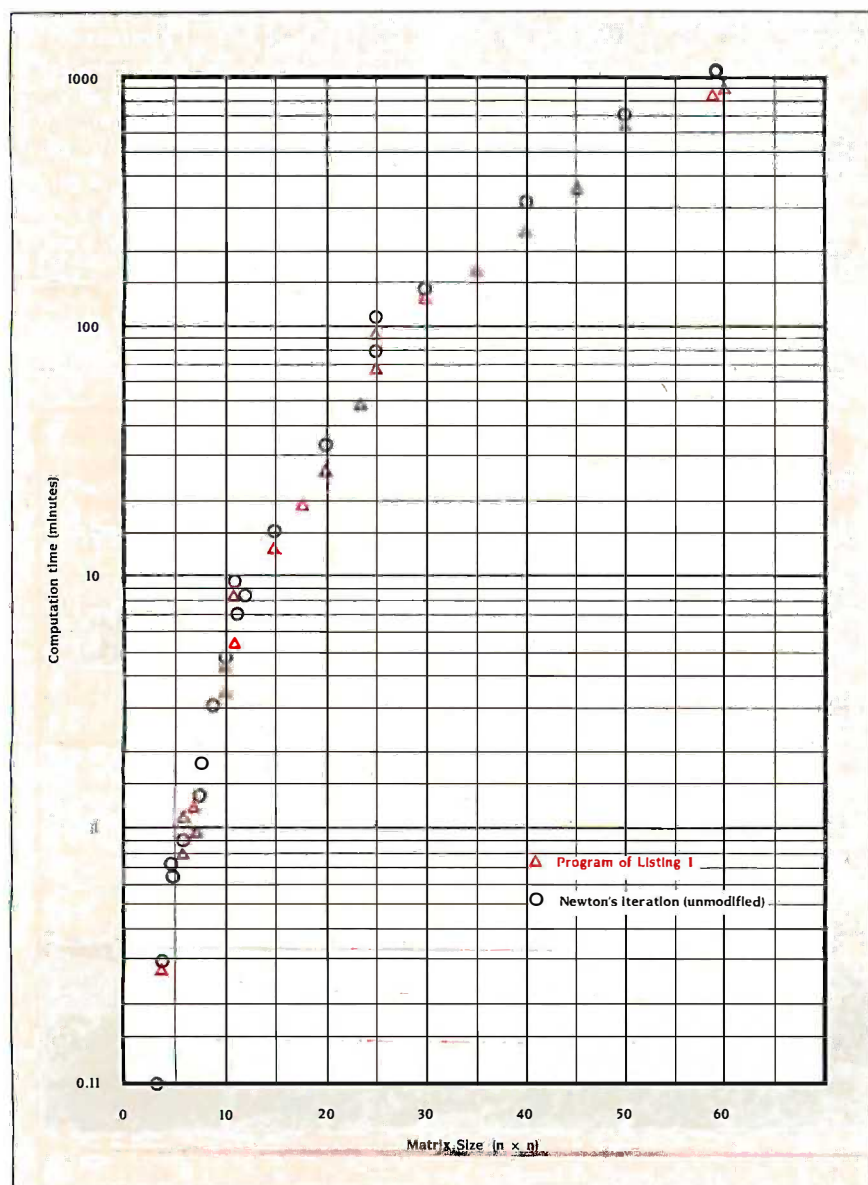

Figure 3: A plot of log (computation time) versus matrix size.

430 is then entered.

The first part of this iteration, lines 290 through 360, updates the error matrix according to step 4 of our algorithm (figure 2) and provides some tests for escape from the loop. Line 320 prints out to the screen, during each loop, information regarding (1) the iteration number, (2) the values of the error matrix at two arbitrary positions, corresponding to the upper left and upper right elements, and (3) the values of the B matrix (approximate inverse of A) at the same two positions. Thus one can monitor the convergence process by arbitrary sampling of the error and inverse matrices.

At line 380 the diagonal matrix O of equation 13 is expressed as an "equivalent" (in information content) row matrix or "list:" $X(I,I)$. (Use of the X matrix for temporary storage, as we noted, avoids having to dimension an-

other large array.) Each entry of this list multiplies all entries of the corresponding row of the error matrix at line 390. At the same line a 1 is added to each diagonal element, in accordance with equation 11, and the result is loaded back into the E matrix, to make maximum use of the available storage arrays. At the next two lines the matrix product on the right side of equation 11 is evaluated and loaded into the temporary storage matrix X , as discussed above. At line 420 the X matrix information is loaded back into the B matrix (representing B_n in equation 11) and the calculation loops back to line 280 to reiterate.

The remaining lines of the program, following escape from the loop, turn off the clock and display results. Line 470 offers the user the option of an additional separately timed iteration to confirm the stability of convergence. The program checks for

convergence by examining the maximum error in BA . As an independent check on the approximation of the inverse, the program calculates the error in multiplying AB in lines 480 through 610.

Readers familiar with other BASICs should have no difficulty translating the Microsoft BASIC dialect of listing 1 for use with their own machines. When I invert a 60 by 60 matrix on my computer, the working time is the better part of a day, so it is desirable to have no other uses planned for the computer. Observed times required by the T300 for inverting random-entry matrices of various sizes by the program of listing 1 are shown in the semilogarithmic plot of figure 3. Of course, the time depends somewhat on the error criterion (DI value) selected, but this generally alters the required number of iterations H by

(continued)

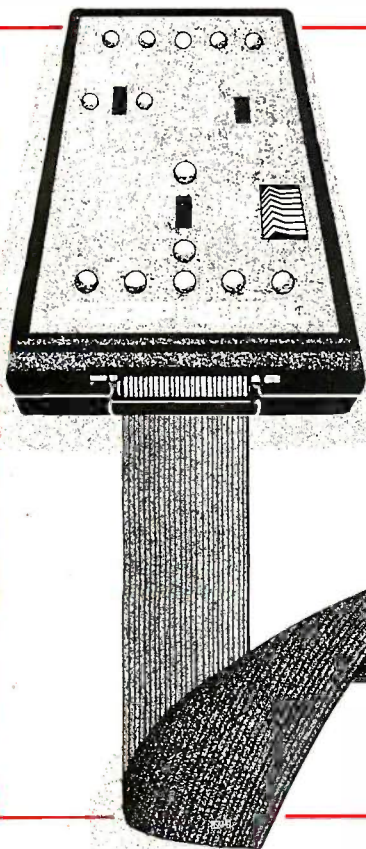

SMART CABLE

**Universal RS-232 connections — Just \$149.95!
Just arrived from I.Q. Technologies Inc.**

The SC821 Plus

- Only **30** sec. from hook up, to communication, to pin configuration display.
- Instantly interfaces all RS 232 Serial asynchronous equipment.
- Displays the correct configuration of the equipment being interfaced.
- Reconfigures for each RS 232 application needed.
- Comes with 2 cables with male and female DB 25 connections on each end.
- Eliminates the need for breakout boxes.
- Cable making has never been easier.

Just \$149.95, plus shipping

CALL SEATTLE DATA SYSTEMS
1-800-232-0817 MASTER CARD, VISA ACCEPTED
IN EUROPE, CALL (31)-(0) 2280-16049

Listing 1: A BASIC program for the modified Pan-Reif matrix-inversion method.

```

10 REM Real-entry matrix inversion (Pan-Reif method)
20 REM Program by Thomas E. Phipps, Jr.
30 REM Ref= Proc. 17th Annual ACM Sympos. on Theory
40 REM of Computing, Providence, RI, May 1985
50 REM Random-entry matrices, single precision
60 REM Quartic modification of Newton's iteration
70 INPUT "Run number = ";RN
80 REM N data is in line 640, D1 data in line 660
90 READ N, D1:RANDOMIZE RN:OPTION BASE 1
100 REM Can optionally insert DEFDBL A,B,E,X here
110 REM A is the matrix to invert, B is the
    approximate inverse of A, E is the error
    matrix for the inverse, and X is a temporary
    storage matrix as explained in the article.
120 DIM A(N,N),B(N,N),E(N,N),X(N,N)
130 REM Generate random-entry A matrix. For real
    data, replace 140 by an INPUT statement
    and input normalized data (each element
    of A is divided by the largest element, L).
    Delete line 150. B and D1 must be
    multiplied by L to find the inverse and error
140 FOR I=1 TO N:FOR J=1 TO N:A(I,J)=RND(1):NEXT:NEXT
150 FOR I=1 TO N:FOR J=1 TO N:IF RND(1)<.5 THEN
    A(I,J)=-A(I,J)
160 NEXT :NEXT
170 CLS:TIME$="00" 'Start clock
180 REM Eval. t by Pan-Reif eq 8 in BYTE article
190 FOR I=1 TO N:R0=0:S0=0:FOR J=1 TO N
200 R0=R0+ABS(A(I,J)):S0=S0+ABS(A(J,I)):NEXT J
210 X(1,I)=R0/E(1,I)=S0:NEXT I:T1=0:T2=0
220 FOR I=1 TO N:IF X(1,I)>T1 THEN T1=X(1,I)
230 IF E(1,I)>T2 THEN T2=E(1,I)
240 NEXT I:T=1/(T1*T2)
250 REM Eval. initial B-matrix
260 FOR I=1 TO N:FOR J=1 TO N:B(I,J)=T*A(J,I):NEXT:
    NEXT H=0
270 PRINT "ITER."TAB(10);"E(1,1)"TAB(28);"E(1,N)"
    TAB(46);"B(1,1)"TAB(64);"B(1,N)"
280 REM Eval. error matrix E
290 FOR I=1 TO N:FOR K=1 TO N:Z=0:FOR J=1 TO N
300 Z=Z+B(I,J)*A(J,K):NEXT J:E(I,K)=-Z:NEXT K:
    NEXT I
310 FOR I=1 TO N:E(I,I)=1+E(I,I):NEXT I
320 BEEP:PRINT H;TAB(6);E(1,1);TAB(24);E(1,N);
    TAB(42);B(1,1);TAB(60);B(1,N)
330 IF H>50 THEN PRINT "STUCK!":BEEP:BEEP:
    GOTO 620
340 REM Test for escape from loop
350 FOR I=1 TO N:FOR J=1 TO N:IF ABS(E(I,J))>D1
    THEN 370
360 NEXT :NEXT :GOTO 440
370 H=H+1 'Newton's iteration
    (quartic modification)
380 FOR I=1 TO N:
    X(1,I)=1+(1+(1+(1+E(I,I))*E(I,I))*E(I,I))*E(I,I):
    NEXT
390 FOR I=1 TO N:FOR J=1 TO N:E(I,J)=X(1,I)*E(I,J):
    NEXT :E(I,I)=1+E(I,I):NEXT
400 FOR I=1 TO N:FOR K=1 TO N:W=0:FOR J=1 TO N
410 W=W+E(I,J)*B(J,K):NEXT J:X(I,K)=W:NEXT K:NEXT I
420 FOR I=1 TO N:FOR J=1 TO N:B(I,J)=X(I,J):NEXT:
    NEXT
430 GOTO 280
440 REM output follows

```

(continued)

*It is great fun
to watch the process
of inverting a 10 by 10
matrix on the screen.*

only 1 or 2. Typical values of H for reasonable convergence (four to five figures of accuracy of B -matrix elements) are 10 to 17 iterations for small (say, 10 by 10) matrices and 21 to 27 iterations for matrices of 30 by 30 and up. The corresponding clock times are roughly four minutes and two hours. The inversion times and iteration numbers vary, as explained below, with the "condition" of the matrix to be inverted.

It is great fun, and instructive, to watch the process of inverting, say, a 10 by 10 matrix evolve on the video screen. The calculation prints out iterations at a pace that is easy to follow (17-second intervals). Typically, there is a steady decrease of the on-diagonal elements of the error matrix, as shown by the sample element $E(1,1)$, starting from around 0.95, as given by the Pan-Reif procedure for evaluating B_0 . The off-diagonal elements, as typified by $E(1,N)$, start small and rise, say, to around 0.1 to 0.3. Then, for iteration numbers around 5 to 10 or more, there is a period of "struggle" during which the error bounds do not decrease very much, but the B -matrix values, which have been small, begin to change fairly rapidly in sign and magnitude. As this phase comes to an end, the next few iterations produce rapid, systematic changes in the B -matrix entries and dramatic decreases in the error bounds both on and off diagonal as the iteration gets itself sorted out and homes in on its target.

Finally, if you have set too stringent an error bound $D1$ (see line 350 in listing 1), there will be an ultimate phase of aimless "hunting" in which typical error magnitudes are small, of the order of 10^{-7} , and in which only

(continued)

Get up to speed for under a hundred bucks.

If you're writing in the BASIC that came with your IBM® PC, now you can make your programs scream. Microsoft's new QuickBASIC Compiler will punch you right into warp speed, accelerating your programs by as much as ten times. And all with hardly any code changes.

You get all this at a price that won't slow you down, either. Just \$99 and you're in.

The new QuickBASIC Compiler was designed to work with the

CIRCLE, PSET, and COLOR.

So your graphics and music routines will look and sound as they should.

And when you're ready to move into structured programming, QuickBASIC also offers language extensions for a speedy transition. With optional alphanumeric labels you can make your programs more readable. And compiled subprograms will save you time.

So get moving. **MICROSOFT**®
Call us now for The High Performance Software™
more information on the QuickBASIC Compiler and the name of your nearest Microsoft dealer. Just ring (800) 426-9400. In Washington State, Alaska, Hawaii and Canada, call (206) 882-8088.

Then go give your programs a swift kick.

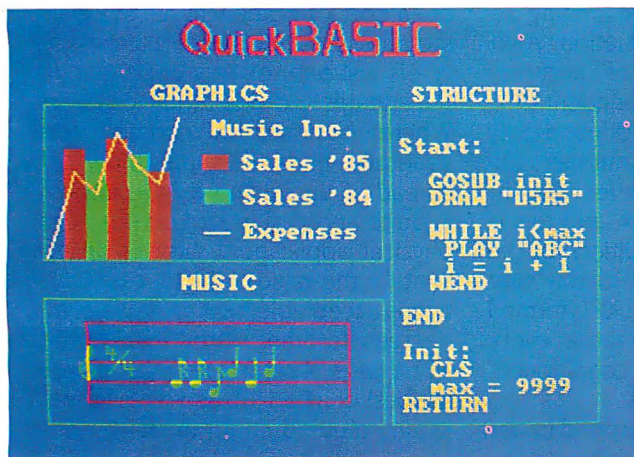

programs you've already written. It supports all BASIC sound and graphic statements including PLAY, SOUND, LOCATE, DRAW, GET, PUT, LINE,

A hand is shown holding the Microsoft logo, which is rendered in a large, bold, 3D block font. The hand is positioned at the bottom right, with the thumb and index finger gripping the letters.

```

450 T$=TIME$:BEEP:BEEP:BEEP:PRINT "Run number";RN,
      "Duration = ";T$
460 PRINT "No. iter.=";H,"Matrix dim.="N,
      "Max. error=";D1
470 INPUT "Another iteration (y,n)";C$:
      IF C$="Y" OR C$="y" THEN TIME$="00":GOTO 370
480 PRINT "The maximum error was calculated by
      multiplying A^-1*A."
490 PRINT "As a check on the true error in the
      approximated inverse matrix"
500 PRINT "the maximum error in A*A^-1 will now
      be determined."
510 ERASE X      'recycle the temporary storage
      matrix for errors in A*A^-1
520 DIM X(N,N)
530 FOR I=1 TO N:FOR J=1 TO N:FOR K=1 TO N
540 X(I,K)=X(I,K)+A(I,J)*B(J,K)
550 NEXT :NEXT :NEXT
560 REM You may print out the matrix and its
      inverse by placing a PRINT command for
      A and B in the following loop.
570 FOR I=1 TO N:FOR J=1 TO N
580 TEST.VAL=ABS(X(I,J)):IF I=J THEN
      TEST.VAL=ABS(1-TEST.VAL)
590 IF TEST.VAL>MAX.ERROR THEN MAX.ERROR=TEST.VAL
600 NEXT :NEXT
610 PRINT "The max. error found this way is ";
      MAX.ERROR
620 END
630 REM Matrix dim. N =
640 DATA 10
650 REM Error criterion D1 =
660 DATA 3E-6
    
```

the least significant two or three decimal places of the B -matrix entries change. This would go on forever (if not stopped at 50 iterations by line 330 of the program), so one must press the Break key and either try again with a larger $D1$ value or record the B -matrix results, which will probably be good to four significant figures. (The listing I program does not provide for printing out any of the matrices, so these remain invisible to the user, but the user who wants to see A and B can add a few steps to the program or command printouts in the "direct" mode after computation has stopped.) The calculation never becomes unstable or divergent but just "bounces around" continually in the last decimal places.

The first explanation that comes to mind for the hunting behavior just described is that it is due to cumulative round-off error in the numerous computations, that is, due to the finite precision of the calculations. However, this is not the main

story, since I have tried the same thing in double precision with no noticeable improvement in the limiting accuracy of B -matrix evaluation. Also, that attainable level of accuracy seems to be fairly independent of n , the matrix size, and to depend only on the particular set of numbers appearing as A -matrix entries. Clearly, another factor is at work, and this is what is called the "condition" of the A matrix. Any matrix sufficiently near to being singular or zero-like is termed "ill conditioned." In a sense every matrix is more or less ill conditioned. It is a matter of degree.

That is, the bouncing around under indefinite repetition of Newton's iteration, producing an uncertainty affecting the K th and higher places of accuracy (significance) of the computed inverse matrix, will occur for some K value for any A matrix. Usually K is greater than 4 or 5 and may be greater than the number of decimal places specifying the precision of our calculation. In that case we call the A

*In a sense every
matrix is more or less
ill conditioned. It is
a matter of degree.*

matrix "well conditioned" and may not be able to detect the bouncing around at all. But occasionally we encounter a nearly zero-like matrix for which K is small, the uncertainty of our answer is great, and the entries of the inverse matrix become very sensitive to the precise numerical values of the entries of the A matrix. This is the ill-conditioned case, typified by numerically large entries of the inverse matrix.

The quantity K , which can be evaluated from the "long run" statistics of Newton's iteration, can in fact be used to quantify the "condition" of a matrix. (The larger K , the better the condition of the A matrix.) An ill-conditioned matrix cannot normally be spotted by prior inspection; so the problem is an insidious one. But the uncertainty we are speaking of—a sort of numerical analogue of the physicist's "Heisenberg uncertainty"—is just nature's way of penalizing the attempt to divide by (almost) zero. Where it arises in practice one generally finds that an enhanced spread of uncertainty of the answer is quite acceptable (for purposes of physical application), just as uncertainty in the value of the tangent function is acceptable near an angle of 90 degrees. In other words, even in the worst case, Newton's iteration makes the best of a bad job and does as well as any method could do. ■

REFERENCES

1. Pan, V., and J. Reif. "Efficient Parallel Solution of Linear Systems." Providence, RI: *Proceedings of the 17th Annual ACM Symposium on Theory of Computing*, May 1985.
2. Pan, V., and J. Reif. Harvard University Center for Research in Computing Technology Report TR-02-85. Cambridge, MA: Aiken Computation Laboratory, 1985.

There's a Familiar Face Behind the New Name



NANAO MONITORS The name is new to the American market. That's because for the first time in history, a huge new line of computer monitors is available to the U.S.—factory direct. 26 different models offered in three series, bringing you a range of features broader than any other. Color resolution from 480 dots x 200 lines up to 720 dots x 480 lines. And E_h scanning from 15.75 to 24.75 KHz. But the truth is that Nanao has been around for a long time. For over a decade we've supplied OEM's worldwide, designing and manufacturing monitors recognized for their outstanding performance and reliability. Now that same quality, selection, and value is yours—right from the source. Nanao. The old standby with a new name.

NANAO

NANAO CORPORATION

153 Shimokashiwano-Cho
Matto-City, Ishikawa, Japan

In Canada, Call Toll Free
1-800-661-9460

NANAO USA CORPORATION

373 G. Vintage Park Drive
Foster City, California 94404
Phone (415) 341-7055

Distributor Inquiries Welcomed

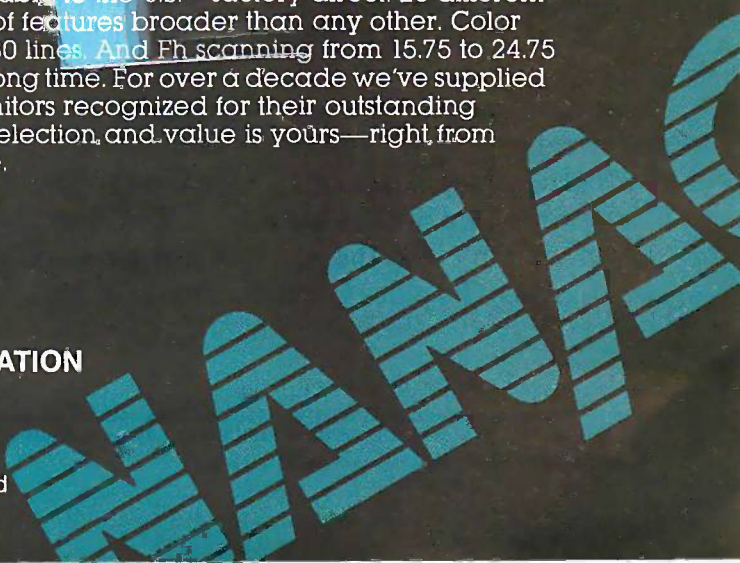

NOW
COMES
WITH FREE
PRINTER CABLE!

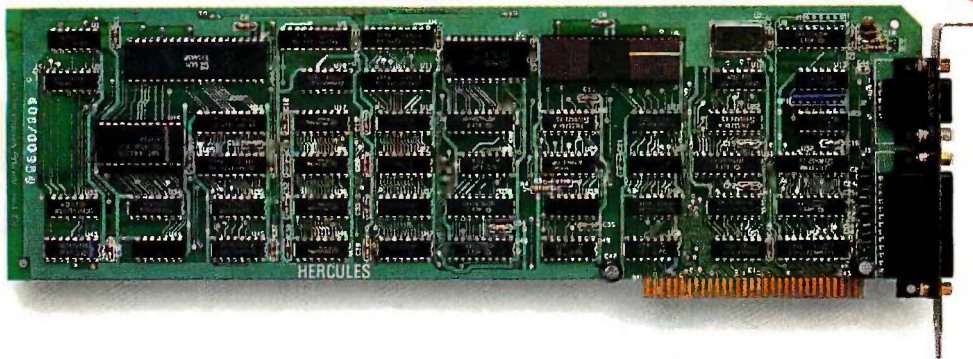

The world's best selling monochrome graphics card for the IBM PC.

There are more Hercules™ Graphics Cards in more IBM® PCs, XT's and AT's than any other monochrome graphics card in the world.

Over a quarter of a million demanding users around the world use a Hercules Graphics Card to improve the performance of their software.

The Lotus® 1-2-3® Booster.

Consider Lotus 1-2-3. Hercules gives an off-the-shelf copy of 1-2-3 the highest resolution possible on an IBM PC, XT or AT. More 1-2-3 users choose the Hercules Graphics Card to get crisper text and sharper graphics than any other monochrome graphics card.

And we bring the same performance to other integrated programs like Symphony™, Framework™, and SuperCalc®3.

But we don't stop there. The Hercules Graphics Card

improves all kinds of software.

Like Microsoft® Word, a word processor that enables you to display text with subscripts, superscripts and italics.

Or pfs:Graph, an easy-to-use business graphics program that converts your data into presentation quality graphs.

Or Microsoft® Flight Simulator, the high flying game for the overworked executive.

Or our own Graph X™, a library of graphics sub-routines that eases graphics programming.

Or AutoCAD™, a computer aided design program that offers features normally associated with expensive CAD systems.

And we supply free software with each card to do hi-res graphics using the PC's BASIC interpreter. **State-Of-The-Art Hardware.**

The Hercules Graphics Card gives you graphics resolution of 720h x 348v and a

parallel printer port. Our unique static RAM buffer provides sharp 9 x 14 characters and flicker-free scrolling. Our exclusive safety features help



prevent damage to your monitor.

State-of-the-art custom IC technology delivers unsurpassed reliability. Ordinary graphics cards use up to 30 ICs to do what one Hercules IC does. By using fewer parts, we reduce the possibility of component failure.

Which is one reason we warranty the Hercules Graphics Card for two years.

Unbeatable reliability. Advanced technology. Proven by over a quarter of a million users. Why settle for anything less than Hercules?

Call 1-800-532-0600 Ext 408 for the name of a Hercules dealer nearest you and we'll rush you our free info kit.

Hercules.
We're strong on graphics.

Inquiry 152

THE RUNGE-KUTTA METHODS

BY BENKU THOMAS

Approximating solutions to ODEs

A DIFFERENTIAL EQUATION is the mathematical relationship between an unknown function of one or more variables and one or more of its derivatives. In solving the differential equation, we obtain an expression for the function so that we may predict its value at any point.

If we are able to obtain an exact expression for the solution to a differential equation, we say we have obtained an analytical, or true, solution to the differential equation. It is possible to obtain analytical solutions to some differential equations. However, most of the time the equations are difficult to solve analytically, and sometimes they are just plain impossible. So we resort to numerical solutions that attempt to give a numerical value (an approximation) of the unknown function for any combination of values of the variables in the function.

DIFFERENTIAL EQUATIONS

Differential equations may be classified into different types, each requiring different numerical methods for their solution. If the equation involves derivatives of a function having only

one independent variable (that is, only derivatives with respect to the one independent variable are involved), then it is an *ordinary differential equation* (ODE). If more than one independent variable is involved, then we have a *partial differential equation* (PDE). ODEs may be further classified by the type of additional information we have about them. If information (such as the value of the function we are solving for) is known at a particular value of the independent variable, the ODE is an *initial value problem* (IVP). However, if information about the function or its derivatives are known at two different values of the independent variable—the boundaries of the problem—we have a *boundary value problem* (BVP). Differential equations describing changes in time are almost always IVPs, since information about the problem is known at zero time (the initial value). On the other hand, steady-state heat-conduction problems are often BVPs, since information is known at the boundaries of the space in which conduction is taking place. The methods I will discuss in this article will solve

only IVPs, but this subject is sufficiently involved that L. F. Shampine and M. K. Gordon have written an entire book about it (see reference 1).

ERROR CONTROL

There are a number of problems with any numerical technique, but the one common to all differential equation solvers is error control. The errors in the solutions arise from a couple of sources. First, because all numerical solutions are necessarily approximations of the true solutions, there is always an error (however small it may be) associated with any numerical answer. This is the *global error*, and it is a measure of the difference between the true solution and the numerical one. We usually use some sort of series approximation of the unknown function and make a prediction of the next value of the function u_{i+1} based on the value u_i that we have

(continued)

Benku Thomas is a Ph.D. student in chemical engineering at Virginia Polytechnic Institute. His research area is heat transfer in fluidized beds. He can be reached at 810 Ascot Lane, Blacksburg, VA 24060.

already estimated. However, u_i is itself a numerically predicted value, and it will be in error to some degree when compared to the true solution. The error in predicting u_{i+1} , caused by our (incorrect) assumption that u_i contained no error, is called the *local (truncation) error* in u_{i+1} . As shown in figure 1, the global error contains two components—the local error and a *propagation error* that results from the propagation of the global error from the previous step. The local error, although a subset of the global error, can actually be estimated, so it is used to keep a check on the global error.

Second, any numerical method, however good, must execute in a machine environment, which means it must work with finite precision arithmetic. So, in addition to the global errors, we will also have *round-off errors*. A good numerical method must be able to minimize all errors and inform the user of the magnitude of error to be expected. (For an excellent introduction to the effects of round-off errors on numerical solutions, see chapter one in reference 2.) You can minimize the effect of round-off error by working in the highest precision

possible. In FORTRAN this means using double-precision variables for all real numbers.

THEORY

From our definition of the IVP, we can write a general equation for any IVP as shown in figure 2.1. Here we use the notation that $y^{(i)}$ represents the i th differential of y with respect to x (i.e., $d^i y/dx^i$). Equation 2.1 in figure 2 is an m th-order equation, since it involves an m th differential of y . It would be difficult to write a numerical solver that would be able to deal with any IVP of any order, so we must find a way of transforming the m th-order IVP into a series of first-order IVPs. Let's do this by way of an example from elementary college physics—simple harmonic motion. [Editor's note: David Leo's text box on page 196 presents a BASIC fourth-order Runge-Kutta routine for solving this problem with damping. Setting C to 0 yields the undamped problem.] Suppose we have an undamped spring-mass system in which a mass of 10 pounds, when attached to the end of a steel spring, causes it to stretch by 2 inches. We would like to know how the mass would move if the spring were

stretched by an additional 2 inches and then released. The spring constant is 60 lb/ft and the weight of the mass is 10/32 lb/(ft/sec²). The equation of motion for this system (as presented in reference 3) is: $y'' = -(32/10)60y$ (y is distance in feet) with the initial conditions $y(0) = 1/6$ ft and $y'(0) = 0$ ft/sec.

To transform this second-order differential equation into a system of first-order IVPs, let's introduce two new variables defined as $w_1 = y$ and $w_2 = y'$. Then we can write $w_1' = y'$ and $w_2' = y'' = -(32/10)60y$. So we now have a system of two first-order IVPs with the new initial conditions $w_1(0) = 1/6$ ft and $w_2(0) = 0$ ft/sec. In this manner, we may reduce a general m th-order IVP into a system of m first-order IVPs. In that case we would introduce the new set of variables— $w_1 = y, w_2 = y', \dots, w_m = y^{(m-1)}$. For convenience, we can write such a system of IVPs using standard vector notation as $y' = f(x, y)$, with initial conditions $y(x_0) = y_0$.

To be completely general, any method we devise must be capable of solving a system of initial-value ordinary differential equations. We state the general IVP as $y' = f(x, y)$ with $y(x_0) = y_0$. Our numerical solution must approximate the true solution, so a good starting point in developing a method is to assume that we may use some sort of series approximation (such as a Taylor series) of the true solution. Suppose we know that the exact solution at x_i is $y(x_i)$ and x_{i+1} is a point close to x_i . Then a Taylor series expansion for $y(x_{i+1})$ about x_i is as shown in equation 2.2.a. If we choose a point z , such that $x_i < z < x_{i+1}$, we obtain the equation 2.2.b. But from our statement of the initial-value problem, we have an expression for y' . Substituting this into the Taylor expansion we get equation 2.2.c, where we have defined $(x_{i+1} - x_i)$ as h , our step size. Also, if the limits of the interval over which we are interested in solving the problem are A and B , $A + N \times h = B$. Suppose the value of $y(x_i) \cong u_i$. Then, if we substitute this for $y(x_i)$ and truncate the series after the second term,

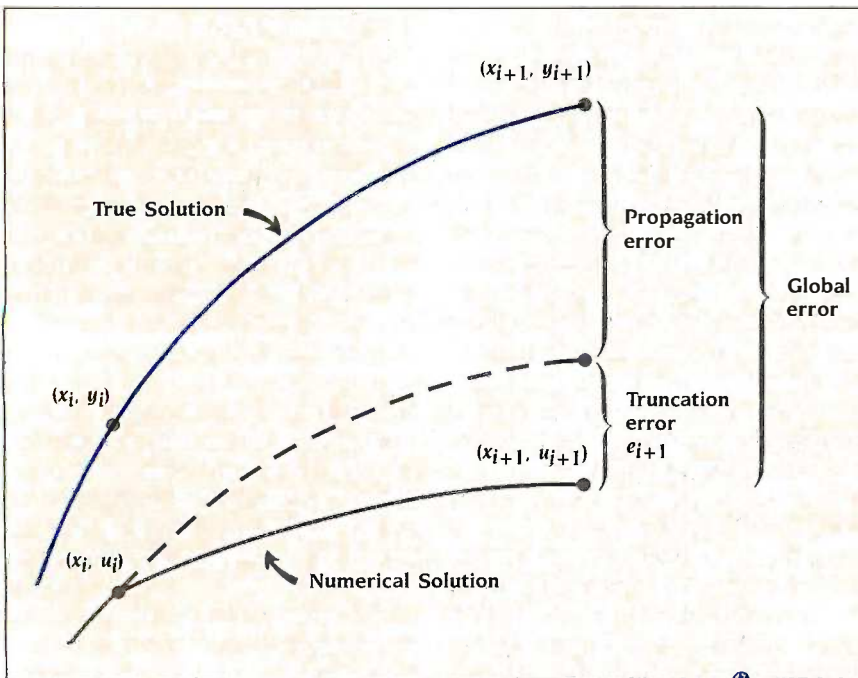

Figure 1: An illustration of errors in a numerical solution.

(continued)

RUNS 3 TO 6 TIMES FASTER THAN A PC XT HARD DISK Removable Winchester Hard Disk Drives for PC's Are Here

- HANG 10/20™
- SLOT DRIVE 10/20™
- SLOT 10/20™
- FLEXI-DRIVE 10™

HANG 10/20 – Hang 10 or even 20 megabytes *inside* your PC. Just plug it in and hang the drive off the front. *That's it!* Use standard DOS 2.0/3.0 commands. No switches to set. Will boot up as a "C" drive. You can turn your PC into an XT and keep your 2 floppies.

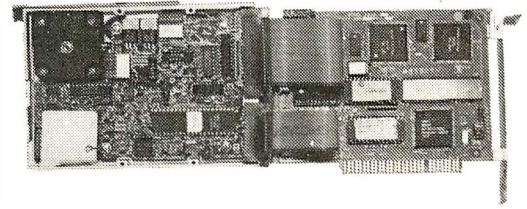

COMPLETE SUBSYSTEM
 Hang 10 – List Price \$ 899
 Hang 20 – List Price \$ 1199

SLOT 10/20 – A 10 or 20 megabyte hard disk, completely self-contained. Installs in any open PC or compatible bus slot, in less than a minute. No special software required.

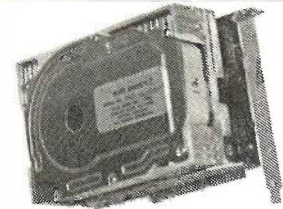

COMPLETE SUBSYSTEM
 Slot 10 – List Price \$ 999
 Slot 20 – List Price \$ 1399

SLOT DRIVE 10/20 – A high speed removable and transportable self-contained hard disk drive enclosed in a compact case for internal and external connection to a PC or compatible bus slot. Pop it in and pop it out. Take it anywhere. Lock it up or send it around the world. It can take a 60g shock if dropped while not operating. You can put several in a briefcase.

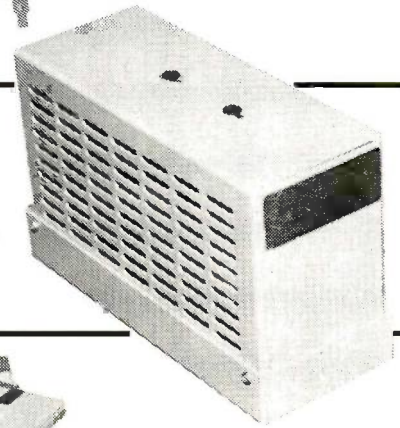

TRANSPORTABLE COMPLETE SUBSYSTEM
 Slot Drive 10 – List Price \$ 1099
 Slot Drive 20 – List Price \$ 1499

FLEXI-DRIVE – The ultimate Winchester storage device. Full 10 megabyte capacity. A true high speed hard disk, not just a back-up tape. Just change the cartridge. Fifty second recycle time. Remove it – store it – mail it – lock it in the vault.



HI SPEED SMART CONTROLLER
 LIST PRICE \$299

Flexi-Drive Only – List Price \$ 1599
 Removable Disk Cartridge – List Price \$ 149

DATA BOX 10 – A 10 megabyte Flexi-Drive. The perfect add-on subsystem for the PC/XT and other hard drive compatibles. High speed backup. True full Winchester operation. Plug in our controller, attach the drives, and you have a fast, flexible subsystem with unlimited storage capacity. Ideal add-on for Tandy, Leading Edge, Sperry, AT&T, and ITT. All subsystems are complete with controller and cables.



Data Box 10 – List Price \$ 2199

DATA BOX 20 – A dual drive subsystem. The ultimate peripheral for your computer system. Available with 2 Flexi-Drives, or 1 Flexi-Drive with a 10 or 20 megabyte hard disk. Complete with surge protector, 6 accessory outlets, and an 8-switch command center. All subsystems are complete with controller and cables.

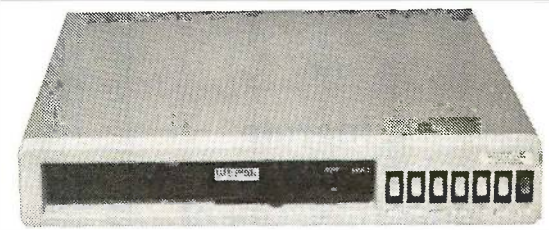

Data Box 20 w/dual Flexi-Drive – List Price \$ 3299
 Data Box 20 w/Flexi-Drive & 10 mb hard disk – List Price \$ 2999

DEALERS AND DISTRIBUTORS WANTED
 OUR PRODUCTS WERE THE HIT OF THE NCC '85 SHOW.
 WE NEED QUALITY DEALERS AND DISTRIBUTORS
 TO SELL, SERVICE, AND SUPPORT OUR CUSTOMERS.

— WE ARE SHIPPING ALL PRODUCTS —
Order Today!
— GENEROUS DISCOUNT STRUCTURE —

DATA ZONE, Inc.

7136 OWENSMOUTH AVE., CANOGA PARK, CA 91303 (818) 704-4955



1	Exxon
2	General Motors
3	Mobil
4	Ford Motor
5	IBM
6	Texaco
7	E.I. du Pont
8	Standard Oil (Ind.)
9	Standard Oil of Cal.
10	General Electric
11	Gulf Oil
12	Atlantic Richfield
13	Shell Oil
14	Occidental Petroleum
15	U.S. Steel
16	Phillips Petroleum
17	Sup

27
million
Americans
can't read.
And guess
who pays
the price.

Every year, functional illiteracy costs American business billions.

But your company can fight back...by joining your local community's fight against illiteracy. Call the Coalition for Literacy at toll-free **1-800-228-8813** and find out how.

You may find it's the greatest cost-saving measure your company has ever taken.

A literate
America is a
good investment.

Ad Council  **Coalition for Literacy**

$$(2.1) \quad y^{(m)} = f(x, y, y^{(1)}, y^{(2)}, \dots, y^{(m-1)})$$

with the initial conditions:

$$y(x_0) = y_0$$

$$y^{(1)}(x_0) = y_0^{(1)}$$

.

$$y^{(m-1)}(x_0) = y_0^{(m-1)}$$

$$(2.2a) \quad y(x_{i+1}) = y(x_i) + (x_{i+1} - x_i) y'(x_i) +$$

$$\frac{(x_{i+1} - x_i)^2}{2!} y''(x_i) + \dots + \frac{(x_{i+1} - x_i)^k}{k!} y^{(k)}(x_i)$$

$$(2.2b) \quad y(x_{i+1}) = y(x_i) + (x_{i+1} - x_i) y'(x_i) + \frac{(x_{i+1} - x_i)^2}{2!} y''(z)$$

$$(2.2c) \quad y(x_{i+1}) = y(x_i) + hf(x_i, y(x_i)) + \frac{h^2}{2!} f''(z, y(z))$$

$$(2.2d) \quad u_{i+1} = u_i + hf(x_i, u_i) \quad i = 0, 1, 2, \dots, N-1$$

$$(2.3) \quad u_{i+1} = u_i + h \sum_{j=1}^q a_j k_j$$

$$x_{n+1} = x_n + h$$

where

$$k_j = f(x_i + c_j h, u_i) + h \sum_{m=1}^{j-1} b_{jm} k_m$$

$$c_1 = 0$$

$$(2.4a) \quad \frac{df_i}{dx} = \frac{\delta f_i}{\delta x} + \frac{\delta f_i}{\delta y} \frac{dy}{dx} \Big|_{x=x_i} = (f_x + f_y f)_i$$

$$(2.4b) \quad u_{i+1} = u_i + hf_i + \frac{h^2}{2!} (f_x + f_y f)_i + O(h^3)$$

$$(2.4c) \quad u_{i+1} = u_i + a_1 hf_i + a_2 hf_i + a_2 h^2 c_2 (f_x)_i + b_{21} a_2 h^2 (f_y f)_i$$

$$(2.4d) \quad a_1 + a_2 = 1.0$$

$$a_2 c_2 = 0.5$$

$$a_2 b_{21} = 0.5$$

$$(2.5) \quad u_{i+1} = u_i + h \sum_{j=1}^4 a_j k_j$$

$$k_j = f(x_i + c_j h, u_i) + h \sum_{m=1}^{j-1} b_{jm} k_m$$

(2.6a)
$$u_{i+1} = u_i + h \sum_{j=1}^5 a_j k_j$$

$$u_{i+1}^* = u_i + h \sum_{j=1}^6 a_j k_j$$

(2.6b)
$$e_{i+1} = h \sum_{j=1}^6 e_j k_j$$

(2.7)
$$y_1 = \frac{1000}{1001} e^{-1001t} + \frac{1}{1001} e^{-t}$$

$$y_2 = \frac{-1000}{1001} e^{-1001t} + \frac{1000}{1001} e^{-t} \quad (t = \text{time})$$

(2.8)
$$k_j = f(x_i + c_j h, u_i + h \sum_{m=1}^j b_{jm} k_m)$$

Figure 2: Equations used in this article.

we get equation 2.2d, with the initial condition that $u_0 = y_0$. This is the Euler method and is the simplest approximation formula. Because of our truncation of the Taylor series after the second term, we neglected the second-order term in $y''(z)$. Since this term contains h^2 , we say that the local truncation error at x_{i+1} will be $e_{i+1} = O(h^2)$, where $O()$ means *terms of the order of*. If the exact solution at x_{i+1} were $y(x_{i+1})$, the global error G at x_{i+1} would be $G_{i+1} = y(x_{i+1}) - u_{i+1}$. A method is p th order (accurate) if $e_{i+1} = O(h^{p+1})$.

So, the Euler method is a first-order method. Since the local truncation error is proportional to the step size to power of $p+1$, decreasing the step size will reduce the magnitude of this error, and the degree of reduction will be larger the higher the order of the method we use.

RUNGE-KUTTA ALGORITHMS

Runge-Kutta methods are a class of algorithms that involve the evaluation of the differential function at points between x_i and x_{i+1} . The general form of the algorithm is shown in equations 2.3. Notice that we can obtain the Euler

formula from this algorithm simply by letting $q=1$ and $a(1)=1$, so that $k(1) = hf(x_i, u_i)$. The Euler method is therefore the lowest-order Runge-Kutta method.

For higher-order schemes, the parameters a , b , and c need to be evaluated. To do this, we compare the Runge-Kutta formula with the Taylor expansion of equivalent order and obtain the parameters by comparing coefficients of like terms. To show how this is done, let's develop a Runge-Kutta method for $q=2$. In this case, we would want to include the second-order term in the Taylor expansion. In addition, if we were to write $f'(x_i, y(x_i))$ as shown in equation 2.4a, then the Taylor expansion we require could be written as shown in equation 2.4b, where $O(h^3)$ are the terms we will truncate. Next, we write the expansions for the k 's about x_i : $k_1 = hf(x_i, u_i) = hf_i$ and $k_2 = hf(x_i + c_2 h, u_i + b_{21} k_1)$. By using a mean-value point Taylor series expansion in two variables for k_2 , we get $k_2 = hf_1 + h^2 (c_2 f_x + b_{21} f_y) f_i$. Using these expressions for the k 's in the equation for u_{i+1} , we obtain equation 2.4c. By comparing the like powers of h from this expression and from the Taylor expansion, equations 2.4d result.

There are three equations and four unknowns, so we are free to choose one of them. Of course, a different second-order scheme will result from each choice of the free parameter. If we decide to choose the value of c_2 to be 0.5, the Runge-Kutta algorithm is $u_{i+1} = u_i + hf(x_i + 0.5h, u_i + 0.5hf_i)$. Or, if we choose $c_2=1$, $u_{i+1} = u_i + 0.5h[f_i + f(x_i + h, u_i + hf_i)]$. For both equations, $i=0,1,\dots,N-1$ and $u_0 = y_0$.

In this manner, it is possible to develop Runge-Kutta methods of any order by choosing an appropriate value for q . Table 1 shows the value for q for the order p that we choose. Note that from the form of the Runge-Kutta algorithm we will have to evaluate the differential function q times, so although we drastically reduce our error for a given step size by using a higher-order method, we do so at the expense of increased function evaluations.

RKG-4

The Runge-Kutta-Gill (RKG-4) scheme is an example of a fourth-order method. Rather than write out the equations in full as I did for the second-order methods, it is more convenient to write out the equations using a "summation" format and put the constants in a table. This is particularly useful when coding the algorithm because the constants may be put in arrays and the algorithm evaluated in a loop. The RKG-4 method is shown in summation format in equations 2.5; the constants are given in table 2.

Remember that one of the demands we make on any method we develop is for it to be able to give us an estimate of the magnitude of the error. Even if we intend to obtain a method that will control the error to within set limits, we need to have a method to evaluate the error. Of course, any scheme based on a knowledge of the form of the analytical solution is out of the question. An estimate of u_{i+1} using a step size of $h/2$ would be more accurate than one based on a step size of h . If the estimate based on $h/2$ is u_{i+1}^* , then an estimate of the error would

(continued)

be: $e_{i+1} = u^*_{i+1} - u_{i+1}$. This would certainly work but would not be very efficient. Table 3 shows why this is so. The number of function evaluations per step is quite high with this scheme. For example, the RKG-4 method that required only 4 function evaluations per step now requires 11 to estimate the error.

RKF-4

A more efficient method is the Runge-Kutta-Fehlberg fourth-order (RKF-4) scheme (see reference 4), which uses a higher-order formula to estimate u^*_{i+1} than the one used to compute u_{i+1} . Using the generalized summation format, the RKF-4 formulas are written as shown in equations 2.6a, with the usual equation for k_j and using the constants given in table 4. Now we have two vectors, a and a^* , for the evaluation of u_{i+1} and u^*_{i+1} , respectively. Also, there is an additional vector, e , that contains the constants used in evaluating the error term and is the vector resulting from the subtraction of a from a^* . Therefore, u^*_{i+1} never actually needs to be evaluated; the error is obtained directly from equation 2.6b.

The interesting point about this scheme is that, although five function evaluations are required for a fourth-order accurate u_{i+1} , only a total of six function evaluations are required for u_{i+1} and the error estimate since the k 's need to be evaluated only once (unlike in the half-step-size error-estimation method). The Fehlberg method's forte is the significant reduction in function evaluations required to estimate the error.

RKV

The Fehlberg technique may be extended to higher-order methods by suitable choice of parameters in the Runge-Kutta algorithm. J. H. Verner (see reference 5) has developed a number of schemes based on this technique. Constants for fifth- and seventh-order methods are given in tables 5 and 6 (RKV-5 and RKV-7), respectively. If you use the Fehlberg fourth-order method to evaluate a quadrature, it will fail because the

error estimate will always be zero. The Verner methods avoid this problem.

Armed with this theoretical information, we are now in a position to develop a working algorithm and code to solve a system of initial-value ordinary differential equations.

DEVELOPMENT OF A WORKING ALGORITHM

[Editor's note: Mr. Thomas has provided FORTRAN source code for a fourth-order Fehlberg method and fifth- and seventh-order Verner method Runge-Kutta subroutines, complete with documentation. In addition, he has provided three applications calling routines: One solves the radioactivity problem discussed later, the second involves temperature versus rate of reaction in a chemical reactor, and the third calculates the orbit of a satellite. All examples are discussed in a text file included on disk. Not only do the sample calling routines demonstrate the proper form for such routines, they are of interest in their own right. The programs are available on disk as explained in Disks and Downloads on page 346, for downloading via modem from BYTEnet Listings at (617) 861-9764, or in hard copy by writing BYTE, POB 372, Hancock, NH 03449.]

Usually, we will want to obtain numerical values for the solution at a number of (normally equispaced) values of the independent variable. For example, if we are interested in the region from $x=0$ to $x=1$, we might want to know intermediate values at $x=0.1$, $x=0.2$, and so on, right up to $x=1$. We could do this by repeated calls to the solver. Starting at, say, $x=0$, we predict a value at $x=0.1$, then use this as a new starting point for the interval from $x=0.1$ to $x=0.2$. However, we need to evaluate the constants in the Runge-Kutta algorithm only once so long as we do not change the order of the method we are using. Therefore, the first thing we do on the initial call to the solver is evaluate the constants. This simply involves evaluating the fractions that are given in tables 4, 5, or 6 and assigning them to the appropriate variables. It is necessary to prevent reevaluation of the constants on each successive call to the solver, unless the order of the

(continued)

RESPONSE OF A SYSTEM TO COMPLEX DRIVING FORCES

BY DAVID M. LEO

The vibration of a nonlinear spring-mass-damper system is most often calculated by numerical integration on a digital computer. I originally wrote the Onebody program (listing A) to calculate the motion of a linear spring-mass-damper system due to complex driving forces, although it may be used to show the effects of nonlinear spring and damper reaction forces as well. The program is written in terms of arrays, so it is easy to model larger systems (more masses) with relatively minor modifications.

I analyzed the system shown in figure A with the program. The spring constant is nonlinear, as it increases rapidly beyond a certain displacement. The Coulomb damping force has constant magnitude, but always opposes the velocity. The driving force $F(t)$ may be any function of time that you can specify in BASIC. Certain discontinuous forces, however, require experience in manipulating the integration time step to avoid numerical instabilities.

To perform the calculation, the program simulates an analog model of the system, also shown in figure A. The integrators shown in the model are simulated on the digital computer by a fourth-order Runge-Kutta algorithm. The output is written to a file, OUT.DAT, in the form: Driving force, velocity, displacement, driving force, velocity, displacement, etc. Plotting the data must be done with a separate routine that would use OUT.DAT for data.

Figures B and C show the displacement, $X(2)$, and the driving force, $FNX(T)$, as functions of time for two simple cases. The remark statements in the program should guide you in making modifications for other cases of interest.

David M. Leo (c/o BYTE, 70 Main St., Peterborough, NH 03458) is senior engineer for a large turbine manufacturer. His area of specialization is vibrations and stress in turbomachinery.

Listing A: The fourth-order Runge-Kutta BASIC program used by the author to produce the data for figures B and C. With the default values, the program's run time is about 5 minutes on an IBM PC.

```

10 REM N = THE NUMBER OF INTEGRATORS
20 REM V(I) = INTEGRATOR INPUTS
30 REM X(I) = INTEGRATOR OUTPUTS
40 REM X(1) = VELOCITY; X(2) = DISPLACEMENT
50 REM C = THE DAMPING CONSTANT
60 REM M = MASS; K = SPRING CONSTANT
70 REM TMIN = TIME AT WHICH PRINTING TO OUTPUT
   FILE BEGINS
80 REM TMAX = TIME AT WHICH PRINTOUT ENDS
90 REM DT = TIME STEP SIZE
100 REM *****
110 OPEN"OUT.DAT" FOR OUTPUT AS #1
120 N=2:C=1500:M=2:K=100000!
130 DIM X(N),K1(N),K2(N),K3(N),K4(N),DUM(N),V(N)
140 DT=.0001:TMIN=DT:TMAX=500*DT
150 REM FNX(T) IS THE DRIVING FORCE
160 DEF FNX(T)=5000*(SIN(200*T))^5
170 REM NEXT ARE THE INITIAL CONDITIONS ON
   VELOCITY,X(1),AND DISPLACEMENT X(2)
180 X(1)=.001:X(2)=.001
190 REM NEXT IS THE EQUATION FOR THE INPUT TO
   INTEGRATOR #1
200 REM IN THIS CASE, THERE IS COULOMB DAMPING
210 V(1)=(FNX(T)-K*X(2)-C*SGN(X(1)))/M:V(2)=X(1)
220 REM NEXT ARE THE STEPS IN THE INTEGRATION
   ACROSS ONE TIME STEP
230 COUNT=COUNT+1:IF COUNT=2 THEN 260:IF COUNT=3
   THEN 270:IF COUNT=4 THEN 280
240 FOR I= 1 TO N:K1(I)=DT*V(I):NEXT I
250 T=T+DT/2:FOR I=1 TO N:DUM(I)=X(I):
   X(I)=DUM(I)+K1(I)/2:NEXT I:IF COUNT=1 THEN 210
260 FOR I= 1 TO N:K2(I)=DT*V(I):
   X(I)=DUM(I)+K2(I)/2:NEXT I:IF COUNT=2 THEN 210
270 FOR I=1 TO N:K3(I)=DT*V(I):X(I)=DUM(I)+K3(I):
   NEXT I:T=T+DT/2:IF COUNT=3 THEN 210
280 FOR I=1 TO N:K4(I)=DT*V(I):
   X(I)=DUM(I)+(K1(I)+K4(I))/6+(K2(I)+K3(I))/3:
   NEXT I
290 REM NEXT STEPS APPROXIMATE STATIC/DYNAMIC
   FRICTION
300 IF ABS(X(1))>.5 THEN 330
310 C=3000
320 GOTO 340
330 C=1500
340 IF X(2)>1! THEN 440
350 REM FROM RUNNING THIS A FEW TIMES, WE EXPECT
   ABS(DISPLACEMENT) < .030
360 REM OVER THIS RANGE, THE NONLINEAR SPRING
   RATE CAN BE APPROXIMATED AS FOLLOWS:
370 K=100000!+300000!*(SIN(50*X(2)))^4
380 IF T<TMIN THEN 210
390 PRINT #1,FNX(T):FOR I=1 TO N:PRINT #1,X(I):
   NEXT I
400 IF T>TMAX THEN 420
410 GOTO 210
420 CLOSE
430 GOTO 450
440 PRINT" DIVERGENT OSCILLATION ENCOUNTERED"
450 END

```

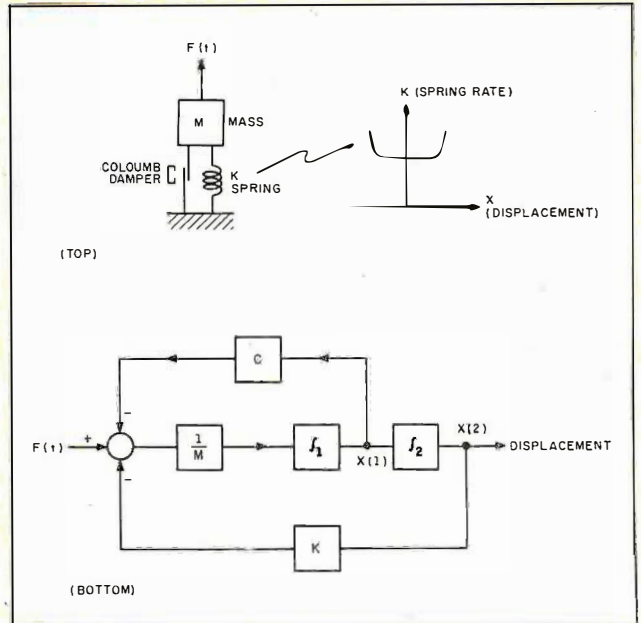

Figure A: The top of this figure shows a mechanical model of a damped spring-mass system. The bottom shows a block diagram of an analog model equivalent to the mechanical model.

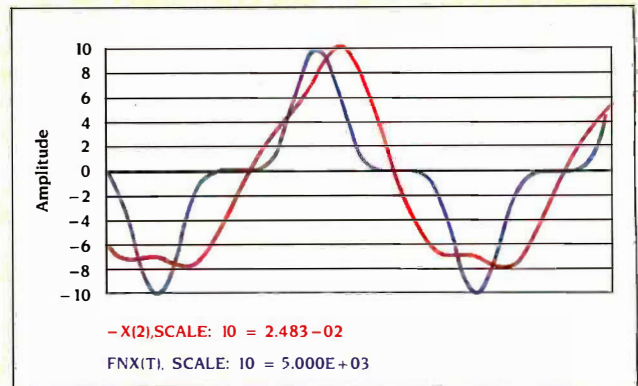

Figure B: A graph of displacement (X(2)) and driving force (FNx(T)) versus time for the startup of the system with Coulomb damping.

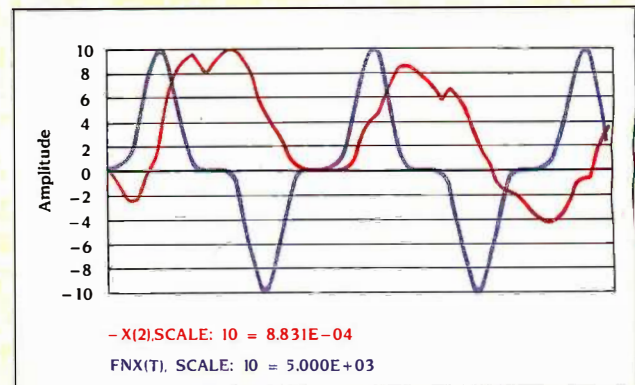

Figure C: A graph of displacement (X(2)) and driving force (FNx(T)) versus time for a system with Coulomb damping and nonlinear spring force.

method is being changed.

Since the Fehlberg/Verner schemes use a higher-order method to estimate u_{i+1}^* , we can cheat a little and use the value for u_{i+1}^* in place of u_{i+1} . This will give us a better estimate and now e_{i+1} will represent an upper bound on the error.

If we examine the vectors a , a^* , and e in tables 4, 5, and 6, we see that there are a number of zero elements in them. The number of zeros increases for the higher-order methods. Because of this, the most efficient way of predicting u_{i+1} is to evaluate the expressions for the k 's in a loop and then evaluate the Runge-Kutta expression for u_{i+1} as one straight equation (i.e., not in a loop). When evaluating

our constants, we will set $a1=a^*(1)$, $a2=a^*(2)$, and so on; $er1=e(1)$, $er2=e(2)$, and so on. The matrix B in the tables have no row 1, and to avoid having an entire row of zeros we store the elements in our working matrix B of size $j-1$ by $j-1$, so that $b_{work}(j-1,m) = b_{table}(j,m)$. The matrix B is lower triangular, so storage of this in a square matrix is not space-efficient. However, the extra space used is not enormous, and in FORTRAN we do not have much choice. For a system of NEQN equations, a procedure for predicting values of u_{i+1} , using the RKF-4 method, given a value for u_i at x_i , and a step size h , would look something like that shown in listing 1.

For the Fehlberg method, q equals

6. Since the code for predicting u_{i+1} using any of the higher-order methods is the same other than the expressions for u_{i+1} and e_{i+1} , the listing 1 code could be modified to include those expressions. In that case, q would be passed in as an input parameter as well as an integer, say IMETH, which would select the order.

STEP SIZE

The code also needs some way of controlling the errors. As we saw earlier, the error is a function of the step size, so one way would be to choose a very small step size for all problems. This is terribly inefficient, since some equations would only require a step size larger than any "safe" lower limit we might specify. Another problem would be that for a given step size, the nature of the differential equations would yield different magnitudes of error. In fact, the step-size requirements for a given differential equation may change over the interval we are interested in.

The best strategy for controlling the error would be to devise an algorithm that, given an error-tolerance limit (a limit on the error we would like to see), would continuously adjust the step size so that the error was kept within that limit. But how do we decide by how much to adjust the step size? One way would be to relate it to the error and keep changing the step size until we obtain an error below the tolerance limit.

It is possible to obtain a scheme based on some semitheoretical arguments. Suppose we have just made a step from (x_i, y_i) to $(x_{i+1}, y_{i+1})_E$ with a step size of h , using a p th-order method. The error at this new point would be: $e_{i+1} = S(h^{(p+1)})$, where $S =$ some function of step size.

If we specify an error-tolerance limit of TOL, there will be some optimum step size that would give us exactly this error had we taken a step of this size from (x_i, y_i) to a point $(x_{i+1}, y_{i+1})_T$. This optimum step size will be a fraction or a multiple (v) of the actual step size h that we used. It would be related to TOL by: $TOL = S(vh)^{(p+1)} =$

(continued)

Table 1: The minimum value for q in the Runge-Kutta summation equations for a given order p .

p	2	3	4	5	6	...
q	2	3	4	6	8	...

Table 2: The constants for the Runge-Kutta-Gill fourth-order method.

$j \setminus m$	c	$B(j,m)$			
		1	2	3	4
1	0				
2	$\frac{1}{2}$	$\frac{1}{2}$			
3	$\frac{1}{2}$	$\frac{\sqrt{2}-1}{2}$	$\frac{2-\sqrt{2}}{2}$		
4	1	0	$\frac{-\sqrt{2}}{2}$	$\frac{2+\sqrt{2}}{2}$	
$a(j)$		$\frac{1}{6}$	$\frac{2-\sqrt{2}}{6}$	$\frac{1}{6}$	$\frac{2+\sqrt{2}}{6}$

Table 3: The minimum number of function evaluations per step (f/step) required to obtain an error estimate using the half-step-size strategy for a given order p .

p	2	3	4	5	6	...
f/step	2	3	4	6	8	...

BetterBASIC, Version 2.0

Runs Existing BASIC Programs

"I write a lot of complicated mathematical models for air pollution control. I have used FORTRAN for its speed, and BASIC for its text handling and graphics, but now I use BetterBASIC for all three. Most of the programs require dozens of different parameters, and BetterBASIC's modular structure allows me to have common routines resident while designing the input forms."

"I have recommended BetterBASIC to my coworkers, and I recommend it to you."

Phil A. Lawless, Ph.D. • Research Triangle Park, NC

ACCESS FULL MEMORY—

BetterBASIC accesses the full memory of the computer enabling you to overcome Microsoft's 64K barrier.

INTERACTIVE

COMPILER—BetterBASIC compiles to an intermediate code giving you five to six times the speed of traditional BASICs. There is immediate feedback on line entry.

COMPATIBLE—Version 2.0 of BetterBASIC is GW-BASIC, PC-BASICA compatible when running on IBM

PCs. BetterBASIC is easy to learn because the syntax is the same.

STRUCTURE—Create well-organized programs using procedures and functions that are easily identified and understood.

NOT COPY PROTECTED—Install BetterBASIC on your hard disk. BetterBASIC is licensed to the programmer, so you can compute at work and at home using the same copy of BetterBASIC.

USER DEFINED KEYWORDS—The BetterBASIC language can be extended by adding your own procedures and functions to the language as keywords.

RUNTIME SYSTEM—Creates stand-alone EXE. files. Developers can distribute their programs written in BetterBASIC without royalties.



SAMPLE DISK—Contains a tutorial, a demo, and allows you to use an abbreviated form of BetterBASIC. It also contains a 60 page on-line mini manual.

AND MORE—Such as DOS and BIOS ROM calls, Chaining, Overlays, Local and Global Variables, Recursion—Graphics and Windows—You can define up to five windows. Optional 8087/80287 Math Chip Support. LIBRARIES—Write reusable code.

TECHNICAL SUPPORT—

Available to all registered users.

BetterBASIC Runs on IBM PC, XT, AT and all IBM-compatibles. Ask your local dealer for BetterBASIC or call **1-800-225-5800**.

In Canada call 416-469-5244. Also available for the Tandy 1000, 1200 and 3000 at Tandy/Radio Shack stores.

PRICES:

Better BASIC	\$199
8087/80287 Math Module	\$99
Runtime System	\$250
Sample Disk with Tutorial	\$10

Better **BASIC.**

Because It's The Best.

Summit Software Technology, Inc.™ • Inquiry 327

106 Access Road, Norwood, MA 02062

MasterCard, Visa, Checks, Money Order, C.O.D. accepted and P.O. on approval.

BetterBASIC is a registered trademark of Summit Software Technology Inc.

IBM PC, XT, AT, are registered trademarks of International Business Machines Corp. Tandy is a registered trademark of Tandy Corp.

(If you're using BetterBASIC and would like to be featured in one of our ads, please write to the Director of Advertising at Summit.)

Table 4: The constants for the Runge-Kutta-Fehlberg fourth-order method.

$j \setminus m$	c	$B(j,m)$					
		1	2	3	4	5	6
1	0						
2	$\frac{1}{4}$	$\frac{1}{4}$					
3	$\frac{3}{8}$	$\frac{3}{32}$	$\frac{9}{32}$				
4	$\frac{12}{13}$	$\frac{1932}{2197}$	$-\frac{7200}{2197}$	$\frac{7296}{2197}$			
5	1	$\frac{439}{216}$	-8	$\frac{3680}{513}$	$-\frac{845}{4104}$		
6	$\frac{1}{2}$	$-\frac{8}{27}$	2	$-\frac{3544}{2565}$	$\frac{1859}{4104}$	$-\frac{11}{40}$	
$a(j)$		$\frac{25}{216}$	0	$\frac{1408}{2565}$	$\frac{2197}{4104}$	$-\frac{1}{5}$	
$a^*(j)$		$\frac{16}{135}$	0	$\frac{6656}{12825}$	$\frac{285161}{56430}$	$-\frac{9}{50}$	$\frac{2}{55}$
$e(j)$		$\frac{1}{360}$	0	$-\frac{128}{4275}$	$-\frac{2197}{75240}$	$\frac{1}{50}$	$\frac{2}{55}$

Table 5: The constants for the Runge-Kutta-Verner fifth-order method.

$j \setminus m$	c	$B(j,m)$							
		1	2	3	4	5	6	7	8
1	0								
2	$\frac{1}{18}$	$\frac{1}{18}$							
3	$\frac{1}{6}$	$-\frac{1}{12}$	$\frac{1}{4}$						
4	$\frac{2}{9}$	$-\frac{2}{81}$	$\frac{4}{27}$	$\frac{8}{81}$					
5	$\frac{2}{3}$	$\frac{40}{33}$	$-\frac{4}{11}$	$-\frac{56}{11}$	$\frac{54}{11}$				
6	1	$-\frac{369}{73}$	$\frac{72}{73}$	$\frac{5380}{219}$	$-\frac{12285}{584}$	$\frac{2695}{1752}$			
7	$\frac{8}{9}$	$-\frac{8716}{891}$	$\frac{656}{297}$	$\frac{39520}{891}$	$-\frac{416}{11}$	$\frac{52}{27}$	0		
8	1	$\frac{3015}{256}$	$-\frac{9}{4}$	$-\frac{4219}{78}$	$\frac{5985}{128}$	$-\frac{539}{394}$	0	$\frac{693}{3328}$	
$a(j)$		$\frac{3}{80}$	0	$\frac{4}{25}$	$\frac{243}{1120}$	$\frac{77}{160}$	$\frac{73}{700}$		
$a^*(j)$		$\frac{57}{640}$	0	$-\frac{16}{65}$	$\frac{1337}{2240}$	$\frac{121}{320}$	0	$\frac{891}{8320}$	$\frac{2}{35}$
$e(j)$		$\frac{33}{640}$	0	$-\frac{132}{325}$	$\frac{891}{2240}$	$-\frac{33}{320}$	$-\frac{73}{700}$	$\frac{891}{8329}$	$\frac{2}{35}$

$\nu^{(p+1)} S(\hat{h}^{(p+1)}) = \nu^{(p+1)} e_{i+1}$. From this we get: $\nu = |\text{TOL}/e_{i+1}|^{(1/p+1)}$. This equation is from C. W. Gear (see reference 6). Using a slightly different argument, L. W. Johnson (see reference 7) shows that ν is given by: $\nu = |\text{TOL}/e_{i+1}|^{(1/p)}$.

The factors affecting the choice between these two equations are discussed in the text file called Examples, included on disk. The ν is a step-size adjustment factor that tells us (after the fact) what would have been the optimum step size to have used. If we stick to absolute values on TOL and e_{i+1} , then ν is always positive. If ν is greater than 1, then we know that we could have used a larger step size than the one we just used, so the error at $(x_{i+1}, y_{i+1})_E$ is less than TOL. On the next step to (x_{i+2}, y_{i+2}) we can hopefully use the larger step size. On the other hand, if ν turns out to be less than 1, we know that we should use a smaller step size, and also that the error at $(x_{i+1}, y_{i+1})_E$ will be greater than TOL. We will have to go back to (x_i, y_i) and try again with the reduced step size (νh). Since the error e_{i+1} is specific to the point $(x_{i+1}, y_{i+1})_E$, there is no guarantee that using this reduced step size to reach the point $(x_{i+1}, y_{i+1})_T$ will result in an error less than TOL. We can only recalculate ν at this new point and keep repeating the process until we have made a successful step.

We now have the basis for developing a successful step-size strategy. But before we actually do so, we have to place some additional constraints on the algorithm to prevent a number of problems that may turn up. Most of these constraints have been developed over the years by researchers who have worked in this area of numerical analysis, and are based on semitheoretical arguments and a great deal of trial-and-error analyses.

Remember that we are adjusting our step size by the magnitude of the truncation error, but are attempting to control the global error. Therefore, the common practice is to aim for a truncation error per unit step of $\text{TOL}/2$, in the hope that this will lead to a global error of the same order of magnitude as TOL (see reference 8). If we replace TOL by $\text{TOL}/2$ in the equation for ν ,

we in effect scale ν by $(1/2)^{(1/p+1)}$. Then the best step size to take is actually $s \times \nu \times h$, where s is the scaling factor on ν . For a fourth-order method, s should be 0.871. The use of a scaling factor on ν also has the effect of keeping down the number of rejections in the choice of step size. If the next step size h_{new} were defined by $h_{new} = \nu h_{old}$, it

is likely that h_{new} would frequently be too large (since it is based on information at (x_{i+1}, y_{i+1}) , and this would mean repredicting the next value of y , (y_{i+2}) , using a reduced step size. In this case, the scaling factor is also a safety margin on how much we allow the step size to grow. By trial-and-

(continued)

Lattice® Works

VERSION 3 OF THE LATTICE MS-DOS C COMPILER IS NOW AVAILABLE.

This is a major upgrade of the product and is available to registered users for a \$45 update fee. Non-registered \$60. The list price remains \$500.

New compiler features include:

- *ANSI language constructs*. □
"unsigned" as a modifier
"void" data type
"enum" data type
structure assignments, arguments, and returns
argument type checking
- *Inline code 8087/80287*
80186/80286
- *Code generation*

The compiler also contains numerous improvements such as better aliasing algorithms, more efficient code generation, and more flexible segmentation. The library includes more than 200 new functions in the following categories:

- *ANSI/UNIX/XENIX compatibility*
- *Extended support for MS-DOS*
- *Extended support for networking, including file sharing, file locking, and I/O redirection*
- *Flexible error handling via user traps and exits*

The Library has also been re-engineered to produce much smaller executables.

LATTICE ANNOUNCES NEW DATA ENCRYPTION SOFTWARE

Now you can keep your confidential data confidential. Thanks to new SecretDisk, a new data encryption system for IBM PC, XT, AT and compatibles.

Utilizing the NBS Data Encryption Standard, SecretDisk provides complete security for salaries, customer lists, or other sensitive information stored on a floppy or hard disk. SecretDisk is loaded as a disk driver by MS-DOS. It creates new DOS drives (like D:) on floppy or hard disks where all data and programs are always fully encrypted.

SecretDisk is extremely easy to use. A password is entered when the system is booted, and protection can be switched on and off with a single password controlled command line. However, without the password, there is no way to access the encrypted files. \$59.95.

LATTICE CREATES C COMPILER FOR COMMODORE AMIGA

Amiga C, produced by Lattice for the Commodore Amiga, supports the Amiga's 68000 microprocessor and offers the same high speed and extensive capabilities of the MS-DOS Lattice C compiler currently used by more than 30,000 software developers worldwide. Available from both Commodore and Lattice. \$149.95.

In addition, Lattice also offers cross compilers that allow you to develop Amiga programs on MS-DOS. Native and Cross \$250.

Contact Lattice, to discuss your programming needs. Lattice provides C compilers and cross compilers for many environments including Tandy, Sony, Hewlett-Packard, Tandem, and IBM Mainframe. Corporate license agreements available.



Lattice

(312) 858-7950 TWX 910-291-2190

INTERNATIONAL SALES OFFICES:

Benelux: De Vooght. (32) 2-720-91-28.

Japan: Lifeboat Inc. (03) 293-4711

England: Roundhill. (0672) 5-1675

France: SFL. (1) 46-66-11-55

RUNGE-KUTTA METHODS

error it has been determined that the best formula for s (if it must also provide this restraint on v) is $(1/2)^{(1/p-1)}$. This gives a value of approximately 0.8 for the fourth-order method, which is in agreement with the value suggested by Johnson (see reference 7). The fifth- and seventh-order methods use values for s based on this formula of approximately 0.841 and 0.891, respectively.

To prevent the step size from swing-

ing wildly from large to small and back to large, it is recommended (see reference 1) that $s \times v$ be constrained so that it is not less than 0.1 and not greater than v_{lim} . This may be likened to a damping factor on the step-size adjuster. For a fourth-order method, v_{lim} is $3/s$ ($\cong 3.78$) and is more conservative than the value of 5 suggested by Shampine and Gordon in reference 1. Values of $4/s$ and $5/s$ were found to work best for the fifth- and seventh-

order methods, respectively.

In addition, if the step just taken (h_{old}) involved a reduction in the predicted step size, it is advisable to restrict the maximum possible size of the next step h_{new} to h_{old} . This also helps prevent oscillations in the step size.

It is clear that we will run into problems if the step size we choose gives an error of zero. A zero error might result because it is possible that we

Table 6: The constants for the Runge-Kutta-Verner seventh-order method.

$j \setminus m$	c	$B(j,m)$									
		1	2	3	4	5	6	7	8	9	10
1	0										
2	$\frac{1}{4}$	$\frac{1}{4}$									
3	$\frac{1}{12}$	$\frac{5}{72}$	$\frac{1}{72}$								
4	$\frac{1}{8}$	$\frac{1}{32}$	0	$\frac{3}{32}$							
5	$\frac{2}{5}$	$\frac{106}{125}$	0	$-\frac{408}{125}$	$\frac{352}{125}$						
6	$\frac{1}{2}$	$\frac{1}{48}$	0	0	$\frac{8}{33}$	$\frac{125}{528}$					
7	$\frac{6}{7}$	$-\frac{1263}{2401}$	0	0	$\frac{39936}{26411}$	$-\frac{64125}{26411}$	$\frac{5520}{2401}$				
8	$\frac{1}{7}$	$\frac{37}{392}$	0	0	0	$\frac{1625}{9408}$	$-\frac{2}{15}$	$\frac{61}{6720}$			
9	$\frac{2}{3}$	$\frac{17176}{25515}$	0	0	$-\frac{47104}{25515}$	$\frac{1325}{504}$	$-\frac{41792}{25515}$	$\frac{20237}{145800}$	$\frac{4312}{6075}$		
10	$\frac{2}{7}$	$-\frac{23834}{180075}$	0	0	$-\frac{77824}{1980825}$	$-\frac{636635}{633864}$	$\frac{254048}{300125}$	$-\frac{183}{7000}$	$\frac{8}{11}$	$-\frac{324}{3773}$	
11	1	$\frac{12733}{7600}$	0	0	$-\frac{20325}{5225}$	$\frac{456485}{80256}$	$-\frac{42509}{7125}$	$\frac{339227}{912000}$	$-\frac{1029}{4180}$	$\frac{1701}{1408}$	$\frac{5145}{2432}$
12	$\frac{1}{3}$	$-\frac{27061}{204120}$	0	0	$\frac{40448}{280665}$	$-\frac{1353775}{1197504}$	$\frac{17662}{25515}$	$-\frac{71681}{1166400}$	$\frac{98}{225}$	$\frac{1}{16}$	$\frac{3773}{11664}$
13	1	$\frac{11203}{8680}$	0	0	$-\frac{38144}{11935}$	$\frac{2354425}{458304}$	$-\frac{84046}{16275}$	$\frac{673309}{1636800}$	$\frac{4704}{8525}$	$\frac{9477}{10912}$	$-\frac{1029}{992}$
$a(j)$		$\frac{13}{288}$	0	0	0	0	$\frac{32}{125}$	$\frac{31213}{144000}$	$\frac{2401}{12375}$	$\frac{1701}{14080}$	$\frac{2401}{19200}$
$a^*(j)$		$\frac{31}{720}$	0	0	0	0	$\frac{16}{75}$	$\frac{16807}{79200}$	$\frac{16807}{79200}$	$\frac{243}{1760}$	0
$e(j)$		$-\frac{1}{480}$	0	0	0	0	$-\frac{16}{375}$	$-\frac{2401}{528000}$	$\frac{2401}{132000}$	$\frac{243}{14080}$	$-\frac{2401}{19200}$

really do not have a truncation error at this step, or more likely, that the error is very small, and the machine sees the error as being zero due to round-off. This means that there is no problem with the step that we just took, but what do we do about the next step? If we used a value of zero for the error, we would in theory get an infinite range of step sizes for the next step, so an obvious policy to adopt in this case is to limit v to v_{lim} .

STABILITY CRITERIA

All Runge-Kutta methods (including the Euler method) have a range of step sizes beyond which the methods are unstable; that is, spurious results would be obtained from the algorithm. This becomes a problem with some types of differential equations and can be illustrated by solving the radioactivity problem $dN(t)/dt = -kN(t)$ with greatly varying values of the decay constant k .

It is possible to dedimensionalize the equation. In this case the equation would be written as $dN^*/dt^* = -kN^*$, and $N^* = N(t^*)/N_0$.

Now, the dimensionless time, t^* , would vary from 0 to 1. The analytical solution to this problem, again using dimensionless variables, would be $N^*(t^*) = e^{(-kt^*)}$.

If we try to solve this problem using the Euler method, we would have to choose a step size such that $0 < = h k < = 2$ to solve it correctly. For the Runge-Kutta-Gill method, the step size would have to be chosen so that $0 < = h k < = 2.8$. Tables 7 and 8 show the effect of changing the step size on the global error in the numerical solution of the problem $y' = -5y$ and $y' = -25y$, respectively, using the Euler and RKG-4 methods.

The cause of this instability is the propagation error I mentioned earlier. This error propagates faster if the slope of the function we are tracking is changing rapidly, causing the global error in turn to escalate rapidly. Reducing the maximum possible step size has the effect of reducing the truncation error to a level at which the propagation-error component in the global error does not increase dramatically. From this we conclude that a higher-order method is preferable since the region of stability is increased, and also that, for a given method, reducing the step size sufficiently will get the method to operate within a region of stability. However, if we were to keep increasing the value of k , we would eventually reach a point at which any algorithm would be taking such small steps that the method would become unworkable in practice. Note that the stability con-

straints on the step size imply that neither the Euler nor RKG-4 method would ever be able to solve a radioactivity problem with a negative value of k (such a value for k is only mathematically possible). Stability criteria are much more difficult to establish for Fehlberg and Verner methods. For the example I have provided for BYTenet Listings, none of the three methods I used has any problems solving $y' = -25y$ over the interval $t = [0,1]$, but the relative error began to grow as $t=1$ was approached.

STIFFNESS

With a system of equations, one of the equations may change much more rapidly than the others. For example, a system of equations that describe a certain chemical reaction described in reference 9 is $y'_1 = -1000y_1 + y_2$ and $y'_2 = 1000y_1 - 2y_2$. The true solution is given in equations 2.7.

Notice that y_1 will rapidly decay to very small values, while y_2 will require a long time to decay to similar values. Because of this function, the algorithm is forced to choose extremely small step sizes to keep the errors within bounds and also to operate within a region of stability. A system of differential equations in which one or more differential equations have solutions that change so rapidly that the algorithm is forced to take prohibitively small steps to keep the error within bounds and the system stable is said to be a "stiff" system.

When we come up against stiffness in a system or instability in a single equation, there is very little we can do with the Runge-Kutta schemes described here other than to warn the user that the problem has arisen and stop the solver. If stiffness is encountered in a system, the step-size algorithm will try to meet error-tolerance specifications and maintain stability by drastically reducing the step size. If we specify a minimum possible step size h_{min} , then we can assume the system is stiff if the step size goes below this value. The h_{min} may be set by the program or by the user. A value of about 10^{-6} was found

(continued)

	: 11	: 12	: 13	:
0				
0	<u>729</u>			
	341			
<u>19</u>				
450				
0	<u>243</u>	<u>31</u>		
	1760	720		
<u>-19</u>	<u>243</u>	<u>31</u>		
450	1760	720		

to work reasonably well; however, an acceptable value of h_{min} will depend on the size of the interval and the degree of stiffness desired.

If the function being tracked is discontinuous over the range of interest, then our program must signal to the

user that all is not well. For example, the solution to the differential equation $y'=y^2$, where $y(0)=1$, is $y(x)=1/(1-x)$, which would have a discontinuity at $x=1$. So if we attempted to solve the equation over the range $x=0$ to $x=2$, a drastic reduction in the

step size would result as the algorithm attempted to track the rapidly varying function at the discontinuity, causing the step size to drop below h_{min} .

Setting a maximum possible step size h_{max} is also desirable, or the step size could grow indefinitely if we are solving over a large interval. The h_{max} is set to 0.5, 1.0, and 2.0, for the fourth-, fifth-, and seventh-order methods, respectively. These are just guideline figures. If these values are greater than the interval length, then h_{max} is set to the interval length. It is also possible to attempt to control the stability problem mentioned above, by imposing an upper limit on the step size. In this case a small number is used for h_{max} , but since the exact value is dependent on the nature of the problem, it is best to let the program use one of the guideline values or the interval width, with the ultimate choice for h_{max} left to the user.

IMPLICIT METHODS

If the Runge-Kutta algorithm is written a little differently, so that the summation for the k s now goes from 1 to j (instead of $j-1$ as we had before), we get a class of algorithms called implicit Runge-Kutta methods. The general summation equation for the k 's will be those shown in equation 2.8.

Now any k , say k_m will appear on both sides of the equation, so that an iterative scheme is required to solve for k_m . It is therefore much more tedious to obtain a value for k_m and make a prediction for y_{i+1} using this scheme. But the advantage of implicit Runge-Kutta methods is that they are inherently stable over all ranges of step sizes for all problems. By using an implicit method, all the problems of instability with stiff equations are overcome. M. L. Michelsen (see reference 10) has developed an algorithm using a semi-implicit form of the Runge-Kutta method in which one ends up with a set of linear equations for the k 's. The parameters for the method have been chosen so that the equations for the k 's may be solved by a single matrix inversion, allowing a standard LU (lower-upper triangular)

(continued)

Listing 1: The procedure in pseudocode for predicting the values of u_{i+1} in the RKF-4 method.

```

for n=1 to NEQN
  K1(n)= h*fn(xi,ui(n))
  {by calling user's subroutine containing equations for y'(n)}
end.
for j=2 to q
  for n=1 to NEQN
    ksum=0
    for m=1 to (j-1)
      ksum = ksum + bj-1,m*Km(n)
    end.
    us(n)=ui(n)+h*ksum
  end.
  Kj(n) = fn(xi+h*cj, us(n)) [n=1,...,NEQN]
end.
for n=1 to NEQN
  ui+1(n)=ui+ h*(a1*K1(n) + a3*K3(n) + a4*K4(n)+a5*K5(n)+a6*K6(n))
  ei+1(n) = h*(er1*K1(n) + er3*K3(n)+er4*K4(n) + er5*K5+er6*K6(n))
end.

```

Listing 2: A FORTRAN subroutine to determine the machine epsilon.

```

$NOFLOATCALLS
$NODEBUG
$STORAGE:2
C*****
      subroutine caleps

C****  subroutine calculates the machine epsilon
C****  EPS using an algorithm adapted from
C****  Forsythe et. al. "Computer Methods for
C****  Mathematical Computations," Prentice-Hall
C****  (1977). The EPS calculated can differ
C****  from the true machine EPS by at most
C****  a factor of 2.

      double precision eps
      common /epsil/eps

      eps=1.d0
      eps=.5d0*eps
      10  if((eps+1.d0).GT.1.d0) goto 10
      c   write(*,*) 'Machine Epsilon used=',eps
      return
      end

```

STATGRAPHICS® ONE KEYSTROKE TURNS LIFELESS DATA...

NEW
VERSION 1.1

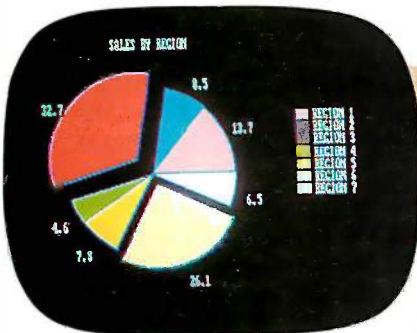

Row	X	Y	sales	temp	humidity	sales
1	43.1	4965	10.1	2.815	42000	
2	36.1	1890	10.2	2.872	22000	
3	32.8	1995	10.3	18.755	84500	
4	38.4	30206	16.0	2.72	110	
5	36.1	1920	16.1	2.815	110	
6	18.9	4325	16.2	2.855	4600	
7	18.4	3735	16.3	2.285	550	
8	20.2	3570	16.8	2.212	27500	
9	18.2	3355	16.7	2.922	31500	
10	23.5	3125	16.2	8.921	76800	
11	20.2	2965	16.9	5.784	12660	
12	25.1	2720	16.1	7.312	22300	
13	20.5	3450	16.7	7.541	56750	
14	18.4	3210	16.3	2.472	15000	

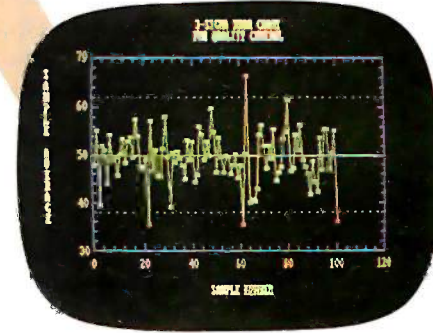
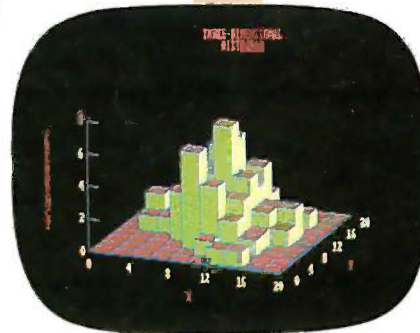
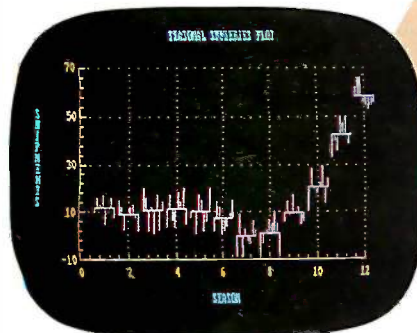
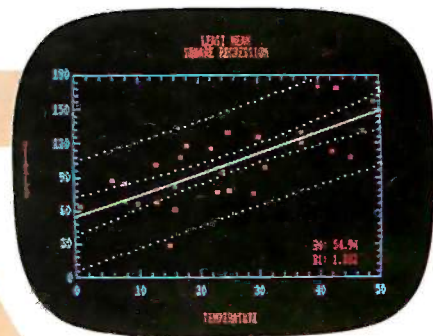

INTO VITAL STATISTICS.

Data. You live with it every day. What you need are the tools to make it come alive. Comprehensive analytical tools. Mathematical precision. And graphics capabilities to broaden your insights—to help you visualize, analyze, and communicate your findings quickly and convincingly.

And now you've got it. With STATGRAPHICS—a new PLUS*WARE™ product from STSC. STATGRAPHICS is the only PC software to fully integrate a wide variety of statistical functions with high-resolution color graphics. Giving you the power and precision you used to find only with mainframe software.

STATGRAPHICS' unique interactive environment allows you to generate graphs from within the statistical procedures. You can change a variable and see the effect—immediately. So your job is easier and you're more productive.

MORE OPTIONS FOR MORE COMPREHENSIVE ANALYSIS.

STATGRAPHICS features over 250 functions for analyzing data—including analysis of variance, regression analysis, experimental design, quality control procedures, multivariate techniques, nonparametric methods, and extensive forecasting and time series analysis.

It also lets you enter data at the keyboard or access data stored in standard ASCII files, LOTUS® 1-2-3 worksheets, and DIF files used by other popular software packages.

TELL A CLEARER, MORE DRAMATIC STORY.

STATGRAPHICS includes a wide variety of graphics programs such as two and three-dimensional line and surface plots, bar and pie charts, histograms, time sequence plots, and quality control charts.

The graphics are supported on color and monochrome graphics boards, dot-matrix printers, and pen plotters for presentation quality graphics.

SOPHISTICATED STATGRAPHICS IS SURPRISINGLY SIMPLE TO USE.

STATGRAPHICS is completely menu-driven, and includes a comprehensive user's guide, online HELP screens, tutorial, and handy reference card. And STSC's HELP-Line is only a phone call away—giving you ready access to our staff of technical experts.

TAKE A LOOK AT STATGRAPHICS. AND LOOK NO FURTHER.

STATGRAPHICS is the most advanced statistical graphics software available for PC's. And the complete system is just \$695.

To order STATGRAPHICS, or for more information, contact your local dealer or call 800-592-0050 (in Maryland, 301-984-5123). Or write STSC, Inc., 2115 E. Jefferson St., Rockville, MD 20852. Major credit cards accepted.

Inquiry 326

Problem-solving at the speed of thought.

RUNGE-KUTTA METHODS

decomposition technique to be used for their solution. This method has been shown to be stable for any type of IVP. However, the code for this method is involved, and a full discussion of this method is beyond the scope of this article.

SETTING ERROR TOLERANCE

If the solutions sometimes come close to zero, defining an absolute error tolerance (TOLA) on y as described previously is difficult because an extremely small value will be required around $y=0$ and a not-so-small value away from zero. This situation

may be avoided by defining a relative error tolerance TOLR on y , so that $TOLA = TOLR \times y$. Some equations are solved more easily by defining an absolute error tolerance, so we provide a mixed error tolerance. That is, $TOL = TOLA + TOLR$.

MACHINE ACCURACY LIMITS

$F(x, Y)$ has to be evaluated at points such as $(x+h/4, y+hk_1/4)$, and h must be large enough so that the numbers x and $x+h/4$ are different in machine arithmetic. The smallest step taken on x is $h/18$ in the fifth-order method, so we need x and $x+h/18$ to be distin-

guishable on the machine ($x+h/18 > x$). For this to be the case, we must always have $h/(18x)$ be greater than the smallest positive real number representable on the machine without an exponent. This number, usually called machine epsilon (EPS), is also defined as the smallest positive number such that $1 + EPS > 1$. EPS is dependent upon the machine, the compiler, and even the word length of the real-number representation being used. A FORTRAN subroutine that determines EPS to at most a factor of 2 of the "true" EPS is shown in listing 2.

(continued)

Table 7: The propagation of global error on the numerical solution of $y' = -5y$ using the Euler and Runge-Kutta-Gill methods.

ABSOLUTE GLOBAL ERROR ON $y(t^*)$

t^*	Analytical solution	Euler method		Runge-Kutta-Gill method	
Step size		0.01	0.0002	0.01	0.00125
0.0	1.000000E + 00	0.00000	0.00000	0.00000	0.00000
0.2	0.367879E + 00	0.02553	0.5002E - 03	-0.5430E - 07	-0.1278E - 10
0.4	0.135335E + 00	0.05042	0.1000E - 02	-0.1086E - 06	-0.2555E - 10
0.6	0.497871E - 01	0.07466	0.1500E - 02	-0.1629E - 06	-0.3831E - 10
0.8	0.183156E - 01	0.09829	0.1999E - 02	-0.2172E - 06	-0.5107E - 10
1.0	0.673795E - 02	0.12130	0.2499E - 02	-0.2715E - 06	-0.6383E - 10
Total function evaluations		100	5000	400	3200

Table 8: The propagation of global error on the numerical solution of $y' = -25y$ using the Euler and Runge-Kutta-Gill methods.

ABSOLUTE GLOBAL ERROR ON $y(t^*)$

t^*	Analytical solution	Euler method		Runge-Kutta-Gill method	
Step size		0.01	0.0002	0.01	0.00125
0.0	1.000000E + 00	0.00000	0.00000	0.00000	0.00000
0.2	0.67379E - 02	0.5294	0.01246	-0.2006E - 03	-0.4079E - 07
0.4	0.453999E - 04	0.7785	0.02477	-0.4012E - 03	-0.8157E - 07
0.6	0.305902E - 06	0.8957	0.03693	-0.6019E - 03	-0.1224E - 06
0.8	0.206115E - 08	0.9509	0.04893	-0.8026E - 03	-0.1631E - 06
1.0	0.138879E - 10	0.9769	0.06078	-0.1003E - 02	-0.2039E - 06
Total function evaluations		100	5000	400	3200

A COMPUTER PROGRAM THAT SPEAKS YOUR LANGUAGE

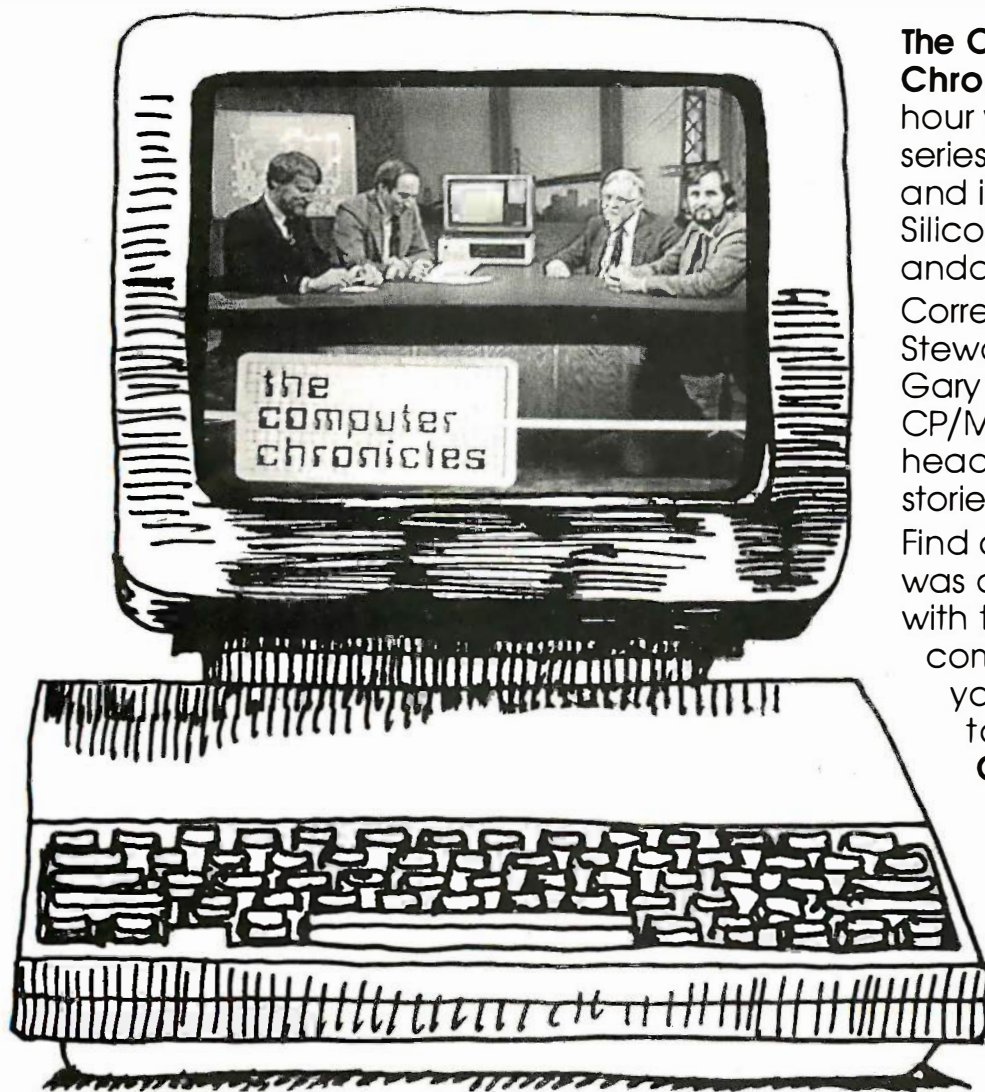

The Computer Chronicles, a half-hour weekly television series brings you news and information from Silicon Valley and around the world. Correspondent Stewart Cheifet and Gary Kildall, creator of CP/M cover today's headlines and the stories behind them. Find out what is, what was and what will be, with the only computer program you're ever going to need. **The Computer Chronicles**, every week on a public television station near you. (Check local listings for time and channel.)

Produced by KCSM, San Mateo, CA and WITF, Harrisburg, PA with funding from AFIPS and McGraw-Hill's **BYTE** magazine.



The machine epsilon is an indicator of the attainable accuracy in a floating-point number system. The higher the value of EPS, the larger will be the effects of round-off error. We need $(h/18|x|) > \text{EPS}$ to prevent severe round-off error. Following the recommendation in reference 1, the

machine epsilon used by the algorithm is set to $20 \times \text{EPS}$ for reasons of safety.

SUMMARY OF THE ALGORITHM

Finally, figure 3 summarizes everything I have said so far (plus shows a few extra trivial constraints) in a gen-

eralized algorithm for an explicit variable-step Runge-Kutta method that I call RUNKUT__SOLVER.

My FORTRAN program (available on BYTenet Listings) is based on this algorithm and has been written to solve IVPs. The program can solve any number of coupled equations, the limitation being the amount of memory available. The code consists of three main subroutines: RUNKUT, which is the solver, RKP, which is the predictor subroutine, and RKCONST, which sets all the constants. RUNKUT is called from the user's program, which also selects the order of the method to be used. The code has a number of refinements over the rudimentary algorithm outlined in figure 3. For example, it allows negative step sizes ($x_b < x_a$) and it uses a "workspace" array that frees the user from having to make a large number of array declarations in the calling program. The order of the method being used may be changed while solving a given system of equations.

CONCLUSIONS

Runge-Kutta methods are an efficient and accurate way of solving IVPs. The advantage of Runge-Kutta methods over multistep formulas is that changing the step size is not as costly in terms of time. This allows the step size to be better adapted to the nature of the function. Runge-Kutta methods are also faster for nonstiff problems. The stability problems of the Runge-Kutta methods may be overcome by using one of the new semi-implicit algorithms. These are slower than the explicit methods—as are all implicit methods—because they require matrix inversion. Also, the only way to estimate the error (so far) is to use a half-step size for u^*_{i+1} . The ultimate program would be one that used both an explicit Runge-Kutta and an implicit (not necessarily Runge-Kutta) method. Then the explicit method could be used for solving the problem in regions where it is not stiff. As soon as stiffness was detected, the program would switch over to the implicit method until the stiffness died away.

(continued)

```

Procedure RUNKUT__SOLVER

INPUT: [order p, interval xa to xb, initial values Y(xa), first guess on step size hstart,
name of function containing differential equations;Func.]

OUTPUT: [Y(xb), round-off error flag, stiffness/discontinuity flag.]

1. If first call to RUNKUT, evaluate machine epsilon and set EPS to
20*[machine epsilon].

2. If first call to RUNKUT or if p has changed since last call, evaluate constants
2a. Evaluate vectors a*, e, c, and the matrix B.
2b. Set s to (0.5)1/(p+1).
2c. Set Slim to (Slim, mesh/s), where Slim, mesh = 3, 4, or 5, for p = 4, 5,
or 7, respectively.
2d. Set hmin to program guideline value or user limit
2e. Set hmax, ser to 0.5, 1.0, or 2.0, for p = 4, 5, or 7, respectively.
2f. Set q to 6, 8, or 13, for p = 4, 5, or 7, respectively.

3. Set hmax to Min.[hmax, ser, |xa - xb|].

4. Set the current step size hold to the first guess hstart.

5. Call the PREDICTOR subroutine using Y, and hold to predict a value
of Yi+1 and Ei+1.

6. Calculate v = Min. { [ ((TOLA+TOLR*|y(n)|)/ei+1(n)) ]POWER with POWER = 1/(p+1)
or 1/p, and n = 1, . . . , NEQN. If y(n) = 0, set y(n) to TOLR. If ei+1(n) = 0, use vlim
for that value of n.

7. Set hnew = Max. { hold/10, Min. [ hold*s*Min. (v, vlim), hmax ] }.

8. Set round-off flag if (hnew/18|x|) < EPS, for |x| = 0.

9. If hnew < hmin set stiffness/function discontinuity flag, set xb to xi+1 and y(xb)
to Yi+1, then EXIT.

10. If v > 1 then set hold to hnew unless there was a reduction of step size
in the last step, in which case keep hold unchanged.

11. Repeat steps 5 through 10 until x + hold ≥ xb.

12. Set hold to xb - x.

13. Call PREDICTOR subroutine with this value of hold to obtain Y(xb).

14. Set hstart to hold.

15. Return to calling program.
    
```

Figure 3: The outline of the algorithm for the author's Runge-Kutta solver program.

COMPUTER WAREHOUSE

CALL TOLL FREE **1-800-528-1054**

FREE FEDERAL EXPRESS

Air Express Shipping

See Details Below

HARDWARE

BEST PRICES

NOW

No Charge for Bank Cards

PRINTERS

Anadex All Models	Call
Brother All Models	Call
Cannon Laser Printer	\$2099
Citizen MSP-10	\$255
MSP-15	\$349
MSP-20	\$319
MSP-25	\$485
Datasouth All Printer Models	Call
Diablo D-25	\$549
635	\$1079
Other Printer Models	Call

EPSON

All Printer Models	Call
Juki 6000	\$169
6100	\$349
6300	\$679
NEC 2010, 2015, 2050	\$629
3510, 3550, 3515, 3530	\$749
8810, 8830, 8850	\$1079
P2, P3	Call
EH 360	\$399
EH370	\$389

OKIDATA

All Printer Models	Call
Panasonic 1091	\$235
1092	\$309
1592	\$429
KXP3151	\$399

STAR MICRONICS

All Printer Models	Call
Silver Reed	
EXP400 Parallel	\$205
EXP500 Parallel or Serial	\$279
EXP550 Parallel or Serial	\$389
EXP800 Parallel or Serial	\$619

Toshiba 321	Call
P351 Parallel & Serial	\$969

DISKETTES

Maxell MD-2 Plastic Box (Qty 100)	\$125
Sony MD/2 (Qty 100)	\$120

MONITORS

Amdex All Monitors	Call
NEC All Monitors	Call
Princeton Graphics	Call
Zenith All Models	Call

VIDEO TERMINALS

IBM 3161 & 3163 Series	Call
Qume QVT Green 101	\$299
QVT Amber 101	\$314
Wyse 30	\$299
50	\$419
75	\$559
Wyse 85	\$439
Wyse 350	\$859
Zenith Z-22	\$455
Z-29A	\$559
Z-49	Call

MODEMS

AT&T	
4000 External	\$309
Anchor Automation	
Anchor Express	\$229

HAYES

All Modems	Call
Prometheus All Models	Call
US Robotics Courier 2400	\$389
Password 1200	\$180
Microlink 2400	\$389

COMPUTERS

Compaq All Models	Call
-------------------	------

Zenith Computer Products

SAVE Up to 50%

Z-158 All Models	Call
Z-138 All Models	Call
Z-148 All Models	Call
Z-171	Call
Z-200	Call

DISK DRIVES

Alpha Omega Turbo 10	\$529
Turbo 20	\$529
Turbo 30	\$729
lomega	
Bernoulli Boxes for IBM	Call
Bernoulli Boxes for Macintosh	Call
Paradise Macintosh Hard Disk	Call

BOARDS

AST Advantage	\$389
Six Pack Plus	\$219
Hercules Color Card	\$149
Graphic Card	\$299
Above Boards	Call
Paradise Modular Graphic 06-1	\$259
Five Pak	\$119
Quadram	
Quadlink	\$325
Tec Mar Graphics Master	\$445
Captain No Memory	\$155

PLOTTERS

Enter Sweet-P600	\$749
Epson Hi-80	Call

KEYBOARDS

Keytronics S151	\$159
-----------------	-------

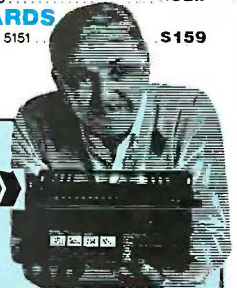

COPIERS

Canon «PC»

Canon PC-10	\$509
Canon PC-14	\$649
Canon PC-20	\$719
Canon PC-25	\$939

XEROX

1020 w/Toner	\$1099
--------------	--------

SANYO

SFT 600	Call
---------	------

SOFTWARE

Gem Collection	\$109
Gem Desktop	\$27
Gem Draw	Call

TRAINING

Flight Simulator	\$29
Typing Instructor	\$28
Typing Tutor III	\$28

LANGUAGES

C Compiler (Microsoft)	\$229
Fortran Compiler (Microsoft)	\$203
Macro Assembler	\$87
Pascal Compiler (Microsoft)	\$174
Turbo Pascal 3.0	Call
Lattice C Compiler	\$242
Run C Interpreter	\$82
Quick Basic	\$58
Turbo Tool Box	Call

PROJECT MANAGEMENT

Harvard Total Project Manager	\$262
Microsoft Project	\$229
Super Project	\$185
Timeline 2.0	\$225

COMMUNICATIONS

CompuServe Starter Kit	\$17
Crosstalk XVI	\$93
PFS Access	\$77
Remote	\$93

IBM PC and 100% Compatibles

INTEGRATIVE SOFTWARE

Enable 1.1	\$312
Framework II	Call
Smart Software System	Call
Symphony	Call

GRAPHICS

Microsoft Buss Mouse w/PC Paintbrush 3.0	\$107
Microsoft Serial Mouse	\$120
Chartmaster	\$205
Turbo Graphix Tool Box	Call
Diagram Master	\$189
Energraphics	\$160
Energraphics w/Plotter Option	\$205
Microsoft Chart	\$170
PC Draw	\$199
PC Draw Light Pen	\$102
PC Paint w/Mouse	\$122
PC Mouse w/Dr. Halo II	\$104
PFS Graph	\$77
Printmaster	\$30
Signmaster	\$134

WORD PROCESSORS

Lightning	\$49
Leading Edge Word Processor	\$49
Leading Edge W/P with Spell & Mail	\$99
Microsoft Word 2.01	\$229
Multimate 3.3	\$203
PFS:Write	\$77
Wordstar w/Tutor	\$162
Wordstar Pro Pack	\$233

Word Perfect (Ver.4.1)	\$199
Wordstar 2000	\$233
Wordstar 2000 Plus	\$280

UTILITIES

Fastback	\$88
1 DIR	\$47
Copy II PC	\$19
Norton Utilities 3.1	\$48
Sidekick	Call
Sidekick (Unprotected)	Call
Sideways	\$35
Superkey	Call
Printworks	\$36
Sidekick-Superkey (Bundle)	Call

SPREADSHEETS

Lotus 1-2-3	Call
Multipan	\$112
Spreadsheet Auditor 2.0	\$82

Supercalc 3 (Ver.2.1) . Call

MONEY MANAGEMENT

All Tax Packages	Call
Dollars & Sense w/Forecast	\$95
Tobias Managing Your Money	\$95

DATA BASE MANAGEMENT

Cornerstone	\$245
dBase II	Call
dBase III	Call
Nutshell	\$49
PFS:File	\$77
PFS:Report	\$68
Quickcode	\$139
QuickReport	\$139
Extended Report Writer	\$80
Think Tank	\$92
Clipper	\$345
Knowledgegeman II	\$289
Knowledgegeman Upgrade Kit	\$145
Reflex	Call

R:Base 5000 \$332

Many other titles available.

We do not guarantee computer compatibility.

Inquiry 86 for MS DOS Products. Inquiry 87 for all others.

COMPUTER WAREHOUSE

Order Line: 1-800-528-1054
Order Processing: 602-224-9345

2222 E. Indian School Rd.
Phoenix, Arizona 85016
602-954-6109

Store Hours: Mon-Fri 10-5:30
Saturday 9-1

Order Line Hours: Mon-Fri 7-5:30
Saturday 9-1

Order Processing Hours: Mon-Fri 10-3

Product shipped in factory cartons with manufacturer's warranty. Please add \$6.00 per order for UPS ground shipping on orders up to 10 lbs. Orders 10 lbs. and under you pay for ground service, receive air service at no extra charge. Available on orders 11-30 lbs. \$17 for air service. Prices & availability subject to change without notice. Send cashier's check or money order...all other checks will delay shipping two weeks.



CFW-286

The program I developed solves systems of IVP ODEs without any significant problems. The error often had to be set at about an order of magnitude lower than what was actually obtained for the global error. However, for each of several test and actual problems, all methods met relative error tolerances of 10^{-6} with-

out any difficulty. This order of accuracy is often enough for most engineering problems. It is possible to vary the accuracy and the speed of the codes provided by playing about with some of the parameters in the step-size adjustment algorithm. Therefore, I urge anyone so inclined to look at the effects of adjusting those

values. Remember that the values for most of those parameters were determined on a trial-and-error basis, and the best values for a large number of general problems were selected. It is possible to optimize those parameters even further if only a particular problem (or a class of problems) is being considered.

Finally, these algorithms and codes, like all other numerical methods, are not infallible, and can occasionally give spurious results. So do not treat them as "black boxes" for solving differential equations. Often, examining a trend or a limiting case will indicate whether the results may be trusted. Sometimes, it is worthwhile to change the magnitude of the error tolerance (by a factor of say 10^{-2} or more) and check if this affects the results significantly. Also, reducing the maximum step size possible (h_{max}) to very small values will give solutions that are closer to the true solution—and a considerable increase in run times—so this may occasionally be used as a further check. ■

REFERENCES

1. Shampine, L. F., and M. K. Gordon. *Computer Solution of Ordinary Differential Equations: The Initial Value Problem*. San Francisco, CA: Freeman, Cooper & Co., 1975.
2. Johnston, Robert L. *Numerical Methods: A Software Approach*. New York: John Wiley & Sons, 1982.
3. Boyce, W. E., and R. C. DiPrima. *Elementary Differential Equations and Boundary Value Problems*. New York: John Wiley & Sons, 1977.
4. Fehlberg, E. *Computing*, Volume 6, page 61, 1970.
5. Verner, J. H. *SIAM Journal of Numerical Analysis*, Volume 15, page 772, 1978.
6. Gear, C. W. *Numerical Initial Value Problems in Ordinary Differential Equations*. Englewood Cliffs, NJ: Prentice-Hall, 1971.
7. Johnson, L. W., and R. D. Riess. *Numerical Analysis*. Reading, MA: Addison-Wesley, 1982.
8. Shampine, L. F., and R. C. Allen. *Numerical Computing: An Introduction*. Philadelphia, PA: W. B. Saunders, 1973.
9. Davis, M. E. *Numerical Methods and Modeling for Chemical Engineers*. New York: John Wiley & Sons, 1984.
10. Michelsen, M. L. *Journal of the American Institute of Chemical Engineers (A.I.C.H.E.)*, Volume 22, page 594, 1976.

Subscription Problems?



We want to help!

*If you have a problem with your BYTE subscription, write us with the details. We'll do our best to set it right. But we **must** have the name, address, and zip of the subscription (new and old address, if it's a change of address). If the problem involves a payment, be sure to include copies of the credit card statement, or front and back of cancelled checks. Include a "business hours" phone number if possible.*

BYTE
 Subscriber Service
 P.O. Box 328
 Hancock, NH 03449



Why your next generation of products should use our 5th generation tools.

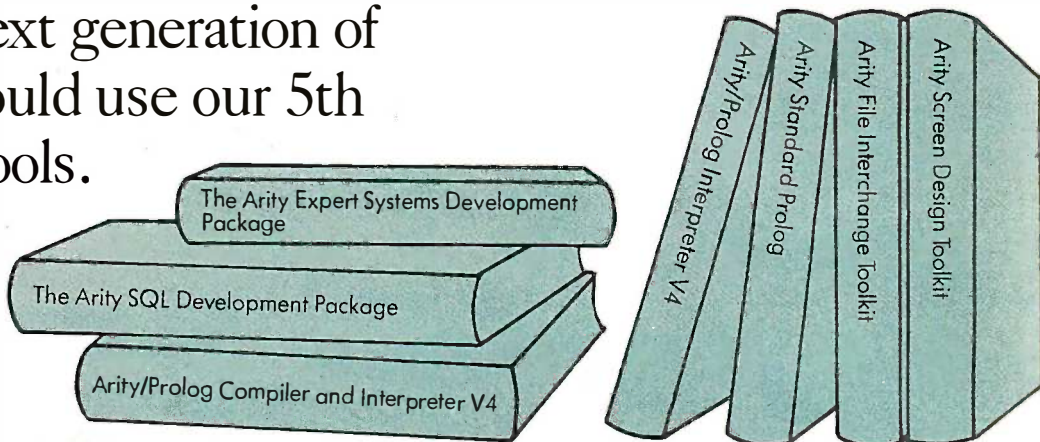

Arity's integrated family of programming tools allows you to combine software written in Arity/Prolog, the best of the fifth generation languages, with Arity SQL, the best of the fourth generation languages, and with conventional third generation languages such as C or assembly language to build your smarter application.

You can use Arity/Prolog to build expert systems using the Arity Expert Systems Development Package. Or to build natural language frontends. Or to build intelligent information management systems. Arity/Prolog lets you build advanced technology into your vertical applications package.

And more...

That's not the whole story. Arity's products are all designed to be fast, powerful, serious. Each of our products contains unexpected bonuses. Such as a one gigabyte virtual database integrated into Arity/Prolog. The most powerful of its kind on a PC.

Quality first. Then price.

In order to be the best, we had to prove it to our customers. Our tradition of quality software design is reflected in every product we sell. Quality first. Then price. And we always provide the best in customer support.

Our products are not copy protected. We do not charge royalties. We offer generous educational and quantity discounts. And we have a 30 day money back guarantee.

Try us to know that we keep our promise on commitment to quality and reliability. Try us by using our electronic bulletin board at 617-369-5622 or call us by telephone—you can reach us at 617-371-2422.

Or fill in this coupon. Whether you order today or not, let us send you full descriptions of our integrated family of Arity products.

Inquiry 22



We design and distribute high quality, serious application software for the IBM PC, XT, AT and all MS-DOS compatibles.

Please complete this form to place your order and/or request detailed information.

		Quantity	Info only
Arity/Prolog Compiler and Interpreter V4	\$795.00	_____	_____
Arity/Prolog Interpreter V4	\$350.00	_____	_____
Arity Standard Prolog	\$ 95.00	_____	_____
Arity SQL Development Package	\$295.00	_____	_____
Arity Expert System Development Package	\$295.00	_____	_____
Arity Screen Design Toolkit	\$ 49.95	_____	_____
Arity File Interchange Toolkit	\$ 49.95	_____	_____
TOTAL AMOUNT (MA residents add 5% sales tax) (These prices include shipping to all U.S. cities)		\$ _____	

NAME _____

SHIPPING ADDRESS _____

CITY/STATE/ZIP _____

TELEPHONE _____

Payment: Check PO AMEX VISA MC

Card # _____ Exp. date _____

Signature _____

ARITY CORPORATION • 358 BAKER AVENUE • CONCORD, MA 01742



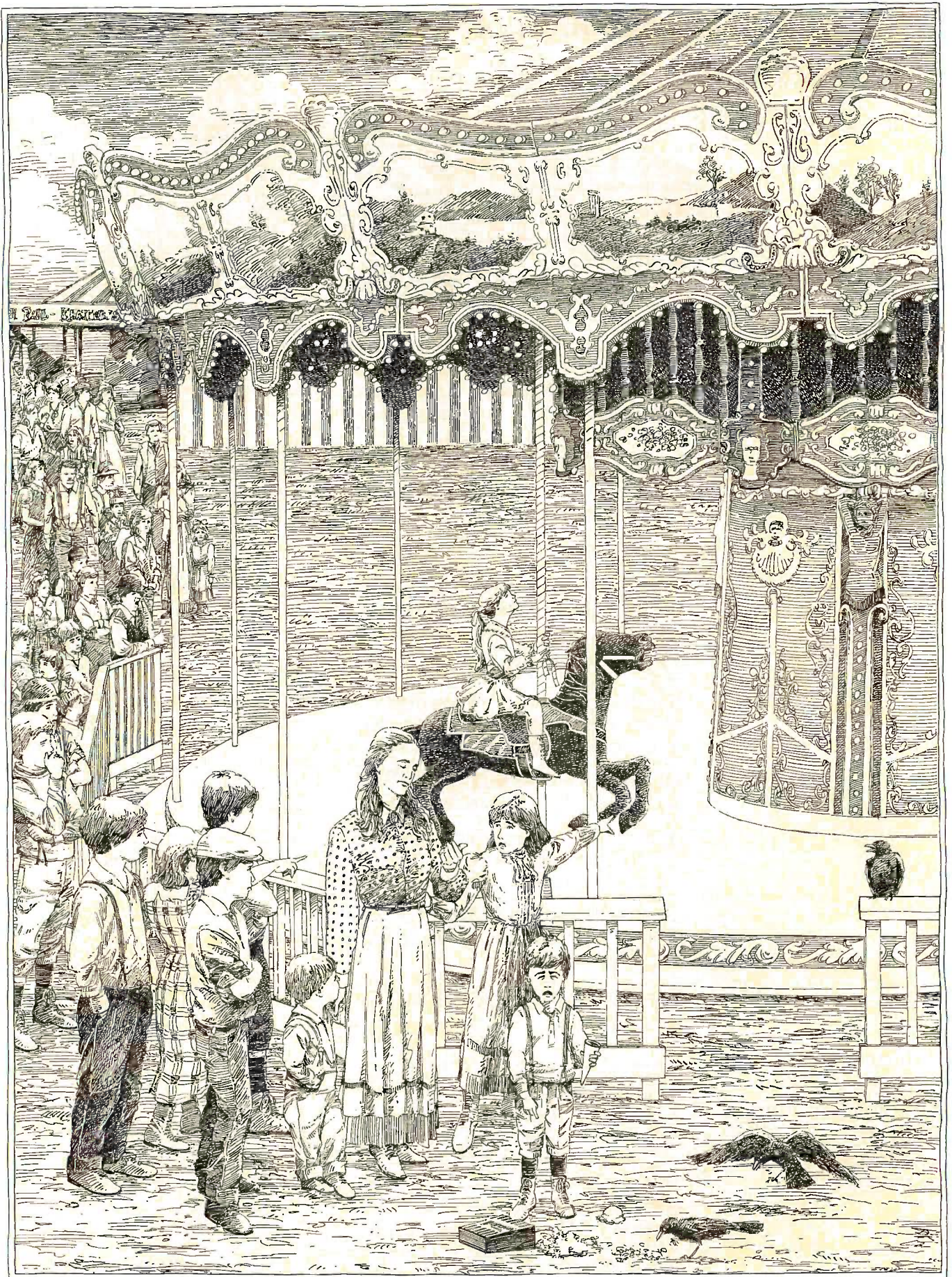

COMMON SENSE IN DATABASE MANAGEMENT
NUMBER FIVE IN A SERIES.

SOME THINGS CAN NEVER BE SHARED. OTHER THINGS SHOULD BE.

The people who make database software have some strange logic. They tell you information is the most valuable thing in the world. And then they design their products for single-user systems. Which means that every time different people actually need to use your data, they have to stand in line for it.

INTRODUCING R:BASE™ 5000 MULTI-USER.

At Microrim, we have a much better idea of the way offices work. So we've developed a multi-user version of R:base 5000. It lets users update their database while other people analyze it. It handles an unlimited number of users. And it's fully compatible with our single-user version. Which means any application you develop on the single-user version today can be run on our multi-user version tomorrow. And as you can see from the table below, it's 100% compatible with every major LAN.

LAN Hardware	LAN Software	Available
IBM PC Network	IBM PC Network Program 1.0 PC DOS 3.1	Now
IBM PC Network	Novell Advanced NetWare™ 86/PCN 1.02	Now
3 COM® EtherSeries®	Novell Advanced NetWare 86/E 1.02	Now
3 COM EtherSeries	3 COM 3 + 1.0	Upon Release by 3 COM
Ungermann-Bass	Net-One Personal Connection® 1.0	Now

At the heart of this new R:base 5000 is the single-user version that Datapro Research Corporation called the best in the business. To that same industry-leading package we added the features our multi-user customers wanted most: a locking mechanism, for example, that lets multiple users work with columns and rows from the same table. And data sharing capabilities that make optimum use of the front end power of the PC.

SEE FOR YOURSELF:

1-800-547-4000.

The list price is \$1500, complete with three sets of documentation. But if you believe in common sense as much as we do, you won't make a decision this big till you get your hands on a copy and see for yourself. And that's just what we'd like you to do. For only \$50, we'll send you a copy of the program that has all the features, one set of documentation, and all the functionality of the full product, except for limitation on the numbers of rows, columns, and tables.

Just call 1-800-547-4000 and ask for Dept. 907. From Oregon, or outside the U.S., call 1-503-684-3000, Dept. 907. Or head straight for a leading software store or computer dealer.

And see how nice it is to take advantage of information. Instead of taking turns at it.

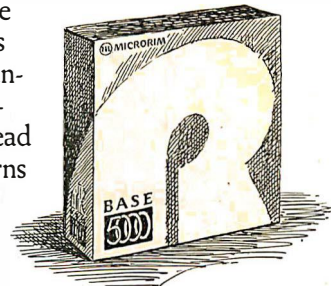

R:BASE 5000 MULTI-USER FROM MICRORIM

IT ALL COMES DOWN TO COMMON SENSE.

DRIVE PLUS

Performance
Reliability
Economy

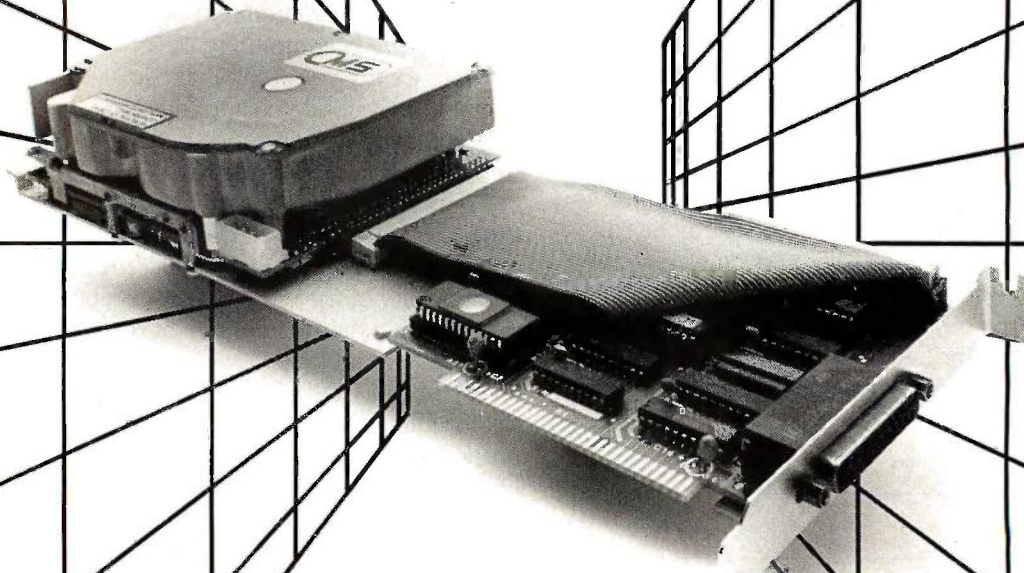

20 MB Hard Disk Expansion Card Family

- | | |
|---------------------------|--|
| DRIVE PLUS SCSI | SCSI interface. 7.5 Mbit/sec transfer rate |
| DRIVE PLUS HI-REL | Automatic head lifters never allow heads to touch media. |
| DRIVE PLUS ECONOMY | Unbeatable low price for a hard disk card. |



Best Price · Best Performance

401 W. Dyer Road, Santa Ana, CA 92707 (714) 549-9111

Inquiry 61 for End-Users. Inquiry 62 for DEALERS ONLY.

THE ATOMCC TOOLBOX

BY Y. F. CHANG

Using Taylor series to solve ODEs

Editor's note: ATOMCC is a FORTRAN program generator that creates FORTRAN source code to solve ordinary differential equations (ODEs). In order to use it, you create a data file called ODEINP, which specifies the ODEs of the system, initial conditions, etc. ATOMCC then creates a program called ATSPGM, which can be compiled to solve the problem. ATOMCC.EXE requires MS-DOS or PC-DOS and so is available only on those disk formats. The required .OBJ files mentioned in the article are included on the disk, as well as a 121K-byte MANUAL.DOC, which prints out to a 55-page user's manual that has copious examples of the program's use.

ATOMCC is available on disk as explained on page 346 or may be downloaded (onto MS-DOS disks, remember) via BYTEnet Listings at (617) 861-9764. The sample output in listing 2 is available in all formats. Since ATOMCC is an executable file, no hard-copy output is available for it.

IT IS POSSIBLE for an engineer, a scientist, or a mathematician to solve very complicated coupled systems of ordinary differential equations on a microcomputer using the ATOMCC toolbox. This toolbox has been used to solve simple student assignments as well as such involved problems as

the detailed calculations of the orbit for Halley's comet. The ATOMCC toolbox is easy to use, and it automatically produces results that have hundreds and thousands of times better accuracy than those from the usual numerical methods available on mainframe computers.

Other important features of ATOMCC are the ability to solve most stiff problems automatically, the ability to stop and restart the solution on any specified value of any variable or any derivative of the variable, and the ability to search out all the singularities in the complex plane of the solution.

Briefly, stiff problems are those whose solution functions have a large negative exponential term, which causes a great deal of difficulty for all numerical techniques including ATOMCC. Stiff problems have to be handled in special ways in their solutions. Basically, you locate the large negative exponential term and factor it out.

The ability to stop and restart a problem solution automatically lets ATOMCC solve very complicated systems of ODEs, where you may wish to obtain precise information about

the results at some particular configuration of the solution, such as the exact date and time of Halley's comet's closest approach to Earth or its closest approach to the sun.

A singularity is the point in a solution of a problem where the result is catastrophic. In nonlinear problems, the complex plane of the solution is full of these singularities, and they usually form some simple lattice. However, in the study of nonlinear dynamics, where some systems may exhibit chaotic behavior, the singularities may form complicated structures called fractals.

The ATOMCC toolbox has been used by a number of scientists at universities and research laboratories to study these fractal structures of singularities. While this feature of following a solution into the complex plane is not available in the usual numerical techniques on mainframe computers,

(continued)

Y. F. Chang is W. M. Keck professor of applied mathematics and computer science at Claremont McKenna College (Pitzer Hall, Claremont, CA 91711). He received his Ph.D. in applied physics from Harvard University. He is a leading authority on the Taylor series.

the ATOMCC toolbox provides it automatically.

THE RUNGE-KUTTA/PREDICTOR-CORRECTOR METHODS

The usual mainframe-computer software packages used to solve ODEs are derived using either the Runge-Kutta method or the predictor-corrector method. These methods are based on approximations to the Taylor series. For example, a 4th-order Runge-Kutta method uses an approximation to a 5-term Taylor series, a 6th-order predictor-corrector method uses an exact fit to a 7-term Taylor series, and a 12th-order Runge-Kutta method uses an approximation to a 13-term Taylor series. Most of these usual methods for solving ODEs are relatively low-order methods, such as 4th or 6th orders. Since they are derived from rather low-order approximations to the Taylor series, they have poor accuracy control. Thus, there are two questions: (1) If these methods are based on approximations to the Taylor series, why not use the Taylor series itself to derive a numerical method to solve ODEs? (2) Since the low-order methods have difficulty producing highly accurate results, why not use very long Taylor series?

To answer the first question, there has been a misconception about Taylor series carried forward from textbook to textbook over several decades. We shall put it to rest here. At least one author has produced a "proof" that the higher-order derivatives of a function near a catastrophic singularity increase in magnitude without bound. He therefore concluded that one should not work with Taylor series, since the higher-order Taylor terms are derived from the corresponding-order derivatives. This "proof" is false, but there are two misleading facts that combine to make it seem like a valid proof.

First, the result of the proof is that the *n*th derivative of a function near a singularity is roughly the same size as the *n*-factorial. The factorials increase very rapidly to very large values. For example, 12-factorial is equal to 479,001,600, and 15-factorial

is about the size of our national debt. This proof continues by concluding that the higher-order derivatives increase without bound just as the factorials increase without bound. This conclusion is misleading because one should really look at the ratio:

$$\text{Ratio} = \frac{d^n f}{dx^n} / n!$$

Note that this ratio is nearly a constant according to the proof. Therefore, instead of concluding that the derivatives increase without bound, the author should have concluded that the derivatives increase within bounds. The bounds are the factorials. Now, what are the Taylor series terms? The Taylor series terms are precisely the ratio given above! Therefore, in the final analysis, the correct conclusion is that the Taylor series terms do not increase without bound, but rather they are very well behaved with values that are nearly constant.

So, what had started out as being a false proof for showing that it is impossible to work with Taylor series has turned out to be a valid proof that Taylor series are quite nice to use as a computational tool. Such is the manner in which a misconception has been carried over the past several generations.

Since we now have a proof that Taylor series are well behaved, there is no problem in developing a very-high-order method for solving ODEs. The ATOMCC toolbox uses a 30-term Taylor series, which produces excellent accuracy control and fast execution.

SOLVING ODES BY TAYLOR SERIES

The ATOMCC toolbox contains an ODE-solving program generator that accepts statements of (1) the differential equations, (2) the initial conditions, (3) the domain of the problem, and (4) any method-controlling parameters. These statements are in standard FORTRAN format. The program generator produces a source program, which is in FORTRAN and

is compiled and linked with the special library of subroutines in the ATOMCC toolbox. You do not have to write any program. The solution is given to you by ATOMCC automatically. As for the control of accuracy, I'll give a brief discussion on this subject below.

The convergence property of a short Taylor series cannot be determined by any means. There is insufficient information in the few terms of a short Taylor series for a reliable analysis of the truncation error. The short-series methods such as Runge-Kutta are forced into taking small incremental steps. This is because the short series does not properly approximate the function at the point of expansion. The many small steps give rise to the propagation of machine round-off errors. Thus, on a difficult problem the short-series methods are bound to produce results with accuracy much poorer than machine accuracy. While large steps give rise to truncation errors, small steps give rise to round-off errors.

The ATOMCC toolbox maintains very tight control over the accuracy of the computations. When the order of the method is high, say about 30, it is possible to find the exact positions of those catastrophic singularities in the solution function. It can be shown that there is a direct relationship between the behavior of Taylor series terms and the locations of singularities. The distance from the solution point to a singularity, defined as the radius of convergence, is the main source of the truncation error. When a computation step taken is larger than an allowable fraction of the radius of convergence, there will be appreciable error.

The accuracy of ATOMCC is totally dependent on the convergence analysis of long Taylor series. Not only does a long series allow for good error analysis, it allows for an integration step size much larger than that for a typical fourth-order Runge-Kutta method. When the order of the Taylor series is sufficiently high, it is possible to calculate or estimate the radius

(continued)



Remember the first time you upgraded your color graphics hardware? The thrill is still the same.

The discovery of color graphics. As a child, it was a significant event. As a business person, it will change the way you use your personal computer.

Genoa Systems proudly introduces a new and colorful technology for the PC called Spectra EGA. The Enhanced Graphics Adapter that lets you rediscover the benefits, and the thrill, of color graphics on your PC.

An EGA with a better vision.

EGA compatibility is an art that only Spectra has mastered. And, while other EGA hardware is incompatible with current industry standards, Spectra EGA fully supports hardware and software designed for the IBM Enhanced Graphics Adapter, Color Graphics Adapter and Monochrome Graphics Adapter. *And* the Hercules Board.

This means that you don't have to wait around for new

software updates in order to begin enjoying your EGA today.

A lot more than just pretty pictures.

The first thing you'll rediscover with your Spectra EGA is color. There is a whole lot more than ever before. Sixty-four separate colors, in fact, from which any sixteen can be displayed at once.

Next, you'll notice a higher resolution in both text and graphics modes.

The real fun comes in putting the board to work. You'll see soft scrolling, panning and windowing that was never before possible on a PC. And the flicker-free display will allow you to regulate these movements at any speed, or in any direction.

There are 512 characters carried in Spectra's memory that can all

be displayed at once. Which is twice as many as previously possible on a PC.

And if you wish to use other characters, or even create your own alternate character set, Spectra will support those, too.

More colorful features.

Each Spectra EGA comes fully equipped with a parallel printer port, light pen interface and 256K RAM on the single board. This is especially good news because a full 256K RAM is needed to run most popular graphics software effectively.

One thrilling price.

Perhaps the best news is Spectra's price.

Upon first glance you may find that the Spectra EGA and the IBM EGA seem to be very closely priced. But look again. Because the standard IBM EGA only comes with 64K RAM, whereas Spectra EGA comes with a full 256K.

Now, you may purchase the extra memory board you'll need from IBM at an additional cost of about 70-80 percent. Or you can buy Spectra EGA from Genoa...and rediscover the thrill of a bargain.

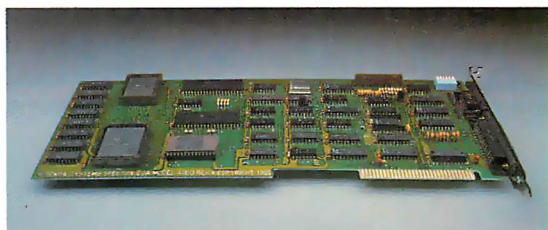

Spectra Enhanced Graphics Adapter

To find out more about Spectra, or a qualified Genoa distributor near you, call 408-945-9720. Or write to Genoa Systems Corporation, 73 E. Trimble Road, San Jose, CA 95131.

Spectra EGA from Genoa. Evolution in color graphics.

 **Genoa**
We make PCs better.

Inquiry 140

With a long Taylor series you can calculate or estimate the radius of convergence.

of convergence. This information allows the integration step to be adjusted to keep the local error below a specified limit. In the ATOMCC toolbox, solutions of problems are calculated only after obtaining both the calculation for the radius of convergence and adjusting the integration step. When a singularity is near the solution path, ATOMCC will adjust the integration step to be very small to meet the accuracy requirements.

The ATOMCC analysis can be applied to linear and nonlinear problems alike. The bases of the ATOMCC analysis are the recursion relation obtainable from the equations of the problem and Leibnitz's rule, also called a Cauchy product. The solutions to all problems, linear and nonlinear, are in the form of Taylor series.

Linear problems in ordinary differential equations have simple Taylor series solutions that may be evaluated without computers.

MAJOR ADVANCEMENTS IN THIS VERSION

The present version (7.10) of ATOMCC for microcomputers will solve stiff problems. This represents a significant departure from the central premise of the ATOMCC system, which is precise error control. For nonstiff problems, you still have the most accurately controlled numerical method ever developed. For many problems, the precision is so good that there is *almost* global error control.

For stiff problems, due to the nature of the "approximating" solution, there cannot be true error control. Therefore, the controlling parameter for errors in stiff problems (called ADJSTF) is only meant to be loosely referred to as an error control.

Another particularly useful feature in the current ATOMCC version is that all the dependent variables are now placed into a temporary two-dimensional array (TMPS) by an EQUIVALENCE statement. This allows you to reference each variable by an index value. For a system with x , y , and z as functions of t , the term $y(5)$ can be

also referred to as TMPS(5,2). Similarly, $z(23) = \text{TMPS}(23,3)$.

REQUIREMENTS OF ATOMCC

The ATOMCC toolbox uses Microsoft FORTRAN-77 (a registered trademark of Microsoft Corporation) and works on a microcomputer operating under MS-DOS. To be able to run ATOMCC on your MS-DOS microcomputer you must have the following hardware and software: an MS-DOS computer with an 8087 coprocessor, at least 256K bytes of RAM, two floppy-disk drives or a hard-disk drive, and Microsoft FORTRAN-77 version 3.30.

A complete system includes the ATOMCC system disk files and the Microsoft FORTRAN-77 disk files. Of the ATOMCC system files, ATOMCC.EXE is the compiler that reads statements of differential equations and generates a FORTRAN program called ATSPGM. (The name ATSPGM for the output program file is fixed, but you may change it after it has been written by ATOMCC.) The other system files are the ATOMCC subroutine libraries: RDCV.OBJ (the ATOMCC subroutine library in single precision), DRDCV.OBJ (double precision), CRDCV.OBJ (complex), and CDRDCV.OBJ (complex double).

(continued)

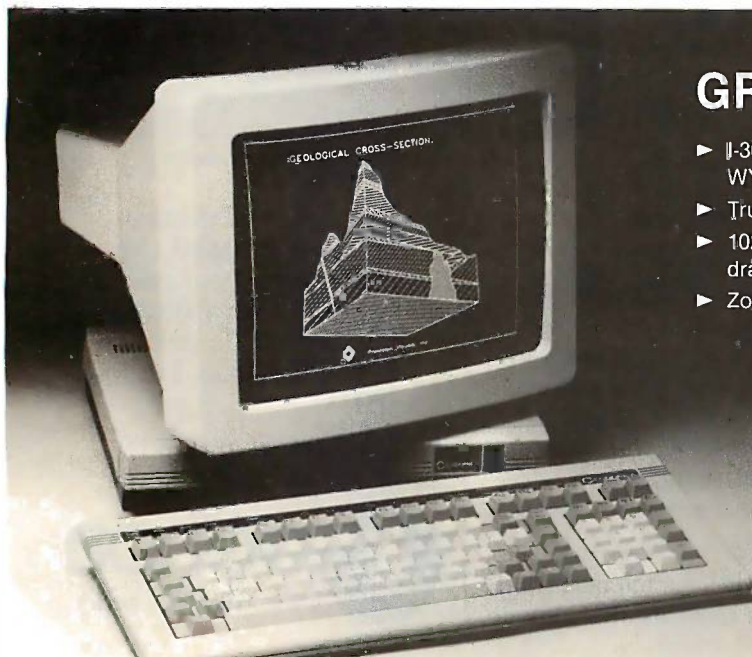

GRAPHICS FOR WYSE

- ▶ IJ-300 Graphics field upgrade for Wyse Technology's WY-50, WY-75 terminals
- ▶ True Tektronix 4010/4014 graphics emulation
- ▶ 1024 by 800 pixel display, 1,000,000 pixels per second vector drawing rate
- ▶ Zoom, pan, rich native command set, hardcopy capability

CODONICS
We Bring the Future into Focus
 CLEVELAND CODONICS, INC.
 18001 Englewood Dr. • Cleveland, Ohio 44130
 (216) 243-1198

Tektronix, Wyse Technology, Codonics are registered tradenames

MACH 1 PAD 4th Generation Productivity ... Under \$1000!

(Cincinnati, Ohio) January, Tominy, Inc. announced the immediate availability of a single-user version of their Mach 1 System Generation Facility on the IBM PC.

Professional Applications Developer on the IBM PC

The Mach 1 Professional Application Developer (PAD) provides the micro computer system developer with an advanced set of System Generation tools to develop applications that run on MACH 1's micro, mini and mainframe multi-user environments.

At the core of all Tominy systems is a powerful Data Base Management System, used worldwide since the 1970's in business and commercial applications.

Logical Data Base, Program Generator, and Query/Report Generator

The Logical Data Base Structure of the Tominy products provide unlimited record sizes, multiple file keys, data independence, record locking and free space management. The Logical Data Base's flexible design supports Relational, Hierarchical, and Network Data Views.

Programs to maintain the Data Base can be completely generated by MACH 1. A MACH 1 Generated Program allows users to inquire on the Data Base and add, update, or delete Data Base information.

Ad hoc data analysis or reports are addressed by the MACH 1 Query/Report Generator. The simple "English-like" Query statements allow data to be selected, sorted, summarized, displayed and printed.

To allow for more complex transaction processing and reporting, MACH 1 contains the fourth-generation procedural language "LOGIC."

Fourth-Generation LOGIC Language

The LOGIC language provides the command structure to manipulate data; perform data base, screen and print I/O; control program flow; manipulate tables and arrays; log system messages; and perform mathematical calculations.

A standardized approach to program development is ensured using the "program framing" concept of the MACH 1 products. MACH 1 "frames" the LOGIC code by "writing" the complete data variable section, and including various LOGIC modules.

This approach to application development ensures a consistent structure while still providing the flexibility required by the serious application developer.

The LOGIC programs are tested on-line using the Interactive Program Tester which steps through the execution of the LOGIC code and permits immediate changes to the program statements, variable values, and the test data base.

Screen Designer, Automatic Editing, and Simplified Print Logic

To facilitate LOGIC program development, MACH 1 includes a full screen designer. Screens for applications and menus are easily created and maintained by entering prompts and data entry fields on the screen itself.

MACH 1 has the capability to automatically edit each data entry field for date format, numeric data, and required field length. In addition, MACH 1 will perform data validation against existing File Keys, or Table Entries.

The Report Design tools of MACH 1 removes report handling (headings, form control, and print queues) from the

program, reducing print logic to a simplicity not found with other programming languages.

Menus, Help Screens, and Full System Security

The MACH 1 is a menu driven package. It is simple and easy to use. Full-screen text editors are included for entering the LOGIC code, Job control statements, and Data Base Descriptions.

On-line HELP screens are provided to guide the developer through the numerous utilities provided with MACH 1. In addition, the MACH 1 manuals walk the owner through designing, developing, testing, packaging, and maintaining their Application System.

And all this is offered with system security. Security codes will be validated upon entry to MACH 1, and whenever a program function is executed.

Full Application and Development Portability

Applications developed using MACH 1 PAD run on micro, mini and mainframe multi-user systems using MACH 1. IBM, DEC and Data General are current MACH 1 environments.

The MACH 1 PAD requires

- IBM PC/XT/AT or Compatible
- PC DOS 2.1 or up
- 128 KB Memory
- 8 MB on-line storage

Discover the power and performance of MACH 1 PAD. Now, just \$129.95 (regular retail \$199.95) when you order by April 31, 1986. **Save \$70.00!** Mail the coupon or call Tominy *toll free* at 1-800-543-8628. In Ohio call 1-800-445-1737.

SAVE \$70 on **MACH 1 PAD**™ only \$129.95

Please send me MACH 1 PAD, the complete development package for single-user environments...

Check Enclosed Money Order Enclosed Single-user Environment @ \$129.95 _____
 MasterCard Visa Shipping & Handling *5 (*10 foreign) _____
 Account Number Expires _____ Sales Tax, Ohio residents: 51/2 % _____
 Total Amount of Order \$ _____
(Offer expires April 31, 1986)

(PLEASE PRINT)

Name _____ Signature _____

Address _____ Phone _____

City, State, Zip _____

Please send me information about the unlimited version of MACH 1
for: Main Frame, Mini, Multi User Micro Systems

MACH 1 and MACH 1 PAD are registered
Trademarks of TOMINY, Inc.

Send to: TOMINY, Inc. • MACH 1 PAD Division • P.O. Box 160 • Cincinnati, Ohio 45242

Listing 1: A sample ODEINP file, used to create listing 2 with ATOMCC.

```
C FIRST PAINLEVE TRANSCENDENT
  DIFF(Y,T,2) = 6.0*Y*Y + T    $
$
C READ INTEGRATION INTERVAL AND INITIAL CONDITIONS.
  READ(5,1010) START,END,Y(1),Y(2)
1010 FORMAT(4F10.3)
  WRITE(*,1020) START,END,Y(1),Y(2)
1020 FORMAT(' SOLVE THE FIRST PAINLEVE TRANSCENDENT' /
+ ' INTERVAL:           ',2F10.3 /
+ ' INITIAL CONDITIONS:',2F10.3 /)    $
$
```

Listing 2: The output file ATSPGM created by ATOMCC from the listing 1 file.

```
C*****
c   This program was produced by the ATOMCC
c   translator version 7.10 Copyright (C) 1985,
c   Y. F. Chang
C*****
c Portions (c) Copyright, Microsoft Corp., 1981.
c All rights reserved.
c This program was written for the following inputs
c
C FIRST PAINLEVE TRANSCENDENT
C   DIFF(Y,T,2) = 6.0*Y*Y + T
c-----
c no instructions in second input block
c-----
COMMON /IPASS/ LENSER,LENVAR,MPRINT,MSTIFF,LRUN,
+ KTRDCV,KNTSTP,KTSTIF,KXPNUM,KDIGS,KENDFG,NTERMS,NOPT
A /RPASS/ RADIUS,ERRLIM,ADJSTF,RCREAL,RCIMAG,RDCERR
B /CPASS/ START,END,ORDER
C /DPASS/ H,HNEW,XPRINT,DLTXPT
DIMENSION TMPS( 36, 1)
CHARACTER*6 NAMES
EQUIVALENCE (TMPS(1,1),Y(1))
DIMENSION NAMES(1),Y(36),T(2),TMPAAB(30),TMPAAA(30)
DATA NAMES(1)/'Y.....'/
Y(33) = 1.1
10 FORMAT(72H ATOMCC Ver. 7.10, Copyright (C) 1985,
A Y. F. Chang; Solution results./9H *****)
11 FORMAT(/5X,11HStep number,I6,13H at the point,
A1P1E12.4/1X,9Hvalues of )
12 FORMAT(1X, A6,(1X,1P4E13. 5))
13 FORMAT(5X,21HStepsize adjusted to ,1PE13.5)
14 FORMAT(/5X,35HThe solution stopped normally after,
A I4,24H steps as set by nsteps. )
16 FORMAT(/5X,63HThe adjustment for stepsize seems to
A be in a loop. Please try a /5X,22Hshorter series
A length. )
WRITE(*,10)
c-----
c Initialize variables to default values
c-----
NSTEPS = 40
H = 1.E0
ERRLIM = 1.E- 6
LENSER = 30
```

(continued)

The Microsoft FORTRAN-77 files are described in the Microsoft manual. The relevant files are FOR1.EXE, PAS2.EXE, LINK.EXE, and FORTRAN.LIB.

To use ATOMCC, you create a file called ODEINP (this name is fixed within ATOMCC). ODEINP contains four separate blocks, each ending with a \$ delimiter (see listing 1). The first block contains the system of ODEs, written in FORTRAN. These equations are processed by ATOMCC to determine the recurrence relations that are written into ATSPGM to generate the Taylor series for each component of the solution. The second block (empty in listing 1) can be used to insert nonexecutable FORTRAN statements (e.g., SUBROUTINE, DIMENSION, or COMMON) at the beginning of ATSPGM. The third block is used to specify the interval of integration and the initial conditions. In the sample program, these values will be read from disk. Alternatively, they may be explicitly declared. The fourth block is usually empty. It may be used to insert statements into ATSPGM at the end of each integration step. The second, third, and fourth blocks are not processed syntactically by ATOMCC; they are copied directly from ODEINP into ATSPGM.

The output ATSPGM file created by using the ODEINP file in listing 1 is shown in listing 2. ATSPGM is a standard FORTRAN source-code file: You may edit and modify it like any other source code.

APPLICABILITY

The ATOMCC method can solve stiff and nonstiff systems of initial value problems in ordinary differential equations in which the highest-order derivative of each dependent variable is given explicitly on the left-hand side of an equation whose right-hand side has a finite sequence of +, -, *, /, **, EXP, SIN, COS, TAN, SINH, COSH, TANH, ALOG, ACOS, ASIN, ATAN, or any function that is the solution to a differential equation.

The known limitations of ATOMCC

(continued)

XEROX

It's not surprising that the company which invented Daisywheel printing should be the one to take it to a breakthrough level of performance.

Introducing the Xerox 635 Diablo Daisywheel Printer; the next generation of printers.

It's fast—up to 55 cps. It's quiet—perfect for a busy office.

And because it's a Xerox printer, the 635 just won't quit.

It's also extremely easy to use. With automatic sheet loading, a simple control panel, and snap-in

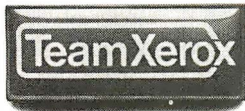

interface cartridges give instant compatibility to most microcomputer systems, including Xerox, IBM and Apple.

The Xerox 635 has a choice of 225 drop-in printwheels including Memorywriter and IBM typestyles and fonts. So you can make almost all your documents look uniform.

And only Xerox offers you such a complete line of peripherals. Like a bi-directional tractor, single-bin sheet feeder, dual-bin sheet feeder or dual-bin sheet feeder with an envelope bin.

Call 1-800-TEAM-XRX, ext. 122, or send the coupon below.

Because you gain a lot by setting higher standards.

Xerox Corporation, P.O. Box 24, Rochester, NY 14692
 I'm interested in learning more about the Xerox 635 Diablo Daisywheel Printer.

Please have a dealer or sales representative contact me.
 Please send me more information.

NAME _____ TITLE _____
 COMPANY _____
 ADDRESS _____ CITY _____
 STATE _____ ZIP _____ PHONE _____

Or, if you can't wait, call
1-800-TEAM-XRX, ext. 122
 (1-800-832-6979, ext. 122)

122 _____ 192 4/86

The people who set the industry standard just raised it.

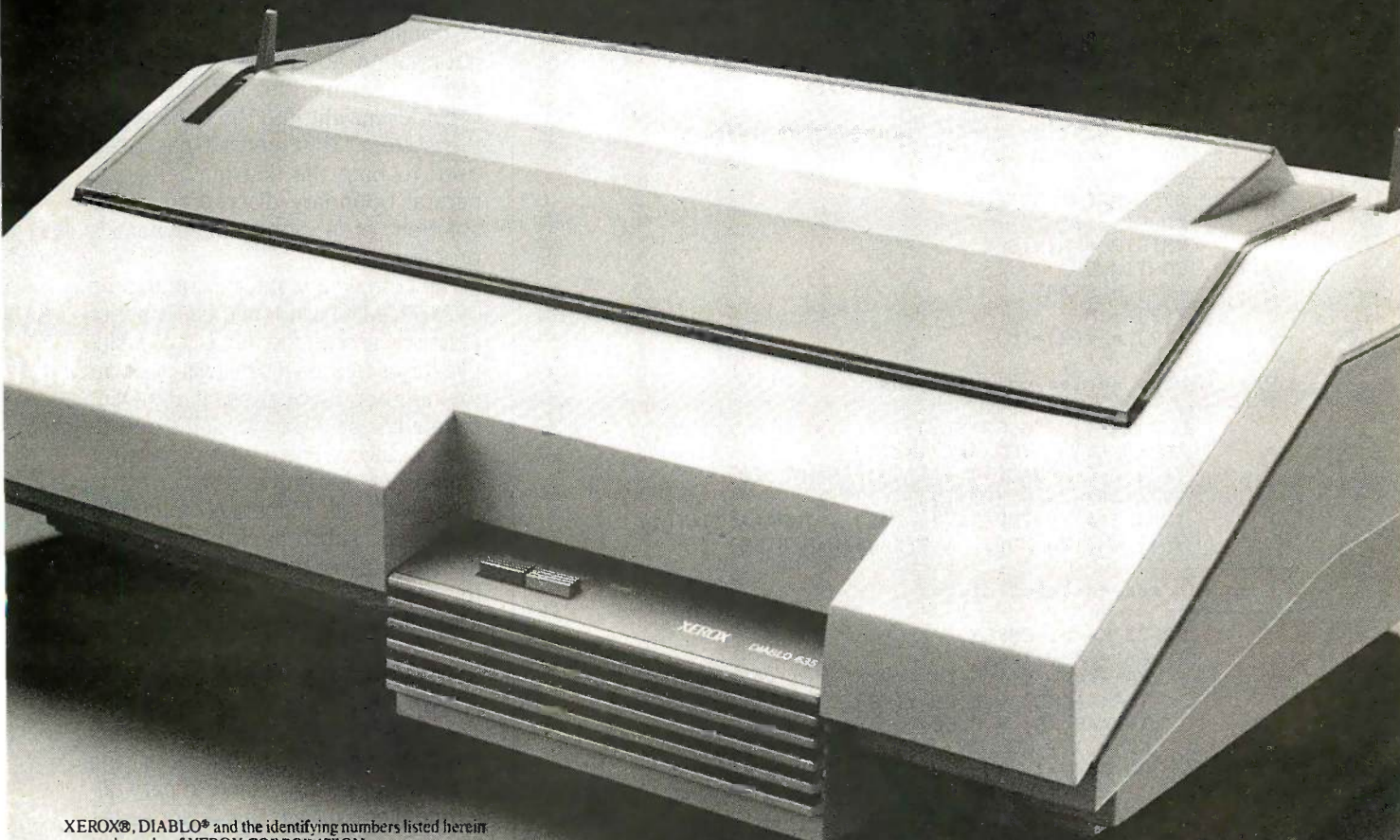

XEROX®, DIABLO® and the identifying numbers listed herein are trademarks of XEROX CORPORATION.
IBM® is a registered trademark of the International Business Machines Corporation. APPLE® is a registered trademark of the Apple Corporation.

FOR MORE INFORMATION ON THE XEROX 635 DIABLO PRINTER, CIRCLE 397 ON THE READER SERVICE CARD.

```

MPRINT = 4
NTERMS = 2
KTRDCV = 1
ADJSTF = 1.E-2
MSTIFF = 0
DLTXPT = 0.E0
C-----
c start of third input block
C-----
C READ INTEGRATION INTERVAL AND INITIAL CONDITIONS.
  READ(5,1010) START,END,Y(1),Y(2)
  1010 FORMAT(4F10.3)
  WRITE(*,1020) START,END,Y(1),Y(2)
  1020 FORMAT(' SOLVE THE FIRST PAINLEVE TRANSCENDENT' /
+ ' INTERVAL: ',2F10.3 /
+ ' INITIAL CONDITIONS:',2F10.3 /)
C-----
c end of third input block
C-----
c More initializations
C-----
  DLTXT = SIGN(DLTXT,(END-START))
  H = SIGN(H,(END-START))
  KDIGS = 6
  XPRINT = START + DLTXT
  KXPNUM = 35
  LENVAR = 36
  LRUN = 1
  KTSTIF = 0
  NUMEQS = 1
  IF (LENSER.GT.(LENVAR- 6)) LENSER = LENVAR - 6
  IF (MPRINT.LT.2) GO TO 17
  WRITE(*,11) KTSTIF,START
  K = Y(33)
  WRITE(*,12) NAMES(K),Y(1), Y(2)
C-----
c Loop for integration steps. Inside the loop,
c print the desired output
C-----
  17 DO 27 KINTS=1,NSTEPS
    KOUNT = 0
    KNTSTP = KINTS
  19 CONTINUE
    T(1) = START
    T(2) = H
    Y(2) = Y(2)*(H)
C-----
c Preliminary series calculations
C-----
    TMPAAA(1) = 6.E0*Y(1)
    TMPAAB(1) = TMPAAA(1)*Y(1)
    Y(3) = (TMPAAB(1) + T(1))*(H*H/2.E0)
    TMPAAA(2) = 6.E0*Y(2)
    TMPAAB(2) = TMPAAA(1)*Y(2) + TMPAAA(2)*Y(1)
    Y(4) = (TMPAAB(2) + T(2))*(H*H/6.E0)
C-----
c Loop for series calculations
C-----
    DO 23 K= 5,LENSER
      KA = K - 1
      KB = K - 2
      TMPAAA(KB) = 6.E0*Y(KB)
      TMPAAB(KB) = 0.E0
      KZ = 1 + KB
      DO 30 N=1, KB
        L = KZ - N

```

(continued)

are that the derivatives may be of an order of, at most, 6 and that there are, at most, 900 equations in the system.

ATOMCC can also solve (with manual intervention) solutions that are polynomials, singular problems that require the application of l'Hospital's rule, or problems that have catastrophic subtractive errors in series generation.

ATOMCC is most attractive for problems with stringent accuracy requirements, stiff problems, problems that must be solved repeatedly (such as parameter identification), or quick and easy problems (students' assignments).

The very high order and precise error control used by ATOMCC have enabled it to solve many problems that other methods were unable to solve.

The ATOMCC toolbox allows for the solution of ODEs in the complex domain. This unique capability can be used to explore the structure of the singularities in the complex domain of nonlinear problems. The analytic information about the location and order of singularities in the solution provides insight into the behavior of the system. This method has been used to map the first mathematical natural boundary discovered in the solution of a nonlinear dynamics problem.

The complexity and execution time of ATSPGM depend on the number of functions and on the number of multiplications in the ODE system, not on the number of equations in the ODE system nor on the order of the derivatives involved. There is no penalty for high-order derivatives.

As with all numerical methods, there is no substitute for insight into the structure of the ODE system and for the application of clever transformations.

THE GENERATED PROGRAM, ATSPGM

The ATSPGM program implements the Taylor series algorithm for solving initial value problems in ordinary differential equations. This Taylor series

(continued)

NEW FROM KOH-I-NOOR — FIBER-TIP PLOTTER PENS.

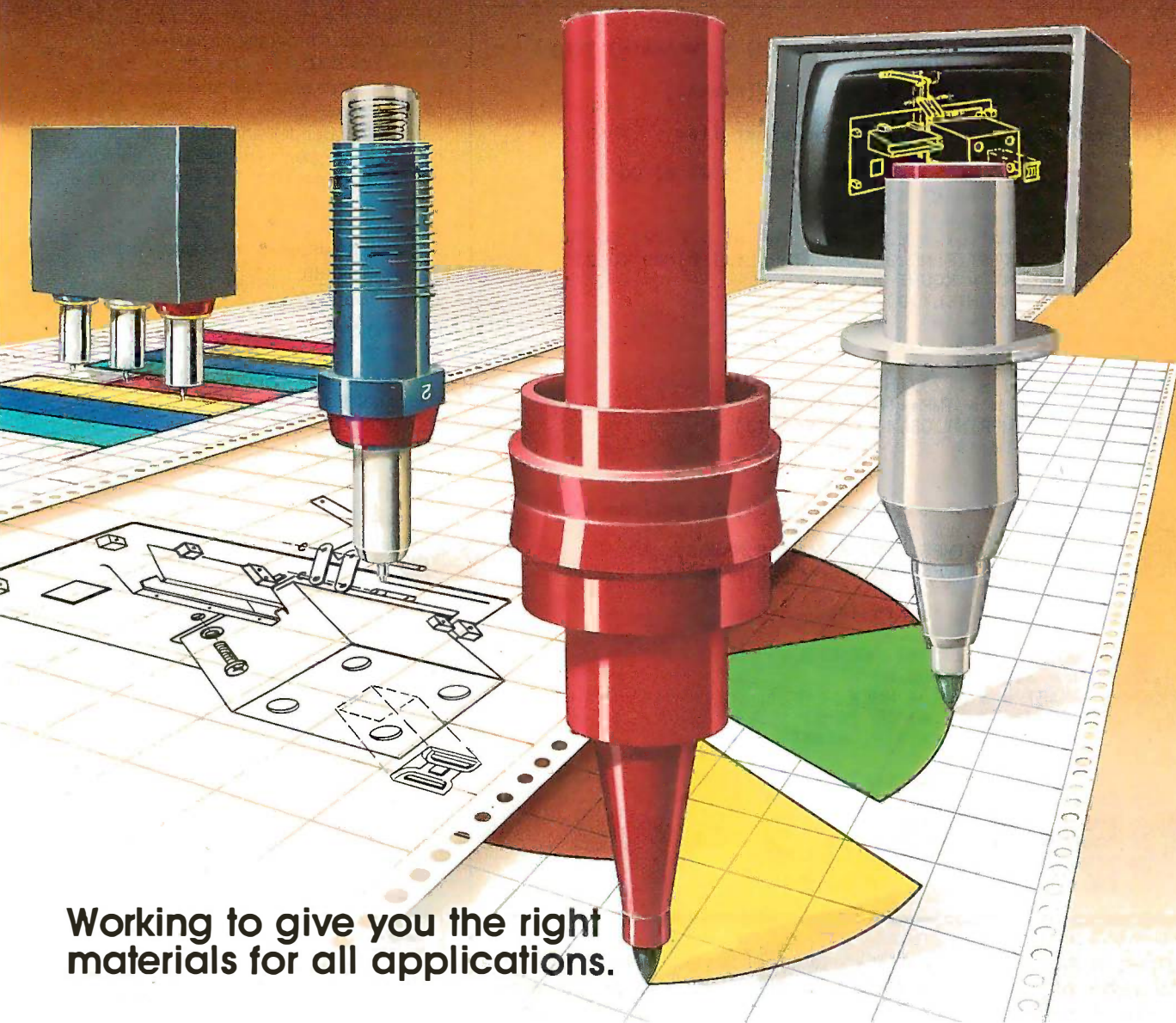

Working to give you the right materials for all applications.

Koh-I-Noor works with manufacturers of automated drafting equipment to develop highest quality plotter supplies for the best possible hard-copy output. The same quality standards that have established Koh-I-Noor leadership in liquid ink plotting apply to the new line of fiber-tip products.

Now you can select from our line of fiber-tip pens, liquid-ink pens, specially formulated inks, drafting media and other materials for a system that works best

for you. The Koh-I-Noor line of plotter materials is available through your Koh-I-Noor plotter supply dealer. For additional technical or product information, contact our Plotter Customer Services Department, Koh-I-Noor Rapidograph, Inc., Bloomsbury, NJ 08804 (201) 479-4124.

Inquiry 180

KOH-I-NOOR
RAPIDOGRAPH®

a  rtring company

Yes, KOH-I-NOOR! Tell me more about your plotter supplies and services. Please send me your free brochure "PLOTTER SUPPLIES — Points, Inks, Accessories."

Please send me the names of Koh-I-Noor dealers in my area.

Name _____

Title _____

Firm _____

Plotter Make _____ Model _____

Address _____

City _____ State _____ Zip _____

B-4/86

```

30      TMPAAB(KB) = TMPAAB(KB) + TMPAAA(N)*Y(L)
      CONTINUE
      Y(K) = (TMPAAB(KB))*(H*H/(KB*KA))
c-----
c Test and adjust H to avoid over/under flow
c-----
      IF(MSTIFF.GE.20 .AND. KTSTIF.GT.0) GO TO 23
      TMP = ABS(Y(K))
      IF(TMP.LE.1.E-35) GO TO 23
      IF(TMP.LT.1.E20 .AND. TMP.GT.1.E-20) GO TO 23
      IF(KTSTIF.NE.0 .AND. TMP.LT.1.0) GO TO 23
      KOUNT = KOUNT + 1
      IF(KOUNT.LT.9) GO TO 22
      WRITE(*,16)
      GO TO 28
22      CONTINUE
      Y(2) = Y(2)/(H)
      H = H * TMP**(0.3/(1-K))
      IF(MPRINT.GE.4) WRITE(*,13) H
      GO TO 19
23      LRUN = 1
c-----
c Calculate radius of convergence and take optimum step
c-----
      CALL RDCV(TMPS,LENVAR,NUMEQS,NAMES)
24      CALL RSET(TMPS,LENVAR,NUMEQS,NAMES)
c-----
c no instructions in fourth input block
c-----
25      GO TO (26,28;24), KENDFG
26      H = SIGN(RADIUS,H)
      START = START + HNEW
      IF(MPRINT.LT.4) GO TO 27
      WRITE(*,11) KNTSTP, START
      K = Y(33)
      WRITE(*,12) NAMES(K),Y(1), Y(2)
27      CONTINUE
      WRITE(*,14) NSTEPS
28      CONTINUE
29      STOP
      END

```

algorithm, in outline, is as follows: Initialize method control parameters that may be modified; assign initial conditions, the integration interval, and method control parameters; initialize method control parameters that may not be modified; and loop for each integration step. To do this, initialize the first few series terms; generate the entire series; call subroutine RDCV to determine the optimal step size from (a) the location and order of the primary singularities, (b) the series length, and (c) the error tolerance and then adjust the step size; and then call subroutine RSET to perform analytic continuation and to print the solution.

In ATSPGM, the step size used to expand the series is related to the

radius of convergence at each integration step. After a series is generated, the location and order of the primary singularity are calculated. Then, the step size is adjusted to control the error.

An exception is made in the solution of stiff problems. The step size is determined in stiff problems by the length of a polynomial that can adequately represent the function. ■

The ATOMCC toolbox presented in this article is a microcomputer version of the original mainframe system. Institutions interested in porting ATOMCC to their mainframes should contact the author for source code and support.

ACKNOWLEDGMENTS

I would like to express my gratitude to Roy

Morris for the initial design and coding of the translator program; to students John Fauss, David Lowery, and Manuel Prieto for their work on series analysis; to Ray Moore, Mike Tabor, John Weiss, Mike Ziegler, Phil Bender, and others for many helpful suggestions; and to Jon Wright for the many suggestions that arose from his extensive use of the ATOMCC system. I am particularly indebted to Professor George Corliss, who assisted me in every aspect of this program.

BIBLIOGRAPHY

- Barton, D. I. M. Willers, and R. V. M. Zahar. "The Automatic Solution of Ordinary Differential Equations by the Method of Taylor Series." *Computer Journal*, vol. 14, 1971, page 243.
- Chang, Y. F. "Automatic Solution of Differential Equations." In *Constructive and Computational Methods for Differential and Integral Equations*, D. L. Colton and R. P. Gilbert, eds. *Lecture Notes in Mathematics*, vol. 430, New York: Springer-Verlag, 1974, page 61.
- Chang, Y. F., and G. F. Corliss. "Compiler for the Solution of Ordinary Differential Equations Using Taylor Series." Marquette University technical report, 1981.
- Chang, Y. F., and G. F. Corliss. "Ratio-like and Recurrence Relation Tests for Convergence of Series." *Journal of the Institute Mathematics and Its Application*, vol. 25, 1980, page 349.
- Chang, Y. F., and G. F. Corliss. "Solving Ordinary Differential Equations Using Taylor Series." *ACM Transactions on Mathematical Software*, vol. 8, 1982, page 114.
- Chang, Y. F., J. Fauss, M. Prieto, and G. F. Corliss. "Convergence Analysis of Compound Taylor Series." *Proceedings of the Seventh Conference on Numerical Mathematics and Computing*, University of Manitoba, 1978, page 129.
- Chang, Y. F., M. Tabor, J. Weiss, and G. F. Corliss. "On the Analytic Structure of the Henon Heiles System." *Physics Letters* 85A, 1981, page 211.
- Corliss, G. F. "Integrating ODE's in the Complex Plane: Pole Vaulting." *Mathematics of Computation*, vol. 35, 1980, page 1181.
- Corliss, G. F., and D. Lowery. "Choosing a Step size for Taylor Series Methods for Solving ODE's." *Journal of Computational Applied Mathematics*, vol. 3, 1977, page 251.
- Moore, R. E. *Interval Analysis*. Englewood Cliffs, NJ: Prentice-Hall, 1966.
- Rall, L. B. "Automatic Differentiation: Techniques and Applications." *Lecture Notes in Computer Science #120*, Berlin: Springer-Verlag, 1981.



Another Futuristic Leap From Goldstar's Long Line of Electronics—5 1/4" & 3 1/2" Floppy Disks

Goldstar is determined to keep pace with the new frontiers in this electronic age. So, we now market both 5 1/4" Floppy Disks and 3 1/2" Micro Floppy Disks for all of your computer consumers.

All of Goldstar's pioneering experience, research, and demand for excellence has been channelled into this surge for technology. Therefore, you can be sure of our reliability, as Korea's electronic history-maker.

Our self-imposed demands match yours exactly—nothing less than perfection; and we're even trying to improve that, as we keep on top of the latest developments in computers and peripherals. Both lines of disks, the 5 1/4" and 3 1/2", are manufactured with the most advanced technology.

All Goldstar disks are individually certified 100% error-free at all levels, equal to or above ANSI, DIN, ECMA, ISO and JIS standards.

Goldstar Floppy Disks are engineered to the highest possible quality precision for the maximum in long archival life, accuracy, data integrity, and reliability.

So, for superiority and reliability—

CHOOSE GOLDSTAR FLOPPY DISKS, either 5 1/4" or 3 1/2":

LINE-UP

Item	Type	Tracks/inch	Bits/inch	Capacity
5 1/4"	M-1S	48	2768	125 KB
	M-1D	48	5536	250 KB
	M-2D	48	5876	500 KB
	M-2DD	96	5922	1 MB
3 1/2"	MF-1D	67.5	8128	250 KB
	MF-2D	67.5	8650	500 KB
	MF-1DD	135	8190	500 KB
	MF-2DD	135	8720	1 MB

(Unformatted)



LUCKY-GOLDSTAR INTERNATIONAL CORP.

Magnetech Group: C.P.O. Box 1899, Seoul, Korea; Tel. (02)756-9090; Tlx. LGINTL K29579.

LUCKY-GOLDSTAR

•New York Office: 2nd Floor 1050, Wall Street West, Lyndhurst, New Jersey 07071, U.S.A.; Tel. (201) 460-8010; Tlx. LGI UR 219108; Fax. (201) 935-5686 •Los Angeles Office: 13013 East 166th Street, Cerritos, Calif. 90701, U.S.A.; Tel. (213) 404-2626/9; Tlx. LGI LA (910) 583-5719; Fax. (213) 926-0849 •London Office: Tel. (01) 840-7111; Tlx. 21765 LGI UK •Frankfurt Office: Tel. 069-6664083/5; Tlx. 4185337 LGIF •Paris Office: Tel. 734-52-06; Tlx. LGIPAR 201877.



Reviews

REVIEWER'S NOTEBOOK <i>by Glenn Hartwig</i>	229
THE PANASONIC EXEC. PARTNER <i>by Rich Malloy</i>	231
KAMAS <i>by Albert S. Woodhull</i>	241
PROFESSIONAL DEBUG FACILITY AND ADVANCED FULLSCREEN DEBUG <i>by Jack Carden</i>	249
MICROTSP <i>by Paul Davenport</i>	257
PCT_EX AND MICRO_TE_X <i>by Hal Varian</i>	267
REVIEW FEEDBACK	273

IN OUR FIRST REVIEW we take a look at one of an intriguing class of transportable computers that features a high-speed processor, an integral printer, and a crisp gas-plasma display. The Panasonic Exec. Partner, according to BYTE Senior Technical Editor Rich Malloy, has made some strides in presenting remarkable new examples of technology at a comparatively low price. On the other hand, he notes that the Exec. Partner is a hefty 28 pounds. That's a lot of bulky, delicate electronic gear to try hauling home on the bus. Beyond the screen itself, how well does the machine measure up to other choices you could make for the same money?

Our next review is of KAMAS, an outline processor and programming language that, according to reviewer Albert Woodhull, gives you considerable freedom in document organization and preparation. KAMAS is described as being "layered like an onion," in which the user discovers successive levels of capability. Starting from the outer layer and working in, you pass through an outline editor and a "leaf" editor to get to a deeper level of screen-oriented layers where you can use all the outline-processing commands from a line-oriented terminal. A still-lower level gets you into programming and lets you specify commands and their arguments either in command lines or as text in a file. Finally, two more programming levels constitute "a general-purpose, extensible, threaded-interpretive language," similar to FORTH. All the features and layers have a purpose in helping you organize your writing, and this review gives you a full explanation of them.

The IBM Professional Debug Facility and the Advanced Fullscreen Debug are compared and contrasted in our next review. According to Jack Carden's analysis, there are considerable areas of similarity between the two. Generally, they each contain most of the features usually available in standard debuggers. They have considerable functionality and each constitutes a valuable tool for the programmer. Nevertheless, the two facilities aren't carbon copies of each other, and the differences provide an interesting look at the number of ways you can go about cleaning up your code.

The time-series regression package microTSP is the type favored by economists and other social scientists. Down-sized from TSP International's mainframe-oriented Time Series Processor, microTSP nevertheless reveals a high level of functionality and ease of use, according to reviewer Paul Davenport of McGill University. The program runs on the IBM PC and such compatibles as the Compaq, requires two disk drives, 256K bytes of RAM, and PC-DOS. Professor Davenport reports that, except for the perennial problem of less-than-sparkling documentation, the program is straightforward, easily understood, and a tool for statistical manipulations that you can start using to good advantage with a minimum of preliminaries.

Lastly, we have a comparison of two professional-quality typesetting programs for use on IBM PCs and compatible MS-DOS microcomputers. PCT_EX and Micro_TE_X are descendants of the powerful T_EX program developed by Donald Knuth of Stanford University. The software is especially valuable for setting such "penalty" text as mathematics, tables, foreign languages, and technical material.

NEW RELEASE

Ecosoft's Eco-C88 Rel. 3.0 C Compiler



\$59⁹⁵

Release 3.0 has new features at an unbelievably low price. ECO-C88 now has:

- Prototyping (the new type-checking enhancement)
- enum and void data types
- structure passing and assignment
- All operators and data types (except bit fields)
- A standard library with more than 200 functions (many of which are System V compatible for greater code portability)
- cc and mini-make that all but automates the compile process
- 8087 support (we sense the 8087 at runtime – no dual libraries)
- ASM or OBJ output for use with MSDOS linker
- Tiered error messages – enable-disable lint-like error checking
- Fast compiles and executing code
- Expanded user's manual
- Enhanced CED program editor (limited time offer)

We also offer the following support products for Eco-C88.

CED Program Editor

\$29⁹⁵

CED now supports on-line function help. If you've forgotten how to use a standard library function, just type in the name of the function and CED gives you a brief summary, including function arguments. CED is a full screen editor with auto-flagging of source code errors, multiple windows, macros, and is fully configurable to suit your needs. You can edit, compile, link, and execute DOS commands from within the editor. Perfect for use with Eco-C88. For IBM PC, AT and look alikes.

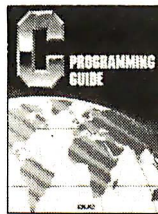

C Programming Guide \$20

After reading the 1st edition, Jerry Pournelle (BYTE Magazine) said: "I recommend this book... Read it *before* trying to tackle Kernighan and Ritchie." The second edition expands this best seller and walks you through the C language in an easy-to-understand manner. Many of the error messages include references to this book making it a perfect companion to Eco-C88 for those just starting out with C.

C Source for Standard Library \$10

Contains all of the source code for the library functions that are distributed with Eco-C88, excluding the transcendentals and functions written in assembler.

(\$20 if not with order)



C Self-Study Guide \$17

(Purdum, Que Corp.). Designed for those learning C on their own. The book is filled with questions-answers designed to illustrate many of the tips, traps, and techniques of the C language. Although written to complement the Guide, it may be used with any introductory text on C.

Developer's Library

Contains the source code for all library functions, including the transcendentals and those written in assembler. Perfect for the developer that wish to write their own custom functions or learn how we implemented the Eco-C88 library.

\$25

(\$50 if not with order)

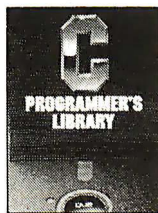

C Programmer's Library \$20

(Purdum, Leslie, Stegemoller, Que Corp.). This best seller is an intermediate text designed to teach you how to write library functions in a generalized fashion. The book covers many advanced C topics and contains many useful additions to your library including a complete ISAM file handler.

ISAM Library

Contains the code from the C Programmer's Library in relocatable format (i.e., .OBJ) including the delete code for the ISAM file handler.

\$15

(\$30 if not with order)

Eco-C88 C compiler requires an IBM PC, XT, or AT (or compatible) with 256K of memory, 2 disk drives and MSDOS 2.1 or later. Call today:

1-800-952-0472 (for orders)

or

1-317-255-6476 (tech. info.)



Ecosoft, Inc.

6413 N. College Ave. • Indianapolis, IN 46220



TRADEMARKS: ECO-C88, ECOSOFT

R·E·V·I·E·W·E·R'S N·O·T·E·B·O·O·K

We were recently handed the Datavue 25 from Quadram and a Z-171 PC from Zenith, which have upgraded, backlit LCD screens and contain more memory than previous flat-screen, sewing-machine-style carry-alongs.

They are both light, but because of their upright profiles, neither of these machines are laptops. The Datavue 25's cordless, detachable keyboard gives you some freedom from the system unit, but since it transmits keystroke information by means of infrared LEDs, you have to maintain a clear line of sight between yourself and the front of the computer. You're going to have a dead keyboard if the keyboard drops below the edge of a table or if you turn in your chair to see who's standing at your office door. For the most part, when you're pointing the keyboard in the general direction of the Datavue 25's front panel, you'll find that transmission is reliable. I started missing characters occasionally when I held the keyboard on my lap and the system unit was in front of, and a little lower than, my knees. I may have been unconsciously trying to compensate by hitting the keys harder (and maybe someone who never used a manual typewriter wouldn't react at all the way I did), but after a few hours, I understood why Quadram said one of its beta testers complained of sore fingers.

The new Datavue has a single disk drive. It also has 640K bytes of RAM, however, and you can set aside up to half of that as a RAM disk. You can get out of a lot of tedious disk swapping by using the RAM disk, as long as you log your data to a floppy and have a relatively reliable electrical outlet or use the batteries. The Zenith has two disk drives. You don't have to set up a RAM disk but, of course, disk-intensive programs will run slower.

Right away people are going to notice the brighter screens on both these computers. You can read words and numbers off these new screens without squinting at punctuation marks or decimal points, for example. A very bright light source at the wrong angle will still wash out the LCD, but the light has to be brighter than it used to and there are fewer really bad angles.

The Quadram unit comes with its own DOS and a diagnostics disk. I tried booting it with the DOS disk from my Compaq without success. The Zenith seemed to boot just fine on several varieties of MS-DOS. The Zenith also has some useful-looking built-in programs for keeping track of appointments, etc.

Another upgrade, and one for which there will also be more coverage in coming issues, was the Macintosh Plus. While the new machine is an upgrade in itself and can be purchased in its full configuration, a good deal of discussion is focusing on the stepwise upgrades for current Macintosh owners. The first is a new ROM and a double-sided 800K-byte drive, with the second being a megabyte of RAM and a new back panel designed to take an external SCSI port. Both of these are supposed to be done by Apple dealers. There is a third upgrade, a new keyboard with numeric pad and cursor keys, but since this doesn't require anything beyond plugging it in, most people seem to be viewing it as a new feature instead of an upgrade.

The memory upgrade for current Macintosh owners costs \$200 more (\$799) if your Mac has 128K bytes of RAM than if it has 512K. If you had your 128K Mac upgraded by someone other than Apple, you pay \$799 as well. People who bought a new

Macintosh between the middle of November and the middle of January, or had their 128K Mac upgraded to a 512K version during that time, will get rebates on upgrade kits.

Lisa and Macintosh XL owners are being invited to take part in the upgrade by swapping their old machines and about \$1500 for a new Macintosh Plus and a 20-megabyte hard disk. Apple isn't creating a schedule of discounts to take into account the different configurations and original prices of the Lisa and the XLS they're taking in trade. There is one price for all.

So far, all the applications that ran on earlier Macintoshes run on the Plus. The increase in speed due to extra memory, memory cache, and new system software is especially noticeable when you're moving around in an application (scrolling through a large document, for example) where you'd gotten accustomed to daydreaming while the Mac poked along. It's quite a change to have to pay attention so that you don't wind up making the machine wait instead of the other way around. Old single-sided disks continue to work, and programs and languages can be run with few or no problems, in our experience.

You'll become more appreciative of the upgraded Macintosh if you've had some experience fidgeting in front of the older versions. I'm not sure how a new user will view the features that I look at favorably. Still, they're the kind of improvements in Macintosh that people have been waiting for Apple to produce for some time. Others have done it, now Apple has done it, and those people who wanted both expanded capability and an intact warranty will probably be reassured.

—Glenn Hartwig
Technical Editor, *Reviews*

MOST COMPATIBLE — LEAST EXPENSIVE XT and AT Compatibles by: AFTON COMPUTER



QUANTUM XT™ \$799.00

- 256K Expandable to 640K
- 2 x 360K Floppy Drive
- 135W Power Supply
- Color or Monochrome Card
- Hi-Res Monitor
- Keyboard
- Parallel Port
- Socket for 8087 CoProcessor

QUANTUM XT TURBO™ \$749.00

System includes:

- 640K on MB
- 360K Floppy Drive
- Keyboard
- 135W Power Supply
- Fully Assembled and Tested



QUANTUM AT™ \$1995.00

(Includes 20MB Hard Disk)

- 512K
- 1.2 MB Floppy Drive
- Floppy/Hard Controller
- 200 W Power Supply
- Keyboard
- Socket for 80287
- 20 MB Hard Drive

60 MEG TAPE STREAMER

For the AT or XT



\$999.00

MONOCARD

Monochrome Display Card with Parallel Port



\$110.00

STANDARD MFC

- Clock/Calendar
- Serial Port
- Parallel Port
- Game Port
- Software



\$129.00

COMPLETE HARD DISK SYSTEMS!

For The **IBM PC™** and Compatibles

1 YEAR WARRANTY!

Half Height Hard Disk Kits for the IBM PC™



- Boots from Hard Disk
- Instruction Manual
- Cables and Mounting Hardware
- Half Height Bezel
- Hard Disk Controller

20MB \$465.00
33MB \$849.00

MONO MONITOR

TTL or COMPOSITE



\$99.00

FDC

Controls Up To 4 Floppy Disk
Includes Internal Cables.



\$45.00

NAME BRAND FLOPPY DISK DRIVES

- Half Height
- DS/DD

\$95.00

STANDARD AT-MFC w/128K

Up to 2.5 MB Memory Expansion, Serial and Parallel Port for IBM AT.



\$275.00

I/O

Serial & Parallel Port Card for IBM PC and AT



\$99.00

COLOR CARD

Color Graphic Card w/ Parallel Port



\$99.00

TAPE BACKUP SYSTEM

- 10.35 Meg Formatted Capacity
- Half Height
- Low Power



\$450.00

5150 KEYBOARD



\$89.00

135 WATT Replacement Power Supply



\$85.00

AMERICAN MADE

300/1200 Baud Modem - Internal with software



\$199.00

— 48 Hour Burn In Period And Testing On Every Machine —
FULL ONE YEAR WARRANTY

CALL for FREE CATALOG and PRICE LIST

AFTON COMPUTER
(714) 259-1127 • TELEX 756731

24825 CALLE EL TORO GRANDE ★ EL TORO, CALIFORNIA 92630

Prices and availability subject to change without notice. • IBM® is a registered trademark of International Business Machines Corporation.

Inquiry 10 for End-Users. Inquiry 11 for DEALERS ONLY.

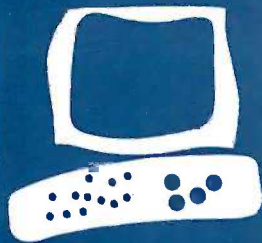

The Panasonic Exec. Partner

**This new
transportable
features a
gas-plasma
display and
a built-in
thermal-
transfer
printer**

BY RICH MALLOY

The Panasonic Exec. Partner is a new transportable IBM PC-compatible computer that comes with not only a high-speed processor and an integral printer, but also a gas-plasma display.

The gas-plasma display is an exciting new technology. By setting the price of the Exec. Partner at \$2595, Panasonic has made this technology affordable. The question is whether the other elements of the Exec. Partner are equally exciting.

PHYSICAL DESCRIPTION

The Exec. Partner looks much thinner and taller than other transportables. In fact, because it may fall over when you stand it on its side, Panasonic recommends that the machine be left lying flat at all times.

One advantage of this thin design is that you can carry it close to your side. Unfortunately, it weighs 28 pounds and seems just as heavy as other transportable computers. I wouldn't want to carry it home regularly.

When set up for use, the thin design gives the machine a low, sleek professional look. In fact, it looks like a large portable electric typewriter, but it's a little longer front to back (21.7 inches). The housing of the display, which acts almost as a keyboard cover, swivels up, revealing the keyboard, the display, and the disk drives. This feature should offer some protection for the system.

Unfortunately, the top of the display housing has a number of ventilation holes located above the electronics inside the display. Thus, even with the display closed, the display electronics are not protected if you spill liquids on the system.

On the right side of the machine is an opening for a short expansion board, such as an internal modem. Adjacent and to the rear of this opening are the 120/220-volt power-selector switch, power on/off switch, and the main power fuse, respectively. On the rear panel from left to right are the connectors for power, the parallel printer port, the serial port, and an expansion connec-

tor. (See the rear-view photo in the "At a Glance" box on page 234.) Immediately above the connectors is the printer access door.

The rearmost four inches of the machine is light gray and houses a thermal-transfer printer. The contrasting color gives the impression that the printer portion can be removed, but unfortunately, this is not the case.

GAS-PLASMA DISPLAY

The best feature of the Panasonic Exec. Partner is its high-contrast gas-plasma display of light-orange characters on a dark-orange background (see photo 1). This display is quick and steady, and each dot is sharp and precise.

In text mode, the display has a fairly high resolution (640 by 400 pixels). Each text character is formed on an 8- by 16-pixel matrix and is very easy to read. By contrast, the IBM PC monochrome display uses a 9- by 14-pixel matrix for each character. In addition, the display is rather large, 11 inches diagonally, compared with the 9-inch diagonal displays on the Compaq and IBM transportables.

The display is very flat, but reflection on the display face does not seem to be a problem. Because of a unique hinge, the display can be set at any angle for easy reading. This is in contrast to other transportables whose displays are limited to a single open position.

As good as the Panasonic display is, it does have a little trouble being compatible with the IBM displays. Panasonic has chosen to emulate the IBM Color Graphics Adapter (CGA), which has the advantage of allowing the system to display graphics. Unfortunately, most software that uses the CGA will attempt to make use of the CGA's 16 text colors, and the Exec. Partner cannot display color. Instead, it represents these 16 colors by using only four text styles: normal, bold, italic, and italic bold.

(continued)

Rich Malloy is BYTE's New York editor. He can be reached at BYTE/McGraw-Hill, 43rd Floor, 1221 Avenue of the Americas, New York, NY 10020.

The result is that text that is beautifully highlighted in color may not be highlighted at all on the gas-plasma display.

Because of the Exec. Partner's monochromicity, it is surprising that Panasonic did not choose to match its text styles with those of the IBM Monochrome Adapter (for example, normal, high-intensity, underlined, etc.). This might have somewhat alleviated the problem of handling multicolored text. Fortunately, however, most software for the IBM PC lets you alter the text colors the programs use, allowing you to choose the optimum combination for the Exec. Partner.

Another problem I noticed is that, for some reason, Borland's desk-accessory program SideKick changes the way other programs use the text modes. I suspect that Panasonic has used some unusual mapping technique, or SideKick is very sensitive to some esoteric section of the display BIOS.

The italic modes of the display are impressive, but I wish that Panasonic had made its system more compatible with the IBM or the Compaq. I also wish that Panasonic had adapted

another feature of the Compaq, a connector for an RGB display.

KEYBOARD

The Panasonic Exec. Partner keyboard is similar to the IBM PC keyboard except for three details. The function keys are aligned horizontally along the top of the keyboard; certain important keys such as Return, Shift, and Backspace are oversize for ease of use; and there is a row of indicator lights above the numeric keypad that indicate functions such as Caps Lock and Num Lock.

Note that the keyboard has the same misplaced left Shift key as the IBM PC. The keyboard seems to have a good feel. Unlike a detachable keyboard, however, it cannot easily be moved around on a desk.

ELECTRONICS

The 8086-2 microprocessor seems to be increasingly popular in new systems and is put to good use in the Panasonic machine. The 8086-2 can run at two clock speeds. In high-speed mode the processor has a clock speed of 7.16 MHz. This clock speed, combined with the wide (16-bit) external data bus of the 8086, allows the

Panasonic to run at almost twice the speed of the IBM PC (see the benchmark results).

In low-speed mode, the clock speed reverts to 4.77 MHz, and the processor runs at nearly the same speed as the 8088 in the IBM PC. The low-speed mode is important for situations where you might want complete compatibility with the IBM PC.

The dual-speed nature of the Exec. Partner is a handy feature. All you have to do to change speed is press Ctrl-Alt-Plus (on the numeric keypad). An indicator light on the keyboard informs you of the speed at which the machine is running. I found it useful to compile programs at high speed and execute them at low speed to find bugs.

Also, in games such as the submarine simulation game Gato, you can cruise for long distances under high speed and then slow down to low speed when situations warrant it.

MEMORY

The Exec. Partner comes with 256K bytes of memory configured as 32 64K-bit RAM chips. To expand the system to 640K bytes of memory, you must remove 16 of the chips from their sockets and replace them with 256K-bit chips. Also, the configuration of a DIP switch inside the machine must be changed. This switch bank has switches for configuring 8087-2 coprocessor and hard disk in addition to memory expansion. (Access to the memory chips and DIP switch is via a removable panel on the underside of the machine).

Two other handy features of the Exec. Partner are an internal clock/calendar that is powered by its own rechargeable battery, and a socket for an optional 8087-2 math coprocessor to speed up mathematical calculations.

DISK STORAGE

There are two configurations available for the Exec. Partner. The first has two 360K-byte floppy-disk drives. The second, which should be available by

(continued)

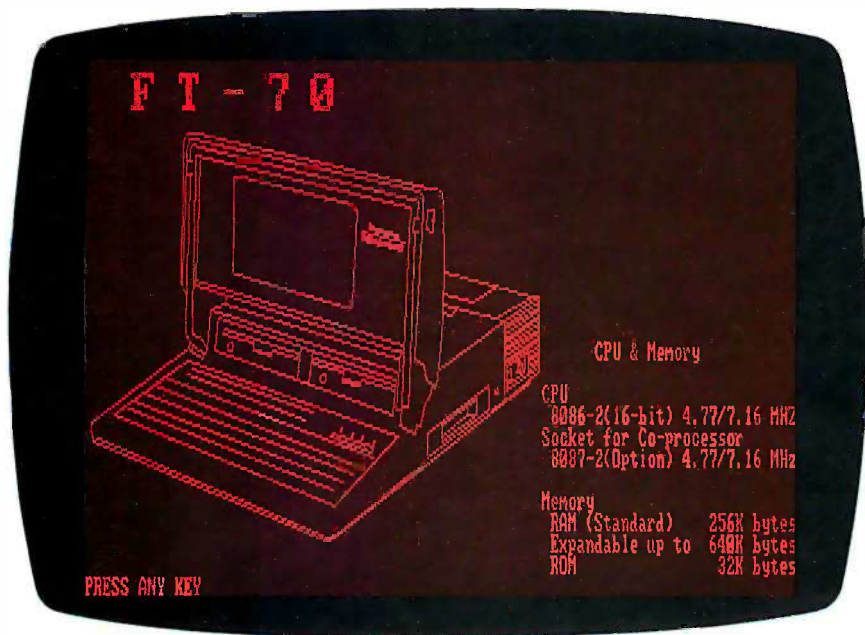

Photo 1: The Panasonic Exec. Partner gas-plasma display panel.

AT A GLANCE

Name

Panasonic Exec. Partner

Company

Panasonic Industrial Company
One Panasonic Way
Secaucus, NJ 07094
(800) 447-4700
(201) 348-7000

Size

21.7 by 16 by 5.3 inches
28 pounds

Components

Processor: 8086-2, 4.77/

7.16-MHz clock speed

Memory: 256K bytes (optional
640K bytes)

Mass storage: Two 360K-byte
floppy disks

Display: Gas-plasma display;
80-column by 25-line text;
640- by 200-pixel graphics;
640 by 400 resolution in text
mode

Keyboard: IBM PC-style; 83
keys; function keys arranged
horizontally; four LEDs

Power: 120 or 220 volts AC

Expansion: One short IBM
PC-style expansion slot;
connector for future
expansion box.

Interfaces: One serial
and one parallel port

Printer

Internal thermal-transfer
printer; requires special
paper; Epson-compatible

Software

MS-DOS, version 2.11
Microsoft BASIC

Options

10-megabyte hard-disk drive
(replaces one floppy-disk
drive)

Documentation

MS-DOS manual, BASIC
manual, Quick Reference
Guide

Price

Two floppy-disk drives: \$2595
10-megabyte drive, one
floppy-disk drive: \$3795

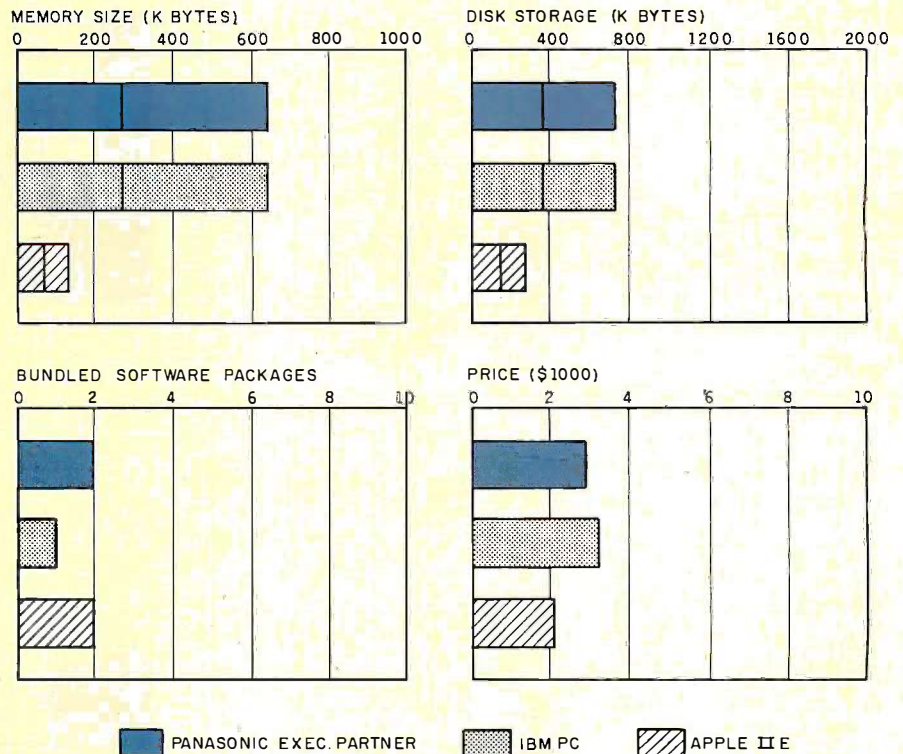

The Memory Size graph shows the standard and optional memory available for the three computers under comparison. The Disk Storage graph shows the capacity of the Panasonic Exec. Partner in comparison with each of the other computers.

The Bundled Software Packages graph shows the number of software packages included with each system. The Price graph

shows the list price of a system with two high-capacity floppy-disk drives, a printer port and serial port, 256K bytes of memory (64K bytes for 8-bit systems), and a monochrome monitor (the Exec. Partner has a built-in neon gas-plasma display). Price includes the standard operating system and BASIC interpreter for each system. Note that the Exec. Partner can display monochrome but not color graphics.



The back of the Exec. Partner showing, from left to right: power plug receptacle, parallel port, serial port, and expansion connector.

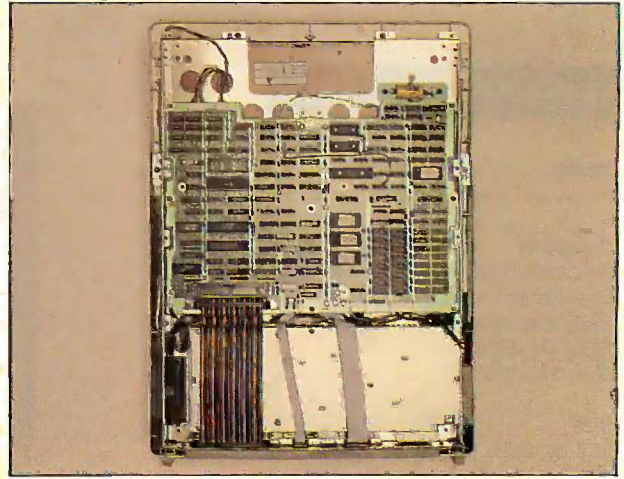

Clockwise from bottom to top: the Exec. Partner's power supply with cooling fan, ribbon cable to expansion connector, and the motherboard.

DISK ACCESS IN BASIC (SEC)

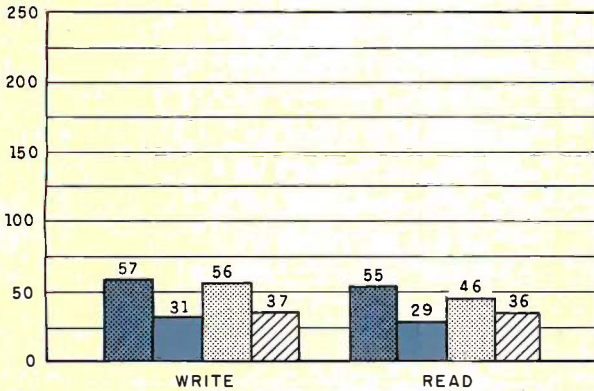

BASIC PERFORMANCE (SEC)

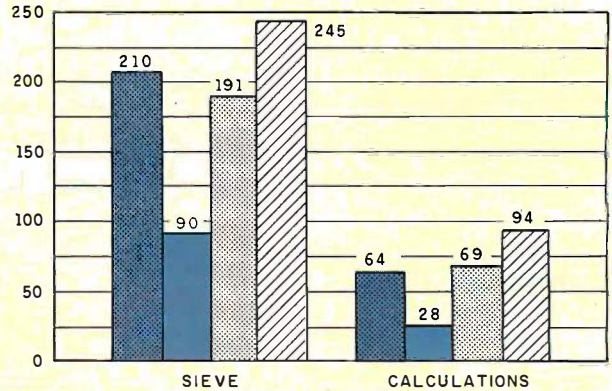

SYSTEM UTILITIES (SEC)

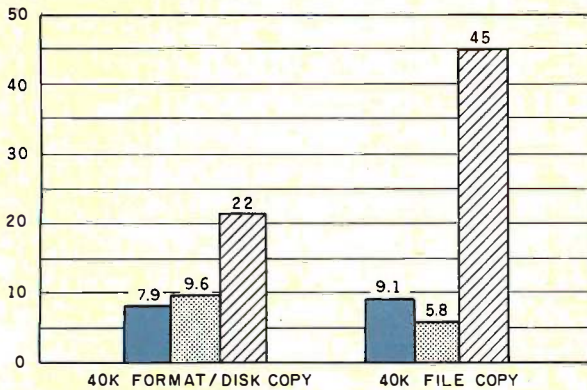

SPREADSHEET (SEC)

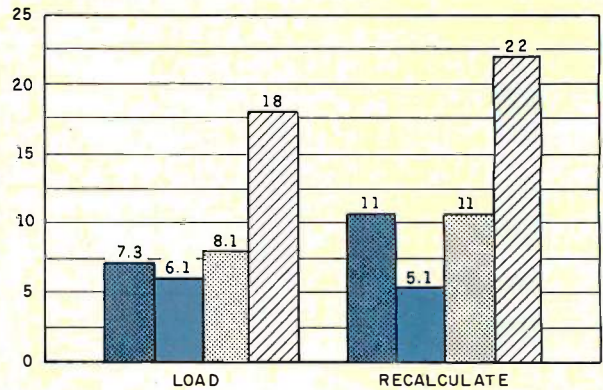

PANASONIC EXEC. PARTNER (LOW)
 IBM PC
 PANASONIC EXEC. PARTNER (HIGH)
 APPLE IIe

The Disk Access in BASIC benchmark writes and reads a 64K-byte sequential text file to a blank floppy disk. (For program listings, see June 1984 BYTE, page 327, and October 1984, page 33.) The Sieve results show how long it takes to run one iteration of the Sieve of Eratosthenes prime-number benchmark. The Calculations benchmark times 10,000 multiply and divide operations. The System Utilities benchmark formats a disk and copies a 40K-byte file to it. The

Spreadsheet benchmark loads and recalculates a 25- by 25-cell spreadsheet where each cell equals 1.001 times the cell to its left. The tests for the Exec. Partner used BASIC 2.0. The tests for the Apple IIe used ProDOS. The IBM PC was tested with PC-DOS 2.0 and BASICA. The Exec. Partner was tested in both high-speed and low-speed mode for comparison to the IBM PC. The Format and File Copy tests were not affected by the change of processor speed.

time you read this, has one 360K-byte floppy disk and one 10-megabyte hard disk.

The system I used was the dual floppy-disk configuration. The floppy-disk drives on the Exec. Partner are somewhat noisy, and the disk-drive doors are a little hard to use. Sometimes they are hard to close completely. In addition, when you remove a disk from the drive, the drive motor continues spinning for about four seconds after you open the drive door.

I was disappointed by the presence of a warning sticker in the documentation stating that you should not put a disk into the drive before powering up the system.

INTERFACES

Sometime in the future, perhaps IBM, Apple, and Compaq may include serial and parallel ports with their computers. Until that time, companies such as Panasonic will continue to distinguish themselves by including such ports as standard equipment.

The Exec. Partner's serial port seems to work well with my 1200-bps modem. Likewise, the parallel port works well with my old Star Micronics Gemini printer. This printer port is actually the second parallel port on the machine. The first is used by the internal printer. You can alternate between the two simply by pressing Ctrl-Alt-PrtSc.

The Panasonic machine also comes with an expansion bus connector. At some point in the future, Panasonic says it will offer an expansion box that uses this connector. This expansion box would presumably have a number of IBM PC-compatible slots to allow you to use various expansion cards.

For internal expansion, the Panasonic contains a slot for a short IBM PC-style expansion card. Note that this card has to be shorter than 6 inches. The main use for this slot will probably be an internal modem. Also, some manufacturers have announced short cards for RGB color displays, which may be useful.

All connectors on the Exec. Partner

have attached plastic lids to cover them when not in use.

PRINTER

The trademark of Panasonic micro-computers seems to be the internal printer. The older Sr. Partner included a small thermal printer with a roll of thermal paper. The new Exec. Partner appears to go one step further: It includes a thermal-transfer printer.

Although more technologically advanced, this printer lacks some of the advantages of the older thermal printer. Like the older printer, the new thermal-transfer printer can print on a roll of thermal paper. Unfortunately, you cannot store the roll inside the computer; you must carry it separately.

Before printing, you must set up the roll of paper on a spindle that attaches to the back of the computer.

The new printer has two modes:

correspondence quality (or thermal transfer), which prints at a nominal rate of 30 characters per second; and draft quality (thermal, 60 characters per second). In addition, there is a switch for light, bold, or dark printing. Thus, you have a theoretical choice of six styles. Your practical choice is much smaller, and though the print quality is better than that of the Sr. Partner, you will probably not want to do much formal printing on this printer.

The older printer was quiet and very compatible with the IBM Graphics Printer. The new one is quiet when printing a line, but before each line, the print head snaps loudly against the paper. And at the end of each line, the print head snaps loudly again, away from the paper. As for compatibility, the printer does seem to respond to the common Epson commands (e.g.,

(continued)

SMD/SCSI And More For . . .

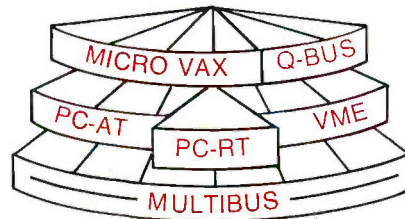

COMPLETE, COMPATIBLE, SMD DISK/TAPE MEMORY SYSTEMS WITH . . .

SMD/SCSI or Pertec, and 8 inch Winchester technology intelligently adapted to meet your needs in **leading system environments**.

Data rates up to 2.4 MB/SEC, access times of 15ms-20ms.

Disk storage/systems of 84MB, 168MB, 335MB, 474MB, 689MB, and up. Compatible with major networks. . . **designed for performance**.

Industry standard nine-track 1/2 inch, and 1/4 inch **tape back up** systems.

Multifunction single board controller for PC-AT, PC-RT, Unibus, and Q-Bus.

Tower, desk top and **rack mount** configurations are optional.

Laser optical disk technology and systems too!



SMD/SCSI multifunction for PC-AT/RT

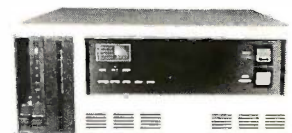

Desk Top/Rack Mount Disk/Tape Systems

TWX 9103866006
TELEX 821892 NMS UD
LIVERMORE, CA 94550



415-443-1669

---WE ARE HERE FOR YOU---



IEEE-488

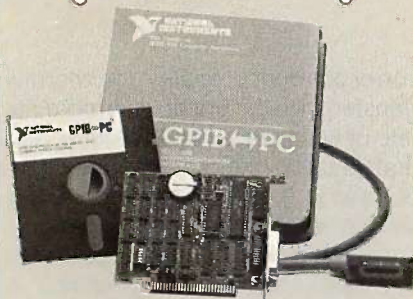

GPIB ↔ PC

Hardware Flexibility

- Low cost for instrument control
 - 300K bytes per second
 - \$395 complete with software
- High performance data links
 - Maximum speed of GPIB
 - On-board buffering

Software

- Over \$1,000,000 in software development
- Easy to use, yet handles any GPIB application
- Works with Lotus 1-2-3
- UNIX, DOS and over 12 languages

Applications Support

- Applications Library with sample programs & TIPS for all major instruments
- Full staff of Applications Engineers dedicated to support your specific needs

Other IEEE-488 Products

- Interfaces & Software for
 - Multibus VMEbus
 - DEC Q-bus & UNIBUS
 - STD & S-100 bus
- General GPIB Products
 - GPIB Bus Testers
 - GPIB Bus Extenders
 - Stand-Alone Controllers



12109 Technology Boulevard
Austin, TX 78727
1 (800) 531-GPIB
In Texas (800) IEEE-488
Telex: 756737 NAT INST AUS

REVIEW: PANASONIC EXEC. PARTNER

Esc-E for emphasized, Esc-G for doublestrike). Like many printers, it has trouble with some of the IBM graphics characters, specifically the characters used to produce double-ruled boxes (characters 200-205).

The new printer also prints on single-sheet paper, but only on special smooth thermal-transfer paper. You can print on common xerographic paper, but this is not recommended, as the results are barely legible.

SOFTWARE

The Exec. Partner comes with only the MS-DOS operating system, version 2.11, and Microsoft BASIC.

Panasonic's version of MS-DOS seems fairly routine. The only significant enhancement seems to be the inclusion of a special driver for the internal clock/calendar. If you include the name of this driver in a CONFIG.SYS file on your system disk, the system will automatically check the clock/calendar for the date and time, without your having to enter the date and time manually.

Similarly, MS-BASIC is also fairly routine and is compatible, by and large, with the BASIC on the IBM PC. I was hoping that this version might have some ability to directly access the 640 by 400 pixels on the display, but the highest resolution you can address is the standard 640 by 200 pixels of the IBM Color Graphics Adapter.

I did have a little trouble running the communications program PC-Talk III, which is written in BASIC. Strangely, the trouble seemed to clear up when I switched the processor to fast mode.

In terms of speed, the benchmarks I did showed that the Panasonic BASIC is approximately as fast as the IBM PC's. When the Exec. Partner is in high-speed mode, however, this BASIC is about twice as fast as that of the IBM PC.

COMPATIBILITY

With the above partial exception for PC-Talk III, the Exec. Partner ran every IBM PC software program I tested. These included Lotus 1-2-3, Multiplan,

WordStar, XyWrite II, SideKick, and SuperKey. The only incompatibilities I noticed were the previously mentioned problem that the printer had with certain graphics characters and a problem that the display had with certain text styles.

MANUALS

The Exec. Partner comes with two manuals and a 20-page quick-reference guide. The MS-DOS manual comes in the usual IBM PC-style binder and slipcase. In addition to notes on the operating system, this manual also includes some notes on the Panasonic hardware.

The BASIC manual is 6 inches by 9 inches, perfect-bound. The pages are the same size as those in the MS-DOS binder, but without the bulky binder. Unless Panasonic issues updates for their BASIC, the bulky binder won't be missed.

SUMMARY

All in all, the Panasonic Exec. Partner is an acceptable computer. Its most prominent feature is its gas-plasma display. It is very easy on the eyes, but it has a slight problem handling multi-color text.

Another good feature is its keyboard-selectable dual-speed processor, whose high speed is about twice as fast as the IBM PC's processor.

On the other hand, the printer seems of limited utility, and in many cases merely provides extra weight for the system. Finally, the short expansion slot hampers your ability to expand the system without the (as yet unavailable) expansion box.

If I were Panasonic, I would make some minor changes. First, I would make the printer optional. Second, I would make the gas-plasma display more compatible with the IBM monochrome display. And finally, I would provide an RGB connector and a full-size expansion slot.

Even without these changes, however, the Exec. Partner is a useful machine, especially for people who are tired of looking at green-phosphor screens. ■

GIVE A MACINTOSH THE DRIVE TO SUCCEED IN BUSINESS.

HYPERDRIVE
GENERAL COMPUTER

The drive in question is HyperDrive. And it succeeds by following a time-honored principle of American business:

It works faster, better and smarter than its competitors.

HyperDrive is the first hard disk that's designed to go inside your Macintosh (either the 512K Macintosh or the new Macintosh Plus). Once installed, it can literally multiply the speed at which your Mac can work.

That also explains why it works better—that and the fact that it lets you keep tabs on huge amounts of information. In fact, HyperDrive lets you store the same information that would other-

wise occupy up to 50 diskettes. (Put another way, that's the equivalent of 2200 two-page documents.)

Finally, HyperDrive works smarter because of the sophisticated software it comes with.

There's a program that protects your files from unauthorized entry. Still another lets you use your Macintosh for other jobs even while you're printing out the one just completed.

And since HyperDrive is installed internally, it expands the Mac's performance without expanding the space it takes up on desktops. With HyperDrive your Macintosh remains every bit as compact and portable as before.

So it's not surprising that InfoWorld described HyperDrive as "unbeatable in the current world of the Macintosh."

To see how this translates into the current world of business, see your authorized General Computer dealer. Or call us at (800) 842-9000, Ext. 7, or (800) 843-9090, Ext. 7.*

**GENERAL
COMPUTER**
The leading edge starts here.

*In Canada, call our distributor at (800) 565-1267. ©1986 General Computer Corp. HyperDrive, The leading edge starts here, and the General Computer Corp. logo are trademarks of General Computer Corp. Macintosh is a trademark licensed to Apple Computer, Inc.

It's amazing what you can reveal when you strip.

Introducing a shape that's about to turn on an entire industry.

The Softstrip™ data strip. From Cauzin.

This new technology allows text, graphics, and data to be encoded on a strip of paper, then easily entered into



The Cauzin Softstrip System Reader replaces tedious typing by scanning the strip and reading it into your computer.

your computer using a scanning device called the Cauzin Softstrip™ System Reader.

Creating a simple, reliable and cost efficient way to distribute and retrieve information.

Softstrip data strips, like those you see here, can contain anything that can be put on magnetic disks.

Facts. Figures. Software programs.

Video games. Product demonstrations.

Sheet music.



The Cauzin Softstrip System Reader is now compatible with the IBM PC, Apple II and Macintosh.

A single strip can hold up to 5500 bytes of encoded data.

It can stand up to wrinkles, scratches, ink marks, even coffee stains.

And it can be entered into your computer with a higher degree of reliability than most magnetic media.

Simply by plugging the Cauzin Reader into your serial or cassette port and placing it over the strip.

The reader scans the strip, converts it to computer code, and feeds it into any standard communication interface.

Because strips are so easy to generate, most of your favorite magazines and books will soon be using them in addition to long lists of program code.

And you'll be able to enter programs without typing a single line.

There is also software for you to generate your own strips.

Letting you send everything from correspondence to business information using our new technology.

Find out how much you can reveal by stripping. Just take this ad to your computer dealer for a demonstration of the Cauzin Softstrip System Reader.

Or for more information and the name of the dealer nearest you, call Cauzin at 1-800-533-7323. In Connecticut, call 573-0150.

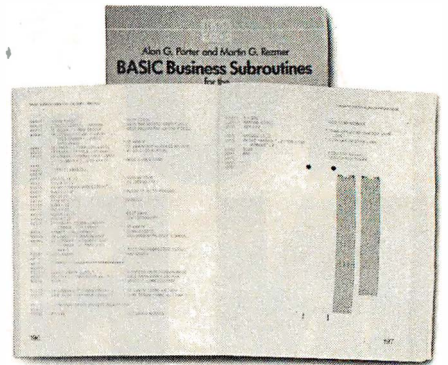

Soon everyone will be stripping as data strips appear in popular magazines, computer books and text books.



Cauzin Systems, Inc.
835 South Main St., Waterbury, CT 06706

Inquiry 51

SOME HELP FOR TODAY'S MANAGER

THE OFFICE ASSISTANT Series by Knowledgeware is an exciting collection of business templates that can be used with most word processors. The series provides an efficient means of gathering data, channeling productivity, and record keeping; while improving your office organization by providing the proper form or letter for each situation. THE OFFICE ASSISTANT lets your PC do the work in paperWORK... not you!!

Templates cover such topics as: general accounting forms, financial sales forms, purchasing forms and letters, sales letters, credit management letters, calendar appointment forms, service forms, contracts, and much more.

The data strips on the right contain several business letters and standardized personnel forms to give you an idea of the time-saving and cost-cutting features of the Series. All of them are written as generic text files for ease of use with most word processors. They may be used as is, or customized to meet the specific needs of the user.

Reprinted with permission of Knowledgeware
Copyright © 1985 by Knowledgeware. All rights reserved.

StripWare Library No. 194

StripWare Library No. 195

StripWare Library #194

StripWare Library #195

1 |

2 |

3 |

4 |

Softstrip

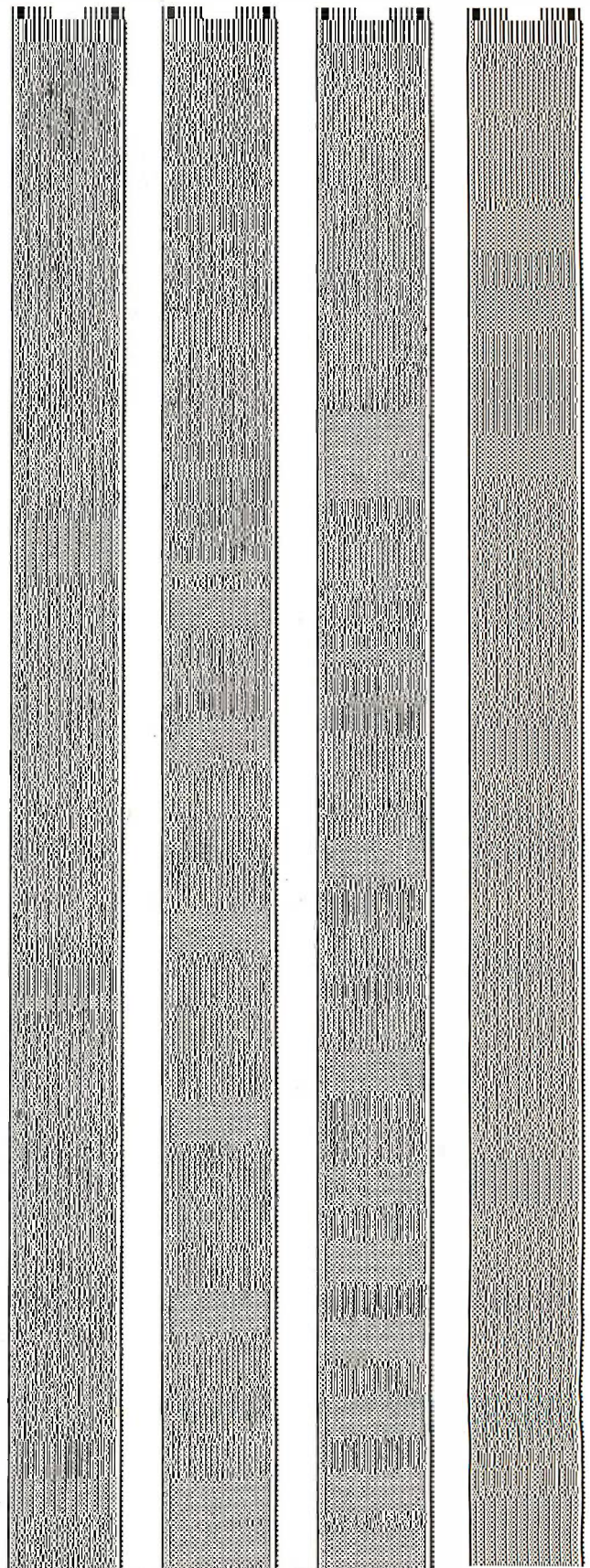

We've got them all by the No's.

TURBO BOARD COMPARISON	CLASSIC 286 SPEED PAK	ORCHID TURBO 186	PHOENIX PFASTER	VICTOR/PCT MOUNTAIN
SPEED: <ul style="list-style-type: none"> • INCREASES PC/XT SPEED • PROCESSOR • 16-BIT PROCESSING/20-30% FASTER THAN CACHE • NO CACHE SPEED REDUCTION RUNNING POPULAR PROGRAMS 	67x 80286 YES YES	3x 80186 NO YES	5x 80286 YES YES	5x 80286 NO NO
COMPATIBILITY: <ul style="list-style-type: none"> • FULLY SOFTWARE/HARDWARE TRANSPARENT • NO SOFTWARE PATCHES NEEDED • RUNS LOTUS/INTEL EMS • RUNS AT PROGRAMS • NATIVE 8088 MODE 	YES YES YES YES YES	NO NO NO NO YES	NO NO NO YES YES	YES NO YES YES NO
UPGRADEABILITY: <ul style="list-style-type: none"> • 80287 CO-PROCESSOR OPTION • MULTITASKING OPTION • MULTIUSER OPTION 	YES YES YES	NO NO NO	YES NO NO	YES NO NO
PERFORMANCE: <ul style="list-style-type: none"> • FULL 16-BIT BIOS • FULL 16-BIT RAM • MEMORY EXPANSION UP TO 16 MB • INCLUDES 1 MB MEMORY • INCLUDES PRINTER SPOOLER/RAMDISK 	YES YES YES YES YES	NO NO NO NO YES	YES YES NO YES YES	NO NO NO NO NO
3-YR. WARRANTY:	YES	NO	NO	NO

Speed. Compatibility. Upgradeability. You need all three in a turbo board for your IBM® PC or XT.

And no one but Classic delivers all three.

Not Victor, PCT or Mountain (the same board, by the way.) They're not as fast, need software patches, and have to be physically removed for certain programs.

In fact, the Classic 286 Speed Pak™ is 20-30% faster than turbo

boards that use cache.

Not Orchid or Phoenix. Certainly not AST or Quadram, whose boards use the much slower 8086 processor.

And only Classic's 286 Speed Pak can grow with your needs to turn PCs and XTs into multitasking, multiuser systems.

Call 800-392-8324 to order or find out more. (In California, call 800-338-0777.)

Because no one else gives

you everything you need in a turbo board. No one, no way, no how. Classic Technology Corporation 2090 Concourse Drive, San Jose, CA 95131.

See us at Comdex/Spring '86 in Atlanta, Booth 2060.

CLASSIC

Everything you always wanted in an IBM.

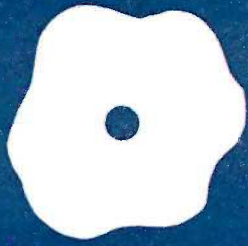

KAMAS

An outline processor and programming language

BY ALBERT S. WOODHULL

KAMAS, billed as a "Knowledge and Mind Amplification System," is one of a class of programs sometimes called idea processors or, less grandiosely, outline processors. But for \$99.95, KAMAS also includes a language in which you can write batch-processing scripts for your word processor or, using more primitive elements of the language, programs to handle any application. [Editor's note: KAMASOFT has produced a version of KAMAS called *Out-Think* for people who don't want or need programming language capabilities (see page 40).] In the KAMAS environment there always seems to be a command that will open up a whole world of other commands on a lower level.

In KAMAS, text is attached to a tree structure, which you create with an "outline editor." At the outline-editing level, you can manipulate and move around a document in a way that corresponds to the logical organization of the document. You enter and edit text in a part of KAMAS called a "leaf editor." The "leaves" you create are attached to the outline.

KAMAS's smartness about the organization of a document also makes it a powerful tool for retrieving information. Browsing through a file with an ordinary word processor, you can search many times for a word or phrase before you find the right part of a large document. With KAMAS, you can strip away the text and see the outline.

KAMAS is layered like an onion. The leaf and outline editors are only two layers. Below these screen-oriented levels is a level at which all the outline-processing commands are available in a form that lets you use KAMAS from a line-oriented terminal. From here, one option gives you access to an even lower level, where you can specify commands and their arguments either in command lines or as text in a file—at this level you are programming. Below this are two more programming levels that constitute a general-purpose, extensible, threaded interpretive language akin to FORTH, STOIC, or Magic/L.

My interest in KAMAS is as a writer. I find it easiest to generate a flow of words when I write as fast as I can, as if I were talking about the subject. I may approach different parts of a topic this way, generating several large and unconnected blocks of text. Organizing the final paper is a major task, as difficult as generating the text. Word processors are more important to me (a horrible typist) than they are to people I know who can type fast and flawlessly on a typewriter. For analogous reasons, KAMAS interests me as a tool for use in the organizational phase of the writing process.

INSTALLING KAMAS

The KAMAS documentation package contains a 55-page booklet of installation instructions. As you would hope from a product that is supposed to help you organize knowledge, this manual is well organized, and the installation instructions are easy to follow.

KAMAS requires a Z80 microprocessor with 64K bytes of RAM, the CP/M operating system, at least one disk drive with 126K bytes of storage space, and a total of at least 200K bytes of disk space. The required 126K-byte disk capacity is calculated to make an Apple II with a Z80 card adequate. I did much of my work with KAMAS using the more-or-less standard configuration of an Apple II with a 64K-byte RAM, a Microsoft Softcard running CP/M 2.2, two Apple Disk II drives, and an 80-column card from Advanced Logic Systems (ALS), the Smarterm II. I also used KAMAS with an ALS CP/M Card and CP/M Plus (CP/M 3.0). I did not have to reconfigure to use CP/M Plus; selection of "Apple II (Softcard CP/M)" in the configuration menu resulted in a KAMAS setup that worked equally well with either version of CP/M.

I did encounter problems configuring KAMAS to take advantage of a Syntex Flashcard RAM disk and a Taurus 8-inch floppy-disk drive. The software drivers for

(continued)

Albert S. Woodhull is associate professor of computer studies and biology at Hampshire College (School of Natural Science, Hampshire College, Amherst, MA 01002).

AT A GLANCE

Name

KAMAS

Type

Outline processor and programming language

Company

KAMASOFT Inc.
(formerly Compusophic Systems)
POB 5549
Aloha, OR 97007
(503) 649-3765

Requirements

CP/M 2.2 or later (Z80 required), 64K-byte RAM, 48K-byte CP/M TPA (see text), at least 200K bytes of disk storage, one floppy-disk drive with at least 126K bytes of storage, 80-column by 24-row ASCII terminal with direct cursor addressing; printer, I/O-mapped serial modem port recommended

Format

5¼- or 8-inch soft-sectored floppy-disk formats for most CP/M systems

Language

KAMAS, a proprietary language

Documentation

Three-volume user's guide, more than 600 pages; installation instructions; two reference cards

Price

KAMAS, \$99.95
Utility Disk 1, \$10 (\$5 if purchased with KAMAS)

both of these were installed in the CP/M transient program area (TPA). The KAMAS documentation claims that a 48K-byte TPA is adequate, and I had slightly more than 48K bytes available with the RAM disk installed, but I could not make this configuration work. A call to KAMASOFT, the publisher of KAMAS, brought an admission that more memory is required than is stated in the documentation.

Fortunately, there is an option to install the RAM-disk driver software in the I/O configuration area provided within Microsoft's implementation of CP/M. I was still unable to use my 8-inch drive with KAMAS under this version of CP/M, however.

USING KAMAS

KAMAS uses various terms to describe its database structures. These terms are "topic," "key," "title," "sub-title," "stem," "branch," and "leaf."

The highest level in the structure is the topic. Each topic corresponds to a disk file. A topic consists of branches, and branches are made up of stems, the basic unit within a topic. Stems have three parts, one required and two optional. The required part of a stem is its key. KAMAS uses these keys to construct an index for searching. A key may have a subtitle, which clarifies its meaning, but the subtitle is not used in key searches. The combination of a key and a subtitle is called a title. The other optional part of a stem is a leaf, which can contain a moderately long block of text.

A topic has one stem at the top-most level, and any number of additional stems may be subordinate to this top stem. Subordinate stems are

also called children, and the top stem is their parent. A child of one stem may be a parent to still more. From any particular parent stem, its children and their children and their children, to whatever level exists, all constitute a branch.

It's important to understand that titles and leaves are separate types of data that you can and must manipulate separately. Depending upon whether you are using the outline editor or the leaf editor, at any given moment you see on the screen either the titles, as in figure 1, or a leaf, a block of text that would accompany one of these titles.

When you invoke KAMAS from the CP/M prompt, you are asked to select an available topic. You then find yourself in the outline editor, with the top-most title and the titles on the next lower level displayed. In the outline editor the cursor is always on the current stem, of which only the title is visible, but pressing Return gives you a display of the associated leaf and moves you down to the next stem. You can expand any branch to see more detail, or you can collapse branches to hide details. Other commands let you move around in the topic and insert, delete, or change titles and subtitles. You can also move stems and branches to different places and change the hierarchical relationships between stems. When you leave the outline editor, you can enter either the leaf editor or the ROVE mode.

Within the leaf editor you can manipulate the text of the leaf, and you can also look at the portions of the

(continued)

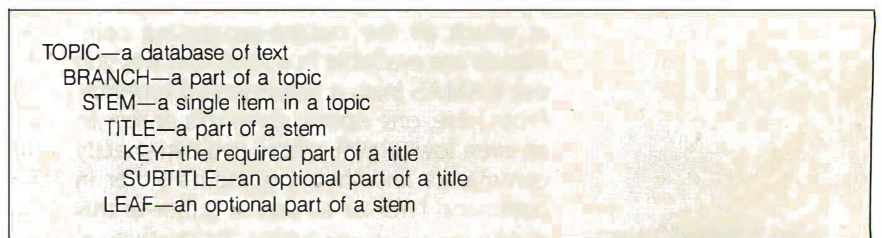

Figure 1: The structure of a KAMAS topic. This figure was generated by KAMAS. It includes the titles for a number of stems, without the leaves of text associated with each title.

How can one small board do so much?

\$299

The ATI GRAPHICS SOLUTION uses revolutionary CMOS VLSI Gate Array Technology to achieve extensive multi-display ability with fewer components, longer life, lower power consumption and lower price.

The "SMALL WONDER" GRAPHICS SOLUTION, amazingly, has all the features below on one small board that fits in the IBM PC/XT short slot!

What's more, Parallel and Serial/Parallel expansion modules are available as options.

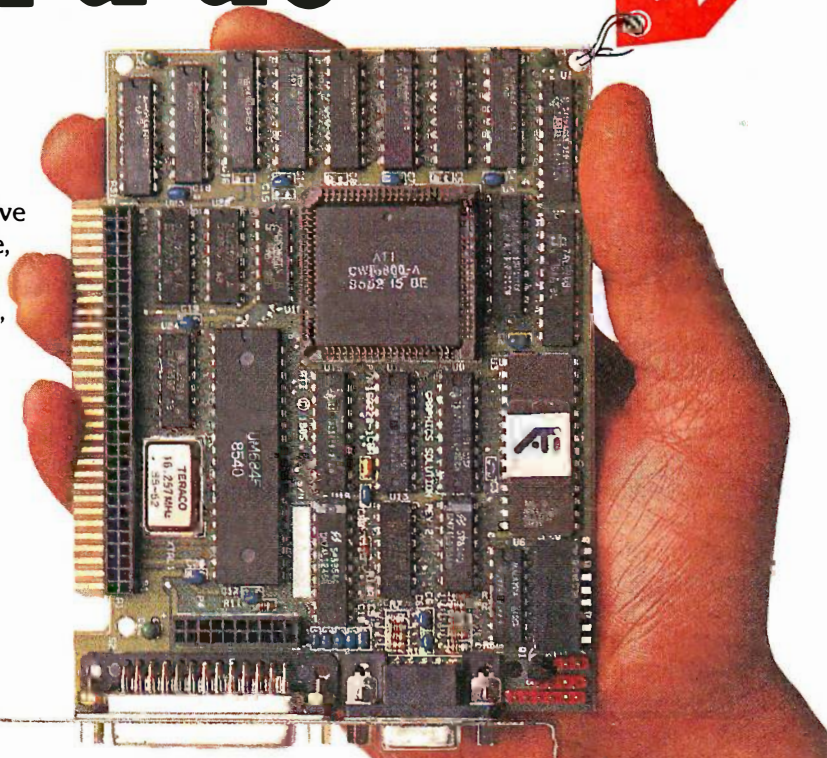

GRAFIX PARTNER — 16 COLORS

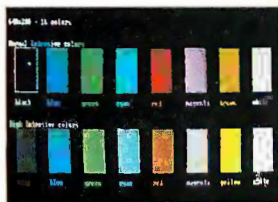

16 COLORS HIGH RESOLUTION



COLOR SOFTWARE ON MONOCHROME MONITOR IN 16 SHADES



SYMPHONY HIGH RESOLUTION

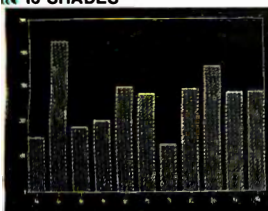

HERCULES COMPATIBLE MONOCHROME GRAPHICS



132 COLUMNS

Distributors:

F.A. Components —

- NY (718) 507-1444, outside NY (800) 847-4148
- IN (219) 432-8540, outside IN (800) 331-7567
- SC (803) 288-2422, outside SC (800) 845-2747

Ossmann Computer Tech.—

- IL (800) 942-5215, outside IL (800) 323-2239
- OH (800) 824-9627, outside OH (800) 824-5934
- NJ (800) 221-2514, outside NJ (800) 624-4010
- NY (800) 628-4466, outside NY (800) 537-5378

Software America — MD (301) 459-2100

First Source — AZ (602) 437-9744

R.C. Data — CA (408) 946-3800

Compu-D — TX (800) 772-5340, outside TX (800) 433-5354

Compuserve — CAN. (416) 477-8088

Wells Data — ONT (416) 890-2600

Santronics — BC (604) 522-9877

Electronic Marketing Specialists

- S.CA (714) 832-9920, (818) 708-2055, (619) 560-5133
- N.CA (408) 245-9291, UT (801) 268-9866
- CO (303) 745-0745, AZ (602) 840-8855

ATI Graphics Solution	ATI Graphics Solution	Paradise Modular Graphics	Hercules Graphics	Plantronics Color Plus
CMOS VLSI Gate Array Technology	✓		✗	
IBM Compatible Monochrome Text	✓		✓	
Hercules Compatible Monochrome Graphics	✓		✓	
Runs Color/Graphics Software on Monochrome Monitor in 16 shades Without Pre-Boot Drivers	✓	✗		
IBM Compatible Color/Graphics	✓	✓		✓
High Resolution 320x200 16 colors Color/Graphics 640x200 4 colors 640x200 16 colors	✓ ✓ ✓			✓ ✓
132 Columns in either Color or Monochrome	✓			
Flicker-Free Scrolling in All Modes	✓	✗	✓	
Parallel Port	Opt *	Opt	✓	✓
Serial Port	Opt *	Opt		
Fits in Short Slot of IBM PC/XT	✓			
Warranty	2 yrs	1 yr.	2 yrs	1 yr.
Suggested Retail Price	\$ 299	\$ 395	\$ 499	\$ 559

* Serial/Parallel Expansion Module \$79 Parallel Expansion Module \$49

Small Wonder From

450 Esna Park Dr.
Markham, Ontario, Canada L3R 1H5
TELEX 06-966640 (CMC — MKHM)
(416) 477-8804 FAX (416) 477-9445



Trademarks: Paradise, Modular Graphics Card—Paradise Systems Inc.; Hercules Graphics—Hercules Computer Technology; Gra Fix Partner—Brightbill—Roberts; Symphony—Lotus Development Corporation; IBM—International Business Machines; Plantronics, Colorplus—Plantronics Enhanced Graphics Corp.

Competitive information based on manufacturer's published information as of January 1, 1985. Specifications subject to change without notice.

Inquiry 405 for End-Users. Inquiry 406 for DEALERS ONLY.

outline close to the leaf being edited. You cannot alter the outline structure from within the leaf editor, except for splitting a leaf at the current cursor position, which creates a new leaf containing all the text following the cursor.

The leaf editor can be configured to look like either an EMACS-style or a WordStar-style editor. This decision cannot be changed later except by configuring anew from a copy of the distribution disk.

I chose the EMACS-style editor. This is not a full-function word processor. The usual single-key commands to move the cursor up and down by lines and back and forth by characters are present, but missing is the ability to move by words, sentences, and paragraphs. The only way to delete text is by characters, or by marking blocks; there are no commands to delete

whole words. The limited ways of moving the cursor can make marking text for deleting or moving a tedious job.

One essential feature is available: The editor holds deleted text in a buffer and lets you reinsert it, either in the same leaf or in a different one, even in a different file.

The leaf editor does not know about justification or line lengths less than the full-screen width. Thus, what you see on the screen is not necessarily what you will get on paper.

When you have finished editing a leaf you have to go back to the outline editor to do anything else. From here you can select a new leaf to edit, exit from KAMAS, or go down a level to ROVE mode.

ROVE is a command-driven mode. Entering ? at any time brings a list of options available. All commands have

secondary options, some have tertiary options; the program prompts you for each. Although most ROVE functions can also be handled by the outline editor, the main reason for retaining this level is to provide a way to interact with KAMAS without a fast CRT terminal—for example, from a remote terminal with a low data-transmission rate.

PROGRAMMING WITH KAMAS

The top level at which you can start programming is called the Expanded Topic Environment. Many of the commands available at this level are non-interactive forms of ROVE commands. Arguments are specified in a FORTH-like postfix notation. You can write a script of such commands, that is to say, a program. Thus, if a topic is to be output to a printer with different portions formatted with different margins, this level allows you to program it as a batch job. Control structures for looping and conditional execution are available at this level.

Below the Expanded Topic Environment, the language looks like a perverse version of FORTH, with FORTH commands hiding under different names. There are important differences from FORTH, however: Control structures can be tested interactively, several data types are available, there is extensive error checking, and the implementation is different from FORTH (it uses direct, rather than indirect, threaded code). None of these changes justifies creation of a language of totally unfamiliar appearance. Alternatively, the language could have been designed to make it look familiar to a user of Pascal or C, as was done with Magic/L, another FORTH-derived language. [Editor's note: See Michael W. Gilbert and Albert S. Woodhull's review of Magic/L in the November 1985 BYTE, page 337.] Instead, KAMAS puts unnecessary obstacles in the way of the experienced programmer.

You may guess that I was not motivated to undertake an extensive programming project in order to evaluate KAMAS as a language. I tried out some of the examples in the user's

Listing 1: The Sieve of Eratosthenes program in the KAMAS programming language.

```
; Sieve of Eratosthenes
LANG SYS
'BARRAY : BUILDS ALLOT TORUN WO+ .
8190 'SIZE :WOCON
SIZE 'FLAGS :BARRAY
'SIEVE :
  " 1 iteration " STOUT
  0 FLAGS SIZE 1 MFILL
  0
  SIZE LOOPS
    IWO FLAGS FETB
    IFSO
    IWO DUPW WO+ 3 WO+ DUPW IWO WO+
    LOOP DUPW SIZE WO>
    UNTILT 0 OVERW FLAGS STOB OVERW WO+
    .LOOP
    DROPD WO1+
  .IFSO
  .LOOPS
  WOOUT " primes" STOUT .
```

Table 1: KAMAS compared with other languages in running the Sieve of Eratosthenes benchmark. Times are in seconds.

	CP/M 2.2 (2-MHz Z80)	CP/M Plus (6-MHz Z80)
FIG-FORTH	16.4	6.6
Magic/L	22.7	9.2
KAMAS	28.6	10.9
MBASIC	365.2	211.9

guide, and I ran a benchmark test using the Sieve of Eratosthenes. The KAMAS program is shown in listing 1; it is a modified version of a sample program from the user's guide.

Table 1 shows the results of a comparison of KAMAS with FIG-FORTH and Magic/L as well as Microsoft BASIC. KAMAS is definitely in the FORTH league.

SUPPORT

In addition to *The KAMAS Report* newsletter and telephone support, KAMASOFT provides good documentation and a vehicle for distribution of updates and applications through utility disks. Volume 0 of the user's manual is a 50-page guide to the outline and leaf editors. Volumes 1 and 2 completely describe the rest of the system. There are numerous examples as well as reference information describing all the commands available to the interactive user and the programmer. There is an index to volumes 1 and 2.

The review copy of KAMAS that I received included the KAMAS Utility Disk 1. The contents come from users as well as from KAMASOFT and have been placed in the public domain. Thus these contributions can be freely copied and distributed through bulletin boards.

Finding what you want on the disk can be confusing, however. Utilities, examples, and documentation text are not always where they are said to be. For instance, the installation manual says some programming examples have been moved from SYSTOPIC.TOP on the system disk to Utility Disk 2, but that disk apparently hasn't been released. As another example, Utility Disk 1 held only one topic file rather than the two that are described in the READ.ME file on the disk.

KAMAS PROBLEMS

Several things strike me as problems with KAMAS. To begin with, the console interaction needs improvement. KAMAS doesn't use cursor positioning well. The entire screen is often rewritten unnecessarily, for instance,

when a paragraph in the bottom half of the screen is reformed or the end of a line is deleted. I'd like a status line to tell me where I am and show the size of the current leaf. There is also no way to have more than one window on a leaf being edited.

The worst console-interface problem is that typing can overrun the

editor. This happens when a word that does not fit on a line is being moved to the beginning of the next line; a few characters or even whole words get lost on every line. If my system had an interrupt-driven keyboard input, there would be no problem, but a hardware solution isn't necessary. The *(continued)*

OASYS
Hardware Breakthrough

EVER WISH YOUR PC COULD OUT-PERFORM A VAX? A SUN?

- Ever wish your PC ran faster? Had 10 to 20 times more throughput?
- Ever wish your PC had the same kind of high quality, professional software development tools (compilers, assemblers, simulators) you'd normally find in VAX, super-mini or super-micro Unix workstations?
- Ever wish you could port a scientific or commercial application to a PC without having to recompile or restructure your software just to accommodate Intel's architecture?
- Ever wish you had a choice of MS-DOS or Unix V on the same system without having to commit your entire system to one or the other? Ever wish MS-DOS was a virtual demand paged operating system?...

OASYS MS-DOS Co-Processor
... your wish has come true!

The DS-32 PC Co-Processor Board is a self-contained 32-bit computer system — it operates at super-micro speeds (10MHz and no wait states), comes with its own large memory space, full floating point support and highly optimized software tools (both native and cross). It's fully compatible with your standard PC MS-DOS system — no file conversions or re-training is needed. Installation takes just a few minutes — plug it in and go to work.

DS-32 Features:

- Uses National's 32032 processor running at 10MHz. (a 32-bit processor running at super-micro speed; out-performs a mid-size VAX and most 68000 workstations. Your PC will run 10 to 20 times faster)
- Uses its own on-board memory: 1 or 2MB versions. 4 to 6MB expansion boards coming.
- Choice of Operating Systems:
 - MS-DOS Standard: You don't have to learn another OS or do any conversion.
 - VIRTUAL MS-DOS Option: the first demand paging version that supports files as big as your disk.
 - Unix System V Option.
- Fits any IBM PC, XT, AT or look-alike. (Compaq, Wyse, etc.). Uses only one slot.
- Provides its own on-board floating point support.
- Based on Definicon Systems technology.
- Supports dozens of NATIVE high level, optimizing languages: C, Pascal, Fortran. Comes with Assembler, Linker, Loader and Debugger. Exciting new additions: Ada, APL, Basic, and AI tools (LISP, Prolog).
- Supports full complement of CROSS development tools to most 32-, 16-, and 8-bit target systems. Example: 68000/10/20 C, Pascal and Fortran Cross Compilers, Assemblers, Simulators, Debuggers, Profilers. 8086/186/286 C, Pascal and Fortran Compilers.

Possible Applications:

- Run large, time consuming CPU-bound applications on a PC:
 - scientific, commercial, avionic, biomedical
 - petrochemical, seismic
 - microprocessor simulations
 - CAD/CAM and graphic designs
 - numerical applications
 - data reductions, matrix operations
 - recursive type programs (e.g., AI tools)
 - ...the possibilities are limitless
- Provide a low cost means of turning your PC into a high-powered software development workstation.
- Minimize porting time, effort, and support problems; eliminates having to contend with Intel 8086/88/186/286 architectural differences (e.g., 64KB addressing limits).

OASYS offers a "One-Stop Shopping" service for software developers. We support, maintain, develop, enhance, and port over 100 high quality, professional software and hardware tools running on numerous hosts (VAX, PC's, Apollo, Sun, Pyramid, etc.) and/or targeting popular 32-, 16-, and 8-bit micros and operating systems.



60 Aberdeen Avenue, Cambridge, MA 02138 (617) 491-4180

We Specialize In:

- Cross/Native Compilers C, Pascal, Fortran, Cobol, Basic, APL, Prolog, Lisp, Ada — Assemblers/Linkers — Symbolic Debuggers — Simulators — Interpreters — Translators
- Converters — Profilers — QA Tools — Design Tools — Comm. Tools, OS kernels — Editors — Spreadsheets — Data Bases — VAX & PC, Attached Processors and more

We Support:
680xx, 80x86, 320xx, 68xx, 80xx, dozens more

Trademarks are acknowledged to: Digital Equipment Corp., AT&T Bell Labs, Microsoft Corp., National Semiconductor Corp., International Business Machines Corp., US DDD Joint Development Office, Intel Corp., Apollo Computer Inc., Pyramid Technology Corp.



REVIEW: KAMAS

STOP SOFTWARE PIRACY . . .

. . . with one of our new sophisticated copy prevention products.

NEW

For Hard Disk Protection

- Fixed Disk Locker

For Disk Security

High Level Security

- PADLOCK II DISK
- SAFEGUARD DISKS
- COUPON DISKS

Low Level Security

User Installable Protection

- PC-PADLOCK

Why should your valuable data or useful software program become available in the Public Domain?

Call or write for more information.

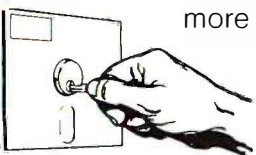

GLENCO ENGINEERING INC.

3920 Ridge / Arlington Hts., IL 60004
(312) 392-2492

software should give very high priority to sensing console input, even if it means letting the display get a little behind the input at times.

Another problem: Practical work requires easier transfer between KAMAS topic files and CP/M text files. You can transfer KAMAS data to CP/M text files but not vice versa, so giving KAMAS access to data in existing text files is complicated. A contributed utility program lets you copy a text file into a newly created topic file, either creating leaves with synthesized unique names or using commands embedded in the source text file to create an outline structure. The first method requires major editing of the new topic; the second method, major editing of the source text file. I would prefer a way to use a split-screen display to view a non-KAMAS text file, move a cursor around within it, and snip out little pieces to be inserted into a leaf being edited on the other half of the screen. This would be a powerful addition to KAMAS.

STYLE AND LANGUAGE

KAMAS has none of the blandness of software developed by a corporation; there is definitely an individual style detectable here. It is generally not my style—calling this a "Knowledge and Mind Amplification System" seems rather immodest, and I would never have titled a chapter in the documentation "Zen and the Art of Knowledge Processing."

In places, the use of language is more than just a question of taste. For example, one of the first things you see on the screen after invoking KAMAS from the CP/M prompt is the message that the program is "auto-jexing." Autojexing (automatic job execution) means interpreting from text in a leaf. Again, as soon as you make an error, you find yourself faced with the word "abend." An abend is an error (abnormal ending). Jargon like this is inexcusable, and it will intimidate users who speak only English.

The documentation is also marred by outright errors of language, such as using the plural "criteria" when meaning the singular "criterion." I

think the audience for this product includes many who are concerned with precise communication. They will be turned off by such careless use of language.

CONCLUSION

Outline processing is a very powerful idea, and KAMAS provides an economical way for users of CP/M-80 systems to try it. KAMAS is a rarity in the current market, a new program released first for use on 8-bit processors. I used KAMAS to draft this review, except for final revisions, when the inability to move easily from leaf to leaf became a serious obstacle.

KAMAS can also process existing documents. It incorporates a language with high-level commands and operations well suited for such tasks, and extensions can be programmed. The KAMAS language is fast and powerful and provides a good interactive programming environment. Learning to use it takes some effort (in my opinion, more than it should) even for FORTH users familiar with stack-oriented languages.

KAMAS has some rough edges. I encountered no serious bugs, but not all the parts of the program mesh smoothly. The documentation is extensive but has not caught up with the material being shipped on disk. The leaf editor is better than a line editor, but it's primitive compared to word processors like Mince or WordStar.

If you are limited to CP/M-80 and your job involves organizing information, you should consider KAMAS. At the time of this writing, I don't know of any other programs that compete with KAMAS in the 8-bit world. As it comes out of the box, KAMAS is ready to use as a tool for creating organized documents; it is also a useful high-level programming environment for creating other programs to process textual data.

As software packages go, KAMAS is relatively inexpensive. Outline processing is the major reason to consider buying it, but the presence of a fast general-purpose programming language might add to its value for you. ■

Introducing! Unsurpassed Surge Suppression...



...only from GTE.

Finally, AC power protection that offers the best technology. And from GTE... a name you can trust.

The SmoothLine™ A surge protector with a strong heritage and known performance. Fully proven on major telephone installations and other sophisticated communications systems around the world.

Flexibility and Convenience? You bet. SmoothLine has a six-foot extension cord with four grounded and switched outlets. Plus, there's a lighted on/off rocker switch for circuit status and control. And, for added protection,

a built-in 15 Amp circuit breaker. Ultra-fast response time is assured with SmoothLine. Even for voltage surges as short as one nanosecond. And, for maximum protection against EMI, RFI and other common interference, there's multi-stage solid-state circuitry.

So relax. Use SmoothLine and get maximum protection from lightning storms, power fluctuations, power surges or voltage transients. Your computers and other electronic equipment will be glad you did.

Call GTE sales today at (800) 392-3908 or (207) 642-4535 for your nearest dealer.

Ask for the SmoothLine at your local computer dealer.

State of the Smart.

SmarTEAM 2400

- * Bell 103/212A, CCITT V.22, V.22 bis (V.21 optional)
- * Auto speed selection (300, 1200 or 2400)
- * Auto answer, auto dial (tone or pulse)
- * Hayes compatible
- * Call progress detection (dial tone, ringing, busy)
- * Speaker with volume control
- * 8 LED status indicators
- * 6 self test modes
- * 2 YEAR WARRANTY

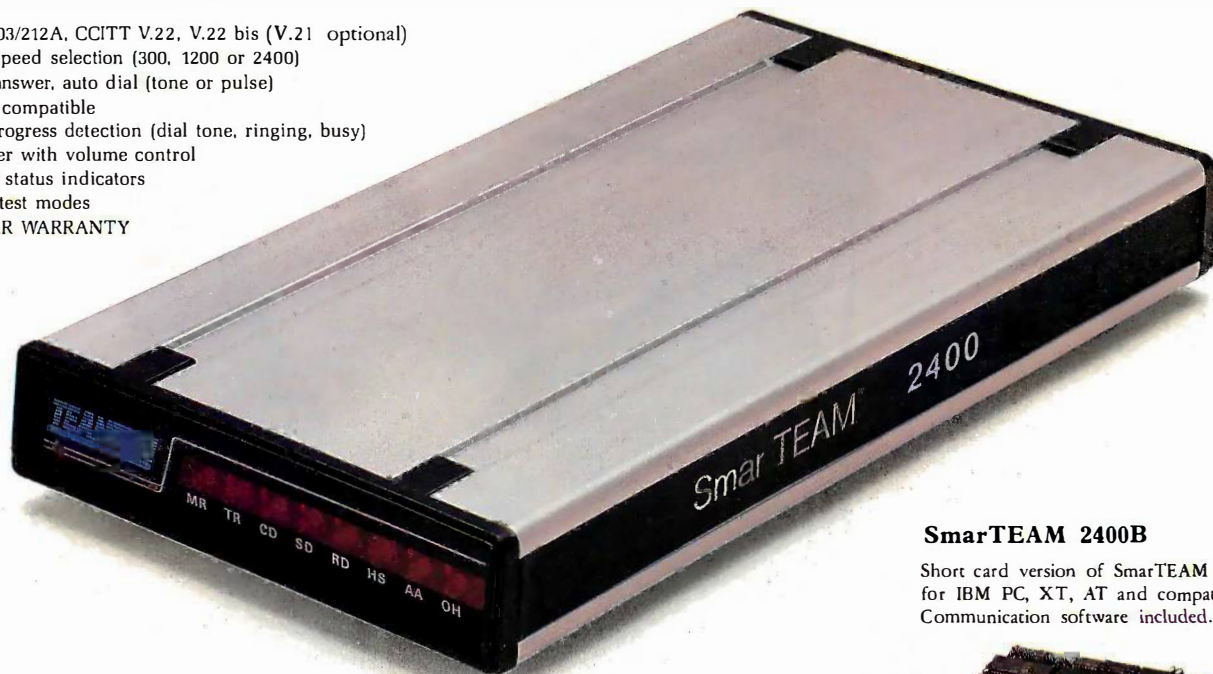

SmarTEAM 2400B

Short card version of SmarTEAM 2400 for IBM PC, XT, AT and compatibles. Communication software included.

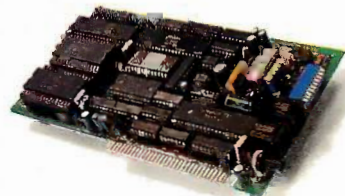

SmarTEAM 1200AT (BELL)

100% compatible with Hayes 1200 plus full call progress detection (dial tone, ringing, busy). 300, 1200 full duplex.



SmarTEAM 1200B (BELL)

Full card for IBM PC, XT, AT and compatibles. Communication software included. 300, 1200 full duplex, plus RS232 serial port.

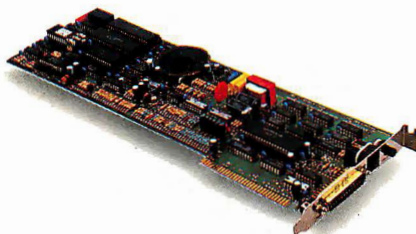

SmarTEAM V.21/22 (CCITT)

300, 1200bps full duplex
Hayes commands compatible.



TEAM
TM
Quality Communication Products

HEAD OFFICE:
TEAM TECHNOLOGY INC.
10F, 270, NANKING E. RD., SEC. 3, TAIPEI,
TAIWAN, R. O. C.
TLX: 19725 PETRCHEN ATTN TEAM
TEL: (02) 7414270, FAX: (02) 771-2985

U.S. SALES & SERVICE
**MORRISON
& DEMPSEY
COMMUNICATIONS**

19209 Parthenia St Ste D
Northridge, CA 91324
TEL: (818) 993-0195
FAX: (818) 993-7209
TLX: 325524 MODEM NTGE

SINGAPORE:
PET Computers Service (S) Pte Ltd.
Tel: 5331313

HONG KONG:
RAINBOW COMPUTER PERIPHERALS
Tel: 3-7281819

SOUTH AFRICA:
SPARTAN MICRO MANAGEMENT
Tel: (011) 788-5177

CANADA
BUDGETRON INC.
1320 Shawson Drive Unit 1
Mississauga, Ontario
Canada L4W 1C3
TEL: (416) 6737800
TLX: 06-968080

See us at
COMDEX Winter '86

April 1-3, 1986
Los Angeles Convention Center
Los Angeles, CA
Booth #1523

- * Hayes is a registered trademark of Hayes Microcomputer Products, Inc.
- * IBM PC, XT, AT are registered trademarks of International Business Machines Corp.
- * MITE is a registered trademark of MYCROFT LABS INC.

Inquiry 337

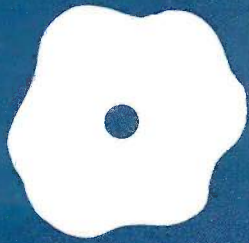

Professional Debug Facility and Advanced Fullscreen Debug

Two more debuggers for PC-DOS

BY JACK C. CARDEN

PC-DOS-compatible debuggers today come in all shapes and sizes. One recent addition is Advanced Fullscreen Debug (AFD), distributed by Puttkammer Software and Microcomputertechnik of West Germany. Another is Professional Debug Facility, distributed by IBM Corporation of Boca Raton, Florida. Professional Debug Facility consists of a Resident Debug Tool (RDT), a Disk Repair (DR) utility, and an NMI (nonmaskable interrupt) card for use in activating RDT.

The outward similarities of the two debugging aids led to this comparative review. Both packages are software-based debuggers that operate at the machine-instruction level and implement breakpoints by replacing a byte of memory with an INT 3 instruction. Both present full screen displays containing multiple windows of information about the program under test (see photos 1 and 2). Both reroute the NMI 2 to allow the use of an external push button to gain control after a runaway software path has missed all breakpoints. The IBM package provides an NMI card with an externally mounted push button, while the AFD user's manual provides instruction for constructing an NMI push button. Both also provide special key sequences to bring up the resident debugger from the background using a keyboard interrupt.

EXPECTED FEATURES

Both programs contain most of the features usually available in off-the-shelf debuggers. Each permits you to compare two areas of memory, copy a block of memory to another area of memory, or search memory for a particular series of bytes. Both allow you to alter the contents of memory or register by moving the cursor to the correct spot on the screen and typing over the data with new data. Each of the debuggers allows program execution to begin at a specified address with specified breakpoints. Most breakpoints are sticky; that is, the breakpoints remain in place until you

remove them. Any breakpoint can be disabled and left in place. Each program provides the ability to do byte I/O, and both support the output of information to a printer. Both programs use the trap flag in the processor for single-step execution. Each allows any area of memory to be treated, displayed, and modified as instructions or data, either hexadecimal or ASCII. RDT also supports EBCDIC character interpretation, but then that should not come as a surprise to IBM users.

Both debuggers support the use of a color and monochrome display at the same time, and can direct output to a selected display, leaving the other display free for the program under test to use. Both programs also allow the use of a screen-save buffer, which can be useful if you are like me and don't happen to have two display systems. RDT requires that during setup you specify whether the screen-save buffer of 4K bytes should be reserved.

SURPRISING FEATURES

AFD provides a procedure-step function key as well as a single-step function key. The procedure step sets a breakpoint on the instruction following the CALL or INT instruction within a routine.

AFD provides two extra registers, called fixed segment (FS) and help segment (HS). The FS and HS registers may be automatically updated following a compare command for use in displaying the mismatching areas of memory. The HS register is updated following a successful search command, for use in displaying the start of the located string in window area 2. It may also be modified to hold a segment address when AFD is requested to display a fixed area of memory. These registers may be set to any desired 16-bit value and used in expressions as any of the machine registers would be used.

In addition to 18 breakpoint registers per screen, RDT provides 40 extra 20-bit regis-

(continued)

Jack C. Carden (POB 3440, Bowling Green, KY 42102-3440) has a B.S.E.E. from the University of Louisville. He is a freelance programmer and consultant to business and industry, specializing in the management of computer system purchases.

ters for use in holding values of interest to the programmer and can be used in expressions as desired. One of these values, IL, represents the instruction length of the current instruction. Following a search, the FX (find hexadecimal) register contains the ad-

dress of the match or zero if no match was found. OP represents the instruction parameter address and probably stands for operand.

RDT also supports the math coprocessor by displaying the state of the coprocessor. RDT can optionally han-

dle any exception interrupts from the coprocessor.

AFD supports the additional Intel 80286 instructions by permitting them to be assembled and disassembled. AFD assumes the real-address mode of operation on IBM PC ATs.

CUSTOMIZATION

Both programs allow customization of displayed data, but RDT goes a step further. RDT allows up to nine different screen definitions to coexist for use with different areas of the program under test. If your program consists of seven different modules, you can set up seven screens to allow references to depths within a module to correspond to the listing you are using. Each screen has separate display parameters to uniquely generate each line within the bottom portion of the display and also has up to 18 unique breakpoints or internal variables. Internal variables allow easy reference to labels once the value is assigned. Theoretically, you can enable up to 162 breakpoints at one time. When a breakpoint is reached during execution, the screen containing the breakpoint definition, and thus the other related information, is displayed.

DISK-FILE I/O

RDT does not provide the ability to save all this setup information to a disk file. In fact, it makes no provision for disk I/O on a file basis. Perhaps this is due to a philosophy of providing stand-alone operation as much as possible. Their justification might be that the NMI push button precludes the need to save setup information, since you can pass control to RDT regardless of the machine state. Perhaps the additional need to support disk-file I/O may be the real reason the ability to save setup information was omitted. RDT does provide commands to read and write disks using logical sector numbers, similar to the PC-DOS interrupt 25 and 26 type interfaces. And since PC-DOS is apparently not used for I/O, RDT might well be used to debug additions to

(continued)

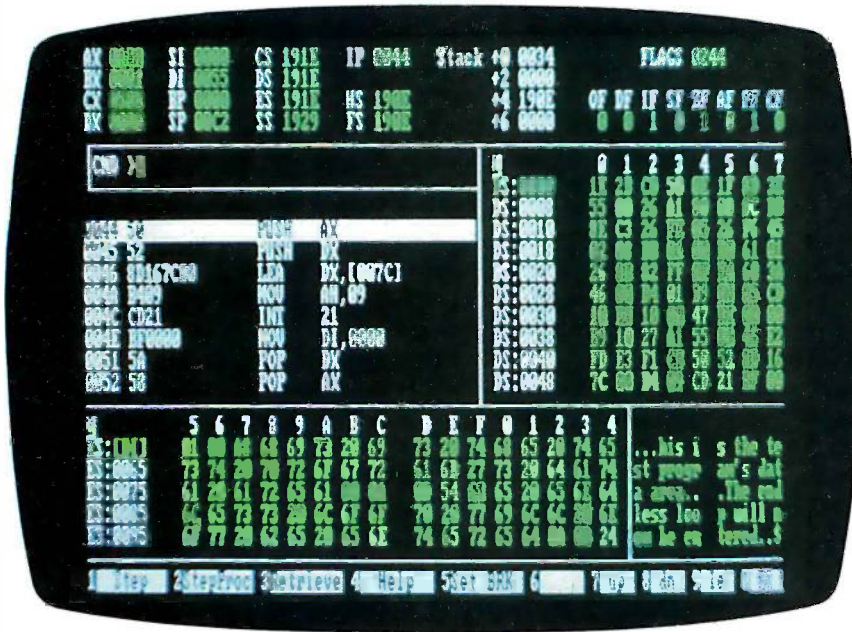

Photo 1: The Advanced Fullscreen Debug main screen.



Photo 2: The Resident Debug Tool memory window display.

THE FIRST AND BEST

Multi-User PC Data Terminal.

Tens of thousands of IBM PC owners have chosen our KT-7/PC data terminal. So should you!

Kimtron has the number one terminal in the world for converting a single-user PC into a multi-user system.

Our full line of ASCII and ANSI terminals feature versatility, multiple emulations and most of all, reliability.

Kimtron terminals come with a 14" green or amber screen.

Kimtron has been a leader in terminal technology since 1979 and will maintain and expand its position by pursuing higher levels of quality and value.

Call us today for your nearest Kimtron representative.

Inquiry 178 for End-Users.
Inquiry 179 for DEALERS ONLY.

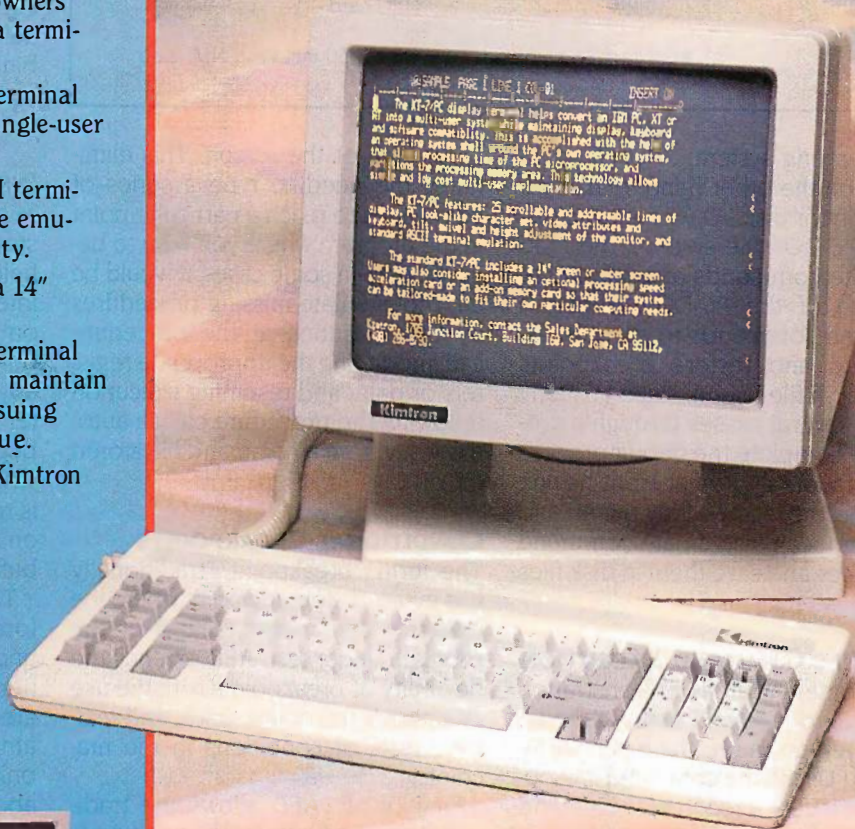

Kimtron

1705 Junction Ct., Bldg. #160
San Jose, CA 95112
TWX: 910-338-0237
(408) 436-6550 (In CA)
(800) 828-8899

AT A GLANCE

Name	Advanced Fullscreen Debug version 1.00	Professional Debug Facility version 1.00
Type	IBM PC software debugger	IBM PC software debugger, plus disk-repair utility
Company	Puttkammer Software and Microcomputertechnik Nelkenstr. 4 D7039 Weil-3 West Germany 0049/7031-52256	IBM Corporation POB 1328 Boca Raton, FL 33433 (800) 426-2468
Hardware Required	IBM PC, PC XT, or PC AT in real-address mode under PC-DOS 3.0, PC-DOS 2.0 or above (except PC AT), 128K bytes of memory, one disk drive, 80-column display with adapter; supports both monochrome and color display as well as printer	IBM PC, PC XT, or Portable PC, 128K bytes of memory, one disk drive, 80-column display with adapter, PC-DOS; supports both monochrome and color display, printer, math coprocessor
Documentation	89-page manual with plastic comb binding	280-page manual in loose-leaf binder with reference card
Price	\$110 plus \$5 shipping	\$150 including NMI card

the operating system.

AFD, on the other hand, makes no provision for disk I/O without the use of the PC-DOS file system. The load and write commands appear similar to those of the PC-DOS Debug. I found the commands to save breakpoints to and restore breakpoints from a disk file useful, since I usually require several passes through a program to complete the debug process and welcome any relief from having to enter the same data again and again. You can also create command sequences and save them in disk files for use later.

DISK-FILE COMMAND EXECUTION

AFD comes with a demonstration batch file to load and execute the included test program. The batch file invokes AFD with the command-line option to execute a recorded command file. This file contains the commands to load the test program, read the breakpoint setting file, and start the test program with an immediate breakpoint set at offset 44 hexadecimal. As the commands from the file are executed, each is displayed on the

input area of the screen. This eliminates the need to type a series of commands to reach a particular point in the program where you wish to begin testing. In some cases, it would be easy to simulate missing procedures by breakpointing at the procedure call, modifying the appropriate registers or data, and resuming execution following the procedure call automatically from a command file stored on disk.

CONDITIONAL BREAKPOINTS

The term "breakpoint" traditionally has meant a stopping point where the operator can regain control of the program under test. AFD extends the flexibility of breakpoints with the use of action fields, count fields, and real-time tests of conditions in the machine.

First of all, AFD allows the traditional stop to occur when a breakpoint is reached. Other options, however, include the ability to count occurrences of a breakpoint or to reset the occurrence counter and reactivate a list of other breakpoints. Alternatively, the programmer may choose to

start or stop the trace feature with the occurrence of a breakpoint.

Each AFD breakpoint has one of the above actions specified along with a condition field and count field. The count field defines how many times the breakpoint must be met with true conditions before the action is performed. A condition is either another *gating* breakpoint specified by number, or an equation or relation involving registers or memory. A gating breakpoint is true if the occurrence counter and count field of that breakpoint are equal. Equations (=) or relations (<, >) may specify an optional offset or mask value to be included in the test. All conditions are ANDed together to determine whether the occurrence count for a breakpoint should be incremented. Then the count is incremented, and if the occurrence count is equal to the count field, the action is taken. The combination of all three fields leads to some powerful options in AFD breakpoints.

INSTRUCTION TRACING

The trace feature of AFD is started or stopped via a breakpoint. The action field of the breakpoint specifies if interrupt-handling routines are to be omitted during the trace. The trace buffer is cleared automatically when any GO command is issued. The buffer will hold 100 instructions before beginning to wrap around and overwrite itself. When a stop breakpoint is reached, the word TRACE appears on the screen to call attention to the buffer if data has been collected.

The trace activity of RDT is performed while stepping the program under test. RDT allows careful selection of the type of instruction and area of memory to be traced. For example, RDT allows the selection of only JUMP or CALL instructions above RDT and below the BIOS. Since the step count can be adjusted under RDT to allow many instructions to be executed, and other options allow the programmer to stop on trace conditions, this is a powerful feature of the RDT program. RDT allows the trace

(continued)

Color 400
Now Supports
AutoCAD® and VersaCAD®

Princeton SR-12 and Sigma Designs Color 400

“The Ultimate in Graphics Resolution and Performance”..

PC Products June 1985

SR-12 and Color 400. A brilliant combination for super-high resolution graphics and a crisp character display.

For a brighter, sharper display with your IBM PC, XT, or AT, here's a team that can't be beat. The SR-12 super-high resolution RGB monitor from Princeton Graphic Systems and Color 400, the advanced color graphics adapter card from Sigma Designs.

A Revolution in Resolution. Begin by snapping the Color 400 into your PC. Without any software modification, text suddenly becomes readable. Graphics turn sharper and cleaner. Jagged edges smooth out, and annoying flicker fades away. Color 400 automatically *doubles* the number of lines on standard line software. It allows true high

resolution display of Lotus 1-2-3 and Symphony charts, graphics from Dr. Halo, CadPlan, Lumena 400, and others. Also, create dazzling business charts in 16 vibrant colors with Paintbrush 400, included with the card. Enjoy fully formed, monochrome quality characters in text mode. For word processing, spreadsheet, CAD/CAM, or pro-

fessional design applications, Color 400 is the answer to your graphic needs.

Turn on SR-12 for the impressive

results. The SR-12 displays your Color 400 image with unmatched clarity and brilliant color. Because the SR-12 combines a .31mm dot pitch tube and a non-glare screen with an incredible 640 x 400 non-interlaced resolution, you get a flickerless image that's as crisp and clean as a personal computer can produce.



SR-12

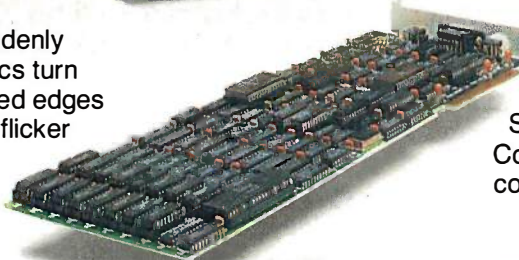

Color 400

See how impressive this state-of-the-art image can be on your own PC system. Visit your local retailer today and ask about this new color graphics team. Princeton Graphic Systems' SR-12 and Sigma Designs' Color 400. An unmatched, brilliant combination.

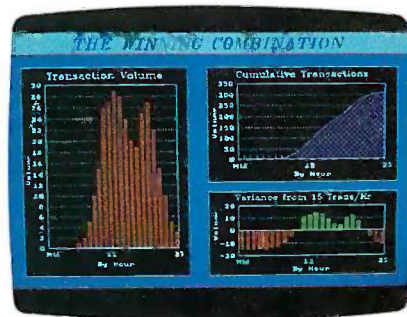

COLOR 400



SIGMA DESIGNS, INC., 2023 O'Toole Avenue, San Jose, CA 95131
(408) 943-9480 Telex: 171240



Princeton Graphic Systems, 601 Ewing Street, Bldg. A, Princeton, N.J. 08540
(609) 683-1660, Telex: 821402 PGS PRIN, (800) 221-1490 Ext. 2204

Graphic Screens courtesy Mouse Systems, Inc. and Forthright Systems, Inc.

IBM PC, PC XT, and PC AT are registered trademarks of International Business Machines, Inc.
AutoCAD is a registered trademark of Autodesk Inc. VersaCAD is a registered trademark of T and W Systems, Inc.

REVIEW: TWO DEBUGGERS

or F8 to see the clusters allocated to the file. Subdirectories are supported as well.

Parameter mode displays information concerning the format of the selected drive, allowing some examination of a non-DOS-formatted disk. Interrupt/Call mode allows controlled use of DOS and BIOS interrupts and calls to subroutines already in memory.

USABILITY

The RDT and DR programs of the Professional Debug Facility were easy to learn to use, quick to respond, and, except for having to remember the command set, can be operated with a 5-minute training session. The help screen of RDT only lists the myriad of two-letter mnemonics that make up the command set of RDT. The reference card is a must for the first few hours with RDT, but DR is so easy to use that the only reason to read the manual is for the great examples of how to restore an erased file.

AFD is a powerful package. To fully utilize all the capabilities of the conditional breakpoint facility would require a rather complicated problem. The program was solid in general, but several little items marred my overall impression of this program. There were slight inconsistencies in the way the cursor keys worked. The combination of some function keys and some cursor keys was confusing even after using the program quite a bit.

The program would not work properly with my Tecmar Graphics Master board unless I used a color display, because the AFD program directly modifies video RAM. This undesirable programming practice points out all too clearly the lack of compatibility with the IBM monochrome-display adapter provided by the Tecmar board. AFD did work better on all other systems tested, including an IBM PC AT with color display, IBM PC XT with color display, IBM PC with monochrome display, and a Kaypro 16. The only problem I noticed on any other system was on the IBM PC with the monochrome system, where the system status messages and error

messages failed to appear.

The conditional breakpoint field in AFD allows the use of a mask value in comparison with a register but does not accept an immediate operand for the second operand. This seems to be an overly restrictive rule, since it prevents testing individual bits.

DOCUMENTATION

The AFD user's manual is not especially impressive. It is obviously written by someone whose natural language is not English, which makes it hard to follow at times. For example, "This function key allows to retrieve the last entered commands." The lack of examples makes the learning process a little intimidating. And there is no index, which makes the manual even less useful.

The Professional Debug Facility, however, comes in the standard three-ring loose-leaf binder with the polished look that you expect from IBM. The manual is nicely laid out, with a useful index and reference card, and enough tutorial to allow even the novice assembly-language programmer to feel comfortable with what is about to happen. The completeness is demonstrated by the inclusion of the "RDT Messages" section detailing most, if not literally all, possible responses from RDT.

CONCLUSIONS

I now understand why the word advanced was used in the title of the West German software distributed as AFD or Advanced Fullscreen Debug. I have only begun to appreciate the power and flexibility after several weeks of use. With a little more polish and a more useful manual, AFD can certainly hold its own in the American marketplace.

The Professional Debug Facility, containing the Resident Debug Tool, Disk Repair, and the NMI card for use with the Resident Debug Tool, is distributed as a package by IBM. This package is probably worth the purchase price for either of the software products for people involved in serious software development. ■

WALTZ LISP

The universal, superefficient LISP for MS-DOS and CP/M.

Waltz Lisp is a very powerful and complete implementation of Lisp. It is substantially compatible with established mainframe Lisps such as *Franz* (the Lisp running under *Unix*), *Common Lisp*, and *MacLisp*.

Ultra fast. In independent tests, **Waltz Lisp** was up to twenty(!) times faster than competing microcomputer Lisps.

Easy to use. Built-in WS-compatible full-screen file editor: Full debugging and error handling facilities are available at all times. No debuggers to link or load.

Practical. Random file access, binary file support, and extensive string operations make **Waltz Lisp** suitable for general programming. Several utilities are included in the package.

Full Lisp. Functions of type *lambda (expr), nlambda (fexpr), lexpr, macro*. Splicing and non-splicing character macros. Full suite of mappers, iterators, etc. Long integers (up to 611 digits). Fast list sorting using user defined comparison predicates. Built-in prettyprinting and formatting facilities. Nearly 300 functions in all.

Flexible. Transparent (yet programmable) handling of undefined function references allows large programs to reside partially on disk at run time. Automatic loading of initialization file. Assembly language interface.

Superbly documented. Each aspect of the interpreter is described in detail. The 300+ page manual includes an exhaustive index. Hundreds of illustrative examples.

Order **Waltz Lisp** now and receive *free* our **PROLOG Interpreter**

Clog PROLOG is a tiny (but very complete) PROLOG implementation written entirely in **Waltz Lisp**. In addition to the full source code, the package includes a 50 page **Clog** manual.

16-bit versions require DOS 2.x or CP/M-86 and 128K RAM (more recommended). Z-80 version requires CP/M 2.x or 3.x and 48K RAM minimum. **Waltz Lisp** runs on hundreds of different computer models and is available in all disk formats.

\$169

*Manual only: \$30 (refundable with order). Foreign orders: add \$5 for surface mail, \$20 for airmail. COD add \$3. Apple CP/M, hard sector, and 3" formats add \$15. MC/Visa accepted.

For further information or to order call



1-800-LIP-4000 Dept. 31



In Oregon and outside USA call 1-503-684-3000.

PRO CODE
INTERNATIONAL

15930 SW Colony Pl.
Portland, OR 97224

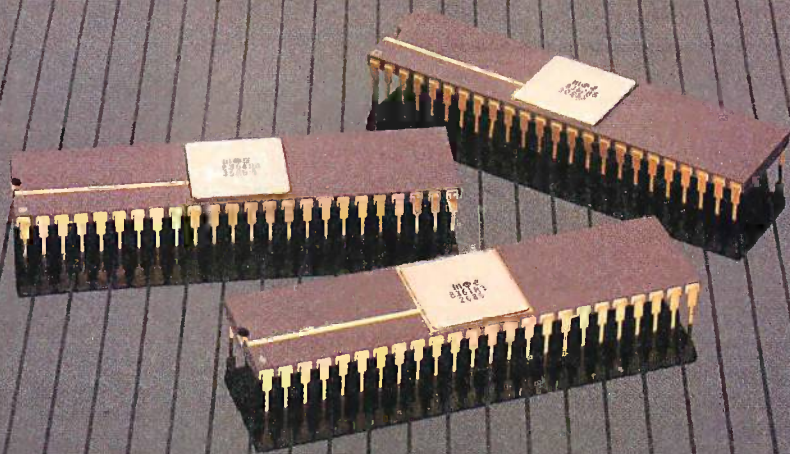

YOU'RE LOOKING AT
4,096 COLORS
4-CHANNEL STEREO
32 INSTRUMENTS
8 SPRITES
3-D ANIMATION
25 DMA CHANNELS
A BIT BLITTER
AND
A MALE AND FEMALE VOICE.

ONLY AMIGA GIVES YOU ALL THIS AND A 68000 PROCESSOR, TOO.

Three custom VLSI chips working in combination with the main processor give Amiga™ graphic dazzle, incredible musical ability and animation skill.

And they make Amiga the only computer with a multi-tasking operating system built into hardware.

All these capabilities are easy to tap because Amiga's open architecture provides you with access to the 68000 main bus in addition to the serial, parallel and floppy disk connectors. Complete technical manuals enable you to take full



advantage of the custom chips and the software support routines in the writable control store on the Kickstart™ disk that comes with every Amiga computer.

You can access these resources in a number of development languages, including Amiga Macro Assembler™, Amiga C, Amiga Basic (Microsoft®—Basic for the Amiga), Amiga Pascal and even Amiga LISP.

So Amiga not only gives you more creativity, it gives you creative new ways to use it.

Amiga by Commodore.

GIVES YOU A CREATIVE EDGE.

™ Amiga is a trademark of Commodore-Amiga, Inc.™ Kickstart is a trademark of Commodore-Amiga, Inc.

*Amiga Macro Assembler is a trademark of Commodore-Amiga, Inc. *Microsoft is a registered trademark of Microsoft, Inc.

microTSP

A flexible,
user-friendly
regression
package for
the IBM PC

BY PAUL DAVENPORT

The program microTSP is a micro-computer version of the very successful mainframe program Time Series Processor (TSP, from TSP International, Stanford, California). Both programs specialize in time-series regressions of the kind done by economists and other social scientists. (For information on time-series regressions, see the "Time Series in Statistical Analysis" text box on page 262.) The microTSP program offers a surprising degree of both power and ease of use, although some of its features require better documentation than the current manual provides. Version 4.1 of microTSP, released in 1984, has a number of improvements over version 4.0. Version 4.1 comes with two disks, one of which drives the 8087 mathematics coprocessor; either disk can be traded for a second copy of the other.

The program microTSP runs on the IBM Personal Computer and compatibles; it requires two disk drives, 256K bytes of RAM, and PC-DOS. You access microTSP from DOS simply by typing TSP. The time-series orientation of the program is immediately evident. Operations begin with the creation of a work file, which demands that you define the periodicity of the data (annual, quarterly, or monthly) and the start and end dates; undated data is also an option. The program is quite flexible. It is easy to change the start and end dates at any time; moreover, a series that covers only a part of the full range has N.A. automatically assigned to missing data. Data can be entered by the keyboard and edited with a special data editor, which lets you move up and down a time series with ease to make corrections or add new observations.

STATISTICAL OPERATIONS

Once the data is ready, you may fit an ordinary least-squares LS regression as follows:

```
SMPL 47 84
LS Inv C i i(-1) i(-2) Q Q(-1)
```

The regression covers the years set by the SMPL command (1947 to 1984, with annual data); LS means ordinary least squares. Investment (Inv) is the dependent variables; C is the constant term; the independent variables are the interest rate (i) and gross national product (Q), with terms for 1- and 2-year lags indicated by negative integers in parentheses. Two-stage least squares TSLS has a similar format, with the instruments placed after @ in the command:

```
TSLS Inv C i i(-1) i(-2) Q
Q(-1) @ MS MS(-1) X X(-1) T
```

The instruments are money supply MS, exports X, and time T, which are considered to be exogenous variables that, in part, determine the explanatory variables i and Q.

The output that appears on the screen and is printed includes the sample period and number of observations; the name, mean, and standard deviation of the dependent variable; a list of independent variables, with coefficients, standard errors, *t*-statistics, and 2-tail significance tests of the *t*-statistics; and the various regression statistics: *R*-squared, adjusted *R*-squared, standard error, Durbin-Watson, Log likelihood, sum of the squared residuals, and the *F*-statistic.

With both LS and TSLS you can request a first-order Cochrane-Orcutt correction for serial correlation by adding AR(1) at the end of the list of dependent variables (before the @ in TSLS). Higher orders of serial correlation require changing the integer: AR(2), AR(3), and so on. Output now includes the rho coefficient (or coefficients) of serial correlation. You can specify the maximum number of iterations (the default is 20) and the convergence change in rho (the default is a change in rho of less than .005, at which point the iteration stops). To correct for a moving-average error specification, you put MA(1)—and MA(2), MA(3), etc., if appropriate—at the end of the list of independent variables.

(continued)

Paul Davenport is associate professor of economics at McGill University (853 Sherbrooke St. W., Montreal, Quebec H3A 2T6, Canada). He received his doctorate from the University of Toronto.

The above should give you an idea of the simplicity of microTSP commands. The program also includes the estimation of polynomial distributed lags; seasonal adjustment and moving-average seasonals; a missing-data MD option, in which regressions are run on those observations with data for all series (if MD is not chosen, any missing data stops the regression); and autoregressive and moving-average models. The manual gives inter-

esting economic and business applications for the various estimators.

SPEED OF COMPUTATIONS

One of the drawbacks of statistical software for microcomputers is that the computations generally take more time than on mainframes. To get an idea of the differences involved, I designed a simple series of computations and regressions that you can easily replicate. I compared the com-

putational speed of microTSP, with and without the 8087 processor, to PEC (Program for Econometric Computation, IBM version 7.0), a mainframe statistical package used by graduate students at McGill University. I began by defining a variable t, where t is 1 for the first observation, then 2, 3, and so on. To compare computational speed, I wrote batch programs for microTSP and PEC, which computed up to 25 variables as functions of t, sine of t, and cosine of t, using the equations shown in figure 1. For each of the two microTSP configurations (with and without the 8087 processor) three batch programs were run: the first computed the first 5 variables in the list for 20 observations (t = 1 to 20), the second computed the first 10 variables for 50 observations, and the third computed all 25 variables for 200 observations. The time in seconds required in each case is shown in column 3, lines 1 to 6 of table 1.

Immediately after each batch program, and while the relevant variables were still in memory, an ordinary least-squares regression was computed, with Y as the dependent variable. The first regression had 4 explanatory variables (X1 to X4), the second had 9 explanatory variables (X1 to X9), and the third had 24 explanatory variables (X1 to X24). In each case the software was instructed to provide a constant term. The times required for the regressions are shown in column 4, lines 1 to 6. The sum of the times required for calculations and regressions is shown in column 5, lines 1 to 6.

Column 5, lines 7 to 9, of the table shows the time required to run a batch program in PEC, which does both the calculations and the regressions, including the time necessary to load the program and any "line wait," which occurs as the mainframe services many users at once. The mainframe is McGill University's Amdahl 5850 with a 5860 accelerator; the MVS/SP operating system is used. Actual time for the computations is less than a second in each case, so that

(continued)

$$\begin{aligned}
 Y &= 1.01*(1 + .1*\sin(t) + .1*\cos(t) + .1*\sin(t)*\cos(t)) \\
 X1 &= t \\
 X2 &= t^2 \\
 X3 &= .980*(1 + .1*\sin(.5*t)) \\
 X4 &= .985*(1 + .1*\cos(.6*t)) \\
 X5 &= .990*(1 + .1*\sin(.7*t)) \\
 X6 &= .995*(1 + .1*\cos(.8*t)) \\
 &\dots \\
 X15 &= 1.040*(1 + .1*\sin(1.7*t)) \\
 X16 &= 1.045*(1 + .1*\cos(1.8*t)) \\
 X17 &= (X1*X2)^{(.5)} \\
 X18 &= (X3*X4)^{(.5)} \\
 &\dots \\
 X24 &= (X15*X16)^{(.5)}
 \end{aligned}$$

Figure 1: The equations used for the table 1 benchmarks.

Table 1: Comparison of compilation times using microTSP without the 8087, microTSP with the 8087, and the PEC mainframe package.

	Number of		Time Required in Seconds		
	Variables	Observations	Calculations	Regressions	Total
	(1)	(2)	(3)	(4)	(5)
A. microTSP					
1.	5	20	14	7	21
2.	10	50	35	10	45
3.	25	200	211	141	352
B. microTSP 8087					
4.	5	20	11	1	12
5.	10	50	25	2	27
6.	25	200	98	25	123
C. Mainframe PEC					
7.	5	20	*	*	4
8.	10	50	*	*	8
9.	25	200	*	*	9

Note: See the text for a description of the arithmetic calculations and the regressions. The total number of calculations is the product of the number of variables and the number of observations (100, 500, and 5000, for the three cases shown).

PERFORMANCE PACKAGE

Blaise Computing Inc. introduces the PERFORMANCE PACKAGE™ for Turbo Pascal programmers.

TURBO PASCAL

Turbo ASYNCH™ With Turbo ASYNCH, you can be in constant touch with the world without ever leaving the console. Rapid transit at its best. Turbo ASYNCH is designed to let you incorporate asynchronous communication capabilities into your Turbo Pascal application programs, and it will drive any asynchronous device via the RS232 ports, like printers, plotters, modems or even other computers. Turbo ASYNCH is fast, accurate and lives up to its specs. Features include...

- ◆ Initialization of the COM ports allowing you to set all transmission options.
- ◆ Interrupt processing.
- ◆ Data transfer between circular queues and communications ports.
- ◆ Simultaneous buffered input and output to both COM ports.
- ◆ Transmission speeds up to 9600 Baud.
- ◆ Input and output queues as large as you wish.
- ◆ XON/XOFF protocol.

The underlying functions of Turbo ASYNCH are carefully crafted in assembler for efficiency, and drive the UART and programmable interrupt controller chips directly. These functions, installed as a runtime resident system, require just 3.2K bytes. The interface to the assembler routines is written in Turbo Pascal.

The Turbo Pascal PERFORMANCE PACKAGE™ is for the serious Turbo Pascal programmer who wants quality tools to develop applications. Every system comes with a comprehensive User Reference Manual, all source code and useful sample programs. They require an IBM PC or compatible, utilizing MS-DOS version 2.0 or later. There are no royalties for incorporating PERFORMANCE PACKAGE functions into your applications.

Turbo POWER TOOLS and Turbo ASYNCH sell for \$99.95 each, and they may be ordered directly from Blaise Computing Inc. To order, call: (415) 540-5441.

◆
BLAISE COMPUTING INC.

BLAISE

Inquiry 32 for End-Users. Inquiry 33 for DEALERS ONLY.

NEW!

Turbo POWER TOOLS™

Turbo POWER TOOLS is a sleek new series of procedures designed specifically to complement Turbo Pascal on IBM and compatible computers. Every component in Turbo POWER TOOLS is precision engineered to give you fluid and responsive handling, with all the options you need packed into its clean lines: High performance and full instrumentation, including...

- ◆ Extensive string handling to complement the powerful Turbo Pascal functions.
- ◆ Screen support and window management, giving you fast direct access to the screen without using BIOS calls.
- ◆ Access to BIOS and DOS services, including DOS 3.0 and the IBM AT.
- ◆ Full program control by allowing you to execute any other program from within your Turbo Pascal application.
- ◆ Interrupt service routines written entirely in Turbo Pascal. Assembly code is not required even to service hardware interrupts like the keyboard or clock.

Using Turbo POWER TOOLS, you can now "filter" the keyboard or even DOS, and create your own "sidekickable" applications.

YES, send me the Best for the Best! Enclosed is _____ for
 Turbo ASYNCH Turbo POWER TOOLS. (CA residents add 6½% Sales Tax. All orders add \$6.00 for shipping.)

Name: _____ Phone: _____
 Shipping Address: _____ State: _____ Zip: _____
 City: _____ Exp. Date: _____
 VISA or MC #: _____

Turbo Pascal is a trademark of Borland International. Turbo POWER TOOLS, Turbo ASYNCH and PERFORMANCE PACKAGE are trademarks of Blaise Computing Inc. IBM is a registered trademark of International Business Machines Corporation. MS-DOS is a trademark of Microsoft Corporation.

Watch us!

- ◆ 2034 BLAKE STREET
- ◆ BERKELEY, CA 94704
- ◆ (415) 540-5441

AT A GLANCE

Name

microTSP version 4.1

Company

Quantitative Micro Software
4521 Campus Dr.
Suite 336
Irvine, CA 92715
(714) 856-3368

Requirements

IBM PC or compatible, PC-DOS,
two disk drives, 256K bytes RAM

Price

\$595

it makes no measurable difference whether you run the calculations and regressions separately or in one batch program.

With regard to accuracy, there were no significant differences in any coefficients or summary statistics for the regressions between the microcomputer and mainframes packages. With 5 and 10 variables, microTSP agreed with the PEC coefficients and summary statistics to 4 or 5 decimal places; with 25 variables, the agreement reached to 3 or 4 decimal places. The microTSP results with the 8087 coprocessor were identical to those without the coprocessor.

BATCH OPERATIONS

Batch operations on microTSP are the equivalent of macros on spreadsheets—they both allow you to save a series of commands. Repetitive operations can often be done more

simply with batch commands; you can leave the machine during the operations if they take a long time. The batch programs are similar to those in PC-DOS: the parameters in a batch program are indicated by a % followed by a single digit; a RUN statement names the program and then lists values for the batch parameters. Suppose you have operations to perform on 20 different manufacturing industries. Consider the batch program Regress (see listing 1). To run the program, call RUN with the name of the program and values for each batch parameter (%0, %1, etc.)

RUN REGRESS LS 1 A

In the Regress program, everywhere %0 appears, LS is substituted, and likewise for %1 and 1, and %2 and A. The batch parameters %3, %4, %5, %6, %7, and %8 are blank and are ignored. The programs set ii, the

MSC-LAT1

\$649

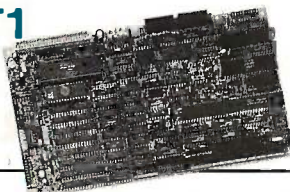

KAYPRO™

users can share the advantage to LAT1. Just take off your main KAYPRO board and put LAT1-K into your cabinet.

All advantage of LAT1 is yours now!

\$674

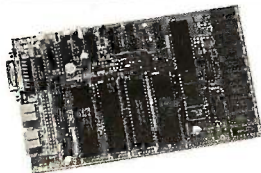

MSC-MTC

MSC-ICO

\$499

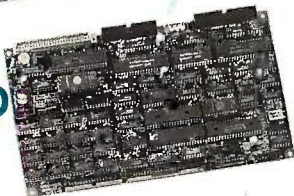

CP/M plus is a registered trademark of Digital Research Inc.
Z80 is a registered trademark of Zilog Inc.
Turbo Dos is a registered trademark of Software2000 Inc.
Mountain Side Computer and ZENET are trademark of Southern Pacific Limited

Distributors

England-Quanta systems 01-253-8423
Denmark-Danbit 03-662020
Finland-BB Soft 90-692-6297
India-Betamatix PVT Ltd. 0812-71989

Manufacturer and international distributor

SOUTHERN PACIFIC LIMITED

Sanwa Bldg., 2-16-20 Minamisaiwai, Nishi, Yokohama, JAPAN 220
Phone: 045-314-9514 Telex: 3822320 SPACIF J

Advanced single board computer technology company

ZENET NETWORK through twist pair

- 6Mhz HD64B180 (Z80 upward compatible) 512K byte on board (256K installed, 384K RAM DISK)
- LAN: ZENET port 800K baud CSMA CD twist pair bus type upto 500 meters HDLC
- Floppy: 3.5, 5 and 8 inch, d/s density, d/s sided and d/s track automatic density/format checking
- Hard disk: SCSI interface on board
- Video: 80 X 24 characters (color) and 640 X 200 pixels color graphic 128K byte video RAM character set is downloaded from disk
- Timer: battery back up calendar

- Serial: RS232C X 2 and TTL X 1
- Parallel: centronics type, 16 bit TTL, 7/8 bit keyboard port (32 characters FIFO)
- O.S.: Turbo Dos, MP/M (multiuser) banked CP/M plus (single user)
- Size: 10 X 6 inch 4 layered
- Assembled and tested
- BIOS source code available
- Faster than other ZBOSBC

MSC-PCX

8088 expansion card for LAT1 soon available

WORLD SMALLEST COMPUTER

- Full personal CP/M system in palm 4mhz Z80 256K RAM (128K RAM DISK)
- Serial: RS232C X 2 automatic baud rate checking
- Parallel: centronics type printer port
- Floppy: 3.5 inch micro floppy disk drive 800K byte (option 5, 35 inch drive d/s sided d/s track automatic density checking)

- O.S.: CP/M plus bank version
- BIOS source code available
- Faster than other ZBOSBC

MSC-MTC/P

Full assembled pcb of MTC Under \$189 in OEM quantity

\$299

Full featured CP/M plus system

- Z80 4mhz 128K Byte RAM Floppy: 3.5, 5 and 8 inch d/s density, d/s sided and d/s track upto 4 disk drives Automatic density/format check
- Serial: RS232C X 2
- Parallel: Centronics type, 16 bits I/O, 7/8 bit keyboard port
- Timer: battery back up calendar
- Video: 80 X 24 high speed CRT controller
- O.S.: CP/M plus bank version included
- Size: 10 X 6 inch 4 layered

- BIOS source code available
- DRI CP/M plus manual \$50
- New word word processor program for MSC-ICO ADD \$50
- Faster than other ZBOSBC

MSC-HCS

Expansion card for ICO RAM disk (upto 2M byte) and SCSI hard disk interface card for ICO with installation program

\$199

USA distributor

SOUTHERN PACIFIC COMPUTER PRODUCTS U.S.A., INC.

P.O. BOX 4427, Berkeley, CA 94704-0427 U.S.A.
Phone: 415-253-1270

Dealer and distributor inquiries welcome

interest rate, equal to the historical value i for the period 1947 to 1984; runs an LS regression in which INV1 (investment in sector 1) depends on the economy-wide interest rate and output in sector 1, over the period 1949 to 1984 (the first year in the sample changes from 1947 to 1949 to accommodate the two lagged values of the interest rate); sets the interest rate equal to a constant 8 percent; forecasts what investment would have been with the constant interest rate and names the forecast INVFA1; computes the ratio of the forecast variable to actual investment as IRFA1 = INVFA1/INV1; and computes the ratio of forecast investment to output as IQFA1 = INVFA1/Q1.

To use instrumental variables, one could call

```
RUN REGRESS TSL5 1 B @
MS MS(-1) X X(-1) T
```

The least-squares regression is now two-stage; the fourth line of the program executes

```
TSL5 INV1 C ii ii(-1) ii(-2)
Q1 Q1(-1) @ MS MS(-1) X
X(-1) T
```

The remainder of the program operates in the same fashion, except that the forecasts are named INVFB1, IRFB1, and IQFB1.

With 20 manufacturing sectors, 40 regressions require as many RUN commands. Having used a mainframe statistical package in which such batch programs were not easily done, I can testify that the batch facility not only speeds things up but increases accuracy—it is far too easy to make a typing mistake that goes undetected when you have to retype the equations of the Regress program 40 times. Moreover, microTSP allows you to repeat the last command line by pressing Control-A; repeating Control-A recalls up to the last 10 lines. Thus, in the sequence above, one would type out RUN REGRESS LS 1 A; wait for the TSP prompt, then Control-A, change the 1 to a 2, press the carriage return, etc. It is relatively difficult to make a mistake in such a routine, and easy to catch when you do.

There are three limitations on the batch programs that severely restrict their power. Plots and graphs cannot be batched; since the printing of graphs is very slow in microTSP, this is a real liability. Moreover, batch programs cannot be nested—you cannot put the 40 RUN REGRESS commands above into a batch program to call the 40 commands in turn. Nor can you use conditional statements (IF . . . THEN) or conventional loops (FOR . . . NEXT) in the batch programs. Removing these restrictions in a future release of microTSP would change the batch facility from useful to superb.

INTERFACE WITH SPREADSHEETS

Version 4.1 of microTSP provides for easy access to the Lotus 1-2-3 and Symphony spreadsheets. The recommended normal storage routine in microTSP is to save each series as a separate file with the command STORE. For communications purposes, you use the command WRITE to write a number of series to a file, which, as one option, can be defined as a Lotus .PRN file. Close TSP, load 1-2-3, and use the 1-2-3 command /FI to read the file into a spreadsheet. To move back, save the file in 1-2-3 with a /PF command; microTSP reads the file with a simple READ command. The microTSP user thus has quick access to Symphony's communications facility for accessing data banks electronically, and to the macro capabilities of 1-2-3 and Symphony, which are much more powerful than the batch

facility in microTSP.

Incidentally, I was initially frightened away from using multiseried files as a standard means of storage on microTSP by the ominous, unexplained warning in the manual: "We do not recommend maintaining data banks with this type of file." Having mastered the use of such files with 1-2-3, I now employ them for virtually all storage, with no problems whatever. For example, the 20 output variables (Q1, Q2, . . . Q20) in the example above can all be stored in one file called Qset; I use a simple batch program to create such files. Fewer larger files make it easier to weed out obsolete files, increase disk-access speed, and may eliminate the need to create a sub-directory. In the next version of the manual, the warning just cited should be justified or withdrawn.

DOCUMENTATION AND USER SUPPORT

The microTSP manual is extremely well written and takes the user step by step through the various features of the program. A separate sample data disk provides data for hands-on examples of regression and forecasting with several different dependent variables: telephone demand by county in California, U.S. auto sales, sales revenue for Holiday Inns, the U.S. Treasury bill rate, and the portfolio of Wells Fargo Bank.

Especially valuable for those beginning regression analysis is the manner in which the different estimating techniques are carefully related to the

(continued)

Listing 1: *The microTSP program Regress.*

```
SMPL 47 84
GENR ii=i
SMPL 49 84
%0 INV%1 C ii ii(-1) ii(-2) Q%1 Q%1(-1) %3 %4 %5 %6 %7 %8
SMPL 47 84
GENR ii=.08
SMPL 49 84
FORCST INV%2%1
GNER IRF%2%1 = INV%2%1/INV%1
GENR IQF%2%1 = INV%2%1/Q%1
STORE INV%2%1 IQF%2%1
```

TIME SERIES IN STATISTICAL ANALYSIS

Time-series analysis involves data in which the different records refer to different periods of time, generally separated by a constant interval, such as a week or a year. It is distinguished from cross-section analysis, in which the records are for different observations at a single point in time.

An alternative to time-series analysis as practiced by social scientists is the Fourier analysis used in the physical sciences. The Fourier series, as a statistical tool, seems most appropriate when the researcher is looking for a steadily repeating pattern (e.g., of light waves or electric impulses), as is often the case in the physical sciences.

In the social sciences, where observations are often drawn from nonrepeatably historical data (e.g., we can never "rerun" the economy or politics of the 1950s), researchers have tended to analyze data with time-series routines, in which a dependent variable is regressed against independent variables, with the different observations referring to different periods of time. Time itself often appears as one of the independent variables. Periodic relations are generally assumed to refer to specific calendar periods—such as a month or a quarter (three months)—and are estimated with the coefficients of particular variables in a multiple regression.

Consider a regression to explain quarterly steel production in the U.S. S_t as a function of time t , the rate of capacity utilization in manufacturing CU_t , and three quarterly variables $Q1_t$, $Q2_t$, $Q3_t$, where $Q1$ is 1 in the first quarter and 0 otherwise, $Q2$ is 1 in the second quarter, and so on

$$\log(S_t) = b_0 + b_1 t + b_2 t^2 + b_3 CU_t + b_4 CU_{t-1} + b_5 Q1_t + b_6 Q2_t + b_7 Q3_t + \mu_t$$

The error term in the regression is represented by μ_t . This kind of regression separates the growth (or decline) of steel production into three parts: a trend component (estimated with the b_1 and b_2 terms), a cyclical component (the b_3 and b_4 terms), and a seasonal variation component (the b_5 , b_6 , and b_7 terms). By writing the log of produc-

tion as the dependent variable, we know that the trend rate of growth—the time derivative of $\log(S)$ —is $b_1 + 2b_2 t$. If b_2 is 0, then b_1 shows the annual trend rate of growth of production when the cyclical and seasonal components are eliminated; if $b_2 > 0$ (or < 0), then trend rate of growth is accelerating (or decelerating) during the period.

The cyclical terms in the equation above show the response of production to changes in overall economic conditions, measured here with the rate of capacity utilization in manufacturing during the last two quarters (the subscript $t-1$ indicates a one-quarter lag). Finally, seasonal variation is estimated with the quarterly variables: If production is usually significantly above the trend in the third quarter, we expect b_7 to be positive. If the fourth quarter is generally the best, then the sum of b_5 , b_6 , and b_7 should be negative.

In ordinary least-squares (OLS) regression, the coefficients are estimated so as to minimize the sum of the squares of the error terms, on the assumption that the error terms are normally distributed with a mean of zero, have a constant variance for all t , and exhibit zero covariance among different error terms. The OLS procedures are not warranted if these assumptions about the error term are violated, which can arise for many reasons. A very common problem in time-series regressions is serial correlation, which arises when the various error terms are correlated with one another. For example, if we are estimating the equation

$$Y_t = b_0 + b_1 X_t + \mu_t$$

and if each error term is a linear function of the previous error term, we speak of a first-order autoregressive error process

$$\mu_t = p\mu_{t-1} + e_t$$

where p is a constant, and e satisfies the assumptions about the error term outlined above. An alternative to the simple OLS estimators in this case is the Cochrane-Orcutt procedure (contained in microTSP), which combines

previous equations as follows

$$(Y_t - pY_{t-1}) = b_0(1-p) + b_1(X_t - pX_{t-1}) + e_t$$

The iteration works as follows: The Y_t equation is estimated, and the residuals are regressed in the μ_t equation to get an estimate of p ; that value of p is substituted in the previous equation ($Y_t - pY_{t-1}$), and the resulting residuals are again regressed in the μ_t equation to get a new estimate of p , which is again used in the ($Y_t - pY_{t-1}$) equation. The procedure continues until p converges to a constant. This procedure is perhaps better known among economists than other social scientists; most statistical packages on the market do not include it.

We can generalize the μ_t equation to speak of an autoregressive process of order n

$$\mu_t = \rho_1 \mu_{t-1} + \rho_2 \mu_{t-2} + \rho_3 \mu_{t-3} + \dots + \rho_n \mu_{t-n} + e_t$$

An alternative to this is the moving-average error process of order n

$$\mu_t = e_t + q_1 e_{t-1} + q_2 e_{t-2} + q_3 e_{t-3} + \dots + q_n e_{t-n}$$

The ρ_h and q_h ($h = 1, 2, \dots, n$) are constants analogous to the constant p in the ($Y_t - pY_{t-1}$) equation. The autoregressive (AR) and moving-average (MA) processes are combined in ARMA or ARIMA models. Such models often seek to forecast a variable, for example, Y_t , solely in terms of its previous values. Generally, the first step in the forecast is to take differences on the variable to be explained to remove any trend. If the trend of Y is a linear function of time, one difference will suffice, and the regressions will seek to explain $DY = Y_t - Y_{t-1}$; if Y is a linear function of time and time squared, then two differences will be required, and so on. The models then seek to explain a time series of the differenced variable with a regression using a combination of autoregressive and moving-average error terms. Forecasting involves adding the estimated differences in future periods to the previous period's value, beginning with the most recent period for which the true value is known.

different economic and business contexts; the manual shows clearly the appropriate applications of the various econometric routines and the meaning of the statistical output generated by each. At many points readers are directed to two books, a general econometrics text by Robert S. Pindyck and Daniel Rubinfeld (*Econometric Models and Economic Forecasts*, New York: McGraw-Hill, 1980) and the classic ARIMA study by George E. Box and Gwilym Jenkins (*Time Series Analysis: Forecasting and Control*, Oakland, CA: Holden-Day, 1976).

My major quibble is that a section should be added to the manual for those with no PC-DOS experience. The use of the DOS DiskCopy, Make Directory, Change Directory, and Directory commands should be explained as part of data disk management and backing up. I also think that the manual should have several additional pages illustrating batch programs.

I had a question about subdirectories and telephoned Quantitative Micro Software. The author of the program called me back within two hours—you can't beat that for user support.

CONCLUSION

Version 4.1 of microTSP contains a number of important advances over 4.0: the creation of model and batch files is greatly improved; the facility SOLVE will solve a system of many equations by the iterative Gauss-Seidel method; the PLOT command now allows many options; the STORE command for saving data files is better (it was too easy to lose data with the old STORE because only the current sample remained on the disk); interaction with Lotus 1-2-3 is improved through the use of .PRN files.

In my view, the next version of microTSP should contain a significant update of the batch facility, to allow for the use of If. . .Then and For. . . Next conditions and loops in batch programs, the nesting of batch routines, and the ability to batch graphics. The use of 256K bytes of RAM, while reasonable in 1984, is inadequate in 1986: A version of TSP for

1 megabyte of RAM would speed up computations and allow the estimation of simultaneous-equations regression models.

The program microTSP is largely successful in its effort to bring mainframe power and convenience to the microcomputer. It is easy to use and easy to learn. Researchers doing si-

multaneous-equations models and advanced techniques like ridge regressions will remain on the mainframe, but those running ordinary and two-stage least squares now have a convenient alternative that allows them to stop paying mainframe charges and to take their disks home at night. ■

ATRON BUGBUSTERS GREASE BORLAND LIGHTNING

"If I were starting a software company again, from scratch, Atron's AT PROBE™ would be among my very first investments. Without Atron's hardware-assisted, software debugging technology, the flash of Turbo Lightning™ would be a light-year away."
Philippe Kahn, President, Borland

HOW BORLAND DOES SO MUCH, SO WELL, SO FAST

We asked Borland International president Philippe Kahn to share his secrets for rapidly taking a good idea and turning it into rock-solid reality. How does the Borland team do so much, so well, so fast?

He begins, "I remember when Atron used the June 24, 1985 *Wall Street Journal* chart of top-selling software in an ad" [Note: At that time, seven of the top ten software packages were created by Atron customers; it's now nine out of ten.] "SideKick was number four, and I let Atron quote me in saying that there wouldn't have been a SideKick without Atron's hardware-assisted debuggers.

"You might say lightning has literally struck again. Turbo Lightning made number four on *SoftSel's Hotlist* within weeks of its introduction! And again, I say we couldn't have done it without Atron debugging technology.

"Cleverly written code is, by definition tight, recursive, and terribly complex," he continues. "Without the ability to externally track the execution of this code, competent debugging becomes very nearly impossible."

Concludes Philippe, "And after Turbo Lightning was solid and reliable, Atron tuning software turned our Probes into performance analyzers. How do you think we greased our lightning?"

Philippe, along with a couple million or so of your satisfied customers, we say congratulations on yet another best-selling product. We can't wait to see what awesomely useful technology will come shooting out of Borland International next.

HOW BUGBUSTERS KEEP YOU FROM GETTING SLIMED

The AT PROBE is a circuit board that plugs into your PC/AT. It has an umbilical which plugs into the 80287 socket and monitors all 80286 activity.

Since AT PROBE can trace program execution in real time, and display the last 2048 memory cycles in symbolic or source-code form, you can easily answer the questions: "How did I get here?" and "What are those silly interrupts doing?"

It can solve spooky debugging problems. Like finding where your program overwrites memory or I/O-impossible with software debuggers.

You can even do source-level debugging in your favorite language, like C, Pascal or assembler. And after your application is debugged, the AT PROBE's performance measurement software can isolate performance bottlenecks.

Finally, the AT PROBE has its own 1-MByte of memory. Hidden and write-protected. How else could you develop that really large program, where the symbol table would otherwise take up most of memory.

LOOK AT IT THIS WAY.

History shows that non-Atron customers don't stand a very good chance of making the Top Ten list. Lightning really does have a way of striking twice!

The PC PROBE™ is \$1595 and the AT PROBE is \$2495. So call Atron today. You can be busting some really scary bugs tomorrow. And maybe, just like Borland, you can also bust some records.



20665 Fourth Street • Saratoga, CA 95070 • 408/741-5900

Copyright © 1985 by Atron Corp. PC PROBE™ and AT PROBE™ Atron, SideKick™ and Turbo Lightning™ Borland International, Inc., Adv. by TRBA, 408/258-2708.

Don't let debris work through

In every specially marked box of ten 5¼" 3M diskettes you'll find a free head cleaning diskette sampler kit that'll clean your disk drive heads three times.

Plus a coupon good for a \$2.00 rebate from 3M on your next head cleaning

diskette kit purchase.

Why are we doing this?

We've done everything but chant and burn incense to take the worry out of diskettes by making the most reliable, worry-free product possible.

But there's one thing we

can't protect you from. Yourself.

If you let your recording heads collect dust and debris without cleaning them, you have to be prepared for the possibility of data loss or errors.

But not to worry.

dust and wories run your head.

Our free
head cleaning
kit will help
get you in
the habit of
cleaning your
heads.

So the most
reliable floppy in



the world can be even
more reliable.

So you can worry even
less about the floppy
you didn't have to
worry about anyway.

One less thing to
worry about.™

Inquiry 385

ONCE IN A LIFETIME A NEW PRODUCT APPEARS ON
THE HORIZON THAT SHINES ABOVE ALL OTHERS

THE CREATOR™

APPLICATION GENERATOR

by Advanced Development Technologies

- ★ ELIMINATE DATABASE MANAGEMENT SYSTEMS
 - ★ A COMPLETE APPLICATION GENERATION ENVIRONMENT
 - ★ DEVELOP APPLICATIONS IN LESS TIME
 - ★ REDUCE CODE REQUIREMENTS BY 90 PERCENT
- ★ TRAPS ERRORS WITH DETAIL ANALYSIS
 - ★ MULTIPLE FILE ACCESS WITHOUT PROGRAMMING
- ★ 99 INDEXES PER DATA FILE
- ★ AUTOMATIC RECORD LOCK
 - ★ UNLIMITED FILE AND RECORD SIZE

INCLUDES:

- Internal Expression Compile
- Relational File Structure
- ISAM File Access Method
- Screen and Report Generator
- Rich Library of Functions

For Only \$99 The **CREATOR™** Lets You Develop Applications Without Being Bugged Down By A Lot Of Code. Regardless Of How Simple Or Sophisticated The Applications, Save Hundreds Of Hours Of Programming By Using This Advanced Method Of Application Development. Manages All Phases Of Program Development:

- Program Generation
- Database Definition
- Screen And Report Formation
- Multiple Levels of Menus.

A Complete Development System Available For IBM, PC, XT, and AT Requires 256K RAM Includes Unlimited Run Time

\$99

MASTERCARD/VISA

800-528-6600

EXT. 239

CHECKS AND MONEY ORDERS ACCEPTED

© THE CREATOR™ IS A TRADEMARK OF
ADVANCE DEVELOPMENT TECHNOLOGIES
2720 N. 68th St., Suite 5379
Scottsdale, Arizona 85257

Inquiry 9

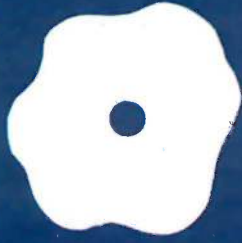

PCT_EX and MicroT_EX

Professional
typesetting
on MS-DOS
machines

BY HAL R. VARIAN

T_EX (pronounced "tech") is a powerful typesetting package developed by Donald Knuth of Stanford University. It gives you unprecedented control over the appearance of typeset output and is especially valuable for setting "penalty" text such as mathematics, tables, foreign languages, technical material, and so on. You can get the complex output in figure 1 by typing:

```
$$$F(b) - F(a) = \int _a^b f(x) dx $$$  
$$$f'(x) = \lim _{\delta \rightarrow 0}  
\{f(x + \delta) - f(x) \over \delta} $$$
```

The T_EX system was written in Pascal to be portable, and it has been installed on a variety of mainframes, primarily at universities and research institutes. (The source code is available from Knuth at a nominal cost.) Despite its portability, however, T_EX typically takes some time and effort to install on a new machine due to its size and complexity. Only recently has it become available on a low-cost microcomputer system, and two very nice T_EX systems are now available for IBM Personal Computers MS-DOS machines.

HOW T_EX WORKS

T_EX is a formatter, not a word processor. You can compose your text using any editor that produces a straight ASCII file and insert commands in the text file to control the appearance of the final document. Then you send the ASCII file to the T_EX program, which reads and processes it. T_EX writes a DVI (device-independent) output file that consists of tightly coded commands to accomplish, for example, the following: move to such-and-such location, set character *n* from font *m*.

You run the DVI file through a DVI driver to actually print the typeset file on an output device. These DVI drivers are not part of the T_EX package itself but are developed independently for each different output device. The final output looks the same—except for resolution—no matter what

device you use. You can print draft output at 120 dots per inch on a dot-matrix printer, then run a preliminary distribution copy on a 300-dpi laser printer, and then typeset the final version on a 1200-dpi phototypesetter.

The T_EX system has a powerful macro-processing facility and is virtually a language unto itself. Large libraries of macros have been created to handle a variety of typesetting chores. Such macro packages can hide the technical details of the particular design from the user while giving the designer great flexibility in creating a unified document style.

For example, you could create a macro called `\title` that skips 20 points, centers the text that follows it, prints the text in 14-point boldface roman, and skips another 20 points. If you change your mind about the style you want in the document, you can simply change the definition of `\title` so that, for instance, it moves to the top of a new page, prints 16-point small-caps text, and skips 30 points. You don't need to change anything else in the document.

T_EX can accept such macro packages as input in two forms: as straight ASCII text files or in a highly compressed form called an FMT (formatted) file. The second form is desirable for packages that you use often because it is much faster. There are many standard packages of T_EX macros, such as AMST_EX, LaT_EX, and so on, that aid in document design. These are usually provided in ASCII form and then converted to FMT form at each installation, since the FMT form has some machine-dependent features.

PCT_EX AND MICROT_EX ON THE IBM PC

Some features are common to both PCT_EX and MicroT_EX. First, they each require a large system. At a minimum, you need 512K bytes of memory and a hard disk. If you want to load all the fonts provided, the systems can each use up to 6 megabytes

(continued)

Hal R. Varian is a professor of economics and finance at the University of Michigan (Dept. of Economics, University of Michigan, Ann Arbor, MI 48109). He has a BS. in economics from MIT; he also has an M.A. in mathematics and a Ph.D. in economics, both from the University of California at Berkeley.

AT A GLANCE

Name	PCT _E X	Micro _T E _X
Type	An implementation of the T _E X typesetting package	An implementation of the T _E X typesetting package
Company	Personal T _E X Inc. 20 Sunnyvale Ave., Suite H Mill Valley, CA 94941 (415) 388-8853	Addison-Wesley Publishing One Jacob Way Reading, MA 01867 (617) 944-3700
Format	For the IBM PC and other MS-DOS computers; includes print driver and fonts; requires at least 512K bytes of memory and a hard disk	For the IBM PC and other MS-DOS computers; includes print driver and fonts; requires at least 512K bytes of memory and a hard disk
Documentation	100-page system description manual, 150-page LaT _E X manual, <i>The T_EXbook</i> , T _E X tutorial	60-page book primarily describing the print driver; <i>The T_EXbook</i>
Price	\$379	\$495

of disk space. (If you don't want all the fonts, you can get by with substantially less disk space—a megabyte or two—for the programs and a few font packages.)

Second, both implementations use exactly the same user interface. This is not surprising. Knuth has copyrighted the T_EX name, and a system can be called T_EX only if it adheres to certain rigid standards. Thus, T_EX looks the same regardless of whether you run it on a large mainframe, an IBM PC, or any other machine.

Since portability is built in, each of these packages should run on any MS-DOS system without modification. Both PCT_EX and Micro_TE_X provide an accurate and complete implementation of T_EX and produce standard DVI files. These are not miniatures of T_EX; you get the real thing: a full-scale professional typesetting system.

The performance of PCT_EX and Micro_TE_X also turns out to be similar. The major features distinguishing the two systems are the documentation, a few capabilities, and the print drivers.

PCT_EX FROM PERSONAL T_EX

PCT_EX comes on 13 disks and has a 100-page manual describing the system. The distribution material includes several disks containing LaT_EX

and the 150-page LaT_EX documentation. LaT_EX and the T_EX fonts are in the public domain and can be freely distributed. The proprietary part of PCT_EX consists of only two programs: T_EX itself and a device driver for the Epson FX-80 printer called PCDOT. The rest of the disks consist primarily of font definitions for PCDOT. Despite being stored in compressed form, these fonts take up a lot of room.

Lance Carnes, an experienced T_EX-nician, ported PCT_EX to the MS-DOS environment using Knuth's original Pascal source code. The major problems he encountered were modifying the standard system calls, handling memory management for T_EX's very large arrays, and manipulating the 32-bit integers that T_EX uses in its internal computations.

$$F(b) - F(a) = \int_a^b f(x)dx$$

$$f'(x) = \lim_{\delta \rightarrow 0} \frac{f(x + \delta) - f(x)}{\delta}$$

Figure 1: An example of the type of technical text that these microcomputer implementations of T_EX can handle.

The documentation for PCT_EX is excellent. The official book for the system is *The T_EXbook* (Addison-Wesley, 1984), and it is an imposing document. However, beginners often find it quite difficult reading despite the fact that it is written in an entertaining and instructive manner. PCT_EX is therefore packaged with a tutorial by Michael Spivak, a well-known and experienced T_EX wizard and author of a number of highly respected mathematics books. I know of no better introduction to T_EX. It will get you up to speed quickly and let you save *The T_EXbook* for detailed reading at your convenience.

PCT_EX has the ability to create and read FMT files. Thus, if you use a lot of macros (designed either by you or by someone else), you can create binary representations of them that you dump to disk and then load at high speed each time you run T_EX. PCT_EX provides two such macro packages with the system: the LaT_EX system and a small set of macros designed by Spivak called VANILLASTY. Spivak's package has a few of the features of AMST_EX, a macro package that he designed and which has been adopted by the American Mathematical Society.

MICRO_TE_X FROM ADDISON-WESLEY

Micro_TE_X comes on eight disks. T_EX and the print driver take up three of them. The rest contain the font specifications used by the print driver.

The documentation consists of *The T_EXbook* and a 60-page manual primarily concerned with the print driver. The manual is quite clear, but it is definitely not a T_EX tutorial. *The T_EXbook* is the definitive reference manual but, as noted earlier, is often difficult for beginners.

The program itself was ported to the IBM PC by David Fuchs, a longtime member of the T_EX project at Stanford. He translated the entire T_EX system into C rather than use the original Pascal. As far as I can tell, this translation is totally transparent, and this implementation of T_EX looks like

(continued)

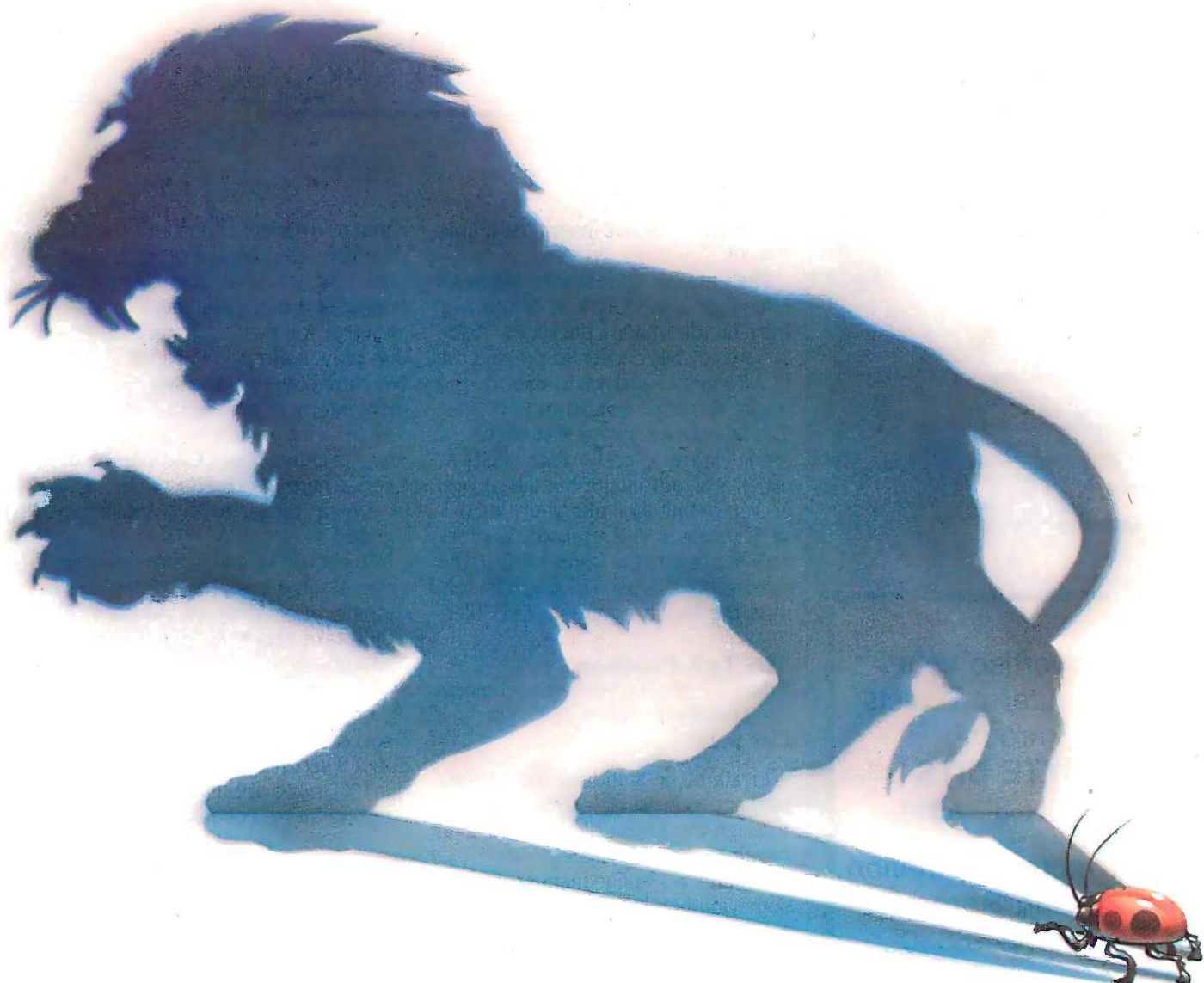

Even the smallest bug is big game.

Eliminate costly delays in microprocessor projects.

There are no insignificant bugs. They're often ferocious... and elusive!

That's why we built the better "bug hunter." The UDL (Universal Development Laboratory). It's actually an:

- **Advanced 48-channel bus state analyzer**
- **8/16 bit in-circuit emulator**
- **EPROM programmer**
- **Input stimulus generator**

All packed into one, compact unit for only **\$2995**.

UDL turns almost any computer into a powerful, integrated workstation for hardware/software debugging. UDL's unique, real-time emulation lets you track bugs of 46 different target microprocessor "species," without buying expensive hardware adapters.

Access all four instruments through the same control program. Handle single-step debugging with the emulator. And quickly define a complex trigger spec, so the built-in logic analyzer can find those nasty, subtle bugs.

When your tested program is bug-free, plug a PROM into the socket. And with one command, simply write your program from emulation memory.

Call **800/245-8500** (415/361-8883 in California) for a no obligation **10-DAY EVALUATION** or write for our 8-page brochure.

Name _____
Firm _____
Address _____
City/Zip _____

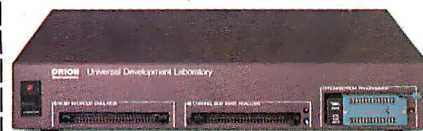

ORION

Instruments

702 Marshall Street
Redwood City, California 94063

6809

Single Board Computer

6809 MPU, 2 serial ports, 4 parallel ports, RAM, EPROM, real-time clock, watchdog timer, 44-pin 4.5" x 6.5" PCB
 EXPANSION MODULES: RAM, EPROM, CMOS RAM/battery, analog I/O, serial I/O, parallel I/O, counter/timer, IEEE-488, EPROM programmer, floppy disks, cassette, breadboard, keyboard/display.



Inquiry 368

Advertise your computer products through **BYTE BITS** (2" x 3" ads)

For more information call Dan Harper at **603-924-6830**

BYTE
 70 Main St.
 Peterborough, NH 03458



SafeSkin™
 KEYBOARD PROTECTOR

Remains in place during keyboard use. Prevents damage from liquid spills, dust, ashes, etc. Fits like a second skin, excellent feel. Available for: IBM-PC, AT, Apple (all), Compaq, Model 100, NEC 8201, C64, Zenith 150, DEC, Kaypro and many others. Send \$29.95, check, M.O., Visa & MC include exp. date. Specify computer type. Dealer inquiries invited. Free brochure avail.

Merritt Computer Products, Inc.
 2925 LBJ Fwy, #180 / Dallas, Texas 75234
 (214) 942-1142

Inquiry 214

REVIEW: PCT_EX & MICROT_EX

every other one—a highly desirable feature.

The major difference between MicroT_EX and PCT_EX is in the way they handle macro packages. Addison-Wesley has chosen to preload the PLAIN format and not to provide the ability to create your own FMT files. The first choice means that MicroT_EX loads more quickly than PCT_EX, which is an advantage, but the second choice definitely limits your flexibility. The casual T_EX user would probably appreciate the faster loading; the serious T_EX user would definitely miss the facility to create FMT files.

THE T_EX PROGRAMS

Table 1 contains some benchmarks for MicroT_EX and PCT_EX. The test files were:

- Errata-b: a standard benchmark package consisting of eight passes through the Errata file from the first printing of *The T_EXbook*
- Volume: a 13-page manuscript with some mathematics
- Matrix: a 4-page manuscript with several matrices
- Webman: the manual for WEB, a program-documentation system provided by Knuth

The best benchmark for these two systems is the multiple-pass run through the Errata file, since that file

contains a variety of text and is a standard used to compare other T_EX systems. As you can see, the performance of the two systems is virtually identical for this document. In fact, the only serious difference in the benchmarks is on the Matrix document. Matrices are hard to set up and require a lot of calls to various alignment routines. The performance difference here may be due to the ways in which these calls were implemented.

You should be aware that the times given in table 1 are for an IBM PC AT running at 9 MHz. A standard AT would take about 30 percent longer, and a standard PC XT about 200 percent longer. As a rough guide, you can figure that the 9-MHz AT takes about 6 seconds per page, a 6-MHz AT takes about 8 seconds per page, and a standard XT takes about 18 seconds per page for most documents.

THE PRINT DRIVERS

Both Personal T_EX and Addison-Wesley provide a device driver for printers compatible with the Epson FX-80. They are similar in nature: Both use the standard T_EX fonts, offer similar performance, and have nearly the same names. However, there are some differences. The MicroT_EX driver has several extra bells and

(continued)

Table 1: T_EX benchmark. The columns compare the four different test files run by each of the packages. (Times are given in minutes:seconds.)

	Errata-b	Volume	Matrix	Webman
MicroT _E X	11:39	1:15	1:05	2:35
PCT _E X	12:00	1:28	0:37	2:31

Table 2: Print-driver benchmark. The columns represent levels of print quality; MicroT_EX offers five, PCT_EX offers two. (Times are given in minutes:seconds.)

	1	2	3	4	5
MicroT _E X	7:13	2:01	1:59	0:52	0:50
PCT _E X	7:43	2:08	—	—	—

SOLVE PROGRAMMING PROBLEMS THE WAY YOU THINK. PURE AND SYMBOL.



Introducing the new APL★PLUS® PC System, Release 5.0

The shortest distance between two points is a straight line. But unfortunately, that's not the case in programming.

Most languages require you to go through an enormous number of steps before an idea becomes reality.

That's why the APL★PLUS PC System is such a dramatic and exciting software tool for serious PC programmers and application developers.

Instead of requiring you to learn—and write—long-winded and complicated programs, APL is based on your instinctive ability to deal in symbols. And once you begin using APL's quick notations, you'll find it the ideal programming

environment for all your application needs.

The incredible shortcuts you get with APL will let you spend less time on drudgery and more time creating. Intricate calculations and modeling on PC's are a snap.

The Release 5.0 version features:

- multi-window, full-screen editing
- graphics primitives, now with EGA support
- spreadsheet-like numeric editing
- fast Assembler library
- built-in terminal mode
- and report formatting.

Plus concise notation for programs like sorting, matrix inversions, string searching,

and more. And the complete package price is just \$595 with major credit cards accepted.

Act now, and we'll send you a free Convincer Kit. Contact your local dealer, or call 800-592-0050 (in Maryland, call 301-984-5123) to order your system, or for more information about our other APL★PLUS products—from our UNIX™ version to the new streamlined Pocket APL.™

Or write STSC, Inc., Software Publishing Group, 2115 East Jefferson St., Rockville, MD 20852.

You'll see how symbol PLUS★WARE products are to use, the very first time you use them.



Problem-solving at the speed of thought.™

STSC
A Contel Company

APL★PLUS PC System requires 256K and DOS 2.0 or later. A soft character set can be used for computers with IBM compatible graphics board. A character generator ROM or software is included for the IBM PC or selected compatibles.

PLUS★WARE and Pocket APL are trademarks of STSC, Inc. APL★PLUS is a registered trademark of STSC, Inc. UNIX is a trademark of AT&T Bell Laboratories.



**WE'LL MEET
OR BEAT
ANY PRICE!!**

**HIGH PERFORMANCE
COMPATIBLES**

**MEGA-XI SYSTEM
(8088 CPU, 4.77Mhz)**

Runs all major IBM software — includes: 640K on board system unit, 360K floppy drive, 135W switching — power supply, keyboard, 8 top rated software packages!

Our Price **\$700**

Optional: MEGA-XI with 20mb hard Disk
\$1195

Comes with software too.

MEGA-AT SYSTEM (60286 CPU)

Includes: system unit 1024K RAM, 1.2MB Floppy Drive, Combined Floppy hard disk controller, AT keyboard, 192W power supply, serial, parallel port, clock/cal, battery backup on board.

Our Price **\$1990**

**LARGEST SELECTION OF
OEM/SELF ASSEMBLY BOARDS**

256/640K on Board, 8088 CPU
(same dimension as IBM)

\$159

Graphics compatible Monochrome Card
with printer port

\$115

Color Graphics Card, 640x200

\$95

Multi Disk I/O card, handles 4 dr serial,
parallel, game ports, clk, cal.

\$115

512K RAM Card — ok

\$55

384K Multifunction Card with serial, parallel,
game adpt., ramdisk, spooler, clock/
calendar.

\$115

IBM style keyboard

\$70

135W switching power supply

\$85

IBM style case, sliding + flip top

\$45

HARD DISKS

Seagate

10MB internal hif hght **\$290**

20MB internal hif hght **\$379**

30MB internal **\$695**

40MB internal **\$795**

60MB **CALL**

UPTO 300 MB **CALL**

CONTACT US FOR LOW PRICES ON PRINTERS:
Large stock of Epson, Star, Citoh, Okidata

**10,000 IBM PC SOFTWARE
WHOLESALE PRICE PLUS 7% ONLY!!**

INTERNATIONAL DEALERS WELCOME!!

TELEX 510 601 0960

24 HOUR QUOTE RESPONSE

CORPORATE ACCOUNTS & OEM

DEALERS WELCOME!!



DATA PROD. CORP.

377 Rt. 17, Hasbrouck Heights,
New Jersey, USA 07604

PHONE: (201) 288 8629

TELEX 510 601 0960 (Wintech Data)

FAX: 201 288 8579

Visa, MC, Check. No handling charge. No
additional export handling charges. Prices subject
to change without notice.

REVIEW: PCT_EX & MICRO_TE_X

*Both PCT_EX and
Micro_TE_X are very
slow at producing
high-quality output.*

whistles and a somewhat nicer user interface. It also has a special quick-and-dirty output mode that produces a low-quality, but quite rapid, print image of the DVI file.

The major problem with both packages is that they are very slow at producing high-quality output. This is not a fault of the programs but is due to the fact that each does a full-page graphics dump, which is an unavoidably slow process on most dot-matrix printers.

Most serious users of T_EX would probably use these drivers for draft output only, but the highest-quality mode looks very good. One user described it as "a laser printer on a bad day," and the description is an accurate one. After all, the Epson at 240 dots per inch is not so different from a Canon-engine laser printer at 300 dots per inch. If you print in a 12-point font and then reduce that to 10-point on a photocopying machine, you can get very nice looking output indeed.

But you pay a price for this quality: It can take more than 7 minutes to print a page in the high-quality mode (see table 2). Micro_TE_X has five quality levels, while PCT_EX has two and is slightly slower at producing similar-quality output.

OTHER PRINT DRIVERS

Other dot-matrix device drivers for DVI files are available. Personal T_EX sells a print driver for the Epson LQ-1500 and the Toshiba dot-matrix machines. (Performance on the newer dot-matrix printers should be better due to improved hardware.) Personal T_EX also sells laser-printer DVI drivers for the Corona Laser printer, the QMS Lasergrafix, and the Apple LaserWriter. Addison-Wesley plans to support more output devices.

I have had experience only with the LaserWriter driver, DVILASER/PS, but I have been very impressed with its performance. It was written by Textset Inc. (416 Fourth St., POB 7993, Ann Arbor, MI 48107) and is sold as an option for both PCT_EX and Micro_TE_X. DVILASER/PS processes pages at a rate of about 5 seconds per page on the AT running at 9 MHz and prints them out at about 4 to 5 pages a minute. DVILASER/PS translates Knuth's device-independent format into PostScript commands, which it then sends to the LaserWriter for printing.

DVILASER/PS allows you convenient access to many PostScript features such as automatic scaling, rotation, graphics, and the LaserWriter's resident fonts, as well as the standard Computer Modern fonts designed by Knuth. The output looks great: PostScript and T_EX together are a terrific combination.

Textset also provides print drivers for various laser printers and phototypesetters, as well as other products relating to T_EX. One particularly interesting new product is a preview-screen program for the IBM PC family and the Hercules graphics board; it allows you to see your manuscript on the screen before you print it.

CONCLUSION

Both of these packages are full and complete T_EX systems. They are each excellent products, and either should serve you well. The primary advantages of PCT_EX are that it produces FMT files for the rapid loading of macro packages; it comes with LaT_EX, a well-known macro package; and it contains an excellent T_EX tutorial by Michael Spivak. The primary advantages of Micro_TE_X are that it provides a quick-and-dirty draft-print mode, and it is a little faster at producing quality output. ■

[Editor's note: For more information on the T_EX system and digital typography, see the interview with Donald Knuth entitled "Computer Science Considerations" in the February BYTE, page 169.]

ADVANTAGE!

I read TJ Byers's review "Advantage! for the AT" (January, page 327) because we were considering purchasing these boards for the Computer Resource Lab at MIT. The key feature I found in installing such cards from scratch is that the AT is only able to recognize expanded memory above 1 megabyte starting on a half-megabyte boundary. This is not made clear in the AST documentation. Thus, if you install an AST card with 384K bytes, with 512K bytes on the motherboard, and a 512-byte expansion card (such as in the Enhanced AT), you are in effect not able to use the AST card with split memory addressing. The 256K bytes left on the AST card after 128K bytes have been added to the 512K bytes on the motherboard are virtually unusable, since it would start at 1.1 megabytes. Prior knowledge of key features is always an advantage!

SIMON LEWIS
Cambridge, MA

ENABLE

The Software Group believes the review of Enable by Steve King with a text box by Rich Malloy (January, page 331) was largely misleading, and we'd like to address some of its inaccuracies.

- "All the documentation [is written] as a tutorial" This is not true, although portions include tutorial sequences as reinforcement of the text.
- "The MCM [Master Control Module] doesn't display files that were not created by Enable." Enable not only reads but converts files from and to a variety of formats.
- "The menus do not help you learn the keyboard commands." Enable's design accommodates users who want either a menu-driven application or a command-driven application.
- "The backspace key sometimes reverts to its default behavior [even after the profile is adjusted]." Did you specify NO PROFILE at the sign-on screen? If so, Enable reverts to its internal (unchangeable) system profile.
- "The Enable 1.0 spreadsheet . . . cannot read files . . . in 1-2-3, VisiCalc, and DIF formats." Version 1.0 can read all these formats, without any rekeying.

- "I chose DBMS to integrate the . . . database with my text." The DBMS option on the top-line menu is not intended as a means of integrating your data; it provides a way to look something up in your database while writing a word-processing document.

- "[The telecommunications module] stores your desired parameters on the utility disk, but the operation disk looks for these parameters on your data disk." We recommend copying the telecommunications setup file to the data disk.

- Enable "locked up irretrievably" when directed to print on a Star Micronics Gemini after you configured Enable for an Epson MX-80. We tell Star Micronics users to choose the Epson RX-80 configuration.

- "Copying a block of text seems to cause some paragraph indentation in the block to be lost." Enable's block-copy feature always copies text to the flush-left position to save you keystrokes when positioning your cursor.

MIKE FISSELL
The Software Group
Ballston Lake, NY

I have been using Enable versions 1.0, 1.01, and 1.1 in a working environment for over a year. Steve King's review of Enable was so at odds with my experiences that I feel I must respond.

Enable's reformatting, as reported by both Steve King and Rich Malloy, has a few rough edges, particularly in dropping double spaces following periods and occasionally losing indentation on block moves. However, dealing with lines longer than 78 characters is not one of Enable's problems; I cannot remember using a version of Enable that did not allow me to use lines as long as 160 characters. I have learned to live with the program's quirks, which rarely cause me serious problems.

The database module is almost unusable without a hard disk, but that is true of every other micro DBMS I have used. I am surprised that King felt Enable's DBMS was the strongest part of the package. I found Enable's DBMS much less satisfactory than either the word-processing or spreadsheet functions. I can agree with King and Malloy about the relative

weakness of Enable's telecommunications abilities. They are adequate for TTY emulation on dial-up lines, but the VT100 emulation is too slow, at least on a 9600-bps line.

In a working environment, if I had limited resources and could afford only one piece of software for an IBM PC, I would choose Enable.

SELDEN S. DEEMER
Atlanta, GA

You state, "I have learned to live with the program's quirks." I believe that personal computer software consumers shouldn't have to learn to live with the quirks of any software costing more than \$5 or \$6 (that is, public-domain programs where you only pay disk costs). If you spend your hard-earned money on software, you have a right to bug-free, tested programs. Furthermore, software should contain a complete implementation of all the features the manufacturer advertises and implies you're getting. That's the primary point of my review—the user interface is secondary and a matter of preference. As a reviewer, I also believe that I should point out what I liked and disliked to assist readers with their decisions about software purchases.

I use PC-Write for editing, WordPerfect for word processing, Paradox for data management, Reflex instead of a spreadsheet, and PC/InterComm for communications. None of those programs required me to learn to live with their quirks. They all perform as expected, can import/export formatted ASCII files, and are probably all as fast as Enable.

Because I had read such positive reviews of Enable in other magazines, I really looked forward to working with it. I was both shocked and disappointed at what I actually found. Since Mr. Malloy reached similar conclusions about an even later version, I believe my review accurately reports what I found.

—STEVE KING ■

REVIEW FEEDBACK is a column of readers' letters. We welcome responses that support or challenge BYTE reviews. Send letters to Review Feedback, BYTE Publications, POB 372, Hancock, NH 03449. Name and address must be on all letters.



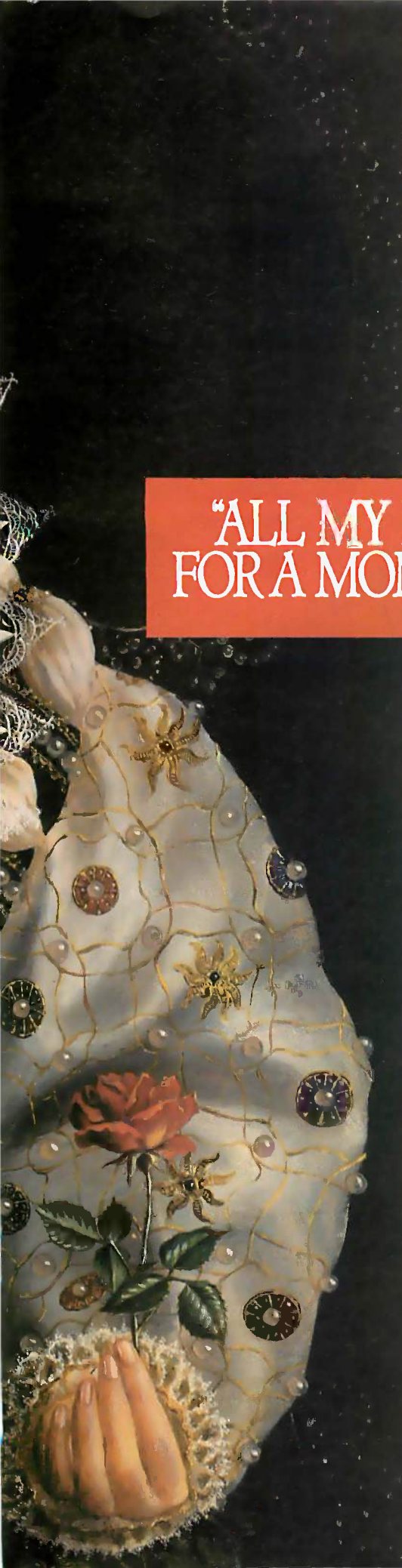

You can't buy time.

Long before the 16th-century reign of Queen Elizabeth I, man began his quest for a way to hoard that most precious of commodities. Time.

But man has found he simply can't create more time for more work or for more play. He can only make better use of the few hours he already has.

Hence, the development of today's business computers.

The ITT XTRA™ XP. Our crowning achievement.

By matching memory to the muscle

of the Intel 80286 microprocessor, we're able to achieve "no wait states!"

Processing flows uninterrupted, never waiting for slower memory to catch up.

Making the ITT XTRA XP thirty percent faster than the IBM AT. And fully XT-compatible.

Good news for the business with precious few moments to waste.

Gain the benefits of 60 years. Today.

ITT has been a telecommunications leader for over 60 years.

And, being a corporation made of many businesses, we're in a unique position to better understand you and your business.

Helping you make optimum use of your time. Today, as well as tomorrow.

A moment's investment today can pay off royally tomorrow.

Call (800) 321-7661. Or in California, (800) 368-7300.

And call quickly. Every moment wasted is a potentially profitable moment you'll never possess again.

ITT

PERSONAL COMPUTERS



The ITT XTRA XP desktop personal computer.

"ALL MY POSSESSIONS FOR A MOMENT OF TIME."

Elizabeth I

	ITT XTRA XP	COMPAQ 286	IBM PC/AT
Lotus 1-2-3	11sec	13sec	15sec
dBase	36sec	52sec	56sec
FormSort	52sec	1min 5sec	1min 10sec

*All comparisons are for purposes of illustration only, user's application performance dependent on application.

BECAUSE TIME IS THE ULTIMATE BOTTOM LINE.

© 1986, ITT Information Systems
IBM, PC/AT and PC/XT are registered trademarks of International Business Machines. Intel 80286 is a registered trademark of Intel Corporation. Compaq 286 is a registered trademark of Compaq Computer Corporation. Lotus and 1-2-3 are registered trademarks of Lotus Development Corporation. dBase is a registered trademark of Ashton-Tate.

Inquiry 168 for End-Users. Inquiry 169 for DEALERS ONLY.



Kernel

COMPUTING AT CHAOS MANOR: JERRY'S BEST OF 1985 AWARDS <i>by Jerry Pournelle</i>	279
CHAOS MANOR MAIL <i>conducted by Jerry Pournelle</i>	302
BYTE U.K.: XENOPHILIA <i>by Dick Pountain</i>	305
ACCORDING TO WEBSTER: CLEARING THE BACKLOG <i>by Bruce Webster</i>	315
APPLICATIONS ONLY: A COUPLE OF WINNERS <i>by Ezra Shapiro</i>	329
CIRCUIT CELLAR FEEDBACK <i>conducted by Steve Ciarcia</i>	336

This month's Computing at Chaos Manor begins with a report on COMDEX. Jerry came away convinced that color will soon dominate the micro industry. Following this are sections on the Amiga versus the Atari 520ST, the information revolution, a new Modula-2 compiler, and another new product from Borland International. And it's also award time at Chaos Manor, both the good and the bad. Many products appeared that Jerry has high praise for, but he also had several nominees for the Folly of the Year.

Apricot Ltd. recently unveiled its answer to the IBM PC AT—the XEN, which offers more performance than the PC AT for substantially less money. Dick Pountain takes a look at this machine, which is also one of the first to be shipped with Microsoft Windows as its standard operating environment.

In the words of Ihara Saikaku, "There is always something to upset the most careful of human calculations." Bruce Webster certainly subscribes to that. His column this month was supposed to be the second round of the 68000 wars. However, because of planned announcements of new machines from Atari and Apple, he postponed it until next month. This month, he looks at new software for the Macintosh, the Amiga, and the Atari 520ST.

This month, Ezra Shapiro talks about two programs he has begun to use daily. Mirror is a telecommunications program that is similar to Microstuf's Crosstalk XVI but costs half as much. Framework II is an improved version of the original Framework.

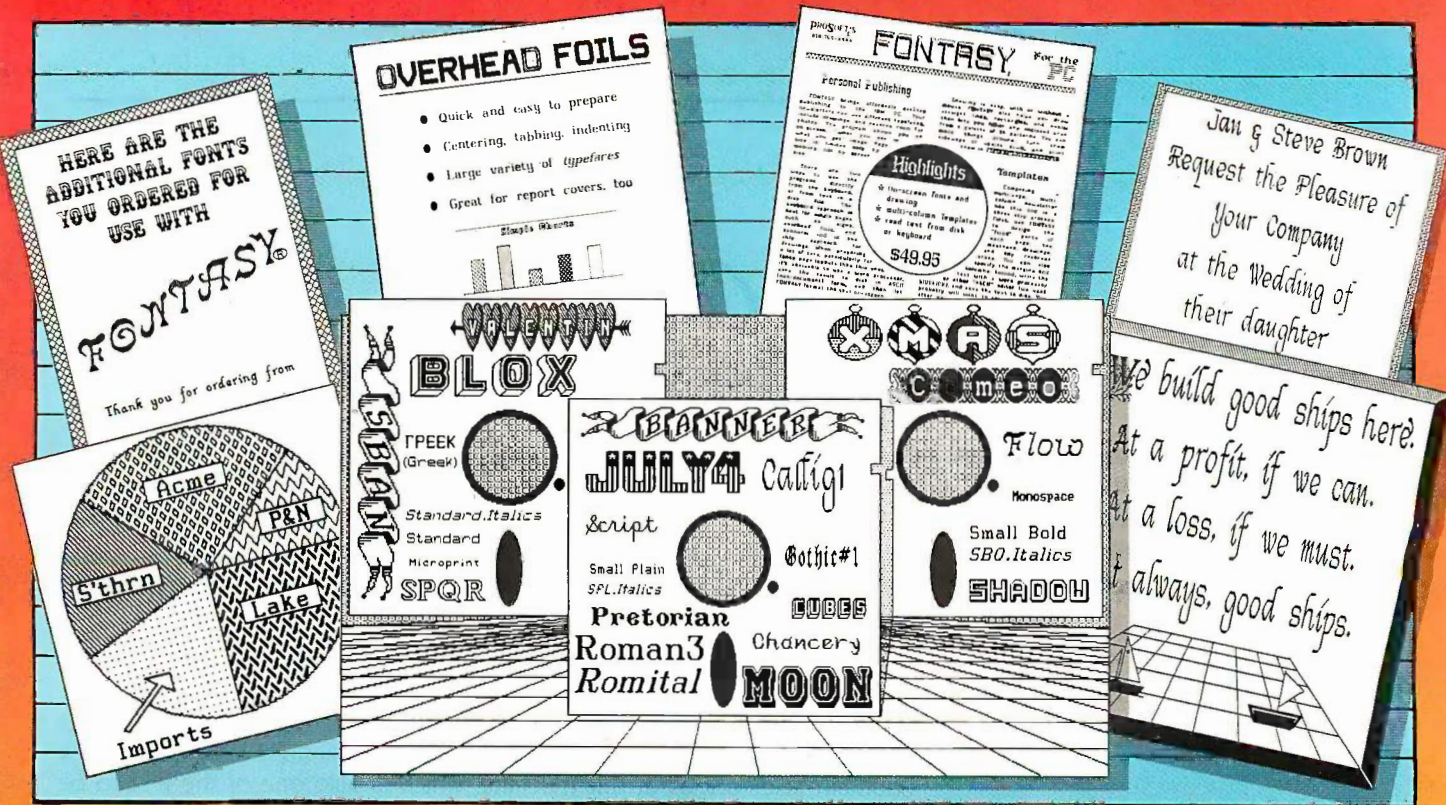

Fontasy printed all of these.

See What You Can Do With

Presentations! Newsletters! Flyers! Signs! Overhead Foils! Invitations! Menus! Logos! Announcements! Banners! Layouts! When you need a goodlooking visual quickly you need FONTASY — superb typefaces and simple drawing in one easy-to-use package.

FONTASY gives you a "what-you-see-is-what-you-get" picture, as you type and draw on the graphics screen of your IBM-PC. You can create a page at a time, see a mini-picture of that page, print it, and save it on disk. Page size is limited only by memory, not by screen size.

Features

Proportional space, justify, kern, bold-face, rearrange, magnify, black/white reversal, rotate, mirror image, lines, rectangles, ovals, draw, fill-in, undo (and un-undo), on-line help, 200-page book, and easy control from keyboard or mouse. Corporate licenses available.

Fonts, fonts, and more fonts! We have over 275 typefaces in our growing library, and will be happy to send you free print samples on request.

When you deal directly with the manufacturer (that's us), you pay rock-bottom distributor prices. If you order FONTASY now, we will give you 28 fonts (a \$50 value) at no extra charge. With so many features at such a low price, FONTASY belongs in your software library even if you already have a "font" program.

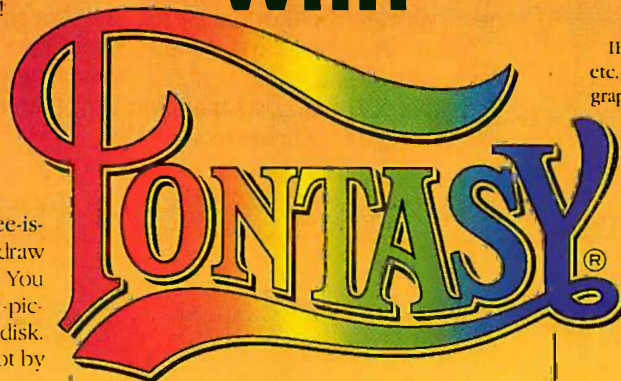

\$49.95

Introductory Price until April 30, 1986

Equipment Needed

IBM-PC, XT, AT, or true compatible (Compaq, etc.) with IBM or Hercules graphics adapter and graphics monitor. 256K memory needed for partial pages, 448-640K recommended for full pages. Dot-matrix printer. Mouse optional. MS-DOS 2.00 or above.

FONTASY supports: IBM graphics printer. Proprietary: Epson FX, JX, LX, MX, RX, and LQ-1500; C. Itoh 8510, 1550, 1570. Pro-writer-Jr, H-P LaserJet, ThinkJet; Microline 92, 93; Gemini 10X, 15X; Radio Shack DMP 105-430, 2100; Toshiba 351, 1340-1351; Star; and most Epson-compatibles.

Money-Back Guarantee

Fontasy is not copy-protected and has a 30-day money-back guarantee. So, take advantage of our breakthrough price and order now TOLL-FREE:

1-800-824-7888, operator 669 (ORDERS ONLY)

For further information and same day shipping, call: (818) 765-4444

PROSOFT

7248 Bellaire Ave., Box 560
No. Hollywood, CA 91603-0560

Name _____ Company _____
Address _____ Telephone _____
City, State, ZIP _____
Visa/MC _____ Exp. Date _____
Computer _____ Memory _____ Printer _____

Terms: M/C, Visa, checks. Please add \$3.00 shipping and handling in U.S. or Canada, \$20.00 overseas, \$2.00 for C.O.D., and sales tax in Calif.

FONTASY \$49.95
Tax _____
Shipping _____
Total _____

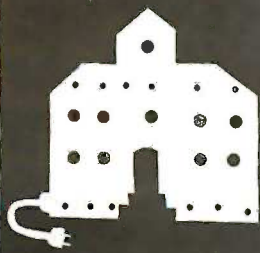

C·O·M·P·U·T·I·N·G A·T C·H·A·O·S M·A·N·O·R

Jerry's Best of 1985 Awards

COMDEX

NEC

Perma Power

Atari 520ST

Amiga

CD-ROMs

FTL Modula-2

Turbo Editor Toolbox

Jerry's Awards

BY JERRY POURNELLE

December is a busy month at Chaos Manor. Everything happens at once. I've just returned from COMDEX. Christmas is coming. I've caught my customary attack of the flu. It's time for my 1985 Best of the Year awards; and since this will go in the April issue, it's also time for the Folly of the Year. Stand by.

COMDEX was hectic. The United States Space Foundation's annual meeting was in Colorado Springs for the first part of the week, overlapping COMDEX by three days. I spent an enjoyable afternoon with faculty and cadets at the Air Force Academy on Wednesday, but of course my luncheon speech to the Space Foundation came on the same day as the Hearst/Pournelle/Dvorak COMDEX party in Las Vegas. I had things all planned out, but Colorado's weather boggled things, so I found myself frantically changing planes. Even so, I didn't get to Las Vegas until about 9 p.m. Thursday evening.

I'd been told that the party was to be in the shopping mall of the Las Vegas Neiman-Marcus. This seemed unlikely, but there were no messages at my hotel, so off I went. When I got to the Fashion Mall, I found polite but astounded security guards, no one else, and no pointers to the real location. I was ready to strangle John Dvorak.

Still, one must cope. So at 10:20 p.m., having been escorted out of the Neiman-Marcus plaza, I set out to find the party I was supposed to cohost. An hour later I got to it. As I arrived, some people were leaving; far more showed up than anyone had expected, and they'd run out of drinks. That dire situation was soon remedied by Borland International's Philippe Kahn, who ordered champagne and pizza for all.

I'm told it was the best party of COMDEX. Certainly there were enough interesting people, including Microsoft's Bill Gates, Cap'n Crunch, editors in chief, writers and reporters, hackers, game designers, and Bixen (inhabitants of BIX). It was crowded enough that I never did find Will Hearst, nor

a number of others I wanted to see, but certainly it was The Place to be. I guess we'll do it again next year. I'd like to think it will be better organized, but it probably won't.

COMDEX

COMDEX is terribly expensive and getting more so. Every year there are more exhibits—or at least more square feet of exhibits. It's a bit like display advertising in leading magazines: companies simply can't afford not to be seen lest they be forgotten, not only by customers but by dealers.

Most companies don't have anything really new to show, but they *have* to be at COMDEX. The result is booth after booth distinguished mostly by gimmicks. One outfit has a yacht. Another has dancing girls. Yet another has grown people dressed up as children playing out a mindless skit. It's hard to find the genuine technological innovations among the magicians, vaudeville performers, ventriloquists, silly robots that whistle the theme from *Star Wars*, bowls of bubble gum, jelly beans, chocolate dollars, coffee cups, buttons, fuzzy animals, stick-ons, plastic back-scratchers, and other paraphernalia of hype. Still, the search must be made. Fortunately, there were some trends to be spotted.

One warning note: show reports describe what I saw at a show and what I concluded from things I was told. I don't make full reports on stuff until it's sitting here in Chaos Manor.

WONDERFUL WORLD OF COLOR

One thing stood out clearly: the future computer world will definitely be in color. Color has always been preferable to monochrome, but until recently, you couldn't get monitors and color cards to display text with enough sharpness and clarity. Now you can, and the best new text-editor software can take advantage of color, so that you can use, say, light-blue letters on a darker-blue background with yellow highlights, instead

(continued)

Jerry Pournelle holds a doctorate in psychology and is a science-fiction writer who also earns a comfortable living writing about computers present and future.

of white on black, or black on amber, or whatever.

Before this, I hadn't seen any affordable color display crisp enough that I could stare at it day after day; but there were several such systems at COMDEX. One of the most interesting was a neat monitor from NEC. It can display the output from the nor-

mal IBM PC color board (not really good enough for text), the Extended Graphics Adapter (which is getting there), or the Professional Graphics Adapter (which does have the capability).

NEC (1401 Estes Ave., Elk Grove Village, IL 60007) also has a new PC AT-compatible computer with some of

the best color graphics and color text I've ever seen. NEC wasn't alone, of course. In fact, it was hard to find a part of COMDEX that didn't have spiffy text-quality color displays; NEC just happened to be the first one to catch my eye.

One wonderful little gadget was unique, one of the most impressive items in the show. Perma Power Electronics Inc. (5615 West Howard Ave., Chicago, IL 60648), an outfit that you usually think of as making power-guard supplies, displayed a thin color-control box for less than \$300. It sits between your computer and your color monitor. Simple controls on the front let you instantly change the colors on your monitor to anything you like. Reds can become blues, greens become greener, or whatever. More to the point, you can change the whole palette from, say, your favorite word processor: different background color, different lettering, different highlight colors. I was really impressed with it at the show. More about it after I've had time to work with it here.

I came away from COMDEX convinced that, within two years, color will dominate the micro industry—and that includes business people as well as hobbyists, students, game players, and home users. Color is just too nice not to take advantage of.

ATARI

The Atari booth was over in West Hall, where crowds don't usually go, which made the ferment around the Atari booth stand out from a long way off. The Atari people brought in a bunch of software developers and set them up in minibooths reminiscent of the West Coast Computer Faire. The result was a bunch of enthusiastic young people showing what they could make the Atari 520ST do. You could get a contact high by just standing there.

I saw databases, text editors, games, accounting systems, languages and compilers, a light-show program, a music-recording program, and all kinds of other stuff. Atari wanted to

(continued)

Programmer Essentials

"Offers many capabilities for a reasonable price"

W. Hunt, PC Tech Journal

"I highly recommend the  UTILITY LIBRARY"

D. Deloria, The C Journal

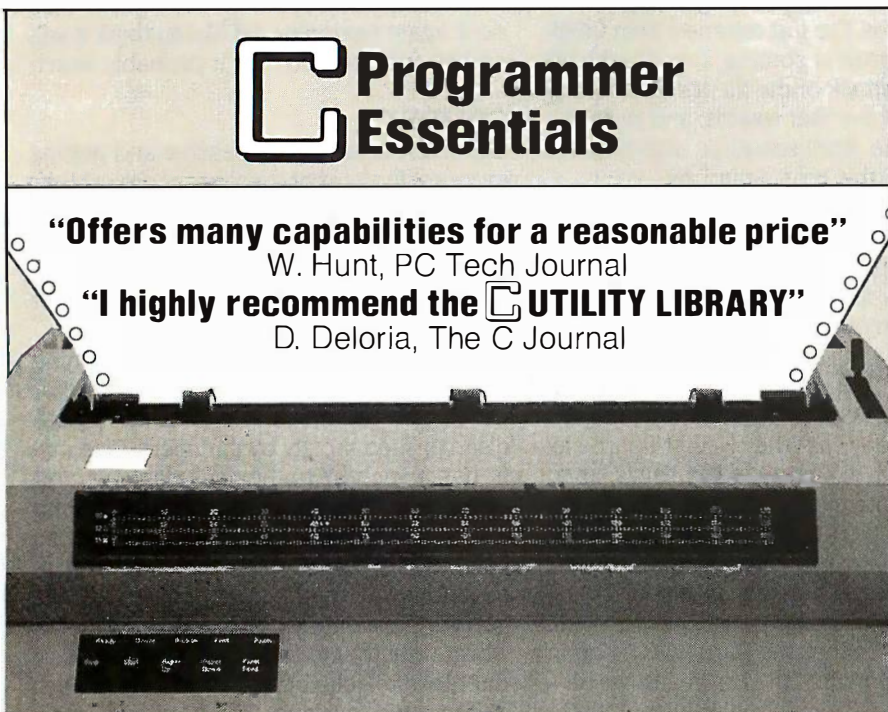

ESSENTIALS

200 functions: video, strings, keyboard, directories, files, time/date and more. Source code is 95% C. Comprehensive manual with plenty of examples. Demo programs on diskette. Upgrade to THE C UTILITY LIBRARY for \$95.

\$100

THE UTILITY LIBRARY

Thousands in use world wide. 300 functions for serious software developers. The C ESSENTIALS plus "pop-up" windows, business graphics, data entry, DOS command and program execution, polled async communications, sound and more.

\$185

ESSENTIAL GRAPHICS

Fast, powerful, and easy to use. Draw a pie or bar chart with one function. Animation (GET and PUT), filling (PAINT) and user definable patterns. IBM color, IBM EGA and Hercules supported (more soon). NO ROYALTIES. Save \$50 when purchased with above libraries. Available February, 1986.

\$250

Compatible with Microsoft Ver. 3, Lattice, Aztec, Mark Williams, CI-C86, DeSmet, and Wizard C Compilers. IBM PC/XT/AT and true compatibles.

Compiler Packages: Microsoft C - 319, Lattice or CI-C86 compilers - \$329. Save \$40 - \$50 when purchasing compiler and library combinations. Specify C compiler and version number when ordering. Add \$4 for UPS or \$7 for UPS 2-day. NJ residents add 6% sales tax. Visa, MC, Checks, PO's.



ESSENTIAL SOFTWARE, INC

P.O. Box 1003 Maplewood, NJ 07040 914/762-6605

SWITCH!



This is draft printing
at 12 characters per inch and
160 characters per second

*Select fast draft quality printing with a very high
throughput. Then flick the switch...*



This is NLQ printing
at 10 characters per inch

...to select NLQ printing for your wordprocessing.

You can assign the 80-column Facit 4513 and 132-column Facit 4514 to whatever printing tasks your application requires.

From wordprocessing NLQ printouts with automatic sheet feeding to high-speed draft printing. Select 10, 12 or 17 characters per inch.

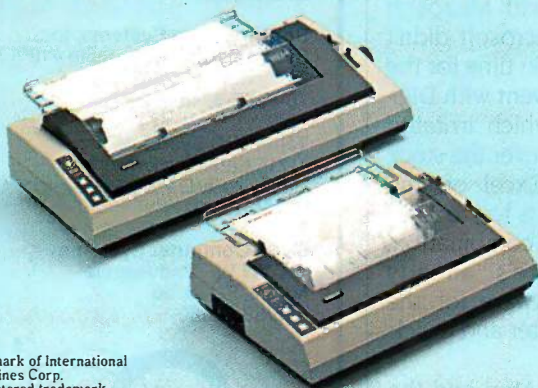

Or proportional printing.

All at the flick of a switch.

The printers incorporate both the IBM/Epson and Epson FX command sets. And thus easily make friends with both IBM PC:s and UNIX supermicros.

Naturally, the printers handle any output from your graphic software packages – logos, business graphics, pictures, semi-graphics, etc.

And when it comes to reliability, the component materials, printhead life and stringent testing ensure that your Facit 4513/14 printers will deliver many years of quality printings. Just like every other printer in the Facit family.

Switch to Facit 4513/14 matrix printers!

FACIT

Inquiry 130

Head Office: Facit AB, S-172 91 Sundbyberg, Sweden. Phone: (8) 764 3000.
USA: Facit Inc. PO. Box 334, Merrimack, NH 03054. Phone: (603) 424-8000

IBM is a trademark of International Business Machines Corp.
Epson is a registered trademark.
UNIX is a trademark of AT&T Bell labs.

AUSTRALIA: EAI Electronics Associates Pty Ltd., 427-3322. AUSTRIA: Ericsson Information Systems GmbH, 0222-613641. BELGIUM: Ericsson S.A., 02-2438211. CANADA: Facit Canada Inc., 416-821-9400. CYPRUS: LBM (Lillytos) Ltd 5164634. DENMARK: Facit A/S, 02-922400. FINLAND: OY Facit, 90-42021. FRANCE: Facit S.A., 1-7807117. GREAT BRITAIN: Facit, 0634-401721. GREECE: Computer Application Co., Ltd., 01-6719722. HONGKONG: Gilman & Co. Ltd., 5-7909555. ICELAND: Gisli J. Johnsen HF, 354-173111. INDIA: Forbes Forbes Campbell & Co. Ltd., 22-268081. IRELAND: Memory Ireland Computers Ltd., 1-989733. ITALY: Facit Data Products S.p.A., 039-636331. JAPAN: Electrolux (Japan) Ltd., 03-479-3411. THE NETHERLANDS: Ericsson Information Systems B.V., 03480-70911. NEW ZEALAND: McLean Information Technology Ltd., 501-801, 501-219. NORWAY: Ericsson Information Systems A/S, 02-355820. PORTUGAL: Regisconta Sarl, 1-560091. SINGAPORE: Far East Office Eqpts Pte Ltd., 7458288. SPAIN: Facit, 91-4571111. SWEDEN: Ericsson Information Systems Sverige AB, 08-282860. SWITZERLAND: Ericsson Information Systems AG, 01-3919711. WEST GERMANY: Ericsson Information Systems GmbH, 0211-61090.

scotch the rumor that there's no software for the 520ST, and, in my view, they succeeded with a vengeance. I think that the Atari 520ST is here to stay.

AMIGA

The Commodore folks were not at COMDEX. They'd reserved space but didn't use it; instead, they held a press conference. The official line was that Commodore is selling all the Amiga computers it can make and thus has all the dealers it needs; it would be silly to spend all that money just to tell potential dealers they can't come aboard.

Atari's comment on that was, "We sell more Atari 520STs than Commodore sells Amigas, and we sure want to sign up more dealers." The rumor in the pressroom was that Commodore's bankers were signing its checks and wouldn't advance the money to pay for COMDEX.

I wouldn't know. What I do know is that the Commodore Amiga is one hell of an exciting machine.

AMIGA VERSUS ATARI 520ST

I've had an Atari 520ST and an Amiga set up side by side for about a week. One thing is clear: either one of these machines could eat Apple's lunch. Both machines have sharp, crisp color graphics. Neither one has a text editor good enough that I'd use it to write books, but that's a software problem: both the Amiga and the 520ST can display professional-quality text in color. It shouldn't be long before someone writes editors transparent enough for creative writers. Indeed, we already have TDI Modula-2/ST up on the Atari, and it wouldn't take a heck of a long time to write a good text editor.

In addition, both the Atari and the Amiga have versions of EMACS, the popular programming editor written by Richard M. Stallman. I haven't worked with the current versions, but real EMACS can be customized to know what language you're programming in, making the programmer's life much easier.

By the time you read this, both ma-

chines will have Lattice C. Lattice also has a bunch of software tools, like Text Utilities and MacLibrary, a collection of C functions compatible with Macintosh QuickDraw. Software developers are enthusiastic about these: they make it easy to convert Macintosh software to the Amiga. Meanwhile, Borland is porting Turbo Pascal to the Amiga, and, as I've already mentioned, we have TDI's Modula-2 for the Atari. The Amiga's Microsoft BASIC is, as I write this, greatly superior to the Atari's present BASIC, but once again things are changing rapidly. Metacomco, a reliable outfit, is working with Atari, and its Personal BASIC ought to be up on the Atari well before you read this. Moreover, Metacomco is also working with Lattice to bring Lattice C and Toolkit to the Atari. There won't be any shortage of programming languages for either machine.

Amiga has one major advantage. Microsoft is emphatic about having no plans whatever to port anything to the Atari; but Microsoft's Excel is still the best spreadsheet on the market, and by a lot. The 520ST with Excel would be a dynamite combination and would practically guarantee Atari's penetration into the business world. Excel is written in C for the 68000-based Macintosh, and both the Atari and the Amiga are 68000 machines; it wouldn't be that hard to get Excel onto either one.

The story I get is that Atari was originally going to run with Microsoft Windows, but when Microsoft didn't have Windows running in time for the 520ST's release, Atari went with Digital Research's GEM, which irritated Microsoft no end. Whatever the story, you're likely to see Excel on the Amiga long before it gets to the Atari 520ST. It'll be a good combination, too. Meanwhile, there's already powerful business software for the Atari, including DB Master and Quickview's Zoomracks.

In my judgment, the Atari and the Amiga between them spell big trouble for Apple. I haven't seen anything you can do with a Macintosh that you

(continued)

**Advanced
Authorized
Dealers**
(Eastern U.S.)

Aardwolf Microsystems
217 East 85th, Suite 102
New York, NY 10028
212/538-7840

Advanced Information Systems, Inc.
1336 Edna S.E.
Grand Rapids, MI 49507
616/243-1312

Corporate Micros, Inc.
333 West 52nd St., Suite 1204
New York, NY 10019
212/315-2853

Crest Systems, Inc.
2101 Magnolia Ave., Suite 208
Birmingham, AL 35205
205/328-4882

Fast Forward, Inc.
129 Adams Street
Louisville, KY 40206
502/589-0301

ICS Software
P.O.C. 359015
Brooklyn, NY 11235
718/743-4050

Micro City Computers
110 West 31st Street
New York, NY 10001
212/563-6110

Mitech Corporation
#1 Perimeter Park South, Suite 335-S
Birmingham, AL 35243
205/967-0605

Modular Management Systems, Inc.
451 Bloomfield Ave.
Caldwell, NJ 07006
201/228-3838

Network Data Systems, Inc.
3419 Pierson Place
Flushing, MI 48433
313/732-6340

**PRISM Computer & Consulting
Services, Inc.**
2100 Riverchase Center, Suite 420
Birmingham, AL 35244
205/988-5111

Southeastern Systems, Inc.
619 East Price Ave., Suite #12
Gastonia, NC 28054
704/866-8048

TRIMARC Systems, Inc.
11716 Parklawn Drive
Rockville, MD 20852
301/231-4991

Open Computer Systems
4701 N.W. 72nd Avenue
Miami, FL 33166
305/594-2980

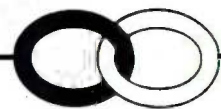

**THE
SOFTWARE
LINK, INC.**



The Most Powerful LAN Fits on a Disk.

Network Power. You knew that someday there would be a powerful LAN that didn't need old-technology network boards. It would be fast, easy to install, and run 99% of PC-DOS software. It would be expandable, provide remote access, password-protection, and enable you to use inexpensive terminals as workstations in a PC-DOS environment. Dream no more, because the power is here.

Its name is LANLink™

A Software-Driven LAN Powerful Enough To Use RS-232 Ports for Network Communications. In development for over three years, LANLink™ represents the next generation of local area networks. All of the logic which has traditionally resided on network boards is on LANLink's Satellite and Server Diskettes.

No additional hardware is required. Inexpensive serial ports replace "Kilobuck" Network Interface Boards making installation costs one-third that of a board-driven network.

How To Configure a Smart Network...With Dumb Terminals, But Without Dedicated Servers. Boasting a wide variety of configurations, LANLink™ is most often set up as a "Star" having up to eight satellites connected to a central, nondedicated server. Larger networks can have multiple servers, supporting a total of 73 or more network users.

R-LAN™ (Remote-LAN) gives users the ability to interact with a LANLink™ network in real time via modem. Plus, if MultiLink Advanced™ is run on a Satellite, inexpensive dumb terminals can be used to access network disks, files, and programs.

99% of PC-DOS Applications Run in a Totally-Transparent Network Environment. If you know DOS, you already know how to use LANLink™ COPY transfers files among users, and a 2-drive PC Satellite boots 1-2-3 from the Server's hard disk with the entry c:\lotus. Each satellite's access can be limited to specific disks, printers, and sub-directories. A wide variety of software including Lotus 1-2-3, dBASE III, and WordStar 2000 is fully compatible. LANLink™ has a collision-free data transfer rate which exceeds 115,000 BPS.

Power Up Your PCs Today. For complete details and the authorized dealer nearest you, call The Software Link TODAY. The LANLink™ Starter Kit is \$495 and includes modules for both a Server and a Satellite. For a limited time, 50 feet of shielded RS-232 cable will be included free of charge. Additional Satellite Modules are only \$195, each.

LANLink™ is immediately available and comes with a money-back guarantee. VISA, MC, AMEX accepted.

Inquiry 309

LANLink™



THE SOFTWARE LINK, INC.
Developers of LANLink™ and MultiLink Advanced™

8601 Dunwoody Place, Suite 632, Atlanta, GA 30338 Telex 4996147 SWLINK

CALL: 404/998-0700

Dealer Inquiries Invited

THE SOFTWARE LINK, INC./CANADA 400 Esna Park Drive, Suite 18
Toronto (Markham), Ont./L3R 3K2 CALL: 416/477-5480

LANLink™ MultiLink Advanced™ & R-LAN™ are trademarks of
The Software Link, Inc.

IBM, PC, & PC-DOS are trademarks of IBM Corp. WordStar 2000,
dBASE III, and Lotus 1-2-3 are trademarks of MicroPro, Ashton-
Tate, and Lotus Development Corp., respectively.

BRIEF:

"There is nothing this editor can't do except make babies and I understand that's in the next release."

— David Irwin, Data Based Advisor, 12/85

Tailor Editing to Your Style

- A high-level, readable *Macro Programming Language* - allows customization for programming languages . . . Complete, unlimited variables, etc.
- Edit multiple files of unlimited size (2 Meg is OK)
- Multiple Windows on screen with different or same file, fragments, etc.
- A bona-fide UNDO stack (up to 300) of all operations: deletions, reading files, search, translate, more.
- Full "regular expression search" - wild cards, complex patterns
- Reconfigurable keyboard
- Adjustable line length - up to 512.
- Keystroke macros - for common typing sequences
- Suspend BRIEF to execute, exit to DOS - run another program (like a compiler, dir, XREF, DIFF, or DEBUG) then resume BRIEF session
- Compiler-specific support like auto indent, syntax check, compile within BRIEF

For PC, AT, compatibles and Tandy 2000.

Only \$195

Full Refund if not satisfied in 30 days.
CALL 800-821-2492.

Solution Systems™

335-B. Washington St., Norwell, MA 02061
617-659-1571

LEARN LISP

Interactively and Write "Realistic" Programs with TransLISP for Only \$75

A "COMMON LISP" compatible Tutorial, Interpreter, Debugging, and Pretty Printer plus a Fast, Full Screen Editor, Samples and Help

- Start Easily and Quickly:**
A complete, modular tutorial helps you learn LISP at your own pace. An integrated, interactive environment provides all of the elements needed to enter, modify, analyze and debug programs.
- Natural Language, Expert Systems and Mailing List:**
Natural Language concepts are illustrated by a phone number retrieval program. Choose the best word processing program for you with the Expert System. File handling and typical data processing work are demonstrated by a Mailing List program.
- Write Realistic Programs:**
Short examples and substantial programs of about 10 pages in length help you learn by modifying, studying and using the key concepts needed to write programs of 1000 lines or more.
- The "COMMON LISP" Standard:**
TransLISP includes a 230+ function subset of the "COMMON LISP" Standard. Use extras like the MSDOS interface and graphics. Or use "strict compatibility" to make programs written in TransLISP, with no changes, work with other COMMON LISP systems like VAX LISP, GC/LISP or LISP Machine LISP.

Use and Modify the Mailing List program to learn how to handle "normal" programming in LISP.

Runs on any MSDOS or PC DOS Systems: Not copy-protected, TransLISP is available in just about any 3", 5" or 8" format. PC compatibles can run TransLISP with no installation procedure. 192K memory and 1 floppy drive are the minimums required.

ONLY For Beginners and Experienced Programmers

\$75

Full refund if not satisfied during first 30 days.

Solution Systems™

335-B Washington St.
Norwell, Mass. 02061
617-659-1571
800-821-2492

can't, at least in theory, do as well with either of these two machines. Hackers assure me that it's much easier to write programs for either than for the Mac—one chap told me he could get a fancy program running on both the Atari and the Amiga quicker than he could get it going on the Macintosh. There are powerful languages for both machines. Both companies have sensible policies to encourage software developers, and both are really working to be nice to hackers. It shouldn't be long before the floodgates open and the software pours out. There will still be Macintosh loyalists, of course, and Apple is likely to cut Macintosh prices; but the Mac's small and colorless screen, inherent speed limitations, and lack of disk controller will count against it.

Both the Atari and the Amiga will, or at least ought to, do well against the Apple II and the Macintosh. The real question is how they'll compete with each other.

I think it's too early to tell. Each machine has strengths and weaknesses. The Amiga has multitasking. Its keyboard definitely feels better, and its color graphics are, I think, aesthetically nicer. The Amiga is also easier to set up. The Atari needs a lot of room, has cables everywhere, and really requires simple but specialized furniture to be useful. However, its color monitor is better than the Amiga's; to get the best from the Amiga, you will want a Sony monitor or something similar. The Atari has good sound quality, but the Amiga has even better and in stereo. And so forth.

I suppose I prefer the Amiga to the Atari; but how much do I prefer it? The price difference between the machines is significant, especially when you consider that the Atari will soon have a \$700 20-megabyte hard disk, and many of the Amiga's hardware features can be simulated in the Atari through clever software. The Amiga is, on balance, the "better" machine—but the Atari 520ST is certainly good enough for a lot more than I originally bought my first computer for.

(continued)

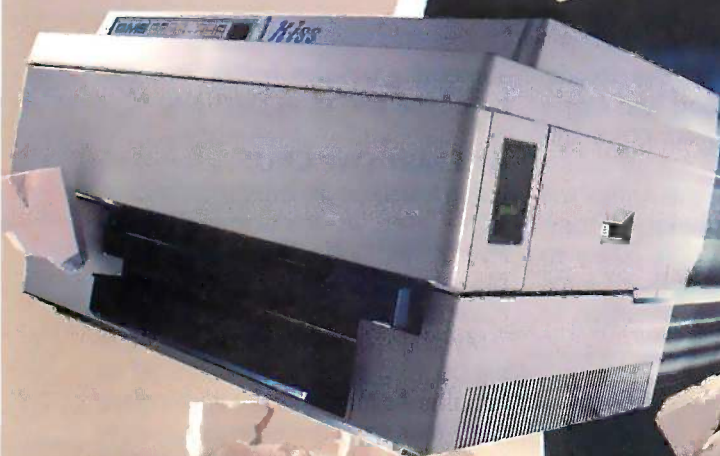

Now There's A Laser Printer That Blasts Through The Price Barrier.

QMS introduces the KISS.™ The first laser printer at the never-before-heard-of price of \$1,995.* KISS keeps it smart and simple. It's the perfect mate to any PC.

It's so sophisticated, you'll want to kiss your old daisywheel and dot matrix printers good-by. KISS is ten times faster. And it's very quiet. It produces crisp, near typeset-quality output at up to 400 characters per second. And it has its own cut-sheet feeder.

With nine resident fonts, you get quality, style and flair. Mix them all on a page—even on one line. Imagine all that power on your desk.

Plus, KISS is smarter than your old printer. It works with WordStar®, Lotus® and any other software that will print to a Diablo 630®, Epson FX 80® and QUME Sprint®. At up to 6ppm, KISS is unmatched in efficiency and versatility.

Can you imagine your present printer performing like that? We can't.

QMS is meeting today's needs with proven technology. Like the KISS. It's inexpensive. Dependable. Exciting.

Let us give you a KISS.
Call toll free, 1-800-523-2696
for more information.

WordStar is a registered trademark of Micropro International. Lotus is a registered trademark of Lotus Development Corporation. Diablo is a registered trademark of Xerox Corp. Epson is a registered trademark of Epson America, Inc. QUME is a registered trademark of QUME Corp.

* This price good in domestic United States only.

Inquiry 276

QMS®

Print Systems With Imagination.™

- Send me more information about the KISS.
 Please contact me to arrange a demonstration.

Name _____

Title _____

Company _____

Address _____

City _____ State/Zip _____

Phone () _____

Type of system you are now using _____

Number of print workstations you are considering _____

Prime application for printer _____

BY 4/86

P.O. Box 81250, Mobile, AL 36689
©1986 QMS® Inc.

My guess is that the Amiga will appeal more to serious computer users—professional artists and writers, hackers, dedicated hobbyists—while the Atari will be the machine “for the rest of us,” meaning the machine that everyone can afford. I wouldn’t be surprised to see a significant portion of U.S. high school students owning Atari

520STs before the end of this decade. The machine is that good, and Atari’s policy is ruthlessly to cut costs and prices.

The nice part is that the Amiga will keep Atari on its technological toes; the Atari will force Commodore to keep prices down; and both will force Apple and IBM to pay attention to

something besides horoscopes and hype. The rest of us can’t lose.

AT LEAST ONE CPU . . .

I don’t believe in multiuser micros. “One user, at least one CPU” is Pournelle’s motto. If you want multiple users, get multiple machines and network them.

My philosophy seems to be catching on. IBM introduced the PC AT as a multiuser machine, but it isn’t often used that way. There probably were some, but I don’t remember seeing one multiuser PC AT at COMDEX. On the other hand, I saw a lot of PC AT clones set up to do multitasking for single users.

That doesn’t surprise me a lot. I’ve been using Big Kat, the Kaypro 286i, since last spring, and I would truly hate to go back to a less powerful machine. Big Kat is fast and, barring the hard-disk problem I previously reported, has never had a glitch.

Big Kat doesn’t have enough memory. That is: the machine is full up with 640K bytes, but that’s not enough for everything I want to do, what with SideKick, SuperKey, the Turbo Lightning spelling checker, Symantec’s Q&A editor and report generator, and Living Videotext’s Ready! outline processor.

There are solutions. Wayne Holder, whose Oasis Software brought you The Word Plus, has developed a new spelling checker and thesaurus program that works with Q&A. Symantec continues to work to reduce the program’s memory requirements. Ready! will currently run on an expanded-memory board, and Gordon Eubanks assures me that Symantec is working hard to get Q&A to do the same. Meanwhile, a number of companies offer expanded-memory boards for the PC AT and its clones.

There are enough outside sources of both hardware and software for the AT to reach a critical mass. Indeed, I think it has already happened. The AT and its clones have become the new “standard” small business computer, and, from here on, more and more programs will take advantage of the

(continued)

MAXIT™
The affordable solution
to the 640K limit
for software like 1-2-3™ 1A.



Why spend more than \$700 for an expanded memory board with 256K and new software versions that may be incompatible with your current software?

MAXIT is a 256K memory board — with software — that increases memory for 1-2-3 Release 1A — and other memory-intensive software, including Sidekick!™

With MAXIT, you don’t have to buy new software versions like 1-2-3 Release 2.

And MAXIT is priced at an affordable \$195.

No matter how much memory your computer has now — even 512K or 640K — MAXIT can increase available memory. It can work above 640K, using memory that was reserved for the operating system but isn’t being used. MAXIT software adds memory above 640K to DOS, and enables 1-2-3 Release 1A or memory-resident programs to use it.

And if you already have software that works with expanded memory, you can use MAXIT’s special driver software. It emulates costly expanded memory boards — giving you increased power at a fraction of the cost.

MAXIT works on the IBM PC, XT, the Portable PC, and many compatibles. It requires DOS 2.0 or above.

MAXIT works on the IBM PC AT, too. It fills out the AT’s memory from 512K to 640K, and even goes beyond that

MAXIT includes a 256K parity-checked memory card that uses the latest technology. It’s a half-size card, too, so you can use it in a short XT slot.

Installation is a snap. Just follow the instructions in the illustrated Owner’s Manual. The menu-driven setup software also gives you screen prompts. And if you have questions, our customer service department will answer them fast.

Once installed, MAXIT loads automatically. You don’t have to learn a single new command to use it to its fullest.

Get the affordable solution to your PC’s memory crisis. We’ve made it easy. Order MAXIT today by calling our toll-free number: 1-800-221-8439. (In Texas, call 1-214-437-7411.)

We accept VISA, MasterCard, American Express, and Diners Club cards.

Or order by writing to: McGraw-Hill Software, 8111 LBJ Freeway, Dallas, Texas 75251.

MAXIT is just \$195 plus \$4.00 shipping (\$12.00 outside the U.S.). Texas residents add \$11.94 sales tax.

Be sure to include credit card number and expiration date with mail orders. Orders paid

by check are subject to delay.

MAXIT is covered by a 30-day money-back guarantee and a one-year warranty.

1-800-221-8439

(In Texas 1-214-437-7411)

McGraw-Hill Software

8111 LBJ Freeway, Dallas, Texas 75251



\$195

MAXIT is a trademark of McGraw-Hill Software. IBM is a registered trademark of International Business Machines Corporation; 1-2-3 is a registered trademark of Lotus Development Corporation; Sidekick is a registered trademark of Borland International, Inc.

THE PROGRAMMER'S SHOP™

helps save time, money and cut frustrations. Compare, evaluate, and find products.

SERVICES

- Programmer's Referral List
- Dealer's Inquire
- Compare Products
- Newsletter
- Help find a Publisher
- Rush Order
- Evaluation Literature FREE
- Over 700 products
- BULLETIN BOARD - 7PM to 7AM 617-826-4086

AI-Expert System Dev't

Arity System - incorporate w/C. PC \$295
 ExpertEASE - Develop by describing examples of how you decide. MS Call
 EXSYS - All RAM, Probability. Why. Trees, Solid, files, popular PC \$359
 Ist Class - by example, interfaces \$250
 Insight 1 - Probabilities, required thresholds, menus, fast (\$79),
 Insight 2 adds backward, forward, partitions, dB2, lang., access. MS \$399
 Others: APES (\$359), Advisor (\$949), ES Construction (\$100), ESP (\$845), Experteach (\$399), Expert Choice (\$449)

AI-LISP

List Our
 GC LISP Interpreter - "Common", rich, Interactive Tutorial \$495 Call
 GC LISP286 Developer - 2 to 15 meg RAM, compiler & Interp. \$1195 Call
 Microsoft MuLisp 85 \$250 \$199
 TLC LISP - "LISP-Machine" - like, all RAM, classes, compiler. MS \$225
 TransLISP - Good for learning MS \$ 75
 WALTZLISP - "FRANZ LISP" - like, big nums, debug, CPM-80 MS \$149
 Others: IQ LISP (\$155), BYSO (\$125),

AI-PROLOG

ARITY Standard - full, 4 Meg Interpreter - debug, C, ASM PC \$ 350
 COMPILER/Interpreter-EXE PC \$ 795
 With Exp Sys, Screen - KIT PC \$1250
 MicroProlog - enhanced MS \$ 229
 MProlog - Improved, Faster PC \$ 475
 Professional MicroProlog MS \$ 359
 Prolog-86 - Learn Fast MS \$ 95
 Others: Prolog-I (\$365), Prolog-2 (\$1795)

Editors for Programming

BRIEF Programmer's Editor - undo, windows, reconfigure PC Call
 C Screen with source 80/86 \$ 75
 EMACS by UniPress - powerful, multifile, MLISP. Source: \$949 \$299
 Entry Systems for C PC \$325
 Epsilon - like EMACS PC \$169
 FirstTime by Spruce - Improve productivity. Syntax directed for Turbo (\$69), Pascal (\$229), or C (\$239)
 Kedit - like XEDIT PC \$115
 Lattice Screen Editor-multiwindow, multitasking Amiga \$100 MS \$125
 PMATE - power, multitask 80/86 \$159
 VEDIT - well liked, macros, buffers, CPM-80-86. MS PC \$119
 XTC - multitasking PC \$ 85

FEATURE

Panel Screen Generator - Create screen w/editor, generates code. Data validation, windows, no royalties. Specify Lat., MSC, C86, MS Fortran or Pascal MS \$239

Free Literature - Compare Products

Evaluate products. Compare competitors. Learn about new alternatives. One free call brings information on just about any programming need. Ask for any "Packet" or Addon Packet AI ADA. Modula BASIC C COBOL Editors FORTH FORTRAN PASCAL UNIX/PC or Debuggers, Linkers

C Support-Systems

Basic C Library by C Source \$139
 C Debug - Source debuggers - by Complete Soft (\$269), MSD (\$149).
 C Sharp - well supported, Source, realtime, tasks \$600
 C ToolSet - DIFF, xref, source \$135
 Lattice Text Utilities \$105
 The HAMMER by OES Systems \$179
 SECURITYLIB - add encrypt to MSC. C86 programs. Source \$250 PC \$125

Fortran & Supporting

Forlib + by Alpha - graph, comm. \$ 59
 Fortran >>> C - FORTRIX C creates maintainable translations. \$5495
 MACFortran by Microsoft - full '77 \$229
 MS Fortran \$219
 No Limit - Fortran Scientific \$129
 PolyFortran - xref, pp, screen \$149
 Prospero - '66, reentrant \$390
 RM Fortran - enhanced "IBM Ftn" \$399
 Scientific Subroutines - Matrix \$149
 Statistician by Alpha \$269
 Strings and Things - registers, shell \$ 59

MultiLanguage Support

BTRIEVE ISAM MS \$199
 CODESIFTER - Execution PRO-FILER. Spot bottlenecks. Symbolic. automatic. MS \$109
 MultiHALO Graphics- Multiple video boards, printer, rich. Animation, engineering, business. Any MS language, Lattice, C86 PC \$189
 PLINK 86 - a program-independent overlay linker to 32 levels for all MS languages, C86 and Lattice. MS \$299
 Pfinish Performance Analyzer by Phoenix MS \$299
 Profiler by DWB Associates MS \$ 99
 PS MAKE by UniPress PC \$129
 Screen Sculptor - slick, thorough, fast, BASIC, PASCAL. PC \$109
 ZAP Communications - VT 100, TEK 4010 emulation, full xfer. PC \$ 85

ATARI ST & AMIGA

We carry full lines of Manx, Lattice, Metacompo and Prospero.

Call for a catalog, literature, and solid value

800-421-8006

THE PROGRAMMER'S SHOP™

128-B Rockland Street, Hanover, MA 02339
 Mass: 800-442-8070 or 617-826-7531 286

RECENT DISCOVERY

Dan Bricklin's Demo Program - Prototype quickly, with realism. User feedback without programming. All 250 ASC characters plus attributes. Subsetting, building blocks, macros, thorough. PC \$ 75

C Language-Compilers

BDS C - solid value, fast CPM80 \$125
 C86 by CI - 8087, reliable MS \$299
 Consulair Mac C w/toolkit MAC \$299
 ECO C/88 MS \$ 60
 Lattice C - from Lifeboat MS \$289
 Lattice C - from Lattice MS \$339
 Mark Williams - w/ debugger MS \$399
 Megamax - tight full ATARI/ST \$179
 Microsoft C 3.0 - new MS \$259
 Q/C 88 by Code Works - Compiler source, decent code, cross/native MS \$125
 Wizard C - Lattice C compatible, full sys. III, lint, fast, MS \$379

C Language-Interpreters

C-terp by Gimpel - full K & R, .OBJ and ASM, large progs. MS \$249
 H.E.L.P. - innovate env. MS \$ 90
 INSTANT C - Source debug, Edit to Run-3 seconds MS \$399
 Interactive C by IMPACC Associates. Interpreter, editor, source, debug. PC \$225
 Introducing C - learn C fast, self paced tutorial PC \$109
 Professional Run/C - Run/C plus create add-in libraries, load/unload them. MS \$199
 Run/C - improved MS \$109

C Libraries-General

Application Programming Toolkit MS \$375
 Blaise C Tools 1 (\$109), C Tools 2 \$ 89
 C Food by Lattice-ask for source MS \$119
 C Power Windows by Entelekon \$119
 C Utilities by Essential - Comprehensive screen graphics, strings, Source. PC \$139
 Entelekon C Function Library PC \$119
 Entelekon Superfonts for C PC \$ 45
 Greenleaf Functions - portable, ASM \$139
 Polytron - for Lattice, ASM source \$ 85
 Software Horizons - Pack I PC \$129

C Libraries-Communications

Asynch by Blaise \$149
 Greenleaf - full, fast \$139
 Software Horizons - pack 3 \$119

C Libraries-Files

FILES: C Index by Trio - full B + Trec, vary length field, multi compiler
 /File is object only \$ 89
 /Pro is partial source \$179
 /Plus is full source \$349
 CTree \$349
 dbVISTA - full indexing, plus optional record types, pointers, Network.
 Object only - MS C, LAT, C86 \$179
 Source - Single user MS \$459
 Source - Multiuser MS \$929

Instant-C™ **The Fastest** **Interpreter for C**

Runs your programs 50 to 500 times faster than any other C language interpreter.

Any C interpreter can save you compile and link time when developing your programs. But only **Instant-C** saves your time by running your program at compiled-code speed.

Fastest Development. A program that runs in one second when compiled with an optimizing compiler runs in two or three seconds with **Instant-C**. Other interpreters will run the same program in two minutes. Or even ten minutes. Don't trade slow compiling and linking for slow testing and debugging. **Only Instant-C will let you edit, test, and debug at the fastest possible speeds.**

Fastest Testing. **Instant-C** immediately executes any C expression, statement, or function call, and display the results. Learn C, or test your programs faster than ever before.

Fastest Debugging. **Instant-C** gives you the best source-level debugger for C. Single-step by source statement, or set any number of conditional breakpoints throughout your program. Errors always show the source statements involved. Once you find the problem, test the correction in seconds.

Fastest Programming. **Instant-C** can directly generate executable files, supports full K & R standard C, comes with complete library source, and works under PC-DOS, MS-DOS, or CP/M-86. **Instant-C gives you working, well-tested programs faster than any other programming tool.** Satisfaction guaranteed, or your money back in first 31 days. **Instant-C** is \$495.

Rational **Systems, Inc.**

P.O. Box 480
Natick, MA 01760
(617) 653-6194

CHAOS MANOR

*It can't be long
before CD-ROM
technology changes
the way we look at
and use information.*

power of the AT's 80286 chip.

It can't happen too soon for me. Eventually, I suppose, the 80386 will become the "new standard," but that's going to take a while. Maybe not as long as I thought: developers are reporting that the first batch of 386s are excellent. Meanwhile, the 286 has its day.

THE INFORMATION REVOLUTION

We've seen it coming for a long time, but now the CD-ROM is here. CD-ROM is the name agreed on for using compact disks as read-only storage for computer information. The CD-ROM disk drive is about the size and price of a good floppy-disk drive. Each CD-ROM disk can hold hundreds of megabytes of information: programs, data, text files, music and speech, animation and motion pictures—all can be put onto the disk and accessed.

Phillips has CD-ROM drives for sale, and there are already a number of commercially available CD-ROM disks, along with software to access the data. Activenture, Gary Kildall's new company, has Grolier's *Academic American Encyclopedia* with a really neat indexing system; in a few seconds to tens of seconds, you can search through the whole encyclopedia. It took less than a minute to find all the references to science fiction (about a dozen) and all references to science fiction with the name Pournelle in the same article (alas, none).

The Phillips people tell me there are about 40 databases on CD-ROMs. These include back issues of newspapers, stock-market histories, all kinds of financial data, technical manuals, math handbooks, you name

it. Many haven't been announced yet, but Phillips is aware of them. Meanwhile, software to access these databases is either in preparation or, like Kildall's, already available.

CD-ROM disks can be manufactured for about \$5 each in quantity and contain all the text information in the *Encyclopaedia Britannica*. A single CD-ROM disk can contain more text than the best industrial-quality line printer will print over its useful lifetime. A set of 20 of those disks would make an encyclopedia like nothing that ever existed: illustrations could include motion pictures and stereo. The article on space could include shots of *Apollo 11* taking off, and so forth.

It can't be long before this technology changes the way we look at and use information. Couple a CD-ROM disk drive to an Atari, and you have the potential for a powerful educational system: the greatest teachers and lecturers in the world complete with every demonstration tool they ever wanted. Want to explain the solar system? You can be a talking head for a while, then switch to color animated models, first of the planets in their orbits, with speedup at perigee and slowdown at apogee; color bars to show that the planets sweep out equal areas in equal times; and actual *Voyager* photographs of the planets themselves. Moreover, a section on integral calculus could use the planetary orbital animation to illustrate just what an integral is.

Now, true, the educational lobby will try its best to hang on to "credentialism" and will continue to insist that no fundamental changes be made in our present educational system. But no matter how hard educators drag their feet, this new technology can't be stopped. Not only the Library of the Month Club but the College Course of the Month Club have just become realities.

CD-ROMs will change the whole nature of scholarship. Even after all these years, only a handful of scholars have had access to the original text of the Dead Sea Scrolls; now, everything known about them, including

(continued)

Frustration Insurance

Computer Books from Osborne/McGraw-Hill.

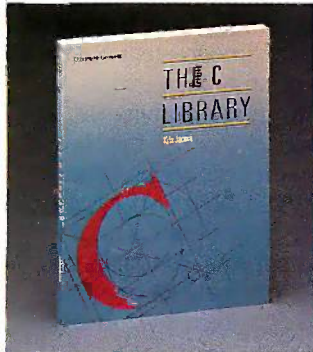

• **The C Library**
 Jamsa
 \$18.95 Order #881110-4
 Experienced C programmers will find over 125 routines ranging from macros to actual UNIX™ utilities. There are tools for string manipulation, pointers, input/output, array manipulation, recursion and more!

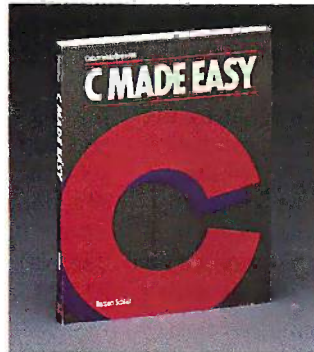

• **C Made Easy**
 Schildt
 \$18.95 Order #881178-3
 Learn C programming in no time at all with this easy-to-use tutorial which introduces general concepts, functions, libraries, disk input/output and a wide range of other facts about the C programming environment and UNIX operating system.

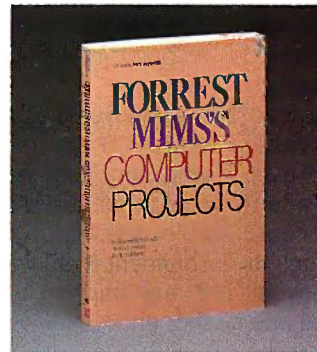

• **Forrest Mims's Computer Projects**
 Mims
 \$14.95 Order #881193-7
 Forrest Mims III, noted author, has amassed a collection of computer projects which include computerized security alarms, psychological testing, experimenting with computer art and how to use your computer as a storage oscilloscope.

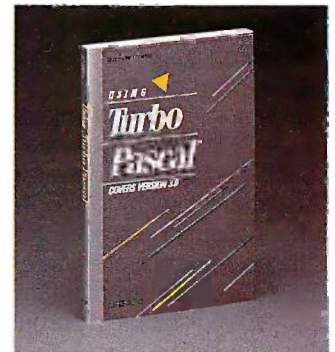

• **Using Turbo Pascal™**
 Wood
 \$19.95 Order #881148-1
 Maximize your advanced programming skills with this thorough volume which covers Turbo Pascal, including version 3.0 for the experienced programmer.

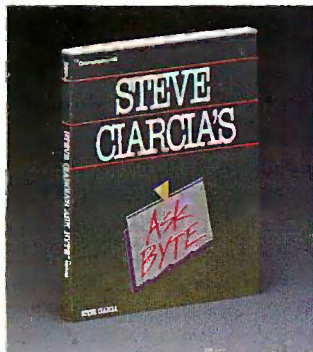

• **Steve Ciarcia's ASK BYTE**
 Ciarcia
 \$14.95 Order #881200-3
 Steve Ciarcia provides insightful solutions to your exasperating hardware and software problems including how to troubleshoot difficulties that affect your peripherals, accessories, and operating systems

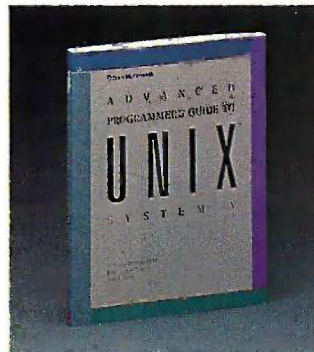

• **Advanced Programmer's Guide to UNIX™ System V**
 Thomas, Rogers, and Yates
 \$21.95 Order #881211-9
 C programmers who already know UNIX fundamentals can use this guide to write more effective programs with the software tools in UNIX System V.

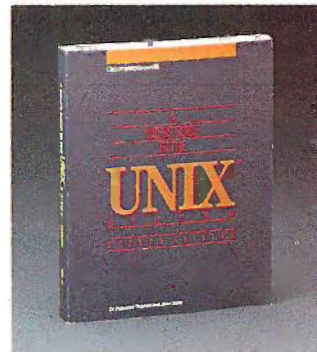

• **A User Guide to the UNIX™ System (2nd Edition)**
 Thomas and Yates
 \$18.95 Order # 881109-0
 Now the best-selling **User Guide to the UNIX™ System** has been revised and expanded to cover applications of the UNIX operating system for Bell Laboratories New System V and Berkeley UNIX.

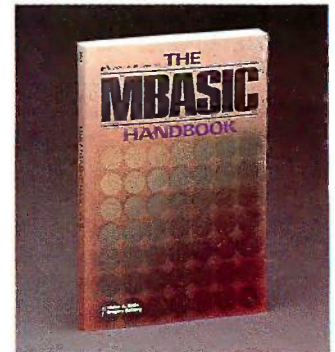

• **The MBASIC Handbook**
 Ettlín
 \$18.95 Order #881102-3
 Gain a better understanding of programming while you learn to develop and customize programs with this fundamental guide to Microsoft® BASIC.

Osborne/McGraw-Hill books are available at bookstores and computer stores everywhere. To order any of these titles by mail, complete the coupon and mail to McGraw-Hill, P. O. Box 400, Hightstown, NJ 08520. All orders must be prepaid. Checks, money orders, VISA and MasterCard are acceptable for payment. No postage or handling charges are required, but please include appropriate tax if applicable in your shipping area. All books will be shipped via UPS. Allow 4-6 weeks for delivery. Books will not be delivered to post office boxes. This offer is valid only in the Continental United States and is subject to change without notice.

NAME _____		
ADDRESS _____		
CITY _____		
STATE _____	ZIP _____	
INDICATE METHOD OF PAYMENT <input type="checkbox"/> CHECK/MONEY ORDER		
<input type="checkbox"/> VISA/EXP. DATE _____	<input type="checkbox"/> MASTERCARD/EXP. DATE _____	
CARD # _____		
SIGNATURE _____		
QTY _____	ORDER # _____	PRICE _____
SUBTOTAL _____		
TAX _____		
TOTAL _____		



Osborne McGraw-Hill

Inquiry 248

video copies of not only the scrolls themselves but every word of commentary ever written about them, can be put onto a single CD-ROM disk and still have room for everything known about, say, the archaeology of Jericho. CD-ROMs don't become profitable until you can sell thousands of copies; but there's so much room on them that you can keep adding topics until the customer pool is large enough. It costs no more to manufacture a full CD-ROM disk than a partially full one. It shouldn't be long before even the smallest university can give its scholars access to primary sources previously available only in a few places.

As I was writing this, Dr. Paul Bohanan, dean of social sciences at USC, came over. It took him about 30 seconds to imagine new uses for CD-ROMs. Ethnographic data on cultures takes up enormous space. Much of it

is irreplaceable, but it is also too expensive to be published in journals. The new computer memory-storage technology will change all that, and soon.

A few years ago, I said that by the year 2000, anyone in a Western nation who seriously wanted to would be able to get the answer to any answerable question. I'm now more than confident that I was right—except that it may happen much sooner than I thought.

FASTER THAN LIGHT

The best software item I discovered at COMDEX wasn't in a booth. Barry Workman had his Australian friend, Dave Moore, in tow. Both were eager to tell me about Moore's new Modula-2 compiler.

When we got back to Los Angeles, I understood why. They're calling it FTL Modula-2, and it's to every other

Z80 Modula-2 what Turbo Pascal is to every other Pascal. FTL Modula-2 is *fast*; compiles to tight, fast-running code; and has an integral text editor. There are installation procedures for putting it onto every terminal Dave and Barry could get hold of; they even set it up to run on Zeke with his memory-mapped VDM board. They also have it running on the big CompuPro 286/Z80, and I am amazed to find that FTL Modula-2 on the Z80 compiles about as fast as Logitech Modula-2 on the 286.

FTL Modula-2 is reasonably priced; is not copy-protected; has a simple and sane licensing agreement; comes with good, clearly written, well-indexed documentation; and works. It wouldn't hurt to have a couple of other books, but you certainly can begin to write Modula-2 programs with nothing but the compiler and its documents; there are all kinds of source-code examples included.

FTL Modula-2 should do for the Modula-2 language what Turbo Pascal did for Pascal. If you have a Z80 machine and you're at all interested in languages, get FTL Modula-2. You won't regret it. Meanwhile, Dave Moore went back to Australia to write code generators to get FTL Modula-2 running on 68000, 8088, and 80286 machines. Watch for new developments.

TURBO!

Borland's Philippe Kahn has done it again. The new Turbo Editor Toolbox is the Turbo Pascal source code to just about anything you ever wanted a PCompatible text editor to do, along with a really excellent book of instructions on what text editors are and how to use the Toolbox to build a custom text editor.

This is the best deal for hackers since Turbo Pascal (which you must have to make the Turbo Editor Toolbox useful). If you're tired of text editors that don't do what you want; if you want features you can't get in a commercial editor; if you're at all curious about text editors, pull-down commands, and the like; you can't af-

(continued)

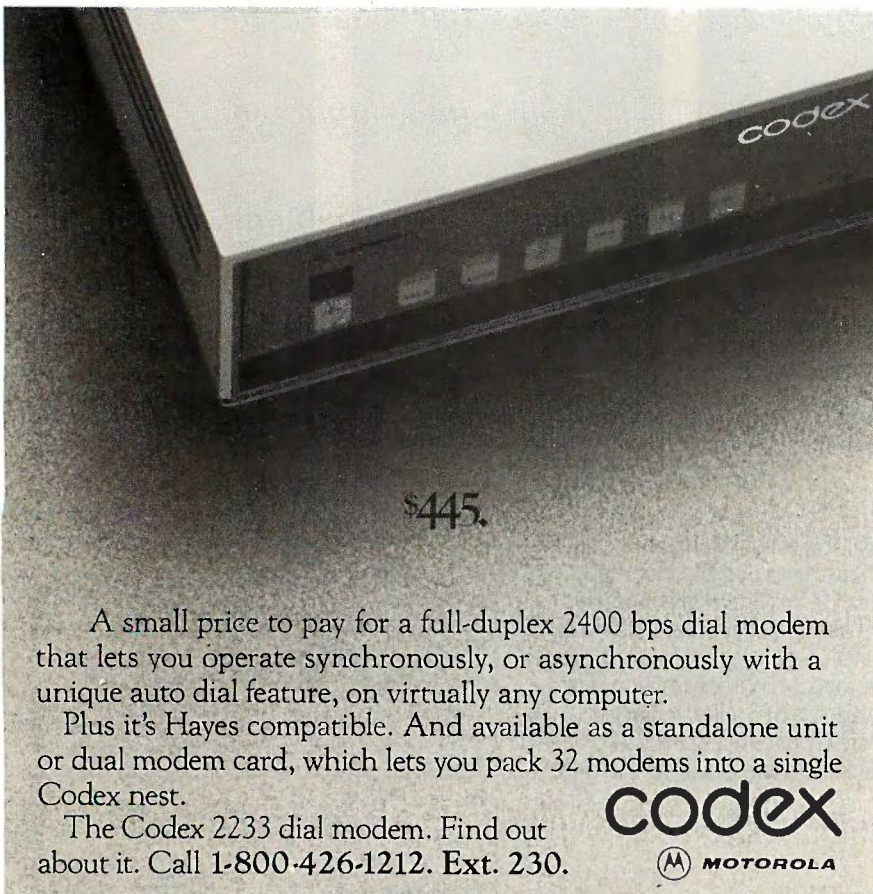

\$445.

A small price to pay for a full-duplex 2400 bps dial modem that lets you operate synchronously, or asynchronously with a unique auto dial feature, on virtually any computer.

Plus it's Hayes compatible. And available as a standalone unit or dual modem card, which lets you pack 32 modems into a single Codex nest.

The Codex 2233 dial modem. Find out about it. Call 1-800-426-1212. Ext. 230.

codex
MOTOROLA

Motorola and are trademarks of Motorola, Inc. Codex is a registered trademark of Codex Corporation.

**ORDER
LINE
800-354-7330**

LOWEST PRICES

**NO SURCHARGE
ON BANK CARDS**

SILICON SPECIALTIES

HARDWARE

PRINTERS

Anodex All Models	Save
Brother All Models	Save
Cannon Laser Printer	\$2099
Citizen MSP-10	\$255
MSP-15 or MSP-20	\$349
MSP-20	\$319
MSP-25	\$485
Datsouth All Printer Models	Save
Diablo D-25	\$549
635	\$1079
Other Printer Models	Save
Epson All Printer Models	Save
Juki 6000	\$169
6100	\$349
6300	\$679
NEC 2010, 2015, 2050	\$629
3510, 3550 3515 3530	\$749
8810, 8830, 8850	\$1079
P2, P3	Save
ElI 360	\$399
ElI 370	\$389
Okidata All Printer Models	Save
Panasonic 1091	\$235
1092	\$309
1592	\$429
KXP3151	\$399
Star Micronics	Save
All Printer Models	Save
Silver Reed	Save
EXP400 Parallel	\$205
EXP500 Parallel or Serial	\$279
EXP550 Parallel or Serial	\$389
EXP800 Parallel or Serial	\$619

BOARDS

AST Advantage	\$39
Six Pack Plus	\$29
Hercules Color Card	\$14
Graphic Card	\$29
Intel	Save
Above Boards	Save
Paradise Modular Graphic 06-1	\$259
Five Pak	\$19
Quadram	Save
Quadlink	\$325
Tec Mar Graphics Master	\$445
Captain No Memory	\$155

COMPUTERS

Compaq All Models	Save
Zenith	Save
Z-158 All Models	Save
Z-138 All Models	Save
Z-148 All Models	Save
Z-171	Save
Z-200	Save

VIDEO TERMINALS

IBM 3161 & 3163 Series	Save
Qume QVT Green 101	\$299
QVT Amber 101	\$314
Wyse 30	\$299
50	\$419
75	\$559
Wyse 85	\$439
Wyse 350	\$859
Zenith Z-22	\$455
Z-29A	\$559
Z-49	Save

DISK DRIVES

Alpha Omega Turbo 10	\$529
Turbo 20	\$529
Turbo 30	\$729
lomega	Save
Bernaull Boxes for IBM	Save
Bernaull Boxes for Macintosh	Save
Paradise Macintosh Hard Disk	Save

MODEMS

AT&T	Save
4000 External	\$309
Anchor Automation	Save
Anchor Express	\$229
Mark XII	\$229
Hayes Smartmodem 300 Baud	Save
Smartmodem 1200 Baud	Save
Smartmodem 1200 B (IBM)	Save
Smartmodem 2400 Baud	Save
Micromodem II (Apple)	Save
Prometheus All Models	Save
US Robotics Courier 2400	\$389
Password 1200	\$180
Microlink 2400	\$389

KEYBOARDS

Keytronics 5151	\$159
-----------------	-------

DISKETTES

Maxell MD-2 Plastic Box (Qty 100)	\$125
MD-20 Plastic Box (Qty 100)	\$158
Sony MD/2 (Qty 100)	\$120

PLOTTERS

Enter Sweet-P600	\$749
Epson H-80	Save

SOFTWARE

IBM PC and 100% Compatibles

WORD PROCESSORS

Lightnina	\$49
Leading Edge Word Processor	\$49
Leading Edge W/P with Spell & Mail	\$99
Microsoft Word 2.01	\$229
Multimate 3.3	\$203
PFS:Write	\$77
Wordstar w/Tutor	\$162
Wordstar Pro Pack	\$233

Word Perfect (Ver.4.1)	\$199
Wordstar 2000	\$233
Wordstar 2000 Plus	\$280

GRAPHICS

Microsoft Buss Mouse	Save
w/PC Paintbrush 3.0	\$107
Microsoft Serial Mouse	\$120
Chartmaster	\$205
Turbo Graphix Tool Box	Save
Diagram Master	\$189
Energraphics	\$160
Energraphics w/Plotter Option	\$205
Microsoft Chart	\$170
PC Draw	\$199
PC Draw Light Pen	\$102
PC Paint w/ Mouse	\$122
PC Mouse w/ Dr. Halo II	\$104
PFS Graph	\$77
Printmaster	\$30
Signmaster	\$134

LANGUAGES

C Compiler (Microsoft)	\$229
Fortran Compiler (Microsoft)	\$203
Macro Assembler	\$87
Pascal Compiler (Microsoft)	\$174
Turbo Pascal 3.0	Save
Lattice C Compiler	\$242
Run C Interpreter	\$82
Quick Basic	\$58
Turbo Tool Box	Save

UTILITIES

Fastback	\$88
I DIR	\$47
Copy II PC	\$19
Norton Utilities 3.1	\$48
Sidekick	Save
Sidekick (Unprotected)	Save
Sideways	\$35
Superkey	Save
Printworks	Save
Sidekick - Superkey (Bundle)	Save

TRAINING

Flight Simulator	\$29
Typing Instructor	\$28
Typing Tutor III	\$28

MONEY MANAGEMENT

All Tax Packages	Save
Dollars & Sense w/Farcast	\$95
Tobias Managing Your Money	\$95
Gem Collection	\$109
Gem Desktop	\$27
Gem Draw	Save

PROJECT MANAGEMENT

Harvard Total Project Manager	\$262
Microsoft Project	\$229
Super Project	\$185
Timeline 2.0	\$225

COMMUNICATIONS

LompuServe Starter Kit	\$17
Crosstalk XVI	\$93
PFS Access	\$77
Remote	\$93

INTEGRATIVE SOFTWARE

Enable I.1	\$312
Framework II	Save
Smart Software System	Save
Symphony	Save

SPREADSHEETS

Lotus 1-2-3	Save
Mulligan	\$112
Spreadsheet Auditor 2.0	\$82

Supercalc 3 (Ver.2.1) . \$AVE

DATA BASE MANAGEMENT

Cornerstone	\$245
dBase II	Save
dBase III	Save
Nutshell	\$49
PFS:File	\$77
PFS:Report	\$68
Quickcode	\$139
QuickReport	\$139
Extended Report Writer	\$80
Think Tank	\$92
Clipper	\$345
Knowledgeman II	\$289
Knowledgeman Upgrade Kit	\$145
Powerbase	Save
(New Ver. Reb. 320K)	\$205
Reflex	Save

R:Base 5000. \$332

SILICON SPECIALTIES
2034 WEST SOUTHERN
MESA, ARIZONA 85202
602-969-0909

**TOSHIBA
PRINTERS
SPECIAL**

321 Parallel	SAVE
321 Serial	SAVE
341 Parallel	\$829
341 Serial & Parallel	\$879
351 Serial & Parallel	\$985

MONITORS

Amdex All Monitors	Save
NEC All Monitors	Save
Princeton Graphics	Save
Zenith All Models	Save

Inquiry 299 for MS DOS Products. Inquiry 300 for all others.

Prices reflect 3% to 5% cash discount. Product shipped in factory cartons with manufacturer's warranty. Please add \$10.00 per order for UPS shipping. Prices & availability subject to change without notice. Send cashier's check or money order... all other checks will delay shipping two weeks.



CVS534b

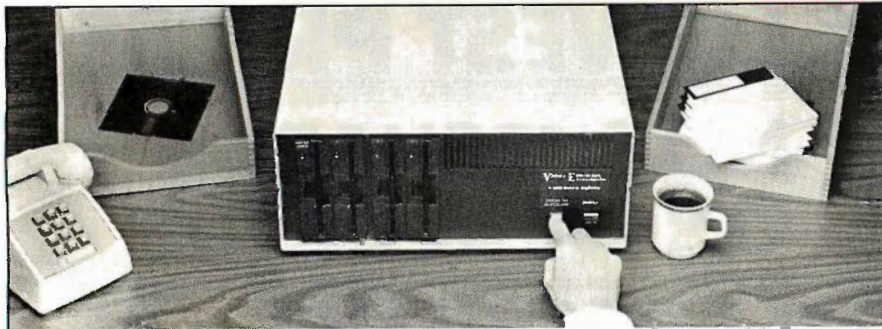

Copying diskettes will never be easier than pushing one button.

While your computer is busy doing other things, your Victory Duplicator can be making as many as eight copies of a diskette at once—producing up to 360 copies in an hour. DualMaster™ models can even make multiple copies of two different diskettes simultaneously. Just insert the diskettes and press one button.

Copy different formats, flawlessly.

An automatic format analysis program makes it possible for the Victory Duplicator to

copy virtually any 5¼, 3½ or 8-inch diskette. The system tests for quality and accuracy at every stage of the process.

It practically services itself.

Each drive has a separate controller to maximize up-time. Simple diagnostics to verify drive alignment and industry standard drives allow you to maintain your system without waiting for outside service.

All at an attractive price.

Victory Duplicators offer fast copying, serialization,

copy protection, a communications port, a four-month warranty and much more—all for one low price.

Call 1-800-421-0103.

Call today for more information. (In Texas, call 512-450-0801.)



VICTORY ENTERPRISES

Technology, Inc.

8910 Research Blvd., Suite B2
Austin, Texas 78758

©1986 Victory Enterprises Technology, Inc.

CHAOS MANOR

Borland International is a public benefactor.

The company continues to pour out good, well-

documented products at reasonable prices.

ford to be without this.

Do note that this is a product for programmers. I'm tempted to say advanced programmers, but that wouldn't be true. You do need to know Pascal in general and Turbo Pascal in particular, but, given interest and study, beginners can start with Turbo Pascal and the Turbo Tutor and work through the Turbo Editor Toolbox; at which point, they'll be advanced programmers.

Incidentally, Borland has a boxed set of Turbo tools that includes Turbo Pascal, Turbo Tutor, DataBase Toolbox, Editor Toolbox, Graphix Toolbox, and GameWorks. All together, this is the perfect present for the hacker in your life, and you don't need to wait until graduation.

The Turbo boxed set is useful for Modula-2 programmers, too. With Richard Gleaves's book *Modula-2 for Pascal Programmers* (Springer-Verlag, 1984), you can rather quickly translate much of the Borland source code into Logitech Modula-2 modules that run quite nicely on PCompatibles.

I've said this before, but I want to nail it down: Borland International is a public benefactor. The company continues to pour out good, well-documented products at reasonable prices. Philippe Kahn has proved that giving customers a better deal is not only fun, it's good business. I wish the rest of the industry would catch on.

Of course, Workman did catch on: the source code to the FTL Modula-2 compiler editor is included with FTL Modula-2, doing for CP/M what Turbo

(continued)

\$445.

A small price to pay for a full-duplex 2400 bps dial modem from the company preferred by more communications managers than any other.

The Codex 2233 dial modem. Find out about it. Call 1-800-426-1212. Ext. 230.

codex
M MOTOROLA

Motorola and M are trademarks of Motorola, Inc. Codex is a registered trademark of Codex Corporation.

You would think when IBM needs EPROM Programmiers they would choose the best and the most expensive. They don't. They only choose the best. GTEK.

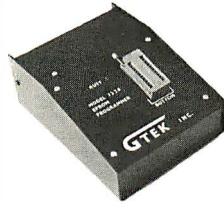

MODEL 7956 (w/RS-232 option) \$1099
 MODEL 7956 (stand alone) \$ 979

GTEK's outstanding Gang Programmer with intelligent algorithm can copy 8 EPROMS at a time! Use the 7956 in a production environment when you need to program a large number of chips. Programs all popular chips through the 27512 EPROMS; supports CMOS EPROMS through the 27C256; supports EEPROMS through the X2864A; supports Intel's 2764A & 27128A chips. The 7956 will also program single chip processors.

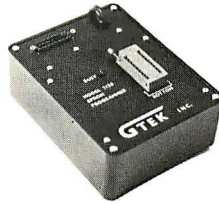
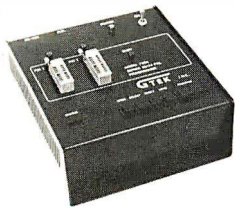

MODEL 7324 \$1499

The 7324 has a built-in compiler. It programs all MMI, National and TI 20 & 24 pin PALS. It has non-volatile memory and operates stand-alone or via RS-232.

MODEL 7322 \$1249

Same as Model 7324 but operates only via RS-232.

MODEL 7316 \$ 749

This PAL PROGRAMMER programs Series 20 PALs. It has a built-in PALASM compiler.

MODEL 705 \$ 299

68705V3, U3, P3 PROGRAMMER.

EPROM, PROM & PAL PROGRAMMERS

— These features are standard from GTEK —

Compatible with all RS-232 serial interface ports • Auto select baud rate • With or without hand-shaking • Bidirectional Xon/Xoff • CTS/DTR supported • Read pin compatible ROMS • No personality modules • Intel, Motorola, MCS86 Hex formats • Split facility for 16 bit data paths • Read program, formatted list commands • Interrupt driven—program and verify real time while sending data • Program single byte block or whole EPROM • Intelligent diagnostics discern bad and/or unerased EPROM • Verify erasure and compare commands • Busy light • Complete with Textool zero insertion force socket and integral 120 VAC power (240 VAC/50Hz available) •

UTILITY PACKAGES

GTEK's PGX Utility Packages will allow you to specify a range of addresses to send to the programmer, verify erasure and/or set the EPROM type. The PGX Utility Package includes GHX, a utility used to generate an Intel HEX file.

PALX Utility Package—for use with GTEK's Pal Programmiers—allows transfer of PALASM* source file or ASCII HEX object code file.

Both utility packages are available for CPM, MS-DOS, PC-DOS, ISIS* and TRSDOS* operating systems. Call for pricing.

CROSS ASSEMBLERS

These assemblers are available to handle the 8748, 8751, Z8, 6502, 68X and other microprocessors. They are available for CPM and MS-DOS computers. When ordering, please specify processor and computer types.

ACCESSORIES

Model 7128-L1, L2, L2A	Erasers	DE4 \$80; PE14T \$129
(OEM Quantity) \$259.		C25 \$349; C50 \$599
Model 7128-24	U/V Eraser DE-4	\$ 80.
Cross Assemblers CPM-80	Cables: Serial or Parallel	\$ 30.
MSDOS; CPM 86	8751 Adapter	\$174.
PGX Utilities	8755 Adapter	\$135.
PALX	48 Family Adapter	\$ 98.

RUN CPM SOFTWARE ON YOUR IBM OR IBM COMPATIBLE

If you are a CPM user who wanted to convert to MS-DOS or PC-DOS but didn't because you wouldn't abandon or rewrite your CPM programs, now you can convert without

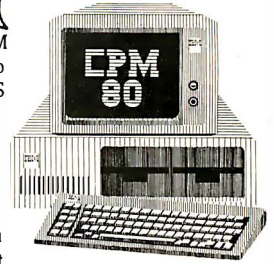

losing or rewriting a single CPM program!

GTEK's CPEmulator emulates Z-80 code and Televideo or Lear-Seigler terminals. The CPEmulator copies to and from 54 CPM disks and the serial port.

Now all the work you accomplished in CPM is still as valuable with your change to MS-DOS or PC-DOS. And you won't see any difference when you run your CPM programs on your IBM or IBM compatible!

GTEK's incredible CPEmulator is just \$199!

JUST RELEASED!!! Need more speed? With GTEK's SPEED KIT you can run your CPM programs much faster. The Speed Kit includes NEC V20 or V30 processors. With your CPEmulator, just \$99.00!

Call GTEK's CPM Hotline...

1-601-467-9019

NEW PRODUCT FROM GTEK! MODEL 8014 PROGRAMMABLE PARALLEL PRINTER SWITCH

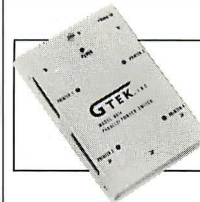

Finally, for everyone using multiple parallel printers, GTEK makes available a reliable and affordable programmable parallel printer switch. With it's programmable printer port, you can connect your IBM PC or other computer with a

single parallel port, to from one to four printers at one time.

Each port is selectable by sending GTEK's 8014 a simple escape sequence. The 8014's microprocessor allows Epson-type graphics codes to pass unchanged. By cascading 8014s, you can access as many printers as you need!

The 8014 will prove invaluable to you... use one computer to print invoices, serial number labels, disk labels, and plain paper... without changing the form each time. There are hundreds of applications for GTEK's 8014 Programmable Parallel Printer Switch.

And with the Model 8014-32k or 8014-128k, you can spool and switch your printer output.

Model 8014 (switch only) \$279.00; Model 8014-32k (32k buffer) \$339.00; Model 8014-128k (128k buffer) \$399.00.



Development Hardware/Software
 P.O. Box 289, Waveland, MS 39576
 601/467-8048; telex 315-814 (GTEK UD), INC.

GTEK, PALASM, CPM, MS-DOS, PC-DOS, ISIS, TRSDOS, & CPEmulator are registered trademarks.

Turbo Pascal Programmers:

Turbo-Task allows any Turbo Pascal Program to run in Foreground or Background

Turbo-Task will make your program resident in memory just like Sidekick, but with one big difference: your program can also operate in background! Turbo-Task is simple to use and complete in its operation. You only add two lines to your source code. Turbo-Task takes responsibility for all multitasking duties. You specify the invoke key that will bring the program to the foreground (it will pop up just like Sidekick) and you specify a time-slice weight the program will have when operating in background. A non-zero weight will allow the program to continue operation if the user moves it to the background. It will still have full access to disk and printer. When it completes its job, (i.e. processing data on disk and printing a report), it has the option to reset its weight to zero, thus remaining dormant until the user presses its invoke key and brings it to the foreground again. Meanwhile, the user has been running other software undisturbed by this background task. Up to 16 programs can use Turbo-Task at the same time, each with its own invoke key, independent foreground window, and time-slice weight. You do not need to understand multitasking theory to use Turbo-Task. All the work is done for you. Turbo-Task does not interfere with SIDEKICK. Works with TURBO EDITOR and GAMEWORKS.

Ram-Page provides a Virtual Screen of any Size

Ram-Page takes heap space to create up to 16 pages that can be used as virtual screens. The dimensions you select are only limited by system memory. 256k of heap could be allocated to a single Page with 80 chars by 1600 lines! All of Turbo's text handling routines will operate on the Pages. Write, Writeln, ClrScr, ClrEol, InsLine, DelLine, Window, and Gotoxy will be redirected to work on the Page you specify. View-Page allows you to display any portion of a Page on the screen. This "view window" is automatically updated as writes are made to the Page. These windows can appear, disappear, move, and overlap. Text written to a hidden window will be there when the overlapping window disappears. Text can be moved between pages. Foreground and background attributes are maintained separately for each Page. Ram-Page also provides two new routines: InsColumn and DelColumn.

Turbo-Linker breaks the 64k Code Segment Barrier

Turbo-Linker performs two important functions: it allows your program to grow beyond 64k, and it eliminates the need to continually recompile debugged routines. Turbo-Linker will convert a set of your procedures into a module that can be loaded into the heap at run time. These procedures will operate in the heap thus freeing space in the code segment for the main program. In effect, it is using the heap for overlays, except these "overlay" module can be shared by any number of programs. Once you create a module, you never have to recompile it. You can maintain a library of modules of your frequently used procedures. There is no limit on the number of modules that can be loaded or the number of routines in any module. A loaded module can be "disposed" and a new module loaded in its place. Handles global variables. Allows calls between modules.

All these utilities — ONLY \$70

Tangent Technologies

180 North Wacker Drive • Suite 350 • Chicago, IL 60606 • (312) 263-0024
MC/VISA Supports version 3.0 for PC-DOS and MS-DOS

Turbo Pascal, Turbo Editor, Gameworks and SideKick are trademarks of Borland Intl.

CHAOS MANOR

Microsoft's Excel

is easy to learn and sets new standards in business software.

Editor Toolbox does for IBM PC systems.

BEST OF 1985

Everyone else gives out Product of the Year awards, so I thought I'd do it too. The ground rule is that no matter how long it has been around, it's the year I started using it that counts.

As to how I choose them: it's purely subjective. Generally, my Products of the Year have to be useful to me in something I do; but I also look for products that look as if they'll greatly and beneficially influence the micro-computer revolution. I also tend to have lots of ties, rather than try to choose just one from a list of excellent products.

SOFTWARE

The business software of 1985 has to be Microsoft's Excel. The program is so darned nice that it overcomes much of my dislike of the Macintosh. Excel is easy to learn, but better, it's also easy to use. Best of all, you can easily get at Excel's powerful macro capability. Excel is what a spreadsheet ought to be and sets new standards in business software. Now if Microsoft will just get it onto machines with screens big enough to see...

In the word-processing category, there's a three-way tie and an honorable mention. Tied for best of 1985 are Symantec's Q&A, Borland's Turbo Lightning, and Living Videotext's Ready! idea processor. It's impossible to choose among these; they're all useful. Two are memory-resident. I suppose that one day the trend to memory-resident software will be halted by a really excellent multitasking operating system. Maybe this year?

(continued)

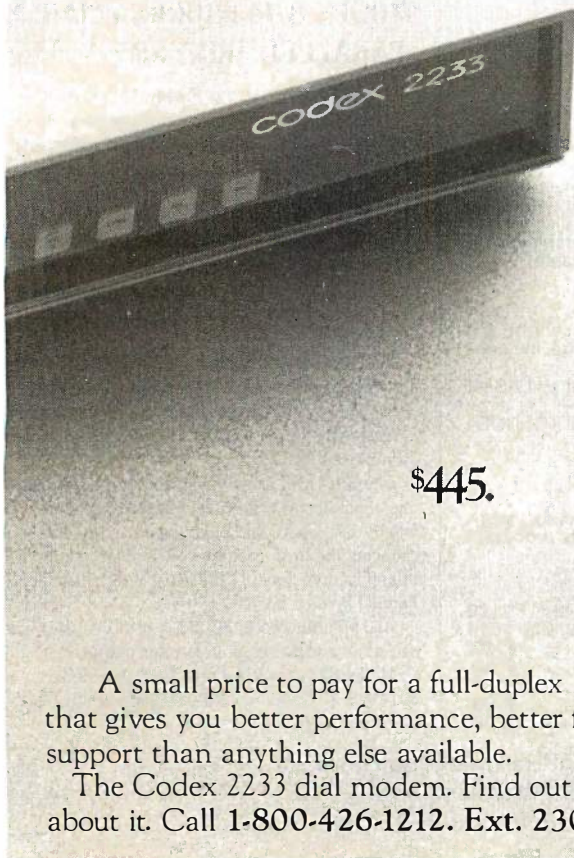

\$445.

A small price to pay for a full-duplex 2400 bps dial modem that gives you better performance, better features, and better support than anything else available.

The Codex 2233 dial modem. Find out about it. Call 1-800-426-1212. Ext. 230.



Motorola and © are trademarks of Motorola, Inc. Codex is a registered trademark of Codex Corporation.

“The C86 C Compiler is Great...

Computer Innovations' Support is Even GREATER”

DALE HILLMAN,
PRESIDENT, XOR CORPORATION
CREATOR OF “NFL CHALLENGE”



When Dale Hillman decided to create the most exciting football simulation game ever, he knew he needed good language support. The portability and maintainability of C made it a natural choice. **Which** C compiler to choose was another matter entirely.

“Of the many C compilers available, choosing the best one for the job was not easy. Comparing benchmarks, most compilers were strong in one or two categories, yet decidedly weak in others.

Computer Innovations' C86 was the exception. I found the C86 Compiler consistently strong in all categories.

“C86 had a reputation for being a solid, reliable, high-performance compiler. 8087 math support, source level debugging — it had it all. BEST of all was Computer Innovations' incredible technical support. Their highly knowledgeable support team was always available. Their assistance helped cut development

time substantially. And since NFL CHALLENGE took 12 1/2 man-years to create — every little bit helped. It was a service you just can't place a dollar value on...”

If you're working on the next great program, call Computer Innovations. We'll show you why you'll never have to look any further than C86.

**For Further Details
Call Toll-Free:
800-922-0169**

**Behind Innovative Programs —
Computer Innovations**

**COMPUTER
INNOVATIONS, INC.**

980 Shrewsbury Avenue,
Tinton Falls, NJ 07724 USA (201) 542-5920
EUROPEAN DISTRIBUTOR
Boston Micro, Inc., TELEX: 6712477 BMI USA

©1986 Computer Innovations, Inc.
* NFL Challenge is a trademark of NFL Properties

All three of these programs are evolving. As I write this, I have on my desk Wayne Holder's newest spelling checker and thesaurus program that mates with Symantec's Q&A, and I hear persistent rumors that Symantec is adding an outline-processor capability as well. Q&A has enormous promise. By integrating the text editor and database, Symantec has greatly

simplified life for new computer users. Symantec's chairman, Gordon Eubanks, has been in the microcomputer movement from the beginning and has a real feel for what we can and ought to do with micros. Of course, he's not alone: Living Videotext has Dave Winer, and Borland's Philippe Kahn has made his mark on this industry, too. Borland has already prom-

ised new database additions to Turbo Lightning.

The honorable mention is General Transformation Company's Beyond Compare, a file-comparison program. At \$30, it's hard to beat for value. A file comparator is something you don't need every day, but when you need one, you need a good one—and you need it bad. I've long had one for CP/M. Beyond Compare is for PC-DOS, and it's excellent.

My final software category is languages and programming tools. Once again, there's a tie: Borland's Turbo Editor Toolbox and Workman's FTL Modula-2 compiler. I should also mention Logitech's Modula-2 compiler for the PC; it wasn't new in 1985, but the dramatic drop in price made it very nearly a new product. Good Modula-2 compilers at reasonable prices will get more people interested in the language, and since Modula-2 is logical and easy to learn, that will get more people involved in programming, which will do great things for the micro field. In their classic work *The Elements of Programming Style*, Kernighan and Plauger say repeatedly that the best way to learn good programming habits is to study good code. Both FTL Modula-2 and the Turbo Editor Toolbox give the programmer well-tested and useful source code. That's a giant step in the right direction.

HARDWARE

There's no competition for most useful computer to arrive here in 1985: the Kaypro 286i PC AT clone has been in constant use. So far, we haven't found any PC programs it won't run. Certainly nothing else I've acquired this year has helped me as much. Rather than ignore the Atari 520ST and the Amiga, which are likely to have an enormous impact on this field, I've decided to rule them ineligible: after all, I've had them only a week.

As to accessories, there are so many! Symantec has a 256K-byte PC clock and memory board that's so cheap they practically give it away

(continued)

JERRY'S BEST OF 1985 AWARDS

Business Software:

EXCEL \$395
Microsoft
10700 Northup Way
POB 97200
Bellevue, WA 98009
(800) 426-9400

Word-Processing Software:

Q&A \$299
Symantec
10201 Torre Ave.
Cupertino, CA 95014
(408) 253-9600

READY! \$99.95
Living Videotext Inc.
2432 Charleston Rd.
Mountain View, CA 94043
(415) 964-6300

TURBO LIGHTNING \$99.95
Borland International
4585 Scotts Valley Dr.
Scotts Valley, CA 95066
(408) 438-8400

Honorable Mention:

BEYOND COMPARE \$30
General Transformation Company
POB 10083
Berkeley, CA 94709
(415) 644-0702

Languages and Programming Tools:

FTL MODULA-2 \$49.95
with source code \$79.95
Workman and Associates
112 Marion Ave.
Pasadena, CA 91106
(818) 796-4401

TURBO EDITOR TOOLBOX \$69.95
Borland International

Most Useful Computer:

KAYPRO 286i starts at \$2995
Kaypro Corporation
533 Stevens Ave.
Solana Beach, CA 92075
(619) 481-4300

Accessories:

TURNER-HALL CARD \$99.95
256K-byte memory board
with PC clock
Symantec

HARDCARD \$1095
Plus Development Corporation
1778 McCarthy Blvd.
Milpitas, CA 95035-9990
(408) 946-3700

OMNITEL 1200-BAUD INTERNAL
MODEM \$399
OmniTel
3090 Oakmead Village Dr.
Santa Clara, CA 95051
(408) 986-8236

Games:

ANCIENT ART OF WAR \$44.95
Brøderbund Software
17 Paul Dr.
San Rafael, CA 94903
(415) 479-1170

WIZARDRY I \$49.95
SirTech
POB 245
323 Washington St.
Ogdensburg, NY 13669
(315) 393-6633

Doors Open When You Know C

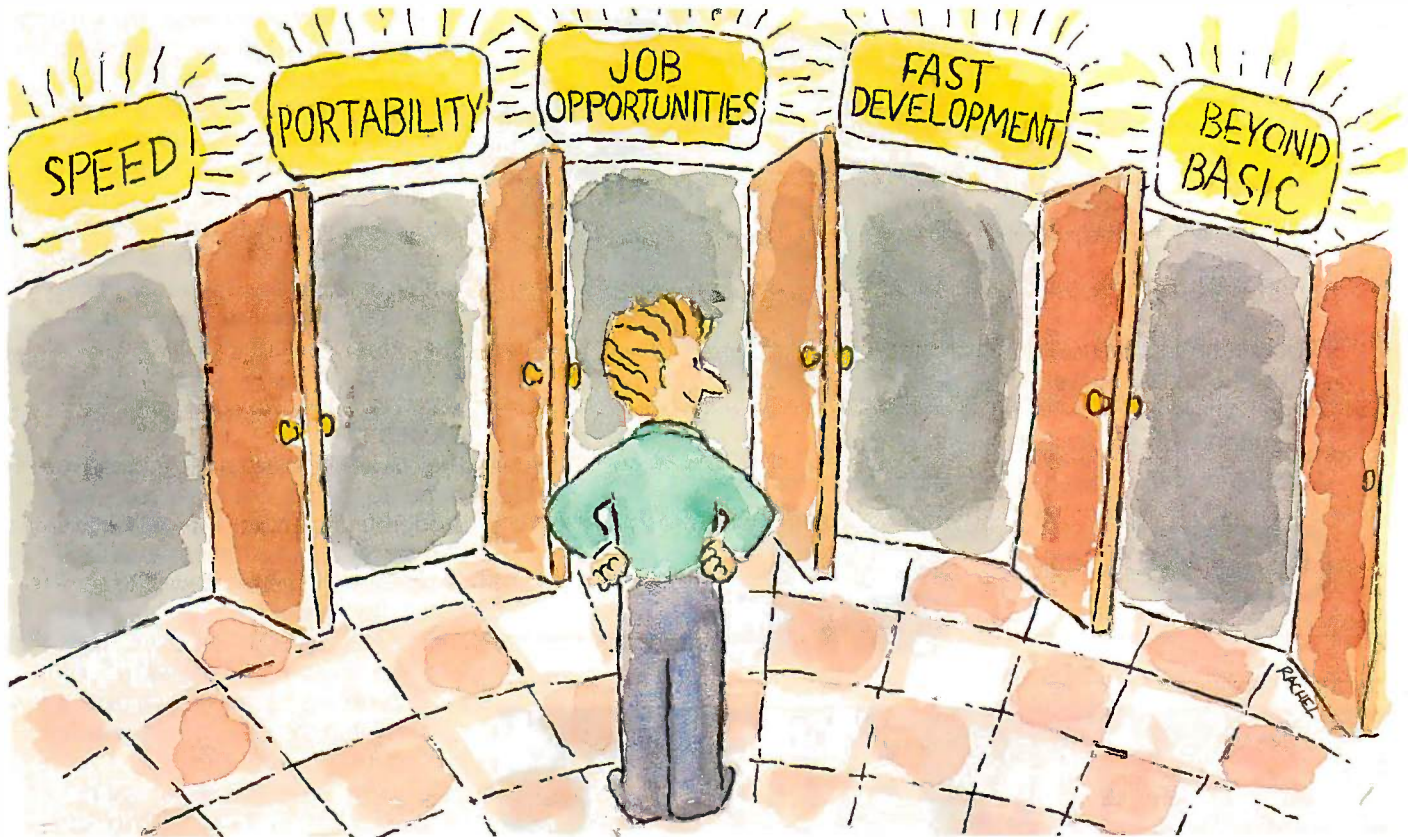

Unlock Them With *Introducing* C

The growth of the C language is nothing short of phenomenal. Over the past five years, it has emerged as the language of choice for most major PC applications. Why? Speed, portability, and compactness of code are a few of the reasons. But more important, its structured approach vastly reduces the time involved in ANY programming task. It's a big step beyond BASIC.

Now, Computer Innovations makes learning C fast and easy with *Introducing C*. A unique, interactive learning system, *Introducing C* combines a thorough, self-paced manual with a C INTERPRETER for fast results. *Introducing C* provides a solid background in standard C functions, operators, and data types including structures, unions, arrays, and pointers. Plus the

package includes a screen text editor, extensive error diagnostics, and sample programs.

"...one of the best C training systems I have seen..." INFOWORLD, 9/85

Introducing C is so effective, many corporations have made it their standard C training system. Make it your personal one!

Introducing C: The Key To Your Future

ONLY \$125 Not Copy Protected
CALL 800-922-0169

**COMPUTER
INNOVATIONS, INC.**

980 Shrewsbury Avenue, Tinton Falls, NJ 07724 (201) 542-5920

EUROPEAN DISTRIBUTOR
Boston Micro, Inc., TELEX: 671-2477 BMI USA

Prices And Specifications Are Subject To Change Without Notice.

©1986 COMPUTER INNOVATIONS, INC.

OUR PLUG-IN CARD GIVES YOU PLUG-IN CONTROL.

PC \leftrightarrow 488 allows your IBM PC/XT/AT or compatible to control IEEE-488 instruments.

With **PC \leftrightarrow 488**, you can:

- Plug-in to BASIC, C, FORTRAN, or Turbo Pascal™
- Emulate hp controllers,
- Use Tek Standard Codes and Formats,
- Run IBM's IEEE-488 software, and much more.

Just \$395 for the complete hardware and software interface.



Capital Equipment Corporation
10 Evergreen Avenue
Burlington, MA 01803
Call today (617) 273-1818

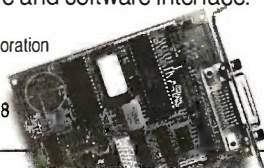

Turbo Pascal is a trademark of Borland International

CHAOS MANOR

with Q&A. Plus Development has Hardcard for the PC; open the machine, drop it in, and have a 10-mega-byte hard disk. I've been running my OmniTel Hayes-compatible 1200-baud internal modem in the Kaypro 286i, and, given my addiction to BIX, that modem is probably the equipment we use most here. Finally, there are two different boards that make the Zenith Z-100 about 98 percent PCompatible, making the Z-100 one of the most useful machines you can buy. I can't choose among all those, so I won't try. They're all great.

GAMES

The most intellectually impressive game to come out this year was Brøderbund's Ancient Art of War. I've still to win a game against a difficult opponent—the game allows the computer to simulate six different generals, ranging from Crazy Ivan, who has no sense of strategy at all, to Sun-tzu, who never makes a mistake—but the game is interesting enough that I keep trying.

However, for sheer time wasted, SirTech's Wizardry I wins hands down. I do not know what the fascination is, but the darned game keeps attracting me to one more expedition.

FOLLY OF THE YEAR

I had a lot of nominees for this one:

- IBM's new ROMs that make sure you're not running the AT too fast
- MacCharlie, a box that takes the marginally adequate Macintosh and tries to make a marginally adequate PC clone out of it
- IBM's media blitz to sell the PCjr after announcing its demise last spring

However, the winner stands out by a mile.

Some years ago, a summer-hire programmer embedded a warning message into Microsoft's shell. The message was supposed to appear when the program detected an attempt to copy one of Microsoft's copy-protected programs. It said, "The tree of evil bears bitter fruit. Now trashing program disk."

Brainy Buffer.

Do you press print and wait? And wait? And wait?

Your waiting is over with the Universal Data Buffer — it frees your computer in seconds while it handles the printing of your file.

And the Universal Data Buffer from HanZon is smarter than the average buffer. For one thing it has two inputs—one serial and one parallel, and two outputs—one serial and one parallel. Since all the ports are active, it means the Universal Data Buffer can interface between serial and parallel devices — even at different speeds and protocols. All that is a bonus to

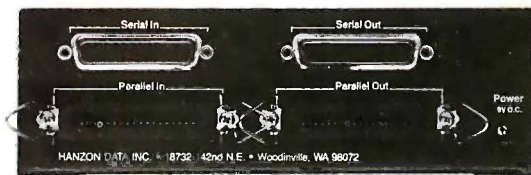

its standard function - as a 64K buffer expandable to 256K. The buffer also has operator controls for selecting additional copies, and pausing.



Call HanZon today for your nearest dealer:
(206) 487-1717.

Suggested Retail Price: \$385 - 64K Buffer
\$59 - 64K Expansion Module



HANZON DATA INC. • 18732 142nd Ave NE • Woodinville, WA 98072

Needless to say, there was no code that would actually harm the disk or do anything other than display that message, which eventually found its way into every copy-protected program Microsoft sells. Of course, it was inevitable: a user got a disk error while running a perfectly legitimate copy of a Microsoft program. The message appeared—and the user found garbage in his disk directory.

In Microsoft's favor, I have to say that once they knew, they scrubbed that message, and in fact they are now dropping copy protection entirely; but meanwhile, Folly of the Year goes to Microsoft, who didn't even know that silly message was in their products.

WINDING DOWN

As usual, I'm out of space long before getting to more than a fraction of the wonderful things people keep sending me. There seems to be absolutely no solution to the software-overload problem.

The book of the month is *The Mind's New Science: A History of the Cognitive Revolution* by Howard Gardner (Basic Books, 1985). I've become very much interested in the new cognitive sciences, which draw on the fields of philosophy, anthropology, mathematics, computer science, physiology,

ITEMS DISCUSSED

AMIGA starts at \$1295
Commodore Business Machines Inc.
1200 Wilson Dr.
West Chester, PA 19380
(215) 431-9100

ATARI 520ST starts at \$799
Atari Corp.
POB 61657
Sunnyvale, CA 94089
(408) 745-2000

MODULA-2/IBM PC \$89
Logitech Inc.
805 Veterans Blvd.
Redwood City, CA 94063
(415) 365-9852

and psychology. This book is an excellent summary of what's been done and gives some indications of where the field is going. Don't expect too much: a great deal of what's past has been clearing out the sterile deadwood of behaviorism.

Gardner isn't alone in concluding that the "science of mind" is ready for

its Galileo or Newton. My own view is that the task may be too big for any one scholar, and, as it happens, I have been working with a university dean, several professors, hackers, writers, students, and volunteers to use BIX to set up a new organization to integrate some of what's known and focus new research. In my judgment, the new communications tools and technologies are going to revolutionize the way we do science and will be at least as important in changing the world as the computer itself. More on this another time.

As I predicted, software for conferencing is beginning to pour in. I already have preliminary versions of programs that will call in, log on, capture my BIX mail and conference messages, log off, and then, while off line, sort and index them—all unattended. More are promised. It won't be long.

Aren't little computers wonderful? ■

Jerry Pournelle welcomes readers' comments and opinions. Send a self-addressed, stamped envelope to Jerry Pournelle, do BYTE Publications, POB 372, Hancock, NH 03449. Please put your address on the letter as well as on the envelope. Due to the high volume of letters, Jerry cannot guarantee a personal reply.

TURBO PASCAL PROGRAMMERS

TURBO PROFESSIONAL 2.0 is available now!!!

- Safe, resident programs
- Virtual windows
- Service interrupts (no assembly)
- DOS program execution
- Change file modes
- Directory searches
- Read & write disk sectors
- Access hidden files
- DOS memory allocation
- Read strings from screen
- Background printing (DOS3)
- Keyboard macro processor
- Many example programs
- Source code included
- Royalty free applications

Expertly crafted Pascal and Assembler, TURBO PROFESSIONAL will take your programs to new heights. Optimized for speed and minimum code size, these routines offer capabilities previously not available. Ever tried writing safe, resident applications which can actually use DOS? Will they work with Sidekick, DOS's PRINT, mouse software, and a RAM disk? They will if you write them with TURBO PROFESSIONAL. In fact, we believe that TURBO PROFESSIONAL offers the most advanced systems level routines available for any language. So, while the other guys are playing catchup, we're not playing at all.

\$69.95 + 5.00 Shipping and Handling, VISA and Mastercard welcome.

ORDER LINE
(206) 367-0650

Requires Turbo 2 or 3 for compatibles. DOS 2.0 - 3.1
Sidekick & Turbo Pascal trademark Borland Intl.

**Sunny Hill
Software**

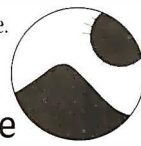

13732 Midvale North Suite 206
Seattle, Washington 98133

COMPUTER MAIL ORDER

THE CMO ADVANTAGE

- ✓ THE BEST PRICES!
- ✓ Next day shipping on all in stock items.
- ✓ Free easy access order inquiry.
- ✓ Orders from outside Pennsylvania save state sales tax.
- ✓ Free technical support with our factory trained technical staff.
- ✓ There is no limit and no deposit on C.O.D. orders.
- ✓ There's no extra charge for using your MasterCard or Visa. Your card is not charged until we ship.
- ✓ No waiting period for cashiers checks.
- ✓ We accept purchase orders from qualified corporations. Subject to approval.
- ✓ Educational discounts available to qualified institutions.
- ✓ FREE CATALOG MEMBERSHIP

ORDER LINE

CALL TOLL-FREE
1-800-233-8950

Educational Institutions
Call Toll-Free

1-800-221-4283
CUSTOMER SERVICE & TECH SUPPORT
1-717-327-1450
DEPT. A104

MAILING ADDRESS

Computer Mail Order
DEPT. A104
477 East Third Street
Williamsport, PA 17701



MEMBER DIRECT MARKETING ASSOCIATION

CREDIT CARDS



Inquiry 82



SHIPPING

Add 3%, minimum \$7.00 shipping and handling on all orders. Larger shipments may require additional charges.

All items subject to availability and price change.

Returned shipments may be subject to a restocking fee.

CANADIAN ORDERS

1-800-268-3974
Ontario/Quebec

1-800-268-4559
Other Provinces

1-416-828-0866
In Toronto

TELEX: 06-218960

2505 Dunwin Drive,
Mississauga, Ontario
Canada L5L1T1

All prices shown are for U.S.A. orders.
Call The Canadian Office for Canadian prices.

HOME COMPUTERS

APPLE

APPLE IIe.....	CALL
APPLE IIc.....	CALL
MacINTOSH.....	CALL
IIc LCD Display.....	CALL

ATARI

65XE (64K).....	CALL
130XE (128K).....	CALL
520ST (512K).....	CALL
800XL 64K.....	CALL
1010 Recorder.....	\$49.99
1050 Disk Drive.....	CALL
1020 Printer.....	\$29.99
1027 Letter Quality Printer.....	\$129.00
1030 Direct Connect Modem.....	\$59.99
Comrex 220 Atari.....	\$89.99

COMMODORE

C128 Computer.....	\$269.00
C1571 (Disk Drive for C128).....	\$249.00
C1902 (RGB 13" Monitor for C128).....	CALL
C1670 (Modem for C128).....	\$179.00
C64 Computer.....	CALL
C1541 Disk Drive.....	CALL
C1530 Datasette.....	\$39.99
C1802 Color Monitor.....	CALL
C1660 Auto Modem.....	\$59.99
DPS 1101 Daisy Printer.....	\$339.00
Comrex 220 (C64 Interface).....	\$89.99

GRAPHICS

■ Polaroid

Palette.....	\$1399.00
Power Processor.....	\$229.00
Illuminated Slide Mounter.....	\$39.99
Polacolor 2 Pack film.....	\$18.99

ACCESSORIES

CURTIS POWER STRIPS

Diamond SP-1.....	\$32.99
Emerald SP-2.....	\$39.99
Sapphire SPF-1.....	\$52.99
Ruby SPF-2.....	\$59.99
Safe Strip SP-3.....	\$19.99

KENSINGTON

MasterPiece.....	\$99.99
MasterPiece Plus.....	\$119.00

PORTABLE COMPUTERS



41CV.....	\$139.00
41CX.....	\$199.00
HP 11C.....	\$49.99
HP 12C.....	\$75.99
HP 15C.....	\$75.99
HP 16C.....	\$89.99
HPIL Module.....	\$98.99
HPIL Cassette or Printer.....	\$359.99
Card Reader.....	\$143.99
Extended Function Module.....	\$63.99
Time Module.....	\$63.99

We stock the full line of
HP calculator products

NEC

PC-8401 LS.....	CALL
PC-8201 Portable Computer.....	\$319.00
PC-8231 Disk Drive.....	\$599.00
PC-8221A Thermal Printers.....	\$149.00
PC-8281A Data Recorder.....	\$99.99
PC-8201-06 8K RAM.....	\$79.99

SHARP

PC-1350.....	\$149.00
PC-1261.....	\$149.00
PC-1500A.....	\$169.00
PC-1250A.....	\$89.99
CE-125 Printer/Cassette.....	\$129.00
CE-150 Color Printer Cassette.....	\$149.00
CE-161 16K RAM.....	\$129.00

SOFTWARE

ARTWORX

Bridger 4.0 (All).....	\$17.99
Strip Poker (All).....	\$19.99

ATARI

ROMS FOR ATARI ONLY

8036 Atari Writer.....	\$24.99
Star Raiders.....	\$4.99
Missile Command.....	\$4.99
Defender.....	\$4.99
Galaxian.....	\$4.99
Asteroids.....	\$4.99
Centipede.....	\$4.99

BRODERBUND

Print Shop (All).....	\$29.99
Graphics Library I, II, III (All).....	\$17.99
Bank Street Writer (64, AT).....	\$34.99
Bank Street Writer (IIe/IIc).....	\$44.99

BATTERIES INCLUDED

Paperclip (AT, 64/128).....	\$37.99
Paperclip (IIe/IIc).....	\$44.99
Homepack (64/AT).....	\$29.99
D.E.G.A.S. (All).....	\$27.99

CONTINENTAL SOFTWARE

Home Accountant (All).....	\$44.99
Tax Advantage (All).....	\$44.99
Home Acct./Tax Bundle (All).....	\$59.99

MICROPROSE

Kennedy Approach (All).....	\$24.99
Acrojet (All).....	\$24.99
Silent Service (All).....	\$24.99

PFS

File (64).....	\$39.99
File, Report, Graph (IIe/IIc).....	\$79.99
Write w/Proof (IIe/IIc).....	\$79.99

SPRINGBOARD

Newsroom (64).....	\$34.99
Clip Arts (64).....	\$22.99
Newsroom (Apple).....	\$39.99
Clip Arts (Apple).....	\$22.99

SUBLOGIC

Flight Simulator (All).....	\$37.99
Jet (64).....	\$37.99

MODEMS



Volksmodem.....	\$59.99
Volksmodem 300/1200.....	\$189.99
Signalman Express.....	\$259.00
Lightning 2400 Baud.....	\$399.00
Expressi.....	\$189.00
6470 (64/128) 300/1200 Baud.....	\$139.00

DIGITAL DEVICES

AT300 - 300 Baud (Atari).....	\$99.99
-------------------------------	---------



Smartmodem 300.....	\$139.00
Smartmodem 1200.....	\$389.00
Smartmodem 1200B.....	\$359.00
Smartmodem 2400.....	\$599.00
Micromodem IIe.....	\$149.00
Smart Com II.....	\$89.99
Chronograph.....	\$199.00
Transet 1000.....	\$309.00



Reach 1200 Baud Half Card.....	\$399.00
--------------------------------	----------



MPP-1064 AD/AA (C-64).....	\$69.99
----------------------------	---------



Smart Cat Plus.....	\$299.00
J-Cat.....	\$99.99
Novation 2400.....	\$549.00
Apple Cat II.....	\$229.00
212 Apple Cat II.....	\$379.00
Apple Cat 212 Upgrade.....	\$229.00
Macmodem.....	\$279.00



Quad modem II	
300/1200.....	\$339.00
300/1200/2400.....	\$499.00

EVEREX

1200 Baud Internal (IBM/PC).....	\$179.00
----------------------------------	----------

DISKETTES

maxell

3 1/2" SS/DD (10).....	\$18.99
3 1/2" DS/DD (10).....	\$29.99
5 1/4" MD-1 w/Hardcases (10).....	\$11.99
5 1/4" MD-2 w/Hardcases (10).....	\$16.99
5 1/4" MD-2-HD for AT (10).....	\$32.99
3 1/2" 5 pack SS/DD/Case.....	\$12.99



5 1/4" SS/DD.....	\$12.99
5 1/4" DS/DD.....	\$24.99
Disk Analyzer.....	\$24.99

Dennison

Elephant 5 1/4" SS/SD.....	\$13.99
Elephant 5 1/4" SS/DD.....	\$14.99
Elephant 5 1/4" DS/DD.....	\$16.99
Elephant Premium DS/DD(50).....	\$79.99
Elephant 3 1/2" SS/DD.....	\$29.99



5 1/4" DS/DD floppy disks	
(Box of 10).....	\$26.99

DISK HOLDERS

INNOVATIVE CONCEPTS

Flip'n File 10.....	\$2.99
Flip'n File 50.....	\$14.99
Flip'n File 50 w/lock.....	\$19.99
Flip'n File 100.....	\$19.99
Flip'n File Data Case.....	\$9.99

AMARAY

50 Disk Tub 5 1/4".....	\$9.99
30 Disk Tub 3 1/2".....	\$9.99

DRIVES

HARD

MEGA

A110H Single 10.....	CALL
A210H 10 + 10.....	CALL
A120H Surge 20.....	CALL
A220H 20 + 20.....	CALL
Save on 10 & 20 Carts.....	CALL



25, 35, 50, 80 meg (PC)	
.....from \$1299.00	

IRWIN

Tape Backup.....	CALL
------------------	------



60 Meg Internal Backup System	\$799.00
-------------------------------	----------

CORE

AT20-AT72MB.....	CALL
------------------	------

PRIAM

40, 60 MB (PC, XT, AT).....	CALL
KITS	
10 Meg with controller.....	\$379.00
20 Meg with controller.....	\$499.00



Atari GT.....	\$199.00
C-64 /128 GT.....	\$199.00



SD1 C-64 Single.....	\$219.00
SD2 C-64 Dual.....	\$469.00



320K 5 1/4" (PC).....	\$119.00
-----------------------	----------

TEAC

320K 5 1/4".....	\$119.00
------------------	----------

DEPT. A104

CALL TOLL-FREE

AMDEK

Video 300 Green.....	\$119.00
Video 300A Amber.....	\$129.00
Video 310A Amber TTL.....	\$159.00
Color 600 Hi-Res. RGB.....	\$399.00
Color 710 Ultra Hi-Res.....	\$439.00
Color 722 Dual Mode.....	\$529.00

MAGNAVOX

8562 RGB/Composite.....	\$279.00
-------------------------	----------

NEC

JB1205A.....	\$79.99
JB1270G/1275A..... (ea.)	\$99.99
JB1280G TTL.....	\$129.00
JB1285A TTL.....	\$129.00
JC1460 RGB.....	\$229.00
JC1225 Composite.....	\$179.00
JC1401 Multi Sync RGB.....	\$549.00

PRINCETON

MAX-12E Amber.....	\$179.00
HX-9 9" RGB.....	\$469.00
HX-9E Enhanced.....	\$519.00
HX-12 12" RGB.....	\$469.00
HX-12E Enhanced.....	\$559.00
SR-12 Hi-Res.....	\$599.00
SR-12P Professional.....	\$699.00

TAXAN

115 12" Green.....	\$119.00
116 12" Amber.....	\$129.00
121 TTL Green.....	\$139.00
122 TTL Amber.....	\$149.00
610 510x200 RGB.....	\$NEW
620 640x200 RGB.....	\$NEW
630 640x200 RGB.....	\$NEW
640 720x400 RGB.....	\$NEW



8400 Quadchrome I.....	\$499.00
8410 Quadchrome II.....	\$339.00
8420 Amberchrome.....	\$179.00
8500 Quad Screen.....	\$1449.00



ZVM 1220 Amber.....	\$99.99
ZVM 1230 Green.....	\$99.99
ZVM 1240 IBM Amber.....	\$149.00
ZVM 135 RGB.....	\$459.00
ZVM 1330 RGB.....	\$459.00
ZVM 1360 RGB.....	CALL
ZVM 1380 E G Comp.....	CALL

INTERFACES



Multi I/O (Apple II).....	\$149.00
---------------------------	----------



Graphcard.....	\$79.99
Serial Card.....	\$99.99
Microbuffer II +.....	\$169.00
Microbuffer 32K.....	\$189.00



Microfazer.....	from \$139.00
Efazer (Epson).....	from \$79.99



Grappler CD (C64).....	\$89.99
Grappler Plus (Ite, IIc).....	\$89.99
Grappler C (Ite).....	\$89.99
Grappler 16K (Ite, II+).....	\$149.00

DIGITAL DEVICES

Ape Face (Atari).....	\$4.99
U-Print A (Atari).....	\$54.99
U-A16/Buffer (Atari).....	\$74.99
U-Call Interface (Atari).....	\$39.99
U-Print C (C64).....	\$49.99
P-16 Print Buffer.....	\$74.99
U-Print 16 apple IIc.....	\$89.99

Canon

A40,A50,A55.....	CALL
LBP-8A1 Laser.....	CALL



MSP-10 (80 col.).....	\$279.00
MSP-15 (132 col.).....	\$389.00
MSP-20 (80 col.).....	\$349.00
MSP-25 (132 col.).....	\$509.00



Prowriter 7500.....	\$169.00
Prowriter 1550P.....	\$349.00
Starwriter 10-30.....	\$399.00
3500 Tri Printer.....	\$1499.00



Lazer LP-300.....	\$2799.00
-------------------	-----------



620 Daisywheel.....	\$299.00
D25 Daisywheel.....	\$549.00
635 Daisywheel.....	\$1099.00
D80IF Daisywheel.....	CALL



2000.....	\$699.00
-----------	----------



Homewriter 10, LX-80.....	CALL
FX-85, FX-286, RX-100, JX-80.....	CALL
DX-10, DX-20, DX-35.....	CALL
SQ-2000, Hi-80, HS-80, AP-80.....	CALL
LQ-800, LQ-1000, LQ-1500.....	CALL



6000 Letter Quality.....	CALL
6100 Letter Quality.....	CALL
6200 Letter Quality.....	CALL
3300 Letter Quality.....	CALL
5510 Dot Matrix.....	CALL



808 Dot Matrix 100 cps.....	\$179.00
1080 Dot Matrix 100 cps.....	\$259.00
1380 Dot Matrix 130 cps.....	\$289.00
1385 Dot Matrix 165 cps.....	\$339.00



3000 Series.....	\$779.00
8000 Series.....	\$1099.00
ELF 360.....	\$399.00
Pinwriter 560.....	\$999.00



182, 183, 192, 193, 2410, 84.....	CALL
Okimate 10 (Specify C64/Atari).....	\$189.00
Okimate 20 (IBM).....	CALL



KX1080.....	NEW
KX1091.....	\$259.00
KX1092.....	\$389.00
KX1592.....	\$469.00
KX1595.....	\$659.00



Quadjet.....	\$399.00
Quad Laser.....	CALL



500 Letter Quality.....	\$279.00
550 Letter Quality.....	\$419.00
800 Letter Quality.....	\$699.00

SG-10A (Atari).....	CALL
SG-10C (C64 Interface).....	CALL
SB/SB/SG/SR Series.....	CALL
Powertype Letter Quality.....	CALL

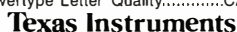

TI850.....	\$529.00
TI855.....	\$639.00
TI865.....	\$799.00



1340 (80 column).....	\$389.00
P341 (132 column).....	\$799.00
P351 (132 column).....	\$1049.00

ANSA SOFTWARE

Paradox.....	\$549.00
--------------	----------



Framework II.....	\$389.00
-------------------	----------

dBase III Plus.....	\$389.00
---------------------	----------



Lightening.....	\$59.99
-----------------	---------

Sidekick (unprotected).....	\$52.99
-----------------------------	---------

Reflex.....	\$59.99
-------------	---------

Newspack.....	\$59.99
---------------	---------



Copy II PC-Backup.....	\$29.99
------------------------	---------



Chartmaster.....	\$229.00
------------------	----------

Signmaster.....	\$169.00
-----------------	----------

Diagram Master.....	\$219.00
---------------------	----------



Fast Back.....	\$99.99
----------------	---------



Quickcode III.....	\$169.00
--------------------	----------



Sideways.....	\$44.99
---------------	---------



Total Project Manager.....	\$269.00
----------------------------	----------



Cornerstone.....	\$279.00
------------------	----------



Volkwriter III.....	\$159.00
---------------------	----------



Think Tank.....	\$109.00
-----------------	----------

Ready.....	\$64.99
------------	---------



Symphony.....	CALL
---------------	------

1-2-3.....	CALL
------------	------



Managing Your Money 2.0.....	\$99.99
------------------------------	---------

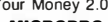

Easy.....	\$94.99
-----------	---------

WordStar 2000.....	\$239.00
--------------------	----------

WordStar 2000 +.....	\$289.00
----------------------	----------

WordStar Professional.....	\$189.00
----------------------------	----------



R:Base 4000.....	\$249.00
------------------	----------

R:Base 5000.....	\$389.00
------------------	----------

Clout 2.0.....	\$129.00
----------------	----------



Flight Simulator.....	\$34.99
-----------------------	---------

MultiPlan.....	\$129.00
----------------	----------

Word.....	\$249.00
-----------	----------

Mouse.....	\$139.00
------------	----------



Crosstalk XVI.....	\$89.99
--------------------	---------

Crosstalk Mark IV.....	\$149.00
------------------------	----------

Remote.....	\$89.99
-------------	---------



Multi Mate Word Proc.....	\$219.00
---------------------------	----------

Advantage.....	\$289.00
----------------	----------

On File.....	\$89.99
--------------	---------

Just Write.....	\$89.99
-----------------	---------



Intuit.....	\$69.99
-------------	---------



Norton Utilities 3.1.....	\$59.99
---------------------------	---------

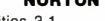

Golf's Best.....	\$37.99
------------------	---------



Proof.....	\$59.99
------------	---------

File/Graph..... (ea.)	\$79.99
-----------------------	---------

Report.....	\$74.99
-------------	---------

Write/Proof Combo.....	\$79.99
------------------------	---------

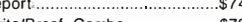

Write-N-Spell.....	\$89.99
--------------------	---------



Enable.....	\$329.00
-------------	----------



Word Perfect 4.1.....	\$219.00
-----------------------	----------



Accounting.....	CALL
-----------------	------

AP/AR/GL/INV/OE..... (ea.)	\$299.00
----------------------------	----------

SuperCalc III.....	\$199.00
--------------------	----------

EasyWriter II System.....	\$239.00
---------------------------	----------

Super Project.....	\$199.00
--------------------	----------



Open Access.....	\$379.00
------------------	----------



Jet.....	\$37.99
----------	---------

IBM PC SYSTEMS

Configured to your specifications.
Call for Best Price!

IBM-PC, IBM-XT, IBM-AT



PC-138 Series, PC-148 Series, PC-158 Series, PC-160 Series, PC-171 Series, AT-200 Series.....	CALL
---	------



MBC 550-2, MBC 555-2, MBC 675 Portable, MBC775, MBC 880 Desktop.....	CALL
--	------



Safari (7300).....	CALL
6300.....	CALL



PPC400 Dual Portable.....	\$1289.00
PPCXT 10 meg Portable.....	\$1989.00
PC40022 Dual Desktop.....	\$1389.00

PC400-HD2 10 meg.....	\$1989.00
-----------------------	-----------



ITT X-TRA 256K, 2 Drive System.....	CALL
256K,10 meg Hard Drive System CALL XP5, 20 meg.....	CALL



Sperry-AT.....	as low as \$1749.00
Sperry-IT.....	as low as \$2699.00
Call for Specific Configuration!	
All Models.....	CALL



KP-2000 Portable.....	CALL
Kaypro PC.....	CALL

MULTIFUNCTION CARDS



RamVantage.....	\$349.00
Rampage-PC.....	\$379.00
Rampage-AT.....	CALL
Six Pack Plus.....	\$229.00
I/O Plus II.....	\$139.00
Advantage-AT.....	\$399.00
Preview Mono.....	\$299.00
PC Net Cards.....	\$379.00
5251/11 On-line.....	\$669.00
5251/12 Remote.....	\$579.00



GAVILAN INFORMATION, ANYONE?

Dear Jerry,

I am one of the few purchasers of a Gavilan computer and have recently run into a hardware problem that requires attention. Unfortunately, most repairmen I have talked to indicate that it would be almost impossible to properly service the machine without a schematic or technical manual that could serve as a guide to the internal circuitry. Since Gavilan has filed for Chapter 11 and is in effect no longer in existence, I am unable to call them for help on this matter. Do you have an idea where I might find a set of schematics?

JESSE MARTINEZ
POB 11284
Reno, NV 89510

Alexander Woollcott is said to have answered a letter by writing, "My dear sir. Oh, my very dear sir. Sincerely. . . ." and I must admit I am tempted to do something similar here. I do know that David Ramsey of Corvus was somehow involved in the sales of some Gavilan machines after the company went west; but I think he never had the schematics either.

I expect, unless a BYTE reader can help, that you are doomed. You might also try BIX or another electronic communications system.

Owners of Otrona machines, incidentally, are not in a similar pickle. Spin and Pop (POB 6458, Denver, CO 80206) managed to get spare parts and schematics for the Otrona machines and can both service them and do the upgrades. Wishing you well.—Jerry

VALDOCS 2

Dear Jerry,

I'm a physicist and journalist who has dealt with computers since 1955. For several years, I have been giving non-technical seminars worldwide on how to choose and use computers. I was an early Valdocs booster. I read all you've had to say about it and usually agree but still had great hopes for it. A quick survey indicated that a majority of my seminar attendees who purchased computers bought Epson.

I am now giving Valdocs 2 heavy usage.

It has made great changes in my life, converting a calm, quiet technocrat into a raging, wild, frustrated maniac!

Why? When Valdocs 2 works, it provides the most efficient, free-flowing creative writing outlet I've ever experienced. It adds incentive to writing. But I have never yet completed an intense period of usage without a disastrous data loss!

I'm not alone. Earlier this evening, a well-known journalist spent two and a half hours crying on my shoulder via telephone for the exact same reason. The contrasting good and bad aspects are maddening. Writers with great seniority have quoted identical figures to me: While Valdocs works, they produce three times as much finished copy per unit of time as they did previously. But the psychological devastation of never knowing which story will be the next sacrifice on the altar of Valdocs is becoming too much for many of these writers. Typewriters, and even pencil and paper, are the writing instruments of their future.

MILTON MANN
Evanston, IL

So what can I say? I agree with every word; Valdocs when it's working is great, if you don't mind that it's a bit slow.

My best advice is to try WRITE for your Z80; WRITE was designed by people fanatic on not losing text.—Jerry

70108 MICROPROCESSOR

Dear Jerry,

I stumbled over an interesting development in microprocessors that I feel is the start of a significant trend.

The October 1985 issue of *Radio-Electronics* carried an ad by JDR Micro-devices. Among the specials was a \$20.95 microprocessor by NEC, designated the μ PD70108. What caught my eye was the statement that it was 8088 pin-compatible and used a superset of the 8088 instruction set. I ordered one and contacted the NEC technical representative for the user's guide. When both arrived, I found that I had more than I bargained for:

1. The 70108 is a high-speed CMOS device, drawing less than half the current of an HMOS 8088. It also has a standby mode that draws almost no current.

2. The 70108 has two internal data buses, which operate together to speed up some calculations. My normal AUTOEXEC.BAT file takes 34 seconds to load using an 8088 but only 32 seconds using a 70108 operating from the same 5-MHz crystal. And the 70108 will operate at 8 MHz.

3. In addition to being 8088 pin- and function-compatible, the 70108 has 8080 emulation-mode commands, which seems to mean that this chip will run 8-bit CP/M software as well as 16-bit (once someone figures out how to switch modes).

4. I don't know enough about assembly language to evaluate the additional instruction set, but it's there.

I installed the 70108 in place of the 8088 in my Heath H-100 three days ago and have found no reason to remove it. As far as I can tell, the 70108 can be installed anywhere a 5- or 8-MHz 8088 is used and will speed everything up by a few percentage points. I don't know about micros with 8087 math chips installed.

I consider this unusually significant for two reasons. First, it is a pin-compatible upgrade, which doesn't require the purchase of either a new microcomputer or board, and can be installed by anyone who can read static-electricity warnings and use a screwdriver. I expect that to become a trend. Second, this chip is of Japanese origin, and I expect that to be a trend as well.

If you decide to drop 70108s into your machines, I'd like to hear about it.

MICHAEL A. SCHULSINGER
Springfield, OH

We have indeed used 70108s in both IBM PCs and Zenith PClones, with results similar to yours. We got the chips at a Heath/Zenith User Group meeting, but there are a number of sources. I haven't myself made any use of the 8080 emulation mode, but I've seen user group articles about doing that. Mostly, though, the decreased power consumption and heat in the computer is itself worth the modest cost of the chip.

Some hackers are making use of the 70108's ability to run with faster crystals, but I haven't tried that yet.

I expect you're right about the trends.—Jerry ■

PRINTER SHARING AND PRINT BUFFERING ALL IN ONE VERSATILE UNIT

Print Master from BayTech is an intelligent printer controller that connects between your computers and printers. It allows you to share one printer automatically, contend for multiple printers automatically, or switch between several printers by sending a simple code. Plus, Print Master's built-in buffer spools data until your printer can receive it.

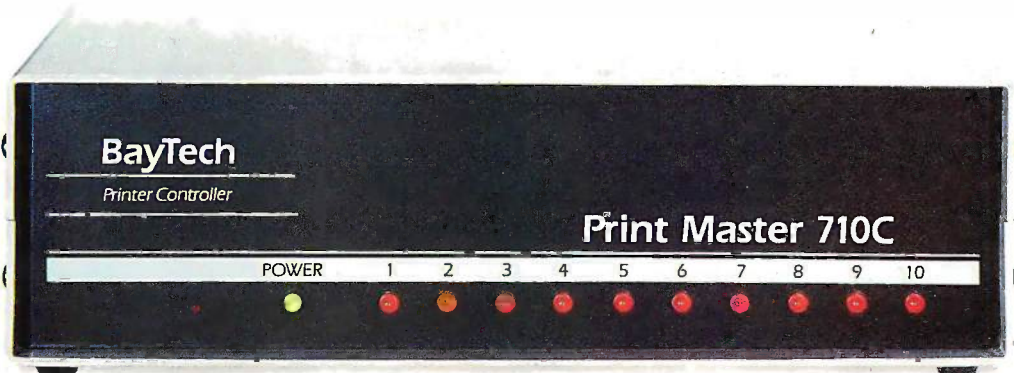

A VERY FLEXIBLE PRINTER SHARER

You configure Print Master's ports for any combination of printers and computers by answering questions from the easy-to-follow menus. For example, with the ten-port Print Master, nine computers can share one printer, eight computers can share two printers, seven computers can share three printers, and so on, to one computer which can share nine printers. You can also menu-select these features: the baud rate, word size, stop bits, parity, and XON/OFF handshaking; the disconnect time-out; and form feeds. Ports may be configured individually to translate for printers and computers using different configurations. All changes you make are saved in non-volatile memory.

PRINT MASTER'S BUFFER KEEPS YOU WORKING

Since Print Master can accept data faster than your printer, you can dump a print job into Print Master's 512K buffer and then go on to another project. All connected users can send data to this common pool buffer, and they can be doing it at the same time, even if no printer is available. Data is stored in the buffer until it can be sent on a first-in-first-out basis to

the selected printer. If you need more memory, Print Master is optionally available with one megabyte buffer.

CONTROL PRINT OUTPUT FROM YOUR COMPUTER

If several users are sharing one printer, printer sharing is completely automatic. There are no codes to send. You simply perform your normal print operation. If you are sharing several identical printers, connection is also

automatic. Again, you perform your normal print operation and are connected to the next available printer on a first-come-first-serve basis. Print Master will send data to all printers simultaneously to keep your printers running at full capacity.

If you are sharing several different printers, such as a letter printer, a laser-jet and a plotter, you do your normal print routine but insert a short printer select code (which you can define yourself) as the first characters of your data. The data is then routed to the selected printer. It's that easy.

CHOOSE SERIAL OR PARALLEL MODELS

Print Master comes in six, eight and ten port models that feature serial, parallel, or combination serial/parallel ports. And BayTech provides technical support and service on all models if you ever have a problem.

Want more details? Call or write BayTech at P.O. Box 387, Bay Saint Louis, MS 39520. Telex 910-333-1618. Phone 601-467-8231 or

800-523-2702

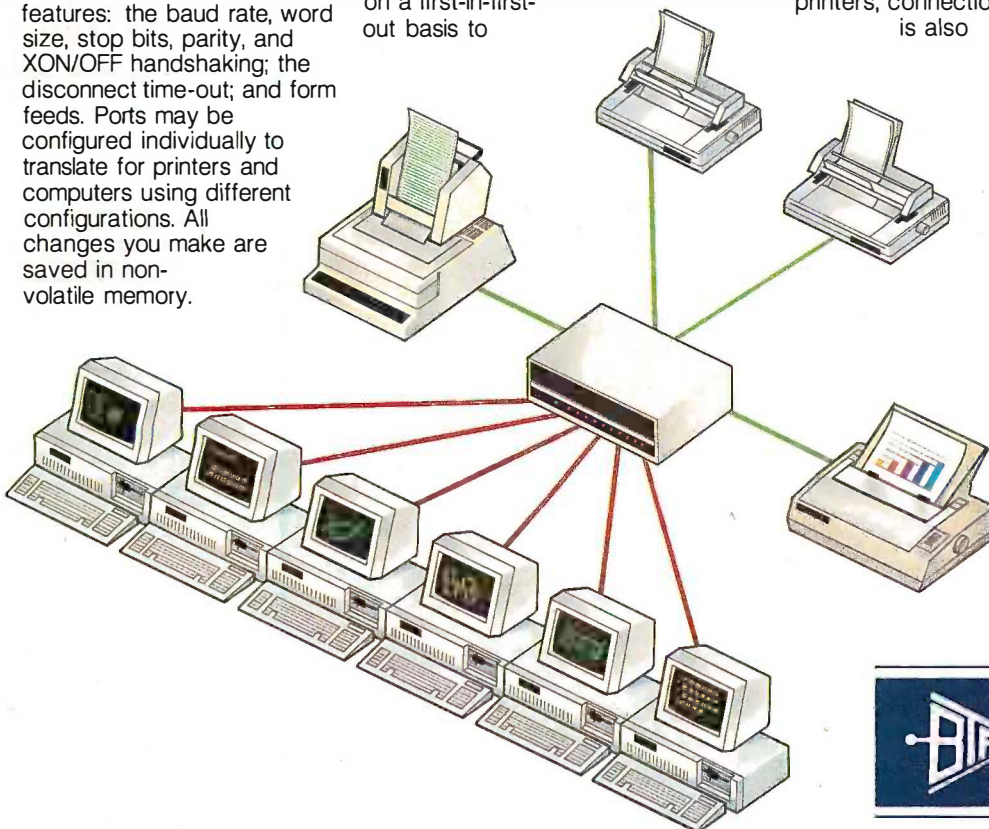



FILE RECOVERY SYSTEM™

FOR THE IBM-PC

*“Brown Bag Software’s™ File Recovery System™...
more powerful than the Norton Utility Version 3.1.”
—PC Magazine*

We May Be Able To Save Your Job Or Your Life

\$69.95

**Recover Erased Files
Edit Any Spot On A Disk
Change File Attributes**

**Fix A Damaged File
Menu-Driven and “Goof-Proof”
Context Sensitive Help**

**Recover Data From Physically Damaged Disks
Works On Hard And Floppy Disks**

YES YOU CAN RECOVER ERASED FILES. Even *.*. With Brown Bag Software’s™ File Recovery System™ for the IBM-PC and compatibles, no programming experience required. If you can erase a file, you can restore it.

MENU-DRIVEN and “FOOL-PROOF.” Do you have “one-of-those” in your office...we do too! That’s precisely why we developed Brown Bag Software’s™ File Recovery System™ for the IBM-PC and compatibles! Our menu-driven system is a snap.

FIX A DAMAGED FILE TOO! Sometimes files can get “glitched,” by a power spike, bumping into the hard disk, dropping the computer on the floor, etc. We understand. That’s why we’ve included a full screen editor to repair any spot in any file, hidden or otherwise.

IS IT HARD OR FLOPPY? We don’t care. We work with floppy disk, most hard disks, and most IBM-PC compatible computers.

HELP IS ONLINE TOO! We know that most people don’t read manuals. (But we include a comprehensive one anyway.) And when you erase a file and need it recovered NOW, you’re not in any frame of mind to pour through any manual. We understand. That’s why we’ve put hand-holding online. Just hit the ? key and the help appropriate to where you are and what you want to do is immediately available. The only thing better would be two aspirins!

OTHER HANDY TOOLS...HELP: WHERE’D THE FILE GO? We provide menu-driven tools to change a file’s attributes, change disk labels, modify screen color, locate a lost file that you know is somewhere on the disk, but it’s lost in a maze of sub-directories (you forgot which).

**WITH YOUR CREDIT CARD, CALL NOW
24 HOURS A DAY, 7 DAYS A WEEK**

800-523-0764

IF LINE IS BUSY OR YOU LIVE IN CALIFORNIA

CALL: 408-559-4545

Xenophilia

The high-
performance,
inexpensive
XEN uses
Microsoft
Windows and
SoftClone

BY DICK POUNTAIN

Apricot Ltd. is the U.K.'s largest indigenous manufacturer of business microcomputers. The Apricot story has been one of almost unblemished success since the design and manufacture of the first 8086-based Apricot computer in 1982.

Flying in the face of conventional wisdom, Apricot achieved a respectable share of the European market with a range of 16-bit machines that are IBM PC-compatible at the lowest possible level; they provide minimal generic MS-DOS support. That means they are scarcely compatible at all. Apricot's success—and consequent corporate wealth—has enabled it to pay some leading U.S. software companies to port their top-selling programs onto its machines. Hence, Apricot users can now run Lotus 1-2-3 and Symphony, albeit a couple of years later than IBM users. (You can contact the company at Apricot Ltd., Shenstone House, Dudley Rd., Halesowen, West Midlands B63 3NT in the U.K. and at Apricot Inc., 47173 Benicia St., Fremont, CA 94538 in the U.S.)

During the grim trade recession of 1985, it seemed at first as if Apricot was immune to the prevailing commercial distress. In the last quarter, however, Apricot suddenly announced a trading loss for the first time, due to poor sales of its portable computer and of its low-end (under £1000) machines with which the company had hoped to gain entry into the educational market. Announcing a change of tack back toward the high end of the business market, Apricot recently unveiled its answer to the IBM PC AT—the XEN (see photo 1).

In common with earlier Apricot machines, the XEN offers more performance than the PC AT does for substantially less money. A basic twin-floppy machine costs £2095 and a 20-megabyte Winchester machine costs £3095, to which you need to add at least £395 for a monitor (more for the fancier options). It is also one of the first machines to be shipped with Microsoft Windows as its standard operating environment. In ad-

dition, Apricot has announced that it will support Digital Research's GEM and XENIX for up to 16 users on the XEN, but not until later in 1986.

However, to the great surprise of the U.K. computer press, the XEN is still not architecturally compatible with the PC AT, despite its using the same 80286 processor. Most people had expected that in today's harsher market, Apricot would have symbolically "bent the knee" and modified the machine to run standard IBM programs, but it has not.

THE HARDWARE

Apricot has always been very strong on industrial design, and the XEN is without doubt the finest-looking machine to come out of the Birmingham laboratories. It has an angular "high-tech" look reminiscent of expensive artificial intelligence workstations. This impression is reinforced when the optional *paper-white* phosphor high-resolution monitor is used to give a display quality not far from that of a Sun or Apollo workstation. Despite its large memory and mass-storage configurations, the XEN has a much smaller footprint than an IBM PC, nevermind the gargantuan PC AT.

To achieve its small size, the XEN's designers left the power supply outside the main box; it sits on the floor near the wall socket, like those used on home computers. The unit is rated at 135 watts and is smart enough to adjust itself to supply voltage, provided this is either between 90 and 130 volts (as in the U.S.) or 180 and 260 V (as in the U.K.). It's housed in a louvered box about a foot long and has two sockets to supply 5- or 12-V direct current to the system unit and 120- or 250-V alternating current to a monitor.

Inside the system unit is a single-board 80286 microprocessor clocked at a brisk 7.5 megahertz. Combined with the zero-wait-state memory system, this permits performance over 60 percent better than the

(continued)

Dick Pountain is a technical author and software consultant living in London, England. He can be contacted *do* BYTE, POB 372, Hancock, NH 03449.

IBM PC AT (for processor-bound tasks). The XEN supports four channels of DMA with three more available as options; you can also fit an 80287 floating-point coprocessor as an option. An RS-232C and a Centronics parallel port are built onto the motherboard. The system unit is cooled by a fan that is about as loud as that in an IBM PC.

The machine I tested was the larger of the two standard configurations offered, having 1 megabyte of RAM on the motherboard, a single 720K-byte 3½-inch floppy-disk drive, and an internal 20-megabyte Winchester disk (of the latest 3½-inch type). The smaller configuration comes with 512K bytes of RAM and dual floppy-disk drives. All the memory is supplied in 256K-byte RAM chips.

You can expand the system in several ways. The hard-disk machine can accept a second internal hard-disk drive, making 40 megabytes in all, while the smaller machine can be

field-upgraded to the hard-disk specification. The motherboard contains six expansion slots, and they accept small Apricot format cards. Four of these are available to expand the memory up to 5 megabytes (using four 1-megabyte cards) or to add an on-board modem; the other two are reserved for video cards. You can gain access to these slots by opening a small hatch cover (like a miniature Apple II), rather than by dismantling the whole case, and you can open it without even displacing the monitor.

On the right side of the system unit is a bus extension to which you can attach an optional card cage that accepts two IBM PC or AT cards. Since the XEN makes no pretense of emulating the IBM hardware, this unit is really designed only to hold some of the more exotic communications cards for a micro-to-mainframe connection. IBM display cards will not work in it because the XEN has a totally different display architecture.

The XEN supports a variety of display resolutions. Monochrome resolution is 800 by 400 pixels, which produces superb text quality and permits numerous "soft" text fonts to be displayed. Three monochrome monitors are offered—a choice of a 9- or 12-inch green screen, or the superb 12-inch paper-white unit I received. (Frankly, the paper-white unit is well worth the extra £150 it costs.)

There are two options for color. The higher resolution is 640 by 350 pixels in 16 colors (from a palette of 64), which is more or less equivalent to the IBM Enhanced Graphics Adapter. However, the XEN video card for this subsystem contains graphics-processing hardware (implemented by gate arrays) that performs fast vector and arc drawing and area fills. It appears to offer a much higher performance than the IBM system; I wasn't able to run any benchmarks to confirm this, but the demo program looks as blindingly fast as an Amiga.

The lower resolution for color is the old faithful 640 by 200 pixels in 4 of 16 colors and is not supported by any fancy hardware. Different 12-inch monitors must be used for these two different-resolution color modes.

Apricot machines have always been well built, except for the keyboards, which I have found rather dead in feel and cluttered in layout. The keyboard problem has been remedied on the XEN; it has one of the best keyboards I have ever used. The feel is excellent; it has both a light touch and a positive click—a hard combination to achieve. All the keys are in sensible places, and truly massive Shift, Return, and Control keys make touch-typing a pleasure. The layout is different from previous Apricot designs: It has a separate pad for cursor-control and numeric keys, provides all the IBM editing keys like PgUp and PgDn, and it also has separate cursor keys (no Num Lock required). Scroll Lock and Caps Locks have red LED indicators.

Apricot has revived the microscreen for the XEN keyboard, a single-line LCD built into the keyboard that shows the date and time by default.

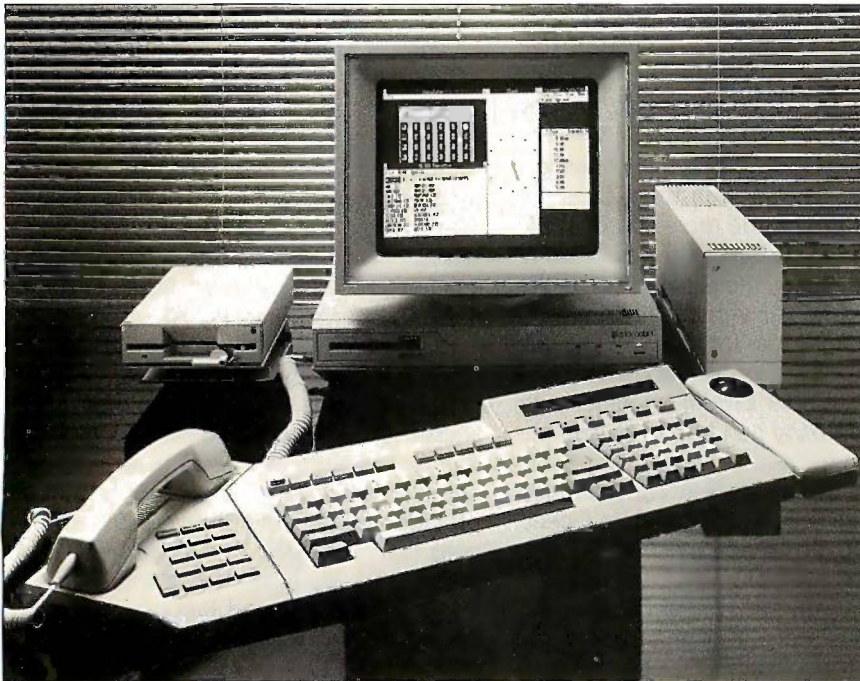

Photo 1: The new Apricot XEN 80286-based business microcomputer. It is shown with a 360K-byte 5¼-inch floppy-disk unit and an expansion box, which can house up to two IBM expansion cards; these units provide some compatibility with the IBM PC and the PC AT. The optional combination trackball/mouse and telephone are also shown. The XEN is seen running Microsoft Windows, which is its standard operating environment.

(continued)

Meet the next generation of data base and business programming language, ALPHA

\$89.00

MS-DOS
VERSION

ALPHA
AUTHOR:
MARC J. ROCHKIND

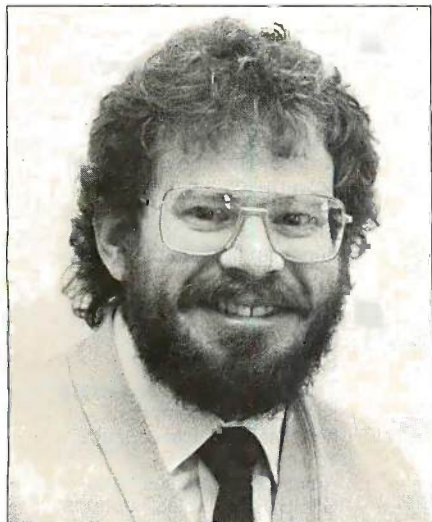

"ALPHA is a new programming language which I designed specifically for programming database and business applications. Think of it as a successor to Cobol mixed with the database power of dBASE."

With ALPHA you can write programs that handle today's most common business problems: accounting, MRP, inventory, customer databasing, order processing, etc. Because ALPHA is a top-down structured language, programming is fast and orderly. Because ALPHA comes with an excellent 430 page manual (with extensive index and examples), programming is a breeze.

Some of ALPHA's features include:

- a fast b-tree data structure
- access dBase II and III .DBF files directly
- on-screen forms generator
- error trapping
- date and day arithmetic
- its own compiler
- dollar and cents arithmetic
- multi-dimensional arrays
- mathematical and trigonometric functions
- transportable between MS-DOS, Unix & Xenix
- its own editor (complete with source)
- import Lotus and Framework data files
- access comma delimited ASCII files directly
- 118 built-in functions

**NOT COPY
PROTECTED**

ALPHA works on the IBM-PC series and compatibles. It is also available for UNIX and Xenix (call for specific systems), and PC/IX.

ALPHA Specifications

Maximum field size	255 bytes
Maximum fields / record	Unlimited
Maximum records / file	Unlimited
Maximum file size	32 Mbytes
Field length	Dynamic
Supports color	Yes
Logical operators	and, or, not
Comparison operators	Yes : 6

DATA TYPES

- Integer (32 bits)
- Dollar (39 bits)
- Float (32 bits)
- String (0 - 255 characters)
- Field of record
- @ERR (error flag)
- Array
- Hash table
- Record

OPERATORS

+	add	>=	greater or equal
-	subtract		or
*	multiply	&	and
/	divide	!	not
%	modulo	=	assign
==	equal	\$	concatenate
!=	not equal	++	increment by one
<	less	--	decrement by one
<=	less or equal	.	select field from record
>	greater	[]	array, table, string element

Call 800-922-3001 today, in Colorado 303-444-1542.

SOPHCO, INC.

PO Box 7430
Boulder, Colorado 80306



ANNOUNCING SPSS/PC+ GRAPHICS™ FEATURING MICROSOFT® CHART

Two software industry leaders — SPSS and Microsoft — have teamed up to provide the ultimate graphics option for SPSS/PC+™. SPSS/PC+, the leading data analysis package, includes fully integrated report writing, plotting, file management and mainframe communications capabilities. Now, you can add presentation-quality graphics with Microsoft Chart.

Analyze your data and bring it into focus.

Choose from a gallery of 45 pre-designed formats including bar, line, scatter and pie. Introduce custom elements into your charts. Combine or overlay images. Move and size chart components. Instantly switch among alternatives to see which communicates your message most effectively.

Produce top-quality output and send it to a variety of devices.

SPSS/PC+ Graphics works with over 14 plotters, more than 30 laser and dot-matrix printers, as well as slide making devices and video display units. Make great-looking printouts, slides and transparencies.

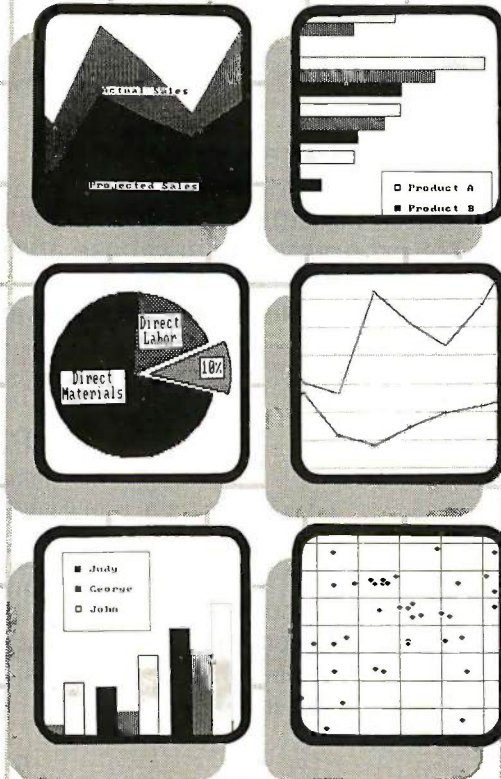

Move between data and graphs instantaneously.

Volumes of unmanageable data can be analyzed and displayed with a few key strokes. The combination of powerful data management and data analysis with SPSS/PC+ Graphics produces an unbeatable team.

Expand your analytical power with the SPSS/PC+ family.

The SPSS/PC+ base system is a powerful, comprehensive statistical package. You can add the SPSS/PC+ Advanced Statistics™ and SPSS/PC+ Tables™ options to further enhance the system's power. And now, with the addition of SPSS/PC+ Graphics, you can give your statistical presentations all the graphic impact they deserve.

SPSS inc.

444 N. Michigan Avenue
Chicago, IL 60611

In Europe:
SPSS Europe B. V.
4200 AC Gorinchem
The Netherlands,
Phone: +31183036711
TWX: 21019

To order, contact our
Sales Department at
312/329-3500.

SPSS

SPSS inc. Productivity Raised To The Highest Power™

SPSS/PC+ and its options run on the IBM PC/XT/AT with hard disk. Contact SPSS Inc. for compatible microcomputers. IBM PC/XT and PC/AT are trademarks of International Business Machines Corporation. Microsoft is a registered trademark of Microsoft Corporation.
SPSS/PC+, SPSS/PC+ Graphics, SPSS/PC+ Advanced Statistics, and SPSS/PC+ Tables are trademarks of SPSS Inc. for its proprietary computer software.

BYTE U.K.

Unlike previous Apricot versions, the microscreen is now backlit by a blue electroluminescent panel so that you can read it under all lighting conditions. Beneath the microscreen are six function keys with red LED indicators; conscientious application vendors can program these to display their assignments on the LCD. In addition, there are 10 IBM PC-style function keys along the top of the keyboard, which have legends such as Help, Repeat, Print, Calc, and Undo stenciled below them. This is not such a good idea, since they don't perform their labeled functions at the Microsoft Windows executive level, and in Windows Write they support functions different from the labels. Some applications do support the labeled keys, though. WordStar 2000 supports most of them—the Calc key, for example, turns the microscreen into a desk calculator complete with memory functions.

I also received an Apricot trackball/mouse, which connects to the keyboard unit by a thin fiber-optic cable. Although you can use it as a mouse by tilting it forward until the large ball contacts the table top, it is more usually used as a trackball by directly manipulating the ball, which saves a lot of desk space. I found it easy enough to use but less convenient than a conventional mouse, since it tends to tire your forefinger.

I tested Apricot's speed claims for the XEN by running the Sieve of Eratosthenes and Disk benchmark tests in interpreted GW-BASIC. The results are shown in table 1. (The AT benchmarks appear in Alan Finger's review "IBM PC AT," May 1985 BYTE, page 270.) The XEN figures are very

fast; the Sieve runs 72 percent faster than on a PC AT (the higher clock rate can only account for part of this), while the floppy-disk access is 48 percent faster.

WINDOWS

The XEN offered me a first opportunity to use the released version of Microsoft Windows. XEN comes bundled with Windows (complete with clock, notepad, calendar, calculator, card file, asynchronous-terminal program, and one game), the Windows applications Write and Paint, and GW-BASIC. You also get a software IBM ROM BIOS emulator that will run completely well-behaved IBM PC programs rather slowly. I was not able to test this latter feature since the optional, external, 5 1/4-inch floppy-disk drive was not available at this writing.

I think Windows was well worth the two-year wait and is the nicest environment I've used so far. It is fast and easy to navigate around. When you want a new window, it comes up in a flash—none of that annoying Genie-out-of-the-bottle stuff that happens on Macintosh and GEM—and on a hard-disk XEN, the little hourglass isn't on the screen long enough for you to get sick of it.

Purists may scoff at the tiling system that Microsoft adopted instead of full overlapping windows, but it does precisely what you want it to do, and quickly. After all, who cares about the hidden part of an overlapped window? It's what you can see that's important. To me, overlapping windows only make sense if they can be summoned and dismissed *instantly* as in SideKick. Windows always lets you

(continued)

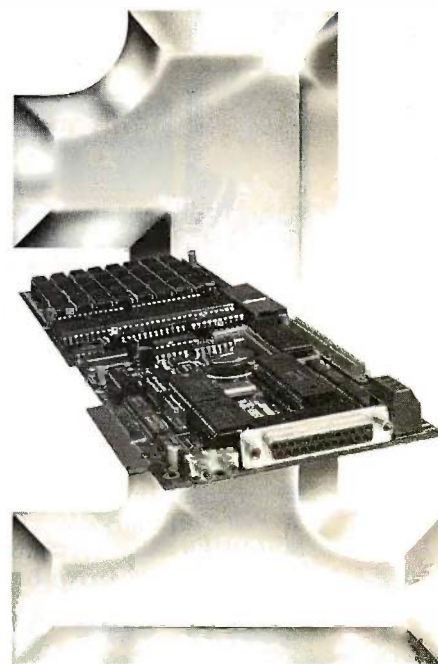

**Number One
in Performance
68010/68000
Coprocessor for
IBM/AT/XT/PC-
8/10/12.5mz No Wait States
\$1295⁰⁰ Qty. 1**

FEATURES

- 1-2 MB RAM (1MB Standard)
- 16K-64K EPROM
- 2-8 Serial Ports
 Async/Sync/Bisync Communications
- Battery-backed Real Time Clock
- Battery-backed 2K-8K RAM
- 2 Parallel Ports
- 68881 Math Coprocessor
- Memory-mapped Dual-port BUS
- 3-9 Users Per Board (3 Standard)
- Up To 16 Boards Per AT/XT/PC
- Can Operate As Standalone Processor

SOFTWARE

- OS9 (Powerful UNIX-like Multi-user OS)
- CPM/68K
- Software selectable OS including concurrent PC DOS/OS-9 or CPM/68K operation
- Support Module for IBM Graphics
- High-speed Local/Global Disk Caching
- Basic, Pascal, Fortran, C, and COBOL

IBM is a registered trademark of International Business Machines Corp. OS/9 is a registered trademark of Microsoft Systems Corp. CPM/68K is a registered trademark of Digital Research Corp. MATH68010 is a registered trademark of Motorola. UNIX is a registered trademark of AT&T.



West: 4704 W. Jennifer, Suite 105, Fresno, CA 93711, 209/276-2345
 East: 67 Grandview, Pleasantville, NY 10570, 914/747-1450
 Distributor: Telemarketing Services, Inc.
 1897 Garden Ave., Eugene, OR 97403, 503/345-7395

Table 1: The XEN's speed-test results (in seconds).

	XEN	IBM PC AT
Write a 64K-byte sequential file to floppy disk	17.5	26
Read a 64K-byte sequential file from floppy disk	16.5	24
Write a 64K-byte sequential file to hard disk	10	
Read a 64K-byte sequential file from hard disk	9	
One iteration of the Sieve of Eratosthenes	46.5	80

UNBEATABLE!

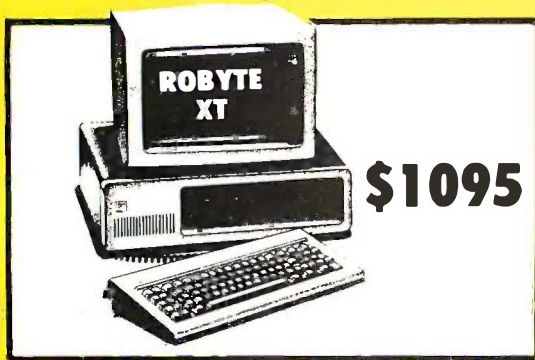

PLUS THESE FEATURES:

- 6 Expansion Slots ■ 360K Floppy Drive
- Full 640K on Mother Board
- 8/16 bit 8088 Microprocessor
- 20MB Hard Drive Included (monitor not included)
- 6 Expansion Slots ■ 360K Floppy Drive
- 256K on Mother Board
- 8/16 Bit 8088 Microprocessor
- 10MB Hard Drive (monitor not included)

AND THE DIFFERENCE ... A \$2800 SAVING!

ROBYTE PC with 2/360K floppy drives on XT mother board and keyboard **\$775**
IBM Compatible

ROBYTE AT with 30mb. hard disk drive and 1 floppy with keyboard **\$2295**
IBM Compatible

ROBYTE
40-60M
Tape Back Up
Int. or Ext.
(For all IBM compatibles)
\$595 to \$795

ROBYTE
Super Quality Boards,
Multi-Ply & Socketed
One year guarantee
MULTIFUNCTION CARD
Serial and parallel ports, 384K expandable, clock/calendar, game
OPTION PORT \$139.00
SERIAL CARD \$59.00
PARALLEL CARD \$39.00
COLOR GRAPHICS CARD \$74.00
MONO GRAPHICS CARD \$99.00
I/O MULTIFUNCTION CARD \$119.00
AT MULTIFUNCTION CARD, EXPANDABLE TO 3M, includes piggyback \$349.00

NEW!
POWER SURGE PROTECTOR
with Monitor Swivel Attached
6 outlets
A \$175 VALUE **\$89**

COMPAQ
"286"
Desktop Model "2"
full configuration
\$4395

WESTERN ELECTRIC
Touch-Tone Modem
Telephones
\$29
Reg. Use Also

ROBYTE
1200 BAUD
Hayes compatible
External Modem
\$229

IBM SPECIAL
IBM, 1-320K DS, DD Disk Drive 10 Meg. Hard Drive, Amber or Green Monitor, 256K, Par Port PFS. Write and File
\$2350.00

ROBYTE
COLOR MONITOR
640 x 200 res.
\$395

Call for special prices on limited supply of T.I. closeouts

Call for special prices on all variety CABLES. 50% and more off!

SOFTWARE	MONITORS	PRINTERS
WORD PROCESSING WORDSTAR 2000 PLUS \$315.00 WORDSTAR EASY \$99.00 WORDPERFECT \$250.00 W/ SPELLER \$240.00 MICROSOFT WORD \$250.00	PRINCETON GRAPHICS HX-12 HI RES \$545.00 SR-12 W/DOUBLER \$714.00 ANDEK COLOR 300 RGB \$359.00 COLOR 600 \$439.00 COLOR 710 HI-RES \$499.00 IBM PROF. GRAPHICS MON \$969.00 ENHANCED GRAPHICS MON \$649.00	EPSON FX-286 \$559.00 FX-85 \$372.00 LQ-1500 \$967.00 STAR MICRONICS SG 10 \$206.00 SD 10 \$279.00 SR 10 \$394.00 BROTHER HR-25 \$554.00 HR-35 \$796.00 TWINWRITER 5 \$973.00 HEWLETT PACKARD LASERJET \$2316.00 6-PEN PLOTTER \$1466.00 THINKJET \$349.95 LASERJET PLUS \$3089.95
SPREADSHEETS & DATABASES LOTUS 1-2-3 \$327.00 SYMPHONY \$459.00 DBASE III PLUS \$417.00 FRAMEWORK II \$417.00 SUPERCALC \$211.00 MULTIPLAN \$117.00	DISK DRIVES SEAGATE SEAGATE 20 MG W/CONT. \$595.00 SEAGATE 30 MG W/CONT. \$895.00 SEAGATE 42 MG W/O CONT (37 M.S.) \$1250.00	GRAPHICS CARDS MERCULES GRAPHIC CARDS \$289.00 COLOR CARD \$145.00 PARADISE GRAPHICS CARD \$272.00 MULTIDISPLAY CD \$197.00
FINANCIAL SOFTWARE HOME ACCOUNTANT \$89.00 MONOGRAM DOLLARS & SENSE \$108.00	HARDWARE AST SIX PACK PLUS \$242.00 AT ADVANTAGE CARD \$381.00	ZOOM MODEM FOR IIE \$90.00 DIABLO RIBBON CARTRIDGES \$2.95
MODEMS HAYES SMARTMODEM 300 \$145.00 SMARTMODEM 1200B \$399.00 SMARTMODEM 2400 \$655.00		

ORDER LINE 1-800-334-8989 IN CALIF. CALL 1-818-341-9193 Inquiry 378
OPEN 6 DAYS/WEEK, MON.-SAT. 6 AM - 6 PM Pacific Std. Time
IBM is a registered trademark of International Business Machines Co.
Shipping & handling charges, 3%. Cal. residents only, 6.5% tax. All prices and availability subject to change without notice. For fast delivery, send cashier's check, certified check or money order. MC and Visa at discount prices above. American Express add 4%. Defective merchandise replaced with same item only. Returns require authorization number. Allow 3 weeks for personal or company checks to clear. Government, quasi-government, or educational institutions on Net 15 terms. Refused shipments subject to 25% charge (\$50 minimum). No returns on software.

Price-Line Computers, Inc.
9710 Topanga Canyon Place, Chatsworth, CA 91311

BYTE U.K.

choose between the keyboard and the mouse for control, and if you are already familiar with MS-DOS, you can use your knowledge to its full effect.

The multitasking aspect of Windows is excellent. You can switch from one application to another in the time it usually takes to move the cursor two inches—faster than Macintosh, even with Switcher.

Windows Write looks great on the high-resolution paper-white monitor and seems to be a plain but likable word processor. It's basically a cut-down version of Microsoft Word, without virtual memory and fancy formatting features like the style sheets. Nevertheless, I was able to get 47 pages of text into the XEN's hefty memory, more than enough for many people.

Windows has an unusual way with fonts. When you tell Windows what printer you are using, it automatically loads the fonts that printer supports; if you select a different printer halfway through writing a document, the whole text may change to a new font. For most printers you have a choice of Courier, Helvetica, or Times Roman print in various sizes, but the large sizes are just blown-up versions of the smaller ones (rather than separate bit maps), and they can look somewhat clunky.

Windows Paint is another MacPaint clone, although it has a few extra features, and it too looks terrific on the paper-white screen. Cutting from a drawing into the clipboard allows you to transfer pictures into documents, just like the Mac. Unlike the Mac, though, Windows lets you run Paint and Write in two adjacent windows and move a drawing right across from one to the other.

IBM PC COMPATIBILITY

Despite its obvious virtues, the XEN will probably succeed or fail on the issue of IBM PC compatibility. This is not necessarily just, but it is reality. Apricot has previously paid lip service to PC compatibility, providing either the minimal level of generic MS-DOS support or grossly inefficient software

emulation. This could have been seen as a reasonable expression of commercial and national pride in 1982; now it seems like hubris.

With the XEN, Apricot is going further than ever before toward the IBM standard. In December 1985, the U.K. trade press was humming with rumors that Apricot intended to buy an IBM-like ROM BIOS from Phoenix Software, suppliers to the IBM-clone industry. If this were true, it would entail extensive modifications to the XEN motherboard, which in turn would involve either a recall or at least a relaunch.

I'm assured by the highest-level sources inside Apricot that this is not going to happen. Instead Apricot will rely upon a novel software solution to compatibility called SoftClone. This program is produced by the California software house Control-C Inc., and it is rather more than the usual kind of software emulator.

SOFTCLONE

SoftClone actually *modifies* the code of IBM PC and PC AT programs. Specifically, it traps badly behaved direct memory accesses in such programs and patches the code with calls to the equivalent addresses in the XEN. Programs like SideKick that write directly to the IBM video buffer are modified to write into the XEN buffer, and so on. Well-behaved programs that only use legal BIOS calls and software interrupts are dealt with by a soft ROM BIOS emulator, which redirects the calls to their equivalents in Apricot's own BIOS 3. In searching for a descriptive label for SoftClone, the best I can manage is cross-disassembler-assembler. As an adjunct to SoftClone, Apricot plans to produce an external 5¼-inch floppy-disk drive that will read all the various IBM disk formats; I have seen a prototype working.

When does this code modification occur? Every time you run a program. To run an IBM PC program, say WordStar, on the XEN, you invoke it with the command line IBM WS at the A > prompt. IBM.EXE is the SoftClone

(continued)



Number One In Performance

Hard Disk Intelligent VCR Backup for AT/XT/PC

FEATURES

- High speed microprocessor controlled backup (68000)
- Two channel interface
- Built in LAN channel
- Software control of most VCR functions including Fast Forward, Rewind, and auto backup using VCR timer capabilities
- Economical VHS or Beta formats



West: 4704 W. Jennifer, Suite 105, Fresno, CA 93711, 209/276-2345
East: 67 Grandview, Pleasantville, NY 10570, 914/747-1450
Distributor: Telemarketing Services, Inc.
1897 Garden Ave., Eugene, OR 97403, 503/345-7395

Get the Picture with COLORPHOTOBASE

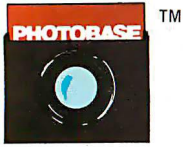

PHOTOBASE is a software package that works with data base management systems such as: **dbase II***, **R:Base 4000*** and the **IBM Filing Assistant***.



PC-EYE is a high speed, high resolution video digitizer board that lets you capture anything you can see.

Now you can open up a whole new dimension in data base applications by merging real-life color pictures with popular data base management systems. Pictures of people, products, diagrams, maps, company logos — whatever you want to photograph — can be integrated with your data base. Consider these typical applications:

Security — verify those employees who have authorized clearance to limited access areas. A data base containing employee pictures and personnel records can be searched and displayed for visual verification.

Real Estate — add pictures of houses to on-line real estate listings for faster property identification and improved sales presentations.

Electronic Cataloging — pictures of products can be combined with a data base system containing product specifications, pricing, availability and much more.

Medical Files — Existing data base systems containing patient histories can incorporate pictures of x-rays, cell slides and external body disorders. The ability to visually inspect previous medical problems of patients can greatly enhance the speed and accuracy of future diagnosis.

Customers, distributors and sales personnel can quickly search data and view the resulting product/picture information on one screen. Files can be updated easily, quickly.

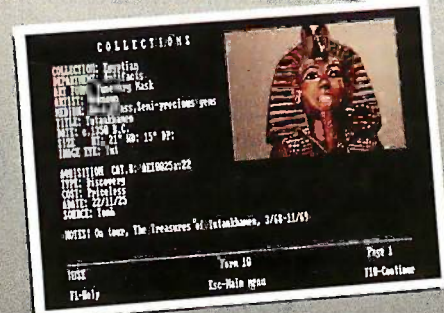
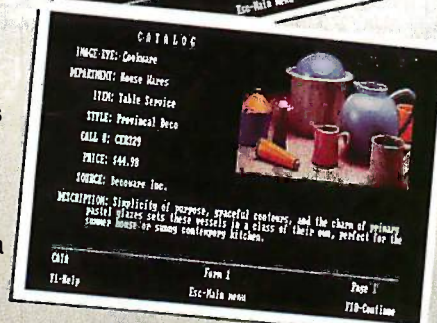
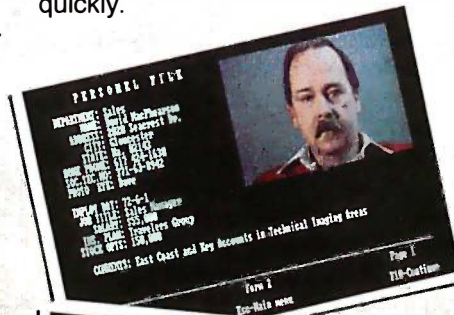

It's Easy

With a simple keystroke, pop-out of your data base system and into the PHOTOBASE menu. Capture images of text, photos, artwork and 3-dimensional objects with an ordinary video camera and our high resolution PC-EYE™ video digitizer. Pop back into your data base system and add the picture name to your data base like you would any other piece of information. The full functionality of the data base system is preserved, but the resulting display is text and picture information on one screen.

Pictures are displayed in the upper right quadrant of the screen or at a full screen resolution of 320 x 200 with 256 optimized colors. Screen display can alternate with text, images, or both simultaneously viewed.

Call or write and we will send you information on PHOTOBASE, PC-EYE, compatible cameras and other imaging equipment in the Chorus Family of products.

**(603) 424-2900 or
1-800-OCHORUS.**

TM PHOTOBASE and PC-EYE are trademarks of CHORUS Data Systems.

*dBase II is a trademark of Ashton-Tate; R-Base 4000 is a trademark of Microrim, Inc.; IBM Filing Assistant is a trademark of International Business Machines Corporation.

CHORUS

Inquiry 55

CHORUS Data Systems, Inc., 6 Continental Blvd., P.O. Box 370, Merrimack, New Hampshire 03054

program that loads, patches, re-locates, and runs WordStar, delayed only as long as it takes to display Control-C's fleeting copyright message. SoftClone only modifies the memory image of WordStar; the code on the disk remains unaltered. The changes shouldn't compromise the program's performance at all and should, in fact, enhance it wherever the XEN executes more quickly than the IBM does.

To accomplish the patching, SoftClone requires a short file for each application called, for example, WS.AD (WordStar Application Descriptor), which contains details of all the poorly behaved parts of the program. Initially, Apricot and Control-C will prepare these AD files for various popular packages, but eventually they hope to persuade application vendors to produce AD files for new releases as a matter of course. The effort involved in producing an AD file is quite small for an application's author, who is familiar with the source code, much less than performing a full port from one system to the other. However, the effort that would be required of a user is out of the question, even for one with programming experience.

Apricot bravely loaned me a very early preproduction version of SoftClone for this report, along with IBM versions of SideKick, WordStar, Lotus 1-2-3, and MultiMate, and their corresponding AD files. WordStar and MultiMate worked perfectly without any apparent speed degradation. Lotus 1-2-3 worked properly, although the display attributes on the paper-white monitor were rather odd. (Solid-color blocks, including the cursor, appeared as thin black underlines.)

The SideKick AD file was clearly not finished, as several of SideKick's functions (e.g., moving and contracting windows) didn't work. All the accessories could be summoned from inside the other IBM programs, but not from within Windows applications. Even so, this was the most impressive demonstration; you wonder how it can be done at all, since SideKick is about as IBM-specific as you can get. It was also the only program that

*SoftClone modifies
only the memory image,
not the disk file.*

showed any performance degradation, and that was mainly in the speed of updating the 25th screen line (the menu line). I suspect that the SK.AD file was redirecting this through a DOS output call rather than through direct video, and it suggests that the proper implementation of AD files could have a critical effect on SoftClone's success.

Overall, I was convinced that the SoftClone concept works and with a minimal degree of inconvenience to the user. There are still some unanswered questions: Can it be integrated into Windows (I only tried it directly from DOS), and what happens with copy-protected programs?

SoftClone may breach some forms of copy protection, but that depends on whether or not you can save the patched memory image and use it. I couldn't find a way to do so, but a serious hacker might.

CONCLUSIONS

I liked the XEN. It's compact, pretty, fast, a pleasure to use, and keenly priced. With the optional paper-white monitor, it's like having a cross between a Macintosh and a PC AT, but it's faster than either one. The high-resolution color-graphics version should do wonders for packages like AutoCAD.

Whether or not SoftClone proves to be a full answer to IBM software compatibility remains to be seen. I found the signs encouraging, as it seems to work technically. A potential problem lies with the backlog of IBM software; although the top 20 programs are sure to be catered to, it's unlikely that some of the older and more obscure ones ever will be. The ultimate question is, How badly do you want to run lots of old IBM programs? For first-time buyers, however, this shouldn't be much of an obstacle. ■

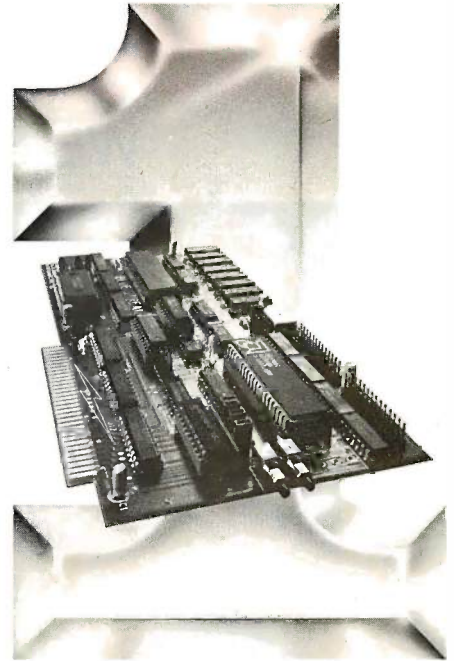

**Number One
in Performance**

**Z80H
BLUE STREAK™**

**IBM/AT/XT/PC- 8mz
No Wait States**

FEATURES

- 64K-256K RAM
- 2K-8K EPROM/Static Ram
- 2 Serial Ports
- Async/Sync/Bisync Communications
- Real Time Clock
- Memory-mapped Dual-port BUS
- On-board/Remote Reset NMI capability
- Up To 32 Boards Per AT/XT/PC
- Can Operate As Standalone Processor
- Less Than Full Size Board
(will fit other compatibles.)

SOFTWARE

- ZP/M™ CP/M Emulation Software (Supports Most CP/M Software)
- Multiuser Capability If Used As A Slave Processor

IBM is a registered trademark of International Business Machines Corporation. ZP/M is a registered trademark of Digital Research Corp.

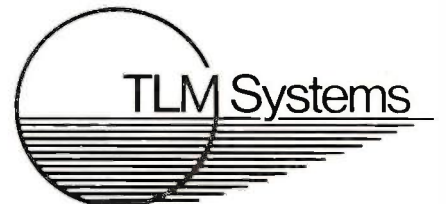

West 4704 W. Jennifer, Suite 105, Fresno, CA 93711, 209/276-2345
East 67 Grandview, Pleasantville, NY 10570, 914/747-1450
Distributor: Telemarketing Services, Inc.
1897 Garden Ave., Eugene, OR 97403, 503/345-7395

ENERGRAPHICS™ 2.0

WE SIMPLY MADE IT BETTER!



It's here! The newest release of **ENERGRAPHICS**. The graphics package once labeled "A Step Ahead of the Rest", has now jumped even further ahead with its **Version 2.0**. In one package we have combined more types of graphics with more capability employing the latest in ease-of-use methods than any PC package available today. To say it simply, Enertronics has made **ENERGRAPHICS 2.0** the easiest to use and the best there is!

Some Highlights of ENERGRAPHICS 2.0

New Ease-of-Use Features:

- Mouse/Digitizer (Optional)
- Help Screens
- On-Screen Graphics Editing
- Drawing Commands On-Screen

New Capabilities:

- 2 and 3 Dimensional Pie, Bar, Line Charts
- Paint/Fill
- New Fonts
- Merge up to 4 Graphs on a Screen
- Entirely New Documentation
- Conversion of 2D Symbols into 3D Symbols
- User Defined Curve Fitting



Of course we can't list all the 2.0 enhancements but we know this is the program for you. And, for those who only want the charting capability of **ENERGRAPHICS 2.0**, we've packaged it into a separate product called **ENERCHARTS**. So whether you want the total graphics solution offered by **ENERGRAPHICS** or just charting with **ENERCHARTS**, you'll have the best in PC graphics available to you.

ENERGRAPHICS 2.0—For your every graphics need!
ENERCHARTS—For only your charting graphics need!

Update Information:

ENERGRAPHICS 2.0—Send \$75.00 and #1 diskette from **ENERGRAPHICS 1.3**.
ENERCHARTS—For a current **ENERGRAPHICS** user, send \$195.00 and your #2 diskette from **ENERGRAPHICS 1.3**.

Ordering Information: All orders require a check/money order or Visa/Mastercard plus a shipping and handling charge.

ENERGRAPHICS 2.0—\$595.00 Retail **ENERCHARTS**—\$395.00 Retail
 Or, call our toll free number for a dealer in your area **(800) 325-0174**.

New Interfaces:

- Lotus® 1-2-3™
- Wordstar™/Multiplan®
- Video Show™
- EGA Board
- Polaroid® Palette

First Software, Intec-1, (United Kingdom) Tel: 0256 463344 Telex: 859030
 First Software Benelux, (Belgium) Tel: 32(16) 202512 Telex: 26202 vector B

ENERTRONICS

Inquiry 383

SEEING IS BELIEVING

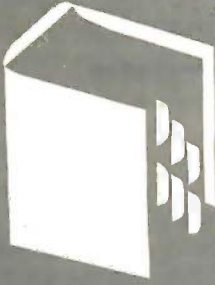

A·C·C·O·R·D·I·N·G T·O· W·E·B·S·T·E·R

Clearing the Backlog

TML Pascal

Mac C

M-Disk

Soft Spool

MichTron Utilities

Mudpies

Flip Side

Mirage

DEGAS

Deluxe Paint

BY BRUCE WEBSTER

Okay, okay, so I lied. Yes, last month I said that this column would have lots of tables with specs and benchmarks comparing the Macintosh, the Atari 520ST, and the Amiga. However, the planned announcements of the Atari 1040ST and the Macintosh Plus in January (it's late December as I write this) convinced me to put things off a month, in hopes of having specs and—just possibly—benchmarks for both. Nothing worse than outdated information, eh?

So what am I going to write about this month? If you could see the pile of software that has been accruing for the past few months, you wouldn't have to ask. However, time and volume are going to keep me from doing too comprehensive a job right now.

PRODUCT OF THE MONTH: TML PASCAL

Hallelujah! Tom Leonard has done in six months what Apple couldn't do in more than two years: produced and shipped a native-code Pascal compiler for the Macintosh that allows full access to the Toolbox and OS routines (including AppleTalk and MacinTalk). Tom's success is further evidence convincing me that Apple's failure was a deliberate marketing decision to encourage sales of the now-defunct Lisa/Mac XL. Unfortunately, all it encouraged was the de facto standardization of C as "the" programming language on the Mac. While I have nothing personal against C—why, some of my best friends use it—the Macintosh (in the form of the Toolbox, OS, and *Inside Macintosh*) assumes Pascal as the standard development language, and working out the differences between the two causes headaches for both compiler writers and programmers using C. Believe me, I know.

Anyway, Tom has developed and is now shipping the MacLanguage Series Pascal compiler through TML Systems. I received version 1.0 a few weeks back, and a new version (with a number of enhancements) is being prepared. The package comes with a

120-page manual, which contains both the user's guide and a reference manual, and two disks. The first disk—Pascal 1—contains stripped-down system files (in other words, it's bootable), the Pascal compiler, an editor (Bill Duvall's), a linker (the same one found in the Macintosh 68000 Development System [MDS]), and the RMaker and Font/DA Mover programs. The second disk—Pascal 2—has the necessary library and include files, as well as 11 example programs, some of which are direct adaptations of the Lisa Pascal examples that Apple has been distributing for so long. The entire package sells for \$99.95, is not copy-protected, and has no licensing fees.

To use TML Pascal, your Mac must have at least 512K bytes of RAM—if it doesn't, you shouldn't be trying to do program development on it. Also, an external disk drive is highly recommended, that is, essential, for any serious work. If you have a new Macintosh Plus with its 800K-byte drive, you could get by with just one. (I personally recommend a 2-megabyte Mac with a hard disk, but then again, I'm spoiled.)

Use of TML Pascal is straightforward and quite familiar to anyone who has used the MDS assembler, Consulair C, etc. With the editor, you create your program text. The Transfer menu then lets you compile your program without having to exit to the desktop. The compiler itself is fast, running at about 1200 lines per minute off a hard disk (MacBottom). Errors, if any, are displayed on the screen and also directed to a separate text file; you then use the Transfer menu to get back to the editor. Once your program compiles correctly, you use Transfer to go to the linker, which is also relatively speedy. If your program links correctly, it will then appear on the Transfer menu, and you can execute it.

The Pascal implementation is fairly good, although a little restricted in places. For example, version 1.0 allows sets to have only up to 32 elements. Leonard has gotten a lot

(continued)

Bruce Webster is a consulting editor for BYTE. He can be contacted *clo* BYTE, POB 1910, Orem, UT 84057, or on BIX as *bwebster*.

THE DATA PAGES

"THE DATA PAGES" is a new NATION wide business directory.

We are building a computerized data base of businesses in most major cities throughout the United States.

"THE DATA PAGES" has such information as business name, address, phone numbers, zip code and type of business, as well as, additional categories further describing the business.

With your personal computer look up businesses by Name, Street Address, Phone Number, or Type of Business. Not sure of a name, the computer will also search generically. You may limit searching by either City, State, Area Code or a Global search that covers the entire data base.

Many businesses listed in "THE DATA PAGES" list additional information about their business, products or services. All this is available to you. Businesses listed in "THE DATA PAGES" have the ability to change their information at any time. This means you, the subscriber, has up-to-date information at all times.

OUR RATES ARE REASONABLE!

12 MONTH SUBSCRIPTION:
 COMMERCIAL SUBSCRIBERS \$39.95 per year.
 INDIVIDUAL SUBSCRIBERS \$29.95 per year.

This subscription fee gives you access to the data base and one hour free time each month. You pay only for the phone call.

ADDITIONAL TIME:
 COMMERCIAL SUBSCRIBERS \$12.00 per hour.
 INDIVIDUAL SUBSCRIBERS \$ 3.60 per hour.

The additional time charges are the same regardless of the speed of your modem; 300, 1200 or 2400 BAUD.

Try the "THE DATA PAGES" you'll like how it works!

Send check or money order with coupon below and deduct \$5.00 from the subscription price.



LMW Enterprises, Inc.
 14031 Quarles
 San Antonio, TX 78247
 (512) 494-0263

Please send application and information. Enclosed is the subscription fee less the \$5.00 discount .

Make check payable to LMW Enterprises, Inc.

Send application and information and bill me .

Type of account: COMMERCIAL
 INDIVIDUAL

Name: _____

Address: _____

City: _____

State: _____ Zip: _____

Phone: _____

Phone: a/c _____ # _____

Please charge services to my credit card.

MasterCard Card #. _____
 Visa Exp. date _____

Signature: _____

of flak about this from programmers (like me) who use set of Char heavily, and he promises that it will be fixed for the version 2.0 release. Likewise, the current implementation doesn't let you pass functions or procedures as parameters, though you can use the "@" operator to get the address of the entry point of a procedure or function. Beyond those restrictions, TML Pascal looks a lot like Lisa Pascal; Leonard's goal is to make it as much like Lisa Pascal as he can.

The extensions—none too extensive—tend to follow Lisa Pascal, which in turn follows UCSD Pascal. UCSD-type strings are implemented, with the standard procedures and functions. The InLine procedures and functions from MacPascal are also implemented, which allows easy conversion of routines. Following Turbo Pascal's lead, Read and Write can be used on files of records; unlike Turbo, the standard Get and Put routines are also implemented and can be used instead. For memory management, New, Dispose, and MemAvail are used; the HeapResult function lets you get the resulting code from the memory manager, just as the IOResult function lets you monitor the results of I/O operations.

TML Pascal offers a plain-vanilla mode for programmers inexperienced with the Macintosh. If you put (Input,Output) in your program statement, TML Pascal will automatically set up a window for you; will handle all calls to Read, Readln, Write, and Writeln; and will give you access to the QuickDraw routines as well. Be warned, though, that the Write and Writeln routines are fairly slow compared to the regular Mac text routines.

The compiler produces two types of output files: .ASM and .REL. The .ASM files are 68000 assembly-language source code and are compatible with the Apple MDS assembler. The .REL files are relocatable object-code files used by the linker to produce the final executable code. The compatibility with MDS, together with EXTERNAL declaration of procedures and functions and the \$U compiler option to specify library files, lets you easily write assembly-language subroutines for your Pascal program, assuming you have MDS. And, if you do, you can use the .ASM files to hand-optimize the code the compiler produces.

As a test of TML Pascal, I decided to convert the Star-Map program that I originally wrote using MacAdvantage, a UCSD Pascal derivative (see "New Perspectives on Near-by Stars," July 1985 BYTE, page 106). The conversion was surprisingly easy and consisted mostly of removing some of the work-arounds that MacAdvantage uses to interface with the Mac (the Locate function, etc.). There is a definite speed improvement, though it's not dramatic, since the program tends to be either waiting for user I/O or calling Toolbox routines. Also, it's become much easier to define application and document icons in the resource file, something I never could get MacAdvantage to do.

TML Pascal is by no means a finished product. Some bugs undoubtedly do exist, though I've found only one

(continued)

Betcha our compiler can beat up your compiler.

Or your money back.

If you program in BASIC, Pascal, Fortran or C, you're using yesterday's technology. We know this statement will start a brawl, but it's true. So, before you start a fight you can't win, take a closer look at the Modula-2 language and the Modula-2 Software Development System (M2SDS) from Interface Technologies. Just compare the features and performance of M2SDS to your system. You'll find a new language and a programming environment that's more flexible, much faster and works on any IBM® PC or 100% compatible with 256 K memory or more.

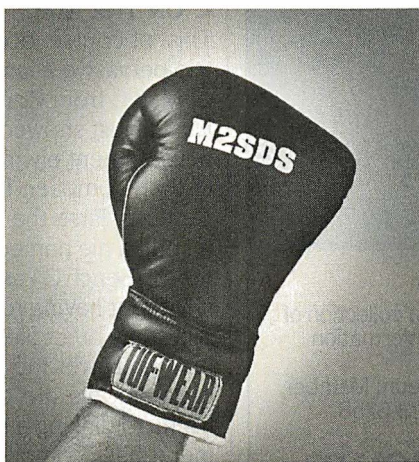

Trade In and Trade Up. Just to prove that we're not all brag... we'll send you M2SDS for just \$50.88 if you mail us your present compiler or interpreter diskette.* That's \$30.00 off the regular price. If within 30 days you're not programming faster than ever, just return the diskette and we'll send you your money back.

Heavyweight Champion SDS-XP. If you're ready to move into light-speed, you need SDS-XP. It has everything M2SDS has with a little "punch" added. Like Extended Libraries, M2MAKE and a Foreign Object Module Importer. SDS-XP offers buyers a stout discount when compared with the cost of buying M2SDS and the additional components as add-ons. For a limited time only, SDS-XP is available for \$99.00 with compiler trade-in. That's \$150.00 off the advertised price of \$249.00.

Knock Out Bugs \$79.95. Announcing M2DEBUG. A symbolic, compact (only 20K RAM) interactive run-time debugger with features most requested by software programmers and system developers. It comes with a Virtual Resource Overlay Operating Manager (VROOM) that speeds up compile time 50%.

Calling All Compilers. So now that you're wise to the limitations of your system, why not trade it in. You'll soon see that it was smarter to switch than fight. And a pretty safe bet.

<i>M2SDS</i>	
<i>COMPILE SPEED (MIN:SEC)</i>	
<i>30 LINES</i>	<i>0:15.58</i>
<i>300 LINES</i>	<i>0:25.48</i>
<i>EXECUTION SPEED (MIN:SEC)</i>	
<i>SIEVE</i>	<i>0:13.92</i>
<i>FIBONACCI</i>	<i>0:53.49</i>
<i>30X30 MATRIX (8087)</i>	<i>0:08.84</i>
<i>FP OPERATIONS</i>	<i>0:27.56</i>
<i>FP OPERATIONS (8087)</i>	<i>0:01.97</i>
<i>SYNTAX CHECKING EDITOR</i>	<i>YES</i>
<i>MULTIPLE WINDOW EDITING</i>	<i>YES</i>
<i>EDITOR FILESIZE LIMIT</i>	<i>MEMORY SIZE</i>
<i>COMPILE ERROR CALLS EDITOR</i>	<i>YES</i>
<i>LINKER</i>	<i>YES</i>
<i>PRODUCES EXE FILES</i>	<i>YES</i>
<i>EXECUTABLE CODE SIZE LIMIT</i>	<i>DISK SPACE</i>
<i>DOS ACCESS FROM EDITOR</i>	<i>YES</i>
<i>DOS ACCESS FROM PROGRAMS</i>	<i>YES</i>
<i>8087 SUPPORT STANDARD</i>	<i>YES</i>
<i>COPY-PROTECTED DISK</i>	<i>NO</i>
<i>COST WITH 8087 SUPPORT</i>	<i>\$50.88/\$80.88</i>

Source: Software Resources, Inc. Sieve program from BYTE, January 1983. Fibonacci program from Dr. Dobb's Journal, February 1985. Matrix program from BYTE, October, 1982. FP Operations program from BYTE, May 1985. M2SDS with or without 8087 uses 8-byte accuracy. Programs compiled with all checking options on. All tests conducted on a standard IBM-PC/XT with 512K of memory and an 8087 math coprocessor.

*Original or back-up diskette may be sent for trade-in. Diskette will be destroyed immediately upon receipt so that your current compiler license agreement is not violated.

IBM is a registered trademark of International Business Machines Corporation.

INTERFACE TECHNOLOGIES

3336 Richmond, Suite 200, Houston, TX 77098

1-800-922-9049

(In Texas, call 713/523-8422) Telex: 322127
In Europe call ITC at: Switzerland 41 (1) 700-3037;
Netherlands 31 (20) 106922; U.K. 44 (1) 656-7333

Here's my diskette. Rush me:

- M2SDS for \$50.88 each, plus \$7 shipping and handling.
- SDS-XP for \$99.00 each, plus \$7 shipping and handling.

Or, send me:

- M2SDS for \$80.88 each, plus \$7 shipping and handling.
- SDS-XP for \$249.00 each, plus \$7 shipping and handling.
- M2DEBUG for \$79.95

- My check is enclosed.
- Apply charges to credit card indicated below:

VISA/MasterCard/American Express (circle one).

Credit Card # _____

Expiration Date _____

Signature _____

Name _____

(please print)

Shipping Address _____

City _____

State/Zip _____

Day Phone _____

Texas residents add 6.125% Sales Tax.

International orders add \$30 for shipping/handling. If paying by check, check or draft must be in U.S. dollars drawn on a U.S. bank.

INTERFACE TECHNOLOGIES CORPORATION
3336 Richmond, Suite 200, Houston, Texas 77098

How a software engineer got to captain the lunar landing module.



The Computer Museum is a lot more than a collection of the most famous machines in the history of information processing, it's also a lot of fun.

For more information, or to become a Museum Member, write The Computer Museum, or call (617) 423-6758.

The Computer Museum

B O S T O N

There's something in it for everyone.

300 Congress Street, Boston, MA 02210

IBM® PC/XT COMPATIBLE MODEL 640

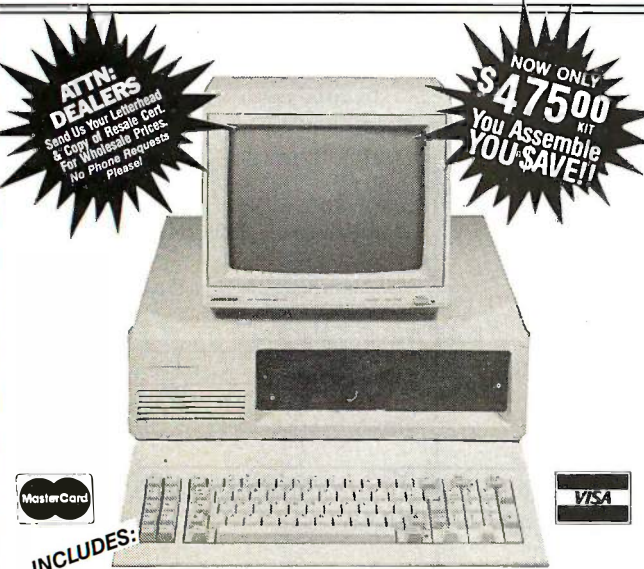

INCLUDES:

- IBM® PC/XT Compatible Motherboard
- W/256K RAM & BIOS on 640K Motherboard (8088 16-Bit 4.77 MHZ)
- Floppy Disk Controller Card, up to 2 drives
- One 360K DS/DD Slim Drive
- Easy Assembly - No Soldering
- 135W Power Supply
- Keyboard... Similar to Keytronic 5150
- Flip-Top Case
- 90 Days Warranty on Parts & Labor
- 134-Page Computer Instruction Manual
- Monitor Optional

OUTSIDE CALIFORNIA

1-213-329-3384 • 1-800-231-6491

NO COD - Only Prepaid or Credit Card Orders
Add 10% Shipping & \$1.50 Handling Fee.
Credit applied if freight is less than 10%
California Residents Add 6½% Sales Tax

ASK FOR OUR 24-PAGE CATALOG

MORE® Computer

DEPT. BYTE/MAG • P.O. BOX 2320
GARDENA, CALIF. 90247-0320

OPEN: 8:30 - 5:00 Monday - Friday
Sorry, No Walk-In Orders - Strictly Mail Order Only.
IBM® is a registered trademark of Int'l Bus. Machines Corp.

minor one so far. Also, Tom is planning on lots of improvements and extensions. TML Pascal has now become my standard development language on the Mac and will probably remain so for the foreseeable future.

C ON THE MAC

This, of course, doesn't mean I've given up on C. It's just too pervasive a language to ignore. Besides, version 4.01 of Mac C from Consulair Corporation (a.k.a. Bill and Ann Duvall) just showed up, easing the pain of learning C. The development environment is similar to that of TML Pascal (editor, compiler, linker, RMaker), with a few notable exceptions. First, the Transfer functions are more intelligent. If I edit a file named BENCH.C, the Transfer menu will give me "C Bench.C" as one of the options. So I can compile it without having to specify the filename. If I want to compile some other file, I simply close BENCH.C, and the Transfer menu gives me just "C" as an option. Second, the Exec program lets me do simple batch processing, which is useful for linking a number of .REL files. Third, the Transfer menu has "compile and go" and "link and go" options, which help cut down the number of steps during the compile-link-run cycle.

Mac C maintains a certain amount of compatibility with the Apple MDS assembler. You can use the Mac C linker to link in .REL files produced by MDS, but you can't use the MDS linker to link in .REL files produced by Mac C. However, since Mac C contains its own assembler (for both in-line and separately assembled routines), and since the Mac C linker is an "intelligent" linker (copying in only the code needed instead of the entire library), you don't really need MDS at all.

Mac C comes with four disks, three manuals, some update sheets, and a hefty price tag of \$425. However, of all the C compilers on the Mac that I've used (including Megamax, Aztec, and Hippo), I prefer Mac C. It's what I'll be using from now on...when I'm not using TML Pascal.

To help me along with Mac C, a close friend of mine—Frank Boosman—gave me a book for Christmas: *Using the Macintosh Toolbox with C*. It's written by Jim Takatsuka, Fred Huxham, and David Burnard and published by Sybex at \$22.95. The book is thick (more than 500 pages), has lots of sample code, and, from what I can tell, does *not* require that you own *Inside Macintosh*. Best of all (for my purposes, anyway), all the examples are written using Mac (Consulair) C, though the authors say they tried to make the code as compiler-independent as possible. The book has already solved one problem that was plaguing me in a benchmark program and, I suspect, will make life much easier for me. If you're going to program in C on the Mac, this book is probably worth owning.

ATARI 520ST SOFTWARE

Many programs for the 520ST have shown up in the past few weeks. In terms of sheer numbers, MichTron Inc. seems

(continued)

A CROSSTALK[®]

Klone FOR \$49.95

The Closer You Look, the Better We Look!



FEATURING
Foreground/Background Communications

MIRROR is the mirror image of Crosstalk XVI V3.6, the industry standard in data communications software for small business computers. **MIRROR**'s design closely reflects Crosstalk XVI's menus, commands and features. In fact, if you have used Crosstalk XVI before, you will feel right at home with **MIRROR**. The one thing you will not find reflected in **MIRROR** is Crosstalk XVI's \$195.00 price. Because we control the reflection, **MIRROR** costs only \$49.95.

If you are new to data communications, it makes sense to go with the industry standard in data communications software, but why pay the industry standard price. **MIRROR** lets you have the industry standard at 1/4 the price. If you or your company have already standardized on Crosstalk XVI, then consider **MIRROR** for future purchases and upgrades, you'll realize significant savings, without sacrificing on quality, standardization or features.

MIRROR™ WILBOB

**THE RIGHT DATA COMMUNICATIONS
 CHOICE FOR ANY USER!**

**For New Users,
 MIRROR Provides:**

- Menu/Command Driver
- Complete Crosstalk XVI V3.6 Compatibility
- New User Script File (Enables you to sign-on to your favorite online service in minutes)
- Auto-dial/Auto-answer
- Alphabetized Help-Command Summary
- Money Saving Offers From Online Information Services

**For Experienced Data Communications
 Users, MIRROR Provides:**

- Complete Background Operation (concurrent operation/memory resident)
- Programmable Script/Command Language (Crosstalk XVI V3.6 compatible with extensions)
- Extended Error-checking Protocol Support (XMODEM-single, XMODEM-multi-file, Crosstalk, Hayes and KERMIT)
- Integrated Wordstar-like Text Editor
- Multiple Terminal Emulations (VT-100/52, IBM 3101, Televideo 912C/920/925, TI 940, ADDS Viewpoint, ADM-3A)
- Enhanced Individualized Password Protection

Inquiry: 304



1210 East Park Avenue
 Tallahassee, Florida 32301
 For Information Call:
 1-904-878-8564
 TLX: 6714280 KLON

\$49.95

Site Licensing Available
 60-Day Money-back Guarantee
 No! Copy Protected.

To Order Call Toll-Free



National:
1-800-538-8157
 Ext. 848

California:
1-800-672-3470
 Ext. 848

\$49.95, plus \$5.00 postage/handling
 (\$8.00 for COD orders) ea.

Florida residents must add 5% sales tax
 Overseas orders: Add \$18.00 for shipping.

MIRROR is available for the IBM PC/XT/AT and compatibles and requires MS-DOS 2.0 or higher.

MIRROR, MirrorWare and SoftKlone are trademarks of SoftKlone Distributing Corporation. Crosstalk XVI and Microstuf are registered trademarks of Microstuf, Inc. HAYES is a registered trademark of Hayes Microcomputer Products, Inc. Wordstar is a registered trademark of Micropro International.

DISTRIBUTED IN CANADA BY:
 Saragway Software Distributors
 121 Avenue Road, Suite 202
 Toronto, Ontario, M5R 2G3
 Ph: (416) 923-1500

ENHANCED GRAPHICS ADAPTER

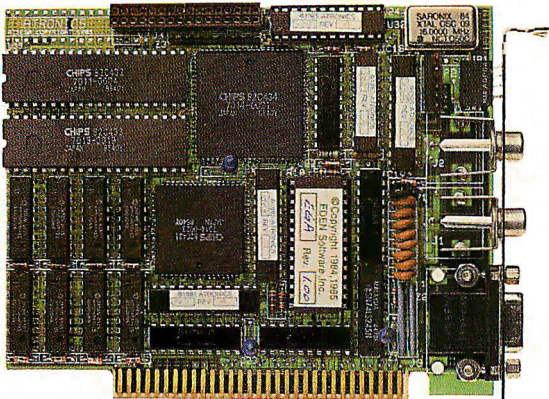

MegaGraph

Half the Size Four Times the Memory

We've designed a smart EGA graphics card! It packs in all the features of IBM adapter cards. That's right, the **MegaGraph®** is fully compatible with the IBM® Enhanced Graphics Adapter (EGA), IBM® Color Graphics Adapter (CGA), IBM® Monochrome Display Adapter (MDA).

We can do every graphics mode that IBM® can in a

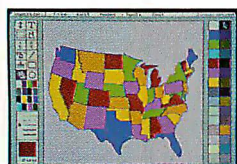

IBM® Drawing Assistant

card less than half-size, which makes the card fit in any slot of the IBM® PC, XT, or AT as well as compatibles or portables.

Of course, the software programs that run on the IBM EGA® card will run on the **MegaGraph**. Examples include AutoCAD™; IBM Drawing Assistant®; Gem Draw™; Microsoft Windows™, Word and Chart; Lotus 1-2-3® and Symphony™ and many more.

There's no need to pay extra for a piggyback memory card which is optional on the IBM EGA®. **MegaGraph** includes 256K byte of display memory. It works with both monochrome and R.G.B. monitors; simply switch between color or monochrome displays. Our warranty is one year. The price is only \$499.00.



GEM™

Call (408) 943-6629 for the dealer near you and for more information about ATronics AT compatible system boards.



ATRONICS INTERNATIONAL INC.
491 Valley Way, Milpitas, CA
(408) 943-6629

Microsoft registered trademark of Microsoft Corporation. IBM registered trademark of International Business Machines Corp. Lotus and 1-2-3 registered trademarks and Symphony trademark of Lotus Development Corp. GEM trademarks of Digital Research Inc. AutoCAD trademark of Autodesk.

ACCORDING TO WEBSTER

to be the winner. Five packages have shown up so far. The three most important are all system utilities written by Timothy Purvis. M-Disk is a RAM-disk package for the ST, which I haven't bothered to use yet since I still don't have TOS/GEM in ROM (and so have only about 256K bytes of RAM free). It should be great on a 1-megabyte ST, though. Soft Spool is a printer spooler to let you quickly complete a printing job and get back to work while the document is still printing. It uses a RAM buffer, so again this would work best with an ST with TOS/GEM in ROM. MichTron Utilities has two programs: a disk editor, which lets you view and change any byte on a disk, and a disk-copy program. The last two, Mudpies and Flip Side, are games; Mudpies is a cute but uncomplicated arcade game, while Flip Side is an ST implementation of Reversi. (Incidentally, Flip Side works with both color and monochrome monitors, while Mudpies works only with color.)

Mirage Concepts Inc. has two products out under its Holmes & Duckworth product line: Forth and Toolbox. I freely admit that I have used the Forth only briefly—I've had too much else to worry about the past few weeks to wrench my mind back into the RPN (reverse Polish notation) mindset—but the documents (55K bytes, distributed on the disk) give me the feeling that this was written by the programmers to satisfy themselves and so is probably a decent implementation. I've played around a little more with Toolbox, which has five programs in it: a disk editor (file or track/sector); a memory editor; a deleted-file-recovery program; a format-and-copy-disk program; and a directory-print program (seems there's no easy way to get a complete directory listing on the computer from GEM). In short, these are five very useful programs for anyone digging into the guts of the ST. All programs work with both monochrome and color monitors.

The best of the ST software so far is DEGAS, which stands for Design and Entertainment Graphic Arts System. Briefly put, it's painting software. Written by Tom Hudson and published by Batteries Included, DEGAS is the perfect "What does it do?" program for the 520ST. The user interface is simply a screen full of labeled buttons, so you don't have to do any icon decryption. The left button on the mouse lets you select buttons or perform actions; the right button switches you instantly between the buttons and your drawing.

DEGAS is full of features: points, lines, shapes (frames and solids), brushes, fill patterns, shadows and mirrors, and a lot of "design your own" power (including a separate font editor). Response time is fast, the manual is well written (but largely unnecessary—a tribute to the program's user interface), and it's just a great program. Best of all, it works on both color (16 colors from a palette of 512) and monochrome monitors, which a lot of ST software (including the public-domain painting program NeoChrome) won't.

The easiest way to put it is this: If you own an ST, you should buy DEGAS. And please *buy* it. The folks at Bat-

(continued)

Contemporary Programming & Software Design Series

TRIAL EXAMINATION ORDER FORM

YES! I would like to learn how to make any computer do exactly what I want it to do and would like to examine the first module in the Series absolutely free. If I decide to keep it, I will pay just \$24.95 plus \$2.25 shipping and handling. I will then receive future modules automatically, one every 4 to 6 weeks. Each of the 10 modules in the Series is \$24.95 plus \$2.25 shipping and handling and comes on the same 15-day Trial Examination basis. There is no minimum number of modules that I must buy and I may cancel at any time simply by notifying you.

If I do not choose to keep the first module, I will return all materials in good condition and pay nothing. Future modules will be canceled and I will be under no further obligation.

Name _____

Please Print

Street _____

City/State/ZIP _____

Phone Number () _____

The interactive disks included with this series will run only on IBM-PC or IBM-PC compatible computers. All orders subject to approval and payable in U.S. funds only. Available in U.S. and Canada only.



Ten modules teach you how to write your own programs or modify existing software to fill your needs:

- Getting Started in Programming & Software Design
- Attacking the Problem
- How to Design the Solution and Arrange It Logically
- Coding the Program: High Level Languages
- Coding the Program: Assembly Language
- Testing and Debugging Made Easy
- Creating Meaningful Documentation
- Modifying & Updating Existing Programs
- Tools & Tricks for Program Design
- Writing Advanced Programs

2500-046



Post Office
Will Not
Deliver Without
First Class
Stamp



McGraw-Hill Continuing Education Center
3939 Wisconsin Avenue
Washington, D.C. 20016-2876



Make Any Computer Do Exactly What You Want With McGraw-Hill's

Contemporary Programming & Software Design Series



From Writing Your Own Programs to Modifying Existing Software, Here's the New, Easy, and Low Cost Way to Unlock the Secrets of Your Computer

Whether you use computers for business, for personal applications, or for fun, off-the-shelf programs will never do everything you want them to do for you. That's because they were written by programmers to satisfy what they perceived as the needs of the greatest number of potential users—often missing some or many of your specific needs.

That's why McGraw-Hill's new Contemporary Programming and Software Design Series teaches you how to create your own software . . . either from scratch or by making key modifications to existing programs.

There is nothing magical about it. You learn the process of building a computer program step-by-step with McGraw-Hill *Concept Modules* sent to you one at a time, once a month. Each of the ten modules in the Series takes you through an important step in the development of the structure and detailed logic of a program, including testing, debugging, and documentation.

Unique Interactive Hands-On Instruction

Each module includes an easy-to-understand guide PLUS a 5¼" floppy disk containing typical programs and interactive instruction that you can run on any IBM or IBM-compatible computer for hands-on experience.

In the first Module, for example, when your sample program (Declining Interest Loans) appears on your screen, you'll find errors on certain program lines. You'll also see that the program is only three-quarters completed.

Now comes the fun part. You'll discover how this program is built, and in the process you'll learn how to identify and correct errors. And by the end of Module 1, you'll actually have

completed this program yourself.

But there's more. Special graphics on your screen work in conjunction with the accompanying guide to amplify, illustrate, and deepen your understanding of software design principles.

Learn the Foundation of All Computer Languages

Although the Series teaches you programming procedures, it is not aimed at

any one language or machine. Why? Because 95% of the programming process is carried out using design techniques that are independent of a specific language or machine. Nevertheless, we include enough training in BASIC and machine language to get you started. You'll find that the whole process of learning new languages will be greatly accelerated once you complete the Series.

Create a Complete, Customized Family Financial Package As You Learn

The sample programs you work with throughout the Series are excellent learning tools. But they're more than that. By combining the sample programs onto one master disk, you'll create your own family financial package that will help you balance your budget, figure loan amortization, and much more. And — of course — you'll be able to further modify your financial package to fit your own specific needs!

15-Day No-Risk Trial

To order your first module without risk, send the postage-paid card today. Examine the first module for 15 days and see how the Series will help you make any computer do exactly what you want it to do!

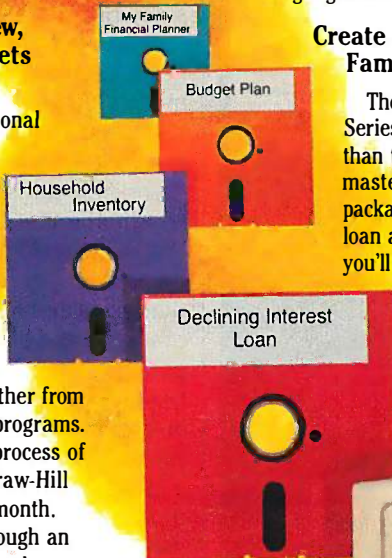

If someone has beaten you to the card, write to us for ordering information about the Contemporary Programming and Software Design Series.

McGraw-Hill Continuing Education Center

3939 Wisconsin Avenue
Washington, DC 20016

IBM is a registered trademark of International Business Machines, Inc.





So you can't get Toshiba Printer Accessories, Bunkie?

Any time (24 hours) grab your VISA or MasterCard
JUST CALL **800/854-0561** EXT 837
IN CALIFORNIA CALL 800/432-7257 EXT 837

Type Font Cartridges for

Toshiba P351, P341 and P321 Printers

T/FC 011 \$69	T/FC 015 \$69
Bold Letter	ORATOR1 Orator2
T/FC 012 \$69	T/FC 016 \$69
Elite Gothic	Outline Script
T/FC 013 \$69	T/FC 017 \$69
Greek/Math/Apl	Theme Italic

Ribbon for 3-in-One Printers

T/R 001 \$12: Ribbon fits Toshiba dot matrix printers.

Start-Up Kit

T/SK \$99: Accessory sample kit contains Type Font Cartridge (Bold Face, Letter Gothic), Type Font Disk (Extended Word Processing), Printer Ribbon, Data Disk, Enhancement Catalog, Type Font Catalog and much, much more.

P351 Dual Emulation Kit

T/DE 351 \$99: Upgrade your early model P351 to add IBM Graphics Printer emulation. Complete instructions included.

User's & Technical Reference Manuals

Complete line of manuals to support Toshiba Printers; P1340, P351, P341, P321. Write for complete catalog.

A minimum shipping and handling charge of \$4.75 will be added to each order. 6% sales tax will be added to California orders.

Type Font Disks (Downloadable)

G/FD 051 \$50:	Designed especially for scientific applications; 4 fonts.
G/FD 053 \$30:	Maxiset (oversized characters for headlines); 1 font.
T/FD 016 \$69:	Extended word processing package. Ideal for desktop publishing; 5 fonts.
T/FD 011 \$49:	Standard word processing packaging; 3 fonts.
T/FD 014 \$49:	Presentation size type fonts; 2 Orators & 1 Outline.
T/FD 015 \$49:	Correspondence quality type fonts; 1 Roman, 1 Script & 1 Italic.
T/FD 013 \$69:	Math and Scientific fonts; 2 Math; 1 Application & 1 Scientific.
T/FD 021 \$49:	Quality Pack; 1 Regular and 1 Bold Italic & 1 Gothic.
F/FD 001 \$95:	2 Micro (10 & 20 cpi), Copper, Reg. Italic, Bold Italic, Zip & Science.
F/FD 002 \$95:	Demi Gothic, Gothic (15 cpi), Boss, Serif Italic, Gothic Italic, Fathead, Greek.
F/FD 004 \$95:	Roman, Elite Italic, OCR A & B, Pres. Pica, Greek, Micro (15 cpi).

PRINTER
ACCESSORIES

WRITE FOR A COMPLETE CATALOG

DIRECT INC./ P.O. BOX 19608-347, IRVINE, CA 92713

ACCORDING TO WEBSTER

teries Included were trusting enough not to copy-protect DEGAS and sensible enough to sell it for a fair price (\$39.95). Please don't abuse that trust by getting it from a friend or letting a friend pirate your copy. And, no, I have no connections whatsoever with Batteries Included or Tom Hudson; I would just hate to see them both get ripped off by a bunch of thieves.

AMIGA SOFTWARE

As mentioned last month, Amiga software has just started to hit the shelves. In the past week, I've received about a dozen programs, all coming from just two publishers: Electronic Arts and Lattice.

As with the ST, the best Amiga program so far is a painting program: Deluxe Paint, written by Daniel Silva and published by Electronic Arts. Deluxe Paint is reminiscent of MacPaint—a menu bar across the top, icons along one side—but there's a big difference: color. And lots of it.

What really makes Deluxe Paint stand out are its features. Let's start with the color palette. In low-resolution mode (320 by 200 pixels), you can have 32 different colors (out of a possible 4096). Like DEGAS, you can individually adjust each color. But the palette's functions don't stop there. You can select any two colors on the palette and have it automatically generate a set of intervening colors. For example, if color #5 is pure red and color #15 is pure green, the spread function will turn colors 6-14 to shades that go from red to green—in this case, passing through orange and yellow along the way. I was able to easily generate a "rainbow" palette by creating the classic rainbow colors (red, orange, yellow, green, blue, indigo, violet) at regular intervals, then using the spread function to create intervening shades. Like DEGAS, you can set up a range of colors to cycle through; unlike DEGAS, you can define up to three different cycle ranges, each with its own speed.

As for painting, you have most of the tools found in MacPaint and DEGAS—like lines, filled and framed shapes, etc.—and quite a few found in neither, like the ability to do smearing, shading, or blending of the colors. You can grab any rectangular portion of the screen and use it as a brush. You can save and load brushes, which gives you an effective "clipboard" for saving chunks of pictures.

Comparing DEGAS (on the ST) and Deluxe Paint (on the Amiga) isn't easy, if simply because they are on two different computers. I prefer the two-screen user interface of DEGAS; it's easier to learn and a bit less cryptic. Deluxe Paint, on the other hand, has significantly more capabilities and options. Just about everything that DEGAS lets you do, Deluxe Paint lets you do in more ways and with more options, though there are a few things that DEGAS does better (or that Deluxe Paint just doesn't do). And like DEGAS and the ST, Deluxe Paint is a program you should buy if you own an Amiga.

Three of the remaining EA programs are games: Seven Cities of Gold, One on One, and Archon. Unfortunately,

(continued)

THE
BYTEK
SYSTEM 125

ALL IN ONE

- A GANG PROGRAMMER,
- A SET PROGRAMMER,
- A UNIVERSAL PROGRAMMER,

PLUS FEATURES LIKE THESE:

- SUPPORTS ALL TECHNOLOGIES
- UP TO 1 MEGA BYTE OF RAM
- CENTRONIC PARALLEL PRINTER PORT
- 16 x 2 LIQUID CRYSTAL DISPLAY AND MUCH, MUCH MORE.
- HIGHEST PERFORMANCE/COST RATIO AVAILABLE TODAY
- OTHER MODELS AVAILABLE
- PRICES START AT \$995
- UV ERASERS FROM \$67
- AVAILABLE FROM STOCK

CALL NOW TO ORDER
(305) 994-3520

Corporation
Instrument Systems Division

1021 South Rogers Circle, Boca Raton, FL 33431
(305) 994-3520, Telex 4310073 MEVBTC

IN ADDITION TO PRINTING TEXT AT 40, 100 OR 200 CPS, THE IBM PROPRINTER CAN PRINT ALL-POINTS-ADDRESSABLE GRAPHICS. →

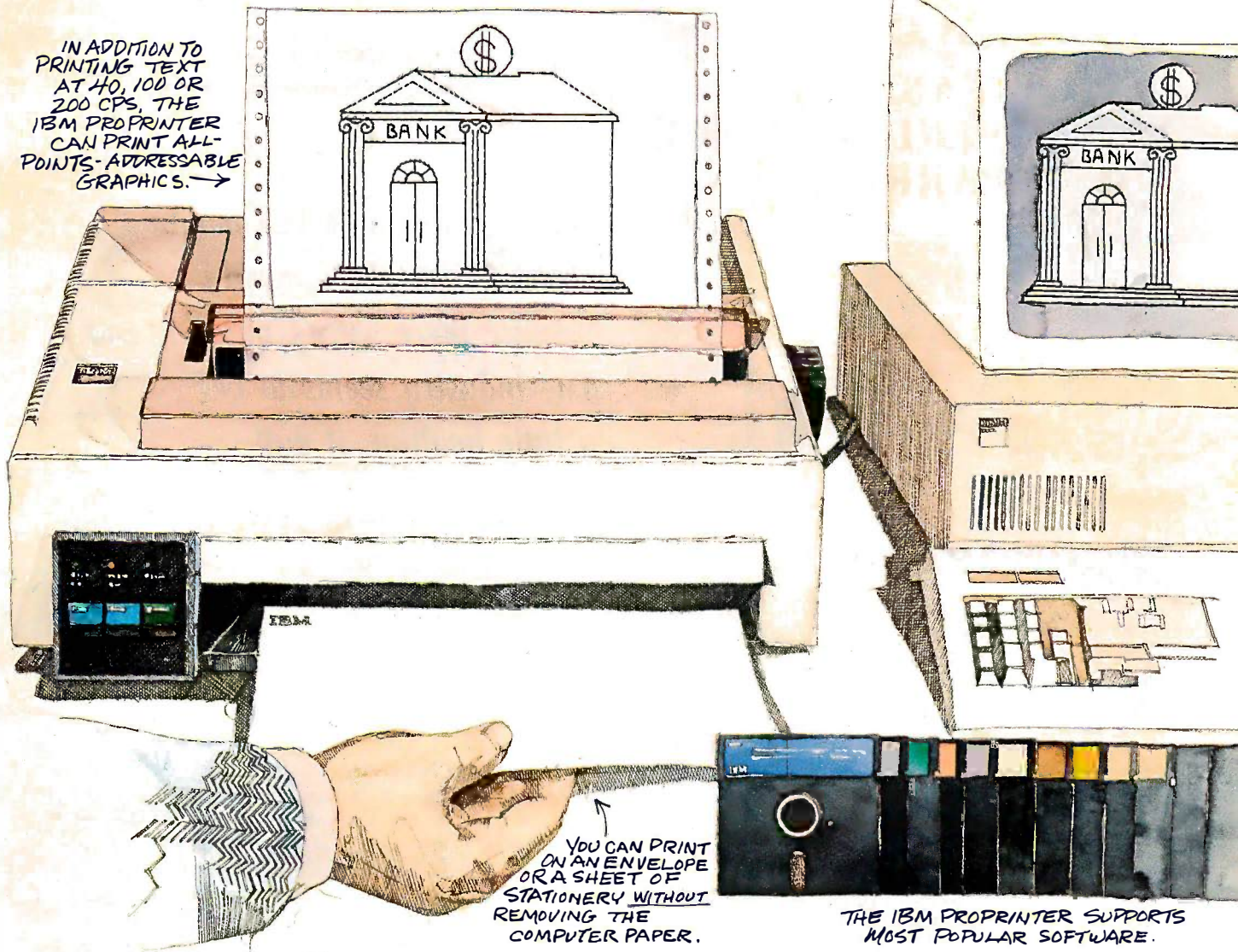

Built to take it. Priced to take it with you. The Proprinter from IBM.

There's just one thing that's as remarkable as the rugged reliability of our most versatile personal printer—and that's its price. Under \$550.

The Proprinter is built by IBM to last. And simplicity of design is what makes it so reliable.

Yet the IBM Proprinter is a full-featured machine. It has three printing speeds to give you everything from fast first drafts to sharp, near-letter-quality correspondence. It takes perforated

computer paper for long jobs and—without removing the paper—will easily print on a sheet of stationery or an envelope, thanks to a handy slot in front.

With its all-points-addressable graphics and its comprehensive character set, the IBM Proprinter supports most popular software.

The Proprinter attaches to every IBM PC and to other leading personal computers. And it's just part of our growing family of personal printers. All are

designed to serve a single purpose: To give everything you do the finishing touch.

For the authorized IBM dealer or the IBM Product Center nearest you—or for free literature—call 1 800 IBM-2468, Ext. 104/LH. Or contact your IBM marketing representative.

IBM Personal Printers...The Finishing Touch

Western Computer

BREAKS THE PRICE/PERFORMANCE BARRIER



WESTERN COMPUTER AT TURBO

STANDARD FEATURES:

- IBM PC/AT Compatible with 512K RAM
- Switch Selectable 6 or 8 MHz operation
- Up to 2 Megabytes of RAM on Main board
- One Parallel Port & Clock/Calendar on Main board
- Enhanced PC/AT style keyboard
- Various mass storage and video display options available
- One Year Warranty



WESTERN COMPUTER PC/XT TURBO

STANDARD FEATURES:

- IBM PC/XT Compatible with 256K RAM
- Switch Selectable 4.77 or 8 MHz operation
- Up to 1 Megabyte of RAM on Main board
- Two 360K Floppy disk drives and controller
- 750 x 350 Monochrome graphics controller or IBM CGA compatible controller
- Amber or green display monochrome monitor
- Enhanced IBM PC style keyboard
- Various mass storage, I/O, and Video display option available
- One Year Warranty

Western Computer

1381 WARNER AVE.
WARNER CORPORATE PARK #B, TUSIN, CA 92680
(714) 259-7755

EUROPEAN HEAD OFFICE
BELECTRONIC SA, RUE CENTRALE 43
CH-1880-BEX, SWITZERLAND
PHONE (025) 631250

TELEX 456 168 ASWERBACK BELE CH.
IBM PC/XT/AT/CGA are trademarks of IBM corp

ACCORDING TO WEBSTER

*I didn't say much last month
about COMDEX, mostly
because there wasn't much to say.*

*The industry seems to be
a little healthy, if dull.*

all three require a joystick, or at least work a heck of a lot better with one. More on these once I can scrounge up a joystick. The remaining EA program, Financial Cookbook, will probably get covered in a later column; I have an aversion to financial software that I must overcome first.

The software from Lattice is all geared toward development (i.e., a C compiler, a "Mac Library," and so on). I'll report more on this next column, since I'll probably convert all my benchmarks over to it.

NOTES AND COMMENTS

I didn't say much last month about COMDEX, mostly because there wasn't a whole lot to say. The industry seems to be a little healthy, if dull. The three most interesting things I saw were Atari's booth, which was crowded with third-party software displays; Commodore's booth, which was noteworthy in that it didn't exist; and the Levco 2-megabyte Monster Mac upgrade being shown in (of all places) the Apple booth. The latter was remarkable, given Apple's past attitude toward third-party memory upgrades; it also gives me hope for Apple.

The Mac Plus and the Atari 1040ST should both have been announced by now. The two machines are remarkably similar: 1 megabyte of RAM; a built-in double-sided 3½-inch disk drive; high-resolution monochrome monitor; a large ROM (128K bytes for the Mac Plus, 192K bytes for the 1040ST); 68000 processor; mouse; large keyboard with cursor keys and numeric keypad. The big difference is price: \$2495 for the Mac Plus, \$995 for the 1040ST. And, of course, the 1040ST has built-in color graphics and a faster clock speed. Some of you may be asking yourselves, "Why does the Mac Plus cost so much more than the 1040ST?" Good question. Wish I knew the answer.

Speaking of the ST. . . Atari says that with the introduction of the 1040ST, the 520ST will be unbundled and sold through the mass market (K-Mart, etc.) for \$299. Of course, since it's nearly impossible to hook up anything but an Atari monitor to it, and since the machine is basically useless without a disk drive, the cost for a working system (monochrome) will be about \$700. You're probably better off spending the extra bucks and just getting the 1040ST. Also, my memory may be playing tricks on me, but didn't Jack Tramiel spend most of 1985 swearing up and down that he was *not* going to sell the ST through the

(continued)

DATAEASE™

The Corporate Database Standard.

DATAEASE

#1 with Corporate users.

Thousands of businesses, both large and small, use DATAEASE to solve their needs. Because DATAEASE, with its ideal combination of power and ease-of-use, allows you to gather, link, calculate and report information key to decision making — all without programming skills.

"We chose DATAEASE over dBASEII™ and Lotus 1-2-3™ because most of the programming was already done."

Joe Dane, Human Resources Director
MCI Telecommunications Corporation

"Office staff members with little to no computer experience are actively using DATAEASE to improve productivity in handling large amounts of information."

Louis M. Brigando, Senior VP,
MetPath, Inc.

"We switched from a \$250,000 mini system to a \$15,000 system of IBM PC's and DATAEASE. Now orders, inventory, sales . . . everything is easier. All without the help of a programmer."

J.A. Fulmer
Robinson
Foundry, Inc.

DATAEASE

#1 with Reviewers

"I was very impressed with its overall performance and features."

Bill Jacobson
BYTE, October 1984

"DATAEASE is a true winner."

Business Computer Systems
April 1984

DATAEASE was rated good or excellent in performance, documentation, ease-of-use, error handling, support...in all areas.

InfoWorld
March 25, 1985

"DATAEASE is perhaps the most effective blend of ease-of-use and performance available for PC users to date."

Data Decisions
January 1985

For information or the dealer nearest you call:

800-243-5123

DATAEASE

#1 in Corporate sales.

According to several recent best seller lists, DATAEASE is now the industry standard for corporate users who want a database that doesn't require programming:

DATAEASE tops dBASEII, R:BASE™ in Corporate Software sales.

Infosystems, March 1985
Corporate Best Seller List

DATAEASE outsold all other database management systems — ahead of dBASEIII™, Symphony™ Framework™ and R:BASE 4000.

MIS, Inc., September 1984
A leading supplier to Corporate America

DATAEASE ranked #3 on best sellers list; outselling Lotus 1-2-3™, R:BASE and Powerbase™

Software News, March 1985
Corporate Best Sellers List

Why settle for less? Contact Software Solutions, Inc. for more information on DATAEASE, the #1 choice of Corporate America.

Software Solutions, Inc.

305 Bic Drive, Milford, CT 06460
203-877-9268
Telex: 703972

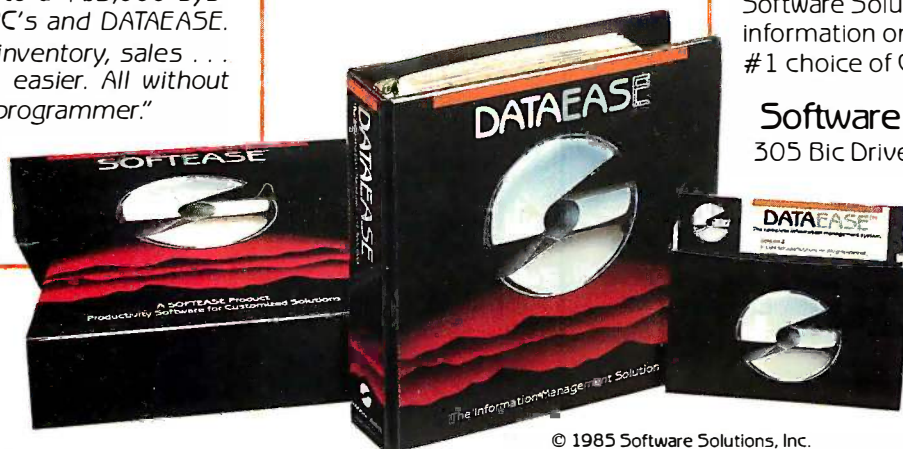

© 1985 Software Solutions, Inc.

Scandinavia
WestSoft AS, Alesund, Norway; (47) 71-41141

South Africa
Dataflex, Craighill; 11724-6353

Switzerland, France
Softsource, S&A 1222 Vesenz, Switzerland; 022-3518-55

United Kingdom
Sapphire Systems, Essex; 01-554-0582

West Germany, Austria
M&T Software Verlag, Munich; 089-4615-0

Second Annual
**Interactive Videodisc West
 APPLICATIONS IN
 DISTRIBUTED EDUCATION AND
 POINT OF PURCHASE
 MARKETING**

May 14-16, 1986
 Los Angeles Airport Hilton
 Los Angeles, California

*Presentations will cover
 Interactive Videodisc applications in:*

- Employee information and training
- New marketing strategies
- Market enhancement through electronic shopping
- Public information stations
- Increased advertising effectiveness
- ... and more

This conference is focused on the use of new electronic technologies to increase sales, reduce costs, and provide distributed product, service, and training information. It is designed for **executives, administrators, and senior professionals** responsible for the introduction of effective media to accomplish sales, marketing or training objectives.

Exhibits of representative technology will be available to conference participants. Optional **pre-conference tutorials** will be offered on May 13.

For further information contact:

SALT

Society for Applied Learning Technology
 50 Culpeper Street, Dept. B.
 Warrenton, VA 22186 (703) 347-0055
 Toll Free 1-800-457-6812



ACCORDING TO WEBSTER

ITEMS DISCUSSED

DEGAS	\$39.95
Batteries Included 17875 Sky Park North, Suite P Irvine, CA 92714 (416) 881-9816	
DELUXE PAINT	\$79.95
FINANCIAL COOKBOOK	\$49.95
ONE ON ONE	\$39.95
SEVEN CITIES OF GOLD	\$39.95
ARCHON	\$39.95
Electronic Arts 2755 Campus Dr. San Mateo, CA 94403 (415) 572-2787	
HOLMES & DUCKWORTH FORTH	\$49.95
HOLMES & DUCKWORTH TOOLBOX VOL. I	\$39.95
Mirage Concepts Inc. 4055 West Shaw, #108 Fresno, CA 93711 (209) 227-8369	
MAC C	\$425
Consulair Corporation 140 Campo Dr. Portola Valley, CA 94025 (415) 851-3272	
MACLANGUAGE SERIES PASCAL	\$99.95
TML Systems POB 361626 Melbourne, FL 32936 (305) 242-1873	
M-DISK	\$39.95
SOFT SPOOL	\$39.95
MICHTRON UTILITIES	\$59.95
MUDDPIES	\$39.95
FLIP SIDE	\$39.95
MichTron Inc. 576 South Telegraph Pontiac, MI 48053 (313) 334-5700	

DESMET C \$150*

Macintosh™ Development Package

- Runs on both **128K** and **512K Macintosh**
- Full **K&R Compiler** — **IEEE Floating Point**
- >450 Function **Macintosh ROM Library**
- Assembler, Linker & Librarian
- >120 Function **STDIO Library**
- Machine Code Debugger
- Source Code Editor
- "Shell" interface
- 300 Page manual
- RAM Disk**

Published and sold direct to the end-user by:

C Ware Corporation
 P.O. Box C, Sunnyvale, CA 94087
 (408) 720-9696

*Price includes domestic shipping. Canada \$5. Europe/Asia add \$20. Call to charge by **VISA, MC or AMEX.** Street address: 505 W. Olive, #767, Sunnyvale, CA 94086.

Macintosh is a trademark licensed to Apple Computer, Inc.

mass market? I wonder how dealers are going to react to all this.

COMING ATTRACTIONS

Okay. Next month for sure, the benchmarks on the Mac, the Amiga, and the 520ST. . . and, if I can, on the Mac Plus and the 1040ST as well. Maybe some more software reviews—I've got a stack of Mac and IBM software I haven't touched yet. And whatever else comes this way. Until then, see you on the bit stream. ■

A fresh breeze across the Pacific.

The airline that serves more top business centers in the United States now serves more top business centers across the wide Pacific with more nonstops than any other airline.

Convenient service to thirteen cities in all, with all the advantages that come with one airline service.

One airline to handle ticketing, seat assignments,

boarding passes, and baggage for your whole trip.

And, of course, United's incomparable Mileage Plus, offering a whole world of exciting travel awards.

You'll enjoy United's famous Royal Pacific Service, the best of the

friendly skies in First Class, Business Class, and Economy.

Best of all, you'll be flying with a friend. United Airlines. Now the friendly skies covers the wide Pacific.

Call United or your Travel Agent.

*You're not just flying,
you're flying the friendly skies.*

Inquiry 352



United

Conquest: Two Cards for the Price of One



One Card, One Slot, One Choice

Introducing Orchid's Conquest, the first PC multifunction card with 2 megabytes of the new Lotus EMS Expanded Memory. It's like having a multifunction card and an EMS card in one slot, but it costs less than you'd expect to pay for either.

Multifunction Card

Conquest is a multifunction card with serial/parallel ports, clock/calendar, and DOS Memory. And Orchid's Switchless Installation gets you up and running in minutes.

Expanded Memory Card

Conquest breaks the 640K DOS memory limit with 2 megabytes of Lotus EMS Expanded Memory. Orchid's Productivity Software lets you use this memory for RAM Disk and Caching, so you take advantage of it with your existing software.

Whether you're buying the first expansion card for your PC or an add-on for Lotus EMS Expanded Memory, Conquest is your choice:

- ▲ **First Card Buyers:** Conquest is a multifunction card with EMS.
- ▲ **Multifunction Card Owners:** Conquest is an EMS card with ports.

Features:

2 megabytes of RAM
DOS & EMS Memory
1 Serial, 1 Parallel Port
Clock/Calendar

Productivity Software:
RAM Disk
Disk Caching
Print Spooling
Alarm & clock display

Optional PCnet connection



47790 Westinghouse Dr.
Fremont, CA 94536
415/490-8586
Tlx: 709289

A Couple of Winners

Mirror and
Framework II

BY EZRA SHAPIRO

I feel a little embarrassed this month. I wanted to find some awful program to expose, some dire warning to issue. Instead, I'm staring at a mass of complimentary adjectives. But these two programs are the first I've encountered in a while that I've actually begun using in my day-to-day routine. I suppose I'll have to wait until next month to develop my reputation as a hard-nosed trasher of software.

SUPERCLONE

For 50 bucks you can buy *Mirror* (SoftKlone Distributing Corp., \$49.95, 1210 East Park Ave., Tallahassee, FL 32301, (904) 878-8564), a telecommunications program for MS-DOS machines that looks like Microstuf's Crosstalk XVI, acts like Crosstalk XVI, and uses preexisting Crosstalk XVI parameter and script files. [Editor's note: Microstuf has filed suit against SoftKlone on charges of copyright infringement for damages in excess of \$1 million.] Since Crosstalk costs more than twice as much even when discounted, this is good news if you were about to plunk down your cash for a copy of Crosstalk. But what if you already own a telecommunications package? This is all a big yawn, right?

No, wait. There's more to it than that! I've deleted my Crosstalk files and plugged in *Mirror*, and I'm not the sort of person who throws out trusted software without good cause. I've got to have *proof*, and here it is.

File-transfer protocols: Crosstalk supports only ASCII (text) transfer, XMODEM (with checksum error detection), and Crosstalk's own batch transfer. *Mirror* does all that and adds Kermit, MITE/Framework batch XMODEM, Hayes Smartcom, and a choice of either checksum or cyclic redundancy error checking.

Fast access to a text editor while on line: *Mirror* has a decent one built in; Crosstalk doesn't (although both programs will accept a DOS path to let you get to your own editor).

Security: You can use Crosstalk as a call-in system, but it lets you establish only one

password for the entire system. Beyond that, you can pick one of four levels of file-manipulation clearance; but even at the most restrictive level, any caller who figures out the password and a one-character trigger command can move through your directories and view the contents of your files. You can configure *Mirror* to do the same thing if you like, but it can also ask for callers' names and *individual* passwords. Further, you can restrict or grant access to specific system commands on a caller-by-caller basis. Finally, you can have *Mirror* execute command scripts written for each caller. In short, although *Mirror* lacks a messaging system, you can turn it into a fairly complete upload/download bulletin board.

And now, here's the kicker: *Mirror* will perform protocol file transfers as a background operation. You initiate a transfer and press both shift keys, and *Mirror* becomes a concurrent memory-resident utility. The other night I downloaded a binary file (using XMODEM/CRC) to my C drive while *simultaneously* doing a DISKCOPY from A to B and spooling a file to my printer with the DOS Print utility. That's three memory-intensive disk-intensive operations at once. All went smoothly, with no noticeable degradation in performance. I then installed a new copy of Framework II in the C drive (talk about constant disk access!), did some maintenance, and typed a page of text. No problems.

According to Bruce Justham, who wrote the program with Don Waldo, the trick is simple. *Mirror* uses an internal 4K-byte buffer. At 1200 bps, it only has to flush the buffer to disk at half-minute intervals, so contention is infrequent.

Mirror is just small enough so that if you aren't running lots of pop-up programs, you can even load a big guy like Reflex or Framework while *Mirror* chugs along in the background. I've been experimenting with different software combinations, and I haven't experienced any major hassles. This

(continued)

Ezra Shapiro is BYTE's West Coast Bureau Chief. Contact him at BYTE/McGraw-Hill, 425 Battery St., San Francisco, CA 94111.

INTRODUCING
SOFTWARE
WITH A MIND
OF ITS OWN

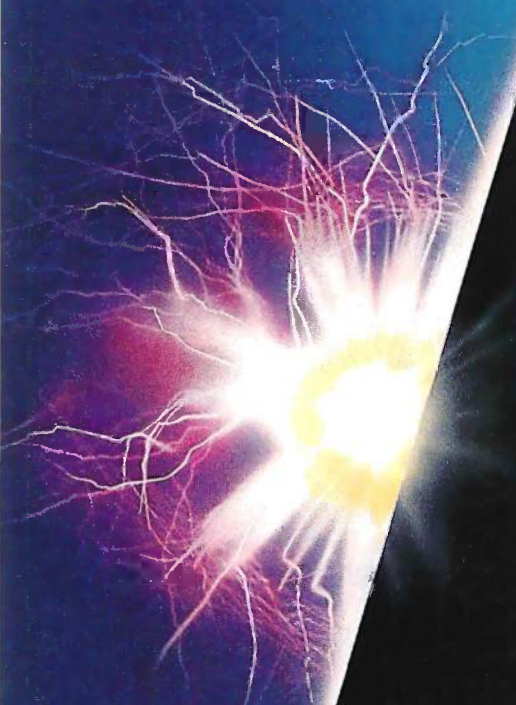

GURUTM

Inquiry 216

ARTIFICIAL INTELLIGENCE THAT MEANS BUSINESS.

For more information, write or call MDS,
P.O. Box 248, Lafayette, IN 47902. (317) 463-2581.

means I might never again have to twiddle my thumbs while sending files. That fact alone makes Mirror worth the price.

Now it's only fair to point out that Crosstalk provides you with a much nicer manual in a nifty plastic slipcase; Mirror gives you a badly printed paperback book. And Mirror has some of the most garish screen displays (when it loads and exits) that I've ever seen. But I'm not complaining; I'll just grit my teeth and *use the product*.

FRAMEWORK REVISITED

When the original Framework was introduced, it took three of us (Rick Jadrnicek, John Markoff, and me) nine magazine pages to present a preview that barely scratched the surface of the program's operation (see "Framework," August 1984 BYTE, page 121). We were dazzled by the demonstrations we saw—windows appearing and

disappearing like lightning, linked spreadsheets and databases recalculated at the touch of a key, massive programming capacity.

Yet, for the next year, every time I sat down and really tried to *use* the product, I'd find myself hesitantly tapping a few keys, scratching my head, and muttering, "How did they *do* that?" I'd decide it was too much bother, and I'd give up.

In some ways, I think Framework suffered because of the visionary nature of the product. In all its incarnations, it's been very much a toolbox for manipulating data. In Framework 1.0 and 1.1, the basic building blocks—word processor, spreadsheet, database, etc.—all seemed somewhat limited. The real power of the program lay in FRED, Framework's macro language. With FRED, you could do amazing things: link data items, replicate long sequences of key-

strokes, manufacture complex computational formulas, incorporate external programs, and even develop menu-driven specialized applications.

Those earlier Frameworks lacked a lot of the amenities one normally expects in business software. For example, if you needed to change the output settings for a text document, you had to write a FRED program to do it, or you were stuck with the default values. If you wanted to learn to use the product well, you had to be willing to commit a lot of time to it, something that I, at least, looked at with a sense of doom.

Enter Framework II (Ashton-Tate, \$695, 20101 Hamilton Ave., Torrance, CA 90502, (213) 329-8000; environment: MS-DOS)—older, wiser, and a lot more in tune with the real world. It's still the same product with the same philosophy, but it's now useful

(continued)

Princeton Graphic Systems—the choice in PC monitors.

High resolution.
Sharp, crisp text.
Bright, vibrant colors.
Full PC compatibility.
Rugged dependability.
We design our monitors to meet your most demanding computer needs.

From sophisticated business graphics to basic word processing, we make sure there's a Princeton monitor for you.



For the second year in a row, you've voted our high resolution HX-12 RGB color monitor the number one color monitor in the world. Thank you for your vote of confidence...*

* Results of PC World's "World Class PC Contest" for 1984 and 1985.



NUMBER SMASHER™

Triple your PC speed for only \$799!

8087 Upgrades™

MicroWay is the world leader in 8087 support. Our 8087 development software has been in use since 1982. By 1984 we had become Intel's 97th largest OEM account. When you buy from us, you can be confident that you will receive the 8087 chip designed for your PC and that our unique diagnostics will instantly verify that your processor works correctly as installed. Call for current prices.

287Turbo™

This card plugs into the 80287 socket on your AT or COMPAQ, doubling the 80287 clock from 4 to 8 Mhz. It does not change the 80286 clock speed or affect your warranty. The card comes with an 8 Mhz 80287 and has provisions for faster crystals as better 80287s become available. It also has a reset button and circuit that provide a hardware alternative to CNTRL-ALT-DEL. 287Turbo with Diagnostics and Reset **\$395**

Number Smasher™

Number Smasher gives you AT speed and 100% compatibility with all PC software and hardware. It comes with a 10 Mhz 8086 and 512K of no wait state RAM. Most are shipped with an optional matched 10 Mhz 8087 and 128K daughterboard. The card runs programs a factor of 2.5 to 4.0 faster than the PC, XT or compatibles it runs in. Other features include FASTROM, a Ram Disk, Print Spooler and Disk Cache. Revision 2 of the Smasher is designed and manufactured by MicroWay in the U.S.A. and has the best service and support of any accelerator card.

MegaPage™

MicroWay's "Lotus/Intel" extended memory card has all the features of the others plus one: it uses low power, cool running CMOS DRAM. Ask for our pamphlet "Extended vs Expanded Memory" and learn why MegaPage is the right card for you. MegaPage with 2 Megabytes CMOS **\$549**



Inquiry 226

The World Leader in 8087 Support

P.O. Box 79, Kingston, Mass. 02364 USA (617) 746-7341
Tempo House, London, U.K. call 01-223-7662

Number Smasher, MegaPage and 287Turbo are trademarks of MicroWay, Inc. MicroWay is a registered trademark of MicroWay, Inc.

right out of the box rather than months later. Some of the improvements have been functional, some merely cosmetic, but they add up to a far less frustrating piece of software. Here are some high points.

Most formatting is now controlled by menus; you no longer have to learn FRED to put headers and footers on your printouts.

Framework II incorporates a decent spelling checker that you can use on spreadsheets or databases as well as text files.

Spreadsheets can now be as large as memory allows, up to 32,000 cells square. Framework II uses sparse matrix algorithms and swaps out to "extended memory," which can be EMS or Lotus/Intel/Microsoft boards, RAM disk, or even hard disk. With FRED's large collection of numeric functions, the spreadsheet portion of Framework II is arguably as good as

any spreadsheet on the market.

The telecommunications interface has been completely redesigned and integrated into Framework II. In earlier versions, MITE, a stand-alone product from another company, was simply grafted onto Framework. Now, telecommunications sessions are treated like any other text; you can edit them or massage them with FRED programs. You could build an automated stock-tracking program that pulls quotes from an on-line service, feeds them into a spreadsheet or database, and hands you printed graphs. Note that this can be done as a background task, while you do other work.

Convenience functions have been added to most menus. You can perform word counts, insert soft hyphens and page breaks, execute mail merge or label printing, import and export files in foreign formats, and "goto" named locations directly rather than

use the cursor. All this was possible before, but you had to load and run FRED programs; you couldn't just select menu items.

Now you can create macro commands by recording keystrokes as you enter them. Prior versions had no record/playback capability. And a library of macros loads automatically when you bring up the program; you no longer have to search for them on disk at the start of every session.

You can now change default configuration settings by means of a setup utility. It's not a great program, but it sure beats the old method that required you to edit a very programmerish text file that looked like the "equates" section of an assembly-language listing.

The documentation has been completely rewritten.

And the list goes on from there.

(continued)

Princeton monitors set the pace.

To become a leader, you've got to keep ahead of the crowd. At Princeton, we set the pace. We delivered a color monitor for the IBM PC before IBM. And continue with a full line of state-of-the-art quality monitors. Monitors that deliver the features you demand.

High resolution. Sharp, crisp characters. Bright, colorful graphics.

Take a close look at a Princeton monitor. You'll see the sharp, crisp characters and fully formed graphics that make our monitors stand out against the competition.

Add to it a fine dot pitch. A nonglare screen. Our flicker free technology. And you've got an image that makes you more productive, less fatigued.



Easy to use. Our monitors are compatible with the leading brands of personal computers. IBM™, Compaq™ and more. But we go one step further. By paying close attention to ergonomic detail, we make monitors compatible with you.



Dependability.

You can count on Princeton monitors when you need them. They're rigorously engineered and manufactured under the highest quality control standards. Backed by a full one-year warranty. Supported by a nationwide service network. The result: monitors you can depend on.



Princeton's HX-12E gives you brilliant 64-color displays and extra sharp text.

Bringing you the future.

Princeton continues to set the industry pace with products like our HX-12E, the first IBM-compatible high resolution RGB color monitor with a .28mm dot pitch to support IBM's Enhanced Graphics Adapter. And our SR-12P, the first IBM-compatible analog color monitor, with a .26mm dot pitch to support IBM's Professional Graphics Controller...



THE PC'S LIMITED AT™ — \$1995.

THE PC'S LIMITED TURBO PC™ — \$795.

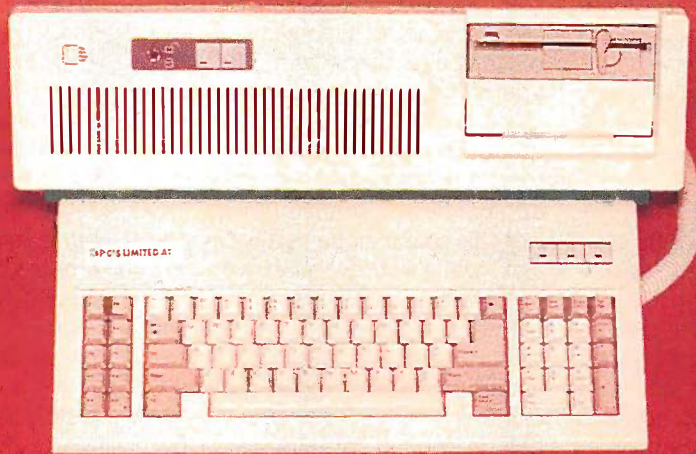

At these prices, it's no wonder
we're burning up the marketplace.

Yes, you can believe it. Since we ran our first advertisement for the PC's Limited AT™ and Turbo PC™, the calls we've received mostly start with comments like "Is this for real?" And "How can that be?" But now that our machines are in the hands of influential buyers, the questions tend to concern quantity discounts for further purchases. (Which are available.) You see, the PC's Limited machines are assembled from components bought worldwide with our strong buying power. Then they are offered directly to you—with no middleman markups. So light a match to your old budgets. With the savings we're providing, you'll have money to burn.

PC'S LIMITED AT™

- 80286-based System Unit running at 6MHz. (8MHz option included at no charge.)
- 1024K on Mother Board
- 1.2 Meg Floppy Drive
- Combined Floppy/Hard Disk Controller Card
- AT Keyboard
- 192W Power Supply
- 2 Serials and 1 Parallel Port
- Clock/Calendar with Battery Backup

Runs all Major Software written for the IBM PC™, PCXT™, and PC AT™. Unit has 8 Expansion Slots. Same Bus Configuration as IBM PC AT™. One year limited warranty.

GW Basic \$95 • DOS 3.1 \$85 • 80287 \$195

PC'S LIMITED TURBO PC™

- 16-bit 8088-2 System Unit (running at 4.77 or 6.66 MHz)
- 640K on Mother Board
- 360K Floppy Drive
- AT Keyboard
- 135W Power Supply

Runs all Major Software written for the IBM PC™ and PCXT™, 40% faster, without modifications. Unit has 8 Expansion Slots, with 7 available in above configuration. One year limited warranty.

GW Basic \$95 • IBM DOS 3.1 \$85 • 8087-2 \$149

IBM® is a registered trademark of International Business Machines Corporation. IBM PC, PC XT, and PC AT are trademarks of International Business Machines Corporation.



PC'S LIMITED™

Inquiry 257

SALES CALLS OUTSIDE TEXAS, 1-800-426-5150

1611 Headway Circle, Building 3, Austin, Texas 78754

Sales Calls from anywhere in country, (512) 339-6962

Technical Support Calls, (512) 339-6963 Customer Service Calls, (512) 339-6964

Telex No 9103808386 PC LTD FAX (512) 339-6721

Ad Number 404/86

What it adds up to is this: The component parts of Framework II now look and act a lot like stand-alone competitive products. The spreadsheet, database, word-processor, and communications sections are much less threatening. I've found that I have something familiar to hang on to: I'm no longer thrust unwillingly into the alien territory of frames and levels and macros and FRED. As a result, I've been able to produce useful work while slowly learning about all the nifty features that have always been part of Framework.

The program is still an integrator's toolbox; you design macro functions as you need them. I wrote my first FRED program a week after I began playing with Framework II, and it wasn't so bad after all. I figure it should take me a total of about two months of daily use before I can really tap the product's power.

That power makes Framework II a spectacular software-development environment. Because you've got both a solid programming language *and* full-blown applications, developing becomes a process of building bridges rather than starting from scratch. Framework has always been a nice front end for those other Ashton-Tate products, dBASE II and III. And as Framework can also digest files—with only sporadic belches—from Lotus 1-2-3 (including most formulas), IBM DCA, WordStar, Multi-Mate, and any program that generates either DIF or ASCII formats, the possibilities for integration extend far beyond the Framework desktop.

There is some irony here. Now that I'm feeling good about Framework II, I went back and looked at Framework 1.1 again, and it wasn't nearly as tough as I remembered. The convenience features of Framework II, coupled

with good documentation and extensive help screens, have propelled me gently into the world of Framework. I'm now as excited as I was when I saw those first demonstrations.

Don't get me wrong; I'm not saying Framework II is for everyone. If you spend most of your time working with one kind of data, be it words or numbers, you might be better off sticking with your current software; Framework is necessarily more generalized. However, if you regularly move between two or more types of software or need tighter integration, Framework II is a good bet.

Just remember that Framework II is a big, powerful program that (like every other program in its category) has its idiosyncrasies. It pushes you toward macro programming, and it demands commitment.

But making that commitment is now quite a bit easier. ■

Princeton outperforms the industry.

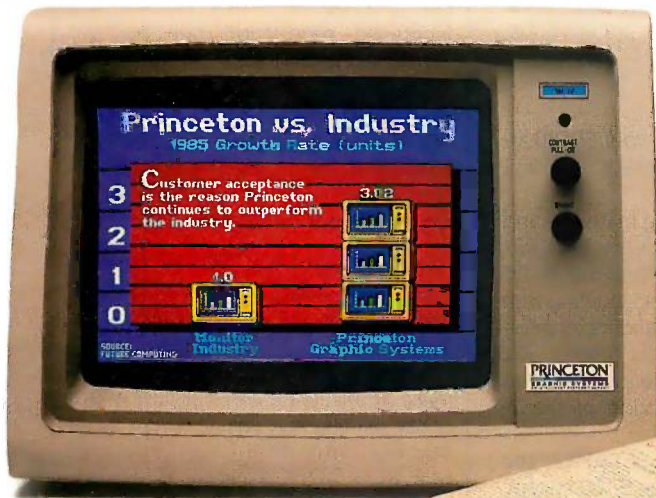

Only Princeton delivers the outstanding price/performance value you've come to expect from an international monitor company.

When we set out to design a Princeton Graphic Systems monitor we do it right. We

combine advanced technology (like a fine dot pitch) with

modern ergonomics (like a nonglare screen) for a superior performance monitor.

We build them with quality components to work day in and day out, even in the toughest conditions.

We're looking better and better.

Your support during 1985 enabled Princeton to grow three times faster than the personal computer industry as a whole. Our installed base of high resolution monitors in this segment alone grew beyond a quarter of a million...

Conducted by Steve Ciarcia

LIS'NER 1000

Dear Steve,

I read with interest your November 1984 article, "The Lis'ner 1000." I have a custom application in mind based on the ideas behind the Lis'ner 1000, using a dedicated Z80A. Your design in figure 8 (pages 118-119) looks straightforward for almost any microprocessor. However, how would you connect the SPI000 pins \overline{CS} , \overline{IRQ} , \overline{RESET} , and R/\overline{W} to a Z80? Also, can you tell me what kind of software considerations I should keep in mind?

Finally, your 300-bps modem project using the TMS99532 was great ("Build the ECM-103, an Originate/Answer Modem," March 1983). I noticed that the Micromint offers a direct-connect transformer for it, and I would like to know how it connects to the modem board and the telephone line.

ANDY PICKETT
Indianapolis, IN

Interfacing the SPI000 to the Z80 microprocessor is not difficult, if you have sufficient experience. Much of the interfacing is concerned with how the SPI000 will be addressed (i.e., which memory locations will be allocated for the chip). You must decide whether or not the SPI000 will be memory-mapped or I/O-mapped. If you don't understand these terms, refer to any book about microprocessor-circuit design.

You will have to determine how to connect the \overline{CS} pin (pin 6), depending on the configuration you choose. The \overline{IRQ} pin (pin 28) can be connected to pin 16 of the Z80. As for the R/\overline{W} pin (pin 5), two separate signals for these operations are on the Z80. One way is to connect just the Write pin (pin 22) of the Z80 to pin 5 of the SPI000. This means that the SPI000 will output data on the data bus whenever Z80 is not writing and Chip Select is active. When a write operation occurs, data is placed on the bus by the Z80 and is written into the SPI000 when Chip Select is active and the Write pin of the SPI000 is active. The \overline{RESET} pin connection depends on your application. It can be hooked up to a system reset of some sort or a power-on reset (or a combination of both). Another alternative

would be to let the microprocessor access a unique address that is set aside as a reset command to the SPI000. In this case, when the microprocessor accesses that memory location, the SPI000 would be reset. Again, this depends on your application and exactly how you want the system to work.

While the Lis'ner 1000 was designed for the Apple II and Commodore 64, there is no reason why you can't design a working system around the Z80. If this is going to be a dedicated microprocessor, you will probably be writing the entire software package in assembly language. This is not a difficult task. Follow the flowchart in figure 11 on page 122 of the November 1984 issue for general guidelines. The following books about the Z80 and designing a working computer around it will help you: Build Your Own Z-80 Computer by me (BYTE Books, 1980) and The Z-80 Microcomputer Handbook by William Barden Jr. (Howard W. Sams, 1978).

Regarding your question about the direct-connect transformer for the ECM-103, the information is included when you buy the transformer. The ECM-103 is not FCC-approved for direct connection to the telephone lines, which means that you should also use an approved and authorized interface between the modem and the telephone lines. —Steve

SB180 ADAPTATION

Dear Steve,

I read with great interest your SB180 article beginning in the September 1985 BYTE. Bravo!

I have been accumulating materials and ideas for the last year with the prospect in mind of building a Z80-based S-100 system. I was fully reconciled to living with the shortcomings of CP/M and looking forward to a system running at 6 MHz. You can imagine how happy I felt when I read your comparative description of the Z-System and CP/M 2.2.

You mentioned that the SB180 was the 29-chip equivalent of a large S-100 system. Is there any way for me to get some help in adapting the SB180 to my S-100 project? I have the technical capability to produce

my own printed-circuit layout for the board. However, if there is hardware already available, I'd sure like to know about it.

WILLIAM BROOKS
Vista, CA

Thank you for your kind words. Far be it from me to discourage you from building an S-100 64180-based system, but I really don't know of anyone doing that at this time. One of my engineer friends claims to have seen a small ad for such a beast but can't remember where. If it is speed you are after, get in touch with a company known as Earth Computers (POB 8067, Fountain Valley, CA 92728, (714) 964-5784). This company has an 8-MHz Z80H S-100 board that is about twice as fast as an IBM PC and comes close to AT performance (at least on the BYTE Sieve of Eratosthenes benchmark). Echelon Inc. (101 First St., #427, Los Altos, CA 94022, (415) 948-3820) has both a manual-install and an automatic-install version of ZCPR3 for CP/M 2.2. Of course, you won't have the memory address space of the 64180, but there are few commercial programs available that make use of the 64180 anyway.

I hope that you have good luck with your project.—Steve ■

Due to an overwhelming response and increased production rate for the SB180, as described in the September and October 1985 Circuit Cellars, the assembled and tested SB180-I-20 "BYTE readers' special" price of \$499 has been extended indefinitely by Micromint.

Over the years I have presented many different projects in BYTE. I know many of you have built them and are making use of them in many ways.

I am interested in hearing from any of you telling me what you've done with these projects or how you may have been influenced by the basic ideas. Write me at Circuit Cellar Feedback, POB 582, Glastonbury, CT 06033, and fill me in on your applications. All letters and photographs become the property of Steve Ciarcia and cannot be returned.

Princeton is the best choice in PC monitors.

When you're looking for a personal computer monitor, look at Princeton Graphic Systems. Our growing family of high quality personal computer monitors delivers compatibility, brilliant colors, high resolution, and dependability. Whether you're designing sophisti-

cated business graphics or number-crunching a financial spreadsheet. That's why Princeton is number one in the minds of more

and more personal computer owners every year.

For the very best in PC monitors, the choice is clear: Pick the company that's at the top. Princeton Graphic Systems.

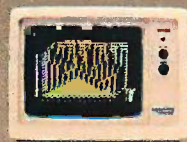

HX-12E. Our EGA-compatible monitor gives you 64 vivid colors. Extra sharp text and graphic displays. The finest dot pitch (.28mm) of any IBM-compatible enhanced monitor. Nonglare screen. Fully compatible with IBM's™ Enhanced Graphics Adapter (or equivalents).

SR-12P. Top-of-the-line analog color monitor features ultra high resolution (640 x 480), 4,096 colors for superb graphics. The finest dot pitch (.26mm) of any PGC-compatible monitor. Laminated nonglare panel.

HX-12. High resolution RGB color monitor with .31mm dot pitch gives you better graphics, better text than IBM's Color Monitor (5153). Nonglare screen. Voted "Best in the World" two years running in PC World's "World Class PC Contest".

SR-12. Super high resolution RGB monitor with a .31mm dot pitch. Compatible with Sigma Designs Color 400 board and others. Gives you 400 lines of resolution. Nonglare screen.

MAX-12. High resolution amber monitor. When used with an IBM-compatible monochrome adapter delivers 720 x 350 resolution. With an IBM-compatible color adapter 640 x 200 resolution with 15 shades of amber. The monitor automatically adjusts to either card.

HX-9/HX-9E. Compact nine-inch high resolution RGB monitor. Perfect for workstations where space is at a premium. Both feature a .28 dot pitch and an etched dark glass screen. Ergonomic features like a built-in tilt/swivel base, nonglare screen, and a built-in green/amber switch. HX-9E is compatible with IBM's EGA (or equivalents).

All monitors come with free data and power cables.

Visit your local computer store today and ask about our full line of high resolution color and monochrome monitors. Monitors that live up to the Princeton Graphic Systems tradition of quality, performance, and value.

Princeton Graphic Systems, 601 Ewing Street, Bldg. A, Princeton, NJ 08540; (609) 683-1660; TLX 821402PGSPRIN; (800) 221-1490, ext. 104.

PRINCETON®

GRAPHIC SYSTEMS
AN INTELLIGENT SYSTEMS COMPANY

IBM is a trademark of International Business Machines, Inc. Color 400 is a trademark of Sigma Designs, Inc. QuadEGA+ is a trademark of Quadram Corp. Compaq is a trademark of Compaq Computer Corp.

BYTE Invites You to Join BIX

BYTE is the world's leading high-tech microcomputer magazine. Its readers collectively possess more information about personal computers and related topics than any other group in the world. BIX is BYTE's brand-new electronic information exchange, a computer conferencing system that puts you in touch with BYTE readers and other computer enthusiasts on a daily basis.

YOU AND BIX

BIX goes far beyond electronic bulletin boards to give you all the advanced features of true computer conferencing. It's the first major system dedicated to microcomputer information. Check these features:

- You can join ongoing discussions about your favorite computers, programming languages, operating systems, and applications programs, exchange information, ask questions, and offer opinions.
- You can read what others have already entered, add your own thoughts, and download information.
- You can participate when it's convenient for you, from home or office or while you're traveling.
- You also get electronic mail with BIX, putting you in direct, private contact with BYTE editors and BIX users everywhere.

CUSTOMIZE BIX TO MEET YOUR NEEDS

As a BIX user, you select only the conferences and topics that are of real interest to you. You may join a new conference or leave an old one anytime you want. Each time you log on to BIX, you're immediately notified of any electronic mail messages waiting for you, and you see which of the conferences you've joined have had new activity since the last time you logged on. BIX keeps track of your interests.

With BIX, you're an active participant in a giant microcomputer information exchange.

WHAT BIX COSTS...HOW YOU PAY

ONE-TIME REGISTRATION FEE:
BYTE Subscriber\$25
Nonsubscriber\$39

BIX HOURLY USAGE FEES (All times are local):
Off Peak (6 p.m.-7 a.m. plus weekends and holidays)\$9
Peak (7 a.m.-6 p.m. weekdays)\$12

TELECOMMUNICATIONS CHARGES:

BIX is available via Tymnet from anywhere in the United States.

TYMNET (Continental U.S.):

Off Peak\$2/hr. Peak\$6/hr.

PAYMENT:

BIX and Tymnet charges are billed through either VISA or MasterCard. No cash, checks, or money orders.

START USING BIX NOW!

With our easy on-line registration, you can start using BIX in the next few minutes. No lengthy waiting for your registration to be processed by mail. (Step-by-step instructions on how to log on to BIX follow. Reading this material before you log on will speed you through the registration process.)

LOG-ON INSTRUCTIONS AND REGISTRATION INFORMATION

BEFORE YOU CALL BIX:

Having your credit card handy (VISA/MasterCard) before you log on will speed you through BIX registration. *You will not be billed for the time you spend on line registering for BIX. If at any time during the on-line process you decide not to register for BIX, just hang up.*

HOW TO LOG ON TO BIX:

Step 1: Set your computer's telecommunications program for full duplex using 8-bit words, no parity,

and 1 stop bit, or 7-bit words, even parity, and 1 stop bit. You may call at either 300 or 1200 baud.

Step 2: To reach BIX via Tymnet.*

* BIX is accessible from anywhere in the country through local Tymnet numbers. If you don't know the Tymnet numbers for your area, contact the BIX Customer Service Line (see below). At other times, numbers can be obtained by calling Tymnet at 800-336-0149.

- Call your local Tymnet number and log on.
- Depending on your baud rate, Tymnet will respond with "garble" or request a terminal identifier. Enter the letter "a". (Ignore quotation marks in this and succeeding entries.)
- Tymnet will ask you to log on. Enter "byteneti" and a carriage return (CR).
- Tymnet will ask you for a password. Enter "mgh" and (CR). You will then be at the door to the BIX computer.

Step 3: (If there is no prompt requesting a login at this point, hit a (CR) which should produce it.) When you see a phrase ending in "login:", enter "bix". (Echoing of this response is normal.)

You should now see the BIX logo scroll onto the screen and a prompt asking you to enter your name. Since this will be your first time on the system, enter "new" and a carriage return. This will

take you to a special section where you enter the information we need to register you as a BIX user. Follow the on-line prompts and supply the information requested. BIX lets you re-enter data if you make a mistake.

When you've completed your registration, BIX will automatically take you to a special "Learn" conference where you'll get a quick tutorial on how to use the system. (Typing "help" or "?" at any prompt while you are on BIX will give you an immediate review of available commands.)

ACCESSING BIX FROM FOREIGN COUNTRIES

To reach BIX from other countries, you need an account with your local Postal Telephone & Telegraph (PTT) company. From your PTT, enter 3106001 57878. Then follow instructions starting at Step 3. A list of PTT addresses and contacts for most foreign countries is available by calling or writing BIX.

CUSTOMER SERVICE

If you follow these instructions but still are unable to log on to BIX, call the BIX Customer Service Line for assistance at 800-227-2983, 8:30 a.m.-11 p.m. eastern time weekdays. In New Hampshire and outside the U.S., call (603) 924-7681.

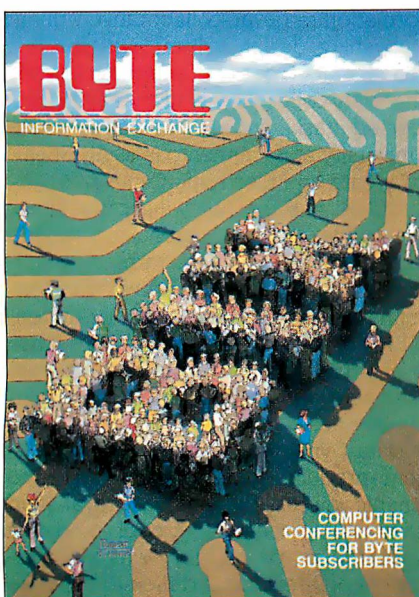

We'll Send You a BIX User's Manual and Subscriber Agreement As Soon As We've Processed Your Registration

**BYTE INFORMATION EXCHANGE
70 MAIN STREET
PETERBOROUGH, NH 03458
(603) 924-9281**

(continued from page 32)

Systems Inc. of Ann Arbor, Michigan; (2) CONFER II resides on mainframe computers at the University of Michigan, the University of Alberta, Canada, and at Hewlett-Packard, as well as Wayne State University in Detroit, and it is accessible from anywhere in the U.S. through public data networks such as Telenet; (3) the Army's think-tank uses of CONFER II, although ini-

tiated through the Delta Task Force, are now in the hands of the Army Forum, who have expanded productivity throughout the Army; and (4) although there are similarities in "information mapping" to the CONFER II structure, it is actually the CONFER II documentation that is based on the principles of "information mapping."

BYTE Associate Editor Donna Osgood was really on target in her comments in

the theme introduction (page 166). Computer conferencing can provide the means for letting creativity and dialogue, the cornerstones of an effective organization, take place; it can help participants work together at their convenience but within the constraints of imposed deadlines and geographic separation. Through computer conferencing, the possibilities are practically limitless for the sharing of ideas and the exchange of information to speed decision making and improve overall productivity.

ROBERT PARNES, PRESIDENT
Advertel Communication Systems Inc.
Ann Arbor, MI

Brock Meeks's December article includes mention of GENIE, an integrated system marketed by Data Dynamics Inc. Some information was omitted from the article that may be of interest to readers.

Data Dynamics is an information-management software company. Its product, GENIE, is a comprehensive, unified, expandable, and fully integrated information system that meets key needs of managers and professionals. GENIE has been installed at over 50 sites worldwide.

Customers use GENIE to expedite communications among managers and professionals by keeping track of schedules; increasing meeting effectiveness; automatically documenting meetings; helping produce memos or documents more efficiently than secretaries can; and facilitating a variety of professional tasks including information retrieval, collaborative writing, publishing, design walk-throughs, project management, decision support, networking with colleagues, and managing dispersed task groups. California State University at Sacramento is using GENIE to create an "Electronic Campus."

GENIE has the following capabilities: electronic mail, conferencing, bulletin boards, screen editing, formatting and publishing, filing and retrieval, calendar management, and system administration. GENIE is easy to learn and use since it has a uniform command set, a training level with automatic instruction, and simplified on-line help.

Data Dynamics' Decision Support System product operates with GENIE to enable discussion, final approval, and automatic documentation of modeling assumptions or budget items via computer conferencing and then to expedite final distribution of resulting models or spreadsheets and associated graphics via electronic mail.

(continued)

Say Hello To PC Dial Log

Votrax's Tele/Voice System

PC Dial/Log™ by Votrax gives the IBM® PC and compatibles full voice management capabilities.

Consisting of an expansion card, software, and a cable for connecting a Touch-Tone® phone to your computer, PC Dial/Log enables your PC to: record and save voice messages; answer up to 40* incoming calls and take messages;

distribute a voice message to as many as 150* numbers; log Touch-Tone® responses; and the list goes on and on.

You also can assign Touch-Tone® ID numbers, define calling hours of outgoing messages; create message distribution lists and a phone directory; and leave or change messages for others from remote locations.

In short, it's an economical way to eliminate phone tag and keep in touch better with everyone.

If the telephone plays a big part in your life and you're interested in getting the most from your telecommunications, investigate PC Dial/Log at your local dealer, or contact Votrax, Inc. directly.

With models starting at just \$495, you can't afford not to.

Interface software package available for your specific applications.

*Depending on storage capacity of your system.

Other Votrax Products

- PSS, T-N-T, Stand-Alone Devices
- IBM, Apple II, Commodore 64 Plug In Board Synthesizers
- Votrax Speech Chips

votrax

VOTRAX, INC. THE VOICE PEOPLE
1834 Rankin Troy, Michigan 48033-4074
(313) 588-2050 TWX: 8102324140 Votrax TRM

Call Votrax at (800) 521-1350



Now You Can Trade-In Your **USED** IBM* PC/XT* or AT* Keyboard!

key tronic KB5151 Professional Series

- Easy to Read Regular Key Legends Rather than Symbols.
- Easy to Identify Status Lights are on "Lock" Keys.
- Easy to Use "Shift" & "Return" Keys are in familiar Typewriter locations.
- Easy to Edit Separate Cursor and Editing Keys.
- Easy for Numbers Separate Numeric Keys.
- Easy to Enter Convenient Enter Key.

Buy a Key Tronic KB 5151 and Receive \$25.

Buy a Key Tronic KB 5151, send in your new or USED IBM* PC, XT* or AT* keyboard and Key Tronic will send you \$25. It's that simple!

Type on the KB 5151 keyboard and feel the difference for yourself. It's the Key Tronic touch!

Look at the layout of the KB 5151. It was designed to increase operator speed and comfort. No wonder it's the choice of professionals.

Ask a Key Tronic customer about our products. You will learn about our reputation for manufacturing durable professional products.

Key Tronic is the world's largest independent manufacturer of full travel keyboards and offers a complete line of integrated input devices.

See your local dealer or call 1-800-262-6006 for more information. (7 am - 3 pm Pacific Time) In Washington State call (509) 928-8000.

"Feel the Key Tronic Touch"

key tronic
The Responsive Input Company

P. O. Box 14687 • Spokane, WA 99214 • USA

The Key Tronic KB 5150 and KB 5151 keyboards are also eligible for trade-in under the terms of this rebate program. Trade-in offer also applies to purchases of other Key Tronic keyboard products.

*IBM, XT and AT are registered trademarks of IBM Corporation.

Inquiry 177

\$25 REBATE COUPON

To the best of my knowledge the below information is correct and the enclosed keyboard is an IBM PC, XT or AT keyboard, or Key Tronic 5150 or 5151 keyboard. I am aware that the conditions for receiving a \$25.00 personal rebate check for the keyboard include: replacing each such keyboard with a Key Tronic keyboard and including a copy of the sales receipt showing the purchase of the new eligible Key Tronic keyboard after January 1, 1986, when mailing the keyboard to Key Tronic. I understand that credit will only be given for IBM PC, XT or AT keyboards or Key Tronic 5150 or 5151 keyboards.

Make check payable to:
Company _____
Name _____
Address _____
City/State/Zip _____
Phone _____
Contact Name _____

Key Tronic Corporation
ATTN: Rebate Program
Building 14
Spokane Industrial Park
Spokane, WA 99216

COMPUTOUGH

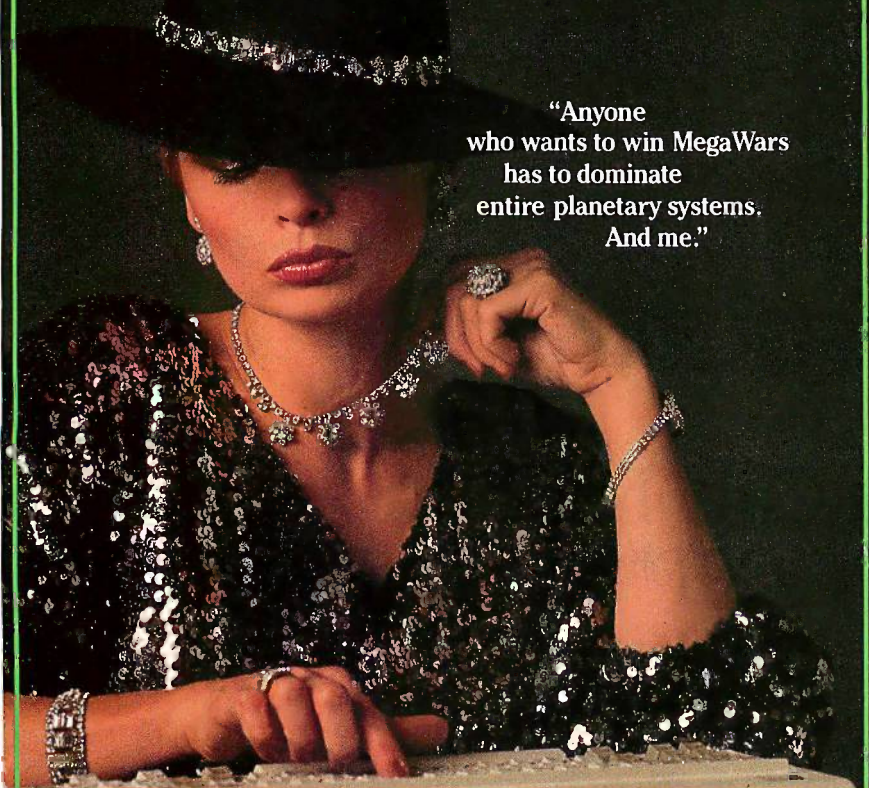

"Anyone who wants to win MegaWars has to dominate entire planetary systems. And me."

COMPUFUN

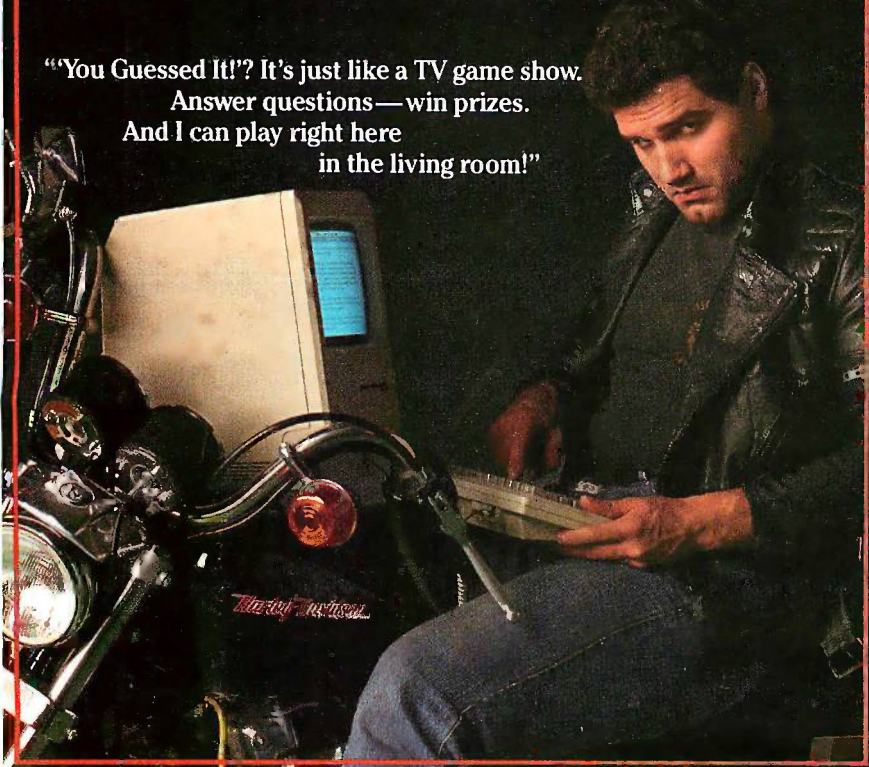

"You Gussed It!?" It's just like a TV game show. Answer questions—win prizes. And I can play right here in the living room!"

LETTERS

GENIE's publishing capability can be used to lay out and print near-typeset-quality camera-ready copy of completed spreadsheets, reports, or papers on a variety of laser printers.

STEPHEN A. HEITMANN, PRESIDENT
Data Dynamics Inc.
Portland, OR

For more information on the availability of the conferencing systems covered in Brock N. Meeks's article, see this month's Fixes and Updates on page 33.

For your readers' information, my company's CONEXUS and MIST+ software package has been acknowledged as the first conferencing package for the IBM PC family. Since its introduction in May of 1984, our software has been installed in over five hundred Fortune 1000, university, association, and small-business locations. It has been proved to be an easy-to-manage product for private electronic mail, unlimited topic-specific computer conferencing, and keyword retrieval of bulletin-board items.

CONEXUS was written by Peter and Judy Johnson-Lenz, who were on the design team that resulted in the Electronic Information Exchange System (EIES). They authored TOPICS, an EIES application that later was transformed into PARTI, and they authored MIST in 1982 and MIST+ in 1983. MIST has been acclaimed as the first integrated communication application language for personal computers.

CONEXUS, although a complete application, was written using MIST+, which means that more experienced users can add their own features as well as take advantage of MIST+'s integrated text-oriented database-management system. We know of no other package that has the track record, power, tailorability, and sophistication of CONEXUS and MIST+.

BILL SPENCER
2B Enterprises
1252 Columbia Rd. NW
Washington, DC 20009
(202) 234-2117

RATIONAL PASCAL

I thought your readers would be interested in learning about our work on the language that will be the successor to Modula-2. Your readership is so diverse and wide-ranging, particularly within the computer-languages community, that I would deem it a privilege to make my first formal announcement of this effort in the pages of your publication. If I may, I would also like to discuss briefly the philosophy

behind our project.

A few years ago, efforts were made to salvage FORTRAN by implementing "Rational FORTRAN," or RATFOR. We are borrowing a leaf from the same philosophical book, so to speak, by implementing "Rational Pascal," which we are puckishly calling "Rascal." We believe that Rascal may fairly lay claim to being the ultimate computer programming language by virtue of its extreme elegance, power, and simplicity. Let me cite a few examples.

In Rascal, recursion is mandatory. Every Rascal routine, once invoked, must immediately do one of two things: It must either call itself, or it must call some other routine that, in turn, immediately calls itself. Any additional code (e.g., that which tests to see whether it is appropriate, or even permissible, to execute a return) must follow this initial recursive call. Thus, the language enforces the elegant simplicity of a unary tree.

Rascal recognizes only one data type: the record. Every Rascal variable and constant must be defined as a record, even if that record has only one member. This requirement yields the inestimable benefit of completely eliminating machine dependencies. It is of absolutely no consequence whether a machine integer consists of 16, 32, or 78 bits, because the very idea of an "integer" is alien to Rascal. Instead, all data objects must be records, and their elements, naturally enough, must also be records. The most primitive record, from which all others must be constructed, is a single Boolean value.

Because Rascal has no machine dependencies whatsoever (and because—of course—it is written in itself), we have decided that a preliminary release of the source code should be made available to *any* individual willing to serve as a beta-test site. This release is scheduled for April 1, 1986. Interested persons are asked to contact me directly, at the address that follows.

GERHARD WERTHER VON WIRTH
Technisches Irrenhaus
Zürich, Switzerland

PRAISE FOR AVSIM

I am writing to report on a product that will interest those of your readers who teach microcomputer architecture or assembly-language programming at a college or university level. At Ryerson Polytechnical Institute we have been using Avocet System's AVSIM family of simulator/debuggers for the past year and a half for our instrumentation course and thesis

(continued)

COMPU CRAZY

Ready for an adventurous challenge?
We're a team. And Nellie
doesn't horse around."

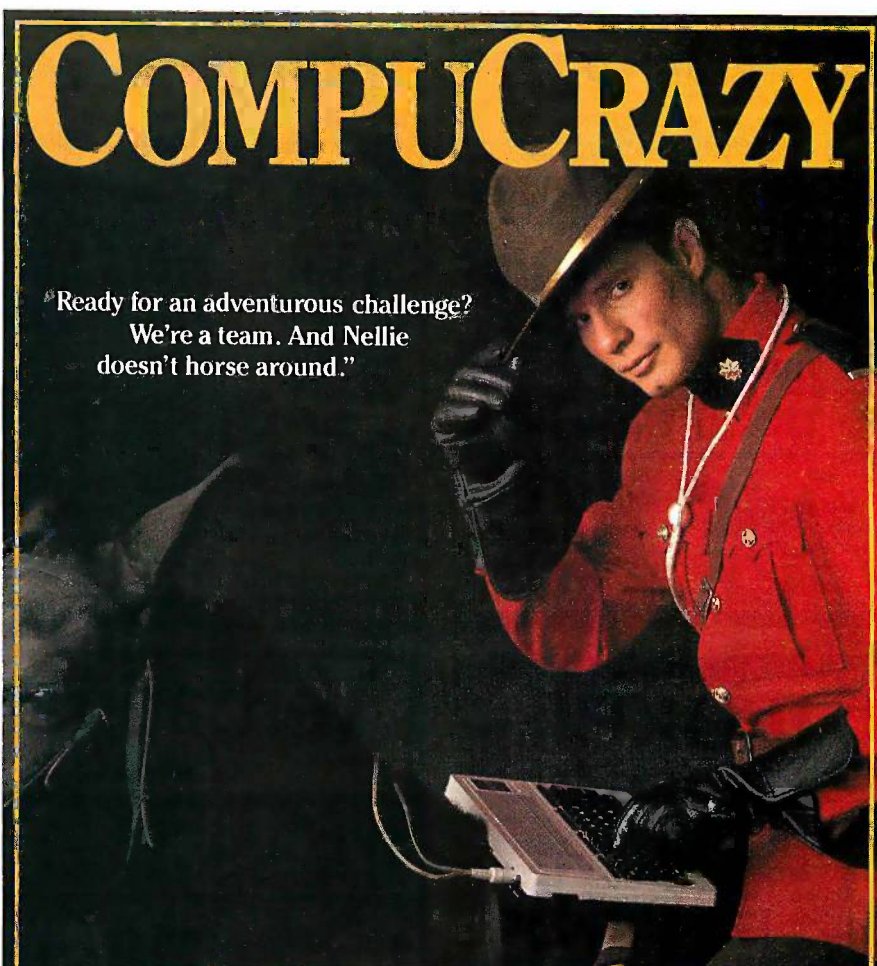

COMPU SERVE GAMES

You never know
who you'll be up against
when you go online
with CompuServe.

To buy your CompuServe Subscription Kit,
see your nearest computer dealer.
Suggested retail price \$39.95

To request our free brochure or order direct,
call or write: **800-848-8199**
(In Ohio, call 614-457-0802)

CompuServe®

5000 Arlington Centre Blvd.
Columbus, OH 43220

dy lan Dysan CORPORATION

LIFETIME WARRANTY

5 1/4" DISKS S-Side D-Den. 13.95	3 1/2" DISKS S-Side 135tpi 23.95	Dysan Interrogator 120.50 ea. Add 3.99 Shipping PHEONIX 16mea CART. 165.00 error free Add 6.99 Shipping
D-Side D-Den. 18.95	8" DISKS S-Side S-Den. 19.95	
S-Side 96tpi 22.95	D-Side S-Den. 21.95	
D-Side 96tpi 29.45	S-Side D-Den. 26.95	
HIGH DEN. 37.95		

Old Reliable the **Diskette Connection**™

* Delaware 1-800-451-1849
* Oklahoma 1-800-654-4058
* Nevada 1-800-621-6221

TERMS: Minimum 20 disks or \$35.99 — VISA or MasterCard accepted COD orders add 2% for special handling. SHIPPING: 3% for 5 1/4" Diskettes; Add 3% for every 100 Diskettes or any fraction thereof. 8" Diskettes; Add 4% for every 100 Diskettes or any fraction thereof. We ship UPS; orders requiring other delivery methods add shipping plus 2% of total order.

3M diskettes **LIFETIME WARRANTY**

* Special

5 1/4" HEAD CLEANER

FREE & Special (5) Box PRICE. "CALL" Specials marked (*) ends 4-15-1986

5 1/4" Disks S-Side D-Den. 10.95	8" Disks S-Side S-Den. 17.95	3 1/2" Disks S-Side 135tpi 19.55
D-Side D-Den. 15.25	S-Side D-Den. 21.45	D-Side 135tpi 27.55
S-Side 96tpi 19.45	D-Side D-Den. 23.95	Data Cartridges DC100A — 11.50 DC300A — 15.25 DC300XL — 18.00 DC600A — 20.00 DC1000 — 12.30
D-Side 96tpi 23.95	ALSO AVAILABLE: 32 Sectors, 1024 FM, MICOM, CPT, WAF, LANIER, DEC RX50.	
HIGH Den. 30.95		

Old Reliable the **Diskette Connection**™

* Delaware 1-800-451-1849
* Oklahoma 1-800-654-4058
* Nevada 1-800-621-6221

TERMS: Minimum 20 disks or \$35.99 — VISA or MasterCard accepted COD orders add 2% for special handling. SHIPPING: 3% for 5 1/4" Diskettes; Add 3% for every 100 Diskettes or any fraction thereof. 8" Diskettes; Add 4% for every 100 Diskettes or any fraction thereof. We ship UPS; orders requiring other delivery methods add shipping plus 2% of total order.

3M Authorized Distributor
Information Processing Products

LETTERS

projects with dramatic improvements in both quality and speed of learning.

To describe AVSIM briefly—it is an interactive, screen-oriented, symbolic simulator for microprocessors that is hosted by any MS-DOS computer. After cross-assembling a program, the student loads the object file and symbol table into the memory space of the simulated target machine and runs the program on the visual CPU, watching what happens to registers, flags, memory areas, etc., as each op code is executed. Besides the usual single-step, run, and breakpoint features that every debugger has, AVSIM also has an invaluable Undo key that lets the student step the CPU backward through the execution history, even backing into interrupt routines. By alternately single-stepping and using Undo on an instruction, the student can see exactly what effect the instruction has on the system. The environment presented by AVSIM is not only friendly but also robust: *It hasn't been crashed by any student's program yet!*

I spend less than five minutes teaching the basics of AVSIM: how to load object code, reset the target CPU, and use the function keys that control the simulation. Changing memory, register, or I/O pin values is intuitive: Position the cursor over the current value and edit it—like a text editor. There are function keys defined to increment, decrement, or toggle the bit, nybble, or byte under the cursor. On-screen editing is possible even while the student's program is running, so that I/O pins or interrupts can be toggled interactively to exercise the program.

My experience with AVSIM has been very gratifying. With 120 thesis projects to coordinate, I must ensure that we can provide development tools for the various CPUs used by students. Now we support seven different CPUs on the same hardware. There are no costly emulators to break down or become out of date every few years. Students can do their debugging after hours, using one of the microcomputers in the college library (or their own, if they have one) and fix the vast majority of bugs by themselves.

Based on this success, we are purchasing 22 IBM PCs for our third-year lab to integrate AVSIM into our existing MC6800/MC6809 software/hardware course. By using AVSIM to teach assembly-language programming before providing hands-on experience with the 6800 hardware, I anticipate similar improvements in student performance and lab efficiency.

MIKE KASSAM

Toronto, Ontario, Canada ■

maxell

FLOPPY DISKS

LIFETIME WARRANTY

5 1/4" Disks S-Side D-Den. 9.50	3 1/2" Disks S-Side 135tpi 16.95
D-Side D-Den. 13.50	D-Side 135tpi 25.95
S-Side 96tpi 18.95	8" Disks S-Side D-Den. 22.95
D-Side 96tpi 23.95	D-Side D-Den. 24.95
HIGH Den. 27.95	

Old Reliable the **Diskette Connection**™

* Delaware 1-800-451-1849
* Oklahoma 1-800-654-4058
* Nevada 1-800-621-6221

TERMS: Minimum 20 disks or \$35.99 — VISA or MasterCard accepted COD orders add 2% for special handling. SHIPPING: 3% for 5 1/4" Diskettes; Add 3% for every 100 Diskettes or any fraction thereof. 8" Diskettes; Add 4% for every 100 Diskettes or any fraction thereof. We ship UPS; orders requiring other delivery methods add shipping plus 2% of total order.

Verbatim

LIFETIME WARRANTY

DataLife

"MARCH ONLY" SPECIALS(*)

Buy 10 and get 2 disk FREE*

5 1/4" S-Side D-Den. 10.95	8" S-Side S-Den. 19.95	3 1/2" S-Side D-Side 18.95 26.50
D-Side D-Den. 14.95	S-Side D-Den. 21.95	HEAD CLEANERS 5 1/4" Kit — 4.95 5 1/4" Refills — 8.95 8" Kits — 5.20 8" Refills — 8.95
S-Side 96tpi 19.95	D-Side D-Den. 24.95	
D-Side 96tpi 24.50	Digital Cassettes	
High Den. 28.95		

Old Reliable the **Diskette Connection**™

* Delaware 1-800-451-1849
* Oklahoma 1-800-654-4058
* Nevada 1-800-621-6221

TERMS: Minimum 20 disks or \$35.99 — VISA or MasterCard accepted COD orders add 2% for special handling. SHIPPING: 3% for 5 1/4" Diskettes; Add 3% for every 100 Diskettes or any fraction thereof. 8" Diskettes; Add 4% for every 100 Diskettes or any fraction thereof. We ship UPS; orders requiring other delivery methods add shipping plus 2% of total order.

SONY

3 1/2" SINGLE-SIDE 16.95	5 1/4" HIGH DENSITY 27.95
DOUBLE-SIDE 25.95	AMARAY Media Mate \$8.95 + 2% shipping

Old Reliable the **Diskette Connection**™

* Delaware 1-800-451-1849
* Oklahoma 1-800-654-4058
* Nevada 1-800-621-6221

TERMS: Minimum 20 disks or \$35.99 — VISA or MasterCard accepted COD orders add 2% for special handling. SHIPPING: 3% for 5 1/4" Diskettes; Add 3% for every 100 Diskettes or any fraction thereof. 8" Diskettes; Add 4% for every 100 Diskettes or any fraction thereof. We ship UPS; orders requiring other delivery methods add shipping plus 2% of total order.

DISKETTES

FACTORY SEALED IN PACKS OF TEN, WITH TYVEK SLEEVE, ID LABEL & WRITE PROTECT TABS. "LIFETIME WARRANTY"

No Manufacture Label or Pretty Box!

Single Side Double Density	.55 ea. (MIN.) 50	Double Side Double Density	.69 ea.
-------------------------------	-----------------------------	-------------------------------	----------------

Manufactured 100% by one of the BIG BOYS. IF you need a good Disk this is it. IF you need a name, we call them GOOD.

Old Reliable the **Diskette Connection**™

* Delaware 1-800-451-1849
* Oklahoma 1-800-654-4058
* Nevada 1-800-621-6221

TERMS: Minimum 50 Diskettes. — VISA or MasterCard accepted COD orders add 2% for special handling. SHIPPING: 3% for 5 1/4" Diskettes; Add 3% for every 100 Diskettes or any fraction thereof. We ship UPS; orders requiring other delivery methods add shipping plus 2% of total order.

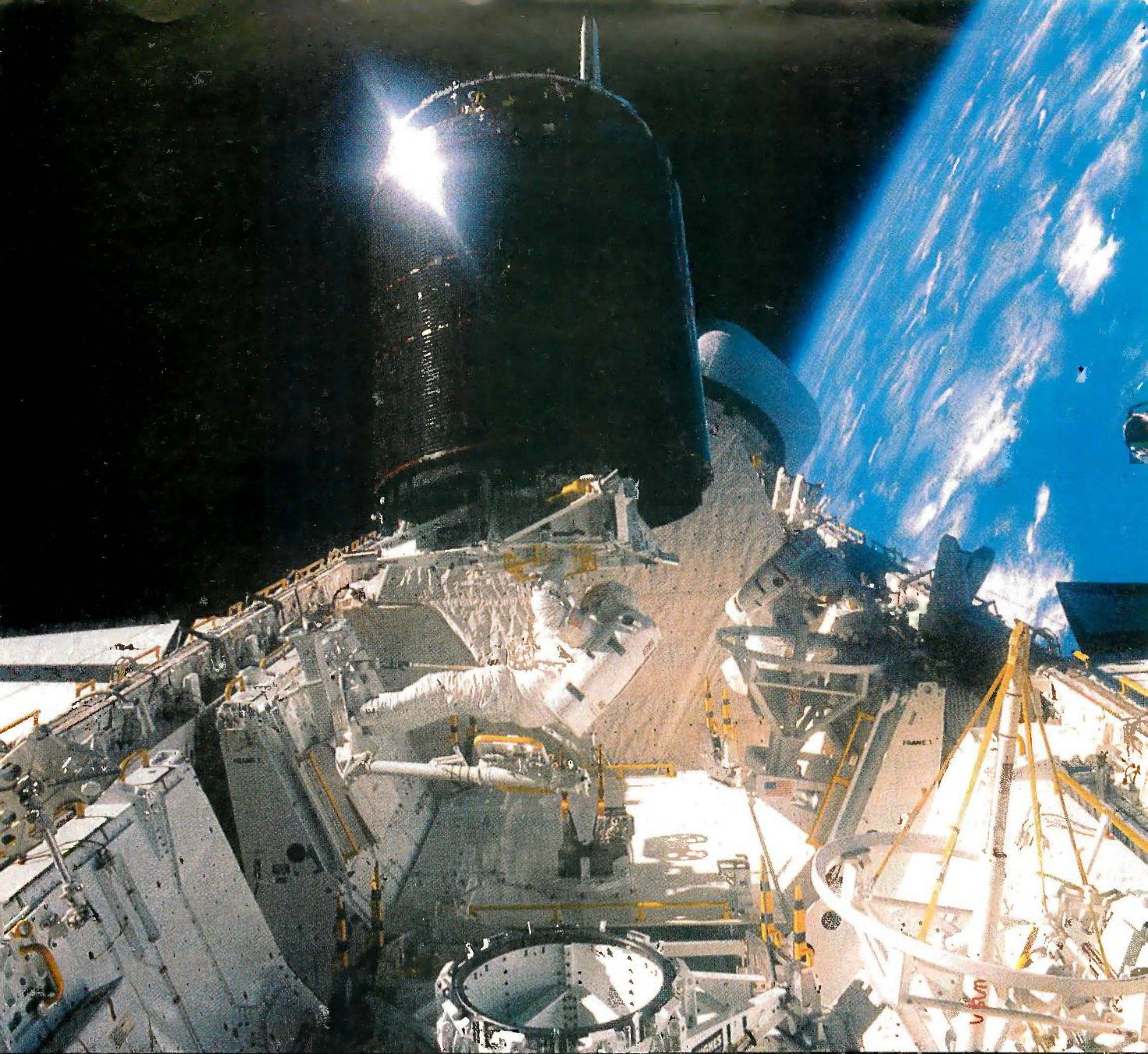

MAKE THE CONNECTION . . .

Our **Connection** systems will solve your problem of trying to read and write diskettes or tapes from almost any computer system using your PC.

The **Diskette Connection** is a hardware system that enables the IBM PC or compatible to read and write most 8 inch, 5¼ inch, or 3½ inch diskettes.

With our **File Connection** software programs you can transfer data files between most computer systems, including CP/M, DEC, Honeywell, Univac, IBM 3740, S/1, S/3, S/23, S/32, S/34, S/36, and S/38.

Our **Word** and **Typesetting Connection** programs use IBM standard Document Content Architecture (DCA-RFT) to transfer document files between most word processing and typesetting systems, including Compugraphic MCS, CPT, Displaywriter, OS/6, Multiset, NBI, Quadex, Xerox, and Wang.

Our **Tape Connection** system will read and write IBM or ANSI standard ½ inch 1600 BPI magnetic tape. A full size 2400 foot tape can store a 45 MByte file and be written in 6 minutes.

Since 1982, we have supplied thousands of systems to customers around the world, including IBM, NASA, AT&T, Kodak, and General Motors.

Our specialty is conversion systems and we can provide a solution to your problem. Call us today to discuss your requirements.

This ad is one of a series featuring NASA missions. For a free poster, send us your written request.

**Box 1970 Flagstaff, AZ 86002
(602) 774-5187 Telex 705609**

Inquiry 132 for End-Users.
Inquiry 133 for DEALERS ONLY.

. . . FLAGSTAFF ENGINEERING

D·I·S·K·S A·N·D D·O·W·N·L·O·A·D·S

ORDERING DISKS OF BYTE LISTINGS

Source-code listings in the form of text files of programs that accompany BYTE articles are now available from BYTE on disk. To order a disk of these listings for noncommercial purposes, indicate the issue (the first available is December 1985) and the kind of disk on the form below. Enclose a check or money order in the correct amount made out to BYTE Listings. All prices include postage. Send requests to BYTE Listings, 70 Main St., Peterborough, NH 03458.

BYTE issue: _____

COMMON 5¼-INCH FORMATS

(all cost \$5 per disk in North America, \$6 in Europe and South America, \$7 in Asia, Africa, and Australia)

- Apple II 5¼-inch DOS 3.3
- Apple II 5¼-inch ProDOS
- Atari
- Commodore 64
- Hewlett-Packard 125
- IBM PC
- Kaypro 2 CP/M
- Texas Instruments Professional
- TRS-80 Model III
- TRS-80 Model 4
- Zenith Z-100

COMMON 3½-INCH FORMATS

(all cost \$6 per disk in North America, \$7 in Europe and South America, \$8 in Asia, Africa, and Australia)

- Apple Macintosh
- Atari 520ST
- Commodore Amiga
- Data General/One
- Hewlett-Packard 150

CP/M STANDARD 8-INCH FORMAT

(\$6 per disk in North America, \$7 in Europe and South America, \$8 in Asia, Africa, and Australia)

- Single-sided single-density

OTHER FORMATS

(all cost \$6 per disk in North America, \$7 in Europe and South America, \$8 in Asia, Africa, and Australia)

Size	Machine
<input type="checkbox"/> 8-inch	_____
<input type="checkbox"/> 5¼-inch	_____
<input type="checkbox"/> 3½-inch	_____

SEND DISK TO:

Name _____

Street _____

City _____ State or Province _____

Postal Code _____ Country _____

Check or money order enclosed for \$ _____

BULLETIN BOARDS IN CANADA

Listed below are some computer bulletin boards that carry program listings from BYTE. Programs are for noncommercial use in connection with BYTE articles only. Some BBSs may charge an annual maintenance fee, and you must pay your own telephone charges.

Western Canadian Distribution Center (101 11112 101st St., Edmonton, Alberta T5G 2A2) will be supplying listings to its member bulletin-board systems. Edmonton, Alberta, (403) 454-6093

Meadowlark, Alberta, (403) 435-6579

Montreal, Quebec, PComm Systems, (514) 989-9450

Prince George, British Columbia, (604) 562-9519

Regina, Saskatchewan, (306) 586-5585

Toronto, Ontario, Epson Club of Toronto (EPCOT), (416) 635-9600

Winnipeg, Manitoba, (204) 452-5529

In addition, arrangements for BYTenet Listings have been made with one or more system operators in the following nations: Australia, Denmark, Italy, Japan, The Netherlands, Norway, Singapore, Sweden, Switzerland, and United Kingdom. Contact us at (603) 924-9281 for an up-to-date list. ■

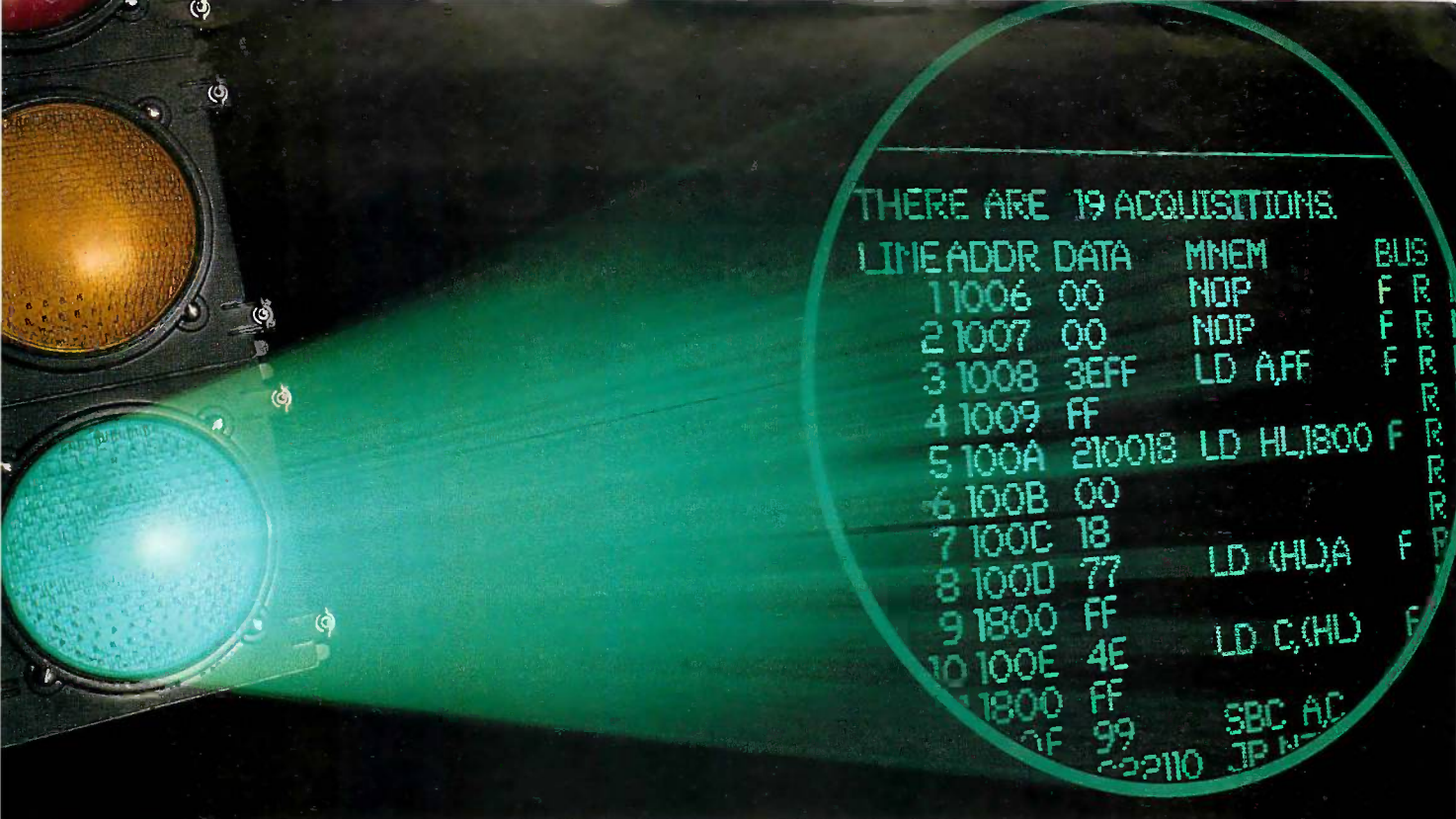

THERE ARE 19 ACQUISITIONS.

LINE	ADDR	DATA	MNEM	BUS
1	1006	00	NOF	F R
2	1007	00	NOF	F R
3	1008	3EFF	LD A,FF	F R
4	1009	FF		F R
5	100A	210018	LD HL,1800	F R
6	100B	00		F R
7	100C	18		F R
8	100D	77	LD (HL),A	F R
9	1800	FF		F R
10	100E	4E	LD C,(HL)	F R
	1800	FF		F R
		99	SBC A,C	F R
		02110	JP NE	F R

GO WITH THE BEST LOW COST 8-BIT SUPPORT.

Tektronix introduces **TekMate, powerful 8-bit support with many more features than you'd expect to find in a low cost development system.** Emulation is non-stop, transparent and real time. A content-selectable 1024-line bus trace buffer simplifies prototype evaluation—while your program runs without interrupting execution.

Tek's eight years of emulation experience brings the user unmatched reliability in this low-cost system. Every feature of TekMate helps keep you on schedule, within budget, and in control. For instance, you can select any of 16 break points for specific address values and ranges. Rapidly detect errors with the aid of full symbolic debug that lets you use an unlimited number of symbols—even define new ones. Versatile and flexible, TekMate provides software analysis and debug at every

stage from initial concept to final integration.

Remarkably easy to use, TekMate supports Z80, 8085 and 6809—plus the 68HC11 microcontroller. Host computers include IBM PC,™ VAX/VMS,™ MicroVAX™ and Tek 8560—and TekMate is integrated via emulation control software and language support tools, such as struc-

ured analysis and structured design tools, plus source editing, C, Pascal, assembler and debug tools.

To save you time, Tek's own Colorkey+ softkey user-interface packages give you simple, single keystroke access to the entire command set.

TekMate—the most powerful emulation system in its price range—is an integral component of Tek's Computer Aided Software Engineering (CASE) program. This growing toolset cluster from Tek's Software Development Products Division demonstrates Tek's commitment to software technology. For product or ordering information,

please contact your Tek representative. Or call today: **1-800-342-5548.**

CASE: From concept to code, Tek's tools take you all the way.

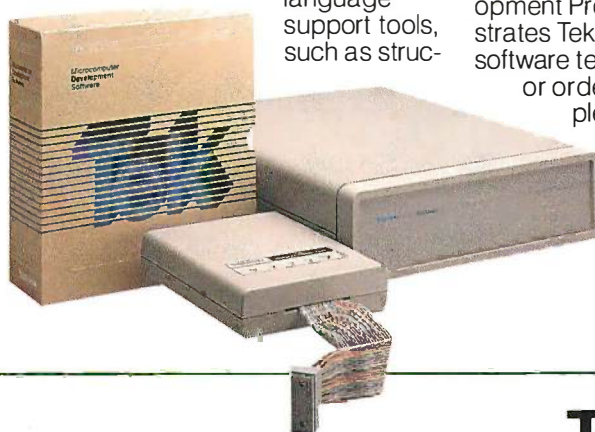

Tektronix
COMMITTED TO EXCELLENCE

Inquiry 341

QNX vs UNIX

A QUESTION OF ARCHITECTURE

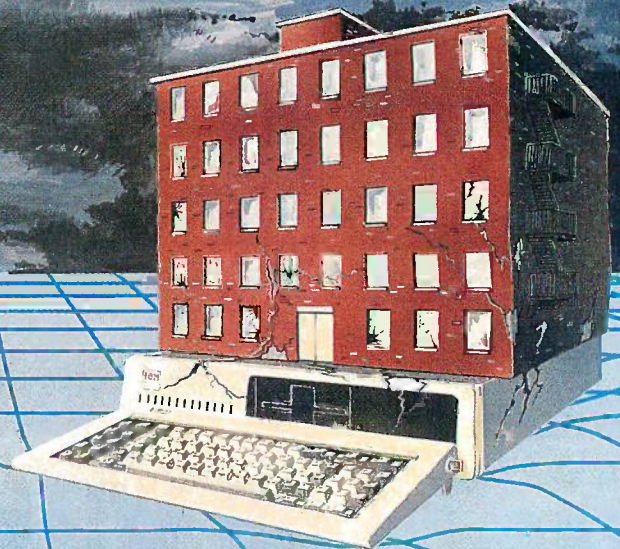
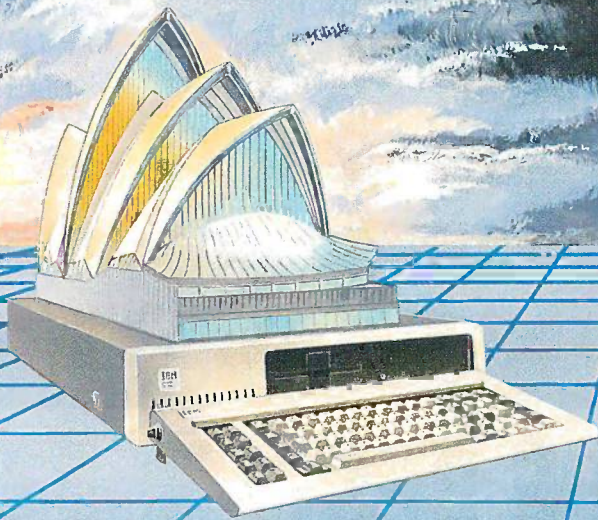

What do QNX and UNIX have to do with architectural design?

The design determines the environment in which you and your applications must survive. If the sheer weight of the UNIX operating system brings the PC to its knees, all applications running under it will suffer. Unix was conceived more than a decade and a half ago and the product today is the result of modifications, additions and patches by hundreds of programmers. The result is a large and convoluted piece of software which needs the resources of an AT or more.

QNX's superb performance and compact size is the result of one dedicated design team with a common purpose, and complete understanding of both the software and the environment in which it must run. It runs quickly and efficiently on PC's and soars on an AT. Unlike Unix, QNX is capable of real time performance and is the undisputed choice for real time process control, and office systems. You can buy an OS that offers you a 1 to 3 user dead end on an AT, OR, you can consider QNX which allows you anywhere from 1 to 10 users on both PC's and AT's. And we don't stop there. Unlike other Unix-type systems for PC's, QNX is also a networked operating system. Not a patch-on network, but a fully integrated networking system for up to 255 micros. QNX allows you to start with a single machine and grow if and as required. There are no dedicated file servers and you can attach terminals (users) to any machine. To choose a solution which ignores networking, is closing the door on your future.

Everyone is talking about Unix like systems, but no one wants to abandon the tremendous amount of DOS software available. QNX does not force you to make that decision. You can run either PC DOS 2.1 or 3.1™ as one of QNX's many tasks. (DOS File compatibility and DOS development tools are also available). Don't misunderstand us. We at Quantum have a great deal of respect for Unix. It was a major force in moving operating systems out of the 1960's and into the 70's. QNX however, was designed in

the 80's and will be a driving force of the 1990's. Over 20,000 systems have been sold since 1982.

Quantum strongly believes that there are good reasons for buying QNX, DOS and Unix. If you want more than DOS and a working alternative to PC Unix, give us a call and we will discuss your needs.

End-Users, VAR's, OEM's and software developers are invited to take the QNX challenge.

- **MULTI-USER:** -10 serial terminals per PC, AT.
- **MULTI-TASKING:** -40 tasks per PC, AT.
- **NETWORKING:**
 - 255 machines.
 - up to 10,000 tasks and 2000 users/network.
 - 2.5 Megabit token ring.
- **REAL TIME:** -2800 task switches/sec (AT).
- **MESSAGE PASSING:** -Intertask communication between any of 1000's of tasks on any machine.
- **MEMORY:** -88K to 110K for QNX.
- **PC DOS:** -Executes as a task under QNX.
- **C Compiler:** -Standard Kernighan and Ritchie.
- **Flexibility:** -Single machine or networked. One to thousands of users. Full resource sharing of disks and devices on all machines.
- **Support:**
 - Online update system allows downloading of new releases over the phone.
 - Technical support hot line.
- **COST:**
 - From US \$450
 - Call for runtime prices.
- **HARDWARE SUPPORT:** -IBM PC, XT, AT™ (both real & protected) and compatibles.



Moodie Drive HiTech Park 215 Stafford Rd. Ottawa, Ontario, Canada. K2H 9C1 Phone (613) 726-1893

IBM PC, AT, XT AND PC-DOS ARE REG. TM OF INTERNATIONAL BUSINESS MACHINES CORP. UNIX IS A REG. TM OF AT&T BELL LABS

Inquiry 282

AMIGA

The April Amiga conference highlights include an in-depth look at specifications for Amiga-compatible monitors, a number of ways to create C and CLI work disks, and more information about upgrading your Amiga to a 68020 CPU. Charlie Heath compares smart refresh versus simple refresh and provokes discussion of various communications protocols including XMODEM files for BIX. This Best of BIX section concludes with instructions for adapting 5¼-inch floppy-disk drives, Bernoulli disks, and different ways of preserving the Preferences from your Amiga Workbench.

MORE ABOUT MONITORS

Editor's note: The following messages should put an end to the controversial rumors that Amigas can use only Amiga monitors. This is absolutely untrue.

amiga/tech.talk #258, from atm [Andrew McLaughlin]

Screen Resolution

I'm a little confused (can anybody help me?). I've been looking for an alternate monitor for the Amiga and I haven't seen any that are exactly 640 by 400 pixels. The closest I've seen has been 720 by 480 pixels. Questions are: Can I use this monitor? If I do use this monitor, will I end up with an extra 80 pixels on the side and bottom of the screen image? Or will the 640 by 400 image be averaged into the 720 by 480 screen?

When the manufacturer says "720 by 480 pixels" I'm assuming that the shadow mask is a matrix of 720 by 480 holes, right? Should I worry about the 640 by 400 interlace from the Amiga? (Do I need a special monitor or will any RGB monitor do the interlace stuff?)

I understand that using RGB analog I can get all 4096 colors but with RGB digital only a select few colors are available. Is this true? Why offer two different RGB modes when the analog mode is obviously more desirable? Or is there an unmentioned trade-off?

Those are all that I can remember (yeah, sure). Hopefully, I'll be able to get the story straight. Thanks in advance for any help.

amiga/tech.talk #259, from jsan [Jez San, Argonaut Software];
a comment to 258

Go buy your 720 by 480 monitor. The extra pixels are probably *overscan*, which is quite normal; it's the border around the displayable portion of your Amiga screen. RGB digital output is for IBM PC-compatible monitors, but naturally, RGB analogue (analog for yanks!) is best if you are given the choice!

amiga/tech.talk #260, from atm:
a comment to 259

Does that mean that the Amiga monitor is 720 by 480?

amiga/tech.talk #261, from jdow [Joanne Dow];
a comment to 260

Make sure the monitor uses 15742-and-change hertz for the horizontal scan and 59.94 or so hertz frame rate interlaced. Otherwise it might not run. The KV1311CR and the XBR series will give you full Amiga resolution. The quoted 640 by 200 lines is for noninterlaced sweep. The vertical resolution in the Amiga interlaced mode is easily sufficient to do anything the Amiga needs.

amiga/tech.talk #263, from atm:
a comment to 261

"Make sure the monitor is '15742-and-change' hertz for the horizontal." I don't understand what you're trying to say here. Please explain.

amiga/tech.talk #264, from hvanderbilt [Henry Vanderbilt];
a comment to 263

That's a 15-kilohertz horizontal sweep rate that you want in your monitor, give or take a bit. That is pretty much the standard for color TV and composite monitors and for RGB monitors that aren't designed to work with some specific nonstandard format. With 60 fields a second and 262 lines a field (only 200 on screen), you get 15,000+ lines displayed per second. The horizontal sweep circuits in most monitors will sync up to anything reasonably close to the right rate, so the exact number isn't vital.

amiga/tech.talk #266, from jdow:
a comment to 264

I waxed a bit technical to say you want a monitor designed to work with NTSC standard sweep rates. Many higher-definition monitors are designed for higher sweep rates on both horizontal and vertical. These will not work very well with an Amiga designed for NTSC sweep rates that are nominally 15750 Hz and 60 Hz, respectively. Actually, they are about 15734.27 Hz and 59.94006 Hz. This latter defines why that noise bar from the leaky line transformer or insulator outside your bedroom window slowly moves down your TV screen. Or is it up (haven't seen one since cable days)?

amiga/tech.talk #267, from duck [Dale Luck, Commodore-Amiga]

Monitor Resolution and Your Amiga

The 640/720 horizontal resolution is actually nearly the same. The 720 monitor puts those dots on a longer line; therefore, the video bandwidth is actually the same.

For those of you rolling your own graphics and not using Intuition, the Amiga is capable of outputting a display of around 700 by 220 pixels. The amount of information you actually see is dependent upon your monitor. The graphics library supports just about any odd/large viewport size as long as it can fit it in the bandwidth of the memory without running into the horizontal sync. Higher resolutions may kill off some of your sprites, though. Just thought you might like to know.

XLISP 1.6 FOR AMIGA

amiga/main #984, from jdow:
a comment to 983

XLISP 1.6 for Amiga—Being a software collector I'd be interested so I can pass data on to interested friends. We have a couple LISPIans at work who would probably find some interest in the PC version as well.

[Editor's note: XLISP 1.6 is now available on BIX in the Amiga section of the Listings conference.]

CREATING C WORK DISKS

amiga/main #987, from dbetz [David Betz]

Minimal Disk

Can anyone suggest what a minimal set of files for a bootable disk would be? I'd like to free up as much space as possible on my working "Workbench" disk, but I can't find a list of "required" files anywhere. I'm using the Lattice C compiler and the CLI for development, so I don't really need to run anything from the Workbench except for the CLI (for that matter, is it possible to get the machine to come up in the CLI in the first place?).

(continued)

8080
Z80
6809

AMX

8086
8088

Now

68000

Real-Time Multitasking Executive

- No royalties
- Source code included
- Fault free operation
- Ideal for process control
- Timing control provided
- Low interrupt overhead
- Inter-task messages

Options:

- Resource Manager
- Buffer Manager
- Integer Math Library

Language Interfaces :

C Pascal
PL/M Fortran

DOS File Access :

CP/M-80
IBM PC DOS

AMX for 8080	\$ 800 US
8086	950
6809	950
68000	1600
Manual (specify processor)	75

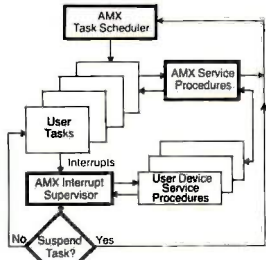

AMX is TM of KADAK Products Ltd.
CP/M-80 is TM of Digital Research Corp.
IBM, PC DOS are TM of IBM Corp.



KADAK Products Ltd.

206-1847 W. Broadway, Vancouver, B.C., Canada V6J1Y5

(604) 734-2796

Telex: 04-55670

Little Board™ \$249

The World's Least Expensive CP/M Engine

CP/M 2.2
INCLUDED

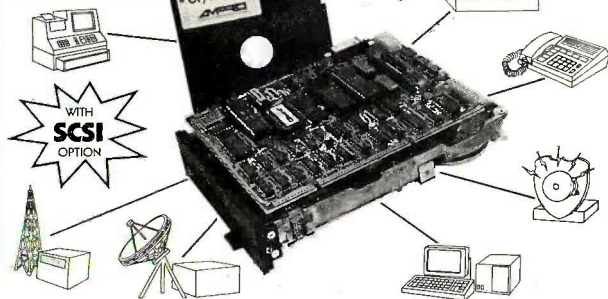

- 4 MHz Z80A CPU, 64K RAM, Z80A CTC, 4-32K EPROM
- Mini/Micro Floppy Controller (1-4 Drives, Single/Double Density, 1-2 sided 40/80 track)
- 2 RS232C Serial Ports (75-9600 baud & 75-38, 400 baud), 1 Centronics Printer Port
- Power Requirement: +5VDC at .75A; +12VDC at .05A / On board -12V converter
- Only 5.75 x 7.75 inches, mounts directly to a 5-1/4" disk drive
- Comprehensive Software Included:
 - Enhanced CP/M 2.2 operating system with ZCPR3

- Read/write/format dozens of floppy formats (IBM PC-DOS, KAYPRO, OSBORNE, MORROW...)
 - Menu-based system customization
 - Operator-friendly MENU shell
- OPTIONS:
- Source Code
 - TurboDOS
 - ZRDOS
 - Hard disk expansion to 60 megabytes
 - SCSI/PLUS™ multi-master I/O expansion bus
 - Local Area Network
 - STD Bus Adapter

AMPRO
COMPUTERS, INCORPORATED

IBM®, IBM Corp.; Z80A®, Zilog, Inc.; CP/M®, Digital Research; ZCPR3™ & ZRDOS®, Echelon, Inc.; Turbo DOS®, Software 2000, Inc.

67 East Evelyn Ave. • Mountain View, CA 94041 • (415) 962-0230 • TELEX 4940302

amiga/main #989, from jsan:
a comment to 987

To make a CLI disk, edit your start-up file on the Workbench, e.g., Edit s/startup-sequence.

Remove the offending line that says "LoadWb." That's the command that tells Workbench to execute. Leaving this line out of your start-up sequence will make you boot up into CLI! Have fun!

amiga/main #990, from greggw [Gregg Williams, Senior Technical Editor, BYTE]:
a comment to 987

I, too, would like to see the definition of a minimal C disk. As for bypassing the Workbench, you can take out those lines (I remember taking out two lines) from s/startup-sequence or hit Control-D as soon as you see the first text message. Using this method, you have a disk that's either a Workbench or a CLI disk!

amiga/main #992, from sdb [Scott Ballantyne]:
a comment to 987

Just remove the LoadWb and the EndCLI > nil: lines from the s/startup-sequence file. Seems to me you can get along with the C directory (some commands can be deleted maybe—edit, for example, if you never use it). You will need the libs, you will need the devs, but you will probably only need one printer driver. Preferences might be worth keeping. That's about it. Anything you leave on the boot disk can be removed from the disk with the "includes" on it. Leaves *lots* of room for source.

amiga/main #1000, from cschepner [Carolyn Schepner, Commodore Business Machines]:
a comment to 990

Some suggestions for minimal C disk:

1. Back up Workbench and boot with the backup.
2. Make sure your Preferences are set the way you want them.
3. Edit the file s/startup-sequence: Remove the LoadWb and the End-CLI lines; add a line: Stack 10000
4. Delete all .info files.
5. Delete all demos, Notepad, Clocktool.
6. Delete system directory and contents (Workbench stuff).
7. If you don't plan to use disk fonts, delete all of them.
8. In devs/printers/... delete all printers you don't need.
9. In the c directory, you can delete anything you'll never use (for example, edit, LoadWb). Remember, many commands such as "if," "lab," and "abort" are used in script files for compiling. Don't delete commands used in your make script.
10. Delete Preferences. If you ever need to change them, you can do it on another disk; then copy the devs/system-configuration/... to this disk.
11. *Note:* Do *not* delete anything in the "i" directory! These items are needed for system management.
12. Copy contents of the C "c" directory to this disk's c directory.
13. Copy contents of the C "s" directory to this disk's s directory.
14. Make a "lib" directory on this disk and copy contents of C "lib" directory to it.

Now you should have everything you need, except for the includes, on a bootable C system disk. Make a backup of the original C disk, delete the c, s, lib, and example directories and contents, and add your own directories for your source. Change your make script so it looks for the includes in df1:include.

(continued)

LOMAS DATA PRODUCTS LETS YOU:

RAM IT

Introducing Megasram.

MEGASRAM is the highest density static RAM board available for the S100 bus today. A full MEGABYTE of high speed, lowpower STATIC RAM on a single height S100 board without a daughter board. MEGASRAM offers the power and density required by today's high speed 16 bit microprocessors. With this board and our 8Mhz 80286 you can run WITHOUT WAITSTATES. NO ONE can offer any better performance on the S100 bus. In addition to the high speed MEGASRAM can be provided with an optional battery backup option to provide non-volatile operation. The standard MEGASRAM offers 150Ns operation, fast enough to run with an 8Mhz 80286 with no waitstates. Faster versions are available at extra cost providing as fast as 100Ns maximum access times. All our access times are quoted as board access times, not chip access times.

Prices starting at \$395.00

IBM COMPATIBLE S100 BUS COLOR GRAPHICS

LOMAS DATA PRODUCTS presents COLOR MAGIC, the most complete compatibility solution for S100 bus computer products. COLOR MAGIC includes three major hardware sub-functions which allow it to emulate the IBM-PC: An entirely compatible video function, an IBM-PC keyboard interface and an IBM-PC compatible timer interface including IBM-PC sound compatibility. HOW COMPATIBLE IS IT? Currently we are running MICROSOFT's FLIGHT SIMULATOR recognized as one of the severest tests of compatibility. We can also directly boot PC-DOS for the IBM-PC with no alterations. Other programs which have been tested and function without problems are: LOTUS 1-2-3, DBASE III, WORDSTAR and VOLKSWRITER. **COLOR MAGIC (16K byte version) . . \$595.00**

■ **THUNDER 186** single board computer provides a high performance 16 bit computer all on one board. It is an ideal companion to the COLOR MAGIC to provide a low cost, high performance IBM-PC compatible system. The 8Mhz 80186 offers 10Mhz 8086 performance. THUNDER 186 provides all the components necessary to form a complete system including: 256K bytes of no wait-state RAM, 2 serial ports, a parallel printer port, high performance floppy disk controller controls both 5 1/4" and 8" drives simultaneously, full IEEE 696 (S100) bus for system expansion. The COLOR MAGIC

and THUNDER 186 combine to provide performance you won't find in other compatibles. The price includes the powerful Concurrent DOS operating system. **THUNDER 186 . . . \$1195.00**

■ **NV-DISK** is a solid state memory with software to emulate a disk drive under MS-DOS, Concurrent DOS, and CP/M-86. NV-DISK is entirely COMPUPRO software compatible allowing COMPUPRO users to take advantage of the lower cost and battery protection support offered by NV-DISK. It offers the advantage of high speed access and no moving parts. It can be battery protected to allow data to stay even while powered down. The board is available in either 512K or 2 Megabyte configurations and multiple boards may be used to create disk drives with up to 16 Megabytes of storage.

NV-DISK 512K, \$495.00 2 MBYTE, \$995.00

■ **MEGARAM** is a high density, high performance dynamic RAM board with up to two Megabytes of storage. Megaram offers no wait state performance in 8086 systems with up to 10 Mhz processors at a fraction of the cost of comparable performance static RAM.

MEGARAM 1/4 MBYTE, \$475.00
1/2 MBYTE, \$595.00 1 MBYTE, \$795.00
2 MBYTE, \$1095.00

IBM-PC COMPATIBLE S100-BUS SYSTEM

LOMAS DATA PRODUCTS offers IBM-PC compatible systems with performance far ex-

ceeding that available from IBM. You can purchase systems offering performance of an eight Mhz 8086 or up to the performance of an 8Mhz 80286. Each system is capable of supporting 8Mhz math coprocessors. Our 8Mhz 80286 system offers IBM-PC compatibility while offering up to 2 times the performance of the IBM-PC-AT. For applications where PC compatibility is desirable but higher performance is a benefit or requirement LDP offers the only viable solution.

WHO IS LOMAS DATA PRODUCTS . . .

LOMAS DATA PRODUCTS has been shipping 16 bit microprocessor S100 bus products for five years. We have earned a strong reputation for reliability and performance over these five years. We were running MS-DOS (SCP-DOS/PC-DOS) before IBM knew the operating system existed. We offer a wide range of 16 bit operating systems including MS-DOS, CP/M-86, CONCURRENT CP/M-86 and CONCURRENT DOS. All our products are backed by a one year guarantee. We offer no 8 bit products and concentrate entirely on high performance 16 bit systems. *If you are looking for the highest performance possible on the S100 bus, you can be sure LOMAS DATA PRODUCTS offers it.*

The S100 Bus Experts.



Dealer inquiries invited.

MS-DOS, trademark of Microsoft
PC-DOS, trademark of IBM
Concurrent CP/M-86, concurrent DOS, trademark of Digital Research

LOMAS DATA PRODUCTS, INC.

182 CEDAR HILL STREET, MARLBORO, MASSACHUSETTS 01752 □ TELEPHONE: (617) 460-0333 □ TELEX: 4996272

For orders outside the U.S., contact our exclusive dealers: □ **Australia** - LAMRON PTY. LTD., (02) 808-3666 □ **Malaysia** - EXA COMPUTER (M) SENDIRIAN BERHAD, 795284 □ **England** - RATIONAL SYSTEMS, 0908-613209 or 0908-611349; SHARPBORN LTD., 018764559.

Train for the Fastest Growing Job Skill in America

Only NRI teaches you to service and repair all computers as you build your own 16-bit IBM-compatible micro

Now that computers are firmly established in offices—and in homes, too—the demand for trained computer service technicians surges forward. The Department of Labor estimates that computer service jobs will actually *double* in the next ten years—a faster growth rate than any other occupation.

Total systems training

No computer stands alone... it's part of a total system. And if you want to learn to service and repair computers, you have to understand computer *systems*. Only NRI includes a powerful computer system as part of your training, centered around the IBM-compatible Sanyo 550 Series computer.

As part of your training, you'll build this highly rated, 16-bit IBM compatible computer system, assemble Sanyo's "intelligent" keyboard, install the power supply and disk drive, interface the high-resolution monitor and dot matrix printer, even expand the memory from 128K to 256K RAM. It's confidence-building, real-world experience that includes training in programming, circuit design, and peripheral maintenance.

No experience necessary—NRI builds it in

Even if you've never had any previous training in electronics, you can succeed with NRI training. You'll start with the basics, then rapidly build on them to master such concepts as digital logic, microprocessor design, and computer memory. You'll build and test advanced electronic circuits using the exclusive NRI Discovery Lab®, professional digital multimeter, and logic probe. Like your computer system, they're all yours to keep as part of your training. You even get over \$1,000 worth of software, including the popular WordStar and CalcStar.

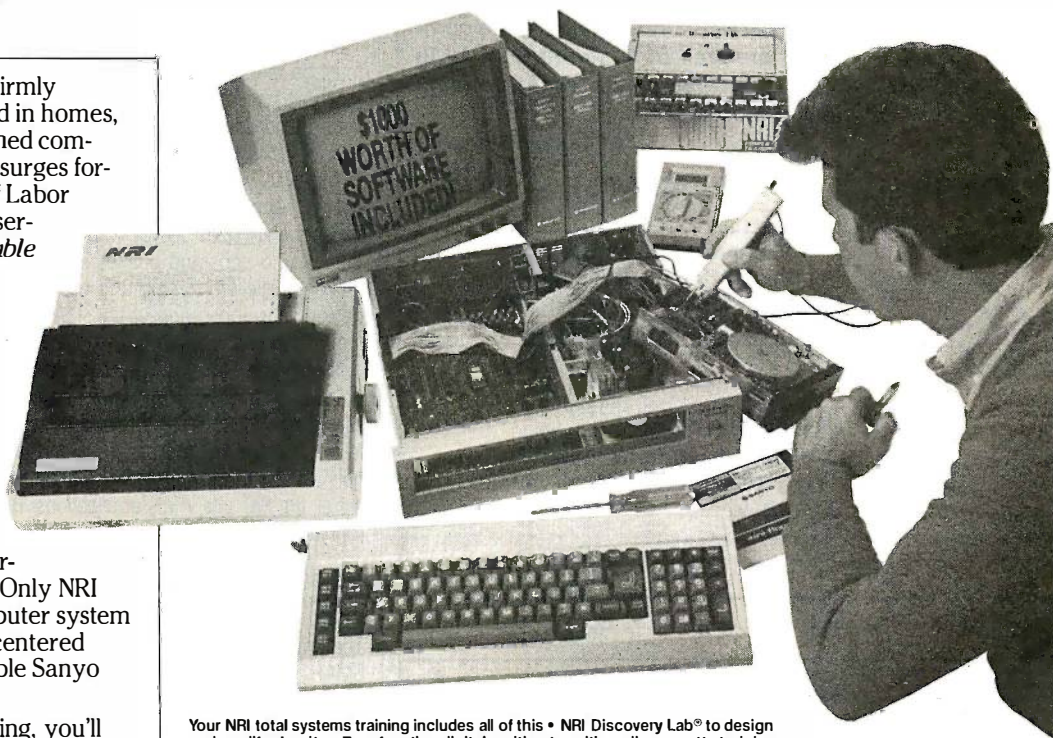

Your NRI total systems training includes all of this • NRI Discovery Lab® to design and modify circuits • Four-function digital multimeter with audio cassette training • Digital logic probe for visual examination of computer circuits • Sanyo 550 Series computer with "intelligent" keyboard and 360K double-density, double-sided disk drive • High-resolution monochrome monitor • RAM expansion module to give you powerful 256K memory • 120 CPS dot matrix printer with near-letter-quality mode • EasyWriter I, WordStar, CalcStar bundled software • Reference manuals, schematics, and bite-sized lessons.

Send for 100-page free catalog

Send the post-paid reply card today for NRI's 100-page full color catalog, with all the facts about computer training. Read detailed descriptions of each lesson, each experiment you perform. See each piece of hands-on equipment you'll work with and keep. And check out NRI training in other high-tech fields such as Robotics, Data Communications, TV/Audio/ Video Servicing, and more.

Mail the postage-paid card today, and see how NRI can prepare you for advancement and new careers in the exciting world of electronics. If the card has been used, write to NRI Schools, 3939 Wisconsin Ave., Washington, D.C. 20016.

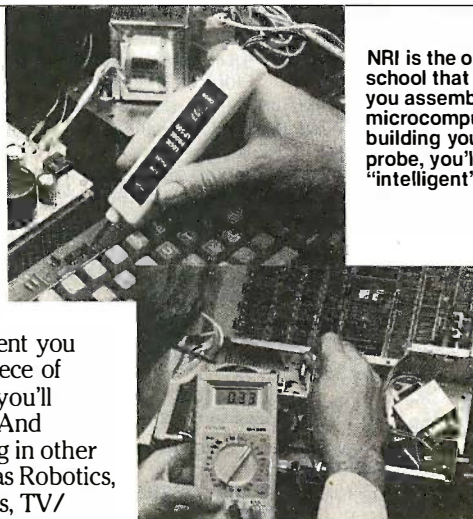

NRI is the only home study school that trains you as you assemble a top-brand microcomputer. After building your own logic probe, you'll assemble the "intelligent" keyboard...

... then install the computer power supply, checking all the circuits and connections with NRI's Digital Multimeter. From there, you'll move on to install the disk drive and monitor.

NRI SCHOOLS

McGraw-Hill Continuing Education Center
3939 Wisconsin Avenue, NW
Washington, DC 20016

We'll Give You Tomorrow.

IBM is a Registered Trademark of International Business Machine Corporation.



FORTRAN PROGRAMMERS

Downloading from mainframes or developing on the PC the choice is F77L.

"Lahey's F77L FORTRAN is the compiler of choice... F77L compiled the five files in a total of 12 minutes which was 4 times as fast as MS FORTRAN and an astounding 6 times as fast as Pro FORTRAN." PC Magazine

"The manual that comes with this compiler is well put together. The messages are clearly explained, the compiler's unique features are well documented... All in all, F77L is a fine, well supported product that we think will do very well in the marketplace."

Computer Language

VERSION 2.0 NOW AVAILABLE — \$477

SEE OUR AD
MARCH BYTE

Full ANSI FORTRAN-77
Source On-Line Debugger
Common/Array greater than 64K
Lattice C and other 3rd Party Compatibility

To order or for more information

(213) 541-1200

Lahey Computer Systems, Inc.

31244 Palos Verdes Drive West, Suite #243
Rancho Palos Verdes, CA 90274

Requires MS-DOS and 8087

MS-DOS and MS FORTRAN are trademarks of Microsoft Corporation
Pro FORTRAN is a trademark of International Business Machines

memory you mention is less than 10 percent of the total 512K bytes of memory. Maybe a different adjective would be more appropriate.

For "text-only" displays, the difference is probably very close to 32K in a full NTSC screen. (Note PAL has an extra 56 lines per screen.) Since text can be efficiently stored in a text array, or just strings of text, the cost to save the text at most is 1K.

For graphics displays, you must also now build a "display list" that must be redrawn each time the user pops it up front. The display list itself can become rather large in size. I think the answer depends on your application and what you think the relative mix of user window ops (wops?) will be.

The SMART_REFRESH does not buy you much if the user is doing a lot of sizing. The bits are not saved when he sizes down. When he subsequently sizes up you must redraw to restore those bits. If he is going to do pops and pushes primarily, then SMART may be smart. Maybe a little prototyping and experimenting is called for. You can design your application using SMART_REFRESH first and then add the refresh stuff later if you need the extra memory.

Note that memory usage is global. Even though you write your program to be a good citizen and use minute quantities of memory and sacrifice a little in display speed does not mean other applications will follow suit. Maybe applications could be written to operate in both manners and let the user customize them. If he has lots of memory he can set all the FAT bits in his applications. If he has very little memory or is running thousands of applications at once he turns off the FAT bits.

amiga/main #1423, from duck:
a comment to 1420

The drawers in your Workbench are SIMPLE_REFRESH. The CLI is SMART_REFRESH.

PROTOCOL PROBLEMS

amiga/main #985, from cheath

Problem with XMODEM and Amiga

I uploaded a file to the Listings conference, a demo version of our text editor TxEd, and it has now been posted. Got a note from jdown, saying she couldn't get it to run. So I downloaded it, and indeed there is a problem. And the problem is that the Amiga binary file loader can't deal with garbage at the end of an executable file. Well, any good XMODEM hacker knows that XMODEM sends blocks of 128 bytes. So, you can't use XMODEM to transfer executable files on Amiga.

For the adventurous among you, I managed to get TxEd working after downloading it by truncating it (using, of course, TxEd) and making sure the size is exactly correct. The correct size of TxEd is 19,896 bytes. The version of TxEd that you will get by downloading is 20,096 bytes. So, figure out a way to chop off those extra 200 bytes, and you're in business.

P.S.: I'm posting a C file in the amiga/tech conference that will allow you to get TxEd running.

amiga/main #1284, from langeveld [Willem Langeveld]:
a comment to 1270

The Amiga BASIC program to cut the last 200 bytes off TxEd after XMODEMing it down is

```
OPEN "TXED" FOR INPUT AS 1
a$ = INPUT$(LOF(1) - 200,1)
CLOSE 1
OPEN "TXED2" FOR OUTPUT AS 1
PRINT# 1,a$
CLOSE 1
END
```

IBM PC AT performance! PCjr price!

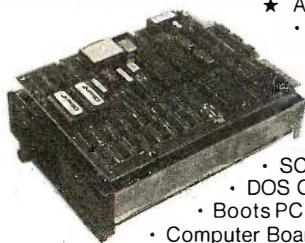

- ★ AMPRO Little Board/186
 - 8Mhz 16 Bit 80186 CPU
 - 512K RAM—No Wait-States
 - 2 Serial Ports 50-38.4K Baud
 - Parallel Printer Port
 - 4 Drive Mini/Micro-Floppy Controller
 - SCSI Bus Hard Disk Interface
 - DOS Compatible ROM-BIOS
 - Boots PC DOS 2.x, 3.x
- Computer Board Assembled and Tested with Tech Manual and DOS utilities... \$499

- ★ DRI Concurrent DOS 4.1 Multi-User O/S... \$395
- ★ Expansion Board for 512K (1Mb total) 8087-2 Socket, Real-Time Clock, 8530 SCC 2 Channel RS232/422, Buffered Expansion Bus and more... from \$295
- ★ AMPRO Little Board (Z80) Same as 80186 board but Z80A CPU, 64K RAM, 16K EPROM, CP/M 2.2 & ZCPR3 and manuals... \$239 (\$279 w/SCSI)
- ☆ Enclosures w/Power Supply... from \$99
- ☆ Floppy Drives... call for current price
- ☆ Xebec Owl SCSI Drive—Low power 1/2 Ht Drive w/built-in Controller 10/20Mb... \$499/\$649
- ☆ Terminals: WYSE, QUME, KIMTRON... from \$395
- ☆ Power supplies, cables, connectors in stock

Complete technical support. Assembled systems available. Write or call for free catalog. Most orders shipped same day.

VISA, MasterCard, Money Order, C.O.D. Checks allow two weeks. Purchase orders and bids welcome. Prices F.O.B. Prairie View, IL.

IBM PC AT PCjr, PC DOS are trademarks of International Business Machines Corporation. Concurrent DOS is a trademark of Digital Research, Inc. Xebec®wi is a trademark of Xebec, Inc.

DISKS PLUS INC 15945 West Pope Blvd.
Prairie View, IL 60069
(312) 537-7888

(continued)

Uplifting news.

Now we've got application software to support our data acquisition hardware for the IBM PC.™

Hold up a minute!

Now you can get all your analog I/O application software at the same place you get your IBM PC compatible hardware. Data Translation.™ We've got four application software packages that cover a broad range of capabilities, all compatible with the DT2801 series of seven analog I/O boards. So you'll never have to write a line of code again.

Take a look at these:

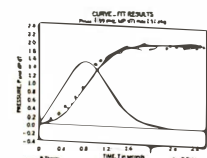

Graph Using Curve-Fit

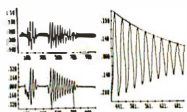

Analysis Functions with Multiple Window Display

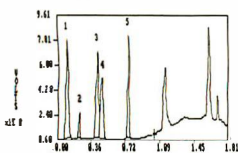

Peak Detection and Integration

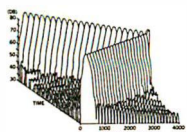

3-D Spectral Display

DT/NOTEBOOK

For the non-programmer. An easy-to-use menu-driven package for real-time data acquisition, process control, and data analysis that automatically interfaces to spreadsheet packages. Its menu-driven interface is ideal for users who aren't very familiar with computers.

ASYST

For the advanced user. A command-driven package for real-time data acquisition and control, advanced data analysis, and graphics display. For the user who requires more sophisticated graphics and analysis capabilities.

CHROMLAB

For the chromatography scientist. A menu-driven, scientific software package for chromatography and spectroscopy applications. For users who need to do real-time data collection/display, peak detection/integration, and report generation.

DT/MLS-PC 1

For the signal processing scientist. Command-driven software for digital signal processing that supports data acquisition, waveform manipulation, design and use of digital filters, and spectral analysis. For users who need advanced analysis tools in both time and frequency domains.

* * *

Call us today. We'll help you choose the right package to give your data acquisition the boost it needs.

Call (617) 481-3700



Fred Molinari,
President



See our new 646 pg. catalog/handbook or see us in Gold Book 1986. Or call for your personal copy today.

DATA TRANSLATION

World Headquarters: Data Translation, Inc., 100 Locke Dr., Marlboro, MA 01752 (617) 481-3700 Tlx 951 646
 European Headquarters: Data Translation, Ltd., 13 The Business Centre, Molly Millars Lane, Wokingham Berks, RG112QZ, England Tlx 851849862 (#D)
 International Sales Offices: Australia (61) 2-6635289; Belgium (32) 2-7352135; Canada (416) 625-1907; Chile (2) 2-253689; China (408) 727-8222, (86) 87214017; Denmark (02) 187188; England (44) 0734-793838; Finland (358) 0-372-144; France (33) 146306839; Greece (30) 031-527039, (30) 13-614300; Hong Kong (852) 3-324563; India (91) 2-231040; Israel (972) 3-324298; Italy (39) 2349751; Japan (81) 3-502-5550, (81) 3-348-8301, (81) 3-355-1111; Korea (82) 753-3101; Malaysia (60) 3-36299; Morocco (21) 9-30-6949; Netherlands (31) 70996360; New Zealand (61) 2-663-5289; Norway (47) (02) 559050; Peru (51) (14) 31-8060; Philippines 818-0103, 818-3073, 818-4230; Portugal (351) 1545313; Singapore (65) 271-3163; South Africa (27) 12469221; Spain (34) 14558112; Sweden (46) 87617820; Switzerland (41) 17231410, (41) 22360830; Taiwan (86) 2-721-7864, (86) 2-531-2434; West Germany (49) 89809020.
 DT/NOTEBOOK © 1984, Laboratory Technology Corp. ASYST © 1984 Macmillan Software Co. CHROMLAB © 1984, University of Southern California.
 DT/MLS-PC 1 © 1984, Signal Technology Inc. IBM is a registered trademark of IBM Corp. Data Translation is a registered trademark of Data Translation, Inc.

NOVAS

**PC/XT/AT
IN TURBO**

**TOP OF THE LINE IBM PC
COMPATIBLE COMPUTER**

MOTHERBOARD

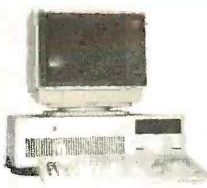

<p>NOVA'S PC/XT TURBO ON BOARD UP TO</p> <p>640K DUAL SPEED (4.77 MHz/8 MHz) keyboard software selectable, 8 slots, external reset \$125.00 (in large OEM quantity)</p>	<p>NOVA'S AT 286 DUAL SPEED (6 MHZ/8 MHZ)</p> <p>using gate array chips count only 36 I.C. (other AT compatible chip count 100 I.C.) 4 serial/1 parallel on board optional memory expandable up to 1MB fully compatible Bios (BASIC Input-Output System) is developed in the United States, fully provided all compatibility restrictions, systems Set-Up programs diskette provided, \$595.00 (in large OEM quantity)</p>
<p>NOVAS - 1000 Enhanced color Graphic Adaptor (E.G.A.) \$375.00 640 x 350 enhanced color mode, 16 color in 640 x 200 resolution 720 x 350 in monochrome mode, total of 256K bytes of memory Plus Printer Port (can select LPT1 to LPT3)</p>	
<p>SYSTEM</p>	
<p>GENIUS PC/XT TURBO COMPUTER . . . \$895.</p> <p>For complete monochrome system includes 640K RAM 130W power, 8 slots, turbo speed, 2 drives, serial, parallel, clock, game port, monographic, AMDEK 310A monitor.</p>	<p>MONO SYSTEM ONLY . . . \$1,495.</p> <p>256K, 2 1/2 TEAC DR, 20 MB H.D./w DTC controller monographic card/w printerport, serial port, monitor.</p>
<p>NOVAS AT 286 BARE BONE</p> <p>1 MB RAM memory, 1.2 M drive, keyboard, 195W power supply, case, HD/FD controller \$1,895.00</p>	<p>NOVAS AT 286 ENHANCED MODEL</p> <p>1 MB RAM memory, 1.2 M drive, 20 MB hard disk, 195W power supply, HD/FD controller, S/P card \$2,495.00</p>
<p>OEM, WHOLESALE, RETAILER, END USER ARE WELCOME <small>* IBM IS TRADEMARK OF INTERNATIONAL BUSINESS MACHINES CORP.</small></p> <p>COMPUTRADE COMPANY 780 Trimble Road, Suite 605, San Jose, CA 95131 Tel: (408) 435-2662 Fax: 171605</p>	

... for those of us who haven't decided what C to buy.
 PS.: Now where are those executables in the Listings area with a little note saying how long they should be?

amiga/main #1009, from crunch [John Draper, Cap'n Software]:
 a comment to 985

I was wondering about that, whether XMODEM would work on BIX. I also wonder about Kermit. I plan on posting another program on BIX and was considering XMODEM. Most of my Amiga programs are stored on the Mac. I find there are better modem programs; besides, I don't have a cable that can connect to the modem. Anyway, back to checking things out in preparation to the major uploading I'm planning soon.

amiga/main #1215, from dbetz

Binary Uploads
 Has anyone developed a file format like BinHex on the Macintosh for transmitting Amiga binary files through phone lines? I remember that there was a problem with the file size being rounded to a multiple of 128 with cheath's TxEed editor. Has anyone come up with a general solution to this problem? It seems like it should be fairly easy to come up with a format for a file that could contain both the executable version of a program and the .info file that contains the icon and Intuition information. Has this been done yet?

amiga/main #1220, from jdow:
 a comment to 1215

MaxiComm supports an extended XMODEM transfer that includes in the header information the exact file length. Then the receiving computer can read the header and dutifully truncate the file to exactly the right length. They did that one right, it looks like.

amiga/main #1222, from jsan:
 a comment to 1220

Trouble with MaxiComm is that files uploaded with it are probably not downloadable by other XMODEM downloaders *except* MaxiComm! What my terminal does to get around this is to put a LONGWORD length at the END of the file, together with a WORD flag of \$1234 after it, to make it valid. When the file is downloaded by a normal XMODEM handler, you are going to truncate it *anyway*, so those extra bytes tagged onto the end don't matter, but if you download it using a *smart* downloader that knows about the *length* at the end, then it will automatically *save* only the correct length of the file, transparently to the user!

I feel my answer to the length problem is better than MaxiComm's, which effectively renders the file incompatible with other XMODEM downloaders, unless I'm much mistaken.

amiga/main #1223, from jdow:
 a comment to 1222

The method MaxiComm uses is very similar to the extended XMODEM used in many modern implementations. The recent C-language one in DDJ for June had this. One full record (128 bytes) is so allocated. It is predictable and removable by a similar smart file diddler as yours and a good deal more robust method for detecting it is there.

amiga/main #1224, from jsan:
 a comment to 1223

Yes, the protocol for adding a 128-byte block is based on MacBinary's

(continued)

New OEM SBC



Base model
 Only **\$250.** 5" x 11"

OEM Discounts Available

Includes:

- 6 MHz Z80[®] Processor
- 64K DRAM
- Provision for 128K of EPROM or E²PROM
- 3 Parallel Ports
- Boot PROM to boot off EPROM, floppy disk or hard disk
- Full Z80 Interrupt Support
- I/O Expansion via either Peripheral Expansion Bus or iSBX[™] connector

Optional features to choose from:

- Floppy Disk Controller 8", 5.25" and 3.5"
- ST-506 Winchester Hard Disk Controller
- 128K or 256K DRAM
- Monochrome or Color CRT Video Controller (Alphanumeric and Graphics)
- Up to 4 additional Serial Ports
- Up to 2 additional parallel ports with counter-timers
- Buffered Peripheral Expansion Interface
- 50 or 60 Hz operation
- Time-of Day Clock with Battery Back-up

The Megatel Quark[™]1400 is a single board computer which allows OEM designers the flexibility of choosing only the features required. Development and system software include a fully configured CPM[™] 2.2 operating system — BASIC and C. All Megatel software includes utilities, drivers and source code. To order or enquire, call us today.
 Megatel Computer Technologies 150 Turbine Drive, Weston, Ontario M9L 2S2 (416) 745-7214 U.S. Address 1051 Clinton St., Buffalo, NY, 14206
 Distributors: NCS Electronics — Varese, Italy • SES Electronics — Nordlingen, Germany • Perdix Microtronics — Biggin Hill, U.K. • Microcomputing — Ghent, Belgium.

Quark is a registered trademark of F & K MFG CO LTD Z80 is a registered trademark of Zilog Inc CP M is a registered trademark of Digital Research Inc. iSBX is a registered trademark of Intel Inc.

megatel

MICROWAY'S 8087 RUNS 1-2-3™!

MicroWay is the world's leading retailer of 8087s and high performance PC upgrades. We stock a complete selection of 8087s that run at 5 and 8mhz. All of our coprocessors are shipped with a diagnostic disk and the best warranty in the business - one year! We also offer daughterboards for socketless computers (NEC PC) and 287Turbo which increases the clock speed of the 80287 from 4 to 8 mhz. Our NUMBER SMASHER™ includes 640K ram. It will run the IBM PC at clock speeds up to 10mhz and achieves a throughput of .1 megaflops with 87BASIC/INLINE, Intel

Fortran, or Microsoft Fortran. Software reviewers consistently cite MicroWay software and 8087 expertise as the best in the industry! Our customers frequently write to thank us for recommending the correct software and hardware to meet their specific needs. They also thank us for our same day shipping! In addition to our own products which support the 8087 and 80287, we stock the largest supply of specialized software available. For information call us at

617-746-7341

FASTBREAK™ employs the 8087 to increase the speed of Lotus 1-2-3™ Version 1A or 1A* by up to 36 to 1 **\$79**
FASTPAK™ includes FASTBREAK software and a 5mhz 8087 **\$179**
87SFL™ MicroWay's Scientific Function Library contains 170 scientific and engineering functions. Callable from most 8087 compatible compilers. First Language **\$250**; Additional **\$100**.
A2D-160™ MicroWay's Data Acquisition Board performs 160,000 12 bit Analog to Digital conversions per second! Includes software drivers. The fastest 12 bit A to D board available. For the IBM PC or XT..... **\$1295**

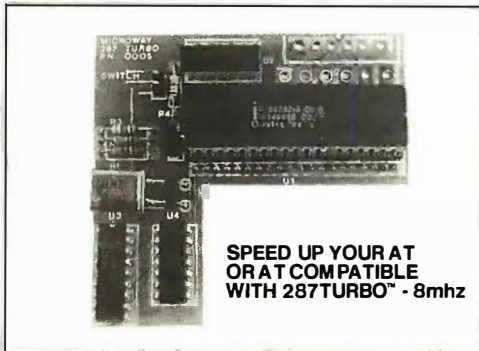

SPEED UP YOUR AT OR AT COMPATIBLE WITH 287TURBO™ - 8mhz

MicroWay® 8087 Support

For the IBM PC, PC XT, PC AT and Compatibles.

NUMBER SMASHER™ The World's Fastest Accelerator Card for the IBM PC, XT, and Compatibles! Includes an 8086 and 8087 pair tested to 10mhz, and 640K bytes of high speed ram. Compatible with all software, operating systems and hardware! Your program speed is increased by a factor of 2.5 to 4.0. Floating point programs run up to 2.8 times faster on the PC than on an 80287 equipped PC AT. One of the few accelerators on the market which is compatible with all EMS cards. Includes FASTBREAK..... **\$1099**

87/88Turbo™ is a stubby card which includes a clock calendar and a speed controller which changes the speed of your motherboard from 4.77 to 7.4mhz. Its use requires your PC to have a socketed 8224. Typical speed increase is 1.6. Some programs run up to 2.5 times faster. The card overcomes the problem of slow hardware by slowing up only when slow devices are accessed and running at full speed otherwise. It includes an 8087-2 **\$350**

286TurboCache™ This new MicroWay accelerator uses 8K of cache memory and 80286/80287 processors to provide an average speed increase of 3 to 1 for most programs. Call for specifications, benchmarks and price.

MATRIXPAK™ manages a **MEGABYTE!** Written in assembly language, our runtime package accurately manipulates large matrices at very fast speeds. Includes matrix inversion and the solution of simultaneous linear equations. Callable from RM or MS Fortran, MS Assembler, or 87BASIC/INLINE..... each **\$99**

87FFT™ Written in assembly language, performs Forward and Inverse FFTs on real and complex arrays which occupy up to 512K bytes of RAM. Also does convolutions, auto correlations, hamming, complex vector multiplication, and complex to radial conversions. Callable from most 8087 compatible compilers..... **\$200**

87FFT-2™ performs two-dimensional FFTs. Ideal for image processing. Requires 87FFT **\$100**

MegaPage™ Our Intel-Lotus specification memory card. The only EMS board which comes with two megabytes of cool-running, low power drain CMOS ram installed. Includes ram disk, print spooler, disk cache, and EMS drivers. For the IBM PC, XT, AT and compatibles **\$549**

DFixer™ Our disk utility which thoroughly checks PC or AT hard disks for bad sectors and updates the MS DOS file allocation table accordingly. Solves the AT hard disk problem! ... **\$149**

DOptimizer™ Optimizes the way your hard disk or floppy stores its files. Speeds up accesses by recombining fragmented files. **\$49**

DCache™ Our disk caching software speeds up your I/O by storing repetitively used tracks in memory. The amount of memory used can be selected in 64K byte banks **\$49**

87Verify™ For users who have to be absolutely sure of their results! This background task periodically performs an 8087 accuracy and stress test. **\$49**

87MACRO/DEBUG™ Contains all the pieces needed for writing 8087/80287 assembly code including 8087 macros, object libraries for commonly used functions, including transcendental, trigonometric, conversions and MicroWay's debugger - 87DEBUG **\$199**

OBJ → ASM™ A multipass object module translator and disassembler. Produces assembly language listings which include public symbols, external symbols and labels commented with cross references. Ideal for patching object modules for which source is not available. **\$200**

87BASIC™ includes patches to the IBM Basic or MS Quick Basic Compiler for USER TRANS-PARENT 8087 support. Provides super fast performance for all numeric operations including trigonometrics, transcendental, addition, subtraction, multiplication, and division. each **\$150**

87BASIC/INLINE™ converts the output of the IBM Basic Compiler into optimized 8087 inline code which executes up to seven times faster than 87BASIC. Supports separately compiled inline subroutines which are located in their own segments and can contain up to 64K bytes of code. This allows programs greater than 128K! Requires the IBM Basic Compiler Version 1 and Macro Assembler. Includes 87BASIC **\$200**

MICROWAY UDI runs RTOS or RMX compilers under DOS **\$300**

8087 UPGRADES

All MicroWay 8087s include a one year warranty, complete MicroWay Test Program and accurate Installation Instructions.

8087 5mhz..... \$109
For the IBM PC, XT and compatibles.

8087-2 8mhz..... \$149
For Wang, AT&T, DeskPro, NEC, Leading Edge.

80287-3 5mhz..... \$179
For the IBM PC, AT and 286 compatibles.

80287-8 8mhz..... \$295
For the Tandy 3000 and ITT-XP.

287Turbo™ 8mhz If you own an AT, Deskpro 286 or AT compatible, this is the card you need to get reasonable numeric performance. It plugs into your 80287 socket and includes a specially driven 8mhz 80287. The card comes in three configurations. The IBM AT version includes a hardware RESET button **\$395**

NEC V20, V30..... CALL

64K RAM Set 150ns..... \$10

256K RAM Set 150ns..... \$34

128K RAM Set PC AT..... \$49

JRAM, AST, INTEL..... CALL

DCache plus 64K ABOVE BOARD PS..... **375**

DCache plus 128K AT ABOVE BOARD..... **475**

Microsoft Fortran Version 3.31 **209**

IBM Professional Fortran **565**

Ryan-McFarland Fortran Version 2.0 **399**

FORLIB+ or STRINGS and THINGS..... **65**

Grafmatic for Fortran or Pascal **125**

Plotmatic..... **125**

NAG Fortran Library..... **300**

Lattice C..... **269**

Microsoft C or QuickBasic..... **CALL**

IBM Basic Compiler Version 2.0..... **465**

Summit BetterBASIC™..... **CALL**

IBM Assembler w/Librarian Version 2.0..... **155**

Microsoft Assembler Version 3.01 **99**

Microsoft Pascal Version 3.31 **199**

STSC APL★PLUS/PC..... **450**

Phoenix Plink86 or Cosmos Revelation... **CALL**

SPSS/PC+..... **595**

EPSILON Text Editor..... **195**

LABTECH NOTEBOOK..... **745**

MultiHalo (one language)..... **189**

Fifth Generation FASTBACK..... **150**

MicroWay P.O. Box 79
Kingston, Mass.
02364 USA
(617) 746-7341

Special Purchase
LAP COMPUTER
FULL FACTORY WARRANTY

BUILT IN 300 BAUD MODEM
 Built in spread sheet, similar to Lotus

Terminal Emulator
 to Communicate with Personal or Mainframe Computers

IT'S A HANDS FREE PHONE
 Comes with Rechargeable Batteries and Charger. Options Available Serial or Parallel Port Workstate Printer

workSlate
 BY CONVERGENT TECHNOLOGIES

THE MOST PORTABLE TERMINAL

OUR BEST PRICE EVER **\$295.00** ORIGINALLY \$1195.00

Includes FREE SOFTWARE WORTH \$88.00
 Information and Consultant Services Software.

Other Software Packages • WITH PURCHASE ONLY

Cost Management	\$15.00	Insurance Analyzer	\$15.00
Financial Statements	\$15.00	Real Estate	\$25.00
Inventory Analysis	\$15.00	Electronic Mail	\$25.00
Marketing Management	\$15.00	Information Services	\$15.00
Sales Reports	\$15.00	Loan Analysis	\$15.00
Travel		Portfolio Analysis	\$15.00

This state of the art computer comes with two instructional cassettes that talk you through the learning process. This means a human voice tells you which keys to press as you are learning to manipulate information on the screen. This computer also has built-in hardware that lets you hook in to services like Dow Jones/News Retrieval, The Source, MCI Mail, and many other services. Including thousands of electronic bulletin boards. • Dimensions: 8 1/2" x 11 1/2" x 1 1/2". • Keyboard: 60 keys. Typewriter-style keyboard and calculator pad. Power: NiCad rechargeable battery. AC adaptor/recharger or 4AA alkaline batteries. Software: Built-in handles management, financial analysis, phone, calendar and communications management. Internal Memory up to 128Kb x 11". Microcassettes store up to 10 worksheets or 45 minutes of audio information.

15 Day Money Back Guarantee

CEC

1745 Adrian Road, No. 1
 Burlingame, CA 94010
 415/342-4058
 800/228-3411

Charge Through Your Number Crunching

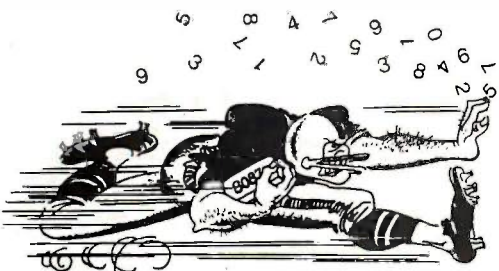

with MATHPAK 87™

MATHPAK 87 is an ideal tool for anyone doing scientific or engineering computation. MATHPAK 87 contains 120 assembler coded routines for virtually all common mathematical operations. These routines are specifically designed to extract the utmost performance from your 8087/80287 coprocessor and run up to 20 times faster than equivalent high level language routines. A 1K complex FFT takes 1.85s; a 1K real FFT takes 1s. The Fortran versions support single, double and mixed precision arithmetic. MATHPAK 87 routines are easy to use — you simply call them from your programs. A detailed, 130 page manual (full of examples) gets you started in minutes.

MATHPAK 87 has routines for:

- real & complex vector/matrix/scalar operations
- matrix eigenvalues/vectors
- matrix decomposition
- matrix factoring
- convolution
- statistical operations
- FFT's — complex, real, 2D, etc.
- solution of linear equations
- solution of differential equations
- spectral analysis, windowing
- Kalman filtering
- numerical integration
- data fitting

To make full use of your 8087/80287 chip order MATHPAK 87 today.

\$69.95 (US) for Turbo Pascal, \$109.95 (US) for Microsoft/IBM Pascal, Microsoft/IBM Fortran or IBM Professional Fortran versions.

MasterCard, checks, money orders and company purchase orders accepted. Specify compiler. Please add \$5 for shipping and handling.

Precision Plus Software, 4095 Kingston Road, Box 172B, Scarborough, Ontario, Canada M1E 2M3. Telephone (416) 761-5309.

efforts. It's known as ABTF (Atari Binary Transfer Format) on the Atari SIG and will be similarly defined on the Amiga SIG on CompuServe.

However, if a 128-byte block is added to the beginning of a file, it's not automatically removed by terminal programs that don't know of its existence. The point about adding *file information* to the *end* rather than *beginning* of the file is that it's more useful because a *normal* XMODEM downloader can successfully download the file, whereas, when you add things to the *beginning*, you restrict the downloading of the file to packages that *know* about the extra 128-byte block tagged onto the start!

amiga/main #1225, from dbetz:
 a comment to 1220

How do we make use of that format on BIX? Does it look like a normal XMODEM transfer until it hits the Amiga? In other words, is the header part of the protocol part of the packet or part of the first data packet?

amiga/main #1226, from dbetz:
 a comment to 1222

I still think it would be nice to have a file packer that would allow the executable file and the .info file to be transmitted as a single file and split at the destination.

amiga/main #1228, from jsan:
 a comment to 1225

The ABTF protocol, as used by MacTerm and (I believe) MaxiComm, has the initial block (block 1) containing header information that includes filename (as stored on disk), real length, type of system to run on, and other useful information. It can be downloaded by any XMODEM downloader, but the file must be doctored at the receiving end to utilize the header information. Alternatively, a suitably equipped downloader can download and make use of the header in one big job, which is what I assume MaxiComm does.

My point is that although ABTF protocol is nice (and I shall be adopting it, too), it is not the all-singing wonderful gift to downloaders, because we have many existing XMODEM downloaders who will be able to download ABTF files and won't use them because they won't know how to doctor the file upon receipt.

Whereas, if the file info block was attached to the *end* of the file (rather than the beginning), then the file can be downloaded by "dumb" XMODEM downloaders, and the normal procedure of simply *chopping* the file to the correct length (as already practiced in the Amiga community) will work fine, and no garbage will prevent the file being used as soon as it's downloaded because all the garbage is at the *end* of the file, rather than the beginning. Naturally, a suitably equipped downloader that *knew* about the info block at the end would utilize the information contained therein and would save the file automatically with the correct length.

I want to confirm that *both* protocols (ABTF and the other one) are able to send and retrieve XMODEM files onto *normal* systems, like BIX, CompuServe, etc. The only difference being extra "data" added to help the host computer determine the correct length of the file, since XMODEM always rounds the length up to the next nearest 128-byte multiple.

ABTF contains other goodies, too, all 128 bytes' worth. In fact, 124 bytes' worth, because the last word of ABTF contains a checksum of the first 124 bytes, allowing it to safely determine whether a file is ABTF or not! Hmmm, I begin to wonder, actually!

If the first sector of a file was all zeros, then the checksum of *all zeros* is indeed *zero*; thus, when ABTF downloader looks for its

(continued)

The Project Scheduler NETWORK™



As a manager, you know the key to a successful project is good planning. You can't afford to overlook critical costs and deadlines.

COMPREHENSIVE PROJECT MANAGEMENT

The Project Scheduler Network will help you meet deadlines and beat cost targets using effective project scheduling, resource planning, costing, and status tracking.

Advanced screen graphics. Produce Network diagrams, Gantt charts, and color graphs to provide the concise information you need for timely decision making.

Work Breakdown Structure (WBS). Organize project activities to produce summary level schedules and reports. Multiple projects can be integrated to present project level schedules and total resource utilization.

Baseline schedules. Save them to compare with current schedules for schedule tracking. Actual, original plan, and current plan costs can be graphically compared for cost tracking.

Comprehensive report generator.

Simplify communications with management by synthesizing project information into presentation-quality hardcopy reports and graphs.

SCHEDULE WITH THE CLICK OF A BUTTON

The Project Scheduler Network provides the most advanced software technology available. Start with our mouse-controlled menus to select spreadsheet-style input templates to enter your project data.

Graphically build your dependency Network with only a "click of a button." Zoom to view the Network at selectable resolution levels. Now use the mouse to edit the Network to your satisfaction.

Select a Gantt chart and obtain schedules at any WBS level with a single click. Window resource graphs with the schedule to analyze resource allocations. And finally, select our integrated graphics to view color histograms, bar charts, and line plots of project resources and costs.

FEATURES

- Critical Path Method
- Network Analysis
- Gantt Chart
- Work Breakdown Structure (subtasks)
- Multiple Project Integration
- Tracking with Baseline Schedule and Complete Status
- Resource Scheduling
- Financial Planning and Tracking
- Presentation-quality Graphics

REQUIREMENTS

- IBM® PC, XT, AT or TI-PRO, WANG PC
- PC-DOS 2.0, 2.1, or 3.0
- Monitor plus IBM graphics adaptor
- IBM or Epson graphics printer
- 320K RAM (minimum)
- Mouse (Microsoft compatible)
- Two disk drives (one double-sided)
- IBM or HP plotter optional

*Project Scheduler Network is a trademark of Scitor Corporation.

†IBM is a registered trademark of International Business Machines Corporation.

(415) 570-7700



SCITOR

SCITOR CORPORATION

250 Lincoln Centre Drive, Foster City, CA 94404

The REAL-TIME CLOCK-CALENDAR for IBM PCs and COMPATIBLES

dClock™

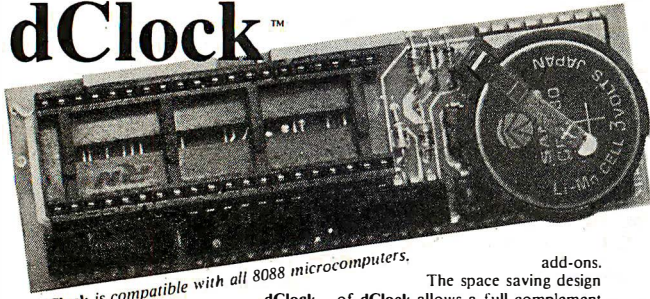

dClock is compatible with all 8088 microcomputers.

dClock is a user-installable, real-time clock-calendar for IBM® Personal Computers and selected compatibles. dClock automatically enters the date and time into the user's computer system each time the computer boots. Through use of an internal battery, dClock maintains precise time and date function when the system is shut down. dClock fits directly onto the system's motherboard in the 8088 socket. It does not occupy an expansion slot, nor does it take space from multi-function cards or memory

add-ons. The space saving design of dClock allows a full complement of expansion cards to be used without compromising dependable time-date system functions.

dClock is easily installed and provides PC users with a convenient way to have automatic date and time functions without paying for expensive or unnecessary expansion cards. dClock comes with installation software, a Limited Warranty and complete documentation (including how to upgrade your XT or COMPAQ® Portable to 640K easily and without using any expansion slots).

Available from **MICROSYNC** for just **\$59.95**
(Please add \$2 for shipping and handling.)

MICROSYNC is a computer peripherals product manufacturer specializing in microcomputer board-level accessories and enhancements.



Computer Products Department • P.O. Box 116302 • Carrollton, Texas 75011 • 214-492-5265

dClock and MICROSYNC are Trademarks of MICROSYNC Inc., IBM is a Registered Trademark of International Business Machines Corp. COMPAQ is a Registered Trademark of COMPAQ Computer Corp.

MAN AND MACHINE THE NEW PARTNERSHIP AM86

**Automated Manufacturing
Exhibition and Conference**

**Textile Hall Convention Center
Greenville, South Carolina, USA
November 3-6, 1986**

The future starts November 3, 1986. Be there as an exhibitor as one of the Southeast's most comprehensive automated manufacturing exhibitions/conferences unfolds.

AM86 will highlight an up-to-date, all encompassing array of state-of-the-art technology available to key management, R & D, engineering, purchasing and the all-important users from industry and business. Exhibits by as many as 300

companies will be complemented by over 40 technical sessions presented by leaders from industry and academia.

Exhibits, as well as technical sessions, will feature robotics, metal working, materials handling, CAD/CAM, process control instrumentation, CNC, lasers, microprocessing, fiber optics and many other related fields.

Call today for complete details.

**(803) 239-2967
P.O. Box 5616
Greenville, SC 29606**

Produced by The Consortium for Automated Manufacturing

checksum and validates it, then it may mistakenly think a file is ABTF when it was really supposed to be all zeros!

Hmmm, food for thought. I'll ask Russ Wetmore what he makes of that and see if he has a nice way of working around it.

amiga/main #1247, from jdow

Here's an example of a MaxiComm extended XMODEM information block. Here is the information block as examined on a CP/M system by ZSID after crossloading from an Amiga via MaxiComm extended XMODEM transfer protocol. It seems this is a rather robust and unlikely-to-be-spoofed format.

d100 17f

```
0100:455854454E444544584D4F44454D1F37 EXTENDEDXMODEM.7
0110:6466303A666F6E74732F6761726E6574 df0:fonts/garnet
0120:2F31360A333032380A0A0A0000000000 /16.3028 .....
0130:00000000000000000000000000000000 .....
0140:00000000000000000000000000000000 .....
0150:00000000000000000000000000000000 .....
0160:00000000000000000000000000000000 .....
0170:00000000000000000000000000000000 .....
```

amiga/main #1278, from jdow:
a comment to 1247

Extended XMODEM Protocol per MaxiComm

The extended transfer protocol for XMODEM embodied in the MaxiComm extended XMODEM protocol is currently capable of single file transfers bundling a file and its associated .info file together if the .info file is present. The MaxiCorp manual (which seems pretty good to me) has an error in its description of the format.

The format includes a relatively unambiguous header block to identify extended XMODEM protocol. It takes 16 bytes, of which the first 14 are EXTENDEDXMODEM. The remaining 2 bytes are in order, send 1F and 37 (hexadecimal). This is at odds with the manual, which accuses these bytes of being 0FF and 0 (hexadecimal), respectively.

Following this are up to four strings defining the filenames in the sending computer and the exact file lengths as existing on the sending computer. These are sent in sequence as follows, with each string terminated by a single linefeed, <LF>:

```
FileName<LF>
FileLength<LF>
InfoFileName<LF>
InfoFileLength<LF>
```

The lengths are sent as ASCII strings representing the decimal number of bytes in the file as present in the sending computer. The remainder of the first block is padded with ASCII <NULL> characters to fill out the 128-character block. The .info file data is only present if there is an .info file included in the transfer. The last block of the file sent is padded with ASCII <NULL> bytes to fill out the last 128-byte block. Following this, the .info file blocks are sent similarly padded in the last block.

Another ZSID dump of the header block for sending the Amiga clock program and its .info file via MaxiComm follows:

d100 17f

```
0100:455854454E444544584D4F44454D1F37 EXTENDEDXMODEM.7
0110:6466303A636C6F636B0A31373038380A df0:clock.17088.
0120:6466303A636C6F636B2E696E666F0A34 df0:clock.info.4
0130:33340A00000000000000000000000000 34 .....
0140:00000000000000000000000000000000 .....
0150:00000000000000000000000000000000 .....
```

(continued)

Lyco Computer Marketing & Consultants



1091 \$228

SEIKOSHA
SP-1000UC (C-64) . . . 169
SP-1000A Centronics . 185

C. ITOH
Prowriter 8510 sp+ Call
15505 sp+ Call
Printmaster Call

TOSHIBA
P1340 469
P351+ 1149
P341P 969
P341S 999
351 Sheet Feeder . . . 529

SAVE ON THESE IN STOCK PRINTERS

CARDCO
32K BUFFER. (C-64) 59

CORONA
LP300 Laser Printer 2686
200361 Toner Cartridge 89

EPSON
LX80 209
FX85 333
JX80 Call
Homewriter 10 193
DX10 207
DX20 297
DX35 597
AP-80 244
HP-80 555
HS-80 298
FX-286 (NEW) 489
LQ-800 (NEW) 529
LQ-1000 (NEW) 659

CITIZEN
MSP-10 255
MSP-15 355
MSP-20 337
MSP-25 495

OKIDATA
Okimate 10 171
Okimate 20 CALL
182 214
192 348
193 563
84P 645

BROTHER
HR-15XL-P 359
HR-15XL-S 359
HR-35P 839
HR-35S 839
2024L-P 949
M1009-P 189

JUKI
Juki 6100 344
RS232 Serial Board . . 55
6100 Tractor 119
6100 Sheet Feeder . . . 209
Juki 6300 757

LEGEND
880 188
1080 Call
1380 258
1385 289
808 148

DIGITAL DEVICES
16K BUFFER 75
32K BUFFER 89
64K BUFFER 125

DIABLO
D25 549
630 API 1599
630 ECS 1759
D 80 IF 2395
P 32 CO1 699
P 38 999
C 150 999
DX-35 (NEW) CALL
AP-80 CALL

SG-10 \$205

PANASONIC
109 228
3131 (NEW) 264
1092 325
3151 409
1080 (NEW) 209
1592 (NEW) 439

SILVER REED
EXP400 249
EXP500 295
EXP550 399
EXP770 749

STAR MICRONICS
SG-10 205
SG-10C 219
SG-15 367
SD-10 319
SD-15 438
SR-10 469
SR-15 578
SB-10 589
Powertype 297

MONITORS

TAXAN
115 12" Green Composite . CALL
116 12" Amber Composite . CALL
121 12" Green TTL 135
122 12" Amber TTL 145
220 14" Color Composite . 259
410 12" RGB Hi Res IBM . . 329
420 12" RGB Super Hi IBM . 409
440 12" RGB Ultra Hi Res . 555
Tilt Stand 35

NEC
JB-1260 Green 95
JB-1201 Green 135
JC 1215 Color 235
JC 1216 RGB 375
JC 1460 Color 265

SAKATA
SG 1000 12" Green 99
SA 1000 12" Amber 109
SG 1500 12" Green TTL . . 119
SA 1500 12" Amber TTL . . 129
SC 100 13" Color Comp . . 209
SC 200 13" RGB 389
STS1 Tilt Stand 29

AMDEK
300 Green 118
300 Amber 128
310 Amber IBM 155
Color 300 Audio 234
Color 500 Composite . . . 369
Color 600 397
Color 700 495
Color 710 569

PANASONIC
DT13000 13" RGB/Composite . 247
DTM140 14" RGB/Composite . 329
DIH103 10" RGB Hi Res . . 395
DTS101 10" Composite . . . 175
DT1000G 10" RGB 166
TX12H3P 12" Color 419
TR120M1PA 12" Green 109
TR120M1PA 12" Amber . . . 109
TR122M9P 12" Green IBM . . 148
TR122M1P 12" Amber IBM . . 148

PRINCETON GRAPHICS
MAX-12 Amber 165
-IX-12 RGB 465
SR-12 RGB 595

TEKNIKA
MJ-10 Composite 179
MJ-22 RGB 255

ZENITH
ZVM 122A Amber 75
ZVM 123G Green 75
ZVM 124 Amber IBM 129
ZVM 131 Color 275
ZVM 133 RGB 389
ZVM 135 Composite 449
ZVM 135 Hi Res Color . . . 589
ZVM 1220 95
ZVM 1230 149
ZVM 1240 149

MODEMS

HAYES
Smartmodem 300 133
Smartmodem 1200 377
Smartmodem 1200B 347
Smartmodem 2400 598
Micromodem IIE 135

TELE LEARNING
Total Telecommunications
(C-64) 29.95
AP-250 (300 Baud Apple) . 69.95
IB-250 (300 Baud IBM) . . 69.95

NOVATION
IBM: 300/1200 MSD-DOS ext. . 319
IBM: 300/1200 CPM-86 ext. . 319
IBM: 300/1200/2400 ext. . . 529
IBM: 300/1200/2400 MSDOS 579
IBM MSD-DOS int. 325
IBM CPM-86 int. 325
Macmodem 300/1200 315

ANCHOR
Volksmodem 55
Volksmodem 12 186

DRIVES

INDUS
Indus GT Atari 195
GT Commodore 209

MSD
SD1 Drive (C-64) 229
SD2 Drive (C-64) 469

TANDON
320K 5 1/4" Drive 115

TYMAC
MDD-640 II: Apple Drive 640K . 289

DISKETTES

DENNISON
ELEPHANT 5 1/4" SSDD . 11.99
ELEPHANT 5 1/4" SSDD . 12.99
ELEPHANT 5 1/4" DSDD . 14.99
PREMIUM 5 1/4" SSDD . 13.99
PREMIUM 5 1/4" DSDD . 15.99

VERBATIM
5 1/4" SSDD 13.99
5 1/4" DSDD 19.99

BONUS
5 1/4" SSDD 8.99
5 1/4" DSDD 12.99

IBM-PC COMPATIBLE

***QUADRAM**
Quad Jr. Exp. Chassis . . . 519.00
Quad Jr. Exp. Memory . . 209.00
Quad Memory Jr. 209.00

***LOTUS**
Lotus 1-2-3 309.00
Symphony 439.00

MICROPROSE (IBM)
F-15 Strike Eagle 20.75
Solo Flight 20.75
Hellcat Ace 20.75
Spitfire Ace 18.75

***LEADING EDGE**
Nutshell 69.95
LEWP Basic 65.00
LEWP Merge Print 85.00
LE Spell Correction 169.00

TOLL FREE 1-800-233-8760



TO ORDER



CALL TOLL FREE 1-800-233-8760
In PA 717-494-1030
Customer Service 717-494-1670

or send order to
Lyco Computer
P.O. Box 5088
Jersey Shore, PA
17740

RISK FREE POLICY

In-stock items shipped within 24 hours of order. No deposit on C.O.D. orders. Free shipping on prepaid cash orders within the continental U.S. Volume discounts available. PA residents add sales tax. A.P.O. F.P.O. and international orders add \$5.00 plus 3% for priority mail service. Advertised prices show 4% discount for cash, add 4% for MasterCard/Visa. Personal checks require 4 weeks' clearance before shipping. Ask about UPS Blue and Red label shipping. All merchandise carried under manufacturer's warranty. Free catalog with order. All items subject to change without notice.

BRADY Knows Programming.

You'll learn to whip every element of your programming into shape with the latest information and guidance by America's foremost technical experts. Just call toll-free or use the coupon below to order today.

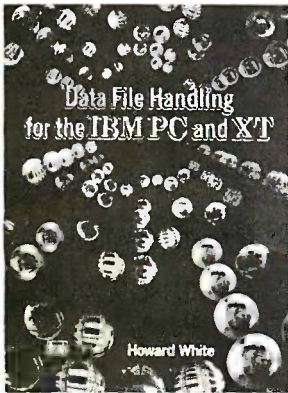

1. Take your programs to the next step... data input/output and manipulation. Learn about data storage and access and create your own database and file managers. Assumes some knowledge of BASIC. \$17.95

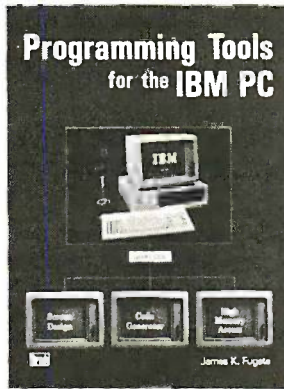

2. Includes a listing for the remarkable QUICKCODE code generator which automatically writes input, locate, and print statements. Also unleashes high memory access and makes screen design a cinch. \$19.95

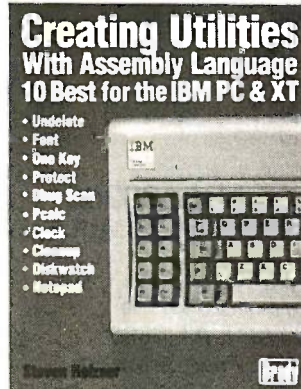

3. Learn the techniques used for creating assembly language utilities. Includes 10 of the most popular utilities such as DBUG, SCAN, CLOCK, UNDELETE, ONE KEY, PCALC calculator and notepad and five others. \$21.95 (Disk available)

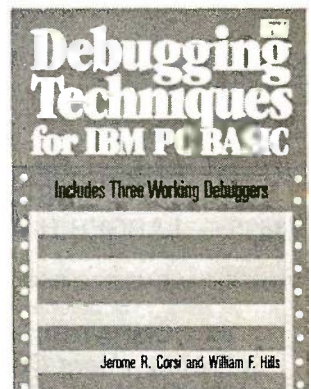

4. Includes code listings for three working debuggers including single-stepping, cross referencing, and mapping utilities. \$19.95 (Disk available)

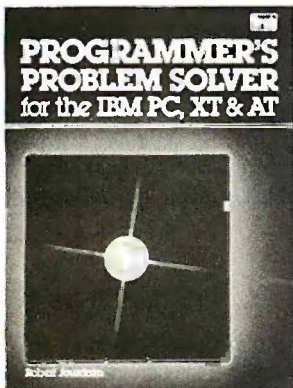

5. A definitive reference text for advanced programmers. You'll find over 150 discussions of common hardware-control tasks (in BASIC, Pascal, or C) as well as assembler overlays, drivers, and real-time operators. \$22.95

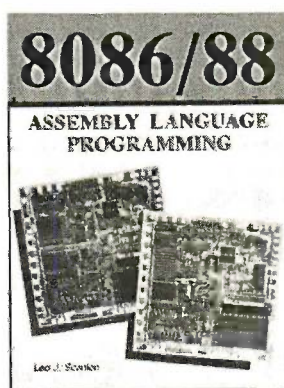

6. Probes the inner workings of the 8086 (used by the AT&T 6300) and 8088 (IBM PC) chips...and describes specific techniques for using the full capability of these chip designs while programming in assembler. \$18.95

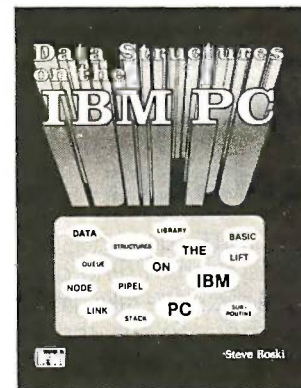

7. Here's a compendium of many of the most useful, but often neglected, advanced programming concepts. A tutorial in format that uses BASIC for examples. It covers techniques such as: linked data structures; recursion; pipelining; and dynamic storage allocation. Includes listings for 25 sub-routines. \$21.95 (Disk available)

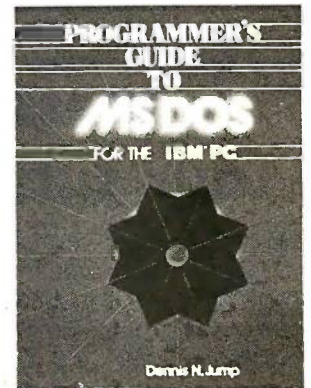

8. A breakthrough explanation to the technical operations of DOS for programmers. Shows how to use the I/O services with discussions of: character and non-character functions; directory and file management routines; and memory management. Includes BIOS functions and info on IBM "compatibles." \$16.95

Now at your book or computer store. Or order toll-free today: **800-624-0023** In New Jersey: 800-624-0024

BRADY COMMUNICATIONS COMPANY, INC. c/o Prentice Hall, P.O. Box 512, W. Nyack, NY 10994		Acc't # _____ Exp. date _____ Signature _____ Name _____ Address _____ City _____ State _____ Zip _____ <small>(New Jersey residents, please add applicable sales tax.)</small> Dept. 3 GR-PTEC-AW(3)
Circle the numbers of the titles you want below. (Payment must be enclosed; or, use your charge card.) Add \$1.50 for postage and handling. Enclosed is check for \$ _____ or charge to <input type="checkbox"/> MasterCard <input type="checkbox"/> VISA.		
1 (0-89303-528-9) 5 (0-89303-787-7)	2 (0-89303-784-2) 6 (0-89303-424-X)	3 (0-89303-584-X) 7 (0-89303-481-9)
		4 (0-89303-587-4) 8 (0-8359-5655-5)



COMPETITIVE EDGE

631 S. Main Street, Plymouth, MI 48170 — 313-451-0665
Compupro®, LOMAS, EARTH, TELETEK
S-100 CIRCUIT BOARDS

CompuPro 286 CPU	\$671	Lomas 2868MHZ	\$821	ColorMagic32K	\$556.
CompuPro SPUZ™ 8MHz	296.	Lomas 8086	420.	Lomas 1 0MHz 8086	520.
CompuPro 8085/86**	263.	Lomas Octaport™ 8Serial	320.	Lomas 4 serial	200.
CompuPro Disk 1A™	371.	Lomas LDP™ 72	206.	Lomas Color Magic™ 16K	476.
CompuPro Disk 3™	446.	Lomas 256K Dram	358.	Lomas MSDOS™ 2.11	200.
CompuPro Ram 22™	446.	Lomas 512K Dram	448.	CompuPro MDrive H*512K	446.
CompuPro Ram 23™	188.	Lomas Ram 67™	599.	CompuPro I/O 3 8 port	371.
CompuPro Ram 23 128	263.	Lomas Hazital™	244.	Teletek SBC 1 6MHz 128	375.
CompuPro CPU Z™	189.	Thunder 186™	895.	Turbodos® for Teletek	650.
CompuPro CCP/M*616*	300.	Lomas CCP/M*86**	280.	Lomas 2 Megabyte	
System Support One™	263.	CompuPro I/O 4	263.	Ram-(2048K) just	\$821.
Teletek HD/	375.	Systemmaster II*	795.	Earth Turbomaster	\$795.
Teletek Systemmaster*	495.			I.T. 1024x1024 Brd	\$995.

Illuminated Technology 1024x1024 Board for Autocad™ \$995.
Earth Computer TURBO SLAVE I 8MHz 128K \$395.
 Turbo Slave I runs with Teletek, North Star Horizon, Advanced Digital and Others under Turbodos™.

SYSTEMS

CompuPro 85/88, 256K, CDOS, SS1, I/O 4, 2-96TPI DRS, 15 Slot	\$3095
CompuPro 85/88, 256K, CDOS, SS1, I/O 4, 1-96TPI, 20MB, 15 Slot	\$4295
CompuPro 286, SPUZ, 40MB, SS1, I/3, CDOS, 15 Slot, 30 amp P/S	\$6995
286, 1024K, 20MB, AutoCad 2 System — Ready to Run	\$8395
Lomas 286, 1024K, 20MB HD, 1-5", CDOS, 6 SERIAL, 2 Par, 15 Slot	\$4995
Lomas Thunder 186, 256K, 20 MB HD, 1-5", CDOS, 4 Slot	\$2895
Teletek 8MHz Master, 4-8MHz 128K SLVS, 1-5", 20 MB HD, TDOS	\$4995
AT CLONE 286, FAST 20 MB HD, enhanced 512K	\$2995
AT CLONE, 10MHz 286, 1024K, FAST 20MB, mono card	\$3695.

VELOCITY 286-10 10 MHz 80286

\$3695 — LARGER HARD DISKS AVAILABLE
 AT COMPATIBLE WITH FAST 30 MB HARD DISK, 256K EGA CARD
 1024K, EXPANDABLE TO 4096K ON MOTHERBOARD & 12.5MHz
 Xenix™, Full Development System Five **\$995.00**

XT COMPATIBLES START AT \$895

Corporate Users Cut Your Programming Time with Our Fast (10MHz 286) AT Compatible

ALL PRICES SUBJECT TO CHANGE AND STOCK ON HAND

CompuPro is a Registered Trademark of Visasyn. CPU 2, Disk 1A, Disk 3, Interlacer 3, Interlacer 4, CPU 286, CPU 6085/88, System Support 1, MDrive/H, Ram 22, Ram 23 are trademarks or registered trademarks of Visasyn. CP/M 2.2, CCP/M are registered trademarks of Digital Research Inc. MSDOS is a registered trademark of Microsoft. Systemmaster & Systemmaster II are registered trademarks of Teletek Enterprises. Turbodos is a registered trademark of Software 2000. Hercules is a trademark of Hercules. IBM & AT are trademarks or registered trademarks of International Business Machines. AutoCad 2 is a registered trademark of Autodesk, Inc. Xenix is a trademark of Microsoft.

a message to our subscribers

From time to time we make the BYTE subscriber list available to other companies who wish to send our subscribers material about their products. We take great care to screen these companies, choosing only those who are reputable, and whose products, services, or information we feel would be of interest to you. Direct mail is an efficient medium for presenting the latest personal computer goods and services to our subscribers.

Many BYTE subscribers appreciate this controlled use of our mailing list, and look forward to finding information of interest to them in the mail. Used are our subscribers' names and addresses only (no other information we may have is ever given).

While we believe the distribution of this information is of benefit to our subscribers, we firmly respect the wishes of any subscriber who does not want to receive such promotional literature. Should you wish to restrict the use of your name, simply send your request to the following address.

BYTE Publications Inc.

Attn: Circulation Department,
 70 Main St., Peterborough, NH 03458

- 15 track zero
- 16 write gate
- 17 write data
- 18 step
- 19 direction select
- 20 drive select d
- 21 drive select b
- 22 index
- 23 + 12 volts (only enough for one 5¼-inch drive)

Thanks to Jay over on CompuServe for this info.

BERNOULLI DISK DRIVE

amiga/main #986, from mposehn [Mike Posehn]:
 a comment to 975

20 megabytes isn't much on a graphics machine like the Amiga. I'm going to wait for 40 megabytes.

amiga/main #991, from skipcave [Ellis "Skip" Cave]:
 a comment to 975

I would suggest that you take a look at the dual 20-megabyte removable cartridge drive from Iomega (New Bernoulli Box). This box gives you 40 megabytes on line with 35-ms access times, fully removable media, and a 3-4 minute backup from one cartridge to the other (20 megabytes). The box has a standard SCSI parallel port and I have driver sources for the 68000 on various machines with SCSI ports. You can turn most any 8-bit port with some handshake lines into an SCSI port without too much sweat.

I have 15 or so programmers developing with the dual 10-megabyte versions of this box, and the easy backup is a developer's dream. (I don't know how often you've blown up the OS on a new machine and lost hours of work, but the instant backup feature of these things is invaluable.) The box is a bit pricey (\$2000 and up) but nothing beats it for developers.

amiga/main #1017, from riplej:
 a comment to 975

What I want is an SCSI host adapter that allows me to use several hard-disk controllers and tape backup units through the same interface. The DMA would be on the host adapter and the software should allow you to configure for any size Winchester including a mixture on a single controller. Even the controller ID could be specified.

Don't forget, one of the things a lot of companies at COMDEX were showing were hard disks (including 360-megabyte 5¼-inch drive) with the SCSI interface built into the drive. So allowing for several controllers might not be a bad idea, as each of these drives uses a separate controller.

Besides, I have an ulterior motive. I picked up several of my company's used Winchesters and controllers with cabinets for \$40-\$45 for 5-megabyte and 15-megabyte drives. I would like to add these to my system, along with the Tandberg streamer I can get through the company at cost. Also, the CD-ROM drives should be controllable using SCSI controllers, I believe. By using this interface I don't see how you can go too far wrong. With a single host adapter you can add a myriad of different mass-storage devices using controllers designed by companies that specialize in that field (I recommend OMTI and Emulex) and can produce the controller cheaply by selling to a larger market than a single computer. Also, once the adapter is purchased you don't waste slots in a chassis and other SCSI peripherals should be cheaper to add.

(continued)

The FASTEST, EASIEST, MOST POWERFUL BASIC EVER!

Amazing New Advance — merits for an Old Friend.

ZBasic is an incredibly advanced and powerful BASIC—but—it's still the old BASIC you're used to. Instead of spending 6 months of your life learning another complicated language, let ZBasic put your programs into light-speed, now! (If you know BASIC, you know ZBasic.)

How Fast is ZBasic?

Lightening fast. Four years of intense development have produced the ultimate BASIC. ZBasic is "Compiled BASIC," and generates stand-alone applications that make any other BASIC completely obsolete. Just look at these speed comparisons.

Sieve Benchmark on Different PC's			
Macintosh™		Apple IIe, IIc	
ZBasic™	7.4 sec.	ZBasic™	486 sec.
Mbasic™	684 sec.	Applesoft™	5,401 sec.
IBM® PC (6088)		Z-80 (CP/M™-80, TRS-80™)	
ZBasic™	13.7 sec.	ZBasic™	30 sec.
BASICA™	2,190 sec.	Mbasic™	2,520 sec.

10 iterations of the Sieve from Byte, January, 1983

Compiler Speed/Interpreter Ease.

Like a BASIC interpreter, ZBasic allows you to write and execute your programs immediately! No messy "Linkers," "Loaders," or clumsy "Subroutine Packages" like most other compilers. To compile and edit, simply type "RUN." Debugging works the same as the interpreter, too. Just type "BREAK" or "CTRL C" to get back to the editor.

Lightning-Fast Compilation.

Computer Language Magazine says. "Compilation is amazingly fast..." After typing "RUN," ZBasic compiles your program at blinding speed—40 lines per second.

Works the Same on All Computers.

If you're tired of throwing away your old programs everytime you switch to a new computer, ZBasic is for you. Source code is portable from one computer to another, and since ZBasic uses Device Independent Graphics and Disk File commands, your programs adapt automatically "Adapt" to any other computer. And the ZBASIC editor is the same on all versions—regardless of the computer.

Einstein Math.

ZBasic offers programmers a math package that surpasses anything else in the industry! (Yes, ZBasic is even better than FORTRAN, PASCAL, MODULA-2 or any other language available!) You will have up to 54 digits of user-selectable accuracy at your power.

"Superb Documentation!"

"The 387 page ZBasic manual is a model of clarity and organization. The documentation is superb, solidifying our impression that someone worked incredibly hard to make ZBasic a benchmark for all other BASIC Compilers."

PC WEEK, Nov. 12, 1985

Easy Structure—If You Want It.

ZBasic helps you "Structure" your programs in a way that's easy and simple...you may use GOSUB or GOTO with names or line numbers. Supports multi-line LONG IFs and LONG FN's. LIST programs with—or without—line numbers! ZBasic automatically indents loops and structures in LISTings, too.



ZBasic Users Say:

"Awesomel It's about time! Great! Unbelievable!"

J.R. CPA
Seymour, MO

"...fast, generates stand alone programs, requires only modest amounts of memory, has outstanding compilation speeds and...was bug free and felt solid. And the price is very attractive."

Bruce W. Tonkin
COMPUTER LANGUAGE

"ZBasic is a powerful offering for BASIC programmers. It provides the flexibility of Turbo Pascal and the speed of compiled BASIC, all at a price that can't be matched. Kudos to Zedcor and to all users who make wise decisions to use ZBasic to the fullest."

Garry Ray
PC WEEK

"The best I have ever seen. I love it! You should be proud of this product."

R. R. Manager
Mesa, AZ

"Mind-blower! Easily the best BASIC I've ever seen!"

J. D.
Baltimore, MD

Versions shipping now!

- Macintosh, Apple IIe - IIc (128K & DOS 3.3)
- IBM PC and MSDOS 2.1 & Compatibles
- Kaypro Graphics version (CP/M-80)
- CP/M-80 2.0 or greater (Z80 only)
- TRS-80 Model 1/3, Model 4/4p

\$ 89⁹⁵

Send me ZBasic right away! \$89.95 complete. plus shipping

CREDIT CARD—MASTERCARD/VISA/AMEX/C.O.D.

Name _____

Card Expiration Date: _____

Address _____ APT. # _____

My computer is a _____

City _____ State _____ Zip _____

Day Phone _____

MAIL TO: ZEDCOR, INC.
4500 E. Speedway, # 93
Tucson, AZ 85712



ZBasic™

Arizona Residents add 9% Sales Tax. In U.S. add \$5.00 shipping. C.O.D. add \$5.00 per order. Outside U.S. and Canada, add \$20.00 per shipment for postage (U.S. currency only). C. Turbo Pascal, IBM PC, Fortran, Pascal, MODULA COBOL are trademarks of their respective companies—Macintosh is a trademark of Macintosh Laboratories, Inc.

ORDER TOLL-FREE:
1-800-482-4567

30 day money-back guarantee.

Technical Support: (602) 795-3996

PRESERVING PREFERENCES

amiga/main #1173, from mbutler [Michael Butler]

Am I missing something, or is there really no standard place in RAM to squirrel away the color table?

I'm particularly interested in being able to tidy up the first four palette entries (i.e., the Workbench colors) when my code is finished running. The hardware manual says that the actual registers are write-only, and I believe that, but is there no stock way of recovering the stuff done in Preferences?

Are the contents of the disk file updated by Preferences laid out in such a way that mere mortals may view them? Are there standard symbolic names in some #include, or some such? RJ? Pariseau? Anybody?

Also, I too would *really* appreciate more documentation on device drivers and printer interfaces. There are some nifty serial chips that are crying out for a side-board.

amiga/main #1174, from duck:
a comment to 1173

Try GetRGB4 where:

(vp,index)

vp = viewport of the Workbench screen

i = 0-3 for Workbench

Returns 12-bit value.

amiga/main #1175, from mbutler:
a comment to 1174

Far out. Thanks! Could you tell me which include file that's in? Thanks again.

amiga/main #1177, from duck:
a comment to 1174

I made a mistake, I think GetRGB4 takes a color map. You can get that from viewport->ColorMap. If you can find the Workbench screen you'll notice a viewport in there. GetRGB4 is a graphics.library function.

amiga/main #1179, from rjmical [R. J. Mical, Commodore-Amiga]:
a comment to 1177

If you aren't opening a window in the Workbench screen, you have no way of getting at the screen's viewport. But there's an easier way to get the default Workbench colors:

Call GetPrefs(), the Intuition function that returns a block of data containing the current system preferences. The data structure is named Preferences (surprise! could you guess? simplicity!) and can be found in the file intuition.h. The GetPrefs() function can be found in the Intuition manual.

amiga/main #1183, from duck:
a comment to 1179

The GetPrefs function only returns the user's preferences, it does nothing to return the current Workbench screen colors if someone else has dickered with them. The GetPrefs only works for Workbench and is not able to handle any screen that you may want to restore colors to after you have changed them.

ATARI ST

This month the ST discussions concern switching resolutions, experience with different versions of C and assemblers, installing TOS in ROM, using the VT52 on the desktop, I/O on the joystick port, printers, alternative disk formats, and the limitations of ST windows. Enthusiasts of Star Raiders will appreciate Jerry's closing fervor.

SWITCHING RESOLUTIONS

atari/tech.st #143, from cheath [Charlie Heath, MicroSmiths]

Is it really impossible to change from low to medium resolution on the color monitor without rebooting? It is possible to toggle the hardware, but the VDI routines will not work. We spoke to Atari and DRI and that



was the conclusion. This means it is impossible for a program to switch between a 16-color low-res graphics display and an 80-column text display. We are shocked, as our current contract job requires the switch.

atari/tech.st #144, from jtittsler [Jim Tittsler, Atari Corp.]:
a comment to 143

You might try doing a close physical workstation call after you have toggled the hardware (with the extended BIOS function call). Then reopen a physical workstation, and theory says VDI will catch on to the new resolution. (This should work within your application, but exiting to the desktop after doing this may be a problem.)

atari/tech.st #146, from jsan [Jez San, Argonaut Software]:
a comment to 143

It's perfectly possible for a program to change between low-res and hi-res quickly and easily. All that is required is a quick mode change on the system register "shiftmd" (Video Shift Mode type).

This is perfect for a hardware point of view, and we use it in our game. The problem comes when you want to use GEM, which was not designed to work in multimode environments! I'm sure someone will figure out a "naughty" (dirty) way of poking GEM's variables to fool it into changing modes, but in the meantime, I know of no *legit* way of doing it.

atari/tech.st #150, from cheath:
a comment to 148

Re: Switching resolution. We tried the "Close workstation; set hardware to other mode; Open workstation," and it doesn't work with the VDI routines.

I/O OPERATIONS

atari/tech.st #50, from skrenek [Steve Krenek]

Can the ST do anything during an I/O operation (like the Amiga) or does it wait until the I/O is complete to proceed (like the Atari 800)?

atari/tech.st #145, from jtittsler:
a comment to 50

Yes, the ST can do some operations during disk I/O operations. This is due, at least in part, to the way the DMA chip buffers the data arriving from the disk (either through the internal floppy controller or the external DMA port). It will request the 68000 bus only when it needs to empty its internal FIFO, leaving the 68000 largely unencumbered even during DMA.

Cs AND ASSEMBLERS

atari/tech.st #205, from abovejoy [Alan Lovejoy]

I would like to know what compilers are available and about their quality.

atari/tech.st #208, from neilharris [Neil Harris, Atari Corp.]:
a comment to 205

- C compilers: Alcyon C, sold directly by Atari as part of developer's package.
- Hippo C, from Haba Systems.
- Lattice C, coming soon from Metacomco and sold by Antic in the U.S.
- Megamax C, almost out.
- Modula-2: TDI Systems, Dallas, TX (written in England).
- BASIC: FAST/BASIC, coming soon from Philon.
- Pascal: Personal Pascal from OSS, native-code compiler.

atari/tech.st #149, from wbaker [Bill Baker]

I have given up on Hippo C. Bugs, fairly slow, and almost no documentation. Just received an early copy of Megamax C. So far it looks very good.

Programs written for DRI C work perfectly. Compiles are fast. Comes with a graphical shell. (Although the linker will not work under the shell if you are using double-sided drives.) Am looking forward to the final release.

(continued)

EMULATORS, AND UV ERASERS: \$50 TO \$5000

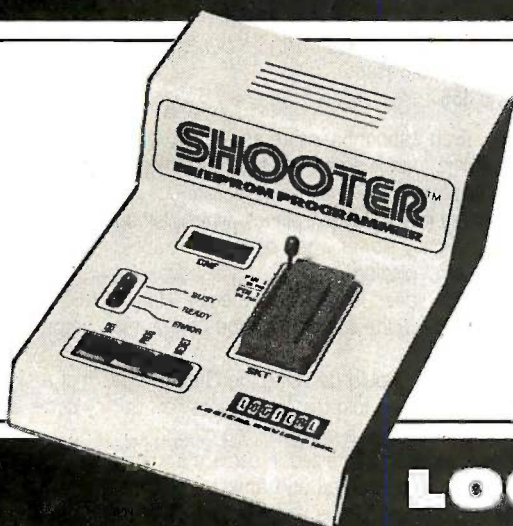

All from Logical Devices. Choose from a complete, full-featured product line of stand-alone or PC driven units designed to meet your every PROM, EPROM, EEPROM, PLD, & PAL* development and production need; including reasonable prices.

*PAL is a registered trademark of Monolithic Memories, Inc.

Compare features, compare price; then make the Logical choice.

IT'S LOGICAL

For details, write or call:
1321 NW 65th Place,
Fort Lauderdale, FL 33309;
(305) 974-0967
toll free 800-EE1-PROM
TELEX 383142

LOGICAL DEVICES INC.

atari/tech.st #204, from dmenconi [Dave Menconi]

TITLE: Micro C Shell

For you UNIX fans out there, there is a relatively new product out called Micro C Shell. It is a C shell that sits on top of TOS and pretends it is UNIX. I have talked to the people at Beckemeyer, and it sounds like it is well worth the \$50 they want for it. It does pipes, script files, redirection, and aliasing and has about 25 of the standard UNIX commands as well as a partial library of C utilities.

The \$50 product doesn't do multitasking, but they are coming out with a multitasking add-on for extra money (\$100?—only approximate) that will.

If you are interested, you should contact

Beckemeyer Development Tools
592 Jean St., #304
Oakland, CA 94610
(415) 658-5318

atari/tech.st #170, from cheath:

I thought the Lattice Amiga compiler had problems, but now we're trying to port stuff from Amiga to Atari, and the Atari compiler generates pseudorandom structure addresses! We're having to convert all structure references into explicit offsets. This is an exercise in high productivity. (It's a good thing the Amiga isn't using this compiler; with all the wonderful Amiga data structures, it would take years to figure out what was wrong!)

atari/tech.st #171, from jsan:

a comment to 170

Metacomco have finished their Lattice C for the Atari ST, which is currently in beta testing at this very moment. If you want compatibility between your Amiga and Atari programs, then you could do worse than use the same C compiler—Lattice.

atari/tech.st #211, from jsan:

a comment to 206

I have used the Metacomco assembler. And it's very slow, but very good and full-featured.

I then went on to use the Kuma Seka assembler, on sale from Antic in the U.S. It's *very, very* fast at assembling but lacks most of the features of Metacomco's. However, it *does* have an integral Debugger and Environment (Shell?) that makes it useful!

Assembly times of my program (back in the days when it was only 100K bytes of source code) were 30 minutes for DR assembler, 20 minutes for Metacomco assembler, and 6 seconds for Seka! Yes, 6 seconds! It accomplishes this because the file is loaded into RAM before assembly. All editing and other functions are done with the file intact. Also, Seka needs no stupid RELMOD program; its output is runnable immediately.

On a 512K-byte machine, it's unlikely you will manage to fill memory with your source file.

There is one further assembler out, which I consider the best of the lot! It's HISOFT's DEVPAI. Phone them in Dunstable, England; number (582) 696421.

It's as fast as Seka but has fewer disadvantages. First, it runs properly with GEM and has a *nice* decent editor. Next, it allows include files, so you are no longer limited by memory size.

There is also a GST assembler coming out, which, knowing their reputation, will *also* be pretty good.

atari/tech.st #151, from qpro [Christina Willrich and Richard Man]

In *Analog*, Tom Hudson did an article on the Mandelbrot set. His DRI C program produced a low-res picture in 20–45 minutes. My back-of-envelope calculation shows that an average picture takes 20–60 million floating-point operations. A friend has written a Mandelbrot program in Amiga BASIC that takes 3.5 hours to do a picture. Since this is a calculation-intensive program, the difference between interpreter and compiler should not be that great. Also, my friend is using the fast floating pointer in his Amiga. What gives?

atari/tech.st #152, from dmenconi:

a comment to 151

It is true that, once the interpreter figures out what the calculation is, the actual calculation will take roughly the same time whether the program is BASIC or C. However, the overhead involved in setting up for each calculation is not trivial. Also, there is the looping and the condition testing, not to mention storing and retrieving data. Given all this I am not much surprised at a 7 to 1 improvement of C over BASIC. In fact, I would expect more. Either the Amiga BASIC is very good or, as you suggest, the type of problem is slightly better suited to BASIC.

Since the two processors are the same and the machines are not doing graphics in real time (I assume), the difference in the two computers would be the language and the clock speeds (I think the ST is a smidge faster, isn't it?) and, of course, how the two programs are written. I would say that there are too many variables to use this as a comparison between the two machines.

atari/tech.st #154, from cheath:

a comment to 153

I'd expect the Atari to be about 5 percent faster if they use the same floating-point routines, on this nongraphic-intensive application. If there are moving images on the screen, the Amiga is 2 to 5 times faster, from our limited experience.

atari/tech.st #155, from skrenek:

a comment to 154

I was surprised that the Amiga came out faster than the ST on this timing. The pixel drawing to fill the screen should be such a small part as to be unimportant. I also would expect the ST to be faster on the pure math. There were some slight differences because of the way the libraries are accessed. In fact, now that I think about it, Tom may have said that the square root function is double precision on the ST.

atari/tech.st #156, from jsan:

a comment to 155

In some ways, even without hardware assistance, it is easier to draw a pixel on the Amiga than it is on the Atari. The Amiga has the most logical video bit-plane logic of all—pure contiguous memory.

The Atari utilizes interleaved bit planes, which, although useful on occasion, make it slightly slower when doing raw graphical functions, like line drawing or pixel plotting.

The Amiga clock speed is 7.2 MHz, whereas Atari's is 8.0 MHz. Having said that, Lattice C, the standard on the Amiga, may be producing tighter code.

A better benchmark would be using the Green Hills C that Amiga themselves use. I've been told that it produces real quality code, which runs much faster than Lattice or any of the others.

Incidentally, I would be interested in someone writing *exactly* the same program on both the Atari and Amiga machines—and even using the *same* compiler. This is now possible because Lattice C has

been written on the Atari ST by Metacomco. It's at the beta-testing stage but should be released shortly.

I think the bottom line is that anything involving *graphics* will be inevitably faster on the Amiga due to hardware graphics support and more logical screen memory, but that in raw processing, the Atari will be very slightly faster than the Amiga.

Having said that, in the *real world*, no program does raw processing without *some* screen interaction. *All* programs have text or graphics routines in abundance, which is, of course, where the Amiga excels. Real world is what counts, and so it's likely that most real-world application programs will apparently run faster on the Amiga.

TOS IN ROM

atari/non.tech.st #125, from dmenconi:
a comment to 124

I have heard (and would like to verify) that the users groups will get the ROMs (EPROMs, if you want to be picky) soon now with the understanding that they should copy them as needed.

atari/non.tech.st #127, from neilharris:
a comment to 125

Users groups who bought STs directly from Atari will get one set of ROMs (*not* EPROMs) per machine purchased, when available (probably January). I believe that we will allow people to copy them on EPROM for members. Otherwise, dealers can install the ROMs. The suggested price is \$25.

atari/non.tech.st #141, from jsan:
a comment to 139

Developers can send blank EPROMs to Atari Tech Support and have them returned with ROM TOS on them. If in England, they can contact Computer Concepts, who are Atari's agents for distribution of the EPROM TOS.

atari/tech.st #164, from jsan

I've just received my TOS on ROM (well, EPROM, actually). It's great, being able to power up and use the machine *instantly!* Especially useful for development of my game because every time it crashes I have to *reset*. At least now I don't wait 30 seconds each time.

One thing I noticed. Colour mode has its display shifted right by a large amount. It's almost off screen compared to TOS on disk. What can I do about that?

atari/tech.st #165, from jtittsler:
a comment to 164

On the back of your "colour" monitor there is an adjustment that will permit you to center the display to your liking. When TOS was put into ROMs for the European market, the decision was made to accommodate 50-Hz PAL displays, and so it will appear shifted on your monitor as it was set up. The monitor has plenty of lock range, however, so it should be easy for you to get it centered.

atari/tech.st #167, from jsan

TITLE: U.K. ROM TOS Patch for Early Machines
Jim Tittsler—Many thanks for the help you (and Shiraz) gave me just now on the phone. The solution was to modify the 50/60-Hz flag back to 60 Hz on boot-up. The following code performs that task, as I'm sure others will be interested in a patch, too. (Although quite how many Brits there are on BIX is not the issue, hehe!)

```
;Patch to fix UK ROM TOS from having shifted display!
;
; (c)1985, Argonaut Software Ltd., UK.
; By Jez San.
;
; Assemble this program, and save it as "FIXIT.PRG" inside
; the "AUTO" folder on your drive 0 disk. When UK ROM TOS
; boots up, it will execute this program, which resets the
; 50/60-Hz flag back to 60 Hz, which puts the display back in
; the centre of the screen for us early ST users. People
; lucky enough to have the recent version of the Glue chip
; will not have this problem (so I'm told!).
;
move.l #stack,sp ; TOS doesn't allow us to use its own stack, snif!
clr.l -(sp) ; Set Supervisor mode (ho hum...!)
move.w #$20,-(sp)
trap #1
addq.l #6,sp ; Reset the stack
move.b #$fc,$fff820a ; Change the flag back to 60 Hz
clr.w -(sp) ; Exit gracefully back to TOS/Desktop
trap #1 ; (Did I say Gracefully!? Surely Not!)
; That's it, possibly the smallest program I have ever written!
; [Also, the first program I wrote that worked first time!]
dc.l 0,0,0,0,0,0,0 ; Call this a "Stack"!?
stack:
end
```

(continued)



PC/AT/XT, TURBO, ADD ON CARDS.
.....IS YOUR RIGHT CHOICE

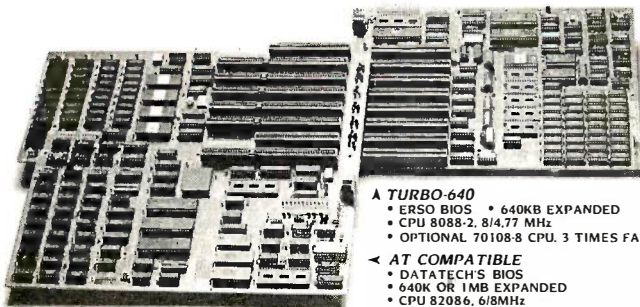

A TURBO-640
 • ERSO BIOS • 640KB EXPANDED
 • CPU 8088-2, 8/4.77 MHz
 • OPTIONAL 70108-8 CPU, 3 TIMES FASTER

← AT COMPATIBLE
 • DATATECH'S BIOS
 • 640K OR 1MB EXPANDED
 • CPU 82086, 6/8MHz

PC/XT COMPATIBLE
 • ERSO BIOS • CPU 8088
 • OPTIONAL CPU 70108-8, 1.7 TIMES FASTER

ADD-ON CARD
 FOR AT: • DISK DRIVE CONTROLLER, SUPPORTS 2x1.2 MEGA FLOPPY DISK DRIVE • I/O CARD
 • 2 MEGA M/F CARD • 3 MEGA RAM CARD
 • SERIAL + PARALLEL PRINTER CARD AND MORE...

FOR PC/XT AND COMPATIBLE:
 • ENHANCE COLOR CARD • MULTI I/O CARD
 • MONOCHROME GRAPHICS PRINTER CARD
 • COLOR GRAPHICS PRINTER CARD AND MORE...

****ALL PRODUCTS HAVE FCC APPROVAL****



DATATECH ENTERPRISES CO., LTD.
 3RD FL. NO. 68 PA TE RD., SEC. 4, TAIPEI, TAIWAN, R.O.C.

TELEX: 12086 DATATECH P.O. BOX: 96-361 TAIPEI, TAIWAN
 TEL: (02)7672553 (4 LINES) FAX: (02)7610681 DATATECH TPE

VT52

atari/tech.st #185, from mofi [Ric Young]

Has anyone had a problem with the VT on the desktop? It seems to lock up for no apparent reason at all.

atari/tech.st #186, from jsan:
a comment to 185

The reason for the lockup is that the dumb ST will occasionally receive an XOFF character. This tells it to stop sending any more characters down the serial port, and hence until you receive an XON character, it will *lock up!*

The problem arises when the XOFF wasn't sent intentionally and was either sent via line noise or was in fact output by the ST but was inadvertently echoed back into the ST due to a Hayes-compatible modem that echoes its command line.

Quite simply, you're stuck!

I/O ON THE JOYSTICK PORT

atari/tech.st #212, from al [Alastair J. W. Mayer, author of BIX's CoSy software]

A question/assumption: Is the pin-out on the ST joystick port the same 9-pin pin-out as the original Atari joystick port (and the VIC-20 and C-64)?

If so, is whatever peripheral chip the port attaches to capable of both reading and writing the joystick button ports? (Obviously can't write the analog paddle ports.)

I have a Sequential Circuits plug-in music keyboard designed for the C-64. It plugs into the joystick port—it takes power from the 64 and is read by using two pins as output to clock out the key-press data in serial form through one input pin.

Can I program the ST to do the same? Or is the ST game port input-only?

atari/tech.st #216, from neilharris:
a comment to 212

It is the same pin-out as far as the digital signals are concerned. There are *no* analog inputs. Data from the joystick/mouse ports is fed into a 6301 single-chip processor, which sends data through a 6850 ACIA to the main system. More info is available in the Atari developer's kit or, at lower cost, in the book *Atari ST Internals* from Abacus Software, (616) 241-5510.

atari/tech.st #220, from jtittler:
a comment to 212

(In addition to Neil's comments.) The ST joystick ports are the same pin-out as the older Atari 8-bit line, but they are input-only. They are sampled by the keyboard microcontroller, and packets of information concerning state change can be sent to the 68000 or the microcontroller can be interrogated about the current state depending upon what is appropriate for the application. There is also one special mode that repeatedly samples the "fire button" input of joystick 2 and packs 8 samples/byte for reporting to the 68K (this was included for a couple of potential applications that required an easy way to sample 1 bit).

atari/tech.st #225, from al:
a comment to 220

That was the impression I got from Neil's comment. The pins are read-only. Fine for joysticks and the like, but darn, I really *like* the ability to use those pins as outputs too. (On the C-64 they're wired to a 6526 in-

terface adapter, on a VIC-20 to a 6522 [you should know that, Neil!]; thus they can be set for I or O by setting the data direction register on the chip.) I've put together a couple of different gizmos that use that ability, and the Sequential Circuits keyboard is another one.

Are there *any* programmable output ports on the ST? (Other than, obviously, the predefined MIDI and RS-232C serial ports and disk ports.) If not, how about a 6522 cartridge for the "ROM" port? (Will that work?)

Or can the keyboard microcontroller be reprogrammed? (I suspect the answer to the latter is that it would be far more trouble than it was worth, if I have to burn a new ROM for it or something.)

atari/tech.st #227, from neilharris:
a comment to 225

You can't even make a new ROM for the keyboard controller, since it is part of the single-chip microprocessor. Why not use the parallel printer port, which happens to be bidirectional?

atari/tech.st #230, from jtittler:
a comment to 225

Yes, as Neil suggests, the bidirectional parallel printer port would be a good candidate. There are also a couple of other parallel output bits available that might serve. One bit is available on the video output connector; we intend that to be used to switch from one monitor to another, but obviously you can use it for other purposes. Another bit is available on the output port of the sound chip that is not even brought out to any connector in the current machine, so you could use it by "blue-wiring" it to the place of your dreams (only with a little bit of peril, since future machines might take advantage of that bit). You could likewise get outputs by using the 6850 modem control lines if you don't mind hacking up your ST.

atari/tech.st #231, from neilharris:
a comment to 230

Keep in mind that these suggestions violate the protocol for keeping compatible with the future. If for one person's application for one machine, fine. Definitely not a good idea for anything commercial!

PRINTERS

atari/non.tech.st #179, from dmenconi

What sorts of printers go well with the ST? Is the Atari printer the best bet or are there better ones?

atari/non.tech.st #181, from neilharris:
a comment to 179

We recommend anything compatible with the Epson Graftrax protocol.

atari/non.tech.st #180, from mofi:
a comment to 179

Well, I use my Epson RX-80 F/T+ with my ST. I went out to Radio Shake (Shack) and got the standard cable and everything works just fine. FirstWord has the drivers for the Epsoms, so printing is simple. I prefer Epson for dot-matrix printing to Atari printers (talking from past experience only, not present new ST printers).

atari/non.tech.st #182, from skrenek:
a comment to 179

I think my Star SG-10 looks great with the ST. (For those of us still in the

Dark Age of black-and-white print, that is!) You may still have to make your own cable, though.

atari/non.tech.st #187, from jtittler:
a comment to 179

The pin-out of the D connector on the back of the ST was designed so that a typical PC printer cable with a DB-25P on one end and a Centronics connector on the other end would work.

atari/non.tech.st #183, from dmenconi:
a comment to 182

Is there enough documentation to figure out how to make a cable?

atari/non.tech.st #184, from skrenek:
a comment to 183

Apparently there is enough info with the developer's package. I don't know what info comes with the consumer version regarding printer port pin connections. Any consumers out there?

atari/non.tech.st #188, from bwebster [Bruce Webster, Consulting Editor, BYTE]:
a comment to 184

The 520ST owner's manual has pin-outs for all the ports in the back; see page 76 for the printer port.

DISK FORMATS

atari/news.st #218, from jsan

We are using a disk format on the ST that gives us 409K of storage in an SF354 disk drive!

We did this by using 1K-byte sectors, instead of the ubiquitous 512-byte sectors that everyone else uses!

I don't see why Atari uses 512-byte sectors, because the cluster size is *two*, which makes DOS use 1K-byte blocks *anyway*, so you might as well have used sectors of 1K byte, and a cluster size of *one*!

The extra 50-odd K that we get using 1K-byte sectors makes it *very* worthwhile.

atari/news.st #219, from jtittler:
a comment to 218

Yes, there are also some folks using 10 sectors per track instead of 9. We wanted 512-byte sectors for a variety of reasons, including compatibility with some future products. But as you have obviously found out, it is not difficult to support a variety of media formats.

ST WINDOWS

atari/non.tech.st #129, from dmenconi

Is it true that the ST does not let you arbitrarily position your icons?

atari/non.tech.st #130, from neilharris:
a comment to 129

You can put your icons where you like on the desktop, but not in the windows.

atari/non.tech.st #131, from dbetz [David Betz]:
a comment to 130

I think that it is really important to be able to arrange the icons in a disk window the way you want to. One of the things that makes the Macintosh so easy for new users to understand is that documents

seem to behave as real objects. When you move a document, it stays where you put it. You can arrange your documents in a convenient order on your desk (in windows) and they remain in place from session to session. If you take away that ability, you are left with something that is no different from a traditional file system with pictures as file extensions.

STAR RAIDERS

atari/non.tech.st #156, from tom__thompson [Tom Thompson, Technical Editor, BYTE]

Truth to the "Star Raiders II" rumor?

atari/non.tech.st #163, from neilharris:
a comment to 156

It is under development by one of our best in-house programmers. He has many of the early routines done, but it will probably be 3-4 months more work for him. Looks awesome—thanks to the ST's better resolution; the different displays from the 8-bit version are combined on one main screen. So the galactic map is displayed as a hex map in the lower part of the screen.

atari/non.tech.st #166, from tom__thompson:
a comment to 163

Thanks for the info, and keep us posted. Please don't cramp the big display too much—a lot of Star Raider's appeal came from getting involved in the big screen display. I'd like to see more sophisticated graphics (shouldn't be too hard with the ST, right?), particularly realism on the attack vessels, and more elaborate attack algorithms from the enemy ships.

atari/non.tech.st #175, from jerry [Jerry Pournelle, Consulting Editor, BYTE]

I want Star Raiders for the ST. I want Star Raiders for the ST. I want Star Raiders for the ST. I want . . .

IBM

This month's selection of activity in the IBM conference features a continuation of the discussion about the NEC V20/V30 CPUs, questions and answers on how extended memory and memory overlays work, more comments on methods to speed up the PC AT, and a suggestion on how to extend the environment space on a PC.

V20/V30 PERFORMANCE

ibm.pc/pc.hardware #370, from Iconfer [Les Confer]

8088 Speedup

Does anyone know if it's possible to speed up the PC by swapping to an 8-MHz 8088 or V20 and timing crystal? How do the "turbo-compatibles" accomplish switching between 4.77 and 8 MHz? Is it possible to implement the same type of scheme in the PC?

ibm.pc/pc.hardware #372, from cjackson [Craig Jackson]:
a comment to 370

There's been some talk of this here and in the cpus/v20v30 conference. I don't think anybody here has actually done it. You can *buy* kits to perform this conversion; back of *PC Week* and back of *InfoWorld* have

(continued)

them. I expect back of BYTE will have them soon, too. There has also been some discussion on ARPANET about this, with mixed results.

ibm.pc.pc.hardware #374, from rsimonsen [Redmond Simonsen]: a comment to 372

There is a good article on V20/V30 user installation and performance benchmarks in a recent issue of *PC Magazine* (December 24 cover date) called "Turbocharging Your PC with the V-Series." The improvement is only about 10 to 20 percent overall (better on pure computational stuff). The *PC* article tells one a pretty complete story.

ibm.pc.pc.hardware #412, from dbetts [David Betts]

Still More on the NEC Devices

Here is some data that I generated testing the NEC 70108 (V20) and the 70116 (V30) on various computers. This data was prepared for an article written for the San Francisco IBM PC newsletter "Bluenotes" (published November 1985).

Three tests were performed: (1) an assembly-language program running one million pure integer ADDs and one million integer MUL instructions; (2) recalculation of a 160K Lotus spreadsheet; and (3) time to replace all the "e's with "x's in a 10-page document.

The times in table 1 were the result of running an assembly-language "benchmark" that performed 1×10^6 ADD instructions and 1×10^6 MUL instructions. One of each kind of possible addressing modes was used for each instruction, and the base group of instructions were duplicated 100 times in the .ASM source (using my editor) to reduce overhead.

Table 1: Execution times for assembly-language benchmark.

Computer	Processor	ADD (sec)	Speedup (% of PC)	MUL (sec)	Speedup (% of PC)
PCjr	8088	13.06	-129	22.92	-8.0
PC	8088	5.70	0.0	21.23	0.0
PC	70108	5.62	3.5	7.69	63.8
Compaq Deskpro	8086	2.80	50.9	14.13	33.4
Compaq Deskpro	70116	2.69	52.8	4.85	77.2
PC AT	80286	2.44	57.2	3.29	84.5

Times are averages of multiple runs, and the percentages are speedup relative to a straight PC. Also, I should point out the Compaq was run in its "Turbo" mode of 7.88 MHz, which "jes' natchrally" makes it faster. Finally, for comparison, I have also included times for the same benchmarks on an IBM AT and a PCjr (both unmodified).

Table 2 is the results for the recalculation of the Lotus spreadsheet.

Table 2: Calculation time for Lotus spreadsheet.

Computer	Processor	Calculate (sec)	Speedup (% of PC)
PC	8088	32.01	0.0
PC	70108	28.82	10.0
Compaq Deskpro	8086	17.15	46.4
Compaq Deskpro	70116	14.14	55.8
PC AT	80286	11.17	65.1

Again, all times are averages, etc. Table 3 is a comparison of the clocks to execute several "popular" microinstructions.

Table 3: Instruction comparison for Intel and NEC devices.

Instruction	Device			
	Intel 8088	NEC 70108	Intel 8086	NEC 70116
	Clock Cycles			
ADD mem16, reg	24	24	16	16
CALL near proc	23	20	19	16
CALL far proc	36	29	28	21
DIV (unsigned 16, integer)	170	25	162	25
INT (< > 3)	71	50	50	38
MOV acc, mem16	14	14	10	10
MOVS (single operation, word)	26	19	18	11
MUL (unsigned 16, integer)	126	30	118	3
RET (no POP)	20	19	16	15

Table 4 is the results for replacing all the "e's with "x's in a 10-page document. Microsoft Word was used for this, and to keep things as fair as possible, I ran the program and document out of a RAM disk on all engines tested, so disk access (very fast on the AT) would not affect the test results.

Table 4: Process time for a 10-page document.

Computer	Processor	Process (sec)	Speedup (% of PC)
PC	8088	103.51	0.0
PC	70108	94.86	8.4
Compaq Deskpro	8086	50.65	51.1
Compaq Deskpro	70116	40.82	60.6
PC AT	80286	32.87	68.2

In all cases but the assembly program test, timing was done by stopwatch. For the first test, DOS calls to the timeofday were used.

One final word in conclusion. A scrutiny of the test results will reveal a more substantial increase for the Compaq (and/or the 8086), presumably due to the fact that the bind in speed in a PC (or other 8088-based machine) is *not* due to the processor but rather the speed at which memory is accessed.

I hope this is some help. 10-4, ovr'n'out.

ibm.pc.pc.hardware #413, from johnf [John Fistere]: a comment to 412

Your benchmarks are very interesting, but I have a different idea on how the speedup should be calculated. If the faster processor completes the task in one-third the time, it is running at 300 percent speed for a 200 percent speedup, right?

Here is how I would calculate the speedups:

Table 1: Execution times for assembly-language benchmark.

Computer	Processor	ADD (sec)	Speedup (% of PC)	MUL (sec)	Speedup (% of PC)
PCjr	8088	13.06	-56.3	22.92	-7.3
PC	8088	5.70	0.0	21.23	0.0
PC	70108	5.62	1.4	7.69	176.1
Compaq Deskpro	8086	2.80	103.6	14.13	50.2
Compaq Deskpro	70116	2.69	111.9	4.85	337.7
PC AT	80286	2.44	133.6	3.29	545.3

What do you think about those numbers?

ibm.pc/pc.hardware #418, from jdown [Joanne Dow]:
a comment to 413

Why not calculate percent of PC speed?

ibm.pc/pc.hardware #426, from johnf:
a comment to 418

I have no problem with that. It would mean adding 100 to the speedup numbers I posted.

ibm.pc/pc.hardware #430, from naro [Richard Naro]:
a comment to 412

I would like to comment on both #412 and #413 to correct some incorrect interpretations. First, I must agree with johnf (#413); the performance increases are as he computed them. Since I have considerable knowledge about the V20/V30, let's make some comments on the validity of this set. First of all, the focus of the assembly-language benchmarks is very narrow—they do point out that certain instructions such as multiply/divide are significantly faster than on the 8086/8088. Use the Lotus/Word benchmarks to see some typical application performance.

The final paragraph is the most serious misstatement. The speed difference between the V20/8088 or V30/8086 is due solely to internal V20/V30 enhancements.

All external timing remains identical; i.e., the CPU clock speed has not been changed and there is no change in memory access time. The performance increase of the V30 over the 8086 compared with the increased speed of the V20 or 8088 is due to the bus bandwidth. Let me use the Lotus example (recomputed to use the correct percentage increases) to demonstrate.

Computer	CPU	Time	% Increase
PC	8088	32.01	0.0
PC	70108 (V20)	28.82	11.0
Deskpro	8086	17.15	0.0
Deskpro	70116 (V30)	14.14	21.3

By virtue of the 8-bit external bus width, the V20/8088 must perform nearly twice as many bus cycles as the V30/8086 to satisfy instruction fetching. These bus cycles (performed by the bus interface unit [BIU]) tend to dominate in the V20/8088 and mask the performance increases of the execution unit (EU). The V30/8086, by virtue of a 16-bit external data bus, are much less constrained by instruction fetch bus cycles—thus, running the same code, the V30 was 21 percent faster than the 8086 while the V20 was only 11 percent faster than the 8088.

One last note—for interested parties, there is a conference (cpus.v20v30) devoted solely to the NEC V-Series.

EXTENDED MEMORY

ibm.pc/pc.hardware #546, from jerry [Jerry Pournelle, Consulting Editor, BYTE]

Extended versus Expanded Memory

I would greatly welcome a good summary of the differences between "extended" and "expanded" memory, the advantages/disadvantages of each, and what software is doing what with which. Since this may well have been done here already, I guess I am really asking for a favor: Perhaps it would be better done by mail? Or put into the tojerry/chaos conference so that the PC conference old hands won't be bored by it?

I really know little about it. We have an Orchid Conquest board that is "expanded" memory and seems to have several major software houses supporting the EMS "standard"; this thing works the way most

Orchid stuff does, which is very well once you get it installed, and installation is easy once you catch on to what they're doing.

Alas, the Conquest doesn't exactly work with the Orchid Turbo-186 in that programs being run under the Turbo mode can't access the expanded memory.

This whole thing confuses me; I am sure that it has been explained many times and in many places, but, unfortunately, I have only limited time to read everything, sigh. Help would be appreciated.

ibm.pc/pc.hardware #556, from conniek [Conrad Kageyama]:
a comment to 546

Let me try, Jerry, but what I say is not gospel. The expanded/extended thing is sort of messy. Extended memory is what the PC AT has, and your Kaypro 286—memory addresses exceeding 640K up to 3 megabytes. If you were to visualize a column of addresses (like a memory map), then extended memory would just continue as an extension of the top of memory on up through the ceiling. This is where VDISK resides in a PC AT. Expanded memory, on the other hand, is parallel memory, so to speak. In your picture, it would be a second column of memory addresses.

A little clarification here. The normal PC actually has 1 megabyte of addresses, but everything from 640K to 1 megabyte is reserved for other uses (video, etc.). So now you have these two columns (memory maps). While extended memory is a continuation of the first column, expanded memory is a parallel column, and the EMS standard physically swaps pieces of the first column with those of the second column; i.e., you load a program in the lower 640K, then swap it out with another chunk of memory from expanded memory to load another program. Clear as mud? It may be a travesty to say so here, but not long ago, *PC Magazine* had a nice picture of the way it was done, discussing the virtues of the various systems, the LIM EMS and the AST superset EEMS.

DEBUG FILE-SIZE LIMIT

ibm.pc/pc.software #489, from jms [Joseph Subitowski]

Can anyone tell me if there is a file-size limit when using PC-DOS Debug? I was attempting to debug a 12-megabyte database index file today and kept getting a divide overflow. All other files I tried worked fine but not this monster. I assume there is a file-size limit then, no?

ibm.pc/pc.software #490, from jrobie [Jonathan Robie]:
a comment to 489

Debug is a .COM file, so it is limited to 64K data and 64K code unless it uses overlays.

ibm.pc/pc.software #491, from barryn [Barry Nance]:
a comment to 489

Yep. The maximum number of sectors that can be loaded with a single Load command is 128 (hexadecimal 80).

ibm.pc/pc.software #494, from rschnapp [Russell Schnapp]:
a comment to 490

I doubt that .COM limitations are the problem. I've loaded some pretty large files with Debug, 300K and more. Sorry, jms, I've never even seen a 12-megabyte file, much less played with one. That's a whopper!

ibm.pc/pc.software #495, from cjackson:
a comment to 489

Debug is trying to load the entire file into memory, so you won't be

(continued)

able to use it for a 12-megabyte file. There may be a limit short of the size of memory; many early programs had problems at 512K because the value of a segment register at that point goes negative if you incorrectly treat it as a signed number. But I wouldn't expect Debug to have that problem.

MEMORY OVERLAYS

ibm.pc/pc.software #504, from jhchan [John Chan]:
a comment to 490

I've heard a lot about memory "overlays." Would someone tell this neophyte what it is, and where I can find more info and learn about it?

ibm.pc/pc.software #505, from bbrown [Bob Brown]:
a comment to 504

What's an Overlay?

The overlay concept is a memory-management technique that lets a programmer write programs larger than the memory space he has available. That's how huge programs can run on 128K PCs. It works like this: The programmer divides his code into "chunks" or "segments" that will be used at different times during the execution of the program. For example, he might have an initialization chunk, a processing chunk, and a termination chunk, which together would be too big to fit into memory. He also writes (or the language he's working in supplies for him) an overlay handler routine.

When you run his program, what you actually execute is the overlay handler. The overlay handler loads the initialization segment and executes it. When initialization is finished, control is transferred back to the overlay handler, which loads the processing segment *on top of* the initialization segment, which is no longer needed. (That's where "overlay" comes from.) When processing is finished, the termination segment is overlaid on top of the processing code. Therefore, the amount of memory needed for this program is enough for the overlay handler and the largest program segment, rather than enough for all the routines at once. Simple, huh?

Actually, I've oversimplified a little. The area where the overlay handler lives is generally called the "root segment," and it may (usually does) contain things other than the overlay handler code itself. For example, the data structures used throughout the program live there, as do frequently used subroutines. If the programmer is writing in a higher-level language, the language's run-time library often lives in the root segment, too. Even so, this technique can let you pack a pretty big program into a pretty small space.

If you've worked with mainframes or super-minicomputers, you've probably encountered "virtual memory." This is similar in concept, except that the management of what code is read in from the disk ("paged in") is left to the operating system rather than each individual program. There are other, more technical differences, too. But the principle remains the same. Hope this helped.

ibm.pc/pc.software #511, from bbrown:
a comment to 504

More Info on Overlays

John, I put your answer here in case others are interested. The handling of overlays is very much implementation-dependent. The concept is the same, but the details are quite different from machine to machine and language to language. Turbo Pascal has overlay features; look on page 149 of the 3.0 manual or Addendum page 2 (back of book) in the 2.0 manual. Also, read about the CHAIN and EXECUTE functions in either Turbo manual. I'm not familiar with the overlay facilities of MS Pascal, but I'll bet some BIX'un is. Watch this space for an answer.

AT SPEEDUP AND HARD DISKS

ibm.at/at.hardware #116, from star (Spencer Star)

8-MHz Crystal and Sargon III

I recently put a faster crystal in my AT so that it now runs at 8 MHz. The only game I have that runs on the AT, Sargon III Chess, no longer loads. Decathlon never worked on the AT. I'm not a game fanatic, but I would like to have chess and maybe a few others. Two questions for my friends with *business* machines. Does Sargon III work on anyone else's speeded-up AT? Does anyone have some recommendations for games that are good and that work on an 8-MHz AT?

ibm.at/at.hardware #119, from jhchan

AT Fixed-Disk Bad Sectors

I just got four AT units at work, and after using CHKDSK, all four units have bad sectors that range from 30K, 70K, 90K, to 260K. The one that has 260K of bad sectors concerns me. Would someone comment on this?

ibm.at/at.hardware #120, from star:
a comment to 119

Core, a company that makes hard disks with a good reputation, states that they keep bad sectors to less than one half of one percent of total disk space. On a 20-megabyte, that comes to 100K. I have a Core 40-megabyte that has about 250K of bad sectors, thus exceeding their specification. I think the key is that the number of bad sectors remains stable. On disks by CMI, every couple of weeks some new bad sectors can show up.

ibm.at/at.hardware #121, from jhchan:
a comment to 120

Star, thanks for your comment. Before these four units, I also have been using an AT with a CMI drive with 30K of bad sectors. It has been over two months, and no increase in bad sectors. One of the new ATs in this batch does not have a CMI drive, but some other might. I could not see any label on the outside at all. Is there a good way to exercise that drive to check it out?

ibm.at/at.hardware #122, from mellon [Ted Lemon]:
a comment to 121

The IBM AT Advanced Diagnostics provides a way of checking your disk for physically bad sectors (as opposed to sectors that MS-DOS *thinks* are bad). Of course, be sure to back the disk up first, since all data is erased.

ibm.at/at.hardware #124, from asantic [Alexander Santic]:
a comment to 123

I've heard several mentions of the IBM Advanced Diagnostics disk. Is this sold through the Product Centers, or what? I haven't encountered it.

ibm.at/at.hardware #125, from star:
a comment to 124

My ComputerLand service center has the Advanced Diagnostics disk. I believe it comes with one of the maintenance manuals, but I'm not sure. I seem to remember trying to order it and being refused, but maybe I decided not to place the order because the price was too high.

ibm.at/at.hardware #126, from jhchan:
a comment to 125

I have an Advanced Diagnostics disk for the XT, but I don't know if it

will work on the AT. They're available at the IBM Product Center for about \$300 U.S. As long as it is not from my own pocket, I think I'll get it. But it is annoying to have over 200K of bad sectors.

ibm.at/at.hardware #128, from dono [Donald Osgood]:
a comment to 126

The AT Advanced Diagnostics disk is different from the PC XT disk. I tried to use the PC XT disk on the AT, but it didn't help with hard-disk formatting and checkout.

ibm.at/at.hardware #129, from jhchan:
a comment to 128

I spent \$295 at the IBM Product Center for the AT maintenance and service manual. After half an hour, the number of bad sectors did not go down a bit. Well, at least I didn't cut anything or screw up the disk controller. I should have listened to the earlier comments and left it alone.

ibm.at/at.hardware #134, from barryn:
a comment to 133

Which BIOS service routine or interrupt contains the nasty timing loop in question? Maybe it would be possible to write a new routine, sans the stinky code, and replace the interrupt vector to point to the new routine. If the old routine isn't exercised at boot time, maybe the new routine could "sneak into place" via the AUTOEXEC.BAT file and the now-faster 80286 would never know the difference.

ibm.at/at.hardware #139, from star

How about some information on this 80286-8 CPU? What is it, who sells it, what is involved in putting it in an AT, what happens to disk accesses, chip temperatures, etc? I know there is no such thing as a free lunch. What's the downside of this miracle chip?

ibm.at/at.hardware #141, from rpluzak [Richard Pluzak]:
a comment to 139

No miracle—just a faster CPU chip guaranteed by Intel to run at the stamped speed (i.e., 6 MHz, or 8 MHz, etc.). However, Intel rates conservatively (by as much as 50 percent), which means the part should run 30 percent faster with no problem. Therefore, a 6-MHz part may run as high as 9 MHz if thermal runaway doesn't occur (might need better heat sinking). The 80286-8 could probably be pushed beyond 10 MHz, maybe as high as 11 MHz, but I doubt 12 MHz.

At these speeds, however, the RAM access time becomes too long, even with one wait state inserted, forcing RAM chip swaps (to 100–120 ns). Also, other motherboard and bus factors come into play, but the board may do 12-MHz system clocking (24-MHz crystal).

I'll have to try this soon, unless someone else has.

ibm.at/at.hardware #144, from leroy [Leroy Casterline]

Some software protection schemes are sensitive to the AT speedups. If you have to run protected software, invest in one of the many crystal switches on the market. Allows operation at old 6-MHz rate at the flip of a switch. I think these products are generally much overpriced, but if they solve a problem...

I've been running my AT at 9 MHz (18-MHz crystal) with the original 80286-6 for over a year with no problems at all. Some complain of problems with the floppy disk at this speed, however (intermittent "abort, retry, ignore" messages; no damage). I use my AT for software development and find the extra speed *well* worthwhile. If you don't replace the 286, the investment is \$50–\$100 for the switching scheme.

The faster crystal itself is available at electronics stores (in Fort Collins, Colorado, at least) for \$2.50 and can be replaced with no tools/soldering in about 30 seconds once the cover is removed. Just plugs right in. Save the old crystal to swap back in case warranty service is needed.

ibm.at/at.hardware #146, from star

Adam-Orian Industries, 18045 Cocklebur Place, Suite A, Rowland Heights, CA 91748, (818) 810-8443, offers an AT Turbo card that holds three crystals with a manual switch on back of the AT (Turbo I) or through the keyboard (Turbo II). Prices are \$74.95 for Turbo I and \$124.95 for Turbo II. I'm thinking of getting one. Seems like the best solution.

ibm.at/at.hardware #152, from mhaas [Mark Haas]:
a comment to 151

Many people don't realize that the DMA channel on an AT (stock crystal) is slower than the DMA channel on a stock PC. I believe the AT's is 3 MHz while the PC's is the same as the CPU—4.77 MHz.

ibm.at/at.hardware #153, from rpluzak:
a comment to 152

However, the AT DMA channel is *word-wide* (i.e., 16 bits). A 3-MHz 16-bit channel is equivalent to a 6-MHz 8-bit channel. Therefore, the data rate (number of bits/second) is the same.

ENVIRONMENT SPACE

ibm.pc/other #38, from dmiller [Dan Miller]

Expand Environment Space?

Is there a way to expand the environment space? After loading all my DOS utility software (fans console, util, PC-Write definition files) I get an environment full message. I have lots of RAM. Anyone got a driver utility that will expand the environment space?

ibm.pc/other #45, from conniek:
a comment to 38

Depending on your version of DOS, and I highly recommend DOS 3.1 for its added functions as well as bug fixes, your environment can be fixed in a couple of different ways. There is a file called DOS31.PAT (and a later version called DOS31A.PAT that gives a patch to COMMAND.COM) that will correct the problem. Another way, in DOS 3.x, is an undocumented feature using the SHELL statement in your CONFIG.SYS: SHELL=C:\COMMAND.COM /P /E:xxxx. The /E:xxxx is the undocumented feature where the xxxx is the number of paragraphs of RAM that you want to preserve for your environment.

The most positive method of fixing your environment is to patch COMMAND.COM, as this allows loading of a secondary command processor and reloading of COMMAND.COM without losing your environment space. Patching COMMAND.COM, though, is always a risky venture at best, so you must weigh the need. Using the /E switch in the SHELL statement is much safer and works fine so long as you don't overwrite the transient portion of COMMAND.COM in your daily work. One other technique, with which I am not familiar, is to load up your environment from the CONFIG.SYS (the environment is open-ended until you load a file, and executing your AUTOEXEC closes the environment), and then in your AUTOEXEC, unload it, thus leaving environment space. As I said, though, I know it's been done this way, but I don't know how to do it.

(continued)

MACINTOSH

This month in the Macintosh conference a number of technical problems were encountered and solved on BIX. A warning about using Rascal with a HyperDrive was posted, along with a code fragment for the rapid handling of dialog boxes. A debate over what constitutes a game started in the Soapbox topic, and assistance was given to a user encountering problems downloading from BIX.

MAC TO PC CONNECTION

macintosh/hardware #40, from joeleben [Joe Leben]

TITLE: Connecting Mac to PC

This is a strange one. I connected my Mac to my PC via the modem port on the Mac and the COM2 async port on the PC. All went well. I transferred files back and forth with no problems. But then I shut the machines off. If I turn on the PC first and then attempt to turn on the Mac, the Mac won't power on. No beep, no Mac face, no nothing. But if I then pull out the plug from the modem port that is connecting the Mac to the PC, the Mac magically powers on. This doesn't happen if the plug is plugged in and the PC is powered off. What's happening here? I can't believe that some condition at a serial port will cause a computer to refuse to power on! Is this just me? Even if I've got the cable wired wrong, this shouldn't happen. Any suggestions?

macintosh/hardware #41, from jeffjacobs [Jeff Jacobs]:

a comment to 40

It is possible that noise generated by the serial port is such that there is a constant stream of interrupts, or an interrupt that generates a hard loop such that the system is "frozen"; i.e., the Mac is powered on but can't get to the code that gets everything started.

The above is just speculation, but you might check to see that the cable is grounded properly.

macintosh/hardware #42, from bvanantwerp [Bill Vanantwerp]:

a comment to 40

Check the cable to make sure that pin 4 on the PC side is tied high. I had similar trouble when trying to make the Mac drive an HP Plotter. A check with a breakout box showed that the Mac constantly monitored pin 4 and, if low, would not power on.

macintosh/hardware #43, from joeleben:

a comment to 41

Could be the ground; I'll check. I had a short cable and spliced in an extension between the two connectors. Chances are I didn't get the ground connected right. But a computer that won't turn on because something is weird on a serial port? That's a new one on me.

HARD-DISK PROBLEM

macintosh/hardware #49, from jeffjacobs

TITLE: MacBottom20 Problems

I just got a MacBottom20 and am having problems; after it has been on for a while, I start getting disk errors (-36) and Bombs (ID = 26, which I believe is Seg Load Failure). If I power off, the problems seem to go away; the longer it's off, the longer it runs okay when powered back on (temperature problem?).

When it first powers up, I can examine blocks with FEdit with no error, but after a while, errors start showing up, usually starting around sector 986 and "spreading" in both directions; the number of rereads

keeps increasing until the Error = -36 appears.

Does anybody know what -36 is? Bomb ID = 26?

macintosh/hardware #51, from lloeb [Larry Loeb]:

a comment to 49

ID 26 is failure to launch. The disk error is wiping necessary segments. I discussed this with the guy that wrote the MacBottom software, and he and I both feel your drive is mechanically bad. *But!* Try this before shipping it back. Boot on a good floppy Finder as startup. Get the disk going and recover any files you may need with data. Then wipe the disk by throwing away all volumes and files on the disk. Try to throw it all away. Then reinstall the volumes and files you want on the disk and see what happens. This is a workaround to reformat that the software won't let the user near. Try this to see if the install that you did was bad (for some reason). If errors still appear, you have a bad Rodime drive.

macintosh/hardware #52, from jeffjacobs:

a comment to 51

The problems are intermittent. There is apparently an area on the disk that gets "bad" as the temperature increases. If I power off and power back on, all the errors go away. But after operating for a while, they reappear. That is, I can launch all the programs and examine the disk sectors with no errors after power-up, but they come back after a few minutes of being powered up.

I'd sure like to know what ERROR = -36 really is. FEdit says "Unspecified I/O Error."

It certainly seems like a bad (marginal) area on the disk. I am going to exchange it. I am very impressed with it; if I could reformat the disk, I probably wouldn't even exchange it.

There was a message on another system where the guy said that an early version of Switcher trashed application files. However, I assume that the files would be *permanently* trashed. If you get a chance to talk with your contact, ask him if he is aware of any possibility that this might be a Switcher problem (I was running 3.5), although it's very hard to see how software could cause this kind of problem.

macintosh/news #196, from jeffjacobs

TITLE: MacBottom Update

I tried the suggested technique of essentially recreating the volume, i.e., copied all files to a new volume, deleted the originals, and then copied back. Seems to have worked; I haven't been able to generate any errors out of the "bad" area. I still have those sectors "tied up," so that they don't get allocated.

I doubt if I'll exchange it, unless I have more problems.

THE MAC AND A UDS MODEM

macintosh/hardware #53, from ceccate [Chuck Pate]

TITLE: Help with a UDS 212A/D

I have a problem that maybe one of you all can help me with. I've got this 1200-baud modem from work to use, but the catch is we don't have documentation for them (we have two). Now is there anyone out there in MacLand who can help me get this puppy working? Can this modem work with anything but an IBM?

If not, what is a good modem that would also be compatible with most other computers? I need to get up with the rest of the world. I have been using an old A/J acoustic for seven years now.

macintosh/hardware #54, from tom__thompson [Tom Thompson, Technical Editor, BYTE]:

a comment to 53

The UDS 212 modem is a smart modem like the Hayes, and as you

might have guessed, its command sequences are different from the Hayes. Here's a quick rundown on the commands that perform roughly the same functions:

UDS 212 Hayes

COMPLETE CONNECT - response when carrier detected.
D(digits) ATDT (digits) - dial the numbers in string (digits).

If you have script or auto-pilot files set up for a Hayes modem, altering the two commands as shown should help. I've had to modify a Hayes script file to play with a UDS modem, and I suggest the following additions to your script files:

1. Start out by issuing a OGOEN (Opal-Green-Zero-Edna-Nancy) to the UDS. This initializes the UDS and places it in the command-ready state. Look for a prompt (:) from the UDS indicating it's prepared to accept commands. Do not pass go if you don't get this prompt.
2. I don't remember if there was a hang-up command like "+++" with a Hayes, so any hang-up sequences will have to be eliminated or modified. □

macintosh/hardware #55, from cecpate

You hit it right on the bit and put a fire under my Mac. I'm at 1200 baud. Now I can let my boss know what to do with his UDS and Mac.

MACPLOT SOFTWARE

macintosh/prod.discussn #248, from bvanantwerp

TITLE: MacPlot

I just received a copy of MacPlot. Quite nice in many regards. The program can turn MacDraw and MacDraft documents into plots on a wide variety of plotters including the HP series, HP emulators, and many others. The program is quite good at using the Mac interface and also produces a variety of types of line and solid shadings on a variety of drawings. Now if it only did Excel graphs or did some curve fitting.

macintosh/prod.discussn #249, from kerskine [Keith Erskine]:
a comment to 248

Can MacPlot work with Calcomp plotters?

macintosh/prod.discussn #250, from bvanantwerp:
a comment to 249

Plotter Support

The version of MacPlot that I have will run a Calcomp 81 plotter. The professional version will support the 104x series Calcomp plotters, as well as some of the larger CAD plotters.

RASCAL LANGUAGE AND HARDWARE

macintosh/prod.discussn #251, from mwelch [Mark Welch]

Re: Rascal and the HyperDrive 20

I noticed a few messages on MacQueue of great importance to people with HyperDrives. According to Leo LaPorte, sysop of MacQueue, any program written in Rascal that uses sound will *destroy* directory information on the HyperDrive 20. One person lost an entire hard disk this way. I don't know what version of Rascal this pertains to, but there are apparently several programs (one called Billiards) released as public domain that were written in Rascal and use sound, so if you have a HyperDrive 20 you should be *very, very* careful when running new public-domain software.

This is not a "trojan horse"—it appears to be a very obscure but quite consistently destructive bug.

macintosh/prod.discussn #252, from jrobie [Jonathan Robie]:
a comment to 251

I'm sending a copy of message 251 to Scott Gillespie of Metaresearch. If he responds I'll also post his response here.

macintosh/prod.discussn #275, from jrobie:
a comment to 251

Message 251 suggests that there is a bug in Rascal that results in the loss of directory information when certain programs are run on a Mac with a HyperDrive. This is Scott Gillespie's response:

As many of you know, the Rascal Billiard Parlour (an application written at Reed College with the Rascal Development System) has been wreaking havoc with HyperDrive 20s. I am a coauthor of Billiard Parlour, and of Rascal itself, and I would like to clarify and explain the source of the crashes.

Clarification:

1. There is no inherent problem with Rascal itself. Period.
2. The root of the Billiard Parlour crash is a bug in the HyperDrive 20 system software.
3. *Any* program (it doesn't matter what development system created the program) that uses the free-form synthesizer mode of the Sound Driver is a potential HyperDrive 20 crasher.

Rascal provides a turnkey sound library, which makes using the free-form synthesizer very simple; hence, we have written a number of programs using complex sound (such as Billiard Parlour).

The Bug:

The HyperDrive people wrote their own version of the Macintosh Trap Manager in order to allow a larger system heap, thereby allowing more drawers open at any one time. In one of the rewritten Trap Manager calls (either GetTrapAddress or SetTrapAddress, I can't remember which), register A2 is not restored to its original value upon completion of the routine.

And the Consequences:

It turns out that not very much code is affected by this bug, but the Macintosh Sound Driver is affected during the execution of free-form synthesizer mode calls. The Sound Driver, apparently, contains code that depends on the value of A2 not changing. It is not clear why there can be such terrible consequences (such as ruined directories on the HyperDrive); nevertheless, there are.

Verification:

This analysis is verified in part by the fact that Billiard Parlour (and other programs that make free-form synthesizer calls) run perfectly well on HyperDrive 20s with new (as-yet-unreleased) HyperDrive software.

Solution:

The only total solution to the problem is to wait for the next official release of HyperDrive software—Billiard Parlour and other programs that use the free-form synthesizer will work fine on a HyperDrive with the new software installed.

You can, of course, boot your HyperDrive Mac from a floppy and then run Billiard Parlour without problems (just don't let the HyperDrive system take over).

I sincerely regret the loss of anyone's HyperDrive files as a result of running Billiard Parlour or any other free-form sound driver programs (we, too, have lost entire HyperDrive 20 systems to both Billiard Parlour and a non-Rascal synthesizer program).

(continued)

I also regret, however, that proper use of the Sound Driver in our programs for the creation of interesting and complex sounds has resulted in Rascal, and Billiard Parlour in particular, receiving bad press.

Thanks go to Jay Roth from General Computer for being so helpful in describing the bug and for letting me test Billiard Parlour with an early version of the new HyperDrive Trap Manager.

—Scott Gillespie, Reed College

DIALOG BOX HINT

macintosh/softw.devpmt #97, from robertwoodhead [Robert Woodhead]

TITLE: A Nice Bit'o

Here is a little fragment of code that came in real handy and that might be of use to you. The idea is this: Many times, Mac programs put up a dialog box that does something and then goes away, triggering a bunch of update events that the program laboriously processes to repaint the screen. It occurred to me that if a dialog didn't change other parts of the screen, it would be possible to save the screen, enter the dialog, and restore the screen when disposing of the dialog. Of course, this works only on Macs with 512K or so, but it does speed up programs considerably (especially mine, which uses dialogs to run special areas of the program). I wrote two procedures, SaveScreen and LoadScreen, that do this properly. You call SaveScreen just before you allocate a dialog or window, and LoadScreen just before you dispose of said object. The procedures are in the responses to this note.

```
{ SaveScreen saves a Mac or Lisa screen in a handle and returns }
{ the handle. Call this routine before allocating the window whose }
{ presence you want to mask. }
}
```

FUNCTION SaveScreen:Handle;

VAR H:Handle; L:LongInt;

BEGIN

```
SaveScreen := Nil;
IF littleMac THEN Exit(SaveScreen); { littleMac global true if <512K }
```

```
L := ScreenBits.rowBytes*(ScreenBits.bounds.bottom - ScreenBits.bounds.
top - 20);
```

```
H := NewHandle(L);
```

```
IF H = Nil THEN Exit(SaveScreen);
```

```
HideCursor;
```

```
BlockMove(Ptr(Ord4(ScreenBits.baseAddr) + ScreenBits.rowBytes*20),
Ptr(H^),L);
```

```
ShowCursor;
```

```
SaveScreen := H
```

END.

```
{ Note that SaveScreen does not save the title bar. }
```

```
{ LoadScreen restores the screen pointed to by Handle H and fixes }
{ up the Window list. W is a WindowPeek to the window or dialog }
{ about to go away. LoadScreen fixes everything so no updates have }
{ to be done. }
```

PROCEDURE LoadScreen(H:Handle; W:WindowPeek);

VAR R:RgnHandle; L,L1:LongInt;

BEGIN

```
IF littleMac OR (H = Nil) THEN Exit(LoadScreen);
```

```
L := ScreenBits.rowBytes*(ScreenBits.bounds.bottom - ScreenBits.
bounds.top - 20);
```

```
HideCursor;
```

```
L1 := TickCount; WHILE L1 = TickCount DO; { sync to the screen refresh }
BlockMove(Ptr(H^),Ptr(Ord4(ScreenBits.baseAddr) + ScreenBits.rowBytes*
20),L);
```

```
ShowCursor;
```

```
DisposHandle(H);
```

```
{ Now we make a copy of the offending window's structure region, }
{ zero the window's various regions so that when it goes away, it }
{ won't trigger any updates, refresh the other window's visRgn, }
{ and, as a final touch, diddle the topmost window's highlighted }
{ Boolean so it doesn't get repainted. }
```

```
R := NewRgn; CopyRgn(W^.strucRgn,R);
```

```
SetEmptyRgn(W^.port.VisRgn); { Some of these may not be needed }
```

```
SetEmptyRgn(W^.strucRgn); { but I'm too lazy to find out which, }
```

```
SetEmptyRgn(W^.contRgn); { when Wiz takes half an hour to }
```

```
SetEmptyRgn(W^.updateRgn); { compile! If it works don't fix it mode! }
```

```
IF W < > Nil THEN
```

```
BEGIN
```

```
CalcVisBehind(W,R);
```

```
W^.Hilited := True; { valid only if W is top window, most likely! }
```

```
END;
```

```
DisposeRgn(R)
```

END;

TEXT PROBLEM

macintosh/tech.talk #119, from jba [Jonathan Amsterdam, Contributing Editor, BYTE]

TITLE: Overwriting Text

I'm having some trouble doing something very simple, and I thought someone could help me.

I'm using MacModula-2 to write a program that needs to move the cursor around the screen and write things. Sometimes it will write over something else, and I want the thing underneath to be erased. So I did a TextMode(srcCopy) (a Modula-2 function that does the obvious thing) before writing. I also called InitViewPort, a Modula-2 function that the manual says I should call after changing anything.

Now, writing a character over something does erase—but it erases way too much. Say I write "YabbaDabbaDoo," then go back to where the "Y" is and write "x." I'll get something that looks like "x abbaDoo" except you can still see the rightmost part of the "D" from "Dabba." Can anyone explain this?

Additional notes: I am using Monaco 12, which is a fixed-width font. I checked the character widths and got 7 (except for the space, which was 8). I set the "spaceExtra" field to 0 as an experiment; it didn't make any difference.

macintosh/tech.talk #121, from rschnapp [Russell Schnapp]: a comment to 119

This isn't a MacModula-2 bug. You're pretty much calling the ROM directly. You've actually hit a bug in QuickDraw. When you use SrcCopy mode, QuickDraw erases far past the end of the string.

If you must really overwrite existing text, I'd suggest using SrcOr mode, after PaintRect'ing with the White pattern.

macintosh/tech.talk #124, from jba: a comment to 121

Thanks! That did the trick.

(continued)

The SB180 Computer Reasserts 8-Bit Computing In A 16-Bit World

You're one of the few heroes left. The stalwart CP/M user who's held the fort despite all the odds against you – a slow, bulky system that can't seem to compete against today's 16-bit computers. Well, help has finally arrived.

IT'S THE SB180 COMPUTER.

The **SB180** is a true single-board computer: A CMOS CPU, 256K Ram, 8K ROM Monitor, disk controller for up to four 3 1/2", 5 1/4" and/or 8" drives, console serial port, modem port parallel printer port . . .
ALL ON ONE BOARD

High Speed And Small Enough To Fit In A Lunchbox

You can run standard 8080/8085 and Z-80 software at up to twice the speed of a 4MHz Z-80. And the entire **SB180** package is only 4" x 7 1/2".

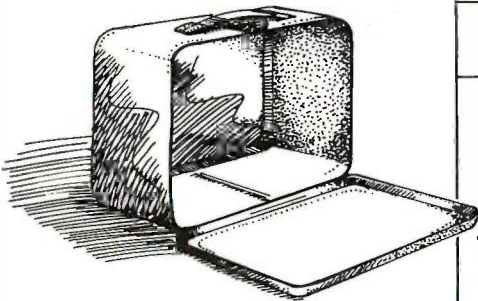

Software Compatibility With The World

Any of the thousands of application programs, languages or utilities which run under CP/M will also run on the **SB180**.

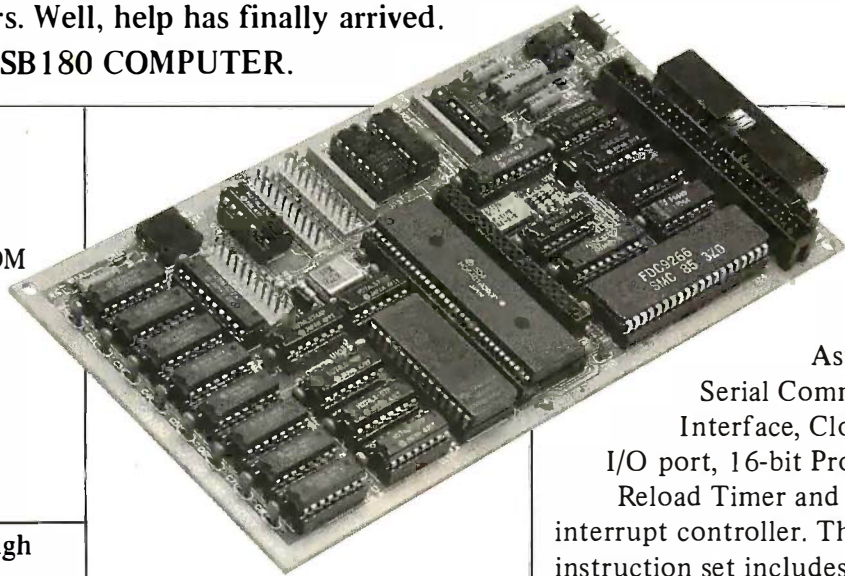

The **SB180's** Z-System is an enhanced 8-bit operating system. It is a complete replacement for CP/M 2.2 from Digital Research, yet provides functions and facilities similar to MS-DOS and UNIX.

Reduced System Cost And Low Power Operation

The **SB180** uses the most powerful of the new generation 8-bit CPU's— the Hitachi HD64180.

The chip is based on a micro-coded execution unit and advanced CMOS manufacturing technology.

System costs are reduced because many key functions have been included on-chip: Memory Management Unit, Direct Memory Access Controller, wait state generator, dynamic RAM refresh,

Asynchronous Serial Communications Interface, Clocked Serial I/O port, 16-bit Programmable Reload Timer and a 12 source interrupt controller. The expanded instruction set includes hardware multiply and a sleep instruction for low power standby operation.

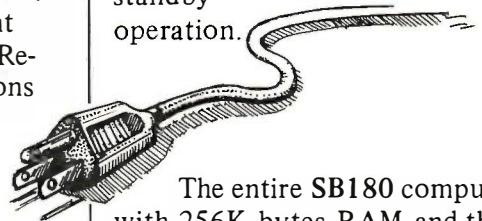

The entire **SB180** computer with 256K bytes RAM and the 8K ROM monitor is only \$369.00. If you want ZCPR3, ZRDOS, ROM and BIOS sources, the whole package comes to \$499.00.

Quantity discounts are also available. Dial toll free 1-800-635-3355 to order the **SB180**. For technical information write us at 25 Terrace Drive, Vernon, CT 06066 or call 1-203-871-6170. (Telex: 643331)

So call now, and say you're a CP/M user who's ready for reinforcements.



REGION PROBLEM

macintosh/tech.talk #122, from tengel [Tone Engel]

TITLE: Region Question

I'm trying to create a region that is the union of the outlines of a number of icons. I've run into the following stumbling blocks:

1. To create a region in the shape of an icon I expected to find some kind of function for turning arbitrary bit maps into regions. No such luck. So I wrote a little function to scan the icon and draw a pixel for each pixel. This much seems to work but is awkward. Typical region size is around 200. Does anyone have a detailed description for the format of the region data? Is there an easier way to do this?
2. So now I try and union the corresponding icon regions together to get one big region, which, you guessed it, I want to pass to Drag-GrayRgn. My real difficulty is that this seems to work fine sometimes, and other times it crashes the system. No neat dialog, just a screen full of garbage and then a hang. This is on a 512K Mac. I've checked the heap space, 300K or so. The overall region size grows to about 640 before it dies.

Are there any limitations on the size of a region? Other than the implied limit arising from the size field being only 16 bits.

Does anyone have a clue what might be going on?

I'm doing all this in Megamax C (V2.3, I believe).

macintosh/tech.talk #123, from robertwoodhead:
a comment to 122

There is a bug in QuickDraw that crashes if a region has more than 20 or so rectangular areas on a single scan line (QuickDraw stores regions as a bounds rect that surrounds the region and y-sorted rectangles that comprise the region; thus your icons, with lots of little dots and white space, are represented by a lot of rectangles). This bug is fixed in the new ROMs. Suggestion: If you are going to be needing the regions of icons, what you really want to do this to is the icon Mask, which, being usually solid chunks of bits, will have fewer transitions and thus not be as likely to smash.

WHAT IS A GAME?

macintosh/soapbox #316, from dsharp [Doug Sharp]

Chris, I'm intrigued by the distinction you made (in July) about ChipWits' status as an educational product rather than a game. I have seen some ChipWits fanatics really play the thing. What would have made it a game? Why is Balance of Power a game?

macintosh/soapbox #318, from stike [Jim Stikeleather]:
a comment to 316

In the wild (nature), games and playing are very serious activities. They are nature's way of preparing (especially mammals with their extended juvenile and adolescent periods) for adulthood by developing skills (predominantly hunting and hiding) needed to survive. I think a good "human" game should do the same thing.

A good game should be educational (maybe developmental would be a better word if you want to include all the hand-eye coordination we are building in the next generation). Maybe the better the game, the more educational it appears, and the better educational systems appear more like games. Comments?

macintosh/soapbox #319, from ccawfor [Chris Crawford]:
a comment to 316

It's been a long time since I used ChipWits, but the factor that most sticks in my mind as "ungamey" is its lack of true interaction between

player and sentient opponent. It is more puzzle-like than game-like. This is not meant as a criticism—a puzzle can be every bit as worthwhile and entertaining as a game. I try to use the sharpest meanings of words that I can, and most people use the word "game" in a very broad fashion.

macintosh/soapbox #320, from ccawfor:
a comment to 318

I agree that most good games are quite educational and have gone so far as to say that games are the original educational technology, predating schools by several million years. I would not say, though, that any good educational effort is necessarily a game.

macintosh/soapbox #322, from dbetz [David Betz]:
a comment to 319

Is the card game "solitaire" a game or a puzzle? It certainly doesn't involve a sentient opponent. I think your definition of the word "game" is too limited. Are arcade games really puzzles? They present rather simple opponents. Certainly not a sentient opponent.

macintosh/soapbox #326, from ccawfor:
a comment to 322

Solitaire is most definitely a puzzle (in my book). Most arcade games, in my book, are also puzzles. Indeed, a great many things that other people call games I call puzzles. Now, you may well conclude from this that I have drawn my definition of the word "game" too narrowly. In defense of this strict constructionist view of games, I will point out two items: First, specialists in any field refine the language applicable to their work; note the old anecdote about the Eskimos having 7 (12? 20?) different words for ice. Two: I devoted an entire chapter of my book, *Art of Computer Game Design*, to the problem of defining the word "game." Even after an entire chapter, I did not have a solid definition, just a useful characterization.

macintosh/soapbox #327, from brian [Brian Holt]:
a comment to 326

Yes, specialists do refine the language applicable to their work. When one converses with nonspecialists, it is customary not to allow redefinitions to get in the way of the conversation (i.e., who cares whether it is a puzzle or a game?). Also, the Eskimo do not have 7, 12, or 20 different words for snow. It is only an anecdote based on some unknowing anthropologists who didn't understand how word endings were being used in the language. Third, concepts such as "game" are usually not definable. Useful characterization (i.e., what everyone generally accepts) is usually the limit. Finally, ChipWits fits all of my criteria for a game, but then again, so does MacPaint.

macintosh/soapbox #329, from dsharp:
a comment to 319

The distinction you make between game and puzzle is that a game requires more than one sentient player (whether human/human or human/computer) and that the players must be opponents. ChipWits falls into the puzzle category because the computer is not an opponent.

In my usage, puzzles are a subset of games. The word "puzzles" also implies a correct solution, which doesn't fit ChipWits.

I've been calling it an educational game since I wrote it, and the only one who objected to the term was the publisher, who considered "games" too low-class to publish.

Thanks for expanding on your usage of "game." ■

FREE CATALOG

Space Saving CRT Arm



This sturdy steel arm swivels 360° at its base and its monitor tray swivels and tilts. It provides a comfortable, glare free viewing angle, while saving valuable desk space. Retails \$89.95

Lintek

P.O. Box 8056
Grand Rapids, MI 49508
(616) 241-4040

UNIVERSAL EPROM PROGRAMMER

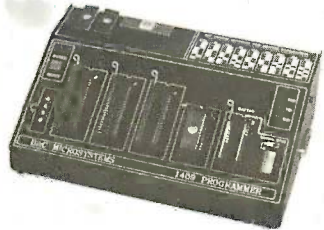

- * NO PERSONALITY MODULES REQUIRED
- * ON LINE HELP AND MENU SELECTION
- * ON BOARD 110/220V POWER SUPPLY
- * FAST PROGRAMMING MODE AT 6V VCC
- * BUILT IN EPROM ERASER W/TIMER
- * GANG PORT FOR FUTURE EXPANSION
- * SOFTWARE DRIVERS FOR MOST PCs
- * SUPPORTS ALL 5V EPROMS, EEPROMS AND INTEL MICROCOMPUTERS

1409C-33 \$545 1409C-34 \$695
DRIVERS \$35 SHIPPING \$6
VISA & MASTER CARD ACCEPTED

B&C MICROSYSTEMS
6322 MOJAVE DR. SAN JOSE CA 95120
PHONE (408) 997-7685 TELEX 4995363

LOW COST UNIVERSAL PROGRAMMER KITS

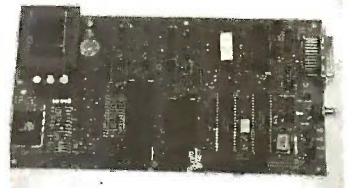

- * NO PERSONALITY MODULES REQUIRED
- * ON LINE HELP AND MENU SELECTION
- * ON BOARD 110/220V POWER SUPPLY
- * FAST PROGRAMMING MODE AT 6V VCC
- * BUILT IN MONITOR FOR I/O DEBUG
- * CAD PCB, SILKSCREEN & SCHEMATIC
- * SOFTWARE DRIVERS FOR MOST PCs
- * SUPPORTS ALL 5V EPROMS, EEPROMS AND INTEL MICROCOMPUTERS

KITS FROM \$125 ASSEMBLED \$295
DRIVERS \$35 SHIPPING \$4
VISA & MASTER CARD ACCEPTED

B&C MICROSYSTEMS
6322 MOJAVE DR. SAN JOSE CA 95120
PHONE (408) 997-7685 TELEX 4995363

Inquiry 187

ROSE ELECTRONICS DATA SWITCHES



SHARE computers, printers, any parallel or serial device
ELIMINATE cable swapping
INEXPENSIVE way to network
COMPATIBLE with all computers.
Businesses, Schools, Homes

WE ALSO OFFER:
Data Buffers, Line Drivers, Modems, Protocol Converters, Parallel - Serial Converters, Cables, Computers, Printers, Disk Drives, and more.

AUTOMATIC - CARETAKER is ideal for a business or school to share a printer or modem among many computers. Operation is fully automatic with no software required.
Parallel or Serial 4 channels - \$295 8 channels - \$395

MANUAL - HARD SWITCH is operated with the flip of a switch. 2:2 and 2:4 models allow simultaneous communication.
Serial 1:2 - \$59 1:4 - \$99 2:2 - \$109 2:4 - \$169
Parallel 1:2 - \$79 1:4 - \$139 2:2 - \$119 2:4 - \$199
LED and spike protection on serial models add \$20.

CODE ACTIVATED - PORTER connects one computer to multiple peripherals. A software code selects the peripheral.
Parallel or Serial 4 channels - \$295 8 channels - \$395
Buffer option 64K - \$100 256K - \$250

REMOTE - TELEPATH connects multiple computers to multiple peripherals. A selector at each computer or terminal chooses up to 4 peripherals and displays busy status.
4:4 - \$495 4:8 - \$795 selector - \$39.

Give a Rose to your computer.

ROSE ELECTRONICS (713) 933-7673
P.O. BOX 742571 MIC & VISA Accepted
HOUSTON, TX 77274 Dealer Inquiries Invited
CALL US FOR ALL YOUR INTERFACE NEEDS

Inquiry 290

Osborne

As available only! Very limited quantity.

Important: Always call to check availability before ordering.	To fix yourself, or for parts. Complete, but known not working.	Guaranteed for 30 days. May be new or refurb., depending on avail.	Outright Repair
Main Board OS-1	\$79	\$79	\$139
Main Board Exec.	\$159	\$139	\$299
Battery Pack, 40 Watt	—	—	\$49
Double Density Kit **	—	—	\$79
** includes board, cable, documentation & disk			
5" CRT (Grn/White)	\$9.95	\$19	\$29
7" CRT (Amber)	\$19	\$49	\$99
15" CRT, no case	—	—	\$85
Drive Analog Card	\$9.95	\$29	\$59
Drive Mechanism	\$19	\$25	\$59
Power Supply	\$4.95	\$24	\$29
Keyboard (No enclos.)	\$9.95	—	\$99

Shipping charged on all orders

Computer Parts Mart 415-493-5930
3200 Park Blvd * Palo Alto * CA 94306

Inquiry 83

DATA ACQUISITION TO GO

INTERFACE FOR ANY COMPUTER

FREE IBM SOFTWARE



Connects via RS-232. Fully IBM compatible. Built-in BASIC. Stand alone capability. Expandable. Battery Option. Basic system: 16 ch. 12 bit A/D, 2 ch. D/A, 32 bit Digital I/O. Expansion boards available. Direct Bus units for many computers.

(201) 299-1615
P.O. Box 246, Morris Plains, NJ 07950

ELEXOR

Inquiry 123



Sure it's insured?

SAFWARE® Insurance provides full replacement of hardware, media and purchased software. As little as \$39/yr. covers:

- Fire • Theft • Power Surges
- Earthquake • Water Damage • Auto Accident

For information or immediate coverage call:
1-800-848-3469
In Ohio call 1-614-262-0559

SAFWARE
SAFWARE, The Insurance Agency Inc.

Inquiry 295

ROMDISK

EPROM OR RAM DISK AND DISK DRIVE EMULATORS

IBM PC*, COMPATIBLES AND APPLE IIe*

- Diskless control and communications system
- Autoboot applications for dedicated workstations and improved productivity
- Customized high speed, smart terminals
- Solid state speed, reliability and performance
- Self contained control and EPROM program circuitry
- PC and MS DOS* compatible
- ROMDISK and RAMDISK are I/O mapped
- RAM disk - with battery back-up
- Plug compatible EPROM and RAM modules

ROMDISK PC-1 (180K) \$495
ROMDISK PC-2 (360K) \$595
RAMDISK PC-D (360K) \$595
ROMDISK A FOR I/E (144K) \$349

CURTIS, INC. 22 Red Fox Road
St. Paul, MN 55110 612/484-5064

*IBM PC and PS DOS is a registered trademark of IBM Corporation MS DOS is a registered trademark of Microsoft Corporation. Apple//e is a registered trademark of Apple Computer Corporation.

Inquiry 376

64K ■ 128K ■ 256K

DRAMS

80287-8 ■ 80287-3
8087-3 ■ 8087-2
8087-1

BITTNER
BE
ELECTRONICS

899 SOUTH COAST HIGHWAY
LAGUNA BEACH, CA 92651
(714) 497-6200
CALL NOW FOR **FREE CATALOG**

Inquiry 31

Introd Lasog

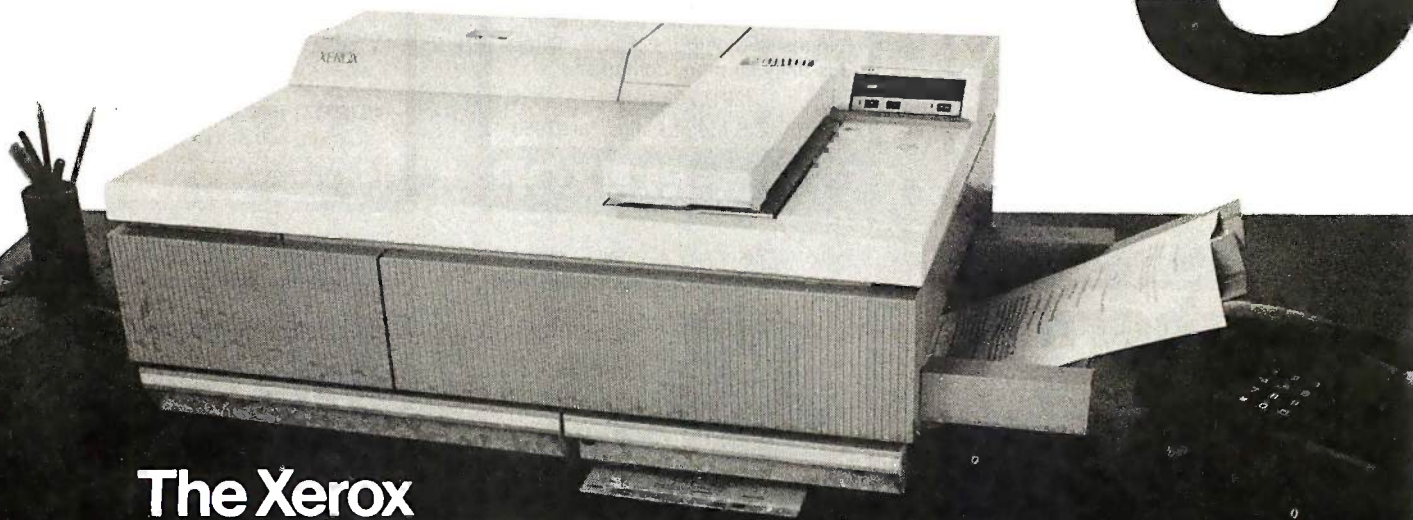

**The Xerox
4045 Laser CP.**

**A desktop
laser printer
that's also
a copier.**

Introducing Lasography.

About twenty-five years ago something happened that changed the world of information forever.

Xerox introduced the first plain paper copier, an achievement that brought xerography into almost every office.

Since then, for more than a decade, Xerox has been applying the power of laser technology in high speed computer printing systems. Systems that produce superb documents of unsurpassed quality. Quickly, quietly and cost effectively.

Now, through this process which we've named Lasography, Xerox has come up with a revolutionary product that lets smaller offices and work groups enjoy these benefits, too.

Introducing the Xerox 4045 Laser Copier Printer.

It's the desktop copier/laser printer

with a totally unique dual personality.

For one thing, it's a sophisticated laser printer. It can print up to ten pages a minute. Which is ten times faster than standard office printers.

And while other desktop printers serve primarily one workstation at a time, the Xerox 4045 Laser CP is designed to accommodate four.

All at the same time.

Not only that, but with the Laser CP's graphics capabilities you can merge all the forms, logos, texts and signatures you want printed and produce documents that anyone would be proud of.

But as we said before, the Laser CP has a dual personality. It doubles as a high quality convenience copier.

The Xerox 4045 Laser CP is only one example of what Lasography has to offer your office, remote or distributed

data processing environments.

Because Xerox is already planning ways to apply Lasography toward an even wider selection of products.

All of which will put your office exactly where it belongs.

Light years ahead.

Call 1-800-TEAM-XRX, ext. 179 for information and product demonstration.



Please send me more information on Xerox Lasography.

- The 4045 Laser CP
 The complete line of Lasographic printers.

Send this coupon to:
 Xerox Corporation, P.O. Box 24, Rochester, NY 14692

NAME _____ TITLE _____

COMPANY _____

ADDRESS _____ CITY _____

STATE _____ ZIP _____ PHONE _____

If you can't wait, call:

1-800-TEAM-XRX, ext. 179
 (1-800-832-6979, ext. 179)

179

192 4/86

NEW SYSTEMS

**Honeywell's
PC-Compatibles**

The EP (Entry Processor) Series of personal computers from Honeywell includes three models based on an 8088-2 microprocessor running at 4.77 or 8 MHz. All models are equipped with 256K bytes of RAM that can be expanded to 640K bytes on the system board, a parallel printer port, a high-resolution monochrome monitor port with Hercules graphics emulation, four full-length expansion slots, and a socket for an 8087-2 math coprocessor. An RS-232C serial port is optional.

The computers are compatible with the IBM PC and are bundled with MS-DOS 2.1, GW-BASIC, the Honeywell Menu Manager, and disk-based tutorials. When equipped with a serial port, Honeywell's multifunction communications adapter, and microSystem VIP emulation software, the computers can emulate a Honeywell synchronous or asynchronous terminal.

The base model in the EP series comes with a single 360K-byte floppy-disk drive and costs \$1450. A two floppy-disk model is \$1550, and a single floppy-disk and 10-megabyte hard-disk model costs \$2650.

Keyboards and monitors are not included. All three models can use PC-compatible keyboards, monitors, and printers or can be equipped with the Honeywell Micro Switch keyboard (\$120) and Honeywell monitors and printers. Two monochrome monitors are available, with resolutions of 640 by 200 pixels (\$175) and 720 by 350 pixels (\$275). A 15-color RGB monitor with a resolution of 640 by 200 pixels costs \$595.

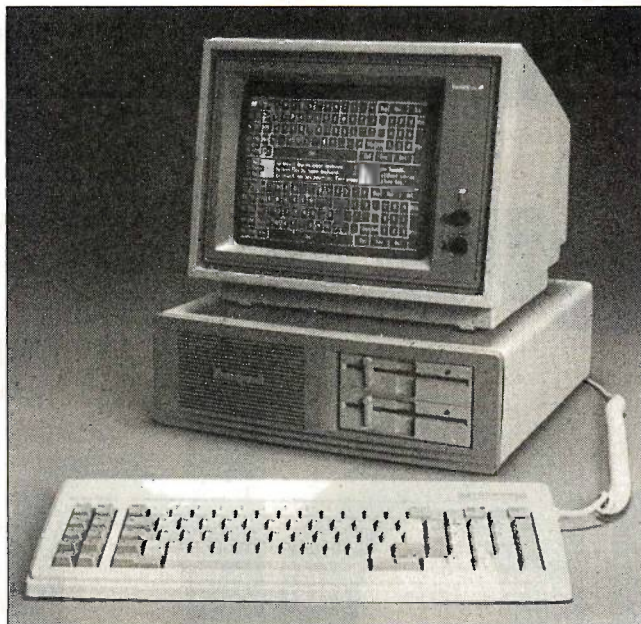

Honeywell EP Series personal computer.

Contact Honeywell Inc., Small Computer and Office Systems Group, 300 Concord Rd., Billerica, MA 01821, (617) 671-2517. Inquiry **566**.

**Low-Cost Multiuser
Computers**

The QT series of multi-tasking, multiuser computers supports from 4 to 20 users at prices ranging from \$2095 to \$8795. Nine models are currently available. All models run the OS9/68K operating system with BASIC, utilities, word-processing, and spreadsheet programs. All have a built-in hard-disk interface and take up less than 1 square foot of desk space.

The basic QT model, which supports four users and two printers, comes with 128K bytes of RAM and an 8-MHz 68008 microprocessor. The computer sells for \$2095 with

one floppy-disk drive. Upgraded to 512K bytes of RAM and with a 20-megabyte hard-disk drive, the system costs \$3595.

The QT Plus model has a 10-MHz 68000 microprocessor and 512K bytes of RAM. It supports four users and two printers in its lowest configuration. With a single floppy-disk drive, the QT Plus is priced at \$2695; with an added 20-megabyte hard-disk drive, the system sells for \$3995. The QT Plus can be upgraded with an additional 512K bytes of RAM (\$395) and eight serial ports.

The QT 20 model comes with a 12.5-MHz 68020 microprocessor and 2 megabytes of RAM and supports a minimum of four users and one printer. A QT 20 with a 20-megabyte hard-disk drive sells for \$8795. The system can be expanded with a 16.67-MHz 68020 and additional serial ports to support 20 users. Prices for the 16.67-MHz microprocessors and addi-

tional ports were not available at press time.

Contact Frank Hogg Laboratory Inc., 770 James St., Syracuse, NY 13203, (315) 474-7856. Inquiry **567**.

**Motorola VMEbus
Computers**

The Microsystems division at Motorola has introduced two VMEbus microcomputers that the firm claims rival VAX-11/780 performance. The System 1121 employs a 16-bit 68010 microprocessor; the System 1131 uses a 32-bit 68020. Both have hard- and floppy-disk storage, DRAM, RS-232C serial ports, and expansion slots (five for the 1121 and four for the 1131). The System 1121 can handle three users, System 1131 can handle four, and you can beef up either system with more serial ports and RAM to handle as many as eight users.

Both computers run Motorola's System V/68 operating system, which the firm claims is derived from and functionally identical to AT&T's UNIX System V.

System 1121 with the OS, 1 megabyte of DRAM, a 40-megabyte hard disk, and a 655K-byte floppy disk costs \$12,495. System 1131 with the OS, 2 megabytes of DRAM, a 70-megabyte hard disk, and a 655K-byte floppy-disk drive costs \$14,995. A cache accelerator and a high-speed SMD controller for these systems should be available by the time you read this. Contact Motorola, MOS Integrated Circuits Group/Microsystems, 2900 South Diablo Way, Tempe, AZ 85282, (602) 438-3000. Inquiry **568**.

SAVE 50% *

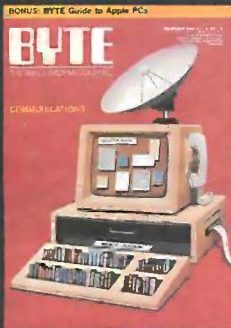

United States One Year \$21 2 Years \$38 3 Years \$55
Canada/Mexico One Year U.S. \$23 2 Years U.S. \$42 3 Years U.S. \$61
Europe \$69 (air delivery), U.S. Funds enclosed
Worldwide \$37 (surface mail), U.S. Funds enclosed

BILL ME. If I'm not completely satisfied with my first copy, I'll simply write "cancel" across your invoice, mail it back, and my subscription will be cancelled.

Check Enclosed Bill VISA Bill Mastercard

Please allow 6-8 weeks for processing your subscription.

Name _____ 4246
Address _____
City/State/Zip _____
Card # _____ Expires _____
Signature _____

* off newsstand price of \$42.00



SAVE 50% *

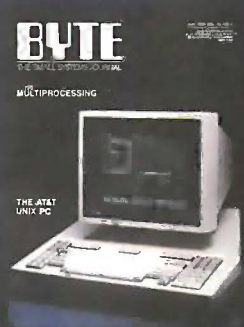
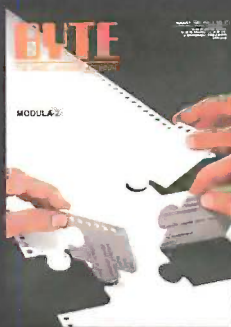

United States One Year \$21 2 Years \$38 3 Years \$55
Canada/Mexico One Year U.S. \$23 2 Years U.S. \$42 3 Years U.S. \$61
Europe \$69 (air delivery), U.S. Funds enclosed
Worldwide \$37 (surface mail), U.S. Funds enclosed

BILL ME. If I'm not completely satisfied with my first copy, I'll simply write "cancel" across your invoice, mail it back, and my subscription will be cancelled.

Check Enclosed Bill VISA Bill Mastercard

Please allow 6-8 weeks for processing your subscription.

Name _____ 4246
Address _____
City/State/Zip _____
Card # _____ Expires _____
Signature _____

* off newsstand price of \$42.00





NO POSTAGE
NECESSARY
IF MAILED
IN THE
UNITED STATES

BUSINESS REPLY MAIL
FIRST CLASS PERMIT NO. 39 MARTINSVILLE, NJ

POSTAGE WILL BE PAID BY ADDRESSEE



BYTE

Subscription Dept.
P.O. Box 597
Martinsville, NJ 08836-9956



NO POSTAGE
NECESSARY
IF MAILED
IN THE
UNITED STATES

BUSINESS REPLY MAIL
FIRST CLASS PERMIT NO. 39 MARTINSVILLE, NJ

POSTAGE WILL BE PAID BY ADDRESSEE

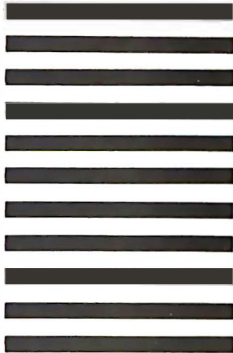

BYTE

Subscription Dept.
P.O. Box 597
Martinsville, NJ 08836-9956

PERIPHERALS

Idetix Digitizing Camera

Micron Technology has introduced the Idetix, a digitizing camera that works with the IBM PC, XT, AT, and compatibles. The camera features the OpticRAM image sensor that offers a resolution of 256 by 256 or 512 by 512 pixels.

Other features of the camera include adjustable frame size, adjustable resolution, high-speed data transfer via DMA, and up to 100 feet of cable for remote transmission. According to the company, the camera operates seven times faster than the Micron Eye digitizing camera. The company says the Idetix is intended for use in robotics, factory inspection, process control, image processing, and manufacturing automation.

The Idetix comes with a demonstration program and an assembly-language driver library with image enhancement routines. The list price is \$695. For more information, contact Micron Technology Inc., Vision Systems Group, 2805 East Columbia Rd., Boise, ID 83706, (208) 386-3800. **Inquiry 569.**

PROM Gang Programmer

Avel Electronics' EP-4 is a PROM gang programmer that works with the IBM PC, XT, AT, and compatible computers. The device can program a variety of PROM types and supports 8- and 16-bit programming modes. It has four 28-pin sockets and accepts Intel MCS-86, Motorola S-record, ASCII block, and binary input files.

The EP-4 comes with software that lets you transfer files into consecutive PROMs or consecutive

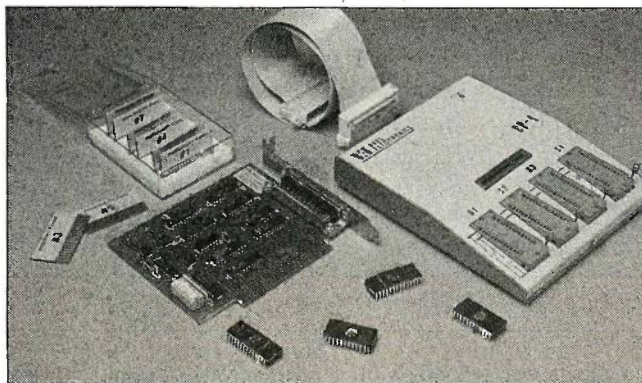

Avel Electronics' EP-4 PROM gang programmer.

pages of multipage PROMS, check blanks, and verify the contents of PROMs with compare or overlay options. The software also has a full-screen RAM editor for displaying and editing RAM contents. You can use DOS commands and run application software from within the program.

When not in use as a PROM programmer, the device can serve as an extra disk drive that supports up to 256K bytes of removable PROM media. The EP-4 sells for \$595, which includes the programmer, a 30-bit parallel control board, a set of personality cards for popular PROMs, a cable with two 36-pin connectors, software, and a manual. For more information, contact Avel Electronics, 3450 Murdoch Ct., Palo Alto, CA 94306, (415) 856-6504. **Inquiry 570.**

Dot-Matrix Printer

Toshiba's P321 is a 24-pin printer that offers draft, near-letter-quality, and graphics printing. The 80-column printer operates at a speed of 216 or 180 cps in draft mode and 72 or 60 cps in near-letter-quality mode.

The P321 comes with a

parallel interface, Qume Sprint 11 daisy-wheel emulation, and three resident typefaces; additional fonts are available on plug-in font cartridges. Graphics resolution is 180 by 180 or 180 by 360 dots per inch, and IBM graphics emulation is optional. Other options include a parallel/serial interface, tractor feed, and automatic sheet feed.

Suggested list price for the printer is \$699. With a parallel/serial interface, the P321 costs \$749. A downloadable font kit sells for \$99, and the IBM Graphics Printer emulation kit costs \$49. For more information, contact Toshiba America Inc., Information Systems Division, 2441 Michelle Dr., Tustin, CA 92680, (714) 730-5000. **Inquiry 571.**

Tape Backup for Tandy XENIX Computers

The X-Drive is a streaming-tape backup system for Tandy/Radio Shack computers that run XENIX versions 1.0 through 3.1. The drive backs up data at a rate of 2 megabytes per minute and uses standard ¼-inch tape cartridges that store up to 25 megabytes (formatted) of data.

Priced at \$1495, the X-Drive comes with menu-driven software that includes formatting and diagnostic utilities. The drive connects to the computer's standard floppy-disk interface and works with the Model II, 12, 16, and 6000 computers. Contact Radio Ranch Inc., Dept. 16., 11658 West Judson Rd., Polo, IL 61064, (815) 946-2371. **Inquiry 572.**

Two Printers from C. Itoh

The C-310 dot-matrix and D10-40 daisy-wheel printers have been announced by C. Itoh. The C-310 model prints at speeds of up to 300 characters per second in draft mode. The printer also produces near-letter-quality text at 50 cps and 28 cps. Other features of the 80-column printer are a parallel port, graphics resolution of 240 by 144 dots, resident character fonts, and a semiautomatic paper loader for handling fanfold, roll, and single-sheet paper. Suggested retail price for the C-310 is \$599.

The 136-column D10-40 daisy-wheel printer operates at a speed of 40 cps. Its features include three character pitches, Diablo 630 compatibility, a parallel and a serial interface, and an 8K-byte buffer. Automatic sheet and tractor feed are optional. Suggested retail price for the D10-40 is \$949. Contact C. Itoh Digital Products Inc., 19750 South Vermont Ave., Suite 220, Torrance, CA 90502, (213) 327-2110 or (800) 423-0300. **Inquiry 573.**

(continued)

ADD-INS

Data Acquisition for Apple IIs

Xcalibur's XAD5 is a multifunction data-acquisition board for Apple II and compatible computers. The board includes 32 single-ended channels of 12-bit A/D conversion, either current loop or voltage input. The analog inputs may be configured for differential input with gain. XAD5 also provides 24 channels of digital I/O and a real-time clock/calendar with battery backup.

The board includes a feature called Autoscan, an interrupt-driven routine in ROM that automatically scans all channels and the real-time clock and then writes the values into the computer's RAM. Scanning is done at a rate of more than 100 channels per second.

XAD5 sells for \$549, which includes a demonstration disk and manual. For more information, contact Xcalibur Computers Ltd., Spencer House, 3 Spencer Parade, Northampton, NN1 5AB England, telephone: 011-44-604-21051. Inquiry 574.

STD Bus and IEEE-488 Interface

Computer Dynamics' CDI-488 board provides an interface from an STD bus to the IEEE-488 GPIB. The board is intended for laboratory automation and applications using equipment with IEEE-488 protocols.

The CDI-488 can be either polled or interrupt driven. Other features include software-readable GPIB address switches and eight GPIB status indicators. The maximum data-transfer rate is 1

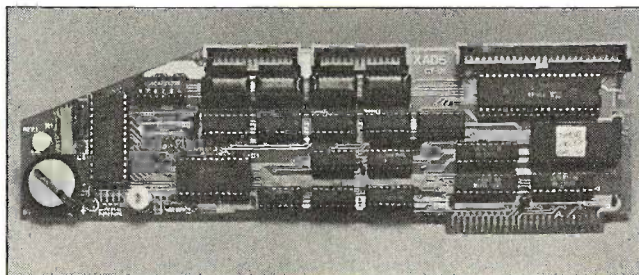

Xcalibur's XAD5 data-acquisition board.

megabyte per second; 250K to 500K bytes per second is typical, according to the company.

The price for the CDI-488 is \$300. Contact Computer Dynamics Inc., 105 South Main St., Greer, SC 29651. (803) 877-7471. Inquiry 575.

More Memory for Ataris

Persistent RAM cartridges from Intra-Tech Computer Products are designed to expand the memory of Atari computers. Available in 16K- and 32K-byte versions, the cartridges use low-power RAM with backup power provided by a lithium cell.

Version I, the 16K-byte model, can be used in a 16K- or 8K-byte mode. Version II, the 32K-byte model, has two switch-selectable 16K-byte blocks. Each model has a switch that lets you change from read/write to read-only. Both can be used to make boot cartridges for most 15K-byte or smaller binary programs.

Version I costs \$49.95, and Version II is \$69.95. They run on the Atari 400, 800, 600XL, 800XL, 65XE, and 130XE computers with one disk drive. Contact Intra-Tech Computer Products, 2288

Portage Ave., Coquitlam, British Columbia V3K 2Z3, Canada. (604) 942-7049. Inquiry 576.

EPROM Writer for IBM PCs

The Addonics EPROM Writer is an add-in card for IBM PCs and compatible computers that lets you program a wide variety of EPROM, EEPROM, and single-chip microcomputers. The EPROM Writer provides normal and high-speed programming modes and performs byte programming, memory fill, block move, RAM editing, check sum, and other functions.

The board comes with software drivers for computers running MS-DOS or Concurrent CP/M. Slight modification of the drivers enables you to program newly developed EPROMs.

The EPROM Writer sells for \$450. For more information, contact Multitech Electronics Inc., 1008 Stewart Dr., Sunnyvale, CA 94086. (408) 773-8400. Inquiry 577.

MaynStream Tape Drive

The MaynStream PCI 20 from Maynard Electronics is an internal streaming-tape backup system for the IBM PC and compatibles. It can back up

a 10-megabyte drive file by file in 3 minutes and uses 1/8-inch data cassettes, which hold up to 20 megabytes of data each.

The MaynStream drive performs read-after-write checks to ensure the accuracy of backed-up data. It also has file-splitting capability, which lets you continue backup on a new cassette when the other is full.

The PCI 20 costs \$1299 and comes with a controller card or module, one 20-megabyte cassette, software, and a manual. Contact Maynard Electronics, 460 East Semoran Blvd., Casselberry, FL 32707. (305) 331-6402. Inquiry 578.

No-Wait-State Memory for the IBM PC AT

The Cheetah Card is a 2.5-megabyte expansion board with no-wait-state memory for the IBM PC AT. The board uses 100-nano-second memory that, the company says, enables the AT to operate at higher speeds without the need to change its normal 6-MHz clock speed.

More than one Cheetah board can be installed. Each 512K-byte bank of memory is switch selectable within the IBM PC AT's 15-megabyte range. The 2.5-megabyte Cheetah Card costs \$945, and the company claims the board is compatible with all AT software. Contact Cheetah International Inc., 107 Community Blvd., Suite 5, Longview, TX 75606. (800) 243-3824; in Texas, (214) 757-3001. Inquiry 579.

ADD-INS

Faster High-Resolution Graphics

The EOgraph is an add-in board for IBM PCs and compatibles that's designed to speed up printing of high-resolution graphics. The board performs vector-to-raster conversion, area fills, and font generation and has a large-capacity print spooler to optimize throughput.

The board can be configured to drive monochrome and color dot-matrix printers and works with Lotus's 1-2-3, AutoCAD, and similar software. It can do multipage plots on fanfold paper and accepts graphics files from software that supports the Houston Instru-

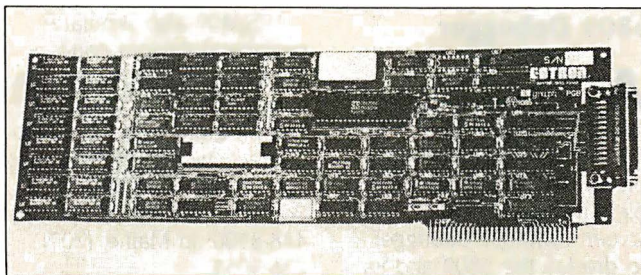

Eotron's EOgraph graphics board.

ments DMP-29 or DMP-41 plotter format.

Suggested list price is \$495 for the 128K-byte version and \$595 for the 512K-byte version. For more information, contact Eotron Corp., 121 Westpark Rd., Dayton, OH 45459, (513) 439-5158. Inquiry **580**.

Practical Modem 1200

The Practical Modem 1200 is an internal 1200-bps modem for the IBM PC, XT, AT, and compatible computers. The modem is Hayes-compatible and meets Bell 212A and 103 standards. It offers auto-

dial and auto-answer capabilities, full- and half-duplex operation, and pulse or Touch-Tone dialing.

The 4- by 5½-inch card fits into either a long or short expansion slot in the computer. The modem is bundled with communications software, including the Practical Terminal Package, which supports the XMODEM protocol, and Pop-Up Telecomm, a complete communications program from Popular Programs.

Suggested retail price for the modem is \$199. For further details, contact Practical Peripherals Inc., 31245 La Baya Dr., Westlake Village, CA 91362, (818) 991-8200. Inquiry **581**.

SOFTWARE • PROGRAMMING LANGUAGES AND AIDS

C Cross-Compiler

Microtec's High C is a C cross-compiler for producing embedded applications for Intel 8086 microprocessors. High C contains an ANSI-standard compiler, run-time libraries for producing an executable program, a set of source-code header files for accessing a library of standard run-time utilities, and a cross-reference feature that works on several program modules at once. A set of UNIX-like utilities is also included.

Features of the C compiler include nested functions with up-level references, a set of memory models, three integer ranges, and three IEEE real precisions. The compiler also provides common subexpression elimination, retention and reuse of register contents, dead-code elimination, and other functions.

High C is bundled with

Microtec's ASMI86L cross-assembler, linker/loader, object module librarian, and Microtec-format run-time libraries for embedded applications. The complete package costs \$1550 and runs on the IBM PC and compatibles. Contact Microtec Research, 3930 Freedom Circle, Santa Clara, CA 95054, (800) 551-5554; in California, (408) 733-2919. Inquiry **582**.

Beginner's Pascal

Alice: The Personal Pascal, from Software Channels, is designed for beginning Pascal programmers. The program is based on a syntax-directed editor that catches syntax and other types of errors when you type them in. The package provides templates that let you build and edit Pascal programs by filling in the

blanks and offers more than 500 screens of on-line help. Alice's Pascal interpreter lets you view programs on screen while you run and debug them.

Programs you write with Alice can be compiled with other Pascal compilers. The program runs on the IBM PC, XT, AT, and compatible computers and costs \$95. Contact Software Channels Inc., 4 Kingwood Place, Kingwood, TX 77339, (713) 359-1024. Inquiry **583**.

GCLISP Developer

GCLISP 286 Developer from Gold Hill Computers is a LISP development package for the IBM PC AT and compatible computers. The package includes an interpreter and compiler, editor, tutorial, and on-line help system. It supports lexical scoping, packages, and transcendental functions and runs in the 80286's pro-

ected mode.

Priced at \$1995, the GCLISP 286 Developer comes with the second edition of *LISP* by Patrick H. Winston and Berthold K. Horn, the *Common LISP Reference Manual* by Guy Steele, and a developer's manual. It requires a PC AT with at least 2 megabytes of memory, PC-DOS 3.0 or higher, one double-sided double-density or quad-density disk drive, and a hard disk. The company recommends 3 megabytes of memory, a Mouse Systems mouse, an enhanced graphics adapter, and color monitor.

Contact Gold Hill Computers Inc., 163 Harvard Ave., Cambridge, MA 02139, (617) 492-2071. Inquiry **584**.

EPROM Programming

The PROMDisk program is aimed at program-

(continued)

SOFTWARE • PROGRAMMING LANGUAGES AND AIDS

mers developing code for EPROM-based IBM PC-compatible systems. The program lets you create an image of any file, including MS-DOS, which you can then load into EPROM. When the EPROM-based system is booted up, the file is copied from EPROM into RAM for execution. This system enables you to put MS-DOS in EPROM to support function calls made by compilers such as C, Turbo Pascal, and BASIC.

The program can create one to four RAM drives in EPROM, usually 16K to 32K bytes in size. PROMDisk costs \$1995. For more information, contact I-Bus Systems, 9235 Chesapeake Dr., San Diego, CA 92123, (619) 569-0646. Inquiry **585**.

6809 Debugger

Avocet Systems' AVSIM09 is designed for debugging object code for a 6809 microprocessor on an IBM PC or compatible. The program uses a full-screen symbolic debugger to display the 6809 and its components, including registers, flags, programs, and memory.

The program has standard symbolic debugger features such as memory and register manipulation, code entry and display in assembly language, breakpoint setting, and single-stepping by instructions or by subroutines. An undo command lets you back up through recently executed instructions to determine where problems occurred.

AVSIM09 also simulates peripheral devices connected to the 6809 and can handle interrupts and I/O. The program sells for \$299. Contact Avocet Systems Inc., 120 Union St., POB 490, Rockport, ME 04856, (800) 448-8500; in Maine, (207) 236-9055. Inquiry **586**.

Library of C Functions

CSL (C Scientific Library) is a collection of scientific functions for the C programming language. The collection is divided into several sublibraries. One group contains advanced algorithms for a variety of applications, including matrix decomposition and factoriza-

tion. Another group offers single- and multistep methods for solving systems of differential equations of any order.

Other groups contain functions for time-valued transactions, graphics and data conditioning, complex discrete and fast Fourier transforms, real and complex polynomials, random numbers, least squares, regression, and probabilities.

CSL runs on a Zenith Z-100 or IBM PC or close compatible, with an 8087 coprocessor, Computer Innovations' C compiler, and MS-DOS version 2.0 or later. The program costs \$245. For more information, contact Eigenware Technologies, 13090 La Vista Dr., Saratoga, CA 95070, (408) 867-1184. Inquiry **587**.

SOFTWARE • SCIENTIFIC AND ENGINEERING

Utility for Digitizing Tablets

Visual Numerics' Vishnu is a utility program for use with digitizing tablets that reduces graphical data to numeric tabular form. You place a graph, chart, map, blueprint, or other types of graphics on the tablet. By pointing with the digitizing stylus or puck, you can perform numerical differentiation, integration, and line integration to yield coordinates, angles, areas, and distances. By saving the data in an ASCII file, you can transfer it to spreadsheet and database programs or analyze it with FORTRAN, BASIC, or Pascal programs.

Vishnu supports Hitachi, Scriptel, GTCO, and compatible digitizing tables ranging in size from 11 by 11 to 36 by 48 inches. The program runs on the IBM PC, XT, AT, and compatibles and costs

\$250. Contact Visual Numerics Inc., POB 1726, Novato, CA 94948, (415) 892-2713. Inquiry **588**.

Schematics for AutoCAD

Icebox is a shape librarian for engineers who want to create schematics with AutoCAD. The program has a design and shape library for integrated circuits, as well as an editor for creating and editing IC shapes. It also includes a set of commonly used symbols such as ground, capacitors, and transistors.

The program comes with a predefined TTL library. Predefined Micro (Motorola/Intel) and Memory libraries are also available.

Icebox sells for \$295; additional libraries cost \$50 each. The program runs on the IBM PC and compatibles

and on CP/M-based computers. Contact International Microsystems Inc., 11554 C Ave., Auburn, CA 95603, (800) 325-6028; in California, (916) 885-7262. Inquiry **589**.

Circuit-Analysis Software

Bloom Associates has released EDAC Inc.'s set of circuit-analysis programs that model control loops of four common switching regulators. The series of programs includes EDAC1-Buck (for buck regulators), EDAC2-TBuck (for transformer-coupled buck regulators), EDAC3-Flyback (for flyback regulators), and EDAC4-Boost (for boost regulators).

Each program displays a standard circuit model for its specific regulator. You fill in the component values on

the schematic and can edit the values as needed. The program finds the DC operating point and determines if the operating mode is continuous or discontinuous. It then plots open- and closed-loop transfer functions, while accounting for the inductor current operating mode. You can print out the completed schematic.

The programs run on the IBM PC, XT, AT, and compatibles with 256K bytes of RAM, a graphics card, and a 360K-byte floppy-disk drive. Each program costs \$295; a set of all four costs \$995. Contact Bloom Associates Inc., 115 Duran Dr., San Rafael, CA 94903, (415) 492-8443. Inquiry **590**.

Ready-to-Run Software

Asstant Ready-to-Run Scientific Software from Macmillan Software is a

SOFTWARE • SCIENTIFIC AND ENGINEERING

menu-driven program for advanced scientific applications. The package includes data-reduction, analysis, and presentation graphics-capabilities. A second version of the program, called Asystant+, can also perform data-acquisition functions.

Asystant's data-reduction features include fast Fourier transform, smoothing, integration and differentiation, and data set averaging. It can perform such data-analysis functions as curve fitting with automatic display of raw data, fitted curve, and residuals; statistics; differential equations; matrix operations; and polynomial operations.

The program also supports high-resolution color graphics and includes a variety of graphics features. Among

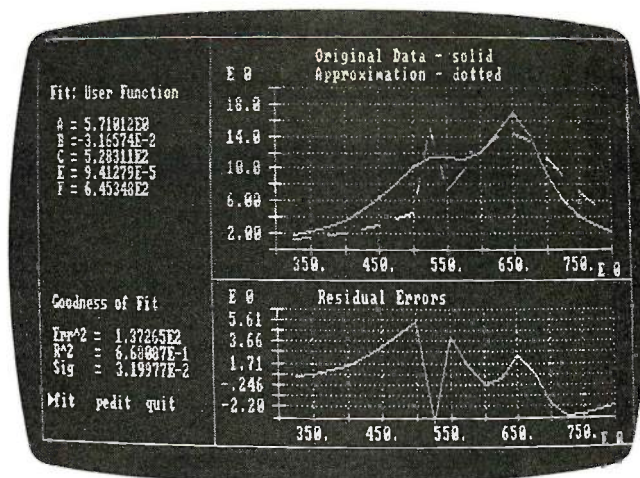

Macmillan Software's Asystant scientific package.

these are line, scatter, polar, and log and semilog plots; axonometric and contour plotting; labeling; and plotter support.

Asystant+ offers the same capabilities as Asystant, along with data-acquisition functions. The company says that these functions simulate

traditional laboratory instruments such as strip-chart recorders, transient recorders, and XY recorders. Features include real-time data display, automatic thermocouple linearization, cold junction compensation, a two-channel function generator, a graphics-based waveform editor, and operator control of A/D gain, data rate, digital output, and D/A range in offset.

Both programs run on IBM PC and compatible computers and require an 8087 coprocessor. Asystant sells for \$495; Asystant+ is \$895. For more information, contact Macmillan Software Co., 630 Third Ave., 8th Floor, New York, NY 10017, (800) 348-0033; in New York, (212) 702-3241. Inquiry 591.

SOFTWARE • BUSINESS AND OTHER

Grammar Checker

Sensible Software has followed up its Sensible Speller with Sensible Grammar, a grammar-checking program for Apple ProDOS. The package uses its library of more than 1000 commonly misused English phrases to identify bad writing. The company says the program will catch "pompous, informal, vague, wordy, repetitive, [or] sexist" prose. The software also traps punctuation, capitalization, and other typographical errors; shows errors in context; and suggests replacement wordings.

Sensible Grammar provides pull-down menus, scroll bars, and dialog boxes. It works with the AppleMouse but comes with a set of keyboard commands for mouseless Apple II users. The program runs on an Apple IIe or IIc with 80-column display and works with most word pro-

cessors for Apple ProDOS. Retail price is \$99.95. Contact Sensible Software Inc., 210 South Woodward, Suite 229, Birmingham, MI 48011, (313) 258-5566. Inquiry 592.

Disk, Diagnostics Utility

Sybil is Sophco's set of utilities that can recover accidentally formatted hard disks, unerase files, edit sectors, and modify file and

directory attributes. The software can also handle diagnostics functions, such as testing system boards, memory, keyboard, ports, and video. Other programs in the package provide a print spooler, a RAM disk, and a graphics editor.

Sybil works on the IBM PC family and close compatibles. The price is \$49.95. Contact Sophco Inc., POB 7430, Boulder, CO 80306, (800) 922-3001; in Colorado, (303) 444-1542. Inquiry 593.

DOS Directory Utilities

SuperPATH, a collection of RAM-resident DOS directory utilities for the IBM PC, lets you run any program from any directory, regardless of where it's stored; sort files by name, extension, date, time, or size (double sorts are allowed); build batch commands by merging filenames with other DOS commands; and choose from three display formats (five-column full-screen, long, or single-column short).

SuperPATH occupies 40K bytes of memory. It costs \$39.95, is not copy-protected, and comes with a 30-day money-back guarantee. For more information, contact Martin Scot Development Corp., 4515 Purdue NE, Seattle, WA 98105, (206) 527-9605. Inquiry 594.

WHERE DO NEW PRODUCT ITEMS COME FROM?

The new products listed in this section of BYTE are chosen from the thousands of press releases, letters, and telephone calls we receive each month from manufacturers, distributors, designers, and readers. The basic criteria for selection for publication are: (a) does a product match our readers' interests? and (b) is it new or is it simply a reintroduction of an old item? Because of the volume of submissions we must sort through every month, the items we publish are based on vendors' statements and are not individually verified. If you want your product to be considered for publication (at no charge), send full information about it, including its price and an address and telephone number where a reader can get further information, to New Products Editor, BYTE, 70 Main St., Peterborough, NH 03458.

THE BUYER'S MART

A Directory of Products and Services

THE BUYER'S MART is a monthly advertising section which enables readers to easily locate suppliers by product category. As a unique feature, each BUYER'S MART ad includes a Reader Service number to assist interested readers in requesting information from participating advertisers.

RATES: 1x—\$375 3x—\$350 6x—\$325
Prepayment must accompany each insertion.

AD FORMAT: Each ad will be designed and typeset by BYTE. Advertisers must

furnish typewritten copy. Ads can include headline (23 characters maximum), descriptive text (250 characters maximum), plus company name, address and telephone number. Do not send logos or camera-ready artwork.

DEADLINE: Ad copy is due 2 months prior to issue date. For example: June issue closes on April 1. Send your copy and payment to THE BUYER'S MART, BYTE magazine, 70 Main Street, Peterborough, NH 03458. For more information call Karen Burgess at BYTE 603-924-9281.

ACCESSORIES

LOWEST PRICES ON DISKETTES

5¼" SSDD \$49, DSDD \$59, High Density \$1.79.
3½" SSDD \$1.55, DSDD \$1.99.

- Lifetime warranty
- Includes tyvek sleeves
- 100% error free
- Reinforced hub ring
- Finest quality
- Labels & write protect tabs

Free UPS shipping. Minimum 100 diskettes.
Send check or call. CA residents add 6¼% sales tax.

Data Bureau Inc.

1633 Westwood Blvd., Ste. 120
Los Angeles, CA 90024
213-479-0345

Inquiry 676.

BAR CODE

BAR CODE READERS/PRINTING

Programs \$49-\$299. Readers \$325 up. PRINT Bar Codes on PC and Epson/Okidata or IBM Proprinter - Code 39, I 2of5, UPC, MSI, DOD-LOGMARS, AIAG. Graphics chs up to 1". Labels, Catalogs from files. Subroutines for BASIC, Cobol, Clipper, Turbo, Pascal, C, dBASE III Plus.

Worthington Data Solutions

130 Crespi Court, Santa Cruz, CA 95060
(408) 458-9938

Inquiry 679.

BUSINESS OPPORTUNITIES

VIDEO STORES

We need ambitious dealers in all U.S. states and Canada to market a powerful system to computerize video tape rental stores.

WINCHESTER DATA PRODUCTS INC.

3301-Executive Drive., #204, Raleigh, N.C. 27609
(919) 872-0995

Inquiry 756.

FREE CATALOG

Outstanding prices on computer accessories for your computer and workstation. Our catalog features a wide selection of quality products to meet all your accessory needs. Call or write today to receive your free catalog.

LINTEK COMPUTER ACCESSORIES

POB 8056, Grand Rapids, MI 49508
(616) 241-4040

Inquiry 707.

BIORHYTHM

Print out/sell BIO charts.

Sophisticated program plots physical, emotional & intellectual cycles for indiv. & compatibility chart for mate. Biorhythm theory used in sports/sales. One-time entry file. Create birthday lists. TIPC, IBM PC compatible. DOS 1.0 or greater. \$39.95. VIS/AMC/COD.

C-Level Software Development Inc.

P.O. Box 128, Cypress, TX 77429
(713) 469-0861

Inquiry 663.

Do you know businesses or people that buy IBM hardware, software, accessories and supplies? If so, you could make commissions just for recommending our national firm. Full or part-time positions available. We discount most major brand name products 20-50%, which makes our prices most appealing. Plus you get \$ for the sale. Call or write for more info.

WGGB

316 North Owen Street Mount Prospect, IL 60056
312-392-2621

Inquiry 755.

BOOKS / DISKS / VIDEOS

ATTENTION PROGRAMMERS!!

Programmers' Handbook of Computer Printer Commands - Vol. 1
Codes for 100's of Printers.

- * 43 Manufa. of Daisy & DMP
- * 272 pgs. in Table Form
- * Code, Hex/Dec. Equiv., and Descrip.
- * \$37.95 + \$2 sh + \$2 COD Visa/MC

ORDERS CALL: 1-800-628-2828 ext. #534 OR WRITE:
CARDINAL POINT INCORPORATED
P.O. Box 596, Ellettsville, IN 47429
(812) 876-7811 (M-F 9-5)

Inquiry 665.

HIGH PROFIT MARGINS

VRBase Professional Video Rental S/W for IBM PC/MS DOS. Features: POS, inventory, Memberships, Barcode, Accounting, On-Line Help, Multiuser, Video Tutorial. Send \$15 for Dealer Kit (includes VRBase S/W). Refundable 30 days or Apply to Order. Circle Inquiry Card or Call. Free S&H.

COMPUVIDEO

1549 West 146th St. Suite 3, Gardena, CA 90247
(213) 515-7325

Inquiry 670.

SOFTWARE PACKAGING, DISKS

Cloth binders & slips like IBM's. Vinyl binders, boxes, and folders—many sizes. Disk pages, envelopes, & labels. Low qty. imprinting. Bulk & branded disks. Much More! Low prices. Fast service. Call or write for FREE CATALOG.

Anthropomorphic Systems Limited

376-B East St. Charles Road
Lombard, IL 60148

1-800-DEAL-NOW (312) 629-5160

Inquiry 653.

CADD/CAM

DATA SWITCHES

Stop recabling forever, with our Serial or Parallel AB or X Data Switches. Two printers can share one computer or two computers can share one printer or plotter, or modem, or monitor, or etc. Prices start as low as \$42.00. Send for our catalog or see our ads in Jan./Mar./May issues. To increase your systems productivity today, call:

602-623-5716

Via West, Inc.

534 N. Stone Ave., Tucson, AZ 85705

Inquiry 752.

★ HARD DISK MADE EASY ★

Every Hard Disk Owner Needs
EASYBRIEF FOR COMPUTERS WITH

A HARD DISK

A How-To Book

\$10 Post Pd. Send Ck or M.O.

CA Orders add 60¢ sales tax.

To: The EASYKEY Co.

Bx. 1758, Murphys, CA 95247

Inquiry 686.

AutoCAD IC LIBRARIES

Integrated circuit symbol libraries allow rapid capture of electronic schematics with AutoCAD 2.X. Symbols can be inserted, scaled up/down, rotated, copied, moved, dragged, put on new layers, erased, made into blocks, and used with data attributes.

LS TTL Library \$295
Z80 & NSC800 Family Lib. \$195
Schematic Library . . . \$295 Memory Library . . . \$95

TKF Systems (301) 730-3542

5478-A3 Harpers Farm Rd., Columbia, MD 21044
AutoCAD is a registered trademark of Autodesk, Inc.

Inquiry 749.

Self-Inking Printer Ribbon

For users of Okidata and other open spool ribbon printers. Controlled Printout Devices are a new kind of printing ribbon that re-ink themselves, and will last 15 times longer than the ribbon you are now using. For further information please call or write.

CONTROLLED PRINTOUT DEVICES, INC.

POB 869, Baldwin Rd., Arden, NC 28704
(704) 684-9044

Inquiry 672.

★ WORDSTAR USERS ★

TRY THE NEW, DIFFERENT, UNIQUE APPROACH
TO LEARNING WORDSTAR.

Introducing an instruction book that skips the unnecessary and gets on with the substance of how to use your program! A superior primer and a concise reference in one manageable text!
CHEATBOOK FOR WORDSTAR

\$10 Post Paid. Send check or M.O. to:

The EASYKEY Company, Bx 1758

Murphys, CA 95247 CA orders add 60¢ sales tax

Inquiry 687.

CADD for \$99.95

FEATURES: Drawing Layers • User Defined Fonts
• Component Libraries • Video & Digitizer Menus
• Color Graphics.

Autocad® file conversion - \$24.95
Dot Matrix Printer/plotter option - \$24.95
MC, VISA, COD, add \$3.00 for shipping
60 day money back guarantee.

GENERIC SOFTWARE

13250 N.E. 40th St., Bellevue, WA 98005
1-800-228-3601

Inquiry 695.

THE BUYER'S MART

COMMUNICATIONS

SMART ANSWERING MACHINE

SAM transforms your IBM PC into an intelligent phone answering & real-voice messaging center. FEATURES: 999 personal messages, call screening, message forwarding, timed or grouped message delivery, sortable phonebook/autodialer, time/date log, voice prompted remote access, AND MORE!! All hardware & software included. Retail \$295. VISA/MC.

DIALECTRON, INC.

2035 California St., Ste #17, Mountain View, CA 94040
(415) 960-3040

Inquiry 764.

CONTRACTS

FOR ENTREPRENEURS

Legal contracts for hardware/software developers. Employee agreement, non-disclosure form, contracts for sale (hardware and/or software), consulting, development, hardware & software maintenance, non-competition, project delivery & more.

\$50 Waters Publishing \$50

8235 Douglas - Suite 1000 -
Dallas, TX 75225
800-628-2828

Inquiry 753.

DISK CONVERSION

DISK AND TAPE CONVERSIONS

High quality conversion services for Dedicated Word Processors, Mini and Microcomputers. Over 600 3 1/2", 5 1/4", and 8" formats. Also 800-1600BPI tape. Included: Wang, NBI, CPT, DEC, Videx, Lanier, OS/6, Xerox, IBM Sys/34/36/38/5520, Mac, Victor, TRS, Apple, NSTAR, IBM PC/AT, HP and most of the other microcomputers. We can convert directly into word processing software such as: DW3, WP, MS/WRD, WS, Samna, MM, PFS, and many others.

DATA FORMATS, INC. (408) 972-1830

Inquiry 770.

INCOMPATIBLE WORD PROCESSORS?

We convert to and from: XEROX, DEC, IBM, LANIER, WANG, PC-DOS, CONVERGENT TECHNOLOGY, WORDSTAR, MULTIMATE, SAMNA ASCII, MICOM.
Also most CP/M systems.
LOWEST PRICES

DATA CONVERSION INC.

6310 Caballero Blvd. • Buena Park, CA 90620
(714) 522-7762 (800) 824-4851 in CA.

Inquiry 677.

CONVERSION SERVICES

Convert any 9 track magnetic tape to or from over 500 formats including 3 1/2", 5 1/4", 8" disk formats & word processors. Disk to disk conversions also available. Call for more info. (312) 459-6010

Pivar Computing Services, Inc.

165 Arlington Hgts. Rd. #B
Buffalo Grove, IL 60089

Inquiry 723.

DOCUMENTATION

COMPUTER ASSEMBLY MANUALS

BIG BLUE SEED for IBM™ BUILDERS: parts list, placement diagrams, instructions for assembling over 65 IBM compatible bare cards - \$14.95.

APPLE SEED II for APPLE™ BUILDERS: instructions for assembling 77 Apple compatible bare cards including the II+ and Iie motherboards - \$12.95.

OVER 40 DIFFERENT BARE CARDS IN STOCK
FOR THE HOBBYIST

NuScope Associates

P.O. Box 790 • Lewiston NY • 14092

Inquiry 729.

DUPLICATING SERVICES

WESTERN TRANSDATA, INC.

Why risk duplicating your important programs on your computer, when our equipment is designed solely to duplicate disks & verify their perfection 100%? Over 600 formats. 3 1/2", 5 1/4" & 8". Plus serialization, copy protection, labeling, packaging, shrink-wrapping and fast, personalized service.

WESTERN TRANSDATA, INC.

1701 E. Edinger Ave. A-4
Santa Ana, CA 92705
714/547-3383 (collect)

Inquiry 754.

DUPLICATION SOLUTIONS

We have the answer to your duplication needs, no matter what the volume. We supply auto-loaders, disks, and technical support. We provide copy protection, serialization, package assembly, and distributive shipping.

MegaSoft

P.O. Box 1143, Freehold, NJ 07728
1-800-222-0490 201-462-7628 (in NJ)

Inquiry 710.

BLANKET SERVICES

Diskette duplication • Packaging • Stocking/Drop shipping • 48 hour delivery • SUPERLoK copy protection • No mastering fee • No charge for standard labels • Place a blanket order with releases as you need them for any quantity at a fixed price.

Star-Byte, Inc.

2564 Industry Lane, Norristown, PA 19403
215-539-4300 800-243-1515

Inquiry 741.

ENTERTAINMENT

BIBLE ADVENTURE GAME

"Keys of the Kingdom" is an exciting Bible adventure game in which you acquire the armor of God, confront the devil, meet characters from the Bible, and solve mazes and puzzles using the Bible. Runs on MS-DOS computers. Price: \$25.00

Peterson Computer Co.

P.O. Box 40067
Bellevue, WA 98004

Inquiry 722.

HARDWARE

DON'T LET POWER PROBLEMS DESTROY YOUR FILES.

GET UNINTERRUPTIBLE POWER SUPPLIES FOR YOUR PC'S. CALL FOR BEST PRICINGS.

Everett/Charles® Marketing Services

6101 Cherry Avenue
Fontana, CA 92335
800-443-1860 Calif. 800-821-0589

Inquiry 691.

\$79 MONO/GRAPHIC/PRINTER BOARD

* Hercules compatible * 720 x 348 pixel
* Lotus 1-2-3 compatible * 80 x 25 text
* Printer, Monitor port * 1 year warranty
* Light pen port * In stock delivery
1 - \$99 2-9 \$89 10 - \$79

SUGAR INTERNATIONAL

420-85th Pl., SW. #L205, Everett, WA 98204
(206) 353-2574 Carl, Mo-Sa, 10-7

Inquiry 744.

HARDWARE

EPROM/EEPROM PROG. \$250

Programs 2716-27512, 25xx and 68764/66 eproms via RS-232. Also 874x micros and 28xxA & 52Bxx EEPROMs. Automatic baud rate select, built in help menus, no personality modules!

16 BIT I/O MODULE \$75

Low cost control via RS-232. Expands to 512!

INTELLITRONICS

P.O. Box 3263, Tustin, CA 92680
(714) 669-0614

Inquiry 703.

USED APPLES & IBM's

APPLE II+ as low as \$275.00

APPLE Iie — CALL

Motherboards & accessories — call
We buy, sell, & horsetrade — Apple, IBM, & IBM.

SHREVE SYSTEMS

845 Lark Ave., Shreveport, LA 71105
318-865-6743 4-9 p.m. C.S.T. VISA/MC

Inquiry 733.

68000 COMPUTERS

Single board computers, 128K to 1M RAM, 4 serial, 2 parallel ports (expandable to 22 ports total), floppy controller for 2 to 4 drives, SASI interface for Winchester addition, timer/clock, real time multi-tasking multi-user operating system, assembler, line editor, 2 screen editors, spreadsheet. From \$995.00

AAA Chicago Computer Center

120 Chestnut Lane - Wheeling, IL 60090
(312) 459-0450

Inquiry 650.

IAM . . . In-Circuit Emulators

Real time full function In-Circuit Emulators for Design Engineers. Load Hex Files, Assemble/Disassemble, Edit Memory, Set Constants, with Break and Print Points. Stand alone operation or turns your Personal Computer into a Development System. And at an incredibly low Price . . . \$498. Models Available Z80, 8085, 8088 and NSC800. For immediate response Call (916) 961-8082

IAM

P.O. Box 2545, FairOaks, CA 95628

Inquiry 701.

Tandy 1000 Hardware

TanPak Multifunction Cards \$329
Memory to 512K, RS232, Clock, DMA
TanPak Secondary \$249
Memory to 256K, RS232, Clock
10 Meg Hard Drive with Controller. \$549
20 Meg Hard Drive with Controller. \$749

Hard Drive Specialist

1-800-231-6671 or 1-713-480-6000
16208 Hickory Knoll, Houston, Texas 77059

Inquiry 696.

POWERLINE GREMLINS?? POWER FAILURES??

The MEIRICK STANDBY POWER SYSTEM is the TOTAL SOLUTION to your powerline problems.
240 watt system - \$365; 400 watt system - \$495;
800 watt system - \$795

MEIRICK Inc., POWER SYSTEMS DIV.

Box 298, Frisco, CO 80443 303-668-3251

Inquiry 711.

THE BUYER'S MART

HARDWARE

"HELLO REAL WORLD"

8 ch. A/D to RS232
+ + +
8 - 10 bits! Prog. gain! 8 TTL out!
BSR out! 6 cu.in! 8 TTL in! \$99-\$199!
BUT WAIT! - THERE'S MORE!!!
circle or write for info

NORTH COAST PERIPHERALS
Box 199, Vermilion, OH 44089
(216) 967-4070

Inquiry 728.

IBM - AT CARDS

128K + RS-232C SERIAL + PARALLEL - \$249
128K CARD - \$199
AT COMPATIBLE RS-232C + PARALLEL - \$149
Piggyback option for additional 512K
Volume discounts - Dealer inquiries welcome
Designed and Manufactured by:

Zubair Interfaces, Inc.
2379 Centre St., West Roxbury, MA 02132
(617) 325-0278

Inquiry 758

SINGLE BOARD COMPUTERS

We feature a series of single board computers based on the 8051, 68008, 8096, and 68HC11. Available as bare boards or assembled and tested. Optional EPROM resident monitors and BASIC available. Cross Assemblers also available.

ALLEN SYSTEMS

2151 Fairfax Road, Columbus, OH 43221
614-488-7122

Inquiry 652.

TANDY-EPSON

Our 10th year of DISCOUNTS
Ed or Joe McManus
Fgt. Prepaid. Save Tax
Toll Free 800-231-3680

MARYMAC INDUSTRIES, INC.

22511 Katy Fwy., Katy (Houston), TX 77450
1-713-392-0747 Telex: 774132

Inquiry 709

Bullet-286 8-MHz 80286 XT Motherboard

- Faster and more compatible than turbo expansion cards
- 9 times faster than XT, 65% faster than AT
- Completely XT hardware and software compatible (except IBM ROM BASIC)
- Up to 1 MB onboard RAM with no wait states
- 10-minutes, screwdriver-only installation
- One-year warranty

Marchand International

1240 N. Van Buren, Unit 108, Anaheim, CA 92807
(714) 630-3382

Inquiry 708

HARDWARE ADD-ONS

APPLE & IBM PERIPHERALS!

FACTORY DIRECT! Ite 64K/80 Column Bd. \$39.
II +/Ite Cooling Fan \$24.95. II +/Ite Mouse w/SFWR \$49.95. Joystick III w/fire on stick Apple or IBM \$24.95. 10 Ft IBM Parallel Cable \$12.95. RAM Set/9 PC-\$5 XT-\$7. Add \$3 Shipping. Write for complete list.

NEXO DISTRIBUTION

8824 Golf Drive - Spring Valley, CA 92077
(619) 589-7928

Inquiry 726.

HARDWARE ADD-ONS

HEATH/ZENITH UP TO 640K

Dolen's \$89.95 G-2 user-installed option upgrades 2960 memory board to full 640K for model 150 or 160. G-3 factory-installed memory expansion is only \$139.95. No additional board required. Prices include shipping. Call (203) 222-1174 to order.

Dolen Computer Corporation

10 Bay Street, Westport, CT 06880

Inquiry 682.

INFORMATION SERVICES

TURBO S.I.X.

The Turbo Pascal Software Information eXchange offers its members megabytes of Turbo Pascal code for only \$8 per diskette. Also a monthly newsletter. Send \$1.95 for the TURBO S.I.X. catalog. Deductible from the \$19.95 membership fee when you join. MC/Visa.

TURBO S.I.X.

2012 Lake Air, Dept. B2, Waco, Texas 76710
(817) 753-2182 (817) 776-3103

Inquiry 743

MMZ8 BUS/HARDWARE

BCC 52 AND MMZ8 BUS COMPATIBLE

16 channel, 12 bit plus sign and overflow bit, A/D converter board is designed to interface to the MMZ8 Bus. Input voltage ranges include 0v to +10v, -10v to +10v, and -5v to +5v. Custom calibration is available. Software and documentation included. Price \$160 plus \$4 shipping and handling.

SMR DESIGN AND PROGRAMMING CO.

17509 Mapleboro Ave., Maple Hts., Ohio 44137
(216) 663-7809

Inquiry 734.

SOFTWARE BUSINESS

PC-Calc™ Version 3

64 columns x 256 rows, math and stat. functions, horizontal bar graphs, title locking, individually adjustable column widths, IF...THEN, link to other spreadsheets or PC-File databases, much more. Requires 256K IBM PC. \$59.95 + \$5 s/h.

ButtonWare, Inc.

P.O. Box 5786, Bellevue, WA 98006
1-800-J-BUTTON

Inquiry 659.

PC-Type™

Fast, compact, capable & easy! Help panels, hands-on tutorial, macros, multiple-line headings & footings, DOS path support, print spooling, block operations, etc. ASCII files. Install program allows customization. \$59.95 + \$5 s/h. For 128K IBM PC.

ButtonWare, Inc.

P.O. Box 5786, Bellevue, WA 98006
1-800-J-BUTTON

Inquiry 660.

SOFTWARE/BUSINESS

LP88-LINEAR PROGRAMMING

A powerful menu-driven system for solving linear programs w/ up to 510 constraints & 2510 variables. Features include interactive & batch operation, spreadsheet-style input & editing, storage of problems & bases, Simplex Algorithm restart, report generator, sensitivity analysis. Req. IBM PC, 192K. \$99 w/8087 support, user's guide. VISA/MC.

EASTERN SOFTWARE PRODUCTS INC.

P.O. Box 15328, Alexandria, VA 22309
(703) 549-5469

Inquiry 685.

TPRO88 - ROUTE FINDER

A powerful interactive system for finding routes on transportation networks w/up to 512 nodes and 16K links. TPRO88 can find the shortest path between two nodes, sequence up to 50 stops, compute minimum spanning trees and times/distances between all points. Req. IBM PC, 192K, graphics adapter. \$99 w/8087 support, user's guide, sample U.S. Highway network. VISA/MC.

EASTERN SOFTWARE PRODUCTS, INC.

POB 15328, Alexandria, VA 22309
(703) 549-5469

Inquiry 684.

PC-Write™ Shareware

Fast, friendly, flexible word processor and text editor for IBM PC. Easy to use. Advanced features like macros, split screen, footnotes, mailmerge. Many good reviews, thousands sold. All software, manual on disk \$10. OK to copy! Register for full manual, support, source \$75.

Quicksoft (208) 282-0452 Visa/MC

219 First N. #224J, Seattle, WA 98109

Inquiry 725.

dFELLER Inventory

A business inventory program written in modifiable dBASE source code. The menu-driven program lets you locate items by inventory name or number. It keeps track of reorder points, vendors, average cost, and other info. Requires dBASE II or III. PC-DOS/CPM \$150.

Feller Associates

550 CR PPA, Route 3, Ishpeming, MI 49849
(906) 486-6024

Inquiry 694.

Programmers:

We guarantee our products to be solid, bugfree.

- * CorrectForth - Very professional.
 - * Correct_Datamizer - 50:1 data compression guaranteed.
 - * SafeModem - Hackerproof.
- \$80.75 per program MC/VISA/MO/Check. Specify computer.

Correct Software, Inc.

RR1 Box 140, Black Hawk, SD 57718
(605) 787-5904

Inquiry 673.

MY WORD!® is just \$35.00

Complete word processing plus sort, add rows & columns, mergeprint, quickprint, macros, math, micro-justly, use all 256 char. Source: add \$35. 150 page printed manual. 30-day money-back guarantee. IBM PC or compatible, 128K, one drive, any printer.

T.N.T. SOFTWARE, INC.

34069 Hainesville Road, Round Lake, IL 60073
(312) 223-8595

Inquiry 750.

TAX-PREP '86 MAKES TAXES EASIER

Multiplan, 1-2-3 or Excel users, easily prepare totally professional tax returns. 22 linked schedules, IRS approved printout. IBM, Apple, TRS-80, CPM \$129.95; MAC \$99.95. Call now for full information.

EZWare Corporation

(215) 667-4064

Inquiry 692.

THE BUYER'S MART

SOFTWARE/BUSINESS

PC-File III™ Version 4

Search, sort, browse, global changes, macros, mailing labels, format reports with selection & calculations, sub-totals, totals, averages, encryption. Exchange data with 1-2-3, WORD, WordStar. Over 190,000 users. \$59.95 + \$5 s/h. For IBM PC.

ButtonWare, Inc.

P.O. Box 5786, Bellevue, WA 98006

1-800-J-BUTTON

Inquiry 661.

SOFTWARE/BUSINESS

MoneyCounts™ Only \$29.95

A complete money management system that provides: checking, savings and credit card management, budgeting, financial statements, graphics, financial database with multiple inquiry levels, special reports, tutorial and on-line help screens. Great for home or small business. FREE BROCHURE. IBM & COMPATIBLES with 192K & DOS 2.0 or later.

PARSONS TECHNOLOGY

6925 Surrey Dr. NE., Cedar Rapids, IA 52402
(319) 373-0197 CHECK/VISA/MC

Inquiry 719.

SOFTWARE/BUSINESS

ALL FORMS TAX SOFTWARE

- Individual Federal Income Tax Software
- Computes all forms and schedules
- Prints all forms
- IBM-PC, XT, AT & compatibles

\$49.95

Unique Computer Systems

140 East Commonwealth Ave. #208
Fullerton, CA 92632

In CA. **1-800-331-5088** 714-525-7118

Inquiry 768.

PC-File/R™

All the power of PC-File III plus: Relational link to other databases, integrated letter writing & mail-merge, context sensitive pop-up help windows. New binary search retrieves data hundreds of times faster. \$149.95 + \$5 s/h.

ButtonWare, Inc.

P.O. Box 5786, Bellevue, WA 98006

1-800-J-BUTTON

Inquiry 662.

TAXPAK™-86 Eases Tax Hassle

Fast, friendly, full-featured tax program in its 4th year. Menu driven. Unique status line shows wealth of info. What-if function explores tax options. Complete recalculation in only 1 second. Prints in IRS format. \$39.95 for IBM PC, Apple II, CPM-80. Try-it-first disk only \$3.

PEOPLEWARE

10762 Twin Spruce, Golden, CO 80403

(800) 621-8385 ext. 669 VISA/MC

Inquiry 720.

INEXPENSIVE PC SOFTWARE

- #1 Loan Amortization and Interest Calculations \$50
 - #2 Business Costs and Breakeven Analysis \$50
 - #3 Prolog Interpreter - Excellent teaching tool! \$65
 - #4 Polynomial Roots - N degree real/complex! \$45
 - #5 Curve Fitting - Ten different tests! \$45
- Add \$1.50 S&H. Va residents add 4% tax.

VIRGINIA INFORMATION SERVICES, INC.

P.O. Box 6566, Richmond, VA 23230
804-745-5012 10 to 6 EST

Inquiry 763.

DATA ENTRY SYSTEM

Heads-down data entry with two-pass verification for the PC/XT/AT & compatibles. Loaded with features like: Auto dup & skip, verify bypass, range checks, & table lookups. Fully menu driven only \$395. Call for free 30 day trial period.

COMPUTER KEYS

6519 193 SW, Lynnwood, WA 98036

(206) 776-6443

Inquiry 668.

WORD IMAGE

Edit 4 large files, undo, key macros, math, search/replace in ranges, all printers, help, on-screen attributes, sub-directories, command driven, batch, manual w/index & tutorial, fast, MORE!!! Needs 320KB, PC DOS 2.0+ - Intro: \$50.00, 30-Day trial.

Software Ideology

P.O. Box 305, Brooklyn, N.Y. 11204

718-236-3876

Inquiry 737.

TIME & BILLING \$99 JOB COST Option \$50

30 Day Money-back Trial
Virtually unlimited direct labor, direct cost and overhead categories. Very flexible. Prints your statements, many reports, and more! MS-DOS/IBM-PC & compatibles. VISA/MC/COD

Accounting Systems

1148-5 Executive Circle, Cary, NC 27511

(919) 467-3428

Inquiry 767.

CUSTOM PAYROLL

All systems have multiple pay categories, calculation of all taxes, user defined deductions, 401(k) handling, many reports, paychecks, W-2 forms, and much more. Custom features are available. Prices start at \$695 for system, manual, and PC Basic source code.

Datasmith, Inc.

Box 8036, Shawnee Mission, KS 66208

(913) 381-9118

Inquiry 678.

★ FORECASTING ★ MODELING ★ PLANNING ★

Compatible with IBM PC & Apple II
MICRO-BJ™
• Box-Jenkins ARIMA
• Identify, estimate, forecast
\$295.00
XTRAPOLATOR™
• Automatic forecasting
\$195.00
PROFESSIONALS CHOICE
• Link to Lotus, Visicalc
• Multiple order discounts
50% off Apple II orders

STRATIX

P.O. Box 4413 • Burlingame, CA 94011

(415) 697-0573 MCM/VISA

Inquiry 742.

FREE SOFTWARE

Send for a sample copy of Timekeeper, our home or office schedule software. For IBM and most MSDOS computers. Please enclose \$5.00 shipping and handling along with your computer type.

SOFTWARE DEVELOPMENT GROUP

P.O. Box 245, Hingham, Massachusetts 02043

(617) 749-8327

Inquiry 736.

ACCOUNTING SYSTEMS

\$49.95 + \$2.50 S&H

- Construction
- General Systems
- Medical Billing
- Retail Sales
- Equipment Rental
- Manufacturing
- Professional
- Wholesale

Each includes GL, AR, AP, INVENTORY, PAYROLL & more!

HIGH TECHNOLOGY, INC.

9312 W. 92nd Ave., Westminster, CO 80020
(303) 431-7596 VISA and MASTERCARD Accepted!

Inquiry 697.

INCOME TAX SOFTWARE

TAXWORKS® software to enter, calculate, and print Federal Form 1040 and 17 supporting schedules. 1985 marks 3rd year of production. 240 programs sold last season. Free phone support. For IBM, MS-DOS, CPM-80. Federal \$400. California \$100. Demo \$25.

TAXWORKS®

881 Alma Real Dr., Suite T-2
Pacific Palisades, CA 90272

(213) 459-2746, In Calif. (800) 232-1040

Inquiry 698.

SOFTWARE/CHURCH

ROMAR CHURCH SYSTEMS™

Membership-61 fields plus alternate address; labels, letters, reports any field(s). Offering-256 funds; optional pledge; statements; post to 255 x/year. Finance-GL with budget; up to 500 sub-totals & 99 depts: month & YTD reports anytime for any month. Size 2000 people/flop-py; 25000/10 meg. Ad too short! Write!

Romar Church Systems, Attn: BMB

P.O. Box 4211, Elkhart, IN 46514

(219) 262-2188

Inquiry 730.

MINUTE-a-DAY MANAGER™ TAX SURVIVAL SPECIAL

New *Shadow Writing™* feature adds the power of AI to your record keeping. 256K MS/PC-DOS package includes FREE Custom Calendar Kit PLUS:
• CHECKBOOK/CREDIT CARD MANAGER
• COMPUTER LOGGER • AUTO LOGGER
Visa/MC (May be tax-deductible.) \$59.95 + \$3 s&h

Multi-Data Management Associates

1-800-255-2255 ext. 3300

Inquiry 717.

ABACUS

ONLY FROM SUNSOFT . . . Complete Accounting System for \$49.95 plus S&H. SOURCE CODE only \$20 extra!!! Complete documentation. Runs on CPM/ & PC-DOS systems. 2-5¼" DSDO min.

- completely menu driven
- full file maintenance
- GL, A/P, A/R, P/R, C/A

SUNSOFT Inc.

P.O. 1168, Marquette, MI 49855

For orders: **1-800-624-7008** For info: **(906) 226-3370**

Inquiry 745.

Church Package

Parishioner Time, Talent and Treasure System program is written in modifiable dBASE source code.

- Contributions • Disbursements • Ledger
- Names with mailing labels
- Personal information database.

Requires dBASE II or III, PC-DOS/CPM-80 \$200.

Feller Associates

550 CR PPA, Route 3, Ishpeming, MI 49849
(906) 486-6024

Inquiry 693.

SOFTWARE/EDUCATION

XENIX TUTOR AT LAST!!!

A 6 hr. training program on effective use of XENIX (UNIX) operating system. Ideal for non pros wanting grasp of multi-user/multi-tasking systems. Runs under PC-DOS on IBM PC, PC/XT, PC/AT & compatibles: Requires 128K + graphics board. \$350. COD/VISA/MC/AE.

Hurricane Software

19415 S. Dixie Hwy., Miami, FL 33157

800-238-2389

FL 305-238-4800

Inquiry 699

War or Peace:

Decision — Making in a Nuclear Age

Stimulates discussion on the role of nuclear weapons in national security. Players choose U.S. or Soviet side. High school or home use, both teacher and student manuals included. IBM or Apple. \$49.95 MC/VISA/AMEX. For info. call: 207-775-1330. For orders call: 1-800-628-2828 ext. 649.

Bright Ideas, Inc.

52 Exeter St., Portland, Maine 04102-2839

Inquiry 657.

SOFTWARE/GENERAL

THE MAGIC KEYBOARD \$46.50

Print Letters from 3/32" to 100", or Sideways to 12". 10 fonts. Print one line at a time or from text file. Store signs, posters, overheads, large labels, etc. Okidata 92-3,192-3, Epson FX. Star Micronics, Proprinter. MS-DOS & Kaypro.®

WOODSMITH SOFTWARE

Rt. 3 Box 550A, Nashville, IN 47448

(812) 988-2137

Inquiry 751.

APPLE II USERS:

3780 RJE WORKSTATION EMULATION
3270 TERMINAL EMULATION

No special software or protocol converter is required in the mainframe. Interfaces to all major IBM operating systems. Fast, error-free bisynchronous transmission, easy to use. APPLE-BISYNC by Urgeo Software, Inc.

Call us collect at: (509) 838-6058

Inquiry 683.

Dr. T's MUSIC SOFTWARE

IF YOU CAN USE A WORD PROCESSOR
YOU CAN MAKE MUSIC!

MIDI music-composition software for Commodore and Apple computers. Also, algorithmic composition programs for computer generation of sequences. Fully editable Bach songbook, Keyboard, Bass, and Drum disks. Patch libraries available for Yamaha and Casio synthesizers. Reviewed in Jan. '85 COMPUTE.

66 Louise Rd., Chestnut Hill, MA 02167

(617) 244-6954

Inquiry 702.

SOFTWARE/GENERAL

Personal Tax Planner, \$75.00 a lotus template for 1-2-3 or symphony One file includes the 13 most commonly used federal forms, which can be combined with one state file (all states with income tax & sales tax are available). All forms federal and state are interactive.

Micro-One-Write, \$95.00 a checkbook accounting system. This unique single entry system is fast, accurate, and very flexible. Unique features include windowing instant viewing of active account or department codes and running balance of money accounts. Export results to Lotus or dBase.

PERMAR & ASSOCIATES

800-538-8157 ext. 955 In CA. 800-572-3470 ext. 955

1125 Sunnyhills Rd., Oakland, CA 94610

Include \$3.00 s&h, CA residents add 6.5% sales tax.

Inquiry 721.

► SOFTWARE FOR PENNIES ◀

GET BEST AND LATEST PC-DOS, CP/M-80 AND CP/M-86 PUBLIC DOMAIN PROGRAMS FOR BUSINESS, PERSONAL, EDUCATION, SOFTWARE DEVELOPMENT, MODEMING, SCIENCE, AND MORE. AT LOW COST OF COPYING. 3-1/2, 5-1/4 AND 8" DISK FORMATS ARE SUPPORTED. SEND \$6.00 FOR CATALOG.

MULTIPATH, INC.

Box 395, Montville, NJ 07045

(201) 575-5880

Inquiry 718.

AI for the IBM PC

TOPSI is a full version of **OPSS** which runs under MS-DOS, Unix or CP/M. A fast, efficient expert system development tool.

Prototyping: \$125

Production: \$250

Professional: \$375

C version, add \$20 Shipping, add \$5

DYNAMIC MASTER SYSTEMS

POB 566456, Atlanta, GA 30356

(404) 565-0771

Inquiry 766.

¿ESCRIBE EN ESPAÑOL?

Escribén is the only Spanish-language spelling checker for IBM PC and compatibles. Versions for Wordperfect, Multimate and Wordstar-ASCII files. Features as in best English-language checkers but designed for Spanish, includes on-line verb conjugation. Full version \$129.95, demo is \$14.95 and includes full documentation. Call for more details or to order. If you know someone that writes in Spanish, tell them about it. They'll love you for it.

Ibersoft Inc.

P.O. Box 3455, Trenton, NJ 08619

CALL NOW. 609-890-1496 MC/VISA

Inquiry 700.

TIME & EXPENSES

Tracks/Bills time & expenses on 1000 accounts, 1 million entries each. Easy to use, fast! PC/XT/AT/IR and compatibles. Only \$49.95 plus \$5 shipping. M/C, VISA, Check, Money Order.

Baker Business Systems

2802 Highway 90 West, Seguin, TX 78155

(512) 372-3949

Inquiry 655.

SOFTWARE/GRAPHICS

THE DGI TYPE SHOP

Turn your IBM or APPLE computer and HEWLETT-PACKARD plotter into a desktop publishing system. THE DGI TYPE SHOP offers a quick and economical alternative to typesetting - PLOTSETTING. Price \$175. Ten optional fonts that range from a very formal script to Greek - Scientific are available.

DECISION GRAPHICS, INC.

P.O. Box 2776-B, Littleton, Colorado 80161

Phone (303) 796-0341

Inquiry 680.

SOFTWARE/GRAPHICS

FORTRAN PROGRAMMER?

Now you can call 2-D and 3-D graphics routines within your FORTRAN program.

GRAFATIC: 75 callable routines for screen output. \$135.

PLOTMATIC: Pen plotter driver. \$135.

For the IBM PC, XT, AT and compatibles. We support a variety of compilers, graphics boards and plotters.

MICROCOMPATIBLES

301 Prelude Drive, Dept. B

Silver Spring, MD 20901

(301) 593-0683

Inquiry 712.

SOFTWARE/LANGUAGES

FINALLY!

A Subroutine Library for Compiled BASIC OVER 100 SUBROUTINES and FUNCTIONS for Use with MicroSoft QUICK BASIC or IBM BASIC Compiler 2.0. Full Documentation Package with Examples, 30 Day Money-Back Guarantee. VISA/MC FINALLY! is only \$99.00 + \$4.00 S&H

KOMPUTERWERK, INC.

851 Parkview Blvd., Pittsburgh, PA 15215

(412) 782-0384

Inquiry 750.

WINDOW & SCREEN Mang't

For Modula 2, C, Pascal, IBM/compatibles, Atari 520ST. Create overlap, pop-up menu/screen/windows without touch program, beat 64K limit. Save, move, zoom/shrink swap/delete, color, border, header, cursor control. \$59.00 VISA/MC.

APPLIED COMPUTING

3368 Westchester Rd., Bloomfield Hills, MI 48013

519-254-4472

Inquiry 654.

K&R standard C COMPILER with extensions

Assembler, Overlay Linker, Librarian, Unix-like Shell w/hierarchical directories, Library source for Shell and ProDos interface, allows production of stand-alone programs. CDOS version w/complete o/s source \$49.95. ProDos versions: Entry: \$49.95, Professional \$99.95. Macintosh version \$199.95. No license fee.

WSM GROUP INC.

1161 N. Eldorado Place, #241, Tucson, AZ 85715

(602) 298-7910

Inquiry 757.

RUN FAST, LOOK BEAUTIFUL

If this is what people expect from your BASIC programs, then you need YES MASTER! a DOS-resident development aid that includes a screen painter, an ISAM file manager, a window manager, a printer generator and more. All in one package. \$245. No royalty.

SOFTWAY, INC.

500 Sutter St., Suite 222 BC

San Francisco, CA 94102

(415) 397-4666

Inquiry 738.

Tools for CB80 & CB86

BDOS, DOS, and BIOS calls from CB80 and CB86! CBC Tools includes functions for directory access, string ops, a debugger, radix conversion, command line parsing, quicksorts, bit and byte ops, and more for CP/M-80, CP/M-86, and PC-DOS, \$180.00. Ask about our Pascal MT+ products.

Minnow Bear Computers

POB 2233 Sta. A, Champaign, IL 61820-8233

(217) 398-6883

Inquiry 716.

POWERFUL FILE MANAGEMENT

I.D.T.'S FileManager® for people serious about their systems. No kid stuff—only powerful managing tools. File sort, copy, move, delete, search & change attributes. Undelete and clear files.

EDLIN enhancer & batch mode clean up and more. Menu driven.

\$34.95 (about 1/2 Norton's) MC/VISA

INTEGRATED DATA TECHNOLOGY, INC.

4775 Bunchberry Lane, Colorado Springs, CO 80917

ORDERS: 303-488-2583

THE BUYER'S MART

SOFTWARE/LANGUAGES

CROSS ASSEMBLERS with "UNIVERSAL" LINKER and POWERFUL LIBRARIANS for IBM PC MS-DOS

Full featured for most microprocessors

ENERTEC, INC.

BOX 1312, Lansdale, PA 19446

215-362-0966

MC/VISA

Inquiry 689.

SOFTWARE/LANGUAGES

Minnesota **SNOBOL4** Language

Powerful string & data handling facilities. Interpreter compatible with mainframe SNOBOL4. 32K strings, 32 bit integers, 8087 for float & large memory model. Sample pgms include ELIZA. For >128K IBM PC & D S or equivalent. Definitive "green" book by Griswold available.

Guide + 5 1/4" 5DD diskette..... \$44.95
Guide + diskette + "green" book..... \$59.95
"Green" book only..... \$24.95

Postpaid in USA. In NY add tax. VISA/MC (914) 271-5855
BERTIS INTERNATIONAL
POB 441, Millwood, NY 10520

Inquiry 656.

SOFTWARE/SCIENTIFIC

Affordable Engineering Software

CALL OR WRITE FOR FREE CATALOG
Circuit Analysis • Root Locus • Thermal Analysis • Matrix Manipulation • Signal Processing • Filter Design • Graphics • Text Proofreader

BV Engineering

2200 Business Way Suite 207, Riverside, CA 92501

VISA/MC

(714) 781-0252

Inquiry 759.

CROSS ASSEMBLERS

Develop microprocessor programs on your IBM PC or MS DOS computer.

* Macros * Conditional Assembly * Editor *

Complete support for most 8 bit microprocessors
Linker and EPROM Programmer Driver

MicroComputer Tools Co.

1255C Kenwal Rd., Concord, CA 94521

(415) 825-4200

Inquiry 713.

Symbolic Debugger for Turbo Pascal™

- Set breakpoints at line numbers or procedures
- Display and modify variables symbolically

- Fully integrated into Turbo Pascal environment
Requires Turbo 2.0 or 3.0, IBM PC version.

Only \$49 plus \$2 S&H.

KYDOR COMPUTER SYSTEMS

812 S. Sherman St., Richardson, Texas 75081

(214) 669-1888

Inquiry 706.

SYSTEM DESIGNER

SD is a tool for the design of hierarchical systems and processes, representable by trees. SD breaks a task of designing a large system into a great number of small, easy tasks while keeping track of all pieces. SD plots a graph of a tree representing the proposed system. The price is \$399.

CUSTOM SYSTEMS

23 Crestwood Ct., Lansdale, PA 19446

(215) 468-7773

Inquiry 674.

SIMULATION LANGUAGE

TurboSim allows large discrete event simulations i.e., manufacturing systems, health-care systems, etc. to be run on a micro. It features a comprehensive final report, histograms, plots and multiple simulation runs in an unattended mode. Source code is written in Turbo Pascal and is included. Borland International's Turbo Pascal and an IBM/PC with 64K are required. \$49.95.

Micro Simulation

37 William J. Heights, Framingham, MA 01701

(617) 875-6098

Inquiry 765.

SOFTWARE/SCIENTIFIC

MATRIX CALCULATOR

Programmable calculator with 70+ matrix opns, statistics, system of lin & nonlin & diff eq'ns, numer. integral, 1-d optm. User program'd func. \$49.95 includes S&H, 100+ pg manual, 1 yr. support. Same for 8087 ver. Visa, MC accepted.

SoftTech Inc.

Suite 104, 18505 W. 8 Mile, Detroit, MI 48219

(For Credit Card Orders) 1-800-835-2246 ext. 60

313-534-4933

Inquiry 735.

BEAM ANALY. & SPRING DESIGN

Beam analysis program calculates shear, moments, reactions, slopes and deflections in beams. Price: \$50.00. Helical spring design program for compression, extension and torsion springs. Price: \$75.00.

Both packages include disk and documentation. For Apple II series of computers or IBM PC, PCjr and compatibles.

SYLCA CORPORATION

33-47 14 Street, Dept B, Long Island City, NY 11106

718-278-4604

Inquiry 746.

* INSTANT EDT/ASEM \$50 PPD *

Full Macro Assembler. All the features of IBM's & Microsoft's. Syntax and file compatible. Runs like Turbo Pascal. Write, assemble and run programs in seconds, in memory! WordStar like editor built in. Supports full Intel 16-bit family. PC DOS-MS DOS compatible. Money back guarantee!

Computer Solutions

P.O. Box 354, Mason, Michigan 48854

1-800-874-9375 VISA/MC 1-517-628-2943

Catalog with 300 items sent with order.

Inquiry 669.

► SCIENTIFIC HANDBOOK ◀

Chemists, Physicists, Engineers:

Fast, accurate unit conversions for all common units (over 100). Also physical constants, periodic table, calculator. Don't reach for the bookshelf! With Handbook PLUS on your PC they're at your finger tips.

\$35 PC/MS-DOS computers.

Cathedral Software

999C Edgewater Blvd., Suite 311F

Foster City, CA 94404

Inquiry 666.

MATRIX 100

Powerful Matrix operations with single statements in IBM PC BASIC. Perform multiple regression, solve simultaneous equations, invert matrices, etc. MATRIX 100 commands are fast, reliable and easy to use. Price \$80. 8087 support \$125; compiler support \$250. (\$4 shipping & handling. CA res. add sales tax).

STANFORD BUSINESS SOFTWARE, INC.

4151 Middlefield Rd., Suite 215, Palo Alto, CA 94303

To Order Call (415) 424-9499

Inquiry 740.

LISP for the MACINTOSH®

MacScheme® implements the Scheme dialect of LISP. It features a fast byte code interpreter, debugger, editor that understands LISP syntax, multiple windows, and Quickdraw graphics. University site licenses available. \$125. (+ \$10 overseas). MC/VISA. To order, call or write:

Semantic Microsystems

4470 S.W. Hall St., Ste. 340, Beaverton, OR 97005

(503) 643-4539

Inquiry 731.

PC TECHNICAL GRAPHICS

TEKMAR is a graphics library for the Tecmar Graphics Master. Similar to PLOT-10, includes WINDOW, VIEWPORT, AXIS. Support for HP, HI plotters. Curve fitting, complete plotting program. Log, semi-log, multi-axis, 3-D, contours. Demo disk, literature available.

Advanced Systems Consultants

21115 Devonshire St., Suite 329, Chatsworth, CA 91311

(818) 407-1059

Inquiry 651.

CMX MATRIX CALCULATOR

Evaluate complicated matrix expressions as easily as arithmetic on a calculator. Over a dozen useful operators invoked by a single keystroke. Fully prompting learning mode plus a rapid entry silent mode. MS/PC-DOS or CP/M8K (Sage/Stride) versions. \$55.

Estanco, Inc.

444 So. Cotner Blvd., Lincoln, Nebraska 68510

phone (402) 489-6435

Inquiry 690.

T-List Data Base Manager

Designed for the Apple II & ProDOS, T-List uses file caching and balanced b-trees to advance beyond ordinary data base managers. Features compact variable length records, multiple fields per key, unlimited records and keys. \$75 with partial source.

Eclipse Systems

P.O. Box 237, Merion Station, PA 19066

(215) 664-2419

Inquiry 688.

ENGINEERING SOFTWARE WRITTEN BY ENGINEERS FOR ENGINEERS

Highest power per dollar. Highest power per K of memory. Satisfaction guaranteed.

Electronic Circuit Analysis.....\$450.
Logic Simulation System.....\$395.

TATUM LABS

33 Main St., Newtown, CT 06470

(203) 426-2184

Inquiry 748.

FORTRAN SOURCE CODE

PROFESSIONAL SIGNAL PROCESSING & MATRIX ANALYSIS UTILITIES

34 PROGRAMS W/TUTORIAL & EXAMPLES
Spectral Analysis, Digital Filters, Singular Value Decomp, Conj. Gradient, Root Finder, Graphics, More. Disk/Hard-copy. Documented. Rsrch Bibliography. Send for info. \$99.

CLAREN SOFTWARE

P.O. Box 5333 • MESA, AZ 85201

Inquiry 671.

SOFTWARE/SCIENTIFIC

Digital Logic Design on the Macintosh™
The LogicWorks™ series allows you to create, test and document digital circuitry on your Macintosh. Full simulation capability lets you catch design errors before committing your circuit to hardware. From \$79.95 (US). Demo pkg. \$10. Visa/MC Accepted.

Caplano Computing Systems Ltd.
Box 86971, N. Vancouver, B.C., Canada, V7L 4P6
(604) 669-6343

Inquiry 664.

TURBO CIRCUIT ANALYSIS

Generates matrix-equation source code for A.C, D.C and Transient Analysis. Source code for Worst Case, Plots, etc. Requires MS-DOS, BI-Turbo Pascal or FORTRAN. Both ME and EE useful.
Circuit Analysis Programming System \$155

CVY, Inc.

1709 N. West Ave. #131, Jackson, MI 49202
(517) 782-2297

Inquiry 675.

forMath® text-formatter

- Equations, matrices, ratios, integrals, diagrams
- Macros, fonts, Greek/math symbols
- Hyphenation, secn/eqn/ref numbering
- Indexes, table of contents, footnotes
- Dot-matrix, daisywheel, laser printers, all monitors

\$400. \$50 for demo

SHANTHA SOFTWARE INC.

50 West 97th St. Room 11N, New York City 10025
(212) 222-SNIP
Touchtone toll free: 950-1088-wait-FORMATH

Inquiry 732.

SOFTWARE/SYSTEMS

CPM-80 LIVES on your PC

CP/Mulator puts a 4mhz 8 bit CP/M emulator in your IBM-PC for \$99. (\$3 s + h).

- A great 8 bit development system
- Saves expensive CPM-80 applications
- Increases PC speed 10% for 8088 programs
- Priced less than most software only products
- Uses no valuable board slots

Source Information

P.O. Box 2974, Warminster, PA 18974
VISA Phone (215) 628-4719 M/C

Inquiry 739.

Multi-Terminal Disk Operating Systems

GASS-General Accounting Scientific Switching system. Multitasking. Can handle 12 terminals off IBM PC. Used in mini's since 1976. Dealers wanted. List Price \$95.

Maxey Systems, Inc.

5910 Youree Dr. Suite D, Shreveport, LA 71105
(318) 868-5422

Inquiry 769.

LASER TYPOGRAPHY \$495.

Typographic composition software to drive the Corona L300 Laser Printer as a typesetter. H & J 24 proportional space fonts, widths for 78 fonts available. Mix face & point size on any line, multicolumn capability.

Micro Print-X, Inc.

P.O. Box 581, Ballinger, TX 76821
(915) 365-2343 Dealer Inquiries Welcome

Inquiry 714.

SOFTWARE/SYSTEMS

pcSHARE MULTI-USER O/S

pcSHARE allows your IBM-XT/AT or compatible to support up to 5 users running 1-2-3, dBASE, WordStar, etc. on inexpensive serial CRTs. For software developers, pcSHARE efficiently runs compiled Basic, Pascal & C programs with full DOS 3.0 compatible record locking.

DIGITROL COMPUTERS INC.

440 Phillip Street
Waterloo, Ontario, CAN, N2L 5R9
(519) 884-4541

Inquiry 681.

BACKBONE™

The Easy DOS-interface for IBM PC/XT/AT and Compatibles. Customize linked menus with the MENU PROCESSOR™. Then, any program, batch process, submenu, even DOS, may be accessed by a keystroke. A perfect hard disk organizer, ideal for LAN'S. Provides speed, convenience, simplicity. Only \$39.95 + \$4 p/h Guaranteed! And Well Supported!

SYNCHRONY SYSTEMS

4191 San Juan Ave., Jacksonville, FL 32210
Orders: 1-800-237-6360 x314 In FL 1-800-282-1152 x314

Inquiry 747.

STATISTICS

RATS!

RATS is a fast, accurate & complete regression package with unsurpassed POWER. Has both time-series & cross section analysis. Includes Box-Jenkins, logit & probit. Spectral analysis & graphics also available. Requires 256K RAM. IBM PC or compatible. \$200. MC/Visa.

VAR Econometrics

P.O. Box 19334, Minneapolis, MN 55419
(612) 822-9690

Inquiry 760.

STATISTICS CATALOGI

If you need statistics for IBM PC or Apple II, call us and let our technical advisors help you find the statistics programs you need. Write or call now to get a FREE catalog of statistics and quality control software.

HUMAN SYSTEMS DYNAMICS

9010 Reseda Blvd., Ste. 222
Northridge, CA 91324

(800) 451-3030 (818) 993-8536 (CA)

Inquiry 761.

The Statistician

includes: Multiple Regression (Stepwise, ridge, all subsets, backward elimination)

- Time series analysis • descriptive statistics
- transformations • survey research • nonparametrics
- X-Y plots • ANOVA • random samples • data base
- data editor • search & sort • hypothesis tests

For IBM, MS-DOS, XENIX, CPM, TRS-DOS.
Please call TOLL FREE 1-800-334-0854 (Ext. 814)

QUANT SYSTEMS

Box 628, Charleston, SC 29402
803-571-2825

Inquiry 724.

STATISTIX™

\$75 - Satisfaction guaranteed

A comprehensive, powerful, yet easy-to-use statistical analysis system for IBM PC/XT/AT's, Apple II's, and MS DOS machines. Clear 200p manual. Write for information.

NH ANALYTICAL SOFTWARE

801 West Iowa Ave., St. Paul, MN 55117
(612) 488-4436

Inquiry 727.

UTILITIES

"USER-FRIENDLY" REDEFINED

Don't laugh. Now if your P.C.'s aren't friendly, it's your own fault. Meet TheEMCEE, your application manager. Replaces DOS prompt with custom menus. Runs programs, batch files and menus. 99 levels of password protection. Fast, friendly interface for users, powerful access and control for systems managers. Only \$49.95. What could be friendlier than that?

COMMAND SOFTWARE SYSTEMS, INC.
1-800-423-9147 or 1-818-707-7100

Inquiry 667.

COPYWRITE

CopyWrite backs up hundreds of the most popular programs for the IBM PC. CopyWrite is revised monthly to keep up with the latest in copy protection, and comes with a trade-in offer. It needs an IBM AT, XT, or PC, 128K and one disk drive, but can use more memory or another drive. \$50 US. Check/Credit Cards.

QUAD SOFTWARE LIMITED

45 Charles St. E. 3rd Fl.
Toronto, Ontario, Canada M4Y 1S2
(416) 961-8243

Inquiry 657.

SOURCE CODE LIBRARIAN & REVISION CONTROL SYSTEM

TLIB™ keeps ALL versions of your program in ONE compact library file, even with hundreds of revisions.

- 5 times faster than PC/IX (Unix) SCCS
- LAN-shared libraries with PC Network

MS/PC-DOS 2.x & 3.x. \$99.95 + \$3 S&H. VISA/MC

BURTON SYSTEMS SOFTWARE

POB 4156, Cary, NC 27511
(919) 469-3068

Inquiry 658.

PACKED UTILITY DISK

HOT FOR
STUFF!! \$10 IBM-PC

EXPECT A MIRACLE!

MICRO TOOLS INC.

POB 357 N. Chili, NY 14514 (716) 594-1088
Circle the Inquiry #715... We'll do the rest

Inquiry 715.

DOS PATHING EXTENSION

Give your software the full PATHING capabilities that are missing from the 2xx and 3xx versions of MS-DOS and PC-DOS. FULLPATH object license: \$19.95, source license: \$399.95, (+\$5 S&H + 6% in MN). VISA/MC/PO/CHK 30 day money back guarantee.

P. R. GLASSEL and ASSOCIATES, INC.

30255 Fir Trail, Stacy, MN 55079
812-482-1337

Inquiry 762.

MEDIA MASTER PLUS

READ, WRITE, and FORMAT over 60 CP/M disks and run most CP/M-80 programs on your IBM PC! Two program package includes ZP/EM, a CP/M-80 emulator program that transforms your IBM PC into a 1.2 MHz CP/M 2.2 computer. \$59.95 + \$3.00 S/H (CA 6%⁶)

INTERSECTING CONCEPTS, INC.

4573 Heatherglen Ct., Ste. 10
Moorpark, CA 93021
(805) 529-5073

Inquiry 704.

The Zipper™ 1200 bps & 2400 bps Modems

Fully Hayes Compatible 2 Year Warranty

Supports all 20 Hayes Commands
and all 6 responses

- Tone & Pulse dialing • Built-in speaker
- Auto dial/auto answer • 8 status lights
- Auto speed selection • Self-test

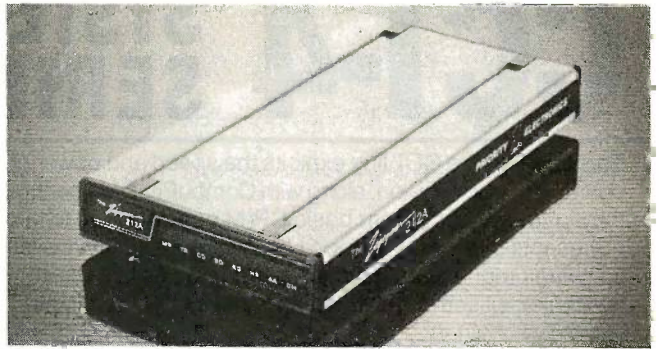

1200 bps Standalone
Bell 103 and Bell 212A
Compatible

\$199

BDPRIZIP12 (4 lbs.) Retail \$299.00

2400 bps Standalone
CCITT V22, V22BIS, Bell 212A,
and Bell 103 Compatible

\$399

BDPRIZIP24 (5 lbs.) Retail \$599.00

1200 bps IBM PC
Compatible Card w/MITE
Communications Software

\$199

BDPRIZIP12B (4 lbs.) Retail \$299.00

VIDEO MONITORS

IDM-PC™ COMPATIBLE MONITORS

PGS MAX-12 Amber 12" 25lbs.	BDPGXMAX12	\$179
PGS HX-12 RGB 12" 37lbs.	BDPGXHX12	\$479
AMDEK 310A Amber 12" 26lbs.	BDADK310A	\$169

GENERAL PURPOSE

AMDEK 300 Green Comp. 12" 25lbs	BDADK300	\$129
AMDEK 300AA Amber Comp 12" 25lbs	BDADK300A	\$139

IBM COMPATIBLE BOARDS

AST

SixPacPlus 64K	BDAST6PACK64	\$259
RAM Page! 256K	BDASTRP256	\$399
MegaPlus II 64K	BDASTMP2	\$349
MegaPak 128K for above	BDASTPAC4	\$179
Preview!	BDASTPRVW	\$279
ColorGraph Plus	BDASTCGP	\$199

QUADRAM

EXPANDED QUADBRD zero K	BDQDRQDBRDXP0	\$239
QUADBOARD II zero K	BDQDRQDBRDII0	\$199
GOLD QUADBOARD zero K	BDQDRG0	\$449
SILVER QUADBOARD zero K	BDQDRS0	\$269
LIBERTY BOARD 128K	BDQDRLIB	\$499
QUAD 512+ 64K	BDQDRS12	\$259
QuadEGA+	BDQDRREGA	\$449
QUADCOLOR II	BDQDRQDCII	\$349

HERCULES

MONO GRAPHICS CARD	BDHECGC	\$329
COLOR graphics card	BDHECCC	\$179

ORCHID

CONQUEST zeroK	BDORCCQ	\$369
CRAMRAM Half BO 186	BDORCTR6	\$829
Serial daughter board for above	BDORCTR650	\$129

PARADISE

5 PACK zero K	BDPAR5PACK	\$149
5 PACK w/384K included you install	BCPAR5PACK384	\$199

STD

EGA Plus	BDSTBEGA	\$399
Chauffer	BDSTBCHFR	\$299

EXPANSION CHIPS

64K Expansion Contains	PDBIBMEM9	\$12.00
9 64K x 1 150nS RAMs	PDBIBMEM36	\$39.00
256K Expansion Contains	PDB256MEM9	\$39.00
36 64K x 1 150nS RAMs	PDB256MEM36	\$149.00
256K Expansion Contains		
9 256K x 1 150nS RAMs		
MEG Expansion Contains		
36 256K x 1 150nS RAMs		

KEYTRONICS KEYBOARDS

Improved PC type 5lbs	BDKEYKB5151	\$189
KB5151 with touch pad 5lbs	BDKEYKB5153	\$379

POWER SUPPLIES FOR IBM PC™

170watt replacement 7lbs	BDTEATP409B	\$159
130watt replacement 6lbs	BDTEATP412	\$ 99

TERMINALS

WYSE 50 32lbs	BDWYS50	\$499
	2 or more	\$479
WYSE 30 32lbs	BDWYS30	\$359
QUME 101 Amber 32lbs	BDQMEQVT101AM	\$359
QUME 101 Green 32lbs	BDQMEQVT101GR	\$359

MODEMS

HAYES

2400bps Smartmodem 4 lbs.	BDDCH2400	\$599
1200bps Smartmodem 4 lbs.	BDDCH1200	\$399
1200bps PC Smartmodem 4 lbs.	BDDCH1200B	\$379

PRACTICAL PERIPHERALS

1200bps 1/2 card w/software	BDPRPPM12	\$199
-----------------------------	-----------	-------

Surge Suppressor & Noise Filter

\$29.95

BDWBRS115's List: \$49.95
(Shipping Weight 2 lbs.)

PROMETHEUS

ProModem 1200 Standalone 4lbs	BDPRMPM1200	\$299
ProModem 1200 for MAC 4lbs	BDPRMPM1200M	\$349
Communications buffer 1lb.	BDPRMPT5	\$129
Alpha/num for ProModem 1lb.	BDPRMDISPLAY	\$ 79
512K ProModem upgrade 1lb.	BDPRMX512	\$ 99
ProModm 1200 Apple IIe card 4lbs	BCPRMPM1200A	\$349
ProModm 1200 PC crd/stwr 4lbs	BCPRMPM1200B	\$279

HARD DISK PC SUBSYSTEMS

Systems include drive, control & data cables & 1/2 card contrlr

INTERNAL (Include \$6 shipping)

21Mbyte 1/2 high	BDPRIPCSUB21I	\$549
33Mbyte full high	BDPRIPCSUB33I	\$899
40Mbyte full high	BDPRIPCSUB40I	\$1399
72Mbyte full high	BDPRIPCSUB72I	\$1999

EXTERNAL (Include \$10 shipping)

Drives mounted in a IBM PC styled enclosure		
21Mbyte subsystem	BDPRIPCSUB21X	\$749
33Mbyte subsystem	BDPRIPCSUB33X	\$1099
42Mbyte subsystem	BDPRIPCSUB42X	\$1599
72Mbyte subsystem	BDPRIPCSUB72X	\$2199

"AT" Subsystems - Drive, Cables & ROM

30 Mbyte Subsystem	BDPRIATSUB30I	\$899
40 Mbyte Subsystem	BDPRIATSUB40I	\$1499

HARD DISK DRIVES

(Sh. wt. 5 lbs.)		
Tandon TM252 13Mbyte	BDTND252	\$329
Seagate ST225 25Mbyte	BDSEAST225	\$ 449
CM1 6640 40Mbyte	BDCMI6640	\$ 699
CDC 94155-086 86Mbyte	BDCCDC86	\$1895
Maxtor XT1140 143Mbyte	BDMXTXT1140	\$3295

FLOPPY DISK DRIVES

(Sh. wt. 3 lbs.)		
TANDON 55-2 5 1/4" DS,40T,1/2 hi	BDTND552	\$ 99
MPI 52S 5 1/4" DS,40T,full hi	BDMP152S	\$ 69
Tandon TM100-2 5 1/4" DS,40T full hi	BDTNDTDM1002	\$129

YOUR SATISFACTION GUARANTEED

CALL FOR DETAILS

IRVINE

18241 Mc Durmott,
Irvine, CA 92714
(714)660-1411



PRIORITY ONE ELECTRONICS®

Inquiry 270

Mail Your Order To:

21622 Plummer St., Chatsworth, CA 91311-9970
RETAIL: (818)709-5464 INDUSTRIAL: (818)709-5111



SAN JOSE

542 W. Trimble Rd.,
San Jose, CA 95131
(408)435-7300

MINIMUM PREPAID ORDER \$25.00. Terms U.S. VISA, MC, BAC, Check, Money Order, U.S. Funds ONLY. CA residents add 6%, 6 1/2%, or 7% Sales Tax, depending on your local rates. Include MINIMUM SHIPPING & HANDLING of \$3.00 for the first 3 lbs., plus 50¢ for each additional pound (25¢ if within Calif.) Plus 25¢ per \$100.00 value of your order for PRIORITY ONE ELECTRONICS and PRIORITY 1 ELECTRONICS are registered service marks of the Heath Group, Ltd.

insurance. Orders over 70 lbs. sent freight collect. Just in case, include your phone number. Prices subject to change without notice. We will do our best to maintain prices through April 1986. Credit card orders will be charged appropriate freight. We are not responsible for typographical errors.

PRIORITY ONE ELECTRONICS and PRIORITY 1 ELECTRONICS are registered service marks of the Heath Group, Ltd. Zipper 212A, Zipper 2400, Zipper 1200B and Zipper Modem are trademarks of the Heath Group, Ltd.



ORDER TOLL FREE (800)423-5922 (NOW IN CALIF. TOO!!)

CCT-4 SYSTEM SERIES

The latest CCT implementation of the new generation Intel 16-Bit Processor technology. This means extreme speed, unequalled power, and the ultimate in reliability, and of course, the innovators at CCT behind it.

This series in the CCT line exploits the speed and power of the Intel 80286 and Zilog Z-80H (8MHz), on the 286Z CPU board. This combination, along with CompuPro DMA controllers and I/O boards, yields a dramatic improvement in system throughput speeds, from basic CP/M operation, up to large powerful multi-user/multi-tasking machines. The CCT-4 represents the most advanced hardware presently available in a microcomputer to run the thousands of CP/M type software programs on the market, and with CONCURRENT DOS 8-16 and the CompuPro PC Graphics board (when available), all software written for the IBM PC machines. This series is for the serious business/scientific user.

CCT-4A State-of-the-art power in it's basic form. Consists of CCT-286Z CPU board and CCT-M256 (256K), along with CompuPro: Enclosure 2 Desk (21 slot MF), Disk 1A, System Support 1, Interfacer 4, the CCT-2.4 floppy drive system, and CP/M 8-16, and with SF-200 surge suppressor system. **\$5,269.00**

CCT-4B Single-user/hard disk power. As the 4A, except priced without the CCT-2.4, to add in your choice of CCT hard/floppy combination drive subsystem, at the published pricing. **\$4,149.00**
 (Example: CCT-4B Mainframe with CCT-10/1 = \$6,198.00) Plus cost of selected drive subsystem

CCT-4C Multi-user/hard disk power. As the 4B, with the CCT-M512 (512K static RAM board) instead of M256; Interfacer 3 instead of Interfacer 4; SF-400 instead of SF-200, plus Concur. DOS 8-16 O.S. (4 to 6 user system) **\$4,999.00**
 (Example: CCT-4C Mainframe with CCT-40/1 = \$8,048.00) Plus cost of selected drive subsystem

Limited Time Offer - FREE 80287 Math Chip with any CCT-4!

The above systems include all necessary cabling, assembly, testing, minimum 20 hour burn-in, and the CCT unconditional 12 month direct warranty.

CCT-M512 WORLD'S TOP SELLING CCT STATIC RAM. IEEE Standard 12MHz. 512K in one slot! — **Special Price: \$799**
CCT-M256 256K version of M512 upgradeable to full 512K. Perfect 256K RAM board for any CompuPro system **\$439**

CUSTOM COMPUTER TECHNOLOGY / BOX 4160 / SEDONA, ARIZONA 86340
TOLL FREE ORDERING: 800-222-8686 / For technical support / service: 602-282-6299

BATTERY BACK-UP ON CCT RAM!

HUGE PRICE CUTS!

HOW CAN YOU REFUSE THIS OFFER, IF YOU ARE SHOPPING FOR IBM CLONE!

Special Sale for IBM PC/XT Compatible Computer System

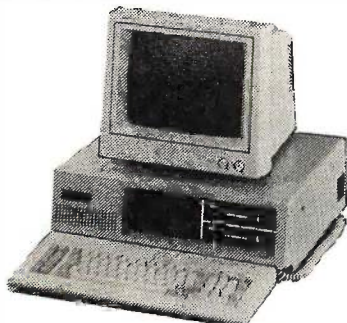

- Fully IBM PC/XT compatible
- 640K on board memories
- 8 IBM PC/XT standard I/O slots
- 8087 coprocessor ready socket
- Standard 4.77 MHz clock speed
- Flip-top type metal cabinet
- 83 key full function key board (enlarged return key and led indicators)
- Color graphic adapter with composit out (RES. 640 x 320)
- One parallel port for printer
- One RS-232 serial port
- One game port for joystick
- Real time clock with calendar (5 years battery back up on board)
- 135 watts hard disk ready power supply
- 2 halfheight 360K floppy drives
- 12" monochrome monitor included
- Fully assembled and tested
- 6 months parts and labor warranty

- OPTIONAL ADDON :**
- A. For 5151 100 keys keyboard add \$40.00
 - B. For 3way RGB color monitor 13" add \$285.00
 - C. For 10 MGB internal hard disk with controller add \$499.00
 - D. For 22 MGB internal hard disk with controller add \$599.00
 - E. For Monochrome graphic adapter with printer port and TTL Monochrome 12" Hi-RES monitor add \$60.00

SHIPPING CHARGES : 5% for C.O.D., 2% for prepaid orders inside Continental U. S. No Personal Checks Accepted.
DEALERS INQUIRIES INVITED. Inquiry 407
 • IBM is registered trade mark of IBM Corp.

SPECIAL OFFER: \$949
PINE COMPUTER INC.

1455 MONTEREY PASS RD., SUITE 103
 MONTEREY PARK, CA 91754
PHONE : (213) 269-1103
STORE HOURS : Mon. - Sat. 9 A.M. - 6 P.M.

IBM PERIPHERALS

- PC/XT 640K MOTHER BOARD, LOADED W/BIOS \$250.00
- COLOR GRAPHIC CARD W/RGB & COMPOSIT VIDEO OUT PUT (640x 400 RES) \$ 88.00
- MONOCHROME GRAPHIC CARD W/PRINTER PORT (720x348 RES) \$120.00
- FLOPPY DISK CONTROLLER CARD W/CABLE \$ 49.00
- O/384K MULTIFUNCTION CARD W/PARALLEL PORT; SERIAL PORT; GAME PORT; CALANDER, CLOCK (BATTERY BACK UP) AND 384K RAM SLOTS \$119.00
- DISK I/O CARD W/PARALLEL PORT; SERIAL PORT; GAME PORT; CALANDER, CLOCK (BATTERY BACK UP) AND FLOPPY DISK CONTROL- LER W/CABLES \$135.00
- PARALLEL PRINTER CARD \$ 25.00
- SERIAL PRINTER CARD (RS-232) \$ 53.00
- DUAL SERIAL CARD (RS-232) (COM-1, COM-2) \$ 75.00
- O/512K RAM EXPANSION CARD \$ 52.00
- MOUSE SYSTEM (MICRO-SOFT COMPATIBLE) (3 BUTTONS) \$ 95.00
- EXTERNAL MODEM 300/1200 BULD (HAYS COMPATIBLE) \$250.00
- 135 WATT POWER SUPPLY 110/220V SIDE SWITCH \$ 95.00
- KEYBOARD : PC/XT LOOK ALIKE 84 KEY (5150) \$ 78.00
- KEYBOARD : SELECTIC-II LOOK ALIKE, LARGE RT KEY \$ 78.00
- KEYBOARD : ADVANCE 100 KEY MODEL : 5151 \$109.00
- KEYBOARD : AT LOOK ALIKE, LARGE RT KEY \$ 98.00
- PARALLEL PRINTER CABLE (6 FT.) \$ 14.00
- SERIAL PRINTER CABLE (6 FT.) \$ 14.00
- JOY STICK (SELF CENTERING W/2 FIRE BUTTON) \$ 25.00
- 360K HALF HEIGHT DISK DRIVE (PANASONIC OR TEAL) \$ 95.00
- SURGE SUPPRESSED POWER STRIP (6 OUTLETS) \$ 18.00

**TOLL-FREE
ORDERING:
800-222-8686**

CCT[®] CUSTOM COMPUTER TECHNOLOGY

A
PAT
MARTINI
COMPANY

**FOR TECHNICAL SUPPORT/
SERVICE / IN ARIZONA:
602-282-6299**

1 CCT PLAZA — P.O. BOX 4160 — SEDONA, ARIZONA 86340

Purchase your Hardware and Software directly from an OEM / Systems Integrator. Take advantage of our buying power! We stock a full line of Board Level Components, Software and Peripherals. Call for your needs. We'll give you the Lowest Prices, and the Technical Support and Know-How we are quickly becoming well-known for. Satisfied Customers Nationwide. The Nation's Custom Systems House for Business, Education and Science. Call for a system quote. CCT Implements Tomorrow's Technology Today!™

• FOREMOST QUALITY • ADVANCED SUPPORT • REASONABLE COST •

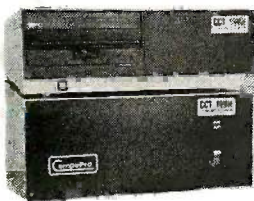

80286 NOW!

□ **CCT-286Z** is our model designation for the **MI-286** dual processor board from **Macrotech**. It features the super high speed combination of **Z-80H** and **80286**, with provision for the **80287** math chip. Directly replaces **8085/88** and **8086** CPUs running **CP/M**, **MP/M** Concurrent **DOS**, and **MS-DOS**, at throughput increases of **3X to 5X!**

SPECIAL PRICE - \$795
80287 Option - Installed - \$250

**SEE THE CCT-4 SERIES
USING THIS BOARD
DETAILED ON THE FACING PAGE**

**NOW!
BATTERY BACK-UP
ON
CCT RAM BOARDS!
VOLATILE PRICES
CALL FOR QUOTE**

LIBERTY TERMINALS

• Superior Reliability •

200-14" AMBER \$489

OKIDATA PRINTERS - Top Quality
182 - 80 Col. **CALL 183 - 132 Col. CALL 192 - 80 Col. CALL 193 - 132 Col. CALL 84 - 132 Col/200cps—Top of the Line. CALL**
For Serial Interfaces. **CALL**

ZENITH SYSTEMS

Z138 Portable \$1439
Z148 \$1299
Z158 \$2019
Z171 fully featured \$2619

WE HAVE ALL SOFTWARE—CALL

\$ ACROSS THE BOARD PRICE REDUCTIONS \$

INDUSTRIAL GRADE **CCT DISK DRIVE SYSTEMS** ROLLS ROYCES OF THE INDUSTRY SUPERIOR QUALITY **S-100 HARD DISK SUBSYSTEMS**

Professionally engineered **ST-506** type systems for the business market **S-100** Computer user. Includes industry top quality drives, **CompuPro** Disk 3 DMA controller, all cabling, **A&T**, formatted, burned-in. Provisions for up to two hard disks in each system. We include operating system update. **CP/M 80**, **CP/M 86**, **CP/M 8-16**, **CCP/M 8-16**, **CP/M 68K**. (1 Systems are CCT innovated hard/floppy combinations, with **Mitsubishi DSDD 8"** drive.) 12 month warranty.

CCT-10 (11 + MEG)	\$1399	CCT-10/1	\$1999
CCT-20 (22 + MEG)	\$1549	CCT-20/1	\$2149
CCT-40 (36 + MEG)	\$2579	CCT-40/1	\$3179
CCT-75 (75 + MEG)	\$3349	CCT-75/1	\$3949
CCT-90 (87 + MEG)	\$4799	CCT-90/1	\$5399
CCT-125 (123 + MEG)	\$6099	CCT-125/1	\$6699

HOT NEW PRINTERFACER 1™ - Print buffer I/O Board. Up to 1 Meg. RAM on board. Looks as/works with **CCT Interfacer 3/4**. Single or Multiuser/Interrupt driven or polled. Super-slick design handles one serial, one parallel, software switchable. Also for Zenith and Alpha. Intro Price — **\$349** Incl. Cable Set.

FLOPPY SYSTEMS

CCT-2.4 • Dual 8" DSDD Mitsubishi 2.4 Megabyte in Extra Heavy horizontal enclosure, IBM Compatible Mitsubishi 360K. Extra Heavy Cabinet removable filter air system, all cabling, **A&T**, Burned in. The fastest system available: **\$1429**

CCT-5 • 5 1/4" DSDD accommodates two drives, hard or floppy. All cabling, **A&T**, Burned-in. Perfect for our Concurrent **DOS** Package. **\$349**

CCT-8/5 • FULL IBM COMPATIBILITY
One Mitsubishi 8" DSDD (1.2 Meg)/One 5-1/4" DSDD (360K) IBM Drive
For Concurrent **DOS** and **PC DOS** **\$1029**

★ SUPER PRICES ★ COMPUPRO COMPONENTS ★ IN STOCK ★

CPU-Z - \$159 • Disk 1A - \$399 • Disk 1A w/CP/M - \$578 • CPU 8086/10 - \$359 • SPUZ/256K - \$319
CPU 8085/88 - \$229 • CPU 286 - \$849 • CPU 68K - 10Mhz - \$359
Disk 3 - \$519 • RAM 22 (256K) - \$489 • RAM 23/64K - \$199/128K - \$289
Concurrent DOS 8-16 CCT Enhanced - \$669 • SUPER SALE — M-Drive/H - 512K - \$399 / 2 Meg - \$899
Enclosure 2 Desk - \$699/Rack - \$749 • Interfacer 3 - \$469 • Interfacer 4 - \$349 • System Support 1 - \$299
Concurrent DOS 8-16 - \$599 • CP/M 80 (CCTHMX) - \$125 • CP/M 86 (CCTTMX) - \$175
CP/M 8-16 (CCTTMX) - \$279 • CP/M 68K (CCTCX) - \$329 • Operating System Updates/Remakes - \$30

16 Bit Upgrade Kit: CP/M 86, RAM 23, System Support 1, Cable \$649 □ CP/M 8-16 - Kit - \$673

CCT-1 — ENTRY LEVEL S-100 BUSINESS SYSTEM

- Enclosure 2-Desk-21 Slot Mainframe •
- CPU-Z - 6 Mhz Z-80 CPU Board •
- Disk 1A - DMA Floppy Disk Controller •
- RAM 23 - 64K Static RAM - 12Mhz •
- Interfacer 4 - 3 Serial/2 Parallel I/O •
- CCT-2.4-Dual 8" Mitsubishi DSDD Drive System - 2.4 Megabytes •
- CP/M 80 - 2.2 HMX - CCT Modified •
- All Cabling, Complete CCT Assembly, Testing, and Minimum 20 Hour Burn-in •

**SPECIAL PRICE
\$3,350**

RUNS ALL STANDARD 8" CP/M SOFTWARE - INCLUDES OUR EXCLUSIVE 12 MONTH DIRECT WARRANTY

Prices & availability subject to change. All products new, and carry full manufacturer's warranties. Call for catalog. Free technical help to anyone. All products we sell are CCT individually tested and set up for your system - Plug-In & Go! Arizona residents add sales tax **CCT**® Trademark — Custom Computer Technology; **MS-DOS**® Trademark — Microsoft; **IBM**® Trademark — International Business Machines; **CompuPro**® Trademark — W.J. Godbout; **CP/M**® **MP/M**® Trademarks — Digital Research **HERCULES**™ Trademark — Hercules Computer Technology

Compu\$ave Of Arizona

Call Toll Free: 1-800-624-8949

MONITORS

Princeton HX9... 435 Amdek310A 143
Princeton HX12E... 529 Amdek 600. 389
PrincetonMAX12E. 165 Amdek 722. 499
Taxan 115... 115 Taxan 620. 399
Taxan 121/TTL... 132 Taxan 640. 519
Casper Mono/TTL. 119 Wyse 500. 169
Zenith 122... 75 Zenith 1330. 465
Lica/12"/RGB & Mono/640x240... 335
Roland/12"/RGB/640x240... 325
Thomson/14"/RGB/Comp/560x240 299
Hitachi/Sharp/Tatung/Tecmar... CALL
Cables/Video Interfaces/Stands... CALL

MODEMS

AST Reach Half-Card W/Soft... 355
Anchor Volksmodem... 55
Anchor Express Half-Card W/Soft... 185
Anchor Lightning 2400... 375
Hayes Micromodem IIE W/Soft... 132
Hayes Smartmodem 1200... 365
Hayes Smartmodem 1200B W/Soft. 345
Prometheus Promodem 1200... 285
Prometheus Promodem1200B W/Soft. 235
Rascal-Vadic 1200PC W/Soft... 215
Rascal-Vadic 2400PC W/Soft... 399
Ven-Tel PC Modem Half-Card... 355
Novation/Rixon/UDS/Zoom... CALL

COMPUTERS

AT&T 6300/1 FDrive/Mono Monit... 1675
Corona PPC-400 Port/2 FDrives... 1145
Sperry IT/1 FDrive/1 40M HDrive. 2995
Wyse1100-PC/2 FDrives... 995
Zenith 171-PC Port/2 FDrives... 1745
Alloy/Altos/Corvus/IBM... CALL
Molecular/NEC/Televideo... CALL

PC-XT CLONE \$635

640K RAM / Intel 8088 Processor / 1 Teac
360K Drive / Floppy Disk Controller / IBM
Style Keyboard / 135 Watt Power Supply
8 Expansion Slots / Speaker / User Docu-
mentation / 6 Months Complete Warranty

OPTIONS

Turbo 4.77/8 MHz Clock Speed Add... 90
Additional Teac 360K Drive Add... 95
TTL Monitor/Card/Parallel Port Add... 195
RGB Monitor/Card/Parallel Port Add... 380
2QM Hard Drive & Controller Add... 499
ASK ABOUT OUR SUPPER PC/AT SPECIAL

TERMINALS

Altos IV... 385 Ampex 210... 375
Televideo 955... 455 Ampex 219... 495
Wyse 30... 293 Qume 101G... 293
Wyse 85... 438 Visual 65... 425
Adds/CIE/IBM/Liberty/Zenith... CALL

PRINTERS

Citizen MSP10... 250 Abati LQ20... 299
Citizen Prem 35... 409 Canon A40... 255
Corona LP300. 2599 Toshiba 321... 495
Diablo D34LQ... 1045 Juki 6100... 345
Epson JX80... 289 NEC Elf... 389
Epson LX90... 255 NEC P5... 975
Epson FX-286... 519 Star SG-10... 209
Data So. 180... 1075 Tally MT86... 425
Panasonic 1080. 205 TI 865... 725
Panasonic 1091. 239 Cables 6"... 15
Anadex/C. Itoh/Fujitsu/Legend... CALL
Okidata/OTC/Qume/Televideo... CALL
Buffers/Sheet Feeders/Tractors... CALL
Stands/Switches/Ribbons... 25% OFF
Enter Sweet-P 100 Plotter... 245
Roland DXY 880 Plotter... 975
Houston And Other Digitizers... CALL
Houston And Other Plotters... CALL

DISK DRIVES

Apple Compatible Floppy Drives... 124
IBM Compatible Floppy Drives... 89
Seagate 20M Kit/IBM Compat... 499
IOMEGA 10M Half-Height Drive... 1595

OTHER FLOPPY AND HARD DRIVES

ALPHA OMEGA • CDC • CORVUS
MAYNARD • MICRO SCI • MIT SUBISHI
PRIAM • SHUGART • TANDON • TEAC
TECMAR • WESTERN DIGITAL
Power Supplies/Controllers... CALL

BOARDS

AST Advantage/128K... 375
AST Six Pack Plus/64K... 225
AST Six Pack Clone/Game/384K... 185
Cardo G-Whiz (Commodore)... 55
Hercules Color Card... 148
Hercules Color Card Clone... 99
Orange Grappler + (Apple)... 70
Orchid Conquest/OK... 265
Paradise Modular Graphics... 258
PC Mono. Graphics (Par Port)... 99
PC RAM Board/OK... 69
Persyst Bob Board... 335
Quadram EGA+... 395
Sigma 400 High Res Card... 455
STB Graphics Plus II... 235
Taxan 555 High Res Card... 189
Tecmar Maestro AT... 379
ABM/Micro Sci/Microtek/PGS... CALL
Prac. Peripherals/Thesys/Vutek... CALL

ALL TYPES OF BUSINESS
AND RECREATIONAL SOFTWARE
VERY LOW PRICES... CALL

WE ALSO CARRY

Keyboards/Joysticks/Power Supplies
Chips/Mice/Labels/Surge Protectors
Cables/Graphics Tablets/Light Pens
VERY LOW PRICES FOR DS/DD DISKS

HOURS: MON - FRI 8AM - 6PM/SAT 9AM - 2PM
IN ARIZONA CALL (602) 437-4855

CompuSave: 4207 S. 37th St., Phoenix, AZ 85040/For Customer
Service Call (602) 437-4856/Prices Reflect Cash Discounts And Are
Subject To Change Without Notice/Minimum Shipping Charge \$4
Purchase Orders & Major Credit Cards Welcome
CompuSave Is A Division Of Adlanko Corp.

IBM XT & AT Compatible Systems

MONITOR ADAPTORS

Mono w/o printer port... \$89
Color Graphics w/o pp... \$89
Mono w/printer port... \$115
Color Graphics w/p. port... \$115
Mono Graphics w/p. port... \$135
STD Chaffer... \$299
Everex EDGE... \$299
Taxan 555... \$225
Genoa Spectrum... \$315

MULTIFUNCTION BOARDS

AST Six Pak 64K... \$265
64K Generic 6-pack... \$145

MISC. ITEMS

Floppy controller... \$59
Hard disk controller... \$175
Floppy Drives... Call
135 W Power Supply... \$85
150 W Switching PS... 135
XT Mother Bd OK... \$250
Turbo Mother Bd OK... \$350
Chassis... \$89
5150 style Keyboard... \$99
5151 style Keyboard... \$155
AT style for XT... \$135

AT SOLUTION

\$1895
IBM AT
compatible

- 1024K RAM on the Mother Board
- 1.2 Meg Floppy drive
- 192W Power Supply, & Keyboard
- Clock Calendar

TURBO SOLUTION

\$775

360 Floppy, 640K, 135 watt power supply, 8 slots, Keyboard
Turbo Systems are equipped with 8088-2
processor with dual speed 4.77 & 7 MHZ. 40% Faster
than IBM XT

PC SOLUTION XT ... \$649

360K Floppy, 256K RAM, expandable to 640K, 135W Power
Supply, enhanced Keyboard

Complete System ... \$995

Two 360K Floppies, 256K Ram, 135W Power Supply, 8 Slots,
Keyboard, Monographics adaptor, TTL Monitor, printer port.
Call for SUPER XT & Hard disk Configurations

Maryland & D.C. Residents include 5% Sales Tax.
All returns require RMA No. and subject to 15% restocking charge.
Advertised prices for mail order only. Retail prices slightly higher.
Prices subject to change, and limited to stock on hand. We
reserve the right to limit quantities.

Hard Disks & Controllers

20 Meg Internal... \$475
30 Meg Internal... \$895
20 Meg card... \$995
20 Meg streamer... \$725
10 Meg Reel tape... \$545

MODEMS

Hayes 1200... \$399
Hayes 1200B... \$355
Everex 1200B... \$195

MONITORS

NEC TTL... \$160
Amdek 310A... \$189
PG5 MAX-12... \$185
PG5 HX-12... \$450
NEC Color... \$395
Taxan 640... \$550
Xtron TTL... \$125

PRINTERS

Star SG-10... \$249
Citizen 35 LQ... \$489
Citizen MSP-10... \$289
Citizen MSP-15... \$399
Epson 800... Call
Epson 1000... Call
Epson 286... Call
NEC P5... \$995

Hi-Tec Computers & Electronics • (301) 564-9500

IBM is trade mark of IBM

10524 Detrick Ave., Kensington, MD 20895

PC Solution is trade mark of Hi-Tec Enterprises, Inc.

ATTAK-286™

HIGH SPEED 12 MHZ OPERATION Software Selectable for **6,8,10, and 12 MHZ!**

- FULL IBM PC-AT* COMPATIBILITY!
- FOUR MEGA-BYTE RAM CAPACITY ON MOTHERBOARD!
USING 1 MEGA-BIT DRAMS.

QUANTITY DISCOUNTS AVAILABLE FOR QUALIFIED DEALER, OEM, UNIVERSITY AND CORPORATE ACCOUNTS.

NEW!

HIGH SPEED INDUSTRIAL GRADE COMPUTER FOR:

- Scientific
- Engineering
- Industrial
- Medical
- University/Education
- Artificial Intelligence
- Etc., Etc., Etc.

Eight Compatible I/O Interface Connectors
(Same as PC-AT)

Keyboard Interface
(Same as PC-AT)

On Board Battery

CMOS Clock Calendar

Standard Power Connector
(Same as PC-AT)

80287 Math Processor
(Same as PC-AT)

Runs Intel 80286 at 6,8,10&12 MHZ!
(Software selectable)

Extended ROM Capability
(Operates on all compatible BIOS ROMS)

Extended Memory Capacity!
Full Four Mega-Byte Capacity on Motherboard!
(Uses 256k or NEW 1 Mega-Bit Drams)

Peripheral Support Circuits
(Same as PC-AT)

ORDER NOW!!

ONLY!
\$199⁹⁵
EVALUATION BOARD KIT

- ATTAK-286™ FULLY ASSEMBLED (LESS ICS) \$499.95
- AT CASE 100% COMPATIBLE.....\$129.95
- AT POWER SUPPLY 192VV.....\$129.95
- ATTAK-286™ TECHNICAL REFERENCE MANUAL \$ 29.95
- TURBO-SCOPE™ A/D BOARD.....\$ 99.95

Board Size: Standard IBM-AT*
Dimensions: 12 inch x 13.8 inch
with 6 mounting holes to fit all AT compatible cases.

100% SATISFACTION GUARANTEED.
10 DAY MONEY BACK GUARANTEE IF NOT COMPLETELY SATISFIED!



ATTAK-286™ evaluation board kit highest quality multi-layer PC board with full assembly instructions and parts lists!

AiT CORPORATION
ADVANCED INTELLIGENCE TECHNOLOGY

4100 Spring Valley Road
Suite 400
Dallas, Texas 75244
(214) 490-0344

TERMS: We accept cash, checks, money orders and credit cards. Prices and availability subject to change without notice. Shipping and handling charges via UPS ground 50¢/lb UPS air \$1.00/lb. Minimum charge \$3.00.

*IBM and IBM PC-AT are trademarks of International Business Machines

© 1986 AIT CORP.

SUN-ST COMPUTER SYSTEM

8 MHz HIGH-SPEED \$995⁰⁰



SUN-ST Computer System is an IBM Compatible System. It works with the same software used on the IBM; Lotus 1-2-3, Symphony, DBASE II & III, Framework, AutoC.A.D., Wordstar, Multi-Plan, etc.

The basic system is fully operational. All you need to do is insert your DOS disk and application software. (Does not run programs that require ROM BASIC).

- Uses MS & PC DOS Operating System & XENIX Compatibility.
- 8MHz High Speed Operation Clock.
- Modifiable to an external switch to allow at 4.77 MHz.

HARDWARE INCLUDES:

- 8 MHz CPU Board with 640K, 70% Faster Speed
- Computer Cabinet
- Enhanced Full Function Keyboard (Large RTN & Shift Keys)
- 2 Disk Drives (DSDD, 360KB, 1/2 Height)
- 135 Watt Power Supply
- Floppy Disk Controller
- 12" Green High-Resolution Monitor (TTU)
- Monochrome Graphic Card (720x348) with Parallel Printer Port
- Fully Assembled and Tested
- Meets FCC Class "A" Reg. for Industry & Business Use.

Multi-I/O Plus Board

- Parallel Printer Port
- Serial I/O Print (Opt. Dual)
- Clock Cal w/Battery Back-up
- Game Port

\$110⁰⁰

Monochrome Graphics Card

- 720(H) x 348(V) High-Res
- 80 x 25 Text Mode
- Runs Lotus 1-2-3, ect.
- With Parallel Printer Port

\$110⁰⁰

Hi-Res Mono \$105⁰⁰ Monitor

Color G. Card \$99⁰⁰

Full Function Enhanced Keyboard \$75⁰⁰

- 10Mb Hard Disk w/Controller . . . \$450⁰⁰
- 20 Mb Hard Disk w/Controller . . . \$550⁰⁰
- ASYNCR RS232 Card . . . \$59⁰⁰
- Parallel Printer Port . . . \$39⁰⁰
- Dual Game Port . . . \$39⁰⁰
- 576K RAM Expansion Card (OK) . . . \$59⁰⁰
- KB5151 Compatible Keyboard . . . \$109⁰⁰
- EPROM Prog. (2716, 32, 64, 128) . . . \$139⁰⁰
- 256K RAM Kit (9 each) . . . \$35⁰⁰
- Parallel Printer Cable . . . \$15⁰⁰
- 6 Outlet Surge Suppressor (Midland Ross Ind.) . . . \$14⁵⁰
- Citizen MSP-10 Printer 160 CPS . . . \$299⁰⁰
- TTX 1424W/TAXAN 555 (640x400,200 Addressable) . . . \$795⁰⁰
- Swivel Monitor Base (MN-5) . . . \$15⁰⁰
- 5 1/4" DSDD 1/2 Height Disk Drive . . . \$89⁰⁰

SUNTRONICS CO., INC.

12603 Crenshaw Blvd., Hawthorne, CA 90250

SUN-XT CPU

- 8088 CPU (8087 Option)
- RAM Expandable to 640K
- Fully IBM Compatible
- Same Dim. as IBM PC/XT
- No RAM Included
- 8 Expansion Slots

\$165⁰⁰

SUN-AT CPU

- 80286 CPU (80287 Optional)
- 640K Memory
- 6MHz System Clock
- Built-in Real-time Clock (Battery Back-up optional)
- Dimensions & Expansion same as IBM-AT 16-bit, 2-8 bit
- Expand Multi-User Many Megabyte with XENIX
- Fully IBM/PC Compatible
- With BIOS

\$899⁰⁰

SUN-ST CPU

Fully IBM PC/XT Compatible. Run 8MHz using 8088-2 with 8087-2 Optional. Same Dimension as IBM PC/XT Expandable to 640K

\$245⁰⁰

PC/XT Power Supply

135 Watt **\$89⁰⁰**
150 Watt **\$109⁰⁰**

"TTX" RGB Color Monitor

- 14" Display
- 720 x 240 High-Resolution
- 0.31mm Dot Pitch

\$365⁰⁰

AT Style Cabinet . . . \$110⁰⁰

200 W Power Supply . . . \$169⁰⁰

AT Style Enhanced Keyboard . . . \$110⁰⁰

FDD & Hard Disk Controller . . . \$265⁰⁰

1.2 MB 5 1/4" Disk Drive . . . \$142⁰⁰

20MB Hard Disk Drive . . . \$699⁰⁰

IBM PC/XT Style Case \$49⁰⁰

Floppy Disk Controller \$49⁰⁰

SUN XT OEM System

System 1

- SUN-XT CPU
- 640K RAM
- 135 WP.S
- FDC W/Cable
- Computer Cabinet
- Full Function Keyboard
- No Disk Drive
- No Graphic Card
- No Monitor

Assembled (For Qty. 5-up) **\$455⁰⁰**

System 2

- SUN-XT CPU
- 640K RAM
- 135 WP.S
- FDC with Cable
- Computer Cabinet
- Full Function Keyboard
- 1 Disk Drive
- Mono G Card or Color G Card

Assembled (For Qty. 5-up) **\$625⁰⁰**

SUN AT Computer System

- SUN-AT w/640K RAM
- 1.2MB Disk Drive (1 each)
- 200 W.P.S.
- FDD & Hard Disk Controller
- AT Enhanced Keyboard

A&T **\$1795⁰⁰**

SUN-XT Computer System

- SUN-XT CPU w/640K
- 2 Disk Drive w/Controller
- Mono G Card w/Parallel P Port
- 12" Green TTL Monitor
- 135 W P.S & Keyboard
- Assembled & Tested
- Meets FCC Class "A" Regulations

* Please Call for Other Configurations Available. **\$895⁰⁰**

STORE HOURS: MON - FRI 9:00am - 6:00pm SATURDAY 10:00am - 5:00pm
DEALER & OEM INQUIRIES INVITED

CALIF. ORDERS & TECHNICAL INFO **ORDERS ONLY - TOLL FREE**
213-644-1140 1-800-421-5775

TERMS: VISA, MasterCard (No Surcharge), C.O.D., Cash or Certified Check (VISA or M.C. Ref. Reserved) School & Gov. Contractor P.D. accepted. Shipping & H/C \$4.00 for 3 lbs plus \$.50 for each additional lb. CA residents add Calif. sales tax. \$10.00 Min. order. IBM is a registered trade mark of International Business Machines

FREE SHIPPING ON ORDERS OVER \$100

HEWLETT-PACKARD

PACKAGE	HP110, Thinkjet Disc Drive	\$ 2295.00*
2225B	Thinkjet Printer	\$ 379.00
7440A	8-Pen Plotter	\$ CALL
9114A	710K Disc Drive	\$ 625.00
82143A	Thermal Printer	\$ 295.00
82161A	Cassette Drive	\$ 423.00
82162A	IL Printer	\$ 346.50
82164A	IL/RS-232 Interface	\$ 227.15
92285A	Laser Jet Toner (Black)	\$ 79.20
92285G	Laser Jet Toner (Brown)	\$ CALL
HP-71B	Handheld Computer	\$ 389.95
HP-75D	Handheld Computer	\$ 858.75

**(Limited quantities)*

COMPUTERS

Sperry "IT" AT compatible

Monitor • 1MB RAM • 80286 • 1.2MB Floppy • 44MB Fixed Drive • 1200B Modem **\$3995**

Sharp PC7000 XT Portable

25 line LCD • Detachable Keyboard • 320K RAM • 8086 • 2-360K Floppy Drives • Wordstar Easy **\$1495**

AT&T

4000 Softcall	Modem	\$ 349.00
		\$ 59.95

PRINTERS

Xerox/Diablo

D-25	25cps Daisywheel	\$ 529.00
635	55cps Daisywheel	\$ 995.00
4045CP	Laserprint/Photocopier	\$ CALL

Okidata

ML182	120cps Dot Matrix	\$ 219.00
ML192	160cps Dot Matrix	\$ 349.00
Ok 20	Color Dot Matrix	\$ 199.00
ML193	160cps Wide Carriage	\$ 499.00

Brother

M1109	100cps Friction/Tractor	\$ 229.00
M1509	180cps Wide Carriage	\$ 379.00
HR-15XL	17cps Daisywheel	\$ 345.00
HR-35	36cps Daisywheel	\$ 699.00
2024L	200cps & NLQ	\$ 825.00
Twinriter 5	Daisywheel & Dot Matrix	\$ 715.00

Panasonic

KXP1091 \$ 249.00

Citizen

120D	120cps Dot Matrix	\$ 199.00
MSP-10	160cps Dot Matrix	\$ 265.00
MSP-15	160cps Wide Carriage	\$ 379.00
MSP-20	200cps Dot Matrix	\$ 359.00
MSP-25	200cps Wide Carriage	\$ 499.00
Premier35	35cps Daisywheel	\$ 439.00

Star

SG10/15	120cps Dot Matrix	\$ 235/375
SG10C	Commodore Intf. & cable	\$ 245.00
SD10/15	160cps Dot Matrix	\$ 339/449
SR10/15	200cps Dot Matrix	\$ 485/595
SB10	24 Pin-head	\$ 549.00

HEWLETT PACKARD

HP-11C	Scientific	\$ 41.95
HP-12C	Financial	\$ 73.95
HP-15C	Scientific	\$ 73.95
HP-16c	Computer Science	\$ 87.95
HP-41CV	Scientific	\$ 130.95
HP-41CX	Scientific	\$ 187.95

EPSON

LX-80	100cps & NLQ Dot Matrix	\$ 219.00
LX-90	100cps & NLQ Dot Matrix	\$ CALL
FX-85	160cps Dot Matrix	\$ 339.00
FX-286	160cps Dot Matrix	\$ 529.00
JX-80	Color Dot Matrix	\$ 369.00
HS-80	Inkjet	\$ 319.00
AP-80	Apple comp. Dot Matrix	\$ 275.00
LQ800	24Pin-head Dot Matrix	\$ CALL
SQ2000	Office Inkjet	\$ 1550.00
LQ1000	24Pin-head Dot Matrix	\$ CALL
DX-10	Daisywheel	\$ 229.00
DX-20	Daisywheel	\$ 315.00
DX-35	35cps Daisywheel	\$ CALL

CAPITAL MICRO

P.O. BOX 29639
 WASHINGTON, D.C. 20017
(800) 544-4442
 in Maryland, call
 (301) 565-3595

TERMS:

- Liberal Return Policy
- Free Shipping on orders over \$100 (Continental U.S.)
- NO ADDITIONAL CHARGE for credit cards
- MD residents add 5% sales tax
- Credit references required for open account
- Allow 2 weeks for personal checks
- C.O.D.'s - cash, money order, bank or certified check

LIQUIDATION! Lowest Prices Anywhere!



100% IBM Compatible Leading Edge® w/20 Meg

- 256K
- 20 Meg Disk
- Monochrome TTL Monitor
- MS-DOS 2.11, GW Basic

Model "M"

30 Meg System—CALL

Dual Floppy System—CALL

30 Meg System and Color Monitor—CALL

\$1495
Complete!

Features

- 256k RAM Installed on Motherboard
- Dual Half Height 360k Floppy Drives or 1 Half Height 360k Floppy Drive with 3.5" 20mg Tandem Hard Drive with 80 msec Access Time
- Serial and Parallel Ports
- Monochrome Hi-Res TTL Monitor with Monochrome Controller Card
- Selectric Style Keyboard
- 8088-2 Processor
- Clock/Calendar with Battery Backup
- Heavy Duty 129.5 Watt Power Supply
- 6 Expansion Slots
- 8087 Socket on Motherboard
- Dual Speed Switchable Clock, Runs 4.77 MHz or 7.16 MHz
- One Year Factory Warranty
- Toll Free Customer Support Line
- Nationwide Service Network

Leading Edge Software at Amazing Prices! W or w/out Computer! 75% Off

- Leading Edge Word Processor—\$39
- Word Processor w/ Spelling Check—\$49
- Nutshell Data Base Manager—\$49

100% Satisfaction Guaranteed

40 cps Wide Carriage Letter Quality Daisywheel Printer

Completely Diablo 630 Compatible

Mfr. Sug. Retail \$1795

Liquidation Price **\$349**

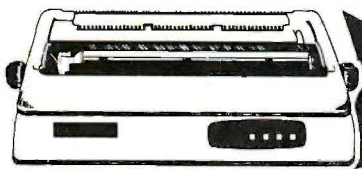

80% OFF

same as C.Itoh F10-40

With Cut Sheet Feeder—Only \$519

• Diablo 630 Compatible • Bi-Directional • 40 CPS • Works with IBM, Apple, Kapro and Most Other Brands • Parallel Interface • Optional Sheet Feeder and Tractor Feed • Uses standard Diablo Print-wheels and Ribbons • Proportional Spacing • Paper width: 15 inch 13.6 inch Print Area • Number of Columns: 136 Pica 163 Elite • Number of Copies: Original plus two Copies • Fonts: Courier 10 Standard plus all other Diablo Fonts • Pitch: 10, 12, 15, Proportional • Physical Dimensions: 6"(h) x 16"(w) x 24"(d) • Weight: 30.8 lbs. **Why Such a Bargain?** The answer is simple—C. Itoh sold these printers to Commodore, who intended to sell them with an expensive business computer they were developing. The computer took longer to develop than Commodore anticipated. So we were able to acquire a super high quality printer that listed at \$1795 at a great price. Should your printer ever need service, it will be available not only at the many dealers who repair C. Itoh printers, but also at the hundreds of Commodore factory authorized service centers located practically everywhere. There is a 90 day factory warranty from Commodore. In addition, we guarantee your 100% satisfaction—no questions asked return within 15 days.

NEC NLQ Printer PR 103A

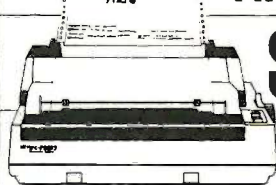

\$149

70% OFF

This is a sample of NLQ print from the PR 103A

Paper Feed Method Tractor or Friction Feed. Paper Width—up to 10 inches. Compatibility NEC 8023A—same as Apple Graphics Printer and C. Itoh Pro-Printer. Print Head Impact Line Dot Type 16 Pins. Print Speed High Speed Pica: 92 cps. High Density: Pica 46 cps. Elite: 110 cps. Condensed: 78 cps. Printing High Speed Pica: 10 characters per inch. High Density Pica: 10 characters per inch. Elite: 12 characters per inch. Condensed: 17.1 characters per inch. Characters per Line: High Speed Pica: 80; High Density Pica: 80; Elite: 96; Condensed: 137. Dot Composition High Speed Pica: 7 x 9; High Density Pica: 13 x 9; Elite: 7 x 7; Condensed: 7 x 9. Number of Copies Original plus two copies. Ink Ribbon Cartridge Type PC PR103A-01; Color—Black; Life—1 million characters. Interface Centronics, 8 bit parallel, works with IBM, Apple, Kaypro, etc. Dimensions 13 3/4"(w) x 5 1/2"(h) x 10"(d). Weight 15.2 lbs.

Specify Product No. NC700-Y4. Add \$12 Shipping, Handling, and Insurance.

Canon 7 Color Ink Jet Printer \$199

PJ-1080A

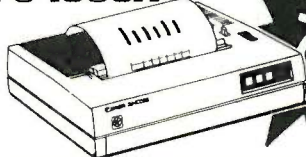

72% OFF

- Works With Lotus 1-2-3
- Snapshot • PC Paintbrush
- ColorScreenPrint
- EV Capture
- InfoGraphics
- Chart, Decision and Sign Master
- pfs Graph, pfs Write
- Keychart
- Telescan Analyzer PJ-Handler

7 Colors • High Resolution-640 Dots Per Inch • 37 cps • Parallel Interface. Does Overhead Projections! Specify Product No. C710-Y4. Please add \$12 For Shipping/Insurance

DSDD DISKS by TDK

- Hubrings
- Sleeves
- Labels
- 48 t.p.i.

59¢

100 @ 65¢ 200 @ 63¢ 1000 @ 59¢

Satisfaction Guaranteed

Add \$8 Shipping/Insurance for orders of 100 & 200, \$40 per order of 1000

IBM® and Name Brand Compatibles

New and Refurbished Models Available
Leading Edge®, Corona®, Olivetti®, Columbia,
and others

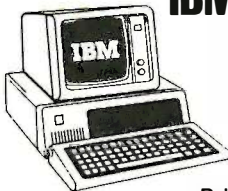

Lowest Prices Anywhere!

Prices and Available Models Change Weekly
Call or Write for Product Descriptions and Prices

Our Guarantee—All products come with manufacturer's warranty plus our 100% satisfaction guarantee. If you are not 100% satisfied, simply call within 5 days for a complete refund.

Order 24 hrs/7 days a week
For Product Information, Please Call
Between 9 AM and 5 PM EST. M-F

Order Now! Call Toll Free
1-800-545-7447

BCE Authorized Liquidators
3233 K Street, N.W.
Washington, D.C. 20007



PRINTERS

- NP \$285
- RD 344
- Compact 2 349
- Star SG-10 239
- Cannon Laser Printer 2169
- Okidata, Epson, NEC CALL
- Brother 1009 149

PLOTTERS

Houston Instrument

- DMP-29 \$1795
- DMP-41/42 2365
- DMP-51/52 3579
- Roland DXY-880 979
- Roland DXY-980 1279

EXPANSION CARDS

- Hercules Graphics Card .. \$325
- AST 6-Pack CALL
- Paradise Multi Display . . . 209
- Orchid PC-Turbo 256K . . . 679
- Tecmar Graphics Master . . 499

MASS STORAGE

TALL GRASS

- 25 MB 1/2 Height Drive . . . \$759
- TG-406060MB Tape B/U . . . 1299
- 25 MB w/60 MB Tape . . . 2769
- 80 MB w/60 MB Tape . . . 5899
- 10 MB Bernoulli Box . . . 1859
- 20 MB Bernoulli Box . . . 2299
- Corvus Trimline Combo . . . 2399
- Corvus 21 MB . . . 2399
- Tecmar 20/60 Disk/Tape . . . 2559

Scottsdale Systems

617 N. Scottsdale Rd, Scottsdale, AZ 85257

(602) 941-5856

For Inquiries

1-800-367-2369

Toll-Free For Orders Only



SOFTWARE

- Wordstar \$195
- Microsoft Word 239
- Samna Word III 279
- WordPerfect 4.1 235
- Easy Writer II 219
- dBasell 299
- Friday! 179
- R:BASE 4000 269
- pfs:File/Report 159
- Framework II 419
- Enable 379
- Supercalc 2 159
- Multiplan 119
- Smart Series 255
- pfs:Plan 89
- GEM Draw 150
- Sidekick 39
- Superkey 49
- Print Shop 45
- Norton Utilities 59
- pfs:Graph 89
- Dollars and Sense 109

- Dow Jones Invest 99
- Peachtree GL/AR/AP 210

ATARI 520ST



- Monochrome \$699
- RGB Color 899

Precision Graphics/Mouse/68000 CPU/512K RAM/BMHZ Clock Software/Parallel & Serial I/O Optional OS Drive

ATARI SOFTWARE

- VIP Professional \$149
- Final Word 115
- 4 x Forth 79
- Express 39
- HippoWord 75
- Hippo-C Compiler 65
- Hippo Disk Utilities 44
- Ultima II 49

Prices listed are for cash/Mastercard and Visa add 3%/American Express add 5%/AZ residents add 6%/All items are new with manufacturer's warranty/Returned product subject to 20% restocking fee/Personal & Company checks take up to 3 weeks to clear/No COD's or APO's/Prices and specifications subject to change/Product subject to availability/All applicable trademarks recognized and on file.

- H & D Toolkit 25
- H & D Database 69
- Zork I 33
- Zork II or III 38
- Hitchhiker's Guide 33

ALTOS

- 2086-2 \$14599
- 1086-T-50 10819
- 586, 986 CALL
- Altos Software CALL

PC-8088 by IDS



An IBM-PC look-alike that's compatible with your bottom line.

- 8088 CPU or 4.77 MHz
- Two DSD Drives
- 8 Expansion Slots
- 256KRAM
- Monochrome Monitor
- MS-DOS, MyWrite, MyCalc
- FILEBASE, Spell
- RGB/CompositeCard
- 1 Year Warranty

The PC-8088 by IDS ... \$1149 with RGB Monitor 1298

COMPUTERS

- The Fox \$995
- TurboFox 1499
- The AMSTRAD System . . . 439

X-VIEW 86™

Application Program

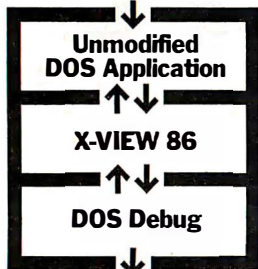

Dynamic Execution Information

X-VIEW 86 profiles the execution of DOS software, and displays information needed to improve program performance, identify compatibility issues, and pinpoint conversion problems.

Profiles DOS application software and solves problems Debug can't touch.

X-VIEW 86 is a DOS software X-ray machine.

X-VIEW 86 monitors internal software operations during execution to help you debug, test, port, or convert programs. X-VIEW 86 adds new features to Debug to profile either your own applications software or top-sellers like 1-2-3®. You get fast, reliable results.

Real solutions to technical challenges.

Save hours of time-consuming, tedious work using data from X-VIEW 86's built-in reports that identify:

- Execution hotspots
- Segment usage
- Memory map references
- I/O port references
- Interrupt calls
- I/O port references
- Interrupt calls
- I/O port references
- Memory data references

Hardware and software requirements.

X-VIEW 86 runs on the IBM PC and compatibles with DOS Debug 2.0 or 2.1. Even if you use a different debugger, X-VIEW 86 turns Debug into your program profiler. And it's not copy protected.

Priced at an affordable \$59.95.

Get a whole new outlook on your work with X-VIEW 86. We've made it easy. Order today by calling 1-800-221-VIEW (in Texas, or outside the U.S., call 1-214-437-7411). We accept Visa, MC, DC, and AmEx cards. Or order by writing to: McGraw-Hill CCIG Software, 8111 LBJ Freeway, Dallas, Texas 75251. X-VIEW 86 is just \$59.95 plus sales tax and \$3.00 shipping (\$9.00 outside the U.S.). Be sure to include credit card number and expiration date with mail orders. Orders paid by check are subject to delay. To order call

1-800-221-VIEW

McGraw-Hill CCIG Software

8111 LBJ Freeway, Dallas, Texas 75251

X-VIEW 86 is a trademark of McGraw-Hill, Inc.; IBM is a registered trademark of International Business Machines; 1-2-3 is a registered trademark of Lotus Development Corporation.

NEW LOW PRICES!

DoKay

COMPUTER
PRODUCTS
Inc.

ORDER TOLL FREE

**(800)
538-8800**

(CALIFORNIA RESIDENTS)

**(800)
848-8008**



RAMS

STATIC		DYNAMIC	
2114L	200ns .99	4116	200ns .35
2016	200ns .99	4116	150ns .45
2016	150ns 1.35	4164	200ns .85
HM6116 P	150ns 1.35	4164	150ns .95
HM6116LP	150ns 1.45	41128	150ns 4.95
Z-6132	300ns 19.89	41256	150ns 2.89
HM6164 P	150ns 3.35	41256	120ns 3.89
HM6164LP	150ns 3.45	4416	150ns 3.95
HM6164LP	100ns 12.45	4464	150ns 6.95

EPROMS

2516	450ns 2.95	2732 A	250ns 2.49
2532	350ns 3.75	2764	450ns 1.89
2708	450ns 2.95	2764	250ns 2.39
2716-5	490ns 1.29	27128	250ns 2.69
2716	450ns 1.89	27256	250ns 6.99
2716-1	350ns 2.35	27512	250ns 29.99
2732	450ns 1.89	MC68764	450ns 15.99
2732 A-2	200ns 3.89	MC68766	350ns 16.99

**8088 / 8086
UPGRADE**

V-20... 5 MHz... **13.95**

V-20... 8 MHz... **19.95**

— High Speed —

DP-25 Solder Cup

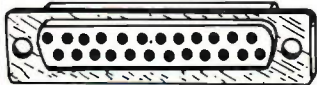

Male, Female, Hoods... **99¢ ea.**

UV ERASERS

QUV-T8/1... **\$49.95**
ECONOMY Model



- Erases 15 EPROMS in 20 minutes
- Plastic Enclosure

74LS00

74LS100	.14	74LS125	.36	74LS260	.46
74LS01	.14	74LS126	.36	74LS266	.36
74LS02	.14	74LS132	.36	74LS273	.76
74LS03	.14	74LS133	.46	74LS275	1.96
74LS04	.14	74LS136	.36	74LS279	.36
74LS05	.16	74LS137	.98	74LS280	1.18
74LS08	.16	74LS138	.36	74LS283	.56
74LS09	.16	74LS139	.36	74LS290	.86
74LS10	.14	74LS145	.86	74LS293	.76
74LS11	.18	74LS147	.86	74LS295	.66
74LS12	.18	74LS148	.86	74LS298	.66
74LS13	.36	74LS151	.36	74LS299	1.46
74LS14	.24	74LS153	.36	74LS323	2.46
74LS15	.24	74LS154	1.46	74LS324	1.68
74LS20	.16	74LS155	.46	74LS352	1.24
74LS21	.20	74LS156	.46	74LS353	1.18
74LS22	.20	74LS157	.34	74LS363	1.28
74LS26	.20	74LS158	.28	74LS364	1.88
74LS27	.20	74LS160	.28	74LS365	.36
74LS28	.24	74LS161	.36	74LS366	.36
74LS30	.16	74LS162	.46	74LS367	.36
74LS32	.16	74LS163	.36	74LS368	.36
74LS33	.26	74LS164	.46	74LS373	.76
74LS37	.24	74LS165	.64	74LS374	.76
74LS38	.24	74LS166	.86	74LS377	.76
74LS40	.16	74LS168	.94	74LS378	1.12
74LS42	.36	74LS169	.94	74LS385	1.84
74LS47	.56	74LS170	.84	74LS386	.42
74LS48	.66	74LS173	.46	74LS390	1.06
74LS49	.66	74LS174	.36	74LS393	.76
74LS51	.16	74LS175	.36	74LS395	1.06
74LS54	.18	74LS181	1.46	74LS399	1.06
74LS55	.20	74LS189	3.86	74LS424	2.86
74LS63	.86	74LS190	.46	74LS447	.92
74LS73	.28	74LS191	.46	74LS490	1.46
74LS74	.22	74LS192	.66	74LS624	1.92
74LS75	.26	74LS193	.66	74LS640	.96
74LS76	.26	74LS194	.56	74LS645	.96
74LS78	.36	74LS195	.56	74LS668	1.46
74LS83	.46	74LS196	.56	74LS669	1.26
74LS85	.46	74LS197	.56	74LS670	.86
74LS86	.20	74LS221	.56	74LS674	9.58
74LS90	.36	74LS240	.66	74LS682	3.14
74LS91	.86	74LS241	.66	74LS683	2.86
74LS92	.46	74LS242	.66	74LS684	2.86
74LS93	.36	74LS243	.66	74LS685	2.86
74LS95	.46	74LS244	.58	74LS688	1.86
74LS96	.46	74LS245	.68	74LS689	2.86
74LS107	.32	74LS247	.68	74LS783	21.96
74LS109	.34	74LS248	.66	81LS95	1.36
74LS112	.26	74LS249	.96	81LS96	1.36
74LS113	.32	74LS251	.46	81LS97	1.36
74LS114	.32	74LS253	.46	81LS98	1.36
74LS122	.44	74LS257	.36		
74LS123	.46	74LS258	.46	25LS2521	2.48
74LS124	2.60	74LS259	1.18	25LS2569	2.48

**MEMORY
EXPANSION KIT**



**41256 150ns
\$2.89 each!**

8000

8031	4.95	8253-5	1.79
8035	1.45	8255	1.59
8039	1.89	8255-5	1.79
8080A	2.89	8257	1.99
8085	2.35	8257-5	2.29
8085A-2	4.89	8259	1.89
8086	7.89	8259-5	1.99
8087-3	124.95	8271	48.95
8087-2	139.95	8272	4.79
8088	5.95	8274	4.79
8089	39.95	8275	24.99
		8279	2.29
		8279-5	2.79
		8282	3.79
		8283	3.79
		8284	2.79
		8286	3.79
		8287	3.79
		8288	4.79
		8289	19.89
		8292	12.90

8100

8131	2.90	8303	1.79
8155	2.35	8304	1.79
8155-2	3.89	8307	1.79
8156	2.89	8308	1.79
8185	26.89	8310	2.29
8185-2	26.89	8311	2.29

8200

8202	8.98	8700	8.89
8203	29.89	8748	6.99
8205	2.98	8749	9.89
8212	1.35	8755	18.89
8214	3.59		
8216	1.35		
8224	2.09		
8226	1.59		
8228	3.29		
8237	4.79		
8237-5	5.29		
8238	3.99		
8243	2.39		
8250	5.95		
8251	1.49		
8251A	1.69		
8253	1.69		

8300

8303	1.79	80000	48.89
8304	1.79	80186	48.89
8307	1.79	80188	48.89
8308	1.79		
8310	2.29		
8311	2.29		

NEW LOW PRICES!

CRYSTALS

ALL STANDARD VALUES... **1.00**

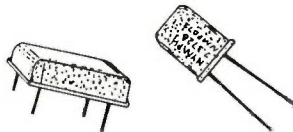

CRYSTAL CLOCK OSC.
ALL STANDARD VALUES... **4.89**

DIP Switches... 79¢



ORBITAL SYSTEMS:

EXTENDED 80-Col. Card for Apple IIe
64K to 128K Upgrade; 2-Yr. Warranty **\$69.95**

Z-80 (CP/M) CARD, for Apple II+, IIe
Compatible with all Apple CP/M

Lifetime Warranty... **69.95**

IBM ACCESSORIES

8087-3 5 MHz... **124.95**

8087-2 8 MHz... **139.95**

80287 1 MHz... **179.00**

80286... **99.00**

Power Supply, 135W... **89.00**

Monochrome Graphic Card... **119.00**

Memory Card... **139.00**

Multifunction Card... **129.00**

AT Crystal: 16, 18, 20 MHz... **4.95**

MACINTOSH UPGRADE

(PARTS ONLY)

128K to 512K... **50.00**

Consists of: (16) 41256, 150ns;

(1) 74F253;

(17) 16-Pin Sockets

Resistors and Capacitors ALSO INCLUDED

APPLE ACCESSORIES

Parallel Printer Card... **49.95**

80-Col. card for Apple II+... **149.95**

80-Col. card for Apple IIe... **69.95**

Cooling Fan... **38.95**

Power Supply... **69.95**

Joystick... **29.95**

RF Modulator... **13.95**

Disk Drive Full Height... **159.95**

Disk Drive 1/2 Height... **129.95**

Controller Card... **49.95**

16K Card... **39.95**

Z-80 Card... **69.95**

★ DISKETTES BULK ★

SS/DD... **25/\$17.25**

DS/DD... **25/\$19.75**

AT disks... **25/\$50.00**

3 1/2" disks... **25/\$50.00**

ALL DISKETTES HAVE A
FULL 1-YEAR WARRANTY

6500

6500	1.99	6502A	2.49
6504	6.79	6520A	2.49
6505	8.79	6522A	4.99
6507	9.79	6532A	9.89
6520	1.59	6545A	6.89
6522	3.99	6551A	6.89
6532	5.99		
6545	4.89		
6551	5.89		

1 MHz

6800	1.89	68800	9.89
6802	4.89	68007	12.89
6803	9.89	68008	14.89
6808	4.89	68009	14.89
6809E	5.89	68010	8.89
6809	5.89	68011	15.89
6810	1.89	68012	6.89
6820	2.89	68013	2.89
6821	1.89	68014	6.89
6828	13.89	68015	2.89
6840	5.99		
6843	18.89		
6844	10.89		
6845	4.89		
6847	10.89		



the alternative.

The SANYO complete word processing system

The alternative for WANG, Xerox or any dedicated word processing system.

At Micro Supply Organization we offer the lowest prices on Sanyo computers and software. With prices like these you can afford the convenience of owning and operating more than one computer.

We also offer the User Support Hotline for questions concerning your computer or about software availability. Whether you need one or a dozen computers, Micro Supply Organization is the place to get them!

The MBC 1160 Accounting Software

We carry a complete line of ADS accounting business software. Buy G/L, A/R, A/P, Inventory and receive the Payroll module **FREE**. The current retail price is \$398. per module. **Now from MSO you pay only \$99 per module.**

20 meg internal hard drive sub-system for SANYO MBC 1150, 1160 & 1250. \$649

USER SUPPORT HOTLINE

805/393-2247

All systems carry full 90 day warranty.

CASH PRICE ONLY

Check in advance. Add 3% for VISA/MC. Shipping & handling charges will be added to each order.

For our catalog with complete details and prices, send \$2.00 to:

Micro Supply Organization, Inc.
4909 Stockdale Hwy. #180
Bakersfield, CA 93309

Get more for your money!

SANYO MBC 1160

Including this **FREE** software:

- Wordstar • Spellstar
- Mailmerge • Calcstar
- Infostar • BASIC

8-Bit Integrated Computer with 640KB Formatted Mini Floppy Disk Capacity

- Z-80A CPU with no-wait mode and large 64KB RAM/4KB ROM memory capacity for fast execution.
- CP/M operating system with editor, assembler and all standard utilities.
- No-glare amber monitor display screen for easy viewing.
- 80-character x 25-line display. 256 characters in 8 x 12-dot matrix cells.
- Two internal double-sided, double-density, double-track 5 1/4" slim-type mini floppy disk drives with 640KB formatted capacity.
- Interfaces for one Centronics printer and one RS-232C port.

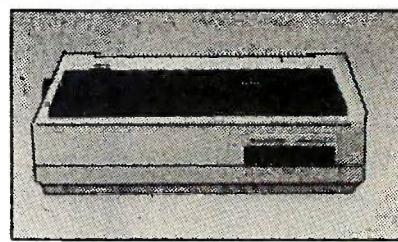

NEC PR103A OR PR 5000

Dot Matrix 110 cps

- 16 Wire print head, 40 cps NLQ
- 80 char/line or dot-image graphics
- Centronics parallel interface
- Tractors or Friction feed
- Pica, elite, condensed or proportional

Includes printer cable & full warranty

Letter quality Daisy Wheel Printer

- Letter-quality printer with 96-character daisy wheel printing element.
 - Accepts paper up to 13 inches in width.
 - 14 cps bidirectional printing.
 - 10, 12 and 15 cpi printing pitches.
 - Centronics parallel interface.
 - Optional form tractor.
- Includes printer cable & full warranty.

This complete package lists for \$3194.00

Computer & Printer ONLY

\$699



WE WILL HELP YOU SAVE! CALL TOLL FREE (800) 662-SALE

GRAND OPENING OF NEW RETAIL STORE IN HAWTHORNE!

SPECIAL #1
CORONA PORTABLE
 • IBM Compatible
 • 256K • 2 Drives
 • Monitor • Keyboard • DOS
\$1195

All Sales Are Warranted for 90 Days, Parts & Labor
WE SERVICE WHAT WE SELL!

MAIL ORDER AND SAVE
ORDER TOLL FREE (800) 662-0753

SPECIAL #2
IBM PC 256K
 • Two 360K Drive
 Only
\$1499

SPECIAL #3
COMPAQ PORTABLE
 • IBM Compatible
 • 256K • 2 Drives
 • Monitor • Keyboard • DOS
\$1795

SPECIAL #4
COMPAQ 286 PORTABLE
 • IBM AT Compatible • DOS
 • 1.2 Meg Floppy • 640K
 • 20 Meg Hard Disk • Monitor
\$4495

SPECIAL #5
20 MEG HARD DISK FOR IBM
 • Seagate
 • Western Digital
\$495

SPECIAL #6
PC XT COMPATIBLE
 • 256K • Two 360K Drives
 • Keyboard • Green Monitor
 • w/Graphics • Dos 2.1
\$799

SYSTEMS

IBM
 PC 256K, 2 Drives \$1499
 XT 256K, 1 Drive 1729
 XT 256K, 1 Drive 1-10 MG 2099

COMPAQ
 Portable, 2 Drives, 256K .. \$1795
 Call on Desk Pro's

CORONA
 Portable \$1195
 Desk Top, 2 Drives, 256K
 w/monitor 1479

MONITORS

PRINCETON GRAPHICS
 Max 12E \$159
 HX-9 Call
 HX-12 425
 SR-12 w/doubler board 749

TAXAN
 620 Color \$399
 640 Color 499
 121 Green 125
 122 Amber 135

AMDEK
 310A \$145
 600 Color 389
 722 Color 519

PRINTERS

EPSON
 Call for Best Pricing

OKIDATA
 182, 120 cps \$218
 192, 160 cps, w/Roms 349
 193, 160 cps, IBM 499
 84, 200 cps, IBM 658
 OKI-MATE 20, Color, IBM . 229

TOSHIBA
 P1340 \$ 519
 P351 1059
 P351 Tractor 159

STARMICRONICS
 SG10/15 \$219/389
 SD10/15 355/469
 SR10/15 489/589

CITIZEN
 MSP-10 \$259
 MSP-15 369
 MSP-20 399
 MSP-25 549

DISKETTES

Qty. BULK PRICES
 100 SS/DD 5¼ \$ 59.00
 100 DS/DD 5¼ 69.00
 100 1.2MG for AT 5¼ .259.00

IBM EXTRAS

AST RESEARCH
 SixPak+, 64K w/Side Kick . \$209
 Reach w/Crosstalk 369
 Preview Mono Card 239
 Advantage w/128K 399

D & D MEMORY CARD
 MF-100+, 64K same/6Pak + \$109

HERCULES
 Color Card w/Printer Port .. \$149
 Mono Graphics Card 299

GOODIES
 IBM Printer Cable \$15
 64K Ram Set of Nine Chips . 13
 256K Ram Set of Nine Chips 49
 Power Supply 135 Watts 84
 8087 CoProcessor 109
 DOS 2.1 65
 DOS 3.1 69

MODEMS

HAYES
 Micromodem IIE \$159
 300 139
 1200 379
 1200B IBM Internal 349
 2400 External 639

PROMETHEUS
 Promodem 1200 \$295
 Promodem 1200A 299
 Promodem 1200B 269
 Promodem 1200MAC 339

DISK DRIVES

IBM COMPATIBLE
 Teac 55B \$99
 Mitsubishi 4851 99
 Tandon TM 100-2 99
 Siemans DT542 89
 In quantities of 2 or more

TEAC
 55B, 320K \$119
 55GF, 1.2MG for AT 149

100% APPLE COMPATIBLE 5¼"
 525A for IIe and II+ \$109
 525C for IIc 119
 350M for Mac Call

HARD DISKS

10 Meg for PC \$259
 20 Meg for PC 359
 20 Meg for AT 489
 30 Meg for AT 789
 Controller for PC 135

BUILD A P.C.

640K Mother Board
 w/8 Slots \$179
 Flip Top Case w/speaker ... 59
 Disk Controller w/cable 49
 Color Card w/printer 99
 Monochrome Card w/printer 129
 Keyboard 99
 Dual Drive Kit 189
 135 Watt Power Supply 79

WE OFFER VOLUME DISCOUNTS! MAKE THAT CALL (800) 662-7253

SPECIAL #7
PC XT Compatible Turbo
 • 640K • 8 MHz • Keyboard
 • Color Graphics • Color Monitor
 • Dos 2.1
 Complete **\$1149**

SPECIAL #8
IBM AT COMPUTER SYSTEM
 • 20 Meg Hard Disk • 1.2 Meg Floppy
 • Color Graphics • Color Monitor • Dos 3.1
FREE UPS SHIPPING ON SPECIAL #8
\$4,399

SPECIAL #9
10 MEG HARD DISK
 • For IBM or Compatible
 Complete **\$379**



SELLING TO YOU SINCE 1978

MAIL ORDER:
 13324 HAWTHORNE BLVD., SUITE 201
 HAWTHORNE, CA 90250

ORDER DESK:
 Inside California (213) 970-0206
 Outside California (800) 662-7253

Hours: Monday—Friday 8 am to 6 pm
 Open Saturdays

WE CARRY TOO MANY ITEMS TO LIST,
 PLEASE CALL FOR A QUOTE ON ANY ITEM.



No Surcharge for Credit Cards

Terms: Prices reflect a cash prepaid discount. All merchandise new. We accept MC, Visa, Wire Transfer, Certified Check, P.O.'s from qualified firms. P.O. subject to approval & surcharge. Terms: 2% 10 net 20. Shipping: minimum \$4.00 first 5 pounds. Call for exact shipping cost. Tax: California residents only add 6½% sales tax. All returns subject to 15% restock fee. Prices Subject to Change.

BYTE CONNECTION INC.

BOTTOM LINE PRICE BUSTERS! — "Who you gonna call?"

(714) 778-6496

PERSONAL COMPUTERS

IBM ★ I (IBM Compatible), 640K, AT Look Alike Keyboard, Two 360 EA Floppies, Hi-Res Graphics Board & Monitor	\$ 995
IBM ★ II, all the above with 360 Floppy, 10 MB HD	\$1495
IBM ★ III, Turbo, all the above with 20 MB HD	\$1750
IBM ★ IV, AT Compatible, 640 K, 1.2 MB Floppy, 30 MB HD, S, P, C/C, Hi-Res Graphics Board, Monitor & K.B.	\$2950

Dealer's Inquiries Invited

IBM PC, with 256K, K.B., FDC, Two 360 Floppies, Hi-Res Graphics Card & Monitor	\$1795
IBM PC XT, with 256K, 360 Floppy, 20 MB HD, K.B., Hi-Res Graphics Card & Monitor	\$2595
IBM PC AT, with 512K, K.B., 1.2 MB Floppy, 20 MB HD, Graphics Card & Monitor	\$4141
IBM PC AT, all the above with 70 MB HD & 60 MB Tape B/U	\$6989

COMPAQ PORTABLE MODEL I	\$1750
COMPAQ PORTABLE, 256K, 360 Floppy, 10 MB Rhodime HD	\$2595
COMPAQ DESK PRO, with 640K, Two 360 Floppies, Graphics Card & Monitor	\$2020
COMPAQ PORTABLE 286, with 640K, K.B., 1.2 MB Floppy	\$3300
COMPAQ DESK PRO 286, with 640K, K.B., 1.2 MB Floppy, 20 MB 40 MS HD, Graphics Card & Monitor	\$4195
COMPAQ DESK PRO 286, all the above with 70 MB 28 MS HD, 60 MB Tape B/U	\$6989

AT & T 6300 PC, with 256K, Two 360 Floppies, AT & T Graphics Card & Monitor, DOS 3.1	\$1925
AT & T 6300 Plus, with 512 K, 1.2 MB Floppy, 360 KB Floppy, K.B., 20 MB HD, AT & T Graphics Card & Monitor, DOS 3.1 & UNIX OS	\$4895
AT & T 7300	CALL

SOFTWARE

ACCOUNTING, A/R, A/P, G/L, INVENTORY, PAYROLL	\$ 495
CAD SYSTEMS	CALL
D base III PLUS	\$ 379
LOTUS SYMPHONY	\$ 489
FRAMEWORK II	\$ 489
MEDICAL & LEGAL SOFTWARE	CALL
LOTUS 1-2-3	\$ 339
MULTIMATE ADVANTAGE	\$ 289
WORDSTAR 2000 PLUS, II	\$ 399

MIC

EXPANSION CHASIS, POWERSUPPLY, M/S	\$ 550
HITACHI HM 3719 & BNW 1024 x 1024	CALL
ORCHID NETWORK, ADVANCE DIGITAL, NOVELL	CALL
MULTI USER SYSTEMS	CALL

PRINTERS

ANADEX 6500	\$1895	CITOH LINE/LAZER	CALL
CITIZEN MSP15 - PREMIER 35	\$ 399 - 450		
DATA PRODUCT 8070 - LINE/LAZER	\$1695	CALL	
DIABLO 635	\$1295	EPSON	CALL
FUJITSU	CALL	HP LAZER JET	\$2350
HP Plus	\$3395	NEC	CALL
OKIDATA 192-193	\$ 379 - 495		
TOSHIBA 1340 - P351	\$ 495 - 1159		

HARD DISK & FLOPPIES

10 MB SUBSYSTEMS for PC	\$ 439	20 MB SUBSYSTEMS	\$ 550
20 MB AT	\$ 595	30 MB AT	\$ 795
70 MB HD & 60 MB TAPE B/U AT	\$2495		
360 FLOPPY	\$ 79	IBM 360 FLOPPY	\$ 110
30 MB SUBSYSTEM for AT & T	\$ 795		

PLOTTERS & DIGITIZERS

ALCOMP & NICHOLET	CALL
HP 7475 - 7550	\$1659 - 3295
HITACHI, GOULD, KURTA, GTCO, SUMMAGRAPHICS DIGITIZERS	CALL
HITACHI 41-42	\$3050, 51-52 \$4695, 29 \$2121
IO LINE 3700, SPECIAL OF THE MONTH!	\$4095

WE CARRY ALL NAME BRAND MFC, MODEMS, MONITOR ADAPTERS AND SOFTWARE. CALL FOR WHAT IS NOT LISTED. PRICES AND AVAILABILITY SUBJECT TO CHANGE WITHOUT NOTICE. NO CHARGES FOR CONFIGURING AND TESTING. WE GUARANTEE THAT YOUR CALL WILL NOT BE A WASTE.

163 West Cerritos Ave., Anaheim, CA 92805
(714) 778-6496

WE STOCK WHAT WE SELL!

If You Don't See It Listed Here, Call Us!!

ZENITH PERSONAL COMPUTERS

Entry Level Desktop Dual Drive 5/8Mhz ZF-148-42	\$ 999	Professional Desktop Dual Drive 5/8 Mhz ZF-158-42	\$1,799
Entry Level Desktop Hard Drive Systems NEW ZW-148-42-K (10 Mg System)	\$1,499	Portable Dual Drive, Battery Operation ZFL-171-42	\$1,799
NEW ZW-148-43-K (20 Mg Systems)	\$1,599	"AT" Compatible ZF-241-81	\$2,599
Transportable Dual Drive 5/8 Mhz ZFA-138-42	\$1,399	"AT" Compatible Winchester System ZW-241-82	\$3,699

SPERRY

Professional Desktop Dual Drive Monochrome 5/8 Mhz MODEL 200	\$1,749	"AT" Compatible Single Floppy Drive System PC/IT BASIC	\$2,199
Professional Desktop 1 Floppy, 1.20 Mg Hard Drive Monochrome 5/8 Mhz MODEL 400	\$2,844	"AT" Compatible 1 Floppy, 1.44 Mg Hard Drive PC/IT EXPANDED	\$3,199

MULTIFUNCTION CARDS

STB Systems Video Cards

Chauffer	\$259
High Resolution EGA	\$399
Graphic + II	\$269
Mono +	\$159

STB Systems Memory Cards

Big Byte 64K (384K Capacity)	\$129
Grande Byte (2M Capacity)	\$269

dca Mainframe Links

Irma Board	\$869
Smart Alec	\$759

PRINTERS

SG-10	\$219
SG-15	\$399
SG-10C	\$249
SR-10	\$439
SR-15	\$589
SB-10	\$593
NB-15	CALL
Gemini 10X	\$169
Power type	\$328

LEGEND

808	\$155
680	\$199
1360	\$280
CP-VII	\$840

MODEMS

Robotics

Password 1200	\$195
Password 300	\$129
Microlink 1200	\$329
Courier 2400	\$429
Microlink 2400	\$429

MONITORS

ZENITH

ZVM-122/123	\$ 79	Video 300G	\$125
ZVM-1220/1230	\$ 89	Video 300A	\$133
ZVM-1240	\$149	Video 310A	\$153
ZVM-130	\$249	Color 300	\$244
ZVM-1330	\$459	Color 600	\$432
		Color 722	\$539

CALL FOR PRICING ON TV'S VCR'S COMPUTER PROJECTORS AND RELATED ITEMS.

Prices Quoted Reflect Cash Discount. Add 3% for Master Card or Visa. Prices and Availability Subject to Change without Notice. Add 3% for Shipping and Handling. \$5.00 minimum. 15% Restocking Charge on All Returns.

Use Our Convenient Toll Free Order Line.

1-800-CALL-REX

IN PA 1-800-821-1059

Telephone Orders Only. 8:30 AM — 5:00 PM (Eastern) Mon.-Fri.



Mailing Address: REXWIL ELECTRONICS
P.O. Box 4585 Philadelphia, PA 19131



REXWIL ADVANTAGE

- 60 Years in the Electronics Field.
- Toll Free Technical and Service Support.
- Quality Products.
- Service Facilities on Premises.
- There is No Limit and No Deposit on C.O.D. Orders.
- We accept purchase orders from qualified corporations. Subject to approval.
- Educational discounts available to qualified institutions.



FORTRON CORPORATION

3225 SELDON CT., FREMONT, CA 94538

IN CALIF: (415) 490-8171
 TLX: 559291 FORTRON
 FAX: (415) 490-9156

ORDER TOLL FREE: (800) 821-9771

U.L. Rated • High Reliability • Full Technical Support



FC 135-40 150W (max)
 PC/XT \$129.00





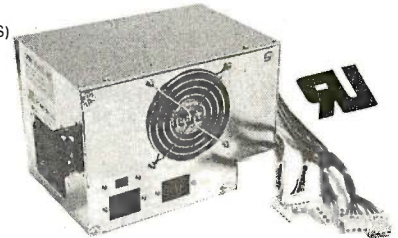

- U.L. recognized, yellow card available File # E-10f115(S)
- Meet FCC class B, european safety spec.
- 115/230V AC convertible
- Low noise DC fan
- OVP, OCP, short circuit protection
- IBM® standard pin out or Faraday type pin out selectable
- 100% 24 hrs. burn-in 100% pre-shipment test.
- One full year warranty





Your PC represents a substantial investment. It does not make sense to risk costly down time due to bargain power supply, when for a few dollars more you can have the confidence of FORTRON QUALITY.







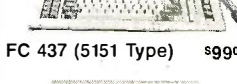
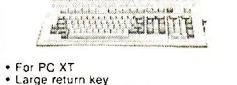

FC 5192 200W (max)
 PC/AT \$189.00

PROFITABLE DISCOUNT PRICES FOR SYSTEM INTEGRATORS & DEALERS - PLEASE CALL

<p>FC 520 Color Graphic/Mono/Printer</p>  <ul style="list-style-type: none"> • TTL/composite level outputs • 320 x 200 (color) 640 x 200 (B&W) • Centronics printer port <p>\$99.00</p>	<p>FC 550 (CT-6040) Monochrome/Graphic/Printer</p>  <ul style="list-style-type: none"> • 80 x 25 text mode • 720 x 348 graphic mode • Run Lotus 1-2-3 auto cad. etc. <p>\$119.00</p>	<p>FC 730 (CT-6050C) 384K Multifunctions</p>  <ul style="list-style-type: none"> • Memory expansion to 384K • Clock/calendar • Serial, parallel ports • Game port <p>(DK) \$129.00</p>	<p>FC 730 AT Multifunction Card for PC AT</p>  <ul style="list-style-type: none"> • 1 EIA-RS232C port (2nd optional) • 128K to 1.5 MB memory • Expandable to 3 MB (optional) by piggy back board • Game port <p>\$199.00</p>
<p>FC 740 Multi-I/O w/Floppy Controller</p>  <ul style="list-style-type: none"> • 1 EIA-RS232C port (2nd optional) • 1 Centronics port, game port • Clock/calendar • Control 2 floppy drives (FC770) w/o Floppy Controller <p>\$119.00</p>	<p>FC 930 AT RS232/Printer Port for PC AT</p>  <ul style="list-style-type: none"> • EIA RS232C port (2nd optional) • Centronics parallel port <p>\$109.00</p>	<p>FC 940 RS232/Real Time Clock</p>  <ul style="list-style-type: none"> • RS232C port • To 9600 baud • Battery back-up <p>\$59.00 \$49.00 (clock only)</p>	<p>Plus More... for PC XT</p> <ul style="list-style-type: none"> • 512K memory expansion card (OK) \$89.00 • RS232/parallel port \$69.00 • Monochrome controller with printer port \$99.00 • Floppy drive controller (w/cable) \$59.00

<p>XT HD Controller AT FD & HD Controller</p>  <ul style="list-style-type: none"> • XT HD Controller • AT FD & HD Controller <table border="0"> <tr><td>DTC 5150 BX</td><td>159.00</td></tr> <tr><td>WD WX-2</td><td>149.00</td></tr> <tr><td>Cable</td><td>10.00</td></tr> <tr><td>AT FD & HD Controller</td><td>270.00</td></tr> <tr><td>DTC 5290</td><td>265.00</td></tr> <tr><td>WD WA-2</td><td>265.00</td></tr> <tr><td>Cable Set</td><td>20.00</td></tr> </table>	DTC 5150 BX	159.00	WD WX-2	149.00	Cable	10.00	AT FD & HD Controller	270.00	DTC 5290	265.00	WD WA-2	265.00	Cable Set	20.00	<p>Internal Modem</p>  <ul style="list-style-type: none"> • Free PC Talk software • 300/1200 baud • Auto busy redial, auto answer • Dual phone jack plus RS232 port <p>\$179.00</p>	<p>XT CPU Board</p>  <ul style="list-style-type: none"> • 4.77 MHz, 8088 CPU • Optional 6.77 MHz • 8 slots • Expandable to 640K on board memory • Optional 8087 co-processor • Optional IBM® comp. BIOS <p>\$149.00 (OK)</p>	<p>FC 447 PC/AT Keyboard</p>  <ul style="list-style-type: none"> • IBM AT compatible keyboard • Enlarge return key • Light on num. lock key <p>\$109.00</p>	<p>FC 427 (5150 Type) \$79.00</p>  <p>FC 437 (5151 Type) \$99.00</p>  <ul style="list-style-type: none"> • For PC XT • Large return key • Light on num. lock keys
DTC 5150 BX	159.00																	
WD WX-2	149.00																	
Cable	10.00																	
AT FD & HD Controller	270.00																	
DTC 5290	265.00																	
WD WA-2	265.00																	
Cable Set	20.00																	

CABINETS & EXPANSION CHASSIS

<p>FC 630 A-2</p>  <ul style="list-style-type: none"> • For PC XT compatible, side switch • To use FC 135-40 power supply • Complete mounting hardware <p>\$99.00</p>	<p>FC 630 A-T</p>  <ul style="list-style-type: none"> • For PC AT compatible • LED lamps, key, key lock, speaker and mounting hardware, included <p>\$139.00</p>	<p>FC 610 Drives Chassis</p>  <ul style="list-style-type: none"> • Capable of holding 2 half-height drives • Come w/power supply, fan • LED power indicator <p>\$149.00</p>	<p>FC 640 5Slot Expansion Chassis</p>  <ul style="list-style-type: none"> • W/5 slot mother board • 100W power supply, fan • Capable of holding 3 half-height drives • Dia. 15 1/2" x 12" x 6 1/4" • *Option of system interface adaptor <p>\$239.00 \$149.00</p>	<p>FC 650 8 Slot Expansion Chassis</p>  <ul style="list-style-type: none"> • PC XT identical size • W/8 slot mother board • 140W power supply • 4 half-height drives • *System interface adaptor <p>\$249.00 \$159.00</p>	<p>FC 660 12 Slot Expansion Chassis</p>  <ul style="list-style-type: none"> • Dia. 15 1/2" x 15 1/2" x 5 1/4" • W/12 slot mother board power supply, fan • Capable of holding 2 half-height drives • *System interface adaptor <p>\$289 \$149.00</p>
--	---	---	---	--	---

<p>MONITORS</p> <ul style="list-style-type: none"> • Monochrome • Tatum MM 1222 A/G 129.00 • Golden Star Green 109.00 • Color Hi-Res (640 x 200) • Tatum CM-1360 359.00 • Enhanced Graphic • Tatum CM-1360 Call • Super Hi-Res (640 x 350) 	<p>DISK DRIVES</p> <ul style="list-style-type: none"> • Floppy • Teac 55V 119.00 • 1.2 MB 149.00 • Hard (w/controller & cable) • 10 MB 419.00 • 20 MB ST-225 499.00 • 20 MB ST-4026 (40ms) 590.00 • 30 MB ST-4038 (40ms) 699.00 • 30 MB CMI 6640 (40ms) 550.00 	<p>ENHANCED GRAPHIC ADAPTOR IBM Compatible</p>  <ul style="list-style-type: none"> • For PC/XT/AT and compatibles • 256K on board memory • Full 16 colors in 640 x 350 on IBM® enhanced color display • Support 640 x 350 IBM® compatibles enhance color and monochrome monitors • Parallel port • Light pen interface <p>• call for price</p>	<p>RAM CHIPS</p> <ul style="list-style-type: none"> • 64K RAM 109-pp • 256K 339-pp • 128K 449 set (for PC AT) <p>Terms:</p> <ul style="list-style-type: none"> • Min. shipping & handling \$6.00 • CA res. add 6.5% tax • Restocking charge 15% • No rtn. goods w/o a RMA no. • Prices subject to change w/o notice
---	--	--	---

IMPORT DIRECT SAVE 30%

MASTER PACKS	SAMPLE	IMPORT	IMPORT*
	1-4	5-49	50+
PC-AT	\$1595.00	\$1495.00	\$1299.00
512K RAM (Up to 1M on Board) 12 M FLOPPY - FLOPPY & HARD DISK CONTROLLER AT KEYBOARD - CLOCK WITH BATTERY BACKUP 195W POWER SUPPLY - DOS 3.10 & MANUAL			
PC-AT COLOR	\$1899.00	\$1799.00	\$1550.00
SAME AS ABOVE WITH COLOR MONITOR AND COLOR/GRAPHICS CARD			
PC-XT TURBO	\$999.00	\$898.00	\$595.00
640K RAM, 8088-2, (4.77 MHz or 6.66 MHz) 360K FLOPPY - KEYBOARD - MONOCHROME/ GRAPHICS PRINTER - 12" TTL HIGH RES MONITOR			
PC-XT	\$898.00	\$595.00	\$495.00
256K RAM - 360K FLOPPY - KEYBOARD MONOCHROME/GRAPHICS/PRINTER CARD (Hercules Comp.) - 12" TTL HIGH RES MONITOR			

DRIVES

	1-49	50+
XT 300K FLOPPY	\$89.00	\$85.00
XT 10 MEG INTERNAL 1/2 HEIGHT	\$395.00	\$355.00
XT 20 MEG INTERNAL 1/2 HEIGHT	\$479.00	\$425.00
AT 1.2 MB FLOPPY	\$149.00	\$129.00
AT 20 MEG INTERNAL 40 MSEC	\$579.00	\$565.00
AT 30 MEG INTERNAL 40 MSEC	\$679.00	\$665.00

INDIVIDUAL PART PRICING FOB TAIWAN

	10-99	100+
PC-XT-256K 8 SLOTS (super XT BIOS)	\$74.75	\$65.00
135W POWER SUPPLY	\$51.75	\$45.00
FLIP-TOP CLONE BOX	\$26.45	\$23.00
MONO/GRAPHIC/PRN (Herc comp)	\$52.90	\$46.00
KEYBOARD	\$36.60	\$32.00
FLOPPY DISK CONTROLLER	\$23.00	\$20.00
RAM KITS 256K	\$25.30	\$22.00
12" TTL HIGH RES MONITOR	\$85.00	\$80.00

SUBTOTAL BASIC PC NO DRIVES	\$380.70	\$313.00
DUTY	\$14.79	\$13.00
OCEAN FREIGHT	\$24.00	\$20.00
AIR FREIGHT \$100 extra		
ACS IMPORT FEE \$350.00/ENTRY+10%	\$71.00	\$34.80
TOTAL LANDED COST, L.A. HARBOR	\$470.49	\$380.80

MONITORS

	SAMPLE	10-49	50+
CL-888 12" TTL MONO	\$98.00	\$86.00	\$80.00
MD-3 14" COLOR RGB	\$361.00	\$278.00	\$235.00
.39 DDT 640 x 200			
MB-7 14" COLOR RGB	\$490.00	\$359.99	\$335.00
.31 MM DDT 720 x 360			

ADD ON BOARDS - PARTIAL LIST

	10-99	100+
PC-XT-640K MOTHER BOARD 8 SLOT	\$76.00	\$73.00
PC-XT-840K TURBO 4.77/6.66 MHZ	\$99.00	\$95.00
TRANS-NET (LAN)CARD 1.0 MRZ	\$199.00	\$185.00
384K MULTI-FUNCT (AST6 comp)	\$88.70	\$56.00
RAM KITS 384K	\$36.80	\$32.00
MODEM CABO 300/1200 (Hayes comp)	\$115.00	\$105.00
COLOR GRAPHICS CARD	\$42.55	\$37.00
AB SWITCH BOX (Centronics 2:1 or 1:2)	\$27.60	\$24.00
AB SWITCH BOX WITH 64K BUFFER	\$65.55	\$57.00
AT SERIAL/PARALLEL CARD	\$81.00	\$55.00
AT COLOR/GRAPHICS	\$89.00	\$51.00
64 INPBT ANALOG/DIGITAL CARD	\$398.00	\$358.00
128 LINE PARALLEL I/O CARD	\$495.00	\$371.00

* 100 UNIT ORDERS MAY BE SCHEDULED OVER 6 MONTHS

ACS IMPORTERS

5311 DERRY AVE., UNIT A
AGOURA HILLS, CA 91301
HOURS 9 AM - 6 PM PST
(818) 889-1092
TELEX: 299353 POST UR

WE CAN MAKE INCOMPATIBLE DATA COMPATIBLE!

We can transfer datafiles between different operating systems; convert media (disks and tapes); decode and translate documents between major dedicated word processors and/or major PC software; re-arrange database files; transfer texts and re-formulate spreadsheet data.

Write or call to discuss your needs, then send a disk or tape sample of your datafile for a complimentary translation.

CompuData Translators, Inc.

6565 Sunset Blvd., Suite 301
Hollywood, CA 90028

(213) 462-6222

ADAPSO Member

Inquiry 71

DATA FLEX™

- Multi-user Database!
- Powerful!
- Multiple Operating System Compatibility!
- Attractive Dealer Pricing!
- Full Dealer Support!

Dataflex is a trademark of Data Access
Dealer Inquiries Invited

COGITATE

24000 Telegraph Road
Southfield, Michigan 48034 USA
(313) 352-2345

Inquiry 66

I/O Bus for Data Acquisition & Control now available for IBM PC & Apple II series computers

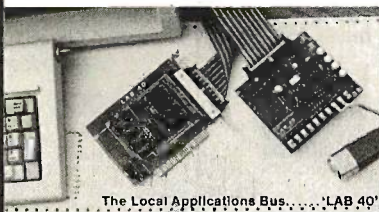

The Local Applications Bus... 'LAB 40'

In photos are 'LAB40-PC' generator & 'LAB40-1' signal acquisition module.

- Modular approach to data acquisition and control.
- A 40 conductor ribbon cable bus is generated by a card in the host computer. Up to 8 low cost modules can be located anywhere on a cable up to 100 ft. long. Our LAB 40 generator cards for the IBM PC or Apple II are priced at \$185.
- Signal Acquisition and Control Module, model 'LAB 40-1'. Features: 8 bit resolution, 4 channels, differential inputs, sampling rate up to 850KHz, software programmable gains and offset, digital output port, low price of \$220. Twelve bit module available.
- Full featured 'digital oscilloscope' software. Documents and user modifiable PC version \$175. Apple II version \$100. Complete data acquisition packages (hardware and software) start at \$450.
- Development tool.
- Unique to LAB 40 is its ability to interface directly to microprocessor compatible integrated circuits and hybrids. We encourage users to develop projects and products. LAB 40 is an ideal educational tool.
- New low cost modules.
- Twelve bit A/D. Port/Relay Driver. Real Time Clock.

Computer Continuum

75 Southgate Ave., Suite 6 • Daly City, CA 94015
(415) 755-1978

TERMINAL EMULATION

Softerm PC emulates over 30 popular terminals including the:

- DEC VT102, VT220
- Data General D200, D410
- IBM 3101-20 (block mode)
- Hewlett-Packard 2622A
- Honeywell VIP7801, VIP7803

Guaranteed Compatibility

Call for free product brief

\$195 MC-VISA-COD

For the IBM PC/XT/AT, DG1, NEC, Wang PC, TI Pro, Gridcase, Tandy

SEIFTRONICS

7899 Lexington Dr., Ste 210
Colorado Springs, CO 80918
(303) 593-9540

Inquiry 307

1-800-826-0843

THE COMPUTER BARN

Super Low Prices on Micro
Computers and Accessories...

WYSE 30	\$ 330	TeleVideo 905	\$ 285
WYSE 50	409	TeleVideo 9220	485
WYSE 75	539	Canon Laser 8A1	2195
WYSE PC	1159	Canon A40	245
WYSE 85	439	Diablo 635	1095
Compaq Port 2100		Compaq DskPro2	
IBM PC	1650		

WY-500 (Green Mono)	\$ 160
IBM XT w/10MB	3295
IBM AT w/20MB	5095

CASE/RIXON, ARK PARADYNE, PRENTICE, Modems. Complete line of Canon, Diablo, Datasouth Printers. Many other Products.

CALL FOR FREE BROCHURE

Inquiry 78

8051 8048

SIMULATORS - CROSS ASSEMBLERS - PROGRAMMERS - SIM51 and SIM48 Software Simulators run on IBM-PC, CP/M-80, MS-DOS. Designed for validation & debugging application software. Simulation includes all on chip functions plus expansion chips. \$250, one year FREE updates. Formats: PC-DOS 2.x DSDD, CP/M-80 8" SSSD, many 5 1/4" formats. CrossAssemblers and EPROM pgmrs also available. Logical Systems Corp. 6184 Teal Station, Syr., NY 13217. (315) 457-9416.

Logical Systems

Inquiry 193

Get the whole story on graphics terminal emulation.



To find out more about software that lets your PC emulate TEKTRONIX™ 4105/6/7/9 and DEC VT100™ terminals, call or write:

GRAFPOINT

4340 Stevens Creeks Blvd., Suite 280, San Jose, CA 95129 (408) 249-7951

Inquiry 145

WAVEFORM SYNTHESIZER



- For IBM-PC/XT/AT and compatibles
- Generates user-definable signal
- Up to 2000 points per envelope

\$795.00
QUA TECH, INC.

478 E. Exchange St. Akron OH 44304
(216) 434-3154 TLX: 5101012726

Inquiry 278

BAR CODES MADE EASY

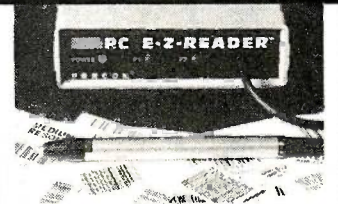

PERCON® E-Z-READER™
Read the Fine Print before You Call.

PC/XT/AT/Compatibles **YES** Serial and Multi-user **YES** Auto-recognition of codes **YES**. Free phone support **YES** 16 second keyboard installation **YES** Bar code printing software **YES** Software changes **HARDLY EVER** 1000's in use. 2 Year Warranty. **\$635 list.**

NOW CALL US AT
503 344-1189

2190 W. 11th St., Eugene, OR 97402

PERCON®

5 1/4" FLOPPY MOTORS

Now Buehler OEM replacement spindle motors for all major 5 1/4-inch, full-height floppy disk drives are available for fast delivery. Built to exact OEM size, performance and quality standards. Pulleys included.

For details and prices, contact:

Buehler Services, Inc.
P.O. Box A, Hwy 70-E
Kinston, NC 28501
Phone: 919/522-4300



INPUT → RS232 SERIAL ← OUTPUT
INPUT/OUTPUT → PARALLEL ← OUTPUT/OUTPUT
← IN → PRINTER BUFFER ← IN →
BI-DIRECTIONAL

This is the most sophisticated Printer Buffer in the market today. Microprocessor controlled, with two separate inputs, Serial and Parallel, and two outputs, Serial and Parallel. Automatic selection of input/output, wherever you connect yours units. Comes in two models: 1) w/64K to 256K and 2) w/256K to 1 MByte of buffer. Including COPY, RESET and PAUSE that allows you to print single sheets. External power supply included.

Also we have a BI-DIRECTIONAL Serial Parallel converter, without buffer, fully modes, baud rate and protocols programmable by Jumpers, with DTR, RTS or XON/XOFF protocol. External power supply (not included).

DCB-A 64K (exp. up to 256K) \$ 255.-
DCB-B 256K (exp. up to 1 MB) \$ 295.-
DCU Bi-directional converter \$ 88.-
??? Order today at:
INTECTRA INC. - Department 232
2629 TERMINAL BLVD
MOUNTAIN VIEW - CA - 94043
(415) 967-8818 - TLX 345545
IN-PARALLEL OUT-PARALLEL IN-SERIAL OUT



DUST COVER PROTECTION WITH ANTI-STATIC, LINT FREE NYLON PACK CLOTH

Keyboard	14.00
Monitor	16.00
Drive	16.00
Mon/Dr Combination 1 pc.	28.00
Mon/Dr/Kybd Comb. 1 pc.	38.00
Printers	from 16.00
Macintosh Set: Compu, Ky, ImageWr. ...	24.00

IBM, APPLE, COMPAQ, AMIGA, AT&T, EPSON, OKI, NEC, HP — OTHER COVERS AVAILABLE
Silver Gray with Black Trim
CHECK/VISA/MC

Plus \$2 Ship. & Hand. (401) 245-0532

computerAid

P.O. BOX 293, BARRINGTON, R.I. 02806

Inquiry 76

M68000 SINGLE BOARD COMPUTER



On board 6-10 MHz CPU, 20K RAM, 32K EPROM, two RS-232, 16-bit port, 5-counter/timers expandable via Memory/FDC Board.

M68K CPU (bare board) \$ 89.95
M68K CPU A&T (6MHz) \$495.00
MD512K Memory/FDC (bare board) \$ 89.95
MD512K Memory/FDC (128K) \$495.00
FDC/Hard Disk interface option \$150.00
M68KE Enclosure w/power supply \$249.00
M68K Monitor EPROM's \$ 95.00
M68K Macro Cross Assembler \$195.00
4XFORTH OS w/assembler, editor \$295.00
CP/M 68K OS w/"C" compiler \$395.00

EMS Educational Microcomputer Systems P.O. Box 16115 Irvine, CA 92713 (714) 854-8545

Inquiry 122

MODULAR DATA ACQUISITION



- For IBM & Compatibles
- Flexible and Inexpensive
- Money Back Guarantee
- Free Technical Support

Fast Delivery
QUA TECH, INC.

478 E. Exchange St. Akron OH 44304
(216) 434-3154 TLX: 5101012726

Inquiry 277

Maxell Floppy Disks

The Mini-Disks with maximum quality.



Dealer inquiries invited. C.O.D.'s accepted. Call FREE (800) 235-4137.

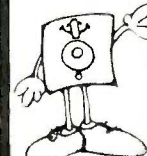

PACIFIC EXCHANGES
100 Foothill Blvd., San Luis San Luis Obispo, CA 93401. In Cal. call (800) 592-5935 or (805) 543-1037.

Inquiry 251

TIME LINE INC.

EPSON QX-10 MOTHERBOARD WITH VIDEO CARD & YOUR CHOICE OF ASCII KEYBOARD (ENCLOSED) OR HASCII (BARE) \$169.95



ONLY 250 SYSTEMS AVAILABLE!

Will work with any IBM compatible disk drive • CPU: µPD780AC-1 (Z80A compatible, 4MHz) • Memory-RAM: 256K on board; Video RAM: 128K on CRT board; C-MOS RAM: 2K; EPROM: 2/4/8K (for IFL); Clock: C-MOS real-time clock. Interface: Serial and Parallel. DMA: 7 channels. Interrupt levels: 15; Counter/timer: 6 channels. Card slots: 5. Compatible with any TTL monitor. Weight: 10 lbs. with enclosed keyboard, 8 lbs. with bare keyboard.

KEPCO/TDK SWITCHING POWER SUPPLY \$39.95



ONLY 250 AVAILABLE!

Model EFX 100T-3 100W. • +5V @ 8A • -5V @ 1.5A • +12V @ 2.0A • -12V @ 2.0A • Input Voltage: 100 to 130Va-c or 200 to 260Va-c. 47-440 HZ. Single phase. • Brownout Voltage: 90Va-c/180Va-c • Fused Input/Output protected against short circuit. Dim: 9 3/4" L x 4 1/4" W x 2 1/8" H. Weight: 3 lbs., Spec Included.

DISK DRIVE CABINET \$12.95

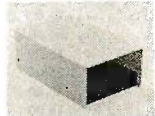

• Full Height Disk Drive case for Apple • Fits 2 half height drives. Can be modified for other uses. Dim: 9 3/4" L x 6" W x 3 1/2" H. Weight: 3 lbs.

IBM STYLE COMPUTER CASE \$39.95



ONLY 150 AVAILABLE
Attractive steel case, fits popular PC compatible motherboards • Switch cut-out in back for PC style power supply

• Cut out for 5 expansion slots. Hardware not included. Weight: 13 lbs.

SIEMENS 8" DISK DRIVE \$44.95 OR 2 FOR \$69.95



FDD100-8. Shugart 801R equivalent. Single Sided. Single/Double Density. Full Height Drive. 48 tpi. Documentation included. Specify 110 or 220 Volt Model • These drives are new

and sold AS IS. Weight: 14 lbs.

4164-15 .89¢ EACH



• MINIMUM 50 PCS. Call for quantity discount.

Minimum order: \$25.00. Shipping and handling charges via UPS Ground: \$.50¢/lb. UPS Air: \$1.00/lb. Minimum charge: \$4.00. We accept cashiers checks, MC or Visa. No COD's. Add 7% of total order for credit card orders. California residents add 6 1/2% sales tax. We are not responsible for typographical errors. All merchandise subject to prior sale. Phone orders welcome.

Continental U.S.A. (800) 428-1616
Inside California (800) 223-9977
Los Angeles Area (213) 217-8912

TIMELINE, INC.

1490 W. ARTESIA BLVD., GARDENA, CA 90247

ATTENTION MEGABYTES

Beat The 33 Mbyte Limit!

Vfeature for **BIG** disks files
User-Transparent
Security Features Included.

Golden Bow Systems

\$80 — \$120
Add \$3 for shipping/handling
California residents add 6% sales tax.

619/298-9349
P.O. Box 3039
San Diego, CA 92103

Inquiry 143

DISKETTES & MORE

NORTH HILLS CORP.

1-800-328-3472

Maxell Brown 3M Diamond

Competitive Prices
COD — VISA — MasterCard
All orders shipped within 24 HRS

NORTH HILLS CORP. INTERNATIONAL
3564 Rolling View Dr.
White Bear Lake, MN 55110
MN. call collect—612-770-0485

Inquiry 242

APPLE II COPROCESSOR & I/O

INTRODUCING
THE BUKOWSKI ROBOTICS VIP CARD
A VERSATILE CONTROLLER CARD THAT CAN STAND ALONE

OR IN AN APPLE SLOT AS AN INTELLIGENT PERIPHERAL CARD THE VIP CARD NOT ONLY GIVES YOU 16 I/O PORTS (EXPANDABLE TO 48) BUT ALSO AN ONBOARD 65C02 MICRO-COMPUTER. VIP WILL RUN MINIBASIC AND HAS ENDLESS APPLICATIONS. FOR EXAMPLE. PARALLEL OR SERIAL PRINTER PORTS, PRINTER CARD, INDUSTRIAL AND HOME CONTROL.

ONLY \$129 VISA/MasterCard ACCEPTED

BUKOWSKI ROBOTICS
1555 W. UNIVERSITY #105
TEMPE, AZ 85281
(602)966-6230

Inquiry 42

VAX/IBM PC

DECKHAND™ Utilities
MS-DOS Utilities with VAX/PDP-11 switch processing. DIR, COPY, DELETE, RENAME, TYPE with extended wildcards, full DATE processing, attribute processing, query, backup and more. \$69.00

ZSTEMpc™-VT100 Emulator
High performance COLOR VT100 / VT102. Double high/wide, smooth scrolling or ISO and attribute mapped color. XMODEM and KERMIT, softkey/MACROS. \$150.00

ZSTEMpc™-4014 Emulator
Interactive zoom and pan. Save/recall images to/from disk. Keypad, mouse, printer, plotter support. \$99.00

KEA SYSTEMS LTD.
#412 - 2150 W. Broadway
Vancouver, B.C. CANADA V6K 4L9
Support (604) 732-7411
TELEX 04-352848 VCR
Order Toll Free (800) 663-8702

Inquiry 374

The GRANDSTAND
PRINTER STAND AND TRAY

- Folds & Stacks Automatically
- Fits ALL Popular Micro Printers
- Space Saving Operation
- Routes Cables Neatly

Grand Union
Micro Systems
P.O. Box 1880
Fallbrook, CA 92028
(619) 723-0882

Inquiry 146

NEC PRINTERS

(1 Year Factory Warranty)

Pinwriter P5.....\$ 925
Pinwriter P5XL.....\$1100
Pinwriter P6.....\$ 445
Pinwriter P7.....\$ 575
Elf 350/360.....\$ 380
3510/15/30/50.....\$ 715
8810/15/30/50.....\$1040

Optional Forms Handling Devices.....CALL

QUALITY PRINTERS
8415 Cement City Road
Brooklyn, Michigan 49230
Phone: 517-592-3749

Inquiry 281

VT102/TEK 4010

For the IBM PC, XT, AT, PCjr, and Compatibles

PC102 precisely emulates DEC VT102, 101, 100, and VT52 terminals.

PC4010 includes all PC102 features plus Tektronix 4010 graphics.

A few reasons why thousands of customers—including GE, Dow, Raytheon, Westinghouse, and Stanford University—prefer our products...

- Complete keyboard and screen emulation w/line graphics (optional 132-columns)
- ANSI color, local printer, bidirectional file transfer support
- Guaranteed compatibility with all DEC applications including EDT, WORD-11, ALL-IN-ONE, DEC-CALC, UNIX v1
- New DOS shellkey, ten programmable softkeys, plus full DOS 2.X-3.X path names.
- Written in "C" and ASM; up to 38.4 KB

PC102-JR	\$69.00
PC102 (for PC, XT, AT, QNX)	\$139.00
PC4010	\$179.00
Prepaid, C.O.D., Mastercard, VISA	

30-DAY money back guarantee!
CALL TODAY!

TERMINAL EMULATION

gms
P.O. Box 5330
Minneapolis, MN 55343

GENERAL MICRO SYSTEMS

(612) 944-0593

RS-422 Communications Board

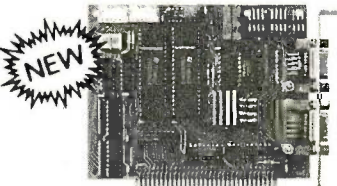

- For IBM-PC/AT/XT and compatibles
- Dual RS-422 serial interface
- Programmable to 56k baud
- Differential drivers to 4000 ft.

\$345.00
QUA TECH, INC.

478 E. Exchange St. Akron OH 44304
(216) 434-3154 TLX: 5101012726

Serial ← ||||| → Parallel



Convert What You Have To What You Want!

- RS232 Serial
- 8 Baud Rates
- Latched Outputs
- Centronics Parallel
- Handshake Signals
- Compact 3 1/2 x 4 1/2 x 1 1/2

No longer will your peripheral choices be limited by the type of port you have available! Our new High Performance 700 Series Converters provide the missing link. Based on the latest in CMOS technology, these units feature full baud rate selection to 19.2K, with handshake signals to maximize transfer efficiency. Detailed documentation allows simplified installation. Order the Model 770 (Ser/Par) or Model 775 (Par/Ser) Today!

Buffer Products Coming Soon!

ligertronics
2734-C Johnson Dr.
Post Office Box 3717
Ventura, California 93006

only \$89.95
Connector Option \$10.00
CA Residents 6% tax
UPS Shipping \$3.00

CALL (805) 658-7466 or 658-7467
For FAST Delivery

Inquiry 139

Inquiry 279

Inquiry 343

PC/XT USERS!

- COGTREE Utilities by Cogitate \$129.95
- LYNC by Norton-Lamber \$199.95
- DATAFLEX by Data Access...Varies
- RMICOBOL by Ryan/McFarlandVaries
- Universe by Omnitrend..... \$ 98.50
- Blue MacI by Cogitate..... \$599.00
- CadPower + by Trilex \$995.00
- Softext Teaching Aids..... \$ 95.00
- PrintSet by Cogitate..... \$ 79.95
- CogITAPE by Cogitate.....CALL!!
- Anti-Static Products.....Varies
- Uninterruptible Power Backups.....Varies
- TeleVideo Software.....CALL!!

COGITATE

"A Higher Form of Software"
24000 Telegraph Road
Southfield, MI 48034
(313) 352-2345/Telex 386581

VISA/MASTERCARD ACCEPTED
Dealer Inquiries Welcomed

DOUBLE THE OPTION CAPACITY OF YOUR IBM PERSONAL COMPUTER

PC-XTRA

- DIRECT EXTENSION OF IBM PC BUS
- NO SOFTWARE CHANGES
- NO HARDWARE MODIFICATION
- STYLING CONSISTENT WITH IBM

Add all those special options that you've been wanting without worrying about filling your plug-in and back panel space

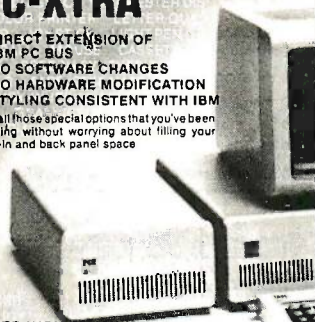

DEALER INQUIRIES INVITED.

\$549.00* F.O.B. SANTA ANA
*CALIFORNIA RESIDENTS ADD 6% SALES TAX

P C HORIZONTALS, INC.
1701 E. Edinger, Ste. A6, Santa Ana, CA 92705
(714) 953-5396

Inquiry 67

Inquiry 250

Inquiry 20

Still Waiting?

ATTENTION BERNOULLI BOOSTERS Go Either Way!

BOOT
from the Bernoulli Box!
from the AT Hard Disk!

FORMAT WITH DOS
PARTITION WITH FDISK
NO SLOWING

We've been shipping Bernoulli Boots
that work for over a year —
still waiting?

Golden Bow Systems

\$95-\$110

Add \$3 post shipping/handling
California residents add 6% sales tax



P.O. Box 3039
San Diego, CA 92103
(619) 298-9349

72 Digital I/O



PXB-721 Parallel Expansion Board

- For IBM-PC & Compatibles
- 72 Digital I/O Lines
- Simple Programming
- Uses One Expansion Slot
- Fast Delivery

\$195

QUA TECH, INC.

478 E. Exchange St. Akron OH 44304
(216) 434-3154 TLX: 5101012726

Inquiry 144

Inquiry 280

PROFESSIONAL HANDICAPPING SYSTEMS

• PRESENTED BY PROFESSOR JONES •

Thoroughbred "Gold" Edition™
A "Full" featured thoroughbred analysis designed for the professional and the serious novice.
\$159.95 complete w/Master Beltor™ \$199.95

Limited "Gold™" Enables Professional Handicappers to assign specific values to racing variables they feel are important, create program weight based on particular track, and fine tune for maximum win percentage. Program designed for "ease of use." User needs no programming experience.
(Contains Integrated Beltor™) \$299.95 complete

Gold Dog Analysis™ \$149.95
The ONLY professional greyhound analysis available that evaluates ALL variables. Limited Version \$299.95

Master Harness Handicapper™ complete \$159.95
Professional software designed to provide a thorough analysis of all trotter and pacer races in the United States and Canada. w/Integrated Beltor \$199.95 Limited \$299.95

Lottery Analysis. Statistical comparison program designed to detect subtle patterns in winning numbers and digits.
Lottery (3-4 digit) \$79.95 w/Lotto (Max. 99 Digits) \$99.95

FREE CATALOG

Professor Jones • 1940 W. State, Boise, ID 83702
CALL 342-6939 • VISA/MasterCard/AMEX Welcome
Terms: 48-Hour Free shipping of software. Add \$6 hardware! \$6 C.O.D. / \$6 UPS Blue / \$9 Out of Country. Idaho residents add 4%. 3 weeks personal checks. Cash price only. Add 2% VISA/MasterCard, AMEX. Prices subject to change.

★ Your BEST BET in Handicapping Software Reviewed by Whole Earth Software Guide, and Corona Data Systems ★

Inquiry 272

Color Diskettes BY T CenTech

The Colorful Solution to Data Organization™

TIMELESS WARRANTY

SS-DD QTY. 100 DS-DD
***69¢** Color Bulk **89¢**
85¢** Color Boxed **\$1.05
.99¢** Color Bulk 96 TPI **\$1.19*
\$1.98** DS-HD

IBM PC-AT Compatible Color Bulk
 100% error-free beyond 75% clipping level.
 Available in 12 useful assorted colors.
 Custom Labeling/Branding available.
 *Color Bulk w/Tyvek sleeves add 6¢. Label Kits 2¢.
 **Pre-packaged in Plastic Library Case/12. A \$4.95 value case for 20/disk extra. DISKS ARE OPAQUE™



***FREE! Headcleaning Diskette plus \$2.00/box rebate on H/C**

LIFETIME WARRANTY

SS-DD QTY. 5 BOXES DS-DD
99¢** w/FREE H/C Kit **\$1.32

\$1.29 ← w/Flip 'n' File/15 → \$1.69

\$1.97 ← 96 TPI → \$2.45

\$1.89 ← 3.5"/135 TPI → \$2.59

\$2.09 3.5"/135 TPI w/Flip 'n' File \$2.89*

DS-HD 96 TPI w/Free Headcleaning Kit \$2.89

DS-HD 96 TPI w/Flip 'n' File/15 \$3.19

3M Headcleaning Kit w/Free H/C Kit \$5.99

(After \$2.00 rebate with purchase of regular 3M disk)

3M Data Cartridges

	QTY. 5	QTY. 10
DC-100A	\$12.15	\$12.10
DC-1000	\$14.34	\$12.42
DC-300XLP	\$21.54	\$19.08
DC-600A	\$21.82	\$20.29

Nashua "Boxed" Diskettes

LIFETIME WARRANTY

SS-DD QTY. 10 BOXES DS-DD
75¢  **80¢**

\$1.95 3.5"/35 TPI \$2.65

Factory fresh in boxes of 10 with sleeves, user ID labels, write-protect tabs and reinforced hub ring.
 High Density for IBM PC-AT Compatible \$2.59

100% Error-Free **BULK** By Leading American Media Manufacturer one of the top 2

LIFETIME WARRANTY

SS-DD QTY. 100 DS-DD
55¢ w/hub ring **60¢**

	6¢ ea.	2¢ ea.
Tyvek envelopes		Labels
PRINTER RIBBONS		DISK STORAGE
Epson MX 70/80	\$2.68	Amray Media Mate
Epson MX-100	\$4.06	Disk Minder-II-75
Okidata 80, 82, 83, 92, 93	\$1.96	Micro Disk Minder-36
Okidata 84	\$2.95	

PRICE PROMISE: We will better any lower delivered price on the same products and quantities advertised nationally.
TERMS: FREE USE OF VISA AND MASTERCARD. American Express also accepted.
Shipping: Add \$3.00 per 100 diskettes or fraction thereof. Other items add \$3.00 for disk storage or headcleaning kit or dozen ribbons or C.O.D. orders. P.O. accepted from recognized institutions and schools on 2%-10 Net 30. Utah residents add 5% sales tax. Minimum order \$30.00.

TOLL FREE ORDER LINE:
1-800-233-2477
INFORMATION AND INQUIRIES:
1-801-942-6717

Computer Affairs, Inc.
 2028 E. FT. UNION BLVD., 105
 SALT LAKE CITY, UTAH 84121
 CALL: 1-800-AFFAIRS
 HOURS: 9AM-6PM M-F (Mtn. Time)

NEW EPROM PROGRAMMER

\$349

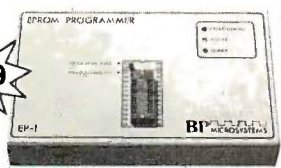

The EP-1 is a great value, here's why:

- IBM PC Compatible, Communication Disk included.
- Also works with CP/M and Development Systems
- Supports over 100 types including 2716 through 27512, CMOS, and A-Suffix Parts
- Menu Driven Chip Selection by Manufacturer end Part Number
- No Personality Modules
- Fast Programming Algorithm
- Gold Textool ZIF IC Socket
- RS-232, 7 baud rates to 9600
- Full One Year Warranty
- UV. Erasers from \$34.95

BP Microsystems

5325 Glenmont, Suite E, Houston, TX 77081
(713) 667-1636

Inquiry 39

REMOTE ANALOG DATA MONITORING BLOCKS:

SAV10 RS232 SERIAL ASCII VOLTMETER \$169

SAV11 RS422 SERIAL ASCII VOLTMETER \$239

MA15 RS232/RS485-RS422 INTERFACE \$149

- 4 analog voltage inputs of 0-2.55V, measured simultaneously at 8 bit resolution.
- Up to 4000 feet distance (SAV11).
- Stand alone operation.
- Selectable data rate.
- Low power consumption.
- Rugged, compact package.

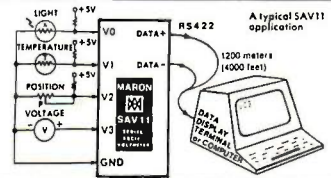

MARON PRODUCTION INC.

DISCOVERY PARK, 105-3700 GILMORE WAY
 BURNABY, B.C., CANADA V5G 4M1
 Phone: (604) 435-6211

Inquiry 206

9-TRACK MAG. TAPE SUBSYSTEM FOR THE IBM PC/XT/AT

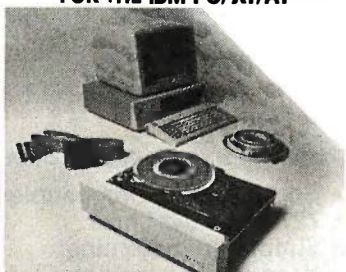

For information interchange, backup and archival storage, IBEX offers a 9-track, IBM format-compatible 1/2" magnetic tape subsystem for the IBM PC, featuring:

- 42 M-Bytes on a single reel.
- IBM format 1600 cpl.
- Software for PC-DOS, MS-DOS.

IBEX
 IBEX COMPUTER CORP.
 20741 Manilla St.
 Chatsworth, CA 91311
 (818) 709-8100
 TWX 910-493-2071

Write, phone or TWX for information

Inquiry 158

PC EXPANSIONS

AST SixpackPlus (384K)	\$259
Advantage (128K)	\$369
Advantage (1.5M)	\$499
Advantage (3M)	\$759
Rampage (2M)	\$469
RampageAT (2M)	\$599
INTEL AboveAT (2M)	\$629
Quadboard (384K)	\$239
Gold Quadboard (384K)	\$429
LibertyAT (2M)	\$135
QuadportAT	\$589
Teemar Maestro (2.5M)	\$299
HERCULES graphics board	\$159
Color Card	\$349
HAYES Smartmodem1200B	\$389
Smartmodem1200	\$100
Maynard Disk Controller	\$call
Sandstar Series	\$979
MaynStream Tape backup from	\$769
WDFile Card (10M)	\$789
Tandon Diskard (20M)	\$10
Set of 9 chips (64K)	\$25
Set of 9 chips (256K)	\$119
8087-3	\$109
Qume 142A:\$99 Teac	\$109
Teac FD55BV (for AT)	\$109
CDC 9409:\$119 Tandon	\$139
Verbatim (Box of 10)	\$39
Maxell (Box of 10 for AT)	\$39

VLM Computer Electronics

10 Park Place • Morristown, NJ 07960
 (201) 267-3268

Quelo® 68000 Software Development Tools

Quelo Assembler Packages are Motorola compatible. Each package includes a macro assembler, linker/locator, object librarian, utilities for producing ROMable code, extensive indexed typeset manuals and produces S-records, intel hex, extended TEK hex, UNIX COFF and symbol cross references. Portable source written in "C" is available. It has been ported to a variety of mainframes and minis including VAX.

68020 Assembler Package
 For CP/M-86, -68K and MS/PC-DOS \$ 750

68000/68010 Assembler Package
 For CP/M-80, -86, -68K and MS/PC-DOS \$ 595

68000 "C" Cross Compiler
 For MS/PC-DOS by Lattice, Inc.
 With Quelo 68000/68010 Assembler Package \$1095
 With Quelo 68020 Assembler Package \$1250

Call Patrick Adams today: Quelo, Inc.
 2464 33rd W. Suite #173
 Seattle, WA USA 98199
 Phone 206/285-2528
 COD. Visa, MasterCard Telex 910-333-8171

Trademarks: CP/M, Digital Research; MS, Microsoft Corporation; Quelo, Quelo, Inc.

Inquiry 283

LEARN C

THROUGH OUR NEW VIDEO TRAINING COURSE

A PROGRAMMER'S INTRODUCTION TO C—This three-hour video tape with text that takes a programmer from an introductory level thru to arrays and pointers. (Introductory Price \$400.)

Also available: our courses on COMPUTER LITERACY, BASIC TELECOMMUNICATIONS and LOCAL AREA NETWORKS.

Call us today for a 15 DAY FREE TRIAL (or request our complete course catalog).

408-374-1235

the INFORMATION FACTORY
 1259 Folsom St. • San Francisco, CA 94103
 (408) 374-1235

FANSI- CONSOLE™

The Integrated Console Utility™
All the little things IBM forgot!
for IBM—PC, XT, AT & clones.

- 1.2 to 3.0 times faster DOS & BIOS screen writing
- more escape sequences than ANSI.SYS
- usable in any language
- scroll recall facility
- compatibility w/PC & AT software
- full EGA support
- 255 character typeahead buffer
- increase key repeat rate
- no scroll blink for some adaptors
- VT 100/52 emulation
- auto dual screen disable
- keyboard induced breakpoints
- window support
- support for 50 line display
- many many more little features

400p Manual (w/slip case) & disk \$75, or just Shareware disk \$25. As described in *PC-World* February 86, pg. 282 and in *Lotus* June 85, pg. 8.

HERSEY MICRO CONSULTING, INC.
Box 82761, Ann Arbor, MI 48107
(313) 994-3259 x525 VISA/MC

Inquiry 155

Set up a complete graphics workstation on your PC for under \$100!

MicroPlot's enhanced PC-PLOT-III graphics emulator software package enables IBM PC and compatibles to appear to a mainframe as a DEC VT-100/VT-52, a Retrographics VT-640, a Tektronix 4010/4014 or a partial Tektronix 4027. Over 12,000 copies are currently in use world-wide at major corporations, educational facilities, research labs and independent consulting firms.

For more information call toll free
1-800-338-0333, Ohio call 1-800-242-0333
Give operator this ID number: 766-8501.



659-H Park Meadow Road
Westerville, Oh 43081 614/882-4786

Inquiry 399

You need a Printer Sharing Unit.

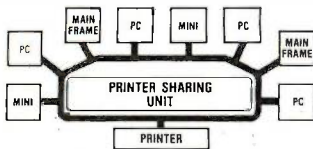

Not another printer.

Save the cost of your next printer with our Printer Sharing Unit. Up to 8 computers can use one printer, automatically, without changing cables.

This rotating electronic switch scans the input ports. When it finds one ready to transmit, it locks-on and puts the printer to work. Printing completed, it starts scanning again.

For a demonstration or more information call us at (206) 355-0590, and we will give you the name of your dealer nearest you.



4-Channel \$395.00
8-Channel \$595.00

Datacom Northwest, Inc.
3303 112th St. SW, Everett, WA 98204

Inquiry 108

OC8000

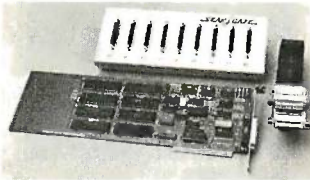

EXPANDS PC PERFORMANCE AT A FRACTION OF NETWORKING COST

- Adds four to eight serial communication ports to IBM PC, XT, AT or compatibles.
- Standard RS-232 or optional RS-422 ports for increased transmission speed and distance.
- Supported by Xenix, Multi-Link, RTCS, QNX, and other multi-user, multi-tasking operating systems.

STAR GATE TECHNOLOGIES, INC.

Suite 109
33800 Curtis Blvd. • Eastlake, OH 44094
Call: (216) 951-5922

Inquiry 323

STRIKE™ \$29.95 for the IBM PC

Perfect for secretaries, executives,
students, and writers

- Check spelling as you type
- Replace incorrect words
- Show similar words
- Add words to dictionary
- Dynamic paragraph checking
- Fast full screen checking
- Works with most word processors
- 49,000 word dictionary

Send check or money order to:

STRIKE
S & K Technology, Inc.
4610 Spotted Oak Woods
San Antonio, TX 78249
512-492-3384

Most orders filled by return first class mail.
Texas residents please add the appropriate
sales tax.

Inquiry 291

maxell® BULK DISKETTES

5 1/4" SS/DD \$.70

Prices based on quantities of 500

CARTRIDGE RIBBONS

EPSON MX 70/80 \$4.68

Prices based on quantities of 24.
Orders shipped within 24 hours.

1-800-222-0490
201-462-7628 in N.J.

MEGAsoft

PO Box 710, Freehold, N.J. 07728

Inquiry 212

PC XT
\$799
ASSEMBLED & TESTED (48 HRS)

QUANTITY PRICES AVAILABLE

FEATURES

640K 2-360K Drives Clock-cal.
RS 232 PORT-PARALLEL PORT-GAME PORT
RAM DISK-PRINT-SPOOLER-ENHANCED KEYBOARD

**8 SLOT XT MOTHER BOARD — IBM™ XT COMPATIBLE-8088
MICRO PROCESSOR WITH 8087 SLOT-150 WATT POWER
SUPPLY-CAN HANDLE 2 HARD DRIVES-ENHANCED KEY-
BOARD WITH LIGHTED NUMBER AND CAP LOCKS.**

RUN
FLIGHT SIMULATOR LOTUS @BASE
I.B.M. DIAGNOSTICS DOS 2.1 MS-DOS

HARD DISKS

10 MEG HARD DRIVE	\$395	 Amber or Green MONITOR \$79
20 MEG HARD DRIVE	\$499	
COLOR GRAPHIC CARD	\$99	

MARC BAER ASSOCIATES
1750 SKIFFLACK PIKE, SUITE 309
BLUE BELL, PA 19422
(215) 279-7961

Inquiry 203

ICs PROMPT DELIVERY!!! SAME DAY SHIPPING (USUALLY)

OUTSIDE OKLAHOMA - NO SALES TAX

V20 \$16.00 V30 \$17.50

8087-2 Math Coprocessors 150.00

DYNAMIC RAM

256K 64Kx4 150 ns \$4.75

256K 256Kx1 120 ns 3.37

256K 256Kx1 150 ns 2.79

128K 128Kx1 150 ns 4.75

64K 16Kx4 150 ns 2.50

64K 64Kx1 150 ns 1.35

EPROM

27C256 32Kx8 250 ns \$7.35

27128 16Kx8 250 ns 3.15

27C64 8Kx8 250 ns 3.75

2764 8Kx8 250 ns 2.95

STATIC RAM

6264LP-15 8Kx8 150 ns \$3.15

640 Kbyte MOTHERBOARD KITS: Zenith 150 - \$75.22
IBM PC/XT - Compaq Portable & Plus: \$70.22

QUANTITY ONE PRICES SHOWN,
100 ns 256Kx1 D-RAM at \$5.95

OPEN 6 1/2 DAYS - WE CAN SHIP VIA FED-EX ON SAT.

NO EXTRA COST FOR FED-EX SAT DELIVERY ON ORDERS RECEIVED BY THE SAT AIR 5P/4 PM FR. PRIOR 3/12/82

MasterCard/VISA or UPS CASH COD
Factory New, Prime Parts
MICROPROCESSORS UNLIMITED, INC.
24,000 S. PEORIA AVE.,
BEGGS, OK. 74421
(918) 267-4961

Prices shown above are for Feb. 24, 1986

Please call for current prices. Prices subject to change. Please expect higher or lower prices on items in short supply & demand and on changing costs. Shipping & insurance extra. Cash discount prices shown. Orders received by 6 PM CST can usually be delivered to you by the next morning, via Federal Express Standard Air @ \$6.00, or Priority One @ \$13.00!

Inquiry 224

NO SHIPPING CHARGES ORDER TOLL-FREE 800-824-3432

In California Call (818) 341-8833

DRIVES

1/2 HI. IBM™ Compatible	89.99
Tandon 100-2	99.99
Tandon 100-4 (96 tpi)	129.99
Tandon 848-2	299.99

ADD ON CARDS

Multi-Function w/OK	119.99
Monochrome Graphics	99.99
Color Graphics	109.99

MONITORS

Princeton Graphics MAX 12E	159.99
Princeton Graphics HX 12E	439.99

SYSTEMS

PC/XT Compatible	699.99
------------------	--------

HARD DRIVE SUB-SYSTEMS

10 Meg.	449.99
20 Meg.	549.99

We carry a complete line of electronic components.
Call or write for our free catalog!



NICORN ELECTRONICS
10010 Canoga Ave. - Unit B-8, Chatsworth, CA 91311

Minimum order \$10.00 - No shipping charges on prepaid orders - C.O.D. add \$3.00 - UPS Blue add \$3.00 - Call residents add 6% sales tax - Personal checks - credit - clearance - VISA - MC

Inquiry 351

P.C. Computer Brokers Inc.

The Place To Buy Your Epson Printers

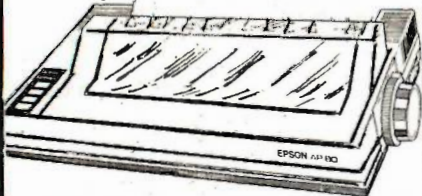

EPSON® AP-80 Dot Matrix Printer. Plug in Compatible

Full Line of Epson & Other Accessories
List \$379.00
\$299.00

Epson Printers	List	SALE
Homewriter Printer	\$249 ⁰⁰	\$199⁰⁰
Spectrum LX-80 Printer	\$299 ⁰⁰	\$209⁰⁰
LX-90 Printer	\$329 ⁹⁵	\$229⁰⁰
RX-100 Printer	\$499 ⁰⁰	CALL
FX-85 Printer	\$499 ⁰⁰	\$330⁰⁰
JX-80 Color Printer	\$699 ⁰⁰	\$295⁰⁰
LQ-1500 Printer	\$1295 ⁰⁰	\$899⁰⁰
SQ-2000 Ink Jet Printer	\$2295 ⁰⁰	\$1579⁰⁰

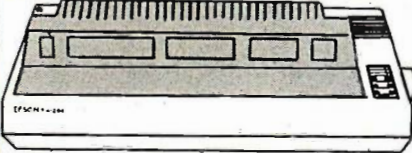

EPSON 1 EPSON FX-286
List \$799⁰⁰
\$495⁰⁰

Epson Printers	List	SALE
HS-80 Ink Jet Printer	\$449 ⁰⁰	\$339⁰⁰
DX-10 Daisywheel	\$299 ⁰⁰	\$230⁰⁰
DX-20 Daisywheel	\$459 ⁰⁰	\$330⁰⁰
DX-35 Daisywheel	\$899 ⁰⁰	\$619⁰⁰
Comrex High Speed Printer	\$2295 ⁰⁰	\$1449⁰⁰
HI-80 Four Pen Plotter	\$599 ⁰⁰	\$359⁰⁰

Call Toll FREE **1-800-245-4122**

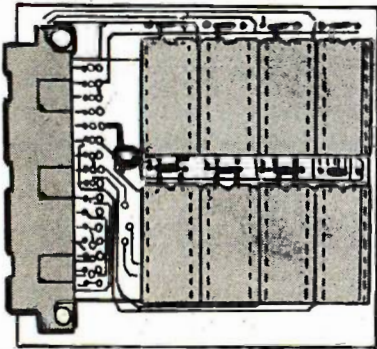

Our Own Make New RAM Card For Epson Equity I
Only **\$99⁰⁰**

- Able to bring the mother board to 512K
- 1/2 the size of other cards
- Save up to \$70.00
- 3 year warranty

These Prices are Good For Mail Order Dept. Only

P.C. Computer Brokers Inc.
3879 East 120th Ave.
Thornton, CO 80233
(303)450-6727

Call Toll FREE **1-800-245-4122**

Nashua Diskettes

5 1/4" DS/DD with hub ring and sleeve, factory warranted, packaged in 50's. Shipping Extra. Quantity 50, 85¢ each.

The same low price our volume customers pay!
75¢ each Qty. 100

We sell 3 1/2" & 5 1/4" disks—all types, major brands. Call toll free:

1-800-321-4668

in Colorado, 303-234-0871

VISA, MASTERCARD, OR COD ACCEPTED

ALF 1315-F Nelson St. Denver, CO 80215

Inquiry 13

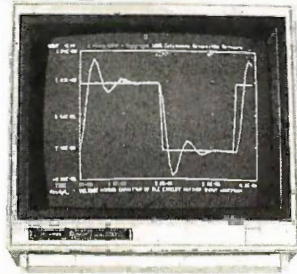

Free Engineering Software Brochure

Micro-CSMP simulates any system including: •Control and Servo Systems •Robotics •High Order Filters •Chemical Processes •Stress & Strain. A full implementation of IBM's S/360 CSMP, Micro-CSMP produces graphical results in minutes, typically requiring 10-20 lines of input. **LSAP** analyzes linear systems producing Bode, Nyquist, and Transient Response plots, and Root-Locus diagrams. Micro-CSMP is \$900, LSAP is \$450 for PC-DOS or MS-DOS systems. **California Scientific Software**, 25642 Hazelnut, El Toro, CA 92630, (714) 581-7654.

Inquiry 48

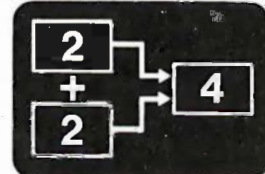

PICTURES THAT THINK

Boxes & Arrows™ is an IBM PC-based block diagram editor and computing system. If you are looking for something more than a spreadsheet, **Boxes & Arrows** will let you combine computation with pictorial representation.

- Automatic box & line drawing
- Labels and algebraic formulas
- Any printer, any display
- No limit to diagram size
- Call or write for full details



Inner Loop Software
5456 McConnell Avenue
Los Angeles, CA 90066
(213) 822-2800

Inquiry 164

DYNAMIC RAMS

41256	100ns	\$4.85
41256	120ns	\$3.35
✓41256	150ns	\$2.75
4164	120ns	\$1.40
✓4164	150ns	\$1.30
4464	150ns	\$5.50

PROCESSORS			E. PROMS		
8087-2	8MHz	\$130.00	27C256	250ns	\$8.50
8087-3	5MHz	\$120.00	27256	250ns	\$4.75
80287-3	6MHz	\$195.00	27128	250ns	\$2.75
80287-8	8MHz	\$ CALL	27C64	200ns	\$3.75
V-20	8MHz	\$ CALL	2764	250ns	\$2.50
V-30	8MHz	\$ 20.00	2732A	250ns	\$2.75
STATIC RAMS			8000's (Parts in stock)		
6264P-15	150ns	\$2.95			

I.C. EXPRESS

15358 Valley Blvd., City of Industry, CA 91746
Phone: 818-369-2688 (Mon-Fri • 8-5)

ORDER TOLL FREE

(800) 892-8889 • (800) 882-8181

Outside California Inside California

CALL FOR CURRENT PRICES & VOLUME DISCOUNTS.

Price Shown for Cash + MasterCard/VISA add 3% more
Prices are subject to change. Minimum order \$10.00
California residents must add 6.5% sales tax.
Shipping & Handling: UPS Ground \$5.00, UPS Air \$7.00 (under 1 lb.)
ALL MERCHANDISE IS 100% GUARANTEED.

Inquiry 161

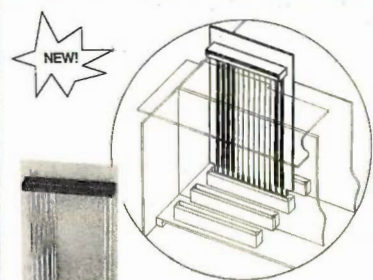

Now its easy to troubleshoot and debug IBM-PC type boards! With the CP1013-1 Right Angle Extender you have easy access to all components. No more standing up and holding the board under test each time you move or attach a scope probe. In addition, the CP1013-1 provides PC-BUS test points, each clearly labeled to ease de-bugging tasks!

ORDER TODAY! Send a check or money order for \$24.50 plus \$2.50 to cover shipping and handling to:

COMPUTER PRODUCTS INTERNATIONAL
P.O. BOX 639
NORTH-BOROUGH, MASS. 01532

COMING SOON: Right Angle Extenders for the PC-AT. In single slot and dual slot versions. For more information, Dealer inquiries, and quantity discounts, circle reader inquiry no.

Inquiry 84

Share A Printer or Modem without Switching

\$44.95
Each

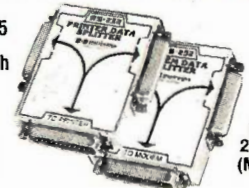

Model 232PDS (Printer)

Model 232MDS (Modem)

Both computers or terminals remain connected at same time. Both view same data. No power required. Data lines isolated by passive OR gates. **Order Now! \$44.95 each.** Specify unit desired. All cash orders ppd. (IL Res. add 6% sales tax), MC, VISA accepted. **FREE:** new illustrated catalog of RS-232 interface & testing equipment. Phone: 815-434-0846. Make checks payable to:

B & B electronics
MANUFACTURING COMPANY
P.O. Box 1008B, OTTAWA, IL 61350

Inquiry 28



TURBO-AT COMP. \$1795.00

DUAL SPEED 6 & 8 MHz; 512K RAM; HARD & FLOPPY CONT.; 1.2M DISK DRIVE; 200W POWER SUPPLY; MONOGRAPHIC CARD + PRINTER PORT; KEYBOARD; ENCLOSURE

TURBO-XT COMP. \$619.00
4.77 & 8 MHz CLOCK; 256K RAM; MONOGRAPHIC CARD + PRINTER PORT; 130W POWER SUPPLY; CASE; KEYBOARD; ONE DISK DRIVE
XT CASE LIKE AT LOOK \$48.00
5151 DUAL AT & XT KEYBOARD \$87.00
MONO MONITOR \$99.00

WEST COAST PERIPHERALS
2558 Seaboard Ave., San Jose, CA. 95131
Tel: (408) 435-5467; 435-8711
Telex: 3716630 AMT SF
DEALER & OEM INQUIRIES WELCOME

Inquiry 360

5 1/4" 3M FLEXYDISKS

Free headcleaner in each box. 5 1/4" only.

	10-90	100+
SS/DD Soft	\$1.09 ^{ea}	\$1.07 ^{ea}
DS/DD Soft	\$1.49 ^{ea}	\$1.47 ^{ea}
High Density (IBM-AT)	\$3.29 ^{ea}	\$3.19 ^{ea}
3.5/SS Micro	\$2.35 ^{ea}	\$2.25 ^{ea}

In Stock — Immediate Shipment.
Mastercard, VISA, Check or Money Order.
Add \$3.00 shipping charges per each 100 or part.
Add \$2.50 additional for C.O.D. shipments.
N.J. residents add 6% sales tax.

Data Exchange
Dept. B, P.O. Box 993
178 Route 206 South
Somerville, N.J. 08876
(201) 874-5050

Inquiry 105

COMPUTERIZED CONCEPTS

(813) 545-1996

4333 66TH ST. N.
ST. PETERSBURG, FL 33709

PC, XT, AT, & COMPATIBLES

From the "Common Sense" software company that brought you **CatMaster**, comes another unique package!

PlayBook Football The best yet! You can play another opponent, not just your computer! Save records/stats. on winners; 30 options, you choose plays! Based on actual stats. Realistic action!
Only \$37 & 300 S&H!

Ask us about our revolutionary new "GENERIC" Business Management System which you can customize for your needs! Comes with "source codes"!

Inquiry 90

GFK MEMORIES

**ADD-IN BOARDS
PIN-FOR-PIN COMPATIBLE
EASY INSTALLATION**

HP 150	(All Versions)	
	512K	\$660
WANG PC	256K	\$460
	384K	\$635
	512K	\$750

GFK
Amandastr: 60, 2000 Hamburg 6
West Germany
Phone (40) 4301051
Telex 2162272

Dealers are invited

US Distributor:
HyPoint Technology (216) 526-0323

Inquiry 141

"CPYAT2PC"

IS LIKE HAVING A
FREE
360K FLOPPY DRIVE

Allows copying of IBM AT file for use on IBM PC's & compatibles with no modification of existing hardware or software. A 360K floppy drive is not required. CPYAT2PC may reside on your IBM PC/AT hard disk and copies 1 file or entire subdirectories in 1 step. Also runs on other AT compatibles such as COMPAQ 286, ZENITH Z-200, and KAYPRO 2861. Dealer inquiries welcome. ONLY \$79 + shipping.

MICROBRIDGE COMPUTERS
Sky Way Building, Suite 125
655 Sky Way, San Carlos, CA 94070
(415) 593-8777 • (415) 595-2150
CHECK, COD WELCOME
(Prepayment Required)

Inquiry 221

ICs and Disk Drives

- 84K / 128K / 256K D-RAMs** at LOW PRICES
- H-P Vectra 128K Upgrade \$49.95**
- V20-5 \$14.00/V20-8 \$20.00/V30-8 \$18.00**
- 8087 \$115.00 / 8087-2 \$135.00**
- 80287-3 [5-MHz] \$195.00**
- CENTER External Modem w/Telephone**
*Intelligent 300/1200 Baud
*Compatible w/most popular modem **\$195.00**
- MEMORY BOARDS**
ABM (Multi-function) Superboard **\$120.00**
JRAM-2 Ramdisk w/2MB **\$349.00**
JRAM-3 Above Board w/2MB **\$399.00**
JRAM-AT Ramdisk w/2MB **\$399.00**
JRAM-AT-3 Above Board w/2MB **\$449.00**
- 155W Power Supply for IBM/PC,XT \$120.00**
- TEAC FD-55BV DS/DD Disk Drive \$92.00**
w/one year factory warranty
- 2732, 2764, 27128, 27256, 6116, 8264,**
etc. are available!

WARRANTY: All ICs are guaranteed for 180 days from the invoice date on defective items. We will replace them free of charge.

ExcelTec Industries, Inc.
P.O. Box 2205 Silver Spring, MD 20902
Phone: (301) 933-3523
OEMs and DEALERS are invited
CALL US FOR THE LATEST PRICES

Inquiry 129

\$99.00

5 1/4" Hard Disk Controllers
for Micromint COMM180 and others



SASI/SCSI to ST506 interface (all 5 1/4" hard disk drives)
EMULATES: XEBEC S1410
DTC 510
SCSI-similar to Adaptec 4000
WORKS WITH MANY POPULAR SYSTEMS
• Micromint COMM180
• Wavemate Bullet
• AMPRO Little Board — All Boards
• MAC, APPLE IIe
• ACS 1000
• ISI 5160
Ask about others

These Shugart 1610 boards are new, Shugart tested controllers are guaranteed 90 days. They will mount on a 5 1/4" hard disk drive. Manual and schematic available.

Computer Surplus Store
3675 Desoto Ave., Santa Clara, CA 95051
(408) 248-0134
Chuck Schuetz, proprietor
Quantity and Dealer pricing available

Inquiry 85

Heritage Systems Corp.

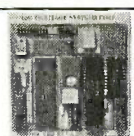

HSC-9128 Video Terminal Card
80 by 24 Alpha-numeric video display
ANSI X3.64 command set
TTL/CMOS serial port (50 to 38.4K baud)
Off card line drivers (RS-232, Fiber optic)
IBM PC compatible keyboard input
On Screen configuration utility
100 by 10mm, 5V only, 200mA
HSC-9128 video terminal card \$129
HSC-9128 with RS-232, cables \$159
HSC-9129 keyboard \$119
Amdek 300G Video monitor (Green) \$139
Amdek 300A Video monitor (Amber) \$149

PO Box 10588,
Greensboro, NC 27404-0588
(919) 274-4818

Inquiry 154



WEDGE-PC OEM PRODUCTS
PC-AT Compatible \$1695/one
512K RAM, 1.2M disk drive, hard disk & floppy disk controller, monochrome card, 200W power, keyboard, enclosure.
PC-XT compatible \$595/one
256K RAM, one 340 disk drive, monochrome card, keyboard, 130W power, enclosure.
20M hard disk with control \$555
Color monitor \$319 Monochrome monitor \$109
Dealer call for qty price

WEDGE TECHNOLOGY INC.
1190 Mt. View-Alviso Rd., Suite R
Sunnyvale, CA 94089 (408) 734-9866
Telex 3719075 EDGE UB

Inquiry 358



MONITORS

- **ULTRA-HI 720x400 RESOLUTION** \$444
- **TATUNG 1370 RGB** \$449
- **AMDEK 710 RGB** \$498
- **TAXAN 640 RGB**

FLOPPY DRIVES

- **PANASONIC 1/2 Ht. PC compatible** \$92
- **SANYO 1/2 Ht. PC compatible** \$83
- **APPLE II compatible, including cable** \$98

AEGIS ANIMATOR

Animation package for the AMIGA™ computer. Includes "Images" paint program. The ultimate drawing/animation program for the serious amateur or professional.

SPECIAL INTRODUCTORY PRICE

\$93

SOFTWARE

- **Dbase III PLUS** \$363
- **FRAMEWORK II** \$349
- **JAVELIN** \$529
- **MICROSOFT Word v2.0/Ready** \$229
- **MICROSOFT Windows** \$62
- **PFS: First Success (Wrt/File Plan)** \$209
- **R:Base 5000** \$339
- **SIDEWAYS v3.0** \$43
- **SIDELICK 1.5 NCP** \$47
- **SIDELICK MAC** \$47
- **SUPERKEY 1.1** \$39
- **TURBO PASCAL 3.0** \$39
- **TURBO EDITOR TOOLBOX** \$41
- **TURBO "NEW" PACK (Gameworks & Editor Toolbox)** \$54
- **TURBO HOLIDAY JUMBO JACK** \$144

WORLDWIDE EXPLODES

YOU LIKE IT, OR WE TAKE IT BACK!

If for any reason, you are not satisfied with any product you purchase, you may return it within 10 days of receipt for replacement, credit or refund.*

WE'LL PAY YOU IF YOU FIND A LOWER PRICE!

If you buy any item from us at pricing in this ad and find a lower price from any source in this issue, that has the identical product in stock, we'll not only refund the difference you paid, but also pay you 20% of the difference for your trouble! If you find a lower price in this issue before you buy, from any source that has the identical product in stock, we'll beat it! **

MULTITECH MULTIFUNCTION BOARD

AST Sixpack™ compatible. Serial port, Parallel port, Game port, Clock/Calendar, RAMDISK and PSPPOOL software. Up to 384K memory expansion. OK installed

\$96

1 Year Warranty

COMPLETE INTERNAL HARD DRIVE SYSTEMS

Includes drive, PC/XT controller card, cables and install procedures. Capacities listed are FORMATTED. We sell only the finest drives from Seagate, Mitsubishi, Microscience and others, guaranteed to meet or exceed original manufacturer's specifications. Boots from hard disk.

- **10MB 1/2 Ht. 85ms** \$388
- **20MB 1/2 Ht. 85ms** \$424
- **30MB Full Ht. 40ms** \$788
- **40MB Full Ht. 40ms** \$928

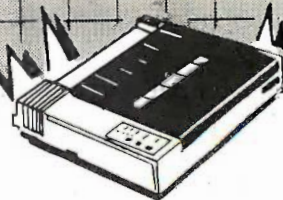

NAME BRAND 100CPS 80 COLUMN DOT MATRIX PRINTER

The perfect addition to any computer, where high quality at moderate speed is required. Parallel interface, friction & tractor feed. Factory closeout pricing! 1 year warranty.

\$148

30 Megabytes for the Price of 20!

The latest technology from Adaptek provides 30 megabytes of storage from a standard 20 megabyte hard-disk drive. Complete system including Adaptek controller, microscience disk drive, cables and install procedures.

\$499

Dealers: Call for quantity prices!

IN CALIFORNIA

OUTSIDE CALIFORNIA

800-358-8881 800-826-3736

6311 L DeSoto Avenue • Woodland Hills, California • 91367 • Phone: (818) 703-7996
Hours: 7:00AM-6:00PM Pacific Time

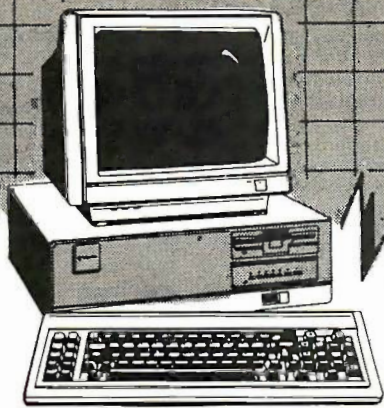

SPERRY PC/HT

PC/XT compatible, 8088-2 switchable 2 speed micro-processor, 256K RAM, 1-360K floppy, RS-232 port, Tatung Monochrome monitor, clock/calendar and 5150 style keyboard. Includes MS-DOS, GW Basic, diagnostics and tutorial disks.

\$1495

ZOOM 1200

1200/300 baud, auto answer/auto dial, Hayes™ (AT) compatible internal modem. Demon dialer, monitor speaker, tone/pulse dialing, dual phone jacks, call progress tone detection. 2 Year Warranty. Made in USA.

\$199

INCLUDING SOFTWARE!

BORLAND

- TRAVELING SIDEKICK \$40
- TURBO LIGHTNING \$55
- REFLEX \$55

PRICES!

GUARANTEED AVAILABILITY!

Any item you order will be shipped within Two working days or you will be given a firm ship date when you order! If for any reason we cannot ship by the date you are given, we will deduct 5% from the price of the products shipped late and credit your order accordingly. **

ACCESSORIES

PC POWER SUPPLIES:

- 150 WATT KEYBOARDS: IBM/XT™ and KEYTRONICS™ COMPATIBLE \$88
- 5150 style \$69
- 5151 style \$89

SEAGATE HARD DISK DRIVES FOR PC/AT*

Includes cables, manual & mounting rails

- 20MB Full ht. 40ms \$566
- 30MB Full ht. 40ms \$677
- 40MB Full ht. 40ms \$844

TAPE BACK-UP

- ALLOY 60Mb internal \$775

BOARD PRODUCTS

- MULTITECH 2 Drive PC floppy controller \$45
- MULTITECH 4 drive PC floppy controller \$58
- Western Dig. 1002SWX2 PC/XT Hard disk cont \$138
- Western Dig. 1002WA2 PC/AT Hard/Floppy cont \$276
- MULTITECH 384K mem. exp. board w/128K \$72
- AST Sixpack + (64K) w/Sidekick & DESQview \$227
- MULTITECH Mono Graphics 720x348, Hercules™ compatible with parallel port & light pen interface \$112
- AST PREVIEW! Mono graphics, Hercules™ compatible with parallel port, P-Spool and RAM Disk soft \$234
- HERCULES graphics board \$286
- MULTITECH color graphics board (1-2-3 comp.) \$98
- HERCULES color board \$144
- TAXAN 553 Ultra Hi Res color board \$246
- SIGMA 400L Ultra Hi Res color board \$439

MODEMS

- ANCHOR VOLKSMODEM 300 baud (cable opt.) \$49
- ANCHOR VOLKS 6420 300 baud Commodore w/soft \$59
- ZOOM IIE AP int. 300 baud AA/AD Hayes™ comp w/ soft \$93
- ANCHOR Volksmodem 1200 (cable opt.) \$164
- SmarTEAM 103/212A 1200/300 baud external AA/AD Hayes™(AT) compatible 2 year warranty \$178
- ANCHOR EXPRESS! 1200/300 baud PC internal, AA/AD Hayes™(AT) compatible \$188
- NOVAION SMARTCAT + 1200/300 baud, int or ext AA/AD, Hayes™(AT) comp w/WRITE™ software \$299
- HAYES 1200B w/ Smartcom II \$333
- ANCHOR LIGHTNING 24 2400/1200/300 baud external Hayes™(AT) comp Built-in speaker \$338
- NOVAION 2400 Professional w/o software \$496
- NOVAION 2400 with MS-DOS or Macintosh software \$547
- HAYES 2400 \$568

MONITORS

- AMDEK 310A 12" Amber \$143
- AMDEK 600 \$399
- PRINCETON MAX-12 Amber \$166
- PRINCETONHX-12E RGB \$544
- TAXAN 122 monochrome \$137
- TAXAN 620 \$392
- TATUNG DM12VL 12" green composite 1000 line res \$118
- TATUNG 1222A 12" Amber TTL 1000 line res \$118
- TATUNG 1360 13" Hi-Res RGB 640 X 200 \$367

PERSYST STRETCH 2 MEGABYTE PC EXPANSION BOARD

Bank switched memory board supporting the LOTUS™, Ashton-Tate™ expanded memory spec. With Print Spool and RAM Disk software. Uses 256K chips.

O-K	1-Mb	2-Mb
\$188	\$292	\$388

COMPONENTS

Quality mfg. from companies like FUJITSU, HITACHI, OKI, NEC, SAMSUNG and TOSHIBA

- 256K DRAMS Set of 9-150ns \$26.46
- 64K DRAMS Set of 9-150ns \$8.91
- 128K DRAMS price each \$3.50
- 8087-3 \$135.00
- 8087-2 \$179.00
- 80287 \$11.00
- Y20-5MHz \$13.00
- Y20-8MHz \$16.00
- Y30 replaces 8086 \$11.00
- 8086 \$2.90
- 8088 \$4.80
- 27128 \$2.98
- 27256 \$2.98
- 2764 \$2.98

FUJI DS/DD Bulk In White Box

With sleeves, labels and slip tabs. Priced per box of 10

1-19	20-99	100-499	500-999	1000+
9.75	9.00	8.40	7.90	7.50

FUJI DS/DD Bulk w/o box, sleeves, labels or w/p tabs

Price each, in increments of 20 only, poly bagged

60-180	200-480	500-980	1000-4980	5K+
.85	.77	.72	.67	.63

**IF YOU DON'T SEE IT, CALL!

We have virtually any product available at the best pricing. Space limits us to only a fraction of what we sell. Call us for a quote and delivery information. If we don't have it, we'll try to get it for you! All items priced and in stock at time of ad placement and subject to vendor change and prior sale at time of ad publication.

*THE FINE PRINT

Excluding software, Prior return authorization required; all items returned must be in original condition with carton, packing and all manuals, etc., some returns may involve a restocking charge. We accept Cashier and Certified checks, Money Orders, personal and company checks (product shipped when check clears), VISA and MasterCard with no surcharge and American Express (4% surcharge). All products shipped UPS ground (freight FREE for orders over \$150), unless specified otherwise. All normal manufacturer's warranties apply.



WORLDWIDE ACCESS

Inquiry 370

EVERYBODY HATES US, BUT OUR CUSTOMERS!

Super DiskTM Diskettes

Now...Diskettes you can swear by, not swear at.

Lucky for you, the diskette buyer, there are many diskette brands to choose from. Some brands are good, some not as good, and some you wouldn't think of trusting with even one byte of your valuable data. Sadly, some manufacturers have put their profit motive ahead of creating quality products. This has resulted in an abundance of low quality but rather expensive diskettes in the marketplace.

A NEW COMPANY WAS NEEDED AND STARTED

Fortunately, other people in the diskette industry recognized that making ultra-high quality diskettes required the best and newest manufacturing equipment as well as the best people to operate this equipment. Since most manufacturers seemed satisfied to give you only the everyday quality now available, an assemblage of quality conscious individuals decided to start a new company to give you a new and better diskette. They called this product the *Super Disk* diskette, and you're going to love them. Now you have a product you can swear by, not swear at.

HOW THEY MADE THE BEST DISKETTES EVEN BETTER

The management of *Super Disk* diskettes then hired all the top brains in the diskette industry to make the *Super Disk* product. Then these top bananas (sometimes called floppy freaks) created a new standard of diskette quality and reliability. To learn the "manufacturing secrets" of the top diskette makers, they've also hired the remaining "magnetic media moguls" from competitors around the world. Then all these world class, top-dollar engineers, physicists, research scientists and production experts (if they've missed you, send in your resume to *Super Disk*) were given one directive...to pool all their manufacturing know-how and create a new, better diskette.

HOW SUPER DISK DISKETTES ARE MANUFACTURED

The *Super Disk* crew then assembled the newest, totally quality monitored, automated production line in the industry. Since the manufacturing equipment at *Super Disk* is new, it's easy for *Super Disk* to consistently make better diskettes. You can always be assured of ultra-tight tolerances and superb dependability when you use *Super Disk* diskettes. If all this manufacturing mumbo-jumbo doesn't impress you, we're sure that at least one of these other benefits from using *Super Disk* diskettes will:

- TOTAL SURFACE TESTING** - For maximum reliability, and to lessen the likelihood of disk errors, all diskettes must be totally surface tested. At *Super Disk*, each diskette is 100% surface tested. *Super Disk* is so picky in their testing, they even test the tracks that are in between the regular tracks.
- COMPLETE LINE OF PRODUCTS** - For a diskette to be useful to you and your computer, it must be compatible physically. *Super Disk* has an entire line of 5 1/4-inch and 3 1/2-inch diskettes for your computer.
- SPECIALLY LUBRICATED DISK** - *Super Disk* uses a special oxide lubricant which is added to the base media in the production of their diskettes. This gives you a better disk drive head to media contact and longer head and disk life.
- HIGH TEMPERATURE/LOW-MARRING JACKET** - A unique high temperature and low-marring vinyl jacket allows use of their product where other diskettes won't work. This special jacket is more rigid than other diskettes and helps eliminate dust on the jacket.
- REINFORCED HUB RINGS** - Standard on all 48 TPI *Super Disk* mini-disks, to strengthen the center hub hole. This increases the life of the disk to save you money and increase overall diskette reliability.
- DISK DURABILITY** - *Super Disk* diskettes will beat all industry standards for reliability since they will give you more than 75% of the original signal amplitude remaining even after an average (Weibull B-50) of 30 million passes. They are compatible with all industry specifications as established by ANSI, ECMA, ISO, IBM and JIS.
- CUSTOMER ORIENTED PACKAGING** - All *Super Disk* disks are packaged 10 disks to a carton and 10 cartons to a case. The economy bulk pack is packaged 100 disk to a case without envelopes or labels.
- LIFETIME WARRANTY** - If all else fails, remember, all disks made by *Super Disk* Inc., have a lifetime warranty. If any *Super Disk* diskette fails to meet factory specifications, *Super Disk* Inc. will replace them under the terms of the *Super Disk* warranty.
- SUPERB VALUE** - With *Super Disk*'s automated production line, high-quality, error-free disks are yours without the high cost.

Order toll free 800-USA-DISK

NOW...NAME BRAND QUALITY AT SUPERCE PRICES

Now, you can buy *Super Disk* brand diskettes directly from Communications Electronics at prices less than "unbranded" generic diskettes. Your data is valuable, so why take chances using a diskette that could be so unreliable that the manufacturer refuses to put their name on it. To save you even more, we also offer *Super Disk* bulk product where 100 diskettes are packed in the same box without envelopes or labels. Since we save packaging costs, these savings are passed on to you. 5 1/4" diskette envelopes are also available from us. These super strong and tear resistant envelopes are only \$10.00 per pack of 100. Use order # CV-5 for a 100 pack of 5 1/4" diskette envelopes.

39¢ per disk Quantity One

Our diskettes are packed 10 disks to a carton and 10 cartons to a case. The economy bulk pack is packaged 100 disks to a case without envelopes or labels. For best value, you should order in increments of 100 diskettes. Almost all diskettes are immediately available from *Super Disk*. With our efficient warehouse facilities, your order is normally shipped in less than a day.

SAVE ON SUPER DISK™ DISKETTES

Product Description	Part #	Super Disk price per disc (\$)
5 1/4" SSSD Soft Sector w/Hub Ring	6431-FA	0.64
5 1/4" Same as above, but bulk pack w/o envelope	6437-FA	0.39
5 1/4" SSDD Soft Sector w/Hub Ring	6481-FA	0.68
5 1/4" Same as above, but bulk pack w/o envelope	6487-FA	0.43
5 1/4" DSDD Soft Sector w/Hub Ring	6491-FA	0.74
5 1/4" Same as above, but bulk pack w/o envelope	6497-FA	0.49
5 1/4" DSQD Soft Sector (96 TPI)	6501-FA	1.09
5 1/4" Same as above, but bulk pack w/o envelope	6507-FA	0.84
5 1/4" DSHD for IBM PC/AT - bulk pack	6667-FA	2.07
3 1/2" SSDD (135 TPI) - bulk pack	6317-FA	1.67
3 1/2" DSDD (135 TPI) - bulk pack	6327-FA	1.99

SSSD = Single Sided Single Density; SSDD = Single Sided Double Density; DSDD = Double Sided Double Density; DSQD = Double Sided Quad Density; DSHD = Double Sided High Density; TPI = Tracks per inch.

BUY YOUR DISKETTES FROM CE WITH CONFIDENCE

To get the fastest delivery of your diskettes, phone your order directly to our order desk and charge it to your credit card. Written purchase orders are accepted from approved government agencies and most well rated firms at a 10% surcharge for net 10 billing. For maximum savings, your order should be prepaid. All sales are subject to availability, acceptance and verification. All sales are final. All prices are in U.S. dollars. Prices, terms and specifications are subject to change without notice. Out of stock items may be placed on backorder or substituted for equivalent product unless we are instructed differently. A \$5.00 additional handling fee will be charged for all orders with a merchandise total under \$50.00. All shipments are F.O.B. CE warehouse in Ann Arbor, Michigan. No COD's. Non-certified checks require bank clearance. Michigan residents add 4% sales tax or supply your tax ID number and reason for tax exemption.

For shipping charges add \$6.00 per 100 diskettes and/or any fraction of 100 5 1/4-inch or 3 1/2-inch diskettes for U.P.S. ground shipping and handling in the continental U.S. For 1,000 or more disks shipped to the continental U.S., shipping charges are \$4.00 per hundred diskettes. UPS 2nd day air rates are three times continental U.S. rates. For Canada, Puerto Rico, Hawaii, Alaska, or APO/FPO delivery, shipping is three times the continental U.S. rate.

Mail orders to: Communications Electronics Inc., Box 1045, Ann Arbor, Michigan 48106-1045 U.S.A. If you have a Visa or Master Card, you may call and place a credit card order. Order toll-free in the U.S. Dial 800-USA-DISK. In Canada, order toll-free by calling 800-CA1-DISK. If you are outside the U.S. or in Michigan dial 313-973-8888. Telex anytime 810-223-2422. Order your *Super Disk* diskettes now.

Copyright © 1986 Communications Electronics Inc.

Ad #040186-FA



Now 39¢ a disk



COMPUTERBANC

FREE SHIPPING ON ALL SOFTWARE \$200 MIN.

HARD DRIVE KITS

20 MB Internal w/Controller **\$469**
30 MB Internal for AT **\$695**

* External Models Add **\$150**

TAPE DRIVES

20 MB | 45 MB | 60 MB
\$599 | \$899 | \$999

* File by File
* Mirror Image * Software Included

IBM PC AT 20 MB

(Seagate Model 225)
512 K. Serial, Parallel

\$4,299

STB RIO PLUS

\$239.00

6 Function 384K

COMPANION PC

\$189.00

0-2 meg, EMS

IBM PC XT

20 MB, 256K

CALL

CALL
256K, 2 Drive
IBM PC

COMPAG 286 PORTABLE

20MB, 640K

\$4,259

\$3,999

44MB, MONITOR

SPERRY IT

STB EGA PLUS

\$339.00

- 16 Colors, 256K, Parallel
- IBM Compatible

IBM PC COMPATIBLES

LEADING EDGE

ITT XTRA 2 Drive, 256K

AMIGA

PC Clone System

EQUITY 1

CALL

\$1,495

CALL

\$899

CALL

* All systems include monochrome monitor, DOS, and parallel port

IBM SOFTWARE

LOTUS 123	CALL
Symphony	CALL
ENABLE	359.00
ASHTON TATE Framework	369.00
dBASE II	279.00
dBASE III Plus	369.00
POWERBASE	CALL
CLIPPER dBASE III Compiler	355.00
LATTICE C COMPILER	249.00
MULTIMATE	225.00
MULTIMATE ADVANTAGE	269.00
SORCIM SUPERCALC III	199.00
MICROSOFT Multiplan	119.00
Word	225.00
Windows	55.00
Project	239.00
FOX & GELLER Quickcode	149.00
BOREALD TURBO PASCAL	39.00
REFLEX	55.00
LIGHTENING	55.00
SUPERKEY	39.00
SIDEKICK (unprotected)	46.00
ASCII PRO Comm Software	69.00
CROSTALK XVI	99.00
PEACHTREE Back to Basics	199.00
BPI GENERAL ACCOUNTING	303.00
OPEN SYSTEMS	CALL
REALWORLD	CALL
ONE-WRITE PLUS	149.00
IN-HOUSE ACCOUNTANT	89.00
ACCOUNTING PARTNER	199.00
MONOGRAM DOLLARS & SENSE	105.00
TOBIAS MANAGING YOUR MONEY	105.00
SATELLITE WORD PERFECT	225.00
MICROPRO WordStar PRO	249.00
WordStar 2000 PLUS	285.00
SAMNA WORD III	279.00
RBASE 5000	359.00
PRINTMASTER	35.00
BREAKTHROUGH TIMELINE	255.00
DICISION RESOURCES CHRTMSTER	219.00
ENERGRAPHICS w/plotter opt.	207.00
FUNK SIDWAYS	36.00
LIFETREE VOLKSWRITER DELUXE	149.00
HARVARD TTL PROJECT MNGR	285.00
THINKTANK	

ALSO HAYDEN, MONOGRAM, BPT, MICROCO-RIM, NORTON AND MORE

IBM HARDWARE

AST 6 Pack Plus w/384k	249.00
Advantage W/128k	399.00
STB Rio Plus 384K 5 function	239.00
RIO Grande 3 function for AT	289.00
Companion PC 0-2 MB	189.00
Chaufeur monographics	229.00
EGA- Plus Color Board	339.00
HERCULES Mono Graphics	319.00
Color Card	159.00
ORCHID Turbo w/256k	669.00
QUADRAM Quadboard 0-K	198.00
EGA + NEW	405.00
QuadPort for AT ser & par	115.00
TECHMAR Graphics Master	469.00
PARADISE Modular Graphics Card	CALL
SIGMA High Res Color 400	CALL
IBM Compatibles	
Multifunction Card 384ks, p.clck	169.00
Multifunction Card 0K-1, 2mb.	179.00
Compatible Mono Card w/par	129.00
Expansion Chasis	CALL
130 WAT Power Supply	85.00
MONOCHROME Graphics Card	110.00
Color Graphics Card	99.00
TALLGRASS W/Tape	CALL
IRWIN Tape Drive	414.00
EVEREX TAPE Pc/Xt/AT	CALL
Graphics Edge Card	249.00
TEAC 55B	95.00
1.2MB FLOPPY for AT	189.00
360K Floppy for AT	110.00
MOUSE SYSTEMS Mouse	117.00
FIELDMOUSE	113.00
MICROSOFT Mouse w/sftwr.	117.00
KOALA KAT	149.00
DISKETTES 2S DD	15.00

MODEMS

ANCHOR Express 300/1200	220.00
Volkmodem 1200 (5 yr wrnty)	169.95
Lightning 2400 Baud	CALL
HAYES 1200	379.00

1200B	349.00
2400	CALL
Micromodem //e	CALL
PROMOTHEUS 1200	CALL
Promodem 1200B	FOR
Promodem 1200A	BLOW-OUT
Promodem 300 IIC	PRICES
Promodem 2400	CALL

MONITORS

AMDEK 300A	139.00
310A Hi-Res Amber	155.00
Color 722 RGB 720 X 350	CALL
PRINCETON GRAPHICS HX-12	469.00
HX-12E RGB 720X350	CALL
SR-12	625.00
MAX-12	179.00
TAXAN 121/122	149.00
620 (RGB) 620 x 200 NEW	CALL
640 (RGB) 720 x 400 NEW	CALL
PANASONIC DT-S101 Color	141.00
DT-H103 10" High Res RGB	369.00
IBM COMPATIBLE Monochrome	99.00
Color RGB Monitor (640X200)	349.00

PRINTERS

PANASONIC (2 yr warranty)	
KX-P1080	199.00
KX-P1091	229.99
KX-P1092	305.00
KX-P1592	439.00
KX-P1595 240 CPS	659.00
KX-P3131 17cps Daisey	269.00
KX-P3151 22 cps Daisey	395.00
Citizen MSP-10	266.00
MSP-15	355.00
MSP-25	489.00
STAR MICRONICS SG-10	219.00
SG-15	399.00
EPSON LX-80	Call
FX-286	for
LQ-800	Best
LQ-1000	Prices
BROTHER	
Twinwriter 5	

We Will Beat Any Advertised Price

OKIDATA - All Models	CALL
TOSHIBA All Models	CALL
CANNON Laser Printer	CALL
HEWLETT PACKARD PRINTERS	CALL
HOUSTON INSTRUMENTS Plotters	CALL
Digitizers	CALL

APPLE PRODUCTS

AST Multi 1/0	CALL
MICRO SCI A2 Drive IIC	169.00
IIC compatible drive	139.00
APPLE Compatible Drive	119.00
MAC Compatible 3 1/2 drive	229.00
BERNOULLI 5MB MAC drive	CALL
MACINTOSH Harddrive	CALL
MICROSOFT Macenhancer	CALL
Softcard II	259.00
Multi-plan //e & Mac Basic (Mac)	129.00
ASCI XPRESS (Communications)	69.00
THE DESK ORGANIZER (Mac)	133.00
APPLE MOUSE II	129.00
APPLEWORKS	219.00
SPELLWORKS 49.00PRINTSHOP	35.00
Mach III Joystick	39.00
SYSTEM SAVER Fan	69.00
VIDEO 7 IIC Enhancer	CALL
Titan Accelerator	229.00
VIDEX Ultratrm	169.00
APRICORN (Lifetime Warranty) Super Serial Imager	75.00
Graphics Interface	65.00
80 Column/64K	75.00
EXTEND IT 64K	55.00
KOALA SpeedKey	99.00
DISKETTES APPLE/MAC	12.00/24.00

Look for our Bulletin Board Featuring Multi-user Games

Call for catalog. Thousands of products available. Volume discounts.



COMPUTERBANC

16783 Beach Blvd., Huntington Beach, CA 92647

TELEX #350757 ANSWER BACK—COMPUTER UD

714/841-6160

For Customer Service Call 714-847-BANC



No Charge for Credit Cards

Orders Only

800/332-BANC

OUTSIDE CALIFORNIA

Cash prices indicated. All products are in factory sealed packages. We guarantee all items for 30 days. Within this period, defective merchandise returns must be accompanied by RMA number. All other returns will be subject to a 10% restocking fee. For prepaid orders, there will be a 3% shipping charge, 5% for UPS Blue Label, \$5.00 minimum; all orders outside U.S.A. at 15% shipping. California residents add 6% sales tax. Prices subject to change without notice.

© Copyright 1985 COMPUTERBANC. All Rights Reserved.

The Greatest buy on BASF Qualimetric Diskettes!

.79 Ea. Qty. 50 **.90** Ea. Qty. 50
5.25"SSDD 5.25"DSDD

Packaged in boxes of 10 with Tyvec sleeves, user ID labels and write-protect tabs.

LIFETIME WARRANTY!

	Qty. 20-40:	Qty. 50+:
5.25"SSDD(P/N3406)	.81	.79
5.25"DSDD(P/N3407)	.92	.90
5.25"SSDD-96TPI(P/N3404)	.92	.90
5.25"DSDD-96TPI(P/N3405)	1.03	1.01
5.25"DSDD-HD(P/N3403)	2.07	2.04
3.50"SSDD-135TPI(P/N3402)	1.85	1.82
3.50"DSDD-135TPI(P/N3412)	2.41	2.37

FOR ORDERS ONLY: **INFORMATION & INQUIRIES:**
1-800-621-6827 1-312-256-7140
(In Illinois: 1-312-256-7140) 1-312-256-7140

HOURS: 8AM - 6PM Central Time, Monday-Friday
WE WILL MEET OR BEAT ANY NATIONALLY ADVERTISED PRICE ON THE SAME PRODUCTS AND QUANTITIES SUBJECT TO THE SAME TERMS AND CONDITIONS AS THE COMPETITIVE AD.

DISK WORLD!, Inc.

6 9 Green Bay Rd. • Wilmette, Illinois 60091

DISK WORLD!

BASF Qualimetric Diskettes in Bulk.

.72 Ea. Qty. 150 **.83** Ea. Qty. 150
5.25"SSDD 5.25"DSDD

Save a lot of money by buying BASF QUALIMETRIC diskettes in bulk. Packed in cartons of 150 diskettes with Tyvec sleeves, User ID labels and write-protect tabs. **LIFETIME WARRANTY!**

	Qty. 150+:
5.25"SSDD(P/N3408)	.72
5.25"DSDD(P/N3409)	.83
5.25"SSDD-96TPI	N/A
5.25"DSDD-96TPI	N/A
5.25"DSDD-HD(P/N3410)	1.73*
3.50"SSDD-135TPI(P/N3411)	1.51**
3.50"DSDD-135TPI(P/N3412)	2.05**

* Available in 250 piece cartons only.
** Available in 200 piece cartons only.

FOR ORDERS ONLY: **INFORMATION & INQUIRIES:**
1-800-621-6827 1-312-256-7140
(In Illinois: 1-312-256-7140) 1-312-256-7140

HOURS: 8AM - 6PM Central Time, Monday-Friday
WE WILL MEET OR BEAT ANY NATIONALLY ADVERTISED PRICE ON THE SAME PRODUCTS AND QUANTITIES SUBJECT TO THE SAME TERMS AND CONDITIONS AS THE COMPETITIVE AD.

DISK WORLD!, Inc.

629 Green Bay Rd. • Wilmette, Illinois 60091

DISK WORLD!

The 1986 DISK WORLD! OFFICE SUPPLY CATALOG IS HERE!

700+ Pages!

21,000+ Items!
Discounts up to 60%!

Don't pay more than you should for any of your office supplies. DISK WORLD! has everything at discount prices. CATALOG FREE WITH \$ 150.00 ORDER. Otherwise, please add \$ 10.00 (Refundable with first order.) (P/N3007)

FOR ORDERS ONLY: **INFORMATION & INQUIRIES:**
1-800-621-6827 1-312-256-7140
(In Illinois: 1-312-256-7140) 1-312-256-7140

HOURS: 8AM - 6PM Central Time, Monday-Friday
WE WILL MEET OR BEAT ANY NATIONALLY ADVERTISED PRICE ON THE SAME PRODUCTS AND QUANTITIES SUBJECT TO THE SAME TERMS AND CONDITIONS AS THE COMPETITIVE AD.

DISK WORLD!, Inc.

6 9 Green Bay Rd. • Wilmette, Illinois 60091

DISK WORLD!

KODAK DISKETTES: Discover the future today!

.92 Ea. Qty. 100 **1.13** Ea. Qty. 100
5.25"SSDD 5.25"DSDD

LIFETIME WARRANTY!	Qty. 20-40:	Qty. 50:
5.25"SSDD(P/N4200)	1.00	1.00
5.25"DSDD(P/N4201)	1.23	1.21
5.25"SSDD-96TPI	N/A	N/A
5.25"DSDD-96TPI	N/A	N/A
5.25"DSDD-HD(P/N4202)	2.35	2.31
3.50"SSDD-135TPI(P/N4206)	1.87	1.84
3.50"DSDD-135TPI(P/N4207)	2.46	2.42

BULK 5.25" DISKETTES!
(Packaged in boxes of 100 with Tyvec sleeves, user ID labels and write-protect tabs.)

5.25"SSDD(P/N4203) .92
5.25DSDD(P/N4204) 1.13

FOR ORDERS ONLY: **INFORMATION & INQUIRIES:**
1-800-621-6827 1-312-256-7140
(In Illinois: 1-312-256-7140) 1-312-256-7140

HOURS: 8AM - 6PM Central Time, Monday-Friday
WE WILL MEET OR BEAT ANY NATIONALLY ADVERTISED PRICE ON THE SAME PRODUCTS AND QUANTITIES SUBJECT TO THE SAME TERMS AND CONDITIONS AS THE COMPETITIVE AD.

DISK WORLD!, Inc.

629 Green Bay Rd. • Wilmette, Illinois 60091

DISK WORLD!

DISK WORLD! Ordering & Shipping Instructions

FOR FASTEST SERVICE, USE NO-COST MCI MAIL. Our address is DISKORDER. It's a FREE MCI MAIL letter. No charge to you. (Situation permitting, we'll ship these orders in 24 hours or less.)

SHIPPING: 5.25" & 3.50" DISKETTES-Add \$ 3.00 per each 100 or fewer diskettes. **OTHER ITEMS:** Add shipping charges as shown in addition to other shipping charges. **PAYMENT:** VISA, MASTERCARD and Prepaid orders accepted. **COD ORDERS:** Add \$ 5.00 special handling charge. **APO, FPO, AK, HI & PR ORDERS:** Include shipping charges as shown and additional 5% of total order amount to cover PAL and insurance. We ship only to United States addresses, except as shown above. **TAXES:** Illinois residents add 7% sales tax.

MINIMUM ORDER: \$ 35.00

FOR ORDERS ONLY: **INFORMATION & INQUIRIES:**
1-800-621-6827 1-312-256-7140
(In Illinois: 1-312-256-7140) 1-312-256-7140

HOURS: 8AM - 6PM Central Time, Monday-Friday
WE WILL MEET OR BEAT ANY NATIONALLY ADVERTISED PRICE ON THE SAME PRODUCTS AND QUANTITIES SUBJECT TO THE SAME TERMS AND CONDITIONS AS THE COMPETITIVE AD.

DISK WORLD!, Inc.

629 Green Bay Rd. • Wilmette, Illinois 60091

DISK WORLD!

ATHANA DISKETTES The great unknown!

.60 Ea. Qty. 50 **.69** Ea. Qty. 50
5.25"SSDD 5.25"DSDD

LIFETIME WARRANTY!	Qty. 20-40:	Qty. 50+:
5.25"SSDD(P/N3700)	.62	.60
5.25"DSDD(P/N3701)	.70	.69
5.25"SSDD-96TPI(P/N3702)	.89	.88
5.25"DSDD-96TPI(P/N3703)	.94	.92
5.25"DSDD-HD(P/N3704)	1.81	1.79
3.50"SSDD-135TPI(P/N3705)	2.03	2.00
3.50"DSDD-135TPI(P/N3706)	2.76	2.73

You've used these diskettes hundreds of times as copy-protected originals on some of the most popular software packages. They're packed in polybags of 25 with Polymer-impregnated sleeves userID labels and reinforced hubs, write-protect tabs.

FOR ORDERS ONLY: **INFORMATION & INQUIRIES:**
1-800-621-6827 1-312-256-7140
(In Illinois: 1-312-256-7140) 1-312-256-7140

HOURS: 8AM - 6PM Central Time, Monday-Friday
WE WILL MEET OR BEAT ANY NATIONALLY ADVERTISED PRICE ON THE SAME PRODUCTS AND QUANTITIES SUBJECT TO THE SAME TERMS AND CONDITIONS AS THE COMPETITIVE AD.

DISK WORLD!, Inc.

629 Green Bay Rd. • Wilmette, Illinois 60091

DISK WORLD!

3M Diskettes at the lowest prices ever!

.87 EA. Qty. 50+ **1.22** EA. Qty. 50+
5.25"SSDD(P/N1000) 5.25"DSDD(P/N1004)->

LIFETIME WARRANTY!
Packed in boxes of 10 with User ID labels and write-protect labels.

	Qty. 20-40:	Qty. 50+:
5.25"SSDD(P/N1000)	.88	.87
5.25"DSDD(P/N1004)	1.25	1.22
5.25"SSDD-96TPI(P/N1008)	1.73	1.70
5.25"DSDD-96TPI(P/N1011)	2.17	2.13
5.25"DSDD-HD(P/N1040)	2.52	2.48
3.50"SSDD-135TPI(P/N1039)	1.73	1.70
3.50"DSDD-135TPI(P/N1046)	2.47	2.42
8.00"SSDD w/WP(P/N1020)	1.54	1.52
8.00"SSDD w/WP(P/N1025)	1.89	1.86
8.00"DSDD w/WP(P/N1030)	2.15	2.11

DATA CARTRIDGES:
(Sold 10 to a carton only.)

	EA.	EA.
(Add \$ 5.00 shipping charges for cartridges.)		
DC1000(P/N1041)	12.62	12.40
DC300XLP(P/N1042)	19.38	19.04
DC600A(P/N1043)	20.61	20.25

DISK WORLD!

Printer Ribbons at extraordinary prices!

Brand new ribbons, manufactured to Original Equipment Manufacturer's specifications, in housings. (Not re-inked or spools only.)

EPSON MX-70/80(P/N2500) \$ 2.70 ea. + .25 Shpng.
EPSON MX-100(P/N2501) \$ 4.08 ea. + .25 Shpng.
Okidata Micro83(P/N2502) \$ 1.37 ea. + .25 Shpng.
Okidata Micro84(P/N2505) \$ 2.98 ea. + .25 Shpng.

FOR ORDERS ONLY: **INFORMATION & INQUIRIES:**
1-800-621-6827 1-312-256-7140
(In Illinois: 1-312-256-7140) 1-312-256-7140

HOURS: 8AM - 6PM Central Time, Monday-Friday
WE WILL MEET OR BEAT ANY NATIONALLY ADVERTISED PRICE ON THE SAME PRODUCTS AND QUANTITIES SUBJECT TO THE SAME TERMS AND CONDITIONS AS THE COMPETITIVE AD.

DISK WORLD!, Inc.

629 Green Bay Rd. • Wilmette, Illinois 60091

DISK WORLD!

Diskette Storage Cases

AMARAY MEDIA-MATE 50:

A revolution in disk storage. Every once in a while someone takes the simple and makes it elegant. This unit holds 50 5.25" diskettes, has grooves for stacking, inside nipples to keep diskettes from slipping and several other features. We like it. (P/N3010)

\$ 9.69 ea. + \$ 2.00 Shpng.

DISK MINDER II:

Low-priced, but effective storage for 75 5.25" diskettes. Smoked plastic top, beige bottom with inside dividers. (P/N2850)

\$ 6.49 ea. + \$ 2.00 Shpng.

DISK MINDER 36:

As above, but holds 36 3.50" diskettes. (P/N2900)

\$ 6.49 ea. + \$ 2.00 Shpng.

DISK CADDIES:

The original flip-up holder for 10 5.25" diskettes. Beige (P/N2200) or Grey (P/N2201)

\$ 1.65 ea. + .20 Shpng.

FOR ORDERS ONLY: **INFORMATION & INQUIRIES:**
1-800-621-6827 1-312-256-7140
(In Illinois: 1-312-256-7140) 1-312-256-7140

HOURS: 8AM - 6PM Central Time, Monday-Friday
WE WILL MEET OR BEAT ANY NATIONALLY ADVERTISED PRICE ON THE SAME PRODUCTS AND QUANTITIES SUBJECT TO THE SAME TERMS AND CONDITIONS AS THE COMPETITIVE AD.

DISK WORLD!, Inc.

6 9 Green Bay Rd. • Wilmette, Illinois 60091

DISK WORLD!

SUPER STAR® DISKETTES: The ultimate value in magnetic media.

No one told us how phenomenally successful Super Star® diskettes would become.

The idea was simple. Very simple.

We would do the same thing that big companies like IBM® do in regard to creating a "brand name" diskette. That is we would go to major manufacturers, buy top-quality diskettes in massive quantities, give them our own name and sell them inexpensively.

**A very simple idea
...that worked!**

Now, tens of thousands of businesses, government agencies, schools and individuals have learned that you don't have to pay inflated "brand name" prices to get "brand name" quality.

Just buy Super Star® diskettes.

**Quality
...without high price.**

We ship almost a million Super Star® diskettes a month and get very few of them back.

Unlike others who offer a "house brand" or "generic" diskettes, Super Star® diskettes are top-of-the-line quality, exceeding ANSI and IBM standards by 50% or more.

They are not cosmetically flawed, duplicator product (where a failure rate of 20% or more is expected) or what we in the diskette industry refer to as "floor sweepings", a term which speaks for itself.

A lifetime warranty.

If you sense pride in our description of Super Star® diskettes, you've got it right.

After all, wouldn't you be proud if you found a way to deliver top-quality diskettes at about half the price of "brand names"?

**When every bit counts,
it's Super Star®!**

Nearly a million Super Star® diskettes a month are being sold to some of the largest and most recognizable names in the nation. They love 'em, because they save money...and they are dependable.

So now is the time for you to re-discover Super Star® diskettes.

And we say "re-discover" for a reason.

**You've already
used Super Star!**

Super Star® diskettes, as noted, are made by some of America's leading diskette manufacturers...and the odds are that you've already used them more than once as the copy-protected masters on some of the best known software programs around.

So, when you want the best...and the least expensive best...order Super Star®!

SUPER STAR SPECIAL!

Your choice of storage at \$ 4.95!

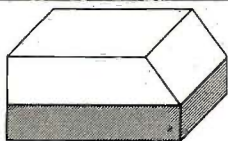

Buy 50 Super Star® diskettes and get a storage case for only \$ 4.95 (shipping included)!

These are durable plastic cases with dividers and are very nice units.

The 5.25" unit holds 50 diskettes and the 3.50" unit holds 40 diskettes.

5.25" Storage Case (P/N3100)..\$ 4.95 ea.
3.50" Storage Case (P/N 3102)..\$ 4.95 ea.

What the world needs now is a complete line of high quality, inexpensive diskettes with a LIFETIME WARRANTY!

And DISK WORLD! has them!

Super Star 5.25" Diskettes

5.25" SSDD (P/N 3800)	.55 ea.
5.25" DSDD (P/N 3801)	.69 ea.
5.25" SSDD-96TPI (P/N 3802)	.87 ea.
5.25" DSDD-96TPI (P/N 3803)	.92 ea.
5.25" DSDD-HD (P/N 3804)	\$ 1.79 ea.

ORDER IN MULTIPLES OF 50 ONLY!

All Super Star 5.25" Diskettes are poly-bagged in lots of 25 with sleeves, write-protect tabs and user ID labels.

QUANTITY DISCOUNTS: 350-500 diskettes, deduct 3%. 500-700 diskettes, deduct 6%. 750-1,000 diskettes, deduct 9%. 1,000+ diskettes, deduct 12%.

Super Star 3.50" Diskettes

3.50" SSDD (P/N 3805)	\$ 1.73 ea.
3.50" DSDD (P/N 3806)	\$ 2.38 ea.

ORDER IN MULTIPLES OF 50 ONLY!

Super Star 3.50" diskettes are packaged in boxes of 50 with user ID labels.

QUANTITY DISCOUNTS: 350-500 diskettes, deduct 1.5%. 500-700 diskettes, deduct 3%. 750-1,000 diskettes, deduct 4.5%. 1,000+ diskettes, deduct 6%.

The Super Star LIFETIME WARRANTY!

Super Star Diskettes are unconditionally warranted against defects in original material so long as owned by the original purchaser. Returns are simple: just send the defective diskettes with proof of purchase, postage-paid by you, with a short explanation of the problem and we'll send you replacements. (Incidentally, coffee stained diskettes or diskettes with staples driven through them or otherwise damaged don't qualify as defective.)

HOURS:
8AM-6PM Central Time
Monday - Friday

**WE WILL MEET OR BEAT ANY
NATIONALLY ADVERTISED PRICE
ON THE SAME PRODUCTS AND
QUANTITIES SUBJECT TO THE
SAME TERMS AND CONDITIONS.**

HOW TO ORDER:

ORDERS ONLY:
1-800-621-6827
(In Illinois: 1-312-256-7140)

INQUIRIES:
1-312-256-7140

FOR FASTEST SERVICE. USE NO -COST MCI MAIL. Our address is DISKORDER. It's a FREE MCI MAIL letter. No charge to you. (Situation permitting, we'll ship these orders in 24 hours or less.)

SHIPPING: 5.25" & 3.50" DISKETTES-Add \$ 3.00 per each 100 or fewer diskettes. **OTHER ITEMS:** Add shipping charges as shown in addition to other shipping charges. **PAYMENT:** VISA, MASTERCARD and Prepaid orders accepted. **COD ORDERS:** Add \$ 5.00 special handling charge. **APO, FPO, AK, HI & PR ORDERS:** Include shipping charges as shown and additional 5% of total order amount to cover PAL and insurance. We ship only to United States addresses, except as shown above. **TAXES:** Illinois residents add 7% sales tax.

MINIMUM ORDER: \$ 35.00

DISK WORLD!, Inc.

629 Green Bay Road
Wilmette, Illinois 60091

MSO
MICRO
SUPPLY
ORGANIZATION INC.

advanced technology.

Complete MS-DOS/CPM Super Turbo

In keeping with industry trends MSO is bringing our customers high performance P.C. compatibles and accessories. MSO takes the P.C. compatible to maximum performance with its SUPER TURBO. The SUPER TURBO features the V20-8 chip which runs at three times the speed of the IBM-PC XT* and also runs CPM 8080 software.

The SUPER TURBO comes complete with the MS-DOS operating system, Read and Run CPM, full Instructional Documentation, Utility software, **plus for our first 100 customers MSO is offering the Micropro Wordstar Professional Software package. This package includes: Wordstar, Mailmerge, Correctstar, Starindex, Dastar and a G.L. Accounting System.** The SUPER TURBO is a complete turnkey system with everything necessary to plug in and operate.

USER SUPPORT HOT LINE

805/393-2247

All systems carry full 90 day warranty.

CASH PRICE ONLY

Check in advance. Add 3% for VISA/MC. Shipping & handling charges will be added to each order.

For our catalog with complete details and prices, send \$1.00 to:

Micro Supply Organization, Inc.
4909 Stockdale Hwy. #180
Bakersfield, CA 93309

MON. - FRI. 7am - 5pm PST *SAT. 9am - 5pm PST

*IBM is a registered trademark of the IBM Corporation.

Super Turbo
Super Price:
\$1299



The Super Turbo P.C. runs IBM software and CPM 8080 programs

- CPU - V20-8 8MHz Super Chip runs *IBM compatible software at 3 times the speed of the IBM-XT and CP/M 8080 software.
- 8087 Math Processor optional
- 256K RAM on mother board expandable to 640K
- ROM 8K Bios
- 6 empty slots for expansion
- 2 serial port one optional with expansion kit
- 1 parallel port
- 1 game port
- Clock calendar with software
- Hi-Res monographics video board
- Floppy controller
- Dual Floppy Drives 360K ea.
- 135 watt XT Power Supply
- 5150 style compatible keyboard
- Hi-Res TTL Green or Amber 12" monitor
- MS-DOS operating system and manual.
- Instructional Documentation and Utility Software
- Assembled and tested in U.S.A.
- **Optional internal 20 meg sub system for Super Turbo add \$549**

**Special printer
pricing with
purchase of
above computer.**

ALWAYS A STEP AHEAD

of the Competition w/Pricing & Specials

COMPUTER CONNECTION
TOLL FREE ORDER LINE

PRINTERS

STAR MICRONICS

SG-10, 120 cps, 2K buffer, 2 yr war	\$ 227
SG-15, 120 cps, 2K buffer	385
SD-10, 160 cps, 10" carriage	365
SD-15, 160 cps, Corr. Qual.	479
SR-10, 200 cps, 10" carriage	520
SR-15, 200 cps, w/Tractor	640

OKIDATA

ML182P, 120 cps	We
ML182 IBM, Graphics Comp	Will
ML182S, 10" Carriage	Beat
ML192P, 160 cps	all
ML192 IBM, Graphics Comp	Pricing
ML192S, 160 cps	on
ML193P, 160 cps	Ok!
ML193 IBM, Graphics Comp	Printers
ML193S, 160 cps	with
ML84P, 200 cps	or
ML84 IBM	without
ML84S, 200 cps	IBM
Okimate 20, 80/40 color	Rom

EPSON

LX80, 120 cps 10" carriage	Call
FX85, 160 cps 10" carriage	Us
JX80, 160 cps Color	First
RX100, 100 cps 15" carriage	For
FX286, 200 cps 15" carriage	Lowest
LQ800, 180/60 P&S 7K 10"	Authorized
LQ1000, 180/60 P&S 7K 15"	Epson
LQ1500, 200/64 15"	Dealer
DX10, LQ Printer	Pricing

BROTHER

HR-15XL, LQ 20 cps P or S	\$ 339
HR-25, LQ 23 cps P or S	449
HR-35, LQ 36 cps P or S	659
DM-40, 160 cps 24 wire	794
DH-45, LQ & Dot matrix 36/160	821

DYNAX

DX15XL, 20 cps By Brother	\$ 335
---------------------------	--------

JUKI

6100, LQ 18 cps w/proportional spc	\$ 355
6300, LQ 40 cps	699

TOSHIBA

P341P, 180/72, 132 col.	\$ 815
P341P/S, 180/72, 24 wire	850
P351P/S, 240/100, 132 col.	1125

PANASONIC

1080, 100 cps 2 yr. war. Prop. Sp	\$ 219
1091 w/Tractor, 120 cps, 2 yr. war.	239
1092, 10" carriage, 180 cps	375

DATA PRODUCTS

8012, 180 cps 10" IBM comp.	\$ 299
8022, 180 cps 15" IBM comp.	472
8050C, 200 cps w/color	1172
8070C, 400 cps w/color	1547

PRINTER ACCESSORIES

ORANGE MICRO

Grappler +	\$ 75
Buffered Grappler +, 16K exp. 64K	149

TOSHIBA

Bi-Directional Trac. 1351/351	\$ 149/155
Font Disk for Down loading P1351	50

MICROTEK

Dumpling GX (same as Grappler +)	\$ 69
Dumpling GX w/16K buffer	125
Dumpling GX w/32 buffer	135
Additional Buffering 16K	7

FOURTH DIMENSION

Par. Card & Cable for Apple	\$ 49
-----------------------------	-------

OKIDATA

Plug n Print for OKI Mate 20	\$ 79
Tractor for 182 & 192	39

JUKI

Bi-Direc. Tractor for 6100/6300	\$ 115/125
Serial Interface for 6100	65

CABLES

IBM PC to Parallel Printer	\$ 14
Serial Cable	16
Centronics M/M or M/F	18

DISPLAY MONITORS

QUADRAM

Amber chrome IBM compatible	\$ 169
-----------------------------	--------

AMDEK

V300G	\$ 119
V300A	129
V310A for IBM PC	155
Color 300	199
Color 600 RGB Hi-Res	389
Color 710 Super Hi-Res	485
Color 722 Super Hi-Res	545

TAXAN

IBM Green Monochrome#121	\$ 135
IBM Amber Monochrome#122	145
RGB IBM w/Cable#620	399
RGB Super Hi-Res. #640 Best Buy	519
RGB#630	450

PRINCETON GRAPHICS

HZ-12 for use with IBM PC	\$ 445
Max 12E Amber for IBM	169
SR 12 Super Hi-Res	555
Scan Doubler	185

QUIMAX

PX-4, RGB Hi-Res w/Gr. Text Mode	\$ 410
DM-14 Monochrome for IBM	150

TAX TIME SPECIALS

CAL PAK

• IBM Compatible • U.S. Made & Licensed • 20%-30% Faster than IBM • 640K on Motherboard • Two Teac 55B D/D • Parallel & Serial Ports • 20 Meg Hard Disk • Hi-Res Color/Comp. Monitor Card • 6 Month Warranty

\$1599

Other Compatibles Starting as low as \$600 CALL NOW!

COMPAQ

Port. 2 Drives 256K
\$1799

BIZCOMP

Internal Modem w/S.W.
\$289

LOTUS 1-2-3

New Version
\$319

IBM TO PAR. CABLE

6' w/Thumbscrew
\$12

PANASONIC

1080 2 Yr. Warr. NEW
\$215

"THE COMPANY THAT DELIVERS"

IBM PC ACCESSORIES

IBM

IBM Dos 3.1	\$ 69
-------------	-------

PARADISE

Modular Graphics Card	\$ 249
Module A	75
Module B 256K w/C & C	120
5-Pak same as 6-Pak-Ser. Port	175
Color/Mono Card New	220

64K MEMORY UPGRADE

64K (9 chips) 200ns & 150ns	\$ 15
-----------------------------	-------

HEXACE TECHNOLOGIES

Hi-Res Color Card for PC, XT, AT	\$ 110
----------------------------------	--------

QUADRAM

Quad Color 1 Board	\$ 179
Exp. Quadboard w/64K & Game Port	199

TECHMAR

Graphics Master	\$ 449
-----------------	--------

APPLE & FRANKLIN ACCESSORIES

ACCESSORIES

Kensington System Saver	\$ 69
Masterpiece Control Unit	119

MICROTEK

Serial Interface	\$ 85
80 col. for II & II+	99

MICROMAX

Viewmax 128K extended 80 col. card for Apple IIE w/64K	\$ 99
80 col. card for Apple II & II+	139

VUTEK (2 yr. war.)

CPS Board, RGB & Comp. w/Par&Ser Ports 2 yr war.	\$ 189
Color Card (Herc. comp.) w/Para.	150

AST RESEARCH

SixPak + w/64K & Sidekick	\$ 210
SixPak + w/384K & Sidekick	255
Game Port	49
Preview MonoGraphics.	220

KEYTRONICS

KB5151	\$ 175
--------	--------

MICROTEK

Monochrome Text Par. & Ser.	\$ 169
Color Graphics Card	165

SIGMA DESIGNS

Color 400 L or H	\$ 459
------------------	--------

ADVANCED LOGIC SYSTEMS

Z Engine 2.2	\$ 120
80 Col./64K	69

APPLE

Super Serial Card	\$ 139
-------------------	--------

SMT

64K, 80 col. Card	\$ 65
-------------------	-------

MICRO-SCI

64K, 80 Col. Card	\$ 79
-------------------	-------

PERSONAL SYSTEMS

APPLE

Professional Sys. incl: Apple IIE w/128K & 80 col. tilt mon., duo disk w/con't kit	\$1299
Pro System w/Color	1545
Apple Iic Lightweight Portable	789
Apple Iic w/Color	1399

IBM

IBM PC Bare	\$1250*
IBMPC 64K, 1 Drive	1399*
IBM PC, 2 Drives w/256K	1599*
IBM XT, 10 Meg, 360K Dr. w/256K 2250*	
IBM XT Bare w/256K & IBM Floppy 1899*	

Call About All "AT" Systems
 *Call for current IBM prices

SANYO

MBC 555-2 w/2, 320K Drives & more software	\$ 899
775 Portable	1795
Serial Port for Sanyo	65

COMPAQ

256K, w/2-320K Drives	\$ 1799
Desk Top Model 1	1649
Desk Top Model 2	1925
Desk Top Model 3	Call
Desk Top Model 4	Call

We have "286" Ports. & D.P. in stock

WYSE

1100-1 incl. 256K w/two 360K Drives 1 par & 2 ser. ports	\$ 1399
1100-2 incl. 10 meg, 1 floppy, 256K, 1 Par. & 2 ser. ports.	2599

*Wyse Monitors & Exp. Chassis Available

SOFTWARE

LOTUS DEVELOPMENT CORP.

Lotus 1-2-3 New Version	\$ 319
Symphony	420

ASHTON TATE

D Base II	\$ 299
D Base III	389

PRINTER SWITCH BOX

EXPONENT

Centronics Two Switch	\$ 60
Centronics Four Switch	85
Serial Two Switch	50
Serial Four Switch	75

MODEMS

ANCHOR

Volksmodem XII, 5 yr war	\$ 185
Express 1200	250

HAYES MICRO

300 Baud Smart Modem	\$ 149
1200 Baud Smart Modem	379
1200 B for IBM PC w/SM II	375
2400 Baud Modem	645
300 For Apple Iic w/Stwr	Call

DISKETTES

PC DISKETTES

Sgl./Dbl. (Box of 10)	\$ 13
Dbl./Dbl. (Box of 10)	15

COMPUTER CONNECTION

Dbl./Dbl. (Box of 10)	\$ 16
Sgl./Dbl. w/Disk Container(10)	15
Dbl./Dbl. w/Disk Container	17
Bulk 50 & Up — Dbl./Dbl.	1.35 each

We Stock What We Sell!!

IF YOU SEE IT ADVERTISED FOR LESS, CALL
COMPUTER CONNECTION FIRST FOR LOWEST QUOTE

MAIL ORDER:

17121 S. Central Avenue, Unit L
 Carson, California 90746



NO SURCHARGE FOR CREDIT CARDS

We accept VISA, MasterCard, COO (w/ deposit), Certified Checks or Wire Transfers. Minimum Shipping Charge \$4.00. Some items subject to back order. California Res. add 6% Sales Tax. All returns are subject to a 15% restocking charge and must be authorized by store manager within 10 days. Prices subject to change without notice. This Ad supersedes all others.

ORDER LINE
(800) 732-0304

(Outside California)

[213] 635-2809

(Inside California)

Mon. Fri. 7 a.m. to 6 p.m.
 Saturday 11 a.m. to 3 p.m.

CUSTOMER SERVICE:

[213] 635-5065
 Mon.-Fri. 9 a.m. to 3 p.m.

TOLL FREE

800-854-8230

CA Residents 714-558-8813

OUR POLICY

- *Surcharge for VISA or Mastercard.
- *Volume purchasing agreements available.
- *Orders subject to availability. *Supply limited on certain items.
- *Pricing subject to change without notice.
- *ACP Retail Store pricing may vary. Not responsible for typos.

Inquiry 8

CORPORATE BUYERS CALL BARRY

IBM Compatible w/20Mb HARDCARD

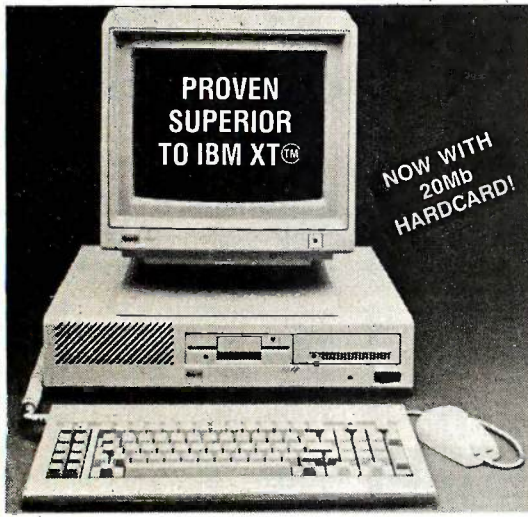

Don't miss out on this unbeatable system manufactured by Toshiba for ACP. ACP has sold over 3,000 **ADVANCED XT's** to satisfied customers including "true blue" users like Rockwell, Hughes, and Kodak. Not only is the price affordable but the features and compatibility are unbeatable. For more details call one of our expert consultants. Don't hesitate this will be a sellout!

ACP
BASE PRICE **\$ 699⁰⁰**

Call for complete Monochrome or Color RGB system prices with 10 or 20 Mb hard disk drives at the **NEW 20Mb Hardcard**.

10 Mb Upgrade **\$379** 20 Mb Upgrade **\$499**
 Package (1 Yr War) Package 1 Yr War
 20 Mb Package for AT **\$556.00**
 SA 712 10 Mb **\$249.95**
 ST225 20 Mb **\$349.00**
 Mountain 20Mb Hardcard... **\$749.95**
 Western Digital Controller... **\$179.95**

IBM COMPUTERS

- IBM PC w/256K, Keyboard, (2) 360K Floppy Disk Drives, Floppy Disk Controller..... **\$1585.00**
- IBM XT w/256K, Keyboard, 360K Floppy Disk Drive, Floppy Disk Controller, Hard Disk Optional..... **1725.00**
- IBM AT w/256K, 1.2 Mb Floppy Disk Drive..... **3199.00**
- COMPAQ PORTABLE w/256K, (2) 360K Floppy Disk Drives..... **1845.00**
- COMPAQ 286 DESKPRO w/256K, 1.2 Mb Floppy, 20 Mb Hard..... **4595.00**
- COMPAQ DESKPRO w/640K, 360K Floppy, 10 Mb Hard..... **2495.00**
- COMPAQ DESKPRO w/640K, 360K Floppy, 10 Mb Hard, 10 Mb Tape back-up..... **3099.00**

IBM HARDWARE

- 130 Watt Power Supply..... **\$89.95**
- PC/AT Keyboard..... **89.00**
- ACP Color Graphics Card..... **95.00**
- ACP Monochrome Graphics..... **135.00**
- ACP Floppy Controller..... **75.00**
- 384K Card Sixpak Comp (OK)..... **129.00**
- Parallel Cable (IBM)..... **19.00**
- Serial Cable (IBM)..... **21.00**
- 12" Monochrome Green TTL..... **99.95**
- Green Composite Monitor..... **69.95**
- 6 Slot Expansion Chassis..... **399.00**
- ACP Hi-res Text Mono Card..... **149.00**
- ACP IBM Style Flip Case..... **69.95**
- ACP Hard Disk Case (FH or HH)..... **169.95**

ARCHIVE

- 20 Mb Tape Back-up (Ext)..... **\$795.00**
- 60 Mb Tape Back-up (Ext or Int)..... **Call**

AST

- Sixpak Plus w/64K..... **\$235.00**
- Advantage 128K, AT..... **399.00**
- AST 5251-11..... **575.00**
- AST 3780..... **575.00**
- RAMpage up to 2 Mb..... **Call**

DCA

- Irma..... **\$785.00**
- IrmaLine..... **895.00**

DIABLO/XEROX

- 620 Serial LQP..... was 1495 now **\$395.00**
- 620 API LQP..... **445.00**
- 620 D36 (36cps)..... **495.00**

- Tractor..... was 395 now **\$99.00**
- F-21 Sheet Feeder..... was 896 now **249.00**
- Cable for 620 (to IBM)..... **29.00**
- Diablo P-11 100cps..... **129.95**
- Diablo S-11 100cps Serial..... **139.95**
- Diablo P-31 Wide..... **249.95**
- Diablo S-31 Wide..... **269.95**
- Other Diablo Dot Matrix's available..... **Call**

EPSON

- FX85 160cps NLQ..... **\$375.00**
- FX185 160cps Wide..... **499.00**
- All Epson Models..... **Lowest Price**

EVEREX

- Graphics Edge or Edge..... **\$259.00**

HAYES

- Smartmodem 1200..... **\$385.00**
- Smartmodem1200B..... **349.00**
- Smartmodem 2400..... **575.00**
- Smartcom II 2.1 Software..... **88.00**
- Hayes Comp. 1200 (Int) w/SW..... **169.95**
- Hayes Comp. 1200 (Ext)..... **199.95**

HERCULES

- Color Card..... **\$166.00**
- Graphics Card w/Software..... **295.00**

INTEL

- Above Board PC or AT..... **Lowest Price**

IRWIN

- 310A 10 Mb Tape (Ext)..... **\$849.00**
- 110D 10 Mb (Int)..... **495.00**

KEYTRONICS

- 5151 Deluxe Keyboard..... **\$169.95**
- 5153 w/Touchpad..... **285.00**
- PC Jr. Numeric Keypad..... **39.95**

MICROSOFT

- Mouse..... **\$125.00**
- Mouse (Serial)..... **145.00**

MOUNTAIN COMPUTER

- 20Mb Hardcard for IBM..... **\$749.95**

MOUSE SYSTEMS

- PC Mouse w/Paintbrush..... **\$138.00**
- ACP Mouse w/Keyboard..... **149.00**

ORCHID

- PC Turbo 186 w/256K..... **\$585.00**

PARADISE

- Color/Monocard..... **\$185.00**
- Modular Graphics Card..... **274.00**

PERSYST

- Mono Board w/Parallel..... **\$159.00**

- Color Board..... **139.00**
- Time Spectrum..... **Sale Call**

PRINCETON GRAPHICS

- HX-12 RGB (640x240)..... **\$445.00**
- MAX-12E Amber TTL..... **175.00**
- SR-12..... **575.00**
- HX-12E (690x350)..... **545.00**

PROMETHEUS

- ProModem 1200 w/Mite (Int)..... **\$239.00**
- ProModem 1200B (Hayes Comp.)..... **289.00**
- Alpha/Num or Options Proc..... **79.95**

QUADRAM

- Expanded Quadboard (OK)..... **\$185.00**
- Gold Quadboard (OK)..... **385.00**
- Silver Quadboard (OK)..... **215.00**
- Quadlink..... **399.00**

SIGMA

- Color 400 Card..... **\$485.00**

SHARP

- 12" Med-res RGB Monitor..... **\$269.95**
- Color Plotter w/Software..... **219.00**

STAR MICRONICS

- Gemini 10X..... reduced **TO LOW TO PRINT**
- Gemini 15X..... sale **TO LOW TO PRINT**
- SG10, SR10, Radix etc..... **Lowest Price Yet!**

TAXAN

- 415 (640x260) RGB..... was 699 now **\$279.95**
- Mod. 640 (Ultra Hi-res)..... **595.00**

TEMPLATES

- Lotus, dBase III, etc..... **Lowest Price**

TITAN

- Accelerator PC w/256K..... **sale Call**

TOSHIBA

- P321 "3 in 1" LQ Printer..... **sale \$599.00**
- P341 24 Pin 136 Col..... **869.00**
- P351 24 Pin w/Serial & Parallel..... **1099.00**
- T-300 MS-DOS Computer..... **Call**

WESTERN DIGITAL

- Filecard 10 Mb Plug-in..... **Call**
- Cobra Hard Disk Controller..... **\$179.95**

ZENITH

- ZVM-1220/30 12" Grn/Amb TTL..... **\$109.00**
- ZVM-1240 & ZVM-135 RGB..... **Call**

PC UPGRADE SPECIAL

\$11⁹⁵ SET OF (9) 64K RAMS
\$36⁹⁵ SET OF (9) 256K RAMS
\$7.95 4128 PIGGYBACK RAM
\$120.00 8087-2 Coprocessor

1200 Baud Hayes™ Comp. Modem

Short Card by U.S. Robotics with Telpac I Software.
 List \$499 ACP... **\$149.95**
 Buy (6)..... **\$139.95**

20Mb Tape Back-up

Archive, #1 in tape back-up technology.
 High speed 20Mb back-up for only **\$795.00**

Gavilan Compass MS-DOS Lap Computer Demo Sale

Call for Details. 100's in **\$999⁰⁰**
 Stock as Low as

STAR MICRONICS One Time Offer

We have 1000's of new in the box dot matrix printers including SG-10, SR-10, Gemini 10X & 15X, all priced substantially below market price. Call now as they will move fast at our too low to print prices!

APPLE Add-on SALE

All ACP Apple Product is priced to move out. Call for values such as:

- Joysticks..... **\$7.95**
- Disk Drives..... **119.00**
- 80 Column Cards..... **69.00**
- 16K Cards..... **34.95**

★ Advanced Computer

Computer Systems

XT-100 FCC & UL APPROVED PC

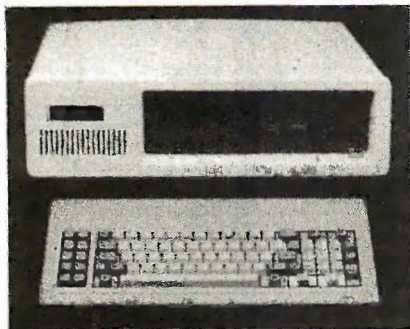

XT-100 EXECUTIVE 640K, 2 DSDD 1/2 HT. FLPYS, SERIAL, PARALLEL & GAME PORTS, CLOCK, COLOR OR MONOCHROME GRAPHICS CARD, 8 SLOTS, 135W POWER SUPPLY & KEYBOARD \$915
 XT-100 EXECUTIVE 20 W/ 20Mb Hard Disk ... \$1,449
 XT-100 EXECUTIVE 20 W/ 10Mb Tape \$1,919

AT-100 FCC & UL APPROVED AT



AT-100 EXECUTIVE 512K, 8 SLOTS, 200W P/S, 1.2Mb FLYP, SERIAL, PARAL. PORTS, CLOCK, COLOR OR MONOCHROME GRAPHICS CARD \$1,998
 AT-100 EXECUTIVE 40 W/ 40Mb Hard Disk ... \$3,095
 AT-100 EXECUTIVE 40 W/ 25Mb Tape \$3,784
 AT-100 EXECUTIVE 85 W/ 85Mb Hard Disk ... \$3,595
 AT-100 EXECUTIVE 85 W/ 85Mb Tape \$4,575



CORE SYSTEM w/256K Ram, I/F-4, Syst. Supp. 1, ENCL. 2D, Disk 1A, Disk 3, 5 1/4" FLYP, & 20Mb H.D. Add Your Choice of CPU & Oper. Sys. ... \$5,395

816/C2 W/ 80286, 512K Ram, SPUZ-256, 40Mb H.D., 10Mb Tape, 5 1/4" 96TPI FLYP, CDOS 816/286, NewWord & Supercalc II REDUCED!!

CALL FOR OTHER SYSTEM CONFIGURATIONS



PC COMPATIBLE & FASTER TOO!

ZENITH Z-158 PC-DESK TOP SYSTEM: 256K RAM, 2 DSDD FLYP DRIVES, Serial, Paral. Monochrome & Color Composite & RGB Color Ports, & MS-DOS w/4.77 & 8 MHz CPU Clock Rates, G or A Monitor, ... \$1,849
Z158 with Floppy & 20Mb H.D. DRVS \$2,395
Z158 with Floppy & 40Mb H.D. DRVS \$2,798
 1/2 HT 10Mb TAPE OPTION INT. \$498/EXT. \$598
Z-148 PC with 256K, 2FLPYS, MS-DOS, 4.77 & 8MHz, Serial & Parallel Ports, \$1,175
Z-138 PCTransportable 24Lbs, 256K, Dual FLPYS, 7"AMB Screen, MS-DOS, 4.77 & 8MHz, S&P ... \$1,409
Z-171 LAP-TOP PORTABLE 2 Drvs., 256K ... \$1,875

Computer Systems



MORROW MICRODECISION MD-3 W/MDT-70 Terminal, CP/M & NewWord Word Processor . \$1,149
 MORROW MICRODECISION MD-11 w/ MDT-70 Terminal, CP/M 3.0, 128K, 11 Mb H.D., FLYP, NewWord Word Processor \$1,849



CORONA PPC-400-22 Portable 256K. Dual Flyp's. 640X400 GRN Monitor, 4 Expan. Slots, Serial & Paral. Ports, MS DOS, GW-Basic & PC-Tutor \$1,229
 CORONA PPC-400-XT Portable w/20Mb H.D. ... \$1,798
 CORONA PPC-400-XT Portable w/40Mb H.D. ... \$2,198
 CORONA PC-400-22 DESK TOP PC w/14" Green Tilt & Swivel Monitor \$1,525
 CORONA PC-400-HD2 w/ 10Mb Hard Disk \$1,995
 For 20Mb ST-225 Add \$79/For 33Mb RO203E Add \$430

Hard Disk/Tape Subsystems

PC's-MAC's-S-100's

AT-INSIDER. PC-INSIDER. PC-OUTSIDER HARD DISK SERIES FOR IBM, BOOTS FROM HARD DISK, FORMATTED W/ CONTROLLER & ALL NECESSARY CABLES, HARDWARE & P/S or PC STYLE CABINET.
 PC-INSIDER-33 33Mb Full Ht. RO203E \$869
 PC-OUTSIDER-33 W/T 33Mb & 10Mb Tape \$1,329
 PC-INSIDER-72 72Mb FMT. Micropolis 1325 ... \$1,675
 PC-OUTSIDER-72 W/T 72Mb & 60Mb Tape ... \$2,849
 PC-INSIDER-116 116Mb Formatted XT-1140 ... \$3,898
 PC-OUTSIDER-116 W/T 116Mb & 60Mb Tape. \$5,095
 AT-INSIDER-33 33Mb FMT. Quantum Q540 \$1,095
 AT-INSIDER-72 Micropolis 1325 \$1,595
 AT-INSIDER-120 120Mb FMT. Maxtor XT-1140 \$3,828
 ALLOY PC-OCTAPE Up to 69Mb \$1,836
 ALLOY PC-9TRACK 42Mb \$5,295
 ALLOY FT-60 EXTERNAL 1.8Mb/Minute 60Mb Streamer for PC's \$796
 ALLOY FT-60 For AT's & Non-Compatible PC's ... \$952
 IRWIN 10Mb Tape Drive SELLOUT: INT \$468 EXT \$569
 SMS OMTI 5510-7 Supports Up To 16 Heads, Programmable Interleaving Up To 1:1, 25 US Step Rate, Fixed & Removeable Drives, Soft/Hard, Sectoring, Multiple Partitions, 2K Buffer, 1 YR. Warranty QTY 1 \$149.... QTY 10 \$145 QTY 50 \$139
 TECMAR QIC-60 External Tape \$1,449
 TECMAR QIC-60 Host I/F Board \$109
 TECMAR 40200 II Slot Expansion. Chassis w/10Mb \$1,395
 TECMAR 40410 33Mb Fixed/5Mb Removeable In 11 Slot Expansion Chassis \$2,495
 TECMAR 73200 MACDRIVE 10Mb 1/2 HT. with Software and Hardware For Easy Installation \$1,325
 TECMAR 73210 MACDRIVE with 10Mb Fixed And 5Mb Removeable Cartridge \$2,195
 WANGTEK PC-36 60Mb Tape Internal For PC's with Controller, Cable, Software, \$949
 CALL For DLR &/or QTY. PRICES on HARD DISKS:

MICROPOLIS 1303 43Mb 30MS. \$1,195
 MICROPOLIS 1325 85Mb 25mSEC \$1,515
 QUANTUM Q54040Mb FACTORY DIRECT! 1 YEAR WARRANTY! REDUCED!! \$1,095
 S-100 BUS SUBSYSTEMS Supporting Turbosds, Concur. Dos, CP/M 80 & 816 Operating Systems CALL
DRIVE SUBSYSTEMS FOR COMPUPRO with DISK 3, CABINET, P/S, FAN, CABLES, ETC.
 •20Mb SEAGATE \$1,085
 •37Mb QUANTUM Q540 \$1,715
 •45Mb MICROPOLIS 1304 \$2,029
 •72Mb 1325 \$2,159. M6085 \$2,459 XT-1085 \$2,349
 •89Mb MAXTOR XT-1105 \$3,695
 •116Mb MAXTOR XT-1140 \$4,395
 10Mb TAPE INTERNAL \$498 EXTERNAL \$579
 ALLOY I/T S-100+ 9TRACK 42Mb w/CTRL, TIP Software For CP/M and Turbosds \$5,295
 ALLOY IDXCX-100T 17.7Mb External Tape Subsystem For CP/M 80, 86 \$1,836

Floppy Disk Drives

MITSUBISHI 2894 STD 8" \$395 2896 1/2 HT 8" \$369
 TEAC FD55GFVIAT 96TPI \$129
 TEAC FD55VF 96TPI \$115
 MITSUBISHI MF501 48TPI \$95 TEAC FD55BV \$95

Computer Accessories

CA P15 Expandable 5 Circuit Monitor Base with Modern Protection & Surge/Noise \$101.97
 CA P150, P151, P152, P15 with ABC Data Switch \$217.28
 CA C1-6 6' IBM-Paral. CBL. (1-9) \$9.50, (10+) \$8.83
 CA C1-9 9' IBM-Paral. CBL. (1-9) \$11.95, (10+) \$11.06
 CA C200 SERIES Premium Molded RS232 Cables (1-9) \$12.48 TO \$28.47, (10+) \$11.86 TO \$27.05
 CA C300 SERIES Premium Molded Parallel Cables (1-9) \$19.98 TO \$45.57, (10+) \$18.98 TO \$43.29
 CA C400 VIDEO CABLES (1-9) \$2.48 TO \$21.29, (10+) \$2.36 TO \$18.10
 CA C500 SERIES Cable Extender Packs w/ MON, PWR, VIDEO & KEYBD. CBLs ... (1-9) \$29.98, (10+) \$28.48
 CA S4 4 Circuit Surge Supp. (1-9) \$26.47, (10+) \$25.15
 CA S6 6 Circuits Surge & Cable Storage (1-9) \$31.77, (10+) \$30.18
 Monitor Tilt & Swivel Stand... (1-9) \$14.95, (10+) \$12.95

Printers, Plotters & Buffers

BROTHER HR-15-XL 17CPS Daisywheel S or P. \$359
 BROTHER HR-10 12CPS Daisy w/ TRAC., S&P . \$249
 BROTHER TwinRiter 5 Dot Matrix & Daisywheel CALL
 BROTHER 2024L 24 Pin Hi-Res Print&Graphics. \$809
 BROTHER M-1509 180/45 NLQ. P&S I/F \$999
 BROTHER M-1009 EPSON Compatible Plug & Play \$599
 BROTHER HR-5 Plain-Paper Thermal Portable .. \$169
 CITIZEN MSP-10 160/40 NLQ 80/132 \$269
 CITIZEN MSP-15 160/40 CPS 15" Low Profile \$385
 CITIZEN MSP-20 200/50 NLQ 80/132 \$369
 CITIZEN MSP-25 200/50 CPS 15" ULTRA QUIET \$515
 CORONA LASER LP-300 w/IBM CTRL CARD. \$2,698
 CORONA LASER PRINTER FONTS \$29
 EPSON LQ-1500 Cut-Sheet Feeder. Single Bin ... \$309
 NEC 3550/PC 30 CPS Daisy Wheel \$1,097
 OKIDATA 182 80 Column 120 DATA/60 NLQ ... \$215
 STAR 120 DATA, 30NLQ: SG10 \$239 SG15 409
 STAR 160 DATA, 40NLQ: SD10 \$369 SD15 \$495
 STAR 160 DATA, 40NLQ: SD10 \$369 SD15 495
 STAR 200 DATA, 50NLQ: SR10 \$535 SR15 \$659
 TEXAS INSTRUMENTS 855 with TRACTOR \$679
 TEXAS INSTRUMENTS 865 W/ Tractor & S or P CBL & Font Module. \$797
 HOUSTON INST. PLOTTERS & DIGITIZERS ... CALL
 HANZON 12315 64K-256K INTELLIGENT BUFFER SER.-SER., SER.-PAR., PAR.-SER., PAR.-PAR. Computer to Printer Combinations Possible. So easy to use-instructions printed on bottom of cabinet ... \$265
 HANZON ADD-IN MODULE 64K RAM \$45
 PRACT. PERIPH. APPLE GRAPHICARD & CBL. ... \$70
 PRACTICAL PERIPH. APPLE SERIAL BOARD ... \$112
 PRACTICAL PERIPH APPLE PRINTERFACE \$55
 PRACTICAL PERIPH SWITCHPORT 232 Serial-Parallel Converter \$77

Monitors & Terminals

AMDEK310 AMBER IBM-PC TTL Monochrome ... \$155
 PRINCETON GRAPHICS HX-12 690X240RGB ... \$465
 PRINCETON GRAPHICS HX-12E IBM Enhanced Graphics Adaptor. \$539
 PRINCETON GRAPHICS SR-12 690X480RGB ... \$589
 TATUNG CM-1322 640X200 RGB Same as IBM ... \$375
 TATUNG CM-1360 LIKE 1322 with G-A Switch ... \$419
 TATUNG DM-12VL 12" Monochrome A \$114 / G \$109
 TATUNG MM-1222Hi-Res 12" TTL (IBM) A \$125/G \$119
 TAXAN 12" 116 AMB.. \$119/115 GRN \$109
 TECMAR ZVM-136 640X480 RGB 13" Grn Switch \$499
 ZENITH ZVM-1240 Amber IBM Monochrome ... \$155
 ZENITH ZVM-1220G or ZVM-1230A Flat Screen .. \$99
 KIMTRON KT-7 14" Green \$459
 LIBERTY FREEDOM TERMINALS CALL
 LINK 1251 Wyse 50 Compat. 14" GRN or AMB w/Higher RES., More Emul'S, Selectric K.B., 6 Scroll Rates \$429
 LINK PC-TERM IBM or ASCII VIDEO, 14" GRN or AMB. IBM-AT Keyboard Layout, 132 Column. Also Compat. w/WY50&TVI925 Ideal w/PC-Slave Bds. \$449

Diagnostic-Keyboards-Voice

DATACOM TRI-STATE RS232 V.24 Break-out Box \$189
 DYSAN DISK DRIVE INTERROGATOR \$115
 DYSAN AAD Analog Alignment Disk SS \$25 / DS \$50
 DYMEK RID FLYP DRV. DIAGNOSTIC DISKETTE \$29
 DYMEK "THE DRIVE ALIGNER" PC XT \$85
 FLUKE 77 DIGITAL VOLT METER w/ Holster ... \$129
 KEYTRONICS 5150... \$169 / 5151... \$185 / 5153 ... \$299
 VOTRAX PERSONAL SPEECH SYSTEM \$295

PLEASE NOTE: We Now Accept AMERICAN EXPRESS...Add 5% To The Cash Prepaid Price



S-100 DIV./696 CORP.
 14455 NORTH 79th ST.
 SCOTTSDALE, AZ 85260

FULL DEALER SUPPORT
 VISIT OUR SHOWROOM
 HRS: 8:00AM - 5:00PM M-F

WORLD'S LARGEST SELECTION OF PC & S-100 PRODUCTS



PLEASE NOTE: We Now Accept AMERICAN EXPRESS... Add 5% To The Cash Prepaid Price

Power Solutions

- PC/XT REPLACEMENT P/S 150 Watt Up To 4 Drvs \$95
- SAFT SPS 400VA 400 WATT & SINE WAVE \$475
- SAFT SPS1000VA 1000 WATT/SINE WAVE \$999
- SOLA 750 WATT "TRUE" Uninterruptible Power Supply with 4500 Watt Hi-Inrush \$1,695
- TRIPPLITE /SOBAR Line Suppressor-Filters from \$35
- TRIPPLITE BC-425-FC 425 Watts 15-20 Minutes. \$398
- TRIPPLITE BC-1000 Watts 20-30 Minutes \$925
- TRIPPLITE LC-1800 Conditioner/Stabilizer \$209
- TRIPPLITE COMMAND & CONSOLE CCI 8-12 \$999

Networking & Switch Boxes

- INTERCONT. MICRO SYS. LAN-PC w/o RAM... \$469
- INTERCONT. MICRO SYSTEMS LANS-100 \$359
- COMPUPRO/VIASYN NET 100/ PC-S-100 BUS . \$297

PC & AT Multifunction/Slave B ds.

- We Have a Good Selection of Multifunction and Memory Boards for PC, XT, AT, JR, AT & T, and PC Portables
- INTEL ABOVE BOARD PCMB 1010 PC/XT 64K to 2Mb Allows Lotus, Symphony, Framework, Etc. to Run Above 640K w/ FREE Microsoft "Windows" \$229
 - INTEL ABOVE BOARD AT 128K-4Mb w/ CPU to Address all Available Memory \$459
 - MACROTECH MSR-AT Up to 3Mb From \$269
 - STB GRANDE BYTE 128K \$225
 - STB RIO PLUS II 64K-512K, S.P. Clock \$216
 - STB SUPER RIO 256K, CLOCK, S.P. & G Ports . \$239
 - STB RIO GRANDE PC-AT 128K-1.5Mb \$269
 - TECMAR CAPTAIN UNPOP w/Treasure Chest ... \$154
 - TECMAR MAESTRO Unpopulated for IBM-AT .. \$325
 - TECMAR MAESTRO For PC/AT 2.5Mb \$529
 - TECMAR WAVE 64K to 256K Fits XT Short Slot . \$179

PC & AT Slave Boards/Pkg's

Make Your Computer A Mighty Multi-User

- ADVANCED DIGITAL PC-SLAVE w/256K, 8MHz 8088 CPU, 2 S Ports, RTNX S/W-For Multi-User P.C. . \$595
- ADVANCED DIGITAL PC-SLAVE PACKAGE with Link PC Term Terminal, RTNX Software \$999
- ALLOY PC-SLAVE 16 512K to 1Mb \$595
- ALLOY PC-SLAVE PKG: 512K With Link PC-TERM Terminal, 9' Cable, RTNX Software \$1,175

PC Video/Graphics & Cad

- STB EGA PLUS TTL MONO. & HI-RES. RGB... \$371
- STB CHAUFFEUR RGB Por/16 Grey Shades Produced on Monochrome TTL Monitor \$195
- STB GRAPHICS PLUS II w/ Paral. PRT Port \$249
- STB SUPER RES 400 Color Hi-Res w/ 32K \$325
- TECMAR GRAPHICS MASTER 16 Color Hi-Res. \$439
- TECMAR GRAPHICS TENDER RGB/PRT Port ... \$195
- CSD-PC AUTOCAD-2 PACKAGE: 1024X1024 Monochrome Graphics • 15" 1100X1250 Res. . \$3,149
- ILLUMINATED TECHNOLOGIES AUTOCAD PACKAGE: 8 Color 1024X1024 S-100 Board • Inside Autocad Handbook • Autocad 2 • Mitsubishi 19" 1024X874 RGB Analog Color Monitor • Hitachi Tiger 11"X11" Tablet with 12 Button Cursor \$4,995
- TECMAR SUPER-RES PKG: Board & 13" ZVM-136 Monitor w/ 16 Colors @ 640X400 \$925
- VECTRIX VXPCA 4096 Colors/Palette of 512 Colors Ultra Hi-Res, 720 X 512 @ 42KHz Scan Rate .. \$1,695
- VECTRIX VX/PC Video Cable \$799

PC Scientific/Industrial Boards

INDUSTRIAL COMPUTER DESIGNS:

- 1018-PC with 96TTL I/O Ports. Like Baseboard Only More Features \$469
- A/D 64-PC 64 Input \$469
- D/A 64-PC 64 Output \$555
- TECMAR BASE BOARD 96 Digital I/O Lines CALL
- TECMAR DAD/O D to A Up to 24 Devices CALL
- TECMAR IEEE-488 Board CALL
- TECMAR LABMASTER CALL
- TECMAR EXPANSION CHASSIS 12AMP P/S, Dual AC Outlets, 7 Useable Slots, Space for Hard Disk ... \$675
- PC PROTOTYPING BOARD \$18.95

Chips

- We Have Some of the LOWEST PRICES in the Nation!!
- 64K, 256K, 8087 & 80287 CALL

S-100 Bus BDS & Accessories

If you purchased before calling us, you probably paid too much! We stock ACKERMAN DIGITAL, ADVANCED DIGITAL, CCS, COMPUPRO, CROMEMCO, DUAL, ELECTROLOGICS, ICM, KONAN, MULLEN, PICKLES & TROUT, INDUSTRIAL COMPUTER DESIGNS, TARBELL, TECMAR, VECTOR ELECTRONICS.....

A FEW OF THIS MONTH'S SPECIALS ARE...

- ACKERMAN KLUGE CARD A&T \$175
- ACKERMAN PROMBLASTER II Up to 27256K'S . \$306
- ACKERMAN PROMBLASTER EXTENDER \$79.95
- SPECTRONICS PE24T/9 EPROM ERASER/TIMER 146 ADV. DIGITAL SUPPER 186/1256K MASTER \$1,295
- COMPUPRO RAM 16 64K STATIC . \$95
- COMPUPRO RAM 22 256K STATIC \$475
- COMPUPRO PC-VIDEO BD & COOS 4.1 \$719
- COMPUPRO CPU 286-8MHz & CDOS 4.1 \$1,039
- COMPUPRO SYSTEM SUPPORT 1 w/ CLK-CAL \$280
- COMPUPRO CPU 8085/88 6 & 10 Mhz \$285
- COMPUPRO CPU 8086 - 10MHz \$319
- COMPUPRO CPU-Z 8MHz \$219
- CROMEMCO XPU 10MHz 68000 CPU \$1,196
- CROMEMCO DPU 68000/Z-80 Dual CPU \$636
- CROMEMCO SCC Z-80 Single BD. Computer... \$396
- CROMEMCO 8P10 8 Port Parallel \$356
- CROMEMCO D-7A 8 Channel 8 Bit D/A \$316
- CROMEMCO BIART Dual Sync/Asynch \$796
- CROMEMCO 64FDC 5"8" Floppy CTRL \$556
- DUAL AIM-12 A/D Input 12 Bit/32 Channel \$629
- DUAL AOM-12 D/A Output 12 Bit/4 Channel \$540
- DUAL WDC Winchester DMA 2 BD. Set SA-4000 \$840
- INTELL. COMP. DESIGNS 8MHz DUAL Z80 Slave w/4 Serial Ports-128K-Software Install. To Turbodos. \$629
- INTERCONTINENTAL MICRO SYSTEMS MASTER & SLAVE BDS. 8&16 Bit FROM AS LOW AS \$395

INDUSTRIAL COMPUTER DESIGNS:

- D/A 64-100 84 Analog Outputs \$375
- A/D 64-100 64 Analog Inputs \$279
- CCT-100 Highly Accurate Time & Date Controller with Battery Back-Up \$315
- KONAN DGC-2000 ST 506 5/4 H.D. Controller .. \$325
- KONAN SMC-200 SMD 8" Controller \$450
- MACROTECH V/ARM 512K Static with Battery Back-Up and MDrive/H Capability \$769
- MACROTECH MI-286 80286/Z80H Dual Proc. \$675
- MACROTECH MSR-II 1Mb Dynamic Ram \$825
- MACROTECH MSR-II 2Mb Dynamic Ram \$1,059
- MULLEN ZB-1 EXTENDER with ZIF Sockets \$125
- MULLEN TB4A EXTENDER BD. w/ Logic Probe. \$69
- MULLEN ICB10 8 Channel Low Voltage Controller \$165
- PICKLES & TROUT P&T 488 IEEE 488 BD & S.W. \$429
- VECTOR RAM 17 64K Static Ram \$299
- VECTOR INTERFACER I Dual Serial (VIASYN) .. \$199
- VECTOR INTERFACER II 3 Para., 1 Serial \$219

Mainframe & Drive Enclosures

- FULCRUM 880 with Front Panel & 20 Slots \$565
- INTEGRAND 2200Aw/4 Slots & 2 X 8" 1/2 HT FLPY \$349
- INTEGRAND 2210 w/4 Slots & 5/4" FLPY + H.D. . \$315
- PARA DYNAMICS 3020D 20 Slot Desk \$639
- PARA DYNAMICS 5820-S "TOWER" with SNAP-ON PANELS For Easy Access to Drive, 20 Slot Card Cage and Power Supply Compartments, Status LED'S and ON-OFF-RESET Key Switch on Front Panel, Houses 5 1/2" & 8" Drives \$1,869
- INTEGRAND 2909 2X8" 1/2 HT Horiz. Stack \$189
- JMR 1H5 5 1/4" H.D. PC Style Cabinet \$189
- JMR 2SV8 Dual Vertical 1/2 HT. 8" \$175
- JMR 2H5 Dual 5 1/4" Horizontal H.D. \$225
- MPS 8462 3020D Horizontal 8" Slimline \$215
- MPS 8465 Dual 5" & 8" Horizontal Slimline \$225
- MPS 5500 1 1/2 5 1/4" Hard Drives, Tape, Etc. \$225
- MPS 5401 5 1/4" STD HT. H.D. or Dual 1/2 HT \$215
- MICROWARE SINGLE STD. 5 1/4" Flipy Horizontal . \$59
- MICROWARE DUAL HORIZ. 5 1/4" 1/2 HT. Floppy ... \$79
- MICROWARE 920004 Dual STD. 5 1/4, PC-Style... \$149
- PARA DYNAMICS 2300-G3 2X8" Flipy & 5 H.D. \$395

Diskettes & Cartridges

- DYSAN 300XL \$21 600A \$24
- DYSAN 104/2D DSDD 5 1/4" \$22.50 CASE \$212
- DYSAN 204/2D 96 TPI DSDD 5 1/4" \$36.95 . CASE \$347
- DYSAN UHR12 Ultra Hi-Density \$47.50 CASE \$449
- DYSAN 3740/2D 8" \$29.95 CASE \$282
- XIDEX PRECISION DSDD 5 1/4" \$8.95 CASE \$77

Modems

- MULTITECH MT212AH Hayes Compatible \$279
- MULTITECH MT224AH Synch & Asynch \$495
- MULTITECH MT224EH MNP Error Correction... \$529
- MULTITECH MT212AR Rack-Mount \$259
- MULTITECH MT224AR Rack-Mount \$459
- MULTITECH MT224ER Rack-Mount With MNP Error Correction \$495
- PROMETHEUS PROMODEM 1200 Hayes Compatible w/ Built-In PWR Supply-RS232 Stand Alone Unit \$289
- OPTIONS FOR PROMODEM 1200 ARE:
- COMMUNICATIONS PROC. BUFFER 2K-512K... \$99
- 512K RAM for Communications Buffer \$49
- ALPHA NUMERIC DISPLAY \$75
- PROMETHEUS 1200A Apple II, II+, IIe Card w/Terminal Software in ROM \$265
- PROMETHEUS 300C Apple IIC Piggy Back \$139
- PROMETHEUS 1200B For PC's with Procom \$239
- PROMETHEUS 1200M Stand Alone MAC Modem with Cable and Communications Software \$348
- HAYES SMART MODEM 1200 RS-232 \$429
- HAYES SMART MODEM 2400 Universal \$659
- U.S. ROBOTICS PASSWORD 1200 \$225
- U.S. ROBOTICS AUTO DIAL 212A \$309
- U.S. ROBOTICS PC/XT MODEM with TELPAC... \$199
- U.S. ROBOTICS PC MULTI-MODEM with Clk-Cal., Batt. Back-up, PRT Port, 256K RAM Telpac \$395
- U.S. ROBOTICS MULTILINK/COURIER 2400 ... \$421

Software • Software • Software

We have Access to all Well Known Brands - ORDER CORRECTLY -- SOFTWARE IS NOT RETURNABLE!

Word Proc./Screen Formatter

- MICROPRO PRO-PAC For PC's \$289
- MICROPRO WORDSTAR 2000/PC's \$289
- MULTIMATE WORD PROCESSOR / PC-DOS... \$315
- NEW STARNEWWORD II w/MergePrint, The Word PLUS Spelling Checker- Easier Than Word Star But File Compatible: 8 Bit \$99.95 16 Bit \$129.95
- NEW STAR NEWWORD III For PC Compatibles, With Context Spelling Checker, Indexing, Table Of Contents, Shorthand Keyboard, Macro's, Run Other Programs In Middle Of NewWord, Supports File Paths For Hard Disks Plus Greatly Increased Speed ... \$209
- PFS WRITE Word Processor For PC's \$85
- QASIS THE WORD PLUS Spelling Checker \$95
- OASIS PUNCTUATION & STYLE \$79
- MARK OF THE UNICORN THE FINAL WORD... \$189
- COMPUVIEW VEDIT \$113 VEDIT Plus \$169
- COMPUVIEW VEDIT PLUS, V-PRINT & SPELL... \$259
- COMPUVIEW V-SPELL CP/M 80 8" & PC DOS... \$59

Communications Programs

- MICROSTUF CROSS TALK XVI \$115
- WOOLF MOVE-IT PC-PC Communications \$96

Language And Tools

- BD SOFTWARE "C" Compiler 8" SS SD 8 BIT ... \$95
- BORLAND PC TURBO PASCAL 3.0 \$44
- BORLAND PC TURBO PASCAL 3.0 W/ 8087 \$70
- BORLAND PC SIDEKICK (Unprotected) \$54
- BORLAND PC SUPERKEY (Unprotected) \$41
- BORLAND PC TURBO GRAPHIX TOOLBOX... \$35
- BORLAND PC TURBO TOOLBOX \$35
- BORLAND PC TURBO TUTOR \$22
- DIGITAL RESEARCH Most Products \$36% OFF
- LATTICE "C" Compiler \$299
- MICROSOFT Complete Line 32% OFF
- SUPERSOFT FORTRAN PC/MSDOS \$199
- AMERICAN TRAINING INT'L TUTORIALS... 36% OFF

Data Bases & Spreadsheets

- ASHTON-TATE ALL PRODUCTS 32% OFF
- DATAFILE FILE/RECORD Locking Multi-User . CALL
- MDBS Knowledgegeman CP/M86 8" \$295
- MICROPRO REPORT STAR \$119
- MICROPRO INFO STAR/16 Bit \$239
- MICROIM R:BASE 4000 @ \$289 R:Base 5000 @ \$409
- PFS FILE \$85 REPORT \$75
- SORCIM SUPERCALC-3 Better Than 1-2-3!! \$179

- V.I.P. PROFESSIONAL For ATARI 520ST More Powerful Than Lotus 1-2-3. \$109

All merchandise new. Advertised prices are cash prepaid only. MC, Visa & P.O.'s from qualified firms - add 3%. Wires, COD's (\$5 min. fee) with Cashiers Check/MO & APO's accepted. Shipping: minimum \$4 first 3 lbs. Tax: AZ RES ONLY add 6% sales tax. All returns subject to 20% restocking fee or credit towards future purchases. Retail prices slightly higher. All prices subject to change without notice.



7400

Part No.	Price	Part No.	Price
SN7400N	.19	SN7485N	.55
SN7402N	.19	SN7486N	.35
SN7404N	.25	SN7489N	1.95
SN7405N	.29	SN7490N	.39
SN7406N	.29	SN7493N	.35
SN7407N	.29	SN74121N	.29
SN7408N	.25	SN74123N	.49
SN7410N	.19	SN74125N	.45
SN7414N	.45	SN74126N	.49
SN7416N	.35	SN74143N	3.95
SN7417N	.35	SN74150N	1.29
SN7420N	.19	SN74154N	1.25
SN7430N	.19	SN74158N	1.39
SN7432N	.29	SN74173N	.75
SN7438N	.29	SN74174N	.59
SN7442N	.45	SN74175N	.59
SN7445N	.69	SN74176N	.69
SN7446N	.79	SN74181N	1.95
SN7447N	.79	SN74189N	1.95
SN7448N	.79	SN74193N	.69
SN7472N	.39	SN74198N	1.35
SN7473N	.35	SN74221N	.89
SN7474N	.35	SN74273N	1.95
SN7475N	.35	SN74365N	.59
SN7476N	.39	SN74367N	.59

74LS

74LS00	.19	74LS165	.79
74LS02	.19	74LS166	.89
74LS04	.25	74LS173	.49
74LS05	.25	74LS174	.39
74LS06	.99	74LS175	.39
74LS07	.99	74LS189	3.95
74LS08	.19	74LS191	.49
74LS10	.19	74LS193	.69
74LS14	.25	74LS221	.59
74LS27	.25	74LS240	.69
74LS30	.19	74LS243	.69
74LS32	.25	74LS244	.69
74LS42	.39	74LS245	.79
74LS47	.89	74LS259	1.19
74LS73	.35	74LS273	.79
74LS74	.25	74LS279	.59
74LS75	.29	74LS322	2.95
74LS76	.29	74LS365	.39
74LS85	.49	74LS366	.39
74LS86	.25	74LS367	.39
74LS90	.39	74LS368	.39
74LS93	.39	74LS373	.79
74LS123	.49	74LS374	.79
74LS125	.39	74LS393	.79
74LS138	.39	74LS590	5.95
74LS139	.39	74LS624	1.95
74LS154	1.49	74LS629	2.49
74LS157	.35	74LS640	.99
74LS158	.35	74LS645	.99
74LS163	.49	74LS670	.99
74LS164	.49	74LS688	1.95

74S/PROMS

74S00	.29	74S188*	1.75
74S04	.35	74S189	1.95
74S08	.35	74S196	1.49
74S10	.29	74S240	1.49
74S32	.35	74S244	1.49
74S74	.49	74S253	.79
74S85	1.49	74S287*	1.69
74S93	.35	74S298*	1.69
74S124	2.75	74S373	1.69
74S174	.79	74S374	1.69
74S175	.79	74S472*	3.49

74ALS

74ALS00	.35	74ALS138	.89
74ALS02	.35	74ALS174	.89
74ALS04	.39	74ALS175	.89
74ALS08	.35	74ALS240	1.79
74ALS10	.39	74ALS244	1.79
74ALS27	.39	74ALS245	2.49
74ALS30	.35	74ALS373	1.95
74ALS32	.39	74ALS374	1.95
74ALS74	.55	74ALS573	1.95

74F

74F00	.59	74F139	1.29
74F04	.65	74F157	1.29
74F08	.59	74F193	4.95
74F10	.59	74F240	2.49
74F32	.65	74F244	2.49
74F74	.69	74F373	1.79
74F86	.89	74F374	2.95
74F138	1.19	74F374	2.95

CD - CMOS

CD4001	.19	CD4081	.25
CD4011	.19	CD4082	.25
CD4013	.35	CD4093	.39
CD4016	.29	CD4094	.39
CD4017	.49	CD40103	1.95
CD4018	.69	CD4503	.49
CD4020	.69	CD4510	.49
CD4024	.49	CD4511	.69
CD4027	.39	CD4515	1.39
CD4030	.39	CD4518	.79
CD4040	.65	CD4520	.79
CD4049	.29	CD4522	.79
CD4050	.29	CD4523	.79
CD4051	.65	CD4541	.89
CD4052	.65	CD4543	.99
CD4053	.65	CD4553	4.95
CD4059	3.49	CD4555	.89
CD4060	.89	CD4566	1.95
CD4065	.29	CD4583	1.19
CD4066	.25	CD4584	.59
CD4070	.29	CD4585	.75
CD4071	.25	MC14411	9.95
CD4072	.25	MC14490P	4.49
CD4076	.89	MC14572	.89

PRICE BREAKTHROUGH!

CUSTOM COMMODORE CHIPS for VIC-20, C-64 and C-128 Personal Computers

Part No.	Price	Part No.	Price	Part No.	Price
*6510CPU	99.95	*6526CIA	25.95	*6581SID	92.95
*6525TPI	89.95	*6560VIC1	29.95	82S100PLA	37.95
*Specs. Available @ \$1.50 ea. NOTE: 82S100 = U17 (C-64)					



MC68701-Microcomputer with EPROM

The MC68701 is an 8-bit single chip microcomputer unit (MFU) which significantly enhances the capabilities of the MC6800 family of parts. On-chip resources include 2048 bytes of EPROM, 128 bytes of RAM, Serial Communications Interface (SCI), parallel I/O, and a three function Programmable Timer.

MC68701..... \$24.95

MICROPROCESSOR COMPONENTS

MICROPROCESSOR CHIPS		6500/6800/68000 Cont.		8000 SERIES Cont.	
Part No.	Price	Part No.	Price	Part No.	Price
D765AC	4.95	6840	6.75	8243	2.49
CDP1802CE	9.95	6843	19.95	8250A	6.95
2661-3	6.95	6845	4.95	8250B (For IBM)	5.95
Z80, Z80A, Z80B, SERIES					
Z80	1.75	6850	1.95	8251A	2.25
Z80-CTC	1.79	6852	4.75	8252-5	2.25
Z80-DART	4.95	68000L8	9.95	8254	9.95
Z80-P10	1.79	68661	8.95	8255A-5	2.25
Z80A	1.85	8000 SERIES			
Z80A-CTC	1.89	8031	6.95	8257-5	2.49
Z80A-DART	5.25	80C31BH	19.95	8259-5	2.49
Z80A-P10	1.95	8035	1.95	8272	4.95
Z80A-S10/0	5.25	8073N	23.95	8273-5	2.95
Z80B	3.95	8080A	3.95	8741	8.95
Z80B-CTC	4.95	8085A	2.75	8748	7.95
Z80B-P10	4.95	8086-2	8.95	8749	9.95
6500/6800/68000 SER.		8087(5MHz)	129.95	8751	29.95
6502	2.75	8087-2(5MHz)	139.95	8755	14.95
6503	2.75	8088	7.95	DATA ACQUISITION	
6522	4.95	8116	8.95	ADC0804	3.49
6532	4.95	8155	8.95	ADC0808	8.95
6532	6.49	8156	2.75	ADC0809	8.95
6551	6.95	8202	9.95	ADC0816	14.95
6800	1.95	8203	29.95	ADC0817	8.95
6802	4.95	8212	1.95	DAC0808	1.95
6810	1.95	8224	2.25	DAC1008	7.95
6821	1.95	8228	3.49	AY-3-1015D	4.95
		8237-5	6.95	AY-5-1013A	3.95

DYNAMIC RAMS

Part No.	Function	Price
4116N-15	16,384 x 1	.89
4128	131,072 x 1	4.95
4164N-150	65,536 x 1	1.25
4164N-200	65,536 x 1	1.19
TMS4416-12	16,384 x 4	4.95
NM5280	4096 x 1	1.95
8118	16,384 x 1	1.95
41256-150	262,144 x 1	3.29
50464-15	65,536 x 4	7.95

STATIC RAMS

TMM2016-12	2048 x 8	1.69
2102	1024 x 1	.89
2102-2L	1024 x 1	1.49
2114N	1024 x 4	.99
2114N-L	1024 x 4	1.05
2114N-2	1024 x 4	1.05
2114N-2L	1024 x 4	1.49
21C14	1024 x 4	.49
2149	1024 x 4	4.95
5101	256 x 4	3.95
HM6116P-3	2048 x 8	1.79
HM6116P-3	2048 x 8	1.89
HM6264P-12	8192 x 8	4.69
HM6264LP-12	8192 x 8	4.79
HM6264P-15	8192 x 8	4.49
HM6264LP-15	8192 x 8	4.59
6514	1024 x 4	4.49

PROMS/EPROMS

1702A	256 x 8	3.95
2708	1024 x 8	3.95
TMS2716	2048 x 8	6.49
2716	2048 x 8	6.49
27C16	2048 x 8	9.95
2732	4096 x 8	2.49
2732A-20	4096 x 8	3.95
2732A-45	4096 x 8	2.75
27C32	4096 x 8	3.95
2758	1024 x 8	10.95
2764-20	8192 x 8	3.95
2764A-25	8192 x 8	2.95
2764-45	8192 x 8	2.19
27C64	8192 x 8	6.95
27128-25	16,384 x 8	2.95
27256-25	32,768 x 8	7.95
27C256-25	32,768 x 8	13.95
68764	8192 x 8	2.95
68766	8192 x 8	16.95
74S387	256 x 4	1.69
74S471	256 x 8	4.95
82S123	32 x 8	2.95
82S129	256 x 4	2.95

LOW PROFILE (TIN) SOCKETS

Part No.	1-9	10-99	100-up
8 pin LP	13	12	11
14 pin LP	17	13	11
16 pin LP	17	15	13
18 pin LP	25	23	21
20 pin LP	28	26	23
22 pin LP	30	28	26
24 pin LP	31	30	29
28 pin LP	39	37	35
40 pin LP	49	46	43

— SOLD RETAIL STANDARD (GOLD & TIN) AND HEADER PLUG SOCKETS ALSO AVAILABLE —

SATELLITE TV DESCRAMBLER

The MM5321 is a TV camera sync generator designed to supply the basic sync functions for either color or monochrome S25 line/60Hz interfaced and camera video recorder applications. **COLOR BURST GATE & SYNC ALLOW STABLE COLOR OPERATION**
MM5321..... \$9.95

DIGITAL TALKER™

DT1050 — Applications: Teaching aids, appliances, clocks, automotive, telecommunications, language translations, etc. The DT1050 is a standard DIGITAL TALKER kit encoded with 137 separate and useful words, 2 tones, and 5 different silence durations. The words and tones have been assigned discrete addresses, making it possible to output single words or words concatenated into phrases or even sentences. The "voice" output of the DT1050 is a highly intelligible male voice. The DT1050 consists of a Speech Processor Chip, MM54104 (40-pin) and two (2) Speech ROMs MM52164SSR1 and MM52164SSR2 (24-pin) along with a Master Word list and a recommended schematic diagram on the application sheet.
Part No. Description Price
DT1050 Digital Talker™ **\$24.95**
MM54104 Processor Chip **\$12.95**

DT1057 — Expands the DT1050 vocabulary from 137 words to over 250 words. Includes two (2) ROMs and specs.
DT1057..... \$11.95

INTERSIL

Part No.	Price	Part No.	Price
FE0202D	12.95	7207AEV/Kit	8.49
FE0203D	12.95	7211IFL (TTL)	7.95
7105CPL	8.49	7211MPL (Micro)	8.49
7106EV/Kit	46.95	7217LJL	10.95
7107CPL	8.95	7217AFL	8.95
7107EV/Kit	46.95	7224IPL	10.95
7207AIPD	5.95	7226AEV/Kit	99.95

74HC1-SPEED CMOS

74HC00	.35	74HC175	.89
74HC02	.39	74HC221	1.95
74HC04	.39	74HC240	1.39
74HC08	.39	74HC244	1.49
74HC10	.39	74HC253	1.59
74HC14	.39	74HC259	.79
74HC30	.39	74HC259	1.19
74HC32	.45	74HC273	1.79
74HC74	.45	74HC373	1.49
74HC75	.69	74HC374	1.49
74HC76	.69	74HC393	1.19
74HC85	1.19	74HC395	1.95
74HC86	.59	74HC688	1.95
74HC123	1.19	74HC4040	1.19
74HC125	.99	74HC4049	.79
74HC132	.79	74HC4050	.79
74HC138	.79	74HC4060	1.19
74HC139	.79	74HC4511	2.95
74HC154	.95	74HC451	

Worldwide • Since 1974

• QUALITY COMPONENTS • COMPETITIVE PRICING • PROMPT DELIVERY

Mail Order Electronics • Worldwide
Jameco
ELECTRONICS

COMMODORE® COMPATIBLE ACCESSORIES



RS232 Adapter
for VIC-20 and Commodore 64

The JE232CM allows connection of standard serial RS232 printers, modems, etc. to your VIC-20 and C-64 (excluding the SX-64 Portable). A 4-pole switch allows the inversion of the 4 control lines. Complete installation and operation instructions included.

Plugs into User Port • Provides Standard RS232 signal levels • Uses 6 signals (Transmit, Receive, Clear to Send, Request to Send, Data Terminal Ready, Data Set Ready).

JE232CM \$39.95

Voice Synthesizer VIC-20 & C-64
Plug-In - Talking in Minutes!

JE520CM \$99.95

300 Baud Auto Modem

Mitey-Mo (For C-64) \$74.95

Parallel Printer Interface
FREE 4K Buffer Included!

MW350 (For VIC-20, C-64 & C-128) \$69.95

TRS-80 COMPATIBLE ACCESSORIES

E-X-P-A-N-D TRS-80 MEMORY
All kits come complete with documentation

TRS-80 MODEL I, III

TRS-16K3 200ns (Model III) \$5.95

TRS-16K4 250ns (Model I) \$5.49

TRS-80 COLOR AND COLOR II

TRS-64K-2 \$11.95

New models only -

TRS-CoCo-Incl. 2-50464's (41464's) \$19.95

TRS-80 MODEL 4, 4P

TRS-64K-2 \$11.95

Expands Model 4 from 16K-64K or Model 4P from 64K-128K

TRS-64K-2PAL \$29.95

Expands Model 4 from 64K to 128K

TRS-80 Model 100 • NEC • Olivetti

M1008K \$29.95 ea. or 3 for \$79.95

TRS-80 Model 100 Expansion

NEC8KR \$29.95 ea. or 3 for \$79.95

NEC Model PC-8201A Expansion

OM108K \$29.95 ea. or 3 for \$79.95

Olivetti Model M10 Expansion

TANDY 200

M200R \$99.95 ea. or 2 for \$189.95

Tandy Model 200 Expansion

PROMETHEUS MODEMS



Intelligent 1200/300 Baud Modem with Real Time Clock/Calendar

The ProModem™ is a Bell 212A (1200/300) intelligent stand-alone modem • Hayes command set compatible plus an additional extended command set • Shown with alphanumeric display option. RS-232 Stand-Alone Unit:

PM1200 \$299.95

Options for ProModem 1200

PM-COM \$79.95

ProCom Communications Software. Please specify Operating System - Apple: ProDOS or CP/M - IBM: PC DOS or MS DOS

PM-OP512K \$129.95

Communications Buffer Option

BUF512K \$54.95

512K Memory for PM-OP512K

PM-ALP \$79.95

Alphanumeric Display for ProModem 1200

PM-SPECIAL #2 \$249.95

Includes PM-OP512K, BUF512K and PM-ALP

APPLE® COMPATIBLE ACCESSORIES

All Apple Cards come complete with instructions. MADE IN THE USA!

16K RAM CARD (Language Card)
For Apple II and II+*



Expand from 48K-64K. Runs AppleSoft, DOS, CP/M and Pascal. (ARC-16K/MEM-1)

JE860** \$39.95

CONTROLLER CARD
For Apple II, II+ and IIe*



Capable of handling up to two drives. Recommended drives: ADD-514 or ADD-12. (ACC-1)

JE875 \$49.95

EXTENDED 80-COLUMN CARD
For Apple IIe*



JE864 is an extended 80-column/64K RAM Card. Ultra-high resolution capability.

JE864 \$69.95



128K RAM CARD
For Apple II, II+ and IIe*

Four key software programs are included: Utilities, Diagnostics, Demos, and RAM Disk Emulators for DOS 3.3, CP/M and Apple Pascal. Expand-A-RAM:

JE868** \$119.95



APPLESURANCE DIAGNOSTIC DISK CONTROLLER CARD
For Apple II, II+ and IIe*

PREVENTS CRASHES!

Test your RAM, ROM, CPU and Disk Drives. DRV-1/Applesurance II:

JE877 \$69.95



PARALLEL PRINTER CARD
For Apple II, II+ and IIe*

Fully compatible with Apple CP/M, Apple Pascal (or FORTRAN), and most other operating systems and software packages. Available for Apple II, II+ and IIe*. PRT-1:

JE880 \$59.95



PARALLEL/SERIAL 64K BUFFER CARD
For Apple II, II+ and IIe*

Using the parallel jumper cable supplied, the JE883 will attach to the JE880 (above). Parallel Card needed for operation. The JE883 includes a standard parallel input with both parallel and serial (RS232) buffered outputs. P/S Buffer:

JE883 \$79.95

*APPLE, APPLE II, II+ and IIe are registered trademarks of Apple Computers.

**When using CP/M, the JE880 and JE868 will only function with Version 2.20 or earlier: PASCAL (JE868) Version 1.1 or earlier.

ADDITIONAL APPLE® COMPATIBLE PRODUCTS

Key: a=Apple II or II+ b=Apple IIe

APF-1	Cooling Fan with Surge Protection • Key: (a,b).	\$ 39.95
KHP4007	Switching Power Supply • Key: (a,b).	\$ 39.95
JE614	Numeric/Aux. Keypad - 11 accessible functions • Key: (b).	\$ 49.95
AMON	12" Green Monitor with Swivel Stand • Key: (a, b and IIc).	\$ 99.95
KB-EA1	Apple Keyboard and Case • Key: (a).	\$ 99.95
JE520AP	Voice Synthesizer - Plug-In, User Ready • Key: (a,b).	\$119.95
ADD-12	5 1/4" Half-Height Disk Drive • Key: (a,b).	\$129.95
ADD-IIc	5 1/4" Half-Height Disk Drive • Key: (IIc).	\$129.95
ADD-514	5 1/4" Full Height Disk Drive • Key: (a,b).	\$139.95
PM1200A	Prometheus Internal Modem - 2 Cards • Key: (a,b).	\$299.95
PM1200M	Prometheus Macintosh Ext. Modem • Key: (Macintosh).	\$349.95

GENERAL APPLICATION POWER SUPPLIES

Power/Mate Corp. REGULATED POWER SUPPLY			
Input: 105-125/210-250VAC @ 47-63Hz • Line regulation: ±0.05% • 3 mounting surfaces • Overvoltage protection • UL recognized • CSA certified			
Part No.	Output	Size (inches)	Weight PRICE
EMAS/6B	5V@3A / 6V@2.5A	4 1/2" x 4 1/2" x 2 1/2" H	2 lbs. \$29.95
EMAS/6C	5V@6A / 6V@5A	5 1/2" x 4 1/2" x 2 1/2" H	4 lbs. \$39.95

4-CHANNEL SWITCHING POWER SUPPLY

Microprocessor, mini-computer, terminal, medical equipment and process control applications • Input: 90-130VAC, 47-440Hz • Output: +5VDC @ 5A -5VDC @ 1A, +12VDC @ 1A, -12VDC @ 1A • Line regulation: ±0.2% • Ripple: 30mV p-p • Load regulation: ±1% • Overcurrent protection • Adjustment: 5V main output ±10% • Size: 6 1/2" L x 1 1/2" W x 4-15/16" H • Weight: 1 1/2 lbs.

FCS-604A \$59.95

IBM® COMPATIBLE ACCESSORIES



83-KEY KEYBOARD

Identical layout as original IBM PC Keyboard • Highly desirable case with palm rest • Complete with cable and data JUST PLUG-IN!

KB83 \$49.95

Build an IBM PC/XT™ Compatible!

IBM-64K 64K RAM Chips (9) \$ 10.49

KB-83 83-Key Keyboard \$ 49.95

IBM-FCC Floppy Controller Card \$ 59.95

IBM-Case Case \$ 59.95

IBM-MCC Monochrome Card \$ 89.95

IBM-PS Power Supply \$ 99.95

FD55B Disk Drive \$119.95

IBM-MON Monochrome Monitor \$109.95

IBM-MB Motherboard \$269.95

Regular List \$870.09

IBM™-Special (Incl. 9 Items above) \$749.95



IBM PC/XT Equivalent 130 Watt Power Supply
Upgrade Your PC!

Input: 110V@60Hz • Output: +5VDC @ 15A, -5VDC @ 0.5A, +12VDC @ 4.2A, -12VDC @ 0.5A • Plug compatible connectors • Fits into IBM PC • Weight: 6 lbs.

IBM-PS \$99.95



IBM Compatible! DISK DRIVES
Documentation Included

FD55B Teac 5 1/4" DS 1/2-Height \$119.95

SA455 Shugart 5 1/4" DS 1/2-Height \$119.95

TM100-2 Tandon 5 1/4" DS Full-Height \$119.95

JMR 5 1/4" DISK DRIVE ENCLOSURES

Complete with power supply, switch, power cord, fuseholder and connectors.

DDE-1FH Houses 1 Full-Height 5 1/4" Floppy Drive \$69.95

DDE-2HH Houses 2 Half-Height 5 1/4" Floppy Drives - Vertical \$79.95

HDDE-1FH Houses 1 Hard Disk Drive \$199.95

Houses 1 Hard Disk Drive

UV-EPROM ERASER



Erases all EPROMs. Erases up to 8 chips within 21 minutes (1 chip in 15 minutes). Maintains constant exposure distance of 1". Special conductive foam liner eliminates static build-up. Built-in safety lock to prevent UV exposure. Compact - 9.00" L x 3.70" W x 2.60" H. Complete with holding tray for 8 chips.

DE-4 UV-EPROM Eraser \$74.95

UVS-11EL Replacement Bulb \$17.95

DATA BOOKS

30003 National Linear Data Book (82) \$14.95

30009 Intersil Data Book (85) \$ 9.95

30013 Zilog Data Book (85) \$14.95

30022 Nat'l. Logic Data Book Set (84) \$24.95

210830 Intel Memory Handbook (83/84) \$19.95

230843 Intel Microsystem Hndbk. (83/84) \$19.95

MUFFIN/SPRITE-STYLE FANS

MUF60 (SPN3-15-2462) \$9.95

Howard Industries (4.68" sq, 60 cfm)

SUZC7 \$9.95

EG&G Rotron (3.125" square, 20 cfm)

\$20 Minimum Order - U.S. Funds Only
Shipping: Add 5% plus \$1.50 Insurance

California Residents: Add 6% or 6 1/2% Sales Tax

Spec. Sheets - 30¢ each
Prices Subject to Change

Send stamped, self-addressed envelope to receive a Quarterly Sales Flyer - FREE!



Send \$1.00 Postage for a FREE 1986 JAMECO CATALOG

1355 SHOREWAY ROAD, BELMONT, CA 94002 • PHONE ORDERS WELCOME 415-592-8097 Telex: 176043

California Digital

17700 Figueroa Street • Carson, California 90248

IBM Compatible Computer

\$495



Eclipse
DATA PRODUCTS

- 256K Expandable to 640K on Motherboard
- Double Sided Double Density Disk Drive
- IBM Type Keyboard (with LED indicators)
- Floppy Controller Card
- Eight Expansion Slots
- 135 Watt Power Supply

The Eclipse 16 is an outstanding value in IBM Compatible Computers. After careful research and evaluation we found it to be the most reliable unit.

Our computer includes some of the newest features available, such as the 4.7MHz, multi-layer motherboard with 256K of RAM upgradable on board to 640K. A generous eight expansion slots and 135 Watt power supply give you ample room and power for add-on boards. The enclosure has an easy-access flip top lid making upgrades a breeze. And our floppy controller supports up to four drives, so as many as three additional drives can be used. Finally, each computer is configured and fully tested before sending it to you.

Satisfaction Guaranteed! We're really excited about this new unit, and so sure you will be too... that you may return the Eclipse 16 for a full credit towards an IBM PC if you are not completely satisfied.

OPTIONS

20MB Hard Drive w/Controller.....	\$495	RGB Color Monitor.....	199
Additional Drive-Installed.....	99	TTL Monochrome Monitor.....	139
Irwin 10 Meg. Tape Back up.....	489	Microsoft Mouse.....	139
Upgrade from 256K to 640K RAM.....	79	Upgrade from Floppy Controller to Disk I/O	
8087 Math Co Processor.....	119	2 drive controller, clock/cal. software	
Color Graphics Card.....	79	parallel, serial, and game ports.....	79
Monochrome Graphics Card.....	99	1200 Baud Internal Modem w/Software	179

XEROX \$299 SUNRISE COMPUTER



The Xerox Sunrise 1810 is by far the best value we have ever seen in a micro computer. This is a self contained battery and AC operated portable. The Sunrise was originally priced at \$2995. Xerox has since elected to drop the computer from their product list. California Digital has purchased all the remaining inventory and is making the unit available at a fraction of its original cost.

This portable features a built in 80 column liquid crystal display, 64K of memory along with both RF monitor and television outputs. The internal 300/1200 baud modem includes an auto dial telephone assembly. The units has both centronics parallel and a serial port programmable to 19,200 baud. The self contained micro cassette is capable of capturing data from the keyboard as well as doubling as a recorder for dictating messages.

An optional dual floppy disk drive module, pictured above, is available for only \$219. Also available, for \$59 is an 80 column printer that mounts in the drive module. The Sunrise features a CP/M operating system which allows the operator to use any CP/M program in Xerox 5 1/4" disk format and over 5000 CP/M programs available in public domain.

We have available a 15 minute tape on the Sunrise Computer. The tape is in VHS format and was produced by Xerox to promote the computer. California Digital is offering the promotional tape at \$15. This will be applied towards purchase price of the Sunrise 1810 computer.

Eclipse 1200 Your Choice 1200 Baud Hayes Compatible \$179

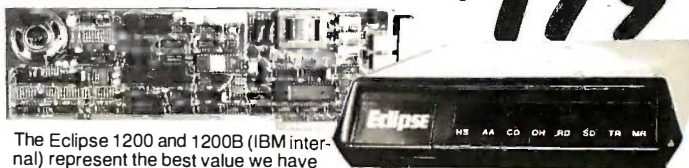

The Eclipse 1200 and 1200B (IBM internal) represent the best value we have ever offered in a fully Hayes Compatible 300/1200 baud modem. Both units include speaker, auto dial and data communication software. The external also features status indicators LED's. The internal includes an auxiliary RS-232 serial port. California Digital is so confident of your complete satisfaction that we will allow the return of either Eclipse 1200 modem and apply the full credit towards the purchase price of any other modem.

1200 BAUD MODEMS



AVATEX 1200

\$99

This 300/1200 baud modem matches the design specs of the Bell 212A, feature by feature, bringing you reliability, impeccable transmission and easy operation. Hayes Compatible, except for "S" register. Communication software included.

The AVATEX 1200, at \$99, is a steal!

SMARTTEAM 1200



\$189

The Team 212A offers all the features of the Hayes Smart Modem 1200 for a fraction of the price. Now is your opportunity to purchase a 1200 baud modem at the price of a 300 baud modem.

SIGNALMAN 300 BAUD MARK VI



\$49

The Anchor Automation Mark VI is a 300 baud direct connect modem that plugs into any slot of your IBM/PC. This modem supports auto answer and auto dial capabilities. Other features include telephone number storage, send / receive text files, single key-stroke dialing along with many other functions provided on disk. The Mark VI was originally priced at over \$300.

UltraLink 1200



The UltraLink is a 1200 baud HALF DUPLEX bell 202 compatible internal modem card for the IBM/PC. This unit operates full duplex at 300 baud. The UltraLink adds a voice/data demodulation to your PC. Manufacturer's original suggested price on this modem is \$795. California Digital's price is only \$99.

\$99

MODEMS

Eclipse 1200 100% Hayes, with status lamps.
Eclipse 1200B internal with software
Hayes Smartmodem 2400 baud modem
Fujitsu 2400/1200 baud auto everything.
Team 1200 Hayes Compatible, 300/1200 baud.
UltraLink 1200 data and voice on same line.
CTS 212AH 1200 baud, auto dial
Terminal software for CTS 212AH
Prometheus 1200 super features
Prometheus 1200B internal PC
Signalman Mark VI, 300 baud internal PC
Hayes Smart Modem 1200 baud, auto dial
Hayes 1200B for use with the IBM/PC, 1200 baud.
Hayes Smartmodem, 300 baud only, auto dial
Hayes Chronograph, time & date

ECP-1200 179.00
ECP-1200B 179.00
HYS-2400 599.00
FUJ-1935D 459.00
TEM-SM1200 189.00
UTL-1200A 99.00
CTS-212AH 219.00
CTS-212SFT 35.00
PRM-P1200 289.00
PRM-P1200B 279.00
SQL-MK6 49.00
HYS-212AD 369.00
HYS-1200B 299.00
HYS-103AD 199.00
HYS-CHR232 199.00

Seagate \$359 20 MEGABYTE WINCHESTER HARD DISK DRIVE

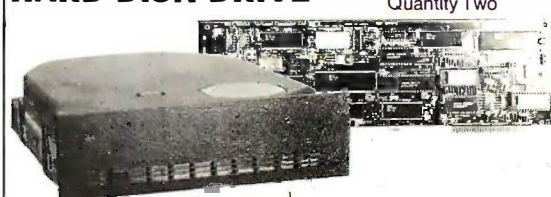

Five Inch Winchester Disk Drives

	each	two+
SEAGATE 225 20 Meg. V2 Hl	389	359
SEAGATE 4026 26 M. 35mS.	859	829
SEAGATE 4051 51 M. 35mS.	1095	1059
FUJITSU 2242 55 M. 35mS.	1799	1729
FUJITSU 2243 86 M. 35mS.	2295	2219
ROOIME RO-202E 27 Meg.	759	729
ROOIME RO-203E 40 Meg.	995	959
ROOIME RO-204E 53 Meg.	1259	1195
CONTROL DATA 94155-86 M.	1829	1779
MAXTOR XT1140 140 Meg.	3379	3295
HONEYWELL 85M. 27 mS.	1795	1695
TOSHIBA MK5670 M. 30mS.	1789	1729
TANDON 502 10 Meg.	419	379

Quantity Two

● Winchester Controllers for IBM/PC	
FALCON FT-HDC half card	189
XEBEC 1220 with floppy controller	269
NATIONAL COMPUTECH 5004	159
DTC 5150BX	159
OMTI 5510 half card	189
ADAPTEC 2010A software install	189
WESTERN DIGITAL WD/1002	189
● SCSI/SASI Winchester Controllers	
XEBEC 1410A 5 1/4" foot print	239
OMTI 20L	119
● Winchester Accessories	
Installation Kit with manual	10
Winchester enclosure and supply	139
Dual 20/34 cable set	25
Switching power supply	49

TOLL FREE ORDER LINE
(800) 421-5041

TECHNICAL & CALIFORNIA
(213) 217-0500

California Digital

17700 Figueroa Street • Carson, California 90248

LETTER QUALITY F-10 DAISY WHEEL PRINTER

\$429

Quantity Two

Single piece price \$499. But if you have already purchased an F-10 printer from California Digital, we will honor the \$429 price on the second printer.



The TEC F-10 Daisy Wheel printer is the perfect answer to a reasonably priced 40 character word processing printer. While this printer is "extremely" similar to C.Itoh's F-10/40 Starwriter printer. Legal counsel for the C.Itoh Company have advised us that we should refrain from referring to the TEC printer as a Starwriter. This 40 character per second printer auto installs with Wordstar and Perfect Writer. Features extensive built-in word processing functions that allow easy adaptability and reduced software complexity. Industry standard Centronics interface provides instant compatibility with

all computers equipped with a parallel printer port. The TEC F-10 accepts paper up to 15 inches in width. These printers were originally priced to sell at over \$1400. Through a special arrangement California Digital has purchase these units from a major computer manufacturer and is offering these printers at a fraction of their original cost. Options available include sheetfeeder, tractor feed, buffered memory and an assortment of printer cables for a variety of computers.

5 1/4" DISK DRIVE SALE \$89

Quantity Two

Your Choice 48 or 96 TPI drive. QUME MODEL 142 • 48 TPI MITSUBISHI 4853 • 96 TPI



TEAC FD55BV half height	119	109	99
TEAC FD55FV 96 TPI, half ht.	119	109	105
TEAC FD55GF for IBM AT	189	179	175
SHUGART SA455 Half Height	119	109	105
SHUGART SA465 1/2 Ht. 96TPI	125	119	109
TANDON 100-2 full height	129	125	119
MITSUBISHI 4851 halfheight	119	109	105
MITSUBISHI 4853 96/TPI 1/2 Ht.	99	89	89
MITSUBISHI 4854 8" elec.	295	285	275
QUME 142 half height	99	89	89
Switching power supply			49
Installation Kit with manual			10
Dual enclosure for 5 1/4" drives			59
34 pin edge connectors			5
Scotch head cleaning kit			19
Flip & File Storage tubs			15

\$159 ~~\$799~~ YOUR COMPUTER CAN READ!

Omni Reader... the first optical character reader designed and priced for small computers. Now you can transfer material directly from the typed or printed page to the screen of your computer, without ever touching the keyboard.

Copy: Manuscripts, Contracts, Articles, Forms, Invoices & Purchase Orders. Applications: Mailing Lists, Editing, Data Base Management, Transferring information between incompatible systems.

Uses a standard RS-232C serial port hookup to interface easily with your computer.

CORNERSTONE Database \$495 \$89

CORNERSTONE, the first sophisticated Database designed specifically for the non-programmer. Created by INFOCOM, well known for their quality software, CORNERSTONE makes building a database as easy as ever before, and has everything you need to start using it productively from the very first day. Designed for you to get the results you need without any help from a programmer, CORNERSTONE is ideal for Sales Managers, Personnel Directors, Accountants or any growing business needing to solve an entire range of information management problems, from Mailing List and Sales Tracking, to Personnel Management and Resource Planning. And you can search for information according to any criteria you think of. This package originally sold for \$495. Pick it up today from California Digital for only \$89, and start being more productive tomorrow!

QUME \$149

Eight Inch Single Sided Drives

QUME 841 single side	159	149	call
SHUGART 801R	359	359	354
SIEMENS FDD 100-8	119	115	109

PLOTTER \$219

The Correx Comscribe I is the ideal solution to make short work of translating financial and numeric data into a graphic presentation. Many ready to run programs such as Lotus 1-2-3, Visi-on and Apple business graphics already support this plotter. The Comscribe I features programmable paper sizes up to 8 1/2" by 120 inches, 6 inch per second plot speed and a 0.004" step size. Easy to implement Centronics interface allows the Comscribe I immediate use with the printer port of most personal computers. The Comscribe I is manufactured for Correx by the Enter Computer Corporation. The plotter is marketed by Health Kit and also sold under Enters own "Sweet P" Label. This is your opportunity to purchase a plotter which was originally priced at \$795 for only \$219. Also available is a support package which includes demonstration software, interface cable, a multicolor pen assortment and a variety of paper and transparency material.

Quick-Link 300 \$59

The Quick-Link 300 gives you an instant link to any dial up data base. Such as Dow Jones, Western Union or the Source. The Quick-Link has four user programmable log-on keys, allowing the operator, with only one key stroke, to dial the data base, log-in and give the password. All this information is permanently stored in non-volatile RAM. Features include video output to television or monitor, auto dial, auto-log, full speed keyboard, 300 baud modem and 1200 baud auxiliary printer port. All this is available for only \$59.

QUME \$149

Eight Inch Double Sided Drives

QUME 842 "QUME TRACK 8"	189	179	call
SHUGART SA851R	495	485	475
OLIVETTI double sided	189	179	159
REMEX RFD-4000	179	169	159
MITSUBISHI M2896-63 1/2 Ht.	459	449	409
Dual 8" enclosure with power and fan			259
Switching power supply			89
Installation kit with manual			10

NEC RGB COLOR MONITOR \$219

The NEC JC-1401D is a 13" medium/high resolution RGB monitor suitable for use with the SanyoMBC-550/555 or the IBM/PC. The monitor features a resolution of 400 dots by 240 lines. Colors available are Red, Green, Blue, Yellow, Cyan, Magenta, Black and White. The NEC monitor carries the Litton-Monroe label and was originally scheduled for use in their "Office of the Future" equipment. A change in Monroe's marketing strategy has made these units excess inventory which were sold to California Digital. We are offering these new RGB monitors at a fraction of their original cost. Sanyo compatible NEC-1401/S; IBM/PC Computer compatible NEC-1401/PC

DRAGON \$99

Compatible with most Radio Shack Color Computer software. The world famous Dragon computer is now available in the United States. Manufactured by the Tatro Corp. under license of the British Broadcasting Company. The Dragon comes complete with 64K Byte of memory, serial modem port along with a Centronics printer interface. This unique microcomputer features Motorola's advanced 6809E microprocessor and comes standard with Microsoft Color Basic, data base manager, and a complete word processing package. The computer outputs color composite video along with R.F. video that allows the unit to be used in conjunction with any color television. This is the ideal low cost computer to be used with any dial up information system such as the Source, EasyLink or any other time share service.

PRINTERS

MATRIX PRINTERS

Star Gemini-SG10 120 char/sec.	STR-SG10	239.00
Star Gemini-SG15, 100char./sec. 15" paper.	STR-SG15	389.00
Star Gemini-Delta 10, 160 Char/sec	STR-D10	359.00
Citizen MSP10FT 160 char/sec	CIT-MSP10	289.00
Toshiba P1351, 192 char/sec. letter quality	TOS-1351	1495.00
Oxidata 182A serial & parallel 9 1/2" paper	OKI-182A	257.00
Oxidata 192A parallel interface, 160 char/sec.	OKI-192A	345.00
Oxidata 84P parallel 15" paper	OKI-84P	789.00
Epson LX-8010 120 Char/sec	EPS-LX80	239.00
Epson FX80FT, 10" 160 char./sec. with graphitrax	EPS-FX80	389.00
Epson RX100+ 15" with Graphitrax	EPS-RX100	389.00
Epson FX100FT 15" 160 char./sec with graphitrax	EPS-FX100	489.00
Epson LX1500, 15" correspondence quality	EPS-LX1500	895.00
Epson JX60 Color printer	EPS-JX60	515.00
Prowriter 8510 parallel 9 1/2" paper	PRO-8510P	329.00
Dalap oducts B-600-3, band printer 600 LPM	DPS-B600	695.00
Printonix P300 high speed printer 300 lines per minute	PTX-P300	395.00
Printonix P600 ultra high speed 600 lines per minute	PTX-P600	5795.00

WORD PROCESSING PRINTERS

Starwriter F10 parallel, 40 char/sec	PRO-F10P	499.00
NEC8810 55 char/second, serial interface	NEC-8810	1659.00
NEC8830 55 char/sec, par. interface.	NEC-8830	1659.00
NEC3550 popular printer designed for the IBM/PC	NEC-3550	1599.00
NEC2050 designed for IBM/PC 20 char/sec par. I.	NEC-2050	689.00
Silver Reed EXP500, 14 char/sec, par. interface.	SRD-EXP500	319.00
Silver Reed EXP550 17 Char/sec, par. interface.	SRD-EXP550	429.00
Diablo 620 40 char/sec, serial	DBL-620	1569.00
Diablo 620, proportional spacing, horz. & vert. tab. 20 cps	DBL-620	769.00
Juki B100, 16 char./sec	JUK-B100	359.00
Juki B200 10 char./sec	JUK-B200	699.00
Comex CR2, 5x buffer, proportional spacing, par. I.	CRX-CR2P	395.00

THE DIVERSIFIED GROUP

**2% DISCOUNT ON ALL ADVERTISED PRICES
WITH PREPAYMENT — Call (800) 523-1041 TO ORDER NOW!**

WHAT'S HOT

ENHANCED GRAPHIC ADAPTOR
16 Colors 256K, Parallel Port
\$292.95

TAXAN 630 MONITOR
Offers Green, Amber,
B & W Reverse, White on Blue
\$446.95

NEC V20
Replace your 8088
to increase speed up to 40%
\$18.95

300/1200 BAUD MODEM
External Hayes Compatible
\$156.95

IRWIN 10MEG
Tape Backup, Software Included
\$446.95

20 MEGABYTE HARD-CARD
21 MB formatted all on 1 card in 1 slot
\$762.95

SURGE PROTECTORS
Surge & Spike Suppression
15A Circuit Breaker
6 Receptacle Strip 6 Receptacle Wall Mount
\$28.95 **\$17.95**

MULTIFUNCTION CARD
384K Memory Included
Parallel, Serial & Clock
Game Port with Software
\$131.95

CLOSE OUTS WHILE THEY LAST

PARADISE MULTIPLAY Color or Monochrome IBM Compatible	\$99	HAYES 300 BAUD MODEM	\$85	APPLE DISK CONTROLLERS	\$25
DISKETTES Sgl Side/Dbt Density In Box with Hub Ring & Sleeves	\$6 a box	ALS CPM 3.0 Card	\$85	TG JOYSTICK	\$20
AMDEX DVM II RGB Interface for Apple	\$70	RF MODULATOR	\$5	APPLE JOYSTICK	\$10
DUAL DISK DRIVE CAB. 5 1/4 with Power Supply	\$60	APPLE 80 COL. CARD for IIE or II+	\$50	RIXON PC 212A MODEM	\$150
				IIC SER. TO PAR CONVERTER	\$70

SERVICE CONTRACTS AVAILABLE — CALL (800)523-1041

HARD DISK DRIVES

All Hard Disks Come With: 1 Yr. Warranty, Cables,
Controller and are Formatted

	QTY. 1	QTY. 5
10 Megabyte w/Controller	\$369.95	\$359.95
20 Megabyte w/Controller	489.95	469.95
30 Megabyte w/Controller	728.00	714.00

Most Hard Disks are
Shugart, Microsci, CMI, Rodine, Segate
Call for Others

BERNOULLI BOX

10 Meg	\$1779.95	—
20 Meg	2399.95	—

TAPE BACK-UP BY IRWIN

10 Meg Internal 1/2 Height, Low Power	\$446.00	\$436.00
10 Meg External Back-up	589.00	579.00

DISK DRIVE CONTROLLERS

Western Digital Hard Disk Cont.	\$179.95	—
Adaptec Hard Disk Cont.	199.95	—

DISK DRIVES

MPI B-52

• Tandon Compatible • 360K
Double Side/Double Density • Full Height
2 for \$137.00

5 1/4" DISK DRIVES

	QTY. 1	QTY. 5
Toshiba 1/2 Height	\$ 89.95	\$ 86.95
IBM "Logo" Drives	119.95	109.95
Tandon TM100-2	89.95	87.95
MPI (Tandon Compatible)	69.95	69.95
AT 360K w/whiteface	109.95	—

DISK DRIVE CONTROLLERS

IBM (Original) Controller	\$ 99.95	—
IBM Compatible Controller	59.95	—

PRINTERS

LETTER QUALITY — DOT MATRIX

OKIDATA

ML182P, 120 cps, Parallel	\$229.95
ML192P, 160 cps, w/NLQ	339.95
ML193P, 15" Carriage, 160 cps, w/NLQ	539.95

PANASONIC

KX 1091	\$259.95
KX 1092	\$349.95

TOSHIBA

P341 24 pin 135 col.	\$869.00
P351 24 pin Par. & Ser.	\$1089.00
P1340 24 pin 80 col.	\$399.00

EPSON — Call for Availability

We also carry Juki, Dynax, Toshiba, Star,
Panasonic, NEC, Brother

MEMORY

64K SETS

All Upgrades Carry a 2 Year Warranty

Nine 4164, 150ns		\$9.95
10 Sets	\$8.95 ea.	100 Sets \$8.33

128K SETS		256K SETS	
Nine, 4128	\$39.95	9, 41256, 200ns	\$26.95
25 Sets	32.95 ea.	25 Sets	24.95 ea.

80287

5MHZ for AT & Deskpro \$189.95

8087-3

5MHZ Math Co-Processor for IBMPC	\$142.95	8MHZ Math Co-Processor for AT&T, Compaq, Deskpro	\$154.95
-------------------------------------	----------	---	----------

DG PC ACCESSORIES

Slide case w/speaker	\$49.95
5151 Keyboard	\$99.95
150 Watt Pwr Supply	\$99.95
200 Watt Pwr Supply	\$149.95
640K Motherboard w/OK	\$159.95



No Surcharge on Credit Cards

THE DIVERSIFIED GROUP

MAIL ORDERS TO:

8726 S. Sepulveda, Suite A132, Los Angeles, CA 90045
WAREHOUSE: 4732 Rosecrans, Hawthorne, CA 90250

**TOLL FREE ORDER LINE
(800) 523-1041**

**INSIDE CALIFORNIA
(213) 675-0717**

THE DIVERSIFIED GROUP

The DG PC Series computers offers the maximum alternatives in the PC XT compatible market. Alternatives which exceed current PC XT configurations.

Standard features on all DG PC Series computers include:

- Full compatibility with IBM PC XT® machines
- 640K bytes of parity checked memory, 8 slots
 - 150 watt power supply
 - 5151 keyboard
- 1 Full Year Warranty on Parts and Labor.
 - 4 Layer Motherboard

SYSTEMS

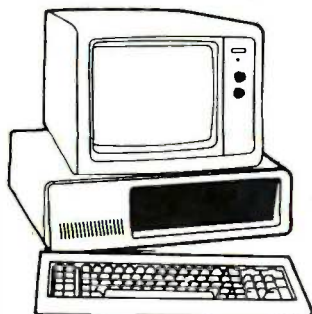

DG-PC

DG BASE UNIT
System Unit
640K on Board
One 360K Drives
w/Controller
150 Watt
Power Supply
\$699.95

DG SYSTEM
System Unit
640K on Board
Two 360K Drives
150 watt pwr sply
Hi-Res Green Mon
w/Interface Card
\$847.95

DG AT
System Unit
80286 Microprocessor
512K Memory
1.2 Meg Floppy
AT Type Keyboard
w/Par. & Ser. Ports
Runs PC, XT & AT Sftwr
\$1889.95

DG-XT
System Unit
640K on Board
One 360K Drive
10Meg Hard disk
Monochrome Mon
Mono Card
\$1195.95

All Systems Assembled and Tested

IBM

COMPAQ

DESKPRO		286	
Model I	\$1755.95	Deskpro 286	\$3391.95
		Portable 286	3391.95

PORTABLE
Two 360K Drives,
256K
\$1963.50

IBM PC
Bare 256K \$1099.00
One 360K Dr, 256K 1199.00

IBM XT
One 360K Drive & 10 Meg Drive
\$2237.95

IBM AT
Unenhanced \$3391.50
Enhanced 3995.95

IBM SYSTEM
PC-XT
with 10 Meg
One 360K Drive,
Monochrome
Monitor
Monochrome
Card
\$2421.95

EXPANSION CARDS

AST SixPac+ w/384K 2 Yr War	\$261.95
MF-100 SixPac Compatible plus Gameport	\$89.95
AST Advantage w/1.5 Megabyte of Memory Parallel & Serial Ports	\$497.95
AST Rampage	\$362.95

MODEMS

HAYES

1200B w/Smartcom II	\$362.95
1200 External	\$392.95
2400 External	\$595.95

DG

300/1200 Hayes compatible	\$156.95
---------------------------	----------

MONITORS

AMDEK

300G Composite Green	\$124.95
300A Composite Amber	134.95
310A Monochrome Amber	159.95

TAXAN

620 (640 x 200)	\$399.95
630 (640 x 400)	446.00
640 (720 x 400)	549.95

PRINCETON GRAPHICS

HX12, 640x200 Dot Pitch .31	\$442.95
HX12E, 640x350 Dot Pitch .28	517.95
SR12, 640x400 Dot Pitch .31	573.95
SR12P, 640x480 Dot Pitch .26	787.95
HX-9, 640x350 Dot Pitch .28	432.95
MAX12E, 720x350	169.95

IBM ACCESSORIES

A-B SWITCH BOXES

Parallel 2 pos.	\$49.95	Serial 2 pos.	\$64.95
-----------------	---------	---------------	---------

DISKETTES

Xidex Dbi/Dbi 5 Year Warranty

1 bx. \$12.95	10 bxs. \$11.95	100 bxs. \$9.95
---------------	-----------------	-----------------

KEYTRONICS KEYBOARDS

5153 Touch Pad	\$289.95
5150 Standard	\$169.95
5151 Deluxe	\$179.95

BELKIN CABLES

6 foot Shielded	
IBMPC to Par.	\$14.95
IBMPC to Modem	\$16.95

VIDEO CARDS

DG GRAPHICS

Color Graphics w/Parallel Port 2 Yr. War.	\$104.95
Monochrome Graphics w/Par Port	119.95

EVEREX

The Edge Color/Mono	\$269.95
The Graphics Edge	269.95

IBM

IBM Monochrome w/Parallel Port	\$226.95
IBM Color Card w/Parallel Port	214.95

PARADISE

Modular Graphics Card	\$259.95
Multi Display	159.95

EGA

DG EGA	\$292.95
STB EGA +	349.95
QUADRAM +	388.95
IBM EGA	498.95

SIGMA

Color 400 Board	\$458.95
-----------------	----------

THE DIVERSIFIED GROUP

TERMS:
P.O.'s from Government Institutes,
Universities, Fortune 1000
C.O.D.'s w/Guarantee, Visa, MC, MO,
Cashier's Check, Cash. Please Call for Shipping:
Minimum Shipping \$4.50
We Ship Federal Express, UPS, U.S. Mail
No Surcharge on Credit Cards



MAIL ORDERS TO:



8726 S. Sepulveda, Suite A132, Los Angeles, CA 90045
WAREHOUSE: 4732 Rosecrans, Hawthorne, CA 90250

TOLL FREE ORDER LINE
(800) 523-1041
INSIDE CALIFORNIA
(213) 675-0717

MANNESMAN-TALLY PIXY 3

3-PEN PLOTTER

\$198 LIST PRICE \$799
YOU SAVE OVER \$600!!!

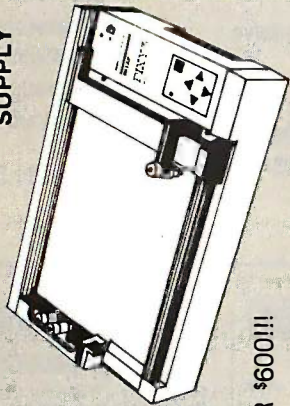

We're probably making a mistake selling this high speed plotter for only \$198. They are easily worth at least \$500 more. Compare the features to plotters costing \$2000 or more.

- High Speed 8 IPS Plotting
- 3 Pen Auto Select
- 8 Colors Available
- Serial Interface
- Full Graphics + Built-in Fonts
- 8 1/2 x 11 Paper or Transparencies

	LIST	SALE
8 Extra Water Base Pens	\$30	\$16.95
4 Extra Oil Base Pens	\$30	\$16.95
100 Sheets 8 1/2 x 11 Paper	\$9	\$4.95
50 Sheets 8 1/2 x 11. Transparencies	\$9	\$4.95
Plotter Software for IBM PC	\$195	\$59.95

20 MEGABYTE HARD-CARD

- Uses only one slot
- 21.3 MB formatted capacity
- Low power—only 11 watts
- Installs in just minutes
- Works with standard power supply

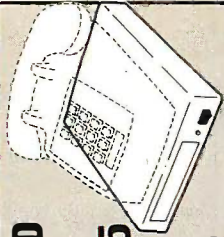

	LIST	JADE
JADE 1200 Baud External	\$349	\$168.95
JADE 1200 Baud PC Card	\$299	\$159.95
JADE 2400 Baud External	\$699	\$499.95
JADE 2400 Baud PC Card	\$595	\$399.95

10 MEGABYTE HARD DISK SYSTEM FOR YOUR IBM PC



\$399.95

Complete with controller card, data cable, and mounting hardware, to tally P.C./XT compatible. For external model (cabinet & power supply)—add \$199.

	LIST	JADE
10 MB Internal 1/2 High	\$990	\$399.95
20 MB Internal 1/2 High	\$1550	\$489.95
20 MB for AT, 60-80 ms	\$999	\$399.95
20 MB Hi-Speed for AT	\$1250	\$429.95
30 MB Hi-Speed for AT	\$1550	\$629.95
10 MB Tape Back-up	\$699	\$399.95

64K RAM Chip Upgrade Kits \$1485

High speed RAM upgrade kit with FREE parity (error detection) and one year warranty. We ship thousands of these kits to satisfied customers every week.

	LIST	JADE
128K RAM Chip Kit for AT	\$359	\$99.95
256K RAM Chip Kit	\$99	\$39.95

360K Disk Drive



\$69.95 IBM PC, XT or compatible

	LIST	JADE
TANDON 100-2, DS, DD	\$299	\$119.95
TEAC 55B, DS, DD	\$249	\$119.95

Why pay \$1149 for a C. Itch STARWRITER™ F-10

when our 40 cps letter quality daisywheel from the same manufacturer is only as low as **\$399.95**

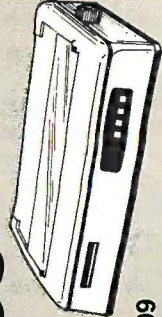

EACH—\$499	
2 to 5—\$429	
5 or MORE—\$399	

Bi-directional deluxe tractor	\$249	\$149.95
Automatic cut sheet feeder	\$449	\$199.95

*StarWriter is a Trademark of C. Itch Digital Products, Inc.

New HAYES 1200B Internal

	LIST	JADE
New 2400B Card w/Smartcom	\$799	\$579.95
HAYES Smartmodem 2400	\$899	\$629.95
HAYES Smartmodem 1200	\$699	\$389.95
HAYES 1200B w/o Smartcom II	\$539	\$339.95
HAYES 1200B for IBM PC	\$599	\$359.95

PROMETHEUS Promodems

ProModem 1200B for IBM PC	\$399	\$289.95
ProModem 1200 RS-232	\$495	\$299.95
Alpha/num Display Option	\$99	\$79.95
New Options Processor	\$149	\$109.95
64K Mem Expansion for above	\$99	\$19.95

STAR GEMINI 10-X \$179.95

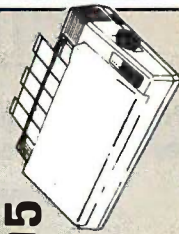

120 cps, friction & adjustable tractor feed w/graphics. Limited quantity.

TALLTREE JRAM-2/JRAM-3

OK JRAM-2	\$179.95
1 MB JRAM-2	\$399.95
2 MB JRAM-2	\$599.95
256K JRAM-3	\$329.95
1 MB JRAM-3	\$499.95
2 MB JRAM-3	\$629.95



High Speed APU Chips

80287	\$199.95
8087-3	\$119.95
8087-2	\$129.95

KEYTRONICS

	LIST	JADE
Improved IBM Keyboard	\$209	\$159.95
Deluxe IBM Keyboard	\$299	\$199.95
Touch Pad	\$399	\$299.95
Deluxe PCjr Keyboard	\$299	\$179.95

Multifunction Card For Your IBM PC \$129.95

Up to 384K, parallel printer port, RS-232 serial port, game port, clock/calendar, RAM disk/printer buffer software package.

OK JADE 7 Pak Plus	LIST	JADE
384K JADE 7 Pak Plus	\$299	\$129.95
	\$649	\$199.95

IBM Video Boards

Hercules Color Graphics	LIST	JADE
JADE Color Graphics	\$245	\$189.95
Hercules Monochrome Graphics	\$199	\$99.95
JADE Monochrome Graphics	\$499	\$339.95
JADE Monochrome Graphics	\$299	\$129.95
JADE Color w/Par & Serial	\$299	\$199.95
Tecmar Graphics Master	\$699	\$499.95
Everex Edge	\$399	\$299.95
Paradise Graphics Card	\$395	\$319.95

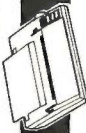

Printers

EPSON FX-85
EPSON FX-286
EPSON LQ-800
EPSON LX-80
EPSON JX-80

PRICED TOO LOW TO PUBLISH!
 Call us for our best price.



ISO-BAR

These industrial quality ISO-BAR's contain surge suppression circuitry and built-in noise filters plus a 15 amp circuit breaker.

6 Socket, 1 Filter ISO-BAR	LIST	JADE
4 Socket, 2 Filter ISO-BAR	\$69	\$44.95
8 Socket, 4 Filter ISO-BAR	\$89	\$59.95
	\$99	\$69.95

Back-Up Power Supply

Emergency back-up power to save our computer system. A must for every computer system.

200 Watt UPS	LIST	JADE
425 Watt UPS	\$359	\$269.95
	\$539	\$449.95

135/150 WATT

Drop-in replacement

POWER SUPPLY

135 Watt	LIST	JADE
150 Watt	\$199	\$89.95
	\$249	\$99.95

MICROFAZER Buffers



Expandable to 64K (Par model to 512K)

8K Parallel in/Parallel out	LIST	JADE
64K Parallel in/Parallel out	\$169	\$139.95
128K Parallel in/Parallel out	\$225	\$164.95
	\$445	\$289.95

Your choice: serial in/serial out; parallel in/serial out; serial in/parallel out.

8K	\$199	\$169.95	64K	\$260	\$199.95
----	-------	----------	-----	-------	----------

FREE Software With MOUSE

Microsoft Mouse w/Paintbrush	LIST	JADE
PC Mouse w/PC Paint Plus	\$199	\$139.95
	\$195	\$139.95

AST Boards On Sale!

AST Six Pak Plus 64K	LIST	JADE
AST Six Pak Plus 384K	\$395	\$249.95
AST Rampage 256K	\$945	\$299.95
AST Rampage 2 MB	\$495	\$379.95
AST Advantage-AT 128K	\$1995	\$679.95
AST Advantage-AT 3 MB	\$595	\$399.95
	\$4145	\$999.95

JADE XPC IBM PC



- 640K of RAM
- 135 watt power supply
- 8 expansion slots
- Deluxe keyboard
- 90 day warranty

- 256K of RAM
- 63 watt power supply
- 5 expansion slots
- IBM keyboard
- 90 day warranty

256K of RAM; Two 360K disk drives, & disk controller

\$995

OPTION #3

640 K of RAM

20 MB hard disk
One 360K drive

135 Watt power supply
Mono graphics card
Parallel printer port
PGS MAX-12E monitor

OPTION #1

256K PC/640K XPC
Two 360K drives
Mono graphics card
Amdek 310A

OPTION #2

256K PC/640K XPC
Two 360K disk drives
Monochrome card
Amdek 310A monitor

IBM PC ___ \$1995
JADE XPC \$1295

IBM PC ___ \$2995
JADE XPC \$1995

IBM PC ___ \$2395
JADE XPC \$1395

IBM PC-XT W/ 20 MB HARD DISK

- 256K RAM
- 20 MB hard disk
- Mono graphics card
- Parallel printer port
- Amdek 310A

\$2895

IBM PC-AT

- 512K RAM
- 20 MB 60 ms hard disk
- 1.2 MB disk drive
- Parallel printer port
- Serial RS-232C port
- Color graphics card
- PGS HX-12 monitor

\$4795

JADE COMPUTER

We accept cash, checks, credit cards or purchase orders from qualified firms and institutions. Minimum prepaid order \$15.00. California residents add 6 1/2% tax. Prices & availability subject to change without notice. Shipping & handling charges via UPS Ground 50¢/lb. UPS Air \$1.00/lb. Minimum charge \$3.00.

4901 W. Rosecrans Ave. Box 5046
Hawthorne, CA 90251-5046



Continental U.S.A.
(800)421-5500
 Inside California
(800)262-1710
 Los Angeles Area
(213)973-7707

PLACE
 ORDERS
 TOLL
 FREE!

1st PLACE

COMPUTER SYSTEMS
13422 N. CAVECREEK RD.
PHOENIX, AZ. 85022

CALL FREE 1-800-841-2748

ALTOS-2086T80	\$14,599
LEADING EDGE	SCALL
ITT PC	SCALL
ZENITH	SCALL

PRINTERS & TERMINALS

STAR SG10	\$214
JUKI 6100	\$339
WYSE 50	\$419
QUME 101G	\$289
CITIZEN MSP10	\$255
HARD DRIVES	SCALL
MODEMS	SCALL

OTHER NAME BRANDS IN STOCK
CALL FOR LOW PRICES

BYTE INDEX

POWERFUL database on a disk summarizes every article, review, program, tip and letter in BYTE Magazine. Finds info FAST!

Cross-references corrections & updates.

A "tip-book" citing 1000's of solutions.

Like owning a "helpline" for little more than the price of a single long-distance phone call!

GUARANTEED to save you TIME and MONEY.

Search it with **FASTFIND** or your word processor. Standard text file. Works on IBM PC, Apple II's, Macintosh, HP-150, C64. Specify which computer.

\$5 for 1985, \$5 for 1984, on 5.25" disks
Monthly updates \$5 each or \$39 for 12 months



FASTFIND is a high-speed search utility. Logical operators & wild card. Searches multiple files & disks up to 100 TIMES FASTER than word processors! Finds lost files, even if you forget their names! A.P.P.L.E.'s BEST SELLER. Prints reports. For APPLE II, II+, IIe, IIc, III. List \$49.

\$12 & get BYTE INDEX for 1985 FREE

(Add: Calif. resid. 6%, credit cards 4%, 3.5" disk \$2, overseas \$3)
FASTFIND CO., 28503 Coveridge Dr. #B, RPV, CA 90274
[Modem: 213/377-0804] VISA/MC 213/544-2350

DATA SWITCH \$39

Parallel 2 pos(A-B)	\$39
Serial 2 pos(A-B)	\$35
Parallel 4 pos(A-D)	\$52

XT, AT POWER SUPPLY

\$65 XT-135 Watt AT-200 Watt **\$129**

ADD-ON & ACCESSORY

5151 Style Keyboard	\$75
AT Style Keyboard	\$77
384K Multifunction (OK)	\$95
Color/Graphic/Printer	\$63
AC Center	\$79
Floppy Drive Controller	\$39
Parallel Printer Cable	\$10
RS232 to RS232 Cable	\$10
XT Type Case	\$39
AT Type Case	\$75

More Items Available

BUDGET COMPUTERS

2620 Concord Ave., Suite 108
Alhambra, CA 91803
(818) 281-2833 Telex 5106006329

Inquiry 375

MEMO:

TO: COMPUTER COMPETENT O.E.M.s,
ENGINEERS, & DEALERS.

FROM: MARTIN GREEN, PRESIDENT
MASTERBYTE COMPUTERS
OF N.Y. INC.

We are distributors for a 4th generation 68000 SUPERMICRO and are currently establishing dealerships and selling to sophisticated O.E.M.s. Contact us now for an exceptional opportunity.

MASTERBYTE COMPUTERS OF NEW YORK, INC.

19 WEST 34TH STREET
NEW YORK, NY 10001
(212) 564 - 2247

TWX #9103801502 (MASTERBYTE)

[Listed in the D&B Procurement Planning Service Directory]

Inquiry 131

20 Meg Hard Disk Kit—\$435⁰⁰

Includes Microscience 20 M.B. Half Height Low Power Hard Disk with controller and cables, 1 year warranty.

Irwin Tape Drive (10 Meg)—\$425⁰⁰

Brother M-1509 Printer—\$425⁰⁰

PC/XT COMPATIBLE PARTS

JUMBO-640 (4.77 MHz) Motherboard w/OK	\$125.00
TURBO-640 (4.77 or 8 MHz) Motherboard w/OK	\$215.00
Mono/Graphic Card w/ Printer Port	\$ 85.00
Color Card with Printer Port	\$ 85.00
Color Card with Video Port	\$ 70.00
I/O Card	\$ 70.00
Floppy Disk Controller	\$ 45.00
5150 Style Keyboard	\$ 70.00
Computer Case	\$ 55.00
Printer Cable	\$ 17.00

LUCKY COMPUTERS

(214) 690-6110

2011 Brandeis, Richardson, TX 75081

Inquiry 197

ENHANCE YOUR

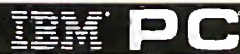

UNIVERSAL PROGRAMMER \$595

Programs EPROMS & PAL expandable to BI-POLAR and single chip micro

LOGIC ANALYZER \$995

50 MHZ, 8 channel expandable to 32 channel

GANG PROGRAMMER \$795

Programs 8 EPROMS with same data or different data.

PROTOCOL ANALYZER \$995

Monitor and Simulator.

Advanced Microcomputer Systems, Inc.

2780S.W. 14th St.

Pompano Bch., FL 33069

1-800-9PC-FREE



Inquiry 207



PORTABLE ADDITIONS

PORTABLE DISK DRIVE \$249

3 1/2" batt. oper., TS-DDS, 100K storage

24K RAM CHIP for Tandy 200 \$89

8K RAM CHIP for Model-100 \$29

and NEC 8201. . . 3 for \$79, 6 for \$149

SIDESTAR for NEC Starlet \$399

128K Ram Disk Cartridge

SIDECAR for NEC PC-8201A \$259

4 banks of 32K in one cartridge

CALL TOLL FREE 1-800-732-5012

Calif: 805-987-1742

Canada: 604-856-8858, Australia: 02-419-8899



VISA MIC &
AMER. EXP.

420 Constitution Ave., Camarillo, CA 93010

Inquiry 275

Inquiry 41

MULTIFUNCTION CARD



FOR IBM-PC & COMPATIBLES

\$149 w/ 384K
INSTALLED

2 YEARS WARRANTY

- * PARALLEL PORT * SERIAL PORT
- * CLOCK/CALENDAR * GAME PORT
- * RAM DISK/ PRINTER SPOOLER
- * CABLES & MANUALS

COMPUTER AGE, INC.

800 Silver Lane, E. Hartford, Ct. 06118

203-569-6774/ 1244

Terms: add \$3.00 for Handling Charges.
Visa/MC accepted, no surcharges

Inquiry 88

FREE SOFTWARE FROM THE PUBLIC DOMAIN

User Group Software isn't copyrighted, so no fees to pay! 1000's of CP/M and IBM software programs in .COM and source code to copy yourself! Games, business, utilities! All FREE!

	Rent	Buy
IBMPC-SIG 1-458 Disksides	460.	845.
IBMPC-BLUE 1-175 Disksides	180.	345.
SIG/M UG 1-246 Disksides	160.	550.
CP/M UG 1-92 Disksides	45.	250.
PICO NET 1-34 Disksides	25.	100.
KAYPRO UG 1-60 Disksides	70.	210.
EPSON UG 1-58 Disksides	70.	230.
Commodore CBM 1-102 Disksides	100.	200.

Public Domain User Group Catalog \$5 pp.
(payment in advance, please)
Rental is for 7 days after receipt, 3 days grace to return. Use a credit card, no disk deposit.

Shipping, handling & insurance \$9.50 per library.
(619) 941-0925 Orders & Technical (9 to 5)
(619) 727-1015 24 Hr. 3 Min. Info Recording
Have your credit card ready!

National Public Domain Software

1533 Avohill Dr.

Vista, CA 92083

800-621-5460

then dial 782-542



BBB



AM EX.

Inquiry 235

Inquiry 7

714/898-0840

Telex: 887841 XORDATA HTBH Fax: 714/897-3363

15392 Assembly Lane, Unit A • Huntington Beach, CA 92649

Our 1986 Catalog is HOT off the press!

Dealers! Check our Profitable Discount Pricing!

LOOK what's Inside!

5 Complete Systems



XAT TURBO

The **XAT** is our most versatile and powerful system. Using Intel's 80286 processor, the system runs at 6 and 8 MHz with a true 16-bit data bus. Comes standard with a 3 meg Add-On board, 2 parallel & one serial port, monitor, keyboard, DOS 3.1, two 1/2-height DD 5.25 meg floppies.



XPC TURBO

This standard system is as compatible with IBM as it can be. Featuring a 4-layer motherboard, 8-slot expansion, up to 640K memory on the motherboard, and the 6.67 MHz **TURBO** mode. Also included: DOS 3.1 keyboard, 135 watt power supply, TTL 720 x 348 resolution video card, green or amber monitor, serial & parallel ports, Real Time Clock and software.



XTC TURBO

The perfect choice for the system integrator who needs the IBM compatibility, but not in the standard PC cabinet. This model features hinged and removable sides, up to 3 1/2 height peripherals out front, front mount AC switch and rear mount 135 watt power supply. Also makes an ideal "Host" or "File Server" unit in multi-user configurations!



XTjr.

The **XTjr.** is only junior in size! With up to 640K memory on the motherboard and four expansion slots, this stand-alone system is also great for workstations in a networking environment. It can be upgraded to the **TURBO** two speed motherboard and you can also add up to 2 serial & 2 parallel ports or any IBM compatible expansion card. A perfect word processing data entry system.



XPC Compact

This is truly the affordable portable, and we'll build it to your specifications. Need a 20 meg hard disk, and 20 meg tape with 640K memory in your portable? No problem! The **XPC Compact** comes standard with a 9" amber TTL monitor, 135 watt P.S., 256K memory, two 360K drives, Real Time Clock, Calendar w/ battery Back-up, serial and parallel ports, and our **TURBO** Motherboard.

Amsterdam 020-45-26-50

24 Add-On Cards

Germany

2 Meg Above Board



This board satisfies the new "Above Board" approach suggested by INTEL and Lotus 1-2-3. Also may be used on our **XT-SBC TURBO** board for memory based at 0K.

Hard Disk Controller



This Western Digital controller handles 1 or 2 drives, 5 to 140 megabytes with minimum software configuration. Features DOS 2.1 & 3.1 compatibility, and ST-506 Interface.

384K Multi-Function



A Multi-function board featuring Parallel Port, Serial Port, Game Port, Real Time Clock, Calendar with Battery Back-up. Expand to 384K, All Cables, PrintSpooler and RAM Disk Software and Manuals.

4 Meg Token Ring



Connect your workstation to an existing 4 Megabyte IBM token ring system or build up your own IEEE 802.5 standard system. The lowest possible cost for 100% industry standard compatibility.

AT H.D. & Floppy



This new Western Digital combo board with its hi-speed VLSI technology will give you a data transfer rate 50% faster than the existing combo board in the AT. Runs both 360K and 1.2 meg floppy disk drives.

Mono & Color Graphics



Supports two levels of graphics and text in composite monochrome or RGB color. Low resolution 320 x 200 pixel, high resolution 640 x 200 pixel.

7 PAK Multi-Function



Features Floppy Controller, Parallel Port, Serial Port (optional 2nd Serial), Game Port, Real Time Clock, Calendar with Battery Back-up, RAMdisk, Print-Spooler, all cables & manuals.

PROM Laser

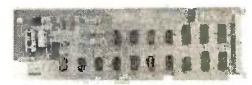

Hi-speed algorithms will burn 2716, 2732, 2732A, 2764 (in 52 sec), 27128, 27256 EPROMs under software control right in your PC. Zero Force Insertion Sockets, Software, and Manual.

England

35 Components

Bombay 357172

Motherboards

XAT TURBO XT-SBC

- RTC Calendar
- 6 & 8 MHz clock
- 8 slot expansion
- Intel 80286

XPC TURBO XPC-XT

- 4.77 & 6.67 MHz
- 4-layer PCB design
- 8-slot expansion
- up to 640K Memory
- 8088-2 processor

Power Supplies

XT 135 watt XT 150 watt

- 135w switching
- Whisper Fan
- Side AC switch
- +5V-15A - 5V-5A
- +12V-4.2A - 12V-5A

AT 200 watt XTC 135

- 200 Watt power
- Exterior AC switch
- 4 DC power conn
- +12V-7.7A - 12V-5A

Cabinets

The **XTjr.** cabinet is only 3" x 16.5" x 15" yet it will hold a standard XT compatible motherboard. Includes a switching power supply. Front panel cut-out for a half-height floppy or hard disk.

Our **XPC-XT** cabinet has an 8-slot back panel with additional cut-outs for two RS-232 I/O ports. Features mounting for up to four half height peripherals.

The right choice for an external add-on cabinet! Add on a floppy, tape back-up, or up to 33 meg of hard disk (half-height). Switching power supply is included.

Keyboards

AT

This Keyboard is standard equipment with all of our **XAT** systems, but the layout is so well liked, we're offering it here.

XT

Our volume purchases of these IBM style units allows us to lower the price once again.

5151

Now a fully selective unit at an affordable price. Features a 10-key numeric pad & a separate cursor pad.

Drives

Archive
Irwin
Maxtor
Memtek
Miniscribe
Panasonic
Seagate
TEAC
Tulin

3 Sub-Systems



This full height cabinet will hold a Tape Back-up with full or 1/2 height Hard Disk inside (or two Hard Disks).





A perfect cabinet for Tape or Hard Disk, a nice addition to your PC.



Choose from single 1/2 height, dual 1/2 height, or 1 1/2 height with full height base. All Sub-Systems include controllers, cables, software and manuals.

3 Networks

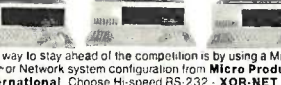
One way to stay ahead of the competition is by using a Multi-User or Network system configuration from **Micro Products International**. Choose Hi-speed RS-232C **XOR-NET** SDLC or Token Ring. Data transfer rates up to 4 megabytes second can be obtained.

Cassette Training



What is the Cassette Training concept? Using Interactive Audio Training to combine the advantage of classroom and self-teaching methods.

The Method: One audio track delivers a lecture explaining the program, while the second track emulates the keyboard, actually running the student's computer. At frequent intervals the tape pauses automatically to allow the student keyboard input, which is monitored for accuracy by the **MITS COED**.

Int/Ext Modems



- FCC approved for direct RJ-11 connection
- Phone Cable & Power Supply
- Runs the popular Hayes communications software

Finally a price breakthrough on a Hayes compatible, external 300-1200 baud modem. Includes driver software.



- O-Modem software included
- Also runs XCOM software
- All cables included
- We included every feature you would want in a modem card. It's FCC registered for direct connection to your modular phone jack with the cord included.
- Runs the popular Hayes communications software

BUILD A COMPLETE XT SYSTEM—\$698

STATIC RAMS

2101	256x4	(450ns)	1.95
5101	256x4	(450ns)(CMOS)	3.95
2102L-4	1024x1	(450ns)(LP)	.99
2102L-2	1024x1	(250ns)(LP)	1.45
2112	256x4	(450ns)	2.99
2114	1024x4	(450ns)	.99
2114L-4	1024x4	(450ns)(LP)	1.09
2114L-2	1024x4	(200ns)(LP)	1.49
2114L-15	1024x4	(150ns)(LP)	1.95
TMS4044-4	4096x1	(450ns)	1.95
TMM2016-150	2048x8	(150ns)	1.49
TMM2016-100	2048x8	(100ns)	1.95
HM6116-4	2048x8	(200ns)(CMOS)	1.39
HM6116-3	2048x8	(150ns)(CMOS)	1.49
HM6116LP-4	2048x8	(200ns)(CMOS)(LP)	1.49
HM6116LP-3	2048x8	(150ns)(CMOS)(LP)	1.59
HM6116LP-2	2048x8	(120ns)(CMOS)(LP)	2.95
HM6264P-15	8192x8	(150ns)(CMOS)	3.89
HM6264LP-15	8192x8	(150ns)(CMOS)(LP)	3.95
HM6264LP-12	8192x8	(120ns)(CMOS)(LP)	4.49

LP=Low power

DYNAMIC RAMS

4116-250	16384x1	(250ns)	.49
4116-200	16384x1	(200ns)	.69
4116-150	16384x1	(150ns)	.89
4116-120	16384x1	(120ns)	1.49
MK4332	32768x1	(200ns)	6.95
4164-200	65536x1	(200ns)(5V)	1.19
4164-150	65536x1	(150ns)(5V)	1.29
4164-120	65536x1	(120ns)(5V)	1.95
MCM6665	65536x1	(200ns)(5V)	1.95
TMS4164	65536x1	(150ns)(5V)	1.95
4164-REFRESH	65536x1	(150ns)(5V)(REFRESH)	2.95
TMS4416	16384x4	(150ns)(5V)	4.95
41128-150	131072x1	(150ns)(5V)	5.95
41256-200	262144x1	(200ns)(5V)	2.95
41256-150	262144x1	(150ns)(5V)	2.95

5V=Single 5 Volt Supply

REFRESH=Pin 1 Refresh

★★★★HIGH-TECH★★★★

NEC V20 UPD70108 \$14.95

REPLACES 8088 TO SPEED UP IBM PC 10-40%

- * HIGH-SPEED ADDRESS CALCULATION IN HARDWARE
- * PIN COMPATIBLE WITH 8088
- * SUPERSET OF 8086/8088 INSTRUCTION SET
- * LOW POWER CMOS

8 MHz V20 UPD70108-8 \$24.95

8 MHz V30 UPD70116-8 \$26.95

★★★★SPOTLIGHT★★★★

ORDER TOLL FREE
800-538-5000
800-662-6279 (CA)



EPROMS

2708	1024x8	(450ns)	3.95
2716-6	2048x8	(650ns)	2.29
2716	2048x8	(450ns)(5V)	2.25
2716-1	2048x8	(350ns)(5V)	2.79
TMS2532	4096x8	(450ns)(5V)	3.95
2732	4096x8	(450ns)(5V)	2.45
2732A	4096x8	(250ns)(5V)(21V PGM)	2.75
2732A-2	4096x8	(200ns)(5V)(21V PGM)	3.95
27C64	8192x8	(250ns)(5V)(CMOS)	5.95
2764	8192x8	(450ns)(5V)	2.45
2764-250	8192x8	(250ns)(5V)	2.85
2764-200	8192x8	(200ns)(5V)	3.49
TMS2564	8192x8	(450ns)(5V)	8.95
MCM68766	8192x8	(350ns)(5V)(24 PIN)	17.95
27128	16384x8	(250ns)(5V)	2.79
27C256	32768x8	(250ns)(5V)(CMOS)	12.95
27256	32768x8	(250ns)(5V)	7.49

5V=Single 5 Volt Supply

21V PGM=Program at 21 Volts

SPECTRONICS CORPORATION EPROM ERASERS



Model	Timer	Capacity Chip	Intensity (uW/Cm ²)	Unit Price
PE-14	NO	9	8,000	\$83.00
PE-14T	YES	9	8,000	\$119.00
PE-24T	YES	12	9,600	\$175.00

8000

8035	1.49
8039	1.95
8080	2.95
8085	2.49
8087-2	139.95
8087	108.00
8088	6.95
8088-2	9.95
8155	2.49
8155-2	3.95
8748	7.95
8755	19.95
80286	129.95
80287	185.00

8200

8203	29.95
8205	3.29
8212	1.49
8216	1.49
8224	2.25
8237	4.95
8237-5	5.49
8250	6.95
8251	1.69
8251A	1.89
8253	1.99
8253-5	1.95
8255	1.69
8255-5	1.89
8259	1.95
8259-5	2.29
8272	4.95
8279	2.49
8279-5	2.95
8282	3.95
8284	2.95
8286	3.95
8288	4.95

Z-80

Z80-CPU 2.5 MHz	1.69
4.0 MHz	
Z80A-CPU	1.79
Z80A-CTC	1.89
Z80A-DART	5.95
Z80A-DMA	5.95
Z80A-PIO	1.89
Z80A-SIO/0	5.95
Z80A-SIO/1	5.95
Z80A-SIO/2	5.95

6.0 MHz

Z80B-CPU	3.75
Z80B-CTC	4.25
Z80B-PIO	4.25
Z80B-DART	14.95
Z80B-SIO/0	12.95
Z80B-SIO/2	12.95
Z8671 ZILOG	19.95

6500

1.0 MHz	
6502	2.79
65C02(CMOS)	12.95
6507	9.95
6520	1.95
6522	4.95
6526	26.95
6532	6.95
6545	6.95
6551	5.95
6561	19.95
6581	34.95

2.0 MHz

6502A	2.95
6520A	2.95
6522A	5.95
6532A	11.95
6545A	7.95
6551A	6.95

3.0 MHz

6502B	6.95
-------	------

6800

1.0 MHz	
6800	1.95
6802	4.95
6803	9.95
6805	5.95
6809E	5.95
6810	1.95
6820	2.95
6821	1.95
6840	6.95
6843	19.95
6844	12.95
6845	4.95
6847	11.95
6850	1.95
6883	22.95

2.0 MHz

68B00	4.95
68B02	5.95
68B09E	6.95
68B09	6.45
68B21	3.50
68B45	6.75
68B50	3.95
68B54	7.95

CLOCK CIRCUITS

MM53669	1.95
MM53669-EST	1.95
MM58167	12.95
MM58174	11.95
MSM5832	2.95

CRT CONTROLLERS

6845	4.95
68B45	2.95
6847	11.95
HD46505SP	6.95
MK1372	2.95
8275	26.95
3.579545	1.95
7220	19.95
4.032	1.95
CRT5027	12.95
CRT5037	9.95
TMS9918A	19.95

DISK CONTROLLERS

1771	4.95
1791	9.95
1793	9.95
1795	12.95
1797	12.95
2791	19.95
2793	19.95
2797	29.95
6843	19.95
8272	4.95
UPD765	4.95
MB8876	12.95
MB8877	12.95
1691	6.95
2143	6.95

BIT RATE GENERATORS

MC14411	9.95
BR1941	4.95
4702	9.95
COM8116	8.95
MM5307	4.95

UARTS

AY5-1013	3.95
AY3-1015	4.95
TR1602	3.95
2651	4.95
IM6402	6.95
IM6403	9.95
INS8250	6.95

SOUND CHIPS

76477	3.95
76489	8.95
SSI-263	39.95
11C20	12.95
2513-001 UP	6.95
AY5-2376	11.95
AY5-3600 PRO	11.95

CRYSTALS

32.768 KHz	.95
1.0 MHz	
1.8432	2.95
2.0	1.95
2.097152	1.95
2.4576	1.95
3.2768	1.95
3.579545	1.95
4.032	1.95
5.0	1.95
5.0688	1.95
6.0	1.95
6.144	1.95
6.5536	1.95
8.0	1.95
10.0	1.95
10.738635	1.95
12.0	1.95
14.31818	1.95
15.0	1.95
16.0	1.95
17.430	1.95
18.0	1.95
18.432	1.95
20.0	1.95
22.1184	1.95
24.0	1.95
32.0	1.95

CRYSTAL OSCILLATORS

1.0MHz	5.95
1.8432	5.95
2.0	5.95
2.4576	5.95
2.5	4.95
4.0	4.95
5.0688	4.95
6.0	4.95
6.144	4.95
8.0	4.95
10.0	4.95
12.0	4.95
12.480	4.95
15.0	4.95
16.0	4.95
18.432	4.95
20.0	4.95
24.0	4.95

MISC.

TMS99531	9.95
TMS99532	19.95
ULN2003	.79
3242	7.95
3341	4.95
MC3470	1.95
MC3480	8.95
MC3487	2.95
11C20	12.95
2513-001 UP	6.95
AY5-2376	11.95
AY5-3600 PRO	11.95

74LS00

74LS00	.16
74LS01	.18
74LS02	.17
74LS03	.18
74LS04	.16
74LS05	.18
74LS08	.18
74LS09	.18
74LS10	.16
74LS11	.22
74LS12	.22
74LS13	.26
74LS14	.39
74LS15	.26
74LS20	.17
74LS21	.22
74LS22	.22
74LS27	.23
74LS28	.26
74LS30	.17
74LS32	.18
74LS33	.28
74LS37	.26
74LS38	.26
74LS42	.39
74LS47	.59
74LS48	.69
74LS51	.17
74LS73	.29
74LS74	.24
74LS75	.29
74LS76	.29
74LS83	.49
74LS85	.49
74LS86	.22
74LS90	.39
74LS92	.49
74LS93	.39
74LS95	.49
74LS107	.34
74LS109	.36
74LS112	.29
74LS122	.45
74LS123	.49
74LS124	2.75
74LS125	.39
74LS126	.39
74LS132	.39
74LS133	.49
74LS136	.39
74LS138	.39
74LS139	.39
74LS145	.99
74LS147	.99
74LS148	.99
74LS151	.39
74LS153	.39
74LS154	1.49
74LS155	.59
74LS156	.49
74LS157	.35
74LS158	.29
74LS160	.29
74LS161	.39
74LS162	.49
74LS163	.39
74LS164	.49

HIGH SPEED CMOS

A new family of high speed CMOS logic featuring the speed of low power Schottky (8ns typical gate propagation delay), combined with the advantages of CMOS: very low power consumption, superior noise immunity, and improved output drive.

74HC00

74HC: Operate at CMOS logic levels and are ideal for new, all-CMOS designs.

74HC00	.59	74HC148	1.19
74HC02			

PARTIAL LISTING ONLY — CALL FOR A FREE CATALOG

CMOS		
4001	.19	14419 4.95
4011	.19	14433 14.95
4012	.25	4503 .49
4013	.35	4511 .69
4015	.29	4516 .79
4016	.29	4518 .85
4017	.49	4522 .79
4018	.69	4526 .79
4020	.59	4527 1.95
4021	.69	4528 .79
4024	.49	4529 2.95
4025	.25	4532 1.95
4027	.39	4538 .95
4028	.65	4541 1.29
4035	.69	4553 5.79
4040	.69	4585 .75
4041	.75	4702 12.95
4042	.59	74C00 .29
4043	.85	74C14 .59
4044	.69	74C74 .59
4045	1.98	74C83 1.95
4046	.69	74C85 1.49
4047	.69	74C95 .99
4049	.29	74C150 5.75
4050	.29	74C151 2.25
4051	.69	74C151 .99
4052	.69	74C163 .99
4053	.69	74C164 .39
4056	2.19	74C192 1.49
4060	.69	74C193 1.49
4066	.29	74C221 1.75
4069	.19	74C240 1.89
4076	.59	74C244 1.89
4077	.29	74C374 1.99
4081	.22	74C905 10.95
4085	.79	74C911 8.95
4086	.89	74C917 8.95
4093	.49	74C922 4.49
4094	2.49	74C923 4.95
14411	9.95	74C926 7.95
14412	6.95	80C97 .95

7400/9000		
7400	.19	74147 2.49
7402	.19	74148 1.20
7404	.19	74150 1.35
7406	.29	74151 .55
7407	.29	74153 .55
7408	.24	74154 1.49
7410	.19	74155 .75
7411	.25	74157 .55
7414	.49	74159 1.65
7416	.25	74161 .69
7417	.25	74163 .69
7420	.19	74164 .85
7423	.29	74165 .85
7430	.19	74166 1.00
7432	.29	74175 .89
7438	.29	74177 .75
7442	.49	74178 1.15
7445	.69	74181 2.25
7447	.89	74182 .75
7470	.35	74184 2.00
7473	.34	74191 1.15
7474	.33	74192 .79
7475	.45	74194 .85
7476	.35	74196 .79
7483	.50	74197 .75
7485	.59	74199 1.35
7486	.35	74221 1.35
7489	2.15	74246 1.35
7490	.39	74247 1.25
7492	.50	74248 1.85
7493	.35	74249 1.95
7495	.55	74251 .75
7497	2.75	74265 1.35
74100	2.29	74273 1.95
74121	.29	74278 3.11
74123	.49	74367 .65
74125	.45	74368 .65
74141	.65	9368 3.95
74143	5.95	9602 1.50
74144	2.95	9637 2.95
74145	.60	96502 1.95

74S00		
74S00	.29	74S163 1.29
74S02	.29	74S168 3.95
74S03	.29	74S174 .79
74S04	.29	74S175 .79
74S05	.29	74S188 1.95
74S08	.35	74S189 1.95
74S10	.29	74S195 1.49
74S15	.35	74S196 1.49
74S30	.29	74S197 1.49
74S32	.35	74S226 3.99
74S37	.69	74S240 1.49
74S38	.69	74S241 1.49
74S74	.49	74S244 1.49
74S85	.95	74S257 .79
74S86	.35	74S253 .79
74S112	.50	74S258 .95
74S124	2.75	74S280 1.95
74S138	.79	74S287 1.69
74S140	.55	74S288 1.69
74S151	.79	74S299 2.95
74S153	.79	74S373 1.69
74S157	.79	74S374 1.69
74S158	.95	74S471 4.95
74S161	1.29	74S571 2.95

VOLTAGE REGULATORS		
TO-220 CASE		
7805T	.49	7905T .59
7808T	.49	7908T .59
7812T	.49	7912T .59
7815T	.49	7915T .59
TO-3 CASE		
7805K	1.39	7905K 1.49
7812K	1.39	7912K 1.49
TO-92 CASE		
78L05	.49	79L05 .69
78L12	.49	79L12 .69
OTHER VOLTAGE REGS		
LM338K	5V 3A	TO-3 4.79
LM338KA	5A	TO-3 3.95
78H05K5V	5A	TO-3 7.95
78H12K	12V5A	TO-3 8.95
78P05K	5V 10A	TO-3 14.95

LINEAR		
TL066	.99	LM733 .98
TL071	.69	LM741 .29
TL072	1.09	LM747 .69
TL074	1.95	LM748 .59
TL081	.59	MC1330 1.69
TL082	.99	MC1350 1.95
TL084	1.49	MC1372 6.99
LM301	.34	LM1414 1.59
LM309K	1.25	LM1458 .49
LM311	.59	LM1488 .49
LM311H	.89	LM1489 .49
LM317K	.39	LM1496 .85
LM317T	.95	LM1812 8.25
LM318	1.49	LM1889 1.95
LM319	1.25	ULN2003 .79
LM320	see 7900	XR2206 3.75
LM322	1.65	XR2211 2.95
LM323K	4.79	XR2240 1.95
LM324	.49	MPQ2907 1.95
LM331	3.95	LM2917 1.95
LM334	1.19	CA3046 .89
LM335	1.40	CA3081 .99
LM336	1.75	CA3082 .99
LM337K	3.95	CA3086 .80
LM338K	3.95	CA3089 1.95
LM338	.59	CA3130E .99
LM340	see 7800	CA3146 1.29
LM350T	4.60	CA3160 1.19
LF353	.59	MC3470 1.95
LF356	.99	MC3480 8.95
LF357	.99	MC3487 2.95
LM358	.59	LM3900 4.49
LM380	.89	LM3909 .98
LM383	1.59	LM3911 2.25
LM386	.89	LM3914 2.39
LM393	.45	MC4024 3.49
LM394H	4.60	MC4044 3.99
TL494	4.20	RC4136 1.25
TL497	3.25	RC4558 .69
NE555	.29	LM13600 1.49
NE556	.49	75107 1.49
NE558	1.25	75110 1.95
NE564	1.95	75150 1.95
LM565	.95	75154 1.95
LM566	1.49	75188 1.25
LM567	.79	75189 1.25
NE570	2.95	75451 .39
NE590	2.50	75452 .39
NE592	.98	75453 .39
LM710	.75	75477 1.29
LM723	.49	75492 .79
H-T0-5 CAN, K-T0-3, T-T0-220		

DATA ACQ INTERFACE		
ADC0800	15.55	8726 1.29
ADC0804	3.49	8728 1.29
ADC0809	4.49	8795 .89
ADC0816	14.95	8796 .89
ADC0817	9.95	8797 .59
ADC0831	8.95	8798 .89
DAC0800	4.49	DM8131 2.95
DAC0806	1.95	DP8304 2.29
DAC0808	2.95	DS8833 2.25
DAC1020	8.25	DS8835 1.99
DAC1022	9.95	DS8836 .99
MC1408L	2.95	DS8837 1.65

IC SOCKETS		
8 PIN ST	1-99	100
14 PIN ST	.11	.10
16 PIN ST	.12	.10
18 PIN ST	.15	.13
20 PIN ST	.18	.15
22 PIN ST	.15	.12
24 PIN ST	.20	.15
28 PIN ST	.22	.16
40 PIN ST	.30	.22
64 PIN ST	1.95	1.49
ST-SOLDER TAIL		
8 PIN WW	.59	.49
14 PIN WW	.69	.52
16 PIN WW	.69	.58
18 PIN WW	.99	.90
20 PIN WW	1.09	.98
22 PIN WW	1.35	1.28
24 PIN WW	1.49	1.35
28 PIN WW	1.69	1.49
40 PIN WW	1.99	1.80
WW-WIREWRAP		
16 PIN ZIF	4.95	CALL
24 PIN ZIF	5.95	CALL
28 PIN ZIF	6.95	CALL
40 PIN ZIF	9.95	CALL
ZIF-TEXT TOOL (ZERO INSERTION FORCE)		

EDGE CARD CONNECTORS		
100 PIN ST	S-100	1.25 3.95
100 PIN WW	S-100	1.25 4.95
62 PIN ST	IBM PC	1.00 1.95
50 PIN ST	APPLE	1.00 2.95
44 PIN ST	STD	1.56 1.95
44 PIN WW	STD	1.56 4.95

36 PIN CENTRONICS		
MALE		
IDCEN36	RIBBON CABLE	6.95
CEN36	SOLDER CUP	4.95
FEMALE		
IDCEN36/F	RIBBON CABLE	7.95
CEN36PC	RT ANGLE PC MOUNT	4.95

INTERFIL		
ICL7106	9.95	
ICL7107	12.95	
ICL7660	2.95	
ICL8038	4.95	
ICM7207A	5.95	
ICM7208	15.95	

DIP CONNECTORS										
DESCRIPTION	ORDER BY	CONTACTS								
		8	14	16	18	20	22	24	28	40
HIGH RELIABILITY TOOLED ST IC SOCKETS	AUGATxxST	.62	.79	.89	1.09	1.29	1.39	1.49	1.69	2.49
HIGH RELIABILITY TOOLED WW IC SOCKETS	AUGATxxWW	1.30	1.80	2.10	2.40	2.50	2.90	3.15	3.70	5.40
COMPONENT CARRIES (DIP HEADERS)	ICCxx	.49	.59	.69	.99	.99	.99	.99	1.09	1.49
RIBBON CABLE DIP PLUGS (IDC)	IDPxx	---	.95	.95	---	---	---	---	1.75	2.95

FOR ORDERING INSTRUCTIONS SEE D-SUBMINIATURE BELOW

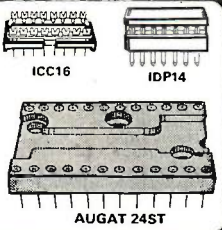

DIODES/OPTO/TRANSISTORS		
1N751	.25	4N26 .69
1N759	.25	4N27 .69
1N4148	25/1.00	4N28 .69
1N4004	10/1.00	4N33 .89
1N5402	.25	4N37 .19
KBP04	.55	MCT-2 .59
KBU8A	.95	MCT-6 1.29
MDA990-2	.35	TIL-111 .99
N2222	.25	2N3906 .10
PN2222	.10	2N4401 .25
2N2905	.50	2N4402 .25
2N3906	.25	2N4403 .25
2N3055	.79	2N6045 1.75
2N3904	.10	TIP31 .49

D-SUBMINIATURE							
DESCRIPTION	ORDER BY	CONTACTS					
		9	15	19	25	37	50
SOLDER CUP	MALE DBxxP	.82	.90	1.25	1.25	1.80	3.48
	FEMALE DBxxS	.95	1.15	1.50	1.50	2.35	4.32
RIGHT ANGLE PC SOLDER	MALE DBxxPR	1.20	1.49	---	1.95	2.65	---
	FEMALE DBxxSR	1.25	1.55	---	2.00	2.79	---
WIRE WRAP	MALE DBxxPWW	1.69	2.56	---	3.89	5.60	---
	FEMALE DBxxSww	2.76	4.27	---	6.84	9.95	---
IDC RIBBON CABLE	MALE IDBxxP	2.70	2.95	---	3.98	5.70	---
	FEMALE IDBxxS	2.92	3.20	---	4.33	6.76	---
HOODS	METAL MHODxx	1.25	1.25	1.30	1.30	---	---
	GREY HOODxx	.65	.65	---	.65	.75	.95

ORDERING INSTRUCTIONS: INSERT THE NUMBER OF CONTACTS IN THE POSITION MARKED "xx" OF THE "ORDER BY" PART NUMBER LISTED.

EXAMPLE: A 15 PIN RIGHT ANGLE MALE PC SOLDER WOULD BE DB15PR.

MOUNTING HARDWARE \$1.00

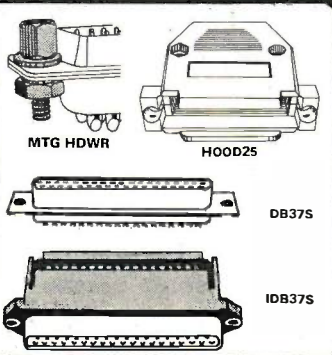

IDC CONNECTORS							
DESCRIPTION	ORDER BY	CONTACTS					
		10	20	26	34	40	50
SOLDER HEADER	IDHxxS	.82	1.29	1.68	2.20	2.58	3.24
RIGHT ANGLE SOLDER HEADER	IDHxxSR	.85	1.35	1.76	2.31	2.72	3.39
WW HEADER	IDHxxW	1.86	2.98	3.84	4.50	5.28	6.63
RIGHT ANGLE WW HEADER	IDHxxWR	2.05	3.28	4.22	4.45	4.80	7.30
RIBBON HEADER SOCKET	IDSxx	.79	.99	1.39	1.59	1.99	2.25
RIBBON HEADER	IDMxx	---	5.50	6.25	7.00	7.50	8.50
RIBBON EDGE CARD	IDExx	1.75	2.25	2.65	2.75	3.80	3.95

FOR ORDERING INSTRUCTIONS SEE D-SUBMINIATURE ABOVE

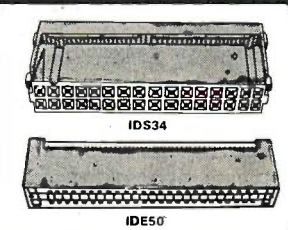

HARD TO FIND "SNAPABLE" HEADERS		
1x40	STRAIGHT LEAD	.99
1x40	RIGHT ANGLE	1.49
2x40	STRAIGHT LEAD	2.49

BARGAIN HUNTERS CORNER FRANKLIN ACE-10 DISK DRIVE FOR APPLE II

- * RELIABLE DIRECT DRIVE MECHANISM MADE FOR FRANKLIN BY MITAC, A WORLD LEADER IN FDDs FOR APPLE
- * 100% COMPATIBLE WITH APPLE II, II+, AND IIe; USE W/STANDARD APPLE CONTROLLER OR OPTIONAL \$49.95 CONTROLLER
- * FULL HEIGHT BEIGE ENCLOSURE MATCHES APPLE; BAKED ENAMEL FINISH RESISTS SCRATCHES
- * SHIELDED CABLE WITH GROUNDING LUG FOR EMI-FREE OPERATION

ONE YEAR WARRANTY
ONLY \$79.95

HURRY - QUANTITIES ARE LIMITED!
SPECIALS END 4/30/86

PAGE WIRE WRAP WIRE PRECUT ASSORTMENT IN ASSORTED COLORS \$27.50

100ea: 5.5", 6.0", 6.5", 7.0"
250ea: 2.5", 4.5", 5.0"
500ea: 3.0", 3.5", 4.0"

SPOOLS

100 feet \$4.30 250 feet \$7.25
500 feet \$13.25 1000 feet \$21.95

Please specify color:
Blue, Black, Yellow or Red

EMI FILTER \$4.95

- * MANUFACTURED BY CORCOM
- * LOW COST
- * FITS LC-HP BELOW
- * 6 AMP 120/240 VOLT



6 FOOT LINE CORDS

LC-2 2 CONDUCTOR .39
LC-3 2 CONDUCTOR .99
LC-HP 3 CONDUCTOR W/STD FEMALE SOCKET 1.49

MUFFIN FANS

3.15" SQ ROTRON 14.95
3.63" SQ ETRI 14.95
3.18" SQ MASUSHITA 16.95

WIRE WRAP PROTOTYPE CARDS FR-4 EPOXY GLASS LAMINATE WITH GOLD-PLATED EDGE-CARD FINGERS



IBM-PR2

IBM

BOTH CARDS HAVE SILK SCREENED LEGENDS AND INCLUDES MOUNTING BRACKET

IBM-PR1 WITH +5V AND GROUND PLANE . . . \$27.95
IBM-PR2 AS ABOVE WITH DECODING LAYOUT . . . \$29.95

S-100

P100-1 BARE - NO FOIL PADS . . . \$15.15
P100-2 HORIZONTAL BUS . . . \$21.80
P100-3 VERTICAL BUS . . . \$21.80
P100-4 SINGLE FOIL PADS PER HOLE . . . \$22.75

APPLE

P500-1 BARE - NO FOIL PADS . . . \$15.15
P500-3 HORIZONTAL BUS . . . \$22.75
P500-4 SINGLE FOIL PADS PER HOLE . . . \$21.80
7060-45 FOR APPLE IIe AUX SLOT . . . \$30.00

SOCKET-WRAP I.D.™

- * SLIPS OVER WIRE WRAP PINS
 - * IDENTIFIES PIN NUMBERS ON WRAP SIDE OF BOARD
 - * CAN WRITE ON PLASTIC; SUCH AS IC #
- | PINS | PART # | PCK. OF | PRICE |
|------|-----------|---------|-------|
| 8 | IDWRAP 08 | 10 | 1.95 |
| 14 | IDWRAP 14 | 10 | 1.95 |
| 16 | IDWRAP 16 | 10 | 1.95 |
| 18 | IDWRAP 18 | 5 | 1.95 |
| 20 | IDWRAP 20 | 5 | 1.95 |
| 22 | IDWRAP 22 | 5 | 1.95 |
| 24 | IDWRAP 24 | 5 | 1.95 |
| 28 | IDWRAP 28 | 5 | 1.95 |
| 40 | IDWRAP 40 | 5 | 1.95 |
- PLEASE ORDER BY NUMBER OF PACKAGES (PCK. OF)

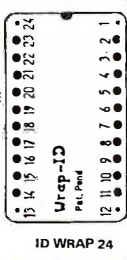

FRAME STYLE TRANSFORMERS

12.6V AC CT	2 AMP	5.95
12.6V AC CT	4 AMP	7.95
12.6V AC CT	8 AMP	10.95
25.2V AC CT	2 AMP	7.95

25 PIN D-SUB GENDER CHANGERS \$7.95



SWITCHING POWER SUPPLIES

PS-IBM \$99.95

- * FOR IBM PC-XT COMPATIBLE
- * 135 WATTS
- * +5V @ 15A, +12V @ 4.2A
- * -5V @ .5A, -12V @ .5A
- * ONE YEAR WARRANTY

PS-IBM



PS-IBM-150 \$129.95

- * FOR IBM PC-XT COMPATIBLE
- * 150 WATTS
- * +12V @ 5.2A, -5V @ 16A
- * -12V @ .5A, -5V @ .5A
- * ONE YEAR WARRANTY

PS-130



PS-130 \$99.95

- * 130 WATTS
- * SWITCH ON REAR
- * FOR USE IN OTHER IBM TYPE MACHINES
- * 90 DAY WARRANTY

PS-A



PS-A \$49.95

- * USE TO POWER APPLE TYPE SYSTEMS
- * +5V @ 4A, +12V @ 2.5A
- * -5V @ .5A, -12V @ .5A
- * APPLE POWER CONNECTOR



PS-SPL200 \$49.95

- * +5V @ 25A, +12V @ 3.5A
- * -5V @ 1A, -12V @ 1A
- * UL APPROVED
- * ALUMINUM ENCLOSURE

PS-SPL200

CAPACITORS

TANTALUM

1.0µf	15V .35	.47µf	35V .45
6.8	15V .70	1.0	35V .45
10	15V .80	2.2	35V .65
22	15V 1.35	4.7	35V .85
.22	35V .40	10	35V 1.00

DISC

10µf	50V .05	680	50V .05
22	50V .05	.001µf	50V .05
37	50V .05	.0022	50V .05
23	50V .05	.005	50V .05
47	50V .05	.01	50V .07
68	50V .05	.02	50V .07
100	50V .05	.05	50V .07
220	50V .05	.1	12V .10
560	50V .05	.1	50V .12

MONOLITHIC

.01µf	50V .14	.1µf	50V .18
.047µf	50V .15	.47µf	50V .25

ELECTROLYTIC

RADIAL	1µf		.1µf	
	25V	.14	50V	.14
2.2	35V	.15	10	50V .16
4.7	50V	.15	22	16V .14
10	50V	.15	47	50V .20
47	35V	.18	100	35V .25
100	16V	.18	220	25V .30
220	35V	.20	470	50V .50
470	25V	.30	1000	16V .60
2200	16V	.70	2200	16V .70
4700	25V	1.45	4700	16V 1.25
COMPUTER GRADE	44,000µf	30V	3.95	

DATARASE EPROM ERASER \$34.95

- * ERASES TWO EPROMS IN 10 MINUTES
- * COMPACT-NO DRAWER
- * THIN METAL SHUTTER PREVENTS UV LIGHT FROM ESCAPING



1/4 WATT RESISTORS

5% CARBON FILM ALL STANDARD VALUES FROM 1 OHM TO 10 MEG. OHM

10 PCS	same value	.05	100 PCS	same value	.02
50 PCS	same value	.025	1000 PCS	same value	.015

RESISTOR NETWORKS

SIP	10 PIN	9 RESISTOR	.69
SIP	8 PIN	7 RESISTOR	.59
DIP	16 PIN	8 RESISTOR	1.09
DIP	16 PIN	15 RESISTOR	1.09
DIP	14 PIN	7 RESISTOR	.99
DIP	14 PIN	13 RESISTOR	.99

SPECIALS ON BYPASS CAPACITORS

.01 µf	CERAMIC DISC	100/\$5.00
.01 µf	MONOLITHIC	100/\$10.00
.1 µf	CERAMIC DISC	100/\$6.50
.1 µf	MONOLITHIC	100/\$12.50

WISH SOLDERLESS BREADBOARDS

PART NUMBER	DIMENSIONS	DISTRIBUTION STRIP(S)	TIE POINTS	TERMINAL STRIP(S)	TIE POINTS	BINDING POSTS	PRICE
WBU-D	.38 x 6.50"	1	100	---	---	---	2.95
WBU-T	1.38 x 6.50"	---	---	1	630	---	6.95
WBU-204-3	3.94 x 8.45"	1	100	2	1260	2	17.95
WBU-204	5.13 x 8.45"	4	400	2	1260	3	24.95
WBU-206	6.88 x 9.06"	5	500	3	1890	4	29.95
WBU-208	8.25 x 9.45"	7	700	4	2520	4	39.95

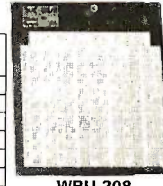

WBU-208

LITHIUM BATTERY AS USED IN CLOCK CIRCUITS

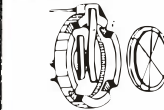

3 VOLT BATTERY \$3.95
BATTERY HOLDER \$1.49

NEW EDITION! 1986 IC MASTER

THE INDUSTRY STANDARD
\$129.95

VISIT OUR RETAIL-STORE LOCATED AT 1256 SOUTH BASCOM AVENUE IN SAN JOSE

JDR Microdevices

1224 S. Bascom Avenue, San Jose, CA 95128
800-538-5000 • 800-662-6279 (CA) • (408) 995-5430
FAX (408) 275-8415 • Telex 171-110

HOURS: M-W-F, 9-5 TU-TH, 9-9 SAT, 10-3
PLEASE USE YOUR CUSTOMER NUMBER WHEN ORDERING

TERMS: Minimum order \$10.00. For shipping and handling include \$2.50 for UPS Ground and \$3.50 for UPS Air. Orders over 1 lb. and foreign orders may require additional shipping charges - please contact our sales department for the amount. CA residents must include applicable sales tax. All merchandise is warranted for 90 days unless otherwise stated. Prices are subject to change without notice. We are not responsible for typographical errors. We reserve the right to limit quantities and to substitute manufacturer. All merchandise subject to prior sale.

PARTIAL LISTING ONLY — CALL FOR A FREE CATALOG

DISK DRIVES FOR APPLE COMPUTERS

AP-150
\$99.95



- 1/2 HT, DIRECT DRIVE
- 100% APPLE COMPATIBLE
- SIX MONTH WARRANTY

BAL-500
\$129.95



- TEAC MECHANISM DIRECT DRIVE
- 100% APPLE COMPATIBLE
- FULL ONE YEAR WARRANTY

AP-135
\$129.95



- FULL HT SHUGART MECHANISM
- DIRECT REPLACEMENT FOR APPLE DISK II
- SIX MONTH WARRANTY

DOUBLE SIDED!
MAG535
\$249.95

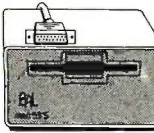

- 3.5" ADD-ON DISK DRIVE
- 100% MACINTOSH COMPATIBLE
- DOUBLE SIDED 800K BYTE STORAGE
- HIGH RELIABILITY DRIVE
- HAS AUTO-EJECT MECHANISM
- FULL ONE YEAR WARRANTY

AD-3C
\$139.95

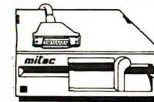

- 100% APPLE IIc COMPATIBLE, READY TO PLUG IN, W/SHIELDED CABLE & MOLDED 19 PIN CONNECTOR
- FAST, RELIABLE SLIMLINE DIRECT DRIVE
- SIX MONTH WARRANTY

DISK DRIVE ACCESSORIES
FDD CONTROLLER CARD \$49.95
IIc ADAPTOR CABLE \$19.95
ADAPTS STANDARD APPLE DRIVES FOR USE WITH APPLE IIc

KB-1000 **\$79.95**

- CASE WITH KEYBOARD FOR APPLE TYPE MOTHERBOARD
- USER DEFINED FUNCTION KEYS
 - NUMERIC KEYPAD WITH CURSOR CONTROL
 - CAPS LOCK
 - AUTO-REPEAT



KEYBOARD-AP **\$49.95**

- REPLACEMENT FOR APPLE II KEYBOARD
- CAPS LOCK KEY, AUTO-REPEAT
- ONE KEY ENTRY OF BASIC OR CP/M COMMANDS



EXTENDER CARDS

IBM-PC \$45.00
IBM-AT \$68.00
APPLE II \$45.00
APPLE IIe \$45.00
MULTIBUS \$86.00

APPLE COMPATIBLE INTERFACE CARDS

EPROM PROGRAMMER \$59.95

MODEL RP525



- DUPLICATE OR BURN ANY STANDARD 27xx SERIES EPROM
- EASY TO USE MENU-DRIVEN SOFTWARE IS INCLUDED
- MENU SELECTION FOR 2716, 2732, 2732A, 2764 AND 27128
- HIGH SPEED WRITE ALGORITHM
- LED INDICATORS FOR ACTIVITY
- NO EXTERNAL POWER SUPPLY NEEDED
- ONE YEAR WARRANTY

16K RAMCARD \$39.95



- FULL TWO YEAR WARRANTY
- EXPAND YOUR 48K APPLE TO 64K
- USE IN PLACE OF APPLE LANGUAGE CARD

BARE PC CARD W/INSTRUCTIONS \$9.95

IC TEST CARD \$99.95



- QUICKLY TESTS MANY COMMON ICs
- DISPLAYS PASS OR FAIL
- ONE YEAR WARRANTY
- TESTS: 4000 SERIES CMOS, 74HC SERIES CMOS, 7400, 74LS, 74L 74H & 74S

300B MODEM \$49.95

FOR APPLE OR IBM
INCLUDES ASCII PRO-EZ SOFTWARE



- FCC APPROVED
 - BELL SYSTEMS 103 COMPATIBLE
 - INCLUDES AC ADAPTOR
 - AUTO-DIAL
 - DIRECT CONNECT
- CABLE FOR APPLE IIc \$14.95

JOYSTICK CR-401 \$7.95

FOR ATARI 400, 800, 2600,
VIC 20/64 AND APPLE IIe



DISKFILE
HOLDS 70 5 1/4" DISKETTES



3.5" DISKFILE HOLDS 40 \$9.95

POWER STRIP
UL APPROVED
15A CIRCUIT BREAKER
\$12.95



3-WAY SWITCH BOXES

- SERIAL OR PARALLEL
- CONNECTS 3 PRINTERS TO ONE COMPUTER OR VICE VERSA
- ALL LINES SWITCHES
- HIGH QUALITY ROTARY SWITCH MOUNTED ON PCB
- GOLD CONTACTS
- STURDY METAL ENCLOSURE



SWITCH-3P CENTRONICS PARALLEL \$99.95
SWITCH-3S RS232 SERIAL \$99.95

PRINTER BUFFERS

- FREES COMPUTER FOR OTHER TASKS WHILE PRINTING LONG DOCUMENTS
- STAND-ALONE DESIGN; WORKS WITH ANY COMPUTER OR PRINTER
- ALL MODELS FEATURE PRINT PAUSE MEMORY CHECK, GRAPHICS CAPABILITY

SP120P PARALLEL \$139.95

- 64K UPGRADABLE TO 256K
- LED INDICATOR SHOWS VOLUME OF DATA IN BUFFER

SP120S RS232 SERIAL \$159.95

- 64K UPGRADABLE TO 256K
- 6 SELECTABLE BAUD RATES, FROM 600B-19,200B

SP110P PARALLEL \$249.95

- 64K UPGRADABLE TO 512K
- SPOOLS OUTPUT OF UP TO 3 COMPUTERS
- LED BARGRAPH DISPLAYS AMOUNT OF DATA IN BUFFER
- RESET FUNCTION CLEARS DATA IN BUFFER
- REPEAT FUNCTION CAN PRODUCE MULTIPLE COPIES OF A DOCUMENT



SP120 SP110

NASHUA DISKETTES DEALS

5 1/4" SOFT SECTOR
DS/DD WITH HUB RINGS

\$9.90 **69¢ea** **59¢ea**
BOX OF 10 BULK QTY 50 BULK QTY 250

NASHUA DISKETTES WERE JUDGED TO HAVE THE HIGHEST POLISH AND RECORDED AMPLITUDE OF ANY DISKETTES TESTED ACCORDING TO "COMPARING FLOPPY DISKS", BYTE 9/84

DISKETTES NASHUA 5 1/4"

N-MD2D DS/DD SOFT \$9.90
N-MD2F DS/QUAD SOFT \$34.95
N-MD2H DS/HD FOR AT \$49.95

NASHUA 8"

N-FD1 SS/DD SOFT \$27.95
N-FD2D DS/DD SOFT \$34.95

NASHUA 3.5"

N-3.5S 3.5" SS/DD FOR MAC \$32.95

VERBATIM 5 1/4"

V-MD1D SS/DD SOFT \$23.95
V-MD2D DS/DD SOFT \$29.95
V-MD110D SS/DD 10 SECTOR HARD \$23.95

Sakata 120 CPS DOT MATRIX PRINTER



MODEL SP-1200 **\$169.95**

- EPSON/IBM COMPATIBLE
- 9-WIRE PRINthead
- 120 CPS-BIDIRECTIONAL, 80 COL.
- FRICTION AND TRACTOR FEED
- PROPORTIONAL SPACING
- CENTRONICS PARALLEL INTERFACE
- 8 CHARACTER SETS AND GRAPHICS

6 FOOT IBM PRINTER CABLE \$9.95
REPLACEMENT RIBBON CARTRIDGE \$11.95

5 1/4" FLOPPY DISK DRIVES

TEAC FD-55B 1/2 HT DS/DD (FOR IBM) \$109.95
TEAC FD-55F 1/2 HT DS/QUAD (FOR IBM) \$109.95
TEAC FD-55GFV 1/2 HT DS/HD (FOR IBM AT) \$154.95
TANDON TM100-2 DS/DD (FOR IBM) \$99.95
TANDON TM50-2 1/2 HT DS/DD (FOR IBM) \$89.95
MPI-B52 DS/DD (FOR IBM) \$89.95
QUIME QT-142 1/2 HT DS/DD (FOR IBM) \$79.95

8" FLOPPY DISK DRIVES

FD 100-8 SS/DD (SA/801 EQUIV) \$119.00
FD 200-8 DS/DD (SA/851R EQUIV) \$159.00

DISK DRIVE ACCESSORIES

TEAC SPECIFICATION MANUAL \$5.00
TEAC MAINTENANCE MANUAL \$25.00
1/2 HT MOUNTING HARDWARE \$2.95
MOUNTING RAILS FOR IBM AT \$4.95
"V" POWER CABLE FOR 5 1/4" FDDs \$2.95
5 1/4" FDD POWER CONNECTORS \$1.19



TEAC FD-55 TANDON TM100-2

DISK DRIVE ENCLOSURES

CAB-APPLE \$24.95
APPLE TYPE CABINET W/OUT POWER SUPPLY

CAB-1FH5 \$69.95
FULL HT 5 1/4" BEIGE CABINET W/POWER SUPPLY

CAB-2SV5 \$49.95
DUAL SLIMLINE 5 1/4" CABINET W/POWER SUPPLY

CAB-2SVR \$209.95
DUAL SLIMLINE 8" VERTICAL CABINET W/POWER SUPPLY

CAB-2FH8 \$219.95
DUAL FULL HT 8" HORIZONTAL CABINET W/POWER SUPPLY



CAB-2SV5 CAB-1FH5

TEST EQUIPMENT FROM JDR INSTRUMENTS

DIGITAL MULTIMETER PEN DPM-1000
AUTO RANGING, POLARITY AND DECIMAL!

\$54.95

- LARGE 3.5 DIGIT DISPLAY
- DATA HOLD SWITCH FREEZES READING
- FAST, AUDIBLE CONTINUITY TEST
- LOW BATTERY INDICATOR
- OVERLOAD PROTECTION



20MHZ DUAL TRACE OSCILLOSCOPE

MODEL 2000

\$389.00

35MHZ DUAL TRACE OSCILLOSCOPE

MODEL 3500

\$549.00

FOR MORE INFORMATION ON THE OSCILLOSCOPES, SEE OUR FULL PAGE AD ON PAGE 11S.

CALL FOR VOLUME QUOTES

© COPYRIGHT 1986 JDR MICRODEVICES

BUILD A COMPLETE XT SYSTEM—\$698

XT COMPATIBLE MOTHERBOARD

\$159.95

- 4.77 MHz 8088 CPU, OPTIONAL 8087 CO-PROCESSOR
- 8 EXPANSION SLOTS
- 0K RAM INSTALLED, EXPANDABLE TO 640K ON-BOARD MEMORY
- ALL ICs SOCKETED-HIGHEST QUALITY PC BOARD
- ACCEPTS 2764 OR 27128 RAMS

PRO-BIOS \$29.95

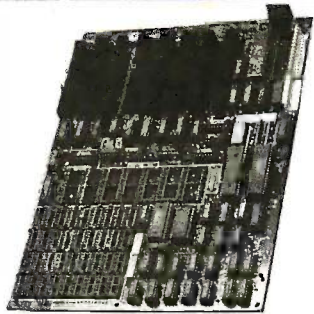

20 Mb HARD DISK SYSTEM

INCLUDES HALF LENGTH HD CONTROLLER, CABLES, MOUNTING HARDWARE AND INSTRUCTIONS. ALL DRIVES ARE PRE-TESTED AND COME WITH A ONE YEAR WARRANTY.

SEAGATE ST-225 \$489.00

IBM COMPATIBLE INTERFACE CARDS

ALL WITH A ONE YEAR WARRANTY

MULTI I/O FLOPPY CARD \$129.95

PERFECT FOR THE 640K MOTHERBOARD



- 2 DRIVE FLOPPY DISK CONTROLLER
- 1 RS232 SERIAL PORT; OPTIONAL 2nd SERIAL PORT
- PARALLEL PRINTER PORT
- GAME PORT
- CLOCK / CALENDAR
- SOFTWARE: CLOCK UTILITIES, RAMDISK, SPOOLER

MULTIFUNCTION CARD \$119.95

ALL THE FEATURES OF AST'S 6 PACK PLUS AT HALF THE PRICE



- CLOCK / CALENDAR
- 0-384K RAM
- SERIAL PORT
- PARALLEL PORT
- GAME PORT
- SOFTWARE INCLUDED

\$9.95

PRINTER CABLE \$9.95
64K RAM UPGRADE \$9.95

COLOR GRAPHICS ADAPTOR \$99.95

FULLY COMPATIBLE WITH IBM COLOR CARD



- 4 VIDEO INTERFACES: RGB, COMPOSITE COLOR, HI-RES COMPOSITE MONOCHROME, CONNECTOR FOR RF MODULATOR
- COLOR GRAPHICS MODE: 320 x 200
- MONO GRAPHICS MODE: 640 x 200
- LIGHT PEN INTERFACE

MONOCHROME GRAPHICS CARD \$119.95

FULLY COMPATIBLE W/IBM MONOCHROME ADAPTOR & HERCULES GRAPHICS



- LOTUS COMPATIBLE
- TEXT MODE: 80 x 25
- GRAPHICS MODE: 720 x 348
- PARALLEL PRINTER INTERFACE
- OPTIONAL SERIAL PORT \$19.95

MONOCHROME ADAPTOR \$49.95

ANOTHER FANTASTIC VALUE FROM JDR!

- IBM COMPATIBLE TTL OUTPUT
- 720 x 350 PIXEL DIPLAY

PLEASE NOTE: THIS CARD WILL NOT RUN LOTUS GRAPHICS AND DOES NOT INCLUDE A PARALLEL PORT

FLOPPY DISK DRIVE ADAPTOR \$49.95

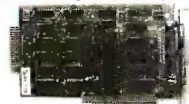

- INTERFACES UP TO FOUR STANDARD FDDs TO IBM PC OR COMPATIBLES
- INCLUDES CABLE FOR TWO INTERNAL DRIVES
- STANDARD DB37 FOR EXTERNAL DRIVES
- RUNS QUAD DENSITY DRIVES WHEN USED WITH JFORMAT

EASYDATA 1200 BAUD MODEM FOR IBM

INCLUDES PC TALK III COMMUNICATIONS SOFTWARE



- HAYES COMPATIBLE
- AUTO DIAL / AUTO ANSWER
- AUTO RE-DIAL ON BUSY
- INCLUDES SERIAL PORT!
- ONE YEAR WARRANTY

\$169.95

CRT MONITORS FOR ALL APPLICATIONS



TAXAN RGB VISION III
MODEL 415

- MADE BY TAXAN FOR ACORN
- 640 x 262 PIXEL RESOLUTION
- 16 COLORS
- 18 MHZ BANDWIDTH
- 12" BLACK MATRIX
- IBM AND LOTUS COMPATIBLE

CABLE FOR IBM \$15.95



SAKATA COMPOSITE COLOR
MODEL SC-100

- TOP RATED FOR APPLE
- 13" COMPOSITE VIDEO
- RESOLUTION: 280H x 300V
- INTERNAL AUDIO AMPLIFIER
- ONE YEAR WARRANTY



CENTER SYSTEMS MONOCHROME
MODEL KLM-1211

- IBM COMPATIBLE TTL INPUT
- 12" NON-GLARE SCREEN
- P39 GREEN PHOSPHOR
- VERY HIGH RESOLUTION
- 25 MHZ BANDWIDTH
- 1100 LINES (CENTER)

\$289.95 \$169.95 \$99.95

BUILD YOUR OWN XT COMPATIBLE SYSTEM!

- XT MOTHERBOARD \$159.95
- PRO-BIOS \$29.95
- 64K RAM \$8.91
- 130 WATT POWER SUPPLY \$89.95
- FLIP-TOP CASE \$49.95
- DKM-2000 KEYBOARD \$79.95
- 1/2 HEIGHT QUME DRIVE \$79.95
- FLOPPY DISK CONTROLLER \$49.95
- MONOCHROME ADAPTOR \$49.95
- MONOCHROME MONITOR \$99.95

TOTAL: \$697.51

MONITOR STAND



TILTS AND SWIVELS

ONLY \$12.95

IBM PRINTER CABLE



- DB25 TO CENTRONICS
- SHIELDED CABLE \$9.95

IBM STYLE COMPUTER CASE

AN ATTRACTIVE STEEL CASE WITH A HINGED LID FITS THE POPULAR PC/XT COMPATIBLE MOTHERBOARDS

- SWITCH CUT-OUT ON SIDE FOR PC/XT STYLE POWER SUPPLY
- CUT-OUT FOR 8 EXPANSION SLOTS
- ALL HARDWARE INCLUDED

\$49.95

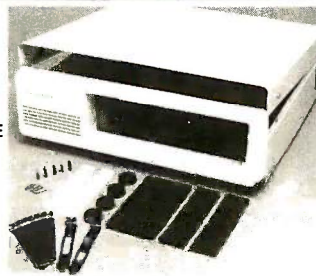

IBM COMPATIBLE KEYBOARDS

DKM-2000 \$79.95 IBM-5151 \$99.95



- "5150" STYLE KEYBOARD
- FULLY IBM COMPATIBLE
- LED STATUS INDICATORS FOR CAPS & NUMBER LOCK
- 83 KEY — SAME LAYOUT AS IBM PC/XT KEYBOARD



- REPLACEMENT FOR KEYTRONICS KB-5151™
- SEPARATE CURSOR & NUMERIC KEYPAD
- CAPS LOCK & NUMBER LOCK INDICATORS
- IMPROVED KEYBOARD LAYOUT

POWER SUPPLY



NOW ONLY \$89.95

- FOR IBM PC-XT COMPATIBLE
- 135 WATTS
- +5V @ 15A, +12V @ 4.2A
- -5V @ .5A, -12V @ .5A

150 WATT MODEL \$99.95

DISK DRIVES TANDON TM50-2

\$89.95

- 1/2 HT DS/DD
- IBM COMPATIBLE
- EXTREMELY QUIET!

- TEAC FD-55B DS/DD \$109.95
- TEAC FD-55F DS/QUAD \$109.95
- TEAC FD-55B DS/HD \$154.95
- QUME QT-142 DS/DD \$78.95
- MOUNTING HARDWARE \$2.85
- AT/RAILS \$4.95

JDR Microdevices

1224 South Bascom Avenue, San Jose, CA 95128
800-538-5000 • 800-662-6279 (CA) • (408) 995-5430 • FAX (408) 275-8415 • Telex 171-110

U·N·C·L·A·S·S·I·F·I·E·D A·D·S

WANTED: Nonprofit agency for learning-disabled children seeks tax-deductible donation of Apple II+ or Iie computer with CP/M and printer. Will provide receipts. California Center for Educational Therapy, 6016 Fallbrook Ave., Suite 201, Woodland Hills, CA 91367, (818) 347-2600.

NEEDED: Nonprofit organization providing community-based services for the elderly in rural Vermont needs donation of IBM PC or compatible. Low-cost, volunteer-oriented agency serves elders in economic need. Tax-deductible. Will pay shipping. James Matteau, Council on Aging for Southeastern Vermont, POB 818, Brattleboro, VT 05301.

NEEDED: Used Apple II computers. The United Blind of Washington State will take your Apple, add a speech synthesizer, instruct a blind person, and loan it to him/her for as long as necessary. Tax-deductible. Frank Cuta, Route 2, Box 2554C, Benton City, WA 99320, (509) 967-2658.

WANTED: The Correctional Education Institute (CEI) of California seeks nonprofit donations of computers, literature, and public-domain software for the vocational EDP program. Alan Clute, 253 Martens Ave. #7, Mountain View, CA 94040, (415) 965-2591.

WANTED: Nonprofit organization for wildlife and habitat preservation seeks tax-deductible donation of Kaypro 2000 with disk drive or similar battery-operated IBM PC-compatible. Also seeking battery-operated printer. Located in remote region; have only photovoltaic power. Resources Limited, Whale Buttes Rd., Polebridge, MT 59928.

WANTED: Nonprofit laboratory studying Appalachian natural history seeks donation of computer system for word processing, statistics, and business applications. Tax-deductible. Dr. George Constantz, Pine Cabin Run Ecological Laboratory, High View, WV 26808, (304) 856-3911 or 822-5016.

NEEDED: Nonprofit group that teaches people about protecting their water resources seeks tax-deductible donation of IBM PC or compatible with 256K RAM, disk drive(s), monitor, and printer. Will provide receipts. National Water Center, POB 548, Eureka Springs, AR 72632, (501) 253-9755.

WANTED: Computer pen pals or clubs with whom I can exchange public-domain software, books, and manuals on the Spectrum computer. Charudatt Uplap, A/13, Kerala Nagar, Tagore Rd., Santacruz (W), Bombay-400 054, India.

FOR SALE: Xerox 820 motherboard, 64K RAM, floppy-disk controller, 80 by 24 video, two RS-232C ports, and two parallel ports. Includes power supply and manual. \$150 or trade on HP 41CV. PC board for 8086 kit from Intel, fully stocked, includes manual: \$55. Dennis Griffith, 6816 Louisiana Dr., Vancouver, WA 98664, (206) 695-3006.

WANTED: Correspondence with Coleco Adam users. Also wanted: public-domain astrology and biorhythm programs for Adam. Linda Harold, POB 8147, Sacramento, CA 95818, (916) 451-9332.

WANTED: A copy of the *Attache Technical Manual*. Would also like information on public-domain applications and utility software. David C. Vaughn, 313 East 5th St., Bethlehem, PA 18015, (215) 536-4660.

FOR SALE: IMSAI 8080 mainframe with 4-MHz Z80A and 2-MHz 8080 processors, 40K static RAM, three parallel and serial I/O board, VDM-1 64 by 16 video card with monitor, 9918A color-graphics board, and more. \$900. Robert Kunzig, 934 North Orange St., Media, PA 19063, (215) 565-7761.

FOR SALE: Complete set of BYTE, \$350. Buyer pays shipping. K. Meyer, 4906 Cottonwood Lane, Salt Lake City, UT 84117, (801) 277-9320.

FOR SALE: Sanyo MBC-555-2 with 128K RAM, two DS/DD drives, and more. \$725. Paul J. Konitzer, 3856 Clark St., Seaford, NY 11783, (516) 783-7274.

FOR SALE: Seattle Computer Products S-100 board set. 8086 8-MHz CPU, floppy-disk controller, I/O board with two serial, one parallel, MS-DOS 2.1.: \$700. Lexicomp 128K 8-MHz static RAM: \$300. A. Paulsen, 27 Alhambra #201, San Francisco, CA 94123, (415) 921-8513.

FOR SALE: BYTE, September 1975 through August 1985: \$250. *Kilobaud*, January 1977 through November 1984: \$100. *Popular Electronics*, October 1981 through April 1985: \$50. Other publications available. Will sell sets only. Send SASE. G. Sabion-ski, 3203 Cedarment, LaPorte, TX 77571.

FOR SALE: BYTE: February 1981 through February 1985 complete plus June 1980 and 1984 IBM PC issue. \$135 or best offer. Will ship COD via UPS. Sam Wilkinson III, POB 140810, Dallas, TX 75214.

FOR SALE: CompuPro 816/A, 8085/88 CPU, 256K RAM, system support, two 8-inch floppy-disk drives (1.2 megabytes each), Interfacer 4, Disk I, Heath H-29 terminal, and more. Greg Puckett, 2325 Buell St., Cincinnati, OH 45211.

FOR SALE: Ohio Scientific OSI-C8P 32K, dual 8-inch floppy drives, parallel and serial interfaces, VT200 auto-dial/auto-answer, RF (TV) converter, manuals, and more. Asking \$1500. Rich McLean, 357 Walker Rd., Great Falls, VA 22066, (703) 759-4840.

WANTED: Radio Shack TRS-80 Model II computer with 64K RAM. Other Model II accessories. Send description and price. John E. Thornton, Route 1, Box 276, White Plains, MD 20695.

FOR SALE: Estimator contractor's estimating computer with wands and disk drive. Originally \$20,000. Looking for offers over \$1000. Barry Barton, Box 9259, Coral Springs, FL 33075, (305) 752-3714.

FOR SALE: Apparat 512K RAM card (64K installed) with printer spooler. Apparat Combo card with clock, parallel, serial, and game ports. Either one for \$100 or \$180 for both, postage paid. J. Lee, 731 Navajo St., Socorro, NM 87801, (505) 835-6051.

FOR SALE: 32K S-100 static RAM boards with memory-protect and incremental 4K-boundary DIP switch select. Also, TMS-4044 chips and LSI ADM 3A built from kit with chips in sockets. Steve Fritts, POB 1543, Beaver Falls, PA 15010, (412) 846-5979.

FOR SALE: Hewlett-Packard Portable computer, #45710A. Never used, includes all warranty information, manuals, etc. Asking \$1300. James Frey, POB 70, Chester, NJ 07930, (201) 879-6180.

FOR SALE: Osborne Executive with dual SS/DD disk drives. 7¼-inch amber monitor. Gorilla Banana Printer with 2000 sheets of printer paper, and more. \$2000 or best offer. Steve L. Geries, POB 636, Farwell, TX 79325, (806) 481-9981.

FOR SALE: IBM Office System 6 with power supply, 12K memory, all ROMs, 8-inch SS/SD disk drive, keyboard, tiltswivel monitor, and more. \$800 or best offer. Robert Hargrove, Rt. 2, Box 2040, McAllen, TX 78504, (512) 686-5219.

FOR SALE: Apple I computer; a collector's item. A 1976 original with cassette and video interface. Runs Apple I BASIC. Also comes with original manual. Best offer. Dave Selinger, 1619 Willow Spring Dr., Encinitas, CA 92024, (619) 436-3135.

FOR SALE: Commodore VIC-20 computer. \$100. David Knowles, 20 Sarah St., Burlington, MA 01803.

FOR SALE: Hewlett-Packard ThinkJet printer; excellent condition. \$300. R. H. Loyer, 3 Campus Court, Trenton, NJ 08638.

FOR SALE: BYTE: 1983 through 1985 at \$30 per year, postage paid. Single issues from June 1982 through December 1982 at \$3 each. John Stokes, 7910 South Memorial Parkway, Suite H, Huntsville, AL 35802, (205) 882-2360.

FOR SALE: Unused 87-key parallel-encoded keyboard (comes with specs): \$90. IBM PC XT motherboard with resistors, capacitors, sockets, and more: \$195. Mark Thomas, 7001 Kingfisher Lane, Lanham, MD 20706, (301) 552-3665.

FOR SALE: TRS-80 Model I. 48K, with expansion, serial port, and more. Asking \$500. P. French, POB 2441, Laguna Hills, CA 92654.

FOR SALE: IBM Monochrome Display: \$135. IBM Display Adapter card with printer port: \$135. IBM Game Adapter card: \$25. IBM Async Adapter (serial) card: \$50. Hayes 300-bps modem: \$140. Paul Silagi, 130 Nutmeg Lane #336, East Hartford, CT 06118, (203) 568-7126.

FOR SALE: BYTE: two sets of 1977 issues. Will sell separately at \$4 each or in sets. Charles Markham, POB 54, MIT Branch, Cambridge, MA 02139.

FOR SALE: Hewlett-Packard HP 110 Portable computer. Battery-powered, 384K ROM, 272K RAM, built-in modem, Thinklet printer, 3½-inch disk drive. \$4000. Gregory Harrison, 875 Derbyshire Rd. #223, Daytona Beach, FL 32017, (904) 252-7647.

FOR SALE: First 16 issues of BYTE in good condition. \$110. Gerald A. Block, 525 North Spoonbill Dr., Sarasota, FL 33577, (813) 955-9087.

FOR SALE: Osborne I with dual double-density disk drives and collection of First Osborne User Group public-domain software: \$600. Tandon TM 100-4 disk drive with cabinet and power supply: \$59. Other equipment available. Ed Hochman, 86 Overhill Rd., Stamford, CT 06902, (203) 322-3619.

FOR SALE: Taxan RGB Vision II monitor: \$250. Zenith ZVM-123 monitor: \$65. Columbia color graphics board: \$75. Crawford Best, 311 Magnolia Dr., Metairie, LA 70005, (504) 835-1798.

FOR SALE: Victor 9000 computer with 2 disk drives, high-resolution monitor, MS-DOS, CP/M-86, and programmable keyboard: \$1700. Laura Clark, 231 Quincy St., Hancock, MI 49930, (906) 482-8260.

FOR SALE: 64K RAM CompuPro with 12-slot motherboard, power supply, two Shugart 801 SS/DD 8-inch disk drives, Visual V200 terminal, US Robotics password 300/1200-bps modem, and more. Best offer over \$1400. Tom Serkowski, 644 North Enid, Covina, CA 91722, (818) 332-3273.

FOR SALE: IBM PC AT with 896K RAM, 33-megabyte hard disk, monitor, Paradise Modular Graphics Card, AST Research Advantage board: \$5700. R. Nels Nelson, Box 158, Loris, SC 29569, (803) 756-6060.

FOR SALE: Motorola 68000 VERSABUS system with CPU, 512K RAM, multichannel I/O, universal disk controller, 13-megabyte disk, card cage, and power supplies. \$1200. Hugh Shain, POB 45292, Seattle, WA 98145, (206) 523-4235.

FOR SALE: Used 64K 80-column extended card for Apple Iie: \$30. I will pay shipping. Chan Sui Wa, POB 35643, King's Road Post Office, Hong Kong.

FOR SALE: CompuPro 816/C with 192K RAM, TeleVideo 950 terminal, Interfacer 4, Disk I, modem, and more. \$4000. Russ Davis, 2520 Cartier Court, Fairfield, CA 94533, (707) 429-1382.

FOR SALE: Hewlett-Packard HP 86A, monitor, two HP 9130A drives, and documentation. Excellent condition. W. G. O'Brien, 104 Michaels Dr., Dewitt, NY 13214, (315) 446-4424.

FOR SALE: TI 850 printer with tractor and friction feed. Great condition. Asking \$450. I will pay shipping. Jim Ward, 9012 Cypress Point Lane, Cincinnati, OH 45249, (513) 683-5816.

FOR SALE: BYTE: March 1978 through December 1985. Also, Apple cards with manuals: Heuristics Speechlab voice-recognition card with microphone; Mountain Hardware Introl remote control system card with dual-channel AC remote box. Make offer. Dale Bartholomew, 22405 Northeast 20th St., Redmond, WA 98053.

FOR SALE: Zenith ZF-151-21; excellent condition. Asking \$1400. A. M. Johnson, 81 North Ridge Rd., Ipswich, MA 01938.

FOR SALE: Three 256K RAM boards and one 512K RAM board for TRS-80 Model 16. Best offer. Barbara, Carpenter & Associates, 510 South Congress, Suite 400, Austin, TX 78704, (512) 477-4002.

FOR SALE: CompuPro 8085/88 system with CP/M-86, CP/M-80, 320K RAM, two 8-inch drives, 9 serial ports, and more. Make offer. Talbot Jaeger, 11162 Tarawa Dr., Los Alamitos, CA 90720, (213) 493-4813.

FOR SALE: OSI C4P-MF computer with one drive and 24K. Good second machine for established OSI user. \$1000. David Shapiro, 5294 Vista del Sol, Cypress, CA 90630.

WANTED: Italian student wishes to correspond with Apple II users to discuss hardware and applications. Francesco Ceccatelli, via G.Monaco 92, 52100 Arezzo, Italy. ■

UNCLASSIFIED ADS MUST be noncommercial, from readers who have computer equipment to buy, sell, or trade on a one-time basis. All requests for donated computer equipment must be from nonprofit organizations. Programs to be exchanged must be written by the individual or be in the public domain. Ads must be typed double-spaced, contain 50 words or less, and include full name and address. This is a free service; ads are printed as space permits. BYTE reserves the right to reject any unclassified ad that does not meet these criteria. When you submit your ad (BYTE, Unclassified Ads, POB 372, Hancock, NH 03449), allow at least four months for it to appear.

B·O·M·B

BYTE'S ONGOING MONITOR BOX

ARTICLE#	PAGE	ARTICLE	AUTHOR(S)	ARTICLE#	PAGE	ARTICLE	AUTHOR(S)
1	9	Microbytes	staff	12	161	Computer Approximations	Moshier
2	37, 384	What's New	staff	13	181	The Inversion of Large Matrices	Phipps
3	44	Ask BYTE	Ciarcia	14	191	The Runge-Kutta Methods	Thomas
4	57	Book Reviews	Clune, Walker, Heberlein	15	215	The ATOMCC Toolbox	Chang
5	84	Ciarcia's Circuit Cellar: Computer On Guard!	Ciarcia	16	231	The Panasonic Exec. Partner	Malloy
6	96	Programming Project: A Simple Windowing System, Part 2: Implementation	Webster	17	241	KAMAS	Woodhull
7	105	Build the Emulo-8	Ball	18	249	Professional Debug Facility and Advanced Fullscreen Debug	Carden
8	113	Making UNIX Secure	Filipski, Hanko	19	257	microTSP	Davenport
9	129	Data Design	Shapiro	20	267	PCT _E X and MicroT _E X	Varian
10	137	DRAGON	Land	21	279	Computing at Chaos Manor: Jerry's Best of 1985 Awards	Pournelle
11	145	A Micro-based Supercomputer	Christ, Terrano	22	305	BYTE U.K.: Xenophilia	Pountain
				23	315	According to Webster: Clearing the Backlog	Webster
				24	329	Applications Only: A Couple of Winners	Shapiro
				25	349	Best of BIX	BIXen

BOMB Results

A GOOD START

The Product Description of "The Atari 520ST" by BYTE staffers Jon R. Edwards, Phillip Robinson, and Brenda McLaughlin is the winning article from January's issue. In second place is Steve Ciarcia's Circuit Cellar: "Build an Analog-to-Digital Converter." Jerry Pournelle wins third place with "One Minor Problem" while Computing at Chaos Manor. What's

New came in fourth. In fifth place and the winner of \$100 is Kirk E. Pennywitt's "Robotic Tactile Sensing" about sophisticated sensory capabilities. In sixth place and the winner of the \$50 prize for writing the second-placed nonstaff-written article is Henning Mittelbach for his Programming Insight entitled "Easy 3-D Graphics." Congratulations to all of these authors.

BYTE ADVERTISING SALES STAFF:

Dennis J. Riley, Advertising Sales Manager, 70 Main Street, Peterborough, NH 03458, tel. (603) 924-9281

NEW ENGLAND

ME, NH, VT, MA, RI.
EASTERN CANADA
Paul McPherson Jr. (617) 262-1160
McGraw-Hill Publications
575 Boylston Street
Boston, MA 02116

ATLANTIC

NY, NYC, CT, NJ (NORTH)
Leah G. Rabinowitz (212) 512-2096
McGraw-Hill Publications
1221 Avenue of the Americas—
39th Floor
New York, NY 10020

Dick McGurk (203) 968-7111
McGraw-Hill Publications
Building A—3rd Floor
777 Long Ridge Road
Stamford, CT 06902

EAST

PA (EAST), NJ (SOUTH),
MD, VA, W.VA, DE, D.C.
Daniel Ferro (215) 496-3833
McGraw-Hill Publications
Three Parkway
Philadelphia, PA 19102

SOUTHEAST

NC, SC, GA, FL, AL, TN
Maggie M. Dorvee (404) 252-0626
McGraw-Hill Publications
4170 Ashford-Dunwoody Road—
Suite 420
Atlanta, GA 30319

MIDWEST

IL, MO, KS, IA, ND, SD, MN, WI, NB, IN
Bob Denmead (312) 751-3740
McGraw-Hill Publications
Blair Building
645 North Michigan Ave.
Chicago, IL 60611

GREAT LAKES, OHIO REGION

MI, OH, PA (ALLEGHENY), KY,
ONTARIO, CANADA
McGraw-Hill Publications
4000 Town Center—Suite 770
Southfield, MI 48075

SOUTHWEST, ROCKY MOUNTAIN

UT, CO, WY, OK, TX, AR, MS, LA
Kevin Harold (214) 458-2400
McGraw-Hill Publications
Prestonwood Tower—Suite 907
5151 Beltline
Dallas, TX 75240

SOUTH PACIFIC

SOUTHERN CA, AZ, NM, LAS VEGAS
Jack Anderson (714) 557-6292
McGraw-Hill Publications
3001 Red Hill Ave.
Building #1—Suite 222
Costa Mesa, CA 92626

Karen Niles (213) 480-5243, 487-1160
McGraw-Hill Publications
3333 Wilshire Boulevard #407
Los Angeles, CA 90010

NORTH PACIFIC

HI, WA, OR, ID, MT, NORTHERN CA,
NV (except LAS VEGAS), W. CANADA
Mike Kisseberth (415) 362-4600
McGraw-Hill Publications
425 Battery Street
San Francisco, CA 94111

Bill McAfee (415) 964-0624
McGraw-Hill Publications
1000 Elwell Court—Suite 225
Palo Alto, CA 94303

WEST COAST SURPLUS

AND RETAIL ACCOUNTS
Tom Harvey (805) 964-8577
3463 State Street—Suite 256
Santa Barbara, CA 93105

The Buyer's Mart

Karen Burgess (603) 924-9281
BYTE Publications
70 Main Street
Peterborough, NH 03458

BYTE BITS (2x3)

Dan Harper (603) 924-6830
BYTE Publications
70 Main Street
Peterborough, NH 03458

Post Card Mailings

National
Bradley Browne (603) 924-6166
BYTE Publications
70 Main Street
Peterborough, NH 03458

International Advertising Sales Representatives:

Mr. Hans Csokor
Publimedia
Reisnerstrasse 61
A-1037 Vienna, Austria
222 75 76 84

Mrs. Gurit Gepner
McGraw-Hill Publishing Co.
PO Box 2156
Bat Yam, 59121 Israel
3 866 561 321 39

Mr. Fritz Krusebecker
McGraw-Hill Publishing Co.
Liebigstrasse, 19
D-6000 Frankfurt/Main 1
West Germany
69 72 01 81

Mrs. Maria Sarmiento
Pedro Teixeira 8, Off. 320
Iberia Mart 1
Madrid 4, Spain
1 45 52 891

Mr. Andrew Karnig
Andrew Karnig & Associates
Finnbodavagen
S-131 31 Nacka, Sweden
8-44 0005

Mr. Alain Faure
McGraw-Hill Publishing Co.
128 Faubourg Saint Honore
75008 Paris
France
(1) 47-20-33-42

Mr. Arthur Scheffer
McGraw-Hill Publishing Co.
34 Dover St.
London W1X 3RA
England 01 493 1451

Mr. Savio Pesavento
McGraw-Hill Publishing Co.
Via Flavio Baracchini 1
20123 Milan, Italy
02 86 90 617

Seavex Ltd.
400 Orchard Road, #10-01
Singapore 0923
Republic of Singapore
Tel: 734-9790
Telex: RS35539 SEAVEX

Seavex Ltd.
503 Wilson House
19-27 Wyndham St.
Central, Hong Kong
Tel: 5-260149
Telex: 60904 SEVEX HX

Hiro Morita
McGraw-Hill Publishing Co.
Overseas Corp.
Room 1528
Kasumigaseki Bldg.
3-2-5 Kasumigaseki,
Chiyoda-Ku
Tokyo 100, Japan
3 581 9811

READER SERVICE

Inquiry No.	Page No.	Inquiry No.	Page No.	Inquiry No.	Page No.	Inquiry No.	Page No.	
375	1ST PLACE COMP. SYSTEMS...	438	69	COMMUNICATIONS ELECTR...	420	138	GENERAL COMPUTER	237
377	2500 AD SOFTWARE INC.	77		* COMPAQ COMP.	INSERT 272 A-D	139	GENERAL MICRO SYSTEMS	413
2	A.S.T. RESEARCH	19	70	COMPETITIVE EDGE	364	140	GENOA SYSTEMS CORP.	217
3	A.S.T. RESEARCH	19	71	COMPUTATA TRANSLATORS INC.	410	141	GFK	417
	* ACS IMPORTERS	410		* COMPUPRO/VIASYN CORP.	177	142	GLENCO ENGINEERING	246
4	ADV. DIGITAL CORP.	36	72	COMPUSAVE	400	143	GOLDEN BOW SYSTEMS	412
5	ADV. DIGITAL CORP.	36	73	COMPUSERVE	342	144	GOLDEN BOW SYSTEMS	413
6	ADV. INTELLIGENCE TECHN.	401	74	COMPUSERVE	343	145	GRAFFPOINT	411
7	ADV. MICROCOMPUTER SYS.	438	75	COMPUTER AFFAIRS INC.	414	146	GRAND UNION MICROSYSTEMS	412
8	ADVANCED COMP. PROD.	426, 427	76	COMPUTER AID	411	147	GTE SYLVANIA	247
9	ADVANCED DEVLPMNT. TECHN	266	77	COMPUTER ASSOC.—MPD	63	148	GTEK INC.	293
10	AFTON COMPUTER	230	78	COMPUTER BARN. THE	410	149	HANZON DATA INC.	298
11	AFTON COMPUTER	230		* COMPUTER CHRONICLES	207		* HARMONY COMPUTERS	352
13	ALF PRODUCTS, INC.	416	79	COMPUTER CONNECTION INC.	425	151	HAYES MICROCOMP. PROD.	112
14	ALPHA MICRO	180		* COMPUTER CONTINUUM	410	379	HEI	48
15	AM'86	360	80	COMPUTER INNOVATIONS	295	152	HERCULES COMPUTER TECH.	190
17	AMERICAN MICRO TECHNOLOGY	163	81	COMPUTER INNOVATIONS	297	153	HERCULES COMPUTER TECH.	144
18	AMERICAN SMALL BUSN. COMP.	139	82	COMPUTER MAIL ORDER	300, 301	154	HERITAGE SYSTEMS CORP.	417
19	AMPRO COMPUTERS INC.	350	83	COMPUTER PARTS MART	381	155	HERSEY MICRO CONSULTING	415
20	APPARAT INC.	413	84	COMPUTER PRODUCTS INT'L	416	156	HIT-TEC COMP. & ELECTR.	400
386	APROTEK	352	85	COMPUTER SURPLUS STORE	417	157	HOUSTON INSTR./BAUSCHGLOMB	23
387	APROTEK	352	86	COMPUTER WAREHOUSE	209	158	IBEX COMP. CORP.	414
22	ARITY CORPORATION	211	87	COMPUTER WAREHOUSE	209	159	IBM - IISG SERVICES	323
405	ARRAY TECHNOLOGIES INC.	243	88	COMPUTER-AGE, INC.	438	160	IBM CORP.	34, 35
406	ARRAY TECHNOLOGIES INC.	243	89	COMPUTERBANC	421	161	I.C. EXPRESS	416
24	ARTEK CORP.	25	90	COMPUTERIZED CONCEPTS	417	162	INFORMATION FACTORY	414
26	ATRON CORP.	263	92	COMPUTRADE	356	164	INNER LOOP SOFTWARE	416
27	ATRONICS INT'L, INC.	320	94	CONROY-LAPOINTE	94, 95		* INECTRA INC.	411
28	B&B ELECTRONICS	416	95	CONROY-LAPOINTE	94, 95	166	INTEGRAND	62
	* B&C MICROSYSTEMS	381	96	CONROY-LAPOINTE	94, 95		* INTERFACE TECH. CORP.	121
	* B&C MICROSYSTEMS	381	99	CUESTA SYSTEMS CORP.	22		* INTERFACE TECH. CORP.	317
29	B.C.E.	403	376	CURTIS, INC.	381	167	IOMEGA	64, 65
30	BOY TECHNICAL ASSOC.	303	101	CUSTOM COMP. TECH.	398	168	ITT INFORMATION SYSTEMS	274, 275
31	BITTNER ELECTRONICS	381	102	CUSTOM COMP. TECH.	399	169	ITT INFORMATION SYSTEMS	274, 275
450	BIX	338, 339	103	D AND D DISCOUNT	407	170	JADE COMP. PROD.	436, 437
32	BLAISE COMPUTING INC.	259	104	DAC SOFTWARE INC.	47	171	JAMECO ELECTRONICS	430, 431
33	BLAISE COMPUTING INC.	259	105	DATA EXCHANGE	417	172	IDR INSTRUMENTS	115
34	BMDP STATISTICAL SFTW.	147	106	DATA TRANSLATION INC.	355	173	IDR MICRODEVICES	440, 441
35	BORLAND INT'L	CII, 1	107	DATA ZONE, INC.	193	174	IDR MICRODEVICES	442, 443
36	BORLAND INT'L	CII, 1	108	DATACOM NORTHWEST INC.	415	175	IDR MICRODEVICES	444
37	BORLAND INT'L	39	109	DATATECH ENTERPRISES CO.	369	176	KADAK PRODUCTS LTD.	350
38	BORLAND INT'L	39	111	DIGITALK, INC.	18	177	KEA SYSTEMS	412
39	BP MICROSYSTEMS	414	112	DISKET CONNECTION	344	178	KEY TRONIC CORP.	341
402	BRADY COMPUTER BOOKS	363	113	DISKS PLUS	354	179	KIMTRON CORP.	251
	* BROWN BAG SOFTWARE	304	114	DISK WORLD, INC.	422, 423	178	KIMTRON CORP.	251
91	BTE COMPUTERS	60	115	DISPLAY TELECOMMUNTS.	126	180	KOHI-NOOR RAPIDOGRAPH	223
41	BUDGET COMPUTERS	438	116	DISYEMIFIED GROUP, THE	434, 435	403	KYOCCERA	157
	* BUEHLER SERVICES, INC.	411	117	DOKAY COMP. PROD. INC.	405	404	KYOCCERA	157
42	BUKOWSKI ROBOTICS	412	118	DRESSSELHAUS COMP. PROD.	50	182	LABORATORY MICROSYS.	70
43	BUSINESS TOOLS INC.	171	119	EARTH COMPUTERS	99	183	LAHEY COMPUTER SYSTEMS	354
44	BYTE CONNECTION, THE	408	120	EARTH COMPUTERS	99	184	LAPTOPP SYSTEMS	50
	* BYTE SUB. MESSAGE	364	121	ECOSOFT	228	185	LATTICE, INC.	201
	* BYTE SUB. SERVICE	210	122	EDUCATIONAL MICROCOMP. SYS.	411	187	LINTEK INC.	381
45	BYTEK COMP. SYS. CORP.	322	123	ELEXOR INC.	381	188	LMW ENTERPRISES INC.	316
	* C WARE/DESMET C	326	124	ELLIS COMPUTING INC.	155	400	LOGICSOFT	INSERT 128 A-D
46	C.I. COMPUTERS	30	383	ENERTRONICS	314	192	LOGICAL DEVICES	366, 367
47	C.I. COMPUTERS	30	330	ENGARDE	4	193	LOGICAL SYSTEMS INC.	410
48	CALIF. SCIENTIFIC SFTW.	416	125	ESSENTIAL SOFTWARE INC.	280	194	LOGITECH INC.	117
	* CALIFORNIA DIGITAL	432, 433	127	EVEREX SYSTEMS	43	195	LOGITECH INC.	119
49	CAPITAL EQUIPMENT CORP.	298	128	EVEREX SYSTEMS	43	196	LOMAS DATA PRODUCTS	351
	* CAPITAL MICRO	402	129	EXCELTEC INDUSTRIES, INC.	417	197	LUCKY COMPUTERS	438
51	CAUZIN SYSTEMS	238, 239	130	FACIT AB	281	198	LUCKY-GOLDSTAR INT'L	225
98	CEC	358	131	FASTFIND	438	199	LYBEN COMP. SYS.	22
52	CERMETEK MICROELECTRONICS	24	132	FLAGSTAFF ENGINEERING	345	200	LYCO COMPUTER	361
53	CHALCEDONY SOFTWARE	58	133	FLAGSTAFF ENGINEERING	345	201	MANX SOFTWARE SYS.	41
54	CHALCEDONY SOFTWARE	58	134	FLAMINGO MICRO	134	202	MANZANA	46
55	CHORUS DATA SYSTEMS	312	135	FORTRON, INC.	409	203	MARC BAER ASSOCIATES	415
56	CITIBANK NA	169	136	FORTRON, INC.	409	204	MARK WILLIAMS CO.	59
58	CLASSIC TECHNOLOGY	240	137	FOX SOFTWARE, INC.	32	205	MARK WILLIAMS CO.	61
59	CLASSIC TECHNOLOGY	240	137	GABE TECH LTD.	54	206	MARON PRODUCTION INC.	414
60	CLEVELAND CODONICS INC.	218						
61	CMS	214						
62	CMS	214						
63	CODEX CORPORATION	290						
64	CODEX CORPORATION	292						
65	CODEX CORPORATION	294						
66	COGITATE	410						
67	COGITATE	413						
	* COMMODORE BUSN. MACH.	256						
69	COMMUNICATIONS ELECTR.	420						
70	COMPETITIVE EDGE	364						
71	COMPUTATA TRANSLATORS INC.	410						
72	COMPUSAVE	400						
73	COMPUSERVE	342						
74	COMPUSERVE	343						
75	COMPUTER AFFAIRS INC.	414						
76	COMPUTER AID	411						
77	COMPUTER ASSOC.—MPD	63						
78	COMPUTER BARN. THE	410						
	* COMPUTER CHRONICLES	207						
79	COMPUTER CONNECTION INC.	425						
	* COMPUTER CONTINUUM	410						
80	COMPUTER INNOVATIONS	295						
81	COMPUTER INNOVATIONS	297						
82	COMPUTER MAIL ORDER	300, 301						
83	COMPUTER PARTS MART	381						
84	COMPUTER PRODUCTS INT'L	416						
85	COMPUTER SURPLUS STORE	417						
86	COMPUTER WAREHOUSE	209						
87	COMPUTER WAREHOUSE	209						
88	COMPUTER-AGE, INC.	438						
89	COMPUTERBANC	421						
90	COMPUTERIZED CONCEPTS	417						
92	COMPUTRADE	356						
94	CONROY-LAPOINTE	94, 95						
95	CONROY-LAPOINTE	94, 95						
96	CONROY-LAPOINTE	94, 95						
99	CUESTA SYSTEMS CORP.	22						
376	CURTIS, INC.	381						
101	CUSTOM COMP. TECH.	398						
102	CUSTOM COMP. TECH.	399						
103	D AND D DISCOUNT	407						
104	DAC SOFTWARE INC.	47						
105	DATA EXCHANGE	417						
106	DATA TRANSLATION INC.	355						
107	DATA ZONE, INC.	193						
108	DATACOM NORTHWEST INC.	415						
109	DATATECH ENTERPRISES CO.	369						
111	DIGITALK, INC.	18						
112	DISKET CONNECTION	344						
113	DISKS PLUS	354						
114	DISK WORLD, INC.	422, 423						
115	DISPLAY TELECOMMUNTS.	126						
116	DISYEMIFIED GROUP, THE	434, 435						
117	DOKAY COMP. PROD. INC.	405						
118	DRESSSELHAUS COMP. PROD.	50						
119	EARTH COMPUTERS	99						
120	EARTH COMPUTERS	99						
121	ECOSOFT	228						
122	EDUCATIONAL MICROCOMP. SYS.	411						
123	ELEXOR INC.	381						
124	ELLIS COMPUTING INC.	155						
383	ENERTRONICS	314						
330	ENGARDE	4						
125	ESSENTIAL SOFTWARE INC.	280						
127	EVEREX SYSTEMS	43						
128	EVEREX SYSTEMS	43						
129	EXCELTEC INDUSTRIES, INC.	417						
130	FACIT AB	281						
131	FASTFIND	438						
132	FLAGSTAFF ENGINEERING	345						
133	FLAGSTAFF ENGINEERING	345						
134	FLAMINGO MICRO	134						
135	FORTRON, INC.	409						
136	FORTRON, INC.	409						
137	FOX SOFTWARE, INC.	32						
137	GABE TECH LTD.	54						

TO GET FURTHER information on the products advertised in BYTE, either pick up your touch-tone telephone and use TIPS (if you are a subscriber), or fill out the reader service card. Either way full instructions are provided following this reader service index which is provided as an additional service by the publisher, who assumes no liability for errors or omissions. *Correspond directly with company.

BYTE READER SERVICE



Fill out this coupon carefully. PLEASE PRINT. Requests cannot be honored unless the zip code is included. This card is valid for 6 months from cover date.

Name _____ APRIL 1986
 (Title) _____ (Company) _____ 4146
 Address _____ Telephone _____
 City _____ State _____ Zip _____

I purchased this copy by Subscription Newsstand, computer store, or bookstore

1 23 45 67 89	111 133 155 177 199	221 243 265 287 309	331 353 375 397 419	441 463 485 507 529	551 573 595 617 639	661 683 705 727 749	771 793
2 24 46 68 90	112 134 156 178 200	222 244 266 288 310	332 354 376 398 420	442 464 486 508 530	552 574 596 618 640	662 684 706 728 750	772 794
3 25 47 69 91	113 135 157 179 201	223 245 267 289 311	333 355 377 399 421	443 465 487 509 531	553 575 597 619 641	663 685 707 729 751	773 795
4 26 48 70 92	114 136 158 180 202	224 246 268 290 312	334 356 378 400 422	444 466 488 510 532	554 576 598 620 642	664 686 708 730 752	774 796
5 27 49 71 93	115 137 159 181 203	225 247 269 291 313	335 357 379 401 423	445 467 489 511 533	555 577 599 621 643	665 687 709 731 753	775 797
6 28 50 72 94	116 138 160 182 204	226 248 270 292 314	336 358 380 402 424	446 468 490 512 534	556 578 600 622 644	666 688 710 732 754	776 798
7 29 51 73 95	117 139 161 183 205	227 249 271 293 315	337 359 381 403 425	447 469 491 513 535	557 579 601 623 645	667 689 711 733 755	777 799
8 30 52 74 96	118 140 162 184 206	228 250 272 294 316	338 360 382 404 426	448 470 492 514 536	558 580 602 624 646	668 690 712 734 756	778 800
9 31 53 75 97	119 141 163 185 207	229 251 273 295 317	339 361 383 405 427	449 471 493 515 537	559 581 603 625 647	669 691 713 735 757	779 801
10 32 54 76 98	120 142 164 186 208	230 252 274 296 318	340 362 384 406 428	450 472 494 516 538	560 582 604 626 648	670 692 714 736 758	780 802
11 33 55 77 99	121 143 165 187 209	231 253 275 297 319	341 363 385 407 429	451 473 495 517 539	561 583 605 627 649	671 693 715 737 759	781 803
12 34 56 78 100	122 144 166 188 210	232 254 276 298 320	342 364 386 408 430	452 474 496 518 540	562 584 606 628 650	672 694 716 738 760	782 804
13 35 57 79 101	123 145 167 189 211	233 255 277 299 321	343 365 387 409 431	453 475 497 519 541	563 585 607 629 651	673 695 717 739 761	783 805
14 36 58 80 102	124 146 168 190 212	234 256 278 300 322	344 366 388 410 432	454 476 498 520 542	564 586 608 630 652	674 696 718 740 762	784 806
15 37 59 81 103	125 147 169 191 213	235 257 279 301 323	345 367 389 411 433	455 477 499 521 543	565 587 609 631 653	675 697 719 741 763	785 807
16 38 60 82 104	126 148 170 192 214	236 258 280 302 324	346 368 390 412 434	456 478 500 522 544	566 588 610 632 654	676 698 720 742 764	786 808
17 39 61 83 105	127 149 171 193 215	237 259 281 303 325	347 369 391 413 435	457 479 501 523 545	567 589 611 633 655	677 699 721 743 765	787 809
18 40 62 84 106	128 150 172 194 216	238 260 282 304 326	348 370 392 414 436	458 480 502 524 546	568 590 612 634 656	678 700 722 744 766	788 810
19 41 63 85 107	129 151 173 195 217	239 261 283 305 327	349 371 393 415 437	459 481 503 525 547	569 591 613 635 657	679 701 723 745 767	789 811
20 42 64 86 108	130 152 174 196 218	240 262 284 306 328	350 372 394 416 438	460 482 504 526 548	570 592 614 636 658	680 702 724 746 768	790 812
21 43 65 87 109	131 153 175 197 219	241 263 285 307 329	351 373 395 417 439	461 483 505 527 549	571 593 615 637 659	681 703 725 747 769	791 813
22 44 66 88 110	132 154 176 198 220	242 264 286 308 330	352 374 396 418 440	462 484 506 528 550	572 594 616 638 660	682 704 726 748 770	792 814

BYTE's BOMB is your direct line to the editor's desk. Each month, the two top-rated authors receive bonuses based on your evaluation. First look at the list of this month's articles and corresponding article numbers (located on the page preceding the Reader Service list), then rate each article you've read as Excellent, Good, Fair, or Poor, based on your overall impression of the article, by circling the appropriate number in each column below. Your feedback helps us produce the best possible magazine each month.

Article No.	1	2	3	4	5	6	7	8	9	10	11	12	13	14	15	16	17	18	19	20	21	22	23	24	25
Excellent	1	5	9	13	17	21	25	29	33	37	41	45	49	53	57	61	65	69	73	77	81	85	89	93	97
Good	2	6	10	14	18	22	26	30	34	38	42	46	50	54	58	62	66	70	74	78	82	86	90	94	98
Fair	3	7	11	15	19	23	27	31	35	39	43	47	51	55	59	63	67	71	75	79	83	87	91	95	99
Poor	4	8	12	16	20	24	28	32	36	40	44	48	52	56	60	64	68	72	76	80	84	88	92	96	100

Article No.	26	27	28	29	30	31	32	33	34	35	36	37	38	39	40	41	42	43	44	45	46	47	48	49	50
Excellent	101	105	109	113	117	121	125	129	133	137	141	145	149	153	157	161	165	169	173	177	181	185	189	193	197
Good	102	106	110	114	118	122	126	130	134	138	142	146	150	154	158	162	166	170	174	178	182	186	190	194	198
Fair	103	107	111	115	119	123	127	131	135	139	143	147	151	155	159	163	167	171	175	179	183	187	191	195	199
Poor	104	108	112	116	120	124	128	132	136	140	144	148	152	156	160	164	168	172	176	180	184	188	192	196	200

BYTE READER SERVICE



Fill out this coupon carefully. PLEASE PRINT. Requests cannot be honored unless the zip code is included. This card is valid for 6 months from cover date.

Name _____ APRIL 1986
 (Title) _____ (Company) _____ 4146
 Address _____ Telephone _____
 City _____ State _____ Zip _____

I purchased this copy by Subscription Newsstand, computer store, or bookstore

1 23 45 67 89	111 133 155 177 199	221 243 265 287 309	331 353 375 397 419	441 463 485 507 529	551 573 595 617 639	661 683 705 727 749	771 793
2 24 46 68 90	112 134 156 178 200	222 244 266 288 310	332 354 376 398 420	442 464 486 508 530	552 574 596 618 640	662 684 706 728 750	772 794
3 25 47 69 91	113 135 157 179 201	223 245 267 289 311	333 355 377 399 421	443 465 487 509 531	553 575 597 619 641	663 685 707 729 751	773 795
4 26 48 70 92	114 136 158 180 202	224 246 268 290 312	334 356 378 400 422	444 466 488 510 532	554 576 598 620 642	664 686 708 730 752	774 796
5 27 49 71 93	115 137 159 181 203	225 247 269 291 313	335 357 379 401 423	445 467 489 511 533	555 577 599 621 643	665 687 709 731 753	775 797
6 28 50 72 94	116 138 160 182 204	226 248 270 292 314	336 358 380 402 424	446 468 490 512 534	556 578 600 622 644	666 688 710 732 754	776 798
7 29 51 73 95	117 139 161 183 205	227 249 271 293 315	337 359 381 403 425	447 469 491 513 535	557 579 601 623 645	667 689 711 733 755	777 799
8 30 52 74 96	118 140 162 184 206	228 250 272 294 316	338 360 382 404 426	448 470 492 514 536	558 580 602 624 646	668 690 712 734 756	778 800
9 31 53 75 97	119 141 163 185 207	229 251 273 295 317	339 361 383 405 427	449 471 493 515 537	559 581 603 625 647	669 691 713 735 757	779 801
10 32 54 76 98	120 142 164 186 208	230 252 274 296 318	340 362 384 406 428	450 472 494 516 538	560 582 604 626 648	670 692 714 736 758	780 802
11 33 55 77 99	121 143 165 187 209	231 253 275 297 319	341 363 385 407 429	451 473 495 517 539	561 583 605 627 649	671 693 715 737 759	781 803
12 34 56 78 100	122 144 166 188 210	232 254 276 298 320	342 364 386 408 430	452 474 496 518 540	562 584 606 628 650	672 694 716 738 760	782 804
13 35 57 79 101	123 145 167 189 211	233 255 277 299 321	343 365 387 409 431	453 475 497 519 541	563 585 607 629 651	673 695 717 739 761	783 805
14 36 58 80 102	124 146 168 190 212	234 256 278 300 322	344 366 388 410 432	454 476 498 520 542	564 586 608 630 652	674 696 718 740 762	784 806
15 37 59 81 103	125 147 169 191 213	235 257 279 301 323	345 367 389 411 433	455 477 499 521 543	565 587 609 631 653	675 697 719 741 763	785 807
16 38 60 82 104	126 148 170 192 214	236 258 280 302 324	346 368 390 412 434	456 478 500 522 544	566 588 610 632 654	676 698 720 742 764	786 808
17 39 61 83 105	127 149 171 193 215	237 259 281 303 325	347 369 391 413 435	457 479 501 523 545	567 589 611 633 655	677 699 721 743 765	787 809
18 40 62 84 106	128 150 172 194 216	238 260 282 304 326	348 370 392 414 436	458 480 502 524 546	568 590 612 634 656	678 700 722 744 766	788 810
19 41 63 85 107	129 151 173 195 217	239 261 283 305 327	349 371 393 415 437	459 481 503 525 547	569 591 613 635 657	679 701 723 745 767	789 811
20 42 64 86 108	130 152 174 196 218	240 262 284 306 328	350 372 394 416 438	460 482 504 526 548	570 592 614 636 658	680 702 724 746 768	790 812
21 43 65 87 109	131 153 175 197 219	241 263 285 307 329	351 373 395 417 439	461 483 505 527 549	571 593 615 637 659	681 703 725 747 769	791 813
22 44 66 88 110	132 154 176 198 220	242 264 286 308 330	352 374 396 418 440	462 484 506 528 550	572 594 616 638 660	682 704 726 748 770	792 814

To get further information on the products advertised in BYTE, fill out the reader service card with your name and address. Then circle the appropriate numbers for the advertisers you select from the list. Add a first-class stamp to the card, then drop it in the mail. Not only do you gain information, but our advertisers are encouraged to use the marketplace provided by BYTE. This helps us bring you a bigger BYTE. The index is provided as an additional service by the publisher, who assumes no liability for errors or omissions.

PLACE
POSTAGE
HERE

BYTE

READER SERVICE
PO BOX 298
DALTON, MA 01227-0298
USA

PLACE
POSTAGE
HERE

BYTE

READER SERVICE
PO BOX 298
DALTON, MA 01227-0298
USA

BYTE

SUBSCRIPTIONS

4146

For a subscription to BYTE, please complete this card.

Name _____

Address _____

City _____

State _____ Zip _____ Country _____

Card No. _____

Expiration date _____

Four digits above name—Master Charge only _____

Signature _____ Date _____

Please allow eight weeks for processing. Thank you.

USA

Canada
Mexico

- | | | |
|----------------------------------|-------------------------------|-------------------------------|
| <input type="checkbox"/> 1 year | <input type="checkbox"/> \$21 | <input type="checkbox"/> \$23 |
| <input type="checkbox"/> 2 years | <input type="checkbox"/> \$38 | <input type="checkbox"/> \$42 |
| <input type="checkbox"/> 3 years | <input type="checkbox"/> \$55 | <input type="checkbox"/> \$61 |

- \$69. Europe (air delivery) payment enclosed
 \$37 Worldwide (surface mail) payment enclosed

(Air mail rates available upon request)

Please remit in US funds drawn on a US bank. Thank you.

- Check enclosed (Bonus: [North American only] one EXTRA issue—receive 13 issues for the price of 12)



- Bill me (North America only)

BYTE

SUBSCRIPTIONS

4146

For a subscription to BYTE, please complete this card.

Name _____

Address _____

City _____

State _____ Zip _____ Country _____

Card No. _____

Expiration date _____

Four digits above name—Master Charge only _____

Signature _____ Date _____

Please allow eight weeks for processing. Thank you.

USA

Canada
Mexico

- | | | |
|----------------------------------|-------------------------------|-------------------------------|
| <input type="checkbox"/> 1 year | <input type="checkbox"/> \$21 | <input type="checkbox"/> \$23 |
| <input type="checkbox"/> 2 years | <input type="checkbox"/> \$38 | <input type="checkbox"/> \$42 |
| <input type="checkbox"/> 3 years | <input type="checkbox"/> \$55 | <input type="checkbox"/> \$61 |

- \$69. Europe (air delivery) payment enclosed
 \$37 Worldwide (surface mail) payment enclosed

(Air mail rates available upon request)

Please remit in US funds drawn on a US bank. Thank you.

- Check enclosed (Bonus: [North American only] one EXTRA issue—receive 13 issues for the price of 12)

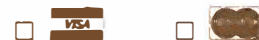

- Bill me (North America only)

*Note our special offer!
Send cash with your order
and receive 13 issues
for the price of 12 for
each year you subscribe.
(North America only, please.)*

Don't Miss An Issue!

Have BYTE delivered to your door.

Each month BYTE will bring you the latest in microcomputer technology.

DISCOVER and IMPLEMENT new ideas. Don't miss the original information presented in the pages of BYTE.

With BYTE you'll always be among the first to know about the important breakthroughs, worthwhile new equipment, and innovative projects in the world of computing.

CHALLENGE US to deliver the very best idea in microcomputers and advanced technology to you. Return the attached card today!

Subscribe to BYTE—the world's leading computer magazine.



NO POSTAGE
NECESSARY
IF MAILED
IN THE
UNITED STATES

BUSINESS REPLY MAIL
FIRST CLASS PERMIT NO. 39 MARTINSVILLE, NJ

POSTAGE WILL BE PAID BY ADDRESSEE

BYTE SUBSCRIPTIONS
PO Box 597
Martinsville, NJ 08836-9956
USA

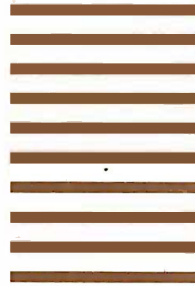

NO POSTAGE
NECESSARY
IF MAILED
IN THE
UNITED STATES

BUSINESS REPLY MAIL
FIRST CLASS PERMIT NO. 39 MARTINSVILLE, NJ

POSTAGE WILL BE PAID BY ADDRESSEE

BYTE SUBSCRIPTIONS
PO Box 597
Martinsville, NJ 08836-9956
USA



TODAY IS THE BLACKEST DAY IN DOT MATRIX PRINTER HISTORY.

It would pay you to mark it on your calendar.

Because today is the day we introduce our new Pinwriter™ P5XL dot matrix printer. The only dot matrix printer available capable of producing the rich, black printing you associate with a letter-quality printer. Because it's the only one designed to use a multi-strike film ribbon — the same ribbon used in typewriters and letter-quality printers.

A LITTLE BLACK MAGIC.

Actual line printed with the
Pinwriter P5XL printer.

Black letter-quality printing is only the beginning. The Pinwriter P5XL printer can also use an optional ribbon to print in seven other colors. And it has the finest graphics resolution of any impact printer you can buy. Plus it's very fast and exceptionally quiet.

It's only natural that

the first dot matrix printer with true letter-quality printing should be an NEC. After all we make Spinwriter® letter-quality printers, the most popular line today, as well as the Pinwriter P5 dot matrix printer, the most advanced 24-pin printer.

The Pinwriter P5XL printer is part of the most extensive line of 24-pin printers available. You'll find a model designed to fit every need and budget. See them at your dealer or call 1-800-343-4418 (in MA 617-264-8635). Or write: NEC Information Systems, Dept. 1610, 1414 Massachusetts Ave., Boxborough, MA 01719.

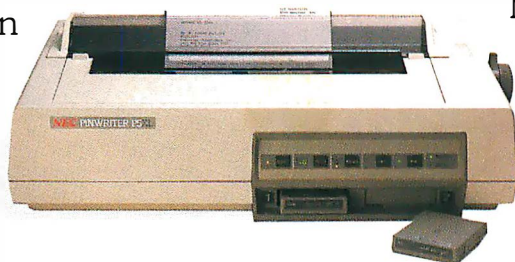

**NEC PRINTERS. THEY ONLY STOP
WHEN YOU WANT THEM TO.**

TANDY... Clearly Superior™



We edged out the competition with the Tandy® 1000, an IBM® PC compatible for only \$999—including software.

This is the one you've heard about. The Tandy 1000 is compatible with the IBM PC, for one of the widest selections of software available anywhere—you can choose from an astounding collection of popular MS-DOS® programs.

Get the DeskMate® advantage

Unlike the PC, the Tandy 1000 comes with its own software—DeskMate. It's word processing, spreadsheet analysis, filing, scheduling, telecommunications and electronic mail all on one disk*.

The high-capacity business machine

The Tandy 1000 is packed with all the features you demand. It comes with 128K RAM, expandable to 640K. Monochrome and color graphics adapters are built right in

for easy hookup to a monitor. We offer both high-resolution monochrome and color monitors, plus a budget-priced color monitor. There's also a three-voice sound circuit, plus a built-in speaker for sophisticated sound and music generation. It's easy to augment your system with user-installable expansion boards, too.

The Tandy 1000 also comes with adapters to use a printer, joysticks and light pen. The Tandy 1000 also includes such "extras" as the industry-standard MS-DOS disk operating system and BASIC. These all cost extra on the IBM PC.

In business for business

When it comes to service and support, you'll find that Radio Shack is second to none.

In-store training is conducted at over 300 Computer Centers nationwide. Low-cost delivery and set-up, new-user orientation, and on-site training are available in all major market areas.

Available nationwide

Come in and see the remarkable Tandy 1000 at your local Radio Shack today. You can get a "hands-on" demonstration of the 1000 and DeskMate. Or drop by a Radio Shack Computer Center and find out how your business can lease a Tandy 1000 system for only \$50 per month†. Come see how you can get the edge on *your* competition.

Radio Shack®
The Technology Store™

A DIVISION OF TANDY CORPORATION
Inquiry 285

*DeskMate communications require an optional telephone modem. †Commercial lease for a Tandy 1000 and color monitor, plus applicable use/sales tax. Prices apply at Radio Shack Computer Centers and participating stores and dealers. Monitor not included. DeskMate/TM Tandy Corporation. IBM/TM International Business Machines Corp. MS-DOS/TM Microsoft Corp.