

BYTE

THE SMALL SYSTEMS JOURNAL

JUNE 1985 VOL. 10, NO. 6

\$3.50 IN UNITED STATES
\$4.25 IN CANADA / £2.10 IN U.K.
A MCGRAW-HILL PUBLICATION
0360-5280

PROGRAMMING TECHNIQUES



ROBERT
35 TINNEY

How to avoid paying your bills

by Alan Greenspan



Alan Greenspan, Famous Economic Advisor

"The other day, a prominent politician in the executive branch of our government phoned me up.

'Alan,' he said to me, 'the budget is a mess.'

'No joke,' I said.

'Not that budget,' the prominent politician continued. 'My budget. My checkings overdrawn. They're threatening to disconnect my phones. I even got into a shouting match with my wife when I tried to lay off the servants.'

'Civil?'

'Not very. And I think I'm about to be audited. What would I show them? Who keeps receipts for embassy parties?'

At this point, we were disconnected. And although it was too late to teach proper money management to this prominent politician, there is a lesson all of us can learn from his misfortune.

Everyone has to pay their bills, and nobody likes to do it.

You can keep file folders full of bills, drawers stuffed with grocery receipts, envelopes brimming with cancelled checks, and at the end of the month, it still takes hours to figure out just where your money has gone. Not to mention how long it takes to straighten things out at the end of the year.

Well, after years of financial consulting, I've discovered a way to avoid paying your bills: let an Apple® II Personal Computer pay them for you.

There are several advantages to letting an Apple handle your finances. It will save you time.

It will organize everything.

It will tell you, at a glance,

exactly what is going on with your money.

It will pay your bills, and never send you any.

And now, I'd like to turn the page over to those nice people at Apple, who will explain, in their own excruciating detail, just what I'm talking about."

The Apple II and the Home Budget.

With software programs like The Home Accountant™ and Dollars & Sense,™ the Apple II makes it easy to set up household books. First, it will ask you some questions about your home finances. Like how much money you bring in each month, how much rent you pay, and whether you owe money to credit card companies, mortgage

holders, or any other surly characters. Then, it will ask you to enter some of the bills you receive each month whose prices may vary:

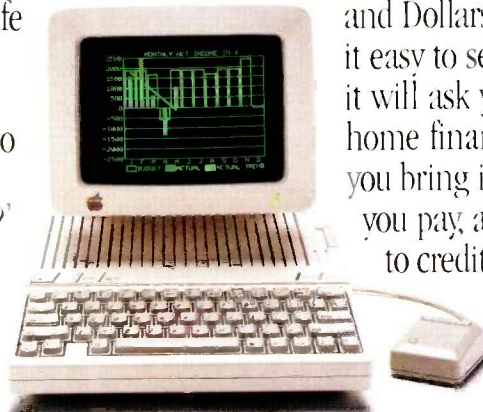

An Apple II will take care of everything from your household budget to your taxes with software programs like Dollars & Sense, The Home Accountant, and Tax Preparer.

phone, utilities, and the like. Then, it will ask you where you keep your money, and for the numbers of your various checking and savings accounts.

That's really all there is to it. After that, an Apple II can automatically write checks for all your fixed expenses each month. It will also tell you what other bills you can be expecting, and when you enter their costs, an Apple II will pay them, too.

An Apple II will see to it that your checkbooks remain balanced, and that you'll know when your expenses are about to exceed your income. It can even help you plan to buy a new car. Or a home.

Or a fur-lined boat, if your budget permits.

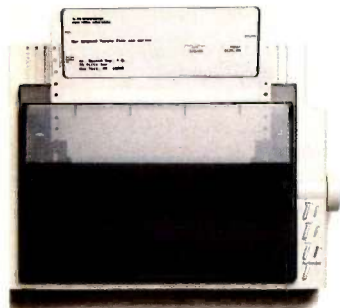

With our Scribe® color/graphics printer, you can automatically print out your own checks — not to mention reports, papers, almost anything, except money.

How to avoid your banker.

After the Apple II writes your checks, it can call your bank with the help of your telephone and an Apple modem. And faster than a teller can say "Next window,

please," you can find out all your balances, enter deposits, see what checks have cleared, transfer money from one account to another, and even pay off some of your credit cards and other bills electronically — without ever writing a check.

So the only time you'll have to go to the bank is when you want to visit with your money, personally.

Which, when done in moderation, we can recommend most highly.

The Apple II and making money.

An Apple II can do wondrous things for your personal finances. With several different software programs, you can become your own stockbroker. Again, by



It can manage your entire stock portfolio with programs like Dow Jones Investor's Workshop™ and Charles Schwab and Company's The Equalizer™. It can even show you what's going on in your bank account.



This is an Apple modem. Not much to look at, we admit, but it does let you pay bills and trade stocks by phone. It also connects your Apple II to a wealth of information services, like THE SOURCE™ and CompuServe®.

using an Apple modem, you'll gain instant access to financial news sources like *The Wall Street Journal*, *Barrons*, and the Dow Jones News/Retrieval® service. Find out what they've been saying on *Wall Street Week*. And in most cases, get up to the minute price quotes on over six thousand stocks, options, and other securities.

An Apple II lets you buy and sell securities right in your home or office, at the moment you want to make the trade. It automatically updates your portfolio and gives you detailed holding reports. It even produces charts and graphs, so you can quickly see how you and your investments are doing.

A little tax relief.

If you become perturbed everytime the subject of doing taxes comes up, an Apple II can do them for you with programs like Forecast™ and Tax Preparer™.

It can store your records, plan for the next year, and calculate your taxes.

You'll be alerted to payments you've made over the year that may be tax-deductible. It even keeps year-round records, automatically updating totals and making corrections for you. It will even print

out completed tax forms that the I.R.S. will accept.

And it can do about 10,000 other things totally unrelat-

ed to taxes or this ad. So there's no telling how far an Apple II can take you.

"Well, I think that about covers it. And what if, after all of this, you still have some money left over?"

Congratulations. You're doing a lot better than the government."



note to Dr. Greenspan's relatives: He says, "Don't get excited. This isn't my real bank account." © 1985 Apple Computer, Inc. Apple and the Apple logo are registered trademarks of Apple Computer, Inc. The Home Accountant is a trademark of Continental Software. Dollars & Sense and Forecast are trademarks of Monogram. Dow Jones News/Retrieval and Dow Jones Investor's Workshop are trademarks of Dow Jones and Company, Inc. Tax Preparer is a trademark of Howard Software Services. Scribe is a registered trademark licensed to Apple Computer, Inc. THE SOURCE is a service mark of Source Computing Corporation, a subsidiary of the Reader's Digest Association, Inc. CompuServe is a trademark of CompuServe Corporation, an H & R Block Company. The Equalizer and Equalizer are trademarks of Charles Schwab & Company, Inc. Spectran is a registered service mark of the Chase Manhattan Corporation. For an authorized Apple dealer near you call (800) 538-9696. In Canada, call (800) 268-7796 or (800) 268-7637.

C·O·N·T·E·N·T·S



106



232

FEATURES

- INTRODUCTION** 106
- INTERACTIVE AUDIO IN A VIDEODISC SYSTEM**
by John Lawler, Paul Hairsine, and Albert E. Miller 108
The tool described consists of a microcomputer, a touch-sensitive display, and an external audio box that's computer-controlled.
- CIARCIA'S CIRCUIT CELLAR: BUILD THE HOME RUN CONTROL SYSTEM, PART 3: THE SOFTWARE** by Steve Ciarcia 121
In this final part of his home-control system, Steve describes the software and demonstrates a schedule entry.
- SALT** by Samuel D. Fenster and Lincoln E. Ford 147
SALT is a reinvention of the threaded interpretive language in which assembly-language routines can be used in a single CALL statement from BASIC.
- THE SUM: AN AI COPROCESSOR** by Phillip Robinson 169
This coprocessor is intended for computers geared toward AI programming.
- INSIDE APPLETALK** by David Ushijima 185
Apple's new local-area network is designed to let Apple and non-Apple products communicate and share information and resources.
- THE EXPERT MECHANIC** by Michael Fichtelman 205
Expert systems needn't be esoteric or waste resources.
- SWITCH** by Werner F. Grunbaum 221
Use color and monochrome monitors simultaneously on your IBM PC.
- TWO'S-COMPLEMENT NUMBERS REVISITED** by Gary Bronson and Karl Lyon 228
A value box helps simplify the conversion of positive numbers from binary to decimal form.

THEMES

- INTRODUCTION** 232
- CHOOSING A PROGRAMMING LANGUAGE** by Gary Elfring 235
It's a three-step process.
- STRUCTURING BASIC** by Arthur Huston 243
Compensate for some of the language's shortcomings with a library of subroutines.
- SUBROUTINE LIBRARIES IN PASCAL** by Bruce Webster 253
The author presents a look at some of the facilities available for developing these libraries.
- USING DATA FLOW FOR APPLICATION DEVELOPMENT** by Wayne P. Stevens 267
This form of linkage results in functions that are easier to understand, develop, and maintain.
- DEBUGGING TECHNIQUES** by Gregg Williams 279
There are no magic formulas, but there are tools, and the most powerful one is your own brain.
- 6502 TRICKS AND TRAPS** by Joe Holt 295
A programmer offers tips for surviving 6502 assembly-language programming.
- SOFTWARE-ICS** by Lamar Ledbetter and Brad Cox 307
Productivity Products International offers a plan for building reusable software components.

REVIEWS

- INTRODUCTION** 320
- REVIEWER'S NOTEBOOK** by Glenn Hartwig 323

BYTE (ISSN 0360-5280) is published monthly with one extra issue per year by McGraw-Hill Inc. Founder: James H. McGraw (1860-1948). Executive, editorial, circulation, and advertising offices: 70 Main St., Peterborough, NH 03458, phone (603) 924-9281. Office hours: MON-THUR 8:30 AM - 4:30 PM, Friday 8:30 AM - 1:00 PM, Eastern Time. Address subscriptions to BYTE Subscriptions, POB 590, Martinsville, NJ 08836. Postmaster: send address changes, USPS Form 3579, undeliverable copies, and fulfillment questions to BYTE Subscriptions, POB 596, Martinsville, NJ 08836. Second-class postage paid at Peterborough, NH 03458 and additional mailing offices. Postage paid at Winnipeg, Manitoba. Registration number 9321. Subscriptions are \$21 for one year, \$38 for two years, and \$55 for three years in the USA and its possessions, in Canada and Mexico, \$23 for one year, \$42 for two years, \$61 for three years, \$69 for one year air delivery to Europe, 17,100 yen for one year surface delivery to Japan, \$37 surface delivery elsewhere. Air delivery to selected areas at additional rates upon request. Single copy price is \$3.50 in the USA and its possessions, \$3.95 in Canada and Mexico, \$4.50 in Europe, and \$5 elsewhere. Foreign subscriptions and sales should be remitted in United States funds drawn on a U.S. bank. Please allow six to eight weeks for delivery of first issue. Printed in the United States of America.

THE MINDSET PERSONAL COMPUTER by Tom Wadlow	324
A machine that works like an IBM PC but adds CAD/CAM-inspired graphics capabilities.	
IDEA PROCESSORS by William Hershey	337
Four packages for organizing text and thoughts.	
CONVENIENCE SOFTWARE by Mark J. Welch	353
A comparative review of pop-up programs.	
BUILDING EXPERT SYSTEMS WITH M.I by Bruce D'Ambrosio	371
A knowledge-engineering tool that's part software, part seminar.	
HEWLETT-PACKARD'S HP 7475A PLOTTER by Rich Malloy	379
A six-pen graphics machine.	
THE IBM QUIETWRITER PRINTER by Jon R. Edwards	385
A letter-quality printer that uses thermal-transfer technology.	
THE WORD PLUS by George Sheldon	393
Software that checks your spelling.	
REVIEW FEEDBACK	401
Readers respond to previous reviews.	



320

KERNEL

INTRODUCTION	406
COMPUTING AT CHAOS MANOR: FROM THE LIVING ROOM by Jerry Pournelle	409
Complete chaos at the Manor causes Jerry to escape to New York, but he still finds time to visit shows and look at new products.	
CHAOS MANOR MAIL conducted by Jerry Pournelle	435
Jerry's readers write, and he replies.	
BYTE U.K.: TELEPHONE COMPUTERS by Dick Pountain	439
The One Per Desk is a personal computer with built-in telephone hardware tightly integrated telecommunications software, and general-purpose desktop computer facilities.	
BYTE JAPAN: NEW NECs AND A CARTRIDGE DISK by William M. Raiké	451
Our Japan reporter tells about three new microcomputers from NEC, a cartridge hard-disk system from Tomas Electronics, and Japan's use of public video-display units as shoppers' directories.	
BYTE WEST COAST: A GEM SEMINAR by John Markoff and Phillip Robinson	455
Our West Coast correspondents report on DR's seminar to teach programmers to adapt their software to the GEM environment, and on MacNosy and advances in disk-controller technology.	
CIRCUIT CELLAR FEEDBACK conducted by Steve Ciarcia	461
Steve answers project-related queries from readers.	
BYTELINES conducted by Sol Libes	468
EDITORIAL:	
THE BYTE INFORMATION EXCHANGE	6
MICROBYTES	9
LETTERS	14
FIXES AND UPDATES	33
WHAT'S NEW	39, 470
ASK BYTE	48
CLUBS & NEWSLETTERS	58
BOOK REVIEWS	65
EVENT QUEUE	86
BOOKS RECEIVED	465
UNCLASSIFIED ADS	525
BYTE'S ONGOING MONITOR BOX:	
BOMB RESULTS	526
READER SERVICE	527



406

Address all editorial correspondence to the Editor, BYTE, POB 372, Hancock, NH 03449. Unacceptable manuscripts will be returned if accompanied by sufficient first-class postage. Not responsible for lost manuscripts or photos. Opinions expressed by the authors are not necessarily those of BYTE. Copyright © 1985 by McGraw-Hill Inc. All rights reserved. Trademark registered in the United States Patent and Trademark Office. Where necessary, permission is granted by the copyright owner for libraries and others registered with the Copyright Clearance Center (CCC) to photocopy any article herein for the flat fee of \$1.50 per copy of the article or any part thereof. Correspondence and payment should be sent directly to the CCC, 29 Congress St., Salem, MA 01970. Specify ISSN 0360-5280/85 \$1.50. Copying done for other than personal or internal reference use without the permission of McGraw-Hill Inc. is prohibited. Requests for special permission or bulk orders should be addressed to the publisher. BYTE is available in microform from University Microfilms International, 300 North Zeeb Rd., Dept. PR, Ann Arbor, MI 48106 or 18 Bedford Row, Dept. PR, London WC1R 4EJ, England. Subscription questions or problems should be addressed to: BYTE Subscriber Service, POB 328, Hancock, NH 03449.



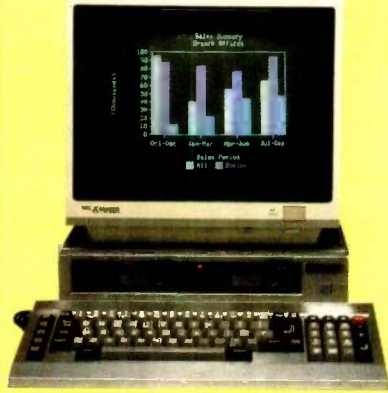

Can You Name Every Dual-Drive Color PC That Runs Lotus 1,2,3 and Costs Under \$1500?

Hints

- It comes with a 14" RGB monitor much like the 14" monitor that comes with the \$2495 Leading Edge PC.
- It has dual 800K disk drives much like the \$2495 Tandy 2000, but unlike the 2000 it will also read and write to 160K, 320K, and 360K IBM-PC formats.
- It's an 8088, MS-DOS system with 256K of RAM, but it comes with a better free software bundle than the 8-bit Kaypro including MS-DOS 2.11, HAGEN-DOS, DOS-TUTOR, WordStar 3.3, Easy Writer, Spell, Mail Track, PC File III, FILE-BASE, CalcStar, games, graphics, utilities, and two BASIC languages.
- Although it's not PC-DOS compatible it will run hundreds of the same programs as the IBM including dBASE II, Multiplan, the PFS series, Lotus 1,2,3 and even Flight Simulator.
- During the dog days of summer computer sales, we've lowered the prices of both our color and monochrome systems. You can receive a free booklet on these systems by calling our machine at 1-800-FOR A FOX, and leaving your name and address at the beep.

Your time is up the answer is:

Color Fox \$1497
also
Fox Jr. ... \$899 Silver Fox .. \$1297



Scottsdale Systems, Ltd
617 N. Scottsdale Rd. #D, Scottsdale, Az 85257
(602) 941-5856

The Silver Fox is sold exclusively by Scottsdale Systems Ltd., 617 N. Scottsdale Road #B, Scottsdale, AZ 85257. Trademarks: Silver Fox, HAGEN-DOS, and Datemate. Scottsdale Systems Ltd., WordStar and CalcStar, Micropro International, MS-DOS, and Multiplan, Microsoft Corporation, FILEBASE, EWDP Software, Inc., dBASE II, Ashton-Tate, IBM-PC, and IBM-PC DOS; International Business Machines Corporation. Ordering: Telemarketing only. Silver Fox price is for cash. F.O.B. Scottsdale, prices subject to change, product subject to limited supply. We accept purchase orders from Fortune 1000 companies and major universities with good credit - add 2% Visa, Mastercard add 3%. AZ residents add 6%. Returned merchandise subject to a 20% restocking fee. Personal or company checks take up to 3 weeks to clear. No COD's or APO's.

BYTE

EDITOR IN CHIEF

PHILIP LEMMONS

MANAGING EDITOR

GENE SMARTE

CONSULTING EDITORS

STEVE CIARCIA
JERRY POURNELLE
BRUCE WEBSTER

SENIOR TECHNICAL EDITORS

G. MICHAEL VOSE, *Themes*
GREGG WILLIAMS

TECHNICAL EDITORS

THOMAS R. CLUNE
JON R. EDWARDS
RICHARD GREHAN
GLENN HARTWIG, *Reviews*
KEN SHELDON
RICHARD S. SHUFORD
JANE MORRILL TAZELAAR
EVA WHITE
STANLEY WSZOLA
MARGARET COOK GURNEY, *Associate*
ALAN EASTON, *Drafting*

WEST COAST EDITORS

EZRA SHAPIRO, *Bureau Chief, San Francisco*
JOHN MARKOFF, *Senior Technical Editor, Palo Alto*
PHILLIP ROBINSON, *Senior Technical Editor, Palo Alto*
DONNA OSGOOD, *Associate Editor, San Francisco*
BRENDA MCLAUGHLIN, *Editorial Assistant, San Francisco*

NEW YORK EDITOR

RICHARD MALLOY, *Senior Technical Editor*

MANAGING EDITOR,

ELECTRONIC PUBLISHING AND COMMUNICATIONS

GEORGE BOND

USER NEWS EDITOR, EAST COAST

ANTHONY J. LOCKWOOD, *What's New*

USER NEWS EDITOR, WEST COAST

MARK WELCH, *Microbytes*

CONTRIBUTING EDITORS

MARK DAHMKE, *video, operating systems*
MARK HAAS, *at large*
RIK JADRNEK, *CAD, graphics, spreadsheets*
MARK KLEIN, *communications*
ALASTAIR J. W. MAYER, *software*
ALAN MILLER, *languages and engineering*
JOHN C. NASH, *scientific computing*
DICK POUNTAIN, *U.K.*
WILLIAM M. RAKE, *Japan*
PERRY SAIDMAN, *computers and law*
ROBERT STERNE, *computers and law*

COPY EDITORS

BUD SADLER, *Chief*
DENNIS BARKER
ELIZABETH COOPER
ANNE L. FISCHER
NANCY HAYES
LYNNE M. NADEAU
PAULA NOONAN
JOAN VIGNEAU ROY
WARREN WILLIAMSON

ASSISTANTS

PEGGY DUNHAM
MARTHA HICKS
BEVERLY JACKSON
LISA JO STEINER

ART

ROSSLYN A. FRICK, *Art Director*
NANCY RICE, *Assistant Art Director*

PRODUCTION

DAVID R. ANDERSON, *Production Director*
DENISE CHARTRAND
MICHAEL J. LONSKY
JAN MULLER

SENIOR VICE PRESIDENT PUBLISHER

HARRY L. BROWN

PUBLISHER'S ASSISTANT

DORIS R. GAMBLE

PERSONNEL

CHERYL HURD, *Office Manager*
PATRICIA BURKE, *Personnel Coordinator*

ADVERTISING SALES (603-924-6137)

J. PETER HUESTIS, *Sales Manager*

SANDRA FOSTER, *Administrative Assistant*

ADVERTISING/PRODUCTION (603-924-6448)

LISA WOZMAK, *Supervisor*
ROBERT D. HANNINGS, *Senior Account Manager*
MARION CARLSON
KAREN CILLEY
LYDA CLARK
MICHELE GILMORE
DENISE PROCTOR
WAI CHIU LI, *Quality Control Director*
JULIE NELSON, *Advertising/Production Coordinator*

CIRCULATION (800-258-5485)

GREGORY SPITZFADEN, *Director*
ANDREW JACKSON, *Subscriptions Manager*
CATHY A. RUTHERFORD, *Assistant Manager*
LAURIE SEAMANS, *Assistant Manager*
SUSAN BOYD
PHIL DECHERT
MARY EMERSON
LOUISE MENEUG
AGNES E. PERRY
JENNIFER PRICE
JAMES BINGHAM, *Single-Copy Sales Manager*
LINDA RUTH, *Assistant Manager*
CAROL AHO
CLAUDETTE CARSWELL
KAREN DESROCHES

MARKETING COMMUNICATIONS

HORACE T. HOWLAND, *Director (603-924-3424)*
VICKI REYNOLDS, *Marketing Production Manager*
PRISCILLA ARNOLD, *Marketing Assistant*
STEPHANIE WARNESKY, *Marketing Art Director*
SHARON PRICE, *Assistant Art Director*
DOUG WEBSTER, *Director of Public Relations (603-924-9027)*
WILBUR S. WATSON, *Operations Manager, Exhibits*

PLANNING AND DEVELOPMENT

MICHELE P. VERVILLE, *Manager*
PATRICIA AKERLEY, *Research Manager*
CYNTHIA DAMATO SANDS, *Reader Service Coordinator*
FAITH KLUNTZ, *Copyrights Coordinator*

MANUFACTURING/FINANCE/SERVICES

DANIEL RODRIGUES, *Director*

ACCOUNTING

KENNETH A. KING, *Assistant Controller*
VICKI WESTON, *Accounting Manager*
LINDA SHORT, *D/P Manager*
EDSON WARE, *Credit*
MARIE CAGGIANI

MARILYN HAIGH

DIANE HENRY

VERN ROCKWELL

JOANN WALTER

TYPOGRAPHY

SHERRY MCCARTHY, *Chief Typographer*

NAN FORNAL

LEN LORETTE

KATHY QUIST

DONNA SWEENEY

BUILDING SERVICES/TRAFFIC

ANTHONY BENNETT, *Building Services Manager*

BRIAN HIGGINS

MARK MONKTON

RECEPTIONISTS

L. RYAN MCCOMBS

CHERYL CASTRO, *Assistant*

Editorial and Business Office: 70 Main Street, Peterborough, New Hampshire 03458, (603) 924-9281.

West Coast Offices: McGraw-Hill, 425 Battery St., San Francisco, CA 94111, (415) 362-4600.

McGraw-Hill, 1000 Elwell Court, Palo Alto, CA 94303, (415) 964-0624

New York Office: 1221 Avenue of the Americas, New York, NY 10020, (212) 512-2000

Officers of McGraw-Hill Information Systems Company: President: Richard B. Miller, Executive Vice Presidents: Frederick P. Jannott, Construction Information Group; Russell C. White, Computers and Communications Information Group; J. Thomas Ryan, Marketing and International, Senior Vice Presidents: Francis A. Shinal, Controller; Robert C. Violette, Manufacturing and Technology; Senior Vice Presidents and Publishers: Harry L. Brown, Computers and Communications; David J. McGrath, Construction; Group Vice President, Peter B. McCuen, Communications; Vice Presidents: Fred O. Jensen, Planning and Development; Margaret L. Dagner, Human Resources.

Officers of McGraw-Hill, Inc.: Harold W. McGraw, Jr., Chairman; Joseph L. Dionne, President and Chief Executive Officer; Robert N. Landes, Executive Vice President and Secretary; Ralph J. Webb, Vice President and Treasurer; Donald L. Fruehling, Executive Vice President, Publishing Operations Group; Ralph R. Schultz, Senior Vice President, Editorial; Walter D. Serwatka, Senior Vice President, Manufacturing and Circulation Services; Vice Presidents: Shel F. Aseo, Manufacturing; George R. Eisinger, Circulation.

Give yourself a Giff.[™]



Now you can network IBM PCs with a powerful, multitasking, multiuser system.

Run popular MS-DOS[™] programs like Lotus[™] 1-2-3, SuperCalc[®] 3 and WordStar[™]. Plus all the thousands of CP/M[®] programs. Plus true multiuser accounting, database management, and electronic mail.

Gifford's MC-NET[™], running on our MC-186[™] and IBM compatible PCs, gives you all this capability and more. It lets you grow a network that shares information and resources among hundreds of people. With full security. Advanced telecommunications. And the ease of use of a standalone PC.

Get the whole story on Gifford hardware, software and service. Just call 415/895-0798 and ask for a Giff Pack[™]. Or write to us at 2446 Verna Court, San Leandro, CA 94577.

Give yourself the Giff that keeps on giving.

G **GIFFORD**
COMPUTER SYSTEMS
A subsidiary of Zitel Corporation
THE MULTIUSER COMPANY[™]

2446 Verna Court, San Leandro, CA 94577 415/895-0798 Telex 704521 2050 North Loop West, Suite 116 Houston, TX 77018 713/680-1944
In Europe: London (01) 878-9111 Telex 28106 (UK)

MC-NET and MC-186 are trademarks of Gifford Computer Systems. MS-DOS, CP/M, Lotus 1-2-3, SuperCalc 3 and WordStar are trademarks of MicroSoft, Digital Research, Lotus Development Corporation, Sorcim/IUS Micro Software, and MicroPro International respectively.

THE BYTE INFORMATION EXCHANGE

BYTE will soon become an interactive magazine by founding the BYTE Information Exchange (BIX). The goal of BIX is to set up ideal forums for exchanging information about computers and related topics. If even 1 percent of our circulation owns a specific kind of computer, that translates to several thousand people—enough to constitute a thriving user community.

Although a new product, BIX is also an extension of the BYTE magazine that you read each month. Through the BYTE Information Exchange, you'll be able to get your messages to Steve Ciarcia and Jerry Pournelle more quickly. You'll be able to download program listings from BYTE articles for noncommercial use. In time, you'll find in BIX more product announcements and scheduled events than we're able to print on paper in BYTE's What's New and Event Queue.

BIX has all the functions of an electronic bulletin board but also provides true computer conferencing. "Computer conferencing" fails to express the kind and quality of person-to-person communication that this technology fosters. Printouts of conferences often read like the transcripts of lively face-to-face discussions, and you wish you had been there. You have to remind yourself that the "speakers" weren't "there" either—like you, they were using personal computers in their homes, offices, or hotel rooms and were transmitting messages at whatever hours they found convenient.

Because computer conferencing makes it possible to have a group discussion without gathering everyone in one place or at one time, it is the ideal way to tap distributed resources. BYTE's subscribers are a paradigm of distributed resources. Collectively you possess more information about personal computers and corresponding topics than any other group of people in the world. We think of you as a living database.

Through BIX, you can share not only the knowledge of other subscribers but also their thinking power. Terms like "distributed resources" and "living database" fall short of the real possibilities for infor-



mation exchange that mechanisms such as BIX can bring about.

HOW BIX MAKES BYTE "SUBSCRIBER-SPECIFIC"

Besides giving you a major new resource for information on computers, BIX will let us customize BYTE for you. How? Once you join a "conference"—just by typing join and the conference's name—you automatically receive all new comments from the conference each time you sign on. You can join all those conferences that meet your individual interests. Suppose you're interested in the Macintosh, FORTH, the 68020, computers in education, and robotics. You can join a conference on each of those topics. When you sign on, you'll find all the new comments on those topics waiting for you to read, and, if you wish, you can enter comments yourself, including queries. Another subscriber may be interested in IBM PCs, C, PC-DOS, XENIX, graphics, the 80286, and scientific computing. Neither of you will have to wade through the comments in topics that don't interest you. BIX will enable BYTE to cover your particular machine, but it will be much better than "machine-specific." Through BIX, BYTE will serve each subscriber's needs.

We will set up conferences and sub-conferences on any topic of legitimate interest in personal computing and related fields. We'll start with conferences on different computers, programming languages, chips, and operating systems, as well as such topics as graphics, artificial intelligence, and telecommunications.

SOFTWARE AND SIGN-UP

The BYTE Information Exchange is based

on CoSy (for conferencing system). CoSy is a powerful and friendly piece of conferencing software developed by friends of ours at the University of Guelph in Ontario. After you first sign on and register, you can see the major groups of conferences by typing show groups. You can see a list of all the conferences by typing show all. If you want to participate in a conference not listed, send a note to the editors proposing the conference. We'll find the right place for the new conference in the BIX structure and let everyone know where to find it. Once you sign up for BIX, we'll send you the BIX user's manual, which has one of Robert Tinney's best covers ever.

CHARTER SUBSCRIPTIONS

Charter subscribers—people who join BIX before January 1, 1986—will receive special low rates. The introductory sign-up fee is \$25. If you call through our own communications nodes, you pay evening and weekend charges of \$6 per hour of connect time, whether for 300 or 1200 bps. Charter subscribers calling through Tymnet will pay the same \$25 sign-up fee plus evening charges of \$8 per hour. During the day, our direct rate will be \$18 per hour and our Tymnet rate \$24 per hour.

In the beginning, there will be direct BIX numbers in four cities: San Francisco, Los Angeles, Chicago, and Boston. You'll be receiving the direct BIX numbers and other information either here in the magazine or through direct mail. The information will include instructions for signing up, which you can do either on line or through the mail. Billing will be through Visa and MasterCard.

Readers who use our free bulletin board to download program listings should rest assured that it will remain available. BIX users will be able to download program listings using either Kermit or XMODEM protocol.

We're excited about the prospect of on-line interaction with subscribers. It should enable us to do a better job of meeting your needs and should make a stronger community of us all. We hope to meet you on line soon.

—Phil Lemmons, Editor in Chief



Maxell Gold.

The floppy disk
that helps IBM® PC AT™
spell it out,
keeps Data General
specific,
and suits AT&T to a T.

Tailored to surpass your most demanding specifications. Maxell. The Gold Standard in floppy disks. From high density floppys for PC AT (ours was the first commercially available) to standard formats for virtually every computer made, Maxell leads the way. Each comes with a lifetime warranty. And each carries the name to make your next floppy disk purchase decision a solid triumph.

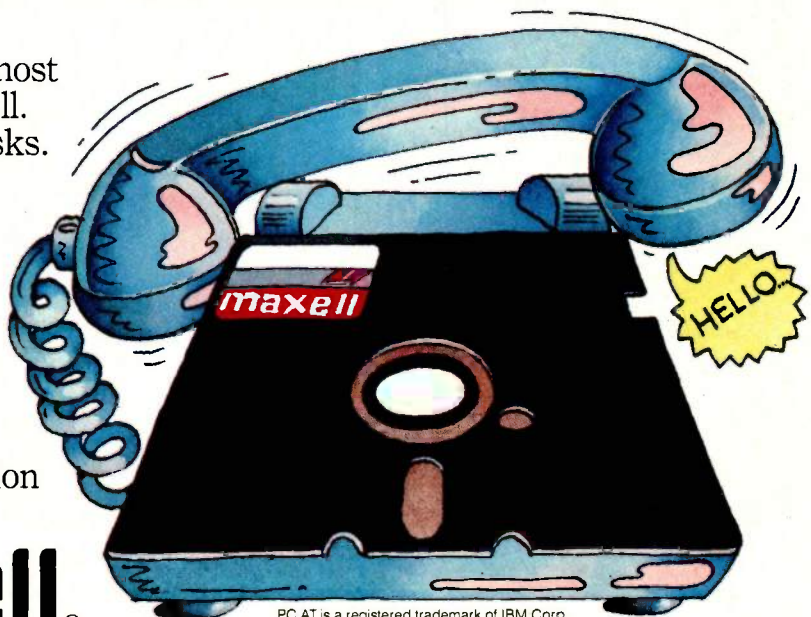

maxell®
IT'S WORTH IT.

PC AT is a registered trademark of IBM Corp.

Maxell Corporation of America, 60 Oxford Drive, Moonachie, N.J. 07074

Inquiry 266

JUNE 1985 • BYTE 7

YOUR DAYS OF BUYING TERMINALS ARE OVER!

Now there's SmarTerm terminal emulation software for your IBM* PC, XT, AT or compatible system. All SmarTerm products offer comprehensive and exact terminal emulation, powerful ASCII and binary file transfer facilities, and include TTY mode to link you to The Source, CompuServe, Dow Jones, Easylink, Tymnet or other popular services. We've included features such as multiple setup configurations, XMODEM and PDIP*

protocol support, "smart" softkeys, plus European DOS support.

NEW! SmarTerm 220 supports A-to-Z and other software which requires DEC* VT220 terminals. It includes the full capabilities of **SmarTerm 100**: DEC VT102, VT100, and VT52 emulation. If you need VT125 ReGIS graphics support, choose **SmarTerm 125**. For Data General Dasher* D400, D200 or D100 emulation you need **SmarTerm 400**.

More than 20,000 smart "cookies" are already using SmarTerm. Try it for 30 days with full refund privileges.

Persoft, Inc., 2740 Ski Lane
Madison, WI 53713
(608) 273-6000 - TELEX 759491



AFTER SMARTERM®, WHAT DO YOU DO WITH YOUR OBSOLETE TERMINAL?

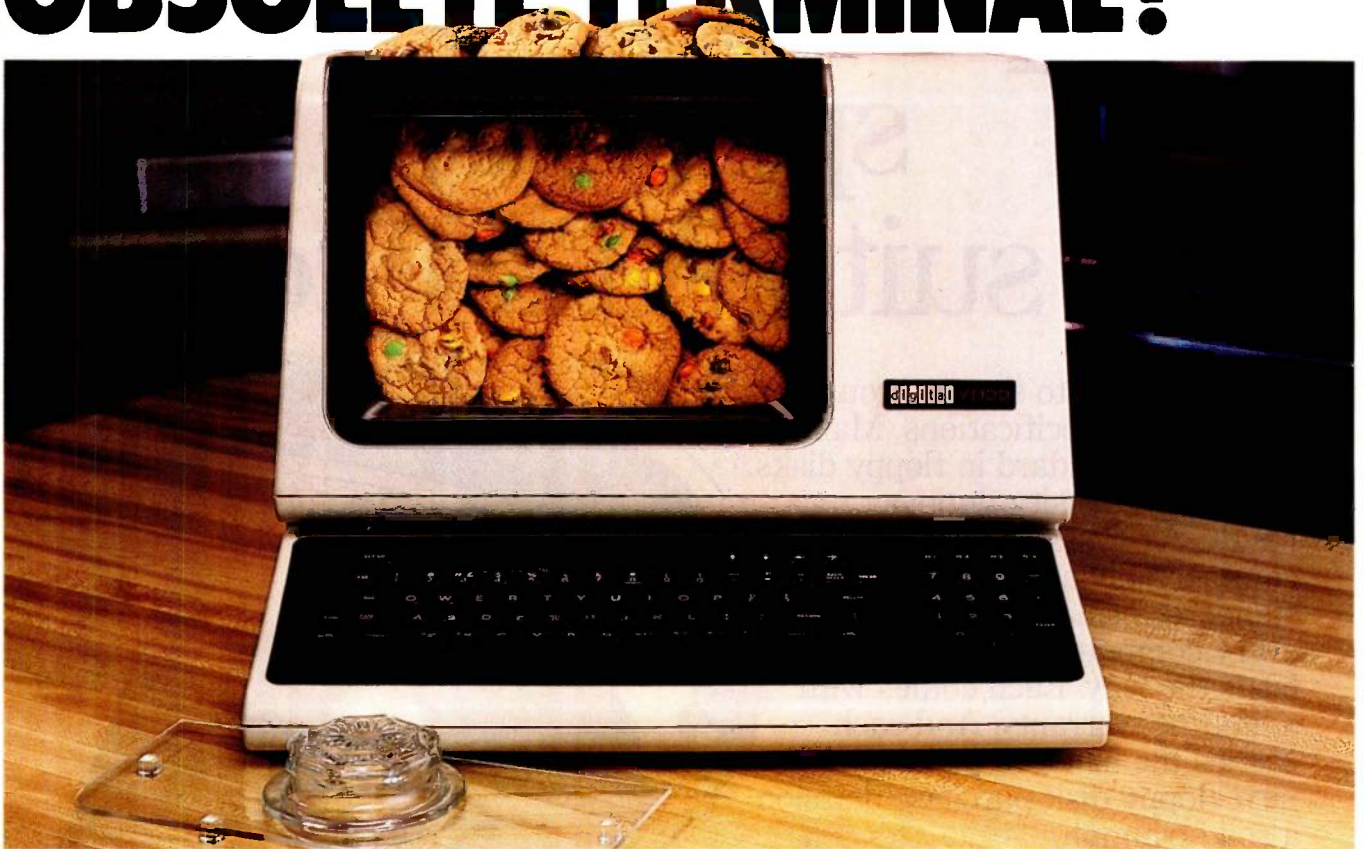

IDEA CREDIT: Hank Cramer of Campbell, California See your name in print! The best ideas for uses of obsolete terminals replaced by SmarTerm will be used in future ads. Write Persoft, Dept. COOKIE., 2740 Ski Lane, Madison, WI 53713.

*SMARTERM and PDIP are trademarks of Persoft, Inc. * IBM is a registered trademark of International Business Machines Corp. * DEC, VT and ReGIS are trademarks of Digital Equipment Corp. * DASHER is a registered trademark of Data General Corp.

persoft
Inquiry 326

M·I·C·R·O·B·Y·T·E·S

Staff-written highlights of late developments in the microcomputer industry.

Complex High-End Chips Hit Snags

Problems in debugging complex microprocessor chips have caused new problems at Zilog and Intel. Zilog admitted that sampling of its Z80000 32-bit processor, announced in the summer of 1983, has been delayed until early 1986. Zilog had originally planned to start shipping the Z80000 in late 1984.

A newly discovered bug in Intel's newest 80286 processor reportedly has delayed Digital Research's work on the Concurrent 286 operating system. The bug, which Intel says was undetected until the third version of the 80286, apparently affects software in the chip's "protected" mode, used in multitasking and multiuser applications.

Intel has also stopped all manufacturing, marketing, and support activities for its 432 microprocessor. The 432 was Intel's first 32-bit chip set, but it was never used in any large-volume computers. Intel is reportedly working on two other 32-bit chip designs, including the Intel 80386, which will be compatible with its 80286 and earlier designs. Intel will begin shipping samples of the 80386 late this year.

Lotus, Intel Agree on 8-megabyte Memory Standard for IBM PC

Lotus and Intel have announced an expanded-memory specification for addressing memory above the IBM PC's 640K-byte limit and the PC AT's 3-megabyte limit. New versions of Lotus 1-2-3 and Symphony and Ashton-Tate's Framework will be able to directly address up to 4 megabytes of memory.

Intel's new Personal Computer Enhancement Operation division announced the first expansion cards that address and also go beyond the specification. Each of Intel's Above Board expansion cards adds up to 2 megabytes of RAM to the IBM PC and 4 megabytes to the IBM PC AT. The Above Board/PC card, with 64K bytes already installed, is \$395; the Above Board/AT card will be available next month for \$595 with 128K bytes installed.

New Computers Unveiled at COMDEX

Several companies had plans to introduce computers in May. Compaq announced 80286-based IBM PC AT-compatible versions of its Portable and DeskPro computers late in April. Both machines feature 6- or 8-MHz clocks and 256K bytes of RAM. The Portable can handle 640K bytes of RAM on its main board, while the DeskPro can be equipped with 2.2 megabytes. Additional boards provide the former with 2.6 megabytes of RAM and the latter with 8.2 megabytes. The Portable's storage configurations range from single or dual 360K-byte or 1.2-megabyte floppy-disk drives with a 20-megabyte Winchester drive to a unit with a single floppy-disk drive and a hard-disk drive with a fixed-disk backup. The DeskPro is offered with the same floppy-disk storage arrangements and hard-disk capacities ranging from 20 to 70 megabytes. Pricing will be competitive with the PC AT.

TeleVideo unveiled a computer designed to outperform the IBM PC AT. The system uses an 8-MHz 80286 processor instead of the 6-MHz version used in the AT and reportedly also has faster disk access. The system features four unoccupied AT-compatible expansion slots and two XT-compatible slots, serial and parallel ports, a 1.2-megabyte 5¼-inch disk drive, and an optional 20-megabyte hard disk. TeleVideo said pricing for the system, including MS-DOS 3.1, would be about 15 percent less than prices for comparable IBM products. TeleVideo will also sell a high-resolution 640- by 400-pixel graphics card and monitor for the computer.

Zenith Data Systems was to unveil the Z-171 and Z-138, two IBM PC-compatible portable computers. The Z-171 is a battery-powered 17-pound portable based on Morrow's redesigned Pivot computer. With a backlit 80-character by 25-line liquid-crystal display, two 5¼-inch disk drives, and 256K bytes of memory, the Z-171 retails for \$2699. The Z-138 is a 25-pound transportable computer with one expansion slot and color graphics capabilities. With one 5¼-inch disk drive and 128K bytes, it will sell for \$2199; with 256K bytes and two

(continued)

drives, it's \$2499. Zenith also planned to unveil three new flat-screen monochrome monitors.

Leading Edge Products hoped to reduce supply problems resulting from its dispute with supplier Mitsubishi by offering a new system manufactured by Daewoo of South Korea. The new machine will offer a smaller footprint than its earlier computer. Pricing will range from \$1495 for a two-drive 256K-byte system with a monochrome monitor to \$2695 with a 10-megabyte hard disk and an RGB monitor.

Columbia Data Products introduced a multiuser system based on its IBM PC-compatible MPC Models 4750 and 4950. Each workstation includes a processor card with an 8-MHz 8088, 256K bytes of RAM (expandable to 768K), and a serial port; the workstation itself features a parallel port and connectors for a color or monochrome monitor. Workstations are connected to the computer via four- or six-wire twisted-pair cables. Up to four \$1200 workstations can be added to a standard MPC. Theoretically, up to 31 workstations could be added using optional expansion chassis. Columbia's system uses software licensed from Alloy Computer Systems, which also sells hardware and software allowing multiuser access to the IBM PC.

New Laser-Class Printers

Data Recording Systems Inc., Melville, NY, announced the LaserScribe/8415 laser printer, available to other manufacturers in versions with print resolutions of 600, 800, and 1000 dots per inch at speeds from three to eight pages per minute. Retail products based on the 8415 will probably be priced well above \$30,000.

Casio announced the LCS-2400 "electro-photographic" printer, using liquid-crystal shutter technology. The LCS-2400 prints up to nine pages per minute at a resolution of about 240 dots per inch. Casio was unsure of U.S. pricing but said the printer currently sells for about \$1600 in Japan. In the U.S., it will be available only to other manufacturers.

Products Will Aid Visually Disabled Computer Users

Computer Aids, Fort Wayne, IN, introduced several microcomputer products for the disabled. One product, Small-Talk, uses a modified Epson HX-20 and a speech synthesizer to allow blind users to perform word-processing tasks. With a printer, microcassette tape drive, and special word-processing software, the computer will cost about \$2000.

NANOBYTES

Advanced Micro Devices unveiled several new products, including a 1-megabit EPROM, a bit-mapped color graphics chip, and a data-compression and -expansion chip. AMD also hopes to begin sampling both 1200- and 2400-bps single-chip modems late this year. . . .

Alpha Software added its name to the list of manufacturers of keyboard-enhancement programs with its new \$90 Keyworks. . . . **Microsoft** unveiled Microsoft Access, a \$250 communications program. . . . **Hayes Microcomputer Products** announced the Transet 1000, an intelligent printer/communications buffer/port expander. The \$399 unit includes a 68008 processor and 128K bytes of memory. . . . In response to customer complaints about copy protection, several companies are dropping software protection or are offering unprotected versions at a higher price. **MicroPro** and **Stoneware** dropped copy protection from their newest IBM PC products. **MaxThink** offers an unprotected version of MaxThink for \$60 extra, following the earlier example of **Borland International**. . . . **Scenic Computer Systems Corp.**, Redmond, WA, has introduced a text-composition system that prepares text for laser printers using an IBM PC. Scenic Writer for the Hewlett-Packard LaserJet is \$995. . . . **Interstate Voice Products**, Orange, CA, announced a connected-speech recognition system for the IBM PC. A vocabulary of 15 to 20 words can be recognized in continuous speech, while an additional 240 words are recognized when pronounced with silence between words. The \$1650 card includes an 80186 processor and 128K bytes of RAM. . . . **Beaman Porter**, Harrison, NY, has unveiled PowerText Formatter, a \$50 program that allows users of most popular word processors to print documents in a two-column format with footnotes. . . . **IBM** introduced PC Storyboard, a slide-show graphics package that can reside as a background task and can be used to "capture" screen graphics from other programs. The \$250 program can then be used to enhance the graphs and display them in a slide-show-like sequence. . . . **Manhattan Graphics Corp.** has unveiled a \$125 page-design program for Apple's 512K-byte Macintosh. Users of ReadySetGo can resize and rearrange blocks of text and graphics on a page for newsletters or other documents.

Both letter-quality and draft hard copy

Fastest document throughput in its class

Both friction and tractor paper feed

Industry standard serial and parallel interfaces

Better, more versatile operator controls

TI reliability

Compatibility with third-party and proprietary software

Better, more durable easy-access font modules

The TI 855 microprinter. No other printer says better so many ways.

ure for feature, no other microprinter match the versatility, compatibility, ability and productivity of the TI 800* Model 855 microprinter.

Why? **Printers In One.** With the TI 855 you get the speed of dot matrix draft plus the precise clarity of the most advanced matrix technology for letter-quality print. It's two printers in one — at one price.

Family Name. Texas Instruments is known for providing the world's industry standard for printers — and TI builds the same reliability into the 800 series microprinter. Both share the data processing Model 800 of the expanding TI line of high-performance, low-cost microprinters.

Hardware Compatible. The TI 855 microprinter is compatible with all major PC hardware. And it provides both serial RS232C subset and "Centronics-type" parallel as standard interfaces.

Software Compatible. The TI 855 uses industry standard escape sequences for compatibility with virtually all third-party software. And for those with proprietary software needs, a model is available with ANSI standard escape sequences.

Tough Font Modules For Quick Character Change. Three font modules can be inserted into the front of the printer at one time, and are accessed individually. Each contains both draft- and letter-quality character sets. They're easier to use, more reliable and more durable than traditional metal or plastic daisy wheels.

More Productivity Than Any Other Microprinter. The 855 offers both friction and tractor paper feed, to handle all types of word and data processing applications. A quick-change snap-in cartridge ribbon. Raster and mosaic graphics. And intelligent printing which maximizes document throughput — regardless of format.

Get the printer that makes for better information systems. For more information visit your nearest TI authorized dealer or write Texas Instruments Incorporated, P.O. Box 402430, Dept. DPF-082BY, Dallas, TX 75380-9063. Or call toll-free: 1-800-527-3500.



TEXAS INSTRUMENTS

Creating useful products and services for you.

COMBINE POWER AND ENHANCE YOUR PC-AT

Quadram introduces the smart way to enhance your IBM PC-AT. Quadmeg-AT and Quadport-AT. Smart because Quadmeg-AT and Quadport-AT make the most of your AT system today and expand to meet your system's growing needs in the future.

Quadmeg-AT comes socketed for memory expansion from 128K to 2 Megabytes. Harness this power to create megabyte-sized RAM drives, access

QUADMEG-AT™

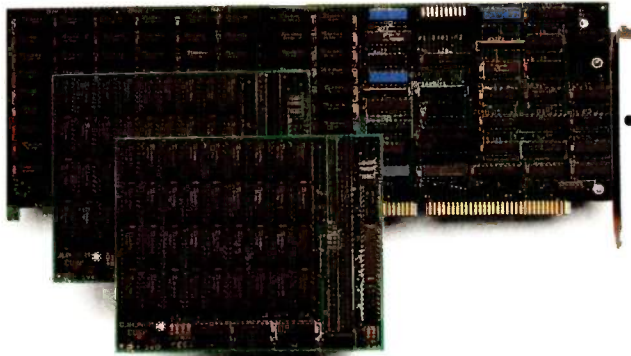

greater amounts of information, and process data faster and more efficiently than ever before. Plus, with "split memory mapping," Quadmeg-AT lets you expand the AT's base system memory to 640K without buying a space-wasting 128K card.

Advance to 4 Megabytes

When you need more than 2Mbytes, Quadmeg-AT adapts with two Quadmeg-AT Expansion Cards. Each packs 512K or 1Mbyte extra RAM.

Both cards filled give Quadmeg-AT a powerful 4Mbyte capacity. Quadmeg-AT delivers the power you need to take full advantage of the AT's capabilities.

Maximum Performance in Minimum Space

Quadmeg-AT and Quadport-AT fit snugly side by side to deliver a powerful 4Mb RAM and multiple I/O expansion in just two AT expansion slots.

Add a Second Quadport

Two Quadport-ATs give your AT system a total of 2 parallel ports and 10 serial ports. Add peripheral devices or workstations for the ultimate in PC-AT performance.

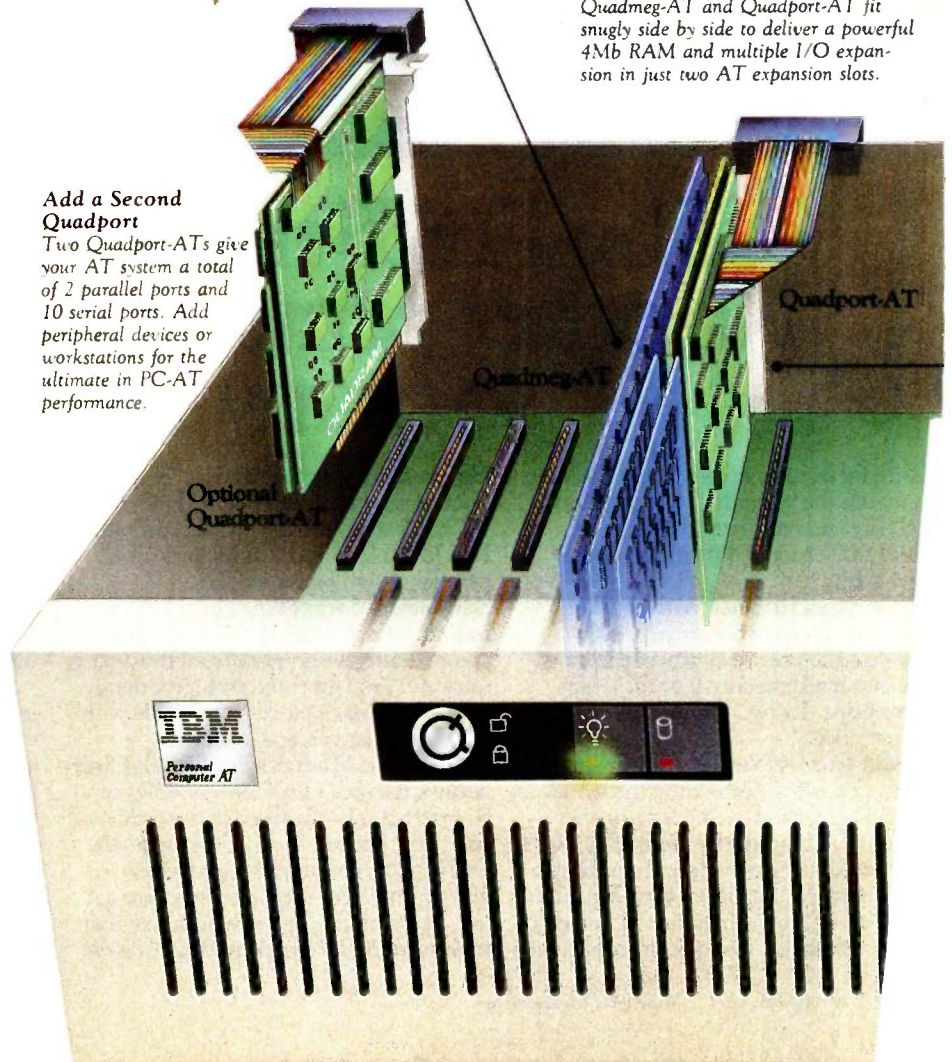

Look for this seal. It's the mark of dependability and performance from the leader in microcomputer enhancements.

IBM PC-AT is a registered trademark of International Business Machines Corporation.

EXPANDABILITY TO THE SMART WAY.

QUADPORT-AT™

Quadport-AT combines a parallel printer port and a serial port to give your AT the features found on IBM's Serial/Parallel Adapter. But at a lower cost and with

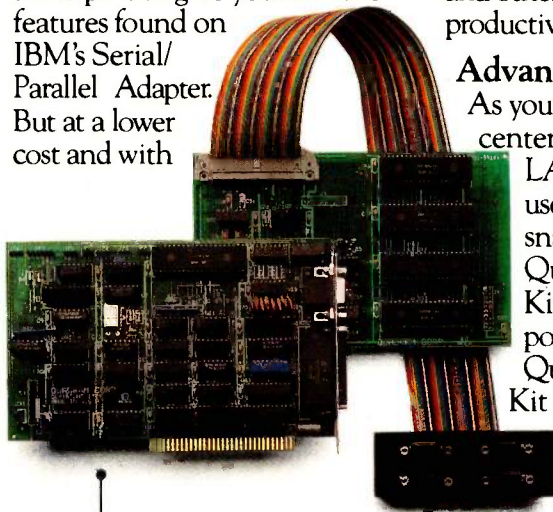

built-in expandability. Connect printers, plotters, modems, and other devices for increased productivity.

Advanced Port Expansion

As your AT becomes the center of a high-performance LAN or growing multi-user, multi-tasking system, snap on the optional Quadport-AT Expansion Kit and add 4 more serial ports to your system. The Quadport-AT Expansion Kit comes with software to access these ports, making it easy to add shared peripherals or workstations.

Enhance the smart way with Quadram.

For basic AT expansion, Quadmeg-AT and Quadport-AT work together to provide 128K memory expansion, a serial port, and a parallel port.

Then, as your system grows, Quadmeg-AT and Quadport-AT give you up to 4MB RAM, 1 parallel port, and up to 5 serial ports in just two PC AT expansion slots. Only Quadram combines so much power and expandability. That's PC AT enhancement the smart way.

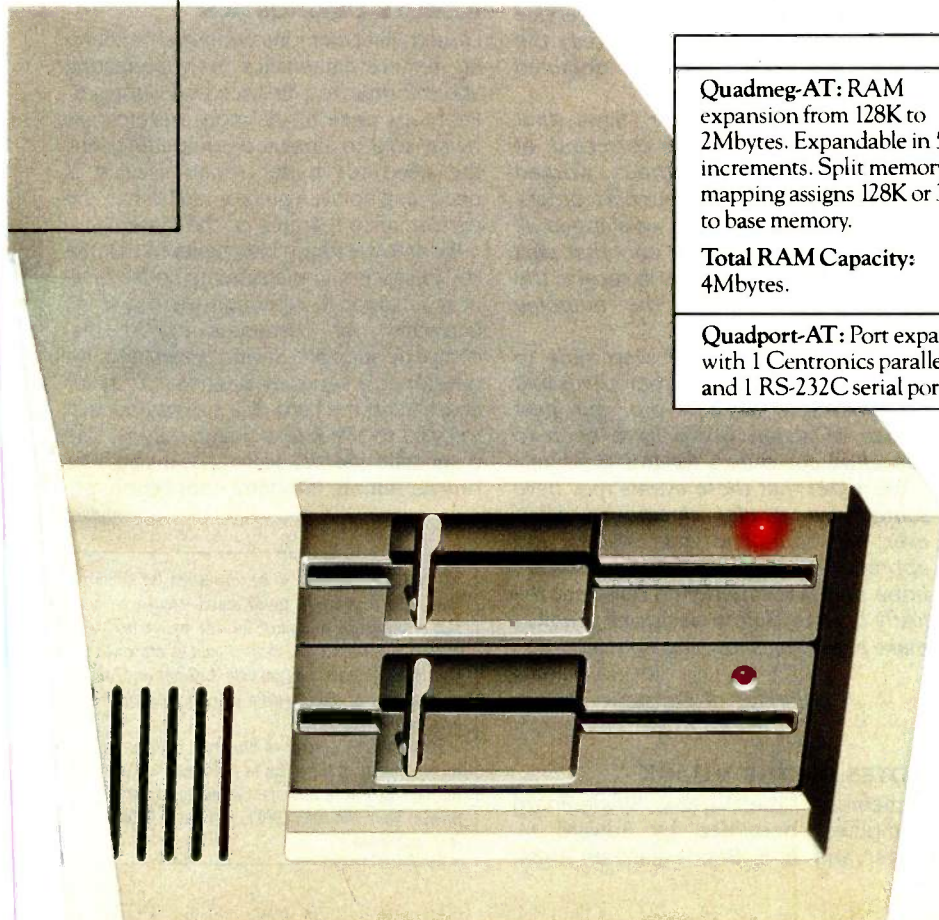

Features	
<p>Quadmeg-AT: RAM expansion from 128K to 2Mbytes. Expandable in 512K increments. Split memory mapping assigns 128K or 384K to base memory.</p> <p>Total RAM Capacity: 4Mbytes.</p>	<p>Expansion Cards: Two cards available. Each comes with 512K or 1Mbyte RAM installed.</p> <p>QuadMaster-AT Software: RAM Drives and Spooling for extended memory.</p>
<p>Quadport-AT: Port expansion with 1 Centronics parallel port and 1 RS-232C serial port.</p>	<p>Quadport-AT Expansion Kit: (optional) 4 RS-232C serial ports. Software to access ports.</p>

For a free demonstration visit the Quadram dealer nearest you. Or, for information, write us at 4355 International Blvd., Norcross, Georgia 30093 (404) 923-6666.



Inquiry 344

L·E·T·T·E·R·S

VOTES FOR PROGRAMMING INSIGHTS

This is a complaint. It is no service to your readers to bury very useful articles under "Programming Insight" at the bottom of your table of contents. "Simultaneous Equations with Lotus 1-2-3" by Jan-Henrik Johansson (February, page 399) was the most interesting article in that issue.

You might justify your position by saying that such articles never get mentioned in the BOMB (BYTE's Ongoing Monitor Box). I agree. But the reason is that you exclude them from the ballot! So here's a vote for Johansson—the only way I can do it.

N. C. WEBB, M.D.
Lincoln, MA

Gene Smarte replies:

Thank you for your vote. It will be included in our tabulation. As of May, we are adding all the Programming Insights, Application Notes, and other brief articles that appear at the back of the book to the table of contents and the BOMB.

MAIL-ORDER DELAYS

Regarding Phil Lemmons's editorial "Service and Support" (February, page 6), I have purchased various computer systems and components via mail order, and I have not had any problems except with Priority One Electronics in Chatsworth, California.

Priority One has been sitting on \$300 of mine since August 1984. Several phone calls resulted only in assurances that my parts would be mailed "Real Soon Now." That was several months ago. I have never been informed that there would be any delay in delivery of my order.

Priority One Electronics continues to advertise and take orders for the same parts that I have yet to receive!

BOB HARRINGTON
Duquesne, PA

Priority One Electronics replies:

First, allow us to apologize for the delays associated with your order. On August 30, the day after we received your order, we shipped the items that were available. But for Prometheus Products' inability to deliver the balance of your

order, the order would have been shipped complete.

As a rule, we advertise only those items we have in stock or for which we have received a firm commitment from the manufacturer that the product will be available by the time our advertisement is published. Our decision to advertise Prometheus's products was based on that company's promise of delivery.

Due to production problems, Prometheus was unable to deliver the options processor and display you ordered as it had promised us some three months earlier. Because we had received numerous broken promises from Prometheus that the processors and displays would ship "any day," we were hesitant to launch a major campaign to notify our customers of a shipping date and instead concentrated our efforts on pressuring Prometheus into expediting our order. When you contacted our customer-service group, we could relay to you only the limited information we had obtained from Prometheus.

Finally, after whatever flaws that delayed production were corrected, at our insistence, Prometheus worked through a weekend to fill our back orders. We are proud to say that we shipped all our customers' orders in only that part of a day that it took for us to receive the product and package the outgoing orders.

We are happy that we were able to complete your order. If Prometheus had not delivered when it did, our next course of action would have been to cancel all our orders for this product.

We regret that these events may have soured your taste for our company. However, we understand your position and appreciate your feelings. It is our sincere hope that this experience does not unjustly bias any future decisions you may make regarding shopping via mail order.

JOHN C. GUNN
Director of Consumer Affairs
Priority One Electronics

NOTES ON THE VU68K

Remember "The VU68K Single-Board Computer" described by Edward M. Carter and A. B. Bonds (January 1984,

page 403)? Well, I finally completed it and found it to be an excellent vehicle to learn about the marvels of the 68000 with little expense. BYTE and the authors are to be commended for the article as there are still readers who want to learn about microcomputers from the ground up.

Here are a few suggestions for others who may be having problems with the project. The address lines A21 and A22 are incorrectly connected to the terminal ACIA (IC11) in the wiring diagram and should be reversed. I tied BR, BGACK, and BERR high although it may not be necessary. Lastly, the monitor program (VUBUG) as I received it was assembled with a one-pass assembler, and therefore all forward references must be resolved before you can use it.

WALTER R. CURTICE
Princeton Junction, NJ

REMOTE DIAGNOSTICS

I found Phil Lemmons's editorial concerning remote diagnostics both interesting and informative ("Service and Support," February, page 6). As more systems are being sold to first-time computer users, the need for better repair service is becoming an even greater factor than the performance features of the system.

We at RACET have long believed that the key to success in the systems-house business is support. Although we're a small company, our customers expect big-company support. Several years ago, we developed a series of diagnostic tests for checkout of the hard-disk subsystems that we sold to the Radio Shack market. The diagnostic was set up so that it could be run via remote (modem) connection, en-

(continued)

LETTERS POLICY: To be considered for publication, a letter must be typed double-spaced on one side of the paper and must include your name and address. Comments and ideas should be expressed as clearly and concisely as possible. Listings and tables may be printed along with a letter if they are short and legible.

Because BYTE receives hundreds of letters each month, not all of them can be published. Letters will not be returned to authors. Generally, it takes four months from the time BYTE receives a letter until it is published.

3 MINUTE BACKUP*!

FAST FILE-BY-FILE PROTECTION!

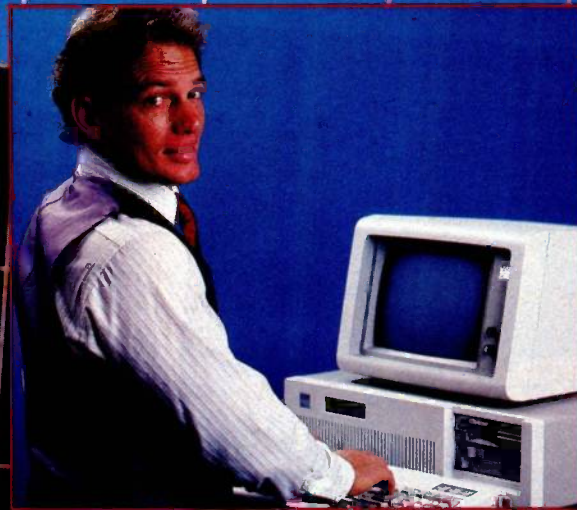
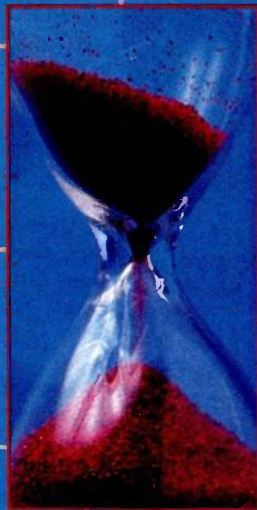

Maynard's new state-of-the-art tape backup system can back up the average 10MB hard drive in just 3 minutes! Protect select files or back up your entire hard drive with a simple command. Offers unmatched efficiency and comes with our industry-leading 1-year warranty.

The MaynStream™ is available in 20MB, 27MB, and 60MB, and as an internal unit for the AT. Compatible with IBM, Compaq, and NCR personal computers.†

*Actual time: 2 min/57 sec. Total files backed up: 376 consisting of 10,002,432 bytes. Computed on IBM-PC with 512K memory and one 10MB hard disk drive. Your actual back-up time may vary.

†IBM is a trademark of International Business Machines. Compaq is a trademark of Compaq Computer Corporation. NCR is a trademark of NCR Corporation.

MAYNSTREAM
TAPE BACKUP SYSTEM
BY MAYNARD ELECTRONICS

Maynard Electronics

Shaping Tomorrow's Technology

430 E. SEMORAN BLVD., CASSELBERRY, FL 32707
305/331-6402 Inquiry 268

If you're tired of waiting, you're using the wrong file manager.



Be fast. Btrieve.™

If batch jobs and reports turn waiting time to nighttime, then wake up! You're using the wrong file manager.

Btrieve™ file management hates waiting as much as you do. It's written in assembly language especially for the IBM PC. And based on b-tree file indexing, with automatic balancing for access speed that won't degrade as your database grows. With Btrieve, your applications always run fast. So you'll be out the door faster.

The standard for networking. Btrieve/N (network version) sets the standard for the industry's most popular LANs, including IBM's PC Network. Btrieve/N offers *safe* network file management that coordinates simultaneous updates and prevents lost data.

Automatic file recovery. Btrieve provides automatic file recovery after a

system crash. Your Btrieve data always comes back intact.

Fully-relational data management. SoftCraft's entire family of products gives you a complete, fully-relational database management system. Rtrieve™ adds report writing capabilities. Xtrieve™ speeds users through database queries with interactive menus.

For professional programmers. Btrieve is the fast, reliable answer for all your application development in BASIC, Pascal, COBOL, C, FORTRAN, and APL. With Btrieve, you can develop better applications faster. And know they'll run—*fast*.



P. O. Box #917 Austin, Texas 78766
(512) 346-8380 Telex 358 200

Suggested retail prices: Btrieve, \$245; Btrieve/N, \$595; Xtrieve, \$195; Xtrieve/N, \$395; Rtrieve, \$85; Rtrieve/N, \$175. Requires PC-DOS or MS-DOS 1.X, 2.X, or 3.X.

abling our support people to check out a reported problem without flying all over the country.

We have since migrated to the IBM PC market, where we offer hard-disk and tape subsystems capable of storing from 100 to 400 megabytes. Our remote-diagnostic program allows us to check out the disk, tape, and controllers and isolate down to the module level. We can then expedite the replacement module or component to the customer before a field technician is sent out. This procedure saves our customers time and money and improves the relationship with *their* customers.

For us, remote diagnostics has been standard practice for several years and we agree totally that the industry should follow suit.

THOMAS S. BERNARD
Vice President, Marketing and Sales
RACET Computes Ltd.
Orange, CA

ICONOCLASM AND THE MAC

Ann Marchant's letter on icons ("Icons Are Arcane," February, page 24) agrees with my own experience, but there's another example of their use that started 4990 years later than hers. We now see rabbits, turtles, and globs of oil used on farm-equipment instrument and control panels where we used to see plain English. The Dymo labeler solved most of the problem, but there were a couple of side effects. First, the suspicion farmers had that agricultural engineers were illiterate was reinforced. The second was more pertinent. Several of my former professors and classmates have worked on projects in the third world. They found that the locals' knowledge of English rarely extended to the fables of Aesop, and there was a problem if rabbits or turtles were not part of the local fauna. Training people who don't know how to drive a car to operate complex modern farm machinery is enough of a problem without having to interpret nonsensical symbols for them.

My own experience with the Macintosh was an exercise in frustration. I was looking for something better than my TRS-80 Model PC-2 pocket computer, and I got the chance to use a relative's Mac for two days. I ran a series of small benchmarks, and I could edit a program on the PC-2 far more quickly than I could on the Mac. The mouse is no substitute for a good set of cursor and function keys. I was so sure this turkey would never fly that I got a bit paranoid and wiped the Apple IIe and IIc off my shopping list as well. I bought a

(continued)

ProModem 1200... **HOT-LINE**

Our ProModem 1200 Makes Smart Modems Look Dumb

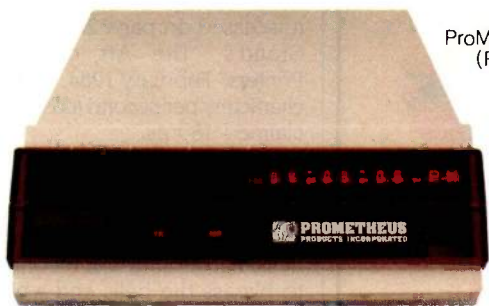

ProModem 1200
(RS-232)



ProModem 1200M
(Macintosh)

Send Or Receive 50 Pages Of Text Without Tying Up Your Computer

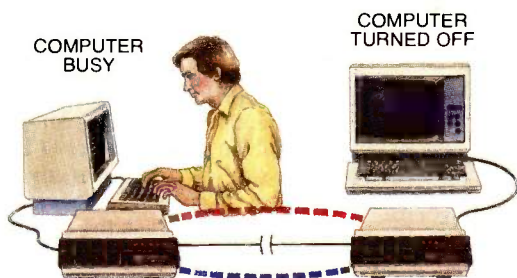

No wonder Smart Modems, Cats, and Maxwells cringe when compared to our \$495 ProModem 1200, an expandable 1200/300 baud modem for use with all personal computers. It costs less, but is smarter than the rest.

And when you add our \$99 Communications Buffer and Alphanumeric Display options, ProModem 1200 becomes a veritable genius!

Imagine, you unplug your computer, take it home for the weekend, and while you're gone, ProModem 1200 answers the phone, collects messages up to 50 pages long, sends out electronic mail, and displays all events with the exact time of each. Thanks to ProModem 1200, expensive, hard-to-use communications software isn't needed. The communications is in the modem, and electronic mail becomes a background function, where it belongs.

Simple To Install And Use

Our Communications Buffer is a 4 by 6 card that plugs into the ProModem 1200 motherboard. It comes with 2K of CMOS battery backed-up memory, expandable to 64K. Part of the memory is used as a dialing directory with the balance reserved for storage. For \$99 more, a front panel Alphanumeric Display can be added to show time, date, and 24 status and help messages. These two powerful options can be included at time of purchase, or can be added later.

Hayes Compatible

ProModem 1200 is Hayes compatible but that's where the resemblance ends. Our standard \$495 modem includes a real-time clock/calendar. Hayes charges hundreds more for a Smart Modem with a time-base. Nor do they have electronic mail capability at any price.



ProModem 1200 contains a battery backed-up real-time clock/calendar, a large dialing directory and can send or receive messages up to 50 pages long without tying up the computer.

Send for complete details and the name of the Prometheus dealer nearest you.



The Hot Line

PROMETHEUS
PRODUCTS INCORPORATED

4545 Cushing Pkwy. • Fremont CA 94538

Call Now For
Complete Info...
415/490-2370

RUN/C:TM The C Interpreter

Only \$149.95!

For both the beginner and the C professional, **RUN/C: The C Interpreter** makes program development easier and faster. With **RUN/C** all those C programs you've been writing — or have been wanting to write — can be up and running in a fraction of the time.

The beauty of **RUN/C** is that it provides a BASIC-like user interface for C; it allows the user to edit and debug code immediately and interactively.

RUN/C is the first program to make C a user-friendly language.

Although C is structured, compact and FAST, the writing and testing of C programs is often a tedious process. **RUN/C** helps bring up to speed both your programs and your C programming skills. C programming has never been so fast and enjoyable!

When running under **RUN/C**, your C program performs exactly as it would if it were compiled (although slower since **RUN/C** is a *true* interpreter). If your program does have an error, **RUN/C** finds it, gives you a comprehensive error message and allows you to correct the error on the spot. Once you are completely satisfied with your C program it can be **SAVEd**, then compiled and linked using your favorite C compiler.

RUN/C offers easy and familiar commands such as **LOAD**, **LIST**, **SAVE**, **RUN**, etc. A powerful line editor is built right in. **RUN/C's** **SHELL** command will also allow you to use your own editor for extensive full-screen editing, and then return your newly edited program to **RUN/C** — all within a single, unified environment.

RUN/C offers:

- A robust implementation of standard Kernighan and Ritchie C.
- Full floating point, 8087 math chip support, **structures**, **unions**, **initializers**, casts and more than 100 built-in standard C library functions.
- An easy-to-read 475-page manual filled with useful examples to help you master the C language.
- **TRON**, **TRACE** and **DUMP** diagnostics PLUS a program profiler.
- Printer and asynchronous communications support.
- A full set of buffered and unbuffered file I/O functions.
- Nearly 100 sample C programs on disk illustrating the most important C functions and concepts.
- System Requirements: IBM® PC or compatible with PC-DOS 2.0 or MS™-DOS 2.0

CALL for information on non-IBM compatible MS-DOS systems.

For immediate delivery or more information:

Call
1-800-847-7078
In NY, **1-212-860-0300**

Lifeboat™ Associates 1651 Third Ave. New York, NY 10128

RUN/C is a trademark of Age of Reason Co.



LETTERS

Tandy 1000 and like it so far, although it is still an immature system. The Text word processor of DeskMate, on which this letter is being written, is a lot nicer than MacWrite, Worksheet, Filer, and the BASIC have a few problems. The Radio Shack DWP-210 printer is a bit faster than advertised, running the 60-column Shannon test (discussed on page 207 of Sergio Mello-Grand's "The Art of Benchmarking Printers," February 1984, page 193) at 19.7 characters per second (cps) rather than the claimed 18 cps.

On further reflection, I think the Mac may find a niche in the educational and graphics markets, but it will never challenge the MS-DOS machines for the business market unless someone finds a way to bypass the bells and whistles.

JACK MONTEITH
Balcarres, Saskatchewan, Canada

THE ORIGIN OF Ø

In his review of the book *Alan Turing: The Enigma* (February, page 65), G. Michael Vose mentioned Turing's habit of writing zero as "l" as possibly the origin of the computer habit of writing zero as Ø to differentiate it from the letter O.

I own an ancient Model 17 Teletype that I am sure, judging by its condition, goes at least as far back as World War II, and it uses a "Ø." I think the convention goes back to telegraphers who had to clearly distinguish between the two as they hurriedly transcribed the clicking of the wires.

WILLIAM D. A. GEARY
Deer Park, NY

GPIB vs. HP-IB

I read Thomas R. Clune's article "Interfacing for Data Acquisition" (February, page 269) with great interest. I am involved with standards, both in the IEEE and HP, for devices that use the IEEE-488 bus. He has done a great service in describing the attributes of a communication medium that has eased the construction of instrument systems for years. I do, however, feel that a few points in the article need clarification.

Hewlett-Packard never uses GPIB in reference to any of its products. We always use HP-IB. Our lawyers say the hyphen is important because it protects the HP trademark.

I was a little confused by the way Clune differentiated between command and data modes. I have always thought of the command mode as involving setting up which device would talk and which would listen. Technically, sending messages to a

(continued)

4 Out Of 5 PC-AT™ Expansion Board Buyers Own Advantage!™

The overwhelming choice of IBM® PC-AT users, Advantage! from AST sets the standard in high-powered multifunction enhancement. Advantage! was the first multifunction board for the PC-AT. And it remains the leader by providing millions of characters of memory capacity, two serial ports, a parallel port and a game port. All in a single expansion slot.

First In Memory. All it takes is Advantage! There's no need to add other cards or hard-to-find chips on your system board. Whether you have an 256K, 512K or 640K AT, our unique memory addressing technique lets you add up to 3 Megabytes of parity checked user memory efficiently and economically. For flexibility, Advantage! can use either 64K or 256K memory chips. And of course, it supports your AT's high performance 16-bit bus and faster program processing speed.

Now you can have the extra memory to run integrated business software such as Symphony™ and

Framework™ To make full use of new concept windowing software such as DESQ™ To utilize multitasking programs such as IBM's TopView™ or multiuser operating systems such as XENIX™ To handle larger amounts of data, faster. Or for RAM disks.

First In I/O. Here's all the I/O capability you need now, even if you're starting with a base model AT. Every Advantage! card includes an AT compatible serial port and a parallel port so you can connect printers, plotters, mice and modems. Or with the appropriate software, you can connect other terminals to create multiuser environments.

With our optional second serial port you can attach even more peripherals, while our optional game port lets you plug in joysticks and other cursor-control devices for business or just for fun.

First In Quality. AST's reputation is built on quality products, quality support and quality service. Our complete documentation means Advantage! is exceptionally easy

to install and use, but if it's not enough we're always here to help.

Four out of five buyers agree, the choice is Advantage!—only from AST. Ask your dealer, or call our Customer Information Center (714) 863-1333 for more information. AST Research, Inc., 2121 Alton Avenue, Irvine, CA 92714 TWX: 753699ASTR UR

FEATURES

Memory Expansion

- 128Kb to 3.0Mb in a single slot
- User Upgradeable with either 64K or 256K memory chips
- Split Memory Addressing rounds out AT's system memory to 640K and continues memory expansion at 1Mb

I/O Expansion

- Up to 2 Serial Ports (1 optional)
- Parallel Printer Port
- Optional Game Port

**Advantage!
Supports AT's Full
Program Process-
ing Speed**

Advantage! trademark of AST Research, Inc. IBM PC-AT and TopView trademarks of International Business Machines Corp. Framework trademark of Ashton-Tate. Symphony trademark of Lotus Development Corp. DESQ trademark of Quarterdeck Office Systems. XENIX trademark of Microsoft Corp.

AST

RESEARCH INC.

Inquiry 4 for End-Users.
Inquiry 5 for DEALERS ONLY.



INTRODUCING 5

**WE INTERRUPT
PRODUCT
BRING**

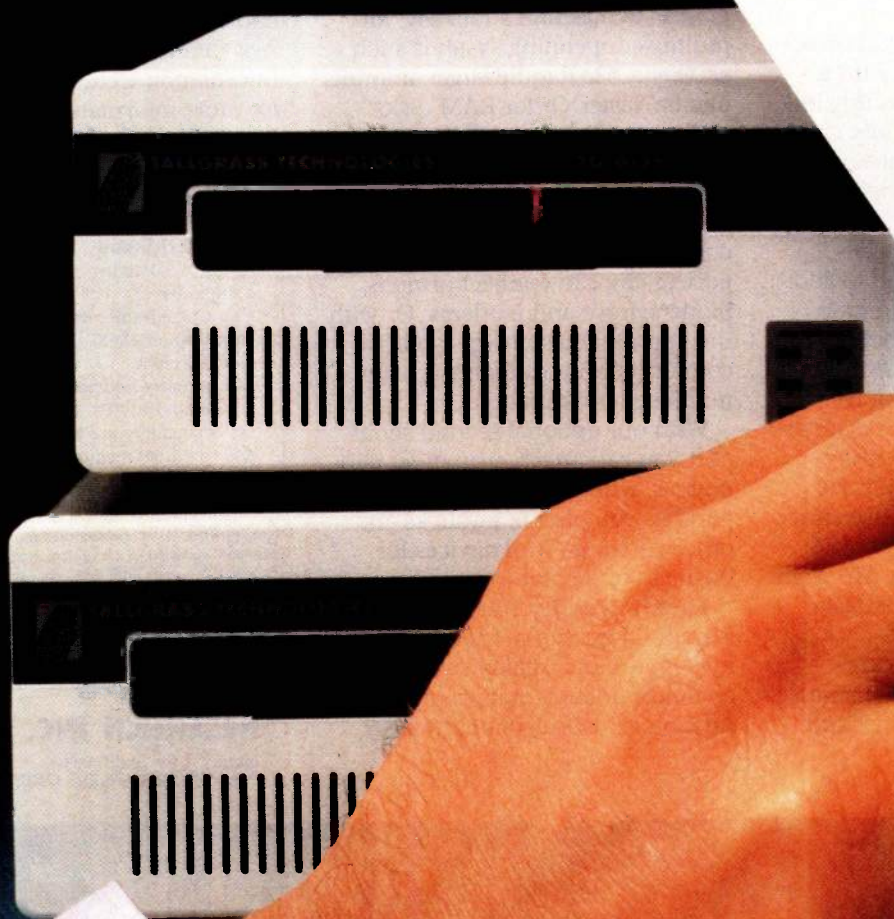

THIS MAJOR INTRODUCTION TO GIVES YOU SOMETHING REALLY IMPORTANT.

THE BIG NEWS IN DISK/TAPE IS PC/T, A SENSIBLE NEW APPROACH TO ARCHIVAL STORAGE.

We've tamed tape. And made it docile. By making it DOS-like.

So, while this started as an ad for our five new HardFile™ subsystems, which deliver 25 to 80 megabytes of hard disk storage and 60 megabytes of tape backup, instead we want to introduce you to PC/T.™

PC/T is a new format that makes tape a more sensible storage solution for personal computers. It puts tape on line, in real time, for instant access. And frees your hard disk for your most current data.

You already know how to use PC/T. Because it responds to standard DOS commands.

Here's the big news: just like any DOS-controlled hard or floppy disk, PC/T enables you to create directories and files on tape. Then you can call up the exact file you need, and change a portion of the tape without having to erase and overwrite the entire cartridge.

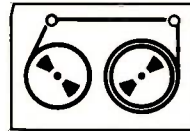

Without PC/T, you have to rewrite the entire 60 MB cartridge each time you make a single change.

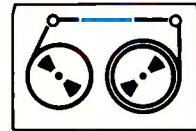

With PC/T, you create and directly access files on tape, just like with floppy or hard disk.

PC/T formats each new tape cartridge, just like you format any hard or floppy disk, locking out bad blocks to assure that every bit of data you write to tape is recorded with utter accuracy.

What's more, PC/T gives tape true error correction capability. 50% redundancy during write operations ensures 100% reconstruction of data lost because of operator error, dust and dirt, or everyday wear and tear.

There is a catch. You can get your hands on PC/T just one way: Buy one of our powerful new HardFile subsystems. With disk plus tape. Or tape alone. Which brings us back to where we started. And gives you a place to start. Just call 1-800-228-DISK for the Tallgrass dealer nearest you.

**TALLGRASS SELLS MORE HARD DISK
STORAGE WITH CARTRIDGE TAPE
BACKUP THAN ANYONE IN THE
WORLD.**



**TALLGRASS
TECHNOLOGIES**

COMMITTED TO MEMORY

Inquiry 399

HardFile™ and Tallgrass™ are trademarks of Tallgrass Technologies Corporation © 1985 Tallgrass Technologies

DATASOUTH WHEELS OUT YOUR NEW CORPORATE IMAGE

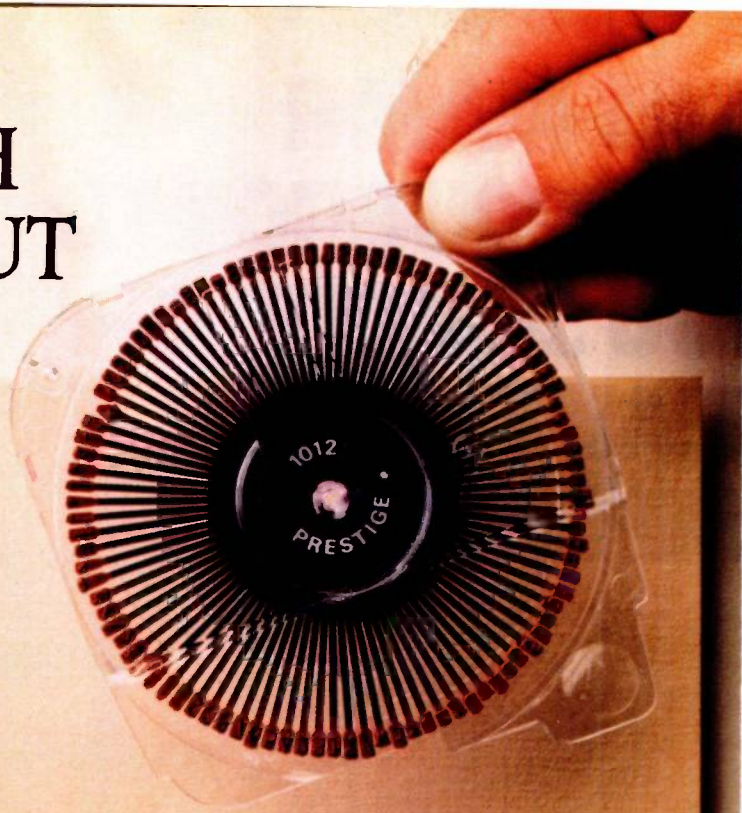

Dear Businessperson:

A good daisywheel printer should work like a pin-stripe suit for your letterhead.

That's why you need a new DaisyWheel 36 from Datasouth. It is, literally, a very impressive machine.

The DaisyWheel 36 is quick, with a top speed of 36 cps. It's more capable than any other daisywheel in its class, with superscripts, subscripts, **boldfacing**, underlining, text reprinting, **red** & black color printing and proportional spacing, among other impressive features. And with its Diablo 630 compatibility, your DaisyWheel 36 will get along with just about any computer in your office.

Your secretary will get along with your DaisyWheel 36 too--thanks to its sheet and tractor feed options, cartridge ribbon, and a whole garden of distinctive daisywheel type faces, each with its own protective cassette.

Best of all, the DaisyWheel 36 comes from a company with a most impressive name: Datasouth--the name that means high performance.

So wheel over to your Datasouth Dealer and run some of your best letterhead through a new DaisyWheel 36, the high performance daisywheel from Datasouth.

By the way, the DaisyWheel 36 lists for just **\$995**

Which is a pretty good price for the best image around.

Eventually yours,

DaisyWheel 36



datasouth

H I G H P E R F O R M A N C E P R I N T E R S

Datasouth Computer Corporation
Box 240947 · Charlotte, NC 28224
704/523-8500 · Telex 6843018 DASOU UW

Inquiry 132

CALL TOLL FREE:
1-800-222-4528

DMM (digital multimeter) to set up its measurement function is done in the data mode. The message is going from the computer (talker) to the DMM (listener). During this time the controller function in the computer is inactive.

While service requests and parallel polls are often used to indicate unexpected conditions, they have applications beyond just indicating problems. A common usage is to synchronize stimulus and measurement devices. A source may take a significant length of time before its output is stable. By asserting SRQ (service request) when everything is ready, the device signals the computer that a measurement can be taken. Some instruments, like swept-spectrum analyzers, take quite a while to complete a measurement. Using polling methods, the computer can process other tasks while waiting.

Table 1 of the article described the bit pattern "N11SSSS" as a secondary address. Actually, it should be described as a secondary command. A secondary command has meaning after either a parallel-poll configure or a primary address. The secondary command after a parallel-poll-configure command programs which bit the device will drive during a parallel poll.

The other use of secondary commands is for secondary addressing. A device may implement extended talker or extended listener functions. If so, the device must receive its primary address followed by its secondary address in order to be addressed. Using secondary addresses to program device functions is not generally done. A device may have several TE (extended talker) and LE (extended listener) functions to allow access to various parts of the instrument. Conceivably, a device could contain both a power supply and a voltmeter. One secondary address would allow programming messages to go to the voltmeter section and another would allow them to reach the power-supply section.

I'm not sure I would describe REN (remote enable) as a "warm boot." REN gives the controller charge over where the instrument will receive its instructions. While REN is false the front panel is active. If REN is true and the listen address is received, the front panel is deactivated. I think the description of IFC (interface clear) as a "panic button" is very accurate.

The IEEE has a companion document to IEEE-488 called "IEEE Recommended Practice for Code and Format Conventions" or ANSI/IEEE Standard 728-1982. This standard is directed toward program-

(continued)

Data communication problem?



Solve it with a BayTech multiport controller

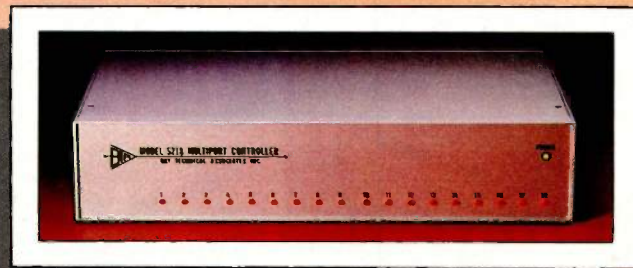

Fifty easy-to-use models for cost-effective, RS-232C serial port expansion.

- Adapt your micro to industrial control and data acquisition applications.
- Add more terminals to your existing computer system.
- Allow your computer to share or select printers.
- Enable your computers to use the same data communication lines by multiplexing.
- Simplify your network with any-device-to-any-device communication.

These intelligent multiports feature many user-programmable functions and are available in 5, 9, 12 and 18-port sizes, \$279 to \$1,795. Call or write for complete details.



BAY TECHNICAL ASSOCIATES, INC.
DATA COMMUNICATIONS PRODUCTS

800/523-2702 or 601/467-8231

Highway 603, P.O. Box 387, Bay Saint Louis, Mississippi 39520
Telex: 910-333-1618 EasyLink: 6277-1271

ming and response messages. The IEEE has also formed a committee, P981, to work on extending and refining the current standards. My article, "Test/Control Update: GPIB Instruments" (*Electronic Engineering Times*, December 17, 1984, page 47), may be of interest.

I think the BYTE article did a good job of communicating the fundamental capabilities and advantages of the IEEE-488

bus. The application example demonstrates the power that is available to the user. I am convinced that this interface will become more widely used with personal computers. I appreciate your efforts in spreading the word.

STEPHEN GREER
Interface Engineer
Hewlett-Packard
Loveland, CO

Thomas R. Clune replies:

I appreciate the clarity of your well-informed remarks. I do, however, think that you have overstated the sharpness of the distinction between command and data modes. For example, a DMM manufacturer would be perfectly free to treat its product as three instruments in one. The voltmeter could be given a different secondary address from the ohmmeter, etc. Thus, addressing the voltmeter to talk would be functionally equivalent to selecting the volts function in data mode on, for example, the HP 3478A. Further, commands like GET are, to my mind, more like programming statements than address information. Having said that, let me thank you for your corrections and additions to my remarks. I look forward to reading your article in *Electronic Engineering Times*.

CONVERSION UTILITIES

I read with interest Ted Carnevale's "C to Pascal" (February, page 138). Carnevale offered a filter program for converting C source code into a form that requires minimal editing to produce the corresponding Pascal. The author's explication of his problem and the chosen method of solving it were informative and lucid. This article was also valuable as an illustration of program construction. Your readers may be interested to know of an alternative method for carrying out such conversions in a few minutes without programming.

The WP Toolset provides 50 utilities for the IBM PC including a program to make any set of regular substitutions in disk files. This general-purpose filter makes multiple global replacements in one pass, replacing any string of printable or nonprintable characters with replacement strings of your choice. The replacements are stored in an ASCII file with nonprintable characters represented in hexadecimal. The filter can be called from the command line or batch files for conversion of programs, word-processing files, or any data whose line delimiters need modification. The WP Toolset is available for \$39 from iRr Software, 28 Ridgewood Rd., Concord, MA 01742.

GAIL JOHNSEN
iRr Software
Concord, MA

ART APPRECIATION

The illustration on page 96 of your March issue, by artist Barrett Root, is without a doubt one of the finest that has ever ap-

(continued)



**GET UP THE RAMP
WITH OUR EE/EPROM PROGRAMMERS & UV ERASERS**

Reliability
Affordability
Maintainability
Program

Choose from our **Stand Alone, Intelligent, RS-232 units.**
COMPATIBLE WITH ANY COMPUTER OR TERMINAL.

GANGPRO-8 \$995.00

High throughput. Gang 8 EPROMs with the fast Algorithm. Optional 512K buffer. Programs **ALL** 24 pin & 28 pin EPROMs. Other units to gang 24 EPROMs.

PROMPRO-8 \$689.00

Powerful commands, easy communications. 128/256K buffer. Alpha Display. Simulation and Keypad option. Programs **ALL** EPROMs & MPU's.

PROMPRO-7 \$489.00

32K RAM buffer, ideal for programming 8748, 8749, other Intel MPU's and 16K-128K EPROMs.

BIPOLAR & PAL Programmers... Call!

TELEX 383 142



UV ERASERS

ECONOMY MODEL QUV-T8/1 . . . \$49.95

Erases over 15 EPROMs. Plastic case.

INDUSTRIAL QUV-T8/2N \$68.95

Metal case, UV indicator, tray, erases over 15 EPROMs in 15 minutes.

INDUSTRIAL QUV-T8/2T \$97.50

With 60 minute timer and safety switch.

INDUSTRIAL QUV-T8/Z \$124.95

Fast Eraser, 15 EPROMs in 7 minutes. 30 EPROMs in 15 minutes.

PRODUCTION UNIT \$149.95

Model: ULTRA-LITE™. Erases 50 EPROMs in 15 minutes.

TOLL FREE **1-800-EE1-PROM**
(331-7766) · FLORIDA (305) 974-0967

AVAILABLE SOFTWARE DRIVERS

- 1. IBM PC
- 2. APPLE II
- 3. Intel-MDS
- 4. CPM
- 5. TEXTRONIX 8002
- 6. COMMODORE 64
- 7. TRS-80 COLOR
- 8. FLEX

LOGICAL DEVICES, INC.

DEPT. 6, 1321-E N.W. 65th PLACE · FT. LAUDERDALE, FL. 33309
DISTRIBUTORS INQUIRY WELCOME Inquiry 254

PERSONALITY PROBLEM?

UNIX™ and DOS™ At the Same Time!

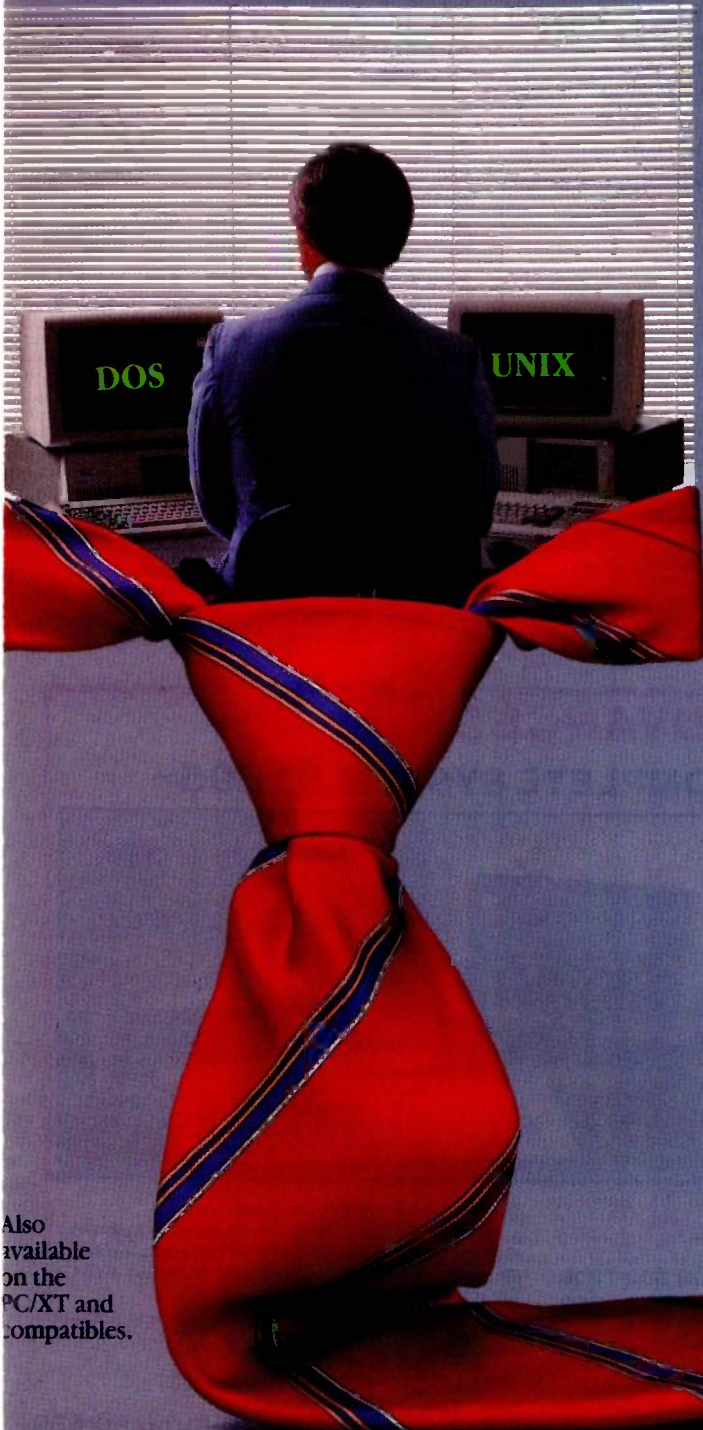

Looking at an IBM PC/AT? Happy with DOS but want UNIX? Happy with UNIX but want DOS? Want them working together?

Get The Connector!™

The Connector is a revolutionary product that allows DOS applications to run on the IBM PC/AT or XT under VENIX/86 (the first licensed AT&T UNIX operating system for the IBM PCs) or PC/IX. That means you can add one or more terminals to your AT which run programs using multi-user VENIX/86 to share the disk and printer. Switch between UNIX and DOS at the console with a single command. And run more than one task simultaneously. Like running a spelling check in the background while you print a report and run Lotus 1-2-3™ or dBaseII™.

Get yourself an AT and load it with VENIX. Collect your DOS and/or UNIX applications. We'll supply The Connector. The right solution to your software personality problems.

Call for complete details.

Unisource Software Corp., Department 4109,
71 Bent Street, Cambridge, MA 02141.
Telex 92-1401/COMPUMART CAM.
617-491-1264

Also
available
on the
PC/XT and
compatibles.



Getting UNIX Software
Down to Business

UNIX is a trademark of AT&T Technologies, Inc. DOS is a trademark of Microsoft, Inc. PC/AT and PC/XT are trademarks of IBM. The Connector is a trademark of Unisource Software Systems, Inc. VENIX/86 implementation by VenturCom, Inc. 1-2-3 and LOTUS are trademarks of Lotus Development Corp. dBaseII is a trademark of Ashton-Tate.

peared in a computer-oriented magazine. The symbolism isn't subtle, but how perfectly right the artist was, that demon terminal and computer have become our gods! And that the temple computer is at the summit of the other lesser computers or terminals.

I actually know computerists who virtually worship their computers and who religiously do obeisance to their electronic gods. I'm sure that the Parthenon did not exert the influence on some of its devotees that the microcomputer does

today on many of its owners.

My sincere compliments and thanks to Mr. Root.

BERNARD A. MCLHANY
Marble Hill, GA

FACTORING WITH S1

Thanks for Richard B. Leining's interesting article, "Factoring with Hyper" (March, page 396). The method outlined is undoubtedly applicable in certain circumstances. However . . .

Instead of comparing Hyper with a so-

phisticated program I compared it with the simplest factoring program possible, which I have called S1 (Simple 1). You start with $Q_{max} = \sqrt{N}$ and try dividing N by each odd number smaller than Q_{max} . Thus for $N=96,001$, $Q_{max}=309.84$, and you try $Q=309, 307, 305$, etc. The most numbers one can ever try with S1 is $Q_{max}/2$; thus for 96,001 after 154 trials you reach $Q=1$ and conclude (correctly) that 96,001 is prime.

Hyper takes 7846 trials to conclude that 96,001 is prime. But wait! One expects to use Hyper for numbers that can actually be factored. The question is, how long do you have to search before finding the factor? If we define Q_{max} as equal to \sqrt{N} and Rq as equal to Q/Q_{max} , where Q is the actual factor that will be found by either Hyper or S1, we can calculate how many trials each will require. For S1, $Trials = Q_{max} \cdot (1 - Rq)/2$. For Hyper, $Trials = Q_{max} \cdot (Rq + 1/Rq - 2)/4$. If Rq is near 1, Hyper gets the job done faster than S1. But as Rq becomes small, Hyper suffers. Table 1 illustrates some examples.

(continued)

Table 1: The number of trials necessary to find a factor.

N = number to be factored
 Q = actual factor to be found
 $Q_{max} = \sqrt{N}$
 $Rq = Q/Q_{max}$

Method	$Rq=0.5$	$Rq=0.2$	$Rq=0.1$
Hyper	$0.125 \cdot Q_{max}$	$0.8 \cdot Q_{max}$	$2.03 \cdot Q_{max}$
S1	$0.25 \cdot Q_{max}$	$0.4 \cdot Q_{max}$	$0.45 \cdot Q_{max}$

8 MHz / 1 Megabyte PC

Where do TAVA PC, WESTERN PC, CONQUEST PC, and STAR PC get their PC compatible system boards? They use the ADVANCED PC from ADVANCED LOGIC RESEARCH, INC.

ADVANCED LOGIC RESEARCH (ALR), the original designer of the TAVA PC, is currently offering the ADVANCED PC to OEMS, DEALERS, and SYSTEM INTEGRATORS.

The ADVANCED PC is a single board computer that was designed to maximize compatibility with the IBM PC. Its features include a switch selectable 8MHz/4.77 MHz CPU clock, 1 megabyte memory without addition of add-on cards, 1 serial and 1 parallel port, and 5 expansion slots. The BIOS used on the ADVANCED PC is the same that is used on the TAVA PC, WESTERN PC, ETC., and has proven to offer the highest degree of compatibility available.

ALR also provides PC-AT storage for your PC with the ALR I/O FLOPPY. The standard features of the I/O FLOPPY include support for 1.2 MB HIGH DENSITY drives, 8" drives, as well as standard 360K drives. Optional features include an AST compatible clock/calendar interface, RS232 serial port, and 1 parallel port.

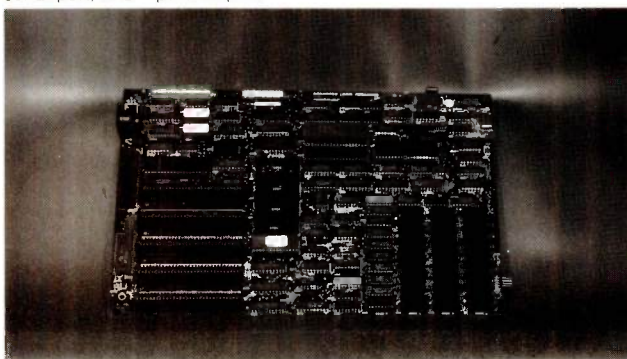

ALR1001T - ADVANCED PC TURBO SYSTEM

ADVANCED PC

COMPLETE SYSTEM \$1695⁰⁰



ALR
 (714) 832-7808
 (714) 832-7809

The complete system includes:
 8 MHz CPU, 256K Memory, 2 Drives, ALR I/O Floppy with AST compatible Clock/Calendar, Monochrome Display Card and Monitor, 5151 Style Keyboard.

ALR ADVANCED LOGIC RESEARCH, INC.

15455-B Red Hill Avenue, Tustin, California 92630

TELEX - 756-731-ANS/WESTERN COMP.

Inquiry 15 for End-Users. Inquiry 16 for DEALERS ONLY.

Ven-Tel's Half Card™ modem is in all the best computers. Here's why...

en-Tel gives you lots of reasons to buy our Half Card™ modem for your IBM PC or compatible. The Half Card™ is a complete system that lets you communicate with other PCs, mainframes, and databases effortlessly. It includes Crosstalk-XVI® software. It's reliable. It's got all of the features you want. And it's a good value.

Do You Own One of These Computers?

Chances are you do. And if you're thinking of buying a modem, consider the Half Card™. Because of its small size, the Half Card™ fits in more computers, including all of the models we've listed here. The Half Card™ is small, so it fits in short slots or long. That means you can save your long slots for other expansion uses.

Effortless Communication

Each Half Card™ comes with Crosstalk-XVI® communications software, by Microstuf. It's the easiest to use, whether you're a beginner or an old hand, and the most powerful. A full on-line help menu makes using Crosstalk® for the first time a snap. It can turn your PC into a terminal on a mainframe computer with its powerful terminal emulation feature. It will even operate your PC when you're not there. You can call into an information service such as The Source or Dow Jones News retrieval, or transfer files and electronic mail, all at the touch of a button. The Half Card™ connects your computer to the world effortlessly.

More Modem for Your Money

When you buy the Half Card™, you don't need anything else. The Half Card™ is a complete communications package that includes full-featured modem and the best known software on the market. Complete easy-to-understand instructions with full technical support on installation and use. And a very competitive price. The Half Card™ with Crosstalk-XVI® software, retails for only \$549.

Features

- 1200/300 baud auto-dial, auto-answer.
- Uses the industry standard "AT" command set.
- Runs with virtually all communications software, including Smartcom II and PC Talk III and integrated packages such as Symphony and Framework.
- Includes Crosstalk-XVI® software.
- On-board speaker and extra phone jack for easy switching from voice to data mode.
- Selective tone or pulse dialing; full or half duplex.
- Automatic answer on any ring.
- True ring or busy signal detection.

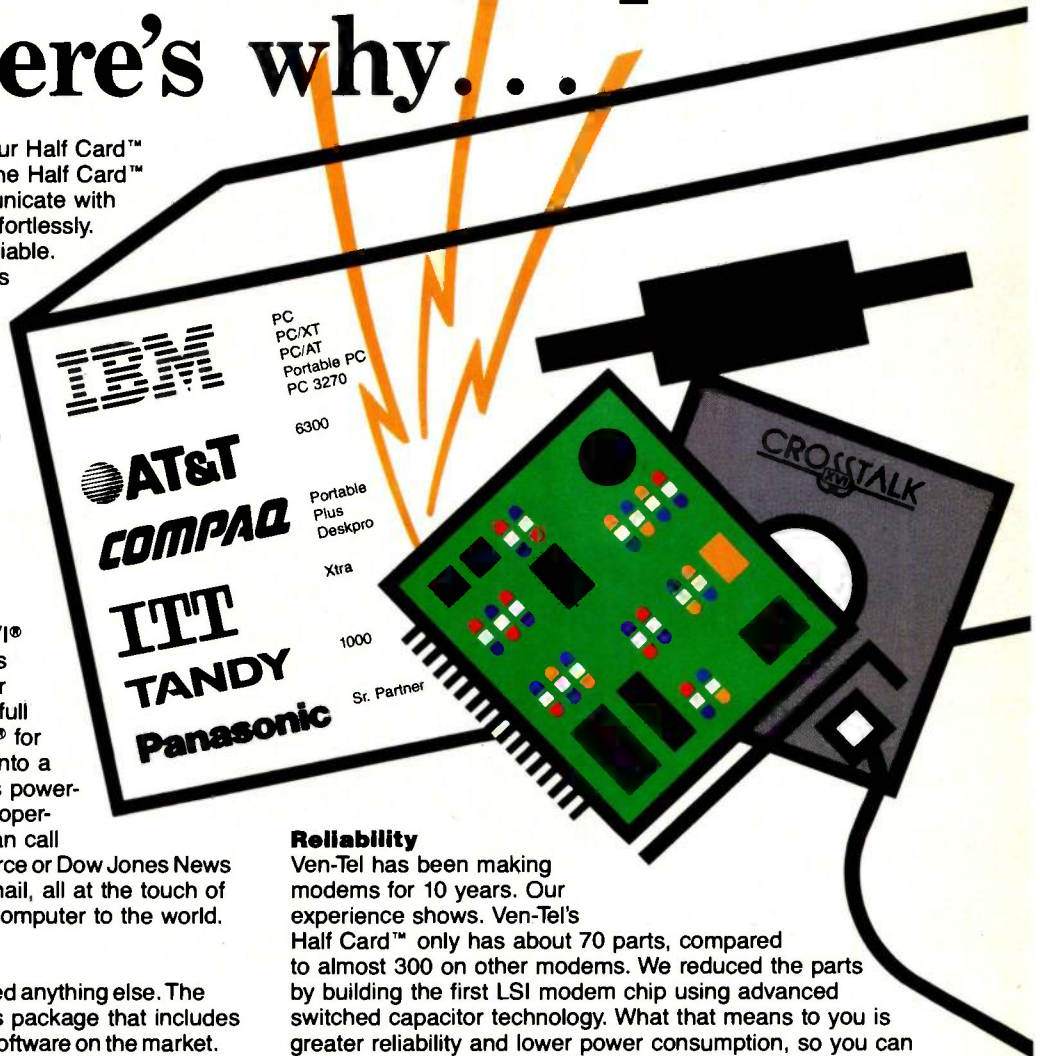

Reliability

Ven-Tel has been making modems for 10 years. Our experience shows. Ven-Tel's Half Card™ only has about 70 parts, compared to almost 300 on other modems. We reduced the parts by building the first LSI modem chip using advanced switched capacitor technology. What that means to you is greater reliability and lower power consumption, so you can load up your PC with expansion boards and not worry about heat or power problems. And we back the Half Card™ with a full two-year warranty on parts and labor.

You Can Buy the Half Card™ Anywhere

You can get the Half Card™ at ComputerLand, Businessland, the Genra Group, Entré Computer Centers, Macy's Computer Stores and other fine dealers nationwide. Also from Ven-Tel: the 1200 Plus™, an external modem and the PC Modem 1200™, an IBM internal with V.22 international capability.

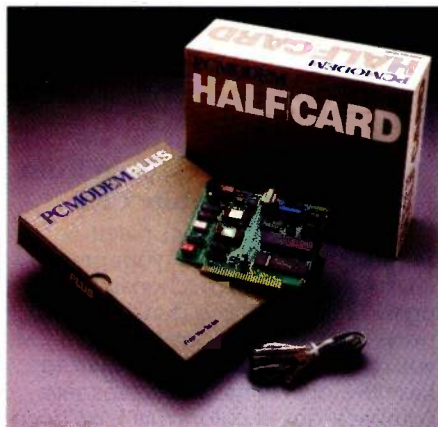

Effortless Communication
Ven-Tel Inc.

2342 Walsh Avenue
Santa Clara, CA 95051
(408) 727-5721

Now last minute presentations can be made from your personal computer. In color. In house. In minutes.

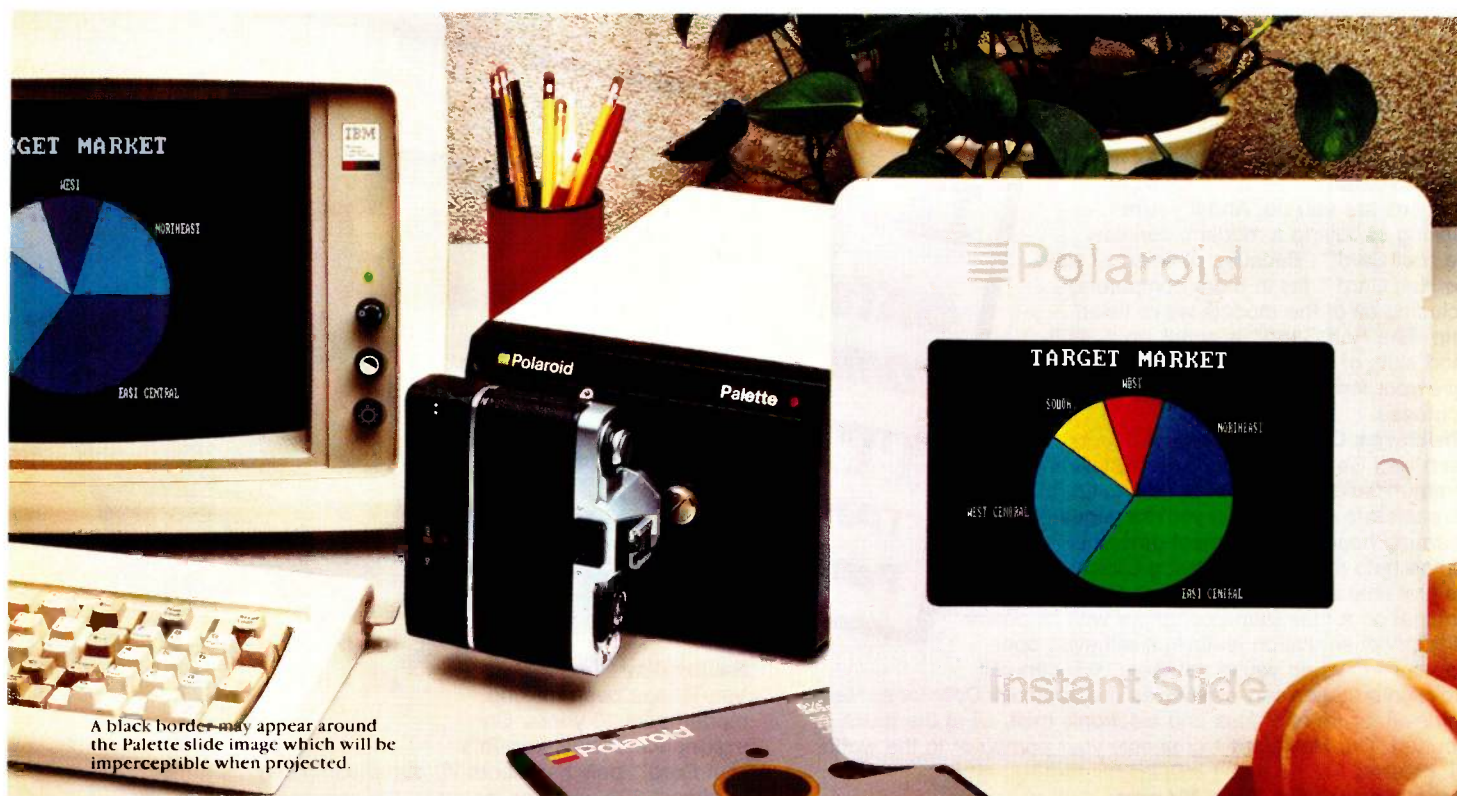

A black border may appear around the Palette slide image which will be imperceptible when projected.

Introducing Polaroid Palette.

Whether your presentation is in 30 minutes or 30 days, the new Polaroid Palette Computer Image Recorder will make it easier. Priced at under \$1800*, it lets you make Polaroid 35mm Instant Slides or prints from personal computer-generated data. Right at your desk. So now you can create a presentation in minutes. Without sending out for processing, paying premiums for rush service or risking the security of your confidential information.

Works with the graphics packages of the IBM PC or XT, DEC Rainbow or PRO, Apple IIe or II+ and AT&T 6300.

The Polaroid Palette is designed to work with many graphics software packages. In fact, when using such programs as Graphwriter, Chart-

Master, Sign-Master, DR Draw, DR Graph, and ATHENA/graph, Palette can virtually double both the horizontal and vertical resolution of your monitor. Plus, a "backfill" feature reduces raster lines for a smoother, more finished appearance. The result—presentation quality slides. On-the-spot.

Color 35mm slides, even from a black and white CRT

Think of it as an artist's palette. Because Palette "paints" your graphs, charts and text. You're choosing from up to 72 colors. If you don't want red, press a few keys—it's green. And if you're not the artistic-type, Polaroid has developed a menu of color sets: combinations of colors that have been specially coordinated to complement your presentations. And all of this is

yours, even if you have a black and white monitor.

Lets you make last minute changes or add up-to-the-minute information.

The Polaroid Palette is the fast, convenient, low-cost way to prepare slides for your presentation. And perhaps even more important, Palette allows you to keep confidential information confidential. You won't have to send your work out to anyone again.

So why wait until the last minute to find out about Polaroid Palette? Contact one of the Palette dealers listed here or call the toll-free number on the opposite page. Look at it this way, now you can change your presentation as fast as you change your mind.

*Suggested list price. Polaroid®

VISIT OUR BOOTH AT THE NATIONAL COMPUTER CONFERENCE.

Alabama: Business Graphics, Birmingham, (205) 663-2492; The Computer Shoppe #210, Huntsville, (205) 830-2615.

Arizona: Computer Superstores, Phoenix, (602) 957-6780; American Computer Svs., Phoenix, (602) 978-3244; MicroAge Computer Store, Phoenix, (602) 265-0065; Computerland Major Accounts, Phoenix, (602) 861-9667; MicroAge Computer Store, Tucson, (602) 571-1201 or 887-1485.

Arkansas: The Computer Shoppe #215, Little Rock, (501) 375-5544.

California: Drake Morton (Lomita Pacific Photo), Lomita, (213) 326-7077; Raytec, Inc., San Diego, (619) 695-8611.

Los Angeles: Media Fabricators, Los Angeles, (213) 937-3344 or (714) 954-0590; Computer Business Center, Santa Monica, (213) 452-2027; Long Beach Micro, Long Beach, (213) 435-3006; Advanced Computer Products, Santa Ana, (714) 558-8813; Photo & Sound, El Monte, (213) 575-1924; Software Central, Pasadena, (818) 793-4101; Computerland of Simi Valley, Simi Valley, (805) 583-5585; Manumit Microcomputers, Anaheim, (714) 520-0411; #33 Businessland, Los Angeles, (213) 387-1938.

San Francisco Area: Image Sales, Inc., Walnut Creek, (415) 932-1031 or (800) 321-1821; KSP Inc., Palo Alto, (415) 327-8996; Computerland/Dublin, Dublin, (415) 828-8090; Able Computer, Belmont, (415) 593-2253; Imago Data, Sunnyvale, (408) 737-9172; PC Support, Sunnyvale, (408) 746-2772; Photo & Sound, San Francisco, (415) 421-0410; #6 Businessland, San Francisco, (415) 989-3741.

Colorado: Fairview Audio-Visual, Englewood, (303) 771-6335; BFA Corp., Denver, (303) 777-8070.

Connecticut: Computerease, Avon, (203) 677-7191; Computerease, Danbury, (203) 794-9493; Computerease, Darien, (203) 656-1494; Computerease, E. Hartford, (203) 278-1080; Computerease, Milford, (203) 877-7447; Entre Computer Center, Stamford, (203) 967-2233.

Delaware: RSG Computer Supplies, Inc., Newark, (302) 368-4938.

Florida: Micro Mart, Altamonte Springs, (305) 830-4076; Micro Mart, Coral Gables, (305) 445-9500; Micro Mart, Ft. Lauderdale, (305) 749-0330; Computer Station, Jacksonville, (904) 724-3174; Micro Mart, Jacksonville, (904) 396-8089; Kendall Computers, Miami, (305) 274-6312; United Computers Business Center, Miami, (305) 371-6100; United Computers Business Center, Miami-Bay Harbor, (305) 868-8300; Procomp Systems, Inc., Pompano Beach, (305) 997-6313; Micro Mart, Tampa, (813) 972-5000.

Georgia: The Computer Pro, Augusta, (404) 737-8313; MicroWorks, Smyrna, Atlanta, (404) 980-1000; OTP Atlanta, (404) 688-3107; Software Atlanta, Atlanta, (404) 934-0924; Boardroom Graphics Systems, Atlanta, (404) 457-2836; Southern Business Communications, Inc., Macon, (800) 282-5687; MicroWorks, Norcross, (404) 446-1678; Southern Business Communications, Inc., Norcross, (404) 449-4088; Micro Mart, Norcross, (404) 449-8081; Software Atlanta, Smyrna, (404) 434-4171; Computer Network, Smyrna, (404) 951-0134; Micro Mart, Smyrna (404) 956-8088; Southern Business Communications, Inc., Savannah, (800) 282-5687.

Illinois: Midwest Visual Equipment, Chicago, (312) 478-1250; Eberhardt Instruments, Downers Grove, (312) 964-4240; Computerland, Elmhurst, (312) 832-0075; NorthBrook Computer, NorthBrook, (312) 480-9190; Software and Beyond, Schaumburg, (312) 882-3733; New Orient Media, W. Dundee, (312) 428-6000.

Indiana: CBM Computer Center, Evansville, (812) 474-0555.

Kentucky: CBM Computer Center, Lexington, (606) 276-1519; The Computer Shoppe #209, Louisville, (502) 426-8787; The Computer Shoppe #217, Louisville, (502) 581-9109; CBM Computer Center, Louisville, (502) 425-7602; Micro Mart, Louisville, (502) 895-5624.

Louisiana: Micro Mart, Metairie, (504) 835-6481.

Maryland: MBI Business Centers, Bethesda, (301) 657-1611; Folkemer Photo & Computer Center, Ellicott City, (301) 465-7788; Software Centre Wintergreen Plaza, Rockville, (301) 424-3024; MBI Business Centers, Rockville, (301) 984-8922; Micro Mart, Rockville, (301) 294-9000.

Massachusetts: Microsource Financial, Boston, (617) 423-0108; The Computer Store, Boston, (617) 426-4385; #52 Businessland, Boston, (617) 542-8099; Micro Store, Brockton, (617) 588-1837; The Computer Store, Burlington, (617) 272-8770; The Computer Store, Cambridge, (617) 354-4599; Entre Computer Center, Centerville, (617) 771-9747; Entre Computer Center, No. Dartmouth, (617) 997-3113; The Computer Store, Framingham, (617) 879-3720; Computerland Leominster, Leominster, (617) 534-5240; Computer Source, Pittsfield, (413) 443-7181; Micro Store, Taunton, (617) 823-8106; Microsource Financial, Watertown, (617) 924-5500; Computer Haus, Wilmington, (617) 657-6433.

Michigan: Inacomp Computer Center, Ann Arbor, (313) 665-4453; Inacomp Computer Center, E. Detroit, (313) 445-8010; Inacomp Computer Center, E. Lansing, (517) 351-1777; Inacomp Computer Center, Flint, (313) 234-0161; Inacomp Computer Center, Grand Rapids, (616) 942-2690; Inacomp Computer Center, Holland, (616) 396-5006; Inacomp Computer Center, Kalamazoo, (616) 323-2222; Lysinger Corp., Troy, (313) 583-1070; Inacomp Computer Center, Troy, (313) 649-0910.

Minnesota: Blumberg Communications, Minneapolis, (612) 333-1271.

Missouri: Photo & Sound, St. Louis, (314) 432-7190.

New Hampshire: McAuliffe, Inc., Keene, (603) 352-0258; Computer Barn, Salem, (603) 893-2511.

New Mexico: BFA Corp., Albuquerque, (505) 292-1212; Computer Superstores, Albuquerque, (505) 293-5370; BFA Corp., Las Cruces, (505) 524-9693.

New York City: Future Information Systems, New York, (212) 732-3905 or 751-7888; Brilliant Image, New York, (212) 736-9661; Erin Data Systems, Melville, (516) 293-4114; MicroAge Computer Stores, Farmingdale, (516) 752-1600.

North Carolina: Carolina Camera Center, Inc. Greensboro, (919) 379-9177; Audio Buys, Raleigh, (919) 821-1776.

Ohio: Radgo Computer, Cincinnati, (513) 752-6920; CBM Computer Center, Cincinnati, (513) 793-1787; Micro Mart, Cincinnati, (513) 621-8898; Programs, Unltd., Columbus, (614) 228-4610; OTEC Computer, Mantua, (216) 274-2818; Northeast Business Center, Richmond Heights, (216) 442-4808; Programs Unltd., Worthington, (614) 431-2228.

Oklahoma: Argus Systems, Inc., Norman, (405) 329-0180; Fairview Audio Visual, Oklahoma City, (405) 521-0031; Fairview Audio Visual, Tulsa, (918) 664-8020.

Oregon: Photo & Sound, Portland, (503) 224-3456.

Pennsylvania: MBI Business Centers, Bala-Cynwyd, (215) 668-0870; MBI Business Centers, Jenkintown, (215) 576-6650; Computers for the Professional, Kulpville, (215) 362-1888; S&S Klinetics, Media, (215) 565-5388; OTP Philadelphia, (215) 925-6300; Monterey Microsystems, Inc., Pittsburgh, (412) 242-1188; MicroAge Computer Stores, Pittsburgh, (412) 323-2700; Micro Mart, Pittsburgh, (412) 391-3456; MBI Business Centers, Wayne, (215) 687-5991.

Rhode Island: The Computer Store, Providence, (401) 331-0220.

South Carolina: Southern Business Communications, Greenville, Spartanburg, (800) 241-5312.

Tennessee: The Computer Shoppe #219, Chattanooga, (615) 267-8107; Southern Business Communications, Inc., Chattanooga, (800) 241-5312; The Computer Shoppe #213, Goodlettsville, (615) 859-4015; The Computer Shoppe #216, Knoxville, (615) 690-8636; The Computer Shoppe #211, Nashville, (615) 366-3810; The Computer Shoppe #214, Nashville, (615) 255-3486; The Computer Shoppe #220, Nashville, (615) 292-4496; CBM Computer Center, Nashville, (615) 385-1855; Micro Mart, Nashville, (615) 292-5600; The Computer Shoppe #218, Memphis, (901) 682-7082.

Texas: The SoftSource, Dallas, (214) 361-4048 or 960-0413; Kimball Audio Video, Inc., Dallas, (214) 869-0117; #17 Businessland, Dallas, (214) 698-0374; Computer Superstores, El Paso, (915) 533-2215; Personal Computing Delta, Inc., Houston, (713) 850-8445; Jobar's Camera Center, Bellaire (Houston), (713) 668-5773.

Vermont: McAuliffe, Inc., Burlington, (802) 658-4444; McAuliffe, Inc., Rutland, (802) 775-1955; Entre Computer Center, Shelburne, (802) 985-3366.

Virginia: Technology Services, Alexandria, (703) 354-8668; Micro Graphics, Annandale, (703) 642-1444; MBI Business Centers, Arlington, (703) 892-1666; Cary's Camera Shop, Charlottesville, (804) 293-4552; MBI Business Centers, Fairfax, (703) 691-8600; Computerland of Hampton, Hampton, (804) 827-8899; Computerland of Norfolk, Norfolk, (804) 625-3427; Micro Age, Norfolk, (804) 461-6460; Computerland, Richmond, (804) 643-0225 or 741-3502; #41 Businessland, Rosslyn, (703) 524-5112; MBI Business Centers, Springfield, (703) 451-7100; MBI Business Centers, Sterling, (703) 430-0300 or (301) 450-4303; MBI Business Centers, Vienna, (703) 893-0300 or (703) 893-0683; Computerland of Virginia Beach, Virginia Beach, (804) 422-8271; Micro Graphics, Virginia Beach, (804) 460-9080.

Washington, D.C.: Memory Systems, Inc., (202) 429-1922; After Computer, (202) 822-0604; MBI Business Centers, (202) 463-7474 or 293-1390; OTP, (202) 371-2150.

Washington State: Savant Computer Support, Inc., Issaquah, (206) 643-9116; Photo & Sound, Kent, (206) 632-8461.

Wisconsin: Graphic Business Systems, Lake Geneva, (414) 248-9690; Allied Computer Group, Milwaukee, (414) 228-9333.

CALL 800-225-1618

The GraFIX Partner is a trademark of Brightbill-Roberts and Company, LTD. *Suggested list price.

Now Polaroid Palette's greatest partner, GraFIX Partner, is free.

**These dealers are offering
this \$149 value* free with
your Palette purchase until
July 15th. It's GraFIX
Partner, the graphics editor
that lets you paint, draw,
add text in 20 different
fonts, and more... all while
your other software is being
run. Then with a single
keystroke you capture the
image on the Palette.
So present this great team
to yourself. Today.**

New Jersey: Performance Software, Bloomfield, (201) 429-9099; MBI Business Centers, Cherry Hill, (609) 428-7055; Prodigy Systems, Edison, (201) 321-1717; Prodigy Systems, East Hanover, (201) 428-0200; Prodigy Systems, Green Brook, (201) 752-6300; TMA Logon, Hackensack, (201) 646-9222; Prodigy Systems, Iselin, (201) 283-0600; Prodigy Systems, Lawrenceville, (609) 452-1858; Clancy Paul Computer, New Brunswick, (201) 246-8585; MicroAge Computer Stores, Paramus, (201) 843-5678; Clancy Paul Computer, Princeton, (609) 683-0060; Clancy Paul Computer, Red Bank, (201) 747-7150; Software House of New Jersey, River Vale, (201) 664-5100.

New York State: The Computer Room, Albany, (518) 869-3818; Computer Professionals, Albany, (518) 438-0010; National Graphics, Albany, (518) 438-8411; Graphic Arts Computer Products, Buffalo, (716) 854-0004; The Computer Room, Glens Falls, (518) 798-1446; The Computer Room, Kingston, (914) 336-4155; Graphic Arts Computer Products, Rochester, (716) 342-0602; All Things Computer, Scarsdale, (914) 723-6262; The Computer Room, Schenectady, (518) 382-1182.

COMPUTEX

TAIPEI '85

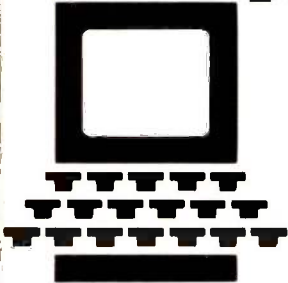

**JULY
12-18,
1985**

**CETDC EXHIBITION COMPLEX,
Taipei Sungshan Airport,
Taiwan, R.O.C.**

Taiwan has been staking out an increasingly important position in the international trade in microcomputers, peripherals such as terminals, disk drives and printers, various computer accessories, and software. Now there is an exhibition that gives you the opportunity to check out the latest products and establish business connections with this dynamic industry. Be sure to attend Computex Taipei '85.



Organizer:
**china external trade
development council**
201, Tun Hwa North Road, Taipei, Taiwan, R.O.C.
Telex: 21676 CETRA. Tel: 715-1515.

Sponsor:
CETDC, Inc.
41 Madison Avenue, New York, N.Y. 10010, U.S.A.
Telex: 426299 CETDC NY. Tel: (212) 532-7055.

LETTERS

One can of course use a hybrid search method, using Hyper until $Rq = 1/\sqrt{3}$, then switching to SI. But the fact remains that there will be little relative gain over SI overall unless Rq is near 1. In public-key encryption, I am not aware of any restriction that would prevent Rq from being quite small—0.1, for example. Hyper or SI or a combination will still take on the order of $0.5 \cdot Q_{max}$ trials to factor the key. For the oft-quoted 200-digit key, that's about $0.5 \cdot 10^{100}$ trials. And Hyper doesn't do any better relative to SI when the keys are smaller.

The above discussion has assumed that a Hyper trial will burn the same computing time as an SI trial. In fact, a Hyper trial will take perhaps three times as long, involving as it does an expression with numbers on the order of N^2 compared to SI's single computation of $N \text{ MOD } Q$. Also note that we can swing the balance further by skipping every third odd number in SI, those that are divisible by 3.

JOHN DELAUBENFELS
Duluth, GA

Richard B. Leining replies:

Basically, we agree on the mechanics but not what to make of them. Let's take your comments one at a time.

First, Hyper is too slow for testing the primality of a number like 96,001. Agreed. Although I've not run it, manually I predict 7847 trials, like your 7846.

Hyper is used primarily where factors are expected to exist—yes, and it is efficient near the square root but not far from it. The number of trials is

$$1 + \frac{(1-a)^2}{4a} \sqrt{N}$$

where

$$a = \text{factor}/\sqrt{N} = \text{your } Rq$$

and

$$\sqrt{N} = \text{your } Q_{max}$$

If I drop the first trial at the critical upper bound of $\phi/4$, then my expression is equivalent to your $Q_{max} \cdot (Rq + 1/Rq - 2)/4$. This expression for the number of trials was edited out of my manuscript.

Your searching of odd numbers below the square root is interesting. For small factors, it is not as trivial as it seems at first glance. But for your example of 96,001, I would use a table of primes. There are only 168 primes below 1000. I suspect that there are less than 154 of them below the square root 309.8. But I don't know how many, as my table and

(continued)



**A
Bouquet
of
Value
to You**

Yours FREE — A Sentinel Dial-A-Disk Plastic Storage System.

Yes, for a limited time only, with each purchase of ten assorted color diskettes packaged in the sturdy Dial-A-Disk container, you receive, at no additional cost, this functional storage system. A \$6.95 VALUE . . . FREE!!!

The all new Sentinel Dial-A-Disk features:

- Instant recognition of data category by color.
- Staggered-step detailing that puts color-coding at a fingertip advantage.

- Attractive, permanent storage for your Sentinel Color Diskettes.
- Ten 100% certified diskettes in assorted eye-appealing colors.
- A written guarantee that each diskette will read/write error free for as long as you own it.

See the Sentinel Dial-A-Disk wherever you buy your Sentinel Color Diskettes.

Sentinel Technologies, Inc.

One Sentinel Plaza, Hyannis, MA 02601/Telephone: (617) 775-5220
Toll-free 1-800-323-5005 (in Massachusetts 1-800-323-5001)

HOW TO CONTROL THE RISE AND FALL OF POWER.

Your small business computer can give you the power to raise your productivity. But first you have to control the power you give it. Because even the slightest dip or surge of electricity can result in a shocking surprise. An instant loss of important data or misinformation. Even worse, a total power line failure can create department devastation... a total system crash. You can't afford errors, delays and other problems. After all, you've invested in a computer to increase efficiency. But now there's a solution you can afford The Sola SPS. This economical, UL listed Standby Power System is designed to protect personal, micro and mini computers from AC line disturb-

ances and failures. Sola SPS provides clean, regulated AC power to your computer when your power line experiences irregular voltage. Line dips or line surges are immediately converted to proper voltage. When the AC line is present, the SPS filters power to eliminate electrical noise. And when the AC line fails, the SPS goes into full action, providing precise AC power to the load from its internal battery. So the only noise you'll hear is the sound of performance. There's no maintenance. No installation. No kidding. Just plug it in and turn it on. Why let your productivity rise and fall with your power? The solution is as simple as SPS. The standby system that Sola stands behind.



Write for free literature. 1717 Busse Hwy., Elk Grove Village, IL 60007 (312) 439-2800

A UNIT OF GENERAL SIGNAL 

SOLA

the computer I use are at work.

My manuscript assessed the possibility of Hyper breaking a large Rivest-Shamir-Adleman cipher, described in C. E. Burton's "RSA: A Public Key Cryptography System, Part I" (Dr. Dobb's Journal, March 1984, page 16). I wouldn't want to pay for 10^{27} trials on a big computer. I concluded that Hyper's cryptanalytic virtues were limited to toy ciphers,

especially in BASIC. Those comments were edited out along with my observations about numbers the order of $N^{2/4}$.

What is the point of Hyper? Well, why does anyone factor? For research, I guess. It fascinates me that two of the equations of the RSA cipher should suggest a new substitute for factoring. It is also interesting that equations (2) and

(2A) of my article lead to factoring substitutes that are mirror images of each other, one searching downward from a critical upper bound, the other searching upward from a critical lower bound, and both bounds found in equation (16). Has some mirror image of Euler's totient function been overlooked?

Your interest in Hyper is appreciated. I'm impressed that you figured out the number of trials so quickly.

Other people helped me develop the Hyper factoring program, to the limit of double-precision BASIC. Scaling down the entire computation by a factor of 4, to defer overflow, was a solution suggested by Professor Bill Viavant of the Computer Science Department of the University of Utah.

DEC RAINBOW WOES

A few words about some bugs I have found in my DEC Rainbow. So far, I've had little luck with DEC customer support.

- The CP/M-86/80 2.0 command to back up the hard disk apparently eats files at random. All I can advise is that you simply not back up files; or you can spend all day using the PIP command.
- Under CP/M-86/80 2.0, the MAINT command produces erroneous results when large files (50K bytes) are involved or the hard disk is over 50 percent full.
- Under WordStar 3.3 and CP/M-86/80 2.0 (exact source of bug unknown), large files (over 30K bytes) mysteriously cannot be edited at times. You can edit them on screen, but after saving the files, they come back with the old text, not the revisions. Neat trick. One solution is to avoid writing long files and try resaving the file as a block write, under a new name. Backing up a work in progress should be done the same way; the "save-&resume" command, the "save-&new" command, and the "save-&exit" command all seem to have this random bug.
- The MS-DOS operating system comes with a very basic user's guide; it doesn't even explain the directory/subdirectory/path commands. In fact, it tells you very little besides how to boot the system. Is there any other documentation available besides the \$250-plus technical manuals?

I also found that "upgrading" to a hard disk means buying a new \$1500 system board (the one different chip can't be swapped) or else keeping the operating system on one floppy all the time; it's no simple upgrade, as promised, either.

JARED SHERMAN
Jackson Heights, NY ■

Data worth keeping deserves a Data Defender.



Data Defenders by Ring King. They're the finest quality protection you can buy for the information you have stored on 5 1/4" mini-diskettes and printout.

The Ring King 070 Tray holds 70 mini-diskettes in a tough copolymer shell with security lock. The Ring King Flip File II binder holds 20 mini-diskettes and converts to a desktop index. Ring King Looseleaf Files are punched to fit standard 3-

ring binders. Ring King Data Binders hold up to 8" of 9 1/2" x 11" or 14 7/8" x 11" unburst printout.

Ask for Ring King Data Defenders at your computer supply dealer. Or send for our free, full-color catalog of computer support products. Write Ring King Visibles, Inc., 2210 Second Avenue, P.O. Box 599, Muscatine, Iowa 52761. For customer service, phone (800) 553-9647, in Iowa (319) 263-8144.

DATA DEFENDER™





**You can still buy
quality and dependability
at a reasonable price**

VIASYN™

The CompuPro People

Where Computers Grow

Without the bugs. And without the worry.

Our drive for more power, reliability and economy.

Since 1973, the CompuPro people have been dedicated to bringing highly innovative computer technology to all users. Their success has been due to making state-of-the-art available at outstanding values, combining high quality and reliability with the best possible prices. This market philosophy is based on the same principles that made the Volkswagen a symbol of reliability and economy all over the world.

Today, VIASYN continues this tradition with its diverse and dependable CompuPro® product line. It covers the needs of experts, beginners, OEMs, VARs, software developers and sophisticated end-users. It goes from boards and subsystems to VIASYN'S powerful CompuPro 816 computer family that extends to advanced multi-user, multiprocessor business computers. This versatile product line is

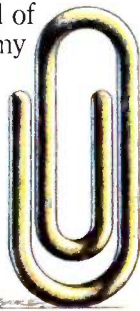

Built to grow.

designed for growth and compatibility with the most popular and successful computer systems in the industry. This is why your purchase is a true investment

you can build on for years to come. It gives you more computer power — without the bugs and the worry about defects or early obsolescence.

The evidence of quality. Our warranty, service and support.

VIASYN offers all customers an exceptional one-year warranty. Since all systems are tested for two years of reliability, this warranty can be extended to cover two full years. Other warranties are available at an extra, nominal charge. It's solid evidence for the built-in quality of our products.

Our customers are also assured of full technical support. The growing, national and international network of CompuPro Full Service System Centers is staffed by expert sales and service personnel who can help with system and software customization. They are prepared to offer technical assistance, expert advice and field maintenance contracts to make certain you get the most out of our products.

True to its commitment to all computer users, VIASYN

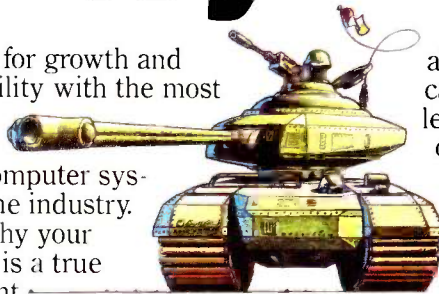

Built to last.

also informs and educates its customers on all levels. In keeping with our drive to bring advanced computing power to the people, we offer a helpful booklet entitled "Bits, Bytes & Buzzwords" that explains computer technology in simple, easy-to-understand terms. It's available at any of our Full Service System Centers.

800-VIASYN-1. Your direct line to unmatched values.

This toll-free number connects you with your nearest Full Service CompuPro System Center (in California, dial 800/VIASYN-2). It can supply all of the products highlighted in the following pages — and more. If you are looking for a product designed for your particular application, you'll find it at your local CompuPro center. Their staffs are trained to provide quality solutions to your problems, now and in the long run. At values that are truly exceptional in our competitive marketplace.

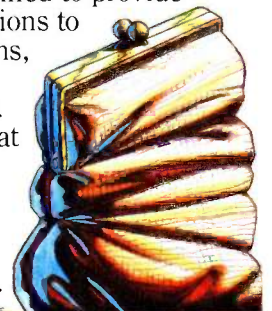

Built to save.

Computers designed to grow, and grow,



The CompuPro 816 (A1 through Z1).

A whole family that offers you exactly what you want in a computer. Dependable performance. Flexibility to grow. Increased productivity over a wide range of applications. You can expand from single to multi-user systems by simply adding more boards and peripherals. Use just as much power as you need — for over 3,000 industry standard business applications, as well as a wide variety of scientific and industrial programs. And this multi-user computer system lets you link as many as 255 systems for networks of more than 1000 users.

Our systems offer you many standard features that give you more functionality and value from the start. Operating system and selected applications pro-

grams are part of each system. All systems adhere to the IEEE 696/S-100 bus standard and may be easily expanded or upgraded with S-100 boards available from VIASYN. And each system is equipped with an 800 Kbyte double-sided, double-density 5¼" floppy disk drive.

In addition, we give you a wide choice of options that increase your system's power and versatility. You can add 5¼" or 8" floppy disk drives. Put on 40-Mbyte or 80-Mbyte hard disks, and get a 10-Mbyte tape backup. Instead of selecting our standard desktop models, you can choose our 19" rack mount option.

No matter which system or what options you choose, you can count on getting optimum performance for your money.

CompuPro 816/A1™ Ideal start-up system. Based on 8085/8088 CPU. Includes 128K RAM and our CP/M® 8-16™ operating system. \$3995.

CompuPro 816/C1™ Advanced 8085/8088 multi-user system. Equipped with 512 Kbytes of RAM. Bundled with Concurrent DOS™ 8-16.™ \$6895.

CompuPro 816/D1™ Based on 8086 processor, featuring 512K RAM and Concurrent DOS 8-16. The logical, economical way to grow. \$6995.

CompuPro 816/E1™ Powered by Motorola's 10-MHz 68000 chip, this 16-bit engine gives you 512 Kbytes of RAM, plus CP/M-68K™ for high-level languages, like mapForth and C. \$6495.

CompuPro 816/F1™ A 16-bit computer that uses Intel's 80286 processor. Features 512K of RAM and operates with Concurrent DOS 8-16. \$7995.

CompuPro 816/G1™ Outfitted with National Semiconductor's 16/32-bit 32016 micro-processor. This system offers you 512 Kbytes of RAM and is designed to run FORTH and UNIX.™ Fast, dependable, efficient. \$6895.

CompuPro 816/Z1™ Uses Zilog's proven 8-MHz Z-80 processor and operates with CP/M 2.2. Offers 64 Kbytes of static memory. It's the ideal personal tool. \$3495.

and grow, and grow

The CompuPro 816 (Fully Integrated Systems).

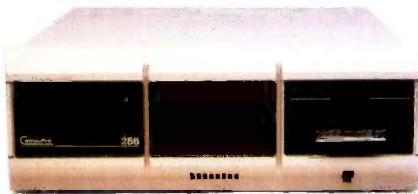

The CompuPro 286. This multi-user, multi-tasking computer is one of the most powerful business systems available in a desktop. Features Intel's 80286 processor for 16-bit operations, while CompuPro's Slave Processor Unit runs all 8-bit tasks via a speedy Z-80. The basic system is configured for 4 users but its expanded version can support eight users or more. Utilizes Concurrent DOS 8-16 and a wide range of sophisticated business programs. \$9995.

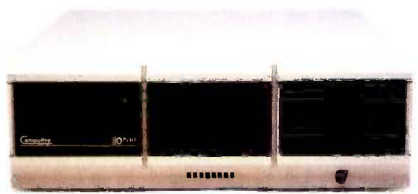

CompuPro 10 Plus 2. Equipped with 2 800 Kbyte floppies, 2 Z80 slave processors, each containing 64K RAM. Features the 8088 processor with 256K RAM. Options let you increase RAM in 256K increments to a maximum of 768K. You can add a second set of 2 slave processors, our MDRIVE[®]/H and our Net 10 board that facilitates network connections. \$3995.

CompuPro 10 Plus 40. In addition to an 800 Kbyte floppy, this system includes a 40 Mbyte hard disk and increases the number of Z80 slaves to four, at 64K RAM per board. The 10 Plus 40 also operates with 256K RAM for the 8088 processor and features the same options as the basic 10 Plus 2 system above, but adds a tape backup to the list. \$6995.

CompuPro 816 makes networking easy.

This multi-user, multi-processor option lets you share data and peripherals via the nodal cluster concept. Each node consists of one CompuPro 816 and its tied-in workstations. Connecting nodes is as easy as installing one of our Net 100 or Net 10 boards in each computer, and running standard RG 62 cables between them. Network hubs allow you to connect three or more computers. In this way, the CompuPro 816 network can support 255 nodes and cover distances to four miles. You work with speedy 2.5 megabit/second transfer rates and get individual, transparent on/off node operation. Thus, nodes can run without involving the entire network and do not affect overall network performance.

Operating Systems for the CompuPro 816 Family.

CP/M 2.2. An 8-bit high-performance, single-user operating system. Works with all CompuPro systems based on Intel's 8085 or Zilog's Z-80 CPUs. Uses the entire family of CP/M application software. Requires minimal hardware configurations.

CP/M 8-16. Single-user 8-bit and 16-bit operating system based on Digital Research's CP/M-86.[™] Downward compatible with most CP/M 2.2 software. Supports a variety of application software and languages as well as many more productivity tools.

CP/M-68K. 16-bit operating system supports Motorola's 68000 CPU. Similar to our CP/M 2.2 because it allows easy information transfer and convenient file manipulation. Lets you utilize all peripherals in your computer system.

Concurrent DOS 8-16. A high-performance, true multi-user, multi-tasking operating system for the CompuPro 816 series. Can be configured in either single- or multi-tasking mode for simultaneous 8- and 16-bit operation. This operating system supports DR/NET[™] allowing peripheral sharing among work stations and facilitating full local processing when used with the CompuPro Net 100 network board. Supports Digital Research's GSX graphics

and grow, and grow,

software and includes modem software. Features single-stroke, virtual screen switching (terminal-dependent). It can support more than eight users and a number of printers in a multi-user mode.

More power and flexibility across the board.

Our versatile CPU and memory boards are fully IEEE 696/S-100 bus compatible. You'll be able to mix or match 8-bit and 16-bit software on the same machine and choose just the power and memory your system needs.

CPU-Z™ 8-bit board with all standard Z80 features. Can be run at slower clock speeds when necessary, generating MWRITE for such operations. Includes plug that takes the connector from IMSAI type front panel. Equipped with 8 MHz Z80. \$275.

CPU 8085/88™ Includes two processors: the 10 MHz 8088, which is an 8-bit bus version of the 8086 16-bit CPU, and the 6 MHz 8085, an advanced 8-bit processor to run existing 8-bit software. Can be run at 2 MHz to accommodate timing-dependent software. \$350.

CPU 86™ Operates with Intel's high-performance 10 MHz 8086 processor. Includes socket for 8087 math processor. Compatible with 8-bit and 16-bit memory. \$395.

CPU 68K™ Based on Motorola's 68000 10 MHz processor. Socket for 68451 Memory Management Unit and sockets for up to 16 Kbytes of EPROM (8K x 16 bit organization). \$425.

CPU 32016™ This true 32-bit 6 MHz processor brings mainframe power to desktop micros. Includes sockets for on-board memory management and floating point units, plus up to 32 Kbytes of ROM. \$895.

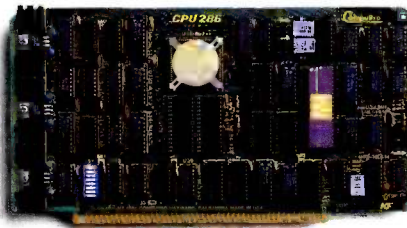

CPU 286™ Intel's iAPX™ 80286 16-bit processor shifts into high gear for you. C-Step 6 MHz version that offers sockets for 16 Kbytes of on-board EPROM and for 80287 math processor. Compatible with both 8- and 16-bit memory, mixing both in the same system. Includes our unique clock switching circuit for bus sharing by special slave processor boards. This feature lets you run alternate 8- and 16-bit software libraries with ease. \$995.

A lot of memory for a lot less.



Ram 22™ 256K x 8 bit or 128K x 16 bit organizations of low power static RAM. High-speed, high-density board automatically works with 8- or 16-bit processors. Smooth handling of fully static operations (e.g. DMA transfers). Draws half the power of dynamic equivalents. Operates with all our CPUs. \$1250.

Ram 23™ Same features as RAM 22 above in 128K x 8-bit or 64K x 16-bit configuration. \$395.

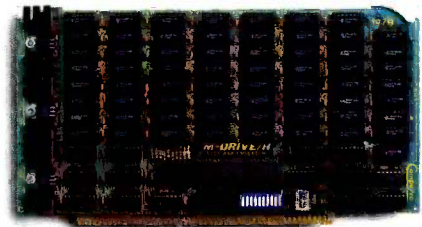

MDRIVE/H. Can increase operating speeds to 3500%! Greatly enhances disk-intensive performance. Emulates disk drive operation but runs at RAM speed. All of CompuPro's operating systems — including CP/M 8-16 and Concurrent DOS 8-16 — support our MDRIVE/H. 512K \$695. 1 Mbyte \$1350 (10 Plus). 2 Mbyte \$2450. 4 Mbyte \$4500 (10 Plus).

and grow, and grow,

Our disk controller boards drive for efficiency.

Disk 1A™ This floppy disk controller is geared for 8" and 5¼" drives. Reads and writes most popular formats. Uses the most advanced LSI floppy controller available. \$495.

Disk 2™/Selector Channel™ Our high-performance disk controller for sophisticated 8" Winchester drives. \$695.

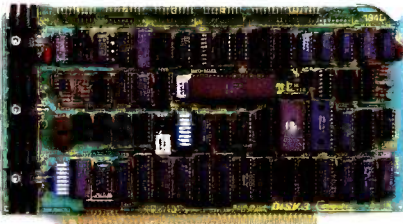

Disk 3™ Winchester controller for up to four 5¼" hard-disk drives. Unprecedented high performance for multi-tasking systems. The disk's channel processor seeks, reads and writes without external prompting. The host can transfer large data blocks between disk and memory on single command, designating source, destination and length. Disk sectors are transferred in high-speed "burst mode" DMA. ST 506 interface standard; SA 1100 available on special order. \$595.

More options for the growing CompuPro 816 network.

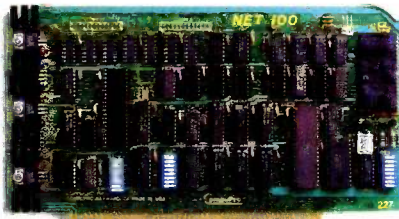

CompuPro Net 100 Board. Meets all IEEE 696/S-100 requirements, featuring eight switch-selectable I/O ports, on any 8-port boundary in the 64K I/O space. Supports 8-bit or 16-bit addressing. Also supports the ARCnet® token passing local area network protocol under Digital Research's DR/NET. Mainframe communication option available. \$395.

CompuPro Net 10. Has all the features of our Net 100 board but is used in CompuPro 10 Plus only. Mainframe communication option available as well. \$395.

Net Passive Hub. Connects up to four CompuPro 816 Computers. \$65.

Net Hybrid Hub. Connects up to eight CompuPro 816 Computers. \$295.

Interface Boards. Smoother ways to make peripherals talk.

Interfacer3™ This eight-channel serial I/O board conforms to all IEEE 696/S-100 specs. Ideal for multi-user, interrupt-driven environments. Includes six asynchronous DCE interfaces with full RS-232C handshaking. Two synchronous/asynchronous DTE/DCE high-speed channels provide RS-232C handshaking and bi-directional clock drivers. CRTs, printers, modems and other computers are easily connected. Also provides an exceptional interrupt structure. \$495.

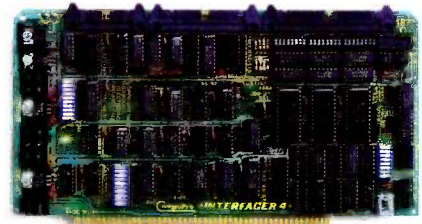

Interfacer4™ Advanced serial/parallel I/O board — the only one needed for most computer systems. Features asynchronous serial interface with full RS-232 handshaking and current

and even multiply.

loop capability. Two synchronous/asynchronous high-speed channels, plus RS-232 handshaking and bi-directional clock drivers. Smooth peripheral connections and Centronics parallel interface for fast printer signal transmission. Unique, easy interrupt structure, fully maskable and designed for flexible strapping. \$350.

A strong showing for better displays.

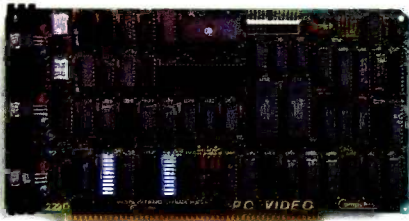

PC Video Board. Our high-speed PC Video board is a bit-mapped monochrome and RGB graphics show. It operates with the IBM®PC compatibility module and with Digital Research's GSX (Graphics System Extension) software, both supported by Concurrent DOS 8-16. Features 80 (normal) or 40 (double-width) columns by 25 lines in alphanumeric screen, in your choice of 16 colors or monochrome display mode. High-resolution: Up to 200 x 640 pixels (monochrome). Comes with Window Manager software. Supports "well-behaved" IBM

PC compatible software programs, plus DR Graph™ and DR Draw™ graphics packages from Digital Research, Inc. This board is the one to watch. \$495.

System support on a single board.

System Support 1™ A multiple-function S-100 board with 4K bytes of on-board RAM, dual interrupt controllers, 16-bit internal timers, a math processor, real time clock/calendar with battery backup and full RS-232 serial channel featuring software-selectable baud rate. ROM/RAM can be enabled/disabled by PHANTOM control and respond to the IEEE 24-bit (16 megabytes) extended address protocol. A board of many talents made for demanding systems. \$350.

A great choice in motherboards.

Pick 6, 12 or 21 slot versions. All are exceptionally quiet, fast and dependable. They offer active termination, full Faraday shielding of all signal traces, plus heavy power busses — with

great bypassing capability. Mating power connections are provided. \$135 (6 slot); \$195 (12 slot); \$295 (21 slot).

Enclosures for hard working systems.

VIASYN offers you CompuPro Desktop or Rack Mount (19") Enclosures. Constant voltage transformers provide cooler and more reliable operation with solid protection against varying line voltages. Rugged, metal construction. Line filter reduces effects of power line spikes and RFI. Fully terminated 21-slot motherboard and Faraday shielding, ideal for high-speed systems to 10 MHz. Enclosures include low-noise fan, air filter, 3 switched rear outlets, circuit breaker, lighted reset button and rear punchouts for DB-25, DB-15 and DB-50 connectors. Desktop \$950. 19" Rack Mount \$995.

Just what your system needs now.

The components, operating systems and the building blocks that can make computer systems grow stronger and more capable. All you have to do is contact your nearest Full Service CompuPro System Center and get the quality, dependability and cost economy you're looking for. Call toll-free: 800-VIASYN-1.

Registered Trademarks: CP/M, Digital Research Inc.; ARCnet, Datapoint Corporation; IBM, International Business Machines Corp.; MDRIVE and CompuPro, Viasyn Corporation; *Compound Trademarks:* CP/M 8-16 and Concurrent DOS 8-16, Digital Research and Viasyn Corporation. *Trademarks:* CP/M-68K, CP/M-86, DR/NET, DR Graph, and DR Draw, Digital Research; iAPX, Intel Corporation; UNIX, Bell Laboratories, Inc.

All prices and information subject to change without notice. Copyright © 1985 by Viasyn Corporation. Printed in the U.S.A.

Viasyn is supplying room and board to OEMs.

As much room and board as you need for your system. CompuPro® IEEE 696/S-100 Bus boards that let your systems grow and multiply. Reliable boards, delivered at prices our competition finds hard to beat.

As an experienced OEM supplier, we give you the choice and versatility you're looking for. For example, one of our CompuPro CPU boards is designed for concurrent 8- and 16-bit operation — mix or match. And you can choose from a wide variety of support boards, such as memory boards, interface boards, motherboards, controller boards — you name it.

In addition, you can count on reliable product performance. Evidence: our exclusive one year warranty with an option to extend it to two years on most products. Plus, the support of our nationwide network of expert service representatives.

So if you're looking for a dependable place that gives you plenty of room and board, just take a look at the preceding pages. Then call us toll-free for the best rates in town.

VIASYN™

The CompuPro People

Where Computers Grow

3506 Breakwater Court, Hayward, CA 94545
Call 800/VIASYN-1 • In CA, 800/VIASYN-2 • Telex: 510-100-3288 VIASYN CORP
CompuPro is a registered trademark of Viasyn Corporation.

F·I·X·E·S A·N·D U·P·D·A·T·E·S

BYTE'S BITS

More Equipment Eases Access to BYTEnet

As a direct result of the phenomenal response to BYTEnet Listings, we have recently increased the number of telephone lines and microcomputers support-

ing our new telecommunications service.

To accommodate the upgraded equipment, we had to change the number called to access BYTEnet Listings. Please

dial (617) 861-9774. When communication is established, please hit a carriage return or two so that the software can determine your data-transmission rate.

Author to Advise C Group

An independent Lattice C Users' Group has been formed under the guidance of Bill Hunt, author of the book *The C Toolbox*. Although the group will address the needs of users of Lattice, Lifeboat, and Microsoft versions of Lattice C, membership is not

limited to those users.

Group members receive a 16-page bimonthly newsletter that explains C's features, provides examples, and offers ways to employ C. A question-and-answer column is featured. Supplementing the

newsletter is a disk containing source files, demonstration programs, library functions, and public-domain programs.

A full year's membership is \$30. For details, contact the Lattice C Users' Group, POB 271965, Concord, CA 94527.

Upgrade to Lowercase Descenders

Tim Worcester, proprietor of the Electronic Closet in Bainbridge Island, Washington, has developed an upgrade kit that may be of interest to owners of the Gorilla Banana Printer.

The Banana, a low-cost printer from DAK Industries, does not produce true lowercase descenders, which, in turn, hampers its use in serious word-pro-

cessing applications.

"The software I have developed," says Worcester, "solves the lowercase problem and gives the user true descenders."

The software resides in EPROM, and installation is said to require the removal of the Banana's standard EPROM, which is then replaced by Mr. Worcester's EPROM.

A limited number of Banana upgrade kits are available for evaluation on a first-come, first-served basis from Mr. Worcester. He also has upgrade kits for Axiom's GPI00 series and for Tandy's TRS-80 LPVII and DMP-100 printers. For further information, contact Tim Worcester, Electronic Closet, 8187 Blakely Court W, Bainbridge Island, WA 98110.

User-Supported VT Terminal Emulator

PC-VT is a user-supported software emulator that enables the IBM PC to function as a DEC VT-52, VT-100, or VT-102 video terminal. It handles communication over an RS-232C port configured as either COM1 or COM2, and it supports common data-transmission rates and data-bit settings.

PC-VT is suitable for use with null modems for direct connection to a host computer or with a modem that does not

require modem-control signals. It sends DSR and RTS.

It supports Hayes dialing commands and has a 10-entry dialing directory. Function keys 1 through 10 can be used as macro keys, and PC-VT supports both numeric and application keypad modes.

It's said to have full-featured uploading and downloading file capabilities. ASCII and XMODEM protocols are supported. The ASCII upload feature has handshak-

ing capabilities.

A copy of the program is available by sending a formatted double-sided double-density disk to Mark C. DiVecchio, 9067 Hillery Dr., San Diego, CA 92126. A stamped, self-addressed mailer must accompany your request. A voluntary contribution is suggested. Contact Mr. DiVecchio for further information at the address above or call him at (619) 566-6810.

BYTE'S BUGS

A Few Points on a Million Points

Several readers have uncovered errors in James Hawley's "A Million-Point Graphics Tablet." (See April, page 120.)

In the caption for figure 1, IC1 through IC4 are inadvertently identified as U1 through U4.

In the parts list, a 100-microfarad capacitor is listed, yet no such device appears in the circuit diagram. Mr. Hawley informs us that this capacitor should be

connected between +5 volts and ground near the 7805 voltage regulator.

Two wiring errors mar the circuit diagram. The connection between pins 2 and 10 of IC2 should go between pins 5 and 10. In addition, a connection, omitted on the diagram, should be made between IC1 pin 6 and IC2 pin 13.

Finally, on page 120 there's a reference to a photo that does not appear. We

apologize for this oversight.

The following are clarifications of the discussion in the article:

The microcode in listing 1 is not a complete program, nor was it ever intended to be one. This code fragment provides access to the KoalaPad. It is all the necessary programming to obtain the *x,y* values that you need for drawing or for

(continued)

MidWest Micro-Peripherals

Gigantic Sale!

Epson Brother Star Zenith

PRICE GUARANTEE

We at MidWest Micro guarantee that we can save you up to 49% or more on your purchase of new fully warranted equipment and supplies. And we will still give you friendly, courteous service. Call today and Save With Confidence!

Don't spend a fortune to own the world's most popular printer . . .

NEW!

EPSON LIST \$349
LX-80 YOUR PRICE **\$269**



The new EPSON LX-80 prints smoothly and quietly at a speed of 100 cps. With the superb near letter quality mode and full graphic capabilities as standard, your correspondence will be letter perfect. The LX-80 comes complete with a parallel interface to quickly connect it to virtually all computers. There are 160 typestyles that are switch selectable and the LX-80 comes with EPSON's full 1 year warranty. Friction feed is standard and an optional tractor feed is available. Let the EPSON LX-80 print your next business letter or report.

Complete EPSON Line . . .	List	Your Price
LX-80 (100 cps, NQJ Mode, 80 Col.)	349	269
RX-100 (100 cps, 136 Col.)	895	399
FX-80+(160 cps, 80 Col, 2k Buffer)	699	389
FX-100+(160 cps, 136 Col, 2k Buffer)	999	589
LO-1500 (200 cps, NQJ Mode, 136 Col.)	1395	SCALL\$



brother

printer's give you all the features of a letter quality and more with . . .

NEW! **HR-15XL** ONLY **\$379**

The HR-15XL gives you Daisywheel printing and added attractions such as text reprinting, red printing, attachable cut sheet feeder and the exclusive Brother keyboard attachment.

Complete BROTHER Line . . .	List	Your Price
HR-15XL (17 cps, 13.5" carriage, 3k Buffer)	\$599	\$379
HR-15 & HR-15XL Keyboard Attachment	200	SCALL\$
HR-25 (23 cps, 16.5" carriage, 3k Buffer)	895	649
HR-35 (32 cps, 16.5" carriage, 7k Buffer)	1245	899
Brother 2024 (160 cps, 24 pin head, NQJ Mode)	1495	999

Get great hard copy and near letter quality with . . .



star Price too Low to Advertise!

SG-10 List \$299 (Replaces the Gemini 10X)

The SG-10 gives you enough versatility for home or office use. It operates bi-directionally at 120 cps and includes many special features such as near letter quality printing, easy access format switches for a wide range of character modes, friction feed for single sheets and tractor feed for fanfold paper, and even hex dump. Another special feature is the IBM character sets available at the flip of a switch. You get all of this plus a 2k memory buffer and Star's full 1 year warranty at a price you can afford!

Complete STAR Line . . . SCALL\$ and SAVE!

ZENITH SAVE up to 49% off!



Computer Systems
Get IBM compatibility, improved keyboard, faster processing speed, more memory capacity, free software, more expansion capability and unbelievable savings! Call today!

Z-150 COMPUTERS		
1/360k DD + 128k RAM + Software	\$2199	SCALL\$
2/360k DD + 320k RAM + Software	2799	SCALL\$
1/360k DD + Hard Drive + Software	4499	SCALL\$
Z-160 Portable COMPUTERS		
1/360k DD + Software	\$2399	SCALL\$
2/360k DD + Software	2999	SCALL\$

Prices subject to change and type errors

FREE CARD USE
Call Today!
Information - Ordering
1-800-423-8215
In Ohio **1-800-321-7731**
CUSTOMER SERVICE (513) 663-4992

CASH PRICES: Cert. Check, Money Orders, VISA or MC
CODs (Add \$5) AMEX (Add 4%) P.O.s (Add 5%)

MidWest Micro-Peripherals
(Division of Intofel, Inc.)
135 South Springfield St.
St. Paris, Ohio 43072

FIXES & UPDATES

cursor movements from the circuit board. If you add a Return at the end of the code, you will convert it into a subroutine that can be used in any graphics program that you devise.

The KoalaPad discussed in the article is the version that's designed to plug into the 16-pin game I/O socket of the Apple computer. The KoalaPad is produced by Koala Technologies Corp., 3100 Patrick Henry Dr., Santa Clara, CA 95050.

Address Correction

On page 370 of the April BYTE, we published an out-of-date address for Multi Solutions Inc., maker of the SI operating system. (See "Computing at Chaos Manor: Over the Moat" by Jerry Pournelle, page 355.)

The correct address for Multi Solutions Inc. is Suite 207, 123 Franklin Corner Rd., Lawrenceville, NJ 08648, (609) 896-4100.

Manufacturer Misidentified

In the April BYTE, we misidentified the manufacturer of KES. (See "The Technology of Expert Systems" by Robert H. Michaelsen, Donald Michie, and Albert Boulanger, page 303.)

On page 306, in the partial listing of domain-independent rule-based expert systems, we identified another company as the manufacturer of KES when, in fact, Software Architecture and Engineering Inc. of Arlington, Virginia, developed and markets the system.

KES, or Knowledge Engineering System,

runs on an IBM PC XT and requires IQLISP, an 8087 coprocessor, and 640K bytes of RAM. The IBM PC XT version is \$4000, which includes documentation. Versions of KES are also available for the VAX and other machines.

Software A&E maintains offices at Suite 800, 1500 Wilson Blvd., Arlington, VA 22209, (703) 276-7910. In the United Kingdom, address inquiries to Software Architecture and Engineering Inc., 16 New Park Rd., Chichester, West Sussex PO19 1XH; tel: 0243-789310.

Bugs Warp Reply

Several typographical errors marred Charles Kluepfel's reply to Martin Kochanski's letter in the March BYTE. (See "The Real RSA Algorithm" on page 26.)

The errors began around the discussion of the subroutine coding on page 30. The text should have read:

In place of the line in listing 1 that says

D:QUOTIENT(2*(P - 1)*(Q - 1) + 1,3),

put the following coding:

```
D:NXPRIIME(P + Q),
LOOP
D: NXPRIIME(D + 1),
X0: (P - 1)*(Q - 1),
X1: D,
A0: 1,
B0: 0,
```

```
A1: 0,
B1: 1,
LOOP
QU: QUOTIENT(X0,X1),
X2: X0 - QU * X1,
A2: A0 - QU * A1,
B2: B0 - QU * B1,
X0: X1,
X1: X2,
A0: A1,
A1: A2,
B0: B1,
B1: B2,
WHEN X1 = 1,
E: ABS(B1), EXIT,
ENDLOOP,
WHEN E > 2026, EXIT,
WHEN 2 * E > N, EXIT,
ENDLOOP,
```

Benchmark Misstated

In a recent What's New write-up, we incorrectly reported the speed of Systems Management Associates' PROMAL language for the Commodore 64. (See "Structured Programming Language Released for Commodore," page 446, April.)

The benchmarks show PROMAL to be from 70 to 2000 percent faster than BASIC, COMAL, FORTH, and Pascal.

PROMAL, a high-level, structured lan-

guage that's similar to C and Pascal, is available in versions for the Apple IIe and IIc and the IBM PC. The price is \$49.95; a developer's package with an unlimited distribution license is \$99.95. Contact Systems Management Associates, 3700 Computer Dr., POB 20025, Raleigh, NC 27619. Technical information is available by calling (919) 787-7703, or, for orders only, you can call (800) 762-7874.

Circuit-Board-Artwork Software for the Design Engineer in a Hurry

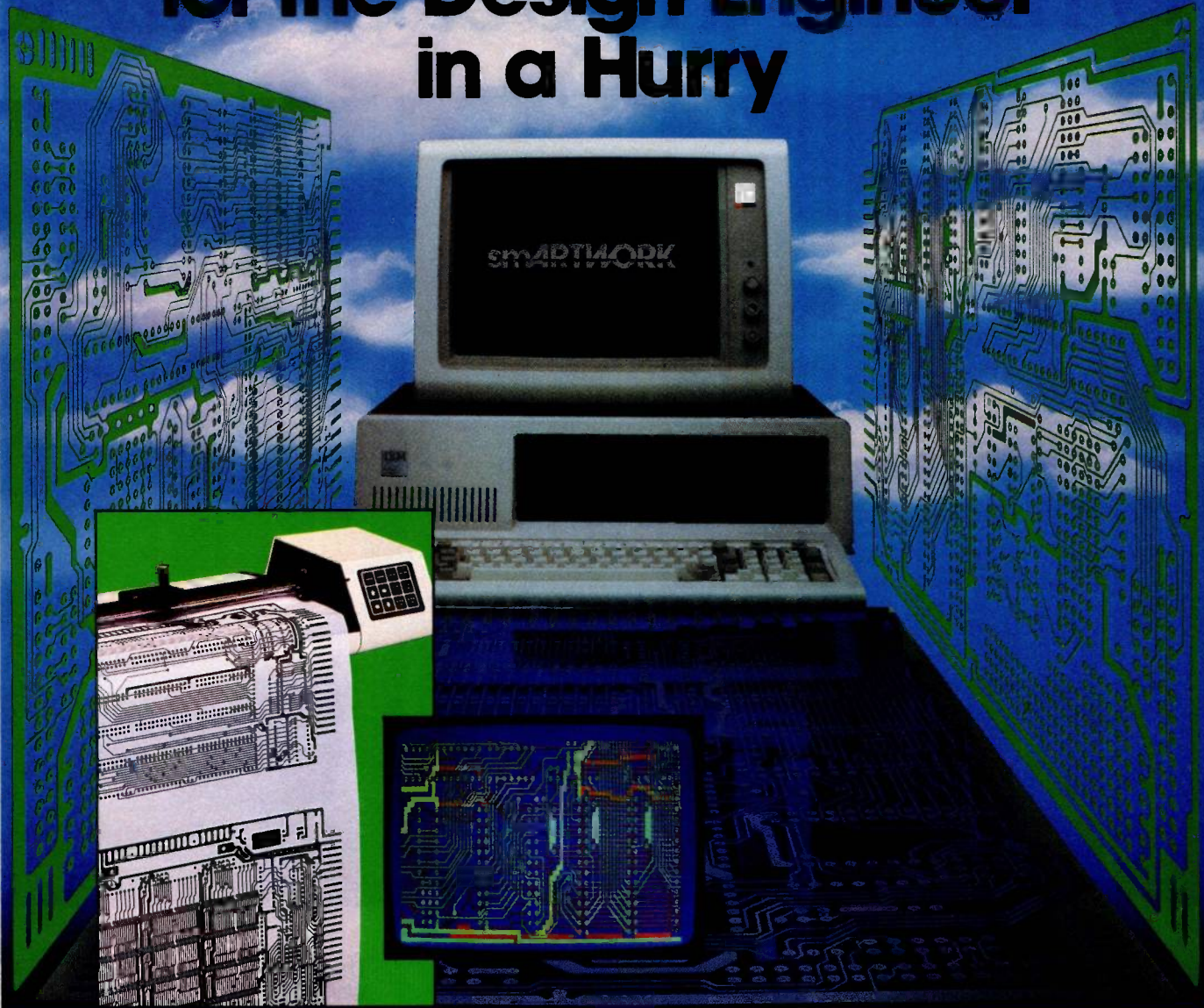

For only \$895, smARTWORK® lets the design engineer create and revise printed-circuit-board artwork on the IBM Personal Computer. You keep complete control over your circuit-board artwork — from start to finish.

Forget the tedium of taping it yourself or waiting for a technician, draftsman, or the CAD department to get to your project.

smARTWORK® is the only low-cost printed-circuit-board artwork editor with all these advantages:

- Complete interactive control over placement and routing
- Quick correction and revision
- Production-quality 2X artwork from a pen-and-ink plotter
- Prototype-quality 2X artwork from a dot-matrix printer

- Easy to learn and operate, yet capable of sophisticated layouts
- Single-sided and double-sided printed circuit boards up to 10 x 16 inches
- Multicolor or black-and-white display

System Requirements:

- IBM Personal Computer, XT, or AT with 256K RAM, 2 disk drives, and DOS Version 2.0 or later
- IBM Color/Graphics Adapter with RGB color or black-and-white monitor
- IBM Graphics Printer or Epson FX/MX/RX series dot-matrix printer
- Houston Instrument DMP-41 pen-and-ink plotter
- Optional Microsoft Mouse

The Smart Buy

At \$895, smARTWORK® is proven, convenient, fast, and a sound value. Call us today. And put it to work for yourself next week.



Wintek Corporation
1801 South Street
Lafayette, IN 47904-2993
Telephone: (317) 742-8428
Telex: 70-9079 WINTEK CORP UD

In Europe contact: RIVA Terminals Limited,
Woking, Surrey GU21 5JY ENGLAND,
Telephone: 04862-71001, Telex: 859502

"smARTWORK"; "Wintek" and the Wintek logo are registered trademarks of Wintek Corporation.
Inquiry 425

Which is the better way to



Any growing business needs to organize, analyze and use data.

Customer orders. Shipping records. Inventory. Billing. Prospect lists.

Now, depending on your Macintosh software, you can manage data one of two ways.

The simple, stuff-everything-into-one-file theory of data management.

That's how ordinary files and information managers work.

You jam data into a single file that includes every piece of information you might ever want to know.

3	1	ROGER ADRES	6	15	503	PATCH KIT	40.0	28.7	13
4	2	TOM BURKE	5	5	501	HOT HELY	88.5	58.3	77.1
5	2	TOM BURKE	3	5	502	ACRYLIC	27.0	22.5	32.2
6	2	TOM BURKE	3	5	503	PATCH KIT	21.1	33.3	33.1
7	2	TOM BURKE	3	5	504	AEROSPACE	7.0	8.1	12.2
8	2	TOM BURKE	3	5	505	PASTE	11.1	8.8	5.1
9	3	CHARLIE CARR	11	5	501	HOT HELY	86.3	54.2	77.2

With an ordinary data manager, you have to re-enter existing information every time you enter new information. Pretty inefficient.

ENTER SALES													
Add		Delete		Next		Previous		First		Last		Quit	
SALESMEN'S SALES STATISTICS													
SALESMAN NO: 2													
NAME: TOM BURKE													
AREA: 3													
LINE: 5													
PROD#	PRODUCT	JAN	FEB	MAR	APR	MAY	JUNE	TOTAL					
501	HOT HELY	88.3	65.3	77.7	87.5	66.0	43.8	400.6					
502	ACRYLIC	27.0	23.6	32.4	33.2	22.2	17.9	205.2					
503	PATCH KIT	21.1	33.3	33.5	19.7	21.4	58.0	187.0					
504	AEROSPACE	7.0	8.5	12.3	9.9	10.5	13.0	61.2					
505	PASTE	11.1	8.8	5.3	0.0	0.0	0.0	25.2					
		154.5	136.5	161.2	142.3	120.1	162.6	877.2					

With MacLion, you only have to enter the new data that has changed. Not only that, you can design your own data entry screens. Now, which is the most efficient way to manage your business data?

The problem?

Well, if you have a sales order entry file, every time you enter new data about a customer's order, you also have to re-enter all the existing data about your customer.

Repeat, repeat, repeat.

Worse, if you ever want to move the data from your sales order entry file to develop a new file, without having to rework it all over again, there's one small problem.

You can't.

Okay. Let's get serious.

MacLion™, on the other hand, is a true relational database management system.

MacLion.™ Serious database power for serious

manage your data?

Run-time
version available.



entirely new applications for your existing database just by adding new relations.

That's the most efficient way to manage your data.

For a MacLion demonstration, see your dealer. Or, send for our "Serious Buyer's Guide to Database Management Systems," which includes a demonstration disk



Simple vs. serious.

And MacLion gives you some other remarkable features, too.

You can design and generate your own custom data entry screens and reports. Just by clicking your mouse through Macintosh pull-down menus—without programming.

Or, if you're a programmer at heart, you can also use MacLion's built-in procedural language and add even more specialized functions.

That's serious database power, only possible with MacLion.

plus complete information on what a database management system can do for your business. Get serious—with MacLion.



1904 Wright Circle, Anaheim, CA 92806

Macintosh is a trademark licensed to Apple Computer, Inc. MacLion is a trademark of Computer Software Designs, Inc.

Inquiry 107

So instead of trying to jam all your business data into one massive file, you can set up several smaller, more manageable "relations." (Picture them as a series of neat file folders.)

The advantage?

In a sales order entry system, one relation contains biographical data about your customers that doesn't change. Another has their order data that does.

There's no duplication.

So when it's time to update customer orders, you only have to enter in new data. Not re-enter what already exists. And you can develop

I'm serious about managing my data.

- Please send me your free "How to Buy a Database Management System" brochure.
 - Please send me "A Serious Buyer's Guide to Database Management Systems." I've enclosed \$9.95.
 - Check or money order enclosed.
 - Please charge my: VISA MasterCard Number _____
- Expiration Date _____ Signature _____



VISA and MasterCard orders can be placed by phone. Call (800) 252-LION or (714) 634-9012.

Calif. residents please add 6% tax.

Send to: Database Guide
COMPUTER SOFTWARE DESIGNS INC.
1904 Wright Circle
Anaheim, California 92806

Name _____

Address _____

City _____ State _____ Zip _____

Macintosh users.

INTRODUCING NEAR LETTER QUALITY AND THROUGHPUT SPEEDS OTHER PRINTERS CAN'T COME NEAR.

The new C. Itoh ProWriter™ 8510S-LQ Near Letter Quality printer is a whole new field of one.

It's priced at just \$549. But it gives you near letter quality printing for beautifully sharp characters like printers costing hundreds of dollars more.

And in a text and graphics speed test against its closest competition, namely the Epson® FX-80 and the Okidata Microline 92, the new and faster C. Itoh 8510S-LQ out printed them all.

The stopwatch proved that the 8510S-LQ, at throughput speeds of 100 full lines per minute, printed text up to 35% faster than the competition. And it created bar graphs and pie charts up to 54% faster.

Of course, speed in itself does not keep a printer in a class by itself. Reliability does. That's something no C. Itoh printer has ever lacked. No other printers are more thoroughly tested or proven on the job. Which is why C. Itoh printers continue to be the world's best sellers, with 1.7 million sold last year alone.

For more information on the new and faster C. Itoh 8510S-LQ or wider carriage 1550S-LQ Near Letter Quality printers just see your C. Itoh dealer. Or call us toll free at 1-800-423-0300.

Or write C. Itoh Digital Products, Inc., 19750 South Vermont Avenue, Suite 220, Torrance, CA 90502.

™ ProWriter is a Trademark of C. Itoh Digital Products, Inc.
® Epson is a Registered Trademark of Epson, America, Inc.
© 1985 C. Itoh Digital Products, Inc.

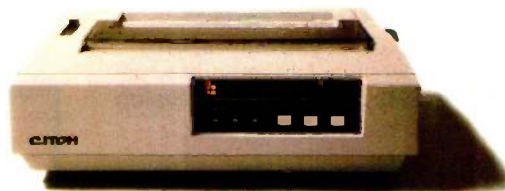

C. ITOH

Printers

Commodore Exhibits Computer Series

Commodore International exhibited its new 900 series computer at the Hannover Fair in West Germany late in April.

The Commodore 900 series consists of a multi-user, UNIX-like system and a high-performance individual workstation. Commodore spokespeople claim that, although the 900 will sell for "well below \$4000," its functionality and performance are similar to workstations costing five times more.

The individual workstation is distinguished by a 14-inch, bit-mapped monitor that has a resolution of 1024 by 800 pixels and a 72-MHz bandwidth. The video controller carries 128K bytes of RAM and will soon employ two-dimensional Bit-BLT technology, which, in short, will give you raster-like, display-screen operations from hardware. With the bit-mapped display, you can mix text and graphics windows on screen. A 17-inch monitor is available.

The multiuser version of the 900 has a monochrome, character-mapped display. Its attributes are similar to those of the IBM Personal Computer's monochrome monitor. The display format is 80 by 25.

An 8-MHz Zilog Z8000, backed by a minimum of 512K bytes of RAM and Mark Williams Company's Coherent, is at the heart of the Commodore 900. A 10-MHz version of the Z8000 is being developed,



The Commodore 900 made its debut in Europe.

although the 8-MHz model reportedly provides the speed and performance of a 286 microprocessor running at 10 MHz.

Coherent, a multiuser, multitasking system, is fully UNIX-compatible. It is currently being optimized for further compatibility with AT&T UNIX System VII as well as for use on the Commodore 900.

Formatted storage is provided by a 20-megabyte hard-disk drive and a 1.2-megabyte, half-height floppy-disk drive. A second floppy-disk drive, a streaming-tape backup, and 40- or 67-megabyte hard-disk units are available as options.

The Commodore 900 has two RS-232C interfaces, a parallel port, and an IEEE-488 connection for a variety of peripherals and instruments. A VDI interface and a graphics kernel system are provided. An optional

eight-port RS-232C board serves as the multiuser link. You can easily access four expansion slots through the back of the machine.

Mounted on the keyboard is a mouse-control pad that can also serve as a standard cursor-control unit. The keyboard itself has 99 keys as well as a separate numeric pad. A three-button mouse is standard with the individual workstation.

In addition to Coherent, the Commodore 900 comes with the new ANSI-standard BASIC and a UUC (UNIX-to-UNIX Copy) package. Pascal and COBOL are among the supported compilers.

User memory can be expanded to 2 megabytes on the main board with 256K-

byte dynamic RAMS. Commodore plans color capabilities and will offer a software plotting package.

At press time, Commodore had not made a final decision on pricing for the multiuser version of the Commodore 900; however, sources at Commodore estimated that the base price will be in the \$3000 range.

European shipments of the Commodore 900 should start during September. It is uncertain when deliveries in the U.S. will commence. Contact Commodore International Ltd., 1200 Wilson Dr., West Chester, PA 19380, (215) 431-9100. Inquiry 600.

NAPLPS Board for IBM

The MGB 8024 NAPLPS/graphics board from Electronic Office Systems (Videotex) Limited of Israel is designed to replace or supplement existing IBM PC graphics adapters. It works with both the IBM PC family and its compatibles.

Its software drivers let you select from the following modes: full SRM NAPLPS decoder with 256 by 210 resolution and 16 colors from a palette of 4096; a graphics mode with resolutions of 640 by 200 or 512 by 256 using 4 colors out of the full palette; a 4-color text mode with an 80-column by 25-line display; and a Prestel decoder emulation mode.

The MGB 8024 comes with a dedicated graphics controller. Installed versions

(continued)



The QuadLaser has 256K bytes of memory for image storage.

of popular graphics applications will be available. With a manual and software, the MGB 8024 is \$495. Contact Electronic Office Systems (Videotex) Ltd., POB 45266, Tel Aviv 61452, Israel; tel: (972)-3-299908; Telex: 341667 RMYM IL ATT EOS/949. Inquiry 601.

Quadram's Laser Printer

Quadram's QuadLaser is an 8-page-per-minute laser printer. It comes with 256K bytes of memory (expandable to 2 megabytes) for storage of bit-mapped images, programs, or up to 60 standard and user-developed type fonts.

QuadLaser has ROM software to emulate Epson and Qume printers. You can download user-written software to emulate other printers or provide more advanced features using the controller's Z8001 processor. Quadram supplies 7 fonts on IBM PC disks with the QuadLaser. You can use each font in portrait or landscape modes (horizontally

or vertically), and you can also create additional fonts using an editor that comes with the QuadLaser. You can get 13 more fonts from Quadram at extra cost.

The QuadLaser can print up to 10,000 pages per month, and Quadram says it will last for about 600,000 pages. In addition to standard 8½- by 11-inch paper, the QuadLaser can print on transparencies and European-size paper. Its paper cassette stores 250 sheets. You replace toner cartridges and the print belt separately—Quadram claims that this reduces the printer's operating cost. The QuadLaser weighs 85 pounds and measures 14½ by 20¾ by 23½ inches with the paper cassette and tray installed.

The QuadLaser will be available this month for under \$3400. Contact Quadram Corp., 4355 International Blvd., Norcross, GA 30093, (404) 923-6666. Inquiry 602.

Victor PCs Are Compatible with IBM

Victor Technologies' VPC and VI are compatible with the IBM Personal Com-

puter. Built around Intel's 8088 processor, these computers come with a minimum of 256K bytes of RAM and VBASICA, a Victor-enhanced version of BASICA. The operating system is MS-DOS 2.1, and an upgrade to MS-DOS 3.0 is planned.

Both systems employ Victor-VU, an on-screen guide that translates DOS functions into easy-to-use instructions. This interface gives you single-keystroke help screens, an on-screen application guide, keyboard programmability, and pop-up windows.

Victor offers three models of the VPC. One features twin 360K-byte floppy-disk drives; the others have a single floppy disk and either 15 or 30 megabytes of hard-disk storage.

Seven expansion slots let you add features to the VPC as your needs evolve. Its standard parallel port gives you links with many printers or plotters. High-resolution monochrome or full-color display screens are available, and the 83-key keyboard has 10 function keys and capital- and number-lock LEDs.

VPC pricing begins at \$2485, which includes a 14-inch monitor. The 30-megabyte version is \$4785.

The Victor VI is offered with a choice of storage arrangements: dual 1.2-megabyte floppy-disk drives or a single floppy-disk unit with either a 10-, 20-, or 30-megabyte hard disk. The VI keyboard, which can be programmed for dual Victor and IBM functionality, has 16 function keys, a numeric keypad, and cursor controls.

In the Victor mode, the nonglare 12- or 14-inch

monitor provides high-resolution, 800- by 400-pixel, bit-mapped images. The format is 80 by 25 with a 10- by 16-dot character cell. The display supports IBM PC screen attributes in the IBM mode. Other display features include color emulation with shading and dot pattern supporting 320- and 640- by 200-dot graphics modes and 40- and 80-column PC text modes.

The VI has two independent, full-duplex RS-232C ports and single 36-pin Centronics and 50-pin user-programmable ports. The Centronics port supports IEEE-488 in the Victor mode. Three slots are available for expansion, and you can expand RAM to 1.98 megabytes.

IBM PC programs can be stored on Victor-formatted disks and vice versa. Victor 9000 MS-DOS programs are supported.

The VI with two floppy-disk drives begins at \$4295. Contact Victor Technologies Inc., 380 El Pueblo Rd., Scotts Valley, CA 95066, (408) 438-6680. Inquiry 603.

BDS Laser Printer

BDS Corporation has introduced the BDS Laser 630/8. Like the Hewlett-Packard LaserJet, the 630/8 is based on Canon's LBP-CX print engine and uses the same replaceable toner/belt cartridge.

The BDS printer comes with nine type fonts: two fonts each in normal, italic, bold, and bold italic, and one font in "landscape mode." Using optional ROM or RAM cartridges, you can download type fonts from a microcomputer. A Diablo

(continued)

MOST SIGNIFICANT PRODUCT OF THE YEAR - PC WEEK

They said it couldn't be done. Borland Did It. Turbo Pascal 3.0

The industry standard

With more than 250,000 users worldwide Turbo Pascal is the industry's de facto standard. Turbo Pascal is praised by more engineers, hobbyists, students and professional programmers than any other development environment in the history of microcomputing. And yet, Turbo Pascal is simple and fun to use!

COMPILATION SPEED
EXECUTION SPEED
CODE SIZE
BUILT-IN INTERACTIVE EDITOR
ONE STEP COMPILE (NO LINKING NECESSARY)
COMPILER SIZE
TURTLE GRAPHICS
BCD OPTION
PRICE

TURBO 3.0	TURBO 2.0	MS PASCAL
8.1	16	206
9 ^{SEC}	13 ^{SEC}	20 ^{SEC}
12 K	12 K	35 K
YES	YES	NO
YES	YES	NO
YES	35K	300K
39K	NO	NO
YES	NO	YES
YES	NO	\$299.00
YES	\$54.95	
\$69.95		

The best just got better: Introducing Turbo Pascal 3.0

We just added a whole range of exciting new features to Turbo Pascal:

- First, the world's fastest Pascal compiler just got faster. Turbo Pascal 3.0 (16 bit version) compiles twice as fast as Turbo Pascal 2.0! No kidding.
- Then, we totally rewrote the file I/O system, and we also now support I/O redirection.
- For the IBM PC versions, we've even added "turtle graphics" and full tree directory support.
- For all 16 Bit versions, we now offer two additional options: 8087 math coprocessor support for intensive calculations and Binary Coded Decimals (BCD) for business applications.
- And much much more.

The Critics' Choice.

Jeff Duntemann, PC Magazine: "Language deal of the century . . . Turbo Pascal: It introduces a new programming environment and runs like magic."

Dave Garland, Popular Computing: "Most Pascal compilers barely fit on a disk, but Turbo Pascal packs an editor, compiler, linker, and run-time library into just 39K bytes of random-access memory."

Jerry Pournelle, BYTE: "What I think the computer industry is headed for: well documented, standard, plenty of good features, and a reasonable price."

Portability.

Turbo Pascal is available today for most computers running PC DOS, MS DOS, CPM 80 or CP/M 86. A XENIX version of Turbo Pascal will soon be announced, and before the end of the year, Turbo Pascal will be running on most 68000 based microcomputers.

(*) Benchmark run on an IBM PC using MS Pascal version 3.2 and the DOS linker version 2.6. The 179 line program used is the "Gauss-Seidel" program out of Alan R. Miller's book: *Pascal programs for scientists and engineers* (Sybex, page 128) with a 3 dimensional non-singular matrix and a relaxation coefficient of 1.0

An Offer You Can't Refuse.

Until June 1st, 1985, you can get Turbo Pascal 3.0 for only \$69.95. Turbo Pascal 3.0, equipped with either the BCD or 8087 options, is available for an additional \$39.95 or Turbo Pascal 3.0 with both options for only \$124.95. As a matter of fact, if you own a 16-Bit computer and are serious about programming, you might as well get both options right away and save almost \$25.

Update policy.

As always, our first commitment is to our customers. You built Borland and we will always honor your support.

So, to make your upgrade to the exciting new version of Turbo Pascal 3.0 easy, we will accept your original Turbo Pascal disk (in a bend-proof container) for a trade-in credit of \$39.95 and your Turbo87 original disk for \$59.95. This trade-in credit may only be applied toward the purchase of Turbo Pascal 3.0 and its additional BCD and 8087 options (trade-in offer is only valid directly through Borland and until June 1st, 1985).

TURBO PASCAL

NOT COPY-PROTECTED

Available at better dealers nationwide. Call (800) 556-2283 for the dealer nearest you. To order by Credit Card call (800) 255-8008, CA (800) 742-1133

Carefully Describe your Computer System!

Mine is: 8 bit 16 bit
 I Use: PC-DOS MS-DOS
 CP/M 80 CP/M 86

My computer's name/model is: _____

The disk size I use is:
 3 1/2" 5 1/4" 8"

Name: _____
 Shipping Address: _____
 City: _____ Zip: _____
 State: _____ Telephone: _____

For update: original Turbo disk must accompany order

YES! I want the Best! Please send: _____ Quantity _____

Pascal 3.0 \$ 69.95 _____
 Pascal w/8087 \$109.90 _____
 Pascal w/BCD \$109.90 _____
 Pascal w/8087 & BCD \$124.95 (SAVE \$24.90)

* These prices include shipping to all U.S. cities. All foreign orders add \$10 per product ordered.

Subtotal (CA 6% tax) _____
 Trade-in Credit Claimed: _____

Amount Enclosed: _____
 Payment: VISA MC BankDraft Check

Credit Card Expir. Date: _____
 Card #: _____

15

COD's and Purchase Orders WILL NOT be accepted by Borland. California residents: add 6% sales tax. Outside USA: add \$10 and make payment by bank draft, payable in US dollars drawn on a US bank.

BORLAND INTERNATIONAL Software's Newest Direction
 4585 Scotts Valley Drive
 Scotts Valley, CA 95066
 TELEX 172373

Turbo Pascal is a registered trademark of Borland International, Inc.
 PC Week is a trademark of Ziff-Davis Pub. Co.
 Inquiry 55 for End-Users. Inquiry 56 for DEALERS ONLY.

630 emulation mode is provided for offices already using a daisy-wheel printer. The BDS 630/8 can print text at a resolution of 300 by 300 dots per inch.

The printer provides a "screen dump" image from an IBM PC and can enlarge text and screen images from two to eight times. It has two Z80 processors and 64K bytes of local memory to store font information and to buffer up to about five pages of text. Parallel and serial ports let you link the printer to two computers.

The BDS 630/8 laser printer sells for \$3495. For more information, contact BDS Corp., 800 Maude Ave., Mountain View, CA 94043, (415) 964-2115.

Inquiry 604.

XTRA XP: An 80286-Based PC

ITT's XTRA XP is compatible with the IBM PC XT but executes programs faster because it uses Intel's 6-MHz 80286 microprocessor. According to ITT, the XTRA XP also features "no-wait-state" RAM, letting it access memory information more quickly than comparable IBM computers. This includes the PC AT, which uses the same processor.

The XTRA XP has 512K bytes of memory (expandable on the main circuit board to 640K bytes), serial and parallel ports, ROM diagnostics software, one 360K-byte 5¼-inch floppy-disk drive, and a 10- or 20-megabyte hard-disk drive. Of the system's five IBM PC XT-compatible expansion slots, one is for the hard-disk controller and another for an optional graphics-display adapter.

You can get an optional



The XTRA XP has "no-wait-state" RAM.

card with 1 megabyte of additional "no-wait-state" RAM for use as a virtual disk. Other options include an 80287 numeric coprocessor and the MS-DOS 2.11 operating system.

The ITT XTRA XP with a 10-megabyte hard disk will carry a suggested list price of \$3995. With a 20-megabyte drive, the price is \$4595. Monochrome or color graphics adapters are \$145 and \$190, respectively. The 1-megabyte RAM-disk expansion card with 512K bytes of memory on board will sell for \$395. Contact ITT Information Systems, 2041 Lundy Ave., San Jose, CA 95131, (408) 945-8950. Inquiry 605.

AT&T Links MS-DOS and UNIX Micros, Offers PC 6300 Enhancements

AT&T has introduced a local-area network and a number of enhancements for its PC 6300 micro-computer.

STARLAN, slated for release at year's end, links

up to 200 computers in a star or ring configuration or a combination of both. Adapter boards tailor the network for computers with IBM PC-compatible expansion slots and for AT&T's UNIX-based systems.

STARLAN uses twisted-pair cabling and can take advantage of existing telephone wiring. The maximum data-transfer rate is 1 megabit per second. Network boards are about \$600, and the network software is \$125 per machine.

AT&T's PC 6300 Display Enhancement Board lets you display 16 colors at a resolution of 640 by 400 pixels on a standard IBM PC-compatible RGB monitor. On a monochrome monitor, the 6300 can produce 16 shades of gray at this resolution. Color mapping for rapid color changes is supported.

The Mouse 6300 attaches directly to the PC 6300's keyboard and comes with software that allows its use with many programs that were not designed for mice.

It comes with a simple word processor and graphics. The suggested price is \$150.

A version of XENIX, adapted for AT&T by the Santa Cruz Operation, is available for the PC 6300. This version of XENIX supports two users, allows file transfers between it and MS-DOS, and provides file and record locking. It's divided into three modules: the basic operating system (\$395), a software-development package (\$450), and a text-processing package (\$150).

The AT&T Communications Manager board for the PC 6300 and the IBM PC comes with a 1200-bps modem, three phone jacks, and communications software. It lets you auto-dial up to 200 numbers and, if connected to two telephone lines, can handle simultaneous voice and data connections. The software lets you switch from communications to any other PC application instantaneously. The modem is not Hayes-compatible, but VT-100 terminal-emulation software is provided. It lists for \$599.

Other enhancements for the AT&T PC 6300 include a 20-megabyte hard-disk drive and an 8-MHz 8087-2 numeric coprocessor. The coprocessor is \$295; the hard disk's pricing was not available at press time. Contact AT&T Information Systems, 100 Southgate Parkway, Morristown, NJ 07960.

Inquiry 606.

GEM Applications

GEM Desktop and GEM Draw are Digital Research's first end-user applications designed exclusively for its Graphics Environment Manager (GEM) operating-system extension. In a related announcement,

(continued)

Borland's SideKick Software Product of the Year*

SideKick is InfoWorld Software Product of the Year. It won over Symphony. Over Framework. Over ALL the programs advertised in this magazine. Including, of course, all the "fly-by-night" SideKick imitations. **SideKick Simply the best.**

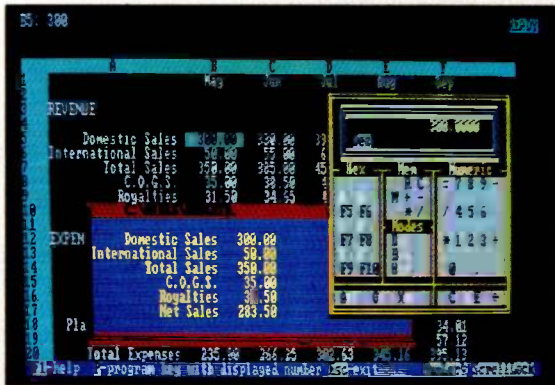

Here's SideKick running over Lotus 1-2-3. In the SideKick Notepad you'll notice data that's been imported directly from the Lotus screen. In the upper right you can see the SideKick Calculator.



All the SideKick windows stacked up over Lotus 1-2-3. From bottom to top: SideKick's "Menu Window", ASCII table, Notepad, Calculator, Appointment Scheduler/Calendar, and Phone Dialer. Whether you're running WordStar, Lotus, dBase, or any other program, SideKick puts all these desktop accessories instantly at your fingertips.



InfoWorld Report Card 1984 by Popular Computing, Inc., a subsidiary of CW Communications Inc. Reprinted from InfoWorld, 1060 Marsh Road, Menlo Park, CA 94025.

Jerry Pournelle, BYTE: "If you use a PC, get SideKick. You'll soon become dependent on it."

Garry Ray, PC Week: "SideKick deserves a place in every PC."

Charles Petzold, PC Magazine: "In a simple, beautiful implementation of WordStar's block copy commands, SideKick can transport all or any part of the display screen (even an area overlaid by the notepad display) to the notepad."

Dan Robinson, InfoWorld: "SideKick is a time-saving, frustration-saving bargain"

BORLAND INTERNATIONAL Software's Newest Direction
4585 Scotts Valley Drive
Scotts Valley, CA 95066
TELEX 172373

SIDEKICK

NOT COPY-PROTECTED

Available at better dealers nationwide. Call (800) 556-2283 for the dealer nearest you. To order by Credit Card call (800) 255-8008, CA (800) 742-1133

Yes, I want the Best.
Please send me SideKick!

SideKick Copy Protected
Quantity: _____ at \$54.95
(CA res. add \$3.30 tax per copy)

SideKick Not Copy-Protected
Quantity: _____ at \$84.95
(CA res. add \$5.10 tax per copy)

Amount: (CA 6% tax) _____

Payment: VISA MC BankDraft Check

Credit Card Expir. Date: _____

Card #: _____

These prices include shipping to all U.S. cities. All foreign orders add \$10 per product ordered.

PCjr requires not copy-protected version

Name: _____

Shipping Address: _____

City: _____ State: _____ Zip: _____

Telephone: _____

S15

COD's and Purchase Orders WILL NOT be accepted by Borland. California residents: add 6% sales tax. Outside USA: add \$10 and make payment by bank draft, payable in US dollars drawn on a US bank.

Symphony, Lotus & Lotus 1-2-3 are trademarks of Lotus Development Corp. dBase & Framework are trademarks of Ashton-Tate. WordStar is a trademark of Micropro International Corp. SideKick is a trademark of Borland International.

*Selected by InfoWorld as the most significant software product of the year.

Inquiry 57 for End-Users. Inquiry 58 for DEALERS ONLY.

Digital Research introduced GEM Paint and GEM Write, a pair of programs that will be bundled with GEM Desktop in a package called the GEM Collection.

GEM applications feature drop-down menus, windows, and icons. They run on the IBM PC and its compatibles.

GEM Desktop replaces operating-system commands with a visual interface. It produces a graphics representation of desktop functions, including floppy disks, a wastepaper basket, and file folders. You use your mouse or a few keystrokes to open files, run programs, and execute other operating-system commands. As many as six Desktop accessories, such as a clock or a calculator, can run with other GEM applications.

GEM Draw is a graphics editor that produces organizational charts, flow charts, logos, and a variety of pictures. It comes with a library of predesigned graphics that you can integrate into your work. You can also use it to edit and augment graphics and charts produced with GEM applications.

The GEM Collection is made up of GEM Desktop, GEM Paint, and GEM Write. GEM Paint is a graphics-design tool, while GEM Write, said to be a full-function word processor, lets you merge graphics from other GEM applications with written reports.

The GEM Collection is due to be released this month for \$199. GEM Desktop is \$49.95. Until August 31, GEM Draw will be priced at \$149; after that it's \$249. Contact Digital Research Inc., POB DRI, Monterey, CA 93942, (800) 443-4200; in California, (408) 649-3896. Inquiry **607**.



Ericsson's Portable PC has a plasma display.

Portable Has Plasma Display

Ericsson says that its Portable PC's plasma display lets you view on-screen information from any angle no matter what amount of ambient light is present. This claim is based on the fact that plasma-display technology generates its own light rather than reflecting light as liquid-crystal technology does. The display resolution is 640 by 400 pixels, and its format is 80 columns by 25 lines, comparable to an 11-inch CRT screen.

A 360K-byte, half-height, floppy-disk drive is built into the Portable PC, as are ports for serial and parallel interfaces. It comes with 256K bytes of RAM and a detachable keyboard. The Intel 8088 serves as the central processor, and the Portable PC operates on either 110- or 220-volt currents. It measures 12½ by 15¾ by 4½ inches and weighs 15 pounds.

User memory can be expanded by 256K bytes, and

a 512K-byte solid-state disk will further increase storage capacity. You can install a 40-character-per-second thermal ribbon-transfer printer with graphics capabilities; it adds 2 pounds to the overall system weight.

An expansion box designed to accommodate add-in boards marketed for the IBM Personal Computer is another option. An internal 300/1200-bps modem will soon be available. With keyboard and plasma display, the basic Ericsson Portable PC is \$2995. Contact Ericsson Inc., Greenwich Office Park I, POB 2522, Greenwich, CT 06836-2522. Inquiry **608**.

HP Touchscreen II

Hewlett-Packard's Touchscreen II Personal Computer is compatible with existing Touchscreen prod-

ucts and comes with a variety of storage and communications options designed to address a range of needs.

The Touchscreen II has a 12-inch display screen and four accessory slots that offer a wider choice of memory and communications cards than its predecessor's 9-inch screen and two expansion slots. The display format is 80 by 27. HP 2623 terminal emulation is built in, and VT-100 and IBM 3276/3278 emulation are optional.

An 8-MHz 8088 serves as the Touchscreen II's central processor. Standard hardware includes 256K bytes of RAM expandable to 640K bytes, 160K bytes of ROM, an HP-HIL interface, one RS-232C port, and one port that can be configured for either RS-232C or RS-422.

The Personal Applications Manager (PAM), a shell over the MS-DOS 2.11 operating system, simplifies use by eliminating the need to memorize system or program commands. Eight on-screen command keys also simplify operation.

You can add networking and communications to the Touchscreen II. An extended I/O accessory provides for communications between the Touchscreen II and the HP Portable and offers a Centronics-type parallel interface. Some other options are a touchscreen, mouse, and graphics tablet.

A Touchscreen II with two 710K-byte floppy-disk drives is \$3545. A 10-megabyte system with a single floppy drive is \$4770. With one floppy and a 20-megabyte Winchester, it's \$5570. All floppy-disk drives are 3½-inch microfloppies. The touchscreen interface is \$300. Contact your local Hewlett-Packard dealer. Inquiry **609**.

(continued on page 470)

Speed, Power, Price.

Borland's Turbo Pascal Family.



The industry standard. With more than 250,000 users worldwide Turbo Pascal is the industry's de facto standard. Turbo Pascal is praised by more engineers, hobbyists, students and professional programmers than any other development environment in the history of microcomputing. And yet, Turbo Pascal is simple and fun to use!

Jeff Duntmann, PC Magazine: "Language deal of the century... Turbo Pascal: It introduces a new programming environment and runs like magic."

Dave Garland, Popular Computing: "Most Pascal compilers barely fit on a disk, but Turbo Pascal packs an editor, compiler, linker, and run-time library into just 29K bytes of random-access memory."

Jerry Pournelle, BYTE: "What I think the computer industry is headed for: well documented, standard, plenty of good features, and a reasonable price."

Portability. Turbo Pascal is available today for most computers running PC DOS, MS DOS, CP/M 80 or CP/M 86. A XENIX version of Turbo Pascal will soon be announced, and before the end of the year, Turbo Pascal will be running on most 68000 based microcomputers.

\$69.95

High resolution monochrome graphics for the IBM PC and the Zenith 100 computers

Dazzling graphics and painless windows. The Turbo Graphix Toolbox will give even a beginning programmer the expert's edge. It's a complete library of Pascal procedures that include:

- Full graphics window management.
- Tools that will allow you to draw and hatch pie charts, bar charts, circles, rectangles and a full range of geometric shapes.
- Procedures that will save and restore graphic images to and from disk.
- Functions that will allow you to precisely plot curves.
- Tools that will allow you to create animation or solve those difficult curve fitting problems, and much, much more.....

No sweat and no royalties. You may incorporate part, or all of these tools in your programs, and yet, we won't charge you any royalties. Best of all, these functions and procedures come complete with commented source code on disk ready to compile!



\$54.95
NEW



Searching and sorting made simple

The perfect complement to Turbo Pascal. It contains: *Turbo-Access*, a powerful implementation of the state-of-the-art B+tree ISAM technique; *Turbo-Sort*, a super efficient implementation of the fastest data sorting algorithm, "Quicksort on disk". And much more.

Jerry Pournelle, BYTE: "The tools include a B+tree search and a sorting system; I've seen stuff like this, but not as well thought out, sell for hundreds of dollars."

Get started right away: free database! Included on every Toolbox disk is the source code to a working data base which demonstrates how powerful and easy to use the Turbo-Access system really is. Modify it to suit your individual needs or just compile it and run.

Remember, no royalties!

\$54.95

From Start to Finish in 300 pages. Turbo Tutor is for everyone, from novice to expert. Even if you've never programmed before, Turbo Tutor will get you started right away. If you already have some experience with Pascal or another programming language, Turbo Tutor will take you step by step through topics like data structures and pointers. If you're an expert, you'll love the sections detailing subjects such as "how to use assembly language routines with your Turbo Pascal programs."

A must. You'll find the source code for all the examples in the book on the accompanying disk ready to compile. Turbo Tutor might be the only reference on Pascal and programming you'll ever need.

\$34.95



TURBO PASCAL FAMILY

Available at better dealers nationwide. Call (800) 556-2283 for the dealer nearest you. To order by Credit Card call (800) 255-8008, CA (800) 742-1133

Carefully Describe your Computer System!

Mine is: 8 bit 16 bit
I Use: PC-DOS MS-DOS
 CP/M 80 CP/M 86
My computer's name/model is: _____

The disk size I use is:

3 1/2" 5 1/4" 8"

Name: _____

Shipping Address: _____

City: _____

State: _____ Zip: _____

Telephone: _____

Pascal 3.0 \$ 69.95
Pascal w/8087 \$109.90
Pascal w/BCD \$109.90
Pascal w/8087 & BCD \$124.95

Turbo Toolbox \$ 54.95
Turbo Graphix \$ 54.95
Turbo Tutor \$ 34.95

*These prices include shipping to all US cities. All foreign orders add \$10 per product ordered.

Amount: (CA 6% tax) _____

Payment: VISA MC BankDraft Check

Credit Card Expir Date: _____

Card #: _____

BORLAND INTERNATIONAL

Software's Newest Direction
4585 Scotts Valley Drive
Scotts Valley, CA 95066
TELEX 172373

Inquiry 59 for End-Users. Inquiry 60 for DEALERS ONLY.

Turbo Pascal is a registered trademark of Borland International, Inc.

F15
COD's and Purchase Orders WILL NOT be accepted by Borland. California residents: add 6% sales tax. Outside USA: add \$10 and make payment by bank draft, payable in US dollars drawn on a US bank.



ROBERT
65 TINNEY

Borland Does It Again: SuperKey \$69.95

Sure, ProKey™ is a nice little program. But when the people who brought you Turbo Pascal and SideKick get serious about keyboard enhancers, you can expect the impossible . . . and we deliver.

SuperKey	ProKey
ALL FEATURES RESIDENT IN RAM AT ALL TIMES	NO
RESIDENT PULL-DOWN MACRO EDITOR	NO
RESIDENT FILE ENCRYPTION	YES
PROKEY COMPATIBILITY	NO
DISPLAY PROTECTION	NO
ABILITY TO IMPORT DATA FROM SCREEN	NO
PULL-DOWN MENU USER INTERFACE	NO
CONTEXT-SENSITIVE ON-LINE HELP SYSTEM	NO
DISPLAY-ONLY MACRO CREATION	NO
ENTRY AND FORMAT CONTROL IN DATA FIELDS	NO
COMMAND KEYS REDEFINABLE "ON THE FLY"	NO
PRICE	129 ⁹⁵

Total ProKey compatibility. Every Prokey Macro file may be used by SuperKey *without change* so that you may capitalize on all the precious time you've invested.

Now your PC can keep a secret! SuperKey includes a resident file encryption system that uses your password to encrypt and decrypt files, even while running other programs. Two different encryption modes are offered:

1. **Direct overwrite encryption** (which leaves the file size unchanged) for complete protection. At no point is a second file that could be reconstructed by an intruder generated. Without your secret password, no one will ever be able to type out your confidential letters again!

2. **COM or EXE file encryption** which allows you to encrypt a binary file into an ASCII file, transmit it through a phone line as a text file and turn it back again into an executable file on the target machine (only of course if your correspondent knows the secret password!). Now, you will even be able to secretly exchange programs through Public Bulletin Board Systems or services such as CompuServe.

Totally memory resident at all times, gives SuperKey the ability to create, edit, save and even recall new or existing macro files anytime, even while running another program.

Pull down macro editor. Finally, a sensible way to create, edit, change and alter existing macro definitions. Even while using another application, a simple keystroke instantly opens a wordprocessor-like window where you're allowed to see, edit, delete, save and even attach names to an individual macro or file of macros, and much more.

Sorry ProKey !

Superb software at reasonable prices!

There is much more to SuperKey. Maybe the best reason to buy SuperKey is that it is a Borland International Product. Each one of our products is the best in its category. We only believe in absolutely superb software at reasonable prices!

An offer you can't refuse.

Whether you are a ProKey user or you've never used a keyboard enhancer before, your boat has come in. You can get your copy of SuperKey at this irresistible price.

Get your PC a SuperKey today!

SuperKey is available now for your IBM PC, XT, AT, jr. and truly compatible microcomputers.

Inquiry 61 for End-Users. Inquiry 62 for DEALERS ONLY.

BORLAND
INTERNATIONAL

Software's Newest Direction
4585 Scotts Valley Drive
Scotts Valley, CA 95066
TELEX 172373

IBM is a registered trademark of International Business Machine Corporation. ProKey is a trademark of RoseSoft. SuperKey and SideKick are trademarks of Borland International, Inc. CompuServe is a trademark of CompuServe Corp.

SuperKey

NOT COPY-PROTECTED

Available at better dealers nationwide. Call (800) 556-2283 for the dealer nearest you. To order by Credit Card call (800) 255-8008, CA (800) 742-1133

\$69.95

YES! Please rush SuperKey to me. Send me _____ copies.

This price includes shipping to all U.S. cities. All foreign orders add \$10 per product ordered.

Subtotal _____
(CA res. add 4.20 tax per copy)

Amount Enclosed: _____
Payment VISA MC BankDraft Check

Credit Card Exp Date _____
Card # _____

Name: _____
Shipping Address: _____
City: _____ Zip: _____
State: _____ Telephone: _____

COD's and Purchase Orders WILL NOT be accepted by Borland. California residents: add 6% sales tax. Outside USA: add \$10 and make payment by bank draft, payable in US dollars drawn on a US bank.

Conducted by Steve Ciarcia

SPEED UP A MICRO

Dear Steve,

I hope I am not asking for the moon, but how does one speed up a microprocessor? Will doing that cause problems in the operation of the computer?

A. C. POSADA
Charlottesville, VA

Microprocessor instructions require a specific number of cycles to execute. These cycles are timed by a system clock, and the speed of the computer is a direct function of the clock frequency. Increasing the frequency of the system clock, simply by changing a crystal or divider circuit, will increase the overall execution speed, but there are some limitations.

The microprocessor chip itself has a speed limitation, so when the clock frequency is increased, often a higher-speed version must be used. This is usually what the letter at the end of the chip number signifies.

The memory chips are also affected by speed and must be replaced with faster versions. Otherwise, additional wait states, which reduce some of the benefits of the increased speed, will be needed. Some of the peripheral driver chips may become speed-limited, also reducing the overall throughput.—Steve

65816 ATARI?

Dear Steve,

I have been considering upgrading my Atari 800 by installing a 65816 chip in place of the 6502. According to the advertisements, the chip is software- and hardware-compatible with any machine using a 6502. The lure of a 16-bit processor able to directly address 16 megabytes is hard to resist, but I am worried.

If the chip from Western Design Center is all that it is claimed to be, why isn't everybody installing it instantly?

JAMES E. RAINEY
Coos Bay, OR

The new 65816 microprocessor chip has a 6502 emulation mode. In this mode, it is pin- and software-compatible with the 8-bit 6502 that is used in your Atari 800.

When used to its full capability, addressing 16 megabytes requires a 24-bit address bus. The 65816 handles the extra 8 address bits by multiplexing them with the data bus. On one half of a clock cycle, the pins are used for address lines; on the other half cycle, for data lines. This multiplexing requires additional circuitry, which is not readily adaptable to your Atari. This is why it has not become widely used.

A complete description of this new chip can be found in the August and September 1984 issues of BYTE in a two-part article by Steven P. Hendrix, "The 65816 Microprocessor."—Steve

HALF-INCH TAPE BACKUP

Dear Steve,

I've been frustrated for a long time because most microcomputer manufacturers don't offer ½-inch tape drives as an optional accessory. The only one I know of that does is Wicat.

Most of them offer ¼-inch streamer tape for backing up hard disks, but ½-inch tape would seem to be an ideal bridge over a wide gap between many mainframe systems and micros. For instance, my firm, a nonprofit organization, maintains a large mailing list with a data-processing service. I've spoken to the people there, and they have neither floppy-disk nor modem capabilities. The only way they can communicate is via ½-inch tape. I have gone the route of transferring from tape to floppy disk, but that is cumbersome and expensive (not in principle, but in practice); few firms offer this service, at least in this area. We could save a lot of money (in key-boarding time and errors) if we could write ½-inch tapes.

I've resisted purchasing the ¼-inch streamer-tape unit that Molecular, the manufacturer of one of our computers, offers because a ½-inch tape drive would allow me to easily back up my hard disk and communicate with the big fellows, assuming enough compatibility were built in. I assume the larger tape drive would cost two or three times as much as the smaller ones do, but it would be worth it to gain both the larger capacity and ability to communicate.

Do you know of anyone offering a solu-

tion to this problem or planning to address it? Would a controller have to be built for each type of micro, or could something be set up to run from a serial port?

STEVE GOLDFIELD
San Francisco, CA

Overland Data Inc. sells a 9-track tape controller for the IBM PC. It is capable of reading and writing industry-standard ½-inch tape and is compatible with most 9-track formatted tape drives. It operates with tape-drive speeds up to 120 inches per second and allows data transfer at rates up to 192,000 bytes per second. It sells for \$880 and can be purchased from Overland Data Inc., Suite A, 5644 Kearny Mesa Rd., San Diego, CA 92111, (619) 571-5555.—Steve

TALL ORDER

Dear Steve,

I make my living writing software, and my only exposure to hardware has been through building several Heathkits. I would like to build a computer system from board level, since it would enable me to create a system to suit my needs. Also, it would probably be cheaper than purchasing a Heath H-100, for example. Just about all I know hardware-wise is the difference between an S-100 bus and a DB-25 connector—I could not tell you the difference between a switching and nonswitching power supply.

How hard is it to get an operating system/software for a machine that I put together myself? What are other major advantages and disadvantages that I should be aware of? Can you recommend some books that can get me up to speed with hardware?

JEFFREY SHULMAN
Highland Park, NJ

Building your own computer from scratch is quite different from assembling Heathkits. If you want to get some idea of the scope of the job of designing and building a computer with capabilities on the order of the H-100, read my articles on the MPX-16 in the November and December 1982 and January 1983 issues

(continued)



**THE AT&T PC.
THE COMPUTER WITH
THE FUTURE BUILT IN.**

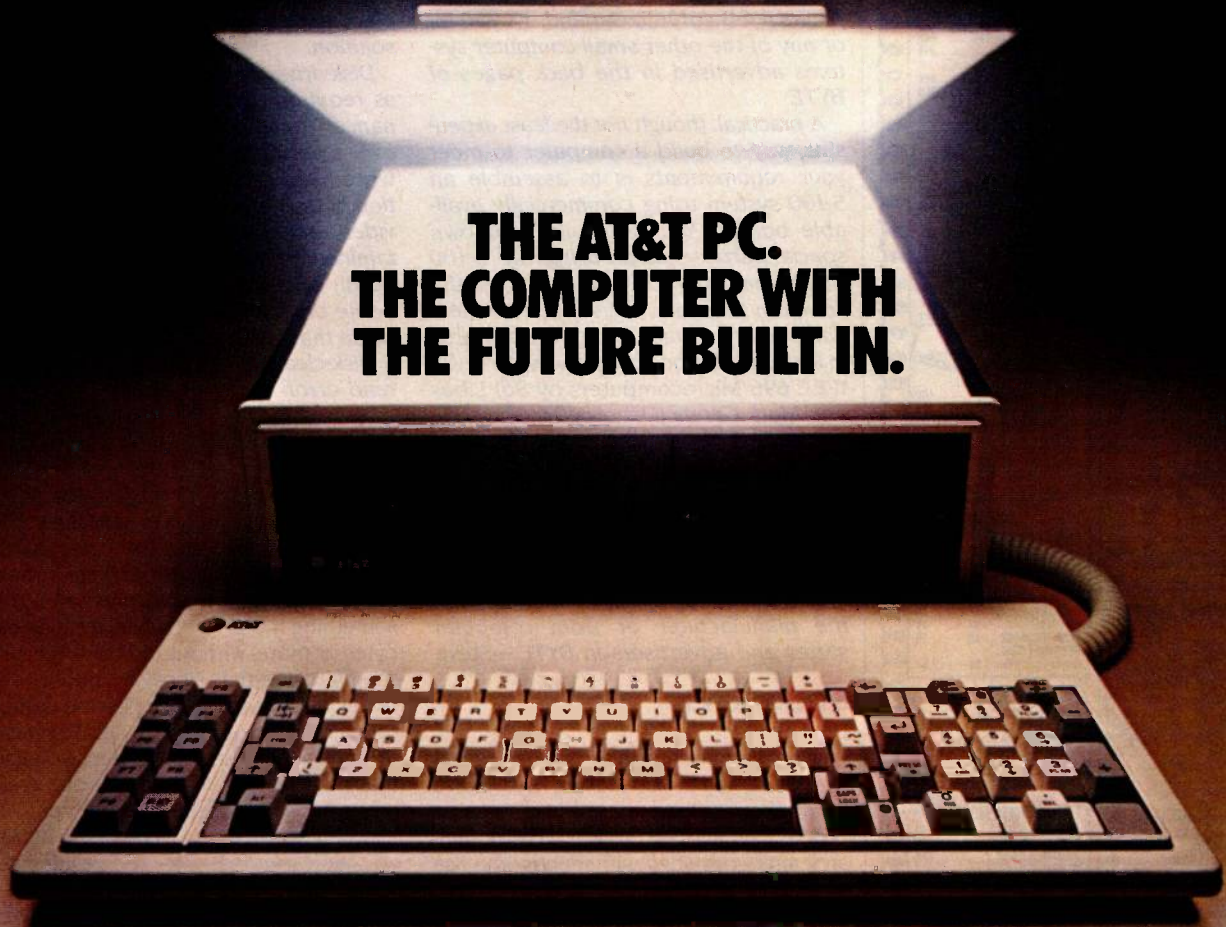

Before you buy a personal computer for your business you should ask yourself two essential questions. One: What do you need today? Two: What will you need tomorrow?

The AT&T PC 6300 is the answer to both. Today, you'll get a high performance computer that's competitively priced. A computer that not only runs the broadest selection of software available, but has the power and speed to make the most of it. A computer with superb graphics in monochrome or color. And a high resolution screen that's easy on the eyes.

For tomorrow, you'll get a computer with the future built in. With its modular architecture and seven expan-



sion slots, it's ready now to work with future technology, and meet your future needs. From additional power to multi-tasking capabilities, even to features yet to come, it can be easily enhanced as time goes by.

That's a commitment from AT&T. And the AT&T PC, the computer with the future built in.

For more information, call your AT&T Account Executive, visit an authorized AT&T dealer, or call 1-800-247-1212.



AT&T

Inquiry 41

The right choice.

ASK

owen

• COMPUTERS • VIDEO • ELECTRONICS • PHOTOGRAPHY
FOR INFO CALL (212) 725-1234 FOR ORDERS (800) 221-3160

IBM PC & COMPAT.

- IBM PC w/drive, monitor....1450
- IBM PC w/256k (2) 360 drives, keyboard, monitor & monitor adapt.....Call
- IBM PC w/(1) 360k floppy & 20Mb disc drive.....2295
- IBM PC as above w/RGB color monitor.....Call
- IBM PC XT w/256k.....Call
- IBM AT Enhanced.....Call
- CANON Athena.....Call
- COMPAQ PORTABLE w/256k, (2) 360 disc drives, DOS & basic.....2199
- COMPAQ Plus.....Call
- COMPAQ Desk ProS.....Call
- LEADING EDGE PC w/728k (2) 360 disc drives, monitor & adapter, basic, DOS 2.11.....1499
- LEADING EDGE PC w/256k as above last RGB color.....1995
- LEADING EDGE 10Mb hard disc system.....2595
- SANYO 550 2.....699
- SANYO 555 2.....979
- ZENITH ZF 151 20 w/(2) 360k disc drives, 128k RAM, IBM compatible, w/free Microsoft Word & free Microsoft Multiplan & Color graphics card.....1599
- ZENITH ZW 151 52 as above but w/color monitor & 10Mb hard disc system.....3495
- ZENITH 3 COM Local Area Network.....Call

BOARDS FOR IBM

- AMDEK MIA.....389
- AST 6 Pak Plus w/64k.....244
- HERCULES color card.....169
- HERCULES graphic card for TTL mono monitor.....289
- KOLA game controller.....44
- TECMAR CAPTAIN.....169

HARD DISKS

- Tall Grass Call Ampex.....Call
- Bernoulli Box 20Mb.....2449
- Tecmar 20Mb & 60Mb tape back-up.....Call

SOFTWARE

- Lotus 123.....289
- WordStar.....189
- Multimate.....249
- Sideways.....39
- Master Type.....34
- TKI Solver.....249
- IBM Topview.....Call
- Framework of dBase III.....39
- Flight Simulator.....229
- Word w/Spell.....249
- Word Star 2000.....249
- PC Paintbrush w/Mouse.....149
- NORDTON utilities 3D.....59
- R Base 4000.....258
- Managing Your Money.....119
- Typing Tutor III.....34
- Desk Organizer.....129
- Electric Desk.....199
- Smart Software.....Call
- XY Write II Plus.....219
- Quick Code III.....149
- Word Perfect 4.0.....249
- Peacefree Decision Manager.....319

IBM PC

- W/64k (1) 360 Disc Drive & Keyboard.....1299
- IBM PC w/256k (2) 360 Disc Drives, Graphics Monitor, Card, Mon., Keyboard & Software Kit.....Call
- IBM PC AT.....Call

LEADING EDGE PC

- W/728k, Leading Edge Monitor, Keyboard, Monitor & Printer Adapter.....1499

ZENITH ZF 151 20

- W/(2) 360k Disc Drives, 128k RAM, Microsoft Word, Multiplan, Keyboard, & 90 Day On Sight Service.....1599

APPLE

- APPLE IIe w/drive.....849
- APPLE IIc.....899
- APPLE IIc Macintosh.....1699
- APPLE IIe professional system w/ 128k (2) duo disc drives & 70 cdk card.....1349
- APPLE Image Writer.....499

PRINTERS & PLOTTERS

- EPSON: RX 80.....229 LO-1500.....1069
- JUKI: 6100.....389 6300.....799
- HP: Laser Printer.....2795
- HP: Plotter.....Call
- Sweet Pea Plotter.....Call
- NEC: 3550.....1349
- OKIDATA: NEW! 192.....239
- NEW! 192.....349 94.....679
- NEW! 193.....569 2410.....Call
- OLYMPIA: RO.....319
- SILVER REO: 400.....249 500.....289 550.....449 770.....789
- TOSHIBA: 1340.....598 351.....1239

MONITORS

- AMDEK 310A.....179
- GORILLA Green.....89
- LEADING EDGE RGB Color.....399
- TTL Green.....139 TTL Amber.....149
- PRINCETON GRAPHICS: HK-12.....459 Max12.....169 SR-12 w/Scan Doubler.....899
- SANYO CRT30.....99
- CRT36.....129 CRT70.....499
- ZENITH: ZVM122.....89 ZVM123.....98 ZVM124 IBM Compatible.....139

MODEMS

- HAYES: 300.....209 1200.....409
- 1200B w/Smartcom II.....369
- SMARTCOM II.....99
- 2400.....Call
- Micro Modem II.....249
- NOVATION SMARTCAT Internal.....344 External.....348
- US ROBOTICS: Password.....329

DISKETTES

- | | | |
|---------------------------|-------|---------|
| | SS/DD | DS/DD |
| Verbatim Data Lite (10)21 | 29 | 29 |
| FUJI (10) | 18 | 24 |
| MAXELL (10) | 19 | 28 |
| BASF (10) | 17 | 23 |
| IBM (10) | 22 | 29 |
| FAMOUS MAKE (13) | 19 | 19 |
| SPECIAL TDK | | |
| Quantities of 100 ea | 1.35 | ea 1.55 |

ACCESS.

- Disc Bank holds 50.....14
- HEAD disc drive cleaner.....13
- VERBATIM IBM drive analyzer.....29
- SURGE PROTECTORS: NETWORK cube w/Rf filter.....29

TYPEWRITERS

- CANON typewriter S.....148
- CANON typewriter G.....196
- BROTHER CE 58.....458
- OLYMPIA Compact II.....384
- SMITH CORONA 350M.....318

CANON COPIERS

- PC 10.....469 PC 20.....665
- PC 25.....939 Stand.....99

SANYO 550-2

- Now Runs Lotus 123! IBM PC Compatible 360k Disc Drive 128k RAM, Word Star, Calc Star & Easy Writer RGB VIDEO CARD.....699
- RGB VIDEO CARD.....149

OLYMPIA RO

- Daisy Wheel Letter Quality, 14 Gps w/Parallel & Serial Ports, w/Built In Tractor Feed 3 Pitch ONLY!.....319

COMPAQ

- Portable W/(2) 360k Disc Drives, DOS & Basic Keyboard.....2199
- COMPAQ Plus W/Hard Disc.....In Stock

1265 Broadway at 32nd Street New York 10001

CORPORATE ACCOUNTS WELCOME Minimum Shipping Order: \$50
TELEX #42782 SPWLU Line \$30 Minimum Shipping \$49.50
Visa, Mastercard Welcome (Line \$30 Minimum Shipping \$49.50)
Some Prices May Vary Only We Reserve the Right to Limit Quantities. Or Manufacturer's Price Changes

ASK BYTE

of BYTE. You could build that yourself and save some money, but I recommend that you buy the circuit board. Wire-wrapping a project such as this is not recommended.

If you want to start with something more modest to learn something about microcomputers, you could build The Little Board from Digital Research Computers (POB 461565, Garland, TX 75046) or any of the other small computer systems advertised in the back pages of BYTE.

A practical, though not the least expensive, way to build a computer to meet your requirements is to assemble an S-100 system using commercially available boards. You can build your own special-purpose cards using the S-100 prototyping boards, and many of the common functions like serial I/O, video, and printer-interface boards are available in kit form. The book Interfacing to S-100 IEEE 696 Microcomputers by Sol Libes and Mark Garetz (Osborne/McGraw-Hill) gives good information on interfacing to things such as memory and I/O for the S-100, and in a general way for most computers.

Operating systems like Digital Research's CP/M and Microsoft's MS-DOS are readily available, either directly from the manufacturer or from computer stores and advertisers in BYTE.—Steve

STICKY KEYS

Dear Steve,

I would appreciate any advice you might give on remedies for sticking keys. I have found them to be a minor but distracting problem on my TI Professional computer, and, after consulting with friends who use other micros, I think the problem is fairly widespread. Is it possible to apply a dry lubricant or a Teflon spray on key mechanisms without interfering with electronic circuitry?

RICHARD S. MOORE
Huntsville, AL

Sticking keys can be a real nuisance, and a spray lubricant may or may not be effective. One of the main causes of the sticking or binding is an interference between the key plunger (the stem under the key top) and the switch housing. Often, the clearance between these parts is very small to preclude dust and dirt

from entering, but some dirt particles can cause binding. In this instance, a control cleaner (available at most electronic supply stores) or some alcohol may successfully flush away these particles.

Swelling of the plastic is another cause, but lubricants have little effect since they are quickly scraped away. A Teflon spray or control cleaner can be tried, but replacement of the switch is often the final solution.

Disk-drive cleaning kits should be used as required and not as regular maintenance. These kits are abrasive and will, over a period of time, damage the read/write head of the drive. The in-out motion of the head on the rotating disk provides a self-cleaning action for most contaminants. Frequency of use will depend mainly on the quality of the disk medium. Some brands seem to have more loose oxide than others. As a general rule, use a disk-cleaning kit when an occasional read error is noted.—Steve

BIGGER BUFFER

Dear Steve,

I own a Dynax DX-15 printer with a built-in 3K-byte buffer that is expandable to 5K bytes. This additional 2K bytes hardly seems worth fooling with. Is there any way this internal buffer can be expanded to something more worthwhile, such as 16K bytes or more, without radical surgery? It seems to me that since the buffer is already present, it shouldn't be too complicated to expand it to 64K bytes. Yes or no?

Thank you for any suggestions you have that might make my Dynax more useful or save it from needless slaughter.

GERRY L. TURNER
Quincy, IL

I have no circuit data for the Dynax printer, so I am unable to determine if it is possible to expand the buffer beyond the 5K bytes that Dynax provides. It is a function of the address decoding that is utilized. Since the control-program and character-generator ROMs require a substantial amount of the controller's address space, it is doubtful that 64K bytes of memory can be obtained. Even if compatible memory chips of higher capacity could be used, decoding limits may cause the controller to ignore anything over the 5K-byte limit.

If you need more buffer space, consider one of the external buffers (spoolers) like the Microfazer from Quadram Corp. or the Spool/64 or Spool/64SP from Apparat Inc. These pro-

(continued)

**YOU'VE GOT THE BEST PASCAL COMPILER!
NOW — GET THE BEST UTILITY!**

TURBO SCREEN™

\$49.95



NEVER AGAIN WRITE SOURCE CODE FOR SCREEN DISPLAYS!

If you LIKE Turbo Pascal, you'll LOVE TURBO SCREEN™!*

Tired of writing line after line of source code just to create effective screen displays and error-proof data handling? Then use TURBO SCREEN's Editor to create the screens, the Collator to define a list of screens . . . and then relax for a few seconds while the Generator writes the code!

TURBO SCREEN™

- 100 Fields per screen, and up to 80 screens in your application.
- One screen or eighty, the size of your program doesn't change.
- I/O field types of:
Real, Integer, String, Character, Boolean.
- "Bullet-proof" data entry.
- Create Window-Style overlays or Full-screen pictures in CPM*, MS-DOS*, or PC-DOS.
- Supports video attributes for your terminal. And YES, if you have an RGB monitor, you can create screens in COLOR on your IBM PC or true compatible.
- A SINGLE LINE of source code invoking TURBO SCREEN'S "display" procedure controls:
—picture selection
—output to screen, printer, or disk
—I/O field update
- TURBO SCREEN™ is completely menu-driven and includes a built-in Screen Editor, Collator, and Generator, each called up with a single keystroke!
- ADVANCED EDITOR:
—Turbo Pascal*-like commands include:
—Block commands for copy, fill, exchange, erase.
—Draw lines in any direction with any character.
—Supports IBM color monitor and graphics characters.
- FAST—Generates code for 20 screens in about 60 seconds!
- DISK UTILITIES built-in:
—directories
—erase files
- REQUIRES:
—Turbo Pascal any version
—80x24 or larger video screen
- AVOID software "bottlenecks!"

PASCOM COMPUTING

23611 Chagrin Blvd., Suite 101
Cleveland, Ohio 44122

Check _____ TURBO SCREEN™
package \$49.95
Money Order _____ Plus Ship.
(UPS) 5.00
/isa _____ Total \$54.95
Master Card _____
Card # _____
Exp. Date: _____

Start letting TURBO SCREEN™ write your I/O source code today!



ONLY — Call TOLL-FREE: 1-800-243-1849

Inside Ohio call 1-216-292-8745 (Lines Open 24 hours, 7 days)

Computer System: _____ 8-bit _____ 16-bit
Operating System: _____ CP/M80 _____ PC-DOS
_____ CP/M86 _____ MS-DOS
Computer Model: _____ Disk Format: _____
Name: _____
Address: _____
City: _____ State _____ Zip _____
Telephone: _____

Ohio residents add 6 1/2 % sales tax. Outside U.S.A. add \$20.00

U.S. Dealer Inquiries Welcome.

10 MB Hard Disk Drive Set \$569
20 MB Hard Disk Drive Set \$749



Includes top quality half height Microscience hard disk drive, Mitsuba hard disk drive controller, cables, full height cover plate, mounting screws, software, installation instructions. Microscience is known for quality & performance. Full year warranty. You cannot beat the value & our low price.

Multifunction Board (OK) \$149

Includes one serial port, one parallel port, one game port, clock/calendar & 6 memory banks. Can add up to addl. 384K to your PC. Software included to perform set/get clock, RAM disk & printer spool.

Please call or write for FREE catalog 312-355-9726

MICRO CITY P.O. Box 571, Downers Grove, IL 60515
A Division of PACE Systems, Inc.

We accept check, money order, VISA, Mastercard, or American Express (include # and expiration date). Our prices reflect a 2% cash discount. Please add 2% for credit card purchase. \$2.50 shipping & handling in continental U.S. (Alaska, Hawaii and foreign add \$5.00 for orders under \$100, 5% for orders over \$100). Illinois residents add 6.25% sales tax. Personal and company checks allow 2 weeks to clear. Purchase orders accepted from schools and major corporations. Prices subject to change without notice. Dealer inquiries invited. If in the Chicago area, we invite you to visit our retail showroom located at 24 W. 500 Maple Ave., Naperville.

130W Switching Power Supply \$109

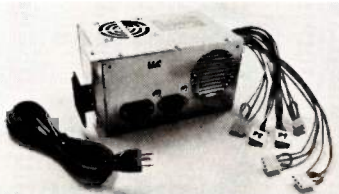

Direct replacement for your IBM PC power supply. Fits inside your PC case. Four power plugs allow you to connect floppy & hard disk drives, tape backup systems, etc.

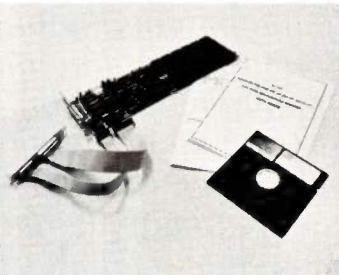

ASK BYTE

vide 64K bytes or more and features like multiple copies and the ability to cancel printing. Such buffers are available to match almost any printer/computer combination for around \$150 and up, depending on memory size and features.
 — Steve

PRINTER TROUBLE

Dear Steve,

We are having trouble printing graphics with our Toshiba P1350 dot-matrix printer, which is hosted by a Zenith Z-100 Model ZW-110-32 desktop computer. The printer has graphics characters and dot-image graphics printing capability. However, it does not respond to any Printgraph commands or any Escape sequence printer setup commands while using Lotus 1-2-3. In Z-BASIC the printer accepts a few Escape sequence commands but not those that enable the graphics mode. We'd appreciate any help you can provide.

DOMINIC AU
 Calgary, Alberta, Canada

If the inability to get your Toshiba P1350 to print graphics were limited to Lotus 1-2-3, I would suspect that the printer driver was not properly installed in the program. Since it doesn't work in BASIC either, it appears that you have a printer problem. The graphics option may be defective or missing, or there may be a bad or incorrectly wired cable. The latter is not too likely since you don't mention any other problems. Toshiba says you need the PaperScreen and the color/graphics adapter to print graphics with Lotus 1-2-3 on the IBM PC, so maybe you are encountering a minor incompatibility with the Zenith graphics board.

There are two other possibilities. If you are using a serial interface, the protocol must be set for 8-bit data to use graphics. Also, check your manual to see if there are any switch settings that could be disabling the graphics. If none of these suggestions help, the printer is either not working properly or does not have the correct options installed. Take it to your dealer or a Toshiba service center for diagnosis.—Steve

INTERCABIN TELEPHONES

Dear Steve,

I am part owner of a summer resort with 11 cabins. The main cabin has the only telephone line out of camp, and the other cabins have no communication lines. I would like to build a telephone system for

(continued)

**The Dream,
 Knee-top PC with APL Productivity
 and Voice Networking too!**

WS-1
 AMPÈRE

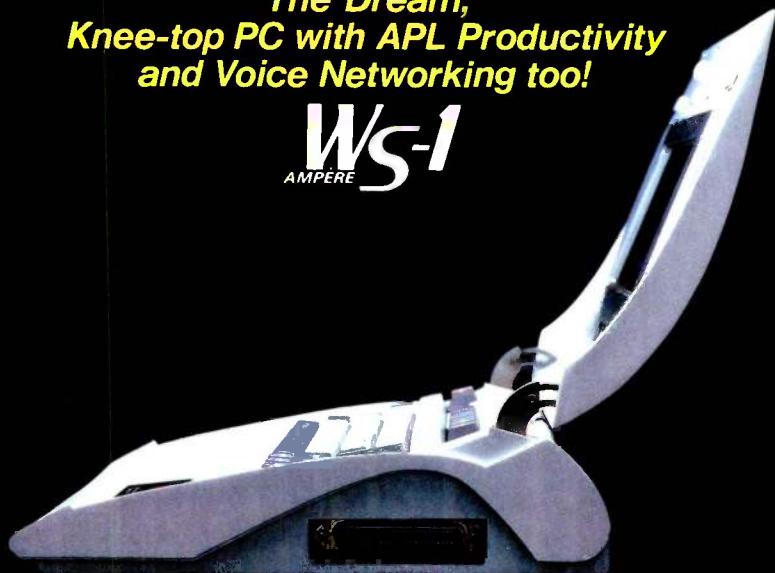

- Battery operation
- 8MHz 68000 CPU
- Up to 448K bytes of RAM
- 128K bytes of ROM
- 25x80 character LCD
- Bit-mapped graphics
- Multiple windowing
- Multitask OS for powerful networking
- Coherent DB-WP-CALC-Graphic software
- Intelligent phone function
- Microcassette voice/data storage

FOR DISTRIBUTORSHIP INFORMATION AND PRODUCT DETAILS PLEASE CONTACT

ampère
 INCORPORATED

Asahi Bldg 5-20, 7-chome Nishi-Shinjuku, Shinjuku-ku, Tokyo, Japan
 Phone 03-365-0825, Telefax 03-365-0999, Telex J33101 AMPERF
 IP Sharp Mail Box Code: AMP (Group Code API WS)

U.S. Representative Office

**WORK SPACE
 COMPUTER INC.**

3848 Carson St Suite 301 Torrance, California 90503 U.S.A.
 Phone 213-540 1553, Telex 322800 WORK SPACE



The Most Powerful C

for the IBM AT • MACINTOSH • MS DOS • CP/M-80 • ROM APPLICATIONS
IBM PC/XT • APPLE II • CP/M-86 • TRSDOS • CROSS DEVELOPMENT

Why Professionals Choose Aztec C

AZTEC C compilers generate fast, compact code. AZTEC C is a sophisticated development system with assemblers, debuggers, linkers, editors, utilities and extensive run time libraries. AZTEC C is documented in detail. AZTEC C is the most accurate and portable implementation of C for microcomputers. AZTEC C supports specialized professional needs such as cross development and ROM code development. MANX provides qualified technical support.

AZTEC C86/PRO

— for the IBM AT and PC/XT

AZTEC C86/PRO provides the power, portability, and professional features you need to develop sophisticated software for PC DOS, MS DOS AND CP/M-86 based microsystems. The system also supports the generation of ROM based software for 8088/8086, 80186, and 80286 processors. Options exist to cross develop ROM code for 65xx, 8080, 8085, and Z80 processors. Cross development systems are also available that target most micro computers. Call for information on AZTEC C86/PRO support for XENIX and TOPVIEW.

POWERFUL — AZTEC C86/PRO 3.2 outperforms Lattice 2.1 on the DHRYSTONE benchmark 2 to 1 for speed (17.8 secs vs 37.1) while using 65% less memory (5.8k vs 14k). The AZTEC C86/PRO system also compiles in 10% to 60% less time and supports fast, high volume I/O.

PORTABLE — MANX Software Systems provides real portability with a family of compatible AZTEC C software development systems for PC DOS, MS DOS, CP/M-86, Macintosh, CP/M-80, APPLE II+, IIe, and IIc (NIBBLE - 4 apple rating), TRSDOS (80-MICRO - 5 star rating), and Commodore C64 (the C64 system is only available as a cross compiler - call for details). AZTEC C86/PRO is compatible with UNIX and XENIX.

PROFESSIONAL — For professional features AZTEC C86/PRO is unparalleled.

- Full C Compiler (8088/8086 - 80186 - 80286)
- Macro Assembler for 8088/8086/80186/80286
- Linkage Editor with ROM support and overlays
- Run Time Libraries - object libraries + source DOS 1.x; DOS 2.x; DOS 3.x; screen I/O; Graphics; UNIX I/O; STRING; simulated float; 8087 support; MATH; ROM; CP/M-86
- Selection of 8088/8086, 80186, or 80286 code generation to guarantee best choice for performance and compatibility

- Utility to convert AZTEC object code or libraries to Microsoft format. (Assembly + conversion takes less than half the time as Microsoft's MASM to produce MS object)
- Large memory models and sophisticated memory management
- Support products for graphics, DB, Screen, & ...
- ROMable code + ROM support + separate code and data + INTEL Hex Converter
- Symbolic Debugger & Other Utilities
- Full Screen Editor (like VI)
- CROSS Compilers are available to APPLE II, Macintosh, CP/M-80, TRSDOS, COMMODORE C64, and ROM based 65xx, and 8080/8085/Z80
- Detailed Documentation

AZTEC C86/PRO-AT\$500
(configured for IBM AT - options for 8088/8086)

AZTEC C86/PRO-PC/XT\$500
(configured for IBM PC/XT - options for 80186/80286)

AZTEC C86/BAS includes C compiler (small model only), 8086 MACRO assembler, overlay linker, UNIX, MATH, SCREEN, and GRAPHICS libraries, debugger, and editor.

AZTEC C86/BAS\$199
 AZTEC C86/BAS (CP/M-86)\$199
 AZTEC C86/BAS (DOS + CP/M-86)\$299
 UPGRADE to AZTEC C86/PRO\$310
 C-TREE Database with source\$399
 C-TREE Database (object)\$149

CROSS COMPILERS

Cross Compilers for ROM, MS DOS, PC DOS, or CP/M-86 applications.

VAX -> 8086/80xxx cross\$5000
 PDP-11 -> 8086/80xxx cross\$2000

Cross Compilers with PC DOS or CP/M-86 hosts are \$750 for the first target and \$500 for each additional target. Targets: 65xx; CP/M-80; C64; 8080/8085/Z80; Macintosh; TRSDOS; 8086/8088/80186/80286; APPLE II.

AZTEC C68K

— for the Macintosh

For power, portability, and professional features AZTEC C68K-c is the finest C software development system available for the Macintosh.

The AZTEC C68K-c system includes a 68000 macro assembler, a linkage editor, a source editor, a mouse based editor, a SHELL development environment, a library of UNIX I/O and utility routines, full access and support of the Macintosh TOOLBOX routines, debugging aides, utilities, make, diff, grep, TTY simulator with upload & download (source supplied), a RAM disk (for 512K Mac), a resource maker, and a no royalty license agreement. Programming examples are included. (Over 600 pages of documentation).

AZTEC C68K-c requires a 128K Macintosh, and two disk drives (frugal developers can make do with one drive). AZTEC C68K supports the 512K Macintosh and hard disks.

AZTEC C68K-c (commercial system)\$500
 AZTEC C68K-p (personal system)\$199
 AZTEC C68K-p to AZTEC C68K-c upgrade\$310

Mac C-tree database\$149
 Mac C-tree database with source\$399
 Lisa Kit (Pascal to AZTEC C68k object converter) ..\$ 99

AZTEC C65

— for the APPLE II

"...The AZTEC C-system is one of the finest software packages I have seen..." NIBBLE review, July 1984.

The only commercial C development system available that runs native on the APPLE II+, IIc, and IIe, the AZTEC C65 development system includes a full floating point C compiler compatible with UNIX C and other MANX AZTEC C compilers, a 6502 relocating assembler, a linkage editor, a library utility, a SHELL development environment, a full screen editor, UNIX I/O and utility subroutines, simple graphics, and screen functions.

AZTEC C65 (Apple DOS 3.3)\$199
 AZTEC C65/PRO (Apple DOS + ProDOS)\$350
 (call for availability)

AZTEC C II/PRO

— for CP/M-80

The first member of the AZTEC C family was the CP/M-80 AZTEC C compiler. It is "the standard" compiler for development on CP/M-80. The system includes the AZTEC C II C compiler, an 8080 assembler, a linkage editor, an object librarian, a full library of UNIX I/O and utility routines, CP/M-80 run time routines, the SMALL library (creates modules less than 3K in size), the fast linker for reduced development times, the ROM library, RMAC and M80 support, library source, support for DRI's SID/ZSID symbolic debugger, and more.

AZTEC C II/PRO\$349
 AZTEC C II/BAS\$199
 C-TREE Database with source\$399
 C-TREE Database in AZTEC object form\$149

AZTEC C80

— for TRSDOS (Radio Shack Model III & 4)

"I've had a lot of experience with different C compilers, but the Aztec C80 Compiler and Professional Development System is the best I've seen." 80-Micro, December, 1984, John B. Harrell III

This system has most of the features of AZTEC C II for CP/M. It is perhaps the best software development system for the Radio Shack Model III and IV.

AZTEC C80 model 3 (no floating point)\$149
 AZTEC C80 model 4 (full)\$199
 AZTEC C80/PRO (full for model 3 and 4)\$299

To order or for information call:

800-221-0440

(201) 530-7997 (NJ and outside U.S.A.). Or write: MANX SOFTWARE SYSTEMS, P.O. Box 55, Shrewsbury, N.J. 07701.

SHIPPING INFORMATION - Standard U.S. shipment is UPS ground (no fee). In the U.S. one day shipment is \$20, two days is \$10. Canadian shipment is \$10. Two days shipment outside the U.S. is by courier and is freight collect.



TRS 80 RADIO SHACK TRS DOS is a trademark of TANDY.
APPLE DOS MACINTOSH is a trademark of APPLE.



For Technical Support
(Bug Busters) call: 201-530-6557

Robotic Development System Using IBM PC/Apple IIe

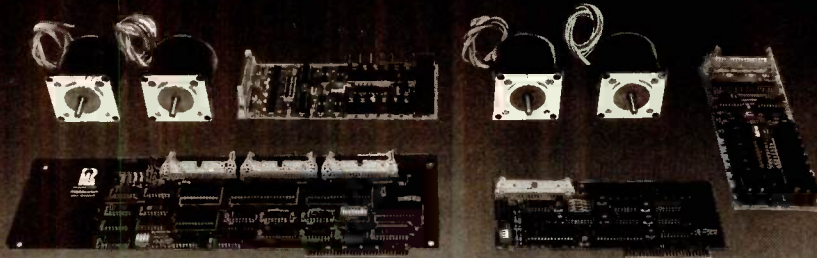

Complete 2 axis systems using 2 size 23 stepper motors with R2D23 dual-axis driver; cable & powerful system software, expandable to 4 axis.

IBM PC/XT Version \$792 Apple II/IIe Version \$420

- 1 432 I/O stepper controller
- 32 digital I/O
- A6 T/D stepper controller
- 32 digital I/O available

Digital I/O accessories, power supply and higher power size 34 stepper motor system are available.

ROGERS LABS

2727-E So. Croddy Way, Santa Ana, CA 92704

(714) 751-0442

TELEX 681393

ASK BYTE

the camp that would allow a telephone in every cabin (preferably pulse dial because of their current low cost), intercabin communications, and access to the one main line from every cabin.

Could you recommend: (1) a circuit to decode pulses from the incoming lines, (2) any telecommunications integrated circuits that might aid me, and (3) an inexpensive microprocessor that would handle all switching requirements?

DAVID A. KEARNEY
Hudson, MA

Jules H. Gilder has written two books on telephones that should give you the necessary information to construct the intercabin telephone system that you require. Telephone Accessories You Can Build and More Telephone Accessories You Can Build, both published by Hayden Book Company, feature the theory of operation and simple construction projects ranging from a simple ring detector to an elaborate telephone system. The specific circuits for your project are in More Telephone Accessories. These books are available at many bookstores.
—Steve ■

Between Circuit Cellar Feedback, personal questions, and Ask BYTE, I receive hundreds of letters each month. As you might have noticed, at the end of Ask BYTE I have listed my own paid staff. We answer many more letters than you see published, and it often takes a lot of research.

If you would like to share the knowledge you have on microcomputer hardware with other BYTE readers, joining the Circuit Cellar/Ask BYTE staff would give you the opportunity. We're looking for additional researchers to answer letters and gather Circuit Cellar project material.

If you're interested, let us hear from you. Send a short letter describing your areas of interest and qualifications to Steve Ciarcia, POB 582, Glastonbury, CT 06033.

IN ASK BYTE, Steve Ciarcia answers questions on any area of microcomputing. The most representative questions received each month will be answered and published. Do you have a nagging problem? Send your inquiry to

Ask BYTE
c/o Steve Ciarcia
POB 582
Glastonbury, CT 06033

Due to the high volume of inquiries, personal replies cannot be given. All letters and photographs become the property of Steve Ciarcia and cannot be returned. Be sure to include "Ask BYTE" in the address.

The Ask BYTE staff includes manager Harv Weiner and researchers Bill Curlew, Larry Bregoli, Dick Sawyer, Robert Stek, and Jeannette Dojan.

FREE CATALOG

YOUR 80-PAGE GUIDE TO COMPUTER SUPPLIES AND ACCESSORIES - INCLUDING COMPLETE NEW PRODUCT DESCRIPTIONS.

- Packed with over 1600 products for microcomputers, mini-computers, and word processors - many available nowhere else.
- Big special section devoted to new supplies and accessories.
- Comprehensive product descriptions - with more than 475 full-color photos - clearly explain features and benefits.
- Easy-to-use cross reference guides to magnetic media, ribbons, and more - along with the industry's most complete cable guide.
- Helpful suggestions and tips, ranging from flexible disk care to proper ribbon selection to useful application ideas.

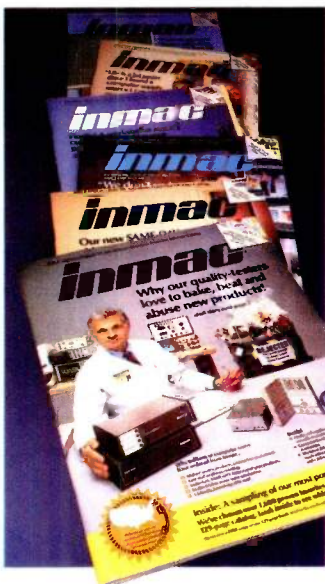

PHONE TOLL-FREE 1-800-547-5444* OR SEND COUPON BELOW TODAY.

*In California, call 1-800-547-5447

inmac™

Inmac Catalog Dept, 2465 Augustine Drive, Santa Clara, California 95054

Please rush my free copy of the Inmac Catalog. I understand there is absolutely no obligation whatsoever.

NAME _____

COMPANY _____

ADDRESS _____

CITY _____

STATE _____ ZIP _____ PHONE _____

For a demonstration of the Z-Engine please see one of the following:

Winner's Circle
2816 Telegraph
Berkeley, CA 94705
(415) 845-4814

Micro Data
813 N. La Cadena
Colton, CA 92324
(714) 824-2266

Software Supermarket
16200 Hawthorne Blvd.
Lawndale, CA 90230
(213) 542-3801

Software Supermarket
11960 Wilshire Blvd.
Los Angeles, CA 90025
(213) 207-1494

Con-Soft
429 Haight Street
San Francisco, CA 94117
(415) 626-8181

Computer Discount Products
4228 Olympic Avenue
San Mateo, CA 94403
(415) 571-1658

Advanced Computer Products
1310-B Edinger
Santa Ana, CA 92705
(714) 558-8813

Software Supermarket
15113 Ventura Blvd.
Sherman Oaks, CA 91403
(818) 783-3233

Computer Wave
6791 Westminster Ave
Westminster, CA 92683
(714) 891-2584

Micro Computer Concepts
13772 Goldenwest Street
Westminster, CA 92683
(714) 898-3002
(800) 772-3914

DMA Digital Computer Systems
105 E. Vermijo
Colorado Springs, CO 80903
(303) 475-2488

Varsity Computing
401 E. Broad
Athens, GA 30601
(404) 548-3434

Cash Register Systems
1501 Hicks Street
Augusta, GA 30904
(404) 724-1747

Computer Pro
2525 Washington Road
Augusta, GA 30904
(404) 737-8313

Varsity Computing
7732 Spalding Drive
Norcross, GA 30092
(404) 446-3434

Ponder's Computer Ctr.
117 W. Jefferson Street
Chicago, IL 60614
(312) 226-3341

Stickly Software
2334 S. King Street #206
Honolulu, HI 96826
(808) 944-0462

Memory Lane
98-1254 Kaahumanu
Pearl City, HI 96782
(808) 487-7999

Caribe Exchange Inc.
213 South Conroy Street
Knockville, IA 50138
(515) 842-3619

Farnsworth Computer Center
1891 N. Farnsworth
Aurora, IL 60605
(312) 851-6567

Compu-Net
1946 North Clark
Chicago, IL 60614
(312) 664-6585

Universal Computer
1890 First Street
Highland Park, IL 60035
(312) 433-8930

Micro City
24 W. 500 Maple Ave.
Naperville, IL 60540
(312) 355-9749

Alpine Computer Center
2418 South Alpine Road
Rockford, IL 61108
(815) 229-0200

Vons Computer
317 West State Street
West Lafayette, IN 47906
(317) 743-4041

Computer SOS
5731 Youree Drive
Shreveport, LA 71105
(318) 865-7188

Computer Shoppe
3828 Veterans Blvd.
Metairie, LA 70002
(504) 454-6600

Advanced Management
2838 Henry Street
Muskegon, MI 49441
(616) 739-3395

Alternate Computer Supply
6034 East Street
Twin Lake, MI 49457
(616) 458-7649

Personalized Computers
12350 Natural Bridge
Hazelwood, MO 63044
(314) 739-0263

Mid West Computing
201 North Pine
Rolla, MO 65401
(314) 364-1998

The Computerworks
121 West Mission
Bellevue, NB 68005
(402) 291-7804

Computer Ark
1921 New Road
Northfield, NJ 08225
(609) 641-4300

Bayonne Computer Center
618 Broadway
Bayonne, NJ 07002
(201) 436-8555

Computerland
2076 E. Route 70
Cherry Hill, NJ 08003
(609) 424-8100

AFC Electronics
Salem Industrial Park Rt. 22
LeBannon, NJ 08833
(201) 534-6343

Round Valley Computer
Box 448 US HWY. 22 East
LeBannon, NJ 08833
(201) 236-9575

Computer Discount of New Jersey
280-B Hwy. 17
Mahwah, NJ 07430
(201) 529-4026

Medford Computer Center
Route 7 Hartford Road
Medford, NJ 08055
(609) 953-0823

Family Computer Centres
154 Valley Street South
Orange, NJ 07079
(201) 762-6661

Family Computer Centres
154 Valley Street
South Orange, NJ 07079
(201) 762-6661

Computer Pro's Inc.
West Belt Mall
Wayne, NJ 07470
(201) 256-7070

Dealer inquiries are invited — please contact one of the following distributors. If a distributor or dealer is not in your area please contact us directly.

The Computer Connection
17121 S. Central Ave.
Union L.
Carson, CA 90746
(213) 514-9019

Softsam
900 West Walnut Street
Compton, CA 90220
(800) 847-6383

Softsam Computer Products
546 Oak
Englewood, CA 90312-6080
(800) 847-6383

Caltex Components
4079 Glen Coe Ave
Marina Del Rey, CA 90292
(213) 827-1851

Computer Discount of America
31 Marshall Hill Road
W. Milford, NJ 07480
In NJ - (201) 728-8082
Out NJ - (800) 526-5313

Sandia Micro Systems
812 Charleston N.E.
Albuquerque, NM 87110
(505) 266-7410

47th Street Photo
115 W. 45th Street
New York, NY 10036
(212) 260-4410

Tec Computer Products Inc.
56 West 45th Street
New York, NY 10036
(212) 944-1166

Byte General Dist.
3 Sierks Lane
Roslyn Harbor, NY 11576
(516) 625-3020

Upstate Computer Shop
99 Commercial Drive
Whitesboro, NY 13692
(315) 768-8151

Computer Store of Laurenburg
1023 South Main
Laurenburg, NC 28352
(919) 276-4424

Audio Buys
1700 Glenwood Ave
Raleigh, NC 27608
(919) 821-1776

Computer Utility Corp.
808 East Main
Ada, OK 74820
(405) 332-4858

Dowling Inc.
3017 N. Stiles Ave
Oklahoma City, OK 73105
(405) 528-2933

Conroy LaPointe
12060 Southwest Garden Place
Tigard, OR 97223
(800) 547-1289

Edu-Care Micro Computer
The Learning Source
Hills Shopping Plaza
Camp Hill, PA 17011
(717) 761-7487

East Coast Software
49 Derrytown Mall
Hershey, PA 17033
(717) 533-8125

Software Hut
2534 South Broad Street
Philadelphia, PA 19145
(215) 462-2268

Opus II
747 Brook Haven Circle
Memphis, TN 38117
(901) 883-0117

Inacomp Computer Center
330 Franklin Road
Brentwood, TN 37027
(615) 373-5667

Software Centre
5545 Richmond Avenue
Houston, TX 77056
(713) 783-9857

Computer Office
22025 61st Ave SE
Bothell, WA 98021
(206) 481-2600

A.P.P.L.E
290 S.W. 43rd Street
Renton, WA 98055
Orders - (800) 426-3687
Info - (206) 251-5222

Computer Horizons Inc.
West Virginia
Morgantown, Wheeling, Beckley
(304) 594-1855
(304) 233-2484
(304) 255-7474

Oryx Systems
425 First Street
Wausau, WI 54401
(715) 848-1374

First Software
17-21 Ballard Way
Lawrence, MA 01843
(617) 689-0077
(800) 343-1290

PC Micro Dealers Co-op
12216 Marc Lane
Glen Arms, MD 21057
(301) 592-5110

Jersey Micro Systems
1200 B Haddonfield Road
Cherry Hill, NJ 08002
(609) 665-7611

Specialists Financial Planning
160 Washington South East
Alb. New Mexico, 87106
(505) 265-8308

Simco
2040 Des Cascades, St. Hyacinthe
Quebec J2S 3J6
(514) 773-7843

Z-Engine delivers CP/M® for your Apple®

Z-Engine delivers a trainload of additional programs to your Apple II, II+, IIe or Apple compatible computer. Many of the most powerful and sophisticated programs available today are CP/M based; Z-Engine opens the door to them all. You might expect that something that gives so much would cost so much. Not so. Z-Engine is, undoubtedly, one of the greatest values in the microcomputer industry. Z-Engine is first class service at economy fare. Once the Z-Engine has been delivered we don't shut off the steam - we support our products - and guarantee them. If you knew what we know about the Z-Engine you'd be our next customer. The Z-Engine delivers.

Advanced Logic Systems
1195 East Arques Ave,
Sunnyvale, CA 94086
(408) 730-0307.



Inquiry 17

CP/M is a registered trademark of Digital Research Inc. Apple is a registered trademark of Apple Computer, Inc.

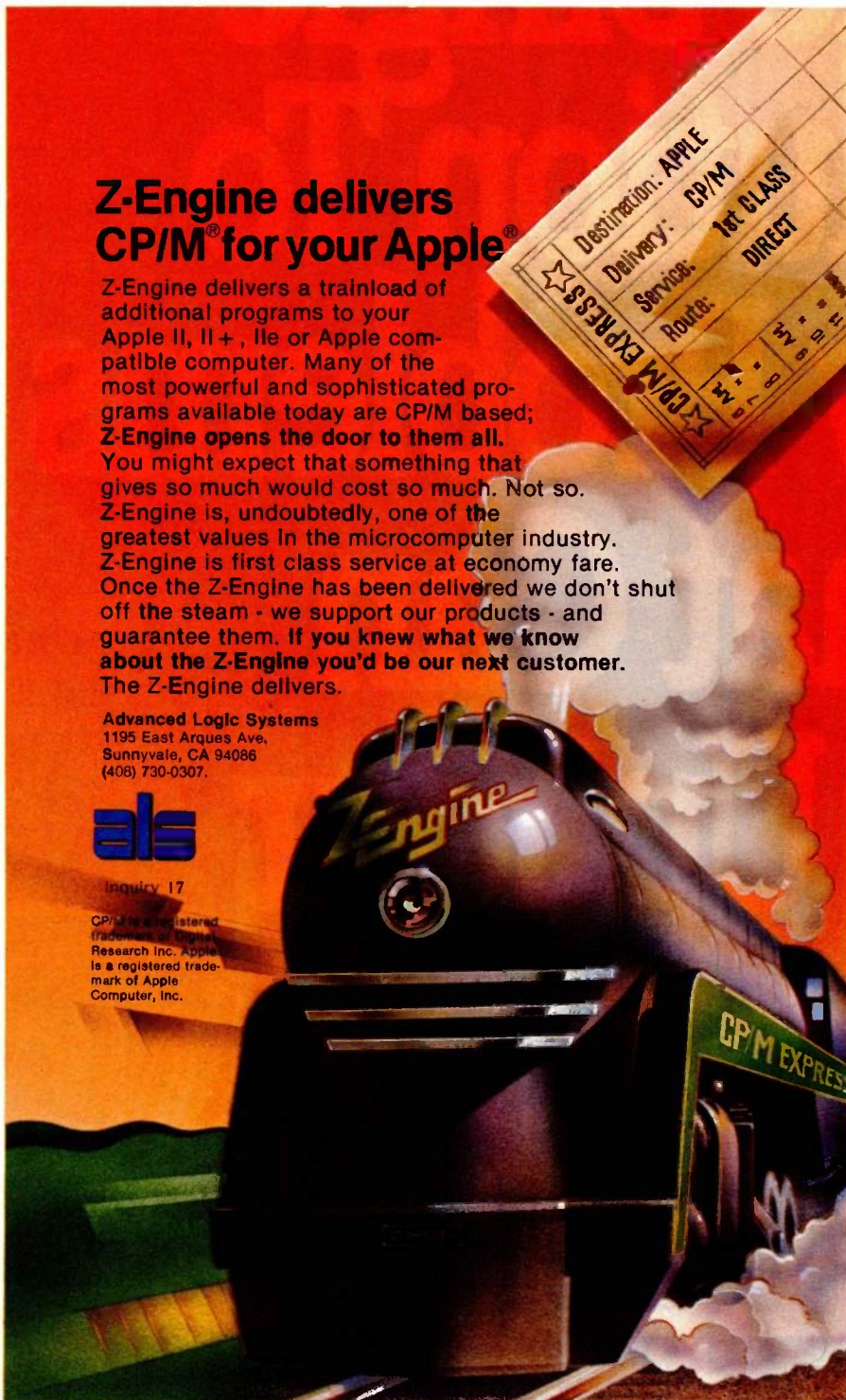

**Introducing
The Single
Solution To
Many Problems
That Can
Tie Up Your
Personal
Computer.**



Transet 1000™. The print buffer, communications buffer, port expander, printer sharer and I/O switcher. All in one.

Anyone with a personal computer and one or more peripherals has faced the all-too-familiar dilemma. You need your computer to do an important job. But you're forced to wait for the system to finish one job (printing, communicating, whatever) before you can go on to the next one. Or you need to stop what you're doing to switch cables when you want to use another peripheral.

Wait no more. Now Hayes introduces an innovative new device that lets you perform many jobs—at the same time—independent of your computer. Transet 1000. It works with a wide range of systems and configurations. And it allows you to continually expand your system as your needs grow.

Transet 1000 frees your computer from waiting on your printer or modem—so you and your computer can go on to another task. It even lets you print out documents in pre-set formats without having to go back into your computer. At the same time, Transet 1000 can operate unattended mailbox communications—24 hours a day—even if your computer is turned off.



Two computers can share one printer with Transet 1000. Or, you can use Transet 1000 to let two computers communicate with each other.

In addition, Transet 1000 is a port expander and software-controlled I/O switcher. Now files can be easily directed and redirected to different peripherals, without physically changing cable connections.

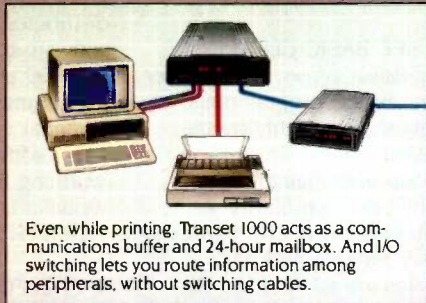

Even while printing, Transet 1000 acts as a communications buffer and 24-hour mailbox. And I/O switching lets you route information among peripherals, without switching cables.

Transet 1000 contains a stand-alone microprocessor, and comes with 128K of memory. It operates with any RS-232 interface computer, and has optional accessory kits available for the IBM® PC and PC XT, Macintosh™ and

Apple® IIc. Kits contain the necessary host cable, a user guide and menu-driven software that lets you graphically set up or customize port

parameters and printing formats. Cables available for IBM PC AT, other computers and peripherals.

Like all Hayes products, Transet 1000 combines sophisticated capabilities with easy operation. Just as Hayes set the standard in personal computer communications, now Hayes is taking the lead in computer task management.

Contact your authorized Hayes dealer to see how Transet 1000 can help you get a lot more productivity

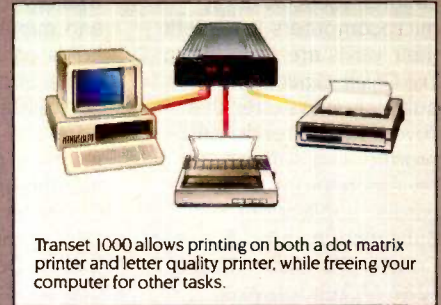

Transet 1000 allows printing on both a dot matrix printer and letter quality printer, while freeing your computer for other tasks.

out of your computer system—without tying up your computer or you.

Hayes Microcomputer Products, Inc., P.O. Box 105203
Atlanta, Georgia 30348
404/441-1617



Hayes® Transet 1000

Innovative products for enterprising people

CLUBS & NEWSLETTERS

● GARDENING ON LINE

Interviews with gardening experts adept at using microcomputers to benefit their yards are included in *The Online Gardener*, a quarterly newsletter that covers news, trends, and product and software reviews relevant to home-garden applications. Subscriptions are \$8 a year. Contact *The Online Gardener*, 1287 McLendon Ave., Atlanta, GA 30307.

● NEWS FROM RIVER CITY

The Sanyo MBC-2000/3000 Forum is designed to provide technical support and an exchange of information without meetings for Sanyo MBC 2000 and MBC 3000 users. Membership includes a subscription to the monthly newsletter, access to a public-domain software library, and nationwide communication by mail and modem. The annual fee is \$15. Contact William Pletcher, Sanyo MBC-2000/3000 Forum, River City Datamation, 2653 Yuma Circle, Sacramento, CA 95827, (916) 362-1537.

● TELESAT INTERNATIONAL

Members of Telesat International benefit from a BBS featuring computing reviews, databases, and international yellow pages. The board is operational 24 hours a day for an annual fee of \$25. For a free membership kit and details, contact Customer Service, Telesat International, POB 2334, Elizabeth, NJ 07207-2334, (201) 352-2319.

● A DENVER GEM

An organization that provides geologists with access to a BBS with extensive pub-

lic-domain geological programs also produces a catalog, monthly newsletter, and member directory and holds conferences and exhibits. Further, experts in geological-applications software and databases present technical papers at the monthly meetings of the Computer Oriented Geological Society (COGS) held in Denver, Colorado. Contact COGS, POB 1317, Denver, CO 80201.

● ACTIVE ON LINE

Users of the Commodore 64 can link into an electronic newspaper, search its database, exchange messages with other users, and upload and download all on line from Ontario, Canada, for a \$20 annual fee. The Stelex Sector BBS, available 24 hours a day at (416) 766-3038, also provides an on-line typing service, bulletins, and products available for sale. The BBS manual sells for \$5. Send an SAE to The Stelex Sector BBS, POB 6238, Station A, Toronto, Ontario M5W 1P6, Canada, or call Roman Kowalczyk at (416) 769-8226.

● DISK ANSWERS

Chicago's First Osborne Group (CFOG) gives new members a disk that contains an explanation of meetings, copies of public-domain programs, a list of members who offer help, and instructions on how to operate the group's 24-hour

RCP/M, which operates on an Osborne I, a 1200-bps Hayes Smartmodem, and a Design One 10-megabyte hard disk. A \$2 initiation fee is required. Contact Benjamin Cohen, CFOG, POB 1674, Chicago, IL 60690.

● SEE BASIC CLEARLY

null-Babel/CBNews, a newsletter for CBASIC programmers, is published monthly by the CBASIC Users Group. The group also maintains a public-domain library. A subscription is \$18; \$28 overseas. Sample and back issues are \$2. Contact Ric Allan, POB 40690, Cincinnati, OH 45240-0690.

● INVESTORS JOURNAL

The MicroComputer Investor, the semiannual journal of the MicroComputer Investors Association (MCIA), furthers the group's intentions to facilitate communications for investors who use microcomputers. Contact Jack Williams, MCIA, 902 Anderson Dr., Fredericksburg, VA 22405.

● INTERACTIVE NEWS

The Society for Applied Learning Technology produces a quarterly newsletter that contains information on scheduled events concerning interactive videodiscs and microcomputers in education. Annual membership is \$30. Members are invited to subscribe to the *Journal of Educational Technology Systems* for an additional \$31. Contact the Society for Applied

Learning Technology, 50 Culpeper St., Warrenton, VA 22186, (703) 347-0055.

● A DIRECT LINE

The Long Island NEC Users Group (LINECUG) is a non-profit organization that distributes public-domain software to users of the NEC PC-8000 and PC-8800. A \$5 annual membership includes biannual updates of the club's software. Contact Jerry Worthing, LINECUG, 75 Weaving Lane, Wantagh, NY 11793, (516) 735-2952.

● PRO FORMA

Transcripts of the C-Pro Users Group's bulletin-board messages at (703) 491-1852 are published in the newsletter, as well as public-domain programs, hardware and software reviews, and technical information for CompuPro and other S-100 bus systems. Membership is \$24 per year. Contact the C-Pro Users Group, POB 1474, 14057 Jefferson Davis Highway, Woodbridge, VA 22193, (703) 690-3312.

● SIGCC TAKES ROOT

The International Council for Computers in Education (ICCE) seeks local chapters for the Special Interest Group for Computer Coordinators (SIGCC), for people with any computer-coordinator responsibilities. A public-message bulletin board, The ICCE Forum, is available on CompuServe at GO EDU18; otherwise ICCE's number on CompuServe is 70014.2117. ICCE houses SIGs for special educators, administrators, and teachers and publishes *The Computing Journal* and a quarterly

(continued)

CLUBS & NEWSLETTERS is a forum for letting BYTE readers know what is happening in the microcomputing community. Emphasis is given to electronic bulletin-board services, club-sponsored classes, community-help projects, and other activities. We will continue to list new clubs and newsletters. Allow at least four months for your club's mention to appear. Send information to BYTE, Clubs & Newsletters, POB 372, Hancock, NH 03449.



Draw Your Own Destiny

If You Can Dream It, Do It With PC-Draw.

Go on. Think big. For the world beats a path to the door of those who *make things happen*. Now, graphically depict your bold new concepts. From ingenious ideas and designs — to master plans and proposals. Communicate with absolute clarity. And create truly *persuasive* presentations and reports.

What fuels the power of your mind? PC-Draw™. An incredibly versatile, *interactive* graphics program for the IBM PC™, XT™, AT™ or enhanced PCjr™ — *unlike anything else* on the market. Using your personal computer and a plotter or printer you conceive, develop, then produce a *hard copy* picture of your thoughts. An optional light pen makes PC-Draw even easier to use.

PC-Draw offers much more than mere painting systems. With it, create *in far greater detail* an endless variety of presentation graphics, proposals, systems design, charts,

forms, diagrams and illustrations. Produce drawings *up to 99 pages* long. Use PC-Draw symbol libraries for applications such as flowcharting, organization charts, forms design, office layout and electrical design. And more.

Or generate and store your *own* unlimited supply of user defined symbols.



Try PC-Draw for a 10 Day Trial Period.

PC-Draw includes an *easy to follow* interactive tutorial. Requires IBM compatible computer, graphics adapter and graphics monitor (or IBM monochrome monitor with **Paradise™ modular graphics card**). Graphic boards, light pens at excellent prices.

Go ahead. Control *your* destiny. Dial **800/2PC-DRAW** to order or for free brochure. In Texas or for customer support call 214/234-1769. MICROGRAFX, Inc., 1701 N. Greenville Ave., Suite 305, Richardson, Texas 75081.

MICROGRAFX™

The Picture of Success.

Inquiry 281

*(Most popular plotters & printers supported.
Version for PCjr available)*

PC-Draw and MICROGRAFX are trademarks of MICROGRAFX, Inc.
IBM, PC, XT, AT and PCjr are trademarks of International Business Machines Corp. Paradise is a trademark of Paradise Systems, Inc.

DISK DRIVE SUBSYSTEMS

PC-INSIDER SERIES FOR IBM
10 TO 116 Mb FORMATTED w/ CONTROLLER
AND ALL NECESSARY CABLES, HARDWARE
& POWER SUPPLY WHERE NEEDED.....FROM \$595

PC-OUTSIDER SERIES FOR IBM
33 TO 116 Mb FORMATTED DRIVES MOUNTED
IN PC-STYLE CABINET.....FROM \$1,595

PC-OUTSIDER 60Mb STREAMING
TAPE OPTION FOR IBM\$1,525

CompuPro / V/ASYN™ 27-120Mb 5 1/4"
EXTERNAL SUBSYSTEMS.....FROM \$1,525

IMPROVE DISK I/O BY 10 TIMES
OVER THE FASTEST 5 1/4" DRIVES WITH THE
50Mb AMCODYNE SUBSYSTEM OR
INTEGRATED MASTER SERVER
AVAILABLE FOR COMPUPRO CONCURRENT
DOS 8-16 & CP/M 8-16, TURBODOS,
AND MSDOS WITH FAST BACK-UP, ULTIMATE DATA
SECURITY/ARCHIVAL AND A VERY EFFICIENT
NETWORKING SOLUTION.....FROM \$4,795

S=100™ (800) SEE PAGE 485
528-3138 FOR OTHER MDSE

DISK COPYING

Whether you need 50 disks or thousands, we have years of experience in creating the highest quality copies. Reasonable prices—fast turnaround. Call today for our free booklet on software duplication and packaging.

BLANK DISKS

Can you tell a good disk from a great one? We can, because we copy thousands each day. We'll tell you which brand is best for your system. Call today—and get great prices, too!

Call ALF first
1-800-321-4668

in Colorado (303) 234-0871

ALF ALF Products • Denver, CO

CLUBS & NEWSLETTERS

called *The SIG Bulletin*. SIG membership ranges from \$10 to \$17 annually, depending on ICCE membership and location. Contact the International Council for Computers in Education, University of Oregon, 1787 Agate St., Eugene, OR 97403. (503) 686-4414.

● REFER TO SNUG

The bulletin boards of the Sanyo National Users Group (SNUG) at (509) 884-0613 and 335-1652 in Wanatchee and Pullman, Washington, provide technical assistance for users of the Sanyo MBC. In addition, a public-domain library is maintained, a monthly newsletter is produced, and group-purchase discounts are organized. The annual fee is \$15. Contact Michael Russell, SNUG, POB 2084CS, Pullman, WA 99163.

● BCS KAYPRO

The Boston Kaypro Users Group (BOSKUG), affiliated with the Boston Computer Society (BCS), runs an RCP/M and publishes a bi-monthly newsletter called *The Boston Kugel*. Meetings are held semimonthly every second and fourth Tuesday. Joining the BCS entitles you to membership both in BOSKUG and the BCS and to receive their respective publications. For membership information, contact BCS, 1 Center Plaza, Boston, MA 02108, (617) 367-8080. For a subscription to *The Boston Kugel* beyond a 75-mile radius of Boston, send \$10 to BOSKUG, 27 Howland Rd., West Newton, MA 02165, or call Lee Lockwood at (617) 965-6343.

● WHAT'S NEXT?

Due to an alleged lack of company-sponsored user support, the managing staff of *NexWorld*, *The Independent NEC APC News Journal*, invites interested users to

discuss a right to company support. Write to Count Me In, *NexWorld*, 388 Old Turnpike Rd., Woodstock, CT 06281, (203) 974-3505.

● V FOR VENTURA

The Ventura County Macintosh Club (VMAC) holds monthly meetings, produces a monthly newsletter, and maintains a software library. Membership is \$15 annually. Contact Ventura County Macintosh Club, 1413-D South Victoria Ave., Ventura, CA 93003, (805) 644-5220 or 985-3400.

● OPEN EXCHANGE

The East Carolina CP/M-MS/DOS Group welcomes an exchange of newsletters, public-domain software, and other information relevant to the CP/M and MS-DOS operating systems. The club produces a newsletter that is published every other month, and a bulletin board is in the works. The annual dues are \$10. Contact East Carolina CP/M-MS/DOS Group, 707 Edge Hill Rd., New Bern, NC 28560.

● DEVELOPERS UNITE

The Software Developers Association is a nonprofit association of computer software developers in Canada. A single monthly newsletter is \$5; an annual subscription is \$50. Contact Bob Bruce, Software Developers Association, Suite 500, 185 Bloor St. E., Toronto, Ontario M4W 3J3, Canada, (416) 922-1153.

● SANYO BLOOMS IN INDIANA

Members of the Bloomington Area Sanyo Users Group wish to exchange information with Sanyo-specific and other MS-DOS computer groups. Contact Robert Cole, Bloomington Area Sanyo Users Group, 430 South Dunn #205, Bloomington, IN 47401, (812) 336-7272. ■

Sweet-P®

Sweet-P Model (SP600)

A six-pen graphics plotter that's more compatible . . . uses more software.

Last year 430 million business slides were made at a cost of \$3.2 billion. Most of these slides were manually generated.* These slides could have been made on Sweet-P® Personal Plotters™. Faster and better. With a savings of millions of \$!

The Sweet-P SP600 is a high quality American made precision machine. It's fast. It plots 14 inches per second. It's beautiful for office and technical work.

Over 100 graphics software packages drive the Sweet-P™ world famous packages like Lotus 1-2-3™, Framework™ and Super-Calc™ technical software like AutoCAD™, PCAD Robographics™ and dedicated business graphics software such as Micro-soft Chart, ChartStar™, Energraphics™, Chart-master™ and pfs Graph™.

Pens are capped automatically when not in use, so that pens last longer and start quicker.

only \$1,095

The Sweet-P easily connects to almost any computer. It has RS-232 serial and Centronics™ parallel connectors. And it supports two standard graphics languages—Sweet-P Graphics Language (SPGL™) and Hewlett-Packard Graphics Language (HPGL™).

The Sweet-P plots on almost any media. Make brilliant overhead transparencies. Plot on film, and on plain and coated papers.

Save on wiring costs too. The Sweet-P will "eavesdrop" on the RS-232 cables that connect your terminals now. (This makes it easy for Sweet-P to join local and long distance networks.)

What about support? Sweet-P customers get fast professional help with software, hardware and interface questions. And warranty and service support is quick.

Sweet-P Model 600 also comes with 18 ANSI ASCII internal Character sets.



U.S. DISTRIBUTORS

Arizona

First Source Distributing
(602) 263-1950

California

Zenith Data Systems • (415) 621-8545

Colorado

Ares Distributing • (303) 752-2972

Florida

Cain Bultman • (904) 356-4812

Illinois

PC Distributing • (312) 356-4812
Zenith Data Systems • (312) 562-7300

Kansas

Inland Computer • (913) 492-9100

Maryland

Federal Data • (301) 986-0800

Missouri

Computime, Inc. • (314) 991-2991

North Carolina

Allison-Erwin • (704) 334-8621

New Jersey

Data Research • (201) 569-2620
Buhl Industries • (201) 423-2800

Pennsylvania

Peirce Phelps, Inc. • (215) 879-7068
Pryor Corp • (800) 245-0209
Chessell Robocom • (215) 968-4422

Tennessee

Multi Computer Products
(615) 528-7777

Texas

AMCAD, Inc. • (214) 323-0700
National Marketing Inc.
(214) 386-8151

Washington

Comquest Systems • (206) 641-7650

Canada

Atiel Data • (403) 259-7814
Interworld Electronics Inc.
(604) 984-4171
The Pringle Group
(416) 449-5640

Enter Computer Inc.
6867 Nancy Ridge Dr.
San Diego, CA 92121

619-450-0601 • 800-227-4371 CA
800-227-4375 • TELEX-181740

Trademarks: Sweet-P, Six Shooter, Personal Plotter, SPGL, Enter Computer, Inc., HPGL, Hewlett-Packard, Lotus, Lotus Development Corp., Framework, Ashton-Tate, Super-Calc, Sorcim, Inc., AutoCAD, Autodesk, PCAD Robographics, Chessell-Robocom, Inc., Chart Star, Micro-Pro Int'l Corp., Energraphics, Enertronics Research, Inc., pfs Graph, Software publishing Corp., Chart-Master, Decision Resources, Centronics, Centronics Corp.

Source notes *Yankee Group, The Technical Office, Vol. III 1983

**Wharton School Study, September 1981

Inquiry 170 for End-Users.

Inquiry 171 for DEALERS ONLY.



For everyone who ever tried doing five things at once

**The perfect computer program
for someone as busy as you.
It lets you keep several other
programs working at once.**

Do you ever go in so many directions
so fast not even a computer can keep up
with you?

Well, now an IBM Personal Comput-
er can—thanks to IBM TopView.

TopView is a new kind of software
that lets you switch between other pro-
grams as quickly as you can change your
mind, even run several programs at the
same time.

Once you load TopView into your
computer, you load the other programs
you use most—as many as your com-
puter's memory will permit.

After that, the greatest distance
between two programs is just a couple of

keystrokes, or (optional) mouse moves.

There's no waiting and a lot less
diskette swapping.

But when you're *really* busy is when
TopView really shines, letting you do
many jobs simultaneously.

For example, you can print a letter
while you search a file, while you analyze
a spreadsheet, while your clock/calen-
dar reminds you that your automatic
dialer is about to place a call for you.



...IBM presents TopView.

And you can see everything through on-screen "windows" and control it all with easy-to-use pop-up menus.

You can even make unrelated programs work together: say a "Brand Y" spreadsheet with a "Brand Z" word processor.

But simplest of all is a certain Brand IBM™, namely the IBM Assistant Series—for filing, writing, planning, reporting and graphing.

Many other popular programs also work with TopView, and the number is growing.

Naturally, the more computer memory you have, the more TopView can help you. At least 512K is recommended.

And the price is only \$149*.

Beyond that, all you need is to be the kind of person who never does a single thing all day, but who wants to do everything, at once.

To learn more, call an IBM marketing representative, or visit an IBM Product Center or Authorized IBM PC or Software Dealer.

For the store nearest you, and a free brochure, call 800-447-4700. (In Alaska and Hawaii, 800-447-0890.)

IBM
Personal Computer Software

EVEREX EVER FOR EXCELLENCE

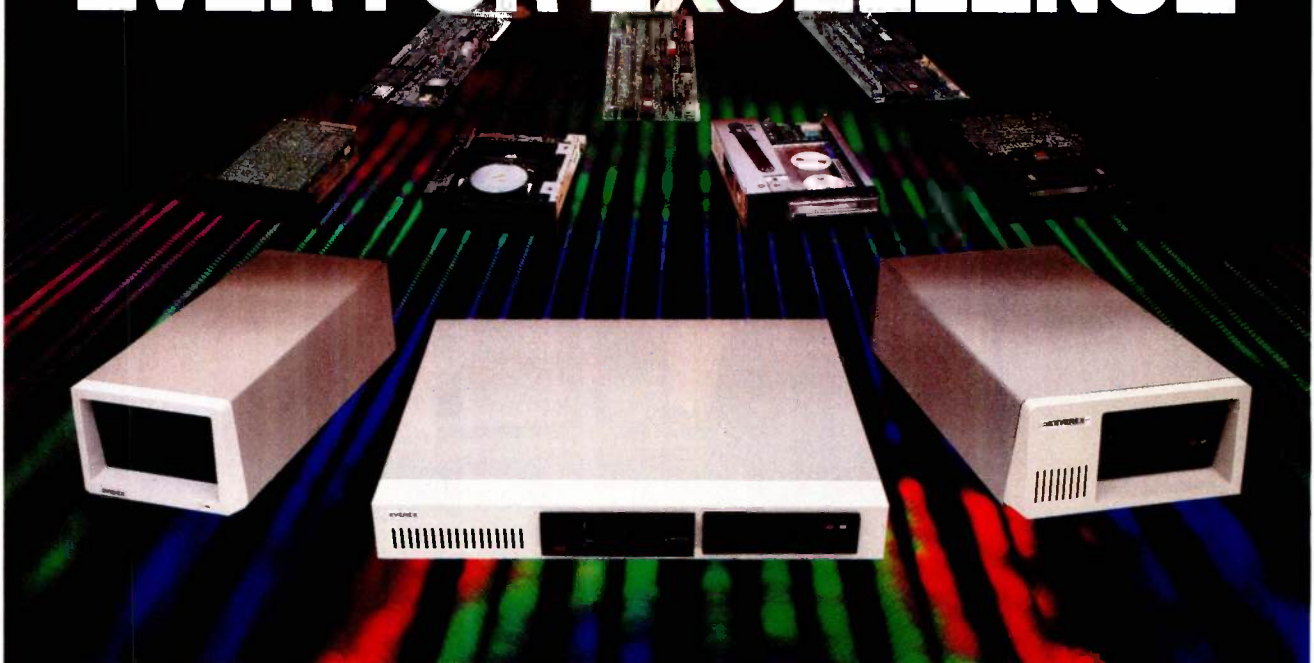

Innovative Backup and Hard Disk Drive Systems For Your IBM PC, XT and AT

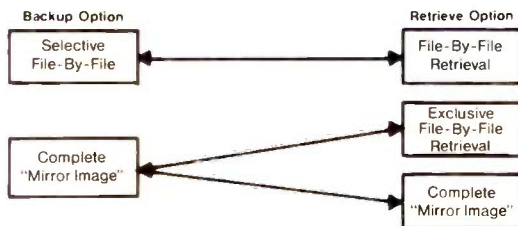

The Standard of Excellence in Backup Software

- Revolutionary Everex Backup systems give you the backup/retrieve flexibility you want while saving you hours of time. You can backup your hard disk drive in minutes with a fast "mirror image," then retrieve this information either file-by-file or the entire hard disk image.
- High speed backup/retrieve—up to 5MB per minute.
- Menu Driven software includes the largest selection of file selectable options—choose from name, date, time interval, global, qualifier and more.
- Advanced installation program automatically configures the optimal backup/retrieve speed with your hard disk drive.

The Leader in External Expansion Systems

- All external systems are available with any combination of Everex Backup and Hard Disk Drive systems.
- Slimline systems include one short and three long expansion slots for adding more accessory boards.
- Half-Size system includes four long expansion slots.

- Full-Size system (looks like your PC) includes eight long expansion slots.
- External systems include one high quality, round shielded cable.

The Total Solution For Backup That Plugs Right Into Your Computer

- A wide selection of backup solutions with the price and performance to meet your needs:
- The EXCEL 4500, 45 and 60 MB high performance ¼ -inch Streaming Tape systems, the EXCEL 200, 20 MB Cassette system and the EXCEL 10 MB Floppy Tape system.
- Space-saving half height units with single board controller.
- Combine with Everex hard disk drives for lower cost and higher performance.
- Unique "piggyback" power supplies ensure dependable operation and save space.

Visit your local Everex dealer today and ask to see Everex products in action. For the name of your nearest Everex dealer, please call (415) 498-1111.

Imagineering Ultimo, Australia TLX: 74349 IMAGIN AA
 Microage Distribution Ltd. London, England TLX: 881 3241 WONGS G
 Feeder Paris, France TLX: 4413241 FEEDER
 Automated Office Systems Hout Bay, South Africa 2721-70-8091
 Survex, 1027 Speers Road, Oakville, Ontario Canada L6L-2X5. 416-842-6093
 Pride Computers, 102-8167 Main Street, Vancouver,
 British Columbia, V5X 3L2, 604-321-5690

IBM, PC, XT and AT are registered trademarks of International Business Machines Corporation.
 EXCEL is a trademark of Everex Systems Inc.

EVEREX
 EVER for EXcellence

Address: 47777 Warm Springs Blvd., Fremont, CA 94539 (415) 498-1111.

Dealer Hotline (800) 821-0806 • In CA (800) 821-0807

B·O·O·K R·E·V·I·E·W·S

PROGRAMMER
PRODUCTIVITY:
ACHIEVING AN URGENT
PRIORITY
Girish Parikh
Reston Publishing
Reston, VA: 1984
236 pages, \$31.50

APPLYING SOFTWARE
ENGINEERING
PRINCIPLES
David Marca
Little, Brown
Boston, MA: 1984
288 pages, \$29.95

CP/M-86 USER'S GUIDE
Jonathan Sachs
Osborne/McGraw-Hill
Berkeley, CA: 1985
568 pages, \$18.95

PROGRAMMER
PRODUCTIVITY:
ACHIEVING AN URGENT
PRIORITY

Reviewed by Michael Martinez and E. Francis Avila

In the world of data processing, systems managers will tell you software development and maintenance are the most expensive costs incurred in running a large system. While computer-hardware costs have dropped, software-development costs have risen. The issue, then, is finding useful, reliable methods of increasing programmer efficiency, crucial to stemming the climbing costs of developing and maintaining software.

In *Programmer Productivity: Achieving an Urgent Priority*, Girish Parikh, an experienced data-processing programmer and manager, tackles this difficult but vital task head-on. He offers practical solutions that promise to increase productivity while reducing maintenance costs.

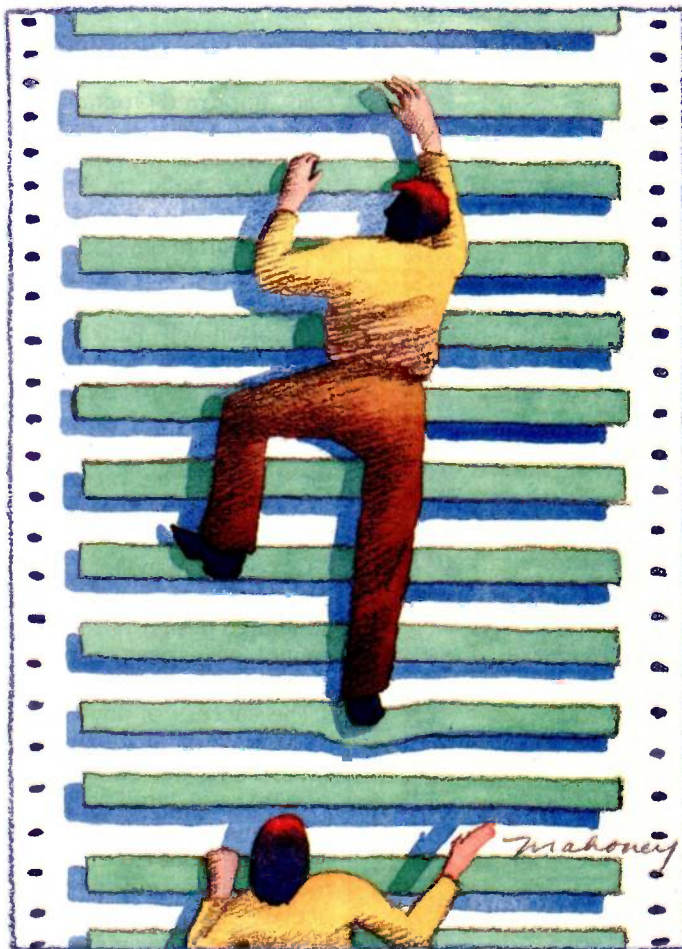

COMPUTER ANIMATION
PRIMER
David Fox
and Mitchell Waite
McGraw-Hill
New York: 1984
522 pages, \$22.95

THE COMPLETE
HOME EDUCATOR:
A COMPREHENSIVE
GUIDE TO MODERN
HOME-TEACHING
Mario Pagnoni
Larson Publications
Burdett, NY: 1984
248 pages, \$10.95

Be forewarned that *Programmer Productivity* is not intended for hobbyists, although amateur programmers would do well to

adopt good programming practices. Parikh has written this text primarily for professional programmers and data-processing managers working in large-systems environments with teams of programmers, designers, and analysts developing applications software that often encompasses thousands upon thousands of lines of code.

Consequently, the book's technical nature often makes for dry, sometimes ponderous reading. Additionally, Parikh assumes the reader possesses more than a casual knowledge of professional programming operations. He does not shy away from technical prose.

Parikh begins each chapter by quoting either his own experiences or those of other data-processing experts. He follows this with a presentation of some of the more

(continued)



COMPUTERBANC

BANC \$AFE

LOWEST PRICES ANYWHERE! ANYTIME! ANYPLACE!

THOUSANDS OF AVAILABLE ITEMS. CALL FOR COMPLETE PRICING.

IBM PC Starter System \$2059 2 drives, 256K, Mono-Card Parallel/Monitor	IBM PC Deluxe \$2999 20MB/2 drs./256K Monocard/Parallel Monitor	IBM PC/AT \$5559 300K 1.2 Meg Floppies 20 Meg Hard 512K Ram
--	--	--

IBM PC/AT BASE CALL
 IBM PC/AT ENHANCED..... CALL
 IBM PC/AT DRIVES/BOARDS CALL
 IBM XT..... CALL

IBM SOFTWARE	MONITORS
ASCI Express For IBM	AMDEX 300
ASHTON TATE Framework	300A
dBASE II	310A
dBASE III	Color 1 +
ENERGRAPHICS	Color II
FOX & GELLA Quickcode	NEC 1201 Hi Res Green
dGraph	1260 Green
LIFETREE SOFTWARE Volkswriter	JC 1215 Composite Color w/audio
Volkswriter Deluxe	JC 1216 Color RGB
Lotus 1-2-3	PRINCETON GRAPHICS HX-12
Symphony	SA-12
MICROPRO Wordstar	MAX-12
2000	TAXAN Composite Amber
Professional	121/122
MICROSOFT Word	420 (RGB)
Multiplan	415 (RGB)
C-Compiler	ZENITH ZVM 122-123
Project	
MICROIM Abase 4000	
MULTIMATE	
PC Mouse W/Software	
PFS Write, File, Report	
Proof, Access	

IBM HARDWARE	PRINTERS
AST Six Pack Plus 64K	BROTHER HR-15
MegaPlus II	HR-25
Pc Net 1 Starter Kit	HR-35
AT Ram to 1.5 MB	2024LQ
FRANKLIN TELECOM	EPSON RX-80 F/T
10 Meg Harddisk	FX-80 +
22 Meg Harddisk	FX-100
Cartridge backup	LQ1500
HERCULES Mono Graphics	JUNI 6100
Color Card	NEC 2030
IBM Floppy 1.2 Meg	2050
IRWIN Tape Drive	3530
MICROSCIENCE	3550
10MB Winchester	OXIDATE 92A
MOUSE SYSTEMS Optical Mouse	93A
ORCHID Turbo	PANASONIC 1091
Pc Net Starter Kit	STAR MICRONICS SG-10
PLANTRONICS Colorplus	TOSHIBA 1340
QUADRAM Quadboard O-H	1351
Quadcolor 1 or Microfaser 64K	
Quad for Pc Jr	
STB Rio plus 64K	
Super Rio	
Graphix + II NEW	
TALL GRASS 12MB W/Tape	
TANDOM TM 100-2	
TEAC 55B	
55F	
ALSO — PERSYST, ORCHID, TITAN AND OTHERS	

MODEMS	APPLE PRODUCTS
ANCHOR Mark X	APPLIED ENGR Mega Ram
Mark XII	APPLE Compatible Drive
Volkswriter 1200	APPLEWORKS
HAVES 1200	APPLEMOUSE II
1200B	APRICOAN Serial
2400	80 col/64 //e only
Micromodem //e	Graphics Card
PROMETHEUS Promodem 1200	ASCI II Express Professional
	MACINTOSH 3 1/4 drive
	Harddrive
	MACINTOSH Software Jazz
	MICROSOFT Softcard II
	Multi-plan //e & Mac
	Basic (Mac)
	MICRO SCI A2 drive //e
	//e drive
	HAVES Mach III Joystick
	SYSTEMS SERVER Fon
	TEAC //e drive
	Titan Accelerator
	VIDEX Ultraterm
	Videoterm
	WESPER Graphics Interface
	Buffered Graphics Interface
	APRICOAN Super Serial Card

WE SUPPORT THESE FINE SYSTEMS: Apple, Compaq, IBM, and many more.

TELEX #550757/ ANSWER BACK—COMPUTERBANC UD



Orders Only
800/332-BANC
OUTSIDE CALIFORNIA

COMPUTERBANC

16783 Beach Blvd., Huntington Beach, CA 92647
714/841-6160

Cash prices indicated. All products are in factory sealed packages. We guarantee all items for 30 days. Within this period, defective merchandise returns must be accompanied by RMA number. All other returns will be subject to a 10% restocking fee. For prepaid orders, there will be a 3% shipping charge. 5% for UPS Blue Label. \$5.00 minimum; all orders outside U.S.A. at 15% shipping. California residents add 6% sales tax. Prices subject to change without notice.

Copyright 1985 COMPUTERBANC. All Rights Reserved.

BOOK REVIEWS

popular (and not so popular) theories and practical methods that promise to increase programming efficiency and lower maintenance costs.

Throughout the book, the author intersperses details of personal successes and failures, as well as other case studies, encountered during the process of implementing and testing the various productivity techniques. Generally, Parikh does not hesitate to show his support for one technique over another.

'IMPROVED TECHNOLOGIES'

The book's central hypothesis revolves around what Parikh calls "improved programming technologies." If these technologies are adopted, dramatic increases in the productivity of programming projects can be realized, according to Parikh. In the first chapter, he lists these technologies: HIPO (hierarchy plus input-process-output), top-down program development, chief-programmer teams, development-support libraries, structured programming, and structured walk-through.

Unfortunately, Parikh does not go into any great detail about any one technique; he leaves that for further research by the reader. Instead, he offers a quick overview of each technique, sometimes listing the good and bad points. With HIPO and structured programming design, for example, he provides simplistic models of these different approaches, mixing each with comments and his own experiences.

Of course, many techniques employed to increase programmer output, such as Warnier-Orr diagramming and structured design, are subjects of books themselves. Parikh cannot be expected to treat them in depth in a book designed as an overview of programmer productivity.

The success of any one of Parikh's recommendations depends on the size and nature of the project. But of the six technologies outlined by Parikh, you'll get the impression that structured programming technique is the method most capable of producing the most success. And indeed it has been our experience that structured programming methods have proven more successful in increasing productivity as well as long-term maintainability of software than many other methods devised.

You might get the impression that the author is addressing only COBOL programmers. However, this is not the case. While a chapter is devoted specifically to COBOL using a preprocessor, the wealth of material Parikh covers is not bound by any language and could be just as easily applied to FORTRAN, C, Pascal, or BASIC.

PEDANTIC

Parikh occasionally drops his guard and comes across sounding a little pedantic, at times condescending. This is unfortunate because it detracts from an otherwise good treatment of material. There are times when Parikh writes more like a crusader waving the banner of improved programming technologies than a professional sharing his

(continued)

BIT FOR BIT THE BEST MODEM ON THE MARKET.

Other people make modems for telecommunications. But our new Courier 2400™ modem is made for business. This modem transmits, over the phone, 240 characters a second, enabling you to upload or download data at twice the speed of a 1200 bps modem. You'll cut phone costs, save precious hours and increase productivity.

BEING FASTER IS IMPORTANT. BUT BEING BETTER WAS OUR GOAL.

The Courier 2400 features auto-dial and auto-answer ... and is fully CCITT and Bell compatible. It responds to the full AT command set, allowing you to use any of the popular telecom software packages, including Telpac™ by U.S. Robotics, Crosstalk™, PC Talk™, Smartcom™ and many others. And the entire AT command set and S-register functions are displayed on "help screens" and again summarized for you on the underside of the unit.



Help Screens

Courier 2400 is accommodating in other ways too. It lets you know the length of each call, tells you (on screen) the status of a call in progress, and even features an adjustable speaker to provide audio phone



Microlink 2400™

line monitoring. Courier can test itself in both answer and originate modes, and automatically adjusts from 2400 bps to 1200 or 300 bps. And a powerful automatic equalizer assures nearly perfect performance on every call.

BEST OF ALL, COURIER IS COMPATIBLE WITH YOUR BUDGET.

At \$699, you'll not find more modem for the money. If you prefer an internal slot modem for IBM-PC and compatible computers, our new Microlink 2400™ will deliver the same superior performance at the same affordable price. And to get the most out of either Courier or Microlink, ask for new, improved Telpac telecommunications software with easy to use windows.

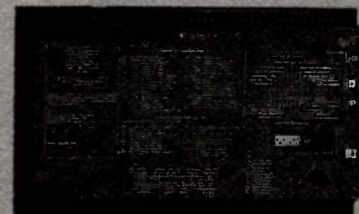

Bottom of Courier

We set out to build the best modem on the market. Now, it's ready. Once you try Courier or Microlink, we think you'll agree — we're not exaggerating one bit.

Inquiry 409

courier 2400

by U.S. Robotics, Inc.

8100 McCormick Blvd.
Skokie, IL 60076
Phone: (312) 733-0497
Telex: 650-186-3130
Outside Illinois: 1-800-Dial USR



NEW!

THE UPS THAT TALKS TO YOUR COMPUTER.

MICRO-FERRUPS™



TOTALLY EFFECTIVE POWER PROTECTION
Protects against blackouts, brownouts, spikes, sags, surges, glitches, noise and frequency shifts. Provides computer grade sine wave power.

TRUE NO-BREAK UNINTERRUPTIBLE POWER
MICRO-FERRUPS provides true no-break uninterruptible power. (Many UPS on market are really standby systems that break power from 2-10 milliseconds when transferring to battery backup. That's an eternity to your computer and disk drive.)

BATTERY INCLUDED
Sealed no-maintenance, long life battery included. An auxiliary 12 volt battery can be added for longer backup time.

TALKS TO COMPUTERS
The on-board microprocessor and RS232 port allows MICRO-FERRUPS to interface with computers. Your power can be monitored by the computer so you know what is happening and an orderly shutdown can be made. AC input and output voltages, output current, load VA, line frequency, battery voltage and backup time remaining can be displayed on terminal. 300 or 1200 selectable baud rate. ASCII.

**250VA \$945
500VA \$1345**

BEST POWER TECHNOLOGY, INC.
P. O. BOX 280, NECEDAH, WISCONSIN 54646

800-356-5794
Wis. 608-565-7200

BOOK REVIEWS

knowledge and experience. Obviously, he feels very strongly about his subject matter.

THE EGOLESS PROGRAMMER

One intriguing subject that Parikh suggests needs more attention is his idea of "egoless programming." He devotes an entire chapter to this ignored topic.

Parikh urges programmers and managers alike to abandon egocentric attitudes and pull together as a team on projects. He asserts that the key to self-fulfillment is to become "egoless." Only then will programmers (and managers) get a clearer picture of the task at hand. He cautions programmers not to take criticism personally but to instead be open to suggestions from peers and accept "humbling tasks."

To merge ego into the programming team may sound a bit offbeat for the average software-development group in this country. Given the prevailing attitudes of most American workers, we doubt that this philosophy would stand much of a chance of being taken seriously, but Parikh's discussion is interesting nevertheless.

Programmer Productivity opens several doors that potentially lead to increasing both the quantity and the quality of computer-programmer output. The author freely acknowledges that the programmer's craft as an intellectual endeavor is very difficult to measure, let alone improve upon. But, he insists, with the proper use of "improved programming technologies" it can be done. Parikh leaves it to the reader to choose which technology is best.

Michael Martinez (7475 San Bergamo Dr., Goleta, CA 93117) is a systems programmer. E. Francis Avila (POB 4401, Auburn, CA 95604) is a contract programmer working on a degree in mathematics.

APPLYING SOFTWARE ENGINEERING PRINCIPLES

Reviewed by Annette Hinshaw

With questions and exercises at the end of every chapter and a dry academic style that tends to obscure the important material it contains, *Applying Software Engineering Principles* looks like a textbook. However, the exercises suggest individual study rather than classroom use. Every problem requires access to a library of programs used in business. The questions ask the reader to analyze both successful and unsuccessful software in light of the principles covered in that chapter. They also suggest ways to implement the ideas from the chapter in upcoming programming projects.

These exercises are excellent, but they seem pertinent only to people working in programming shops large enough to require multiperson projects. On the other hand, the exercises may require more time to complete than most working programmers can spare for self-improvement.

(continued)

When Your Chips Are Down,

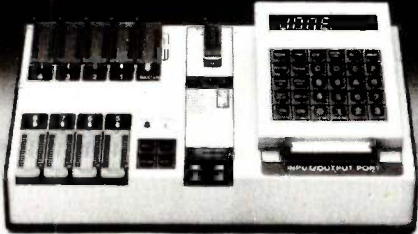

**Bank on BYTEK's
(E)PROM MultiProgrammer System S15-G
With Less Restrictions & a FREE KEYBOARD
For Only \$1150.**

Stand Alone or Hook Up to your Terminal,
3 Voltage Devices, Simulation Module,
Supports Bipolar, PALs, 40 Pin Chips.
Also Available: S5 Basic (E)PROM
Programmer, \$690. UV Erasers from \$67.

BYTEK® COMPUTER SYSTEMS CORPORATION
1021 South Rogers Circle, Boca Raton, FL 33431
CALL TO ORDER (305) 994-3520, Telex 4310073 MEVBTC
Distributor Inquiries Welcome

You may be the best programmer in the world.

TELEPHONE ORDER ENTRY FORM

Salesperson: SMITH Ship To: Infranco Office Systems
 Today's Date: 12/12/84 123 80th Street
 Middle Vill, NY NY 11375

Acct Num	Ship Date	Ship Via	FOB Point	Terms	Order Number
12345	12/12/84	UPS	Dest	Net 10	12345678

Quantity	Item Num	Description	Unit Price	Amount
2	123-GH12	12 Plug Pin	\$ 2.15	\$ 4.30
1	567-AS78	12 Ft Cord	\$ 2.00	\$ 2.00
0			\$ 0.00	\$ 0.00

For \$125 you can let the world know it.

You're a good programmer. Maybe even the best.
But do your users know it?

After all, they weren't around while you were working on your latest program. They can't know all the creative energy, all the problem-solving persistence that went into it.

All they know is what they see on the screen. Is it handsome? Is it elegant? Does it make the program easier to use?

Or is the screen dull, unimaginative and not as clear as it might be?

Now you can remove the last obstacle between you and programming perfection. You and Screen Sculptor can create a beautiful, logical screen in minutes. Then Screen Sculptor automatically writes the program—in IBM Basic, IBM Pascal, or Turbo Pascal—to display the screen and allow

the user to enter data.

Design a screen you like and rearrange it whenever you like. Select colors from a mouth-watering menu. Choose special characters, draw lines and boxes, paint in areas, repeat a character in any direction!

Specify input fields, variable names, data types, acceptable data ranges and more. If you like, design one screen to input data, another to output it.

Then Screen Sculptor generates actual program source code based on your screen design.

You'll need an IBM PC, XT, PCjr, PC AT or 100% compatible, 128K, DOS, one 320K disk drive and any 80-column display. We supply the rest.

Screen Sculptor. For \$125 you can make your users very, very happy.

While making yourself look very, very good.



**SOFTWARE
BOTTLING
COMPANY**

Try it FREE for 30 days!

Here's a no-risk offer. Order now and you'll also get a full demo disk. Use the demo and the manual for 30 days. If you don't love it, return the package for a full refund!

Credit card orders only call 24 hours a day, 1-800-824-7888, operator 268.
For all other orders and inquiries call or write: The Software Bottling Company of New York, 6600 L.I. Expwy, Maspeth, NY 11378.
(718) 458-3700. If we're shipping to a NYS address, please add 8 1/4% sales tax.

High performance to cost ratio...

Programming Chips?

Projects develop profitably with development hardware /software from GTEK.



MODEL 7956
(with RS232 option) \$1099.
MODEL 7956 (stand alone) \$ 979.
GTEK's outstanding Gang Programmer with intelligent algorithm can copy 8 EPROMS at a time! This unit is used in a production environment when programming a large number of chips is required. It will program all popular chips on the market through the 27512 EPROMS. It also supports the Intel 2764A & 27128A chips. It will also program single chip processors.



MODEL 7228 - \$599
This model has all the features of Model 7128, plus *Intelligent Programming Algorithms*. It supports the newest devices available through 512Kbits; programs 6x as fast as standard algorithms. Programs the 2764 in one minute! Supports Intel 2764A & 27128A chips. Supports Tektronics, Intel, Motorola and other formats.

EPROM & PAL

PROGRAMMERS

—These features are standard from GTEK—

Compatible with all RS232 serial interface ports • Auto select baud rate • With or without handshaking • Bidirectional Xon/Xoff • CTS/DTR supported • Read pin compatible ROMS • No personality modules • Intel, Motorola, MCS86 Hex formats • Split facility for 16 bit data paths • Read, program, formatted list commands • Interrupt driven — program and verify real time while sending data • Program single byte, block, or whole EPROM • Intelligent diagnostics discern bad and/or erasable EPROM • Verify erasure and compare commands • Busy light • Complete with Textool zero insertion force socket and integral 120 VAC power (240 VAC/50Hz available) •



MODEL 7324 - \$1199
This unit has a built-in compiler. The Model 7324 programs all MML, National and TI 20 and 24 pin PALs. Has non-volatile memory. It operates stand alone or via RS232.



MODEL 7128 - \$429
This model has the highest performance-to-price-ratio of any unit. *This is GTEK's most popular unit!* It supports the newest devices available through 256Kbits.

MODEL 7316 Pal Programmer \$ 599
Programs Series 20 PALs. Built-in PALASM compiler.

DEVICES SUPPORTED

by GTEK's EPROM Programmers

NMOS		CMOS		EEPROM		MPU'S	
2758	2764A	2508	68764	27C16	5213 12816A	8748	8741H
2716	27128	2516	8755	27C16H	5213H 12817A	8748H	8744
2732	27128A	2532	5133	27C32H	52B13	8749H	8751
2732A	27256	2564	5143	27C64	X2816	8741	68705
2764	27512	68766		27C256	48016	8742H	

UTILITY PACKAGES

GTEK's PGX Utility Packages will allow you to specify a range of addresses to send to the programmer, verify erasure and/or set the EPROM type. The PGX Utility Package includes GHEX, a utility used to generate an Intel HEX file. PALX Utility Package — for use with GTEK's Pal Programmers — allows transfer of PALASM® source file or ASCII HEX object code file. Both utility packages are available for CPM,® MSDOS,® PC DOS,® ISIS,® and TRSDOS® operating systems. Call for pricing.

AVOCET CROSS ASSEMBLERS

These assemblers are available to handle the 8748, 8751, Z8, 6502, 68X and other microprocessors. They are available for CPM and MSDOS computers. When ordering, please specify processor and computer types.

ACCESSORIES

Model 7128-L1, L2, L2A (OEM Quantity) \$259.	XASM (for MSDOS)	\$250.
Model 7128-24	UV Eraser DE-4	\$ 80.
Cross Assemblers	RS232 Cables	\$ 30.
	8751 Adapter	\$174.
PGX Utilities	8755 Adapter	\$135.
PALX	48 Family Adapter	\$ 98.
	68705 Programmer	\$299.



Development Hardware/Software
P.O. Box 289, Waveland, MS 39576
601/467-8048
. INC.

GTEK, PALASM, CPM, MSDOS, PC DOS, ISIS, and TRSDOS are all registered trademarks.

BOOK REVIEWS

David Marca has divided his book into four sections: general concepts, engineering with a computer language, engineering using existing software, and engineering with regard to human and machine environments.

Marca researched this book extensively; he supports many important ideas with numerous citations. The book is long on general principles, but it never quite makes it to the "applying" of the title. For the most part, these general principles are not related to concrete, real-world issues. Although he promises early in the book that he will help software engineers make specific design choices, Marca does not fulfill this promise. The book contains the pieces to develop decision guidelines, but they are like unstrung beads. I wanted walk-through examples showing how to apply principles to specific situations. And I had trouble making the obviously sound ideas in the book jell into a set of rules for making decisions.

Marca defines software engineering as "the act of an individual who learns to develop software in a practical setting." He emphasizes that engineering is different from writing program code. Just as most of the engineering on a bridge is complete before construction begins, so software engineering is largely a series of planning decisions on what to include in a software system and how to arrange the program for easy use and maintenance. This planning comes in stages: analysis, design, implementation, and installation. Marca devotes most of the book to the implementation stage, where actual code is generated.

All programming examples are in FORTRAN. The author's decision to use only one language limits coverage on some topics. He mentions recursion but does not discuss it because FORTRAN does not support this technique. He uses FORTRAN's poor string handling as an example of a need to extend a computer language, but he does not address strings as a data type because most versions of FORTRAN do not use text. He touches on the difficulty of using files in FORTRAN but does not provide examples of this function from another language.

Marca discusses designing software with parameters such as cost-effectiveness, timely production, and simplicity. He recommends organizing activities into analyzing a problem, designing a system that can solve the problem, writing a program to the design, and installing the finished program. His principles are not original, but they are a sound basis for operation.

MODELS

The chapters on modeling are a good example of my frustration with this book. Obviously a good model for a system is central to good software design. Marca begins by analyzing what makes a model and then explains limitations. He talks about form and language and offers an algorithm for creating a model. Instead of providing something concrete, he moves on to validating a model. The exercises at the end of the chapter do offer concrete examples, but this makes the book useless for anyone who

(continued)

Just hatched



We just hatched a new line of automatic sheet feeders for the Epson FX-80+ and FX-100+.

They're called the LetterMate I/e's and they sell for chicken feed; starting at \$199.00.

Being LetterMates from BDT Products, they have all the features you'd expect: continuous feeding action, an adjustable bin for horizontal or landscape printing, and easy, super-fast installation by the user.

Your local BDT dealer would be proud as a peacock to show off the LetterMate I/e's. Give him a whistle.



Nothing tops a printer like a LetterMate **BDT**

For More Information, call or write: BDT Products Inc.

BDT Products Inc. 17152 Armstrong Ave. • Irvine, CA 92714 • (714) 660-1386 • Telex 681-334 • Telecopier (714) 474-0480
In West Germany BDT GmbH • P.O. Box 80 • D-7210 Rottweil, W. Germany • Telephone (0741) 248-0 • Telex 762-876 (bdtr) d
Inquiry 48 for End-Users. Inquiry 49 for DEALERS ONLY.

WE'RE BUILDING A NETWORK FOR SALES,

NO ONE BACKS IT UP LIKE WE DO.

From first-time user to seasoned pro. From national telemarketing to local retail stores. Whoever you are, and whatever your microcomputer needs, for sales, service and support, you can count on Micro Mart.

CUSTOMIZED SYSTEMS, CUSTOMIZED SUPPORT.

Micro Mart customizes personal and business computers because we have the expertise to do it right. Our specialties include advanced memory systems like hard disk drives and multifunction boards. And much more.

Now you can depend on Micro Mart for customized service and support. Our service center is the largest in the Southeast, and it backs up every telemarketing sale we make, nationwide. Our retail sales are supported by the best in-store Techs in the business. So our service is on-line, on site or on-the-spot. And we do it on time. Try us and see.

MICRO MART NATIONAL. ALWAYS UP-TO-DATE.

Micro Mart is the place to find the latest products. Our state-of-the-art mainframe-to-inventory connection puts every buyer on-line with our ten million dollar inventory. Instantly.

Our telemarketing salespeople are highly trained consultants, constantly up-to-date, so you don't have to be. And we offer equally innovative financing, like the Micro Mart Blue Chip Credit Card. Call us today for systems, sales and support, and discover why Micro Mart is way out in front.

Orders only

1-800-241-8149

For information or the store location nearest you, call

(404) 449-8089

YOUR PERSONAL BLUE CHIP CARD

**MICRO
MART**



1234 567 890 123

Micro Mart has financing options available. Ask for a Micro Mart Blue Chip Credit Card application, today.

Service & Repairs

- On-Site— We have hundreds of service locations nationally.
- Depot— Our National Service Center is one of the fastest in the U.S.
- We have— A wide variety of services available. Please call us.

® Copyright Micro Mart 1985
Technology Corporate Campus
3159 Campus Drive
Norcross, Georgia 30071

MICRO MART HAS OVER 20 STORE LOCATIONS. CALL FOR THE ONE NEAREST YOU.

NATIONAL REFERRAL SERVICE AND SUPPORT.

Computers

LEADING EDGE Complete systems. FROM \$1495
AT&T Color and Mono systems. In stock!!

Call for Low, Low Price!
COMPUTER SPECIAL OF THE MONTH!
CALL FOR DETAILS!

Networking/Protocol Conversion

SNA & BISYNC 3780, 5251 Mod 12 & Mod 11, 3274, 3278.
PC TURBO 186 by ORCHID, 80186 coprocessor board. \$599
IRMA Complete line. FROM \$799
FORTEGRAPH for IRMA, upgrades IRMA to 3279 S3G graphics.
PCnet ORCHID's new complete line. FROM \$299
TECHLAND SYSTEMS Blue Lynx 5251 Mod 12 & 3276 Emulators and 3270 Keyboards.

Printers & Plotters

We have thousands in stock.
PRINTER SPECIAL OF THE MONTH!
CALL FOR DETAILS!

HOUSTON INSTRUMENTS Plotters & Digitizers.

Dot Matrix

EPSON FX80 Plus/100 Plus.
EPSON LX80/100, RX80/100.
EPSON LQ1500.
EPSON JX80, color printer.
COMREX 420. 400 cps. Epson compatible. \$1795
OKIDATA 192 & 193, ML84, Pacemark 2410. CALL
OKIDATA Color printers. Complete line.
TOSHIBA P-351 & 1340. New Low Prices!
TEXAS INSTRUMENTS 855, 865 & 850XL. FROM \$729

Letter Quality

NEC Spinwriters 2050, 3550, 8850. New Low Price!
JUKI 6100/6300. \$419/\$749
COMREX CR III, CR III & CR IV.
DIABLO New LQ printers. CALL

Floppy Disk Drives

TANDON TM 100-2, DD/DS, 360K. New Low, Low Price!
1/2 HEIGHT DISK DRIVES From SHUGART, MITSUBISHI, TEAC, PC, XT & AT comp. FROM \$119
!SPECIAL! Two 1/2 HEIGHT DRIVES, "Y" cables & brackets \$229

Hard Discs

Micro Mart carries all the major brands. If you don't see it—ask for it.
PEACHTREE TECHNOLOGIES P-10, 20, 30 & 50, int. & ext. For your PC, XT, AT, AT&T, COMPAQ or others. FROM \$695
PEACHTREE TECHNOLOGIES, New 1/2 Height tape and Winchester back-up system.
SYSGEN 10 & 20 Meg w/streamer tape. NEW MODELS—CALL!
SYSGEN Image & Quickfile, streamer tape back-up for your IBM XT & AT. New Low Price!
BERNOULLI TECHNOLOGY Hard Disc Subsystems. CALL
DAVONG New line of hard discs. 21 & 32Mb w/tape. Start @ \$2495

Chips

We guarantee the lowest price for chips! Call us!
INTEL 8087, 80287 High speed coproc. FROM \$129
64K RAMCHIPS. Call For Market Price
256K RAMCHIPS. Call For Market Price
128K PIGGY-BACK Chips for your AT. Call For Market Price

Multifunction Boards

We have a complete line of multifunction boards compatible with the Portable, AT, XT, & Jr.
THE BOARD SPECIAL OF THE MONTH!
CALL FOR DETAILS

SIX PACK 64-384K, multifunc. CALL
MPII RAMboards, for PC & PC compatibles. CALL
I/O MINNIE, I/O shortboard for Portable & AT.
ADVANTAGE 128K-3Mb, expansion for AT. CALL
QUADRAM QUADBOARD, 64-384K, multifunction. \$259
TECMAR CAPTAIN, 0-384K multifunc. \$185
TALLTREE J-RAM II, III, IV. New Low Price!
STB RIO GRANDE & GRANDE BYTE, Expansion for AT, 128K. FROM \$259

Graphic Cards

PREVIEW Monochrome graphics. Hercules look-alike for less. CALL
HERCULES Mono & color graphics cards.
TECMAR Graphics Master, HiRes color & mono supports Lotus. \$459
QUADRAM Quadcolor I & II, color cards.
PARADISE SYSTEM Multi-display or Modular Graphics Cards, color & mono, par. port. FROM \$249
SIGMA Color 400, HiRes color board. New Low Price!

Software

SOFTWARE SPECIAL OF THE MONTH!
CALL FOR DETAILS

Accounting

SORCIM/IUS Complete line including windows. FROM \$289/EA.
CYMA Complete business series.

Spreadsheets & Integrated Packages

ASHTON-TATE Framework.
MICROSOFT MultiPlan, w/templates.
SORCIM SuperCalc 3, vers. 2.0. New Low Price!

Enhancements & Utilities

FOX & GELLER Complete line of enhancements for dBase II, III & Rbase 4000. \$69
NORTON Utilities 3.0. \$89
ROSESOFT ProKey 3.0. \$89
CENTRAL POINT SOFTWARE Copy II PC. \$35
ATI Training. \$55
SOFTSTYLE Set FX + and Printworks. Printer control pkgs.
SIDEWAYS inverts printout. \$45
BORLAND SideKick and SuperKey.
LIVING VIDEO TEXT Think Tank. \$125

Compilers & Language Tools

LATTICE C-Compilers. \$299
MICROSOFT Complete line.
BORLAND Turbo Pascal, Turbo Toolbox and more. FROM \$35/EA.

Graphics & CAD

Micro Mart carries all major CAD packages. Call if you don't see it.
Zsoft PC Paint Brush, mouse driven graphics. \$95
DECISION RESOURCES ChartMaster/ Sign-Master pkgs.

MICROPRO ChartStar.

MICROSOFT Chart.

Communications

MICROSTUF CROSSTALK XVI. Latest version. \$99
HAYES SMARTCOM II.

Word Processors

MULTIMATE w/Spelling checker & tutorial. Low Price
SAMNA + word processor.
MICROSOFT Word. New Version.
LIFETREE Volkswriter Deluxe. \$169
SSI WordPerfect. New version.
MICROPRO WordStar Professional Series. New Low Price

Office & Project Planning

HARVARD Total Project Manager. \$299
SORCIM/IUS Super Project.
MICROSOFT Project.

Data Base Managers

Call for our unadvertised Data Bases.
MICROIM 4000 or 6000, Report Writer & Clout options. New low price!
WARNER SOFTWARE The desk organizer. \$145
ASHTON-TATE dBase II & III. AT compatible.
MICROSTUF Infoscope.

Modems

HAYES Smartmodem 300, 1200, 1200B & 2400. The best stock in the U.S. CALL
PROMETHEUS Modems.
VEN-TEL 1200 BAUD Half Card w/ Crosstalk. \$419
POPCOM Popcom, int. & ext. w/voice and data communications.

Miscellaneous

DYSAN DISKETTES PC, XT, & AT compatible. GUARANTEED LOWEST PRICE IN THE U.S. CALL!
MOUSE SYSTEMS PC Mouse, optical w/software. MICROSOFT MOUSE Bus or serial mechanical mouse.
KEYTRONICS 5150 & 5151. Keyboards for PC and Jr.
KENSINGTON MICROWARE Master Piece. \$119
CURTIS Accessories. Pedestals, cables, etc.
HAYES Mach II & Mach III Joysticks.
QUADRAM Microfazer. Printer buffer 8-128K. FROM \$129

TRIPPELITE Back-up power supply. 200-1000 watts, and ISOBAR surge protectors, 4 & 8 plug. \$1345
POLAROID Palette.

Monitors and CRT's

PGS Max12 (E), Amber, Monochrome that also runs on color card. New Special Prices
PGS HX-12 & SR-12, Color RGB's. New Special Prices
QUADRAM Quadchrome, 690 Dot RGB. \$429
QUADRAM Amberchrome. Amber monochrome. \$159

AMDEK Color 300, 500, 600, 700, 710, 722.
AMDEK 300A/300G Composite monitors. \$129/\$119
AMDEK 310A, Amber monochrome. In Stock!!
WYSE 50 Terminal. \$475
TAXAN RGB Color Monitors. Complete line at low, low prices. CALL!

America's PC Specialist

MICRO MART

Prices are subject to change without notice and are similar, but vary at Micro Mart Retail Stores. IBM is a registered trademark of International Business Machines Corporation.

100% GUARANTEE

Undeniable.

Deluxe Computer Forms means undeniable quality. Your order must match your requirements — or you won't pay! That's quality, undeniably. Guaranteed.

Unquestionable.

Our unquestionable guarantee means the forms you select are 100% compatible with your software. Forms Consultants can answer your questions and we'll pay for the call. Tough questions about forms or compatibility — easy answers.

Unbelievable.

Unbelievable 3-day turn around means . . . fast service. You save money and time. Most custom forms orders 5-10 day turn around. Believe us, that's service. Fast.



FREE CATALOG!

Call Toll Free to receive your
FREE 32 page, color catalog.
1-800-328-5727 Ext. 514
In Minnesota 1-800-742-5685

 **DELUXE**
COMPUTER FORMS

7761

A DIVISION OF DELUXE CHECK PRINTERS, INC.

BOOK REVIEWS

use, it could be a reasonable basic textbook. As a guide for software engineers in the field, the book is seriously lacking. Engineers will still have to derive most of their own specific application guidelines.

Annette Hinshaw (POB 580635, Tulsa, OK 74158) is a freelance technical writer.

CP/M-86 USER'S GUIDE

Reviewed by Paul W. Lowans

This guide covers Digital Research's CP/M-86 family of operating systems, including MP/M-86, Concurrent CP/M-86, and Concurrent DOS. In the beginning of *CP/M-86 User's Guide*, author Jonathan Sachs, a computer consultant on technical writing and software development, suggests how to set up your system, discusses hardware, and introduces a basic implementation of commands. The rest of the book explains CP/M's more advanced features, covering in more detail the commands and utilities. An additional "Note to the System Manager" describes how to assist a CP/M novice in using the guide with hands-on experience. Sachs has written this book for people at different levels of expertise.

Appendixes cover the differences in various releases of CP/M systems. The book also contains a resource guide of names and addresses of computer-related publications, products, and accessories, as well as a listing of bulletin boards. Also included are specific notes for users of CompuPro, DEC Rainbow, and IBM PC and PC XT computers.

Sachs points out in the acknowledgments that he wrote the book while Concurrent CP/M-86 and Concurrent DOS were still being developed; thus, the syntax he explains could be in error. Since I work strictly with CP/M-86, I cannot determine any such errors; you should check this out before you buy the guide.

A main drawback in the book is its organization by operation, not by family member. It is fragmented by having a little bit of material on each command for each system. Sachs jumps from one system to another, which can cause confusion. He begins one section with how to boot each system, then explains how to format a disk for each system, then how to manipulate files, and so on.

This fragmentation forces the reader who wants to get the full story about an operating system to read the book from cover to cover, but jumping from system to system forces the reader to skip portions that do not apply to his CP/M family member.

CONCLUSIONS

Sachs uses plain English and simple examples to explain the operations of each system. Throughout the book are boxes titled "Things That Might Go Wrong"; they explain error messages and how to recover. Sachs begins the guide simply and moves on to the more complex. It is similar to taking a programmed book course whereby the

BOOK REVIEWS

user is encouraged to try examples that build on each other in the learning process.

Because the guide covers the family of CP/M, it is good for people who want to use more than one version. The appendixes are not only well written but prove to be good references for the user who has some familiarity with CP/M. However, Sachs does not explain the CP/M-86 assembly language or the 8086 instruction set other than the syntax for ASM-86.

Paul W. Lowans (2709 South Union St., Spencerport, NY 14559) is an electronics engineering technician at Xerox Corporation in Rochester, New York.

COMPUTER ANIMATION PRIMER

Reviewed by Jeff Campbell

Computer Animation Primer provides the armchair programmer and would-be computer animator with a fascinating overview of a technology capable of bringing the illusion of reality to our most abstract imaginings. From the high-tech marvels of *Star Wars* special effects to BASIC programs to run on your personal computer, David Fox and Mitchell Waite explore how to become involved in computer animation today.

Fox and Waite begin with a brief history of animation. Antique animation devices with such exotic names as Thaumatrope, Phenakistoscope, and Zoetrope almost seemed to anticipate their computerized futures. The discussion highlights the major advances by animation pioneers like Walt Disney, Walter Lantz, Max Fleischer, et al. The perspective concludes with an examination of how computer animation is used today in the film industry, medical research, sports, education, engineering, advertising, and arcade games.

One section extensively describes the basic hardware used in computer animation. Brief explanations cover everything from the mechanics of creating movement and color on a cathode-ray tube to the light pens, digitizing tablets, and joysticks used to create and manipulate graphics images. The authors conclude this section with the observation that the "trickle-down" effect will continue to allow increasingly sophisticated equipment to become available to the personal computer user.

In a chapter on computer-animation software and applications, Fox and Waite focus on techniques for defining graphics objects in ways that a computer can understand. Some rather complex algorithms come into play when images are rotated, translated, and scaled, yet these discussions do not bog down. The text is lucid, and the authors are not above an occasional humorous touch.

SAMPLE PROGRAMS

The bulk of the book deals with actual programs for animating on a personal computer. The authors have

(continued)

"Switch boxes are sold by many suppliers, but by far the two best values are from MFJ Enterprises."



"The MFJ RS-232 Transfer Switch. Buy it before the manufacturer comes to his senses!"

Joe Campbell, *The RS-232 Solution*
Sybex Computer Books

Now you can have *reliable* and *affordable* and unplugging cables. You can easily switch your computer to your high-speed printer, letter-quality printer, modem, terminal - any RS-232 peripheral device. MFJ's range of Transfer Switches includes one to fit your needs at a price you can afford. Look at these choices; then look at these prices. Compare others at any price! Then ask them for *their* reviews. When they won't show you, call MFJ...

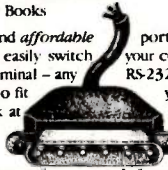

When you need to switch between two peripherals... or you need to have two computers sharing the same peripheral... Model 1240/\$79.95

Never unplug a cable again. Now, with the push of a button you can go from dot matrix to letter-quality printing, or go from your printer to your modem. MFJ's Model 1240 Transfer Switch features a built-in transmit/receive switch allowing you two-way information flow. LEDs monitor important data lines while a built-in surge protector guards them. The 1240 also acts as a null modem. All this for just \$79.95. No wonder it's MFJ's No. 1 seller!

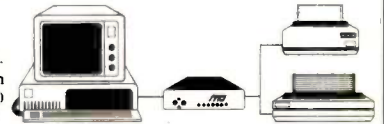

When you need 1-to-4 computers to share one peripheral or 1-to-4 peripherals to share a common computer... Model 1243/\$119.95



The perfect office Transfer Switch. Don't buy multiple printers or modems. Just buy MFJ's Model 1243. Then you can connect one or all your computers to a *single* printer or modem. Or let your one computer share up to *four* peripherals. Think of the money you'll save. LEDs monitor important data lines while a built-in surge protector guards them. Two-way communication is allowed with *no complicated software to learn: just push a button!*

Seven additional models to choose from. Each unit's casing is constructed from high-quality aluminum. Printed circuit boards assure maximum reliability by eliminating crosstalk, line interference and any need for wiring. *All MFJ switches have LEDs to monitor data lines and MOV surge protectors.* Enhance the investment you've already made in your computer by choosing from the finest line of Transfer Switches on the market, including MFJ's IBM & Centronics Parallel Switches.

You've got a lot of money tied up in your computer. Don't blow it!

Your valuable computer and peripheral equipment can be damaged by electrical surges *much smaller than you've been led to believe.* Far more likely to happen is having your important data wiped out. These disasters, and others, can be prevented with **MFJ's Power Centers.** Relay latches power off during power dropouts (Model 1108). Multi-filters isolate equipment, eliminate interaction, noise and hash. MOV's suppress spikes and surges. **MFJ's Power Centers** also have 3 isolated, switched socketpairs, with at least one unswitched socket (so you can add a clock, etc.), lighted power switch, fast-acting fuse, 3-wire, 6-foot cords, 15A, 125V, and 1875 watts. Although each model is attractively housed in a protective aluminum casing, *these are heavy-duty, commercial-quality power centers.*

Watch out for fancy names that cost twice as much, last half as long, and have half the features of **MFJ's Power Centers.**

Model 1107 8 sockets, 2 unswitched, \$79.95
Model 1108 7 sockets, 1 unswitched, with dropout relay, \$99.95
Model 1109 is like 1107 but intelligent (switch on the device that's plugged into the control socket and every thing else comes on), \$129.95

There are other **RS-232 Switches, Power Centers, and Computer Peripheral Products** available from MFJ. Call and talk with us about all your computing needs, and when you do, ask for our latest catalog. **Both the call and the catalog are free.**

1-800-647-1800

For technical/repair information, or in Mississippi, or outside the Continental United States, please telephone...

1-(601)323-5869 or telex **53-4590 MFJSTKV**

All MFJ products come with a *double* guarantee we think is unmatched. Order from MFJ and try any product for 30 days. If it doesn't satisfy your needs, just return it for a *full refund*, less shipping. If you keep it you can be assured of continued service with our *One Year Unconditional Guarantee.*

Call toll-free 1-800-647-1800 and charge the products you need to your VISA or MasterCard, or send a check or money order, plus \$5.00 shipping, and our shipping department will promptly have your computer peripheral on its way to you.

MFJ Enterprises Inc.
921 Louisville Road
Starkville, MS 39759

NOVA PC/XT

THE TOP OF THE LINE IBM COMPATIBLE SUMMER SPECIALS

COMPUTER SYSTEM:

NOVA basic system 64K entry model
(Expandable to 256K)\$645
Includes: 1 drive controller, 1 64K mother
board, 1 hitec keyboard, 1 130W power
supply.

NOVA PC 256K system\$1295
Includes: 1 hitec keyboard, 1 130W power
supply, 2 360KB floppy drives, 1 Ast 6
pack compatible multifunction board, 1
color graphic card, 4-drive controller.

NOVA XT 256K system\$1935
Includes: 1 hitec keyboard, 1 130W power
supply, 2 360KB floppy drives, 4-drive con-
troller, 1 10MB hard disk drive, 1 DTC hard
disk controller card, 1 Ast 6 pack compati-
ble multifunction board, 1 color graphic
card.

NOVA PC/XT BARE BOARD w/MANUAL\$79.00

DISK DRIVE:

SHUGART SA455 1/2 drive\$90.00
Teac 55B 1/4 floppy drive\$115.00
Miniscribe 10MB h.d. w/controller
card and CABLE\$650.00
Miniscribe 20MB Hard Disk Drive\$695.00
Miniscribe 30MB-60MB hard disk for AT
(30ms seeking time, close loop)CALL

UPGRADE KITS FOR IBM/AT:

IBM/AT compatible CASE\$165.00
IBM/AT compatible POWER SUPPLY (195W)\$225.00
IBM/AT compatible KEYBOARDCALL
#4128 pigback ram\$22.00



HARDWARE:

The best quality 130W power supply
(110/220) same dimension as IBM\$130.00
Multifunction card\$195.00
Case for PC/XT\$90.00
Hitec Keyboard\$130.00
Color graphic card\$150.00
Hercules compatible
monochrome card\$185.00
Floppy disk controller card
with cable\$100.00

STREAM TAPE:

Irwin 10MB stream tape for backup
(Use standard floppy controller)\$625.00

MONITOR:

Amdek 300 color monitor\$245.00
Amdek 310A\$143.00
Amdek RGB 600 color monitor\$445.00
Amdek RGB 700 color monitor\$495.00
Amdek 710 double scan\$545.00

DEALER INQUIRIES WELCOME. — NOVA PC/XT KITS AVAILABLE

COMPUTRADE COMPANY (in Koll Commercial Center)

780 Trimble Road, Suite 605, San Jose, CA 95131

Tel. (408) 946-2442, Telex: 171605

Hours: Mon-Fri 9:00 a.m.-6:00 p.m.

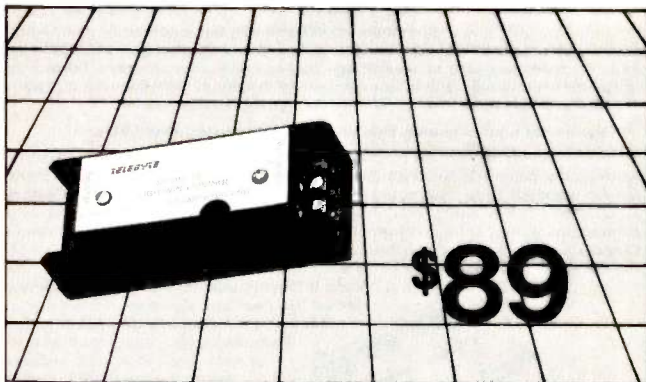

LIGHTNING SPONGE MODEL 22

- Prevents damage to modems, converters and terminals from direct strikes
- Triple stage protection
- Fast response time
- Supports 4 circuits
- Available with lugs or modular jacks, RJ-11

TELEBYTE

A PUBLIC COMPANY

Remark Division • Telebyte Technology, Inc. 270 E. Pulaski Rd.,
Greenlawn, NY 11740 • (516) 423-3232 800-835-3298

BOOK REVIEWS

chosen to work with Atari BASIC because they think it has high potential for graphics and animation. The programs themselves are widely adaptable for use on other micro-computers. Fox and Waite provide instructions for creating customized character sets (or making do with the ones you have) and then animating them. They cover animation loops; with this information you can create galloping horses, a walking man, or an exploding bomb. Movement can also be suggested by changes in color. This is covered in a section on color-register animation.

Separate chapters deal with player-missile graphics, employed in many arcade games, and using machine language in BASIC programs. The final chapter offers the information necessary to create scrolling backgrounds. By applying this knowledge, it's possible to create some very impressive animated graphics.

VISUAL EFFECTS

The layout of this book deserves special mention. Wide margins on the outside of each page not only contribute to an uncluttered page but allow the inclusion of four "flip book" computer-animation movies. By flipping through the upper corners of this book—both forward and backward—you can view approximate real-time segments of the animation discussed in the book. Fox and Waite use one of the oldest animation techniques to elucidate one of the newest.

The book also has a 16-page color section. Appendixes include a compilation of all program listings reproduced in larger detail, a character-set grid, listing conventions for representing hidden (or invisible) characters, methods for storing machine-language routines in strings, parameter-table entries for black-box routines, source-code listings of assembly-language routines, and Atari hardware and shadow registers.

Computer Animation Primer is the book for people who want action livening up their computer screens.

Jeff Campbell (9296 West 98th Place, Broomfield, CO 80020) is president of Campbell Photo/Graphics.

THE COMPLETE HOME EDUCATOR:

A COMPREHENSIVE GUIDE
TO MODERN HOME-TEACHING

Reviewed by Hunter Holmes Alexander

Many parents despair of the public schools but few act to set things right. *The Complete Home Educator: A Comprehensive Guide to Modern Home-Teaching* is a step-by-step handbook for teaching youngsters at home. It is also a book about the mediocrity of schools and how micro-computers can be used to improve education.

Mario Pagnoni, a teacher for 13 years, decided to leave his school in order to teach his two sons math, computer skills, writing, spelling, and problem solving at home. He

(continued)

New Version

Sizzling C.

The fastest C. The C that Microsoft developed to write its own software programs. Hot.

So hot that we can make this claim: Virtually every program runs faster with Microsoft® C Compiler than with any other MS-DOS® C compiler.

Efficient C.

We give you everything you need to write code so tight your computer will scream.

“Preliminary testing on the Microsoft C Compiler produced code that was significantly smaller than that produced by other C compilers.”

Paul Springer, Ashton-Tate.

“We found the FAR pointer very helpful for situations where a mix of memory models offers the greatest efficiency.”

Robert Frankston, Software Arts.

“The portability of the code between MS-DOS and XENIX® is great.”

Jim Bean, Peachtree Software.

But it's really no surprise that our C stretches your micro to its limits. We wrote both the MS-DOS and the XENIX operating systems.

For the name of your nearest Microsoft dealer, or to upgrade from Microsoft C Compiler or Lattice C, **MICROSOFT®** call (800) 426-9400. The High Performance Software™
In Washington State, Alaska, Hawaii and Canada, call (206) 828-8088.
And make your programs really cook.

Microsoft C Compiler Version 3.0

Microsoft C Compiler

- Produces compact code and fast executables.
- Implements register variables.
- Small, Medium and Large Memory model Libraries-Mix models with NEAR and FAR pointers.
- Transport source and object code between MS-DOS & XENIX operating systems.
- Library routines implement most of UNIX System V C library.
- Choose from three Math libraries and generate in-line 8087/287 instructions or floating point calls.
 - Floating point emulator (utilizes the 8087/287 if installed).
 - 8087/287 coprocessor support.
 - Alternate math package—extra speed on systems without an 8087/287.
- Link routines written in Microsoft FORTRAN (V 3.3 or higher), Microsoft Pascal (V 3.3 or higher) or Microsoft Macro Assembler.
- Supports MS-DOS pathnames and Input/Output redirection.
- File sharing and record and file locking is supported.
- Do source level debugging, with the Symbolic Debug Utility, available separately with the Microsoft Macro Assembler Package.*

Library Manager

Create, organize and maintain your object module libraries created with Microsoft languages.

Object Code Linker

- Simple overlay linker combines relocatable object modules created using Microsoft Languages into a single program.
- Link very large programs (over 1MB, using overlays).

EXEPACK Utility

A new utility to compress sequences of identical characters from an executable file and to optimize the relocation table.

EXEMOD Utility

A new utility used to modify the fields in the header according to the instructions given by the user in the command line.

'C' Benchmarks—done on a Compaq Plus with 512k memory with no 8087. Program “SIEVE”, with register variables,

	Exec Time	Code Size	EXE Size
Microsoft C	:9.39	141	5,914
Lattice C	:12.24	164	20,072

*Purchase both Microsoft C Compiler and Microsoft Macro Assembler and get a \$25 rebate direct from Microsoft. See package for details.

Microsoft, MS-DOS and XENIX are registered trademarks and The High Performance Software is a trademark of Microsoft Corporation.



IBM's best efforts are now going into Macintosh.

Macintosh and IBM PC software. Compatible at last, thanks to MacCharlie, a rather innovative coprocessing system.

And imagine the consequences.

Nearly 10,000 IBM PC software programs designed for general business and specific applications in real estate, insurance, law, medicine, banking, etcetera, can now join forces with Macintosh's own popular programs.

And, the myriad of IBM PC-compatible software adopts Macintosh's many beloved features, including desktop utilities such as the clipboard and the calculator.

In addition, MacCharlie allows

IBM PC and Macintosh data files to be exchanged. Talk about flexibility.

But the good news gets better.

You see, MacCharlie delivers hardware compatibility, as well. For example, IBM letter-quality printers can be easily used with Macintosh.

Furthermore, MacCharlie

now allows Macintosh to perform virtually any networking an IBM PC can perform. Even to the extent of tying in with IBM mainframes.

In other words, your networking capability goes beyond the Apple family.



The Macintosh keyboard slides right into MacCharlie's keyboard. About as easy as slipping a letter in an envelope.



Macintosh sets snugly beside MacCharlie, on a custom-fit pedestal.



Once you plug in MacCharlie's power and keyboard cords, you're ready to enjoy a very happy marriage.

How does it happen? As easily as slipping on penny loafers.

In mere moments, MacCharlie combines the best features of the world's premier personal computers.

And despite the fact that it turns one computer into two,

MacCharlie adds but a handful of square inches to Macintosh's physique.

In short, one of life's most perplexing decisions—whether to buy a Macintosh or an IBM PC—can now be made with the greatest of ease.

Ask for MacCharlie at your local computer store. Suggested retail price for the 256K single disk drive model is only \$1195, and just \$1895 for the 640K dual disk drive version.

For more information, call Operator 14 toll-free, 1-800-531-0600. (In Utah, call 801-531-0600.)

MacCharlie offers 256K RAM, with optional upgrade to 640K RAM; 360KB disk drive, and optional second disk drive.



MacCharlieTM

THE BEST OF BOTH WORLDS.

MacCharlie is a product of Dayna Communications,
50 S. Main, Salt Lake City, Utah 84144

Inquiry 133

Apple is a trademark of Apple Computer, Inc. Macintosh is a trademark licensed to Apple Computer, Inc. IBM is a registered trademark of International Business Machines Corporation.



LIONHEART

BUSINESS & STATISTICAL SOFTWARE

Explanatory books with professional compiled software; the new standard for statistical use. The influential Seybold Report on Professional Computing has this to say about Lionheart "...our sentimental favorite because of its pragmatic approach to the basic statistical concepts... The thinking is that the computer merely facilitates the calculations; the important thing is to be able to formulate a problem correctly and to determine what type of analysis will be most valuable."

- **BUSINESS STATISTICS** \$135
- **EXPERIMENTAL STATISTICS** 115
- **EXPLORATORY DATA ANALYSIS** 75
- **FORECASTING AND TIME-SERIES** 115
- **BUSINESS AND ECONOMIC FORECASTING** 135
- **DECISION ANALYSIS TECHNIQUES** 85
- **LINEAR & NON-LINEAR PROGRAMMING** . 75
- **PERT & CRITICAL PATH TECHNIQUES** ... 75
- **MONTE CARLO SIMULATION** 125
- **OPTIMIZATION** 80

PC/MS-DOS, CP/M (Apple and Macintosh formats slightly more expensive) Add \$2 per book for shipping and handling.

VISA, MasterCard, AMEX, Check

P.O. Box 379, ALBURG, VT 05440
(514) 933-4918

StatPac™

The World's Best
Micro Computer Based Statistical
Analysis Package

Forecast Plus™

Time Series Analysis Package
The Business Forecasting Tool
for the Non Statistician

Call For Free Comprehensive Brochures

1-800-328-4907

WALONICK ASSOCIATES

6500 Nicollet Ave. S. Minneapolis, MN 55423
(612) 866-9022

BOOK REVIEWS

used an Apple II+ as an aid in instruction.

What tricks did he discover? Pagnoni advises home-schoolers to be the educational consultant for their children rather than the traditional pedagogue. He cites test scores to show that his sons, ages 7 and 10, learned more in the year he tutored them at home than in the years they endured in the traditional school with its regimentation and instructors who are sometimes underqualified.

This book is written primarily for parents who want to take their children out of the school system or those who want to tutor their children after school. But it could benefit computerists who don't know about teaching, people who aspire to teach about computers, and computer businesspeople, as well as sociologists, salespeople, politicians, and people interested in school-board positions. Mostly it is for parents who know little about computers, as was the case with Pagnoni only a few years ago.

PARENT/CHILD BOND

Pagnoni advises against forcing youngsters to learn something the way you learned it. He suggests that home-schoolers write to a private school for its curriculum. He recommends a list of read-aloud books and encourages parents and children to read aloud together.

One advantage of home-schooling, Pagnoni says, is that it strengthens the parent/child bond since the parent and child spend more time together. Also, teaching will make parents feel more in charge of their children's education. Children taught at home generally test higher than those in public schools and have more self-esteem; Pagnoni says that students who have been taught at home can get into Harvard.

The disadvantages of home-instruction include the possibility of failure. Also, children could miss out on some peer-group experiences, although the author suggests ways to prevent this.

Pagnoni discusses BASIC programming and word processing for novices. Appendixes cover sources for legal information, correspondence courses, and resources for learning programming. A subject index is included.

The introduction endorsing Pagnoni's work is by John Holt, author of *Growing Without Schooling* and editor of a newsletter on home-schooling.

The Complete Home Educator is entertaining and useful. Pagnoni shows how to put the fun back into schooling. More and more court cases are going in favor of home-schoolers, and "unfriendly" school boards seem to be getting poor publicity. Home education is a growing social movement and no longer seems as radical as it once did. About 40,000 Americans teach their children at home. Pagnoni's book provides them with a good model for home education with high technology. ■

Hunter Holmes Alexander (4520 King St. #404, Alexandria, VA 22302) is BYTE's Washington correspondent, belongs to the Washington Apple Pi users club, and is a former teacher.

Finally, business computer software for the hard-nosed.



No one takes a harder look at software than small to mid-sized businesses.

So take a long, hard look at The Accounting Solution,[™] a new, totally integrated software package from Business Tools, Inc.[™]

You'll find its breakthrough features are designed to pay off where it counts—on the bottom line.

Hard-nosed economy, \$99.*

Contrary to popular opinion, you don't need a small business loan to buy quality software. Not if you're buying The Accounting Solution. For \$99, you get a language/data base manager with more hard-nose capabilities and speed than any program available at any price; \$249 buys the language plus accounts receivable/payable and general ledger; \$399 gets you all the above plus inventory control, sales order entry, purchase order entry and payroll. Even more good news for the budget minded—source code is included with applications.

Easy for any hard-nose.

The Accounting Solution is easy

enough for the novice hard-nose to use within minutes of receiving the package. Yet it's also sophisticated, offering unlimited flexibility and opportunity to the hot-shot hard-nose. And it's designed to run on CP/M-80, MP/M-80, IBM PC and compatibles.**

Multi hard-nose capability.

The Accounting Solution never

stands in the way of progress. Thanks to multi-user capability, two or more hard-noses can use the same application at the same time.

Hard-nosed flexibility.

With The Accounting Solution, it's easy to change your mind because the source code is so simple to modify. Ready to grow? Great. You can change hardware without spending a dime on new software.

Take it from hard-nose Phil Mickelson.

Phil created The Sensible Solution[®],* a highly respected software package. Now he's offering the next step, another breakthrough: The Accounting Solution. It's simple. Sophisticated. Affordable. And backed by Phil's reputation and personal service. If you're looking for hard-nosed value and quality, you'll agree, The Accounting Solution is the only solution.

BUSINESS TOOLS[™]

Accounting Solution

Write or call:

Business Tools, Inc.
4038-B 128th Avenue SE
Bellevue, WA 98006

1-800-648-6258

Washington State:
(206) 644-2015

Dealer inquiries welcome.

*Suggested retail price.

**CP/M-80 and MP/M-80 are registered trademarks of Digital Research, Inc.; IBM PC is a registered trademark of International Business Machines Corporation; The Sensible Solution trademark rights are claimed by O'Hanlon Computer Systems.

STAR'S NEW
SPREADSHEET
PRINTERS:
4 WAYS TO A
BETTER
BALANCE SHEET.

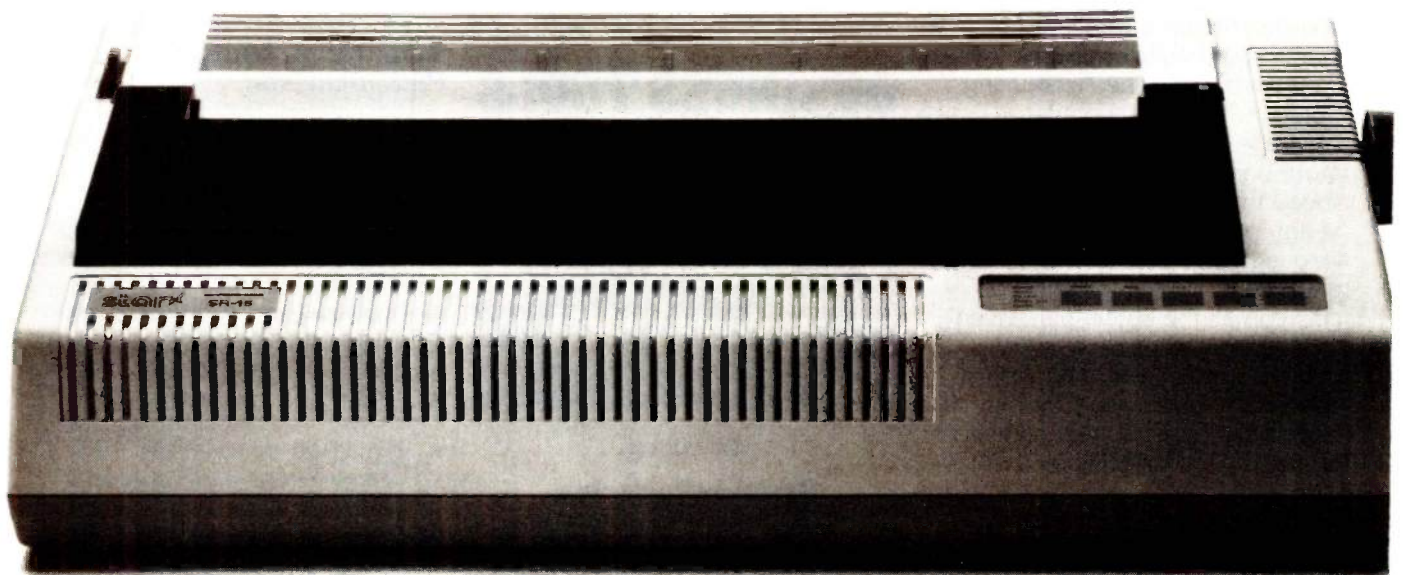

SR-15™ features a 16K buffer and prints at 200cp



For a better return on your computer investment, consider Star's new "S" series spreadsheet printers.

They're faster—with 20% increased throughput and an unbeatable 16K memory. And better—100% IBM® compatible, with prices that make these printers the best value in the business.

0 TO 15" IN JUST .66 SECONDS



No other printer gives you greater throughput-per-dollar than Star. With the highest-speed NLO in its class. And the best print quality in the business.

All our new business printers feature draft and near-letter-quality standard (no extra charge). So whatever the assignment, these printers come fully qualified.

16K AND NOT A BIT LESS

On all Star's new business machines, the convenience of a 16K buffer is standard. No leading spreadsheet printer has more memory. So hooking up with a Star gives your system the power to process and print at the same time.



EASY AS 1-2-3

Star's business printers are fully compatible with IBM®-PC, Apple®, and all compatibles.

They're ready to run with hundreds of popular spreadsheet packages including 1-2-3™, General Accounting™, dBase III™ and MultiPlan®. Even integrated formats like Framework™ and Symphony™.

All Star printers are covered by a full one year warranty on parts and labor. Plus a network of factory-trained service centers.

Faster. More memory. More flexibility. More compatibility. Greater reliability. The best print quality. And the best value in the business.

Star's spreadsheet printers give you the best-looking financial statements you've ever seen.

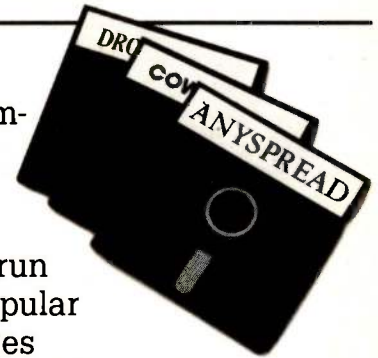

star

THE POWER BEHIND THE PRINTED WORD®

200 Park Avenue, New York, NY 10166
Chicago, IL (312) 773-3717 • Boston, MA (617) 329-8560
Irvine, CA (714) 586-8850

All trademarks (except SG-10/15, SD-10/15, SR-10/15 and Star Micronics Inc.) are proprietary to or registered trademarks of companies other than Star Micronics, Inc.

E·V·E·N·T Q·U·E·U·E

June 1985

● C STUDIED

C Language Workshops, various sites throughout the U.S. Workshops and seminars on C programming and issues. Contact Plum Hall Inc., 1 Spruce Ave., Cardiff, NJ 08232. (609) 927-3770. *June*

● FIX-IT WORKSHOP

Computer Repair User Workshops, various sites throughout the U.S. A one-day seminar on repairing computers. The fee ranges from \$140 to \$175, depending upon location. Contact Cascio School of Computer Technology, Suite B109-Q, 2580 San Ramon Valley Blvd., San Ramon, CA 94583. (415) 829-5140. *June*

● CONFERENCES FOR MANUFACTURERS, USERS

Conferences for Manufacturers and Users from the Institute for Graphic Communication, various sites throughout the U.S. Planned are "Slidemaking with Computer Graphics" and "Digital Facsimile." Contact Richard D. Murray, Institute for Graphic Communication, 375 Commonwealth Ave., Boston, MA 02115. (617) 267-9425. *June*

● SEMINARS FOR MANAGERS, PROFESSIONALS—Datapro

Seminars, various sites throughout the U.S. Among the topics covered are microcomputer communications, telecommunications, and local-area networks. Contact Datapro Research Corp., 1221 Avenue of the Americas, New York, NY 10020. (800) 257-9406. *June*

● SEMINARS AND SYMPOSIA—EDP Seminars

and Symposia, various sites throughout the U.S. "Database Management and Fourth Generation Languages for Personal Computers" and "Introduction to the UNIX System" are among the offerings. Fees range from \$395 to \$895. Calendar available. Contact Software Institute of America Inc., 8 Windsor St., Andover, MA 01810. (617) 470-3880. *June*

● PROFESSIONAL DEVELOPMENT—Intensive

Seminars for Professional Development, various locations in the Boston metropolitan area, Syracuse, NY, and Saddle Brook, NJ. Computer, management, and manufacturing seminars. Catalog available. Contact Kathy Shaw, Office of Continuing Education, Worcester Polytechnic Institute, Higgins House, Worcester, MA 01609. (617) 793-5517. *June*

● MICRO WORKSHOPS

Microcomputer Workshops, various sites throughout the U.S. and Canada. More than 20 workshops for all levels of expertise. Contact Rhonda Carney, Intel Corp., Customer Training, 27 Industrial Ave., Chelmsford, MA 01824-3688. (617) 256-1374. *June*

● HOME, OFFICE COMPUTING—New Olden Spring and Summer Computer Workshops, New York City. Introductory and advanced workshops on personal, executive, and

secretarial computing. Fees range from \$45 to \$400, depending upon duration. Contact The Olden Computer Workshops, 1265 Broadway, New York, NY 10001. (212) 685-1234. *June*

● SEMINAR, WORKSHOP

Personal Computers and the Mainframe Connection; Advanced Applications Techniques: Using Lotus 1-2-3 Macros and Functions, various sites throughout the U.S. For information on these seminars, contact Data-Tech Institute, Lakeview Plaza, POB 2429, Clifton, NJ 07015. (201) 478-5400. *June*

● SUMMER SEMINARS

Summer Seminar Series, Rochester Institute of Technology, NY. A series of one-week seminars. Titles include "Introduction to Linear Systems and Digital Signal Processing" and "Advanced Digital Logic." Contact Yvonne Fish, School of Engineering Technology, Rochester Institute of Technology, One Lomb Memorial Dr., POB 9887, Rochester, NY 14623. (716) 475-2915. *June*

● AI, EXPERT SYSTEMS BRIEFING—Artificial Intelligence and Expert Systems: What Users and Suppliers Must Know Today to Deploy These Technologies as Profitable Strategic Corporate Resources Tomorrow, Boston and Framingham, MA. A one-day executive briefing. The fee is \$790. Contact Ms.

Lee Burgess, Professional Development Programs, Rensselaer Polytechnic Institute, Troy Building, Troy, NY 12180-3590. (518) 266-6589. *June-July*

● DATA SWITCHING

Distributed Data Switching Seminar, various sites throughout the U.S. A one-day seminar on the technology and application of distributed data switching in telecommunications. The fee is \$395. Contact Timeplex Seminars, 400 Chestnut Ridge Rd., Woodcliff, NJ 07675. (201) 930-4600. *June-July*

● INFO MANAGEMENT SEMINARS—NYU Seminars

on Information Management, various sites throughout the U.S. On the agenda are "Legal Issues in Acquiring and Using Computers" and "Networking Personal Computers." Contact School of Continuing Education, Seminar Center, New York University, 575 Madison Ave., New York, NY 10022. (212) 580-5200. *June-July*

● CAD COURSE

Computer-Aided Design, Colorado State University, Fort Collins. Three one-week courses with participants using a high-performance dynamic graphics machine. The fee is \$800. Contact Professor Gearold Johnson, Center for Computer-Assisted Engineering, Colorado State University, Fort Collins, CO 80523. (303) 491-5543. *June-August*

● ENGINEERING CONFERENCES—Engineering Summer Conferences.

IF YOU WANT your organization's public activities listed in BYTE's Event Queue, we need to know about them at least four months in advance. Send information about computer conferences, seminars, workshops, and courses to BYTE, Event Queue, POB 372, Hancock, NH 03449.

(continued)

THE PROFESSIONAL'S CHOICE

Lotus
1-2-3
Call

Lotus
Symphony
Call

dBase III
\$349

FrameWork
\$349

MultiMate
\$249

Word
Perfect
\$209

Software

Word Processing Editors

FANCY FONT	\$139
FINAL WORD	\$189
MICROSOFT WORD	\$229
MULTIMATE	\$249
OFFICE WRITER/ SPELLER	\$279
PFS: WRITE	\$ 95
SAMNA WORD III	\$279
VOLKSWRITER DELUXE	\$159
VOLKSWRITER SCIENTIFIC	\$279
THE WORD PLUS (OASIS)	\$105
WORD PERFECT	\$209
WORDSTAR	\$199
WORDSTAR 2000	\$269
WORDSTAR 2000+	\$309
WORDSTAR PRO	\$259
XYWRITE II+	\$199

Spreadsheets/

Integrated Packages	
ELECTRIC DESK	\$209
ENABLE	\$359
FRAMEWORK	\$349
LOTUS 1-2-3	\$Call
MULTIPLAN	\$135
OPEN ACCESS	\$359
SAMNA PLUS	\$379
SMART SYSTEM SPREADSHEET	\$559
AUDITOR	\$ 79
SUPERCALC 3	\$179
SYMPHONY	\$Call
TKI SOLVER	\$269

Languages/Utilities

CONCURRENT DOS	\$189
C86 C COMPILER	\$299
DIGITAL RESEARCH C COMPILER	\$219
DR FORTRAN 77	\$219
LATTICE C COMPILER	\$299
MICROSOFT C COMPILER	\$249
M8 BASIC COMPILER	\$249
MS FORTRAN	\$239
NORTON UTILITIES	\$ 89
TURBO PASCAL	\$ 59

Database Systems

ALPHA DATA BASE MANAGER II	\$179
CLIPPER	\$Call
CLOUT V 2.0	\$139
CONDOR III	\$299
CORNERSTONE	\$329
DBASE II	\$299
DBASE III	\$349
INFOSTAR+	\$319
KNOWLEDGEMAN	\$269
PFS: FILE/PFS: REPORT	\$169
POWERBASE	\$319
QUICKCODE III	\$169
QUICKREPORT	\$169
R BASE 4000	\$249

Project Management

HARVARD PROJECT MANAGER	\$209
HARVARD TOTAL PROJECT MANAGER	\$269
MICROSOFT PROJECT	\$159
PERTMASTER	\$549
SCITOR PROJECT 5000 W/GRAPHICS	\$259
SUPERPROJECT	\$199
TIME LINE	\$259

Desktop Environments

DESK ORGANIZER	\$129
SIDEKICK	\$ 45
SPOTLIGHT	\$109

Accounting

BPI	\$329
GREAT PLAINS	\$479
IUS EASYBUSINESS	\$279
ONE WRITE PLUS	\$199
OPEN SYSTEMS	\$379
PEACHTREE	\$299
REAL WORLD	\$469
STATE OF THE ART STAR ACCOUNTING PARTNER	\$389
STAR ACCOUNTING PARTNER II	\$249
STAR ACCOUNTING PARTNER II	\$549

Personal Finance

DOLLARS AND SENSE	\$119
HOWARD TAX PREPARER 85	\$195
MANAGING YOUR MONEY	\$129

Graphics/Statistics

ABSTAT	\$279
AUTOCAD	\$1475
BPS BUSINESS GRAPHICS	\$229
CHARTMASTER	\$239
CHARTSTAR	\$209
DR DRAW	\$199
ENERGRAPHICS W/ PLOTTER	\$279
EXECUVISION	\$259
GRAPHWRITER	\$359
COMBO	\$159
MS CHART	\$139
OVERHEAD EXPRESS	\$259
PC DRAW	\$ 89
PC PAINTBRUSH	\$ 85
PFS: GRAPH	\$ 95
SIGNMASTER	\$179
STATPAK-NWA	\$329
STATPAC- WALONICK	\$349
SYSTAT	\$419

Professional Development

EXPERTEASE	\$Call
MANAGEMENT EDGE	\$159
SALES EDGE	\$159
THINK TANK	\$119

Communications/ Productivity Tools

CROSSTALK	\$105
PROKEY	\$ 89
RELAY	\$ 99
SMARTCOM II	\$109

Hardware*

Displays

AMDEK 310A	\$169
PRINCETON HX-12	\$459
PRINCETON MAX-12	\$179
PRINCETON SR-12	\$599
QUADRAM	\$179
AMBERCHROME	\$159
TAXAN 122 AMBER	\$399/\$599
TAXAN 420/440	\$145
ZENITH 124 AMBER	\$145
ZENITH 135 COLOR	\$Call

Display Boards

EVEREX GRAPHICS EDGE	\$329
HERCULES GRAPHICS CARD	\$299
HERCULES COLOR CARD	\$169
PARADISE MODULAR GRAPHICS	\$275
PARADISE MULTIDISPLAY CARD	\$295
PERSYST BOB	\$449
PRINCETON SCAN DOUBLER	\$Call
SIGMA COLOR 400	\$559
STB GRAPHICS PLUS II	\$309
TECMAR GRAPHICS MASTER	\$479
TSENG ULTRA PAK	\$399
TSENG ULTRA PAK-S	\$349

Networks

AST PC NET	\$Call
CORVUS NET	\$Call
ORCHID PC NET	\$Call
3 COM	\$Call

Mass Storage/Backup

IOMEGA BERNOULLI BOX	\$2895
MT25 TAPE BACKUP	\$885
TALLGARSS TG5025	\$2945
SYSGEN IMAGE	\$850
SYSGEN QICFILE	\$Call

Printers/Plotters

C. ITOH	\$Call
DIABLO 620/630	\$Call
EPSON FX-80+	\$349
EPSON FX-100+	\$489
EPSON LQ-1500	\$999
HP 7475A PLOTTER	\$Call
JUKI 6100	\$419
NEC P3 COLOR	\$1099
NEC P3	\$799
NEC 2050	\$769
NEC 3550	\$1139
OKIDATA 84P/93P	\$729/\$619
PANASONIC	\$Call
QUME SPRINT 1155	\$1569
STAR SG/SR/SD	\$Call
TOSHIBA P1340	\$779
TOSHIBA P351	\$1279

Input Devices

KEYTRONIC 5151	\$179
KOALA	\$Call
MICROSOFT MOUSE	\$139
PC MOUSE W PAINT	\$159

Emulation Boards

AST	\$Call
CXI 3278/9	\$950
IRMA	\$799
IRMALINE	\$999
IRMAPRINT	\$Call
QUAD 3278	\$949

Modems

AST REACH 1200	\$Call
HAYES 1200	\$389
HAYES 1200B	\$365
HAYES 2400	\$609
VENTEL 1200 HALF CARD	\$379

Multifunction Boards

AST ADVANTAGE	\$375
AST 6 PAK PLUS (64K)	\$259
AST 6 PAK PLUS (384K)	\$339
ORCHID BLOSSOM (64K)	\$289
ORCHID PC TURBO	\$739
PERSYST TIME SPECTRUM (64K)	\$259
QUADBOARD (8K)	\$229
QUADBOARD (384K)	\$329
TECMAR CAPTAIN	\$Call
TECMAR JR CAPTAIN (128K)	\$329
TECMAR JR WAVE (64K)	\$249
TECMAR MAESTRO	\$429
TECMAR WAVE (64K)	\$209

Accessories

CURTIS SURGE PROTECTORS	\$Call
DATASHIELD BACKUP POWER	\$Call
GILTRONIX A/B SWITCH MICROBUFFER INLINE (64K)	\$264
MICROFAZER INLINE (64K)	\$219
64K RAM SET	\$25
256K RAM SET	\$ 79
8087 MATH CHIP	\$150

*CALL FOR SHIPPING COSTS

Samna
Word III
\$279

Chart-Master
\$239

Quadboard
384K
\$329

Tseng
Ultra Pak
\$399

Smartmodem
1200B
\$365

Smartmodem
2400
\$609

**FREE
SHIPPING**
on all credit card
or prepaid orders
and all orders over \$1000.

LOWEST PRICE GUARANTEE!!

We will match current
nationally advertised
prices on most products.
Call and compare.

free!

Diskette
Library
Case
with your order



1-800-221-1260

In New York State call (718) 438-6057

TERMS:

Checks—allow 14 days to clear. Credit processing—add 3%. COD orders—cash, M.O or certified check—add \$3.00. Shipping and handling UPS surface—add \$3.00 per item (UPS Blue \$6.00 per item). NY State Residents—add applicable sales tax. All prices subject to change.



MON.-THURS. 9:00 AM-8:00 PM
SUN. & FRI. 9:00 AM-4:00 PM

Softline

Softline Corporation
P.O. Box 729, Brooklyn, N.Y. 11230
TELEX: 421047 ATLN UI

ELEPHANT II SPR 2800



\$399.00 U.S.

(F.O.B. Edmonton, Canada)

LOW COST PROM PROGRAMMING

- Use with Printers, Video Displays, Personal Computers, Main Frame Computers.
- Base price includes CSA UL approved wall adaptor, 8K RAM, 2716/2516, 2732, 2732A, 2764 EPROM Personality Modules.
- Purchase Personality Kits for the 2532, 2564, 2764A, 27128, 27128A, 27256.
- RS232 Interface to View, Upload, Download, Modify, Examine, etc.
- Extremely easy to use, no complicated key sequences.
- In Stand Alone mode copy, verify and check for all locations erased. A proven product, successor to the Elephant I, SPR 2700 (for 2708, 2716, 2732).
- Accept VISA or Money Order
- Distributor Inquiries Welcome.

SHERREX SYSTEMS LIMITED

4196 - 93 Street, Edmonton, Alberta Canada.
T6E 5P5, (403) 462-4085

EVENT QUEUE

Chrysler Center for Continuing Engineering Education, University of Michigan, Ann Arbor. Conferences in such areas as biomedical, chemical, civil, computer, electrical, and environmental engineering. Contact Engineering Summer Conferences, 200 Chrysler Center, North Campus, University of Michigan, Ann Arbor, MI 48109, (313) 764-8490. *June-August*

● **COMPUTER SHORT COURSES**—The Fifteenth Annual Institute in Computer Science, University of California, Santa Cruz. Among the offerings are "Relational Database Management," "Data Storage," and "Computer-Aided Geometric Design." Contact Sally Thomas, University of California Extension, Santa Cruz, CA 95064, (408) 429-4534. *June-August*

● **SOFTWARE COURSES** Software Short Courses, various sites throughout the U.S. Among the courses are "UNIX: A Hands-on Introduction," "Programming in C: A Hands-on Workshop," and "Software Requirements, Specifications, and Tests." Contact Integrated Computer Systems, 6305 Arizona Place, POB 45405, Los Angeles, CA 90045, (800) 421-8166; in California, (800) 352-8251 or (213) 417-8888; in Canada, (800) 228-6799. *June-August*

● **DEVELOPMENT SEMINARS**—Professional Development Seminars, various sites around Boston, MA. A brochure describing one- and two-day seminars on computer competence, management, sales, and finance is available. Contact Boston University Metropolitan College, 735 Commonwealth Ave., Boston, MA 02215, (800) 255-1080; in Massachusetts, (617) 738-5020. *June-September*

● **SME CONFERENCES, EXPOS**—Conferences and Expositions from the Society of Manufacturing Engineers, various sites throughout the U.S. For a calendar, contact the Society of Manufacturing Engineers, Public Relations Department, One SME Dr., POB 930, Dearborn, MI 48121, (313) 271-0777. *June-November*

● **SNA SEMINAR** IBM's Systems Network Architecture (SNA) Seminar, various sites throughout the U.S. Covers such topics as local-area networks, SNA distribution services, and personal computer connections. Contact Communications Solutions Inc., 992 South Saratoga-Sunnyvale Rd., San Jose, CA 95129, (408) 725-1568. *June-December*

● **PICK EDUCATION** Pick System Educational Series, various sites throughout the U.S. and Europe. Seminars and workshops on the Pick operating system. Contact IES & Associates Inc., POB 19274, Irvine, CA 92714, (714) 786-2211. *June-December*

● **MUMPS MEETING** The Fourteenth Annual Meeting of the MUMPS Users' Group, McCormick Center Hotel, Chicago, IL. Tutorials, workshops, site visits, discussions, and exhibits. Contact MUMPS Users' Group, Suite 510, 4321 Hartwick Rd., College Park, MD 20740, (301) 779-6555. *June 10-14*

● **ROBOTIC STRATEGIES** Robot Manipulators, Computer Vision, and Intelligent Robot Systems, University of Stirling, Stirling, Scotland. The emphasis is on developing strategies for solving robotic-sensing, spatial-reasoning, and manipulation problems. Contact Director of Summer Session, Room

(continued)



MAX. IBM® AT/PC COMPATIBILITY
Made In USA

\$995
PC-2001* COMPLETE SYSTEM

*OEM BASIC System	\$555 (Minimum Order 10 Units)
*PC-2001 Complete System	\$995 (Dealers at Quantity 2)
*XT-2001 10 MB Complete System	\$1695 (Dealers at Quantity 2)
*AT-7000 Call For Evaluation Unit	\$ (Approx. \$2000 Off IBM Pricing)

PC-2001 Partial Features: (Dealers Please Call For Details)
• Multi-layered Mother Board • RAM Memory Upgradable to 640K • K-8400 or K-9600 Keyboard • TEAC Drive & Controller • 2 Serial & 1 Parallel Ports • Runs Lotus 1-2-3, Symphony, Flight Simulator and thousands more

***DEALER INQUIRIES INVITED**

PLEASE CALL FOR DEALERS NEAREST YOU

Other OEM Accessories:

- *20 MB HARD DISK
- *TAPE BACK UP
- *8 SLOT MOTHER BOARD
- *AT-7000 MOTHER BOARD



IBM is a trademark of IBM Corporation

IBM CORPORATION

2700 E. IMPERIAL HWY. - BLDG. A
BREA, CA 92621
(714) 579-0680, 579-0891
TELEX 753197

Inquiry 434 for End-Users.
Inquiry 435 for DEALERS ONLY.

NEW!
Zorro AT



AT Power / XT Prices

Our new Zorro AT systems give you: an 80286 CPU operating at a quick 6 Mz., eight expansion slots, a clock/calendar with battery backup, a 1.2 Megabyte 5 1/4" floppy disk drive, and IBM-AT compatibility.

Zorro AT's also include options that would cost you almost \$1000 from IBM: a 360K drive to give you PC/XT media compatibility, a copy of DOS 3.0 to get you started, and a full 512K of RAM on the main board.

Zorro AT-20's feature a 20 Mb. Winchester drive from NEC, and you still have room to add a fourth drive or tape backup.

To be quite frank, we believe our Zorro AT's are built better, and we back each system with a limited warranty for a full year. Our quality and features invite comparison, our prices speak for themselves.

Zorro AT	\$2695
Zorro AT-20	\$3895



The Silver Fox Trots Through Lotus Like 1,2,3

The Silver Fox is not IBM-PC compatible yet it runs hundreds of MS-DOS programs including Lotus 1,2,3, dBASE II, Multiplan, and even Flight Simulator.

The Silver Fox does not have IBM compatible expansion slots but you can economically add printers, serial ports, modems, 10-40 Mb. hard disks, clock/calendar cards, RAM, joysticks, an 8087 co-processor, and more.

What makes the Silver Fox unique, however, isn't what you can add to it, but what comes with it. Each Silver Fox comes with an 8088 CPU, 256K of RAM, four video ports, and a printer port. Plus you get more than twice the storage of a standard PC, 1.6 Megabytes on dual 5 1/4" floppies, and the Fox will read and write to standard 160K, 320K, and 360K IBM-PC formats.

Standard equipment also includes a better keyboard, a 12" high resolution monitor with a full 25x80 display, and we back each Silver Fox with a one year limited warranty.

Were this not enough each Silver Fox comes with the best free software bundle in the business including: MS-DOS 2.11/HAGEN-DOS 2.11, DOS Tutor, Wordstar 3.3, Easy Writer, Spell, Mail Track, PC File III, FILEBASE, CalcStar, games, graphics, utilities, and two BASIC languages.

Because computer sales usually slow down during the summer we've given you an extra incentive to buy a Fox by lowering our prices. If you want to get the most for your computer dollar, call our machine or 1-800-FORAFox, leave your name and address at the beep, and we'll send you a Silver Fox booklet that will tell you how it can.

Silver Fox	\$1297
Color Fox	\$1497

Altos



High-performance, Xenix-based, multi-user systems from Altos-world leaders in multi-user systems and applications software.

As part of TRW's marketing support group we can have your Altos system installed on your site (additional charge).

Altos systems are easy to expand, and with shared printers and hard disks are cost competitive with multiple single user systems. Call for additional pricing and availability.

486-20	\$4539
586-40	\$7249
986-40	\$8829
Altos Acc't	\$2779

The Bernoulli Box™

- Hard disk capacity and performance
 - Removable cartridge economy and convenience
 - Cartridge convenience
 - Flexible disk economy
 - Winchester capacity
 - Unparalleled reliability
- | | |
|-----------|--------|
| 10 Mb | \$1839 |
| 20 MB | \$2529 |
| 5 Mb./Mac | \$1379 |

Now!

Fox Jr.

\$899

call for details

PRINTERS



Epson FX-80+	\$265 \$180 off
LX-80	\$300 \$100 off
Okidata 92	\$215 \$125 off
Okidata 93	\$235 \$210 off
Okidata 84	Call
Star 5G-10	\$239
Star SR-15	\$599
Panasonic 1091	\$298
Toshiba 1340	\$579
Toshiba 351	\$1319

LETTER QUALITY

Powertype	\$299
Juki 6100	\$399
Juki 6300	\$719
Silver Reed 500	\$299
Silver Reed 550	\$409
Silver Reed 770	\$724
Diablo	Call
NEC	Call
Daisywriter 2000	\$824

HOUSTON INSTRUMENTS	
DMP-29	\$1795
DMP-40	\$745
DMP-41	\$2340
other models	Call

Columbia 4220 or 2220

\$1698

OLYMPIA

Scottsdale Systems Ltd.
 617 N. Scottsdale Road, Suite B, Scottsdale, Arizona 85257

(602) 941-5856

Call 8-5 Mon.-Fri.

 We participate in arbitration for business and customers through the Better Business Bureau of Maricopa County.

SINCE 1980

TELEMARKETING ONLY: If you plan to stop by please phone ahead. Prices listed are for cash. P.O.'s from Fortune 1200 companies and universities with good credit add 2% / Mastercard and Visa add 3% / Arizona residents add 6% sales tax / Shipping extra / All items are new with manufacturers warranty / Returned merchandise subject to 20% restocking fee / Personal or company checks take up to 3 weeks to clear / No COD's or APO's. Trademarks: Silver Fox, HAGEN-DOS, and Zorro AT, Scottsdale Systems, Ltd.; Wordstar and CalcStar, Micropro International; MS-DOS, and Multiplan, Microsoft Corporation; FILEBASE, EWDP Software, Inc.; dBASE II, Ashton-Tate; IBM-PC, IBM-PC DOS, and IBM-AT, International Business Machines.

WYSE50's
\$449



1200 BPS Modems	
Volkmodem 12	\$199
Password	\$209
Prometheus	\$315
Hayes 300/1200	\$429

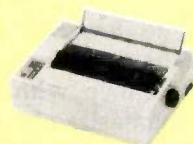

To LQ or NLQ That is the Question

Whether it's nobler to zip along at 165 CPS in draft mode and use an incredible 17x17 NLQ mode for letters, or produce letter perfect output - Olympia gives you a choice.

Compare the Olympia NP to the popular Epson FX-80 or the Okidata 92. The NP is slightly faster, noticeably quieter and includes push-type tractor (and friction feed) as standard equipment.

But the NP's really big feature is its fine script mode which is superior to the Okidata 92, and even better than an FX-80+ with a \$199 "NLQ" option. To quote PC magazine:

"The NP printer is a sure thing if it falls into your price range, and even if it doesn't."

If you're looking for the best buy in a true letter-quality printer (like the Silver Reed 550 or the Juki 6100) the Olympia RO is for you. The RO is a 14 CPS, wide-carriage, that comes with both friction and tractor feed, serial and parallel ports, and quality that has made Olympia a world leader in type-writers.

To LQ or NLQ is up to you, the price for either the Olympia RO or the NP with a 10' shielded cable to your computer is only:

\$344

New C Books from Plum Hall

The business of Plum Hall is C Language: training courses, video-tape presentations, and authoritative books. We are introducing two new advanced books: **Efficient C**, and **Reliable Data Structures in C**.

Efficient C (Thomas Plum and Jim Brodie, 1985) provides a small suite of C functions into which the reader can "plug in" any C statement and determine how many microseconds of CPU time it takes to execute. Expanding upon this technique, the book presents tables of CPU time and code space for C operators, control structures, and function calls. These allow the reader to make fairly accurate estimates of the resources that a program will take, without resorting to assembler listings. The book discusses optimization techniques performed automatically by several compilers, as well as those techniques which can be effectively used by the programmer.

Plum and Brodie are respectively Vice-Chair and Chair of the ANSI committee X3J11 which is standardizing C language.

Reliable Data Structures in C (Thomas Plum, 1985) describes techniques for a "no surprises" usage of pointers, structures, and files. Standard data structure techniques like stacks, queues, and trees are presented using reliability techniques, along with a complete menu-and-forms screen generator. Relevant information about the draft ANSI standard for C is presented to allow programmers to write compatibly with existing and forthcoming compiler and interpreter environments.

Two other well-received books from Plum Hall:

Learning to Program in C (Thomas Plum, 1983) presents the fundamentals of C. Presupposing only an acquaintance with computers, it covers C up through the basics of pointers and structures.

C Programming Guidelines (Thomas Plum, 1984) provides a style standard for projects working in C language. Arranged in "manual-page" reference format, it gives rules for using variables, data types, operators, expressions, statements, functions, files, libraries, and documentation.

Each book is \$25.00 (plus 6% within NJ), \$30.00 outside USA (airmail). We ship within two days when ordered by phone or mail with credit card, purchase order, or check. Plum Hall Inc also provides introductory and advanced training in C, both at public courses and in-house. Please call or write for our public course schedule and inhouse course details.

Plum Hall Inc
1 Spruce Av
Cardiff NJ 08232
609-927-3770

EVENT QUEUE

E19-356. Massachusetts Institute of Technology, Cambridge, MA 02139. June 10-14

● CARACAS EXPO

The First International Communications and Computer Exhibition and Technical Conference: VenCom '85, Caracas Hilton Hotel, Caracas, Venezuela. Contact VenCom '85, Suite 219, 3421 M St. NW, Washington, DC 20007, (703) 685-0600. June 11-14

● UNIX, C CONFERENCE

USENIX Conference and Vendor Exhibition, Marriott Hotel, Portland, OR. USENIX is a nonprofit organization promoting UNIX, UNIX-like systems, and C-language programming. Contact USENIX Conference Office, POB 385, Sunset Beach, CA 90742, (213) 592-3243. June 11-14

● NETWORK CONTROL AND MANAGEMENT—Network Management/Technical Control, Santa Clara Marriott, Santa Clara, CA. Diagnostic and test instruments will be displayed. Contact Louise Myerow, CW Conference Management Group, 375 Cochituate Rd., POB 880, Framingham, MA 01701, (800) 225-4698; in Massachusetts, (617) 879-0700. June 12-13

● COMPUTERS IN CLINICAL LABS—Clinical Laboratory Computers: Symposium 1985, The Towsley Center, University of Michigan, Ann Arbor. Contact Dove Margenau, Office of Continuing Medical Education, The Towsley Center, Box 057, University of Michigan Medical School, Ann Arbor, MI 48109-0010, (313) 763-1400. June 12-14

● CLINICAL COMPUTING Computing in Clinical Laboratories: The Fifth International Conference, Stutt-

gart, Federal Republic of Germany. Topics include databases, data presentation, and expected developments. Demonstrations and exhibits. Contact PD Dr. Chr. Trendelenburg, Katharinenhospital KCl, Kriegsbergstrasse 60, D-7000 Stuttgart 1, Federal Republic of Germany; tel: (07 11) 20 34-4 82. June 12-14

● INFO MANAGEMENT INFO/West: The Western Information Management Exposition and Conference, Convention Center, Anaheim, CA. Trade show for executives and data-processing and management-information system managers. Contact INFO/West, 999 Summer St. Stamford, CT 06905, (203) 964-8287. June 12-14

● FORTH CONFERENCE The 1985 Rochester FORTH Conference, University of Rochester, Rochester, NY. The focus will be on software engineering and management. Contact Ms. Maria Gress, Institute for Applied FORTH Research, 70 Elmwood Ave., Rochester, NY 14611, (716) 235-0168. June 12-15

● ELECTRONIC PUBLISHING Pages That Fly, New York University, New York. Sessions of interest to telecommunications experts, publishers, and corporate and educational professionals. Contact Arlene Krebs, New York University, 51 Press Building, New York, NY 10003, (212) 598-3993. June 13-14

● LOGICAL MACHINES The Second Annual Conference on Logic, Logic Machines, and Public Education, University of Houston—Clear Lake, Houston, TX. Formal and informal sessions, symposia, and work-

(continued)

Innovation

A system that keeps
your private computer files
from becoming public.



GTX-100. Computer security so advanced, it could even keep secrets from Mata Hari.

Does your computer talk to strangers? Before you answer no, remember, today's computer intruders are very skillful.

In fact, even a famous spy like Mata Hari would be hard pressed to match their inventiveness. With one deft phone call, these electronic trespassers can tamper with such secret items as privileged customer reports, confidential correspondence, and marketing intelligence.

Inquiry 252

Data thieves can steal information like that. Or erase it. Or alter it to their advantage.

That's why your computer needs the protection of GTX-100. It's a new kind of security subsystem developed from Lockheed's years of experience with high technology and strict security.

GTX-100 puts an electronic wall around your sensitive computer files and keeps your private data private.

Use the coupon to get a GTX-100 brochure plus the name of your nearest sales office. They'll show you how GTX-100 can guard your secrets the next time a stranger comes calling.

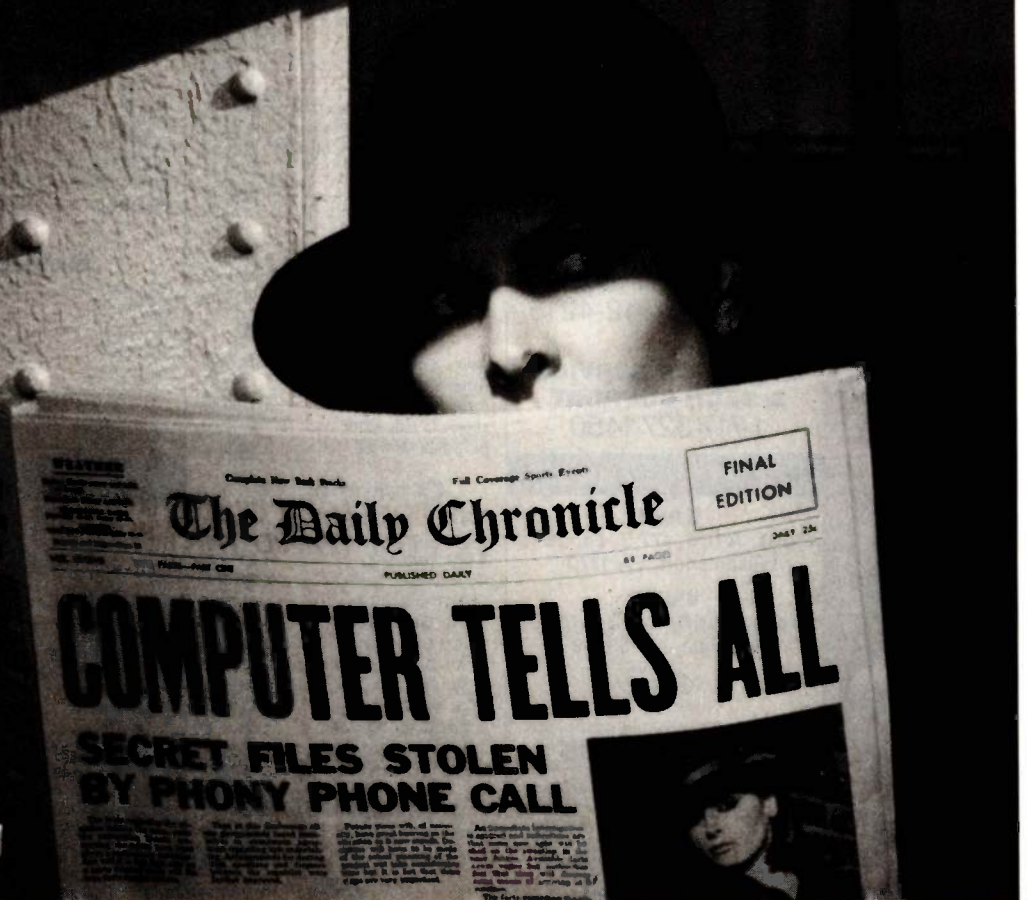

© Lockheed-GETEX 1985

Mail to:

Lockheed-GETEX, Suite 945,
1100 Circle 75 Parkway, Atlanta,
GA 30339. (404) 951-0878.

Please send me:

- GTX-100 brochure.
- The name of my nearest sales office.

Name _____

Title _____

Company Name _____

Address _____

City _____

State _____

Zip _____

 **Lockheed-GETEX**
Giving shape to imagination.

JUNE 1985 • BYTE '91

No More WAITing with . . .

FASTBREAK™

8087 SPEED for
LOTUS 1-2-3™

FASTBREAK speeds up 1-2-3 recalculations by up to 36 to 1 on a 4.77 MHz PC and by 79 to 1 on a NUMBER SMASHER equipped PC. It extends DOS functionality to include the 8087 and comes with a daughterboard which fits into the 8087 socket, an 8087, a break button and the necessary software. A number of additional features are invoked through its novel break button. These enable the user to lock out the keyboard, exchange information with programs written in BASIC, FORTRAN or C that are running concurrently, spool LOTUS output to a printer and install a single protected copy of 1-2-3 and FASTBREAK on your hard disk. An optional LOCK BOX makes it possible to RESET your PC and remove the break button from the computer \$339 LOCK BOX \$60

See our full page ads elsewhere in this issue for other MicroWay products including:

8087 5MHz	\$109
64K RAM Set	\$12
256K HMOS RAM Set	\$72
256K CMOS RAM Set	\$135

Contact MicroWay, Inc. or your local MicroWay® Installation Center to order.

Lotus and 1-2-3 are trademarks of Lotus Development Corp. MicroWay, FASTBREAK and NUMBER SMASHER are trademarks of MicroWay, Inc.

MicroWay

P.O. Box 79
Kingston, Mass.
02364 USA
(617) 746-7341

**The World Leader
in 8087 Support!**

COMPETITIVE EDGE

P.O. Box 556 — Plymouth, MI 48170 — 313-451-0665

Compupro®, LOMAS, EARTH, TELETEK, Macrotech
S-100 CIRCUIT BOARDS

Compupro 286 CPU**	\$750.	Lomas 286	\$821.	Macrotech 286/280H	\$795.
Compupro SFU Z™ 8MHz	261.	Lomas 8086	420.	Lomas 10MHz 8086	\$200.
Compupro 8085/88	245.	Lomas Octaport™ B Serial	320.	Lomas 4 serial	500.
Compupro Disk 1A™	347.	Lomas LDP™ 72	206.	Macrotech 256K Dram	499.
Compupro Disk 3™	417.	Lomas 256K Dram	556.	Macrotech 512K Dram	799.
Compupro Ram 22™	850.	Lomas 512K Dram	821.	Macrotech 512K static	1595.
Compupro Ram 23™	277.	Lomas Ram 67™	725.	Macrotech 256K static	795.
Compupro Ram 23 128	487.	Lomas Hazitall™	244.	Lomas Color Magic™ 16K	476.
Compupro CPU Z™	189.	Thunder 186™	1095.	Lomas MSDOS™ 2.11	200.
Compupro CCP/M™ 816*	250.	Lomas CCP/M™ 86*	280.	Compupro MDrive H™ 512K	495.
System Support One™	245.	Compupro I/O 4	245.	Compupro I/O 38 port	459.
Teletek HD	375.	Teletek SBC 1	525.	Teletek SBC 1 6MHz 128	699.
Teletek Systemmaster*	557.	Systemmaster II™	899.	Turbodots® for Teletek	650.

Lomas 2 Megabyte Ram-(2048K) just \$1595.

Earth Computer **TURBO SLAVE I 8MHz 128K \$395.**

Turbo Slave I runs with Teletek, North Star Horizon, Advanced Digital and Others.

SYSTEMS

Compupro 85/88 256K CDOS, SS1, I/O 4.2, 96TPI DRS, 10 Slot	\$3095
Compupro 85/88 256K CDOS, SS1, I/O 4.1, 96TPI 20MB, 10 Slot	\$4295
286/280H 1024K Static, CDOS, SS1, I/O 4.1, 96TPI 40MB, 10 Slot	\$7495
M-Drive-H Option \$495 per 512K or \$1795 per 2048K each	
Lomas 286, 1024K 20MB HD, 1-5, CDOS, 6 SERIAL, 2 Par, 10 Slot	\$4995
Lomas Thunder 186, 256K, 20 MB HD, 1-5, CDOS, 4 Slot	\$2895
Teletek 8MHz Master, 4-8MHz 128K SLVS, 1-5, 20 MB HD, TDOS	\$4495

UPGRADE YOUR IBM® PC™ !!

MONITORS		GRAPHIC BOARDS	
Amdex 310A	\$159	Hercules Monochrome	\$299
Taxan Color 440	\$549	Hercules Color Card	\$159
Princeton color HR-12	\$459	Tecmar Graphics Master	\$449
Princeton Color SR-12	\$649	Paradise Graphics	\$279
		STB Graphix . II	\$279
MULTI-FUNCTION BOARDS		FLOPPY DRIVES	
AST 6 Pak 64K	\$245	TEAC 1/2 HT FD55B	\$119
Quadram Expanded Quadboard 0K	\$219	Mitsubishi 96 TPI	\$125
Tecmar Captain 64K	\$199	5" DSDD Color Diskettes	\$ 21

ALL PRICES SUBJECT TO CHANGE AND STOCK ON HAND

Compupro is a Registered Trademark of Viasyn, CPU Z, Disk 1A, Disk 3, Interfacor 3, Interfacor 4, CPU 286, CPU 8085/88, System Support 1, MDRIVE-H, Ram 22, Ram 23 are trademarks or registered trademarks of Viasyn. CP/M 2.2, CCP/M, are registered trademarks of Digital Research Inc. MSDOS is a registered trademark of Microsoft. Systemmaster & Systemmaster II are registered trademarks of Teletek Enterprises. Turbodots is registered trademark of Software 2000. IBM is a registered trademark of International Business Machines.

EVENT QUEUE

shops. Contact the Institute for Logic and Cognitive Studies, University of Houston—Clear Lake, Box 269, Houston, TX 77058, (713) 488-9274. June 13-15

● **INTERNATIONAL SHOW**
The International Computer Show, Trade Fair Center, Cologne, West Germany. More than 350 manufacturers are expected to display their wares. Contact Messe- und Ausstellungs-Ges.m.b.H. Köln, Messeplatz, Postfach 210760, D-5000 Köln 21, West Germany; tel: (0221) 821-1; Telex: 8 873 426 mua d. June 13-16

● **SYSTEM/38 SEMINAR**
The IBM System/38: Standards and Practices, Halloran House Hotel, New York City. The fee is \$595. Contact DGC Inc., 1450 Preston Forest Square, Dallas, TX 75320, (214) 991-4044. June 17-18

● **BIO RESEARCH RESOURCE**—Introduction to BIONET: A National Computer Resource for Molecular Biology, Rutgers University, Piscataway, NJ. Workshops on using computers for molecular biology research. Contact Selma Gitelman, Continuing Professional Education, Institute of Microbiology, Rutgers University, POB 759, Piscataway, NJ 08854-0759, (201) 932-4258. June 17-19

● **PC IN BIG APPLE**
PC Expo, Coliseum, New York, NY. Seminars and product displays. Contact PC Expo, 333 Sylvan Ave., Englewood Cliffs, NJ 07632, (800) 922-0324; in New Jersey, (201) 569-8542. June 17-19

● **INTRO TO FORTH**
Beginning FORTH Programming, Humboldt State University, Arcata, CA. A hands-on, introductory course for

those wishing to learn FORTH and write applications in it. The fee is \$150 or \$200 with three credit hours. Contact Claire Duffey, Office of Continuing Education, Humboldt State University, Arcata, CA 95521, (707) 826-3731. June 17-21

● **ENGINEERING SOFTWARE**—Engineering Software: Engsoft '85, The Fourth International Conference and Exhibition, Kensington Exhibition Centre, London, England. Exhibits and sessions. Contact Elaine Taylor, Computational Mechanics Centre, Ashurst Lodge, Ashurst, Southampton SO4 2AA, England; tel: (042 129) 3223; Telex: 47388 Attn. COMPMECH. June 18-20

● **COMPUTERS AND MANUFACTURING**—Successful Implementation of Computer Integrated Manufacturing, Constellation Hotel, Toronto, Ontario, Canada. Topics covered include components of computer-integrated manufacturing, methods of implementation, and planning and management. Contact Computer and Automated Systems Association, Society of Manufacturing Engineers, One SME Dr., POB 930, Dearborn, MI 48121, (313) 271-1500. June 18-20

● **DATA COMMUNICATIONS UPDATE**—Data Communications: A Complete Overview and Update, Newport Beach, CA. The managerial, operational, and technical aspects of data communications and facilities are covered. Contact Data-Tech Institute, Lakeview Plaza, POB 2429, Clifton, NJ 07015, (201) 478-5400. June 19-21

● **TIPS FOR NET MANAGERS**—Network Management/Technical Control,

(continued)

Alloy takes your PC to the limit.

QICSTOR-PLUS. The ultimate in PC expansion with five IBM compatible slots, hard disk storage, and streaming tape backup in one neat package.

Alloy's QICSTOR-PLUS meets all your expansion needs. It's the ideal upgrade for a growing PC or AT system.

QICSTOR-PLUS has five full size expansion slots which are completely compatible with the IBM PC bus and they also support Alloy's PC-SLAVE/16 multi-processor, multi-user capability. Its high performance hard disk has a capac-

ity of 36 to 128 MBytes. And QICSTOR-PLUS has file-oriented streaming tape backup with a formatted capacity of over 50 MBytes. Alloy provides file-oriented QTIP software with a transfer rate of 2 MBytes/minute.

QICSTOR-PLUS is available right now. So call Alloy today at (617) 875-6100.







ALLOY QICSTOR-PLUS

COMDEX/Spring '85

ALLOY
Computer Products, Inc.

Alloy Computer Products Inc., 100 Pennsylvania Avenue, Framingham, Massachusetts 01701. Tel: (617) 875-6100, TWX: 710-346-0394
In Europe: Alloy Computer Products (Europe), Ltd., Cirencester, Gloucestershire, England. Tel: 0285-68709, Tlx: 43340

IBM P.C. AVAILABLE PRODUCTS						
	10 MEGABYTE HARD DISK • 100% XT compatible • Boots directly from hard disk • Low power consumption • 10, 22, 33, 87, 240 Megabyte, Internal & External	<table border="1"> <tr> <th>PORTABLE</th> <th>XT</th> </tr> <tr> <td>• 10 Megabyte hard disk fully shock mounted • Tape Backup in Power Center™ • 640K expansion on mother board using 256K chips NEW</td> <td>• Tape Backup 1/2 height (floppy tape) • 640K expansion on mother board using 256K chips • 20, 40, 60 Megabyte tape backup NEW • Economical, fast, reliable</td> </tr> </table>	PORTABLE	XT	• 10 Megabyte hard disk fully shock mounted • Tape Backup in Power Center™ • 640K expansion on mother board using 256K chips NEW	• Tape Backup 1/2 height (floppy tape) • 640K expansion on mother board using 256K chips • 20, 40, 60 Megabyte tape backup NEW • Economical, fast, reliable
PORTABLE	XT					
• 10 Megabyte hard disk fully shock mounted • Tape Backup in Power Center™ • 640K expansion on mother board using 256K chips NEW	• Tape Backup 1/2 height (floppy tape) • 640K expansion on mother board using 256K chips • 20, 40, 60 Megabyte tape backup NEW • Economical, fast, reliable					
IBM P.C. AT AVAILABLE PRODUCTS						
	• Optional 2nd hard disk or removable hard disk for backup • CMI 20/30 Megabyte hard disk (Same as used by IBM) • 20, 40, 60 Megabyte 1/2 height Tape Backup Very fast, efficient & reliable • Removable hard disk 10 Megabyte	EXPANSION BOARDS <table border="1"> <tr> <th>AT RAM CARD</th> <th>AT I/O</th> </tr> <tr> <td>• 128K expansion, 1.5 Megabyte using 256K chips NEW • 128K Piggy Back Chips for mother board expansion</td> <td>• Serial Port RS232 & Parallel Port • Fully IBM AT compatible</td> </tr> </table>	AT RAM CARD	AT I/O	• 128K expansion, 1.5 Megabyte using 256K chips NEW • 128K Piggy Back Chips for mother board expansion	• Serial Port RS232 & Parallel Port • Fully IBM AT compatible
AT RAM CARD	AT I/O					
• 128K expansion, 1.5 Megabyte using 256K chips NEW • 128K Piggy Back Chips for mother board expansion	• Serial Port RS232 & Parallel Port • Fully IBM AT compatible					
COMPAQ DESK PRO AVAILABLE PRODUCTS						
HARD DISK 	TAPE • D.O.S. 2.1 & 3.0 compatible • 1/2 height • 20, 40, 60 Megabyte • Standard data format • Image or file by file • 10 Megabyte (floppy tape) • Same as used by Compaq	RAM UPGRADE • 640K expansion on mother board using 256K chips				
COMPAQ PORTABLE						
	10, 20, MEGABYTE HARD DISK • Low power consumption • External Backup in Power Center™ • Special shock mounted (Same as used by Compaq)					
AT & T AVAILABLE PRODUCTS						
HARD DISK 10, 22, 33, 87, MEGABYTE INTERNAL & EXTERNAL UNITS • Low power consumption • 100% compatible • Controller same as used by AT & T	TAPE • External Tape Backup in Power Center™ • 10, 20, 40, 60 Megabyte	RAM UPGRADE • 640K expansion on mother board using 256K chips				
YOUR ONLY SOURCE FOR IBM PC, XT, PORTABLE, AT, COMPAQ PORTABLE & DESK PRO, AT & T UPGRADE KITS, HARD DISKS, TAPE BACKUP, RAM UPGRADES & EXPANSION BOARDS.						
 ONE CALL DOES IT ALL! (714) 953-0470 1512 E. Edinger Ave. • Santa Ana, CA 92705						

EVENT QUEUE

Convention Center, San Jose, CA. A conference and exposition. Contact CW Conference Management Group, 375 Cochituate Rd., POB 880, Framingham, MA 01701, (800) 225-4698; in Massachusetts, (617) 879-0700. *June 24-27*

● **WORK WITH A COMPUTER**—Using a Personal Computer, Breckenridge Concourse Hotel, St. Louis, MO. A hands-on course for those who want to use integrated software packages. The fee is \$965. Contact The Center for Professional Advancement, POB H, East Brunswick, NJ 08816, (201) 238-1600. *June 24-27*

● **ADVANCED FORTH** Using FORTH Effectively, Humboldt State University, Arcata, CA. An advanced, hands-on workshop in applying FORTH to real-world problems. The fee is \$150 or \$200 with three credit hours. Contact Claire Duffey, Office of Continuing Education, Humboldt State University, Arcata, CA 95521, (707) 826-3731. *June 24-28*

● **ADVANCED LOTUS CLASS**—Advanced Lotus 1-2-3, Georgia Institute of Technology, Atlanta. A concentration on macros, macro menus, and multiple linked worksheets. The fee is \$390. Contact Trish Stolton, Department of Continuing Education, Georgia Institute of Technology, Atlanta, GA 30332, (404) 894-2547. *June 25-26*

● **GRAPHICS IN SUNSHINE** Computer Graphics '85 West, Los Angeles, CA. Contact National Computer Graphics Association, 8401 Arlington Blvd., Fairfax, VA 22031, (703) 698-9600. *June 25-27*

● **UNIX FOR MANAGERS** UNIX Overview for Managers, City University,

Bellevue, WA. For managers considering a UNIX system for office automation or software development. The fee is \$100. Contact David Cheyette, Specialized Systems Consultants, POB 7, Northgate Station, Seattle, WA 98125, (206) 367-8649. *June 26*

● **CAD TECHNOLOGY** CAD 2001: The Countdown, Boston, MA. Presentations on the future of computer-aided design. The fee is \$900. Contact CAD Seminars Inc., Suite 400, 150 East Riverside, Austin, TX 78704, (512) 445-7342. *June 26-28*

● **DATA COMMUNICATIONS UPDATE**—Data Communications: A Complete Overview and Update, Philadelphia, PA. See June 19-21 for details. *June 26-28*

● **COMPUTERS IN AUSTIN** The Third Annual Austin Computer Fair, Municipal Auditorium, Austin, TX. More than 150 exhibits and seminars are planned. Contact David Orshalick, Austin Seminars Inc., POB 4531, Austin, TX 78765, (512) 451-2954. *June 27-29*

July 1985

● **COMPUTER TRAINING** Computer Training Programs, Wintergreen Learning Institute, Wintergreen, VA. Hands-on training in word processing, information management, spreadsheets, and graphics. Contact Dr. M. D. Corcoran, Wintergreen Learning Institute, POB 7, Wintergreen, VA 22958, (804) 325-1107. *July-September*

● **AUTOMATION DOWN UNDER**—AutoMach Australia '85, Melbourne. An automated manufacturing conference and exhibition. Contact SME World Head-

(continued)

64K SBCs...\$99.

in OEM quantities



- Save development time and costs with Megatel Quark® single board computers
- Select only the features you require
- We deliver your first unit in two weeks or less

- | | |
|--|--|
| • 6MHz Z80B® | • Up to 128K EPROM |
| • 8088 Co-Processor | • E²PROM Support |
| • 64K, 128K or 256K RAM | • Time of Day Clock |
| • Alpha/Graphics Video Controller | • Up to 4 Parallel I/O Ports |
| • Floppy Disk Control (8", 5 1/4" or 3 1/2") | • Peripheral Expansion Interface |
| • Winchester Hard Disk Control | • CP/M® 2.2 or CP/M® 3.0 Operating Systems |
| • Up to 2 Full Duplex Serial Ports | |

Special Packages:

Entry Level Quark 10 with Z80B®, 64K RAM, EPROM, Video, Serial and Parallel I/O only \$295.*

64K SBC Package with CP/M® 2.2 on disk only \$375.*

Custom designs and layouts available

To order your first unit call our Toronto sales office today. (416) 745-7214

Or write us: Megatel 1051 Clinton St., Buffalo, N.Y. 14206

CP/M is a registered trademark of Digital Research. *Quantity one price. Z80B is a registered trademark of Zilog Inc.

megatel

AMAZING DAISY

NOW! FULL SIZE, FULL FEATURE, LETTER QUALITY AT ONLY \$353

If you have been searching for a letter quality printer you have probably found the flood of claims and counterclaims to be a real roadblock in your search. Not long ago we were in the same position. We tried to determine which daisy wheel printer had all the features our customers wanted, yet would not set them back a month's salary. Recently several manufacturers have introduced machines that had features we were searching for. After a thorough assessment, we eliminated one model after the other for lack of one feature or another until we only had one left.

THE RESULTS ARE IN

We found the printer which has all the features anyone could want. The winner is the Aproték Daisy 1120, a real heavy-duty workhorse printing at 20 characters per second. The manufacturer is Olympic Co. Ltd., a highly respected Japanese firm.

FEATURES GALORE

This printer has it all. To start with, it has a front panel Pitch Selector button with indicators which allows 10, 12, 15 characters per inch (CPI) or Proportional Spacing. There is a Select (Online) button (with indicator) and a Line Feed button. You can also set Top-of-Form or Form Feed with the touch of the TOF button. Other front panel indicators include Power and Alarm.

To load a sheet of paper, simply place it in the feed slot and pull the paper bail lever. PRESTO! The paper feeds automatically to a 1 inch top margin and the carriage aligns to the selected left margin. In this manner, each page can have identical margins automatically. You can continue to compute while the Daisy 1120 is

printing. The built in 2K buffer frees up your computer while printing a page or two allowing you to go to your next job.

To really put your printer to work, the Cut Sheet Feeder option is great for automatic printing of those long jobs. Also available is the adjustable Tractor Feed option. Compare our option prices! Best of all the Daisy 1120 is quiet: only 57 dB-A (compare with an average of 62-65 dB-A for others).

COMPLETE COMPATIBILITY

The Daisy 1120 uses industry standard Diablo® compatible printwheels. Scores of typeface styles are available at most computer or stationary stores. You can pop in a 10, 12, 15 pitch or proportional printwheel and use paper as wide as 14". At 15 CPI you can print 165 columns—great for spreadsheets.

The Daisy 1120 uses the Diablo Hytype II® standard ribbon cartridges. Again universally available.

Not only is the hardware completely compatible, the control codes recognized by the Daisy 1120 are Diablo 630® compatible (industry standard). You can take advantage of all the great features of word processing packages like Wordstar®, pfs: Write®, Microsoft Word® and most others which allow you to automatically use superscripts, subscripts, automatic underlining, bold-face (shadow printing) and doublestrike.

The printer has a set of rear switches which allow the use of standard ASCII as well as foreign character printwheels. Page length can be set to 8, 11, 12, or 15". The Daisy 1120 can also be switched to add automatic line feed if required.

THE BEST PART

When shopping for a daisy wheel printer with all these features (if you could find one), you could expect to pay \$600 or \$700 dollars. The options would add much more. *Not now!* We have done our homework. We can now offer this printer for only \$353. Order yours today!

NO RISK OFFER

Try the Daisy 1120 for 2 weeks. If you are not satisfied for ANY reason we will refund the full price—promptly. A full 1-year parts and labor warranty is included.

THE BOTTOM LINE

Aproték Daisy 1120 (Order#1120) \$353 w/standard Centronics parallel interface and 2K buffer.

Options

Auto Cut Sheet Feeder (#1110) \$188

Tractor Feed (#1112) \$77

Accessories

8' Cable for IBM PC® and compatibles (#1103) \$26

Interface with cable: •TI-99/4A (#106) \$66

•Apple II or IIe (#1104) \$76

•All Commodore (except Pet) (#1105) \$44

•All Atari (#1107) \$66

Shipping is \$11—UPS continental USA. If you are in a hurry, UPS Blue or Air Parcel Post (second day air) is \$25. Canada, Alaska, Mexico and Hawaii are \$30 (air). Other foreign is \$60 (air). California residents add 6% tax. Prices are cash prices—VISA and M/C add 3% to total. We ship promptly on money orders, cashier's checks, and charge cards. Allow 14-day clearing for checks. No C.O.D.'s. Payment in US dollars only.

TO ORDER ONLY CALL TOLL FREE

(800) 962-5800 USA (8-8 PST)

(800) 962-3800 CALIF.

Or send payment to address below:

Technical Information & Customer

Service: (805) 987-2454 (8-5 PST)

Dealer Inquiries Invited

©1985 APROTEK. All rights reserved.
Trademarks: Diablo, Hytype II, 630-Xerox Corp. Wordstar-Micropro Corp.; PFS-Software Publishing Corp.; Microsoft Word-Microsoft Corp.; Apple, II, IIe-Apple Computer, Inc.; IBM PC-IBM Corp.; PET, CBM.



 **APROTEK**

1071-A Avenida Acaso, Camarillo, CA 93010

The best of two worlds

The MYTECH COMAL interactive programming language gives you the simplicity of Basic and the power of Pascal. Many of the concepts are influenced by ADA¹⁾, for example exception handling, packages etc.

Mytech Comal features

- Friendly, interactive user interface with help facilities
- 100% orthogonal.

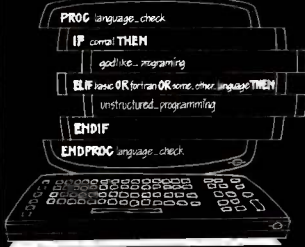

- Screen editor
- Fulfills the Comal 2.00 requirements

- Available for IBM²⁾, MACINTOSH³⁾, HP, OLIVETTI, APRICOT⁴⁾, WICAT etc
- Implemented on UNIX⁵⁾, CPM/86⁶⁾, C-CPM/86⁴⁾, MS-DOS⁷⁾, PC-DOS⁸⁾
- Easily ported to 16/32-bits systems
- The package concept makes Mytech Comal extensible
- Turtlegraphics package (LOGO) is available
- Easily customized for foreign languages
- Support for the 8087.
- Is written in "C".
- Comal is an official education language in Europe.

Mytech Comal is the perfect language for students as well as for the professional programmer. For further information please ask for a data sheet. Or why not do it the right way, order your Mytech Comal system today and move in to a new fascinating and powerful programming dimension.

1) DoD, 2) IBM, 3) Digital Equipment, 4) AT & T, 5) Digital Research, 6) Microsoft, 7) Apple Computer Inc., 8) ACT Int.



Mytech Software INC, 111 20 Rosell Street no.E, San Diego, CA 92121 USA
Tel. 619-452-9847, Telex. 705340

EVENT QUEUE

quarters, One SME Dr., POB 930, Dearborn, MI 48121, (313) 271-1500; in Australia, Mr. Greco, Integrated Project Management Services, POB 1399, Crows Nest 2065, New South Wales, Australia; tel: 02-439-4014; Telex: AA25468. July 2-5

● **ADVANCED AUTOMATION**—Robot Manipulators, Computer Vision, and Automated Assembly, Cambridge, MA. Contact Director of the Summer Session, Room E19-356, Massachusetts Institute of Technology, Cambridge, MA 02139. July 8-12

● **COMPUTATIONAL LINGUISTICS**—The Twenty-Third Annual Meeting of the Association for Computational Linguistics, University of Chicago, IL. Papers, demonstrations, and tutorials. Contact Don Walker (ACL), Bell Communications Research, 445 South St., Morristown, NJ 07960, (201) 829-4312. July 8-12

● **SYMPHONY TIPS** Advanced Symphony, Georgia Institute of Technology, Atlanta. Areas covered include auto-dialing to remote computers and "smart" spreadsheets using AI concepts to preanalyze numeric outputs. The fee is \$390. Contact Trish Stolton, Department of Continuing Education, Georgia Institute of Technology, Atlanta, GA 30332, (404) 894-2547. July 9-10

● **AWC CONFERENCE** The Fourth Annual National Conference of the Association for Women in Computing, Allerton Hotel, Chicago, IL. Workshops and sessions on technical and career-enhancement topics. For more information, contact Joan Wallbaum, AWCC '85, 407 Hillmore Dr., Silver Spring, MD 20901. July 13-14

● **THE NCC** The 1985 National Computer Conference: NCC '85, McCormick Place, Chicago, IL. Exhibits, technical sessions, and development seminars. This year's theme is "Technology's Expanding Horizons." Contact Helen Mugnier, AFIPS, 1899 Preston White Dr., Reston, VA 22091, (703) 620-8926. July 15-18

● **IRMX USERS MEET** The iRUG Annual International Conference, Palmer House, Chicago, IL. The theme is "The Future Direction of Real-Time Software Applications." iRUG is a nonprofit organization made up of Intel iRMX operating system users. Contact Catherine Moon, MS/HF2-57, Intel Corp., 5200 Northeast Elam Young Parkway, Hillsboro, OR 97123. (503) 640-7038. July 17

● **SIMULATION** The 1985 Summer Computer Simulation Conference: SCSC '85, Westin Hotel, Chicago, IL. Contact Charles Pratt, Society for Computer Simulation, POB 2228, La Jolla, CA 92038, (619) 459-3888. July 22-26

● **COMPUTER WORKSHOPS**—Personal Computer Workshops, Aspen and Colorado Springs, CO. Tutorials, including an introduction to personal computers, word processing, spreadsheets, and database management. Contact Rocky Mountain Institute of Software Engineering, 1670 Bear Mountain Dr., POB 3521, Boulder, CO 80303, (303) 499-4782. July 22-26

● **SIGGRAPH** SIGGRAPH '85: The Twelfth Annual Conference on Computer Graphics and Interactive Techniques, Moscone Center, San Francisco, CA. Contact SIGGRAPH '85, (continued)

No Lower Price Anywhere

We have the lowest prices for **Sanyo**
Greywolf MARKETING 203-928-3654 PHONE ORDERS ONLY

Included with Each Computer
WORDSTAR MAILMERGE SPELLSTAR CALCSTAR INFOSTAR BASIC

NEW Computers with Full Sanyo Warranty

1 Year on Mother Board — 90 Days on All Other Parts

SECOND DISC DRIVE : \$166⁰⁰

PR 5000
Affordable Letter-Quality Daisy Wheel Printer

- Letter quality printer with 96-character daisy wheel printing
- Accurate paper up to 13 inches in width
- 14 cps bidirectional printing

\$365

MBC 1100 **\$599**
8-Bit Integrated Computer with 64KB RAM

- Z 80A CPU with no-wait mode and large 64KB RAM/4KB ROM memory capacity for fast execution
- CPM operating system with editor, assembler and all standard utilities
- Easy-to-use Sanyo BASIC
- No-glare green monitor display screen for easy viewing
- 80-chr actx + 26-line display 256 characters in 8 × 12-dot matrix cells
- One (MBC 1100) or two (MBC 1150) internal double-sided, double-density, 5 1/4" 5 1/4" min floppy disk drives with 300KB formatted capacity
- Specially designed detachable keyboard with coiled cable for easier operation
- Interfaces for one Centronics printer and one RS-232C port

MBC 4000 **\$999**
Compact 16-Bit Integrated Computer with 128KB RAM

- CPM file opening system with editor, assembler and all standard utilities
- 128KB RAM memory capacity, expandable to 512KB
- Interfaces for one Centronics printer and one RS-232C port
- 15" no-glare green monitor display screen for easy viewing
- One (MBC 4000) or two (MBC 4050) internal double-sided, double-density, double track, 5 1/4" 5 1/4" min floppy disk drives with 640KB formatted capacity
- Specially designed detachable keyboard with 15 user-programmable function keys and coiled cable for editor operation

MBC 1200 **\$799**
8-Bit Integrated Computer with High-Resolution Display

- Two Z 80A CPUs (main and secondary) with no-wait mode and large 64KB RAM/4KB ROM memory capacity for fast execution
- High-resolution 640 × 400-dot matrix display with full graphics functions
- Choice of 33 line or 40 line text mode
- CPM operating system with editor, assembler and all standard utilities
- Easy-to-use Sanyo Graphic BASIC
- One (MBC 1200) or two (MBC 1250) internal double-sided, double density, double track 5 1/4" 5 1/4" min floppy disk drives with 640KB formatted capacity
- Specially designed detachable keyboard with coiled cable for easier operation
- Interfaces for one Centronics printer and one RS-232C port

★ CASH PRICE ONLY ★

Check in advance. Add 3% for VISA/MC. No Returns. Shipping & Handling charges will be added to each order.

For complete technical literature send \$1⁰⁰ to:
P.O. Box 689 Putnam, CT 06260 PHONE ORDERS ONLY: 203-928-3654

Now! Tek quality and expert advice are just a free phone call away!

The industry standard in CRT performance.

Crisp, easy-to-read, bright CRT; 14kV accelerating potential, provides high writing rate and small spot size. Full size 8x10 cm display for measurement accuracy.

Display controls are flexible and easy to use.

Separate intensity controls reduce blooming in alternate sweep mode. Focus tracking minimizes control adjustment and BEAM FIND eliminates confusion.

Vertical system provides measurement assurance.

Flat transient response and high accuracy ensures true reproduction of your signals. Fast risetime and high bandwidth is well suited for a variety of measurement.

Perform delayed sweep measurements accurately and easily.

Both sweeps can be displayed alternately making differential measurements easy and accurate (1%). An interlocking SEC/DIV control simplifies set-up.

Stable hands-off triggering.

P-P AUTO detects signal peaks, then sets the trigger level for you. Display asynchronous signals using VERT MODE triggering. Independent TV field and line selection.

Front panel laid out by function for ease of use.

Color coding aids the user in operation. Functions and modes are placed logically. All nomenclature is clearly labeled, and protected behind a scratchless Lexan surface.



1-800-426-2200

Our direct order line gets you the industry's leading price/performance portables... and fast answers from experts!

The 60 MHz single time base delay 2213A, the 60 MHz dual time base 2215A and the 100 MHz dual time base 2235 offer unprecedented reliability and affordability, plus the industry's first 3-year warranty* on labor and parts, CRT included.

The cost: just \$1275 for the 2213A, \$1525 for the 2215A, \$1750 for the 2235.† Even at these low prices, there's no scrimping on performance. You

have the bandwidth for digital and analog circuits. The sensitivity for low signal measurements. The sweep speeds for fast logic families. And delayed sweep for fast, accurate timing measurements. All scopes are UL Listed and CSA approved.

You can order, or obtain literature, through the Tek National Marketing Center. Technical personnel, expert in scope applications, will answer your questions and expedite delivery. Direct orders include comprehensive 3-year warranty*, operator's

manual, two 10X probes, 15-day return policy and worldwide service backup.





Order toll free: 1-800-426-2200, Ask for Rick.

In Oregon, call collect: (503) 627-9000. Or write Tektronix, Inc. P.O. Box 1700 Beaverton, OR 97075

Tektronix®
COMMITTED TO EXCELLENCE

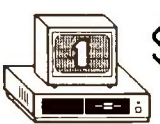
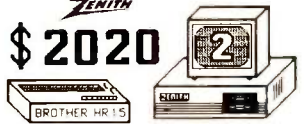
EVENT QUEUE

MICROTIME
5020 N. ORACLE, TUCSON, AZ 85704

 <p>SANYO \$1224</p> <p>WORDSTAR • EASYWRITER • CALCSTAR MSDOS 2.11 • 128K RAM (2)360K DRIVES • PARALLEL PORT ZENITH MONITOR • EPSON RX-80FY</p>	 <p>ZENITH \$2020</p> <p>THE WORD* • MULTIPLAN* GRAPHICS CARD • PARALLEL PORT 320K RAM • (2)360K DRIVES ZENITH MONITOR • BROTHER HR-15</p>
<p>CALL FOR AT&T</p>  <p>IBM-PC COMPATIBLE BETTER GRAPHICS GREATER SPEED 2400 SERVICE LOCATIONS</p> <p>RUNS ALL THE BEST SOFTWARE</p>	 <p>ZENITH \$5499</p> <p>BROTHER 2024</p> <p>320K RAM • 360K DRIVE • GRAPHICS CARD THE WORD* • MULTIPLAN* • MS DOS 2.11 BROTHER 2024/CABLE • 20 MEG IOMEGA Z133 COLOR MONITOR</p>
<p>SANYO</p>  <p>COLOR PORTABLE • MONO PORTABLE OPTIONAL 10 MEGABYTE HARD DISK</p> <p>CALL FOR PRICES</p>	<p>IBM-PC CALL</p>  <p>HERCULES GRAPHICS CARD AST SIX-PACK WITH 64K 320K RAM • (2) 360K DRIVES ZENITH Z124 MONITOR</p>

800-642-7684
ST. LOUIS 773-6951 TUCSON 293-1444

*WHILE SPECIAL LASTS

DISKETTES

WOW!
NEW LOWER PRICES!

Datalife
BY
Verbatim

AND GET A **FREE**
HEAD
CLEANING KIT!...

a '10 Value, Yours **FREE** with a 4 Box Order

We carry diskettes compatible with
all 5 1/4" & 3 1/2" drives.

WE'LL BEAT ANY PRICE!

CALL TOLL FREE 1-800-524-8130
IL. CALL COLLECT 312-455-4488

Disk Jockey
P.O. BOX 35146
CHICAGO IL • 60635-0146
MASTERCARD/VISA/C.O.D.

Conference Services Office, Smith, Bucklin and Associates Inc., 111 East Wacker Dr., Chicago, IL 60601, (312) 644-6610. July 22-26

Old Chain Bridge Rd., McLean, VA 22101, (703) 790-1745. July 28-August 1

● **INTELLIGENT MACHINES** Logic Programming & Expert Systems, The Turing Institute, Edinburgh, Scotland. Lectures, demonstrations, and sessions on programming techniques, system structure, and Prolog. Contact The Turing Institute, 2 Hope Park Square, Edinburgh EH8 9NW, Scotland; tel: 031-668-1737. July 24-25

● **COMPUTERS AND EDUCATION**—The 1985 World Conference on Computers in Education, SCOPE Convention Center, Norfolk, VA. Exhibits, papers, panel sessions, tutorials, and preconference workshops. Contact WCCE/85, AFIPS, 1899 Preston White Dr., Reston, VA 22091, (800) 622-1985; in Virginia, (703) 620-8900. July 29-August 2

● **TECH CONFERENCE** Semi-Official Get-together: SOG IV, Central Oregon Community College, Bend, OR. Sponsored by Micro Cornucopia, this conference features forums on communications and single-board systems design. Admission is free. Contact Micro Cornucopia Inc., POB 223, Bend, OR 97709, (503) 382-8048. July 25-28

August 1985

● **CHEMICAL ENGINEERING** The Seventh C.C.C.E. National Computer Workshops-East, Clarkson University, Potsdam, NY. Sponsored by the American Chemical Society Division of Chemical Education's Committee on Computers in Chemical Education and Project SERAPHIM. Advanced registration is \$100. Contact Dr. Donald Rosenthal, Department of Chemistry, Clarkson University, Potsdam, NY 13676, (315) 268-6647. July 28-August 1

● **ENGINEERING CONFERENCE, EXPO**—The 1985 ASME International Computers in Engineering Conference and Exhibition, Sheraton Boston Hotel, Boston, MA. The theme is "Expert Systems: A New Dimension in Computer Engineering." Contact The American Society of Mechanical Engineers, 345 East 47th St., New York, NY 10017, (212) 705-7100. August 4-8

● **PUBLIC COMPUTING** The Twenty-Third Annual Conference of the Urban and Regional Information Systems Association, Westin Hotel, Ottawa, Ontario, Canada. The conference theme is "Computers in Public Agencies, Sharing Solutions." Contact URISA Secretariat, Suite 300, 1340

● **EVENT FOR TRAINERS** COMTRED '85: The National Computer Training and Education Conference and Exhibition, Civic Center, Philadelphia, PA. Seminars and conferences for educators, computer trainers, retailers, and distributors. More than 50 exhibits. Pre-conference workshops on August 6. Contact National Computer Education Expositions Inc., Suite 200, 1411 Walnut St., Philadelphia, PA 19102, (215) 972-8792. August 7-9

● **TOMORROW'S COMPUTERS**—International Symposium on New Directions in Computing, Norwegian Institute of Technology, Trondheim,

(continued)

Introducing the new and improved IBM PC. \$49⁹⁵

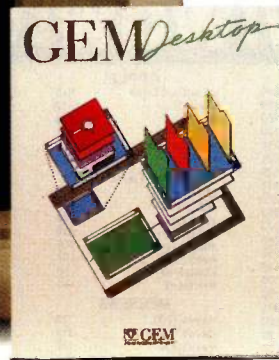
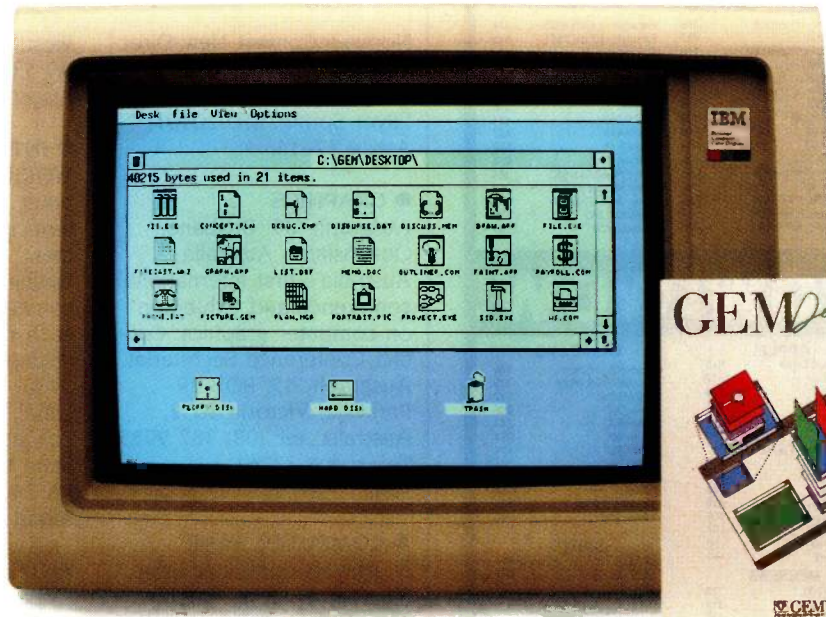

Actually, it's not a new IBM® PC. It's GEM DESKTOP!™ The \$49.95 software breakthrough that makes your old IBM PC so astonishingly easy to use that it seems like a new one.

So long PC DOS, hello GEM.™

GEM DESKTOP software looks like an ordinary floppy for your PC. But slide it into your IBM's disk drive, and the change begins.

From this moment on, you can run most of the important PC programs—but instead of typing cryptic commands to get into your program menu, you simply point and click your mouse* or use your cursor keys to open a window. It's like a breath of fresh air compared to the complex PC DOS operating system you've been using.

Point and click vs. stroke, stroke, stroke.

Next, instead of typing and retyping long file names, you simply point and click again at the appropriate symbols. And voila! Your file appears on screen. But it's not quite the same screen you've been used to.

Simple menu headers at the top to guide you effortlessly from one function to the next. So instead of making more complex keystrokes that can easily be mistyped, your IBM PC is easier and faster to use than ever before. There is also a clock and a calculator both built right in.

Indispensable. And only \$49.95.

Your GEM Desktop includes all operating system interface software and comes with amazingly simple instructions. In fact, GEM DESKTOP software makes it possible, for the first time, for anyone to learn to use an IBM PC. (Who knows, maybe even the most dedicated computerphobes in your company will warm up to the PC, after this.)

And you can just as easily justify the cost—only \$49.95 for complete operating package. Which makes it affordable enough to have several.

If you can use a phone, you can have GEM DESKTOP. Right Now.

To order GEM DESKTOP, just call toll-free (800) 443-4200. Charge your order to your Visa, MasterCard or American Express. While you're on the line ask us about GEM DRAW,™

our nifty \$149.00 graphics package with an extensive gallery of art.

Or mail this order form, along with your payment.

Name _____
Address _____
City _____
State _____ ZIP _____

GEM DESKTOP
\$49.95 plus \$3.00 shipping and handling.

GEM DRAW
\$149.00 plus \$4.00 shipping and handling.

Applicable sales or use tax will be added. COD, checks or purchase orders will not be accepted. (Outside USA add \$10.)

Method of payment. Circle one.

VISA MASTERCARD AM. EX.

Card number _____
Exp. date _____
Signature _____

Mail to: **GEM Software**
Digital Research Inc.
60 Garden Court
Box DRI
Monterey, CA 93942
Or call (800) 443-4200.

*GEM requires that your computer have appropriate graphics capability and that the pointing device be compatible. Call for exact requirements. GEM, GEM DRAW and GEM DESKTOP are trademarks of Digital Research Inc. IBM is a registered trademark of International Business Machines Corporation. Digital Research is a registered trademark of Digital Research Inc. © 1985, Digital Research Inc. All rights reserved.

HARMONY VIDEO & COMPUTERS

2357 CONEY ISLAND AVE., BROOKLYN, NY 11223
800-VIDEO84 OR 800-441-1144 OR 718-627-1000



IBM PC 256K
\$1248.95
STAR SG 10
\$212.50

COMMODORE 64
\$149.95
APPLE 2E w/DRIVE
\$819.95

"PRINTER SPECIALS"

Brother HR15 XL	338	Juki 6100 Televideo	349	Panasonic KXP 1093	474
Brother HR 35	770	Juki 6300	687	Panasonic KXP 3151	442
Brother Keyboard	120	Mannesman Spirit 80	174	Powertype	275
Citizen MSP 10	289	NEC 2050	624	Rilteman Blue +	198
Citizen MSP 15	468	NEC 3550	999	Star SG10	347
Corona Laser	2496	NEC 7730	1399	Star SG15	318
Daisywriter	728	NEC 8850	1399	Star SD10	411
Epson RX 80 FT +	249	Nec p3 or p2	832	Star SD15	457
Epson RX 80	194	Okidata 92	349	Star SR15	552
Epson RX 100	374	Okidata 93	564	Star SR15	678
Epson FX 80	329	Okimate 10	125	Silver Read Exp 550	249
Epson JX80	546	Olympai Compact 2	338	Silver Read Exp 770	650
Epson FX 100 +	514	Olympai ro	297	Toshiba 1340	515
Epson LQ 1500	909	Panasonic KXP 1091	249	Toshiba 1351	1103
HP Laser Jet	2808	Panasonic KXP 1090	174		
		Panasonic KXP 1092	338		

WOW! WOW! WOW!

IBM	APPLE	MONITORS
PC w/Drive	2E w/Disk Drive	Amdek 300 Green
PC XT	Macintosh	Amdek 300 Amber
IBM Drive	Apple 2C	310 Amber
AST Six Pack	Imagewriter	Color 300
Taligrass 20 Meg	Add. Drives	Color 500
Quad Board	Modem 12	Color 600
Keytronics		Color 700
Hercules Color	ATARI	Color 710
Hercules Monochrome	800 XL	Princeton HX12
Paradise Graphics	1027 Printer	Princeton Max 12
Paradise Multi Display	1050 Drive	Taxan 122A
STB Graphics + 2	Indus. Drive	Taxan 420
STB R10-2	1025 Printer	
Tecmar Graphics	Rana 1000	
Tecmar Captain	Koala Pad	SANYO
Persyst Monocard	Printer I/F	550 D.S.
Bernoulli Box		555 D.S.
10 Meg Drive	MODEMS	MBC 775
Joystick	Hayes 1200	
Tandon 100-2	Hayes 1200B	COMMODORE
	Hayes 300	Commodore 64
ZENITH	Micromodem 2E	1541 Disk Drive
Zenith PC 2150	Novation J-cat	1702 Monitor
Zenith PC 15152		MPS 802
Zenith PC161-52		Indus. Drive

800-441-1144

Items reflect cash discount. For your protection we check for stolen credit cards

YOUR COMPUTER'S FUTURE

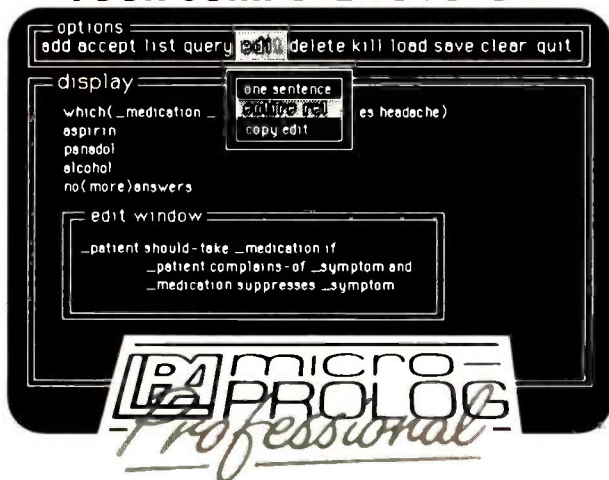

LPA micro-PROLOG professional is a new more powerful version of LPA micro-PROLOG with its own window handling primitives and "Wordstar-like" screen editor. With "Macintosh-style" menus and windows, LPA micro-PROLOG professional is fully integrated with the MS DOS 2 environment using all the memory available.

LPA micro-PROLOG professional is considerably faster than LPA micro-PROLOG 3.1 and is an unbeatable production tool for Artificial Intelligence programs, writing of Expert Systems and the rapid prototyping of micro computer software.

Launch price US \$395.00. Upgrade price is US \$195.00.

For information contact—

NORTH AMERICA
Programming Logic Systems Inc.
31 Crescent Drive, Milford, CT 06460, U.S.A.
Tel. (203) 877-7988

REST OF THE WORLD
Logic Programming Associates Ltd. Dept. BY/2
10 Burnwood Close, London SW18 3JU
Tel. 01-874 0350

EVENT QUEUE

Norway. Contact New Directions in Computing, IEEE Computer Society, POB 639, Silver Spring, MD 20901.
August 12-14

● **GRAPHICS**
Ausgraph '85, Brisbane, Queensland, Australia. Australia's first international conference and exhibition on computer graphics. Contact Conference Secretariat, Ausgraph '85, POB 29, Parkville, Victoria 3052, Australia; tel: (03) 387 9955; Telex: AA 33761.
August 12-16

● **COMPUTER SWAP**
Northwest Computer Swap Number 9, Fiesta Exhibit Hall, San Mateo County Fairgrounds, San Mateo, CA. Admission is \$5. Contact Northwest Computer Swap, 4883 Tonino Dr., San Jose, CA 95136, or call Robert Kushner, (408) 978-7927.
August 17

● **AI INVESTIGATED**
IJCAI-85: The International Joint Conferences on Artificial Intelligence, University of California, Los Angeles. Topics include AI architectures and languages, intelligent CAI, automated reasoning, and expert systems. Tutorials. Contact IJCAI-85, American Association for Artificial Intelligence, 445 Burgess Dr., Menlo Park, CA 94025, (415) 321-1118.
August 18-24

● **FOR EDUCATORS**
Innovative Applications of Microcomputer Technology in Vocational Education, University of Wisconsin, Madison. The emphasis will be on interactive video, networking, hard-disk systems, and telecommunications for agriculture, education, and health applications. Contact Dr. Judith Rodenstein, Vocational Studies Center, 964 Educational Sciences Building, University of Wisconsin-Madison, 1025

West Johnson St., Madison, WI 53706, (608) 263-4367.
August 19-21

● **INTERFACING WORKSHOP**—Personal Computer and STD Computer Interfacing for Scientific Instrument Automation, Washington, DC, area. A hands-on workshop with each participant wiring and testing interfaces. The fee is \$450. Contact Dr. Linda Leffel, C.E.C., Virginia Polytechnic Institute and State University, Blacksburg, VA 24061, (703) 961-4848.
August 22-24

● **OFFICE AUTOMATION EVENT**—INTECH '85: The Integrated Information Technology Conference and Exposition, Moscone Center, San Francisco, CA. An office-automation forum. Contact Jill Nieman, National Trade Productions Inc., Suite 400, 2111 Eisenhower Ave., Alexandria, VA 22314, (800) 638-8510; in Virginia, (703) 683-8500.
August 26-29

● **VIDEODISC CONFERENCE**—The Fifth Annual Nebraska Videodisc Symposium, University of Nebraska, Lincoln. The theme is "Videodisc—The Industry Comes of Age." Panel discussions, presentations, and exhibits. Registration is \$375. Contact Videodisc Design/Production Group, KUON-TV/University of Nebraska-Lincoln, POB 83111, Lincoln, NE 68501, (402) 472-3611.
August 27-30

● **NEW ZEALANDERS CONVENTION**—The Ninth New Zealand National Computer Conference, Sheraton, Auckland, New Zealand. Speakers, panel sessions, and exhibits. For details, contact Conference Committee, POB 3839, Auckland, New Zealand. August 27-31 ■

"Quick! Find the Accounts Receivable File."



You just experienced one of the benefits of CenTech Color Diskettes.

They're easy to find.

Now you can locate everything from Accounts Receivable to Payroll; and you can do it at the speed of color.

CenTech Color Diskettes are the logical solution to data organization. They come in 13 useful colors, to give you more color coding possibilities.

Designed, engineered, and manufactured in America to specifications and standards that exceed those developed by the industry. CenTech diskettes are exceptionally consistent in accepting and maintaining data.

CenTech is a registered name of Cenna Technology, Inc.

Every diskette is tested, certified, and warranted to be 100% error free and free of manufacturing defects, or we will replace it at no charge.

Cost competitive, color diskettes by CenTech. Engineered to surpass the best the world has to offer.

Ask for CenTech Color Diskettes by name at your dealer, or become a

dealer yourself by calling toll free: (800) 255-3999, or write CenTech, 185 Cottage Avenue, Sandy, Utah 84070. Telex: 499-6093

CENTECH®

The Colorful Solution to Data Organization™



© 1985 Cenna Technology, Inc.

Discover what 50,000

QUBIE' delivers the finest peripheral available in terms of features, reliability and price/performance. That's why corporations like IBM, GM and Exxon buy peripheral equipment from Qubie', and have for years. Check some of your old back issues of PC — we've been satisfying PC owners since 1982.

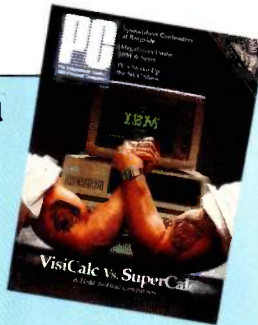

Select products at low prices, with service and support unparalleled in the microcomputer industry. Our 30 day No Risk Guarantee and 48 Hour Repair Service during the 12 month warranty period is proof our products are first rate. We stand behind everything we sell. No "call the manufacturer" responses when you have a question. We also offer our exclusive **Preferred Customer Plan***1 with 24 hour repairs and 24 months of coverage.

Our low, money-saving prices are the total prices. No small print telling you to add up for credit card charges or shipping and handling. Our prices include surface UPS charges and insurance. In a hurry? 2-day air UPS service is available.*2

At Qubie', customer satisfaction is one of the cornerstones of our philosophy. Ask your friends, business associates and colleagues about Qubie'. Chances are they are one of our fifty thousand satisfied customers.



STANDBY POWER SUPPLY

SB200 \$329
XT300 \$429
AT800 \$779



Noise Filtering/Surge Suppression • Powers Your Computer For Up To 30 Minutes In The Event Of A Blackout Or Brown-out • SB200 (200 Watt) For Floppy-Based Systems, XT300 (300 Watt) For Hard Disk Based Systems, AT800 (800 Watt) For Multi-User Systems

HIGH RESOLUTION MONOCHROME MONITORS

HR 39 \$149
HR 134 \$159

Plugs Into The IBM Monochrome or Compatible Adapter Card • 720 x 350 Resolution • 12" Diagonal Screen • Super Crisp Text Capability • High Resolution TTL • Includes Tilt/Swivel Base and Interface Cable • HR 134 (Amber) HR 39 (Green)

MULTIFUNCTION CARD

BT6Plus (0K) \$195
BT6Plus (384K) \$299

Memory Sockets For Adding Up To 384K • Parallel Printer Port • Asynchronous Serial Communications Port • Battery-powered Clock / Calendar • BTPak Software — BTDrive

INTERNAL MODEM PC212A/1200 \$249

Auto-dial, Auto-Answer • 300/1200 Baud Operation • Runs Hayes Compatible Software Like Crosstalk, Smartcom II, and Sidekick • Two Phone Jacks Allow You To Hook Up Desk Phone • Includes PC-



TALK III Software (Complete Communications Package), Modular Phone Cord, User's Manual / Installation Instructions • Optional Serial Port (\$30) Allows You To Use Port For Other Peripherals When Modem Is Not Being Used.

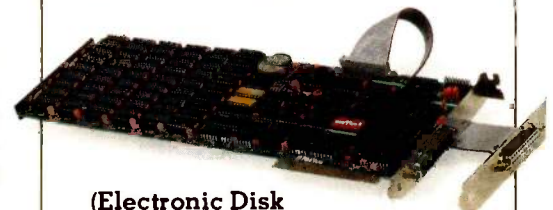
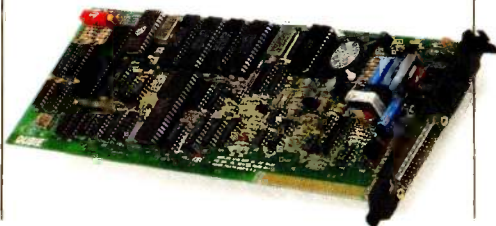

(Electronic Disk Emulation) and BTSpool (Print Spooling Software) •

PC owners now know.

Optional Game Port – Chips, Dual Mounting Bracket and Cable (\$20) • 64K Memory – Installed and Tested (\$25) • Includes Cable, Single Slot Mounting Bracket, Installation Instructions / User's Manual

INTERNAL HARD DISK SUBSYSTEMS

PC10 \$649
PC20 \$699

Boot From The Hard Disk – No Software Patches or Drivers To Install • Runs All The Popular Software •



Low Power Consumption • High Reliability And Durability – Specially Plated Drives • Faster Access Time Than XT • Includes Idir "Visual Shell" Software, Cables, Mounting Hardware, Installation Instructions/User's Manual, Full-Height Bezel – Optional Half-Height Bezel (\$15) • Auxiliary Power Supply And External Models Are Also Available.



KEYBOARD

#5151 \$159

Solid State Capacitive Key Switches • 3-Position Height



HIGH RESOLUTION COLOR MONITOR

HR31 200 \$439

14" Diagonal Screen • Black Matrix Picture Tube • Dot Pitch .31mm • Plugs Into IBM Color/Graphics Or Compatible Adapter Card • 640 x 200 Resolution • Includes Interface Cable And Tilt / Swivel Base

Adjustment • Keys In Standard Typewriter Positions • Separate Cursor Control and Numeric Keypads • Easy-To-Read Key Legends • LED Indicators On All Lock Keys • Extra-Wide Left-Hand Control Key Adjacent To "A" • Control/Reset Replaces Awkward Control/Alt/Delete • Plugs Into IBM PC, PC/XT and Compaq Desktop



EXTERNAL MODEM

212A/1200E \$299

Auto-dial, Auto-Answer • 300/1200 Baud Operation • Runs Hayes Compatible Software Like Crosstalk, Smartcom II, And Sidekick • Two Phone Jacks Allow You To Hook Up Desk Phone • RS-232C Compatible • Includes 8' Shielded Cable (Specify Male Or Female) • Eight Status Indicator Lamps • External Volume Control Knob

	*1 PREFERRED CUSTOMER PLAN	*2 UPS BLUE LABEL
PC10 and PC20	\$150.00	\$12.00
Modems	50.00	5.00
#5151	35.00	7.50
BT6Plus	50.00	5.00
HR 39 and HR 134	50.00	NA
HR31 200	95.00	NA

No Risk Guarantee

If you are not completely satisfied with your purchase, you may return it within 30 days for a full refund, including the cost to send it back.

The Acid Test

If you can get any dealer or competitor to give you the same No Risk Guarantee, buy both products and return the one you don't like.

For fastest delivery, send cashier's check, money order, or order by Mastercard/Visa. Personal checks, allow 18 days to clear. Company purchase orders accepted, call for prior authorization. California residents, add 6% sales tax.

Hours: M-F 8 am-5 pm PTZ
Sat 9 am-1 pm PTZ

London (01) 223-4569
Paris (01) 321-5316
Sydney (02) 579-3322



Outside California

1-800-821-4479

Inside California

1-805-987-9741

4809 Calle Alto
Camarillo, California 93010

QUBIE'

Order Today,
Shipped Tomorrow!™

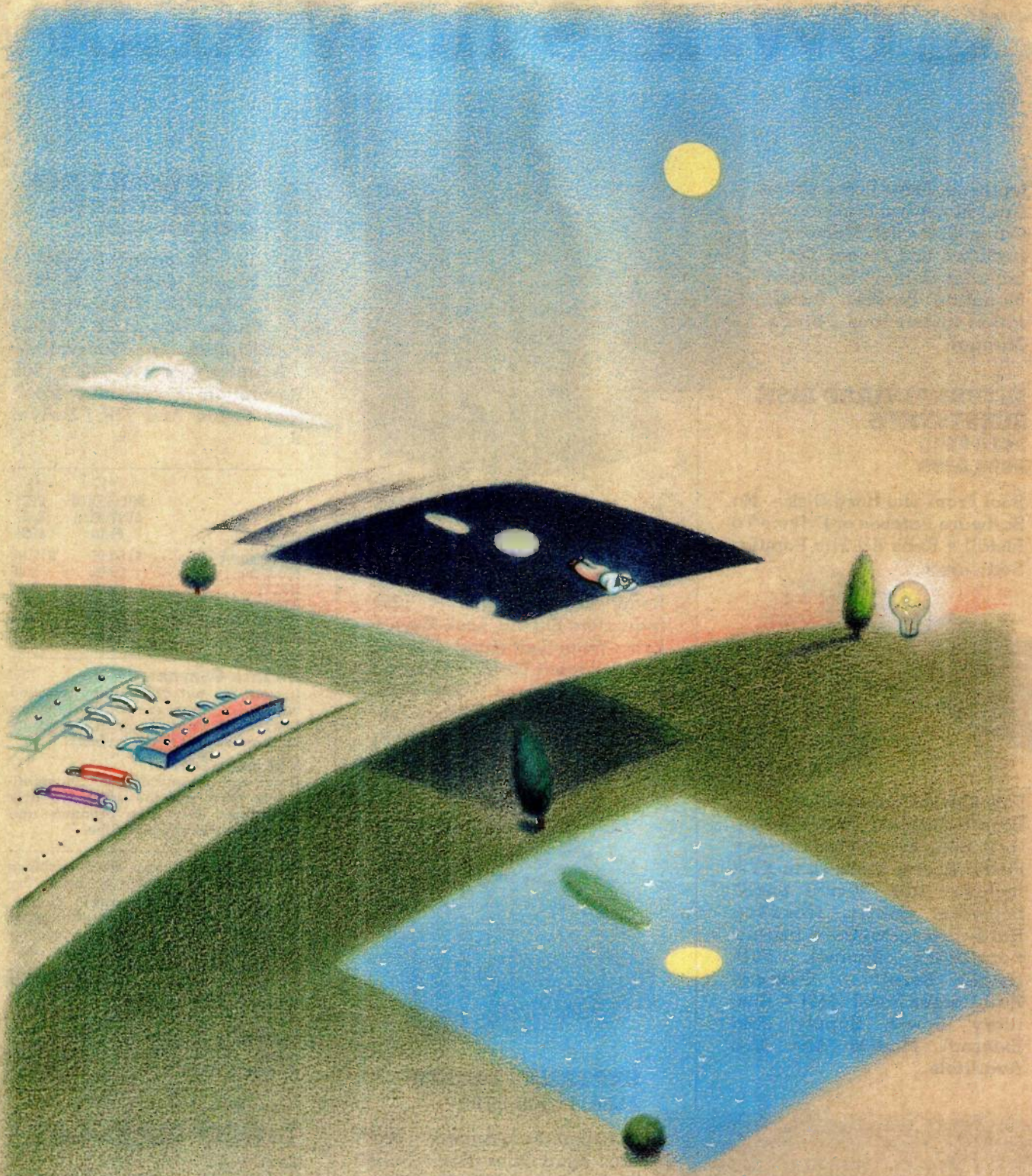

Features

INTERACTIVE AUDIO IN A VIDEO DISC SYSTEM <i>by John Lawler, Paul Hairsine, and Albert E. Miller</i>	108
CIARCIA'S CIRCUIT CELLAR: BUILD THE HOME RUN CONTROL SYSTEM, PART 3: THE SOFTWARE <i>by Steve Ciarcia</i>	121
SALT <i>by Samuel D. Fenster and Lincoln E. Ford</i>	147
THE SUM: AN AI COPROCESSOR <i>by Phillip Robinson</i>	169
INSIDE APPLE TALK <i>by David Ushijima</i>	185
THE EXPERT MECHANIC <i>by Michael Fichtelman</i>	205
SWITCH <i>by Werner F. Grunbaum</i>	221
TWO'S-COMPLEMENT NUMBERS REVISITED <i>by Gary Bronson and Karl Lyon</i>	228

LAST JULY OUR THEME was computers and video. This month we present a different aspect of this interesting topic. John Lawler, Paul Hairsine, and Albert Miller explain the design and operation of the Search 400-R audio box, which transfers sound from a cassette recorder to videodisc systems.

June also sees Steve Ciarcia finishing up his Home Run Control System (HCS) project by describing the system's software. The heart of the HCS is an interrupt-service routine. All of the system's other functions are subroutines that are called from this main routine.

Prior to the development of their SALT language, Samuel Fenster and Lincoln Ford spent a lot of time developing programs that would accommodate their work in research laboratories. SALT is a threaded interpretive language that performs repetitious procedures rapidly and does not use much memory space.

Phillip Robinson, a senior technical editor in our Palo Alto office, looks at the SUM coprocessor, which is being developed for computers geared toward AI programming. Originally, the SUM research team planned to develop a unification chip, but it became clear that at present levels of integration a single chip would be impractical; therefore, the group decided to design a full-blown processor.

In February our BYTE West Coast staff previewed AppleTalk in "The Macintosh Office" (page 120). This month David Ushijima takes a closer look at Apple's new local-area network (LAN), which is designed to let Apple and non-Apple products communicate and share resources. AppleTalk is extremely flexible and can be used in three ways: as a peripheral bus, as a small LAN, or as a path to a more complex network.

Imagine your computer taking the place of your car mechanic. Michael Fichtelman presents an expert mechanic program written in Logo. The expert mechanic analyzes problems with knowledge-base searches—probing until the source of the mechanical problem is found. This program could serve as a model for many areas of expertise.

Switch is a BASIC program for IBM PCs that enables you to use both monochrome and color monitors at the same time. Werner F. Grunbaum shows you how to write graphic instructions on your monochrome monitor and display the results on your color monitor—a neat idea.

Converting negative numbers on a computer can be difficult. Gary Bronson and Karl Lyon show us a new two's-complement conversion method using the "value box," which simplifies the process by visually connecting a two's-complement binary number to its decimal value.

—Phil Lemmons, Anne Fischer, and Joan Roy, BYTE

INTERACTIVE AUDIO IN A VIDEODISC SYSTEM

Create various sound tracks for your videodisc show

Microcomputer-driven videodisc teaching systems usually consist of a microcomputer, such as an Apple IIe or an IBM Personal Computer (PC), and a videodisc player controlled externally by computer. Some systems also use an input device like a TSD (touch-sensitive display) or a mouse. The system described in this article consists of a microcomputer (which controls the videodisc player), a TSD, and an external audio system that uses ordinary cassette tapes. (For an in-depth discussion of videodiscs, see "Videodiscs and Computers" by Stan Jarvis, July 1984 BYTE, page 187.)

While you can use videotape players interactively, videodiscs are more readily controlled by computer, have much faster interimage access times, and can store up to 54,000 frames on one side. You can also connect a TSD so that the computer can determine what action to take depending on the area of the screen you touch.

Such a system needs computer control. While some videodisc players have a small amount of memory and therefore can have rudimentary programs encoded on the actual videodisc, a microcomputer-driven system

is infinitely more versatile.

Software written for the computer can easily drive not only the videodisc player but other connected devices as well. These programs offer you higher levels of interactivity because most computers are not limited to small amounts of memory. Keep in mind that the interactivity of such a system comes not from the media (videodisc, etc.) but from the computer program. How well it uses the various parts of the system and the techniques of an effective presentation determines the success of your videodisc system.

You can create teaching packages with slides and videotaped motion sequences that have been transferred onto the videodisc and mixed with computer text and graphics either on the videodisc or overlaid on the videodisc image on the display. The resulting system is not merely an expensive, glorified slide show. You can have as interactive a teaching tool as you want as long as it is controlled by computer. You can easily program as many help buttons, quizzes, etc., as you need using the information on the videodisc. There are many applications for such a system in all phases of education—lab work, review, remedial help, self-paced courses, etc.—and at any grade level.

While pictures and animation may serve many purposes, speech and sound are often invaluable. Most videodiscs have an audio track for recording sound. But while sound can accompany a sequence of frames (animation), such as a space-shuttle launch, it cannot accompany a single

still picture because a single frame does not have enough space to hold it. There are two ways around this. One is to show many copies of the same picture, one after the other, or, in other words, animate it. This is the same as showing a sequence, and sound can accompany it. But even a 15-second use of videodisc-recorded sound uses 450 copies (30 frames = 1 second of motion) of one picture, an obvious waste of space. Sony has

(continued)

John Lawler is currently a junior at the University of Notre Dame majoring in electrical engineering with a concentration in computer engineering.

Paul Hairsine, who designed the board described in this article, has both a B.S. and an M.S. in electrical engineering from Notre Dame and is currently working at McDonnell Douglas.

Albert E. Miller is a graduate of the Colorado School of Mines and has a Ph.D. from Iowa State University. He is a professor in the Department of Metallurgical Engineering and Materials Science at Notre Dame and directs a group involved with interactive videodisc systems for training purposes. All authors can be reached at the University of Notre Dame, Department of Metallurgical Engineering and Materials Science, Notre Dame, IN 46556.

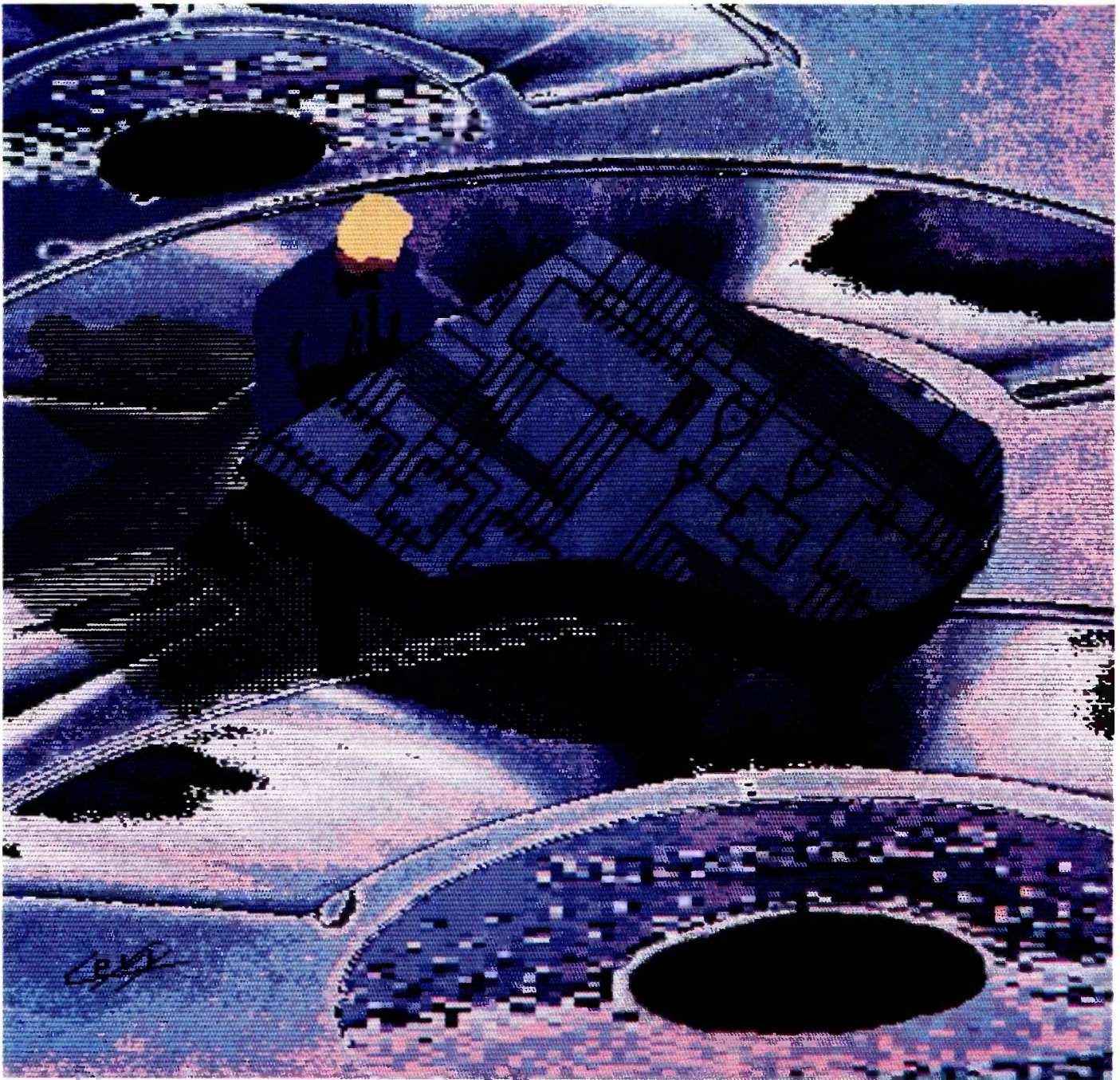

ILLUSTRATED BY FRANK LEVY

THE OPERATION OF THE SEARCH 400-R

The Search 400-R is a self-contained box consisting of a cassette deck mounted on an electronics board, a keyboard control with a light-emitting diode (LED) display, and a 16-pin dual-inline-package (DIP) cable connected to a computer interface. You can operate the unit manually or by computer.

The main difference between the Search 400-R audio system and a normal cassette player is in the way you record sound on the tape. Normal cassette tapes have only one track, or one recording surface, on which to record sound. The Search 400-R audio box, however, divides the tape into four tracks, each of which can be recorded on separately. It sections each track further into either 25, 50, or 100 locations. Therefore, you can divide a standard C120 (2-hour) tape into as many as 400 locations. However, tracks have a finite amount of recording surface, so the more locations you have per track, the less sound you can fit into each location. With 100, 50, or 25 locations per track, you can have 0.5, 1.1, or 2.3 minutes of audio per location, respectively. A by-product of this recording scheme is an increased tape capacity—from the original 2 hours to as much as 3.83 hours (4 tracks \times 25 locations per track \times 2.3 minutes per location).

The Search 400-R is especially useful in a computer system because the tape locations are accessed randomly. This shortens the time between requesting a location and playing it. Accessing a location 25 minutes away from your current position takes about 12 seconds; the search time between adjacent locations is substantially less—approximately 1 second for each location; i.e., it takes 10 seconds to jump 10 locations. These locations are indexed from 00 to 99 while track selections are 1 through 4.

The deck finds various sections of

*One by-product is a
greater tape capacity:
as much as 3.83 hours
on a 2-hour tape.*

audio by counting the number of times the tape reel turns. This indirect method of addressing specific tape locations results in high-speed searches without tape-to-head contact. There are up to 100 locations per track, and each needs a particular number of reel turns to be found; these numbers are stored in the Search 400-R's on-board ROM (read-only memory). The deck counts the number of reel turns optically and saves it in an up-down counter, which is then compared to the number stored in ROM. Then the deck fast forwards or rewinds itself as necessary to find the desired location.

One inherent source of error in such reel-count methods is the variable packing density of different tapes. How tightly or loosely the tape is wound around the reel can distort the reel count enough to compare incorrectly with the number stored in ROM. This results in selecting the wrong audio location. Differences in packing density arise because the take-up reel winds the tape more tightly during fast forward than during normal play. The reverse reel, however, maintains a consistent packing density regardless of the operation. The Search 400-R, therefore, counts the number of times the reverse reel turns to minimize the differences in reel counts.

Another possible source of error is uneven braking. To stop the tape, the deck sends equal amounts of braking currents to the two reels. However, momentum causes the reel containing the larger amount of tape to stop more

slowly. The Search 400-R alleviates this problem by boosting the braking current to this reel, so both reels stop at the same time.

Counting errors can also occur if the deck goes directly from, for example, fast forward to rewind. This doesn't always allow enough time to properly update the reel count. The Search 400-R avoids this by not allowing the audio deck to switch modes (i.e., play to rewind) until it stops completely and updates the reel count. Therefore, the deck can search for specific audio locations with a great deal of accuracy.

The audio deck has more than one format of operation, that is, 25, 50, or 100 locations per track. A small rotary switch inside the audio box selects the mode. You can access this switch by removing the four screws on the back of the unit and sliding the deck out of its housing. The switch simply selects which portions of the ROM will be addressed, either manually or by computer.

The longest piece of audio any location can hold is 2.3 minutes. However, this does not preclude a 5-minute explanation. If the audio content in a particular location exceeds the defined length, the deck continues to record, but it erases whatever is in the next location; likewise, it is erased if you record another piece of audio in that next location.

To facilitate manual operation of the Search 400-R, the audio box is equipped with a 16-button keypad, an LED readout, a manual track selector, a volume control, and status lights. The keypad contains the following keys:

0-9	address digits
A	run
B	fast forward
C	stop
D	rewind
*	search
#	record

The front panel also contains three side switches: auto run, auto search, and auto repeat. When you set auto search on, the deck begins to search as soon as you enter the two location digits. When auto run is turned on, the deck doesn't wait for the actual run command but plays the message as soon as it is found. Auto repeat continues repeating the message until you enter a stop command. These three functions are useful in manual mode, but you should turn them off if you are running under computer control to prevent messages from playing before you want them to.

The deck also has a silence-sense circuit that detects the end of the audio and automatically stops the deck after 2.5 seconds of silence. This circuit senses the sequence of audio then silence, so that the silence before the audio doesn't stop the deck.

The following operating procedure applies to both manual and computer control of the Search 400-R. It is important to remember that you can manually override computer control. When you insert a new tape into the audio deck or turn the deck on, you (or the computer) first issue a rewind command to properly reset the reel counter. Then you enter the appropriate track and location information followed by a search command. After the search completes, the bulb next to the search button lights up to tell you that the audio deck is waiting for a new command. If the box is under computer control, the bulb lights up, and the computer is informed of its status. Then you enter the run command so the message found by the search will begin to play. When the message ends, the deck stops and the bulb next to the stop button lights up, indicating that it is ready for new selections and commands. If any of the side switches, such as auto run, are on, some steps will be done automatically. It is important that the track and location entered be consistent with the internal settings of the machine. In other words, you can't effectively search for location 78 when the system is set up for 50 locations.

The audio deck can record tapes as

well as play them. When you press the # button—or the computer sends the record command—the system enters record mode provided the record-protect tab on the tape has not been removed. The deck does have some idiosyncrasies that you need to understand. It has a four-track format but only two tape heads. Each head covers a pair of tracks (tracks 1 and 2 and tracks 3 and 4). When recording in stereo, this causes no problem because you are recording two tracks simultaneously. When recording in mono, however, you must be careful not to erase locations. The circuitry of the audio deck requires that you select track 2 or 4 to activate the tape heads. This means that you should record track 2 before track 1, and track 4 before track 3. Otherwise, while you are recording one track, you will be erasing the other. You also have an automatic volume control when you record a tape. The Search 400-R user's manual contains instructions on how to adjust it.

The general operating procedure for recording a tape is basically the same as for playing it. After you insert the tape in the deck, you fast forward it to the end and then completely rewind it. This resets the reel counter and ensures proper packing density. (It is not necessary to fast forward and rewind the tape just to play it, but it won't hurt either.) After the tape stops, you give it the record command, either programmatically or manually with the # button. Then you enter the track and location you wish to record. A search command advances the tape to that location, and when the search status light goes on, you enter the run command to start recording. A built-in delay mutes the recording for two seconds to provide a gap between locations; this allows for small deviations in searching for a location. When the commence light appears, you speak your message into a microphone; when you finish, you enter the stop command. Pressing the # button returns the deck to playback mode, where you can check the location and message you have just recorded.

a way of recording sound on a videodisc while showing only one frame, but it too uses a great deal of space.

Another problem with recording sound on a videodisc is that once recorded, it is permanent. At the present time you cannot erase videodiscs. This is not a problem unless you decide that some recorded sound sequence isn't very clear; how can you change it? You could make another videodisc for a few thousand dollars, or you could use an external audio box.

The audio box described in this article uses cassette tapes, so if the sound is not right, you can simply record over it, allowing greater presentation flexibility. Indeed, the combination of a computer and a separate audio box means that you can make one videodisc master and use it for two completely different groups. Assume, for example, that you want to use a videodisc about the space program for both grammar school students and aerospace engineering students. Since the two groups have different comprehension levels, you would gear a different program and audiotape to each group—an easier one for the grammar school students and a more difficult one for the college students.

Recording sound onto cassette tapes is not enough; you must integrate the audio box into the system—it must be controllable by the computer. It must also have facilities for random access—given the location, to quickly find some piece of sound without searching the entire tape. And there must be some sort of interface between the computer and the audio box.

We decided to include audio capabilities in our interactive video system and to begin with something simple and inexpensive. And we wanted an easily erasable, readily available recording medium—essentially a computer-controlled cassette tape recorder. This need was met by the Search 400-R by Phi Technologies.

The Search 400-R is a self-contained box consisting of a cassette deck

(continued)

FINALLY! MAIL ORDER SERVICE YOU CAN DEPEND ON!

EXPRESS

BUSINESS SOFTWARE

PROFESSIONAL SUPPORT PLUS RELIABLE PERSONALIZED SERVICE
AND WE'LL STILL BEAT MOST PRICES IN THIS MAGAZINE!

WORDSTAR PROPAC	SYMPHONY	SIDEKICK (C.P.)	SUPERCALC 3	WORD PERFECT	LOTUS 1-2-3
\$239	\$419	\$35	\$189	\$235	\$309

AID Typequick 85 69	FUNK Sideways 60 39	MONOGRAM Dollars and Sense (IBM) 179 109
ALPHA SOFTWARE Data Base Manager 2 295 169	HARVARD SOFTWARE Harvard Project Mgr 395 219	Dollars and Sense (Mac) 149 99
ANDERSON-BELL Abstat 395 267	Harvard Total Project Mgr 495 279	MULTIMATE INTERNATIONAL Multimate 495 253
ASHTON-TATE D Base II 495 CALL	HUMAN EDGE Mind Prober 50 35	OASIS Word Plus 150 105
D Base III 695 CALL	KOALA Touch Tablet (PC) 150 95	Punctuation and Style 150 95
Framework 695 CALL	MacVision 400 249	PEACHTREE Peachtext 5000 425 185
Friday 295 CALL	LEXISOFT Spellbinder 495 239	Business Graphics System 295 219
ATI Training Word Star 75 45	LIFEFREE Volkswriter Deluxe 295 158	Peachpak 4 395 199
Training dBase III 75 45	LIVING VIDEO TEXT INC. Think Tank (IBM) 195 109	PETER NORTON Norton Utilities (Vers. 3.0) 100 65
BPI General Accounting 595 399	Think Tank (Mac) 245 149	PRENTICE-HALL Execuision 395 289
BORLAND INTERNATIONAL Superkey 54 42	MDBS Knowledgeman 500 275	PRO TEM SOFTWARE Notebook II 189 123
Turbo Graph 54 42	K Paint 100 65	Footnote 99 84
Toolbox 54 35	K Graph 225 145	ROSEOFF Prokey 130 79
Turbo Pascal 54 35	MECA Managing Your Money 199 119	SAMNA Word III 550 279
CDEX Advanced Lotus 1-2-3 70 45	MICROGRAFX P C Draw 395 289	SORCIM SuperCalc 2 295 149
CHANG LABS Rags to Riches Ledger 99 79	MICROPRO WordStar 350 179	Super Project 395 209
CONDOR Condor 3 650 239	SpellStar 99 55	Easy System II 395 184
CONTINENTAL SOFTWARE Home Accountant Plus 150 89	CorrectStar 145 99	General Ledger 595 289
DIGITAL MARKETING Writers Pak 250 165	MailMerge 99 55	Accounts Payable 595 289
Milestone (PC) 250 165	InfoStar 250 199	SOFTWARE PRODUCTS INT'L Open Access 695 349
Datebook II 150 98	WordStar 2000 CALL	SOFTWARE PUBLISHING PFS File or Write 140 85
Proofreader 50 38	WordStar 2000 Plus CALL	SSI Word Perfect 495 249
DIGITAL RESEARCH Concurrent PC DOS 295 209	MICRORIM R Base 4000 495 259	TELOS Filevision (Mac) 195 119
ENERTRONICS Energraphics 350 239	Extended Report Writer 150 109	TYLOG dBase Window 249 149
Plotter Option 100 55	Clout 250 135	WARNER SOFTWARE INC. The Desk Organizer 195 129
FOX & GELLER DGraph 295 139	MICROSOFT Multiplan 195 139	WOOLF SYSTEMS Move It 150 85
dUtil 99 58	Chart (MAC) 125 99	
Quickcode II or III 295 139	Project 250 179	
	MICROSTUFF Crosstalk 195 98	

Free UPS shipping on orders over \$1,000.00

CALL FOR PRODUCTS YOU DON'T SEE HERE!

CALL FOR OUR FREE CATALOG

TO ORDER CALL TOLL-FREE:

(800) 235-3020 (USA)

(800) 235-3021 (CA)

(415) 382-9085

TERMS:

- Call for shipping charges and support policies
 - Full guarantee against manufacturers defects
 - Allow 3 weeks for checks to clear
 - Prices may change
 - Call for availability
 - No cash refunds!
- Due to our low prices, all sales final.



448 IGNACIO BLVD., STE. 332
NOVATO, CA 94947

- SAME DAY SHIPMENT ON MOST ORDERS
- Prompt UPS service
- Authorized purchase orders accepted
- Dealer, institutional and quantity discounts available
- No surcharge for credit card purchases
- VISA & Mastercard accepted
- COD

INTERACTIVE AUDIO

mounted on an electronics board, a keyboard control with an LED (light-emitting diode) display, and a 16-pin DIP (dual-inline package) cable connected to a computer interface. The unit can be operated either manually or under computer control. There are, however, differences between a normal cassette player and the Search 400-R audio system, which are described in the text box "The Operation of the Search 400-R" on page 110.

The 16-pin DIP connector lets you interface the cassette deck with a personal computer from which you can enter all necessary track and location data, as well as any desired commands. However, you must build an interface for the two machines to communicate with each other. The text box "Designing an Interface Card" at right describes this process.

SOFTWARE SUPPORT

To make the hardware described in the text boxes useful, it must be supported by software. Luckily, simple BASIC programs can provide such support. Operating the Search 400-R with an Apple IIe is a simple process. The peripherals are plugged into internal expansion slots—called I/O (input/output) slots—numbered 0 through 7. The Apple IIe treats its I/O slots like memory locations (addresses); therefore, to communicate with a peripheral device plugged into an I/O slot, the software program must merely access the address that corresponds to the slot it wants. Table 1 provides the slot numbers for the Apple IIe, along with their corresponding addresses in decimal form.

If the interface card between the Apple and the Search 400-R is present in slot 3, for example, the program must address location 49328. Since the Apple IIe accesses the I/O slots as memory locations, you can establish communication with the audio box by using the BASIC statements PEEK(x) and POKE(x) where x is a memory address such as 49328.

To function properly, the program

(continued)

DESIGNING AN INTERFACE CARD

To design an interface card to control the Search 400-R with a micro-computer, you must first understand the microprocessor interface on the audio deck. On the back of the deck you will find a 16-pin connector that attaches it to the computer. The pins are all 5 volts and compatible with TTL (transistor-transistor logic), Schottky, and CMOS (complementary metal-oxide semiconductor). (For more information, see table A.)

The first seven pins are used to enter track and location data into the audio deck. If you want to use an address, you enter two binary-coded-decimal (BCD) numbers sequentially into pins 1 through 4, the most significant digit (MSD) first. Then you send a strobe pulse through the address strobe at pin 5 to inform the audio deck that an address, rather than a command, has been entered. The track number is entered into pins 7 and 8 and must be there when you input the first number of the address. Remember that counting starts at 0 in this system: 0 represents the first track, 1 the second, etc. Therefore, you must enter the location's MSD and the track information into the appropriate pins before you activate the strobe. Then you can input the location's least significant digit (LSD) and strobe it as well.

You enter commands to the audio box in exactly the same manner but you don't activate the address strobe. Commands are entered as BCD numbers with decimal values 10 through 15, as follows:

search	10
record	11
run	12
fast forward	13
stop	14
rewind	15

These numbers must stay on the input pins for at least 1 millisecond to register the commands properly.

Pins 10 through 15 are known as the status outputs and are used for data coming from the audio box. They are connected directly to the LED (light-emitting diode) display on the Search 400-R and can tell the computer what

the audio box is doing at any given time. They are active low, so finding the pins at ground determines the status of the unit. (The start run pin is used by remote-control devices such as timers and therefore is not applicable for computer control.)

CONTROLLING THE SEARCH 400-R

Both the Apple IIe and IBM Personal Computer (PC) have internal expansion slots for plug-in circuit boards that are directly connected to the I/O (input/output) channels. Each slot consists of a bidirectional data bus, address lines, and interrupt and DMA (direct memory access) control lines. The channels have I/O read or write lines, clock and timing lines, and power and ground for the circuit boards. You can put information on or take it off the I/O channel's data lines by connecting them to the clock's input lines, which allows the computer to control the deck, and by

connecting them to the deck's status-output lines, which allows the computer to monitor the status of the deck. Thus, by connecting the Search 400-R unit in this manner, you can—with the appropriate software—have two-way communications between the deck and the controlling computer.

THE APPLE INTERFACE

We purchased an interface card made by Phi Technologies for the Apple IIe rather than designing one from scratch. It uses only the data lines, a read/write line, a clock line, and the device-select line from the Apple's I/O channel to control the audio box. It is available as item #9000-009 from Phi Technologies Inc. (4605 North Stiles, Oklahoma City, OK 73105) for \$160.

Each I/O slot in the Apple IIe has a specific address and uses the device-select line for decoding instead of the

(continued)

Table A: The functions and active levels of the 16 pins in the 16-pin connector found on the back of the Search 400-R and used to connect it to the computer. (LSB stands for least significant bit, and MSB stands for most significant bit.)

Pin 1	data bit 1 (LSB)	active high
Pin 2	data bit 2	active high
Pin 3	data bit 3	active high
Pin 4	data bit 4 (MSB)	active high
Pin 5	address strobe	active high
Pin 6	track bit 1 (LSB)	active high
Pin 7	track bit 2 (MSB)	active high
Pin 8	ground	
Pin 9	start run	active high
Pin 10	search OK status	active low
Pin 11	rewind status	active low
Pin 12	fast forward status	active low
Pin 13	run status	active low
Pin 14	stop status	active low
Pin 15	record status	active low
Pin 16	+5 volts	

Table B: The addresses you can use to activate two channels if you wish to attach two audio boxes.

	A ₉	A ₈	A ₇	A ₆	A ₅	A ₄	A ₃	A ₂	A ₁	A ₀
Channel 1	1	1	0	0	0	X	X	0	0	0
Channel 2	1	1	0	0	0	X	X	0	1	1

INTERACTIVE AUDIO

address lines. When you wish to either send or receive data from the I/O slot's address, you activate that slot's device-select line. Its data lines are connected to the status-output lines, and to the deck's two input lines (pins 1-7) via seven clocked D-type flip-flops. Of the seven data bits sent through the input lines, the four LSD bits are the address bits, the next two the track bits, and the seventh the address strobe. Note that the MSD bit is

not used. The clock inputs to the seven D-type flip-flops are connected to the output of another clocked D-type flip-flop that is further connected to the output of the decoding circuitry. When you activate the device-select line, and the read/write line is in the write state, the input to the lone D-type flip-flop goes from low to high.

The corresponding clock line is connected to a system clock that goes high halfway through the I/O cycle. If

the input to the lone D-type flip-flop has been set high by the decoding circuitry, when the system-clock line goes high, the output of this flip-flop goes from low to high. This is seen as a clock pulse that initiates the data transfer from the data lines to the input lines.

A series of three-state gates connects the status-output lines to the data lines. These gates act as buffers and prevent the data from the status lines from entering the data lines

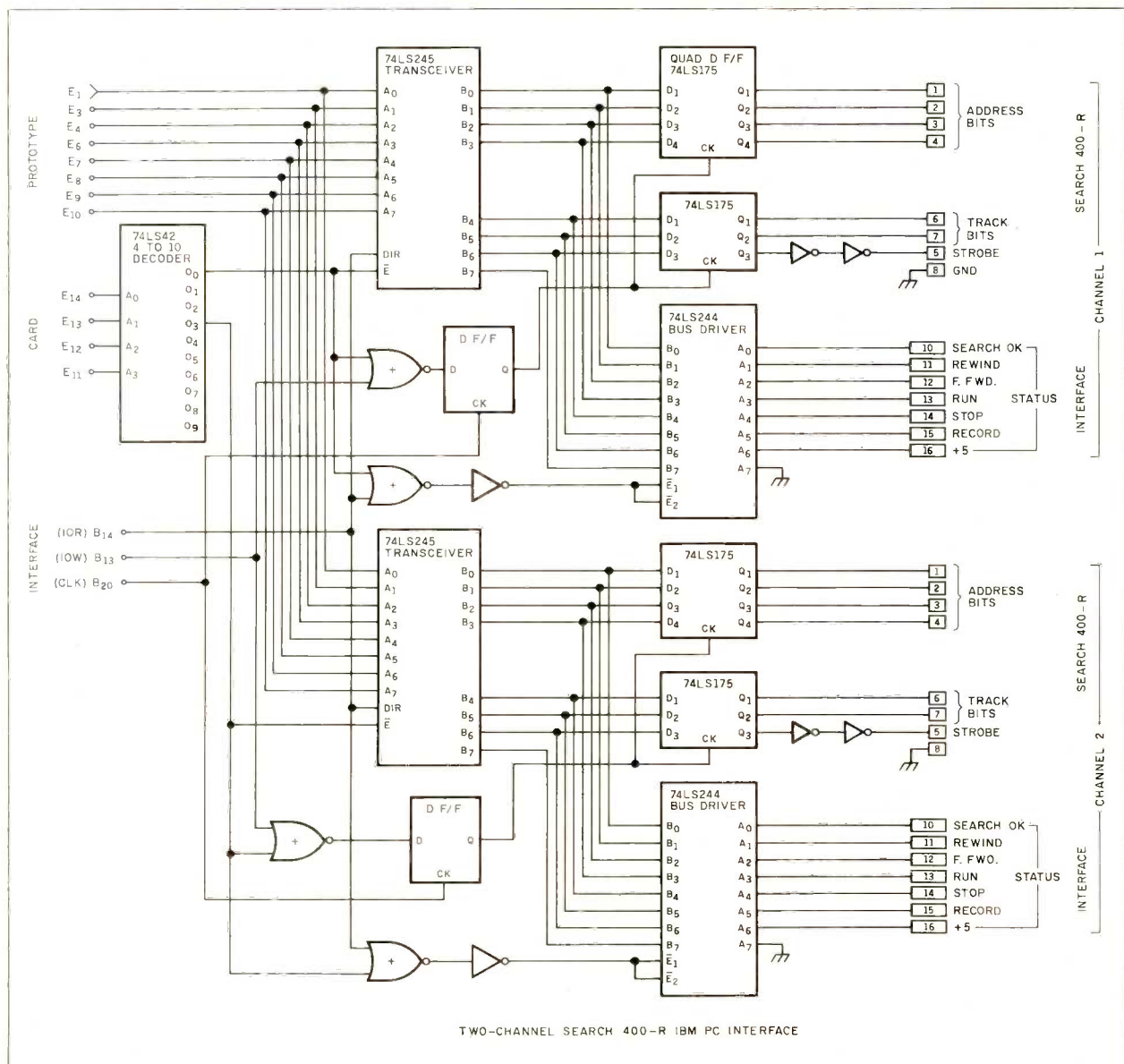

Figure A: A logic diagram of Paul Hairsine's interface card for the IBM PC.

unless the interface card requests a read. When the computer asks for the status of the Search 400-R, the device-select line is activated and the read/write line goes to the read state, activating the three-state gates. This action puts the data from the status line onto the I/O channel's data line. It remains there until the end of the I/O instruction cycle, at which time the three-state gates deactivate. In this manner, the computer can monitor the status of the audio box.

THE IBM INTERFACE

Although there was an interface for the Apple IIe, there was none for the IBM PC, so we had to design one. We used an IBM prototype card that plugs into an expansion slot. The logic diagrams for the designed interface and the prototype card are included in figure A.

The prototype card contains a voltage bus (+5 volts) that borders on its back and a ground bus on its front. It has a system-interface design that ensures that you only use the I/O address assigned for user design and protects the computer from faulty circuit designs. The prototype card's interface has five address lines not used as part of its decoding circuitry, allowing you to assign different addresses to different cards or to different circuits on the same card. The rest of the address lines are decoded into an I/O decode line, which activates the circuitry on the card. The prototype card's interface also has eight data lines that are used for its circuitry.

Because the IBM PC's I/O channel can address two different circuits on the same board, we designed the interface card with two channels so you can drive two Search 400-Rs with it. Two audio boxes on the same system provide faster access time to tape locations and allow two separate videodisc systems to share the same computer. Having only one interface card instead of two also leaves one of the IBM PC's few expansion slots free for other uses. Its design is similar to the Apple's to allow easy software transfer between the two systems.

We used a 4-to-10 decoder to create the two channels. It uses the last three address bits, E₁₄-E₁₂, and the I/O select bit, E₁₁, from the prototype card for its four input lines (see figure A). The out-

Table C: The chips required to build the IBM PC interface card.

1	74LS42 4-to-10 decoder
2	74LS245 octal-bus transceivers
2	74LS244 octal-buffer line drivers
4	74LS175 quad D-type flip-flops
1	74LS74 dual D-type flip-flop
1	74LS04 hex inverter
1	74LS02 quad NOR gate

12 chips total

put lines that activate the two channels also determine their addresses. Outputs O₀ and O₃ are used with the interface card and provide the possible addresses for each channel shown in table B. The Xs can be either 0s or 1s. If you use all possible combinations and convert these binary numbers to decimal, you can address channel 1 with 768, 776, 784, and 792 and channel 2 with 771, 779, 787, and 795. If you use these addresses properly, you can easily transfer data to or from the appropriate audio deck. The two channels are identical except for the addresses that activate them.

Each channel uses an octal transceiver to connect its data lines to the prototype card's data lines. A transceiver is a device that allows one of three possible actions between the two points it connects: Data can flow from A to B or from B to A, or A and B can be isolated from each other. This is ideal for the interface card; each channel can be bidirectional when activated or it can be isolated from the computer. The direction of the data transfer through the transceiver is determined by the I/O read line: If the line is active, the data is sent to the computer; if it is not, the information is sent only to the audio deck.

The deck's input lines for each channel are connected to its transceiver through seven clocked D-type flip-flops, with the pin assignments identical to those of the Apple IIe interface. The clock of all seven D-type flip-flops is connected to the output of another clocked D-type flip-flop, which in turn is connected to the output of the

decoding circuitry. The decoding circuitry is simply a NOR gate whose inputs are connected to the I/O write line and the decoder output corresponding to that channel. Both inputs are active low, so when both lines activate the input, the control D-type flip-flop goes high. Its clock is connected to the system clock, so after the I/O write and the decoder output both activate, the output of the control D-type flip-flop goes from low to high on the next system clock pulse. The track and location data are on the data lines when the I/O write line is activated; when the decoder output activates, the transceiver is activated. The seven D-type flip-flops see this low-to-high transition as a clock pulse and pass the data on the data lines from the computer to the Search 400-R.

An octal-buffer line driver connects the status-output lines for each channel to its transceiver. This driver allows only two possible states: Data is transmitted from A to B, or A and B are isolated. When the computer requests information from the audio box, the I/O read line and its corresponding decoder line are activated. Both are active low, and since the line driver activates on a low signal, you must OR the two inputs to enable it. Since we used inverters and NOR gates to design the interface board, we used an inverted NOR to implement the OR gate. This saved us from having to add an OR gate to the board. After the line driver activates, data from the status outputs appears on the I/O channel's data lines and remains there until the end of the instruction cycle. This provides the computer with enough time to fetch the data and to monitor the status of an audio box on either channel.

We built the interface card with the chips shown in table C. The card is connected to the Search 400-R through a 16-line flat cable. Each end of the cable has a 16-pin DIP (dual-inline package) connector, which plugs into the 16-pin wire-wrapped sockets on the interface card and into the audio deck's interface receptacle. You can find a layout of the card in figure A. The pin assignments of the 16-pin wire-wrapped sockets correspond to the numbers of the Search 400-R's receptacle shown in table A.

INTERACTIVE AUDIO

needs the track and location of the desired sound sequence. These two numbers, track and location, first must be converted to binary-coded-decimal (BCD) numbers and then output to the audio box through the interface card. The most significant digit (MSD) is output first and the least significant digit (LSD), last. If you set the Search 400-R audio box for computer con-

trol, you must set bits 4 and 5 of the input data to the track number used when the MSD is output; you must set bit 6 high on both the track and location address outputs. The Search 400-R has six commands, and each has a two-digit code. Issuing a command to the audio unit is simply a matter of implementing a POKE to insert its code into the address of the

audio system. The following is a list of the commands and their codes:

Command name	Code
search	10
record	11
run	12
fast forward	13
stop	14
rewind	15

Table 1: The slot numbers for the Apple IIe along with the corresponding decimal addresses. (Note: Slot 0 is not present in the Apple IIe but is present in the Apple II and the Apple II+.)

Slot	Decimal Address
0	49280
1	49296
2	49312
3	49328
4	49344
5	49360
6	49376
7	49392

Listing 1: The Apple IIe code required to tell the audio box to search for a specific location on the tape.

```
100 INPUT "Enter track number: ";T
110 INPUT "Enter location: ";L
120 A = INT(L/10): B = L - (A*10)
130 A = A + (T*10) + 64: B = B + 64
140 POKE 49328,A: POKE 49328,0
150 POKE 49328,B: POKE 49328,0
160 POKE 49328,10: POKE 49328,0
```

Listing 2: This section of Apple IIe code contains a search followed by a wait for the search OK before issuing the run command.

```
10 POKE 49328,10: POKE 49328,0
20 IF PEEK(49328) < > 110 THEN 20
30 POKE 49328,12: POKE 49328,0
```

Listing 3: The code required to establish communications between the audio box and the IBM PC and the Apple IIe, respectively.

IBM PC

```
100 INPUT "Enter track: ";T
110 INPUT "Enter location: ";L
120 A = INT(L/10): B = L - (A*10)
130 A = A + (T*10) + 64: B = B + 64
140 OUT 768,A: OUT 768,0
150 OUT 768,B: OUT 768,0
160 OUT 768,10: OUT 768,0
170 IF INP(768) < > 110 THEN 170
180 OUT 768,12: OUT 768,0
```

Apple IIe

```
100 INPUT "Enter track: ";T
110 INPUT "Enter location: ";L
120 A = INT(L/10): B = L - (A*10)
130 A = A + (T*10) + 64: B = B + 64
140 POKE 49328,A: POKE 49328,0
150 POKE 49328,B: POKE 49328,0
160 POKE 49328,10: POKE 49328,0
170 IF PEEK(49328) < > 110 THEN 170
180 POKE 49328,12: POKE 49328,0
```

You must follow each POKE of a command code with a POKE of 0, which prepares the interface card to accept another command. For example, to tell an audio box connected to I/O slot 3 (address 49328) to rewind the tape (code 15) you would have to send the commands POKE 49328,15: POKE 49328,0.

Listing 1 provides a simple but workable example of how to tell the audio box to search for a certain location on the tape. Lines 100 and 110 ask for the track and location of the piece of sound desired. Line 120 sets A to the location's MSD and B to its LSD. Line 130 sets up the data for proper output. This is done by setting the address strobe (bit 6) high (+64) for both A and B. T*10 sets bits 4 and 5 of the first address digit to the track number. Lines 140 and 150 output the address to the interface, and line 160 gives it the search command. These few lines can fully control the Search 400-R audio box.

Occasionally, you might want to check for proper operation of the audio deck by reading the status lines. Essentially, the status information works like a stoplight that tells the computer when the next command can continue to its destination. The status line can tell you if everything is running smoothly. If it is, you can have the next command sent. If not, the computer delays the command until it is ready for it. Reading the status is easy with BASIC's PEEK command. Seven status lines provide information on the audio deck's operation. Combined, they make up a status byte. The Apple IIe is an 8-bit machine, and it reads 8-bit bytes, such as the status byte of the audio box.

The status lines are all considered *active low* except for the power on line.

INTERACTIVE AUDIO

This means that if a certain status is *on*, its particular bit in the status byte is equal to 0—just the opposite of what you would expect—and if the status is off, the bit equals 1. The exception lies in the status of power on, which follows the more common usage; i.e., 1 means on and 0 means off. The following list shows what functions the various status bits imply:

Status	Data bit
search OK	0
rewind	1
fast forward	2
run	3
stop	4
record	5
power on	6

Consider the status byte shown in figure 1. Bits 0 through 6 are the status bits, and each provides some piece of information: for instance, bit 4 tells you whether the audio deck has stopped. Therefore, if you need information about the current status of the audio box, your program must access the status byte. This can be done by looking at the address of the interface using the PEEK command, which is the same process as using POKE to enter a command. However, PEEK(*x*) reads a *decimal* number *x*, while the status information is in binary form. You must, therefore, convert the binary number to decimal form. Consider the status byte in figure 2. The binary number is 1101110, telling us that the power is on, the search for a piece of sound was successful, and the audio unit has stopped doing anything and is ready to accept another command. The decimal equivalent of 1101110 is 110, so the PEEK command would retrieve the number 110. Line 20 in listing 2 demonstrates how you can make the computer wait until a search OK appears after having issued a search command.

The software used to control the Search 400-R from the Apple IIe is straightforward. Controlling the audio box from an IBM PC requires basically the same process; however, the IBM PC doesn't treat the I/O addresses as memory locations, so the chart of slot

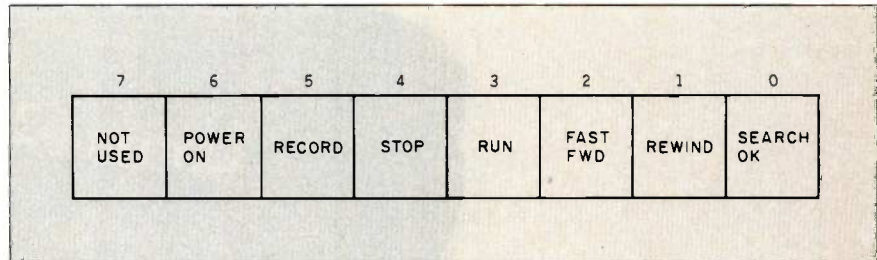

Figure 1: The layout of the audio deck's status byte.

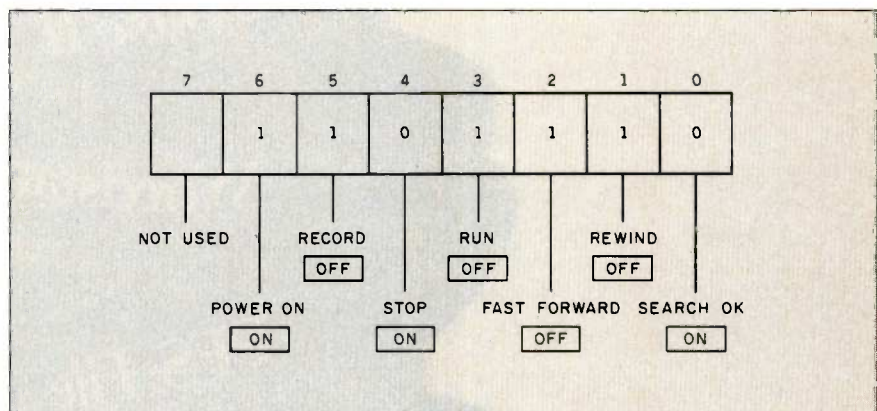

Figure 2: An example of the status byte for the audio deck.

numbers and addresses given above is not applicable. POKE and PEEK won't allow communication between the IBM PC and the audio box either. Instead, you must use the commands OUT *x,y*, and INP(*x*).

Listing 3 contains the programming necessary to establish communications between the audio box and the IBM PC and the Apple IIe, respectively. Both programs need to have the track and location of the desired piece of sound, a search (code 10) for the sound, a check of the status byte for search OK, and if found, a run command (code 12). You can see from the similarity of the two programs that you can transfer BASIC programs written on either machine to the other with a minimum of translation.

While we have used BASIC in the example, you can use any computer language to accomplish the same thing, as long as you know how to output data to the I/O channel and accept input from it. Furthermore, after the audio box rewinds the tape to the beginning, approximately 100 millisec-

onds must elapse between stopping the tape and entering a command to move it. This allows the counting circuits in the audio box to reset. In addition, the IBM PC changes its data bits too quickly when trying to input address locations. This means that data doesn't stay on the lines long enough to properly activate the audio deck. You can correct this by writing a software delay into the program.

CONCLUSION

By using an interactive audio system, such as the Search 400-R, you can create more versatile interactive-videodisc training packages. While this article describes using interactive audio in conjunction with interactive video, the concept can just as easily be used in normal computer-based teaching packages. ■

ACKNOWLEDGMENT

The authors wish to express their gratitude to the IBM Corporation, the National Science Foundation, and the Notre Dame College of Engineering for continued support of this work.



Lotus 1-2-3

dBase II

Wordstar

PFS: File

Crosstalk

Multi-Plan

Framework

Symphony

IBM
Personal
Computer
Keyboard

How do you get your PC to wear many different hats at the same time?

E-Z-DOS-IT.™

Introducing E-Z-DOS-IT™ Concurrent Processing – for IBM PCs and PC compatibles.

Before today, your IBM PC (or PC compatible) could wear only one processing hat at a time. Now, with E-Z-DOS-IT Concurrent Processing, your PC can be an editor, financial analyst, and artist all *at the same time*. And you can be a writer. Or a programmer. In fact, E-Z-DOS-IT is the only concurrent processing system that can run effectively on machines with 256K and up.

Switch from one program to another at the drop of a hat.

With your current system, each time you need to access information on a different disk, you have to save your files, unload and load a program. E-Z-DOS-IT enables you to switch con-



veniently from one application to another instantly. With this easy referencing capability, you can quickly respond to questions, and finish projects significantly faster.

E-Z to use, E-Z to afford.

You'll find it takes only ten minutes to master E-Z-DOS-IT Concurrent Processing. And the suggested retail price is only \$199.95 – improved productivity was never this affordable.

Improved personal productivity at your fingertips.

E-Z-DOS-IT is the one system software package you can't afford to be without. For more information and the name of the dealer nearest you, call toll-free: 800/228-9602 (in California, call 800/423-5592), ask for Operator 1.

 **HAMMER**
Redefining Your PC Productivity.

E-Z-DOS-IT is a trademark of Hammer Computer Systems, Inc., 700 Larkspur Landing Circle, Suite 285, Larkspur, CA 94939

The following registered trademarks are acknowledged: IBM and IBM PC, International Business Machines; Lotus 1-2-3 and Symphony, Lotus Development Corporation; dBase II and Framework, Ashton-Tate; Wordstar, MicroPro International; PFS:File, Software Publishing; Crosstalk, Microstuff, Inc.; Multi-Plan, Microsoft Corporation.

BASF QUALIMETRIC™ FLEXYDISKS.® A GUARANTEED LIFETIME OF OUTSTANDING PERFORMANCE.

BASF Qualimetric FlexyDisks feature a unique lifetime warranty, firm assurance that the vital information you enter on BASF FlexyDisks today will be secure and unchanged tomorrow. Key to this extraordinary warranted performance is the BASF Qualimetric standard... a totally new set of criteria against which all other magnetic media will be judged.*

You can count on BASF FlexyDisks because the Qualimetric standard reflects a continuing BASF commitment to perfection in magnetic media. One example is the unique two-piece liner in our FlexyDisk jacket. This BASF feature traps damaging debris away from the disk's surface and creates extra space in the head access area for optimum media-head alignment. The result is a guaranteed lifetime of outstanding performance.

For information security that bridges the gap between today and tomorrow, look for the distinctive BASF package with the Qualimetric seal. Call 800-343-4600 for the name of your nearest supplier.

**Contact BASF for warranty details.*

Inquiry 46

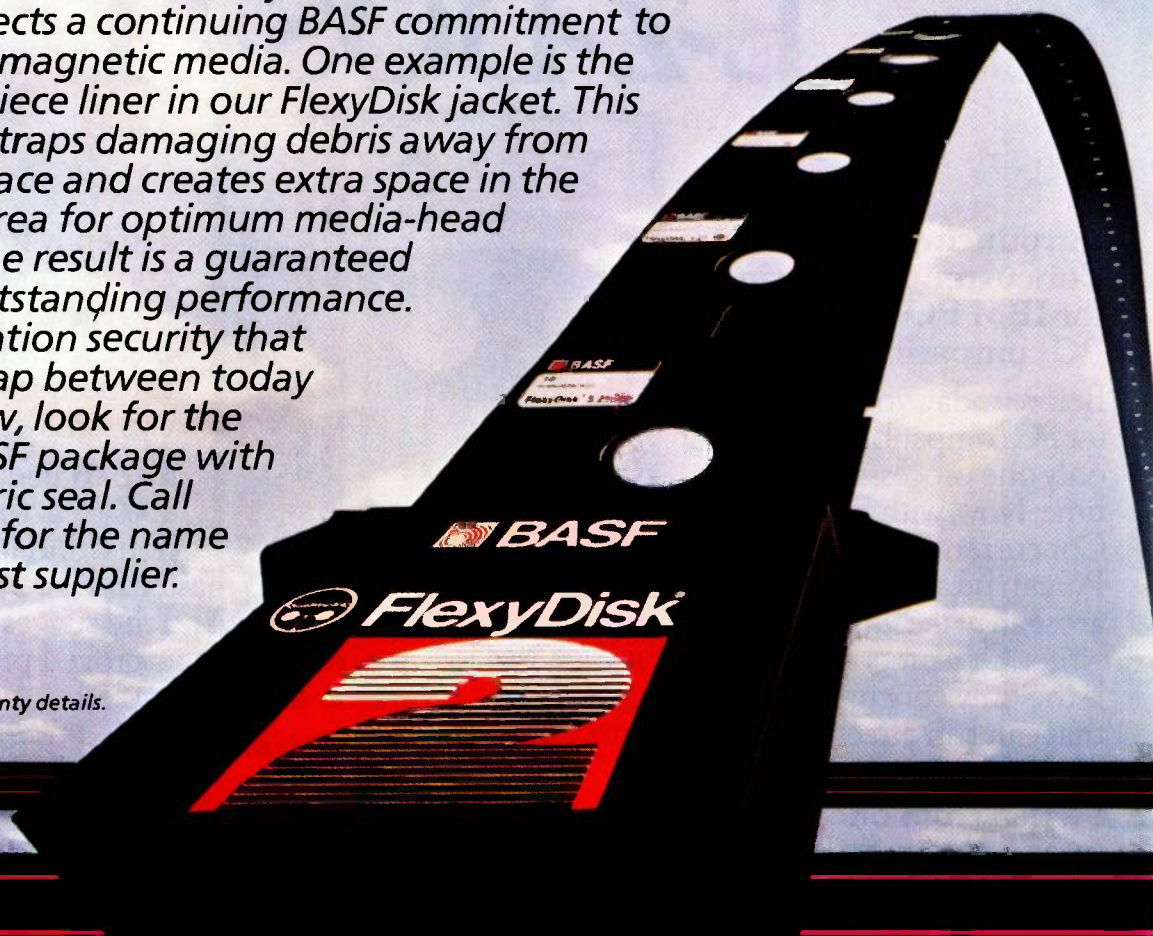

ENTER TOMORROW ON BASF TODAY.

© 1983 BASF Systems Corp., Bedford, MA



BASF

BUILD THE HOME RUN CONTROL SYSTEM

PART 3: THE SOFTWARE

BY STEVE CIARCIA

*Energy management, convenience,
and security in one package*



Over the past few months I've been describing the Home Run Control System (HCS), my rendition of a sophisticated yet cost-effective home-control system. Briefly, the HCS is a single-board computer with the hardware and software needed to control lights and appliances in a home or a specific production process in a small business. The system uses BSR home-control modules that are activated by signals superimposed on the house wiring and can also directly control the process through hard-wired inputs and outputs. Home Run can accommodate 48 BSR modules, 16 digital inputs, 8 TTL (transistor-transistor logic)-compatible outputs, and 16 messages.

In the first two parts, I introduced you to the overall system parts, the hardware. This month, I'll finish by describing the HCS's editing software and demonstrating a simple schedule entry.

HOME RUN IS INTERRUPT-DRIVEN

The heart of the HCS is an interrupt-service routine. All other HCS functions are subroutines that are called from this main routine. I have outlined the software in great detail because many readers can understand and appreciate the HCS better from that perspective. Also, the control methodology can

be used as a model for more personalized control designs should you not care to specifically build mine.

Figure 1 is the main interrupt handler. Each block in the flowchart represents a program action that in most cases is self-explanatory and requires few statements to implement. In more involved tasks, subordinate flowchart sections (figures 2 through 8) are referenced to explain those operations in greater detail. Together, they function as follows:

The timing-generator circuitry sends interrupts to the processor at approximately 601 hertz (Hz). When the processor detects the interrupt, it finishes the current instruction, saves its status, and gets the address of the interrupt-service routine. The processor executes the routine at that address until it encounters a return-from-interrupt instruction. When that occurs, the processor will recover its status and continue from where it left off prior to the interrupt.

When the interrupt-service routine is called, it decrements the interrupt counter. When this counter reaches 0, one second

(continued)

Steve Ciarcia (pronounced "see-ARE-see-ah") is an electronics engineer and computer consultant with experience in process control, digital design, nuclear instrumentation, and product development. He is the author of several books about electronics. You can write to him at POB 582, Glastonbury, CT 06033.

is added to the current time. If the time changes to a new minute, the routine will check the status of the Command FIFO (first-in/first-out) buffer. If there are any commands (turning a module or output on or off), they are executed one at a time in the order they entered the FIFO buffer.

When the Command FIFO buffer is finished, the processor checks the status of the Time FIFO buffer. If it is empty, the table of events is scanned to find events that are activated by one of the input lines. When one such event is found, the appropriate input line is checked to see if it has changed status within the last second. If it

has, the appropriate on or off command is placed in the Command FIFO buffer for execution. The scan continues until all input-activated events are checked.

If the Time FIFO buffer is not empty, the first time in the FIFO buffer is saved, and the table of events is scanned to find events that are scheduled to occur at that time. If the time matches, the appropriate on or off command is placed in the Command FIFO buffer for execution, and the event scan continues until all events have been checked.

(continued)

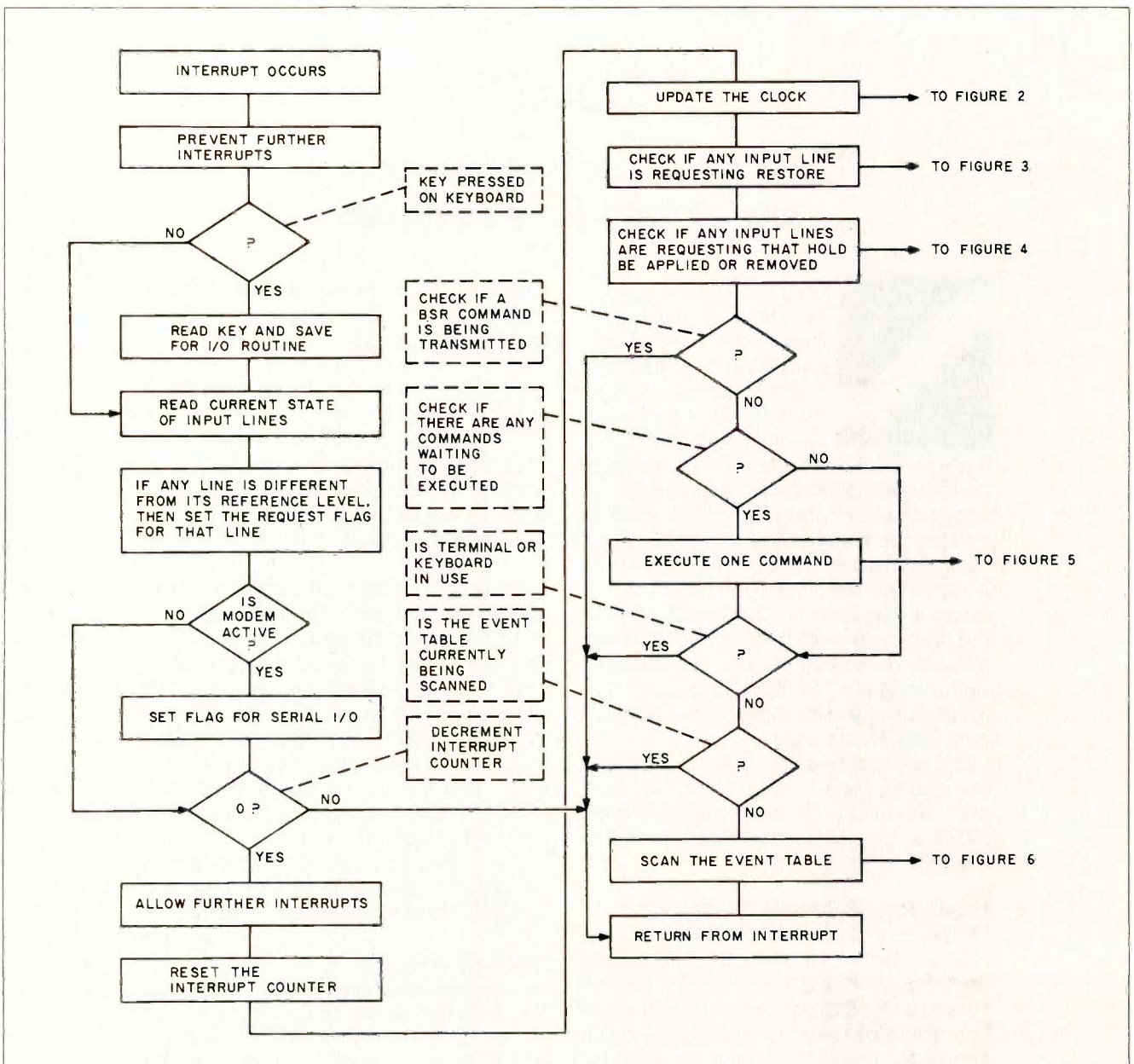

Figure 1: Master Interrupt Handler flowchart.

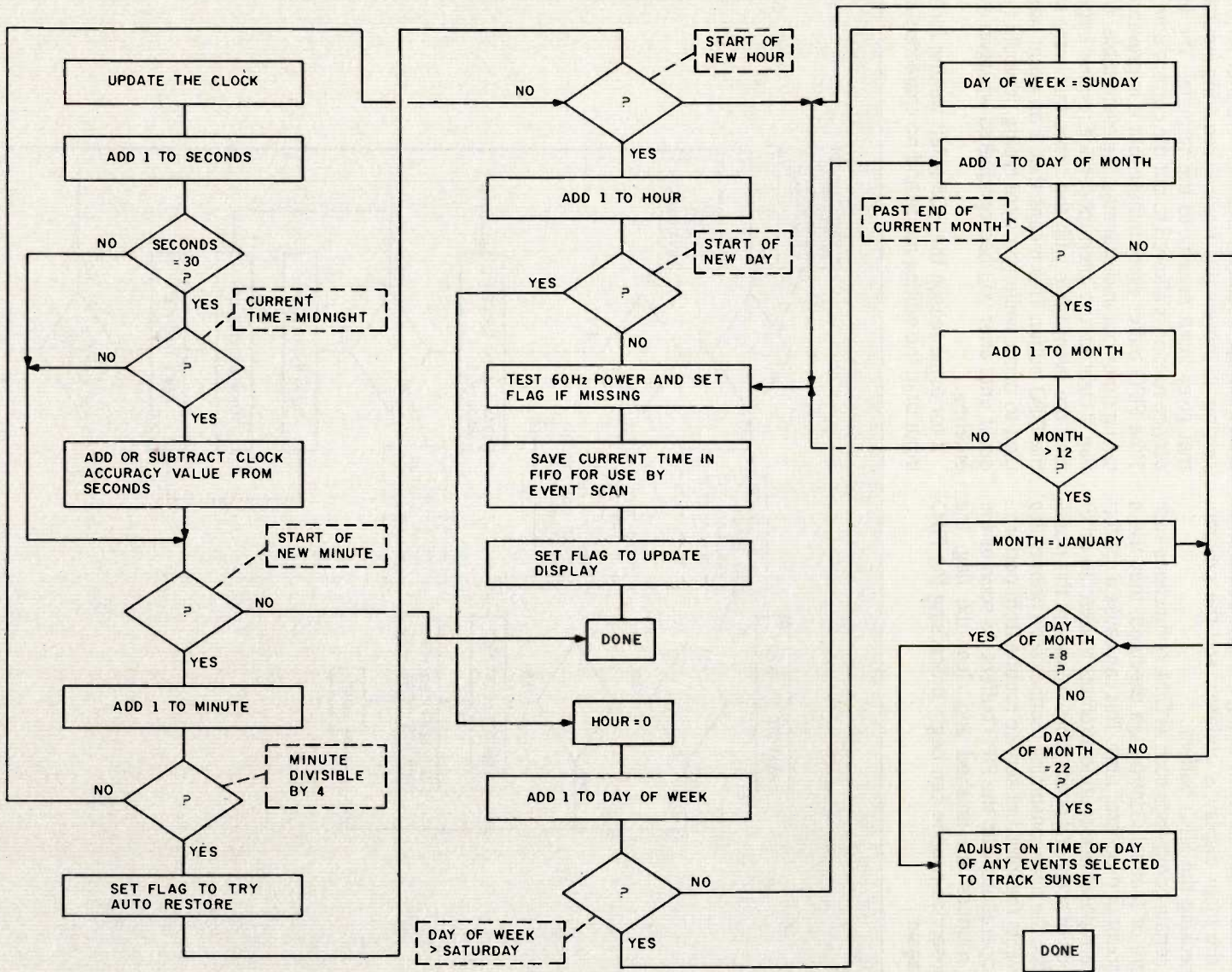

Figure 2: Clock Update flowchart.

If the time is the start of a new minute, the current time is put into the Time FIFO buffer for use in the event scan. If the terminal is not currently being used for some other display, the main display is updated, and the program starts checking the FIFO buffers.

When certain commands such as DIM, or functions such as Restore or Manual Control, are executed, they use a large amount of processor time. This can cause a conflict if the interrupt-service routine attempts to execute other commands or scans the event table. To prevent this possible conflict, the time-consuming routines set a priority flag that prevents the interrupt-service routine from performing any operations with the FIFO buffers. As soon as the priority routines are finished and clear the flag, the interrupt-service routine can begin processing the FIFO buffers again.

Whenever a function requires input from the terminal, it would be possible to miss a character that was typed if an interrupt occurred and a FIFO buffer required processing. To prevent this, routines requiring input set a flag that gives input priority to the terminal. The interrupt-service routine is allowed to put the current time into the Time FIFO buffer every minute, but it is prevented from taking times out and scanning the event table. When the flag is cleared, the interrupt-service routine begins scanning the event table with the times that were stored in the FIFO buffer. This means that if an event was scheduled to occur while you were typing, it would not really occur until after you had completed whatever you were entering.

If for some reason the HCS is left waiting for terminal input or in the editing mode and no characters are input

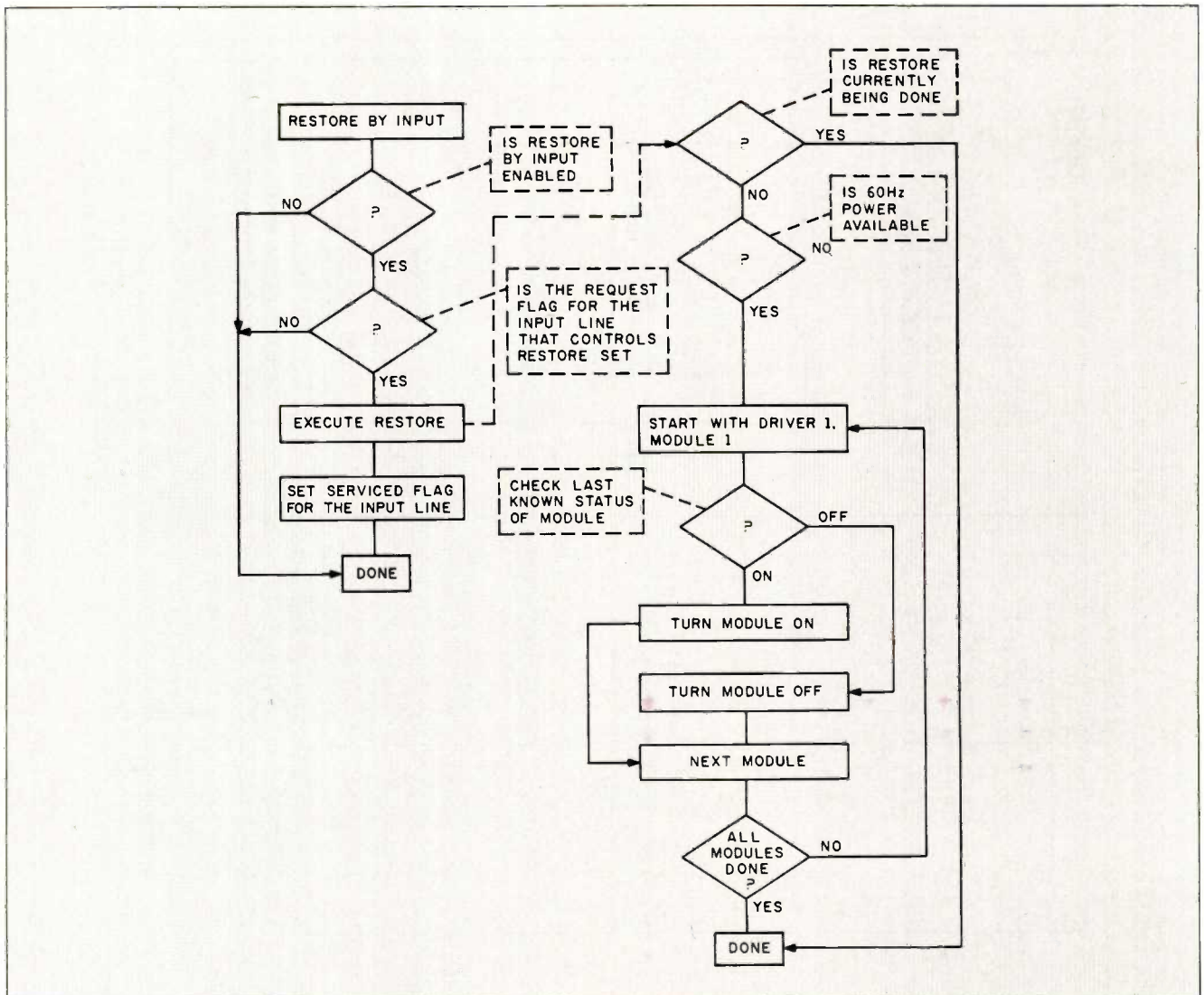

Figure 3: Restore Request Check flowchart.

CIRCUIT CELLAR

for 5 minutes, it will return to the status display and begin processing the FIFO buffers.

NOMENCLATURE

Before I can adequately discuss all the menu options and control features of the HCS, the nomenclature must be described in more detail.

A module can be a message, a BSR module, or some electrical equipment connected to a direct output line. Each module is identified by a module number from 1 to 16 (8 in the case of the direct outputs). For messages, the module number identifies 1 of 16 possible messages (each can be any length). For BSR modules, the module number identifies the number you set on the BSR module's unit-code switch. For direct outputs, the module number refers specifically to the 1-of-8 output lines to

which directly controlled equipment can be connected.

An event is a set of actions that you want performed on a module. Each event has four parts: the driver, the module, what turns the module on, and what turns the module off. "On" and "off" actions result from coincidence with a prespecified time and date, a logic-level transition on 1 of 16 input lines, or a predefined time duration.

A driver defines what an event does when it is executed. Seven drivers are used in the HCS (an eighth driver is the Superkey, which will be explained later), and their functions are as follows:

The Message driver (#7) displays messages on the terminal.

The BSR On/Off driver (#1, #4, and #5) turns a BSR module on or off.

(continued)

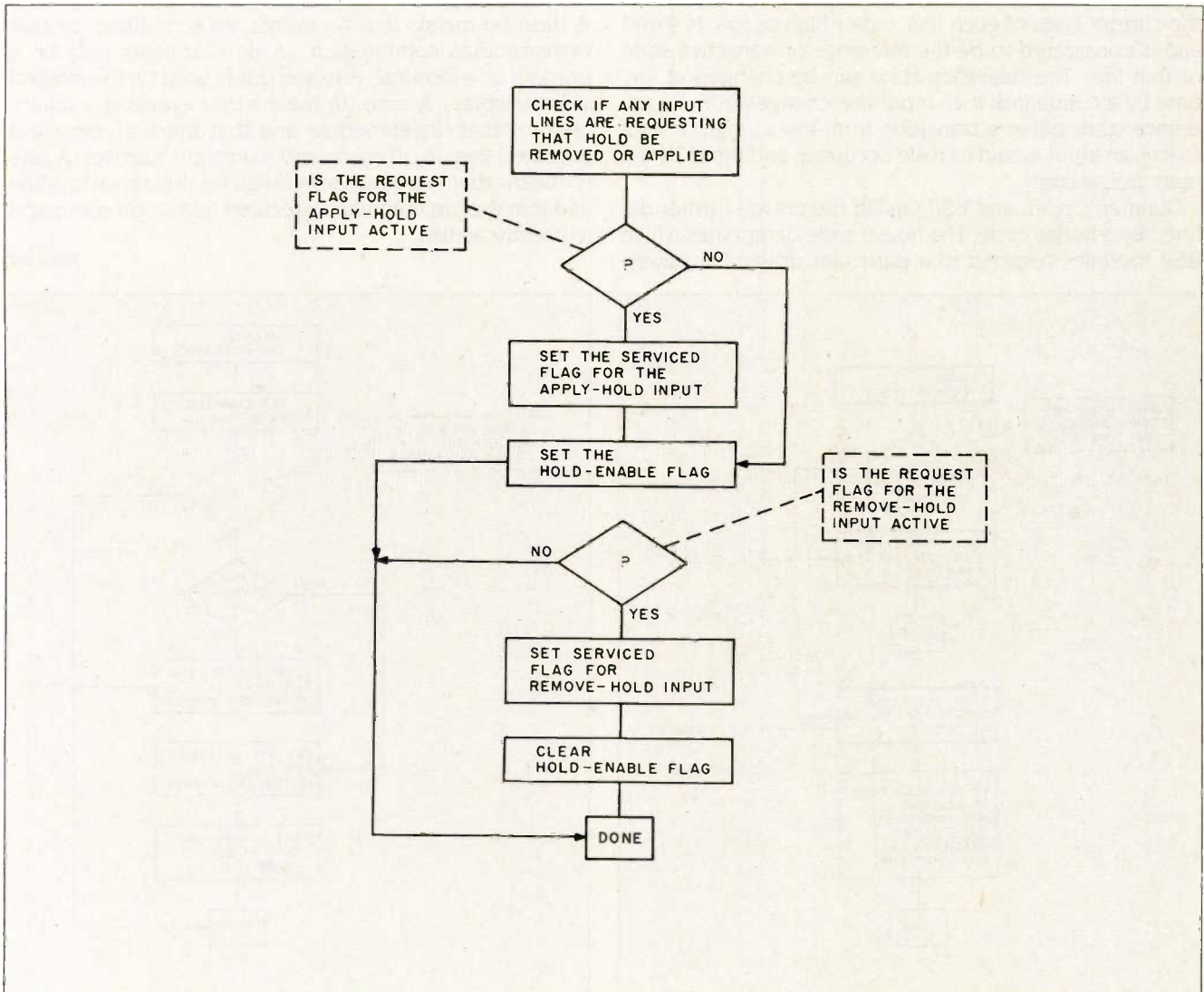

Figure 4: Hold Request Check flowchart.

The BSR Dimmer driver (#2) lets you remotely control the brightness of a lamp connected to a BSR lamp module. The brightness of the lamp is defined by a level from 1 to 16. Level 16 is fully on.

The BSR Cycler driver (#3) will turn a BSR module on for a selected time interval and then off for the same interval. This cycle repeats until the event is scheduled to stop. The interval is specified in minutes and can have a value from 1 to 180 minutes.

The Direct Output driver (#6) provides an open-collector TTL-compatible control signal on each of eight output lines. An 'ON' signal is a logical high, greater than 2.4 volts (V); an 'OFF' signal is a logical low, less than 0.4 V.

An input is an electrical signal that is less than 0.2 V (logic 0) or greater than 3.0 V (logic 1). The HCS can accommodate -9-V to +9-V input levels. When the HCS is first powered up or the manual Reset button is pushed, the current state of each line, either high or low, is saved and is considered to be the reference or nonactive state of that line. The reference state can be changed at any time by a command. If an input line changes from its reference state, either a transition from low to high or high to low, an input is said to have occurred, and the HCS will react accordingly.

Dimmer, Cycler, and BSR On/Off drivers are further defined by a house code. The house code determines which BSR modules respond to a particular driver. On power-

up, the HCS defaults to house code A. It can be alternately redefined as any one of the 16 possible house codes through a menu-selected editing command. The first BSR driver and the Cycler and Dimmer drivers use the A house code, while BSR drivers #4 and #5 each use the next sequential letters. This allows control of 48 BSR modules independently.

THE STATUS DISPLAY

When the HCS is functioning, the current on/off status of each module is presented with the time and date in a status display. Typically, it is a 24-line display that appears as shown in listing 1 and photo 1.

The number in the left column is the driver number used in input routines. The next column is the driver type and the house code for those that designate BSR drivers.

The status of each module is represented by a symbol. A dash (-) means that no events are scheduled for that driver/module combination. (A dash appears only on a printout or a terminal. A raised dot is used on the integral video display.) A zero (0) means that events are scheduled for that driver/module and that the last command executed was an off command (currently inactive). A one (1) means that events are scheduled for that driver/module and that the last command executed was an on command (currently active).

(continued)

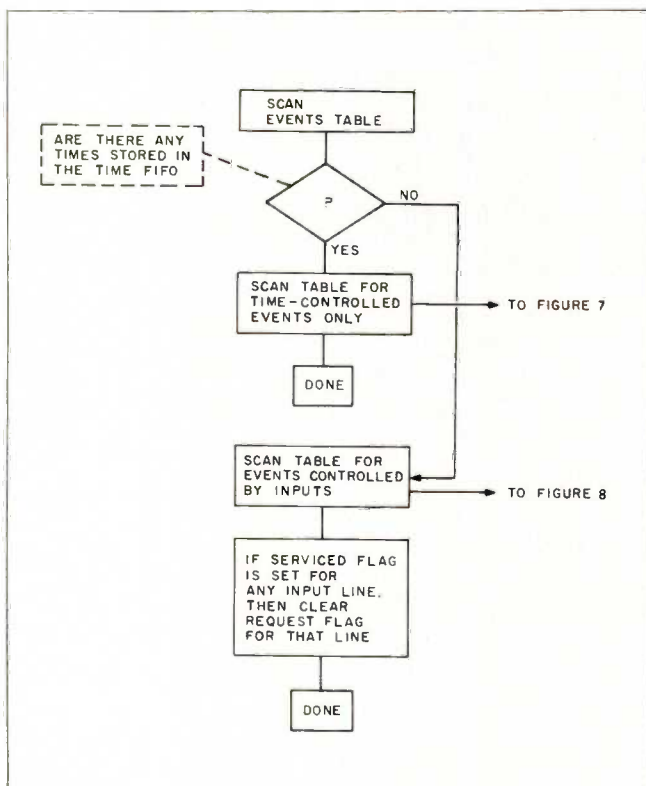

Figure 5: Execute Command flowchart.

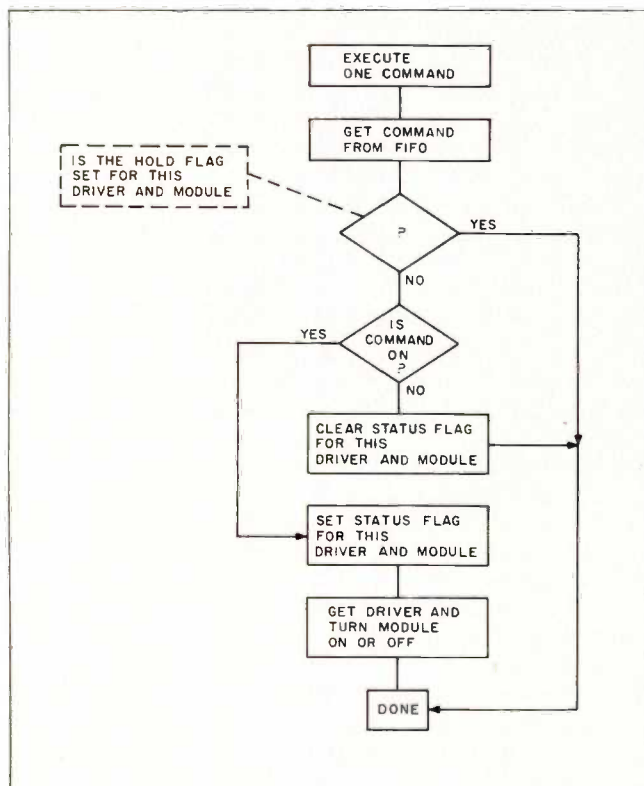

Figure 6: Scan Events Table flowchart.

CIRCUIT CELLAR

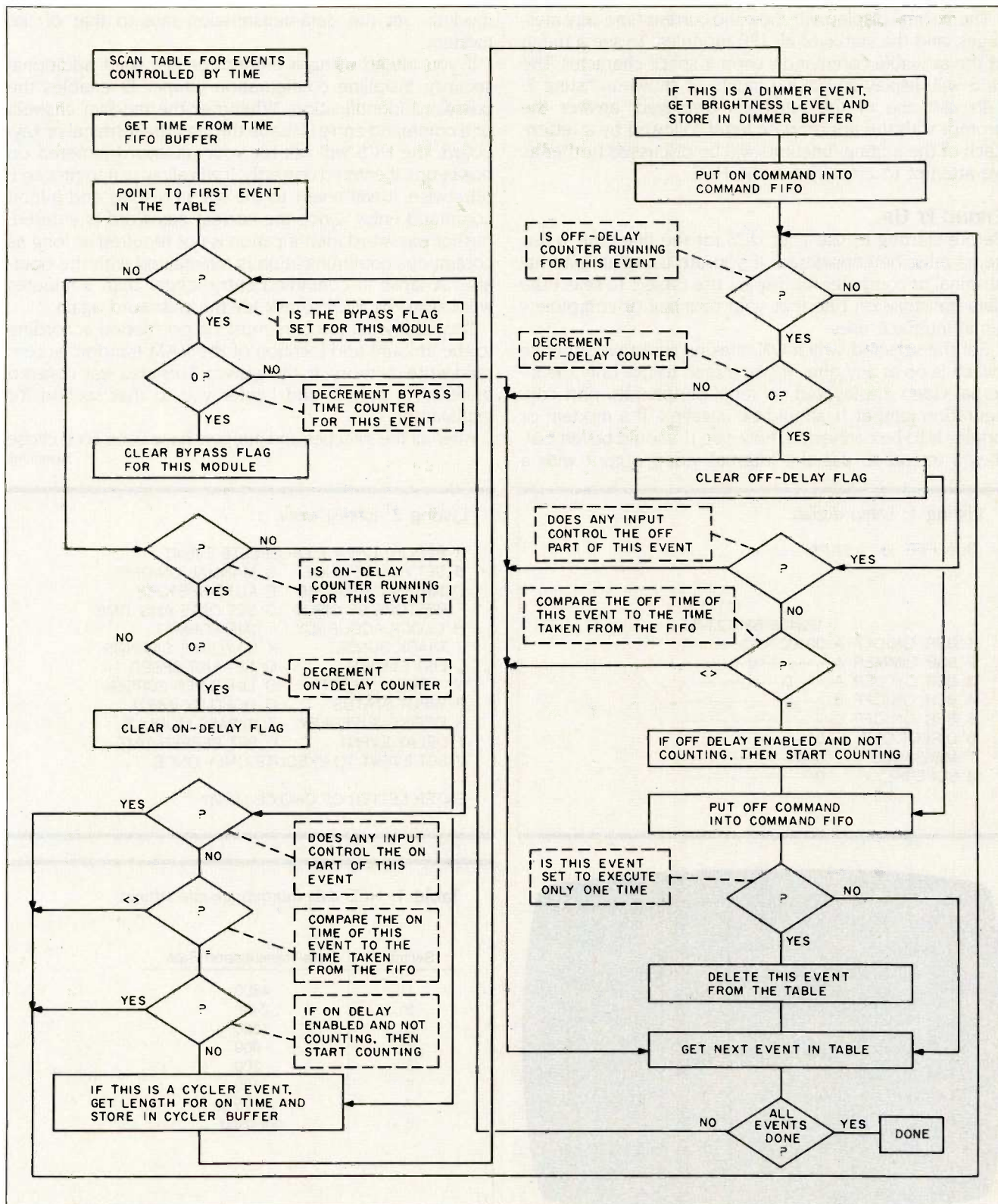

Figure 7: Scan for Time Events flowchart.

The normal display will show the current time, any messages, and the status of all 120 modules. To see a menu of the available commands, enter a space character. The HCS will display an editing menu, as shown in listing 2.

To use one of the functions displayed, answer the prompt with the appropriate letter followed by a return. Each of the editing functions will be discussed further as we attempt to actually run the HCS.

FIRING IT UP

Before starting to use your HCS for the first time, a few items must be considered. If you are using an external terminal or computer for display, use table 1 to select the data-transmission rate that your terminal or computer's serial interface uses.

Set the selected switch ON, making sure that only one switch is on at any time. If you intend to use only the internal video display and no serial peripherals, port configuration jumper J1 should be installed. If a modem or printer is to be connected, however, J1 should be left out. If you intend to use the internal video output with a

modem, set the data-transmission rate to that of the modem.

If you intend using a modem or just want additional security, installing configuration jumper J2 enables the password identification. Whenever the modem answers or a command entry is made through the terminal or keyboard, the HCS will ask for your password (entered on power-up). If entered correctly, it will allow you to proceed; otherwise, it will revert to the status display and inhibit command entry. Once the correct password is entered, further password identification is not required as long as continuous communication is maintained with the operator. A lapse in command entry longer than 3 minutes will cause the HCS to ask for the password again.

Two additional jumpers must be positioned according to the amount and location of the RAM (random-access read/write memory) in the system. This area was covered in detail in part 2, and I refer you to that section for explanation.

After all the switches and jumpers have been set (I chose *(continued)*)

Listing 1: Status display.

```
SUN FEB 3 3:37 PM

                                1111111
                                1234567890123456
1 BSR ON/OFF A 00100--1-0-----1
2 BSR DIMMER A -----0-----
3 BSR CYCLER A -----0-----
4 BSR ON/OFF B -----
5 BSR ON/OFF C -----
6 DIRECT OUT 01-----
7 MESSAGES    000-----
8 SUPERKEY    0-----
```

Listing 2: Editing menu.

```
A REPORT,CREATE,OR DELETE EVENT
B SET HOUSE CODE   C MANUAL ON/OFF
D MANUAL RESTORE  E AUTO-RESTORE
F RESTORE BY INPUT G SET DATE AND TIME
H CLOCK ACCURACY  I TIME FORMAT
J TRACK SUNSET    K DAYLIGHT SAVINGS
L LIST EVENTS     M SET LIST SPEED
N **TOTAL RESET** O LINES PER SCREEN
P INPUT STATUS    Q HOLD BY INPUT
R DEFINE SUPERKEY S BYPASS MODULE
T DELAY EVENT     U SET BEEPER TIME
V SET EVENT TO EXECUTE ONLY ONCE
```

ENTER LETTER OF CHOICE (A-V)?



Photo 1: Status display.

Table 1: HCS data-transmission-rate settings.

Switch	Data-Transmission Rate
1	4800
2	2400
3	1200
4	600
5	300
6	150
7	75
8	not used

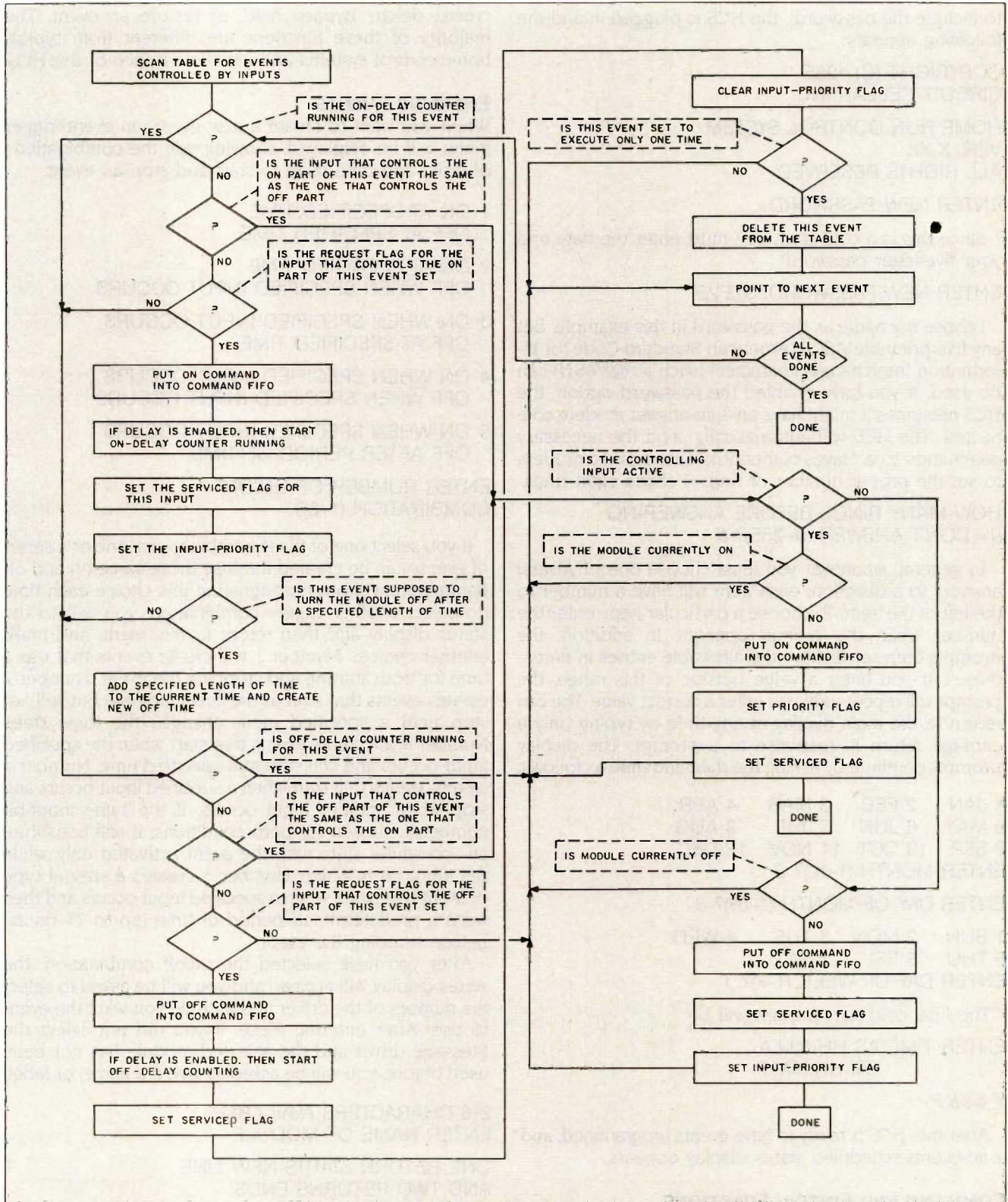

Figure 8: Scan for Input Events flowchart.

to include the password), the HCS is plugged in and the following appears:

COPYRIGHT (C) 1985
CIRCUIT CELLAR INC.

HOME RUN CONTROL SYSTEM
VER. X.XX
ALL RIGHTS RESERVED

ENTER NEW PASSWORD:

Since this is a cold start, you must enter the date and your five-letter password:

ENTER NEW PASSWORD: *STEVE*

I chose my name as the password in this example, but any five printable ASCII (American Standard Code for Information Interchange) characters (such as *@#%&N*) can be used. If you have enabled the password option, the HCS presumes it might have an auto-answer modem connected. The HCS will automatically send the necessary commands to a Hayes-compatible auto-answer modem to set the proper number of rings. I chose eight rings.

HOW MANY RINGS BEFORE ANSWERING
0 = DON'T ANSWER (0-255)? *8*

In general, whenever you must choose one of several answers to a question, each item will have a number to the left of the item. To choose a particular item, enter the number when the prompt appears. In addition, the prompts themselves have the allowable entries in parentheses. If you enter a value outside of this range, the prompt will repeat until you enter a correct value. You can return to the main display at any time by typing only a carriage return in response to a prompt. The display prompts continue by asking the date and time as follows:

1 JAN 2 FEB 3 MAR 4 APR
5 MAY 6 JUN 7 JUL 8 AUG
9 SEP 10 OCT 11 NOV 12 DEC
ENTER MONTH (1-12)? *2*

ENTER DAY OF MONTH (1-31)? *3*

1 SUN 2 MON 3 TUE 4 WED
5 THU 6 FRI 7 SAT
ENTER DAY OF WEEK (1-7)? *1*

The final cold-start prompt will be

ENTER TIME AS HH:MM:A
OR HH:MM:P

? *4:56:P*

After this, HCS is ready to have events programmed, and a no-events-scheduled status display appears.

COMMAND AND EDITING FUNCTIONS

It's time to get back to an explanation of the editing-menu options. By selecting the different functions, you can

create, delete, bypass, hold, or restore an event. The majority of these functions are different from typical home-control systems and are the essence of the HCS.

ENTERING EVENTS

When you want to create a new event, an event-trigger menu will be displayed, showing you the combinations of input and time used to start and stop an event:

- 1 ON AT SPECIFIED TIME
OFF AT SPECIFIED TIME
- 2 ON AT SPECIFIED TIME
OFF WHEN SPECIFIED INPUT OCCURS
- 3 ON WHEN SPECIFIED INPUT OCCURS
OFF AT SPECIFIED TIME
- 4 ON WHEN SPECIFIED INPUT OCCURS
OFF WHEN SPECIFIED INPUT OCCURS
- 5 ON WHEN SPECIFIED INPUT OCCURS
OFF AFTER PERIOD OF TIME

ENTER NUMBER OF ON/OFF
COMBINATION (1-5)?

If you select one of these combinations, one or a series of events can be created that use those same on and off parameters without redesignating this choice each time (to select another trigger combination, you exit to the status display and then return to this menu and make another choice). Number 1 will create events that use a time for both starting and stopping the event. Number 2 creates events that start at the specified time but will not stop until a specified input changes the logic state. Number 3 will create events that start when the specified input occurs and will stop at a specified time. Number 4 creates events that start when a specified input occurs and stop when another input occurs. If the same input-bit number is chosen for both conditions, it will constitute an "on while" state with the event activated only while the input bit is active. Number 5 creates a special type of event that starts when a specified input occurs and then waits a predetermined period of time (up to 24 hours) before stopping the event.

After you have selected the on/off combination, the status display will appear, and you will be asked to select the number of the driver and module you want the event to use. After entering these, if you did not select the Message driver and the selected module has not been used before, you will be asked to give it a name, or label:

216 CHARACTERS AVAILABLE
ENTER NAME OF MODULE

ONE RETURN STARTS NEW LINE
AND TWO RETURNS ENDS
? *Front Porch Light*

The first line indicates the number of characters set aside

for use as labels. The available space depends on the quantity of RAM in the system. If the module already exists (i.e., you have already programmed the porch light to come on by some other combination of parameters), the label will be displayed, and you will be prompted to add to or delete these events.

Next, you will be asked to enter the parameters for the on and then the off part of the event. There will be prompts for either the time or input, depending on which combination you chose.

The prompts for a time look like this:

ENTER ON TIME

1 SUN 2 MON 3 TUE 4 WED
5 THU 6 FRI 7 SAT
8 REPEAT 9 DAY OF MONTH

ENTER DAY OF WEEK, REPEAT CODE,
OR DAY OF MONTH CODE (1-9)?

If you enter a number from 1 to 7, the event will use the day of the week that you select. If you enter a 9, you will be asked for the day of the month:

ENTER DAY OF MONTH (1-31)?

If you enter 8, you will be prompted for how many days you want the event repeated:

HOW MANY CONSECUTIVE DAYS DO YOU
WANT THIS EVENT REPEATED (2-7)?

For example, if you enter 5 and an event that starts on Monday, the event will occur every day from Monday through Friday. Repeating an event for seven days makes it a daily program. (For all modules, a combination of events can be designated. We could, for example, have the front porch light come on Monday through Friday from 5 to 11 p.m., Saturday and Sunday from 8 p.m. to 2 a.m., for 10 minutes every time the front door opens [contact-closure input], and on one night for as long as necessary until you get home.)

After the day is entered, you will be asked to enter the time:

ENTER TIME AS HH:MM:A
OR HH:MM:P

?

The time of day is entered on a single line, the same way as setting the clock.

If input is selected as part of the combination, you will be asked to enter the number of the input line that you want to control the event:

ENTER INPUT # FOR ON (1-16)?
or

ENTER INPUT # FOR OFF (1-16)?

If you select the Message driver and a message already exists for that module, you will be asked if you want to

delete the old message. If you enter Y or no message existed, you can enter a message in the same way that you enter a label. Messages can be any length but are limited by available memory space. (Can't remember when to put the trash out? Have the HCS display PUT THE TRASH OUT every Friday morning at 8 a.m.)

If you select the BSR Dimmer, you will be asked to enter the brightness level (1 to 16); if you select the BSR Cycler, you will be asked for the time interval you want to use. Along with the BSR driver, these routines will repeat the prompts to create a new event using the same driver and module unless you abort the routine.

MANUAL CONTROL

Manual Control lets you turn modules on and off without having to schedule an event. The routine will display the current driver/module status table and ask for the driver number. The routine then displays which keys perform which functions.

KEY ASSIGNMENTS:

1-16	-	MODULE NUMBER
Y	-	MODULE ON
N	-	MODULE OFF
D	-	DIM LIGHT
R	-	NEW DRIVER

>

To turn a module on or off, you must type the module number and the appropriate letter, such as 1Y to turn module number 1 on or 1N to turn it off. You can enter more commands on the same line, such as 1Y2Y3N, which would turn modules 1 and 2 on and module 3 off. If you want to manually dim a light, you must first turn it fully on and then type D until the desired brightness is reached. When you are finished with Manual Control, type a return to exit to the status display.

THE RESTORE ACTUAL STATUS FUNCTION

The Restore function is one of the more unique functions of the HCS. BSR control modules are notorious for arbitrarily turning on or off as a result of power-line transients. While the HCS has direct outputs for the most critical control signals, it is disconcerting to find that BSR-controlled appliances and lamps are not in the desired state after a few hours. The HCS has the ability to restore the current state of all modules on command, on input, or at regular intervals.

Restore lets you make sure that every module in use is set to the same status, on or off, that is currently in the status table. Since BSR modules can be manually controlled without the HCS (i.e., you can directly turn on the hall light by pressing the BSR wall-module button), it might be necessary to return the house or office to a known condition.

(continued)

If a power failure occurs and the HCS is equipped with battery backup, a restore operation will be performed automatically after the power returns (it allows a few extra minutes for the line to settle first). Or, at any time, you can select the Manual Restore function to restore all outputs to that status listed in the status display.

The Auto-Restore function causes the HCS to perform a restore operation every 4 minutes automatically. This is useful, for example, if the HCS is being used to control modules that are unattended for long periods of time and will not be manually overridden.

A restore operation can also be triggered by an input. On power-up, restore by input is preset to bit 14 and inactive. When selected through the editing menu, the sequence is as follows:

```
RESTORE BY INPUT DISABLED
INPUT NUMBER FOR RESTORE IS 14
ENABLE RESTORE BY INPUT (Y-N)? Y
ENTER INPUT NUMBER THAT YOU
WANT TO CAUSE RESTORE, OR
RETURN TO USE THE CURRENT
INPUT NUMBER (1-16)?
```

HOLD BY INPUT

An equally unique HCS function is the Hold command. Hold is used to stop modules from turning on or off. For example, in a security system, the alarm modules could be put on hold when the building is open. Hold is activated and deactivated by input lines that you select. The lines default to 15 and 16 on power-up. The command displays the following:

```
HOLD STARTED BY INPUT #15
HOLD STOPPED BY INPUT #16
HOLD INPUTS CANNOT CHANGE HOLD STATUS
MODULE(S) ARE NOT ON HOLD
```

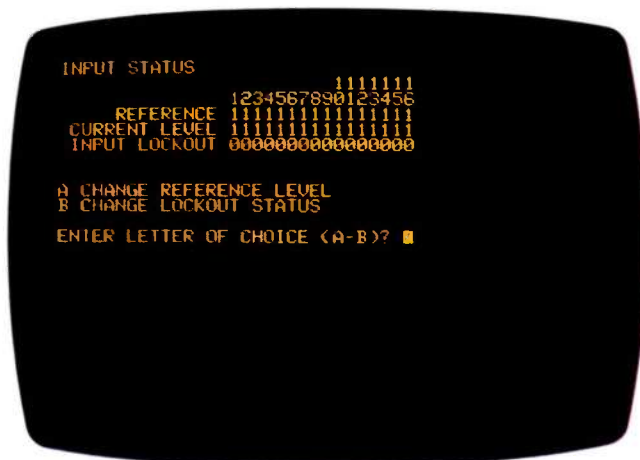

Photo 2: Input status display.

- 0 REDISPLAY STATUS
- 1 ALLOW INPUTS TO CHANGE HOLD STATUS
- 2 STOP INPUTS FROM CHANGING HOLD STATUS
- 3 ASSIGN HOLD-INPUT NUMBERS
- 4 SELECT MODULES TO PUT ON HOLD

ENTER OPTION NUMBER (0-4)?

When selecting modules to put on hold, the status display will show the letter "H," indicating which modules are set for hold. The "H" will toggle similar to the "S" in sunset when you enter a driver and module. When in the main display, modules on hold in the on state will be represented by an inverse "1," and a module in the off state will be represented by an inverse "0" on the video display. When Hold is enabled, the above display will state that inputs can change Hold status and whether they are or are not currently on hold.

In my application, I have the Hold input connected to the alarm system. When I am not home and the alarm is on, the HCS simulates occupancy. When the alarm is off and I am home, these functions are put on hold.

DELAYING AND BYPASSING EVENTS

Delay Event allows you to postpone the actual execution of an event for a time period up to 23 hours and 59 minutes. For example, if you have an event that is scheduled to turn a light on when you return home in the evening and you are going to be 2 hours late, instead of creating a new event for this one occurrence, simply delay the event for 2 hours. If the light is scheduled to turn on at 18:00 and turn off at 18:15, a delay of 2 hours would cause the light to turn on at 20:00 and turn off at 20:15 instead. After the delay has timed out, the event returns to its normal schedule.

The Bypass Module function allows you to instruct the HCS to ignore a driver/module combination for a time period up to 44 days, 23 hours, and 59 minutes. During the time Bypass Module is enabled, the scheduled events for that module will not occur. For example, if you have a large number of events for a driver/module, such as heating or cooling your home, and you are going to be away for several days, instead of deleting all the events before you leave and reentering them when you return, you can bypass that module for the amount of time you will be gone. The bypass time begins as soon as you enable it.

When selected, Bypass Module will display the current driver/module status and ask you for the driver and module to bypass. When you have entered these, it will ask for the length of the bypass in days, hours, and minutes. If you wish to remove a bypass early, entering 0 for the days, hours, and minutes will abort the bypass that is in progress and restore normal operation.

INPUT STATUS

The current status of the input lines can be displayed by typing the P option. It is displayed as shown in photo 2.

The row labeled REFERENCE is the nonactivated level for each input line. A reference level of 0 indicates a normally low/active high input signal. A reference level of 1 indicates a normally high/active low input. The row labeled CURRENT LEVEL is the current level of each input at the time the input status-display command is called.

INPUT LOCKOUT (indicated by a logic 1 in the designated display position) allows a user to selectively shut off inputs without using the Bypass Module or Hold functions. In the following display, inputs 1 through 6 are active low, and inputs 7 through 16 are active high. Inputs 6, 8, and 10 are locked out. The current input levels are as displayed:

```

INPUT STATUS
                1111111
                1234567890123456
REFERENCE      0000001111111111
CURRENT LEVEL  0110000110001111
INPUT LOCKOUT  0000010101000000
    
```

SUPERKEYS

When I first started testing the HCS, it was necessary to continually preset the on/off conditions of many modules so that I could observe specific functions. To facilitate this, I designed the Superkey. Superkeys enable you to perform a large number of Manual Control operations with just two keystrokes. To create a Superkey, you specify which number you want to define (16 Superkeys are designated as #1-#16) and enter a list of modules you want to turn on or off. To execute a Superkey, you enter its number followed by an escape. A typical Superkey list might appear as follows:

```

8 SUPERKEY      1
1 BSR ON/OFF A  1 OFF
1 BSR ON/OFF A  2 OFF
1 BSR ON/OFF A  3 ON
1 BSR ON/OFF A  4 ON
1 BSR ON/OFF A  5 OFF
1 BSR ON/OFF A  8 OFF
    
```

If you press 1, then Escape, driver 1 modules 1, 2, 5, and 8 would turn off and modules 3 and 4 would turn on.

TRACKING SUNSET AND ONETIME EVENTS

One function that the HCS can perform is turning lights on at the same time relative to sunset each day. Sunset changes from day to day throughout the year. Ordinarily, fixed-time controllers would need to have their program manually changed every few weeks in order to keep up with the sunset. The HCS has a special menu selection that allows you to designate which modules will have their on times changed, according to the long-term variation in actual sunset. Each month, on the 8th and 22nd, the HCS recalculates the on times of sunset-adjust-designated modules. (The calculation is accurate only for North America at the present time.)

The 1-Time Event function allows you to create an event that will automatically delete itself after it executes the off portion of the event. When selected, it will display the current driver/module status table and ask you for the driver and module numbers. After you enter these, it will display all the events for that driver and module, each with an identifying number. To enable the 1-Time Event function for an event, enter the number of the event. If the particular event already has the 1-Time Event function enabled, the HCS will ask you if you want to cancel it.

A SIMPLE HCS APPLICATION

As I mentioned earlier, the Circuit Cellar and my home are somewhat unconventional. While many of you will no doubt find applications for the HCS as an environmental controller or security system, my initial use is for automatic lighting (I have a separate security system). Perhaps when you read this I'll have connected the air conditioning and vent fans, but right now I'm motivated by deadline and necessity. I am tired of walking in the dark, and it's hard to think about air conditioning when it's 7° and snowing outside. The only environmental control worth considering right now as I write this is keeping the doors closed and all the heat on.

When I go from the kitchen down to the storage area behind the Circuit Cellar, it is a long trek with six light switches along the way. In addition, there are a few other items I frequently switch on and off. If I assign a BSR module to each for remote control, the list could start as follows:

Circuit Cellar floor lamp	module #8
HCS CRT monitor	module #6
Upstairs hallway light	module #5
Staircase light	module #4
Circuit Cellar hallway/copier light	module #3
Storage-area lights	module #2
Garage light	module #1

In a standard off-the-shelf open-loop BSR controller, we'd be limited to timed activation of these lights or walking around with the BSR ultrasonic hand-held controller aimed at a command controller in each room. This is hardly convenient. My idea of automatic lighting is noncontact and not user-activated! I want a completely passive system. When I walk into a room, the lights come on. As long as I stay there, they remain on. When I leave, they turn off after a reasonable period of time.

The HCS can be easily programmed to control lights and appliances in this manner by monitoring certain signals through its direct input lines. In this instance, passive infrared motion detectors are used to scan the affected areas and indicate to the HCS when a person walks into a particular area. The motion detector senses a difference in heat level between the person and the surrounding area and simply opens a relay contact. Using a +5-V source and a pull-up resistor, the motion detector can be con-

(continued)

nected to the HCS as a simple TTL input.

To control all the lights in the areas I listed above, it was necessary to run a few wires around my house. Fortunately, I already have an elaborate commercially installed security system, and I was able to tap off many of the required signals directly from the alarm box. Unfortunately, security systems are perimeter-oriented and specific in purpose. I had to add more motion detectors to cover all the areas I wanted to control. I spent a few days stringing wires and drilling holes. There are now a dozen little infrared eyes watching my every move. Now, as I walk down the stairs, lights come on automatically, both on the staircase and the top and bottom landings.

Some of you may not want a computer-controlled house, but connecting these inputs and controlling the lighting provides a simple illustration of the HCS's capability and a process that I can describe. First, each motion detector

is attached to a separate input bit. No motion is a logic 0 (gnd), and motion detected is a logic 1 (+5 V). The inputs are as follows:

- Input #1 Garage-area motion detector
- Input #2 Circuit Cellar storage-area motion detector
- Input #3 Staircase motion detector
- Input #4 Upstairs hallway motion detector
- Input #5 Circuit Cellar office area

Next, we fire up the HCS and enter the statements that turn on the appropriate light and extinguish it after the prescribed duration. For brevity, I have chosen to edit out some of the more repetitive displays. In the following communication exchange (done with a live HCS via modem), HCS keyboard or terminal entries are in italics. The explanations I've added are presented in lowercase letters.

(continued)

Listing 3: Programming events on the HCS to occur when a certain input occurs.

COPYRIGHT (C) 1985
CIRCUIT CELLAR INC.

HOME RUN CONTROL SYSTEM
VER. 5.17

ALL RIGHTS RESERVED

ENTER NEW PASSWORD: *STEVE* (password is asked for if jumper 2 has been installed)

HOW MANY RINGS BEFORE ANSWERING
0 = DONT ANSWER (0-255)? *5* (if your Hayes-compatible auto-answer modem is installed, the HCS will send it ATSO=5 to tell it to answer at 5 rings)

1 JAN 2 FEB 3 MAR 4 APR
5 MAY 6 JUN 7 JUL 8 AUG
9 SEP 10 OCT 11 NOV 12 DEC

ENTER MONTH (1-12)? *1*

ENTER DAY OF MONTH (1-31)? *27*

1 SUN 2 MON 3 TUE 4 WED
5 THU 6 FRI 7 SAT

ENTER DAY OF WEEK (1-7)? *1*

ENTER TIME AS HH:MM:A
OR HH:MM:P

? *2:48:P*

(the status display appears here with nothing scheduled; next, A is entered to create an event)

ENTER LETTER OF CHOICE (A-V)? *A*

ENTER YOUR PASSWORD: ******* (the first time that you enter a command, the HCS requires a password verification; it will not be required again unless 3 minutes expire with no communication; an asterisk and not the password is actually displayed)

* MEANS EVENTS ARE SCHEDULED

```

                                1111111
                                1234567890123456
1 BSR ON/OFF  A -----
2 BSR DIMMER  A -----
3 BSR CYCLER  A -----
4 BSR ON/OFF  B -----
    
```

(continued)

CIRCUIT CELLAR

5 BSR ON/OFF C
6 DIRECT OUT
7 MESSAGES
8 SUPERKEY

(each time you enter the create or delete option, the HCS lists the status display with an asterisk to indicated modules that are in use—this is called the scheduled-events display)

ENTER DRIVER NUMBER (1-8)? 1

ENTER MODULE NUMBER (1-16)? 1

THIS DRIVER/MODULE NOT IN USE

CREATE EVENT,DELETE EVENT,OR
REPORT EVENTS AGAIN (C/D/R)? C

(the event-trigger listing appears again here)

ENTER ON/OFF COMBINATION (1-5)? 5

ENTER INPUT # FOR ON (1-16)? 1

ENTER PERIOD OF TIME TO WAIT
BEFORE TURNING OFF

NUMBER OF HOURS (0-23)? 0

NUMBER OF MINUTES (0-59)? 5

(here we have selected to turn on BSR #1 for 5 minutes each; input #1 goes high; the time duration extends if input #1 is retriggered before the 5 minutes has expired)

374 CHARACTERS AVAILABLE
ENTER NAME OF MODULE

ONE RETURN STARTS NEW LINE
AND TWO RETURNS ENDS
GARAGE LIGHT

GARAGE LIGHT

1 INPUT# 1 PERIOD 00:05

(this is the form the HCS lists its programmed events)
(more events could be added)

ENTER INPUT # FOR ON (1-16)?

(entering just a return redisplay the status menu)

SUN JAN 27 2:53 PM

111111
1234567890123456
1 BSR ON/OFF A 0.....
2 BSR DIMMER A
3 BSR CYCLER A
4 BSR ON/OFF B
5 BSR ON/OFF C
6 DIRECT OUT
7 MESSAGES
8 SUPERKEYA

(the event we just scheduled is shown on the status display; it is presently inactive)

* MEANS EVENTS ARE SCHEDULED

(we can go directly to the create function without displaying the editing menu; just enter A and return)

111111
1234567890123456
1 BSR ON/OFF A *.....
2 BSR DIMMER A
3 BSR CYCLER A
4 BSR ON/OFF B
5 BSR ON/OFF C
6 DIRECT OUT
7 MESSAGES
8 SUPERKEY

(scheduled-events display)

ENTER DRIVER NUMBER (1-8)? 1

ENTER MODULE NUMBER (1-16)? 2

THIS DRIVER/MODULE NOT IN USE

(continued)

CIRCUIT CELLAR

```
CREATE EVENT,DELETE EVENT,OR  
REPORT EVENTS AGAIN (C/D/R)? C
```

(the event-trigger listing is redisplayed here)

```
ENTER ON/OFF COMBINATION (1-5)? 5
```

```
ENTER INPUT # FOR ON (1-16)? 1
```

```
ENTER PERIOD OF TIME TO WAIT  
BEFORE TURNING OFF
```

```
NUMBER OF HOURS (0-23)? 0
```

```
NUMBER OF MINUTES (0-59)? 5
```

358 CHARACTERS AVAILABLE

```
ENTER NAME OF MODULE
```

```
ONE RETURN STARTS NEW LINE  
AND TWO RETURNS ENDS
```

```
STORAGE-AREA CEILING LIGHT
```

```
STORAGE-AREA CEILING LIGHT
```

```
 1 INPUT# 1 PERIOD 00:05
```

```
ENTER INPUT # FOR ON (1-16)? 2
```

```
ENTER PERIOD OF TIME TO WAIT  
BEFORE TURNING OFF
```

```
NUMBER OF HOURS (0-23)? 0
```

```
NUMBER OF MINUTES (0-59)? 5
```

```
STORAGE-AREA CEILING LIGHT
```

```
 1 INPUT# 1 PERIOD 00:05
```

```
 2 INPUT# 2 PERIOD 00:05
```

```
ENTER INPUT # FOR ON (1-16)?
```

(this time we have scheduled the storage-area light to come on if either inputs #1 or #2 are triggered)

(enter return)

The HCS begins with a cold start, as shown in listing 3.

Rather than bore you with continued display listings, I'll add a bit more without repeating it. In a similar manner (using option 5 from the event-trigger listing in all cases) as presented in listing 3, the following is scheduled:

```
CIRCUIT CELLAR HALL LIGHT
```

```
 1 INPUT# 3 PERIOD 00:03
```

```
 2 INPUT# 2 PERIOD 00:05
```

```
STAIRCASE LIGHT
```

```
 1 INPUT# 3 PERIOD 00:03
```

```
 2 INPUT# 4 PERIOD 00:03
```

```
UPSTAIRS HALL LIGHT
```

```
 1 INPUT# 3 PERIOD 00:03
```

```
 2 INPUT# 4 PERIOD 00:03
```

```
HCS CRT MONITOR
```

```
 1 INPUT# 2 PERIOD 00:15
```

```
CIRCUIT CELLAR FLOOR LAMP
```

```
 1 INPUT# 5 PERIOD 00:30
```

At this point, seven modules have been programmed with all events of the "on-duration" format. To give you some traditional control reference, I'd also like to dem-

onstrate a time-on/time-off event as well. In my case, I'll turn the porch light on at 4:30 p.m. each day and off at 6 a.m. the next morning, as shown in listing 4.

IBM PC HCS EXEC

While the menu-driven event programming is straightforward in the basic HCS and requires no external support hardware, the facilities afforded in a larger computer can greatly expand user-friendliness. An IBM PC HCS Exec upload/download program written by Robin Computing takes HCS programming from sequential menu entry to "paint by numbers." Shown in photo 3 (the display can be either black-and-white or color), HCS Exec uses cursor positioning, return, and escape as its primary entry codes. It can communicate with the HCS at up to 4800 bits per second and upload and download the complete HCS event program sequence.

In Exec, drivers and module numbers are referred to as devices, selected by name, as shown in photo 4. By positioning the cursor over the "upstairs hall light" and pressing Return, we display that device's particulars, as shown in photo 5. In Exec, any time a device selection is necessary, a window with the device list appears, and

(continued)

CIRCUIT CELLAR

Listing 4: Programming events on the HCS to occur at a certain time.

SUN JAN 27 3:06 PM

```

1111111
1234567890123456
1 BSR ON/OFF A 000000-0-----
2 BSR DIMMER A -----
3 BSR CYCLER A -----
4 BSR ON/OFF B -----
5 BSR ON/OFF C -----
6 DIRECT OUT -----
7 MESSAGES -----
8 SUPERKEY ----- A
    
```

(our status display indicates that we have seven modules in use—none on)

* MEANS EVENTS ARE SCHEDULED

```

1111111
1234567890123456
1 BSR ON/OFF A *****-----
2 BSR DIMMER A -----
3 BSR CYCLER A -----
4 BSR ON/OFF B -----
5 BSR ON/OFF C -----
6 DIRECT OUT -----
7 MESSAGES -----
8 SUPERKEY -----
    
```

(create an event by entering A)

(scheduled-events display again)

ENTER DRIVER NUMBER (1-8)? 1
 ENTER MODULE NUMBER (1-16)? 12

THIS DRIVER/MODULE NOT IN USE

CREATE EVENT,DELETE EVENT,OR
 REPORT EVENTS AGAIN (C/D/R)? C

(the event-trigger listing shows up here)

ENTER ON/OFF COMBINATION (1-5)? 1

(this time we select item 1)

ENTER ON TIME

1 SUN 2 MON 3 TUE 4 WED
 5 THU 6 FRI 7 SAT
 8 REPEAT 9 DAY OF MONTH

ENTER DAY OF WEEK, REPEAT CODE,
 OR DAY OF MONTH CODE (1-9)? 8

(I want the event repeated seven days a week starting on Sunday)

HOW MANY CONSECUTIVE DAYS DO YOU
 WANT THIS EVENT REPEATED (2-7)? 7

ENTER TIMES FOR THE FIRST DAY

1 SUN 2 MON 3 TUE 4 WED
 5 THU 6 FRI 7 SAT

ENTER DAY OF WEEK (1-7)? 1

ENTER TIME AS HH:MM:A
 OR HH:MM:P

? 4:30:P

(turn on at 4:30 p.m. Sunday)

ENTER OFF TIME

1 SUN 2 MON 3 TUE 4 WED
 5 THU 6 FRI 7 SAT

ENTER DAY OF WEEK (1-7)? 2

(continued)

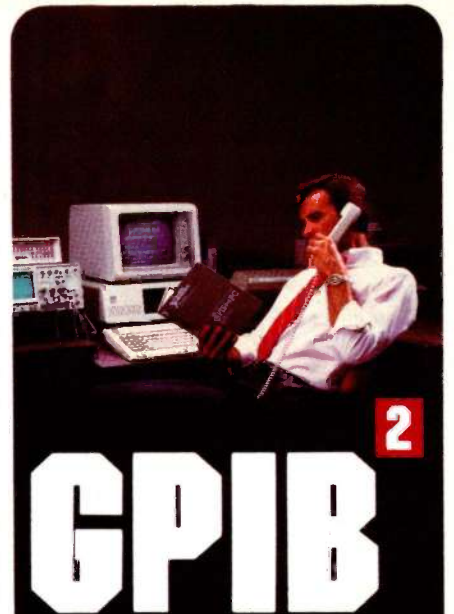

2

GPIB

**IEEE-488 Interfaces and
 Bus Extenders For:**

**IBM PC, PCjr
 & COMPATIBLES**

**DEC UNIBUS, Q-BUS
 & RAINBOW 100**

**MULTIBUS, VMEbus
 STD & S-100**

Full IEEE-488 functionality, with the most comprehensive language and operating system coverage in the industry. It takes experience to make IEEE-488 systems work with nearly 4000 devices available from more than 500 different manufacturers, and experience is what enables National Instruments to take the GPIB to the second power and beyond.



2

Your personal guarantee of unsurpassed customer support and satisfaction. CALL 1-800-531-GPIB for instant access to 100 + man-years of GPIB experience.

**NATIONAL
 INSTRUMENTS**

12109 Technology Blvd.
 Austin, TX 78727
 1-800-531-5086 512/250-9119
 Telex: 758737 NAT INST AUS

IBM and PCjr are trademarks of International Business Machines, MULTI-BUS is a trademark of Intel, DEC, UNIBUS, Q-BUS, and Rainbow 100 are trademarks of Digital Equipment Corporation.

LOOK AT THESE PRICES!



maxell®

A disk for every need, every one backed with a lifetime warranty.

GOLD STANDARD FLOPPY DISKS

5 1/4" Single Sided/ Double Density	50 +	\$1.45 ea.	100 +
5 1/4" Double Sided/ Double Density		\$1.54 ea.	\$1.95 ea.
5 1/4" High Density for IBM AT		\$2.04 ea.	\$3.99 ea.
3 1/2" Micro Single Sided/ Double Density		\$4.08 ea.	\$3.15 ea.
		\$3.24 ea.	

Minimum order 50 diskettes.

DATA-CASE

Stores and files up to 50 5 1/4" diskettes. Made from durable styrene plastic. With order of 100 or more diskettes

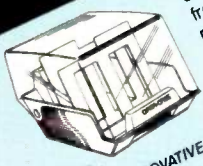

Only Regular \$8.95 \$9.95

INNOVATIVE CONCEPTS, INC.

CALL TOLL FREE 1-800-USA-FLEX
IN ILLINOIS 1-312-351-9700

Please mention this ad when calling in your order. MasterCard, Visa, C.O.D. or net 30 days with approved credit on purchases over \$200.00. Prices subject to change without notice.

COMARK

COMARK, INC. 135 N. Brandon
Glendale Heights, Illinois 60139

CIRCUIT CELLAR

ENTER TIME AS HH:MM:A
OR HH:MM:P

? 6:00:A

(turn off at 6:00 a.m. Monday)

236 CHARACTERS AVAILABLE

ENTER NAME OF MODULE

ONE RETURN STARTS NEW LINE
AND TWO RETURNS ENDS
FRONT PORCH LIGHT

FRONT PORCH LIGHT

- 1 SUN 4:30 PM MON 6:00 AM
- 2 MON 4:30 PM TUE 6:00 AM
- 3 TUE 4:30 PM WED 6:00 AM
- 4 WED 4:30 PM THU 6:00 AM
- 5 THU 4:30 PM FRI 6:00 AM
- 6 FRI 4:30 PM SAT 6:00 AM
- 7 SAT 4:30 PM SUN 6:00 AM

SUN JAN 27 3:09 PM

(the HCS automatically generates the complete weekly schedule)

- | | | |
|---|--------------|------------------|
| | | 1111111 |
| | | 1234567890123456 |
| 1 | BSR ON/OFF A | 000000-0---0--- |
| 2 | BSR DIMMER A | ----- |
| 3 | BSR CYCLER A | ----- |
| 4 | BSR ON/OFF B | ----- |
| 5 | BSR ON/OFF C | ----- |
| 6 | DIRECT OUT | ----- |
| 7 | MESSAGES | ----- |
| 8 | SUPERKEY | ----- |

(turning on the porch light at 4:30 p.m. in January is fine but not in July; returning to the editing menu, we select J and sunset-adjust the porch light)

ENTER LETTER OF CHOICE (A-V)? J

SUNSET ADJUSTMENT

- | | | |
|---|--------------|------------------|
| | | 1111111 |
| | | 1234567890123456 |
| 1 | BSR ON/OFF A | ----- |
| 2 | BSR DIMMER A | ----- |
| 3 | BSR CYCLER A | ----- |
| 4 | BSR ON/OFF B | ----- |
| 5 | BSR ON/OFF C | ----- |
| 6 | DIRECT OUT | ----- |
| 7 | MESSAGES | ----- |
| 8 | SUPERKEY | ----- |

ENTER DRIVER NUMBER (1-8)? 1

ENTER MODULE NUMBER (1-16)? 12

SUNSET ADJUSTMENT

- | | | |
|---|--------------|------------------|
| | | 1111111 |
| | | 1234567890123456 |
| 1 | BSR ON/OFF A | -----S--- |
| 2 | BSR DIMMER A | ----- |

(space brings up the edit menu, then the following)

CIRCUIT CELLAR

```

3 BSR CYCLER A -----
4 BSR ON/OFF B -----
5 BSR ON/OFF C -----
6 DIRECT OUT -----
7 MESSAGES -----
8 SUPERKEY -----
    
```

(the porch-light event schedule will now be automatically adjusted every 8th and 22nd to follow the change in sunset)

ENTER DRIVER NUMBER (1-8)?

(just enter a return to get the status display again)

SUN JAN 27 3:10 PM

```

                                1111111
                                1234567890123456
1 BSR ON/OFF A 000000-0---0---
2 BSR DIMMER A -----
3 BSR CYCLER A -----
4 BSR ON/OFF B -----
5 BSR ON/OFF C -----
6 DIRECT OUT -----
7 MESSAGES -----
8 SUPERKEY -----P
    
```

(input events take priority over everything else; to keep the status from changing while I was communicating via a live terminal to an installed HCS, I locked out inputs 1-5; entering P displays the input status)

INPUT STATUS

```

                                1111111
                                1234567890123456
REFERENCE 0000011111111111
CURRENT LEVEL 0000111111111111
INPUT LOCKOUT 1111100000000000
    
```

(for this illustration, I had only five inputs connected; 6-16 are open and read logic 1)

A CHANGE REFERENCE LEVEL
B CHANGE LOCKOUT STATUS

ENTER LETTER OF CHOICE (A-B)?

(at this point the lockouts are removed from input bits 1 through 5; the input status then appears as follows:)

INPUT STATUS

```

                                1111111
                                1234567890123456
REFERENCE 0000011111111111
CURRENT LEVEL 0000111111111111
INPUT LOCKOUT 0000000000000000
    
```

(note that bit #5 is high)

A CHANGE REFERENCE LEVEL
B CHANGE LOCKOUT STATUS

ENTER LETTER OF CHOICE (A-B)?

(return entered to see status again)

SUN JAN 27 3:16 PM

```

                                1111111
                                1234567890123456
1 BSR ON/OFF A 001110-1---0---
2 BSR DIMMER A -----
3 BSR CYCLER A -----
4 BSR ON/OFF B -----
5 BSR ON/OFF C -----
6 DIRECT OUT -----
7 MESSAGES -----
8 SUPERKEY -----
    
```

(while the input display showed only me at the terminal in the Circuit Cellar when I called it—motion sensors are short-pulse output devices—apparently the system caught me running upstairs to the bathroom; it turned the lights on, by the way)

GET SERIOUS!

*** JUNE MODEM SPECIAL ***
ANCHOR VOLKSMODEM 1200 \$179.95

* SYSTEMS *

ITT EXTRA PC-256K
Two 1/2 Hl. 360K Dr's, Monochrome Board, 12" Amber/Green Monochrome Monitor, Serial & Parallel Port, Wordstar, Multiplan, Advanced Basic, DOS 2.1. \$1,995.95
* Same features in IBM PC \$2,624.95

IBM PC-256K
One TEAC 360K Dr., Monochrome Board, Parallel Printer Port, Amber/Green Monochrome Monitor, DOS 2.1. ONLY \$1,995.95

IBM PC-256K
Two TEAC 360K Dr's, Color/Monochrome Graphics Board, Parallel Printer Port, Taxan Monochrome Display, DOS 2.1. ONLY \$2,145.95
10 Meg Upgrade \$639.95

* TOP TEN SOFTWARE *

dBASE III IBM \$359.95
Print Shop APPLE 34.95
Bankstreet Writer IBM/APPLE 49.95
Managing Your Money IBM/APPLE 115.95
Dollars & Sense IBM 113.95
Norton Utilities 3.0 IBM 59.95
PFS Write/File/Report 85.95
Sideways IBM/APPLE 39.95
Multimate IBM 269.95
Crosstalk IBM 104.95
Microsoft Word IBM/MAC 249.95/119.95

* HARDWARE *

AST Six Pack Plus 64K \$259.95
STB Rio Plus II 64K 249.95
PARADISE 5-Pack 64K 179.95
QUADRAM Quadboard 64K 249.95
STB Color/Monochrome Graphics 259.95
STB Monochrome Graphics 259.95
HERCULES Monochrome Graphics 329.95
HERCULES Color Card 179.95

* PRINTERS DOT MATRIX *

PANASONIC 1091 120CPS \$289.95
PANASONIC 1092 180CPS/NLQ 33CPS 379.95
EPSON FX-80+ 160CPS 395.95
EPSON FX-100+ 160CPS 644.95
OKIDATA 92P 160CPS 389.95
BROTHER 2024L 200CPS/NLQ 96CPS 995.95

* PRINTERS LETTER QUALITY *

BROTHER HR-15 17CPS \$369.95
BROTHER HR-25 24CPS 609.95
BROTHER HR-35 36CPS 849.95
PANASONIC 3151 23CPS 495.95

* MONITORS *

TAXAN 121/122 Monochrome \$145.95
PRINCETON HX-12 469.95
PRINCETON MAX-12 179.95
ZENITH Amber/Green Composite 85.95
NEC 1260 Green Composite 85.95
NEC 1305 RGB/T.V. 449.95

* MODEMS *

HAYES 1200B Internal w/Smartcomm 2 \$369.95
HAYES Micromodem IIe 219.95
HAYES 2400 649.95
ANCHOR Volkmodem 300 54.95
PROMETHEUS Promodem 1200 324.95

* APPLE *

80 COLUMN 64K Iie Only \$99.95
80 COLUMN Card II+ Only 58.95
VIDEX Ultraterm 178.95
ASCII Express 79.95
Z-80 Card 49.95
APRICORN Serial Card 59.95
MICRO SCI A2 Drives 159.95
APPLE Compatible Drive for IIC 169.95
16K Card 49.95

THOUSANDS OF ITEMS AVAILABLE.
CALL FOR COMPLETE PRICING.

714/840-2406
Se Habla Espanol

CALIFORNIA MICRO HOUSE

16835 Algonquin St., Huntington Beach, CA 92649

Corporate accounts welcomed, purchase orders accepted with net 30 day terms, subject to credit approval. All prices represent cash prices. All items shipped next day in factory sealed packages. We guarantee all items for 30 days. California residents please add 6% sales tax. Prices subject to change without notice.

CIRCUIT CELLAR



Photo 3: HCS Exec initial menu.



Photo 4: Device selection on Exec.



Photo 5: Device particulars as shown on Exec.



Photo 6: Input selection on Exec.



Photo 7: Input particulars as shown on Exec.

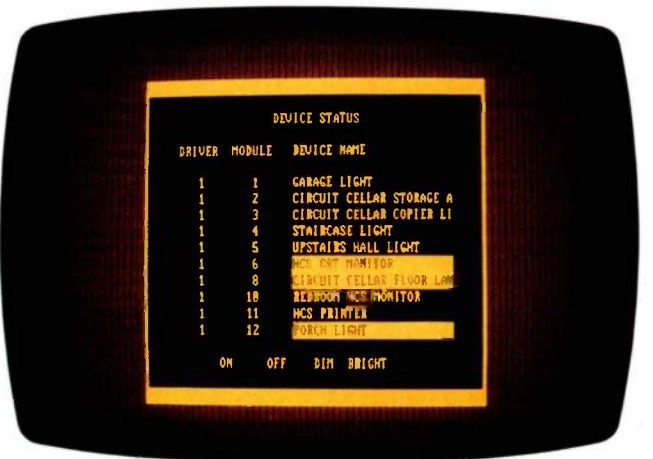

Photo 8: Device status on Exec.

the cursor is merely positioned over the device to select it.

In a similar manner, Exec defines and designates inputs by name, as photo 6 shows. Ten of the inputs are shown at a time (they scroll up and down), and positioning the cursor over an input gives the particulars for that input. In photo 7, the "Circuit Cellar Staircase" input designates a motion detector connected to input line #3, which is currently enabled and is activated with a logic 1 input level. When all inputs are defined, Exec can monitor inputs or devices in real time. The status display and input option (see photos 1 and 2) are polled once a second by Exec and used to update a real-time display on the PC. Devices that are currently active are highlighted (see photo 8).

Once the devices, and inputs if necessary, have been defined, events can be designated for each output device. In the case of the porch light (photo 9), seven daily events turn the light on at 7 p.m. and off at 6 a.m. For the upstairs hall light (photo 10), 3-minute time periods are triggered by either inputs from the "Circuit Cellar Staircase" motion detector or the "Upstairs Hallway" motion detector.

One thing that I hadn't thought of until late in the process is shown in photo 11. Under program control, this HCS option enables you to connect a parallel printer to produce a permanent record of time, date, and events triggered by an input change of state.

IN CONCLUSION

It's impossible to demonstrate all the features of the HCS in a few articles. My system has expanded considerably since the first few automatically controlled lights. Now I can call the Circuit Cellar from anywhere in the world, assess the situation, and modify the control accordingly. Of course, this same capability can be accomplished with your average personal computer, an elaborate I/O (input/output) interface, and many programmer-months of effort.

The HCS is a stand-alone single-board realization of all these fantasies. It is not an exercise left to the reader but a tried-and-proven design that allows control-happy computerists to come out of the closet at a reasonable expense.

For those of us who are beyond help, the maze just keeps growing. The 3- by 4-foot plywood area is full, a second HCS is performing dedicated control tasks, and I really am thinking about the air conditioning. Given all the installed motion detectors, the HCS can make real-time decisions and direct air conditioning only to inhabited areas. What's another 18-lead cable strung through the Circuit Cellar?

EXPERIMENTERS AND OEM USERS

As always, I try to support the computer experimenter by providing sources for many of the components. The Circuit Cellar HCS is suitable for OEM applications as well. It is available in various configurations that are all ultimately upgradable to the same potential.

If you plan on building the unit from scratch, good luck



Photo 9: Event triggers for a porch light.



Photo 10: Event triggers for a hall light.

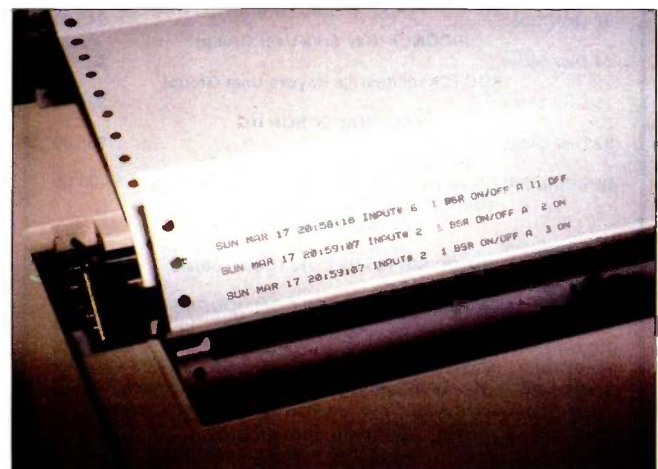

Photo 11: Printer-interface capability.

8086
8088
Now
68000

8080
Z80
6809

Real-Time Multitasking Executive

- No royalties
- Source code included
- Fault free operation
- Ideal for process control
- Timing control provided
- Low interrupt overhead
- Inter-task messages

AMX is TM of KADAK Products Ltd.
CP/M-80 is TM of Digital Research Corp.
IBM, PC-DOS are TM of IBM Corp.

Options:

- Resource Manager
- Buffer Manager
- Integer Math Library

Language Interfaces :

C	Pascal		
PL/M	Fortran		

DOS File Access :

CP/M-80	AMX for 8080		\$ 800 US
IBM PC DOS	8086		950
	6809		950
	68000		1600
	Manual (specify processor)	75	

KADAK Products Ltd.
 206-1847 W. Broadway, Vancouver, B.C., Canada V6J 1Y5

(604) 734-2796
 Telex: 04-55670

ONLY PUBLIC DOMAIN SOFTWARE

is uncopied, so no license fees to pay to anyone! Thousands of useful dbase, spreadsheet, word processors, games, utilities and business programs you can copy yourself from our User Group rental libraries. Join hundreds of companies and users enjoying a wealth of inexpensive software!

RENTAL LIBRARIES FOR CP/M

SIG/M UG (New Jersey Area Computer Club)	
216 Disk Sides	\$125.00
CP/M UG (New York Area Computer Club)	
92 Disk Sides	\$45.00
PICONET (Bay Area User Group)	
34 Disk Sides	\$25.00
KUG (Charlottesville Kaypro User Group)	
25 Disk Sides	\$25.00
NATIONAL EPSON UG	
32 Disk Sides	\$35.00
PD DIRECTORY CATALOG DISK	
SPECIAL SALE—includes CP/M, SIG/M UG & PNET	
	\$5.00 pp
RENTAL LIBRARIES FOR IBM PC DOS	
PC-BLUE (NYACC)	
82 Disk Sides	\$85.00
IBM-PC SIG (Santa Clara Group, others)	
230 Disk Sides	\$250.00
RENTAL LIBRARIES FOR COMMODORE 64	
28 Disk Sides	\$25.00
PD DIRECTORY BOOKLET	
	\$12.00 pp

Rental is for 7 days after receipt. 3 more days grace for return. Use your credit card — NO DISK DEPOSIT! Most formats available — even Apple! Specify. Software also available for sale, \$6.00 per disk full.
24 hr., 3 minute info. recording
(619) 727-1015

NATIONAL PUBLIC DOMAIN RENTAL CENTER
1533 Avohill Dr., Vista, CA 92083
(619) 941-0925 Orders

CIRCUIT CELLAR

and take heart. Send me a picture of your board, and I'll send you a hexadecimal dump (16K bytes) of the control software (provided it is for noncommercial private use). If you're a bit more well-heeled, I'll supply the code on two 2764 EPROMs (erasable programmable read-only memories) and a manual for \$32, postpaid in the U.S., \$5 extra overseas. (No picture is required.)

CIRCUIT CELLAR FEEDBACK

This month's feedback begins on page 461.

NEXT MONTH

I'll present a collection of alarm and environmental monitoring circuits. ■

Special thanks to Bill Summers and Leo Taylor for their software expertise.

Editor's Note: Steve often refers to previous Circuit Cellar articles. Most of these past articles are available in book form from BYTE Books, McGraw-Hill Book Company, POB 400, Hightstown, NJ 08250.

Ciarcia's Circuit Cellar, Volume I covers articles in BYTE from September 1977 through November 1978. *Volume II* covers December 1978 through June 1980. *Volume III* covers July 1980 through December 1981. *Volume IV* covers January 1982 through June 1983.

The following items are available from

The Micromint Inc.
25 Terrace Dr.
Vernon, CT 06066
(800) 635-3355 for orders
(203) 871-6170 for information

1. Home Run HCS—Complete assembled system with enclosure and parallel-encoded keyboard. HCS01, \$589
2. Home Run HCS—Populated PC board. Assembled and tested PC board. No enclosure or keyboard. HCS02, \$429
3. Home Run HCS—Video-based kit. Includes PC board and all components except enclosure, keyboard, and serial-interface components (IC16, IC17, IC20, and two DB-25 connectors) . . . HCSV05, \$329
4. Home Run HCS—Terminal-based kit. Includes PC board and all components except video-display processor (IC22, IC25, and IC26). No keyboard, enclosure, or RF modulator HCST06, \$289
5. 8K-byte static-RAM upgrade. Increases RAM to 16K bytes HCS20, \$35
6. Apple II-compatible ASCII-encoded keyboard. HCS21, \$79
7. Wall transformer/transmitter module (available separately) HCS22, \$40
8. IBM PC Upload/Download event-schedule-storage software with terminal emulator, written in C, provided on IBM PC-DOS 2.0 disk HCS25, \$49

All kits and assembled units include operators manual, power supply with wall transformer/transmitter module, and 8K bytes of RAM. All units are supplied without keyboard-encoder chip (not necessary when using encoded keyboard, IC18—optionally available). All item numbers that list enclosures also include backup battery holder (six C cells), less batteries. Serial-port and video-display-processor upgrades for items 3 and 4 and various other components are also available.

Please include \$8 for shipping and handling in the continental United States, \$12 elsewhere. New York residents please include 8 percent sales tax. Connecticut residents please include 7.5 percent sales tax.

To receive a complete list of Ciarcia's Circuit Cellar project kits, circle 100 on the reader-service inquiry card at the back of the magazine.

142 BYTE • JUNE 1985

Inquiry 304

C PROGRAMMING COMES TO LIFE

"Difficult to use", "Amazingly powerful", "Can't spot syntax errors", "It's so much faster." C is the programming language of the decade. It has the power and the sophistication everyone is looking for, yet it's so difficult to use.

With Living C everyone can program in C. That means you can learn how to write powerful applications in C that run at great speed. Living C is a systematic programming tool, that shows you, through cursor movements, the statements that are actually executed (and their consequence) rather than the ones you think are executed. This one feature alone will allow immediate and correct understanding of your own, or equally importantly, someone else's program.

So what's Living C got? Well, it consists of a full function Screen Editor, compiler and run-time package that allows you to 'animate' the code on screen. Breakpoints may be set, or programs may be traced one line at a time. Several windows may be displayed on your PC's screen, so that your program's output is kept separate from your debugging information.

Variables may be examined or altered, and in addition, the value of a variable may be continuously displayed in a window.

Furthermore, Living C gives you full menu and multi-level intelligent help facilities, allowing you to call for help and advice at any time during entry, execution or debugging of your C code. During compilation any errors are automatically highlighted in the text, which can then be corrected immediately using Living C's full screen editor.

Finally, once you've finished developing and editing your program, Living C will disappear into the background to let you get on with running the program you've created.

Main Features:

- Full C compiler compatible with Kernighan and Ritchie standard
- Programs are fully animated on screen
- Multiple windows to separate output and ease testing
- Full trace and debug facilities
- Full screen editor included. Errors can be corrected without leaving the environment and the compilation continued
- Teaching tool for learning C or understanding complex programs

LIVING C - PERSONAL ONLY \$99

Living Software, 250 North Orange Avenue, Suite 820, Orlando, Florida 32801

Mail to: Living Software
250 North Orange Avenue, Suite 820
Orlando, Florida 32801

Please Send	Quantity	
Living C - Personal @	\$99 x	= \$ _____
Code Generator @	\$99 x	= \$ _____
Handling & Shipping Orders		= \$ 10.00
Florida residents please include Florida Sales Tax		= \$ _____
TOTAL		\$ _____

Payment Visa MC Check Money Order

Credit Card expiry date _____ / _____

Name on Card _____

Card # _____

To order your copy of Living C -Personal, please complete this form:

Name _____

Shipping Address _____

City _____

State _____ Zip _____

Telephone _____

Living C - Personal is available for PC-DOS with min 192KB RAM.

COD's and Purchase Orders will not be accepted by Living Software.

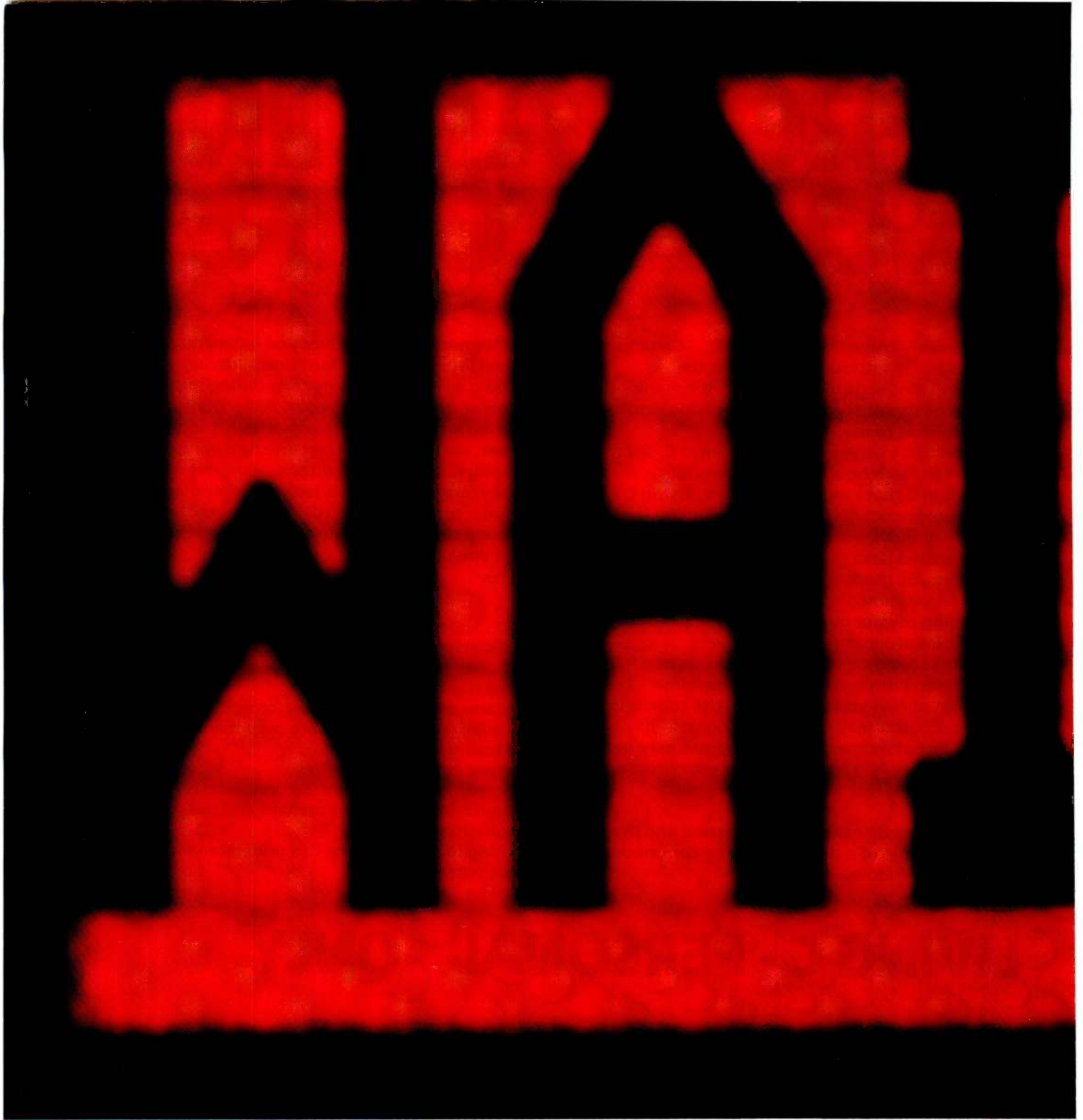

DOES WORKING ON LOTUS 1-2-3™ MAKE YOU SEE RED?

Granted, Lotus 1-2-3™ can be a fast spreadsheet.

Except when you first buy it, take out the five floppy disks, study the manual to figure out which ones do what, put the plastic doohickey over the keyboard, and begin reading about all the installation procedures you need to get the thing up and running.

Or if you never make a circular calculation (any simultaneous equation, even something as simple as "bonus equals 10% of profit after bonus") when doing a complicated spreadsheet.

By the time 1-2-3 calculates it correctly, you may have retired.

Or if you'd like to plot your data with a single keystroke, because it can take several minutes (including a disk change) just to start the process.

Or if you'd like to quickly create a file directory under program control. 1-2-3 can't do that at all.

What's the point of all this?
We'd like you to go down to



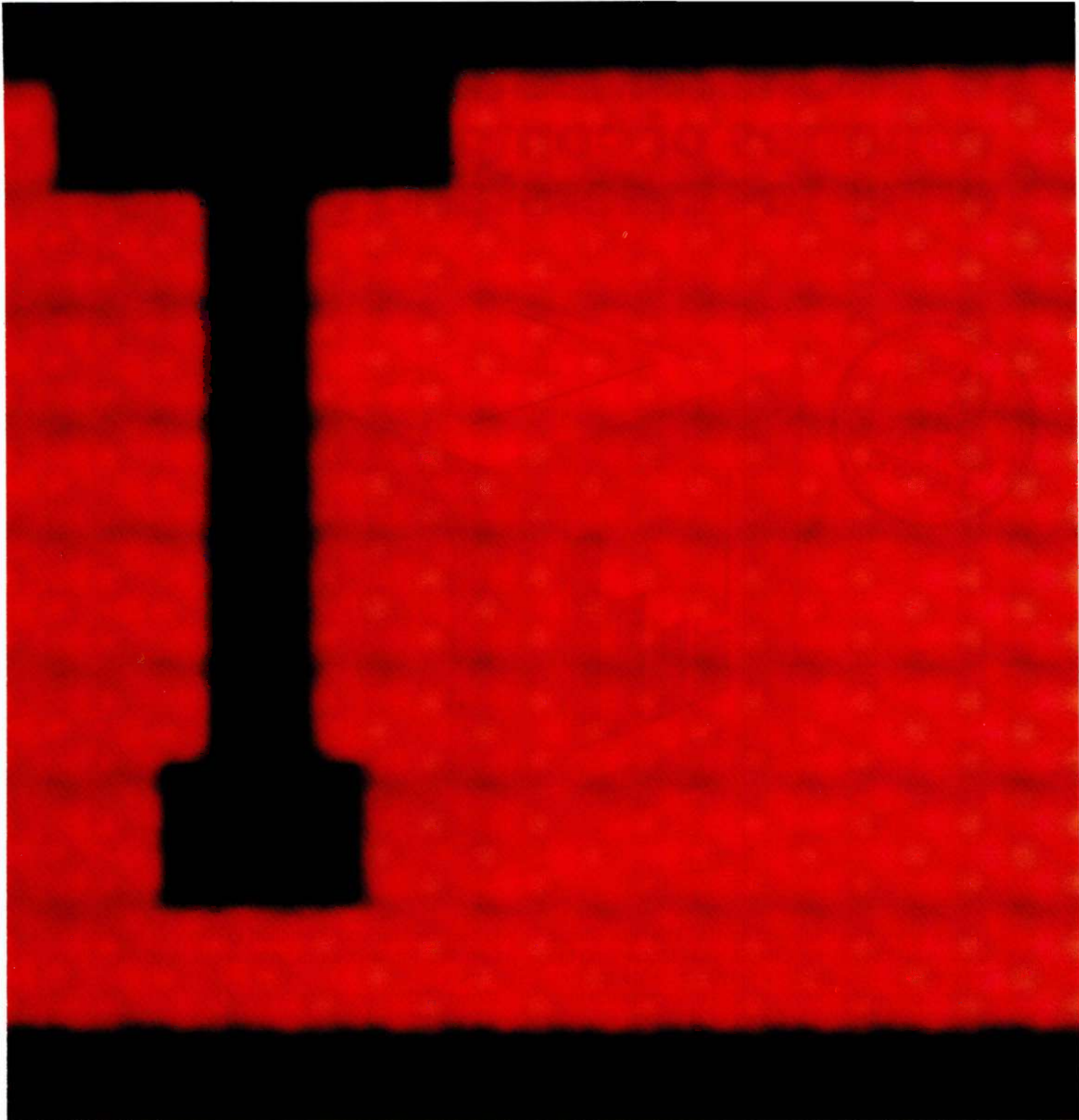

your software dealer and see a new product called SuperCalc® 3 Release 2, which, unlike Lotus 1-2-3, does all of the above.

Along with a larger spreadsheet. Vastly superior graphics. Incredible speed (that becomes even faster when used with the 8087 or 80287 math co-processors, which 1-2-3 doesn't support). And more.

For a lot less money.

All on one disk that you can run right out of the box. (Our lawyers want you to know we include an addi-

tional file disk. Which also contains the popular printing program Sideways™, so you'll never have to cut and paste wide printed reports together again. Unless you use 1-2-3.)

But don't believe us about all this. Go take a look.

After you do, one thing should become obvious.

What are you waiting for?

SORCIM / IUS
MICRO SOFTWARE

A Division of Computer Associates International, Inc.

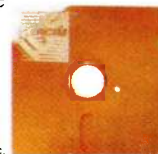

© 1985 Computer Associates International, Inc. SuperCalc is a registered trademark of Computer Associates International, Inc. Lotus and 1-2-3 are trademarks of Lotus Development Corporation. Sideways is a trademark of Funk Software, Inc.

Chart-Master™ turns volumes of complex data into easy-to-understand graphics.

**RATED
NUMBER 1
BY
SOFTWARE
DIGEST!**

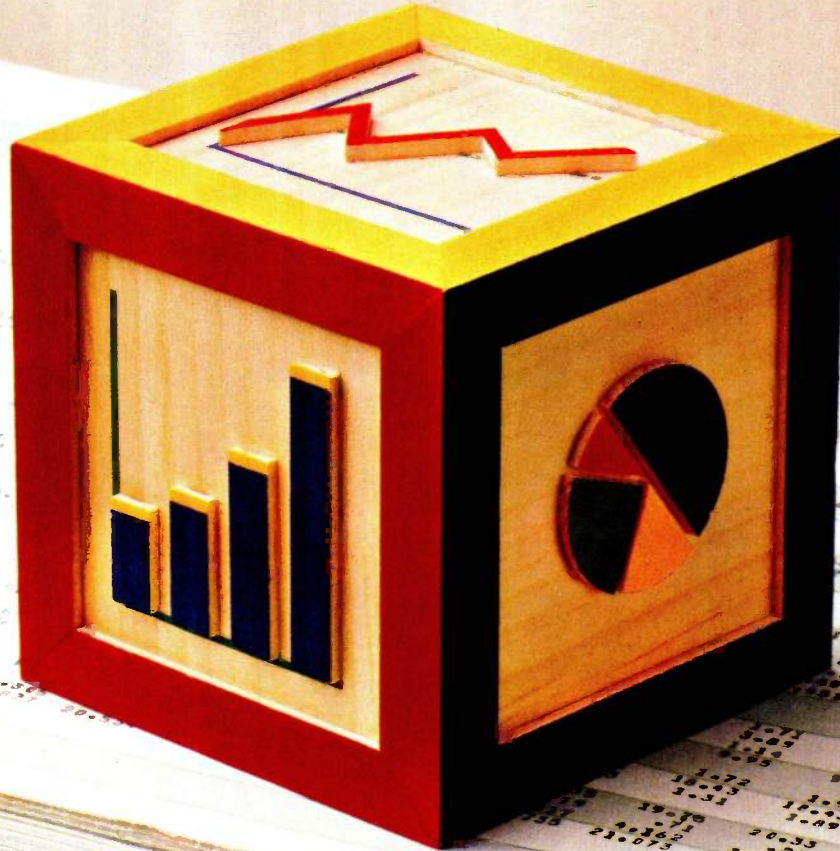

"A picture is worth a thousand words." With this simple concept as a building block, Chart-Master is changing the way busy executives, analysts and secretaries look at, interpret and present information. In a fraction of the time required to wade through volumes of printouts, you can

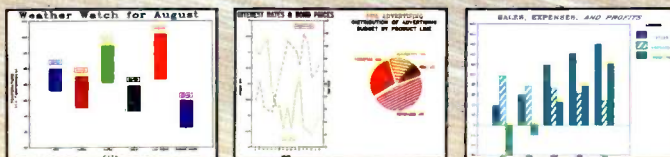

Values printed at data points; both left and right Y-axis scales; floating legends & bars; both horizontal & vertical formats; exploded pie sections.

produce easy-to-understand bar charts, pie charts and scatter diagrams quickly and dramatically. Chart-Master makes it easy to customize reports and presentations with six different fonts, label placement, proportional pie charts and more.

Menu-driven Chart-Master allows you to enter data and select a chart format at the press of a button. You then preview your selection on your personal computer screen as it would appear in final form. Or, you can review the various Chart-Master graphic options to make sure you have selected the most effective format. When satisfied,

you can transfer your selection to paper or acetate transparencies for a colorful, presentation-quality chart in seconds.

Chart-Master presents a *clear picture* of the "bottom line," which conveys of information understand and decision makers appreciate. That's why major corporations like GE, Eastman Kodak, Exxon, Union Carbide, GM, AT&T, DuPont, 3M, Citibank, Motorola, Procter & Gamble, and GTE rely on Chart-Master to translate "volumes of complex data into meaningful information."

Chart-Master supports the IBM Instruments XY750, Panasonic VP Series, Houston Instruments DMP29, Yokogawa PL1000 and Strobe plotters, in addition to the Hewlett-Packard family of plotters, for use with IBM PC and other compatible computers.

The retail price of Chart-Master is \$375. For a complete information kit and name of your nearest dealer, contact Decision Resources, Inc., 25 Sylvan Road S., Westport, CT 06880. (203) 222-1974.

DecisionResources
Software Designed for Decision Makers

SALT

*A threaded interpretive
language interfaced
to BASIC
for research laboratory
applications*

Research laboratories such as ours have become increasingly dependent on computers. This spiraling dependence has been fueled by the decreasing cost and increasing availability and power of microcomputers. A major impediment to the further use of computers is the lack of adequate software. To overcome this limitation, we developed a method of combining compiled and interpretive higher-level languages for general use in a diversity of laboratory applications.

In our previous work with mini-computers, control programs were written in a higher-level language, such as BASIC, with assembly-language subroutines for each specialized task. When two tasks were to be performed in immediate sequence, we either wrote a new routine combining the two earlier versions or made two separate calls to the routines from BASIC. Rewriting programs requires a great deal of programming time, but making repetitive calls from BASIC frequently took unacceptably long execution times. To eliminate both of these problems, we decided to develop a means of linking assem-

bly-language routines together so that they could be used in a single CALL statement from BASIC. Before we had progressed very far, we found that we had reinvented the threaded interpretive language (TIL), this time in a form that was interfaced directly to BASIC.

THREADED INTERPRETIVE LANGUAGES

TILs consist of a set of "words." Primary words, called *primitives*, consist of machine-language subroutines. More complex words, *secondaries*, consist of a sequence of calls to primitives. Higher-level words may call primitives or previously defined secondaries in any order. They consist simply of a list of calls to starting addresses of the words. Program execution is rapid because all the primitives are run in machine language and the only extra time is that which is required to pass parameters to each routine and to proceed from one routine to the next.

A TIL has two distinct functions, *compiling* and *running*. Compiling consists of creating the lists of tasks to be performed in sequence and placing the necessary parameters in a place where the primitives can obtain them. Running consists of carrying out the tasks in sequence. The major difference between types of threaded interpretive languages is the way the program passes from one routine to the next by a process called *threading* (see reference 1). We use the technique called *subroutine threading*. When running, the program simply makes a subroutine call to each word in sequence. Every word, both primary and secondary, ends with a return (RET) instruction. Since the se-

quence of routines in our application is initially called from BASIC, the final RET statement in the list returns program control to BASIC.

It might be asked why we do not use one of the existing TILs. The principal reason is that we require a more interactive control language in the laboratory, where every possible turn of events cannot be anticipated when a program is written. Another reason is that we find looping and conditional branching restrictive and difficult to use in other TILs. Finally, other higher-level languages contain commands that are convenient for performing routine tasks but are not readily available in most TILs.

BASIC

BASIC was developed as a language for beginners. In fact, most people can learn to write programs in BASIC within a few hours. This is an advantage in a university laboratory populated partially by students, where inexperience is common and personnel turnover is high. It is not, however, the major reason for using BASIC as the principal language in the laboratory. Its major virtue in this setting is a characteristic that might usually be considered a drawback, namely, that it is

(continued)

When Sam Fenster isn't working as a computer programmer at the University of Chicago, he is a sophomore majoring in mathematics and computer science at Columbia University. Lincoln E. Ford is associate professor of Medicine and Cardiology at the University of Chicago.

You can write to the authors at the University of Chicago, Section of Cardiology, Department of Medicine, Hospital Box 249, 950 East 59th St., Chicago, IL 60637.

*BASIC has become
the standard language
of many small
computers, and thus
is constantly
being improved.*

an interpretive language. This means that every command in a program is translated to machine language immediately before it is carried out. The need for separately interpreting each command slows program execution greatly, but it also makes the programs highly interactive. That is, a program can be stopped at any point and the operator will know precisely where he is because his original program is unaltered.

Once a BASIC program has been interrupted, the computer can be run in immediate mode. The operator can instruct the computer to carry out commands one at a time. In this manner, it is possible for the operator to determine the value of a variable, change a variable, or even change the path of program flow. The ability to interrupt a computer that is interfaced to laboratory apparatus is invaluable when the operation of the apparatus is not entirely predictable, as is often the case.

A final advantage of BASIC is that it has become the standard language of many small computers, including the IBM Personal Computer (PC). As a result, it is constantly being improved and has many useful features.

One disadvantage of some forms of BASIC is their limited memory capability. The version used on the IBM PC can address only 64K bytes. Although this is sufficient space for most programs, laboratory apparatus can frequently generate enough data to make this space seem cramped. Subsequent analysis can usually reduce the data to a more manageable size,

but it is necessary to find some way to hold the data without severely limiting the program area. To this end we have designed SALT to store raw data in areas of "high" memory above the BASIC space. An entire block of data can be transferred between this space and disk. Portions of the data in a block can also be transferred between high memory and BASIC arrays. This ability to move large amounts of data between high memory and disk and to operate on smaller parts of it in BASIC arrays provides a type of virtual memory, greatly expanding the capability of BASIC.

The major disadvantage of BASIC is its slowness. While running programs in an interpretive language, the computer cannot respond fast enough for many laboratory applications. To overcome this slowness, machine-language subroutines control the computer when it is interacting with the laboratory apparatus. A difficulty with using simple subroutines occurs when two or more of them are to be run in sequence. Program control returns to BASIC after each subroutine call. This return costs valuable time, and more importantly, the time required may be somewhat unpredictable, especially when parameters must be passed from BASIC to the subroutines. For time-critical operations in which subroutines are to be run sequentially, it was previously necessary to write additional subroutines, combining earlier ones in the proper sequence. As the number of computer applications in the laboratory increased, the continued rewriting of subroutine sequences became costly. To overcome this difficulty, we have developed a method of calling subroutines from a master machine-language routine, with one CALL statement from BASIC.

SALT

SALT is a laboratory TIL. As with all TILs, SALT's two distinct functions are compiling and running. All compilation is performed by a single assembly-language routine called from BASIC. This routine, named LOADER, creates secondary machine-language words that are subsequently called

from BASIC. A secondary word consists of a sequence of CALL instructions, each followed by the starting address of the routine being called and any necessary parameters. Thus, a call from BASIC to a secondary word initiates a second call to the first word in a sequence. The final instruction in a list is RET, bringing the program back to BASIC. It is not possible to call any of the primitive subroutines directly from BASIC. The LOADER routine must first translate the name of the routine to its starting address and create a secondary word consisting of a machine-language CALL instruction followed by all necessary parameters and RET at the end.

The secondary words in a program are recompiled each time the program is run. Thus, programs in SALT are actually created and stored from within BASIC programs. It is not possible with SALT, and probably not desirable in general, to create secondary words that retain their identity outside the individual program. To use SALT, a programmer must be familiar only with the general requirements of the assembly-language routines he wishes to run and with the requirements of the LOADER command. He need not know about any previously written programs or about the specifics of the assembly-language programs. [Editor's note: See the end of the article for details on obtaining copies of the SALT software package.]

At present, we have more than 100 separate assembly-language primitives. These are grouped into functional categories described in detail below.

HARDWARE

The software described here was written specifically for an IBM PC equipped with a Tecmar Lab Master board, 512K bytes of memory, and two floppy-disk drives. It was developed out of a need for an easy and efficient way to make use of the Lab Master. The general principles can, however, be applied to any similar computer system. Almost all laboratory applications can be described as

(continued)

Make Stat Magic

Now for the IBM PC/AT*
with hard disk

Statistics, reports and plots happen magically with SPSS/PC™—the Statistical Package for IBM PC/XTs.*

SPSS/PC is the most comprehensive statistical package for performing simple or complex tasks, regardless of data size. It maintains feature and language compatibility with mainframe SPSS, while optimizing for the PC environment.

Statistics range from simple descriptive to complex multivariate, including Multiple Regression, ANOVA, Factor and Cluster analysis. Loglinear and nonparametric procedures are also included.

Simple facilities allow transfer of files between

SPSS/PC and programs like Lotus 1-2-3, dBase II and SAS. A complete Report Writer, Plotting facilities and a Communications program for mainframes round out a fully integrated product.

For more information, contact our Marketing Department without further ado. And see what a little stat magic can do for you.

SPSS Inc., 444 N. Michigan Avenue,
Chicago, IL 60611, 312/329-3500.

In Europe: SPSS Benelux B.V.,
P.O. Box 115, 4200 AC Gorinchem,
The Netherlands, Phone: +31183036711
TWX: 21019.

VISA, MasterCard and
American Express
accepted.



SPSS inc. PRODUCTIVITY RAISED TO THE HIGHEST POWER™

*SPSS/PC runs on the IBM PC/XT or AT with 320K memory and a hard disk. An 8087 co-processor is recommended. Contact SPSS Inc. for other compatible computers.

IBM PC/XT and AT are trademarks of International Business Machines Corporation. dBase II is a trademark of Ashton-Tate. 1-2-3 is a trademark of Lotus Development Corporation. SAS is a registered trademark of SAS Institute, Inc. SPSS and SPSS/PC are trademarks of SPSS Inc. for its proprietary computer software. © Copyright 1985, SPSS Inc.

a combination of the following functions: control of experiments, including timing and synchronization of external events, and setting external voltages; data acquisition, usually through the digital conversion of electrical analog signals; data storage; and data analysis. All of these functions can be implemented with the hardware and programs described here, except that the topics to be described under the heading of data analysis are limited to a few routines for simple arithmetic procedures and display that might be used as part of more sophisticated analyses.

The Lab Master board has four discrete functions required for laboratory application: an analog-to-digital (A/D) converter with 16 channels of input; two digital-to-analog (D/A) converters; a 24-channel digital input/output (I/O) device; and a chip with five programmable counters and an internal 1-MHz clock, whose basic frequency can be divided either by powers of 10 or powers of 16. Most of the software routines that we will describe are directed at implementing the four functions of the board. The remainder are used for performing simple arithmetic operations on blocks of num-

bers and for moving blocks of data between storage areas.

DETAILS OF OPERATION

SALT consists of a single compiling routine, LOADER, and a large number of small subroutines that perform very specific operations during program execution. The small subroutines are no different from any other type of assembly-language routine except that many are designed to be used in sets. For example, one subroutine may set up a counter for timing operation and another may be required to start the actual timing. The aspect of SALT that makes it unique is the LOADER routine that establishes the secondary words that are called from BASIC.

LOADER

The LOADER routine that compiles the secondary words converts all other subroutine names to addresses, eliminating the time required to look up addresses during execution. It then uses the addresses in a sequence where each one is the operand of a CALL, which is followed by any necessary parameters. A RET is placed at the end of the sequence,

and the starting address of the entire sequence in memory is placed in a table. The use of memory by the LOADER routines, as well as the memory allocation for SALT and the A/D data operation, is shown in figure 1. As illustrated, separate memory areas are reserved for secondary routines and for their addresses when SALT is loaded into memory. The LOADER routine fills these areas as it compiles secondary words. In the present version of SALT, those reserved areas are relatively small because there is no need in our application to have them any larger. In principle, the only limitation to the size of these areas is the amount of available memory.

The parameters passed to the routine can be of three types: fixed integer values placed after the routine call; positions of binary bits to be set in a byte that is then placed after the routine call; and BASIC integer variables whose addresses are stored after the call. The following example illustrates the operation of LOADER.

In this example, a word called DR.2 (driver routine number 2) will first configure the 24 I/O lines into three 8-bit

(continued)

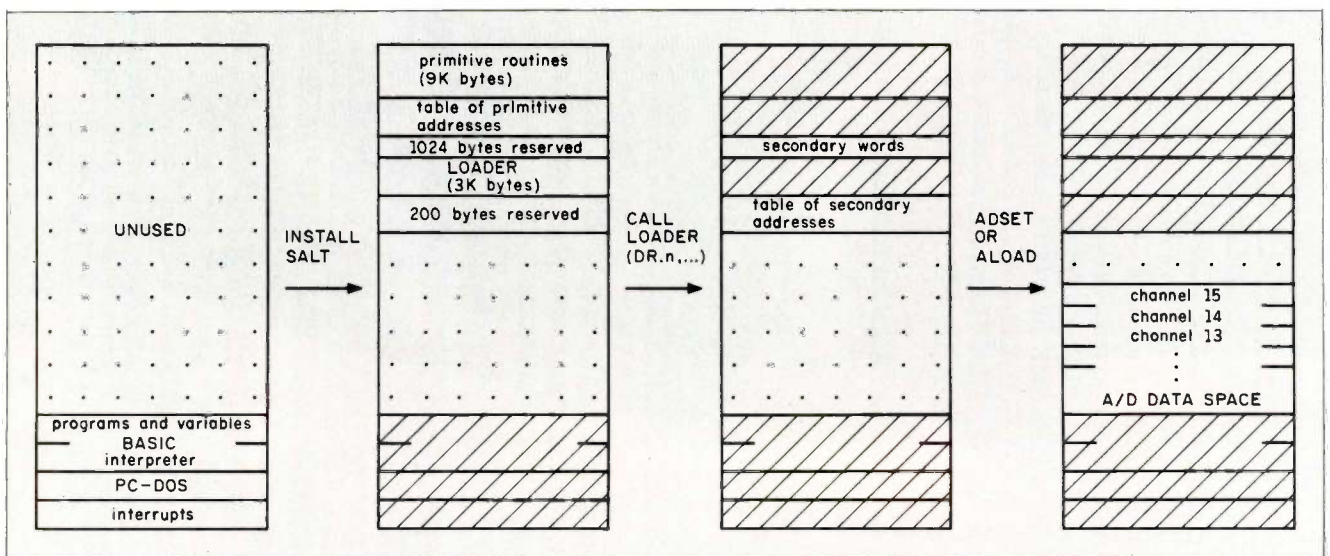

Figure 1: Installing SALT with a BASIC BLOAD instruction puts the primitives and LOADER routines at the high end of memory and reserves space for the compiled secondary words and for a table of addresses of the secondary words. A CALL to

LOADER creates a secondary word and places the starting address of the word in a table. The ADSET or ADLOAD routines allocate data space in memory immediately above BASIC. The data space is arranged into equal-size channels.

The most BASIC.

Microsoft® BASIC is the language spoken by nine out of ten microcomputers worldwide. It's the language with the most programs written for it.

So if you want to access the power of your Macintosh™, only one language makes the most sense. Mac's first language, Microsoft BASIC.

Not only is it the industry standard, it's the most advanced BASIC for Macintosh. It lets you add mouse commands. Graphics. Windows. Change type fonts and styles. Customize menus. Incorporate music and sound effects. Write your own dialog boxes. Basically, it lets you take advantage of everything that makes Mac 'Mac.'

It makes editing programs as easy as cutting and pasting and pointing and clicking. Debugging is easier

than ever with the advanced trace command.

It's no wonder Microsoft is the most logical choice for the Macintosh.

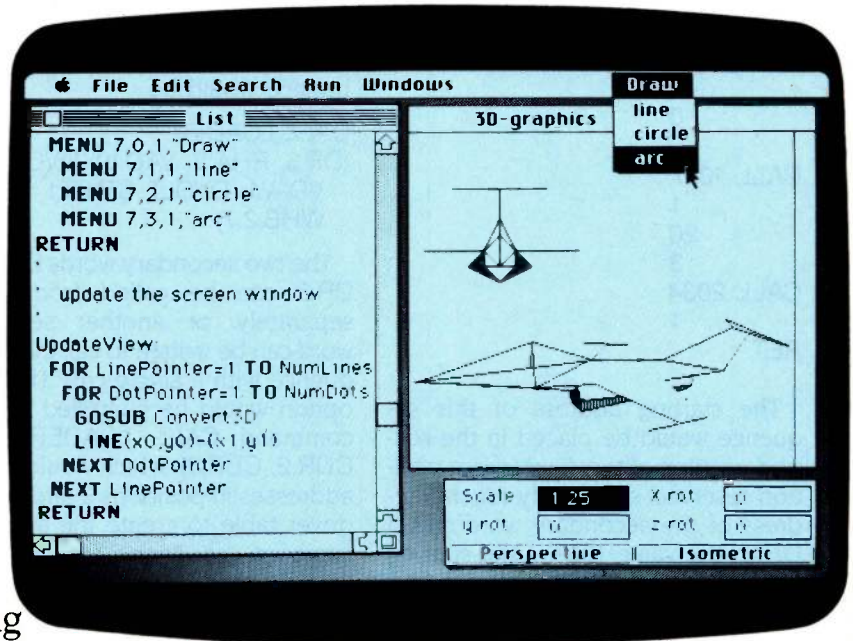

MICROSOFT We've The High Performance Software written more Macintosh programs than any other software company. Including Mac's spreadsheet, Multiplan®.

So if you want to get the most out of your Macintosh, call (800) 426-9400 for the name of your nearest Microsoft dealer. In Washington State, Alaska, Hawaii and Canada, call (206) 828-8088.

Microsoft and Multiplan are registered trademarks of Microsoft Corporation. Macintosh is a trademark licensed to Apple Computer, Inc.

MSOFT

ports such that the first (A) port is input and the remaining two (B and C) are output. Second, DR.2 initializes counter number 1 to count 20 milliseconds. Finally, DR.2 stops the counter at its initialized value to wait for the command START to begin counting. The BASIC command to perform this sequence is

```
CALL LOADER (DR.2,IOSET.1.0.0,
TIME.1.20.3, STOP.1).
```

LOADER would then create a secondary word in memory consisting of the following sequence:

```
CALL 1003
    1
    0
    0
CALL 1097
    1
    20
    3
CALL 2034
    1
RET
```

The starting address of this sequence would be placed in the second position of the *driver table*, a position reserved specifically for the address of the secondary word called DR.2. The value 1003 is the starting address of the IOSET primitive that initializes the I/O ports, and the parameters 1.0.0. specify the desired configuration. The value 1097 is the starting address of TIME, the routine that sets a counter to count from the Tecmar clock. The parameter 1 specifies the first counter, and the parameter 20 gives the number of pulses to count. The parameter 3 specifies the millisecond rate. The STOP routine, which begins at address 2034, holds counter number 1 at its pre-set count until a START.1 command begins the count.

Once the initialization is complete, another secondary word can use parts of the Lab Master board for other purposes. For example, a word called DR.3 can be written to: wait for I/O line A2 to go high; read a voltage value on A/D channel 10; put the same voltage on D/A channel 1; wait

Table 1: Functional categories of SALT's primitive subroutines.

File and data management
Timing
Analog-to-digital conversion
Digital-to-analog conversion
Digital input/output
Arithmetic procedures
Miscellaneous routines

20 milliseconds using counter number 1, which was initialized by DR.2; and set I/O channels B2 and B7 high. The BASIC command to create this sequence would be

```
CALL LOADER
(DR.3, RHA.2, VAD.10, DVOLT,
VDAV.1, DVOLT, START.1, WAIT.1,
WHB.2.7)
```

The two secondary words DR.2 and DR.3 can be called from BASIC separately, or another secondary word can be written to call them in sequence with a single call. This latter option would be compiled with the command CALL LOADER (DR.4, CDR.2, CDR.3), which would use the addresses in positions 2 and 3 of the driver table to create the assembly-language sequence

```
CALL 812
CALL 871
RET
```

CALL DR.4 is the BASIC command that would execute the entire sequence of tasks before returning to BASIC.

The LOADER command has very specific requirements, some of which have been imposed for ease of the initial programming, some of which have been created for ease of subsequent programming, and some of which have been imposed by the idiosyncrasies of IBM BASIC. For example, all of the secondary words are called DR.N where N is an integer between 0 and 100, and the commands DEFINT D and LOADER = 3 must precede the first call to LOADER in the BASIC program. The starting address of the LOADER routine is 3. The

necessity for using the DEFINT D statement has been imposed to eliminate the need for typing the "%" character following each DR definition and each BASIC integer variable parameter, such as DVOLT. The term DR is always used to name the secondary words so that the LOADER program can find the beginning of the parameter list following the words CALL LOADER. A CALL statement from BASIC pushes the entire parameter list in the statement onto the stack. The LOADER routine examines the stack to find the first variable, which always begins with DR. Once this is found, the integer following DR. is used to identify the secondary word.

PRIMITIVE SUBROUTINES

The individual primitive can be grouped under the separate functional categories listed in table 1. They are described below in detail by category. The listings of the individual routines are not given here because they require too much space and because they are, for the most part, specific to the Lab Master board.

When these routines were developed, the highest priority was given to speed, because they were designed to be used in real-time applications. To achieve this speed, the routines were made as simple as possible. The number of Test and Conditional Jump instructions was kept to a minimum because they take a moderate amount of program execution time. The desired simplicity was achieved at the expense of some redundancy in the program. For example, there are nine separate routines to write nonvariable data to the three digital I/O ports. These nine routines differ from each other in only two characteristics, the I/O port to be written to, and the type of output, i.e., whether the specified channels are to be made high, made low, or to toggle (change from the previous value). Since there are three alternatives for each of the three channels, there are nine combinations. Each of the routines is short (about 18 bytes), so that the memory required for nine

(continued)

New Version

Classic COBOL.

True mainframe COBOL for your microcomputer. Validated by the GSA at the highest possible level of compliance with the ANSI '74 standard. With Microsoft® COBOL, mainframe programmers can be productive on MS-DOS™ and Microsoft XENIX® micro-computers immediately.

Speed and Beauty.

High performance in a COBOL program comes mostly from the speed of the ISAM. And Microsoft COBOL 2.0 has the fastest ISAM on the market.

And our advanced screen handling capability lets you create the highly interactive programs that end users prefer.

We wrote the book.

It's no surprise that IBM®, DEC®, AT&T, H-P and Wang® all chose Microsoft COBOL for their MS-DOS machines. We know how to get the most out of their micro-computers. After all, we designed the operating system.

So call (800) 426-9400. In Washington State, Alaska, Hawaii and Canada, call **MICROSOFT®** (206) 828-8080. The High Performance Software®
We'll give you the name of your nearest Microsoft dealer or help you update to Microsoft COBOL 2.0.

Certified High Level Compiler:

- GSA validation at the Federal High Level of compliance with the ANSI '74 standard.
- Built in sort-merge, chaining, dynamic calling, and overlays.

Fast multi-key ISAM:

- Split-keys and duplicate keys.
- Benchmark results of 5000 reads and writes to an ISAM file:

	Microsoft COBOL 2.0	Realia COBOL	MicroFocus® Native Code	Ryan-McFarland® COBOL 2.0
hours:				
minutes	1:32	1:56	2:58	3:30

Interactive extended screen section:

- Cursor positioning, auto skip, automatic data field formatting.
- ACCEPT and DISPLAY data by the screen full.

Productivity utilities:

- Interactive Symbolic Debugger.
- Rebuild file recovery utility restores corrupted ISAM files.

Price:

- \$700 for compiler and utilities.
- No runtime royalty fees.

Minimum System requirements:

- MS-DOS 2.0 or later, 192K RAM, and one disk drive.
- Xenix 286, 512K RAM, and one disk drive.



MSOFT

Microsoft and Xenix are registered trademarks and The High Performance Software is a trademark of Microsoft Corporation. IBM is a registered trademark of International Business Machines. DEC is a registered trademark of Digital Equipment Corp. Wang is a registered trademark of Wang Laboratories, Inc. MicroFocus is a registered trademark of MicroFocus. Ryan-McFarland is a registered trademark of Ryan-McFarland.

separate simple routines is not much greater than that for a single routine that would accept the I/O port and the type of output as parameters. A larger, single routine would, however, require much more execution time.

Execution times were measured for

all the time-critical routines that might be used during an experiment. These were estimated in two ways. Some execution times were measured from failures to make A/D recordings on a regular schedule. A ramp voltage was put into one channel of the A/D con-

verter, which was programmed to make conversions at regular intervals that had been established by the frequency of the internal clock. The intervals between clock cycles were decreased in increments of 1 microsecond (μs) until the A/D failed to make a conversion. To detect a failure, the recorded ramp voltage was output to the oscilloscope using the D/A routine. A missed sample was recognized as a double step between voltage levels in the displayed ramp, as shown by the arrows in figure 2. This method could also be used to measure execution times of routines by directing the computer to perform the routines between sampling periods. A second, more straightforward, method of measuring execution times was to use a primitive called COUNT that returns the value in the buffer of a specified counter without influencing the counter's operation. By setting the counter to count down from a large number at microsecond intervals, it was possible to estimate execution times with a resolution of 1 μs . The COUNT routine took $68 \mu\text{s} \pm 1 \mu\text{s}$ each time it was called. The execution time of routines inserted between two calls to the COUNT routine was therefore calculated by subtracting $68 \mu\text{s}$ from the measured interval.

It might be expected that the execution time for a given routine could be calculated from the number of clock cycles required for each instruction in the routine. In general, the routine took 30 to 50 percent longer than expected. A possible explanation for these longer times has been given in *PC TECH JOURNAL* (see reference 2). Further explanations are beyond the scope of this article. In addition, the execution times were somewhat variable. A possible cause of this variability in timing arises from memory-refresh cycles that occur at unpredictable intervals during program execution. This variability may cause a routine to take variable periods of time, so that variations in execution times will not occur regularly or predictably. Thus, it was necessary to

(continued)

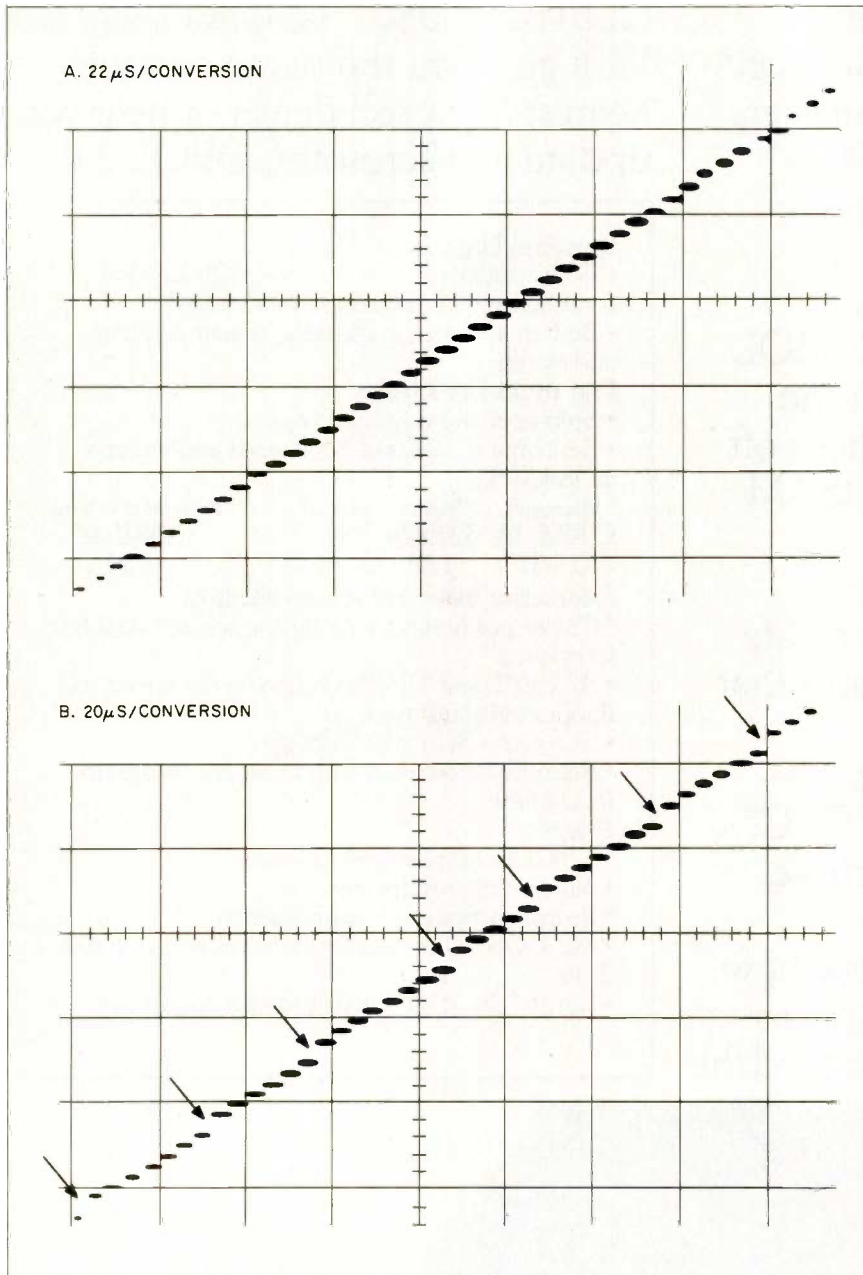

Figure 2: A voltage ramp was recorded at two sampling intervals, differing by only 2 μs . The digitized data was displayed at the same rate for both. Failure to make a conversion, indicated by the arrows in B, resulted in a complete sample being missed after every 5-8 conversions. The voltage step after a missed sample is twice normal.

Ferocious FORTRAN.

Microsoft® FORTRAN crunches numbers with a vengeance!

It combines fast and efficient native code compilation with built-in 8087 coprocessor support. The result? Mini and mainframe performance from your MS™ DOS micro.

Based on the '77 standard, Microsoft FORTRAN supports extensive statements and data types—including complex numbers and IEEE single and double-precision floating point accuracy.

Support for large arrays (greater than 64K bytes), separate module

MICROSOFT compilation, The High Performance Software and overlays, allow you to create very large programs—up to one megabyte, with access to more than 65 thousand records in a file as large as four gigabytes.

How do programmers feel about Microsoft FORTRAN?

“The first FORTRAN compiler

that takes advantage of the full addressing capability of the 8088 and the power of the 8087.”

—Jack Wilschke, *Softalk*

“We decided to use the Microsoft FORTRAN Compiler for its INTEGER 4 capability and the flexibility of its 8087 implementation.”

—Charlie Huizena & Chip Barnaky, *PC World*

Call 800-426-9400 to order
the ferocious FORTRAN.
\$350*

In Washington State, call 206-828-8088. Ask for operator A4, who will rush you your order, send you more information, or give you the name of your nearest dealer to see Microsoft FORTRAN in action.

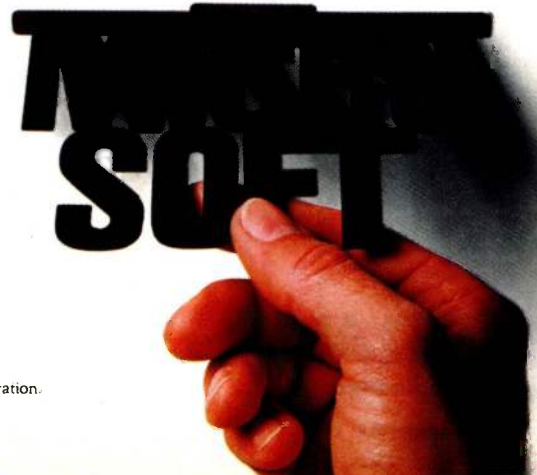

measure execution times repetitively and to estimate an average and a range of speeds.

FILE AND DATA MANAGEMENT

All data is handled as 2-byte integer samples. A few primitives operate on a single number. For example, one primitive sets a voltage value on one of the D/A channels and another records the voltage of a single A/D channel. Most data is handled as long arrays. Before such data can be recorded, a space must be reserved for it in high memory using the ADSET routine, as shown in figure 1. This primitive requires two parameters to establish the number of channels and the number of samples per channel. Once recorded, the data can be transferred to disk using the SAVEF primitive, which creates a disk file using a filename previously specified as a BASIC string variable.

The first 2 bytes in the file are used to record the number of samples per channel. When a file is read from disk using the LOADF primitive, a buffer of the correct size is first created in high memory, and the data is read into it. To use the recorded data in a BASIC program, it is necessary to move the data from its buffer in high memory to a BASIC integer array (e.g., DATAARRAY). This is done with the FETCH primitive, which requires two parameters. The first is an integer that designates the channel number, the second (e.g., D.N2) is a BASIC variable that has been set by the BASIC VARPTR function to the starting address of the BASIC array. The BASIC instruction

```
D.N2 = VARPTR(DATAARRAY(0))
```

should immediately precede a CALL to a secondary containing the FETCH primitive because BASIC moves its ar-

rays around unpredictably. The number of the first sample to be transferred from a channel is placed in the zero position of the BASIC array using a BASIC instruction. Samples are transferred sequentially until the defined array is filled or until the end of the channel is reached. In this manner, only a portion of a record is transferred at one time, so that only a small amount of BASIC array space need be used. Another instruction called STORE performs the inverse of FETCH. It transfers data from a BASIC array to a previously defined data space in high memory.

Two additional routines, SAVEF and LOADF, transfer arrays of data in high memory to and from disk. The arrangement of data into channels is the same as that produced by the ADSET routine (see figure 1).

There is a primitive called SWITCH that allows the operator to switch be-

DISKETTE ORGANIZA

Media Mate.™ **The best diskette** **file for the money.**

For organizing, protecting and transporting your diskettes, the Amaray Media Mate is the best file you can own. And you can buy it for just \$15.95*.

The Media Mate is available in two sizes, to hold up to fifty 5¼" diskettes, or thirty 3½" diskettes.

*Suggested retail price. Media Mate 5
Media Mate 3



AMARAY
Makers of Media Mate

tween two simultaneously existing buffers in high memory. Since each buffer can be as large as 64K bytes, a total of 128K bytes of high memory is available. The combination of ADSET, FETCH, STORE, SAVEF, LOADF, and SWITCH greatly expand the amount of space available to BASIC for handling data. Because data can be transferred between buffer and disk and then to and from BASIC, the routines provide BASIC with a form of virtual memory.

TIMING

Precise timing is essential in almost all laboratory applications. Such timing is made available by a 1-MHz clock in the timer-counter chip on the Lab Master board. The basic frequency can be divided either by powers of 10 or powers of 16. To keep the application simple, we have chosen to use only the decimal divisions. The

divided frequencies are available in two forms. They can be divided further by numbers ranging from 1 to 16 and made available externally as an "F-out" square wave. We have not yet found this provision useful and instead have chosen to perform timing using one of the five counters in the chip. There were two reasons for this decision: The F-out pulse is not available internally to software, and more importantly, it cannot be synchronized to external events. The 1-MHz clock and its dividers operate continuously so that they cannot be synchronized at all. The counter can, however, be made to begin counting in synchronization with an externally applied signal. By counting a large number of high-frequency pulses, it is possible to synchronize the counters to within the limits of the basic frequency. Since the counters can count to two pulses, it is possible, in princi-

ple, to achieve 1- μ s accuracy of synchronization. In practice, the accuracy is limited to 3 μ s because about 3 out of every 15 μ s (14 out of every 72 central-processor clock cycles) are used by the computer for memory refresh, and it is not possible to control when the 3- μ s interruptions will occur.

The counters on the Lab Master board are complex and have 18 different modes of operation. Despite this complexity, the chip containing the five counters, the 1-MHz frequency generator, and the frequency divider is controlled using two 1-byte ports. While it would be possible to initialize the counters directly from BASIC by sending data to the two control bytes, the complexity of the timers makes it much easier to use separate subroutines to establish each of the modes of operation.

(continued)

TION FROM AMARAY™

DiskBank.® **Organization as** **you need it.**

Whether you have 10 diskettes — or 210 — you can organize them, and keep them organized, with the Amaray DiskBank. It changes and grows right along with your needs.

The DiskBank is available for 8", 5¼" and 3½" diskettes*.

Ask for the Amaray Media Mate or DiskBank wherever computers and computer products are sold. Or call 800-4-AMARAY for the dealer nearest you. Amaray International Corporation, 14935 N.E. 95th Street, Redmond, WA 98052.

*Suggested retail price, System 5 — \$29.95; System 3 — \$15.95.

Single module fits in a briefcase.

Modules stack and interlock to create an expandable library system.



Adjustable file doors hold disks in place whether DiskBank is placed vertically or horizontally.

AMARAY
Makers of DiskBank

The complexity of the counters arises from the combinations of available functions. Each counter can count either internal pulses or external pulses, each can count repetitively or give a single count, and each counter can be gated either internally or externally. Finally, each counter has two 16-bit registers from which it

obtains its count.

In our application the counters are used for two main purposes. The first is the timing of D/A and A/D conversion. Since conversions are usually made at regular intervals, the counters are usually set to run continuously. In most cases, the duration of the pulses is not critical because the digital con-

versions are triggered on the changing edge of the counter pulses, so that only one of the two counter registers is used at one time to generate the correct frequency. In one application, the counter pulses are also applied to sample-and-hold circuits used to synchronize the conversion. In this case the pulses from the counter must be sufficiently long to hold all the external circuits in the hold mode until the analog values are converted. Both counter registers are used, one to establish the frequency and the other to set the pulse duration. In another application, the two counter registers are used to establish two separate frequencies. Switching between the two frequencies is accomplished with gating pulses applied externally. The use of these gates eliminates the need for reprogramming the counters and thereby hastens program execution.

The second application of the counters is to control external events by providing pulses of specified duration at specified times. The counter registers are used to establish pulse duration as well as the delay between some initiating event and the onset of the pulse. The counters can be very useful for this purpose because they operate independently of the computer's central processing unit once they have been started. This independent operation speeds program execution greatly.

A/D CONVERSION

The simplest A/D primitives convert a single analog voltage value on one A/D channel and place the digitized integer value in the BASIC variable space. All the other A/D primitives make sequential conversions at a frequency determined by a counter on the timer chip. The principal need for speed in laboratory applications is in the rapid accumulation of digitized data from electrical analog signals. There are four separate routines for this purpose and each has separate advantages with respect to simplicity, speed, and synchronization. All of the routines have been written in a way that makes it possible to interrupt

(continued)



Dot Matrix Made Beautiful

All the type in this ad was printed on an inexpensive dot matrix printer with Fancy Font, the program that works with almost any word processor to produce high resolution, proportionally spaced, letter quality printing.

No special hardware or installation is required, so you'll be using Fancy Font as soon as you get it.

Fonts, including Roman, Sans Serif, Bold, *Italic*, *Script*, Old English and more, from 8 to 24 points come standard with Fancy Font.

FLEXIBLE. Fancy Font comes with a complete set of over 1500 mathematical, foreign language and other special symbols.

Hundreds of additional fonts in sizes from 6 to 72 points are available, at a nominal additional charge, from our growing font library.

You can edit any character and also create your own characters or logos, up to 1 inch by 1 inch.

Powerful formatting features let you center, justify, wrap and type flush left or right, with or without running headers and footers — even with different fonts and sizes on the same line.

COST EFFECTIVE. You buy Fancy Font from your local dealer or direct from us, the software developers, for only \$180.

You get near typeset quality at a small fraction of the time and cost of using art or typesetting services.

Fancy Font runs on PC DOS, MSDOS and CP/M systems with Epson, Toshiba and compatible dot matrix printers.

You'll be turning out great looking reports, newsletters, presentations, letters, mathematical texts, overheads or invitations after getting your copy of Fancy Font. The applications are limited only by your imagination.

Call or write now to order Fancy Font or ask for additional information including actual samples and independent reviews.

CALL TODAY 1-800-351-0500 MasterCharge and Visa Accepted

SoftCraft, Inc.

222 State Street, Madison, WI 53703 (608) 257-3300

Fancy Font is a registered trademark of SoftCraft, Inc.

from MicroComputer Accessories, Inc.

LOCK & ROLL.



It's here to stay. Our Rolltop 100 Disk File[®] with optional lock, holds 120 5 1/4" diskettes (twice the capacity of "flip top" files), in ten sections, with color coded divider labels. Anti-skid feet. Textured buff plastic body with your choice of bronze baked enamel or walnut rolltop. Also available in black with silver mylar rolltop. And 3 1/2" microdiskette and 8" disk models. They're all lock & roll to you.

MicroComputer Accessories, Inc.

5721 Buckingham Parkway
P.O. Box 3725
Culver City, California 90231
Telephone 213/641-1800

In Europe:
N.V. Microcomputer Accessories Europe S.A.
Rue de Florence 37
1050 Bruxelles, Belgique
Telephone 02/538.61.73

These and other fine products are available at Computerland, Businessland, IBM Product Centers and other computer/software retail locations.

Inquiry 438 for End-Users.
Inquiry 439 for DEALERS ONLY.

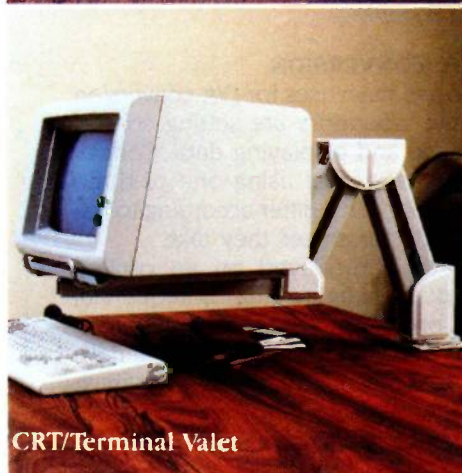

CRT/Terminal Valet

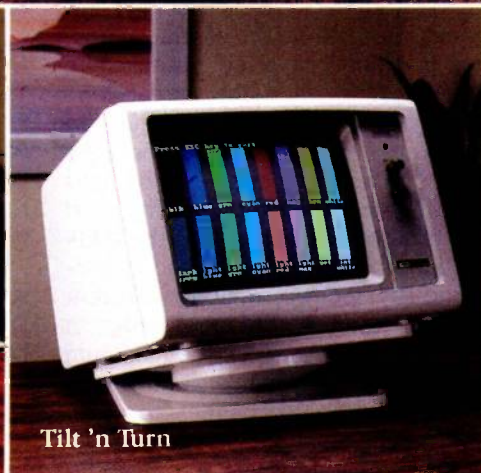

Tilt 'n Turn

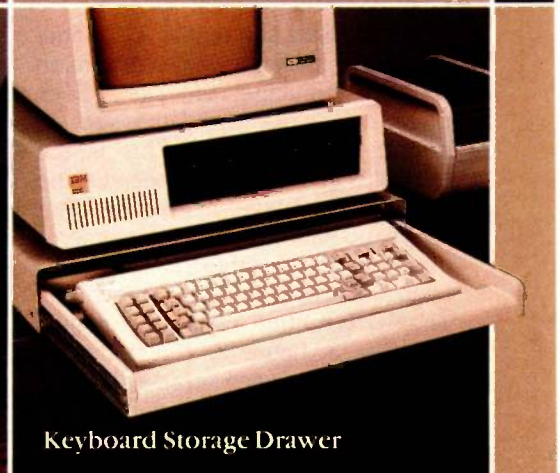

Keyboard Storage Drawer

*The two main uses
for digital-to-analog
conversion in
the laboratory
are setting
control voltage and
displaying data.*

recording to perform some task, such as changing the speed of recording or outputting a control pulse. This latter provision makes it possible to exert a great deal of control over the experiments while collecting data.

All of the sequential A/D routines require that a buffer for the digitized data be established in high memory above the BASIC program area. This is done with the ADSET primitive described above. If recording is stopped before the buffer is full, data will be placed in the next available space when recording resumes. It is also possible to establish two buffers in the present version of SALT. This provision permits data to be collected from a different number of channels at different times. It also makes it possible to transfer data from one buffer to another while performing mathematical manipulations, without destroying the original data.

The simplest sequential A/D primitive, AD1E, makes a single conversion from one channel on every clock pulse and the digitized data is sent sequentially to memory. This is the fastest form of operation because the assembly-language instruction that sends the data to memory increments automatically and there is no need to keep track of the memory location. The AD1E routine was used to collect the data in figure 2. The minimum safe time between conversions is 22 μ s. Timing is accomplished by wiring the external output of a frequency generator to the external start in-

put of the A/D converter. This mode of operation is used because it provides the most accurate timing; each conversion is initiated on a counter pulse without any program intervention.

The three other sequential A/D primitives collect data from multiple channels in sequential order. The Lab Master board has a provision that automatically increments the channel number, beginning with a channel that is specified by software and ending with a channel that is specified by switches on the board. We keep our switches set at the highest channel number to be able to use all 16 channels on the board. The simplest of these multichannel primitives, ADQE, sends data to memory as it is collected, so that the first sample of channel 1 is followed by a first sample of channel 2, and so on. At the end of the period of recording, a routine called SORT orders the data by channels so that the first sample of channel 1 is followed by the second sample of channel 1 and the last sample of channel 1 is followed by the first sample of channel 2, etc. Data acquisition with this routine is as fast as AD1E (22 μ s per conversion) because the channel number is incremented automatically, without program intervention, and because the routines for memory storage are the same.

The remaining A/D primitives order the data as it is collected, sending data from each channel to its proper place in memory. Even though the auto-increment mode is used, the program must keep track of which channel is being converted because the data must be sent to the correct channel block within the buffer. Thus, the program must use two counter registers, one for the channel number and one for the sample number. The need for two counters, as well as the additional programming required to continuously redirect data to different parts of the memory slows program execution substantially. The minimum interval between conversions ranges from 40 μ s for 16 channels to 48 μ s for two channels. The main advantage of these routines over ADQE is that

the data need not be reordered after recording, so that a second buffer is not needed. For many applications this routine is more satisfactory because it is simpler.

The multichannel A/D primitives described above collect data from the different channels at regular intervals so that the first sample of channel 2 is collected later than the first sample of channel 1, and the first sample of channel 3 is collected later than the first sample of channel 2, etc. This is not a major disadvantage because the values in any channel at any given time can be estimated by interpolation. The final A/D primitive, AD, is designed to make nearly simultaneous conversions from all channels. With this primitive, each round of conversions is initiated on a single clock pulse and all samples are converted as rapidly as the software will allow, thereby minimizing the intervals between samples taken from different channels. The interval between samples is not critical because the routine is designed to be used with external sample-and-hold circuits. This routine uses a "software start" to initiate each A/D conversion and instead of detecting an "A/D done" flag, it detects the presence of a pulse on the counter output to start the round of conversions. The same pulse is also output externally to trigger sample-and-hold circuits for each channel. Synchronization occurs because the sample-and-hold circuits are triggered to hold their values on the rising edge of the pulse.

D/A CONVERSION

The two main uses for D/A conversion in the laboratory are setting control voltage and displaying data. Control voltages are set using one of three routines, which differ according to the type of parameter they take.

Data is displayed on an oscilloscope, as in figure 2, using sequential D/A primitives. There are 2 D/A channels and there are 16 A/D channels, so it is necessary to specify which channels are to be displayed. In addition, it is necessary to specify the

(continued)

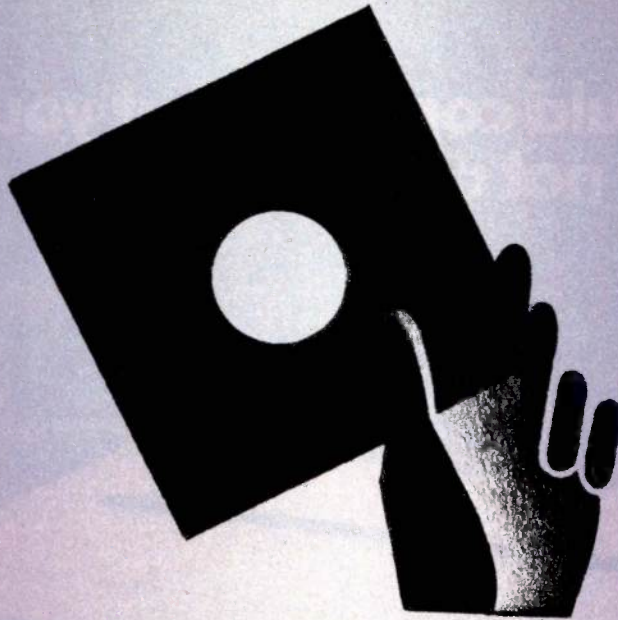

Dick Bard
AND KNOWLEDGEMAN



Most people are satisfied doing one thing well. Not Dick Bard. He runs a successful construction company *and* a successful software design firm.

Fortunately, he has a very hard-working partner: KnowledgeMan.™

"It's a terrific all-purpose tool for designing easy-to-use programs," says Bard, who uses KnowledgeMan to write software for everything from home building to hospitals. "You can design beautiful, user friendly screens; programs that are very simple to follow. And they're a pleasure to write.

"KnowledgeMan puts very few restrictions on the programmer. You don't have to stop and ask yourself, 'Will the system let me do this? Will it let me open as many tables as I want? Will it let me bring in an array if I need it?' It lets you create them on the fly. It's wonderful.

"I considered Lotus™ and Framework™. KnowledgeMan is more logical — far more powerful, too. And it thinks the way I do."

If you're interested in forming a great partnership with KnowledgeMan, contact Micro Data Base Systems, Inc. P.O. Box 248, Lafayette, IN 47902 (317) 463-2581.

A variety of KnowledgeMan options, including K-Text,™ K-Graph™ and K-Paint,™ are available from MDBS.

Current version is 1.07 as of 9/10/84. Operating Systems: PCDOS, MSDOS, CP/M-86. Minimum RAM required is 256K.

Lotus is a trademark of Lotus Development Corporation. Framework is a trademark of Ashton-Tate.



**KNOWLEDGE
man**

The Knowledge Management Software
from MDBS®

LAN Versions Now Available

A printer should complement your computer, not compromise it.



It's a simple fact that your small computer can compute a lot faster than your printer can print. A problem that becomes even more frustrating in business, when your computer is tied up with your printer while you're ready to move on to other work.

Of course, the only thing more frustrating than waiting on a slow printer is waiting on a printer that's down. Unfortunately, chances are the initial printer you purchased with your computer system just isn't designed to work on continuous cycle high volume printing.

More than likely, you've already experienced one, if not both of these frustrations. But now, you can turn printer frustration into printing satisfaction with the new Genicom 3014, 3024, 3304 or 3404. Professional printers for personal computers...price/performance matched for small business systems.

Designed and built to increase productivity and maximize the value of your personal computer, the range of 3000 PC printers offers 160-400 cps draft, 80-200 cps memo, and 32-100 cps NLQ printing...performance for both high productivity and high quality printing.

The 3014/3024 models print 132 columns. The 3304 and 3404

models give you a full 136 column width, and offer color printing as well.

Each printer is easy to use, lightweight, functionally styled and attractive. And you can choose options from pedestals and paper racks to document inserters, sheet feeders and 8K character buffer expansion, plus more.

Genicom 3000 PC printers feature switch selectable hardware, dual connectors and dual parallel or serial interfaces. Plus the 3014 and 3024 emulate popular protocols for both Epson MX with GRAFTRAX-PLUS™ and Okidata Microline 84 Step 2™, while the 3304 and 3404 emulate popular protocols for Epson MX with GRAFTRAX-PLUS™. So your current system is most likely already capable of working with these Genicom printers without modification.

Most important, the Genicom 3000 PC printers are quality-built, highly durable printers designed for rapid, continuous duty cycle printing.

So why wait? And wait. And wait. Get a Genicom 3000 PC printer now.

Genicom Corporation, Department C411, Waynesboro, Virginia 22980. In Virginia, call 1-703-949-1170.

GENICOM

The New Printer Company.

For the solution to your printing needs call

TOLL FREE 1-800-437-7468

In Virginia, call 1-703-949-1170.

SALT

rate of conversion. Since the output is displayed repetitively on an oscilloscope, it is important to make this routine as fast as possible. In addition, it is highly desirable to have the sample output rate be a round number of milliseconds. The D/A routines can operate without failure at 48 μ s per conversion and so can be used conveniently at 50 μ s per conversion. At this rate two channels of 1000 samples each require 50 milliseconds for display. The two-channel repetition rate is thus about 10 per second. The repetition rate is actually a little lower because the oscilloscope requires a few milliseconds to reset its beam to the beginning of each trace. A repetition rate of 12 to 18 Hz is not flicker-free, but is also not too uncomfortable to scrutinize.

DIGITAL I/O PRIMITIVES

The I/O ports are used in our laboratory to transfer 5-volt TTL (transistor-transistor logic) pulses between the computer and other apparatus. This transfer of digital signals enables the computer to control the experiments, or in some cases, to be directed by external events. Frequently the digital pulses must be transferred during other time-critical operations, such as making rapid A/D recordings. For this reason, these routines were made as simple and therefore as short as possible. As explained above, this need for simplicity resulted in a large number of very similar primitives. The simple routines take about 31 μ s. If the routine is to be run during A/D sampling, an additional 50 μ s is required to stop and start the sequential A/D routines.

ARITHMETIC PRIMITIVES

A group of primitives perform simple arithmetic manipulations on entire channels of data located in high memory. The manipulations include addition, subtraction, multiplication, and division by constants as well as integration and differentiation. These routines can be very useful in making displays, finding maxima, and detecting trends.

(continued)

**New Release
4.1**

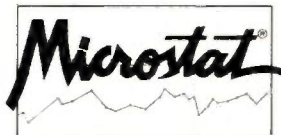

We've continually improved Microstat since it was introduced in 1978, and the latest release includes many new features you've wanted.

- | | |
|--|--|
| Interactive and Batch Processing | Data sets that can exceed memory |
| Expanded Data Management | Multiple Regression (including Stepwise) |
| Subsystem with New Data Transforms | Scatterplots (including best fit regression) |
| Reading data files created by other programs | Correlation Analysis |
| 3 types of Analysis of Variance | 12 Nonparametric tests |
| Time Series | 8 Probability Distributions |
| Crosstabs and Chi-Square | Descriptive Statistics |
| Factorials, Permutations, and Combinations | Easy Installation |
| Hypothesis Tests | |

Microstat's algorithms have been designed to prevent numeric overflow errors and yield unsurpassed accuracy. Microstat's price is \$375.00 including the user's manual and is available for the Z80, 8086, 8088 CPU's and CP/M80, CP/M86, MS-DOS, and PC-DOS. To order, call or write.



6413 N. College Ave. • Indianapolis, IN 46220
(317) 255-6476



Trademarks: Microstat (Ecosoft), CP/M (Digital Research), MS-DOS (Microsoft), PC-DOS (IBM), Z80 (Zilog), 8086, 8088 (Intel).

IF POWER FAILS, DATASAVER® TAKES OVER!

- PROTECTION** - saves data during power failures.
- saves hardware from overvoltage transients.
- PORTABILITY** - allows mobile or extended holdup time using auxiliary 12 volt battery.
- FEATURES** - internal battery provides 5 min. + operating time - AC line conditioning
- audible and visual alarms, interrupt signal - compact, desktop styling
- no installation required.

200 WATT - \$495 / 90 WATT - \$350
For special applications and product information, call 805-541-4160.

Instant power order line
805-541-4161



CUESTA SYSTEMS, INC.
3440 Roberto Court, San Luis Obispo, California 93401

INSTANT AC POWER



There are a few miscellaneous routines for operations that could also be run from BASIC, but which have been included in SALT so that program control would not have to return to BASIC each time they were to be run. These routines print messages on the monitor, sound the beeper, etc. They can be used, for example, to provide

warning sounds and error messages in SALT.

FUTURE IMPROVEMENTS

This first version of SALT contains all the necessary routines for interfacing a computer to laboratory apparatus and for manipulating blocks of data, but it contains very little else. It is ob-

vious that more primitive routines for data analysis would be useful, and that the language might be useful outside the lab. Rapid routines for displaying records with cursors on the displays, finding maxima and minima in records, etc., would greatly speed some types of analysis. High-speed mathematical routines, such as fast Fourier transforms, could also be extremely useful in some specialized applications. Nonlaboratory applications would include all forms of assembly-language routines to be run in batches under control of an interactive higher-level language, such as BASIC. The use of assembly-language routines for performing repetitious procedures and for handling large blocks of data can greatly hasten program execution time and expand the memory space available to BASIC, without sacrificing its interactive qualities. Fortunately, the structure of the language permits the simple addition of the necessary primitives. Once the routine is written, its name, starting address, and parameter format are simply added to the tables of primitives. Since the assembly-language routines are short, it will generally not be necessary to remove old routines to make room for new ones. The current version of SALT occupies about 12K bytes of instruction space, of which 9K bytes are used for primitives. As written, the program can fill up to 64K bytes of higher memory with assembly-language programs, so that the space occupied by the primitive routines can be expanded over fivefold before economy of space becomes a consideration. [Editor's note: You can obtain a copy of SALT on disk and documentation of its operation by sending \$50 to Sam Fenster, 4949 S. Woodlawn Ave., Chicago, IL 60615.] ■

FINALLY!

Communications Hardware and Software that's Inexpensive, Easy to Use and Guaranteed.



"The Amazing SpiderNet ... an incredible amount of utility available to almost any small-sized application."
Ron Exner, 12/84 *Hardcopy*

SNARE™—SpiderNet's Callback Security System

- Protects ANY dialup computer system from unauthorized intruders
- Authorized users are called back at specific locations
- SNARE secures three modem lines at less than \$200/line
 - Up to three separate computers can use SNARE simultaneously
 - Uses Hayes-compatible modems or others like DEC's DF03
 - Stores 70 authorized users, expands to 150 (300+ soon)

\$595

SpiderNet—Printer/Plotter Sharing Unit

- Shares expensive RS-232 plotters, daisy wheel or laser printers
- Makes laser printers affordable for your office or department
- Two to five micros or minis can share a peripheral
- Connect and use—no software modifications required!
- Optional 64K buffer for spooling

\$495

SpiderNet—Computer and Peripheral Networking \$495

- Six port, intelligent software-controlled RS-232 switch
- Share multiple peripherals between systems
- Interconnect computers to share data and files
- Three pairs of ports can be connected simultaneously
- Links ports at different baud rates
- Programmable, perfect for custom RS-232 control application

SpiderNet—Multiplexer, Terminal Concentrator and more \$495

- Five to one RS-232 multiplexer/demultiplexer
- 5x1 or 4x2 concentrator for expanding terminal ports

ENVOY™—Telecommunications Software

- Access to electronic mail, remote systems and data networks
 - Error free, text and binary file transfers via XMODEM or ANSI X3.28
 - Smart terminal mode with capture buffer, autodial and autologin
 - Easy to use, menu driven, compact and high speed
 - Utilities menu for copy, type, print, erase and rename files
 - For IBM PC, PCjr, PC compatibles, Sanyo MBC-55X, CP/M-80 or -86

\$49.95

30-day money-back guarantee on all products

ARTISOFT INC

2828 N. Country Club #105
Tucson, Arizona 85716
(602) 327-4305

Inquiry 37 for Dealers.
Inquiry 38 for End Users.

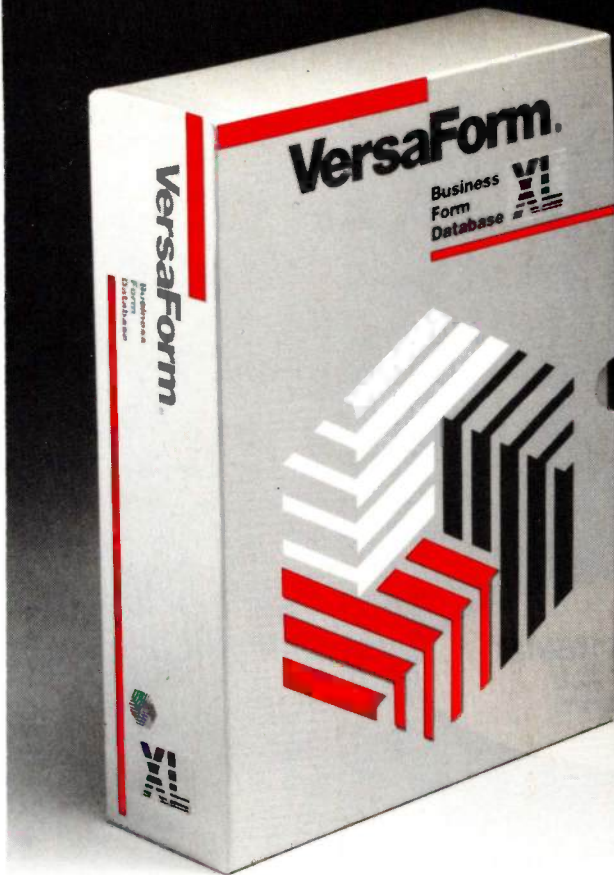

NEW

A powerful multfile database with a programming language for only \$99

Versaform's new XL database isn't just promises—it's here now! And it offers—YES, FOR ONLY \$99—all the features you'd expect in a database costing 4 times as much.

Accounting applications are XL's strength. Invoicing, purchasing, receivables, and shipping almost create themselves as you design the forms—and XL transfers data between them. There's an Invoicing, A/R and Inventory application—source code included—in the package that shows how it's done. The power's there. And unlike packaged accounting programs, you can do them YOUR way.

	VersaForm XL	dBASE III*	R-BASE 4000*
PRICE	99	695	495
STRUCTURED LANGUAGE	Y	Y	Y
MULTI-FILE	Y	Y	Y
COLUMNS WITHIN DATA RECORD	Y	N	N
DATA ENTRY CHECKING	BUILT-IN	MUST WRITE PROGRAM	BUILT-IN
ON-SCREEN CALC	BUILT-IN	MUST WRITE PROGRAM	MUST WRITE PROGRAM
FORMS OUTPUT	BUILT-IN	MUST WRITE PROGRAM	MUST WRITE PROGRAM
DATE ARITHMETIC	Y	Y	N
DATA TYPES	DYNAMIC	FIXED	FIXED
COLUMN TOTAL OPERATOR	Y	N	N
QUERY BY EXAMPLE	Y	N	EXTRA
MAX FILE SIZE	4 MB	OPEN	OPEN
MAX RECORD SIZE	4000	4000	1530

*dBASE III is a registered trademark of Ashton-Tate. R-BASE 4000 is a trademark of Microrim, Inc.

- XL's structured language can access multiple files. 48 built-in functions give control of file access, printing, and user dialogues. You'll develop transaction-based applications with an ease you've never experienced before. And all at this unheard-of low price.
- VersaForm XL's unique form-oriented data structures let you easily set up forms and ledgers—even those with columns! Application development is FAST, FAST, FAST. And since forms are the way that businesses already store their data, the transition is smooth. That's why VersaForm XL is so easy to operate even for high-turnover clerical people—it starts from where they are now.
- Automatic data entry checking and on-screen calculation make transactions error-free. Stored print formats make output formatting a snap—you can quickly match existing paper forms. VersaForm XL's report generator is clear and intuitive. Designers can pre-install reports,

users can set up their own.

- Query-by-forms (at no extra cost) lets users go right to the data they need. No query language to learn—forms are the natural language of business.

Ironclad Money-Back Guarantee

Try VersaForm XL for 30 days. If you're not fully satisfied, return it. We'll gladly refund your money.

Order now, and have the pleasure of using the right tool at the right price. You can't lose!

VersaForm XL runs on IBM PC, XT, AT and compatibles. Requires 192K, two 360KB drives, DOS 2.0 or later. Hard disk recommended.

Standard VersaForm (single file, no language) available for 64K, 2-drive Apple II or 128K IBM PC. \$69.



VersaForm

Applied Software Technology, Dept 685, 1350 Dell Ave., Suite 206, Campbell, CA 95008
(408) 370-2662

Yes! Rush me Versaform XL for the IBM PC (\$99) _____

Standard Versaform (Single file, no language) for the IBM PC (\$69) _____

Apple II (+,E,C) (\$69) _____

Credit card members can order by phone.  

Toll-Free: 1-800-824-8145

In California

Toll-Free: 1-800-854-4448

Enclose check or money order with coupon. Include \$4.50 for U.S. Shipping and handling. \$7.00 for C.O.D. California residents add 6.5% tax.

_____ My check or money order is enclosed _____ Send C.O.D.

Charge my _____ MasterCard _____ Visa

Account No. _____ Expires _____

PLEASE PRINT CLEARLY

685

Name _____

Address _____

City _____

State _____

Zip _____

Phone _____

Signature _____

A black and white advertisement. The background is a dark, textured wall with a grid pattern. On the left, there is a blurred, long-exposure photograph of a city street at night, showing light trails from cars and streetlights. In the center, a man in a dark vest and light shirt is seen from the back, sitting at a desk in a brightly lit room. He is looking out a window. Above his head, a thought bubble contains the text: "LOTUS®, PC-DOS™, DISOSS™, XENIX® ... HOW DO YOU GET IT ALL TO WORK TOGETHER?"

*"LOTUS® , PC-DOS™ , DISOSS™ , XENIX®
... HOW DO YOU GET IT ALL
TO WORK TOGETHER?"*

© Lanier, 1985

Lotus is a registered trademark of Lotus Development Corporation. PC-DOS and DISOSS are trademarks of International Business Machines Corporation. XENIX is a registered trademark of Microsoft Corporation.

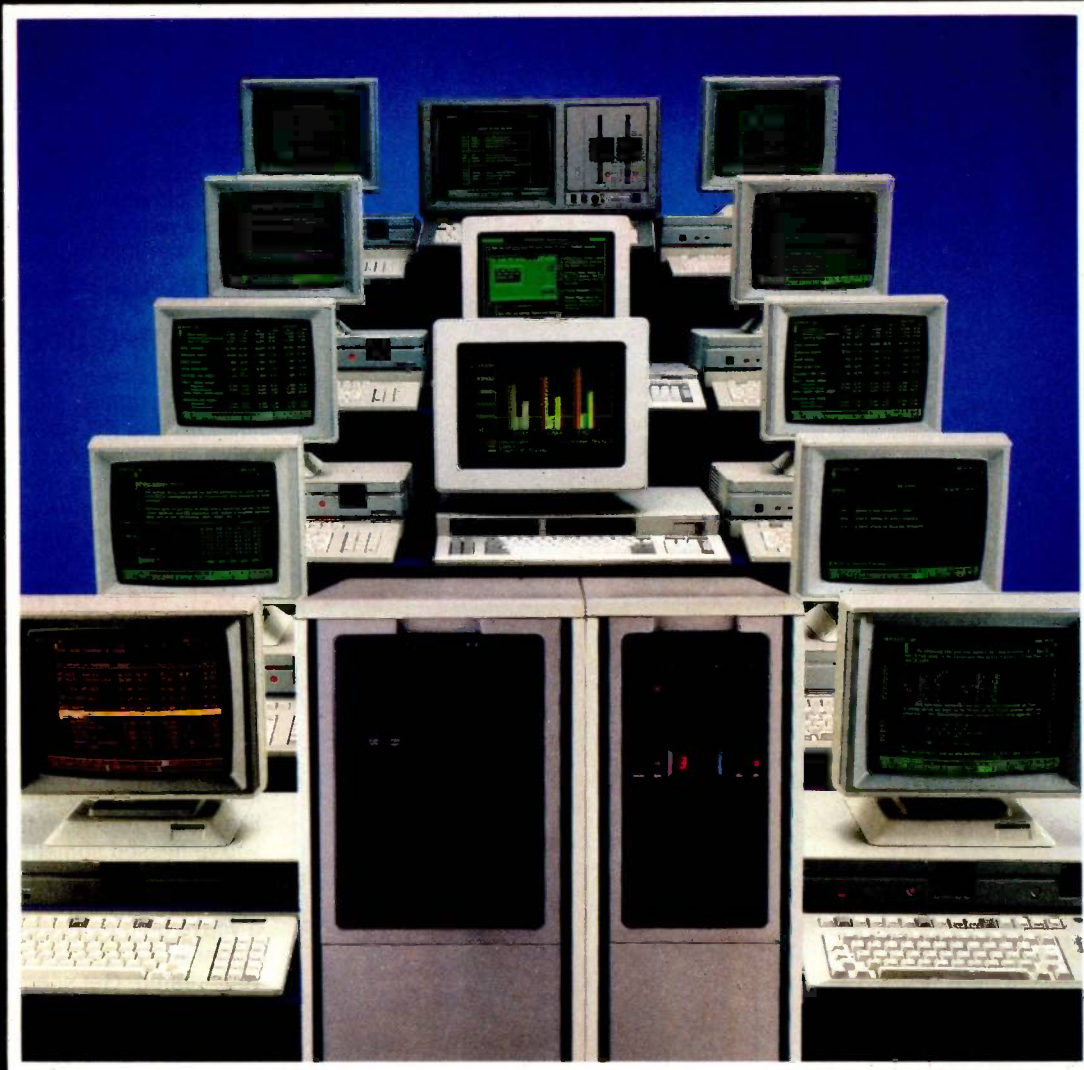

SEE LANIER.

For Concept III. The networking family of multifunctional integrated systems. Interconnects to IBM mainframes, remote data files, other vendors' equipment. A new Perspective on office automation that lets you add processing power as you grow.

Lanier customer training and service are second to none. And we're backed by Harris, a world leader in Information Technology. Call for a demonstration. 800-241-1706.*

Or send the coupon. Today.

**FOR YOUR INFORMATION,
WE'RE NOW PART OF HARRIS.**

*In Georgia, call 404-321-1244 collect.

Harris/Lanier, Electronic Office Systems Div.

SEE LANIER. For a new Perspective on office automation

LANIER, A HARRIS COMPANY
1700 Chantilly Drive, N.E., Atlanta, GA 30324

Name _____

Firm _____ Title _____

Address _____

County _____ Phone _____

City _____ State _____ Zip _____



June '85, Byte '4 75 H F5

from Lanier, please circle #242.

EVERYTHING ABOUT YOU IS UNIQUE.

You need nothing
less than a
custom news service

From your fingerprint to your monogram, you are unique. You wear a business suit tailored just for you; now you can get business news tailored just for you. With NewsNet you get vital, in-depth business news. You get expert information on your industry or profession. Through your computer and telephone, you get news on a vast range of subjects from the world's largest retrieval service of business newsletter information.

3,000 New Articles Screened Each Day

You'll get access to more than 250 business newsletters, plus wire services like UPI and PR Newswire. There's news on everything from computers to investments, from taxes to telecommunications. 3000 new articles are added every day and each one is screened specially for you.

Fast, Versatile, Simple

You enter key words, names or phrases. NewsNet stores them and saves every article containing those words. Check in daily, even hourly; scan the headlines or read entire articles, and print out what you want to keep. Change key words when you like. You're free from the worry that you've missed something important—and your topics may turn up in publications you'd never have time to read. If you're onto a new topic, the entire NewsNet database is available for your search. Get special reports on your competition, the inside story on an industry, or press coverage of a company's new product.

Start Saving Now

The average newsletter carried by NewsNet costs \$200 per year in print form. That's \$50,000 worth of newsletters. Yet with NewsNet you pay as little as \$15 per month for access. And NewsNet has no initiation fee. It's a tremendous value. So call today. We'll send everything you need to start saving now.



800-345-1301

(In PA 215-527-8030)

945 Haverford Rd. Bryn Mawr, PA 19010

Inquiry 309

THE SUM: AN AI COPROCESSOR

Turning a common AI operation into silicon

Logic programming is a staple of artificial-intelligence (AI) software and is often dominated by the pattern-matching process of unification (see the "Resolution and Unification" text box on page 173). In fact, when logic-programming languages such as Prolog and LOGLISP are used, as much as 50 to 60 percent of a computer's processing time is spent on unification. When a single algorithm is used that frequently, it is natural to consider implementing it as custom hardware. When that same algorithm lends itself to parallelism and concurrency because of its recursive, tree-search characteristics, it practically begs for VLSI (very large scale integration) implementation.

SUM HISTORY

Professor John Oldfield and a team of researchers at Syracuse University are developing the SUM (Syracuse Unification Machine), a coprocessor for computers geared toward AI programming. The project combines the resources of the Syracuse CIS (Computer and Information Science) department, ECE (Electrical and Computer Engineering) department, and the CASE Center (Computer Applications and Software Engineering Center, set up by New York State). Key SUM individuals are Dr. Oldfield himself (who contributed CAD [com-

puter-aided design] and VLSI expertise), Professor Alan Robinson (who is the head of the logic-programming efforts at Syracuse), and Kevin Greene (who made the initial designs of the SUM). Because of a famous 1965 paper, Dr. Robinson is often credited with inventing unification. He is more modest, pointing to the work of Herbrand in the 1930s and the studies of Prawitz and Kenger concerning unification. Dr. Robinson contends that he was just the first to formalize the unification process and apply it to resolution.

In 1981, the Syracuse CIS logic-programming group learned that Caltech (California Institute of Technology) student Sheue-Ling Lien had designed a chip that embodied Dr. Robinson's original unification algorithm (see the "Unification on a Chip" text box, page 174). Dr. Robinson and his colleagues were somewhat taken aback that someone else had taken this step. Lien's report was a major inspiration for the development of the SUM, even though the chip it described was never actually made. Because ECE had been developing custom VLSI

chip-design capability and had a strong logic-programming group, combining the pursuits "seemed a natural thing" according to Dr. Oldfield.

COPROCESSOR STRATEGY

As Dr. Oldfield explains, "Although we started talking about a unification chip, following along the lines of the Caltech one, it soon became fairly clear that at present levels of integration that was fairly ridiculous. You could make a chip, but it would be limited to solving such small problems that it wouldn't be worthwhile." The SUM group wanted to design a full-blown, practical processor. Besides, Lien's chip used Dr. Robinson's original 1965 algorithm. Much more efficient algorithms have been developed since.

When they realized that a single chip wasn't realistic, the members of the group looked at the possibility of a coprocessor, initially for the LMI

(continued)

Phillip Robinson is a senior technical editor at BYTE. He can be contacted at 1000 Elwell Court, Palo Alto, CA 94303.



(LISP Machine Inc.) Lambda computer. Dr. Oldfield continues, "Here's the LMI Lambda executing a LISP program. When it comes up to the point where it needs to do a unification, then that task is given over to the SUM," which would handle it more efficiently than the Lambda could. The SUM interface is tailored to the LMI Lambda's high-speed, parallel Nubus (developed by Texas Instruments) but could easily be adapted to other machines and buses.

RESOLUTION, UNIFICATION, AND TREES

Although the unification algorithm has a number of uses, it is often employed as part of a wider process called *resolution*. Resolution is a rule of inference for constructing deductive proofs from any number of accepted clauses. Practical problems may involve thousands or millions of

clauses. One way to view resolution is as the exploration of a tree of possible proofs. Resolution uses unification to help reduce the number of clauses. Unification, in effect, works on its own tree, moving down branches and trying to bind—find acceptable values for—variables. If unification is successful on one branch, it switches to another branch farther down and binds some more variables.

Failure of resolution on a branch of the resolution tree is not a disaster; it just means another branch must be explored. Similarly, when unification fails on a branch of the unification tree, the process keeps all bindings except the most recent and explores another branch.

SUM ARCHITECTURE AND OPERATION

Figure 1 is a block diagram of the SUM that Kevin Greene developed.

Unification tasks come into the SUM from the Lambda, are performed, and the results are passed back. The communication agent, which is the interface between the Lambda and the SUM, passes unification tasks to the work manager. Initially, the work manager's task pool will have only one task, but as processing continues other tasks will come back from the binding agents. Those tasks must be coordinated with the tasks coming from the communication agent. The work manager pushes the unification task out into the analysis agent, which executes the heart of the unification algorithm.

The analysis agent must decide what to do with the expressions it receives. What it does depends on the type of expression. If both expressions are simple constants, unification succeeds only if they are identical. If

(continued)

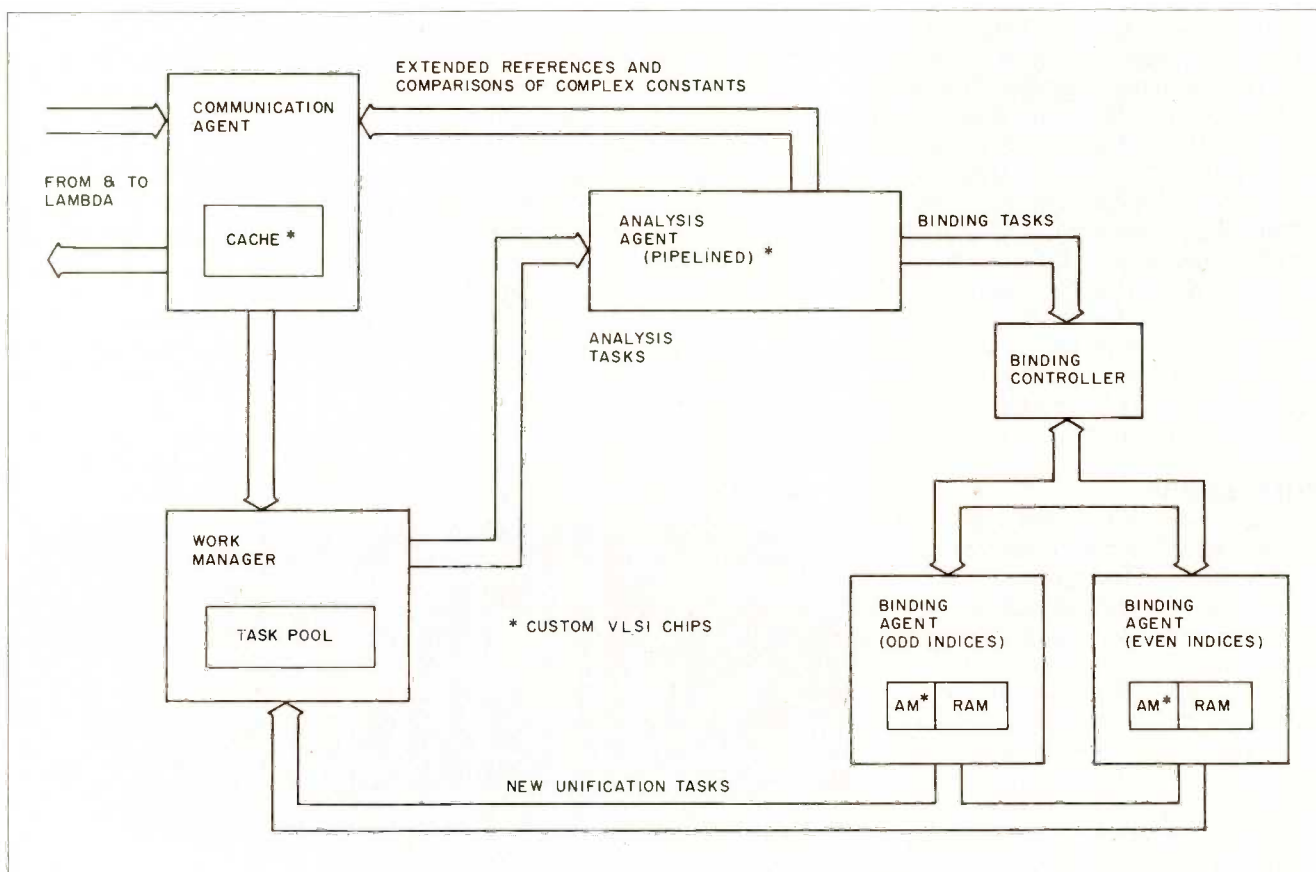
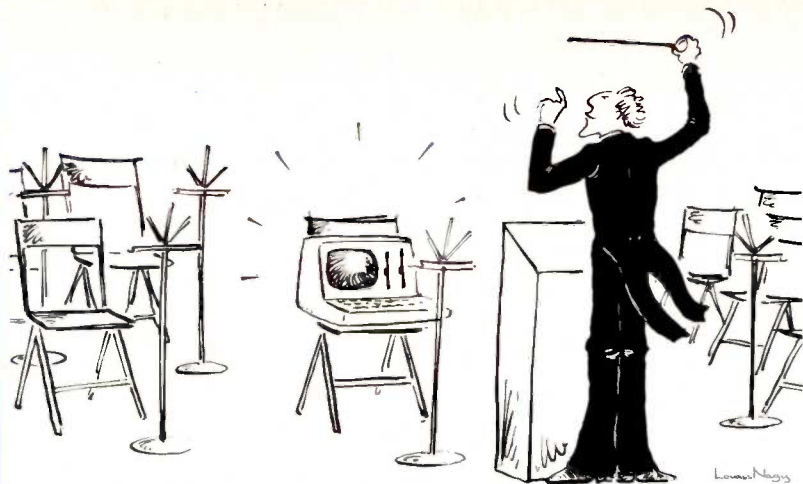

Figure 1: A block diagram of the Syracuse Unification Machine.



Would you hire an entire band when all you need is one instrument? Of course not.

So why use a whole orchestra of computers when all you need is one to develop software for virtually any type of micro-processor?

The secret? Avocet's family of cross-assemblers. With Avocet cross-assemblers you can develop software for practically every kind of processor — *without having to switch to another development system along the way!*

Cross-Assemblers to Beat the Band!

Development Tools That Work

Avocet cross-assemblers are fast, reliable and user-proven in over 4 years of actual use. Ask NASA, IBM, Xerox or the hundreds of other organizations that use them. Every time you see a new micro-processor-based product, there's a good chance it was developed with Avocet cross-assemblers.

Avocet cross-assemblers are easy to use. They run on almost any personal computer and process assembly language for the most popular microprocessor families.

Your Computer Can Be A Complete Development System

Avocet has the tools you need to enter and assemble your software and finally cast it in EPROM:

VEDIT Text Editor makes source code entry a snap. Full-screen editing plus a TECO-like command mode for advanced tasks. Easy installation - INSTALL program supports over 40 terminals and personal computers. Customizable keyboard layout. CP/M-80, CP/M-86, MSDOS, PC DOS \$150

EPROM Programmers let you program, verify, compare, read, display EPROMS but cost less because they communicate through your personal computer or terminal. No personality modules! On-board intelligence provides menu-based setup for 34 different EPROMS, EEPROMS and MPUs (40-pin devices require socket adaptors). Self-contained unit with internal power supply, RS-232 interface, Textool ZIF socket. Driver software (sold separately) gives you access to all programmer features through your computer, lets you download cross-assembler output files, copy EPROM to disk.

Model 7228 Advanced Programmer — Supports all PROM types listed. Superfast "adaptive" programming algorithm programs 2764 in 1.1 minutes.

Model 7128 Standard Programmer — Lower-cost version of 7228. Supports all PROM types except "A" versions of 2764 and 27128. Standard programming algorithm programs 2764 in 6.8 minutes.

Avocet Cross-assembler	Target Microprocessor	CP/M-80	CP/M-86 IBM PC, MSDOS**
XASM04	NEW 6804	\$ 250.00	\$ 250.00
XASM05	6805	200.00	250.00
XASM09	6809	200.00	250.00
XASM18	1802/1805	200.00	250.00
XASM48	8048/8041	200.00	250.00
XASM51	8051	200.00	250.00
XASM65	6502/65C02	200.00	250.00
XASM68	6800/01, 6301	200.00	250.00
XASM75	NEC 7500	500.00	500.00
XASM85	8085	250.00	250.00
XASM400	COP400	300.00	300.00
XASMF8	F8/3870	300.00	300.00
XASMZ8	Z8	200.00	250.00
XASMZ80	Z80	250.00	250.00
XMAC682	NEW 68200	595.00	595.00
XMAC68K	NEW 68000/68010	595.00	595.00

Model 7956 and 7956-SA Gang Programmers — Similar features to 7228, but program as many as 8 EPROMS at once. 7956-SA stand-alone version copies from a master EPROM. 7956 lab version has all features of stand-alone plus RS-232 interface.

EPROM: 2758, 2716, 2732, 2732A, 2764, 2764A, 27128, 27128A, 27256, 2508, 2516, 2532, 2564, 68764, 68766, 5133, 5143. CMOS: 27C16, 27C32, 27C64, MC6716. EEPROM: 5213, X2816A, 48016, I2816A, 5213H. MPU (w/adaptor): 8748, 8748H, 8749, 8749H, 8741, 8742, 8751, 8755.

7228	Advanced Programmer	\$ 599
7128	Standard Programmer	429
7956	Laboratory Gang Programmer	1099
7956-SA	Stand-Alone Gang Programmer	979
GDX	Driver Software	95
481	8748 Family Socket Adaptor	98
511	8751 Socket Adaptor	174
755	8755 Socket Adaptor	135
CABLE	RS-232 Cable (specify gender)	30

HEXTRAN Universal HEX File Converter — Convert assembler output to other formats for downloading to development systems and target boards. Also useful for examining object file, changing load addresses, extracting parts of files. Converts to and from Intel, Motorola, MOS, RCA, Fairchild, Tektronix, TI, Binary and HEX/ASCII Dump formats. For CP/M, CP/M-86, MSDOS, PC DOS \$250

Ask about UNIX.

68000 CROSS-ASSEMBLER — With exhaustive field testing completed, our 68000 assembler is available for immediate shipment. XMAC68K supports Motorola standard assembly language for the 68000 and 68010. Macros, cross-reference, structured assembly statements, instruction optimization and more. Linker and librarian included. Comprehensive, well-written manual.

To find out more, call us toll-free.

1-800-448-8500

(in the U.S. Except Alaska and Hawaii)

VISA and Mastercard accepted. All popular disc formats now available — please specify. Prices do not include shipping and handling — call for exact quotes. OEM INQUIRIES INVITED

*Trademark of Digital Research **Trademark of Microsoft



Sales and Development:
10 Summer Street
P.O. Box 490, Dept. 685-B
Rockport, Maine 04856
(207) 236-9055 Telex: 467210 AVOCET CI

Corporate Offices:
804 South State Street
Dover, Delaware 19901

ABSOLUTELY THE LOWEST PRICES

We will BEAT any price advertised in this magazine!

EPSON

10" JX80 160 cps, color	585
Homewriter 100 cps	227
15" LQ1500 200 cps, needs interface, specify serial or para.	1195
10" LX80 100 cps	265
10" FX80 160 cps	460
15" FX100 160 cps	690
Serial/Parallel Interface	135/75
Tractor Feed	52

OKIDATA

A Real Work Horse

Dot Matrix	
15" 83P 120	595
10" 82P 120cps	329
15" 93P 160cps	595
10" 92P 160cps	399
10" 182 120cps	Call
Serial Interface 2K Buffer	94

Canon

Canon Dot Matrix
This one a Special Purchase
Commercial Quality
Very Limited Quantity
Hi Speed 160cps IBM Clr Comp.
only 379

daisywriter

LETTER QUALITY
When you want your letter to look like a million \$
40 cps 700
Factory reconditioned,
90 day guarantee
REGULARLY 1,495.

PANASONIC

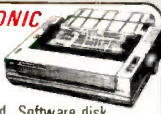

With IBM Cable
Friction & Tractor Feed, Software disk to change type size & style.
1090 80 cps 219
1091 120 cps 299
Specify computer
Two Reliable Workhorses.

AMDEK

Video 300, Green	129
Color 1-	199
Color 300	235

RGB

Color 500	325
Color 600	450
Color 700	520

Hayes

2400	Call
1200/300	489
1200B w/Smartcom Sft.	419

ANCHOR

2400	Call
Mark XII	265
Volks 12 w/cable	199
Volks 3 w/cable	59

TAXAN

Perfect Compatible for your IBM
400, 12" Res. 640/262
IBM Styling w/IBM Cable 463
Vision III, RGB, Res. 640/262
Without Cable 395

BMC Color Composite
Stylish Plastic Cabinet, Built-in Sound, Perfect for Apple, Commodore, Atari 179

PANASONIC

12" Green	137
13" color RGB, CT1300D	259

USI



Hi Res Metal Cabinet
1-9 79 Large qty
10-19 70 Call
20 up 68

AMDEK/RICOH

Daisy Wheel Hi Speed	
Low Noise Level (50DB)	
5025 25 cps	525

POWER DEVICES

Datashield back-up power source	
200 PC-200 watt	265
300 XT-300 watt	390
Brooks 6 Outlet-Surge Suppressor/Noise Filter	54

QUADRAM

Quadram	224
384K	344
AB's Version 384K	299

AST

Multi-function card

64K	313
384K	413

HERCULES

Graphic	319
Color	169

PARADISE

5 Pk w/o parallel port-no memory	169
384K	283
Modular Graphic Card	279

RAM

Kit 64K	20
---------	----

ZENITH data systems



Zenith Data Systems
More than IBM compatible

- 2-DS DD 36K Disk Drives
- 320K Ram
- Amber 20 Mhz Monitor-P3
- Microsoft Software Package includes MS-DOS 2.1, Word, Multiplan
- Pearl Database, \$100 with system

\$1,850

AB DISKETTES



with Media Mate
30 - 3.5" 125
100 - 5" DS/DD 160

GENERIC DISKS

Made by one of the leading manufacturers

SS/DD	1.00
DS/DD	1.05

TEAC

Disk Drive DS/DD, 360K	120
------------------------	-----

Cables

Parallel Cable (36pin/36pin)	23
RS232 Male to Male 6'	17
RS232 Male to Female 6'	18
Parallel Cable for Columbia	25

AMRAY



Media Mate	9.95
Flip N File/25	16.50
Flip N File/50	22.95

REDIFORM

Computer Supplies

- Computer paper
- Self-adhesive labels
- Computer form
- Carrier mounted letterheads
- Carrier mounted envelopes
- Data binder MORE

Call for current pricing!

AB Computers' own PC 100% IBM Compatible



256K RAM
2 - 360K Disk Drives
Serial & Parallel Ports
Your choice of 20 Mhz Amber or Green Monitor
Introductory Offer
\$1,595

IBM

Software

dBase III	458
Lotus 123	290
Prokey 3.0	87
Millionaire	40
Summer Games	28
Typing Tutor III	35
Hitchhikers Gd. Galaxy	28
Multiplan	129
Copy II PC	35
Mind Probe	35
Turbo Pascal 3.0	54
PFS Graft/Report	79
PFS Write: file/plan	89

Utility Program

Side Kick	Call
Norton Utilities	Call
Copy 11 PC IBM install Lotus dBase etc. on hard disk.	Call
Print shop	Call

Software Apple

Typing Tutor III	35
Hitchhikers Gd Galaxy	28
Multiplan	84
Copy II	35
Mind Probe	35
Turbo Pascal 3.0	54
Corner Stone	Call
Millionaire	35

Software Macintosh

Typing Tutor III	40
Hitchhikers Gd to Galaxy	28
Multiplan	129
Mind Probe	35
Millionaire	40
Ensemble	230
Jazz	Call
Helix dBase	Call

AB SATISFACTION GUARANTEE
Every product sold by AB Computers is factory packed and comes with the manufacturer's warranty. However, if an item is defective when received, you may return it to us within 15 days for repair, adjustment or replacement at our option. Returns must be accompanied with copy of your invoice, letter detailing defect, blank warranty card and all original factory packing. To expedite handling, please call for return authorization number. (Sorry, no return on computer software once opened.)

ORDERING INFORMATION: Order by check, Mastercard or VISA. Personal checks take 15 days to clear, no waiting on certified checks or money orders. Add 3% shipping and handling on all orders (minimum \$2.00) Mail, APD/PPD. Air may require additional charges. PA residents add 6% sales tax. MA residents add 5%. All items subject to availability. Prices subject to changes. Additional discounts available to qualified educational institutions. Requests for bid on volume requirements invited.



Use our TOLL FREE Order Line Mon. - Sat. 9am - 6pm EST
800-822-1211
In PA: 215-822-7727
252 BETHLEHEM PIKE, COLMAR, PENNSYLVANIA 18915

We support Apple, Macintosh, Commodore, IBM & compatibles



Customer Service
215-822-7727

THE SUM

the expressions are complex constants, such as floating-point numbers or strings, the analysis agent may be given pointers to the data structures rather than the data structures themselves. Since unification requires an equivalency check, the SUM must pass the pointers back to the Lambda. As Dr. Oldfield says, "SUM doesn't know anything about list

structures. All it can handle are pointers to structures that continue to reside in the Lambda." In this case, the comparison is made by the Lambda, and the result is then returned to the SUM.

Finally, the analysis agent may encounter the job of having to unify a variable and an expression. It can try

(continued)

RESOLUTION AND UNIFICATION

Many problems in AI are most efficiently solved by logical operations. In fact, the language Prolog is specifically oriented to the use of propositional and predicate logic. In their simplest forms, the rules of logic deal with operators such as AND, OR, and NOT. However, complex problems in AI are nearly always solved by application of a more powerful logical technique, a deduction method known as resolution.

Propositions are statements of fact that may be true or false. These are propositions:

My hard disk just crashed.
My warranty expired yesterday.

We frequently represent propositions symbolically as single letters:

p q

Atoms are propositions that cannot be broken down into other propositions. Atoms are also called positive literals; atoms preceded by the NOT operator are called negative literals. The propositions described above are atoms, while the following are not:

My hard disk just crashed AND my warranty expired yesterday.
p OR q

A series of literals connected by OR operators forms a clause, and we can use resolution to work with clauses in this way:

If there is a clause p OR q and another clause (NOT q) OR r then p OR r

follows by resolution. Resolution makes no statement about the truth of p, q, or r; it merely assures that we can perform that particular manipulation of

the logical instructions.

Where does unification come in? To resolve two clauses, two literals must be found, one in each clause, such that one literal is the exact negation of the other. If the literals do not match, they can sometimes be made to do so by substitutions that follow certain rules. You can replace a variable with a constant (this is called *instantiation*), with another variable, or with an expression (as long as that expression does not contain the original variable). If you follow the rules and find a substitution that resolves the two clauses, then you have found a unifier and have performed unification.

In general, after you have converted the logical statements describing a situation into clauses, you can use unification to try to prove a theorem about the situation. Resolution will terminate either when clauses remain that are not resolvable or when resolution is attempted on a statement and its negation—a contradiction (this produces the empty clause, often called NIL).

For instance, if a robot were underwater and wanted to know if its batteries were endangered by the water, it would first combine all the rules it knew about water and batteries with the data from its sensors. That information would be put into clause form along with the negation of the theorem "My batteries will be damaged." The robot would then use unification substitutions to attempt resolution. The result will either be unresolvable clauses, in which case the theorem is false and the robot can go on to worry about something else, or an empty clause, in which case the theorem is true and the robot may be doomed.

MORE ABSOLUTELY GREAT PRICES!

AB is one of the oldest Commodore Dealers
C-64, 1541, 1702, 1530, 1531, Mps 801
BEST PRICES BEST SUPPORT
Buy a C-64, drive monitor, get over 330 programs free! 27 disks. Call for details.

OPTIONAL ACCESSORIES

MSD Drives, Single/Dual	Call
Bus Card II by Batteries Included	149
● full buffered IEEE 488 bus for speed	
● cartridge extension slot	
● parallel printer port	
● DOS "wedge" commands included	
● machine language monitor included	
● extended BASIC	
Muppet Learning Keys	Call
Modems, 1600, 1650, WC6420	Call

PETSCAN I

PETSCAN allows you to connect up to 37 CBM/PET computers as a networked cluster to shared disk drives and printers (up to 8 Peripherals can be in the shared cluster along with 37 computers).

Configur. to attach 2 computer + 9' cable	245
Additional computer modules w/6' cable	100
Cables beyond standard length/per ft.	1
Extra 9' master cable	28
Extra 6' slave cable	18
C-SCAN for C-64	125

TECH SKETCH LIGHT PEN

Includes Micro Illustrator software. Easiest to use and more accurate than Koala

	44
KDALA PAD for C-64 with Paint Software	70

BUSINESS

EDUCATIONAL

Wordpro 3+	85	Agent USA	21
Microsoft MultiPlan	69	Spell Diver	21
Omniwrit/speller	45	Secret Flier	14
Bank Street Writer	49	Kinder Comp.	20
PFS: File	60	Cell Defense	24
Flexfile II AB Exc	59	Typing Tutor	35
KMMM Pascal	95	Rocky's Boots	32

ENTERTAINMENT

Lode Runner	26	Flight Simulator	41
Mind Prober	20	Zaxxon	30
		Bridge, C-64	Call

We carry full software lines by Electronic Arts, Scholastic, Scarborough, PFS, Spinnaker, Batteries Included and many others. If you don't see the program you want listed, call our toll-free order phone 1-800-822-1211.



Use our TOLL FREE Order Line Mon - Sat. 9am - 6pm EST

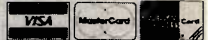

CUSTOMER SERVICE

215-822-7727
800-822-1211
In PA 215-822-7727

252 BETHLEHEM PIKE, COLMAR, PENNSYLVANIA 18915

to bind the variable to the expression, in which case the task is pushed out to the binding agent.

PARALLELISM AND RECURSION IN BINDING

The SUM team decided that the binding process could exploit parallelism because many bindings can be done concurrently. The original design uses two binding agents, but the work could be split up for four, eight, or more.

Before you make a binding, you have to find out whether the variable is already bound. For example, if A is already bound to 15, or to a character string, you don't make a new binding of A to 3. For efficiency, the SUM must be able to check bindings quickly in what is basically a table lookup. A subsidiary unification task is generated, goes back into the work manager's task pool, and then goes around the system again.

UNIFICATION FAILURE AND SUCCESS

Unification can fail in only one of two places: the Lambda or the analysis agent. If unification fails, all activity in the SUM must cease. Then the SUM must inform the Lambda of the failure. However, the Lambda may find out by

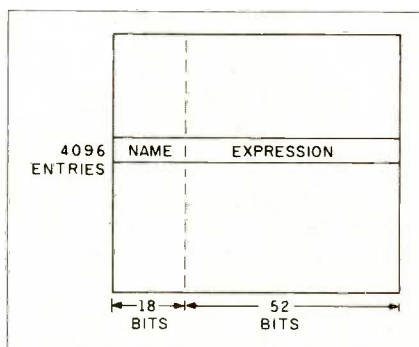

Figure 2: A diagram of the binding agent.

itself. For example, in the case of the complex constants that are passed back to the Lambda, the Lambda recognizes failure before the SUM does. In that case, the Lambda immediately directs the SUM to move on to the next task.

Unification has succeeded when there are no tasks waiting in the SUM—nothing in the analysis agent and no bindings in progress. In that case, any new bindings are extracted and passed back to the Lambda.

The bindings are made in a stack that grows from the bottom up. The shift-register-like organization of the stack pointer makes for fast and flexible manipulations. For example,

when unification succeeds and bindings have to be extracted for return to the Lambda, you can unwind the stack without losing its contents. This is important if you are performing more than one unification using the same set of bindings. Also, in cases such as failure of unification, the Lambda can instruct the SUM to relocate its stack pointer and adjust to an earlier context.

BINDING AGENT—CUSTOM CAMS

The asterisks in figure 1 indicate the parts the SUM team feels have the most promise for VLSI implementation. While the cache and various controllers have had some development, "The binding agent is the part that we've done the most work on and where there seems to be a tremendous amount of payoff for custom VLSI," according to Dr. Oldfield.

Figure 2 is a simple block diagram of the binding agent. It has 4096 entries, each with a name composed of a 12-bit index and a 6-bit identifier. Associated with each name is a 40-bit expression and another 12-bit index. In other words, the binding agent requires a lot of RAM. Rather than inte-

(continued)

UNIFICATION ON A CHIP

While many people have talked about putting unification on a chip, a computer science graduate student's attempt was the charge that galvanized the Syracuse team to seriously address the challenge. As a master's project in 1981 for Professor Jim Kajiya, Caltech student Sheue-Ling Lien—now Dr. Sheue-Ling Chang of Sun Microsystems—designed a chip that implemented Robinson's original 1965 unification algorithm. She called it the UNIF-chip.

Dr. Chang had been very interested in Prolog and realized that unification presented a bottleneck to efficient Prolog execution. She decided that a unification-chip coprocessor, combined with Caltech's strong interest in VLSI, was just what the doctor ordered.

DARPA (Defense Advanced Research Projects Agency) sponsored the research. Dr. Chang designed the chip with the idea that many of them might be linked together to concurrently solve unification problems on different branches of a Prolog tree structure.

About 18 months after the first design was complete, Chang and Kajiya discussed the possibility of taking some of the stack memory off the chip to make it small enough for actual production. They decided against it because Chang had become ensconced in her solid-modeling graphics Ph.D. work and didn't have time to completely redesign a chip. The paper disappeared into the Caltech library.

Professor Kajiya says no one else at Caltech took up the challenge of silicon

unification because they were waiting for better design tools. In his opinion, those tools haven't arrived yet. Still, when they do get here, he feels that putting complex tasks such as unification into silicon is "definitely the way to go." He points out that, while the past 20 years has seen much effort in improving algorithms, there is now evidence that sheer processing speed and power can accomplish more than was previously thought. Kajiya points to the championship chess-playing programs, such as Belle (which has its own custom hardware) and Cray Blitz (for the Cray supercomputer), which exploit tremendous hardware power. Kajiya says that the success of these chess machines may "teach us that the eighties is the decade of brute force."



Why people choose an IBM PC in the first place is why people want IBM service...in the first place.

After all, who knows your IBM Personal Computer better than we do?

That's why we offer an IBM maintenance agreement for every member of the Personal Computer family. It's just another example of blue chip service from IBM.

An IBM maintenance agreement for your PC components comes with the choice of service plan that's best for you—at the price that's best for you.

Many customers enjoy the convenience and low cost of our carry-in service. That's where we exchange a PC display, for example, at any of our Service/Exchange Centers.

And for those customers who prefer it, we offer IBM on-site service, where a service representative comes when you call.

No matter which you choose for your PC, an IBM maintenance agreement offers you fast, effective service.

Quality. Speed. Commitment. That's why an IBM maintenance agreement means blue chip service. To find out more about the specific service offerings available for your PC, call 1 800 IBM-2468, Ext. 104 and ask for PC Maintenance.

Inquiry 217

Blue chip service from **IBM**

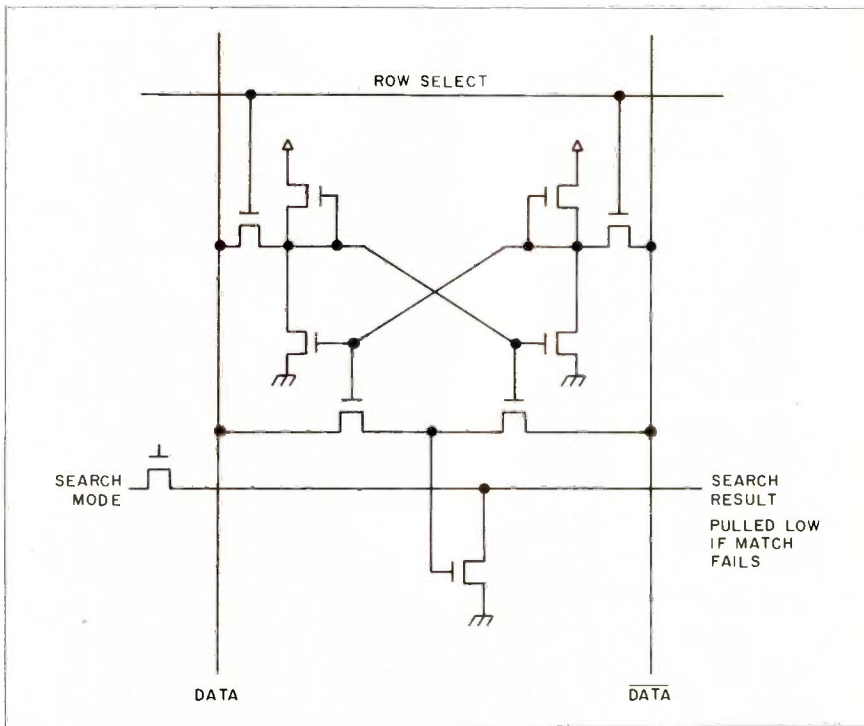

Figure 3: A 9-transistor associative-memory cell. By adding another 3 transistors to a basic 6-transistor static RAM cell, you get a well-known but rarely used cell that is the basis of the custom CAM. This cell has a very attractive search feature: Every word in the memory can simultaneously be searched by a single read access that takes about 100 nanoseconds.

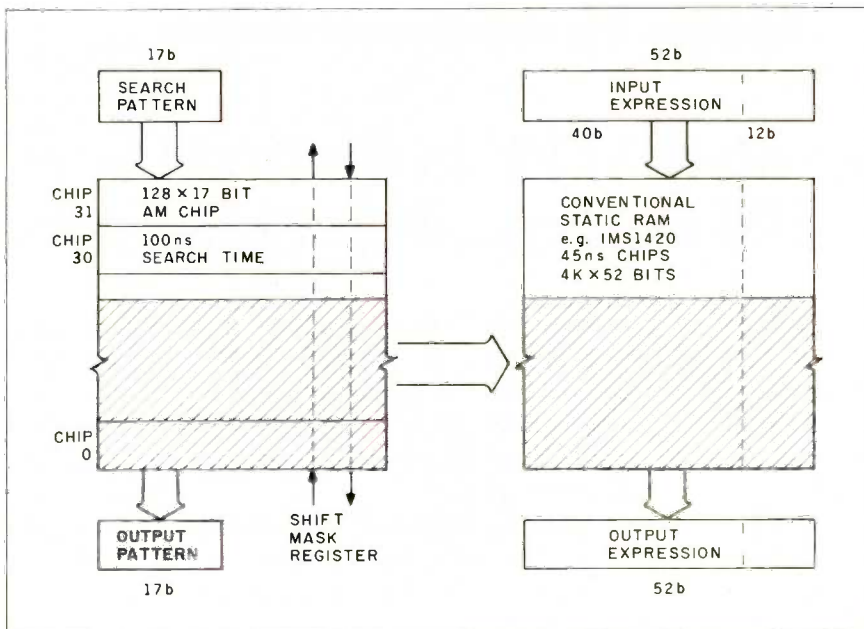

Figure 4: Two parts of the binding agent: an associative-memory stack (left) and a conventional RAM (right).

grating it all on custom silicon, Dr. Oldfield decided to use conventional memory chips wherever possible.

A student's VLSI project on associative memories gave Dr. Oldfield the clue to the fast table-lookup architecture he needed. An ideal CAM (content-addressable memory) or AM (associative memory) would allow you to simultaneously search all entries for a name, an expression, or both. As Dr. Oldfield states, "It's very, very much faster than you can do by software techniques" (see figure 3). Such a memory could even have wild-card fields. Dr. Oldfield split the binding agent into the two parts shown in figure 4: an AM stack (on the left) and a conventional RAM (random-access read/write memory) (on the right).

To maximize the SUM's performance, the designers squeezed as many variable names as they could onto the CAM chip. The result was 128 entries of 128 rows by 17 bits. Each bit is implemented by a 9-transistor AM cell. (If you recall that each name entry is composed of $12 + 6 = 18$ bits, you are probably wondering what happened to 1 bit. The explanation is that it has been split off and indicates which of the two binding agents to use.) The system of 4096 entries requires 32 of the custom CAM chips.

CAD PROBLEMS

With a theoretical design for the binding agent's CAM completed, the SUM team decided to make the largest prototype chip possible with its CAD facilities. But, as Dr. Oldfield admits, "At the time our CAD facilities were very rudimentary." Most of the powerful tools (mainly computer-aided design and test programs) are written in C for a UNIX machine but were too big to run on Syracuse's DEC PDP-11. "It's a funny way to describe it," says Dr. Oldfield, "but you really have to have a VAX to do anything in this business. So we had to do all of our software locally."

In fact, all of the students had to lay chips out in CIF (Caltech Intermediate Form). CIF is a low-level, machine-

(continued)

Trade-in Your New IBM* PC or XT* Keyboard and Upgrade Your System.

Key Tronic is Offering \$50 for Your New IBM* PC or XT* Keyboard

The reason why Key Tronic is having a special \$50 trade-in offer is because we want you to get the most from your IBM PC or XT!

Buy a KB 5151 and send us your unused IBM PC or XT keyboard, and Key Tronic will send you \$50!

Type on the KB 5151 and feel the difference! Then take one home.

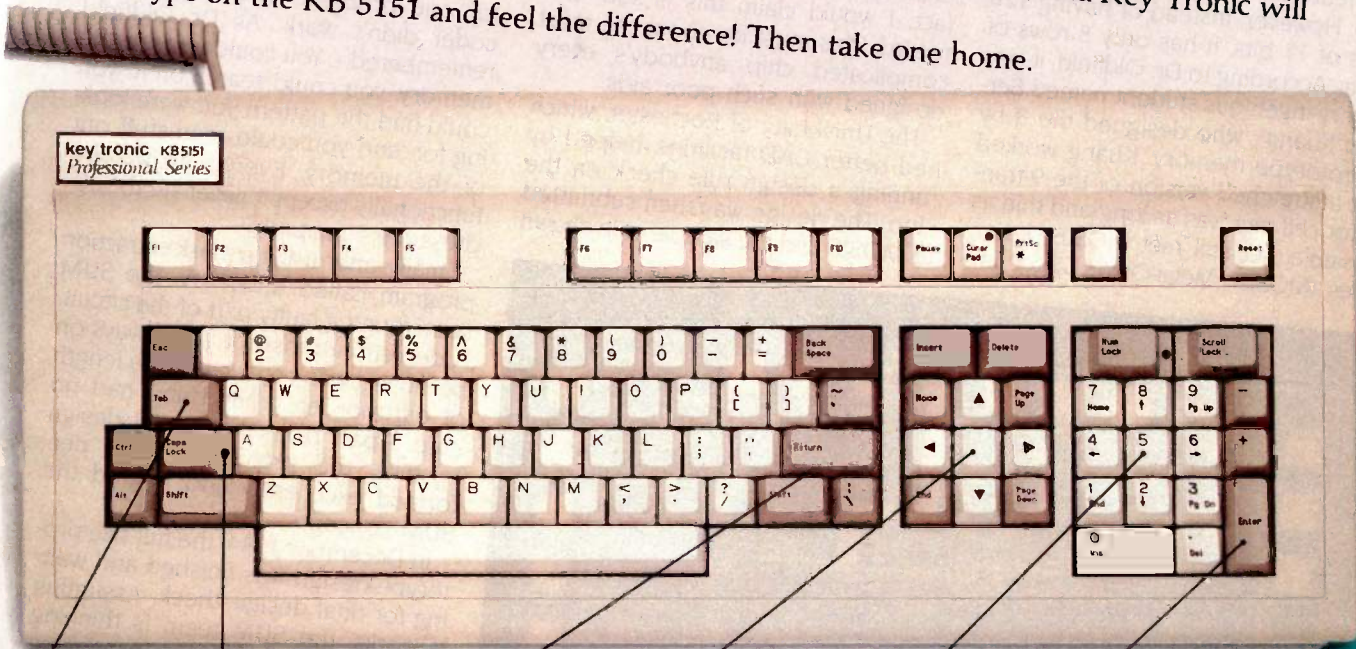

Easy to Read
Regular Key Legends Rather than Symbols.

Easy to Identify
Status Lights on "Lock" Keys.

Easy to Use
"Shift" & "Return" Keys are in familiar Typewriter locations.

Easy to Edit
Separate Cursor and Editing Keys.

Easy for Numbers
Separate Numeric Pad is Great for Spreadsheets.

Easy to Enter
Convenient Enter Key.

"Feel the Key Tronic Touch"

key tronic

The Responsive Input Company

Spokane, Washington
509-928-8000

Inquiry 236

Key Tronic is the world's largest independent manufacturer of full travel keyboards, and offers a complete line of integrated input devices.

Take advantage of this limited time offer. Contact your local dealer or call 1-800-262-6006 today!

*IBM and XT are registered trademarks of IBM Corporation

Key Tronic Corporation
Rebate Program
Building 14
Spokane Indus. Park
Spokane, WA
99216

\$50 REBATE COUPON

Name _____
Address _____
City/State/Zip _____
Phone _____

To the best of my knowledge the above information is correct and the enclosed keyboard is an unused IBM PC or XT keyboard. I am aware that the conditions for receiving a \$50.00 personal rebate check for the IBM PC or XT keyboard include: replacing each such IBM PC or XT keyboard with a Key Tronic keyboard and including a copy of the sales receipt when mailing the keyboard to Key Tronic. I understand that credit will only be given for those keyboards which are new and pass a functional inspection by Key Tronic or its assignee.

*Please allow 4 to 6 weeks for delivery of rebate check.

readable, layer-description language that, as Dr. Oldfield describes, is "painfully" written out by hand. Fortunately, Syracuse now has a set of tools from the University of Washington running on a borrowed VAX and is installing its own VAX.

The experimental prototype has all the features of the full-scale CAM chip. However, instead of having 128 rows of 17 bits, it has only 8 rows of 3 bits. According to Dr. Oldfield, it was "a very ingenious student named Ser-Hou Kuang" who designed the 8 by 3 prototype memory. Kuang worked out a stretched version of the 9-transistor cell that was as long and thin as possible, yet still met MOSIS design rules. (MOSIS—Metal-Oxide Silicon Im-

plementation System—is a nonprofit intermediary organization affiliated with the University of Southern California and DARPA that accepts prototype chip designs from universities, government agencies, and others, and arranges to have those designs fabricated by Silicon Valley manufacturers.) Referring again to his group's poor CAD facilities, Dr. Oldfield said, "In fact, I would claim this is sort of a record. This must be about the most complicated chip anybody's ever designed with such poor aids."

The University of Rochester, which had better CAD facilities, helped by running a design rule check on the chip. The design was then submitted to MOSIS and the sample chip shown

The prototype has all the features of the full-scale CAM chip.

in photo 1 was fabricated. Figure 5 is a floor plan for the prototype.

All of the chips functioned except for one problem: The address encoder didn't work. As Dr. Oldfield remembered, "You could write to the memory, you could search on it, you could find the pattern you were looking for, and you could read stuff out of the memory. Everything worked functionally except it never set the address lines properly."

Finally, after using a mask-extraction program called MEXTRA, the SUM team found a faulty part of the circuit. A depletion transistor was always on because it was connected by a length of diffusion to ground and had no gate. Apart from that trivial design mistake, the prototype chips performed excellently and proved the SUM concepts.

In December 1984, the full-size prototype design was finished and waiting for final design check. Assuming it works, the SUM team is thinking about the next phase, producing quantities of the chip. Dr. Oldfield points out that university work often "leads to just one chip" and that it is "interesting to find a case where you can usefully use a significant number in an operation."

POSSIBILITIES FOR THE FUTURE

A negative aspect of the SUM concerns its overall impact on AI. Even if unification takes up a full 60 percent of a LISP machine's time, an infinitely fast SUM could speed up the overall process only by a factor of slightly better than 2. Coprocessors in other circumstances sometimes speed processing on the order of hundreds of times. As Dr. Oldfield freely admits, this is "not the same story at all."

Looking down the road, Dr. Oldfield

(continued)

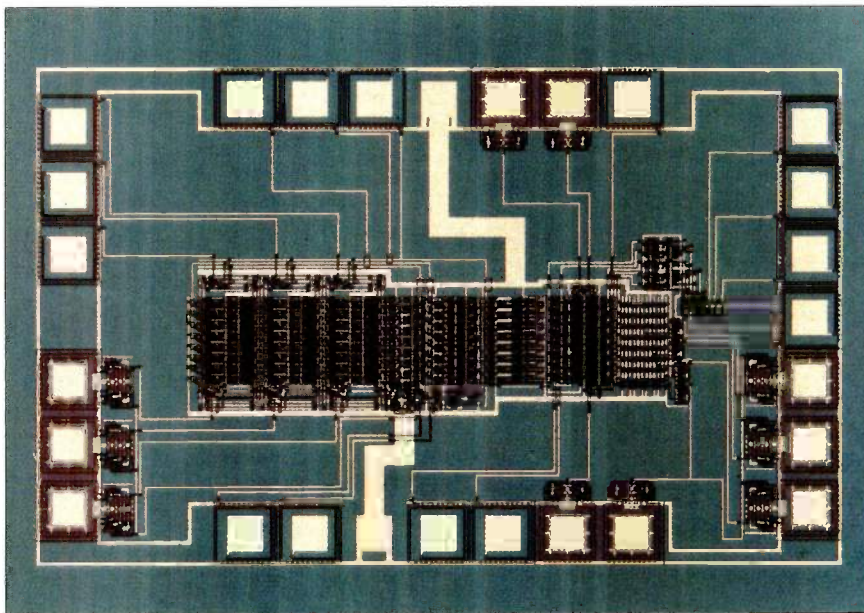

Photo 1: Prototype content-addressable memory chip used in the SUM's binding agent.

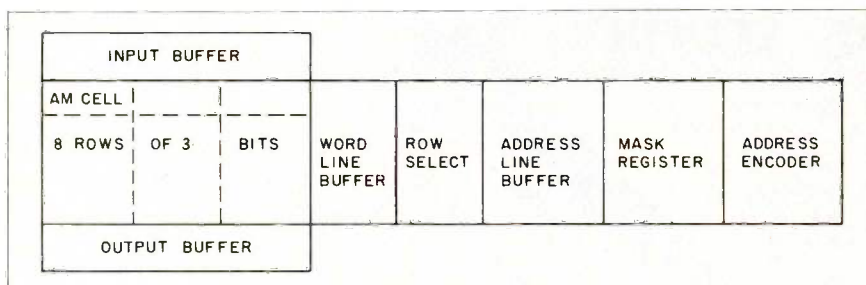
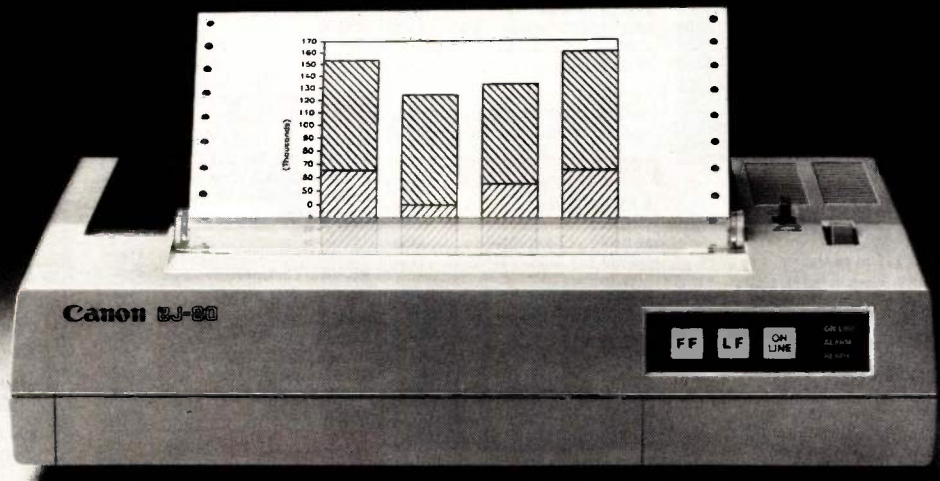

Figure 5: The 8 by 3 prototype associative memory.

The new Bubble-Jet Printer from Canon. Feature for feature, you can't burst our bubble.



Canon's exclusive bubble-jet technology has rewritten the industry's standards in four categories. Speed, quality, quietness and economy.

The Bubble-Jet Printer with bi-directional logic-seeking capabilities can quickly and quietly turn even the most complicated printing job into a breeze. It prints out 80 characters per line at an ultra-fast 220 characters per second. And its whisper quiet operation prevents your nerves from rattling.

If you're heavy into word processing, you'll be glad to know that the Bubble-Jet Printer's characters have character. The Near-Letter-Quality mode produces a whirlwind 110 characters per second. And you can choose from condensed, enlarged, superscript and subscript printing.

And since a picture says a thousand words, the new

Bubble-Jet Printer from Canon has two different high resolution graphic image modes, including a remarkably clear 1440 dots per line.

The Bubble-Jet Printer also incorporates a large capacity ink cartridge. So you can produce a small mountain of printouts before you need to replace the cartridge.

What's more, it can feed in roll paper, fan fold paper or single sheets with equal ease. And the Bubble-Jet Printer is IBM compatible. Plus it gets along well with most popular software programs.

If you're interested in speed, quality, quietness and economy, look into the lightweight, compact Bubble-Jet Printer from Canon. Because feature for feature, you can't burst our bubble.

© 1985 Canon U.S.A., Inc.

Inquiry 72

Canon
PRINTERS

For more information: call 1-800-323-1717, ext. 300. (In IL, call 1-800-942-8881, ext. 300.)
Or write Canon U.S.A., Inc., Printer Division, P.O. Box CN 11250, Trenton, NJ 08650.

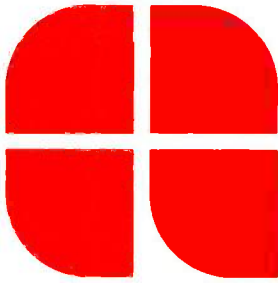

GenTech

THE SUM

COMPUTERS

IBM SYSTEM SPECIALS

256K, 2 Drives	SCall
256K, 1 Drive & 10 MB Hard	SCall
COLUMBIA MPC 4220	\$1899
CORONA 400 Series	SCall
FUJITSU Micro 16s (8086/Z80A)	\$1995



KAYPRO All Models	SCall
LEADING EDGE PC	SCall
MORROW DESIGNS All Models	SCall
NCR All Models	SCall
NEC APC-III PACKAGES	
w/2 Dr, Wordstar Pro Pk, 2050	\$2299
w/plotter, digitizer & AutoCAD	SCall
SEEQUA Chameleon/Plus	SCall
WANG	
PC w/256K, 2 Dr.	SCall
Office Assistant w/printer	SCall
ZENITH	
ZF-151-52 w/Zenith Monitor	SCall
ZF-151-21 w/10 MB Hard Disk	SCall
ZF-161-52 (Portable, 2 Dr)	SCall

FOR IBM PC/AT/JR & COMPAQ

BLUE LYNX 3278	SCall
DCA Irma/IrmaLine/IrmaKey	SCall
IOEComm 3278	SCall
ANCHOR Mark XII	\$245
HAYES	
Smartmodem 1200/2400	SCall/\$649
1200B w/Smartcom II	\$399
NOVATION SmartCat Plus	\$329
PRENTICE POPCOM	
C100/X100	\$289/\$299
VEN-Tel 300/1200 Half Card	\$409



AST RESEARCH INC.	
ADVANTAGEI (for AT)	SCall
SIX PACK PLUS w/64K	SCall
jrCOMBO (exp. to 512K)	SCall
HERCULES Graphics Card	\$299
Color Card (RGB/Comp/Par)	\$155
INTEL 8087/80287	SCall
ORCHID PC Turbo (80186, 8MHz)	\$815
PARADISE SYSTEMS Multi-Display	\$280
Modular Graphics Card	\$269
Module A/B	\$75/\$179
PLANTRONICS Color Plus	SCall
QUADRAM	
EXPANDED QUADBOARD w/64K	\$239
QUAO 512+ w/384K	\$309
SIGMA DESIGNS Color 400	
/Mouse	SCall
STB SYSTEMS Graphix Plus II	\$269
Super Rio w/64K	\$279
TALL TREE JRAM-2	SCall
TANDON TM 100-2 (DS00)	\$149
TEAC FD-55B (Thinline OS00)	\$125
TECMAR Graphics Master	\$485
Captain w/DK	\$179
jrCaptain w/128K	\$309

HARD DISK

AMPEX 20 MB w/25 MB Tape	SCall
CORVUS	
11.1 MB Omniride Starter Kit	\$1649
45 MB Omniride	\$4149

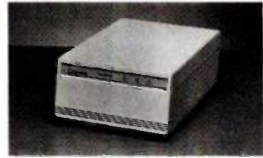

DAVONG 21 MB w/24 MB Tape	\$2459
IDOMEGA Bernoulli/Plus	SCall
MICROSCIENCE Internal 10 MB	\$649
MAYNARD ELECTRONICS	SCall
SYSGEN Image/Qic-File/XL	SCall
TALLGRASS	
TG-5025 (25 MB w/60 MB Tape)	\$2899
TG-6180 (80 MB w/60 MB Tape)	\$6399

DOT MATRIX PRINTERS

C-ITOH All Models	SCall
CITIZEN	
MSP-10	\$329
MSP-15	\$489
MSP-20	SCall
MSP-25	SCall



EPSON JX-80 Color	\$499
LQ-1500	\$910
LX-80	\$239
FX-80+	\$349
FX-100+	\$495
NEC P2/P3 Pinwriters	\$525/\$735
OKIATA	
192/193	SCall
ML 84 P	SCall
Okimate 20	SCall
Pacemark	SCall
PANASONIC KX-P1091/1093	SCall
STAR MICRONICS	
Gemini 15X	\$345
SG-10/15	SCall
SD-10/15	SCall
SR-10/15	SCall
TOSHIBA	
P1340	\$575
P351	SCall

LETTER QUALITY

BROTHER/DYNAX	
HR-15 XL (20 CPS)	\$369
HR-25/HR-35	SCall/\$859
HEWLETT-PACKARD Laser Jet	SCall
DIABLO 630 ECS/IBM	\$1799
JUKI 6100/6300	\$409/\$730
NEC	
ELF 360	\$415
2050	\$669
3550	\$1069
8850	\$1499
QUME Sprint 1140/1155/1190	SCall
SILVER-REED EXP 500/550	\$369/\$449
STAR MICRONICS Power Type	\$339

PLOTTERS & DIGITIZERS

POLAROID PALETTE	\$1175
ENTER COMPUTER Six Shooter	\$779



HOUSTON INSTRUMENTS	
PC-695	\$549
OMP-41/42	\$2349
OMP-29	\$1799
DMP-51/52	\$3529
OT-11 Digitizer	\$679
ROLAND OXY-800/880	\$699/\$949
SUMMAGRAPHICS SummaSketch	SCall

MONITORS & TERMINALS

AMDEK	
Video 300/300A/310A	\$129/139/159
Color 500/710	\$359/\$579
PRINCETON GRAPHICS Max-12E	\$175
HX-12/SR-12	\$469/\$609
QUME All Models	SCall
ROLAND	
MB-122G	\$155
MB-142	SCall
CB-141	\$269
CC-141	\$559
TAXAN	
115	\$115
116	\$125
420/L	SCall
440	\$559
TELEVIDEO All Models	SCall
WYSE	
WY-50	\$469
WY-350	SCall
ZENITH	
ZVM-123A	\$79
ZVM-124	SCall
ZVM-135	\$439
ZVM-136	SCall
Z-29A	SCall
Z-49	SCall

FOR APPLE II/IIe

ALS Smarter II (80 Col. Card)	\$129
AST RESEARCH INC. Multi I/O	SCall
DIGITAL RESEARCH CP/M Gold Card	\$269
FOURTH DIMENSION 16K RAM Card	\$55
80 Column Card (Ile)	\$55
HAYES	
Micromodem IIe w/Smartcom I	\$149
MICROSOFT Softcard II	\$339
MICROTEK Dumping GX	\$69
NOVATION Apple Cat II	\$209
212 Apple Cat II (1200)	\$389
ORANGE MICRO Grappler +	\$79
Buffered Grappler +	\$145
PCPI Applicard 6 MHz	SCall
RANA Elite I/II/III	SCall

MISCELLANEOUS

RAM CHIPS	
64K SET	\$20
256K SET	SCall
DOUBLE-SIDED DISKETTES	
3M	\$27
Dysan	\$30
Maxell	\$25
Wabash	\$19
PRINT BUFFERS	
QUADRAM Microfazer	
Parallel/Parallel 16K	\$139
64K	\$185
128K	\$239
Serial/Serial, Ser/Par, Par/Ser	
8K	\$139
64K	\$159
INTER.STRUCT. Shuffle-Buffer 32K	\$269
SURGE PROTECTORS	
EPD/CURTIS All models	SCall
NETWORK Wire Tree/Plus	\$45/\$60
ULTIMA SF-600	\$39
EMERGENCY POWER SYSTEMS	
SOLA Mini UPS	SCall
TrippLite BC425-FC (425 Watts)	\$375
SWITCHBOXES	
CABLECO 3 Way Serial/Parallel	SCall
COMPUTER ACCESSORIES	
Data Directors (All Models)	SCall

CUSTOMER SERVICE

401-781-0020

ORDERS ONLY

800-843-4302

150 Broadway, Suite 2212, NY, NY 10038

HOURS 9-8 EST, MONDAY-SATURDAY
Personal Ck (2 Weeks To Clear), Cashier's Ck.
Money Order
APO Orders Add 6% (minimum \$7). Add 3%
For Net Terms. All Returned Non-Defective
Merchandise Are Subject To A 20% Restocking
Charge. GenTech Reserves the Right to Change
Advertised Prices.



sees the SUM shrinking. He says that while "this overall machine's not a chip, at the beginning we sort of hoped to have a chip." As it turns out, each binding agent comprises at least 32 chips. But the chips are made using a fairly conservative 4-micron NMOS (N-channel metal-oxide semiconductor) process. MOSIS already is offering a 1.25-micron process that could substantially increase chip density. And although it will be some years, Dr. Oldfield explains that "It's not unrealistic to think of the effect of higher packing density leading to SUM as a custom VLSI component." ■

REFERENCES

1. Robinson, J. A. "A Machine-Oriented Logic Based on the Resolution Principle." *Journal of the Association for Computing Machinery*, 1965, vol. 12, pages 23-41.
2. Mead, Carver, and Lynn Conway. *Introduction to VLSI Systems*. Reading, MA: Addison-Wesley, 1980.
3. Clark, K. L., and S. A. Tarnlund (eds.). *Logic Programming*. Orlando, FL: Academic Press, 1982.
4. Robinson, J. A., and E. E. Sibert. "Logic Programming in LISP." Syracuse University: School of Computer and Information Science, 1980.
5. Warren, D. H. D., L. M. Pereira, and F. Pereira. "PROLOG—The Language and Its Implementation Compared with LISP." *Proceedings of the Symposium on Artificial Intelligence and Programming Languages (ACM)*; SIGPLAN Notices 12(8); and SIGART Newsletter 64, pages 109-115, 1977.
6. Lien, Sheue-Ling. "Toward a Theorem Proving Architecture." California Institute of Technology, Computer Science Department, 1981.

ACKNOWLEDGMENTS

I would like to extend special thanks to Professor John Oldfield and Professor Alan Robinson of Syracuse University, Professor Jim Kajiyi and Paula Samazan of the California Institute of Technology, Dr. Sheue-Ling Chang of Sun Microsystems, and Dr. George Lewicki of the USC/Information Sciences Institute. They made this article possible by their willingness to spend some of their valuable time discussing or digging up information for me. Melgar Commercial Photographers of Santa Clara, California, photographed the prototype chip.

SuperSoft Languages When Performance Counts

A programmer's most important software tool is the language compiler or interpreter he uses. He has to depend on it to work and work well.

At SuperSoft, we believe it. That's why we offer four excellent compilers: SuperSoft FORTRAN, SuperSoft A, SuperSoft C, and SuperSoft BASIC. They answer the programmer's need for rock solid, dependable performance on microcomputers.

SuperSoft FORTRAN

With large code and data. SuperSoft FORTRAN version 2.0 with large code and data space is now available under MS DOS and PC DOS. It gives you the power to compile extremely large FORTRAN programs on micros. It allows double precision and complex numbers, full IEEE floating point, and a full range of other important features for the serious FORTRAN programmer. Both 8087 support and a RATFOR pre-processor are optionally available. FORTRAN (CP/M-80 & 86, MS DOS, PC DOS): \$325
8087 support: \$50 RATFOR: \$100

SuperSoft A

A true Ada* subset
SuperSoft A is a completely standard subset of the Ada language, incorporating approximately 63% of the standard Ada syntax and including such important features as packages and separate compilation. For CP/M-80 microcomputers: \$300.

SuperSoft C

SuperSoft C is a high-powered, full-featured C compiler designed for serious C applications. It is fast – both in compilation and execution, and it is packed with more than 200 library functions (all delivered in source code form). SuperSoft C produces optimized assembly code, and object code can be ROMed.

SuperSoft C (for CP/M-80, CP/M-86, MS DOS, PC DOS): \$350



SuperSoft BASIC

The SuperSoft BASIC compiler lets you get serious with business and financial programs. It uses BCD math to give you highly accurate results for demanding applications. SuperSoft BASIC is a true native code compiler that is generally compatible with Microsoft's BASIC interpreter. And an additional bonus – no run time license fee is required.

SuperSoft BASIC Compiler (for MS DOS, PC DOS, and CP/M-86): \$300

Also available for programmers:

Star-Edit, a full-featured programmer's text editor: \$225.00
Disk-Edit, an invaluable programmer's disk data editor: \$100.00

To order call: **800-762-6629**

In Illinois call **217-359-2112**

In conjunction with SuperSoft, SuperSoft FORTRAN was developed by Small Systems Services, Urbana, IL, a leader in FORTRAN development.

Japanese Distributor: ASR Corporation International, TBL Building, 7th Floor, 1-19-9 Toranomon, Minato-Ku, Tokyo 105, Japan Tel. 03-5025550. Telex 222-5650 ASRTYO J.

*Ada is a trademark of the Department of Defense
PC DOS is a trademark of International Business Machines.
MS DOS is a trademark of Microsoft.
CP/M-80 and CP/M-86 are trademarks of Digital Research, Inc.

Inquiry 397

SuperSoft

SuperSoft, Inc., 1713 S. Neil St.,
P.O. Box 1628, Champaign, IL 61820

#B20

DEALERS
WE BUY
EXCESS
INVENTORIES

THE WORLD'S LARGEST COMPUTER MAIL ORDER FIRM

CONROY

TELEX 910 380 3980

ALL MAIL: 12060 SW Garden Place, Portland, OR 97223

FOR YOUR APPLE

MACINTOSH COMPUTERS BUSINESS SOFTWARE UTILITIES SOFTWARE
ASSIMILATION PROC, Turbo Touch \$ 129 \$ 92
BLUECHIP, Millionaire, Barron, Tycoon, ea. \$ 60 \$ 39
CENTRAL POINT, Copy II Mac or MacTools, ea. \$ 40 \$ 24
CONROY-LA POINTE, Diskettes, 10 pak \$ 65 \$ 29
50 pak Diskettes \$ 325 \$ 140
CONTINENTAL, Home Accountant \$ 100 \$ 65
CREATIVE SOLUTIONS, MacFourth Level I \$ 149 \$ 95
DOW JONES, Market Manager Plus \$ 249 \$ 159
EXPERTELLEIGENCE, ExperLogo \$ 150 \$ 95
FIRST BYTE, Smooth Talker \$ 150 \$ 95
FORETHOUGHT, Fact Finder \$ 150 \$ 95
HAYDEN, Sargon III \$ 50 \$ 31
Music Works \$ 80 \$ 50
HUMAN EDGE, Sales or Mgmt Edge, ea \$ 250 \$ 159
Mind Prober \$ 50 \$ 32
INFOCOM, Hitchhiker's Guide \$ 40 \$ 25
INNOVATIVE, Flip-n-File, 40 \$ 30 \$ 19
KOALA, Mac Vision \$ 400 \$ 229
LIVING VIDEOTEK, Think Tank \$ 145 \$ 85
MEGAHAUS, Megafilr \$ 195 \$ 125
Megaworks or Megamerge, each \$ 125 \$ 79
MICROSOFT, Business Pak NEW \$ 595 \$ 395
Multiplan, Word, or File, each \$ 195 \$ 129
MILES, Mac the Knife, v. 1 \$ 39 \$ 25
MONOGRAM, Dollars & Sense \$ 150 \$ 95
NOVATION, Smartcat Plus Modem w/Software \$ 499 \$ 349
ODESTA, Helix \$ 395 \$ 265
PENGUIN, Graphics Magician \$ 50 \$ 32
PROVUE, Overvue \$ 295 \$ 185
SIMON & SCHUSTER, Typing Tutor III \$ 50 \$ 30
SOFTWARE PUBL., PFS, File & Report Combo \$ 195 \$ 125
SOFTWARE ARTS, T/K Solver \$ 249 \$ 159
STATE OF THE ART, Electronic Checkbook \$ 80 \$ 50
STONEWARE, DB Master \$ 195 \$ 125
TELOS, File Viewer \$ 195 \$ 125
WARNER, Desk Organizer \$ 149 \$ 99

DISKETTES
+ CONROY-LAPOINTE™ DISKETTES +
We guarantee these top quality products with our name, 5 YEAR LIMITED WARRANTY. Discounts on orders we labels.
10 ea. SS/SD, (Apple, etc) 35 Trk, W/FLIP BOX \$ 12
100 ea SS/SD, (Apple, etc) 35 Trk \$ 90
1000 ea SS/SD, (Apple, etc) 35 Trk \$ 849
10 ea. DS/DD, (IBM, H/P) 48 Trk, W/FLIP BOX \$ 15
100 ea. DS/DD, (IBM, H/P) 48 Trk \$ 119
1000 ea. DS/DD, (IBM, H/P) 48 Trk \$ 859
10 ea. DS/DD, 3 1/2" (MAC, H/P), W/FLIP BOX \$ 29
50 ea. DS/DD, 3 1/2" (MAC, H/P) \$ 140
100 ea. DS/DD, 3 1/2" (MAC, H/P) \$ 270

CONROY-LAPOINTE™ IBM PRE-FORMATTED
10 ea. DS/DD, 48 Trk W/FLIP BOX \$ 19
100 ea. DS/DD, 48 Trk \$ 149
1000 ea. DS/DD, 48 Trk \$ 959

SINGLE-SIDED, DOUBLE DENSITY
CDC, 10 ea. SS/SD, 40 Trk (Apple, etc) \$ 55 \$ 29
DYSAN, 10 ea. SS/SD, (Apple, etc.) \$ 40 \$ 27
MAXELL, 10 ea. SS/SD, MD1 (Apple) \$ 55 \$ 19
VERBATIM, 10 ea. SS/SD, MD515-01, (Apple) \$ 49 \$ 25

DOUBLE-SIDED, DOUBLE DENSITY
CDC, 10 ea. DS/DD, 40 Trk (IBM, H/P) \$ 75 \$ 23
DYSAN, 10 ea. DS/DD, (IBM, H/P) \$ 69 \$ 35
MAXELL, 10 ea. DS/DD, MD2 (IBM) \$ 75 \$ 26
VERBATIM, 10 ea. DS/DD, MD34 (IBM) \$ 84 \$ 29

3 1/2" MICRO DISKETTES
CONROY-LAPOINTE, 10 ea. DS/DD (MAC, H/P) \$ 29
MAXELL, 10 ea. SS/SD (MAC, H/P) \$ 60 \$ 35
MEMorex, 10 ea. SS/SD (MAC, H/P) \$ 60 \$ 35
VERBATIM, 10 ea. SS/SD (MAC, H/P) \$ 65 \$ 35

HIGH DENSITY DISKETTES FOR IBM-AT
MAXELL, 10 ea. DS/QD (IBM-AT) \$ 77 \$ 49
MEMorex, 10 ea. DS/QD (IBM-AT) \$ 84 \$ 54

* GENERIK DISKETTES *
Top quality, w/jackets, no labels. Quantity discounts. 90 day "No hassle, money back guarantee."
100 ea. SS/DD, 35 Track (Apple, etc) \$ 80
100 ea. DS/DD, 48 Track, (IBM, H/P) \$ 95

COMPUTERS
apple
Ile, Ilc, Mac, Mac XL IN STOCK, CALL
FLOPPY DISK DRIVES

MICRO-SCI, A2 Disk Drive, 143K \$ 345 \$ 185
A2 Controller Card \$ 100 \$ 60
Half Height Drive for Ile \$ 269 \$ 189
Half Height Drive for Ilc \$ 299 \$ 199
RAVA, Elite I, 163K, 40 Track \$ 299 \$ 189
Elite II, 326K, 80 Track \$ 499 \$ 369
Elite Controller \$ 145 \$ 79

HARD DISKS
QUARK, QC10 for Ilc/Ile/III/MAC \$1995 \$1595

OTHER HARDWARE
CCS, 7711 or 7710-A Interface, ea. \$ 115 \$ 85
CPS/EASTSIDE, Wild Card II (copier, II +/Ile) \$ 140 \$ 99
COMX, 80 Col. + 64K RAM Card (Ile) \$ 199 \$ 99
16K RAM Card (II+) \$ 119 \$ 29
HAYES, Mach III/III Joystick (II+/Ile) \$ 80 \$ 65
KENSINGTON, System Saver Fan \$ 90 \$ 65
KEY TRONIC, KB200 Keyboard \$ 298 \$ 188
KOALA, Muppet Keys \$ 80 \$ 49
Touch Tablet w/Micro Illustrator (Ile/Ilc) \$ 125 \$ 75
KRAFT, Joystick (III/II+/Ile) \$ 65 \$ 35
Game Paddles (III/II+/Ile) \$ 50 \$ 26
MICROSOFT, Premium Softcard (Ile) \$ 395 \$ 275
ORANGE MICRO, Buffered Grappler Plus, 16K \$ 239 \$ 159
16K Buffer Board for Grappler Plus \$ 99 \$ 59
PCPI, Applicard, 6 MHz, 14 features \$ 375 \$ 250
RH ELECT., Super Fan II w/surge protector \$ 89 \$ 59
TITAN, Accelerator Ile \$ 319 \$ 219
128K RAM Card (II+) \$ 269 \$ 189
TRACKHOUSE, Numeric Key Pad (II+/Ile) \$ 149 \$ 94
TG, Select-a-Port \$ 40 \$ 26
Joystick or Game Paddles, each \$ 35 \$ 22
VIDEO 7, V Color 7, Ilc, RGB Card \$ 200 \$ 139
V Color 7, Ile, RGB Card \$ 250 \$ 169
VIDEX, UltraTerm (II+/Ile) \$ 379 \$ 229
VideoTerm 80 Col. Card (II+/Ile) \$ 279 \$ 175
WICO, Smartcard (spec. II/II+/Ile) \$ 199 \$ 159

UTILITIES SOFTWARE
BEAGLE, GPLE, Alpha Plot or B.Basic, ea \$ 50 \$ 27
Promo DOS, Disk Quick, Ap, Mech, or I.O. Silver, ea \$ 30 \$ 19
Full line IN STOCK CALL
BORLAND, Turbo Pascal \$ 55 \$ 33
3 Pak (Pasc, Turbo Tut, Toolbox) NEW \$ 105 \$ 59
CENTRAL POINT Copy II Plus (bit copier) \$ 40 \$ 23

MODEMS
ANCHOR, Signalman Mark XII (IBM) \$ 399 \$ 259
HAYES, 2400B External Modem (IBM) \$ 899 \$ 699
Smartmodem 1200B (IBM) \$ 549 \$ 389
Smartcom II Software (IBM) \$ 149 \$ 107
Smartmodem 1200 (AP or IBM) \$ 599 \$ 429
Micromodem Ile w/Smartcom (AP) \$ 329 \$ 239
KENSINGTON, Portable Modem, 300 Baud (MAC) \$ 140 \$ 109
NOVATION, Apple Car II 300 Baud (AP) \$ 389 \$ 219
212 Apple Car, 1200 Baud (AP) \$ 725 \$ 419
SmartCat Plus w/software (MAC) \$ 499 \$ 349
ACCESS 1-23 1200B Modem + Crossstalk (IBM) \$ 595 \$ 369
PROMETHEUS, 1200 Standalone Modem \$ 495 \$ 345
ProModem 1200 w/software (MAC) \$ 549 \$ 429
ProModem 1200A (AP) \$ 449 \$ 349
ProModem 1200B (IBM) \$ 399 \$ 289
QUADRAM, Quadmodem, Internal (IBM) \$ 595 \$ 425
Quadmodem, External, (IBM) \$ 695 \$ 495

MONITORS
AMDEK, Color 300 - Comp/Audio \$ 349 \$ 249
Color 500 - Comp/VCR/RGB/Audio \$ 625 \$ 375
Color 600 - Hi Res/RGB/Audio \$ 599 \$ 449
300A - 12" Amber \$ 199 \$ 139
300G, 12" Green \$ 179 \$ 129
310A, 12" Amber/Comp \$ 230 \$ 159
PRINCETON, HX-12 - Hi Res/RGB \$ 795 \$ 495
SR-12 - Hi Res/RGB \$ 799 \$ 519
MAX-12 - Amber (monochrome) \$ 249 \$ 199
ZENITH, ZVM122 - 12" Amber \$ 159 \$ 99
ZMV123 - 12" Green \$ 149 \$ 85
ZMV124 & ZVM 135 20-30% OFF

PRINTERS
DOT MATRIX:
EPSON, RX / FX Series - In Stock LIST CONROY
LX80 - 100 cps DQ/16 cps NLQ \$ 349 CALL
JX80 - Color Printer, 160 cps. \$ 799 CALL
LQ1500 - 200 cps DQ/67 cps LQ \$ 1395 CALL
MANN-TALLY, Spirit-80 - 80 cps/80 col \$ 269 \$ 219
OKidata, Okimate 20 - Color, Hi Res \$ 268 \$ 208
182 - 120 cps/80 col \$ 299 \$ 239
92 - 160 cps/80 col/para. \$ 499 \$ 399
93 - 160 cps/136 col/para. \$ 799 \$ 639
2410 Pacemaker - 350 cps/para. \$ 2995 \$ 1975
PANASONIC, P1090 - 80 cps/10" \$ 349 \$ 249
P1092 - 180 cps/10" \$ 599 \$ 459
QUADRAM, Quadjet - Inkjet Color \$ 895 \$ 395
STAR MICRO, SG10 - 120 cps DQ/30 cps NLQ \$ 299 \$ 249
SG15 - 120 cps DQ, 30 cps NLQ, 16K \$ 499 \$ 419
SD10 - 160 cps DQ, 40 cps NLQ \$ 449 \$ 379
SD15 - 160 cps DQ, 40 cps NLQ, 16K \$ 599 \$ 509
SR10 - 200 cps DQ, 50 cps NLQ \$ 649 \$ 549
SR15 - 200 cps DQ, 50 cps NLQ, 16K \$ 799 \$ 679

LETTER-QUALITY:
JUKI, 6300 - 40cps/para. \$ 995 \$ 795
6100 - 18 cps/para/3 pitch \$ 599 \$ 439
PANASONIC, P3151 - 22 cps/15 1/2" \$ 699 \$ 549
TOSHIBA, Prop. spacing & hi-res graphics
1351 - 192 cps DQ & 100 cps LQ \$ 1895 \$ 1375
1340 - 144 cps DQ, 54 cps LQ \$ 995 \$ 659
Bi-direction Tractor Feed \$ 195 \$ 175

PLOTTERS:
EPSON, 4 Pen Plotter \$ 599 CALL
Printer Stand \$ 30 \$ 20
NETWORK, Wiretree, 4 outlet, w/lift & surge \$ 70 \$ 39
Wiretree Plus \$ 100 \$ 59
PERFECT DATA, Head Cleaning Kit \$ 16 \$ 12
PROD TECH INTL., Uninterruptible Power Supply
200 Watts, PC200 for IBM-PC \$ 359 \$ 229
300 Watts, XT300 for IBM-XT \$ 499 \$ 379
800 Watts, AT800 for IBM-AT, 72 lbs. CALL

ORDERING INFO & TERMS: MAIL TO: 12060 SW Garden Place, Portland, OR 97223
Cashiers checks, money orders, Fortune 1000 checks and government checks honored immediately. Personal and other company checks - allow 20 days to clear. Prices reflect 3% cash & Conroy-LaPointe Credit Card discount, so AOD 3% to above prices for VISA/MasterCard/American Express. Your cards NOT charged til we ship. ADD SHIP CHARGES: U.S. Mainland, 3% (\$5 minimum) for standard UPS ground; UPS Bulk, 6% (\$10 min.); for U.S. Postal APD or FPO or Alaska, 6% (\$15 min.). Canada, 12% (\$15 min.). Foreign orders except Canada, 18% (\$25 min.). Monitors by Postal or to foreign countries, 30% (\$50 min.). Orders received with insufficient SHI will be refunded. All prices, availability and specifications subject to errors or change without notice, so call to verify. All goods are new, include warranty and are guaranteed to work. Due to our low prices and our assurance that you will get new, unused products - ALL SALES ARE FINAL. We do not guarantee compatibility. Call before returning goods for repair or replacement. ORDER DESK HOURS - 6AM to 6PM PST, Monday through Friday, Saturday 10 to 4. EconoRAM™, Fastrak™, and Generik™ are trademarks of ComX Corporation.

BUSINESS SOFTWARE

ALS, Word or List Handler, ea \$ 90 \$ 36
Handler Pak (Word/List/Spell) \$ 170 \$ 73
ASHTON-TATE, dBase II (Reg CP/M 80) \$ 495 \$ 289
BPI, AR, AP, PR or INV, each \$ 395 \$ 240
BRODERBUND, Print Shop \$ 50 \$ 29
Print Shop Graphics Library \$ 25 \$ 18
Bank St. Writer or Speller, ea \$ 70 \$ 45
Bank St. Combo (Writer & Speller) \$ 140 \$ 85
CDEX, for Visicalc, Multiplan, Apple Ile, ea \$ 60 \$ 40
DOW JONES, Market Manager Plus \$ 249 \$ 159
Market Analyzer or Microscope, ea \$ 349 \$ 219
HOWARD SOFT, Tax Preparer for 84 taxes \$ 250 \$ 165
Kit for California \$ 95 \$ 63
HUMAN EDGE, Sales or Mgmt Edge, ea \$ 250 \$ 165
LIVING VIDEOTEK, Think Tank \$ 145 \$ 89
MECA, Managing Your Money \$ 200 \$ 125
MEGAHAUS, Megawriter \$ 100 \$ 65
Megaworks \$ 125 \$ 80
MICRO PRO, WordStar \$ 350 \$ 189
WordStar w/ Starcard \$ 495 \$ 265
WordStar Professional, 4 Pak \$ 495 \$ 265
MailMerge, SpellStar, or Starindex, ea \$ 99 \$ 54
InfoStar and StarCard Combo \$ 595 \$ 295

UTILITIES SOFTWARE
BEAGLE, GPLE, Alpha Plot or B.Basic, ea \$ 50 \$ 27
Promo DOS, Disk Quick, Ap, Mech, or I.O. Silver, ea \$ 30 \$ 19
Full line IN STOCK CALL
BORLAND, Turbo Pascal \$ 55 \$ 33
3 Pak (Pasc, Turbo Tut, Toolbox) NEW \$ 105 \$ 59
CENTRAL POINT Copy II Plus (bit copier) \$ 40 \$ 23

UTILITIES SOFTWARE

EPSON, Graphics Dump \$ 15 \$ 7
FUNK, Sideways \$ 60 \$ 37
HAYES, Terminal Prog. for Smartmodem \$ 99 \$ 65
MICROSOFT, Full Line in Stock CALL
OMEGA, Locksmith \$ 100 \$ 70
PENGUIN, Complete Graphics System II \$ 80 \$ 49
Graphics Magician \$ 60 \$ 40
QUALITY, Bag of Tricks \$ 40 \$ 29
UNITED SWI, ASCII Express-The Pro \$ 130 \$ 82
UTILICO, Essential Data Duplicator III \$ 80 \$ 49

HOME & EDUCATIONAL

BEAGLE BROS., Full line IN STOCK CALL
BRODERBUND, Print Shop \$ 50 \$ 29
CONTINENTAL, Home Accountant \$ 75 \$ 43
DOW JONES, Home Budget \$ 99 \$ 69
KOALA, Full line IN STOCK CALL
MICROSOFT, Typing Tutor II \$ 25 \$ 17
MONOGRAM, Dollars & Sense or S.A.M., ea \$ 100 \$ 59
Dollars & Sense for Ilc \$ 25 \$ 69
Forecast \$ 60 \$ 38
SCARBOROUGH, Mastertype \$ 40 \$ 27
Your Personal Net Worth \$ 80 \$ 50
SIERRA/ON-LINE, Homework \$ 50 \$ 45
SIMON & SCHUSTER, Typing Tutor III \$ 50 \$ 33
PLUS: BARRONS, CBS, DAVIDSON, EDU-WARE, HARCOURT, LEARNING CO., TERRAPIN

RECREATIONAL SOFTWARE

BLUECHIP, Millionaire, Squire, Barron, ea. \$ 50 \$ 32
DATA SOFT, Aztec or Zaxxon, each \$ 40 \$ 27
ELECTRONIC ARTS, Sky Fox & others, ea \$ 130 \$ 28
HAYDEN, Sargon III (Chess) \$ 50 \$ 30
INFOCOM, Zork I, II, or III, ea. \$ 40 \$ 25
ORIGIN, Ultima III \$ 60 \$ 37
PENGUIN, Transylvania \$ 35 \$ 24
PROFESSIONAL, Trivia Fever \$ 40 \$ 25
SPINNAKER, IN STOCK CALL
SUB LOGIC, Flight Simulator II \$ 50 \$ 30
PLUS: BRODERBUND, DATAMOST, MUSE, SIR-TECH

PRINTER INTERFACES AND BUFFERS

ARBO, IBM-PC to Para Printer Cable \$ 29 \$ 19
ASSIM PROC, Mac to Epson Conn I/IF \$ 89 \$ 69
EPSON, Parallel Interface for LQ1500 \$ 100 \$ 79
Serial Interface Board \$ 130 \$ 105
MPC, Apple II I/IF & Cable for Epson & Gemini \$ 95 \$ 59
OKidata, Plug'n Play, Tractors, Okigrap, ea \$ 50 \$ 42
ORANGE MICRO, Grappler Plus for Apple \$ 149 \$ 99
Serial Grappler \$ 119 \$ 79
Buffered Grappler Plus, 16K \$ 239 \$ 159
QUADRAM, Microfazers, full line IN STOCK CALL
Microfazers 8K, P-P, w/copy \$ 189 \$ 139

CABLES

ARBO, IBM-PC to Modem Cable \$ 29 \$ 19
IBM-PC to Para Printer Cable \$ 60 \$ 30
ASTAR, RF Modulator for T.V. (Apple) \$ 35 \$ 20
CURTIS, Monitor Extension Cable (IBM) \$ 50 \$ 35
3-9" Keyboard Extensions Cable (IBM) \$ 40 \$ 30
RCA, Monitor Cable \$ 15 \$ 9

ACCESSORIES

CURTIS, Diamond, 6 outlets, switched \$ 50 \$ 29
Emerald, 6 outlets, 6' cord \$ 60 \$ 35
Ruby, 6 outlets, 6' cord, filter \$ 90 \$ 52
Sapphire, 3 outlets, w/filter \$ 80 \$ 46
EPD, Lemon, 6 outlets/wall \$ 45 \$ 29
Lime, 6 outlets/cord \$ 70 \$ 45
Orange, 6 outlets/cord \$ 100 \$ 60
Peach, 3 outlets/wall \$ 60 \$ 39
INNOVATIVE, Flip-n-File 50 (disk holder) \$ 22 \$ 15
KENSINGTON, Masterpiece (IBM) \$ 140 \$ 99
System Saver Fan (Apple) \$ 90 \$ 65
Printer Stand \$ 30 \$ 20
NETWORK, Wiretree, 4 outlet, w/lift & surge \$ 70 \$ 39
Wiretree Plus \$ 100 \$ 59
PERFECT DATA, Head Cleaning Kit \$ 16 \$ 12
PROD TECH INTL., Uninterruptible Power Supply
200 Watts, PC200 for IBM-PC \$ 359 \$ 229
300 Watts, XT300 for IBM-XT \$ 499 \$ 379
800 Watts, AT800 for IBM-AT, 72 lbs. CALL

CONROY-LAPOINTE CREDIT CARD
NAME ADDRESS CITY STATE ZIP
MAIL TO: 12060 SW Garden Place, Portland, OR 97223

SAVE 25% - 75% OFF LIST !!!

#B20

-LA POINTE INC.

© 1984 by Conroy-LaPointe, Inc. All Rights Reserved

TO ORDER, CALL (800) 547-1289 FOR YOUR IBM-PC, XT, AT or JR

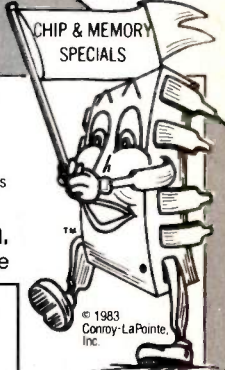

PRICES ARE DROPPING. SO CALL!

NEW! * ComX *

EconoRAM Plus™

*** 256K * CHIP KIT \$99**
9 Each, 4256 chips
150 ns
\$79 ea.
10 or more

*** 64K * CHIP KIT \$19**
9 Each, 4164 chips
90 Day Warranty by us
\$14 ea.
10 or more

*** 384K Multifunction RAM Board**
expandable to 1.5 Megabyte
Works like AST SixPakPlus™ with capacity for up to 1.5 meg. game port.
Fastrak™ RAM Disk and Spooler Software.

EconoRAM™ 384K Single Function Board
\$195
With Fastrak™ and Spooler.
Fully Compatible, 1 Year Limited Warranty.
Works on DOS 1.1, 2.0 or 2.1
Prices and availability subject to change. Call

COMPUTER SYSTEMS

Call for Details — 256K IBM-PC



360K Disk Drives by CDC
90 Day Limited Warranty By Us

COMPAG Portable, 256K, 2 360K Disk Drives

Z150, 256K, 2 320K Disk Drives, MS DOS 2.1, 8088 Chip, 2 S/P

HARD DISKS & TAPE BACKUP

- KAMERMAN, Internal 10 meg kit \$ 895 \$ 745
- External 10 meg Kit w/power \$1295 \$1049
- MF-10/10, H Disk, tape back, cont, power \$2295 \$1795
- MICRO SCIENCE, 10 meg w/controller \$ 895 \$ 689
- RANA, External 10 meg w/controller \$1495 \$1095
- Internal 10 meg w/controller \$ 995 \$ 689
- TALLGRASS, 25 meg disk, 55 meg tape, int. \$3660 \$3160

FLOPPY DISK DRIVES

- CDC, Limited 30 day warranty; Call for quantity prices
- Full Height \$129
- Half Height \$109
- MAYNARD, Controller Card w/para port \$ 300 \$ 185
- Controller Card w/serial port \$ 310 \$ 195
- Sandstar Cont Card (accepts 3 modules) \$ 265 \$ 205
- PERFECT DATA, Head Cleaning Kit \$ 16 \$ 12

OTHER HARDWARE

- AST, SixPak Plus, 64K \$259
- SixPak Plus, 256K, S/P/CC + S/W \$ 895 \$ 395
 - SixPak Plus, 384K, S/P/CC + S/W \$ 895 \$ 465
 - Game Port for SixPak \$ 50 \$ 39
 - Preview™ Graphics Card w/para, 64K \$ 399 \$ 299
 - Advantage™ Multif. Bd. for AT, 128K \$ 595 \$ 445
 - I/O Plus II, S/P/CC \$ 215 \$ 150
 - I/O Plus II, S/P/CC/G \$ 265 \$ 185
 - I/O Plus II, 2S/P/CC/G \$ 315 \$ 215
 - Port Kits - ser, para, or game, ea. \$ 50 \$ 39
 - MonoGraphPlus™ P/CC (for Lotus) \$ 495 \$ 375
- CONX, NEW
- EconoRAM™ Plus, 384K to 1.5 meg board, S/P/CC/G Fastrak & Spooler \$265
- EconoRAM™, full 384K board \$ 295 \$ 195
 - HAUPPAGE (HCW), 8087 Chip \$ 175 \$ 129
 - 8087 Math Pak (Chip & softw.) \$ 295 \$ 235
 - HAYES, Mach II Joystick \$ 45 \$ 29
 - Mach III (PC or Jr.) \$ 55 \$ 35
 - HERCULES, Color Card w/para. Mono Graphics Card \$ 245 \$ 169
 - KENSINGTON, Masterpiece™ PC Saver™ Line Cord w/Filter \$ 140 \$ 99
 - KEY TRONIC, KB5151, Std. Keyboard \$ 255 \$ 195
 - KOALA, Speed Key System \$ 100 \$ 63
 - Speed Key Tablet w/software \$ 200 \$ 115
 - Koala Pad w/PC Design \$ 150 \$ 89
- MAYNARD, SAND STAR SERIES
- Multifunction (6) Card \$ 89 \$ 79
 - Memory Card no RAM \$ 199 \$ 139
 - Memory Card 256K \$ 495 \$ 395
 - Floppy Cont. Card (accepts 3 modules) \$ 265 \$ 205
 - Hard Disk I/F Module \$ 499 \$ 399
 - Hard Disk Cable \$ 30 \$ 27
 - Serial Port Module \$ 95 \$ 79
 - Para or Clock Cal. Module, ea. \$ 59 \$ 49
 - Game Adapter Module \$ 49 \$ 43
 - Memory Module, OK \$ 122 \$ 99
 - Memory Module 256K \$ 422 \$ 357

OTHER HARDWARE

- MICROSOFT, Mouse (for PC) \$ 195 \$ 135
- Serial Mouse \$ 195 \$ 135
- MOUSE SYSTEMS, PC Mouse & Paint \$ 295 \$ 140
- PARADISE, Modular Graphics Card \$ 395 \$ 285
- Parallel or Serial Port, ea. \$ 95 \$ 65
- PERSYST, NEW
- PC/Mono Board, w/para port \$ 250 \$ 195
 - PC/Color Graphics Bd w/light pen & I/F \$ 244 \$ 176
 - BOB Board Color Adapter, hi res. \$ 595 \$ 465
- QUADRAM,
- Quadboard 64K, to 384K, S/P/CC/G \$245
- Quadboard, no RAM, expand to 384K \$ 295 \$ 225
 - Quadboard 256K, to 384K, S/P/CC \$ 395 \$ 295
 - Quadboard 384K (full), S/P/CC/G \$ 795 \$ 495
 - Quadboard II, no RAM, to 256K \$ 295 \$ 215
 - Quadboard II, 64K, to 256K, 2S/CC \$ 395 \$ 265
 - Quadboard II, 256K, 2S/CC \$ 595 \$ 395
 - Quad 512 + 64K w/serial port \$ 325 \$ 245
 - Quadcolor I, board, 4 colors \$ 295 \$ 195
 - Upgrade Quadcolor I to II kit \$ 275 \$ 199
 - Quadvue, board, Mono, S/P/CC \$ 345 \$ 269
 - Quad 3278 \$1195 \$1050
 - Quadnet VI \$2295 \$1545
 - Quadnet IX \$1995 \$1745
 - Quadlink \$ 495 \$ 385
 - Quadsprint \$ 645 \$ 495
 - WG Products, Joystick \$ 45 \$ 29
 - WICO, Smartboard Keyboard \$ 400 \$ 279

FOR YOUR PC-JR

- KEY TRONIC, KB5151 Jr. Keyboard \$ 255 \$ 195
- Numeric Keypad \$ 100 \$ 77
- KOALA, Touch Tablet for Jr. \$ 125 \$ 75
- MICROSOFT, Booster 128K w/Mouse \$ 495 \$ 339
- MOUSE SYSTEMS, Mouse (for Jr.) \$ 195 \$ 125
- QUADRAM, Expansion Chassis \$ 695 \$ 540
- Memory Expansion Board (128K P/CC) \$ 275 \$ 215
- TECMAR, Jr. Captain \$ 395 \$ 325

SOFTWARE FOR YOUR IBM-PC, XT, AT or JR

BUSINESS	LIST PRICE	CONROY PRICE
ASHTON-TATE, Framework	\$ 695	\$ 349
dBase III	\$ 895	\$ 359
dBase II, (req. PC-DOS & 128K)	\$ 495	\$ 289
ATI, Training Programs—Large Inventory	\$ 75	\$ 50
BPI, General Acctg. AR, AP, or PR, ea.	\$ 595	\$ 365
BRODERBUND, Bank St. Writer (PC or Jr.)	\$ 80	\$ 49
CDEX, Training Programs—Large Inventory	\$ 70	\$ 45
CONTINENTAL, Ultrafile (PC)	\$ 195	\$ 115
Tax Advantage (PC or Jr.)	\$ 70	\$ 40
Property Management (PC)	\$ 495	\$ 295
DATA TRANS., Foxitrix	NEW	\$ 125 \$ 75
DOW JONES, Investment Evaluator	\$ 149	\$ 99
Market Manager Plus	\$ 249	\$ 159
Market Analyzer or Market Microscope	\$ 349	\$ 219
Spread Sheet Link	\$ 249	\$ 159
FOX & GELLER, Quickcode III	\$ 295	\$ 185
HARVARD, Total Project Manager	\$ 495	\$ 295
HOWARDSOFT, Tax Preparer '85	\$ 295	\$ 195
Kit for California	\$ 125	\$ 83
HUMAN EDGE, Mind Prober (PC or Jr.)	\$ 50	\$ 32
Sales Edge or Management Edge, ea.	\$ 250	\$ 159
Negotiation Edge	\$ 295	\$ 185
KENSINGTON, Easy Link Mail Manager	\$ 95	\$ 59
LIFETIME, Volkswriter Deluxe	\$ 295	\$ 159
LIVING VIDEOTEK, Think Tank	\$ 195	\$ 105
LOTUS, 1-2-3	\$ 495	\$ 309
Symphony	\$ 695	\$ 465
MDBS, KnowledgeMan	\$ 500	\$ 300
MECA, Managing Your Money (PC)	\$ 195	\$ 125
Managing Your Money Cartridge (Jr.)	\$ 199	\$ 179

BUSINESS	LIST PRICE	CONROY PRICE
MICROPRO, WordStar (PC)	\$ 350	\$ 139
WordStar (Jr.)	\$ 195	\$ 115
WordStar 2000 (copiable)	\$ 495	\$ 295
WordStar 2000 Plus (copiable)	\$ 595	\$ 325
WordStar Professional Plus	\$ 695	\$ 395
WordStar Professional, 4 Pak	\$ 495	\$ 265
MailMerge, SpellStar or StarIndex, ea.	\$ 99	\$ 54
InfoStar Plus (+ Starburst)	\$ 595	\$ 315
Correct Star	\$ 145	\$ 77
MICRORIM, RBase Clout	\$ 195	\$ 139
Extended Report Writer	\$ 150	\$ 95
RBase Series 4000 (New Version)	\$ 495	\$ 259
MICROSOFT, Spell	\$ 50	\$ 32
Multiplan (PC or Jr.)	\$ 195	\$ 125
Chart or Project, each	\$ 250	\$ 159
Word	\$ 375	\$ 235
MONOGRAM, Dollars & Sense w/Forecast	\$ 180	\$ 99
MULTIMATE, Multimate Ver. 4.0	\$ 495	\$ 295
PEACHTREE, Back to Basics	\$ 395	\$ 239
Peach Pak (GL/AR/AP)	\$ 395	\$ 225
QUE, Using 1-2-3	\$ 15	\$ 12
1-2-3 for Business	\$ 15	\$ 12
Using Symphony	\$ 20	\$ 15
SAMNA, Word Plus	\$ 695	\$ 479
Word III	\$ 550	\$ 279
SATELLITE, WordPerfect (PC)	\$ 495	\$ 235
WordPerfect (Jr.)	\$ 69	\$ 45
SOFTW. ARTS, Spotlight	\$ 150	\$ 95
TK Solver (specify DOS)	\$ 399	\$ 269

BUSINESS	LIST PRICE	CONROY PRICE
SOFTWARE PUBL. PFS:Report	\$ 125	\$ 79
PFS:File	\$ 140	\$ 89
PFS:Write	\$ 140	\$ 89
PFS:Graph	\$ 140	\$ 89
PFS:Plan	\$ 140	\$ 89
PFS:Proof or PFS:Access, each	\$ 95	\$ 59
SORCIM, SuperCalc III	\$ 395	\$ 245
STONEWARE, Advanced DB Master	\$ 595	\$ 375
THORN EMI, Perfect Pak (Jr) (Writer/Spell/Thesaurus)	\$ 139	\$ 89
WARNER, Desk Organizer (PC or Jr.)	\$ 195	\$ 125

UTILITIES	LIST PRICE	CONROY PRICE
BORLAND, Sidekick or Toolbox, ea.	\$ 55	\$ 31
Sidekick (Copiable) (PC or Jr.)	\$ 85	\$ 50
Turbo Pascal (PC or Jr.)	\$ 70	\$ 39
Super Keys	\$ 70	\$ 45
3 Pak (Pascal, Turbo Tut, Toolbox)	\$ 105	\$ 65
CENTRAL POINT, Copy II PC	\$ 40	\$ 23
COMX, Fastrak™, RAM/Disk emulator & printer spooler	\$ 100	\$ 59
For any PC/DOS or RAM Card. Menu Driven	\$ 100	\$ 64
DIGITAL RES., CP/M-86™ (PC/XT)	\$ 100	\$ 64
CBASIC Compiler (CP/M-86 or PC/DOS, ea)	\$ 600	\$ 395
DR LOGO-86 (CP/M-86)	\$ 150	\$ 99
FUNK SOFTWARE, Sideways	\$ 60	\$ 37
IBM, BASIC Cartridge (Jr)	\$ 75	\$ 69
HAYES, Smartcom II (Data Comm.)	\$ 149	\$ 99
LIFEBEAT, Lattice C	\$ 500	\$ 250
Dr. He	\$ 100	\$ 50
MICROSOFT, Macro Assembler	\$ 150	\$ 99
BASIC Compiler or C Compiler, ea	\$ 500	\$ 259
Business BASIC Compiler	\$ 450	\$ 300
COBOL Compiler	\$ 700	\$ 459
FORTRAN Compiler	\$ 350	\$ 229
PASCAL Compiler	\$ 300	\$ 199

UTILITIES	LIST PRICE	CONROY PRICE
MICROSTUF, Crosstalk XVI (PC or Jr)	\$ 195	\$ 129
MOUSE SYSTEMS™, PC Paint	\$ 95	\$ 69
NORTON, Utilities (14 prgms)	\$ 100	\$ 65
ROSESOFT, Prokey	\$ 130	\$ 79
WESTERN UNION, Easy Link Mail Mng'r	\$ 95	\$ 59

HOME & EDUCATIONAL	LIST PRICE	CONROY PRICE
BPI, Personal Accounting	\$ 99	\$ 63
CONTINENTAL, Home Accountant (Jr)	\$ 75	\$ 56
Home Accountant Plus (PC)	\$ 150	\$ 90
DOW JONES, Home Budget	\$ 139	\$ 92
KOALA, Graphics Exhibitor (Jr)	\$ 40	\$ 23
MONOGRAM, Dollars & Sense w/forecast	\$ 180	\$ 99
SCARBOROUGH, MasterType (PC or Jr)	\$ 40	\$ 25
Your Personal Net Worth	\$ 100	\$ 63
SIMON & SCHUSTER, Typing Tutor III	\$ 50	\$ 33

PLUS: BPI, CBS, COMPREHENSIVE, DAVIDSON, HARDCOURT, PBL CORP.

RECREATIONAL	LIST PRICE	CONROY PRICE
BLUECHIP, Millionaire, Barron, Tycoon, ea.	\$ 60	\$ 39
BRODERBUND, Large Inventory In Stock	CALL	CALL
ELECTRONIC ARTS, Large Inventory In Stock	CALL	CALL
HAYDEN, Sargon III (Chess)	\$ 50	\$ 34
INFOCOM, Large Inventory In Stock	CALL	CALL
Hitchhiker's Guide	\$ 40	\$ 25
Zork I, II, or III, ea.	\$ 40	\$ 25
MICROSOFT, Flight Simulator (PC or Jr)	\$ 50	\$ 33
ORIGIN, Ultima III (PC or Jr)	\$ 60	\$ 39
SIERRA/ON-LINE, Ultima II (PC or Jr.)	\$ 60	\$ 40
SPECTRUM HOLOBYTE, Gato	\$ 40	\$ 25
SPINNAKER, President's Choice, Amazon	\$ 40	\$ 25
Fahrenheit, Rendezvous, Dragon, each	\$ 40	\$ 25

CASH-n-CARRY COMPUTER STORES, INC.
Retail Sales only. Store prices may vary.

SAN FRANCISCO — 550 Washington Street (at Montgomery, opposite the Pyramid), Interstate 80, to Highway 480; take Washington Street Exit. CALL (415) 982-6212.

PORTLAND, OREGON — At Park 217, Tigard at intersection of Highways 217 and 99W. CALL (503) 620-5595.

SEATTLE, WASH. — 3540 128th Ave. SE, Bellevue 98006. In Loehmann's Plaza near Factors Square, SE of Highway 405 & 90 and at SE 36th and Richards. CALL 641-4736.



OUR REFERENCES:
We have been in computers and electronics since 1958, a computer dealer since 1978 and in computer mail order since 1980. Banks: 1st Interstate Bank, (503) 643-4678. We belong to the Chamber of Commerce (503) 228-9411, and Direct Marketing Association; call Dun and Bradstreet if you are a subscriber. Recipient of OREGON BUSINESS MAGAZINE'S 1984 Enterprise Award.



CALL (800) 547-1289 Foreign & Portland Residents Call In Oregon: (800) 451-5151 (503) 620-9877

QUESTIONS (503) 620-9878

ORDER DESK HOURS Mon-Fri 6am to 6pm (PST) Saturday 10am to 4pm (PST) Weekdays Only (6am here is 9am in New York)

INTRODUCING CONQUEST PC TURBO..... A COMPLETE AND POWERFUL COMPUTER SYSTEM



FEATURES INCLUDE:

- 16Bit CPU
With 256k Memory -
Expandable to 1 Mega
Bytes of Parity Checked
- Built-in turbo
Switchable, Dual Speed
Operation Regular 4.7
MHZ or High
Performance 8 MHZ
- Two 360k Slimline Disk
Drives
- Floppy Disk Controller
- Video Adapter
- Parallel and Serial I/O's
- 130W Power Supply
(110-220 Vac
Convertible)
- Enhanced Keyboard

CONQUEST

Conquest PC Turbo supports standard industry operating systems: PC-DOS, MS-DOS, CP/M 86 and Concurrent CP/M.....Plus utilizes all of the applications software such as: Lotus 1-2-3, Symphony, Framework, DBASE II, Visicalc, Wordstar, Multiplan, Flight Simulator, and most of the popular IBM PC software products. For More Details Call or Write To:

Microshop
COMPUTER PRODUCTS

2640 Walnut Ave. Unit K Tustin, California 92680 (714) 838-7530

184 BYTE • JUNE 1985

IBM PC. is a registered trademark of IBM Corp.
MS DOS, Flight Simulator & Multiplan are the registered
trademark of Microsoft, Inc.
Wordstar is a registered trademark of MicroPro.
Multimate is a registered trademark of Multimate Intl. Corp.
Visicalc is a registered trademark of Visicorp.

Inquiry 442 for End-Users. Inquiry 443 for DEALERS ONLY.

INSIDE APPLETALK

A closer look at Apple's new link

In January Apple Computer Inc. unveiled its long-awaited AppleTalk local-area network (LAN), designed to let Apple and non-Apple products communicate and share information and resources. (See "The Macintosh Office" by John Markoff and Phillip Robinson, February BYTE, page 120, for more information.)

Physically, AppleTalk consists of a simple shielded twisted-pair cable called a trunk cable. You attach devices such as computers and peripherals to the trunk cable using connection boxes (see figure 1). Each connection box contains two miniature 3-pin connectors and a short length of cable terminating in a DB-9 connector. With the connector modules joining the segments of the trunk cable, you can connect up to 32 devices to a single AppleTalk network over a total distance of up to 300 meters. In addition, you can interconnect a number of such networks using a special device called a bridge.

Electrically, AppleTalk is an RS-422A balanced transmission line with a raw data-transfer rate of 230.4K bits per second. The data is sent over the bus in a synchronous format using a bit-oriented protocol based on the

synchronous data-link control (SDLC) protocol. Currently, only the Macintosh has the hardware necessary to support this standard.

Serial port B on the back of the Macintosh (the printer port) can be attached to AppleTalk. The circuitry required to implement the AppleTalk protocols is entirely contained on the Macintosh's digital board. The heart of the serial interface is the Zilog 8530 serial communications controller (SCC). This chip takes care of all the details necessary to send and receive data in the format required by Apple-

Talk. The RS-422A drivers and receivers (26LS30 and 26LS32) provide the balanced line interface to the bus.

To allow IBM Personal Computers (PCs) to share resources and data with Macintosh office products, Apple is marketing an interface card for the IBM PC that will let it communicate via AppleTalk. While Apple has not announced an AppleTalk card for the

(continued)

David Ushijima (2600 Tenth St., Berkeley, CA 94710) is a technical editor at Osborne/McGraw-Hill.



Apple II, it would be easy for the company to add one.

CONFIGURING THE BUS

AppleTalk was designed specifically as a network for personal computers. As a result, it is extremely flexible and can be used in three ways: as a peripheral bus, as a small LAN, or as a path to a large, complex network.

As a peripheral bus, AppleTalk allows the implementation of so-called virtual slots. While you cannot expand the Macintosh by plugging in boards (as with the Apple IIe or the IBM PC), you can add devices via AppleTalk. Since the bus is fast enough to accommodate the connection of devices such as hard disks, it provides the functional equivalent of slots—thus the term “virtual slots.”

Although the speed with which the Macintosh can access a device via AppleTalk is slower than that which could be obtained if you were to plug a controller card directly into a slot, the overall performance is still respectable (approximately 29K bytes per second).

The LAN configuration of AppleTalk is probably the most common for most small- to medium-size businesses. In this configuration AppleTalk is used to connect small clusters of computers so that they can exchange information and share hard disks and high-speed printers (such as Apple's new LaserWriter).

Devices that let computers share a resource are called servers. A file server lets users share files on a hard disk and a print server lets them share a high-speed printer. The LaserWriter and the as-yet unreleased file server are examples of servers. An LAN configuration is shown in figure 2. In this case, a node is any device connected to the bus. Thus, a node could be a Macintosh or an IBM PC with the proper AppleTalk interface card.

One variation of the LAN configuration would allow a local AppleTalk network to serve as a path to a larger, more complex network such as GTE's Telenet. This would allow you to communicate with computers that are located beyond the confines of the local area.

The most complex configuration of AppleTalk is that of a full-blown network such as the one shown in figure 3. While AppleTalk was designed to accommodate a large number of computers configured in complex arrangements, most users will never have to deal with this level of complexity. Universities and large businesses that need to incorporate a large number of personal computers into a unified network will be concerned with this configuration.

THE APPLE TALK ARCHITECTURE

In the real world, the development of a network can be likened to the development of a telephone system. For communication to take place, you must have a connecting link, the telephone cable. Before you can lay the cable, you must have a set of plans that everyone agrees to follow. In the case of AppleTalk, the plans for the system consist of a set of rules or protocols that a device such as the Macintosh or Lisa must follow in order to talk to other members of the network.

The AppleTalk architecture consists of a set of well-thought-out rules that allow a wide range of devices to be connected together. Apple has designed the architecture to be an open system, that is, one in which outside or third-party developers are encouraged to add to or modify the system according to their needs. Essentially, Apple is providing third-party developers with a set of tools that will allow them to connect their devices to the network and with a set of sug-

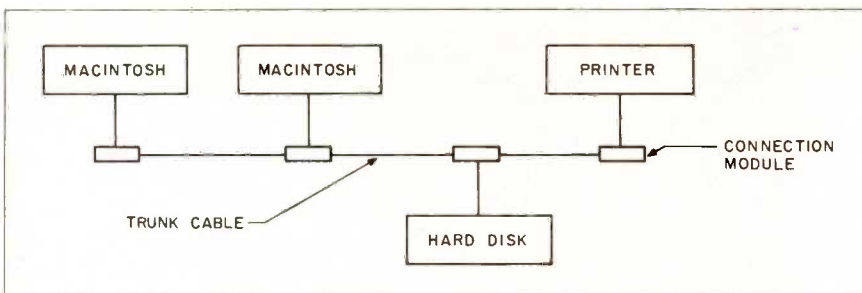

Figure 1: The typical AppleTalk configuration.

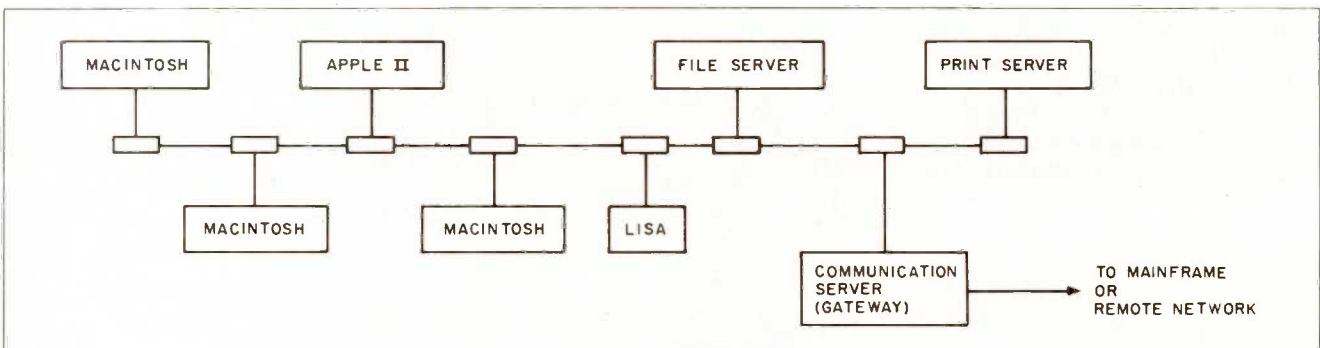

Figure 2: AppleTalk configured as a local network.

gested rules that will let them implement various functions. Beyond the basic rules, developers are free to select and design their own protocols to add to what Apple supplies.

THE ISO OPEN SYSTEMS MODEL

To understand the workings of AppleTalk let's take a look at the ISO (International Standards Organization) Open Systems Model. The ISO was established to guide network developers and promote compatibility between networks. Since different networks are designed with different goals in mind, one network may implement a number of features that are not necessary on another network. However, it is desirable to have compatible networks. To promote compatibility, the ISO Open Systems Model defines what it calls "levels" or "layers" of a network. Each layer consists of a particular set of rules. The layers at the bottom of the network specify the most elementary or basic rules or protocols. Each successive layer, proceeding from bottom to top, adds a function or feature that depends on the mechanism defined in the layer below it.

Because the Open Systems Model is based on logical rather than physical divisions, it can be somewhat confusing when you are trying to interpret how a physical system is actually put together. To get a feel for how a model like this represents a process that occurs in the real world, consider the analogy of a telephone conference.

Suppose you set up a conference call between members of different countries. For this to be possible, the basic telephone equipment must be compatible. Furthermore, everyone must agree to speak the same language. The participants must agree on a set of rules (formal or informal) detailing, for example, who may speak when, for how long, etc. Without this groundwork, the conference call could result in a *mélange* of voices. In this example you can see several levels of protocol that must be in effect for communication to take place.

The ISO Open Systems Model con-

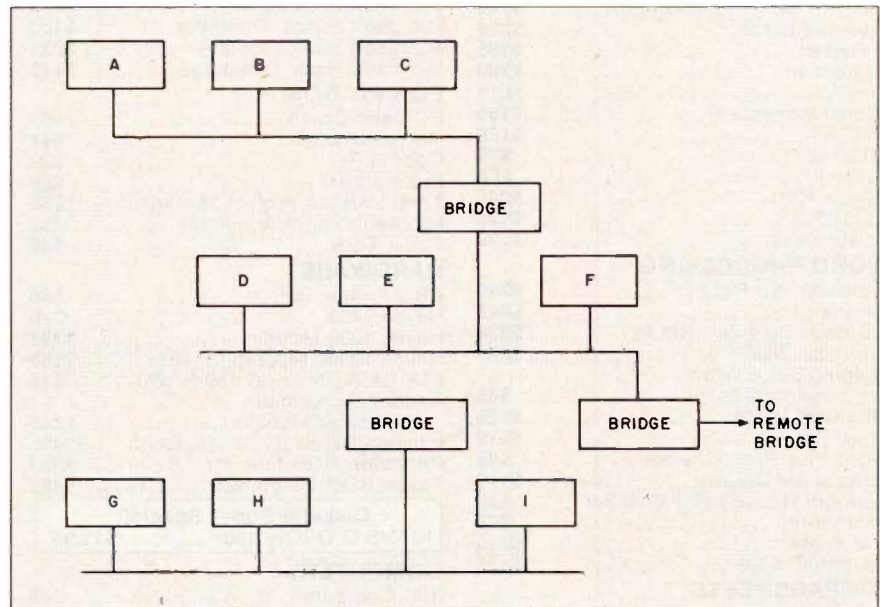

Figure 3: An AppleTalk internet.

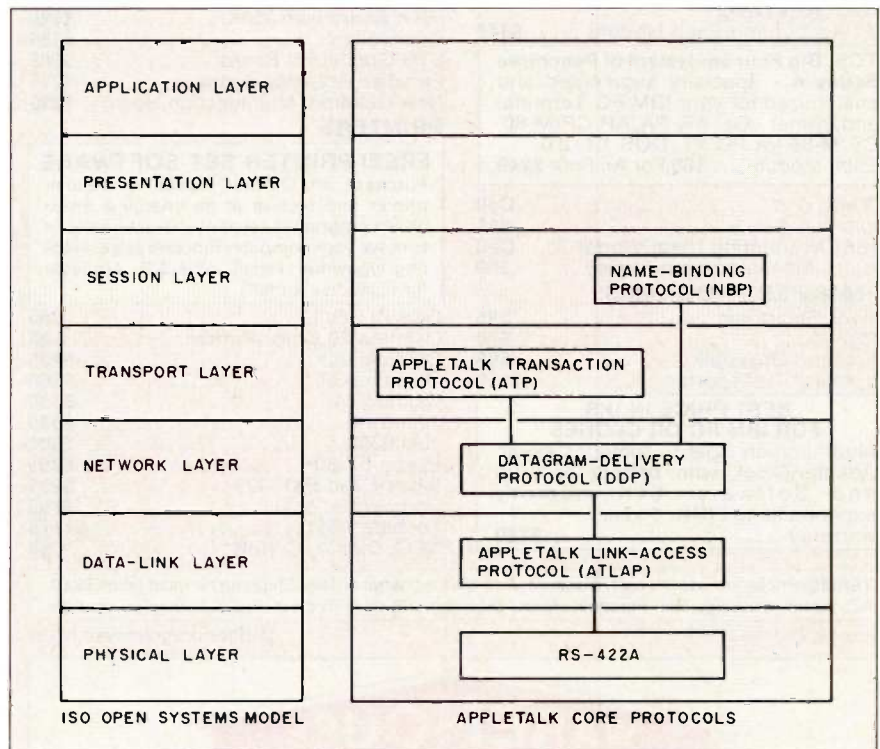

Figure 4: The ISO Open Systems Model and the AppleTalk core protocols.

sists of seven layers: physical, data link, network, transport, session, presentation, and application (see figure 4). While the model allows you to

understand the workings of the system, it doesn't necessarily reflect the system's physical structure. Let's take

(continued)

Call for pricing on
other Sperry Computers.

SPERRY PC COMPUTERS

Authorized Sperry
Dealer

Mono Desktop 256K, 2 Drives, Serial Port, Par. Port,	
Clock, MSDOS 2.11, GWBasic plus Other Software	\$1650
Portable Computer 256K 2 Drives Full IBM Compatibility	\$1650

DATA BASE

MANAGEMENT SYSTEMS

Fox and Geller Quickcode	\$125
Fox and Geller QuickReport	\$140
Knowledgeman	\$225
K Report	\$135
Condor III	\$289
Tim IV	\$219
DBase Manager II	\$165
FRIDAY	\$159
PFS File	\$78
Nutshell	\$55
RBase 4000	\$240
CLOUT 2	\$129
Power Base	\$199

WORD PROCESSING

Wordstar Pro Pack	\$240
Samna III	\$265
Wordstar 2000 for IBM PC	\$238
Wordstar 2000 +	\$285
Leading Edge Word Processor/Merge	\$85
Microsoft Word	\$225
Word Perfect	\$219
Word Plus Spell Checker	\$89
Volkswriter DeLux	\$149
Random House Spell Checker	\$36
PFS Write	\$78
Multimate	\$255
Peachtext 5000	\$185

SPREADSHEETS

Supercalc II	\$145
Supercalc III	\$165
Microsoft Multiplan	\$119
!TK Solver	\$239

ACCOUNTING

BPI Accounting Each Module	\$349
----------------------------	--------------

TCS. Big Four equivalent of Peachtree Series 4 - Specially augmented and customized for your IBM PC Terminal and Printer - GL, AR, PA, AP, CP/M-80, CP/M-86 for PC XT, DOS 1.1, 2.0. Each Module . . . **\$65 For All Four \$249**

CYMA	Call
Dollars & Pence	\$95
MBSI Accounting (Real World)	Call
Tobias Managing Your Money	\$99

TRANSFER PROGRAMS

Hayes Smartcom	\$85
Move-it	\$79
Microstuf Crosstalk	\$95
Microstuf Transporter	\$150

BEST PRICE IN U.S. FOR IBM PC OR CLONES

Multifunction Board - includes Async Adapter, Clock with battery back-up and Software, 64K memory expandable to 384K. 1 year warranty. **\$189**

LANGUAGES

Lifeboat Lattice C Compiler	\$265
Run C Compiler	\$100
Microsoft C Compiler	\$245
Microsoft Pascal Compiler	\$180
Microsoft Basic Compiler	\$235
Microsoft Basic Language	\$225

FOR PC DOS

PC Paint Brush	\$85
Norton Utilities	\$54
Copy II PC	\$22
Prokey V3.0	\$69
Total Harvard Project Manager	\$255
Microsoft Flight Simulator	\$32
Think Tank	\$98

HARDWARE

ABC Printer Switch	\$85
Hayes 2400	Call
Hayes 1200 Modem	\$395
Hayes 1200b Modem for IBM PC	\$369
64K RAM Chips (9) 150 NSEC	\$15
Anchor Signalman 1200 baud Modem	\$245
IOmega Bernoulli 20 Megabyte	\$2495
Princeton RGB Monitor	\$459
Taxan RGB Vision 425	\$399

Diskette Super Special!

10 D/S D/D (Qty 100) **\$12.95**

COMPUTERS

IBM Computer	Call
--------------	-------------

BOARDS FOR THE IBM PC OR LOOKALIKES

Hercules Color Board with Par. Port.	\$149
AST Six Pack	\$249
384K Board with 256K	\$220
Quadcolor I	\$185
STB Graphics II Board	\$245
Paradise Graphics Board	\$275
New Quadram Multifunction Board	\$225

PRINTERS

FREE! PRINTER SET SOFTWARE

Purchase an Okidata, Epson or Gemini printer and receive at no charge a menu driven program to set print characteristics or to make your computer function as a correcting typewriter. Retail value \$35. Available for most disk formats.

Gemini SG/10	Call
Okimate 20 Color Printer	Call
Okidata 182	\$235
Okidata 93P	\$569
Okidata 84P	\$665
Juki 6100	\$389
Juki 6300	\$689
Epson FX 80+	\$335
Silver-Reed EXP 400	\$235
Daisywriter 2000	\$795
Toshiba P351	\$1175
NEC, Diablo, C. Itoh	Call

TERMS: Prices include 3% cash discount. Add 3% for charge orders. Shipping on most items \$5.00. AZ orders +6% Sales Tax. Personal check, allow ten (10) days to clear. Prices subject to change.

Se habla Español

Call for programs not listed



WAREHOUSE DATA PRODUCTS

2701 West Glendale Ave., Suite 6, Phoenix, Arizona 85021

Technical & Other Information (602) 246-2222

TOLL FREE ORDER LINE 1-800-421-3135



APPLETALK

a look at what each of the levels represents.

The lowest level is the physical link. This is simply a set of rules specifying the electrical and physical connection between devices. The physical link specifies the cable connections and the electrical rules necessary to transfer data between devices. Typically, the physical link corresponds to established interface standards such as RS-232C, RS-422A, or RS-423A.

The next layer up is the data-link or link-access layer. This layer specifies how a device gains access to the medium specified in the physical layer. With a number of devices vying for access, this becomes an important issue. The data-link layer is also responsible for framing—that is, enclosing the data in the electrical equivalent of the envelope you use to mail your letters. Finally, this layer is responsible for addressing the envelope to the destination device on the link.

The network layer is responsible for setting up a logical connection between a source and a destination on the network. In a complex network, a source and a destination may not be directly connected by a single path. Rather, the path may consist of many subpaths. Thus, the network layer is responsible for routing the data over this path through the network system.

The transport layer is responsible for guaranteeing that a message is correctly received. This is often implemented by having the receiving party return an acknowledgment upon receipt of a message from the sending party.

While the first four layers are fairly well defined, the top three layers may vary depending on the network. Generally, though, the session layer will allow two devices on the network to coordinate their actions (for example, one device accessing the files of another device). Messages at this level may consist of commands that allow one device to control another over the network.

The presentation layer is responsible for formatting data in such a way

(continued)

POWERFUL CP/M[®] SOFTWARE

Diskette & Manual **\$29.95**

NEVADA FORTRAN[™] DISKETTE & MANUAL

Nevada FORTRAN is based upon the ANSI-66 standards (FORTRAN IV) with some 1977 level features. Advanced features include: IF... THEN... ELSE statement; COPY (Include); CHAINing with COMMON; and TRACE debugging. Package includes a diskette, 214-page manual and 5 sample programs. Included also is an 8080 assembler. Requires 48K RAM.

\$29.95

NEVADA COBOL[™] DISKETTE & MANUAL

Nevada COBOL, based upon the ANSI-74 standards, has all the popular features. Powerful level 2 features include: compound conditionals and full CALL CANCEL. This software package includes a diskette, 165-page manual, plenty of examples and 16 complete COBOL source code programs.

\$29.95

NEVADA BASIC[™] DISKETTE & MANUAL

With the built-in, full-screen text editor, you can easily develop programs for 1/10 the cost of a comparable BASIC interpreter. What's more, Nevada BASIC has full Matrix operations, Single- and Multi-Line functions, and BCD math (no round-off errors). You get a diskette and a 220-page manual. Requires 48K RAM.

\$29.95

NEVADA PASCAL DISKETTE & MANUAL

Advanced features include: 14-Digit precision; BCD math (no round-off errors); Floating point +63 -64; TRACE debugging; Arrays up to 8 dimensions; 64K strings; External procedures; and Dynamic Module loading. You get a diskette and a 184-page manual. Requires 60K RAM and one disk drive with at least 90K storage.

\$29.95

NEVADA PILOT[™] DISKETTE & MANUAL

Nevada PILOT, written by Prof. John Starkweather, the language's creator, meets and exceeds all PILOT-73 standards. See the review in January 1983 MICROCOMPUTING. This package includes a diskette, 131-page manual, and 10 useful sample programs.

\$29.95

WHY WAIT? ORDER YOURS TODAY!

Satisfaction guaranteed—or your money back. If for any reason you're not completely satisfied, just return the package—in good condition—with the sealed diskette unopened, within 15 days and we'll refund your money.

Checks must be in U.S. Dollars and drawn on a U.S. Bank.

California deliveries add 6% or 6.5% sales tax.

SHIPPING AND HANDLING FEES: Add \$4.00 for the first package or manual and \$2.00 each additional. **OVERSEAS:** Add \$15.00 for the first package or manual and \$5.00 each additional. **COD's:** Add \$4.00.

WE WELCOME C.O.D.'s



(415) 753-0186

ELLIS COMPUTING, INC.
3917 Noriega Street
San Francisco, CA 94122

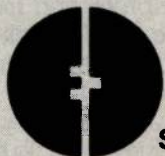

Since 1977

ELLIS COMPUTING[™]

Nevada EDIT, a full-screen, video-display text editor, is designed specifically for computer program text preparation. Nevada EDIT is completely user-changeable, can be configured to almost any terminal and takes up only 12K of disk space. This package includes a diskette and 59-page manual.

\$29.95

ALSO AVAILABLE:

- ★ EXTRA MANUALS \$14.95
- ★ COBOL Application Packages, Book 1 \$ 9.95
- ★ BIG PRINT-Diskette \$19.95

The CP/M Operating System, an 8080, 8085, or Z-80 (8-Bit) microprocessor, and 32K RAM are required, unless otherwise stated above.

WHEN YOU ORDER, PLEASE SPECIFY ONE OF THE FOLLOWING DISKETTE FORMATS:

- | | |
|---|--|
| <input type="checkbox"/> 8" SSSD (Standard CP/M IBM 3740) | <input type="checkbox"/> Kaypro Double Density (NCR) |
| <input type="checkbox"/> 5 1/4" Diskettes for: | <input type="checkbox"/> Micropolis Mod II |
| <input type="checkbox"/> Access/Actrix | <input type="checkbox"/> NEC PC 8001 |
| <input type="checkbox"/> Apple CP/M | <input type="checkbox"/> North Star Double Density |
| <input type="checkbox"/> DEC VT 180 | <input type="checkbox"/> North Star Single Density |
| <input type="checkbox"/> DEC Rainbow | <input type="checkbox"/> Osborne Single Density |
| <input type="checkbox"/> Epson QX-10 | <input type="checkbox"/> Sanyo 1000, 1050 |
| <input type="checkbox"/> Heath Hard Sector (Z-89) | <input type="checkbox"/> Superbrain DD DOS 3.X
(512 byte sec) |
| <input type="checkbox"/> Heath Soft Sector
(Z-90, Z-100) | <input type="checkbox"/> Televideo |
| <input type="checkbox"/> IBM-PC (Requires Z-80,
Baby Blue II Card) | <input type="checkbox"/> TRS-80 Model 1 (Base O Mapper) |
| | <input type="checkbox"/> Xerox 820 Single Density |

CP/M is a registered trademark of Digital Research, Inc. Microsoft is a registered trademark of Microsoft Corp. TRS-80 is a registered trademark of Tandy Corp. Apple II is a trademark of Apple Computer, Inc. Osborne is a registered trademark of Osborne Computer Corp. Xerox 820 is a trademark of Xerox Corp. Kaypro is a trademark of Non-linear Sys. Heath/Zenith is a trademark of Heath Corp. IBM is a registered trademark of International Business Machines, Corp. Nevada BASIC, Nevada COBOL, Nevada FORTRAN, Nevada PILOT, Nevada EDIT, Nevada PASCAL, and Ellis Computing are trademarks of Ellis Computing, Inc. © 1984 Ellis Computing, Inc.

Multi-user PC, single-user price.

Introducing affordable PC expansion for IBM PCs. MicroSystems Executive Workstations transform your IBM PC into a multi-user, multi-processor system with shared data access and communication between users. And the Executive Workstation comes with everything you need: PC-on-a-card, terminal, cables, and software. So expand your PC, not your budget. Call MicroSystems International today.

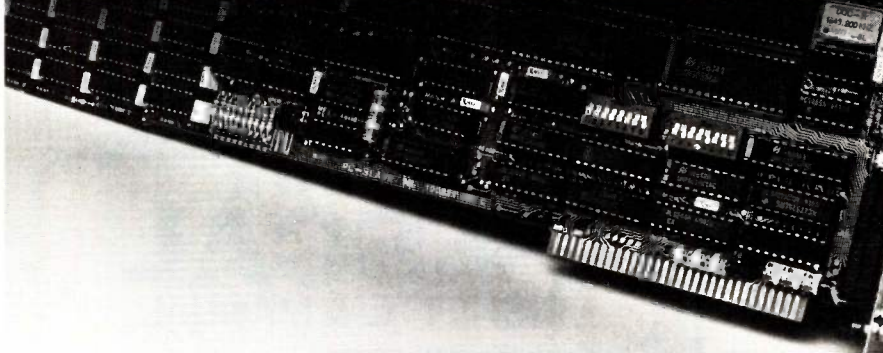

MicroSystems International Corporation An **Alloy** Company
100 Pennsylvania Ave., Framingham, MA 01701 (617) 875-9700 TWX 710-346-0394

INSTANT FINANCIAL PICTURE!

Corporate Financial Simulation Model on your IBM PC, XT or AT with Lotus 1-2-3, Multiplan, SuperCalc, VisiCalc or PeachCalc. Also available on most PC/M & all Apple systems. A \$6,000 value for \$295.



Bottomline V

A Financial Decision Support System - budgeting, planning, analysis, and five-year forecasting. Now used nationwide by Peat, Marwick, Mitchell & Co. ("Big 8" accounting firm).

Fill out this card and mail for complete details, or call 1-800-828-7257, CA only 1-800-523-7201, or 714-476-2842 for UPS COD delivery.

- Send more information
- My check for \$10 is enclosed. Please send me a (circle one) **black and white/color** Demo for my IBM PC.
- Please send me Bottomline V for _____ Spreadsheet on the _____ computer. My check for \$295 plus \$5 for shipping and handling is enclosed.

Name _____ Title _____
Company _____ Phone _____
Street _____
City _____ State _____ Zip _____

Mail to: **ILAR Systems, Inc.** • 1300 Dove St., Suite 105 • Newport Beach, CA 92660
Inquiry 195 for Dealers. Inquiry 196 for End-Users.

APPLETALK

that information sent from one device can be properly used by the receiving device. For example, the presentation layer would translate a document into a form that could be understood and printed by the LaserWriter.

Finally, the application layer ensures that data from an application running on one device is directly usable by an application running on another device.

A CLOSER LOOK AT APPLETALK

Figure 4 shows the relationship of the primary AppleTalk protocols to the ISO Open Systems Model. The five levels of AppleTalk represent what Apple calls the core protocols. These are the protocols that Apple will be providing for use by third-party developers with computers such as the Macintosh and the Lisa. Since AppleTalk was designed as an open system, developers are free to add to the basic set of protocols. Similarly, a developer may choose to use only the bottom layers provided by Apple and institute its own higher-level protocols. For example, by using the services provided by Apple at the three lowest layers of the ISO model, a developer will still have the ability to send messages, or "datagrams" in AppleTalk terminology.

Let's take a closer look at the major protocols or services that Apple will provide.

THE PHYSICAL LINK

The lowest level or physical layer of AppleTalk is the shielded twisted-pair cable and the connection box. Through the use of the connection box, each node is coupled to the trunk cable with a transformer. Thus, a missing node or one that is unable to receive or transmit will not affect the performance of the bus. Also, transformer coupling provides ground isolation as well as protection from static discharge. The physical link of AppleTalk is also defined to be RS-422A-compatible.

So far we have a cable and a set of pin definitions for the interface. To this we now add a method of bit encoding

(continued)

The fastest micro in the world

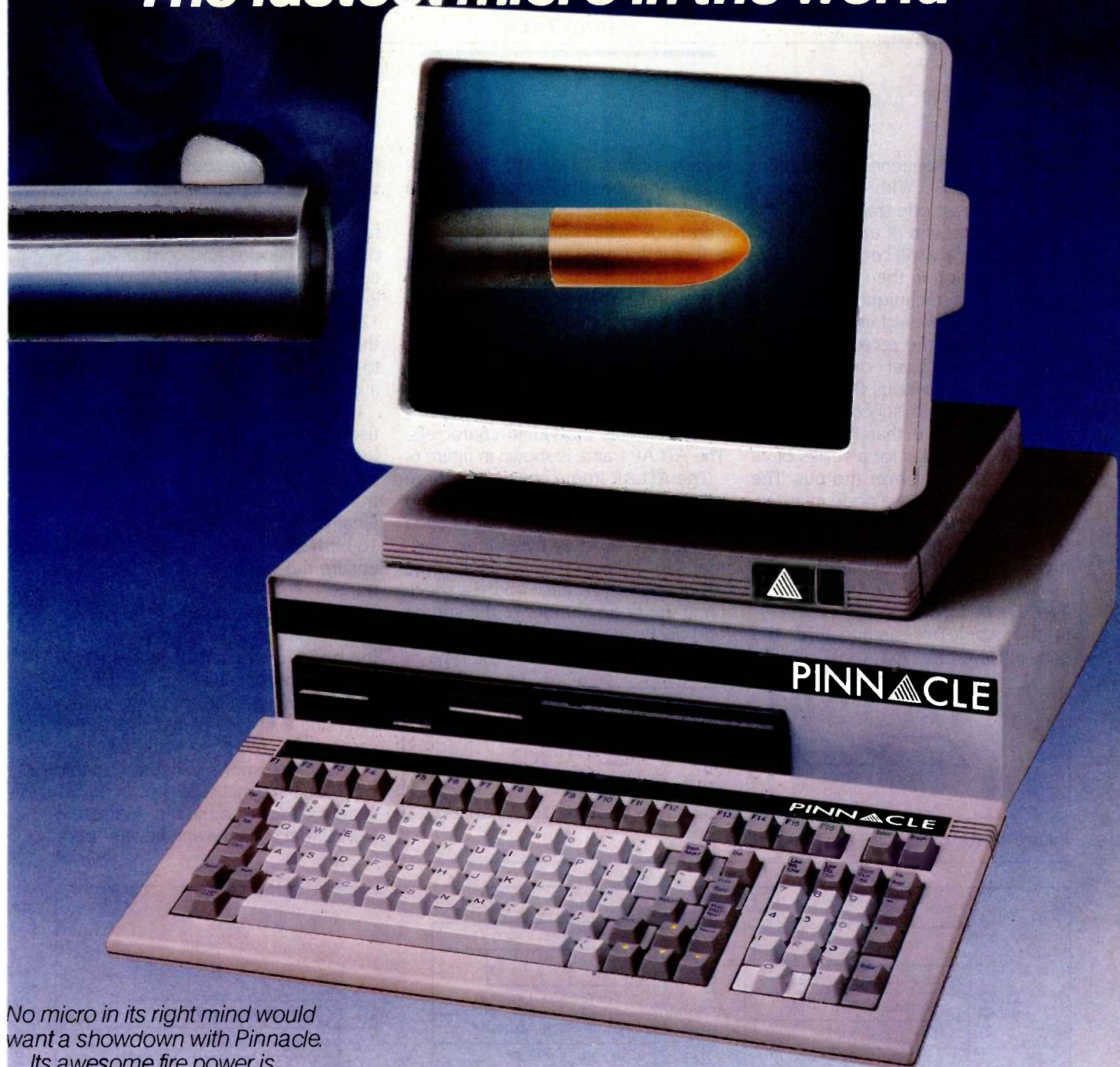

No micro in its right mind would want a showdown with Pinnacle.

Its awesome fire power is provided by the superb Motorola 68000 charging along at 12MHZ with no wait states (giving about 3MIPS).

And Pinnacle's ammo belt is just bristling with high powered options to give rapid fire to all seven users.

P-System, Unix,[™] CP/M-68K,[™] Mosys, BOS, Mirage, Tripas all obey instantly – along with their armies of applications.

Up to 8 Megabytes of directly addressable RAM and 110 Megabytes of Winchester storage dance when Pinnacle barks its sharp orders.

And that's just for starters. There's also the Pinnacle IX with TWO 68000's, DMA, and Memory Management hardware. Ideal for disk intensive operating systems like Unix[™] and Pick.

And a Pinnacle LX expansion chassis allowing nine 68000 processors to network 56 users.

A micro's gotta do what a micro's gotta do.

And starting at under \$4000 Pinnacle's just the fastest there is.

PINNACLE
The accessible peak of performance

US DISTRIBUTORS **Pinnacle Systems Inc.** 10410 Markinson Road, Dallas, Texas 75238. Tel. (214) 340-4941. Telex 88-8442

ELECTRONIC MANUFACTURING/SERVICE **Lamtech Electronics Corporation**, 620 Easy Street, Garland, Texas. Tel. (214) 272-3504

INTERNATIONAL SYSTEMS GROUP **ISG Pinnacle**, Dallas, Texas. Tel. (214) 340-4941. (Distributor enquiries invited).

VERTICAL MARKET SYSTEMS **VMS Pinnacle**, Dallas, Texas. Tel. (214) 340-4941.

EUROPEAN DISTRIBUTORS **TDI Pinnacle Ltd**, 29 Alma Vale Road, Bristol BS8 2HL, England. Tel. (0272) 742796. Telex 444653.

UNIX is a Registered Trade Mark of Bell Labs. CP/M-68K is a Registered Trade Mark of Digital Research.

Inquiry 327

known as FM (frequency modulation) 0 (see figure 5). With this method, there is at least one transition at the beginning and end of each bit. A cell representing a 0 will contain an additional transition in the middle of the bit cell. This technique allows the clock to be recovered using a phase-locked loop at the receiving end.

The physical layer of AppleTalk defines a synchronous RS-422A bus upon which each succeeding layer can build. Notice that the physical layer only provides for a series of 1s and 0s to be sent over the bus. The rules governing how a node gains access to the bus and how the 1s and 0s are to be interpreted are left to higher levels of the architecture.

THE DATA LINK

In the AppleTalk architecture, the data-link layer uses the AppleTalk link-

access protocol (ATLAP). There are three functions implemented in the ATLAP: framing, bus-access control, and node addressing.

To send a message, a device must have some way of putting the message into the equivalent of an envelope. In the terminology of a network, an envelope is called a frame. ATLAP specifies a frame that is based on a bit-oriented message; that is, messages are sent as pure sequences of bits, not as individual characters. The ATLAP frame is shown in figure 6.

The ATLAP frame consists of three parts: the header, the data, and the check field. At the beginning of each header are two flag bytes (hexadecimal 7E), followed by a single byte destination and source address specifying the node number of the source and destination. This is followed by a type field used to specify the type of

frame. ATLAP frames may be one of two types: control or data.

ATLAP uses control frames for its internal functions such as assigning addresses to nodes and controlling access to the network. A control frame is indicated by a type field value from 128 to 255 (hexadecimal 80 to FF) in the ATLAP type field. Values from 1 to 127 (hexadecimal 01 to 7F) indicate a data frame.

In a data frame, up to 600 bytes of user data (provided by the higher-level protocols) can follow the ATLAP header information. ATLAP control frames do not contain a data field. Finally, following the data field is a 16-bit frame-check character used to ensure the validity of the data in the frame.

The second function of the ATLAP layer, controlling who gets access to the bus and when, is of fundamental importance because up to 32 different devices may be trying to talk on a single AppleTalk network at the same time. Suppose you have the configuration shown in figure 2. In this case you have many devices or nodes vying for access to the bus. In the real world, that's like having several peo-

(continued)

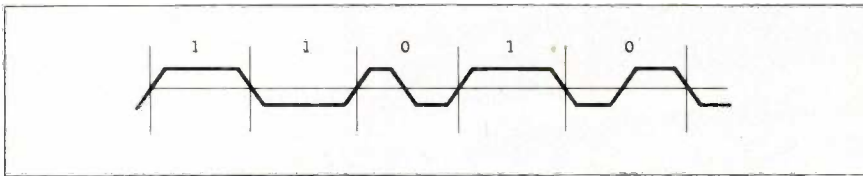

Figure 5: An example of FM 0 modulation.

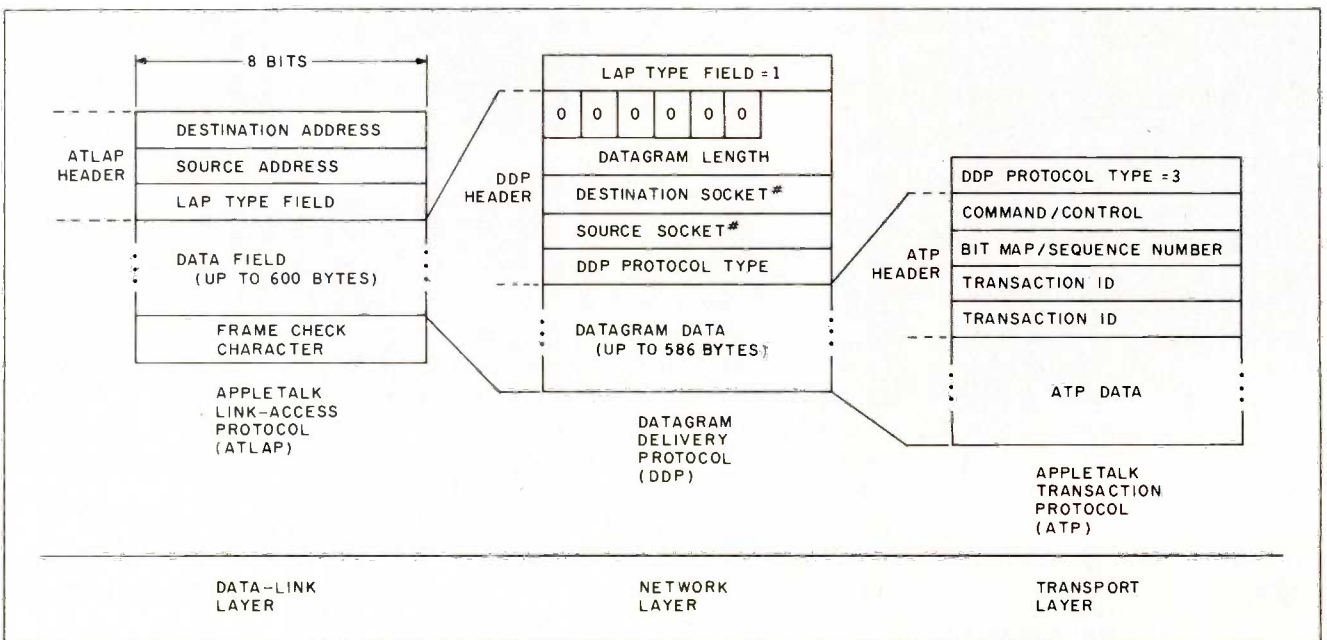
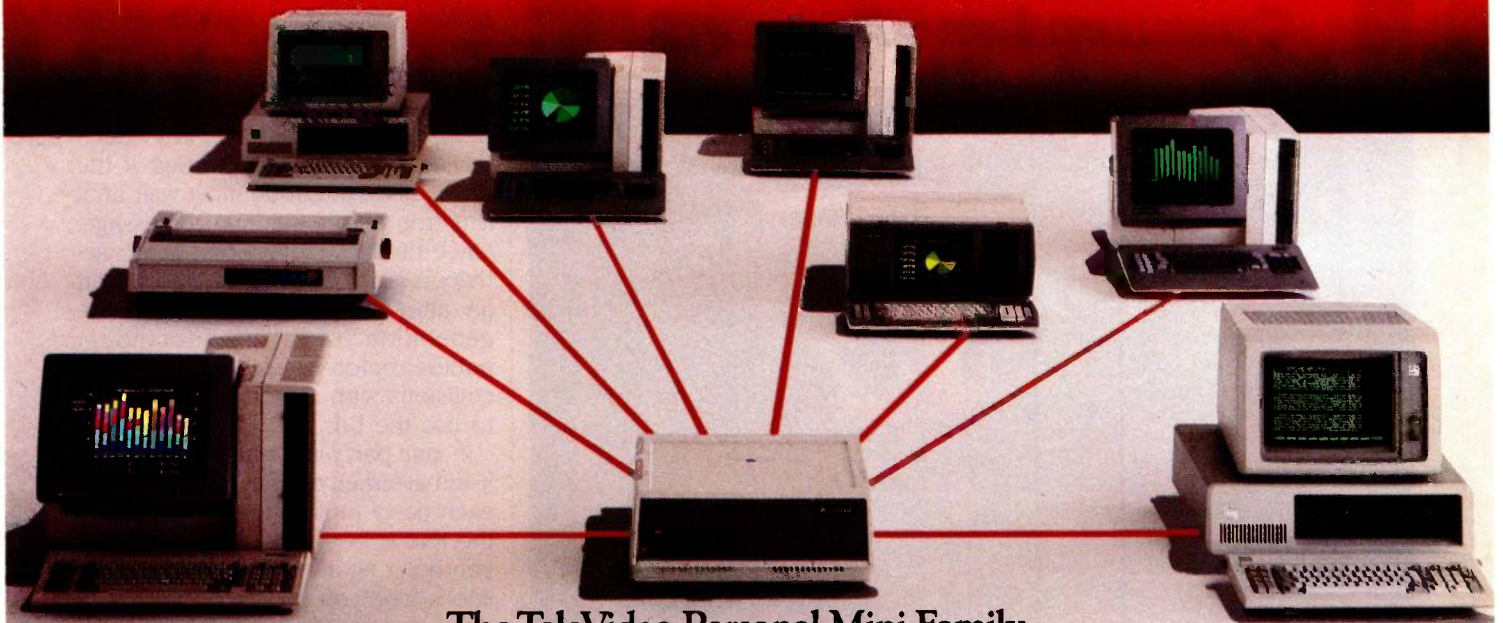

Figure 6: The ATLAP packet format, DDP packet format, and ATP packet format.

TeleVideo is the multiuser system for companies who expect to grow.



The TeleVideo Personal Mini Family

Growing companies need a computer system that will grow right along with them. Simply and economically.

A computer system that lets people communicate and share resources. Even work on the same file simultaneously.

The TeleVideo® Personal Mini™ Family is that system.

Runs PC, mini and multiuser software.

With the TeleVideo Personal Mini, users of IBM® or TeleVideo PCs, XTs, and portable computers can share data, as well as expensive peripherals, like printers and plotters.

The Personal Mini dramatically increases computing power. So it not

only runs PC software, but also hundreds of popular, fast mini-computer and multiuser programs. Without destroying your established PC environment.

And, unlike less advanced networks, the Personal Mini never sacrifices performance or speed regardless of how many workstations are on line.

Build on your original PC investment.

Even our system expansion costs are substantially less than what you'd pay to add new IBM PCs. And your original investment in hardware, software and personal computer education is never lost.

Your TeleVideo dealer has the Personal Mini. Arrange to see it today by calling toll free, 800-521-4897. In California, call 800-821-3774. Ask for operator 10.

The TeleVideo Personal Mini. The growing business computer.

Regional Sales Offices: Northwest (408) 971-0255, Southwest (714) 476-0244, Southcentral (214) 258-6776, Midwest (312) 397-5400, Southeast (404) 447-1231, Mid-Atlantic (703) 556-7764, Northeast (617) 890-3282, East (516) 496-4777, Rocky Mountain (714) 476-0244.



Systems

TeleVideo Systems, Inc.

IBM is a registered trademark of International Business Machines

ple on a party line all trying to make a call at the same time. You need some way of controlling who can use the line and when.

In AppleTalk, the method used to resolve this contention problem is called CSMA/CA (carrier-sense multiple-access with collision avoidance). When two devices try to talk at the

same time, a collision occurs. When a collision is detected, each sending device must back off or wait some predetermined amount of time before trying again.

One method to avoid collisions requires each device to listen to the bus. If a device hears some activity on the bus, it knows that the bus is busy, and

When two devices try to talk at once, a collision occurs.

it waits until the bus is free before transmitting.

One of the limitations of AppleTalk is that nodes do not have special hardware to detect collisions. This is true simply because of the limitations of the serial interfaces used on most microcomputers: A device (unlike a person) can either be transmitting (talking) or receiving (listening) but not both simultaneously. To overcome this limitation, AppleTalk uses the scheme described above, whereby each device must listen to the bus. If the bus is busy, the node must wait until it is free before sending a message. Once the bus is free (that is, no activity is going on), a device must wait an amount of time based on the generation of a pseudorandom number before transmitting to avoid collisions with other devices waiting to use the bus.

In our party-line analogy, this collision-avoidance method means that each party must listen to the line. If the line is busy, you must wait until you don't hear any voices. Once the line is free, you must wait some random amount of time before dialing.

The third function implemented by the ATLAP is addressing. Each node on the AppleTalk network is assigned a unique 8-bit address known as the node ID (identification). However, a node is not required to have a fixed node address. When a node is switched on, it chooses a node ID by either looking up a previously saved value from nonvolatile memory (like a disk file) or by generating a random number. Once a node has chosen a node ID, it sends a special ATLAP control frame called an enquiry (ENQ) frame to its own address. Any node receiving an ENQ frame must send out a control frame called an acknowledge (ACK) frame. Therefore, if a node

(continued)

Graphics Takes A Quantum Leap Forward!



THE INOVION PERSONAL GRAPHICS SYSTEM FEATURES:

- The most advanced color mapping capabilities available.
- 250,000 simultaneously displayable colors.
- A palette of 2.1 million colors.
- Frame Grabber/Digitizer to capture TV, VCR or Video Camera pictures.
- Quality three-dimensional texture capabilities.
- Built-in Icon/Menu software.
- Completely Mouse/Trackball driven.
- Fonts, Brushes, Microscope, Patterns, and Rotations.
- A complete stand alone system.
- A 19" enhanced color monitor.
- 780K Graphics Memory.
- 512 x 480 pixel display with 24 bits per pixel.
- RS232C port allows access to all system functions and memory.
- NTSC composite video and NTSC RGB signal.
- 1-year warranty on graphics generator and 90-day warranty on enhanced monitor.
- Special introductory 30-day satisfaction guarantee.
- **Complete system for \$4,495**

INOVION

195 East Gentile St.
Layton, Utah 84041
(801) 546-2850

Clear advantage!

This board will expand to 4 Megabytes, 4 serial ports and starts at \$395. That's only part of the story . . .



We love a good story. Better than that, we love a great product. After researching the expansion needs of AT users, we have concluded that the Basic Time AT4X4Plus provides the best array of standard features and upgradeability available. Compare the AT4X4Plus, feature by feature, to the AST Research Advantage!™ expansion board in terms of main board memory, total expansion memory, I/O capability, and price. You will then discover who has the clear advantage.

You Can Never Have Enough Memory.

That is the oldest saying in computers. Two years ago, customers asked us what they could do with 256K on a PC. How times have changed . . . AT4X4Plus can hold up to 4 Megabytes of memory—2 Megabytes on the board itself and 2 on the 4X4RamPak. An important feature for future multi-user systems.

The 4X4's "double split memory addressing" capability gives you the choice of using 64K or 256K RAM chips in the first bank of memory. A single row of 64K chips gives you 128K and is just right for the enhanced AT. Using 256K chips in the first row enables you to "max out" user memory to 640K on an unenhanced AT with a single row of chips. The remaining 128K will be available above the 1 MEG memory boundary. A first

row using 256K chips added to an enhanced AT will give you 640K user memory and 384K above the 1 MEG boundary. The memory above 1 MEG can be used by DOS 3.X for VDISK, a virtual ram disk. We think that a 512K board (a first row of 256K chips) is your best buy.

Want Real I/O Power?

Multifunction boards only start with memory. The AT4X4Plus comes standard with a parallel printer port and an asynchronous serial (RS-232C) communications port. Have more than one serial device? No problem, 3 more are optional, 1 on the AT4X4Plus itself and 2 more on the 4X4DualSerialPak piggy-back board. Need a game port for a joystick or mouse? It's also available as an option.

Your Satisfaction Is Guaranteed.

With apologies to AST Research's advertising, we think at least 4 out of 5 AT expansion board buyers want more capability at lower cost. The AT4X4Plus is the clear choice and we guarantee it. If you are not completely satisfied with your AT4X4Plus within 30 days of purchase you may return it for a full refund, including the freight to return it. And if you should ever have a problem during the twelve month warranty period, we will fix or replace your board within 48 hours of receipt.

AT4X4Plus Prices:

AT4X4-128 1 parallel, 1 serial, 128K	\$395
AT4X4-512 1 parallel, 1 serial, 512K	495
AT4X4-1MB 1 parallel, 1 serial, 1 MEG	695
AT4X4-2MB 1 parallel, 1 serial, 2 MEG	1095

AT4X4Plus Option Prices:

AT4X4-2S second serial port on 4X4 board	\$50
AT4X4-RAM 2 MEG 4X4RamPak	995
AT4X4-SER 2 serial port 4X4DualSerialPak	295
AT4X4-GAME game port	35
AT4X4-PCP preferred customer plan (24-month warranty, 24-hour repairs)	75

All prices include UPS surface charges. For fast delivery, send cashier's check, money order, or order by Mastercard/Visa. Personal checks, allow 18 days to clear. In a hurry? UPS Blue Label is just \$5.00. Company purchase orders accepted, call for prior authorization. California residents, add 6% sales tax.

Hours: M-F 8 am - 5 pm PTZ
Sat. 9 am - 1 pm PTZ
London (01) 871-2855
Paris (01) 321-5316
Sydney (02) 579-3322
Canada (403) 438-0994



Outside California

1-800-821-4479

Inside California

1-805-987-9741

4809 Calle Alto
Camarillo, California 93010

QUBIE'

Order Today,
Shipped Tomorrow!™

© 1985, Qubie'. Advantage! is a registered trademark of AST Research Inc.

sends out an ENQ to the address it has chosen and receives an ACK, it knows that the node ID is already being used. If, after repeatedly sending out ENQ frames, no ACK is received, the new node simply takes the node ID as its own.

THE DATAGRAM DELIVERY PROTOCOL

While the ATLAP provides a delivery service from one node to another, often a node may contain more than one logical source or destination. In AppleTalk terminology, a logical source or destination is referred to as a socket. For example, consider the case of a program that manages a disk-file system that can be accessed by many users. This program could be handling many requests for file reads and writes from many different users. To keep these requests straight, the file manager could require many

sockets, in this case, one for each user.

To provide a delivery service that extends the functions of ATLAP to the socket level, AppleTalk provides a protocol called the datagram delivery protocol (DDP). At the network layer, the DDP defines a packet of information called a datagram.

The format of a datagram is shown in figure 6. Note that the datagram is actually contained within the ATLAP frame—thus the concept of layering. The datagram is essentially enclosed within the envelope defined by the ATLAP in the data-link layer.

You can also see that the datagram header directly follows the ATLAP header. If the ATLAP type field is equal to 1, the next 5 bytes are taken as the datagram header.

The datagram header consists of 5 bytes. These bytes contain the following fields: a 10-bit length field, the destination-socket number, the

source-socket number, and the DDP protocol type field.

The first 6 bits of the datagram (DDP header) are set to 0. The following 10 bits contain the length of the datagram (from the first byte of the DDP header to the last part of the DDP data field). A datagram packet arriving at a destination node is immediately checked for correct length using the value stored in the datagram's header. If the length of the received datagram does not match the DDP length field, the packet is immediately discarded.

The next byte is the destination-socket number, followed by the source-socket number. Finally, the last byte of the header is the DDP protocol type field. This field specifies the type of protocol used in the next higher layer; that is, it indicates to the destination node the format of the data contained in the DDP data field.

Last year the experts tested the top-of-the-line Toshiba 3-in-One™ printer. Here's what they said.

“When Toshiba America called to see if there were problems testing their printers, I responded, ‘You bet—I can’t get the P1351 off Bill Machrone’s desk long enough to get its picture taken!’ It’s that good.”

(Bill Machrone is the editor of PC Magazine.)

PC Magazine
November 27, 1984

“It is setting new standards for quality and performance in the dot matrix arena.”

Computers & Electronics Magazine
November 1984

Up to 586 bytes of data may follow the DDP header. Again, because of the layered protocol, the definition of this data depends upon the protocol used in the next higher level.

The DDP also allows for the delivery of packets over a complex network composed of what are called internets. By connecting individual AppleTalk networks (up to 32 nodes) through what are called bridges, an internet is formed. A complex network can be formed by connecting many AppleTalk buses this way.

To handle the addressing on a complex internet, the DDP uses an extended form of the DDP header that contains a source and destination network number, node ID, and socket number. These six values completely specify the address of any source and destination on an internet.

Suppose you have the following situation: A datagram is to be sent

from point A to point I on the complex network shown in figure 3. To get from one AppleTalk to another, the datagram must pass through several bridges. Each bridge contains routing tables, which contain the information necessary to forward a datagram to a destination network. By passing through various bridges, a datagram will eventually arrive at the proper network, node, and socket.

There is one additional field in the extended DDP header: the hop count. Each time a datagram passes through a bridge, the hop count is incremented. A datagram containing a hop count of 15 will not be forwarded but instead will be discarded. This prevents a datagram from endlessly circulating through the network.

THE TRANSACTION PROTOCOL

At the next level up is the AppleTalk transaction protocol (ATP). This pro-

tol corresponds to the transport layer of the ISO Open Systems Model. The ATP guarantees that a packet sent to a node is correctly received. It implements this through a series of transaction requests and responses. The requesting end sends a transaction request, specifying, for example, a command to be executed at the receiving end. When the receiving end gets the request, it sends one or more transaction responses, which carry data generated by the execution of the command. The responses also serve as acknowledgment of delivery of the transaction request.

The format of an ATP packet (in figure 6) also consists of a header and a data field. Notice that the ATP header directly follows the DDP header; that is, the ATP packet sits on top of the DDP packet. If the DDP protocol type field is equal to 3, the

(continued)

“

”

Imagine what they will say about its successor.

The New Toshiba P351 3-in-One printer. They could say that inside the sleek new Toshiba P351 you'll find the ultimate 3-in-One printer. Because it offers a combination of:

Letter-quality printing. Perfectly translated graphics. And speed. (100 cps letter. And draft speed improved to 288 cps.)

They could say you'll appreciate the 24-pin dot matrix head that gives the P351 its exemplary letter and graphic quality.

They could say the new P351 gives you an almost unlimited number of ways to express yourself. With both unloadable software fonts and new plug-in font ridges.



And they could say the new P351 is not only the best looking printer in the \$1,000 to \$2,000 range. But also the most reliable.

Of course, we're not putting words in their mouths. Just the ultimate 3-in-One printer in their hands. And yours.

For complete information call 1-800-457-7777, Operator 32.

In Touch with Tomorrow

TOSHIBA

TOSHIBA AMERICA, INC. Information Systems Division

receiving node knows that the DDP data field contains an ATP packet.

The first 8 bits of the ATP header contain a command and control field. The first 2 bits are used to identify a transaction request (01), a transaction response (10), and a transaction release (11).

The following 8 bits constitute a se-

quence bit map used to keep track of transactions where multiple responses are necessary. For example, a transaction request could be a read command to a disk. The transaction response would consist of a series of packets containing the data read from the disk. The bit map is used to keep track of what packets have been prop-

erly sent. It also provides a means of requesting the retransmission of selective packets, thus avoiding the need to retransmit the entire sequence of packets.

Finally, the last field of the ATP header is the transaction ID. This is a 16-bit number assigned to the transaction request by the sending node. The transaction ID allows each node to accurately track transactions and responses. This is done by including the same value in all requests, responses, and release packets belonging to a particular transaction.

THE NAME-BINDING PROTOCOL

One service Apple provides at the layer corresponding to the session layer of the ISO Open Systems Model is the name-binding protocol (NBP). Recall that in a complex network or internet, the extended DDP header specifies a source and destination network, node, and socket number. Such numerical addresses are efficient when used by network protocols but inconvenient and clumsy for human users who prefer dealing with names and strings of characters. The AppleTalk architecture includes facilities in its NBP for the use of names.

The actual NBP functions are implemented in a series of lookup tables distributed throughout the nodes in a network. These lookup tables correlate names with networks, nodes, and socket numbers. Each node contains a socket dedicated to the NBP function. The user can issue a call to the NBP process requesting the address corresponding to a name. Given the name, the NBP will search through the tables in all nodes in a zone and return the corresponding address, that is, network, node, and socket number.

HIGHER-LEVEL PROTOCOLS

AppleTalk's higher-level (presentation- and application-layer) protocols will allow the formatting of data for specific devices and applications. At the presentation level, Apple has introduced a protocol in conjunction with the LaserWriter printer. To allow

(continued)

Lattice makes the pieces fit . . .

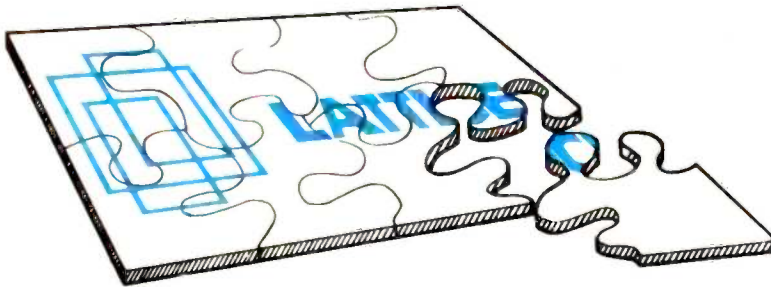

Puzzled by complex programming problems? Lattice has the tools to help you "get it together!"

Lattice provides the software tools and utilities you need to design, create, modify, analyze, and maintain your C programs and your documentation.

Lattice offers a wide range of C Compilers, C Cross-Compilers, C Function Libraries, and C Utility Programs to save you time and effort and help manage your complex software systems.

Lattice products are used by more than 26,000 software developers worldwide — including Lattice, Inc. as they develop their own new products, updates, and enhancements.

Call Lattice today. We have the programming tools you've been looking for to help you complete your projects!

Ask about our Trade Up to Lattice C Policy.



P.O. Box 3072
Glen Ellyn, IL 60138
312/858-7950
TWX 910-291-2190

International Sales Offices
Belgium: Softshop. Phone: (32) 53-664875.
England: Round Hills. Phone: (0672) 54675.
Japan: Lifeboat Japan. Phone: (03) 293-2311.

**WHEN HEWLETT-PACKARD
DEVELOPED A PERSONAL COMPUTER
PRINTER THAT USES A QUIET JET OF INK,
PRINTS 150 CHARACTERS PER SECOND
AND COSTS ONLY \$495,**

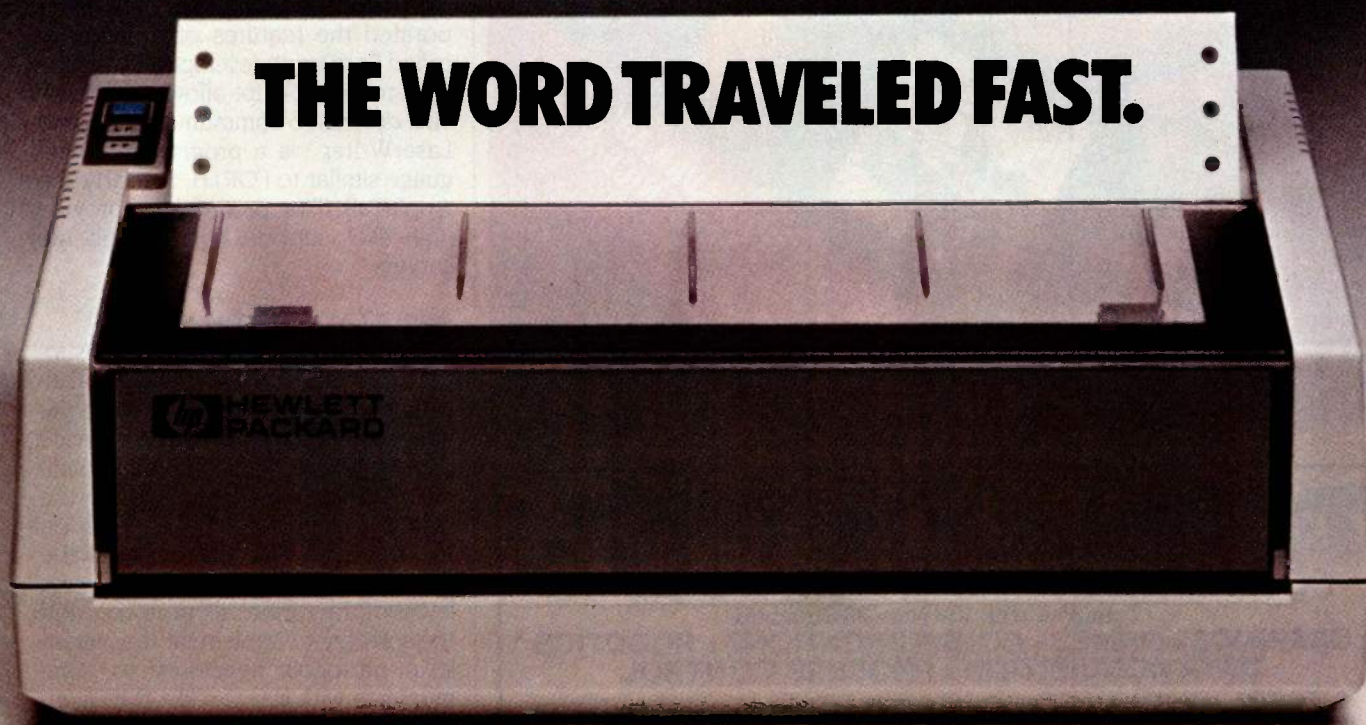

THINKJET.

Hewlett-Packard research has used inkjet technology to make the ThinkJet personal computer printer surprisingly quiet while printing 150 high quality, dot-matrix characters per second for text or graphics. The ThinkJet printer weighs only 6½ pounds and it takes up just a bit more room than your telephone. So, it can work right on your desk. And, the ThinkJet printer's ink supply and printhead are designed in one neat disposable unit that simply clicks out when it's time to change.

The ThinkJet printer will work with most

popular personal computers, including Hewlett-Packard, IBM®, COMPAQ™ or Apple®.

Finally, as quiet, fast and compact as the ThinkJet printer is, it still has one more feature that's going to cause a commotion; its price... \$495.00*.

See the entire family of personal computers, software and peripherals at your authorized Hewlett-Packard dealer.

Call (800) FOR-HPPC for the dealer nearest you.

PG02510

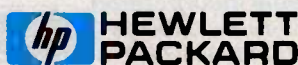

IBM is a registered trademark of International Business Machines Corporation. COMPAQ is a trademark of COMPAQ Computer Corporation. APPLE is a registered trademark of Apple Computer, Inc. *Suggested retail price.

Inquiry 209

JUNE 1985 • BYTE 199

Powerful in circuit emulation, priced well within your grasp. That's NICE.™

NICE may be only 3" square and 1/2" thick, but it hands you full speed, real-time emulation—over 50 emulation functions, software breakpoints, all memory addresses and all I/O ports.

Just plug NICE directly into the target MP socket and any RS232 terminal for system development, troubleshooting, debugging or testing . . . at home, in the lab or in the field.

And NICE hands you all this performance, portability and versatility for only \$498 . . . the best emulator price/performance ratio on the market, hands down.

Call in your order today using

your VISA or Mastercard number: (800) NICOLET outside CA, or (415) 490-8300 in CA.

Or send your check or money order to NICE, Nicolet Paratronics Corporation, 201 Fourier Avenue, Fremont, CA 94539.

*Payment by check, money order, VISA or MasterCard.

NICE is a trademark of Nicolet Paratronics Corporation
*Z80 is a trademark of Zilog, Inc.

NICE Nicolet



APPLETALK

Plans for Apple's "telephone system" are complete.

the Macintosh to send documents to the LaserWriter, Apple has incorporated the features of a language called PostScript developed by Adobe Systems. PostScript allows all AppleTalk devices to communicate with the LaserWriter via a programming language similar to FORTH. Similarly, the AppleTalk filing protocol will provide high-level support for Apple's file servers.

APPLETALK SOFTWARE

While the hardware necessary to support AppleTalk is built into the Macintosh, the software required to use the network consists of a set of device drivers. On the Macintosh this is simply a file that must be installed in the system folder of each Macintosh on the network. This file contains the software that implements the lower levels of the AppleTalk protocols and the software to implement the higher-level protocols necessary to communicate with devices like the LaserWriter.

The core protocols are implemented in a driver referred to as the Macintosh protocol package (MPP). The MPP, along with the driver that implements the ATP, takes up less than 6K bytes on the disk. To use the LaserWriter, an additional driver, the LaserWriter print manager, is also required.

SUMMARY

Plans for Apple's "telephone system" are complete. At this point, the poles have been set up, the cables strung, and conversational rules established. Apple and third-party developers have announced a series of AppleTalk products. Now, the time it takes for AppleTalk to develop into the electronic counterpart of today's telephone system will depend on the availability of network software. ■

TOTAL CONTROL:

FORTH: FOR Z-80®, 8086, 68000, and IBM® PC

Complies with the New 83-Standard

**GRAPHICS • GAMES • COMMUNICATIONS • ROBOTICS
DATA ACQUISITION • PROCESS CONTROL**

- **FORTH** programs are instantly portable across the four most popular microprocessors.

- **FORTH** is interactive and conversational, but 20 times faster than BASIC.

- **FORTH** programs are highly structured, modular, easy to maintain.

- **FORTH** affords direct control over all interrupts, memory locations, and i/o ports.

- **FORTH** allows full access to DOS files and functions.

- **FORTH** application programs can be compiled into turnkey COM files and distributed with no license fee.

- **FORTH** Cross Compilers are available for ROM'ed or disk based applications on most microprocessors.

Trademarks: IBM, International Business Machines Corp.; CP/M, Digital Research Inc.; PC/Forth+ and PC/GEN, Laboratory Microsystems, Inc.

FORTH Application Development Systems include interpreter/compiler with virtual memory management and multi-tasking, assembler, full screen editor, decompiler, utilities and 200 page manual. Standard random access files used for screen storage, extensions provided for access to all operating system functions.

Z-80 FORTH for CP/M® 2.2 or MP/M II, \$100.00;
8080 FORTH for CP/M 2.2 or MP/M II, \$100.00;
8086 FORTH for CP/M-86 or MS-DOS, \$100.00;
PC/FORTH for PC-DOS, CP/M-86, or CCPM, \$100.00; **68000 FORTH** for CP/M-68K, \$250.00.

FORTH + Systems are 32 bit implementations that allow creation of programs as large as 1 megabyte. The entire memory address space of the 68000 or 8086/88 is supported directly.

PC FORTH + \$250.00
8086 FORTH + for CP/M-86 or MS-DOS \$250.00
68000 FORTH + for CP/M-68K \$400.00

Extension Packages available include: software floating point, cross compilers, INTEL 8087 support, AMD 9511 support, advanced color graphics, custom character sets, symbolic debugger, telecommunications, cross reference utility, B-tree file manager. Write for brochure.



Laboratory Microsystems Incorporated
Post Office Box 10430, Marina del Rey, CA 90295
Phone credit card orders to (213) 306-7412



**WHEN HEWLETT-PACKARD USED
LASER TECHNOLOGY TO BRING YOUR
PERSONAL COMPUTER A LETTER QUALITY
PRINTER THAT OPERATES AT UP TO
300 CHARACTERS PER SECOND,**



LASERJET.

Now you can print an entire page of text in just 7½ seconds. That's the equivalent of 300 characters per second. The LaserJet personal computer printer can do it. Hewlett-Packard has brought the speed, quiet and letter quality of laser printing to the personal computer user for under \$3,500*.

The LaserJet printer is designed for Hewlett-Packard personal computers, the IBM® PC, PC

compatibles and most other personal computers.

No other personal computer printer is engineered to do what the LaserJet printer can do at such an affordable price. But then consider where it came from.

See the entire family of personal computers, software and peripherals at your authorized Hewlett-Packard dealer. Call (800) FOR-HPPC for the dealer nearest you.

PG02417

 **HEWLETT
PACKARD**

IBM is a registered trademark of International Business Machines Corporation.

Inquiry 210

*Suggested retail price.

JUNE 1985 • BYTE 201

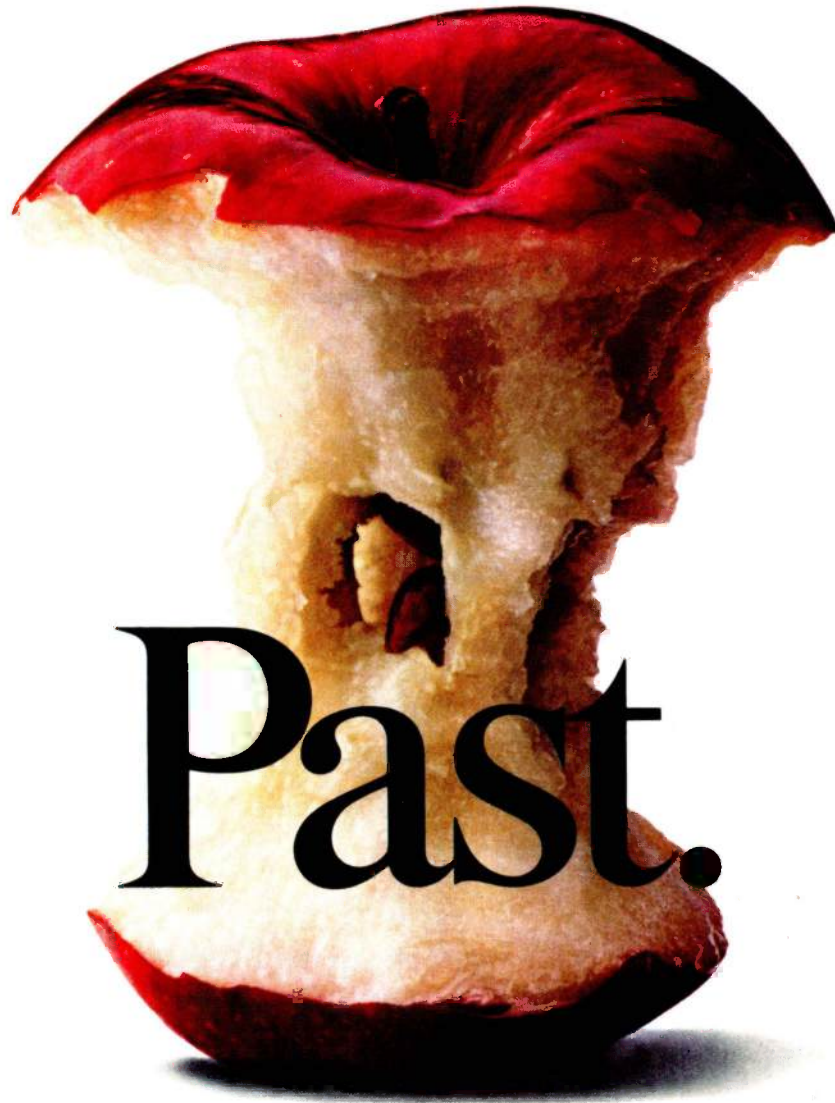

Gone are the glory days for Apple. Because Europe's most successful business computer company is now doing business in America.

Introducing Apricot. A full line of computers specifically designed for business.

Not adapted to it.

In fact, the facts speak for themselves.

Apricots are elegant and compact, true 16-bit computers. They employ the MS-DOS operating system, and a minimum of 256K memory. One of our models, the Apricot Xi, boasts an incredible 1 Mega-

byte of memory, and features a Winchester hard disk with 20 Megabytes of storage. We also have models that feature speech recognition, full-size LCD, and icon driven menus.

In addition, you have a choice between 9" or 12" b/w or 10" color monitors. All of

Present and Future.

which have a higher screen resolution than Apple.

And as if all that weren't enough, all of our models can be networked from the moment you take them out of the box. They're also capable of running thousands of business software programs like Lotus™,

pfs®, and d-Base III.™ Specially written for Apricot on 3½ inch disks.

Now, how do you like them Apricots?

Apricot, Inc., 3375 Scott Blvd., Santa Clara, CA 95054. Call 800-227-6703, or in California 800-632-7979.

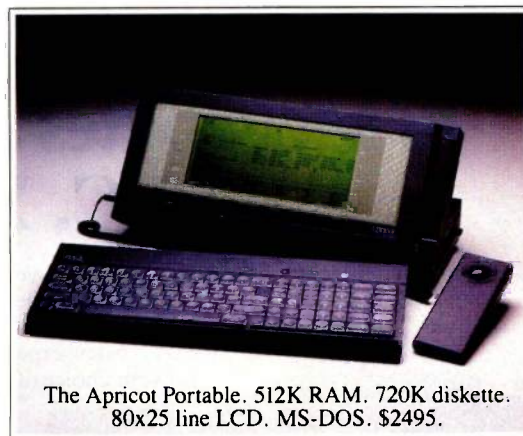

The Apricot Portable. 512K RAM. 720K diskette. 80x25 line LCD. MS-DOS. \$2495.

apricot[™]
We're changing how
American business does business.

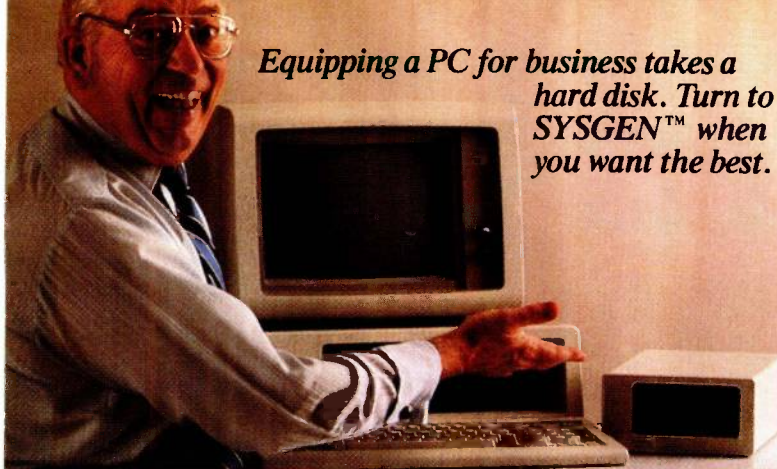

*Equipping a PC for business takes a hard disk. Turn to **SYSGEN™** when you want the best.*



*Smart disk users insist on tape for data file back-up. **SYSGEN** is the leader.*



*And, if your needs begin to exceed the limits of PC memory and slot expansion, **SYSGEN** has the solution.*



18 Megabytes and 6 expansion slots for the PC, XT, or AT™. \$1995.

For demanding PC owners who need more versatility and memory, Sysgen introduces a powerful, reliable, and unique solution: The DISK I/O™.

It includes 6 new expansion slots for your choice of plug-in



boards, plus, an 18 MByte hard disk—all for slightly more than a hard disk alone.

Sysgen offers the full range of expansion, storage, and tape back-up solutions with the best performance ratings for the IBM® PC, XT, AT and compatibles.

For more information on the Sysgen family of expansion products contact your local dealer.

SYSGEN 47853 Warm Springs Blvd.,
Fremont, CA. 94539
INCORPORATED (415) 490-6770 Telex 4990843
800-821-2151

Trademarks: Sysgen, DISK I/O—Sysgen, Inc.; AT—International Business Machines Corporation. Registered trademarks: IBM—International Business Machines Corporation.

THE EXPERT MECHANIC

*Expert systems
needn't be esoteric or
waste resources*

Most people who have heard of Logo probably think it is a programming language for kids. Likewise, most people who have heard the term "expert system"

probably think it refers to something esoteric on the frontiers of computer science. Both conceptions contain an element of truth, but both are oversimplifications. In fact, Logo can be used to develop an expert system that learns.

DEFINITIONS

Expert systems are exactly that: systems that do what an expert in a given field can do. One of the first expert systems was a program called DENDRAL, developed by Edward Feigenbaum of Stanford University. DENDRAL operated at the intellectual level of a chemistry Ph.D.

Most expert systems are developed using languages like LISP and Prolog. With these languages it is relatively easy to write programs that modify themselves—programs that learn. Of course, you can write an assembler program that dynamically modifies its own code, but that involves considerable effort. Unfortunately, few implementations of LISP and Prolog are available for microcomputers since both languages require fairly large amounts of memory. Logo provides many of their capabilities, and versions of Logo are available for most microcomputers.

Logo was developed by Seymour Papert, a professor of mathematics at MIT. Logo has some of the features of its parent language, LISP, in addition to a powerful graphics capability. In Logo, a program or procedure is a list of lists. Because the process

(continued)

Michael Fichtelman is a systems analyst at the European American Bank in New York. You can reach him at 72-61 113 St., Forest Hills, NY 11375.

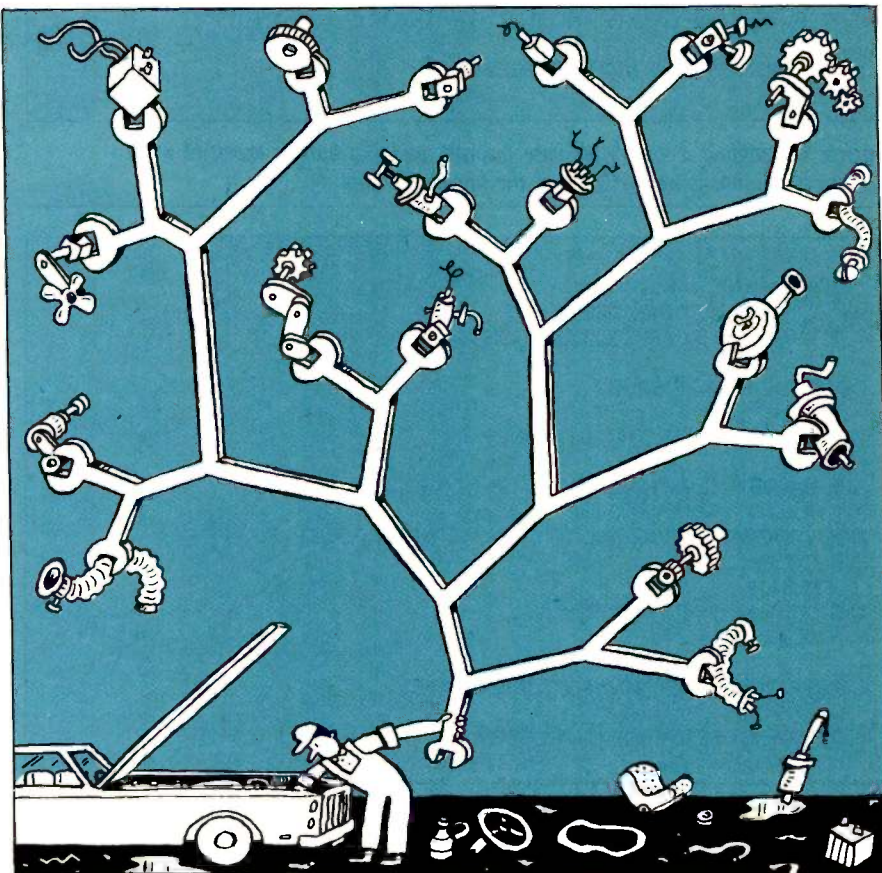

DeSmet C

8086/8088
Development
Package

\$109

FULL DEVELOPMENT PACKAGE

- Full K&R C Compiler
- Assembler, Linker & Librarian
- Full-Screen Editor
- Execution Profiler
- Complete **STDIO** Library (>120 Func)

Automatic DOS 1.X/2.X SUPPORT
BOTH 8087 AND S/W FLOATING POINT
OVERLAYS

OUTSTANDING PERFORMANCE

- First and Second in AUG '83 BYTE benchmarks

SYMBOLIC DEBUGGER

\$50

- Examine & change variables by name using C expressions
- Flip between debug and display screen
- Display C source during execution
- Set multiple breakpoints by function or line number

DOS LINK SUPPORT

\$35

- Uses DOS .OBJ Format
- LINKs with DOS ASM
- Uses Lattice® naming conventions

Check: Dev. Pkg (109)
 Debugger (50)
 DOS Link Supt (35)

SHIP TO: _____

_____ ZIP _____

CWARE
CORPORATION

P.O. BOX C
Sunnyvale, CA 94087
(408) 720-9696

All orders shipped UPS surface on IBM format disks. Shipping included in price. California residents add sales tax. Canada shipping add \$5, elsewhere add \$15. Checks must be on US Bank and in US Dollars. Call 9 a.m. - 1 p.m. to CHARGE by VISA/MC/AMEX. Street Address: 505 W. Olive, #767, (94086)

EXPERT MECHANIC

of recursion is easy to implement in Logo, procedures or lists can refer to themselves. A complete discussion of Logo is outside the scope of this article, but for our purposes knowledge of Logo is important only if you want to understand how to implement an

expert system. Once the system is implemented, anyone can interact with and modify its knowledge base.

MAKING AN EXPERT

Mechanic is an expert system that
(continued)

EXPERT MECHANIC
WE WILL TRY TO DIAGNOSE
THE PROBLEM BY ASKING QUESTIONS.

DOES THE ENGINE START?

YES

DOES THE ENGINE STALL?

NO

DOES ENGINE MISFIRE?

NO

DOES ENGINE LACK POWER/PERFORMANCE?

NO

DOES ENGINE IDLE ROUGHLY?

YES

COULD IT BE FUEL VOLATILITY?

NO

WHEN YOU FIND THE SOURCE OF THE PROBLEM, ADD IT TO KNOWLEDGE
BASE.

WHAT WAS THE CAUSE OF THE PROBLEM?

CHOKER

PLEASE TYPE IN A QUESTION WHOSE ANSWER

IS "YES" FOR THE CHOKER AND "NO" FOR THE FUEL VOLATILITY

LET'S DIAGNOSE THE NEXT PROBLEM.

Figure 1: Building a knowledge base involves applying human expertise when the correct solution is not yet part of the knowledge base.

EXPERT MECHANIC
WE WILL TRY TO DIAGNOSE
THE PROBLEM BY ASKING QUESTIONS.

DOES THE ENGINE START?

NO

DOES THE STARTER CRANK ENGINE?

NO

ARE BATTERY TERMINALS LOOSE OR CORRODED?

NO

DOES STARTER MOTOR FAIL TO OPERATE WHEN POWER IS APPLIED
DIRECTLY?

YES

COULD IT BE THE STARTER?

YES

CONGRATULATIONS! NOW FIX THE PROBLEM.

LET'S DIAGNOSE THE NEXT PROBLEM.

Figure 2: Here, Mechanic already has the information to move directly to a correct solution to the problem of why the car won't start.

THE ADVENTURE CONTINUES . . .

THE EXCITEMENT IS BACK!

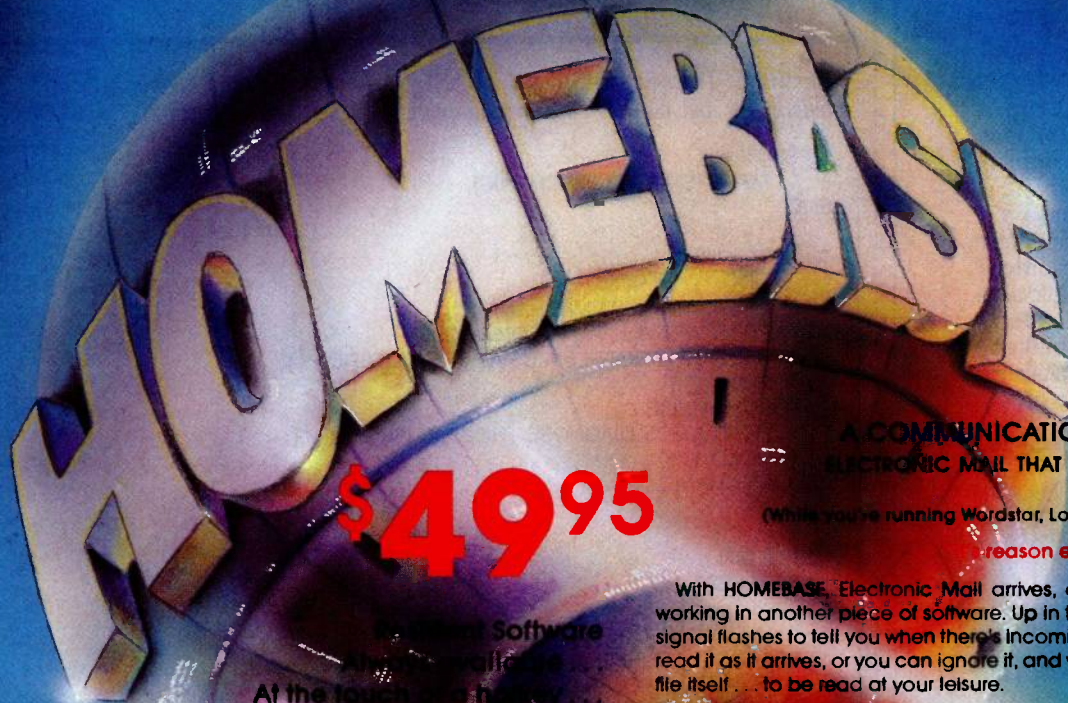

\$49.95

A COMMUNICATIONS BREAKTHROUGH!
ELECTRONIC MAIL THAT TAKES CARE OF ITSELF . . .
IN THE BACKGROUND
 (While you're running Wordstar, Lotus, a compiler or whatever.)
 "The only reason enough to own a modem."

With HOMEBASE, Electronic Mail arrives, automatically, while you're working in another piece of software. Up in the corner of your screen, a signal flashes to tell you when there's incoming mail. You can choose to read it as it arrives, or you can ignore it, and your mail will automatically file itself . . . to be read at your leisure.

AMBER'S HOMEBASE - CHECK THE DIFFERENCE IN VALUE!

HOMEBASE™	SIDEKICK™	POLY WINDOWS™	SPOTLIGHT™
Noteepad Autodialer Calendar Calculator DOS Services Databases Auto Dialer Alarm Phone Directory Card Printer Tables & Pages Template Maker Data Transfer Cut & Paste Programmable Hatkey Phone Message Pad Time & Expense Diary To-do List Electronic Mail Quickterm Terminal Mailing Label Printer	Noteepad Autodialer Calendar Calculator ASCII Table Phone Directory Card Printer	Noteepad Keyboard Macros Calendar Calculator Game Alarm File Cards	Noteepad Calendar DOS Services Calculator Phone Directory Card Printer File Cards
\$49.95!	\$49.95	\$49.95	\$149.95

Sidekick is a trademark of Borland International Inc. Poly Windows is a trademark of Polytron Corp. Spotlight is a trademark of Software Arts (1 and 8) is a trademark of Ashton-Tate. Lotus (1-2-3) is a trademark of Lotus Development Corp. Wordstar is a trademark of MicroPro.

INSTANT DATABASES . . . BECAUSE THAT'S HOW MOST OF US NEED INFORMATION . . . INSTANTLY!

Homebase provides you instant access to your own private universe of databases. Just hit the hotkey to freeze whatever software you're working in, and you're ready to find, insert or manipulate data. Hit it again, and you're back working in your original software, without skipping a beat.

DOS SERVICES

Need to shift a file up a directory while you're working in Wordstar? It's just a keystroke away with Homebase. You can open multiple directories and sub-directories onscreen, move, copy, view, and even edit files from within this powerful Homebase feature.

AND A VERY FULL TOOLCHEST

Tools that will save you time and help you organize information, schedule, calculate, file and notate. You can even set up your own reference pages for instant recall.

ORDER YOUR COPY OF HOMEBASE TODAY!

For Visa and MasterCard Orders Call Toll Free: 800-538-8157 Ext. 824

Call Mon.-Fri. 6 A.M. to 12 P.M., Sat. & Sun. 6 A.M. to 8 P.M. (P.S.T.) In CA 800-672-3470 Ext. 824

Or fill in this ORDER FORM and enclose a check, money order or your VISA or MasterCard number.

Homebase is available for the IBM PC, XT and True Compatibles - \$49.95 + \$5 for shipping and handling*

YES! Site licenses are available for companies . . . large and small. If you would like to order a single copy, now, to examine and show around your company, its cost can be deducted, later on, from your site license. For further information on site licenses call 408-996-1883.

NAME _____
 TITLE _____
 COMPANY NAME _____
 ADDRESS _____
 CITY _____ STATE _____ ZIP _____
 HOME PHONE () _____ WORK PHONE () _____

CHECK MONEY ORDER VISA MASTERCARD Card # _____ Exp. date _____

30 day money-back guarantee!

* California residents add 6% sales tax. Outside U.S. please add \$15. Checks must be on a U.S. bank and in U.S. dollars. Sorry, no C.O.D. or purchase orders.

AMBER'S HOMEBASE
\$49.95 and \$5 for shipping and handling*

SEND TO:



Amber Systems, Inc.
 AMBER SYSTEMS, INC.
 1171 S. Saratoga-Sunnyvale Road
 San Jose, CA 95129

For dealer and site license information, call 408 996-1883.

Mac Inker

Re-ink any fabric ribbon **AUTOMATICALLY** for less than 5¢. Extremely simple operation with built-in electric motor. We have a MAC INKER for any printer: cartridge/spool/harmonica/zip pack. Lubricant ink safe for dot matrix printheads. Multicolored inks, uninked cartridges available. Ask for brochure. Thousands of satisfied customers.

\$54.95 +



Mac Switch

Mac Switch lets you share your computer with any two peripherals (serial or parallel). Ideal for word processors—never type an address twice. Ask us for brochure with tips on how to share two peripherals (or two computers) with MAC SWITCH. Total satisfaction or full refund.

\$99.00

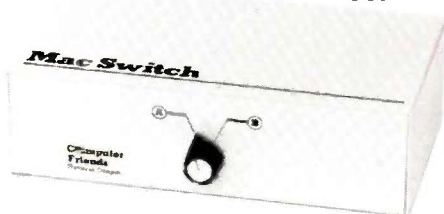

Order toll free 1-800-547-3303

Computer Friends

6415 SW Canyon Court
Suite #10
Portland, Oregon 97221
(503) 297-2321

EXPERT MECHANIC

Listing 1: Procedure DISPLAY.KBASE shows you the entire knowledge-base binary tree and includes both the information and its logical structure.

```

TO START UP
    MAKE "STARTUP [MECHANIC]
END

TO MECHANIC
    ND
    PRINT["***EXPERT MECHANIC***"]
    PRINT[WE WILL TRY TO DIAGNOSE]
    PRINT [THE PROBLEM BY ASKING QUESTIONS.]
    PRINT []
    SEARCH :KBASE
    PRINT [LET'S DIAGNOSE THE NEXT PROBLEM.]
    HOLD 1000
    MECHANIC
END

TO HOLD:N
    REPEAT :N[]
END

TO SEARCH :POSSIBLES
    IF (WORD? :POSSIBLES) END.SEARCH:POSSIBLES STOP
    LOCAL "RESPONSE
    MAKE "RESPONSE QRY.POS.OR.NEG (QUERY:POSSIBLES)
    IF :RESPONSE = [YES] SEARCH POS.BRANCH:POSSIBLES STOP
    SEARCH NEG.BRANCH:POSSIBLES
END

TO END.SEARCH :POSSIBLE
    LOCAL "LAST.QUESTION
    LOCAL "RESPONSE
    MAKE "LAST.QUESTION (SE [COULD IT BE] ARTICLE :POSSIBLE [?])
    MAKE "RESPONSE QRY.POS.OR.NEG :LAST.QUESTION
    IF :RESPONSE = [YES] PRINT [CONGRATULATIONS! NOW FIX THE
    PROBLEM.]
STOP
    LEARN:POSSIBLE
END

TO QRY.POS.OR.NEG :QUESTION
    LOCAL "ANSWER
    PRINT 1 :QUESTION
    IF ""? = LAST LAST :QUESTION PRINT [] ELSE PRINT?
    MAKE "ANSWER REQUEST
    IF :ANSWER = [YES] OUTPUT [YES]
    IF :ANSWER = [NO] OUTPUT [NO]
    PRINT [PLEASE TYPE "YES" OR "NO"]
    OUTPUT QRY.POS.OR.NEG :QUESTION
END

TO QUERY :BTREE
    OUTPUT FIRST :BTREE
END

TO POS. BRANCH :BTREE
    OUTPUT FIRST BUTFIRST :BTREE
END

TO NEG. BRANCH :BTREE
    
```

(continued)



You know that choosing the right software is serious business. So does WATCOM.

So before you make any decisions about your software needs, talk to WATCOM—the people major software users around the world have trusted for years. WATCOM has the products you need to get the job done right. Proven performers like WATFOR*, WATFIV*, WATBOL*, and SCRIPT. Plus new leaders in software for PC workstations and micro-to-mainframe communications. Networks, language interpreters and compilers. Text preparation and data management. All WATCOM products are human engineered to provide the optimum in people efficiency and productivity. And they're designed to run compatibly on IBM mainframes and PC's, Digital main-

frames and micros, and Commodore micros. Whatever you need is backed up by WATCOM's innovative maintenance and support services. You'll be kept up to date with the latest in product enhancements and information. And our publications and seminars will help you get the most out of your software investment. WATCOM. Quality products. Professional service. And a reputation built on more than 150,000 licensed mainframe and micro software programs throughout the world. So talk to us before you decide. After all, choosing the right software is serious business. For you. And for WATCOM.

Make the right choice: WATCOM INTERPRETERS

Excellent error diagnostics make WATCOM Interpreters the right choice in software for efficient program development in APL, BASIC, COBOL, FORTRAN, or Pascal. WATCOM Interpreters emphasize error detection so that program corrections are more easily executed. Hard-to-find errors can be quickly located with the integrated debugging system for COBOL, FORTRAN, and Pascal. And programs can be efficiently entered and corrected with the integrated full-screen editor in all languages but APL.

WATCOM Interpreters are available for IBM PC, IBM 370 VM/SP CMS, and Digital VAX VMS*. Make the right choice. Call or write WATCOM today and we'll tell you all about WATCOM Interpreters or any of WATCOM'S other people-efficient products.

WATCOM

The right choice in software.

Inquiry 423

Yes! I want to make the right choice in software. Send me more information on:

WATCOM INTERPRETERS WATCOM Software Catalogue

Name: _____

Company: _____

Title: _____

Address: _____

City: _____ State: _____ Zip: _____

WATCOM PRODUCTS INC.

415 Phillip Street
Waterloo, Ontario, Canada
N2L 3X2

(519) 886-3700

Telex 06-955458

*WATFOR, WATFIV and WATBOL are registered trademarks of the University of Waterloo.
*IBM PC and IBM 370 VM/SP CMS are registered trademarks of International Business Machines Corporation.
*VAX, VMS are registered trademarks of Digital Equipment Corporation.

Who Knows What Evil lurks In The Lines Of Power?

Graham Wilson

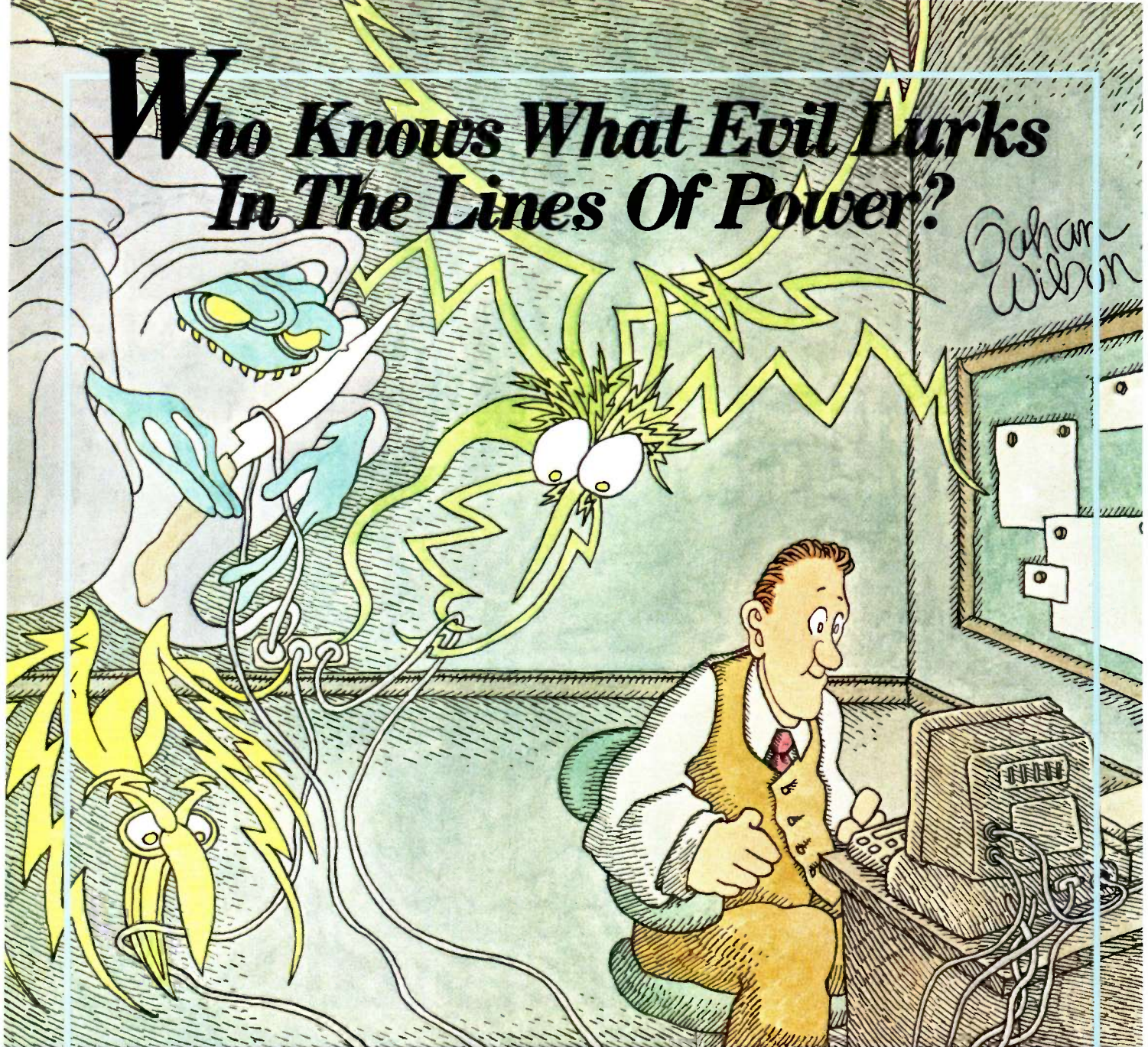

DynaTech Knows.

This humorous illustration is no comfort to those who have experienced the frustration of losing hours of programming and data entry due to a power outage or surge. In addition to the inconvenience, such occurrences can mean lost programs and perhaps an expensive component destroyed.

DynaTech boasts 25 years of engineering experience in power and data line interference problems. We are one of the largest manufacturers of products solving these problems—and, without question, the engineering trendsetter in the industry.

The latest DynaTech trendsetter is our PowerHouse™ line of standby power supplies. Available in 300- and 500-watt models, PowerHouse protects your computer in two ways. First, should power fail, you instantaneously get clean, regulated power to your system, allowing for an orderly shutdown. Second, while on commercial power, our SurgeSentry™ circuitry protects your system from surges and other hazards.

To learn more about PowerHouse and other fine DynaTech products, call one of the dealers listed here or call us toll free for one near you: (800) 638-9098.



DynaTech

Computer Power Inc.

4865 Scotts Valley Drive, Scotts Valley, CA 95066

DynaTech Dealers

201/462-9696-CMI (COMPUTER MADNESS)
201/487-0919-MICROMED
205/355-4583-SEQUENTIAL SYSTEMS/COMPUTER
COTTAGE
207/772-1622-ENTRE COMPUTER CENTER
213/391-6763-ELECTRONIC TRADING POST
213/970-1242-STRICTLY SOFTWARE
214/385-8885-MP SYSTEMS
214/785-0041-BUSINESS SYSTEMS
215/362-1888-COMPUTERS FOR THE PROFESSIONAL
219/232-7921-COMPUTER ASSOCIATES
219/493-6505-COMPUTER CORNER
303/761-5763-DATA SPECIALTIES
305/894-3354-G.M.I. DISTRIBUTORS
309/346-5181-ILLINOIS VALLEY COMPUTER
312/885-0008-DIEHL OFFICE PRODUCTS
313/573-8120-COMMAND COMPUTER SYSTEMS INC.
313/694-3740-COMPUTER CONTACT
316/564-3636-GENESYS SYSTEMS
317/844-5960-HEALTH CARE SYSTEMS INC.
319/236-3861-DHEIN'S TRUE VALUE
404/292-8050-PEACHTREE MICROSYSTEMS
405/269-2554-PROCESS INC.
405/332-5588-ADA TYPEWRITER SUPPLY
405/373-3210-COMCON SYSTEMS INC.
405/632-6007-COMPUTER SOFTWARE CENTER
406/443-1710-MSD COMPUTER SUPPLY
408/438-5971-PC LAND
414/276-5585-APPLIED DATA SYSTEMS CORPORATION
415/383-8800-COMPUTERTIME
415/397-6776-COMPUTERTIME
415/459-8080-COMPUTERTIME
415/864-3026-EXPRESS COMPUTER SUPPLIES
419/224-3746-LIMA BUSINESS MACHINES
419/625-2232-DATA DIMENSIONS INC.
501/224-7770-ENTRE COMPUTER CENTER
502/589-1258-COMPUTER EMPORIUM
502/782-9466-COMPUTER MARKET
503/754-4323-OSU BOOKSTORE INC.
505/883-4545-OMEGA BUSINESS PRODUCTS
509/922-6665-NOVA SYSTEMS
509/943-5608-ALPHA COMPUTER CENTER
512/226-8188-COMPUTER & BUSINESS SUPPLIES
512/280-1183-RESPONSE TECHNOLOGIES INC.
512/682-2372-ADVANCED SYSTEM TECHNIQUES
513/299-4594-THE BLUE CHIP COMPUTER
513/548-3326-HOWELL'S COMPUTER CENTER
515/224-1992-COMPUTER EMPORIUM
515/288-6668-THE COMPUTER SUPPLY STORE
602/274-0124-STEWART TECHNOLOGIES
602/990-7276-DAYZ SYSTEMS INC.
605/772-5229-RESEARCH DATA SYSTEMS
612/888-4444-ON LINE INTERNATIONAL
614/895-7747-ON LINE COMPUTER CENTER
614/774-6565-THE CHILLICOTHE COMPUTER STORE
615/366-3810-COMPUTER SHOPPE
615/892-3253-COMPUTER CONNECTION
616/243-1312-ADVANCED INFORMATION SYSTEMS
616/924-0310-POS ELECTRONIC BUSINESS SYSTEMS
617/342-9707-HYLAND/RICE SYSTEMS
618/797-6640-METRO CONNECTION
619/448-9240-COMPUTER KONTROL
619/450-0810-ALLEN MICROCOMPUTER SERVICES
702/322-4559-HARRY'S BUSINESS MACHINES
702/737-1510-AMERICAN OFFICE EQUIPMENT
702/870-4138-PC COMPUTERS
704/658-2795-COMPUTER AID/MICROMASTERS
713/890-1025-SOUTHWEST COMPUTER SUPPLIES
713/988-8560-TYNER AND ASSOCIATES
714/727-1142-COMPUTER KINGDOM
714/969-2225-WEH COMPUTERS
800/528-7100-SAFEGUARD BUSINESS SYSTEMS, INC.
800/528-7300-SAFEGUARD BUSINESS SYSTEMS, INC.
801/224-8887-COM-TEL COMPUTER
802/447-2186-COMPUTER SUPPLIES INTERNATIONAL
804/320-6496-FIRST STEP COMPUTERS
805/658-0355-ENTRE COMPUTER CENTER
806/935-7492-THE UNLAUB COMPANY OF TEXAS
808/486-4848-PEARL CITY COMPUTERS
808/969-1166-THE COMPUTER STORE
814/472-6066-INFOCON CORPORATION
816/891-6512-TOTAL SOFTWARE INC.
817/284-5251-TAYLOR COMPUTER PRODUCTS
817/383-2631-AUDIO CONCEPTS ULTD. DBA RADIO
SHACK ASSOCIATES
817/429-9166-GEORGE DOWLING ASSOCIATES
901/722-8280-MICROAGE COMPUTER STORE
907/443-5111-GOLD RUSH BUSINESS & ELECTRONIC
EQUIPMENT
907/562-3900-ALASKA MICROSYSTEMS
913/541-0001-MIDWEST COMPUTER ASSOCIATES
915/563-1108-THE COMPUTER DIVISION OF I.C.I.
918/687-3161-DIGITAL COMPUTER SYSTEMS
919/799-0327-COMPUTER 'S

DynaTech Computer Power, Inc., was formed as the result of the acquisition and merger of RKS Industries, Inc., and Dymarc Industries by Dynatech International, Inc.

EXPERT MECHANIC

```
OUTPUT LAST :BTREE
END

TO ARTICLE :WORD
  OUTPUT SENTENCE "THE :WORD
END

TO LEARN :MISTAKE
  PRINT (WHEN YOU FIND THE SOURCE OF THE PROBLEM, ADD IT TO THE
  KNOWLEDGE BASE. WHAT WAS THE CAUSE OF THE PROBLEM?)
  MAKE "RIGHT.ANSWER (LAST REQUEST)
  PRINT (PLEASE TYPE IN A QUESTION WHOSE ANSWER)
  PRINT ( SE (IS "YES" FOR) ARTICLE :RIGHT.ANSWER(AND))
  PRINT ( SE ["NO"FOR]ARTICLE :MISTAKE)
  MAKE "QUESTION REQUEST
  INCREASE.KBASE :QUESTION :RIGHT.ANSWER :MISTAKE
END

TO INCREASE.KBASE :NEW.QUESTION :POS.ANSWER :NEG.ANSWER
  MAKE "KBASE CHANGE :KBASE :MISTAKE(LIST :NEW.QUESTION
  :RIGHT.ANSWER :MISTAKE)
END

TO CHANGE :DATA :WORD :NEW.BRANCH
  IF :DATA = :WORD OP :NEW.BRANCH
  IF WORD? :DATA OP :DATA
  OP (LIST QUERY :DATA CHANGE POS.BRANCH :DATA :WORD
  :NEW.BRANCH CHANGE NEG.BRANCH :DATA :WORD :NEW.BRANCH)
END

TO START.KBASE
  MAKE "KBASE [(DOES THE ENGINE START?) [(DOES THE ENGINE STALL?)
  [(ANY AIR LEAKS IN OR AROUND INTAKE MANIFOLD?) MANIFOLD [(ARE
  VALVES SET TOO TIGHT?) VALVES [(ARE IGN POINTS BURNED, PITTED,
  OR GAPPED IMPROPERLY?)POINTS [(IS IDLE SPEED SET TOO LOW?)
  IDLE-SPEED CARB-MIXTURE ]]]] [(DOES ENGINE MISFIRE?) [(ARE SPARK
  PLUGS FOULED, DAMAGED, TOO HOT, TOO COLD, OR GAPPED
  INCORRECTLY?) PLUGS [(IS HEAD GASKET BLOWN?) HEAD GASKET
  [(ARE POINTS BURNED, PITTED, OR INCORRECTLY GAPPED?) POINTS
  [(ARE VALVES WORN, STICKING, OR VALVE SPRINGS BROKEN, WEAK?)
  VALVES [(IS CARBURETION POOR DUE TO CLOGGED OR LOOSE JETS,
  AIR LEAKS, OR INCORRECT FUEL-TO-AIR MIXTURE?)CARBURETOR
  IGN-TIMING]]]]] [(DOES ENGINE LACK POWER/PERFORMANCE?) [(IS IGN
  TIMING OFF?) IGN TIMING [(HAS VACUUM ADVANCE FAILED?)
  VACUUM-ADVANCE [(ARE POINTS BURNED, PITTED, STICKING, OR
  BOUNCING?) POINTS PISTON-RINGS]]] [(DOES ENGINE IDLE ROUGHLY?)
  FUEL-VOLATILITY CYL-HEAD]]]] [(DOES THE STARTER CRANK ENGINE?)
  [(ARE POINTS BURNED, PITTED, DIRTY, OR FAIL TO FUNCTION?)
  POINTS[(IS COIL RESISTOR BURNED OUT OR OPEN?) COIL [(ARE SPARK
  PLUGS DAMAGED, DIRTY, WET, OR GAPPED INCORRECTLY?) PLUGS [(IS
  FUEL PUMP WORN, LEAKING, CLOGGED, OR INOPERATIVE?) FUEL
  PUMP [(IS CARB FLOAT LEAKING OR SET INCORRECTLY, ARE JETS
  CLOGGED, IS NEEDLE VALVE OR SEAT DIRTY OR WORN, IS CHOKE
  INCORRECTLY SET OR INOPERATIVE?) CARBURETION [(IS DISTRIBUTOR
  CAP, ROTOR, TERMINAL INSULATOR DAMAGED, IS DISTRIBUTOR WET?)
  DISTRIBUTOR [(ARE IGN CABLES CRACKED, WET, CORRODED?) IGN-
  CABLES [(DOES IGN SWITCH REMAIN OPEN WHEN KEY IS TURNED?
  IGN-SWITCH FUEL ]]]]]]] [(ARE BATTERY TERMINALS LOOSE OR
  CORRODED?) TERMINALS [(DOES STARTER MOTOR FAIL TO OPERATE
  WHEN POWER IS APPLIED DIRECTLY?) STARTER [(DOES STARTER DRIVE
  GEAR FAIL TO ENGAGE FLYWHEEL?) SOLENOID BATTERY]]]]]
END
```

(continued)

NEW!

SINGLE BOARD COMPUTER PC BUS SYSTEM

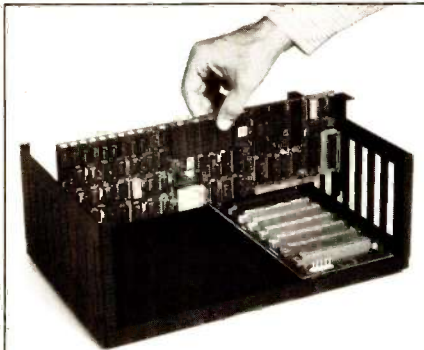

Put the power of the IBM PC into your OEM system with the new I-Bus Single Board Computer and Enclosures. Now you can make use of that vast array of PC-compatible expansion cards—for communications, graphics, data acquisition, peripheral control, and every other imaginable task.

I-Bus Systems has coupled Intel's powerful new 80188 CPU with 64K of RAM and up to 160K of on-board EPROM, plus a serial console port to talk to a terminal or a PC. Just plug the SBC into an I-Bus 6-slot chassis or 9-slot card cage and you have the heart of a computer system, ready to run.

Best of all, the IBM PC works perfectly as a software development system. You can assemble and test applications programs on the PC, then download them to the I-Bus system for dedicated execution.

For all the details, give us a call today at (800) 382-4229. In California, call (619) 569-0646.



I-BUS

SYSTEMS

9235 Chesapeake Drive
San Diego, CA 92123

IBM PC is a trademark of International Business Machines

EXPERT MECHANIC

```
TO DISPLAY:KBASE
  DISP :KBASE 0
END
```

```
TO DISP :KBASE :TIER
  IF WORD? :KBASE BDISP :KBASE :TIER STOP
  BDISP (QUERY :KBASE ) :TIER
  BDISP [IF YES:] :TIER
  DISP POS.BRANCH :KBASE :TIER + 1
  BDISP [IF NO:] :TIER
  DISP NEG.BRANCH :KBASE :TIER + 1
END
```

```
TO BDISP :BRANCH :TIER
  REPEAT 2* :TIER [PRINT1""]
  PRINT :BRANCH
END
```

DOES THE ENGINE START?

IF YES:

DOES THE ENGINE STALL?

IF YES:

ANY AIR LEAKS IN OR AROUND INTAKE MANIFOLD?

IF YES:

MANIFOLD

IF NO:

ARE VALVES SET TOO TIGHT?

IF YES:

VALVES

IF NO:

ARE IGN POINTS BURNED, PITTED, OR GAPPED IMPROPERLY?

IF YES:

POINTS

IF NO:

IS IDLE SPEED SET TOO LOW?

IF YES:

IDLE SPEED

IF NO:

CARB MIXTURE

IF NO:

DOES ENGINE MISFIRE?

IF YES:

ARE SPARK PLUGS FOULED, DAMAGED, TOO HOT, TOO COLD, OR GAPPED INCORRECTLY?

IF YES:

PLUGS

IF NO:

IS HEAD GASKET BLOWN?

IF YES:

HEAD GASKET

IF NO:

ARE POINTS BURNED, PITTED, OR INCORRECTLY GAPPED?

IF YES:

POINTS

IF NO:

ARE VALVES WORN, STICKING, OR VALVE SPRINGS BROKEN, WEAK?

IF YES:

VALVES

IF NO:

IS CARBURETION POOR DUE TO CLOGGED OR LOOSE JETS, AIR

(continued)

Teletek

One Success After Another.

Since 1978 Teletek has been a leader in the design and manufacture of single board computers, controllers, memory boards and interface boards.

Teletek offers five distinct single board computers (SBCs), each with its own unique features, to meet the varied needs of the system integrator. Based on the 8086 16-bit and Z80 8-bit microprocessors, Teletek's SBCs

will run at 4, 5, 6, or 8MHz and are available with up to 512K of onboard dynamic RAM. The SBC 86/87 also offers an optional 8087 math coprocessor for numeric intensive applications.

Teletek's Systemmaster II provides two RS232C serial ports and two Centronics-compatible parallel ports or may be optionally configured to provide a SCSI interface or an IEEE-488 interface to support many laboratory testing and measuring instruments.

Teletek also offers a dual controller board, the HD/CTC, which will control any two ST506-compatible hard disk drives and any QIC-02/QIC-24-compatible cartridge tape drive. This unique design saves hardware cost as well as space in the mainframe.

Teletek's IEEE 696/S-100 boards run under the multi-user, multi-processing operating system TurboDOS by Software 2000, supporting up to 16 users and capable of running PC-DOS application programs. For single-user systems, Teletek is supported by the CP/M operating system.



In Europe:
Kode Limited
Station Road
Calne, Wiltshire
SN11 0JR England
tel: 0249-813771
telex: 449335

In Brazil:
DANVIC S.A.
R. Conselheiro
Nebias, 1409
01203 São Paulo, Brazil
tel: 221-6033 (PABX)
telex: 1123888 CICIP BR

Teletek provides a 30 day evaluation program to qualified customers. For more information, call our Sales Department at 916-920-4600 or write for our information package.

TELETEK

4600 Pell Drive
Sacramento, CA 95638
916-920-4600

Inquiry 405

© 1984 Teletek

Systemmaster II (128K, 6.0 MHz)



PROGRAMMER'S UTILITIES
 especially for Turbo Pascal on
 IBM PC/XT/AT and compatibles

MORE POWERFUL THAN UNIX UTILITIES!!!

Whether you are a
 -- Student -- Hobbyist -- Professional Software Developer --
 THESE UTILITIES WILL IMPROVE YOUR
 PROGRAMMING PRODUCTIVITY!!!

These Powerful, Ready-to-Use programs fully support Turbo Pascal versions 2.0 and 3.0, and MSDOS 2.X and 3.0. Here's what you get:

Pretty Printer

Standardize capitalization, indentation, and spacing of source code. Don't waste your own time! Several adjustable parameters to suit your tastes (works with any standard Pascal source).

Program Structure Analyzer

Find subtle problems the compiler doesn't: uninitialized and unused variables, modified value parameters, "sneaky" variable modification, redefined standard identifiers. Also generates a complete variable cross reference and a program hierarchy diagram. Interactive or write to file (works with any standard Pascal source).

Execution Timer

Obtain a summary of time spent in each procedure and function of your program, accurate to within 200 microseconds. Also counts number of calls to each subprogram. Fully automatic.

Execution Profiler

Obtain a graphic profile of where your program spends its time. Interactive, easy-to-use. Identify weak code at the instruction level (Profiler and Timer for Turbo Pascal Source code only)

Command Repeater

Go beyond MSDOS batch files to combine a powerful text parser with general-purpose command execution capability. Use to copy, print or delete across subdirectories, "make" programs and more.

Pattern Replacer

Find and REPLACE versatile regular expression patterns in any text file. Supports nesting, alternation, tagged words and more. Over a dozen programmer's applications included.

Difference Finder

Find differences between two text files, and optionally create an EDLIN script which rebuilds one from the other. Disregard white space, case, arbitrary characters and Pascal comments if desired.

Super Directory

Replace PCDOS DIR command with extended pattern matching, sort capability, hidden file display, date filtering, and more.

File Finder

Locate files anywhere in the subdirectory tree and access them with a single keystroke. Display the subdirectory tree graphically.

**AVAILABLE IN SOURCE
 AND EXECUTABLE FORMAT**

Executable: \$55 COMPLETE including tax and shipping. Compiled and ready to run, includes user manual, reference card and one 5 1/4" DSDD disk. Ideal for programmers not using Turbo.

Source: \$95 COMPLETE including tax and shipping. Includes all of the above, and two additional DSDD disks. Disks include complete Turbo Pascal source code, detailed programmer's manual (on disk) and several bonus utilities. Requires Turbo Pascal 2.0 or 3.0.

Requirements: MSDOS 2.X or 3.0. 192K RAM — programs run in less RAM with reduced capacity. Two drives or hard disk recommended.

TO ORDER:

VISA/MasterCard orders, call 7 days toll-free 1-800-538-8157 x830. In California, call 1-800-672-3470 x830 any day. Or mail check/money order to:

TurboPower Software
 478 W. Hamilton Ave., Suite 196
 Campbell, CA 95008

EXPERT MECHANIC

LEAKS, OR INCORRECT FUEL-TO-AIR MIXTURE?

IF YES:

CARBURETOR

IF NO:

IGN TIMING

IF NO:

DOES ENGINE LACK POWER/PERFORMANCE?

IF YES:

IS IGN TIMING OFF?

IF YES:

IGN TIMING

IF NO:

HAS VACUUM ADVANCE FAILED?

IF YES:

VACUUM ADVANCE

IF NO:

ARE POINTS BURNED, PITTED, STICKING, OR BOUNCING?

IF YES:

POINTS

IF NO:

PISTON RINGS

IF NO:

DOES ENGINE IDLE ROUGHLY?

IF YES:

FUEL VOLATILITY

IF NO:

CYL HEAD

IF NO:

DOES THE STARTER CRANK ENGINE?

IF YES:

ARE POINTS BURNED, PITTED, DIRTY, OR FAIL TO FUNCTION?

IF YES:

POINTS

IF NO:

IS COIL OUTPUT WEAK OR NONEXISTENT, IS COIL RESISTOR BURNED OUT OR OPEN?

IF YES:

COIL

IF NO:

ARE SPARK PLUGS DAMAGED, DIRTY, WET, OR GAPPED INCORRECTLY?

IF YES:

PLUGS

IF NO:

IS FUEL PUMP WORN, LEAKING, CLOGGED, OR INOPERATIVE?

IF YES:

FUEL PUMP

IF NO:

IS CARB FLOAT LEAKING OR SET INCORRECTLY, ARE JETS CLOGGED, IS NEEDLE VALVE OR SEAT DIRTY OR WORN, IS CHOKE INCORRECTLY SET OR INOPERATIVE?

IF YES:

CARBURETION

IF NO:

IS DISTRIBUTOR CAP, ROTOR, TERMINAL INSULATOR DAMAGED, IS DISTRIBUTOR WET?

IF YES:

DISTRIBUTOR

IF NO:

ARE IGN CABLES CRACKED, WET, CORRODED?

IF YES:

(continued)

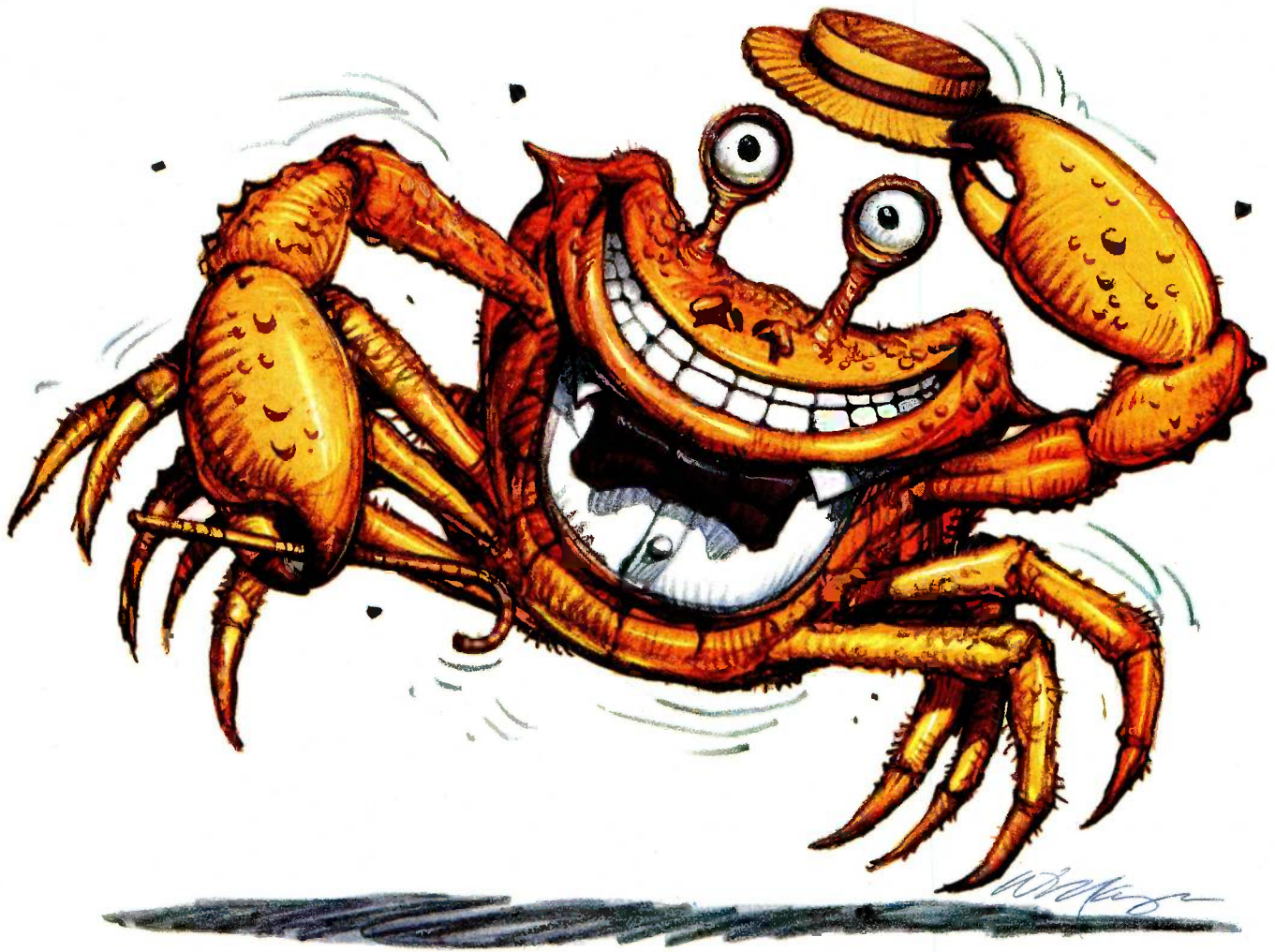

Sometimes the best way to get ahead is to go sideways.

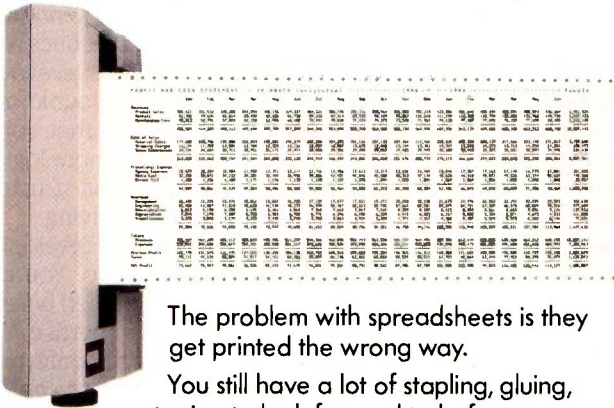

The problem with spreadsheets is they get printed the wrong way.

You still have a lot of stapling, gluing, or taping to look forward to before your printout is readable.

To really get ahead, go Sideways.™

Sideways is the clever software program that prints your spreadsheets—you guessed it—sideways. So your spreadsheet columns need never fall off the edge of your printer paper again.

With Sideways on your side, no spreadsheet you invent with Lotus 1-2-3,® Symphony,™ VisiCalc,® Multiplan,® or SuperCalc™ is too wide! And it's just as powerful an ally when you're creating far-into-the-future schedules and pert charts. So for a presentable printout, get rid of that glue stick and scotch tape—put your best foot forward and go Sideways.

You can go Sideways today with an IBM® PC or an Apple® II, and over a dozen different printers, including Epson,® Okidata, IBM,® Apple,® C. Itoh and Mannesmann Tally. Ask for Sideways at your local ComputerLand,® Entre, or other computer store. Or mail a \$60 check to Funk Software, P.O. Box 1290, Cambridge, MA 02238. Or call 617-497-6339. MC/Visa accepted.

SIDEWAYS™
SIDEWAYS PRINTS SPREADSHEETS SIDEWAYS.

```

    IGN CABLES
  IF NO:
    DOES IGN SWITCH REMAIN OPEN WHEN KEY IS
    TURNED?
    IF YES:
      IGN SWITCH
    IF NO:
      FUEL

  IF NO:
    ARE BATTERY TERMINALS LOOSE OR CORRODED?
    IF YES:
      TERMINALS
    IF NO:
      DOES STARTER MOTOR FAIL TO OPERATE WHEN POWER IS APPLIED
      DIRECTLY?
      IF YES:
        STARTER
      IF NO:
        DOES STARTER DRIVE GEAR FAIL TO ENGAGE FLYWHEEL?
        IF YES:
          SOLENOID
        IF NO:
          BATTERY
  
```

simulates an automobile mechanic. Due to memory constraints, I decided to limit the knowledge base to include only the expertise required to diagnose engine failure. If you have enough memory, there is no reason why you cannot extend the knowledge base to include comprehensive automobile diagnostics. An alternative would be to build different knowledge bases for each area—one for the electrical system, one for suspension, one for steering, and so on.

The Mechanic procedure applies the concept of the binary tree to perform knowledge-base searches. Each question is a node on the search tree, and every node has exactly two branches. For example, the highest node is the question "Does the engine start?" If the answer to this question is "Yes," the next node is "Does the engine stall?" If the answer is "No," the next node is "Does the starter crank engine?"

In this way, Mechanic navigates the knowledge base until the problem is

solved or a new node is added. Figures 1 and 2 are examples of the complete execution of Mechanic. In figure 1, the solution to the problem is not in the knowledge base. Mechanic can take you only to the limit of its expertise. However, the program asks to be informed if you discover a solution. It also asks you to formulate a question that will distinguish the actual solution from the solution Mechanic proposed. In this way, the program learns and the knowledge base grows. The next time someone uses Mechanic, its ability to solve problems can be extended further.

In figure 2, Mechanic moves directly to a solution. It simply suggests that the user fix the problem since computer programs cannot yet replace starter motors.

THE PROCEDURES

The main procedure is MECHANIC. It is recursive and calls the procedure SEARCH. SEARCH is also recursive; if the answer to a prompt is "Yes," it

calls the procedure POS.BRANCH. Otherwise, SEARCH calls NEG.BRANCH to display the next node in the binary tree. If the end of a particular branch is reached before a positive reply is received, END.SEARCH is called to suggest a solution to the problem. If END.SEARCH proposes the correct solution, a congratulatory message is displayed and MECHANIC executes again. If END.SEARCH is wrong, it calls the procedure LEARN. LEARN asks the user if the solution was found and adds it to the knowledge base by calling INCREASE.KBASE.

To initialize the knowledge base before it is first used, execute START.KBASE. This procedure sets the value of the global variable KBASE. Thereafter, you can directly modify the knowledge base by altering the lists in this procedure.

The procedure DISPLAY.KBASE is a utility you can use to display the knowledge-base binary tree. It calls the procedures DISP and BDISP. Listing 1 is this procedure's output, including both the information and its logical structure.

NEW DIRECTIONS

An expert system is only as good as the expertise it contains. I deliberately limited the size of the knowledge base to allow room for experimentation. Obviously, the knowledge base can grow to fill a computer's available memory. When you build your knowledge base, keep in mind that some binary-tree structures are more logical than others. A carefully built structure can expedite problem solving.

Mechanic is a model for developing expert systems using Logo. You can use the procedures described here as a shell for any area of expertise. You can easily modify them to conform to the requirements of different applications and to build a variety of knowledge bases. ■

BIBLIOGRAPHY

McCorduck, Pamela. *Machines Who Think*. New York: W.H. Freeman & Co., 1979.
 Papert, Seymour. *Mindstorms*. New York: Basic Books, 1982.

Introducing
the new
and improved
IBM PC.

Introducing GEM.



*Suggested retail price. GEM requires that your computer have appropriate graphics capability and that the pointing device be compatible. GEM, GEM COLLECTION, GEM DESKTOP, GEM WRITE, GEM PAINT, GEM DRAW, GEM GRAPH and GEM WORDCHART are trademarks and Digital Research is a registered trademark of Digital Research Inc. GEM WRITE is by Liferise Software, Inc. IBM is a registered trademark of International Business Machines Corporation. © 1985, Digital Research Inc. All rights reserved.

Congratulations.

You just found the perfect way to get a brand new and improved IBM® PC without buying one.

Get GEM™ software from Digital Research instead. And your IBM PC, PC/XT, AT or compatible will become something it's never been before.

Easy to use.

Now instead of getting lost in PC DOS,



you can actually use your PC to get something done. (An astonishing idea, if ever there was one.)

It all starts with GEM DESKTOP™, a clever little \$49.95* program that hides the rigmarole of PC DOS. And lets you work with a simple header menu, icons, drop-down menus and a pointer.

So opening a file, for instance, is as easy as pointing with your mouse (or your cursor keys, if mice make you uneasy) to the file folder you want to work on. And click. It's open.

That's how GEM works. Here's what it works with. First of all, you can still run most important programs ever written for the IBM PC. And GEM software will make them easier to get into.

Then there are GEM programs we've written ourselves.

Like the GEM COLLECTION™, a bundle that includes GEM DESKTOP™, GEM WRITE™* and GEM PAINT™. So you can process words and pictures together.

GEM DRAW™ with an extensive gallery of art to help you create everything from fine art to line art. GEM GRAPH™ to turn numbers into something more tangible. And GEM WORDCHART™, the simplest last word (and chart) in presentation graphics.

And soon you'll see important programs from a host of major software houses.



Now, GEM is as easy to find as it is to use. Call (800) 443-4200. Ask for our GEM brochure. The name of your GEM software dealer. Or simply place an order.

Because with GEM, the best new computer on the market isn't a computer at all.

 **GEM**
FROM DIGITAL RESEARCH®

Inquiry 141

This is the only place you'll find Optically- Isolated Analog Modules.



Optically isolated analog input or output modules available from Opto 22.

Five years ago we introduced the industry standard optically isolated digital I/O modules. The optically isolated analog I/O modules are now ready.

Our engineers have combined signal conditioning A/D or D/A conversion and optical isolation in a single module at prices you have been waiting for, and they've designed a module for every application: ■ Thermocouple input modules (Type J & K) ■ Voltage input and output modules ■ Current input and output modules ■ Temperature sensing module with ICTD probe

All modules plug into four position or sixteen position racks with an on-board microcomputer that communicates to your host computer via a simple twisted pair.

Optically isolated analog modules — the new industry standard.



15461 Springdale Street • Huntington Beach • CA • (714) 891-5861 • (800) 854-8851

SWITCH

Use color and monochrome monitors simultaneously on your IBM PC

Editor's note: In November 1983, BYTE presented an assembly-language program for the IBM PC entitled Screen ("Enhancing Screen Displays for the IBM PC," by Tim Field, page 99), of which one function was the ability to connect both color and monochrome monitors to the IBM PC and switch back and forth between them. This article describes a simple program that allows you to do the same thing while developing BASIC applications.

Many IBM PC owners have both monochrome and color/graphics adapters in their computers. Unfortunately, only a few programs take advantage of the opportunity to use both a monochrome and a color monitor at the same time. The programs that do, such as Lotus 1-2-3 and SuperCalc3, simultaneously display graphics on one monitor and a spreadsheet on the other when the monitors are connected to separate cards. Such a setup has advantages, as these two cases illustrate: You can check the spreadsheet data and the graphics at the same time, and you can easily

change graphics commands on one screen while viewing the graphics themselves on the other screen.

Switch enables you to write graphics instructions in BASIC on your monochrome monitor and to display the output on a color monitor connected to your color/graphics card. Minimum requirements for using this program are an IBM PC with two monitors connected to separate internal cards, one disk drive, and BASICA.

USING THE PROGRAM

Essentially, Switch is a program kernel to which you can add your own graphics applications. Once you have keyed in the 45 lines of code (listing 1), you

can run Switch and begin to experiment, adding your own graphics application beginning at line 1000. Lines 1000 to 7500 are reserved for your application. Listings 1, 2, and 3 are available on BYTENet Listings at (617) 861-9774.

Two function keys control the program's operation, execution, and screen display. Function key 5 trans-

(continued)

Werner F. Grunbaum, Ph.D. (Department of Political Science, University of Missouri—St. Louis, St. Louis, MO 63121), is a professor of political science. He is a member of the Association for Computing Machinery and a regular reviewer of legal applications for ACM Computer Reviews.

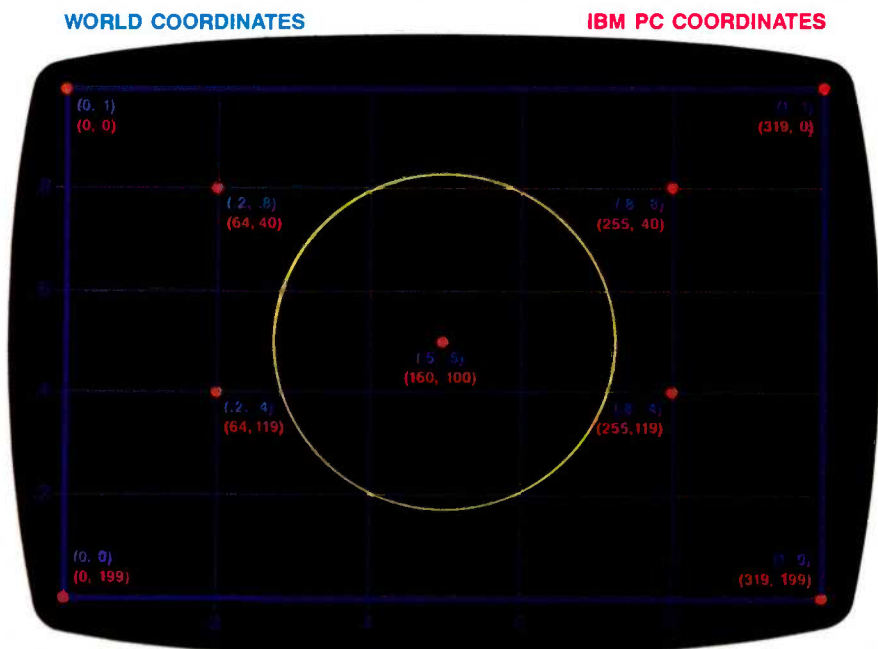

Figure 1: Nine sample screen locations, shown with both the IBM PC screen coordinates and world coordinates.

CLEAN THE MACHINE!



STOP DATA LOSS.

As a computer maintenance professional, you're well aware that most of computer downtime and data loss are caused by dust and dirt contamination.

That's why more and more computer servicing organizations are taking Dust-Off® II with them on every service call. Unlike liquid cleaners, Dust-Off II is a safe, dry, "canned air" cleaning system for computers, printers, disk and tape drives, CRTs, media storage containers and modems.

Dust-Off II's patented valve gives you pinpoint fingertip-control to blast away dust, dirt and grime before they cause downtime. Add the Stat-Off® II accessory, and you have the only dry, non-contact method for eliminating dust-holding static electricity. The Dust-Off II system also includes the Dual Extender and the Mini-Vac miniature vacuum for eliminating hard-to-reach dust.

Your customers depend on you to keep their precision equipment in top

working order. You can depend on Dust-Off II to help you do it.

Dust-Off II can be a source of additional profit for you. Sell it to your customers so they can maintain their machines between service calls.

Dust-Off II is as close as your Falcon distributor. Contact us for his name and details on the complete Dust-Off II line.



Dust-Off® II
THE SAFE, DRY, "CANNED AIR" CLEANING SYSTEM.

fers control to the graphics monitor and then executes the program, which displays the graphics on the color monitor. Function key 4 returns program control to the monochrome monitor and lists the graphics commands in lines 1000 to 7500, to which you can add new commands. You can test these commands at any time by pressing function key 5.

Correcting errors, deleting unwanted commands, and adding new commands is easy with Switch, since the graphics (on the color monitor) are not obscured by commands and new commands are not fouled up by the inclusion of stray bits of graphics or text, as can happen when you're working with one monitor. Screen-refresh time is quite fast for both monitors, and you can make changes quickly, without having to make print-outs or relying on your memory.

With Switch, you can make corrections on either monitor. Correcting minor errors is faster and easier on the color screen than switching monitors. After you make the corrections on the color monitor, press function key 2 (RUN) to try the program again. To correct major errors, it is better to switch back to the monochrome monitor, because the color monitor can display only 40 characters of text and because the graphics display will be at least partially blanked by major corrections.

If your graphics contain text, it is best to position the text on the color screen as it will appear when the program is executed. This way you can check the layout before you write the commands that will print the text.

Once the screen layout of the text is satisfactory, you can save it by using the LOCATE (row, column) statement immediately before your normal PRINT statements. To do this, determine the row number for screen text locations by starting the cursor at the upper left-hand corner of the screen. Use the cursor to count down (rows) and to the right (columns) to where the text is located. Use the row and column numbers in the LOCATE statement, which is placed just before the appropriate print statement, as in:

STAT OFF II neutralizes dust-holding static electricity from media and machines



SWITCH

```
10 LOCATE (row, col.)
20 PRINT "Graphics Screen"
```

For another way to locate the row and column, without counting, see the text box on page 226 of this article.

When you are satisfied with the output of your graphics application—assuming that you have run GRAPHICS.COM under DOS 2.0 before you wrote the application—you can press Shift-PrtSc and get a graphics dump of the screen. If you do not have DOS 2.0, several commercial graphics dumps run under earlier versions.

A couple of warnings. Remember not to execute graphics on the monochrome monitor. It can run graphics only if it is connected to a special card designed to run graphics on IBM monochrome monitors, such as the Hercules card. BASICA will respond with an Illegal Function Call error message if you try to run graphics on the monochrome monitor. If this error occurs, press function key 5 to run your program on the other monitor. Also, don't try to use Switch without a monochrome adapter, or the program will hang up when you press F4.

PROGRAM DESCRIPTION

Switch consists of a main section that performs the housekeeping functions, space for graphics commands, and two subroutines that transfer monitor control. The code for the subroutines that transfer monitor functions appears in the IBM BASIC manual, Appendix I, page I-8. The code instructions to reset the monitor appear to be straightforward. However, a programming trick is added to synchronize the color screen after switching monitors. IBM's trick becomes obvious when the color screen rolls just before the screen is refreshed. There appears to be no way to overcome this problem, but, fortunately, it is only cosmetic. Finally, the main program and each subroutine contain their own screen menus, which do not scroll.

Switch also includes a scaling function, which allows graphics mode commands, such as LINE and CIRCLE, to be expressed in what are

known as "world coordinates." As shown in figure 1, the usual IBM PC screen coordinates start at the top of the screen (rather than at the bottom, as in normal graphics applications) and range from (0,0) to (319,199). World coordinates start at the lower left of the screen and range from (0,0) to (1,1). Neither of these coordinates should be confused with the coordinates for text, which range from (1,1) to (24,40) and are used with the LOCATE command.

In practice, it is easier to specify, for example, the midpoint of the screen by using (.5,.5) in world coordinates, rather than (160,100) in IBM PC units. However, you can use both types of coordinate systems in the program. You can use IBM's screen coordinates without modification, but world coordinates must follow this format:

FNY(y) for the *y*-coordinate
FNY(x) for the *x*-coordinate

(continued)

Listing 1: Switch, a monochrome to color/graphics monitor switching program.

```
10 REM *****
20 REM "SWITCH" graphics design aid to support simultaneous graphics and text
30 REM display for the IBM PC by Werner Grunbaum, July 1984.
40 REM *****
50 KEY OFF
60 KEY 4,"GOSUB 8000" + CHR$(13) 'Switch to monochrome monitor
70 KEY 5,"GOSUB 9000" + CHR$(13) 'Switch to color monitor, medium resolution
80 LOCATE 25,1
90 PRINT "1:LIST 2:RUN 3:LOAD 4:MONO 5:COLOR"
100 DEF FNY(Y) = CINT(199 - (Y*199))
110 DEF FNX(X) = CINT(319*X)
120 IF FLAG = 1 THEN GOTO 150 'Displays graphics on color monitor
130 FLAG = 1: GOSUB 9000
140 '
150 '      Begin graphics text at line 1000.
1960 '
1970 LOCATE 1,1 'Sets graphics image at Row 1, Col. 1, for printing
1980 GOTO 10000
1990 '
2000 '      Switch to monochrome monitor
2010 '
2020 DEF SEG = 0
2030 POKE &H410, (PEEK(&H410) OR &H30)
2040 SCREEN 0
2050 WIDTH 40
2060 WIDTH 80
2070 LOCATE ,,1,12,13
2080 LOCATE 25,1: PRINT "1:LIST 2:RUN 3:LOAD 4:MONO display 5:COLOR
      display"
2090 LOCATE 1,1: PRINT "Ready for text editing at line 1000": LIST 1000-7500
2100 RETURN
2110 '
2120 '      Switch to color monitor
2130 '
2140 PRINT "Color subroutine reached."
2150 DEF SEG = 0
2160 POKE &H410, (PEEK(&H410) AND &HCF) OR &H10
2170 SCREEN 1,0,0,0
2180 CLS
2190 WIDTH 40
2200 LOCATE ,,1,6,7
2210 COLOR 1,2
2220 LOCATE 25,1:PRINT "1:LIST 2:RUN 3:LOAD 4:MONO 5:COLOR"
2230 GOTO 100
2240 RETURN
10000 END
```

Listing 2: FLOWCHRT.BAS, a flowchart application that describes, and was developed using, Switch.

```

1000 CIRCLE (FNX(.505),FNY(.9)),23,1      Flowchart application
1010 LOCATE 3,19: PRINT "Start"
1020 LOCATE 7,14: PRINT "Initialization"
1030 LOCATE 9,18: PRINT "Display"
1040 LOCATE 10,13: PRINT "Graphics Screen"
1050 LOCATE 12,9: PRINT "Fn4      Select      Fn5"
1060 LOCATE 13,17: PRINT "Monitor"
1070 LOCATE 15,5: PRINT "Mono Mntr.      Color Mntr.:"
1080 LOCATE 16,4: PRINT "Edits Text      Displays"
1090 LOCATE 17,8: PRINT "at      Graphics"
1100 LOCATE 18,4: PRINT "Line 1000ff      Stop"
1110 LOCATE 22,7: PRINT "Retr      Retr"
1120 CIRCLE (FNX(.2),FNY(.14)),18,1
1130 CIRCLE (FNX(.8),FNY(.14)),18,1
1140 LINE (FNX(.295),FNY(.78))-(FNX(.7),FNY(.71)),2,B
1150 LINE (FNX(.295),FNY(.685))-(FNX(.7),FNY(.6)),2,B
1160 LINE (FNX(.295),FNY(.57))-(FNX(.7),FNY(.47)),2,B
1170 LINE (FNX(.06),FNY(.28))-(FNX(.36),FNY(.44)),2,B
1180 LINE (FNX(.64),FNY(.28))-(FNX(.95),FNY(.44)),2,B
1190 CIRCLE (FNX(.5),FNY(.3)),24,1
1200 LINE (FNX(.5),FNY(.805))-(FNX(.5),FNY(.78)): DRAW "NH4 E4"
1210 LINE (FNX(.5),FNY(.71))-(FNX(.5),FNY(.685)): DRAW "NH4 E4"
1220 LINE (FNX(.5),FNY(.6))-(FNX(.5),FNY(.57)): DRAW "NH4 E4"
1230 LINE (FNX(.5),FNY(.47))-(FNX(.5),FNY(.4)): DRAW "NH4 E4"
1240 LINE (FNX(.7),FNY(.52))-(FNX(.8),FNY(.52)),&HCCCC
1250 LINE -(FNX(.8),FNY(.44)),&HCCCC: DRAW "NH4 E4"
1260 LINE (FNX(.8),FNY(.28))-(FNX(.8),FNY(.21)): DRAW "NH4 E4"
1270 LINE (FNX(.295),FNY(.52))-(FNX(.2),FNY(.52)),&HCCCC
1280 LINE -(FNX(.2),FNY(.44)),&HCCCC: DRAW "NH4 E4"
1290 LINE (FNX(.2),FNY(.28))-(FNX(.2),FNY(.21)): DRAW "NH4 E4"

```

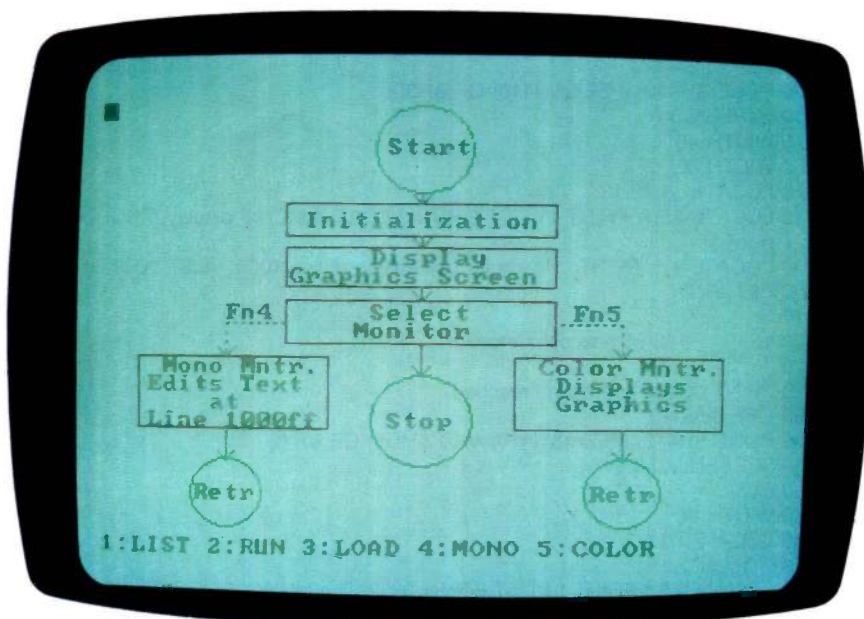

Photo 1: A screen display of the flowchart application in listing 2.

The scaling function is performed by line 100 (listing 1), which scales the y -coordinate, and by line 110, which scales the x -coordinate, translating them into IBM PC screen coordinates.

Although using world coordinates requires extra keystrokes, it simplifies graphics layout. Just as important is that, when you use world coordinates, programs require only minor changes for adaptation to high-resolution mode as well as adaptation to plotters, different computers, and other types of output devices.

AN APPLICATION

Listing 2 is a sample application that creates a flowchart to illustrate Switch. The color graphics display produced by this application is shown in photo 1. Note that the code in listing 2 uses world coordinates for the graphics commands, as discussed above.

Initially, I drew the flowchart on paper and made a screen layout by positioning the text on the screen. I determined the column and row cursor positions by moving the cursor and keeping a record of cursor positions. Then I composed the appropriate PRINT command statements on the monochrome screen.

I programmed the graphics commands around the text, then tested and corrected the instructions in small groups. Finally, I added the arrows with the DRAW command and put in the broken lines with the bit pattern found in the BASIC manual.

The same application could also be adapted to high-resolution mode, which allows more text to be shown but provides only monochrome output. This would require making changes in the SCREEN and WIDTH commands, deleting the COLOR command, changing the text locations to fit 80 columns, and so on.

CONCLUSION

In addition to developing your own graphics applications, you can use Switch to edit output from a number of commercially available graphics packages that provide output in the form of BASIC files. You can then

(continued)



Faster than a speeding bullet.

NOTHING CAN STAND UP TO SAFT'S NEW SUPER PROTECTION SYSTEM (SPS).

Pull a fast one on the high cost of protecting your computer's memory against sudden voltage drops or power outages. Get the fastest-switching power protection unit on the market today: the SAFT SPS-1000VA.

The SPS-1000VA can do everything a UPS system can do... except cost a lot of money. When the line drops to 108 volts, the new SAFT leaps into action in 1 millisecond or less. But the cost is only about 60% of the UPS price.

All computers, including IBM PC and AT networks, are right for the benefits of the SPS-1000VA. It provides clean, surge-free power, which is both voltage and current limited.

Best of all, the SPS-1000VA is made by SAFT, the hottest name in the power protection industry. So are the 200VA and 400VA Standby Power Systems. To prove how extraordinary they really are, each comes with a 2-year warranty.

For complete information on the truly super SPS-1000VA, and 200VA and 400VA, call SAFT at 602-894-6864. SAFT Electronic Systems Division, 14th St., Tempe, Arizona.



MORE POWER TO YOU.

Inquiry 445 for End Users.
Inquiry 446 for DEALERS ONLY.

BUY
EPSON
DIRECT
FROM

MIDWEST COMPUTER AND VIDEO SUPPLY

Why pay shipping from
the East or West Coast?

We ship from St. Louis and
most orders are shipped
UPS same day!

CALL TOLL-FREE
1-800-527-5274
IN MISSOURI 314/423-8300

Best Prices! Fastest Delivery!
No extra fee to use your
Master or Visa . . . Call Us Last!

CALL FOR PRICES

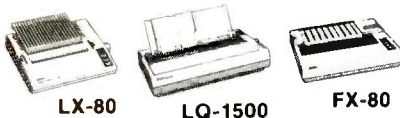

Other Printers

HOMEWRITER 10
RX-100
FX-100
JX-80
CR-420

Monitors

CR-5650 A
CR-5650 G
CR-6600
CR-6700

Diskettes . . . Lowest Prices!

TIRED OF SOME
MAIL ORDER RUNAROUND?
**WE DELIVER PRODUCT . . .
NOT PROMISES!**

Dealer Inquiries Invited

Exclusively **EPSON**
AND COMREX

**Midwest
Computer & Video
Supply Company**

P.O. Box 28448
St. Louis, Missouri 63146



C.O.D.

SWITCH

CURSOR LOCATION MADE EASY

If you'd rather not spend your time counting rows and columns in order to locate text in the right places for your graphics applications, try Blackboard (listing A). This add-on to Switch lets you position the cursor where you want text to begin, hit Return and receive the screen location from the computer. The code fits into the unused lines 9500 to 9800 in Switch and adds line number 75 to initiate Black-

board when you press function key 6. You can also add to lines 90 and 9100 of Switch so that function key 6 is identified as the Blackboard key.

To use Blackboard, position the cursor using the cursor arrow keys and hit Return. After identifying the desired cursor location, Blackboard will switch you back to the monochrome monitor, where you can incorporate the row and column into a LOCATE statement.

Listing A: BLACKBRD.BAS, an optional cursor-location subroutine for Switch.

```

75 KEY 6,"GOSUB 9500"+CHR$(13)'Switch to Blackboard
9500 '*****
9510 '      Blackboard
9520 '*****
9530 PRINT "See color monitor and press F6 for Blackboard screen."
9540 DEF SEG=H800:Z=PEEK(&H410)
9550 IF Z=125 THEN 9030 ELSE 9560
9560 ON KEY(11) GOSUB 9730
9570 ON KEY(12) GOSUB 9750
9580 ON KEY(13) GOSUB 9770
9590 ON KEY(14) GOSUB 9790
9600 SCREEN 1,0,0,0
9610 SCREEN 0:COLOR 7,0,1
9620 LOCATE 25,1:PRINT "Move cursor with arrows. RETURN to mark."
9630 LOCATE 1,1,1,2,6
9640 FOR I=11 TO 14:KEY(I) ON:NEXT
9650 A$=INKEY$:IF A$<>CHR$(13) THEN 9650
9660 X=POS(0)
9670 Y=CSRLIN
9680 FOR I=11 TO 14:KEY(I) OFF:NEXT
9690 LOCATE 25,1
9700 PRINT USING " Location ##,##. SWITCHED to monochrome.";Y,X;
9710 LOCATE Y,X:GOSUB 8000
9720 RETURN
9730 IF CSRLIN>1 THEN LOCATE CSRLIN-1,POS(0),1 ELSE LOCATE 24,
      POS(0),1
9740 RETURN
9750 IF POS(0)>1 THEN LOCATE CSRLIN,POS(0)-1,1 ELSE LOCATE
      CSRLIN, 40,1
9760 RETURN
9770 IF POS(0)<40 THEN LOCATE CSRLIN,POS(0)+1,1 ELSE LOCATE
      CSRLIN, 1,1
9780 RETURN
9790 IF CSRLIN<24 THEN LOCATE CSRLIN+1,POS(0),1 ELSE LOCATE 1,
      POS(0),1
9800 RETURN

```

enhance or modify such files to suit your needs.

With Switch, you can use one of the features of expensive CAD/CAM systems in your office and home: display-

ing graphics on one screen and graphics commands on another. By experimenting and adding a few routines, you should be able to add other features to the program. ■

dBASE III vs. dBASE III

MORE POWERFUL!

dBASE III IS A **DRAMATIC AND POWERFUL** NEW BUSINESS PROGRAMMING LANGUAGE.

—Bob Davies, President/SBT Corporation

AFTER A TWO-HOUR HANDS-ON SESSION WITH dBASE III, IT IS **EVIDENT** THAT ASHTON-TATE HAS MADE A **SIGNIFICANT** ADVANCEMENT IN THE TECHNOLOGY OF MICROPROCESSOR-BASED DBMS.

—Robert Dew, Vice President/
The Computer Society

RATHER THAN BEING AN **IMITATOR**, ASHTON-TATE HAS ONCE AGAIN SHOWN ITSELF TO BE AN **INNOVATOR**.

—Larry HelmIndinger/Origin, Inc.

ASHTON-TATE HAS LISTENED TO THEIR USERS. THIS PRODUCT **ADDRESSES EVERY** ITEM ON MY **WISH-LIST**.

—Mark DaVia/National Microware, Inc.

ASHTON-TATE HAS USHERED IN A **RENAISSANCE**. THE NEXT **GENERATION** OF SOFTWARE IS NOW A **REALITY**.

—Chris MacNeil/Abel Computers

THE NEW REPORT GENERATOR IS **SUPER** TO USE AND MODIFY. LABEL GENERATION IS ALSO A NICE TOUCH.

—Michael Broska/Agate Systems, Inc.

EASY TO USE!

dBASE III IS MUCH **EASIER** TO OPERATE AND UNDERSTAND. PROGRAMMING WITH IT IS A **BREEZE**.

—Michael Broska/Agate Systems, Inc.

dBASE III IS BY FAR THE **EASIEST**, MOST **COST-EFFECTIVE** WAY TO MANAGE A LARGE DATA BASE.

—Robb Auspitz/McEntyre Designs

THE NATURAL CHOICE OF THE NOVICE USER WITH EXPANDABLE NEEDS. dBASE III IS REALLY **EASY TO USE!**

—Alex Gersen/Alex Systems

dBASE III SUCCESSFULLY COMBINES THE FEATURES OF A **POWERFUL** DATABASE MANAGER WITH THE SIMPLICITY AND USER-FRIENDLINESS OF A FILE MANAGER. IT SETS THE STANDARD AGAINST WHICH ALL OTHERS WILL HAVE TO BE **COMPARED**.

—Jerry Schneider, Vice President/WBS & Associates

ASHTON-TATE HAS **OBVIOUSLY** LISTENED TO THE END USERS.

—Dave Browning, Chairman/
Database SIG, Capital PC Users Group

THE DEGREE OF RESPONSIVENESS WHICH ASHTON-TATE HAS SHOWN IN ITS **WILLINGNESS TO LISTEN** AND ADAPT TO USER **NEED** SHOULD GUARANTEE IT A COMMITTED FOLLOWING IN THE MICROCOMPUTER COMMUNITY.

—Phillip Wood, Director of Data Processing/
Search Institute

dBASE III™ is the powerful and easy-to-use relational database management system you've been waiting for. You can use it without hesitation whether you're a beginner or an expert. The big winner in the easy-to-use vs. more powerful controversy is you. If you want to know all about dBASE III, come to your Ashton-Tate software dealer for a free demonstration. For more information call (800) 437-4329 ext. 232 or in Colorado call (303) 799-4900 ext. 232.

Software from

ASHTON-TATE™
We'll put you in control.

dBASE III and Ashton-Tate are trademarks of Ashton-Tate. ©Ashton-Tate 1985. All rights reserved.

Publish the Most Important

Names. Addresses. Phone numbers. All those little notes... If you stop and think about it, they're probably your most valuable business tools. But if you're like most people, those little pieces of paper never seem to be quite where you need them. Which means, they're everywhere. That's why we created "The Little Black Book."TM A practical little software package that takes all those names and numbers and puts them together. Then, prints them out quick. In little black book size.

400 Entries. 30 Categories.

Think of The Little Black Book as your personal contacts database. And it holds 400 of them. But what's really important is that it lets you index your contacts. Set up 30 different categories (like sales offices, friends, customers, etc.). Call them whatever you want. Put 30 entries in each index. Even all entries in multiple indexes. Now, sort and print alphabetically; by index; addresses and phone numbers... you name it. What you get is personal electronic white and yellow pages for your PC. Oh, and one more thing. Each entry can have a couple of lines of notes. So you can really make it personal.

Pops in. Pops out. Even dials.

Here's how it works. You're preparing a spreadsheet and you need to look up a phone number. Tap <Alt><Space bar> and up pops your 30 most frequently used entries. Hit the view number function key and the two-digit code next to the person you want, and there's the number. Tap <F1>, and you're back to your spreadsheet. Exactly where you left it.

If you have a modem, here's a pleasant surprise. The Little Black Book may also be the most powerful autodialer you can buy for your PC. Tap the two-digit code, and your PC dials automatically through the modem. Including all the access and security codes for SPRINT, MCI, etc. No modem? Use our inexpensive Dialer Board accessory. With the

money you save on your calls, it'll probably pay for itself several times over.

And now the book. Included in our package is a handsome cover for your very own little black book. After you've entered your names, numbers, etc., just tell it to print. A couple of quick keystrokes and bingo, out of your printer comes your little black book. On standard printer paper. Just cut along the dotted lines, staple to the heavy backing we provide and slip it into the cover. When you've changed a few numbers, or added a few addresses, print it again. The whole process only takes

*Print, cut, staple,
then slip into the cover*

The Little Black Book (Actual Size)

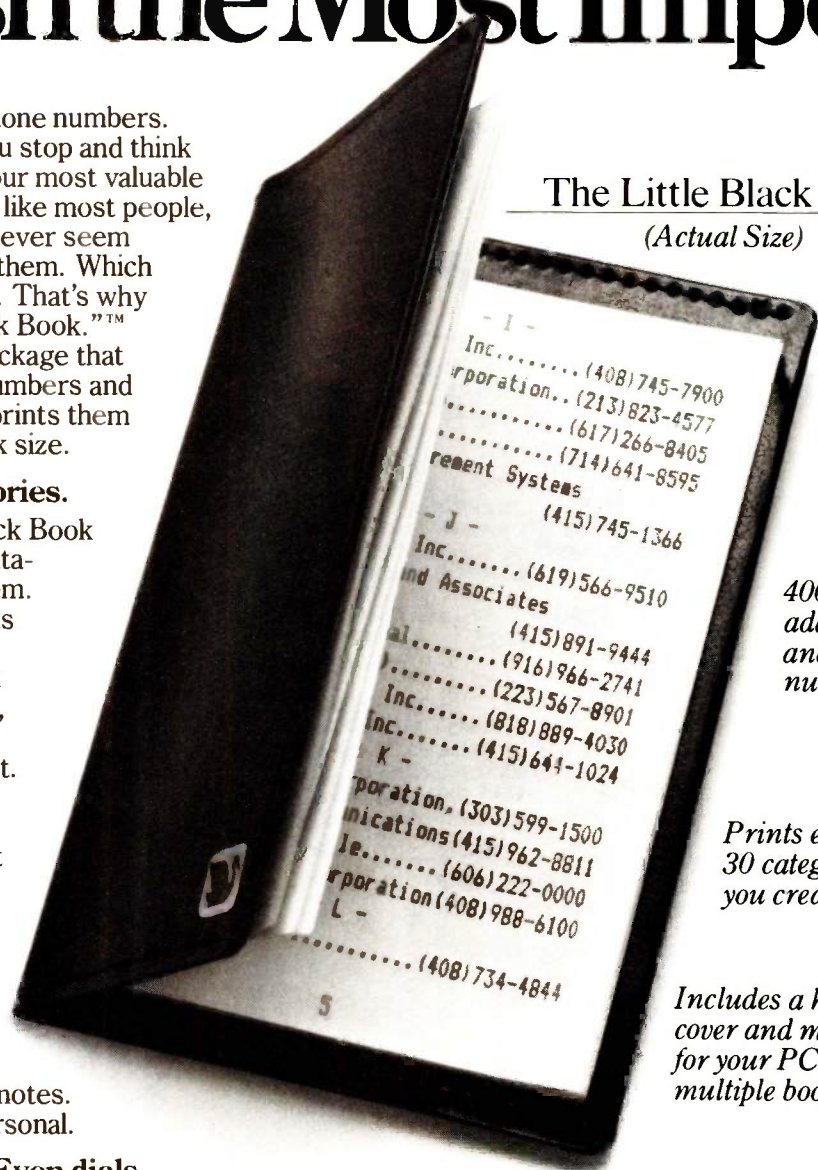

*400 names,
addresses,
and notes
numbers*

*Prints entries in
30 categories that
you create*

*Includes a handsome
cover and materials
for your PC to make
multiple books*



© 1985 Cygnet Technologies, Inc.

The Little Black Book is a trademark and Cygnet is a registered trademark of Cygnet Technologies, Inc. SPRINT is a trademark of SP Communications. Lotus 123 and Symphony are trademarks of Lotus Development Corp. The Little Black Book works with IBM PC's and 100% compatibles.

ant Book You'll Ever Own.

minutes. Think of it this way. If you lost your address book, how long would it take you to replace it? Could you replace it? With The Little Black Book it's as easy as P R I N T. And it's always stored safely on diskette.

Use it Yourself. Share it with Friends.

Use The Little Black Book to keep track of sales prospects. Print one book for the office, one for home, and another for the road. Buy one program and make books for everyone in your company. Keep it in your pocket. On your desk. In your briefcase... enough already. The Little Black Book is pretty flexible. And quite frankly, we can't think of someone who wouldn't benefit from using it.

Bells. Whistles. And a Guarantee.

We want to tell you about our Area Code Directory window that pops in on command (know the area, find the city and vice versa). And about our screen dialer that dials phone numbers from other applications programs (like your existing database of phone numbers, or an accounts receivable program). And that if you have a hard disk, you don't have to keep our disk in your A drive. But, we're almost out of room. What is important is that we work in background just fine with Lotus 123, Symphony, and virtually every PC-DOS program on the market (even Sidekick).

There are thousands of reasons to buy The Little Black Book, but maybe the

most important is the On-Off switch on your PC. With the switch off, other software is useless. But your Little Black Book is in your pocket.

Call in your order today and get the special introductory price of only \$49.95. Your call is TOLL-FREE and RISK-FREE because if for any reason you don't like The Little Black Book, simply return it within 30 days. We'll refund your money. No questions asked.

Call today:
1-800-621-4292
1-800-331-9113
(in California)

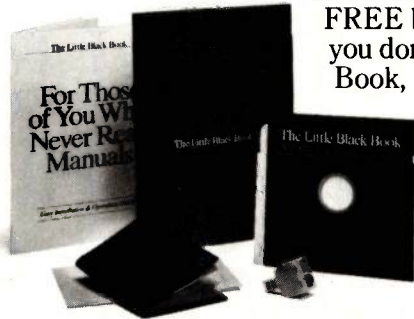

C Y G N E T

Handy software for busy people.

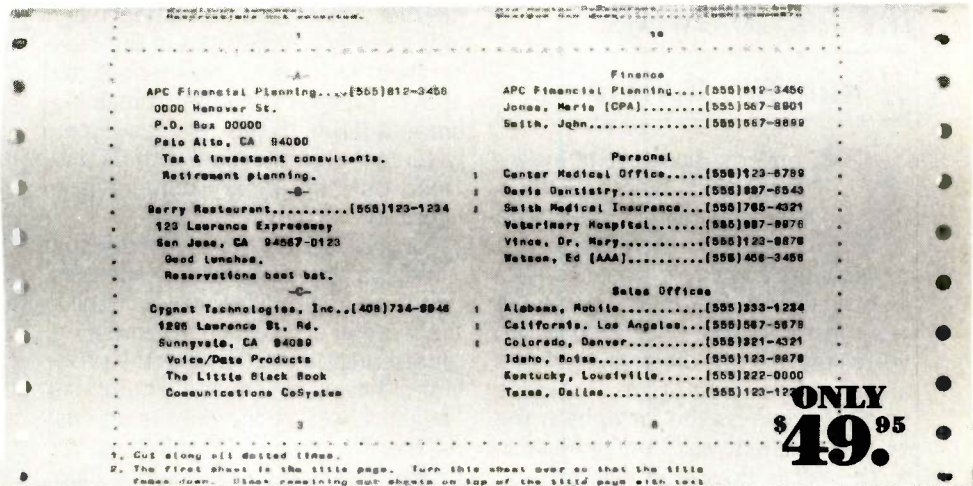

ONLY \$49.95

Let Your PC Make 'em. and Make 'em. and Make 'em...

Charge By Phone or Send in the Coupon Today.

BY685

- Please send me The Little Black Book for \$49.95. If I don't like it, I'll send it back for a full refund.
- Also send the optional Cygnet Accessory Dialer Board for \$69.95. Ditto on the refund. (California residents add appropriate sales tax)

\$ _____ is enclosed/authorized (include \$5.00 for shipping and handling)

- Check or money order enclosed
- Please bill my Visa or MasterCard

Name _____

Address _____

City _____ State _____ Zip _____

Phone _____

US funds only. Outside US add \$10 for shipping and handling. Sorry, but no COD's or P.O.'s. Corporate quantity discounts and site licenses available. Dealer inquiries invited (408)734-9946.

To: **Cygnet Technologies, Inc.**
19961 Applegate Stadium Road, Sunnyvale, CA 94089

(in California) 1-800-331-9113

Absolutely No Questions Asked 30-DAY MONEY BACK GUARANTEE

TWO'S- COMPLEMENT NUMBERS REVISITED

A new tool for dealing with the fundamentals of number storage

Converting positive numbers from their binary to their decimal form (and vice versa) is generally easy to understand. Here, traditional conversion methods (and there are many) work just fine. One such method involves the use of a diagram known as a "value box" (see figure 1). Notice that the value on the far right in the box is 1 and each succeeding position to the left is double in value.

For example, let's say that you want to find the decimal value of the binary number 0101111. Since this is an 8-bit binary number, you can use the 8-position value box shown in figure 1. Insert the binary number into the empty boxes from left to right; add the numbers above each slot that contains a 1, and you'll arrive at the answer, 95 (see figure 2).

It is also possible to convert decimal numbers to binary using the box in

figure 1. For instance, to find the binary number corresponding to 43, first see if there is a 43 on the top row of the value box. If there isn't (and there isn't), take the next smaller number. This would be 32. Place a 1 in the corresponding slot in the box, subtract 32 from 43, and repeat the above process on the remaining amount (11) until 0 is reached. Finally, fill in the empty slots with 0s and "read out" the binary number (see figure 3).

Conversion becomes more difficult when you consider negative numbers on the computer. This involves finding the number's "two's complement," a representation that handles the problem of having to indicate a number's "negativeness" using only 1s and 0s. At the same time, it maintains the proper functioning of mathematical operations, so that addition, subtraction, etc., of positive and negative numbers yield correct results. Rather than describe the traditional two's-complement conversion technique (which you can find in any introductory programming book), we'll show you another method that yields the same result. We believe this new method is unique, easy, and more insightful than the traditional negative-number conversion method. For sim-

plicity, we will continue to use 8-bit binary numbers.

To find the two's-complement binary representation of both positive and negative numbers, use the standard value box with one simple modification—change the largest (leftmost) value in the box to a negative number (see figure 4).

To illustrate the ease of converting negative numbers, we will use the value box in figure 4 to convert the binary number 10000011 to its decimal form. We put the digits 10000011 into the value box, and by adding up the slots with 1s in them, we get $-128 + 2 + 1 = -125$. The traditionalists among you can verify that 10000011 works out to -125 using the conventional procedure.

The beauty of the value-box technique is that it connects a two's-complement binary number visually to its decimal value. As you can see in figure 4, the most negative two's-complement binary number that can be represented using 8 bits is -128 . Any other nonzero bit will simply add a positive amount to the number. Additionally, it is clear that a negative number must have a 1 as its leftmost bit and a positive number must have a 0 as its leftmost bit. From this you can see that the largest positive 8-bit

binary number is 01111111 or 127.

Do you want to find the two's-complement representation of -120? Using the value box illustrated in figure 4 reduces the conversion to finding what positive values, when added to -128, equal -120. Since -128 plus 8 is -120, the two's-complement representation of -120 is 10001000. Notice that you can almost read 10001000 directly as a decimal number.

For the aficionados among you, the new technique is related directly to the original mathematical basis of two's-complement numbers. Actually, two's-complement numbers is a misnomer. Two's complement is a procedure for converting a negative decimal number into a weighted-sign binary number. Weighted-sign simply means that the leftmost bit of the binary number represents both a sign and a value. A 1 as the leftmost bit corresponds to a minus sign and a 0 corresponds to a plus sign. The value assigned is equal to 2 raised to the $n-1$ power, where n is the number of bits in the binary number.

The value-box technique presented here is simply another procedure for performing decimal to weighted-sign binary conversions and finding what is commonly called two's-complement numbers. ■

Dr. Gary Bronson is a professor in the department of computer and decision systems at Fairleigh Dickinson University. He has been a regular visiting instructor to Bell Laboratories' in-house continuing education program and is a consultant to AT&T documentation and educational organizations. He can be reached at 891 Ridgewood Rd., Millburn, NJ 07041. Karl Lyon is currently a senior studying computer science at Fairleigh Dickinson University. He is interested in all aspects of computer science and can be contacted at 21 Orchard Pl. E., East Hanover, NJ 07936.

128	64	32	16	8	4	2	1

Figure 1: An eight-position value box.

128	64	32	16	8	4	2	1
0	1	0	1	1	1	1	1

$$64 + 16 + 8 + 4 + 2 + 1 = 95$$

Figure 2: Using the value box to convert the binary number 01011111 to its decimal equivalent.

128	64	32	16	8	4	2	1
0	0	1	0	1	0	1	1

$$43 = 32 + 8 + 2 + 1$$

Figure 3: Using the value box to convert the decimal number 43 to its binary equivalent.

-128	64	32	16	8	4	2	1

Figure 4: An eight-position two's-complement value box.

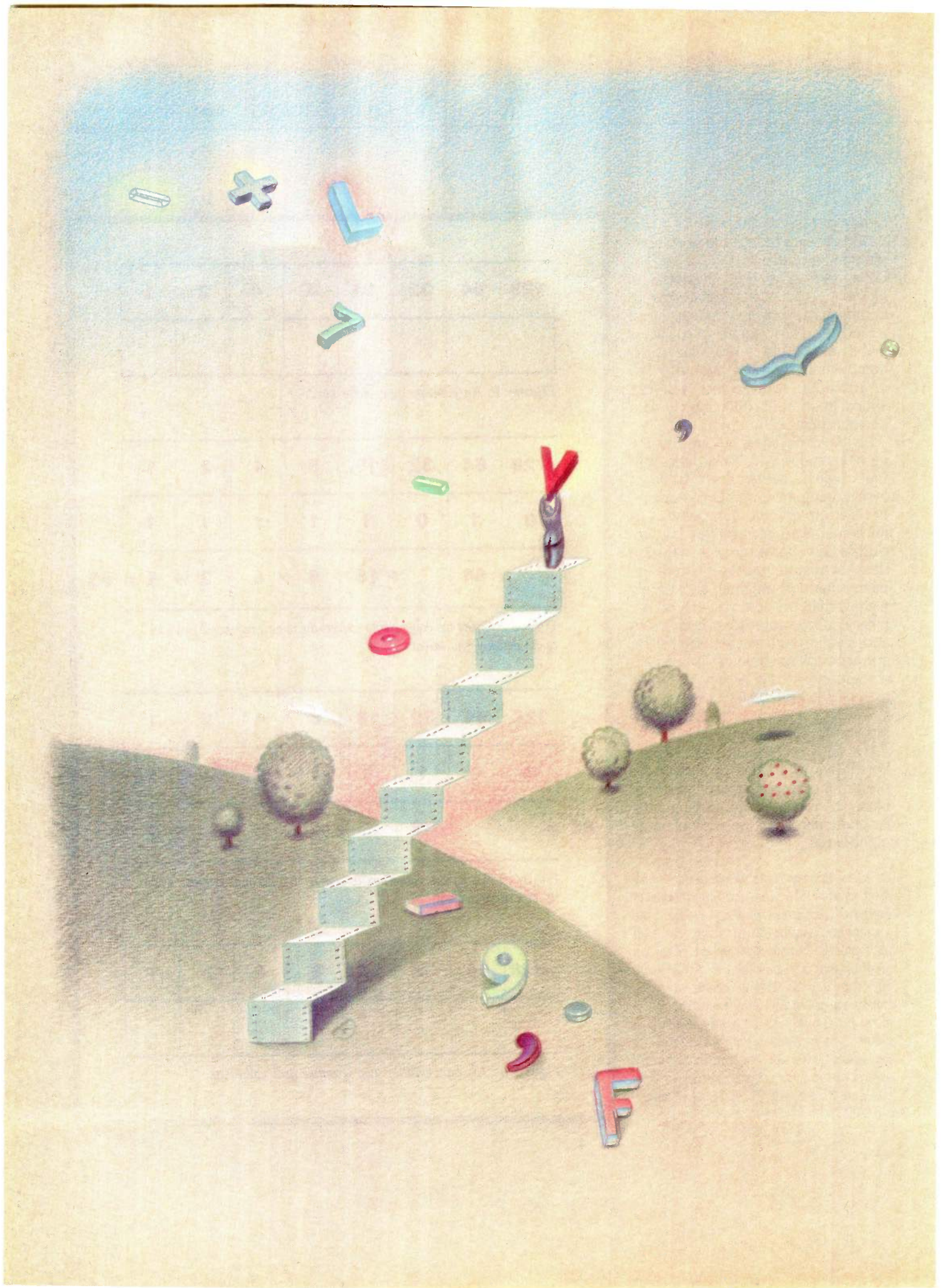

Programming Techniques

CHOOSING A PROGRAMMING LANGUAGE by Gary Elfring	235
STRUCTURING BASIC by Arthur Huston	243
SUBROUTINE LIBRARIES IN PASCAL by Bruce Webster	253
USING DATA FLOW FOR APPLICATION DEVELOPMENT by Wayne P. Stevens	267
DEBUGGING TECHNIQUES by Gregg Williams	279
6502 TRICKS AND TRAPS by Joe Holt	295
SOFTWARE-ICS by Lamar Ledbetter and Brad Cox	307

LEO BRODIE SAID IT BEST in the preface to his book *Thinking FORTH*: "Building models in the mind is both the challenge and the joy of programming." It's true. For most of us, software reigns supreme—we like what it does, and we like to make it do new things. Of course, we can't do it without hardware, but hardware is more like the canvas and paint that makes the painting itself possible.

Because it is such a complex activity, programming requires both craft and insight. We hope that the articles in this theme section will help you become more intimate with both the theory and practice of programming.

"Choosing a Programming Language," by Gary Elfring, explores a decision that many of us usually don't think about: "What computer language should I use for this problem?" It is said that a (human) language determines the thoughts a person can have, and the same is true with programming languages. The fit between the language and the problem to be solved is only one of several issues that Elfring talks about in his article.

Reinventing the wheel is a common human experience, bad enough when I reinvent *your* wheel but even worse when I reinvent my own. With some planning, you can develop a library of tested, reliable subroutines for your own work that reduce the amount of repetitive programming, allowing you to concentrate on the novel aspects of your current program. Arthur Huston's "Structuring BASIC" and Bruce Webster's "Subroutine Libraries in Pascal" present two schemes for doing this in two popular languages.

The flowchart is a ubiquitous but mediocre design and documentation tool, but the data-flow diagram is a simple, useful tool that too few people know about. Wayne P. Stevens's article, "Using Data Flow for Application Development," explains one use of data-flow diagrams in the design process.

Because we have not yet developed a computer that does what we *mean*, not what we *say*, program debugging still consumes a significant part of a programmer's energy. In my article, "Debugging Techniques," I try to classify and explain the debugging techniques available to most of us.

The 6502-family microprocessor is present in many of the most popular personal computers, but this relatively old chip still contains surprises for the unsuspecting programmer. Joe Holt's "6502 Tricks and Traps" explains how best to use the 6502 if you have the occasion to program in 6502 assembly language.

Finally, "Software-ICs," by Lamar Ledbetter and Brad Cox, describes an approach to building reusable software. We asked the authors to describe the philosophy behind their product, Objective-C, because it ties a conventional language available on many microcomputers—C—to the increasingly popular concept of object-oriented languages, which have traditionally been associated with more powerful machines than today's micros.

By learning more about programming, we become better programmers and create better software. Enjoy this month's theme section.

—Gregg Williams, Senior Editor

Golden Common LISP

Gold Hill Computers brings the language of Artificial Intelligence to Your Personal Computer.

Why every Computer Professional should know COMMON LISP.

You know how frustrating it is to deal with programs that are stupid and inflexible like those buried inside automated bank teller machines and airline reservation systems. You also know how frustrating it is to engineer solutions to today's information-processing problems with languages designed mainly for number crunching. *It doesn't have to be this way.*

Programs based on the ideas of Artificial Intelligence and implemented in COMMON LISP can be intelligent, flexible, and human-like. When you use COMMON LISP in combination with artificial intelligence techniques, you will be able to *solve problems you could never solve before*. You will be able to write powerful programs that can accommodate naive computer users who want intelligible answers to questions quickly.

The best way to get started is to buy GOLDEN COMMON LISP™, the first COMMON LISP for personal computers.

GOLDEN COMMON LISP: The AI Tutor

GOLDEN COMMON LISP makes it easy for you to learn to use COMMON LISP, on your personal computer, by yourself, at your own pace. The San Marco LISP Explorer™, a 1000-frame interactive software slide show developed by Patrick H. Winston and San Marco Associates, takes you through COMMON LISP and exciting *artificial intelligence applications* like expert systems, intelligent data-access systems, and natural language interfaces.

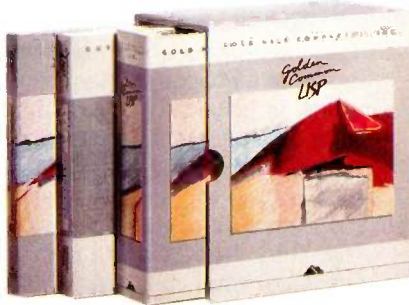

GOLDEN COMMON LISP: The Complete LISP Environment

The GOLDEN COMMON LISP package includes:

- the GCLISP interpreter
- the GMACS editor
- the San Marco LISP Explorer
- the On-line Help system
- LISP, 2nd edition by Winston and Horn
- the COMMON LISP Reference Manual by Steele
- the GOLDEN COMMON LISP User's Manual

GOLDEN COMMON LISP: The Powertool for Personal Computing

GOLDEN COMMON LISP is an extensive subset of COMMON LISP, supporting more than 400 LISP primitives. Advanced features of GOLDEN COMMON LISP include co-routines for multi-tasking, macros for code clarity, streams for I/O, closures for object-centered programming, and multiple-value-returning functions for efficiency.

GOLDEN COMMON LISP requires an IBM, PC XT, PC AT, or 100% IBM PC compatible computer with 512K bytes of memory and PC-DOS 2.0 or higher. More memory is recommended for applications development.

ORDER GCLISP TODAY using the coupon below. Or call our Sales Department at:

617-492-2071

Gold Hill Computers		BJ-85	
163 Harvard Street Cambridge, MA 02139			
Name _____			
Title _____			
Department _____			
Organization _____			
Address _____			
Phone _____		Today's Date _____	
Type of computer _____			
<input type="checkbox"/> Enclosed is a check to Gold Hill Computers for GCLISP.			
<input type="checkbox"/> Please bill my <input type="checkbox"/> MasterCard <input type="checkbox"/> VISA card.			
Card # _____		Expiration Date _____	
Signature _____			
Quantity	Description	Unit Price	Total Price
	GOLDEN COMMON LISP	\$495	
Subtotal			
MA residents add 5% Sales Tax			
Total Amount			
We welcome inquiries about volume discounts, dealer discounts, and educational discounts for university-affiliated purchasers.			
<input type="checkbox"/> Please send me more information.			

G O L D H I L L C O M P U T E R S

163 Harvard Street, Cambridge, Massachusetts 02139

Inquiry 197

GOLDEN COMMON LISP and GCLISP are trademarks of Gold Hill Computers. The San Marco LISP Explorer is a trademark of San Marco Associates. LISP is copyrighted by Addison-Wesley Publishing Company, Inc. The COMMON LISP Reference Manual is copyrighted by Digital Equipment Corporation. IBM PC, PC XT, PC AT, and PC-DOS are trademarks of International Business Machines.

CHOOSING A PROGRAMMING LANGUAGE

BY GARY ELFRING

It's a three-step process

IF YOU WERE a carpenter building a new house, the first thing you would do would be to collect your tools. The tools you'd select would vary depending on the type of job. The same thing should be true if you are a programmer. You have a wide range of tools available, and you just choose the right tools for the job. Your tools are the languages that you program in and the environments needed to support those languages.

How do you go about selecting the right tool for the job? There are more programming languages available for microprocessors than most people could learn in a lifetime. What you need is a methodology that can be used to select one language from all the rest for a given application.

This article presents a practical method for comparing programming languages. It has an inherent bias toward compiled high-level languages. Compiled languages are faster than interpreted ones, and most interpreted languages also offer a compiler version. Since program speed is often an issue, I chose compilers over interpreters.

The actual process of evaluating a group of programming languages can be broken down into three major steps. The first step is to characterize the application the language is being selected for. Then you must identify the features that a language should have in order to deal with the previously described application. Finally, you should take into account practical considerations to further narrow down the language selection.

THE APPLICATION

You can't choose a tool unless you know what you intend to do with it. You have to describe your application. Once you have this information you can then proceed to determine whether or not the existing language choices are the right tools for the job.

To describe an application, you must consider both the type and size of the application. These questions must be answered before you can proceed any further in the language evaluation:

*What is the type or class of application?
What level of language is needed?*

There are a number of different classes of program applications. An application can belong to a single class or several. Identifying the class of your application is relatively simple and helps narrow the list of acceptable languages. Some of the more common classes include scientific, business, and system programming; text processing; expert systems; and real-time control.

Most programming languages are better suited to solving one particular class of problem than another. COBOL is one example. While it is easy to write maintainable business programs with COBOL, no one would expect to use this language to solve real-time control problems.

Another consideration is the level of programming that the application will require. If you need low-level control of various machine-dependent features, then a very high level language

(continued)

Gary Elfring (4N899 West Mary Dr., St. Charles, IL 60174) is the president of Elfring Consulting Inc., a microprocessor consulting firm. His interests include robotics and artificial intelligence.

would be a bad choice.

*Is it too big to be expressed as one module?
Is it too big to be fully understood by one
programmer?*

Just how big is the potential application? Large programs should not be squeezed into a single module. This implies that the language chosen must support separate program module compilation. It is always easier to compile many small programs and combine them into one large version than to compile one gigantic program.

Related side questions consider the complexity of the application itself. Can a single programmer understand it? If not, then the language chosen must support multiple program modules and some way of managing them. Also, remember that a number of programs start out small and end up growing quite large.

LANGUAGE FEATURES

After characterizing the nature of the software application, the next step is to identify what features are required or desired to implement it. This list of features can then be used to rate each available language. The result of this process will be a short list of acceptable programming languages.

*What audience was the language designed for?
What class of problems was the language
designed to solve?*

Some languages were designed for a specific audience instead of a class of applications. This type of language was typically designed to do something like teach programming techniques. A language that was designed to solve a specific class of problems will generally do a much better job at that task than one designed to teach the techniques of programming.

Most languages were designed with some class of applications in mind. This inherent bias toward certain classes of problems will affect the way a language is used on other classes of problems. A short history of each language under consideration is necessary to aid in the evaluation of that language. For example, knowing the

history of COBOL and APL will allow you to reject them immediately as languages for programming a real-time control application.

*Can the syntax be understood?
Is it terse or verbose?
Is it consistent?*

The syntax of a language should be both readable and intelligible. A syntax should aid the mechanical aspects of reading it and help you understand what the program is doing.

A syntax should be concise, yet expressive. Verbose languages can turn what should be a one-page program into a multipage listing. Since, generally, the longer a program is, the harder it is to follow, such verbose syntax can actually defeat its own purpose of increasing the understandability of a program.

Inconsistency in syntax makes a language hard to learn. It also increases the possibility of error significantly. The syntax should be an aid to programming, not a hindrance.

*What data types are supported?
How are data types treated?*

The organization and representation of data is an important part of programming. Some basic data types on microprocessors are 8-, 16-, 32-bit integers, single- and double-precision floating point, records/structures, pointers, bit fields, and arrays of all data types. Some compilers even allow you to create user-defined data types.

Structures or records, in particular, are important data-handling tools. They let you group items of different data types together so they can be referenced as a unit. The more control a language gives over the use and construction of structures, the easier it will be to handle data.

The use of data types not only gives you great flexibility in how you manipulate data but also lets a good compiler do a considerable amount of error checking. The compiler can check for mismatches in the use of data types and flag them as errors. This will catch a large percentage of the simple errors that a programmer

makes, well before the program enters the debugging stage. For these reasons a language should offer as rich a selection of data types as is possible.

*Does the language support structured
programming?
Are exceptions possible?*

Languages that support structured programming are inherently more safe to use than those that do not. A programming language should at least offer you the choice of using structured programming techniques. Modern structured programming generally requires, at a minimum, a grouping syntax (either functions or procedures), two types of decision statements (generally the IF and CASE statements), and two types of loops (counted and uncounted).

Sooner or later exceptions will arise that must be dealt with in some manner. Languages that allow no exceptions can make it quite difficult to write certain kinds of programs. Some languages totally rule out exceptions or can deal with them only in an uncontrolled fashion such as with a GOTO. One structured way of handling exceptions, the BREAK command, is used as an escape from counted and uncounted loops. It is preferable to the use of a GOTO and is featured in languages like Ada, C, and Modula-2.

*Is portability needed?
How portable is the language?*

The portability of programming languages is becoming more and more important in the world of microprocessors. Large amounts of time and money are spent developing software that becomes obsolete when the next microprocessor comes out. Some method is needed to protect this large investment in software. The answer is portability.

There are several levels of portability. At the lowest level, the language is portable from compiler to compiler on the same microprocessor. The next level of portability covers the ability to port code from one micro-

(continued)

MARCH INTO SPRING WITH....

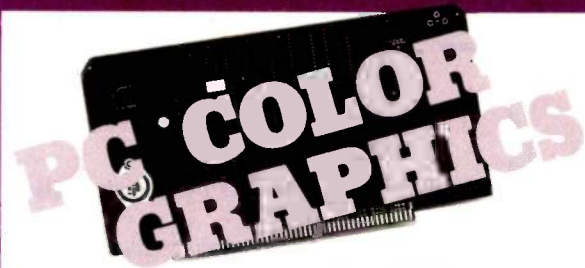

COLOR MAGIC: IBM-PC compatible \$100 BUS graphics board.

Gives your 16 bit \$100 BUS system IBM-PC compatibility. ■ RGB and composite outputs ■ IBM PC keyboard port ■ All IBM-PC display modes plus two higher resolution modes

PRICE16K — \$595.0032K — \$695.00



LIGHTNING ONE: The standard by which other 16 bit boards are judged.

The LIGHTNING ONE offers math processing capabilities only available on large mainframes previously. ■ Up to 10MHz operation ■ 8MHz 8087 option ■ Optional 8089 coprocessor

PRICES start at \$425.00 8086/87 (8MHz) \$900.00
.....8086 (10MHz) \$625.00



MEGARAM: High performance high density Dynamic RAM.

Offers cost effective memory expansion in 16 bit systems. ■ No wait states with 8086's up to 10MHz ■ Only one wait state with 6MHz 80286 ■ Up to two MegaBytes of memory

PRICE256K — \$595.00512K — \$1095.00
.....1024K — \$1995.002048K — \$3795.00



THUNDER 186: Single board 16 bit microprocessor offers 10MHz 8086 performance.

THUNDER requires no other support boards. ■ 256K RAM ■ FDC controller ■ 2 Serial ports ■ Parallel printer port ■ Concurrent DOS is included

PRICE \$1595.00



LIGHTNING 286: Highest performance processor available on the \$100 BUS.

This 6MHz 80286 offers performance equivalent to a 14 MHz 8086. ■ 5 times IBM-PC performance ■ 16 Mbyte physical memory space ■ 1 Giga byte virtual address space

PRICE 80286 — \$1095.00 80286/287 — \$1649.00

NEW PRODUCTS!

■ WINCHESTER/FLOPPY CONTROLLER

Controls both floppy drive and Winchester drives from one board. Save slots and money. Features include: error correction, 16 head control, mixed 5¼ and 8" floppy drives. The price is less than one popular manufacturer charges for a floppy only controller. **PRICE** \$649.00

■ MEMORY DISK

I/O mapped memory drive expandable to 16 Mbytes by cascading boards. Each board may contain up to 2 Mbytes and may be battery protected. Parity is included to insure corrupted data does not go undetected. The board is entirely COMPUPRO software compatible. **PRICE** 2 MBYTES \$2595.00

Dealer inquiries invited.

LDP

LOMAS DATA PRODUCTS, INC.

66 Hopkinton Road, Westboro, MA 01581
Tel: (617) 366-6434 □ Telex: 4996272

For orders outside the U.S., contact our dealers:

□ Australia — LAMRON PTY. LTD., (02 808-3666

□ England — FULCRUM 0621828763; RATIONAL

SYSTEMS 0908-613209 or 0908-611349.

Sharpborn Ltd., Tele: 01-876 4559

Telex 25520 CHASE G

□ Malaysia — EXA COMPUTER (M) SENDIRIAN BERHAD,

795284

Computer Systems . . .

LOMAS DATA PRODUCTS offers a full line of single and multi-user computer systems, including systems compatible with the IBM-PC and PC-AT. If you have a requirement for a high performance 16 bit computer system and require IBM-PC compatibility call LOMAS DATA PRODUCTS, the only supplier of \$100 BUS PC compatibles.

Prices and specifications are subject to change.

*CPM-86, MP/M-86 and CONCURRENT DOS are trademarks of Digital Research.

**MS-DOS is a trademark of Microsoft.

***Lightning One is a trademark of Lomas Data Products, Inc.

****PC-DOS is a trademark of IBM.

LDP will be closed for summer vacation from July 1st to July 5th.

CHOOSING A LANGUAGE

processor to another of the same level, for example, between 16-bit microprocessors. A final level of portability is between any two microprocessors.

If an application can be ported from an 8-bit microprocessor to a 32-bit one (say from Intel's 8051 to Motorola's 68020), then the language

is truly portable. Note that it is probably unreasonable to expect that any application be ported all the way down from a 32-bit microprocessor to an 8-bit one, but you should expect a language to offer upwardly compatible extensions.

How is I/O (input/output) handled?

Is access to other programming languages needed?

Is stand-alone product support required?

Is real-time control needed?

Not all programs need file or terminal I/O. However, almost anyone would agree it is a useful function. Device-independent I/O is preferable to any other kind. Languages that make no distinction between different types of I/O devices are easier to program in. They are inherently more consistent since they don't differentiate between hardware devices.

Some applications require the use of more than one language. The second language is typically assembly language. If your application needs an interface to another language, then the amount and type of support for the other language must be assessed.

Is the software application going to be for a stand-alone product (such as a microprocessor-controlled blender) or a product run on a computer with an operating system (such as a database-management system)? A language for a stand-alone application must be able to get "close" to the hardware; that is, it will need features that allow absolute control over addressing, I/O, and interrupts. It will also generally have to run from some kind of ROM (read-only memory). However, a product such as a database-management system interacts with the hardware through the operating system and runs from RAM (random-access read/write memory).

Yet another consideration is real-time control. Does the intended language support it, or will it at least allow itself to be modified or extended to do so?

PRACTICAL CONSIDERATIONS

There is more to selecting a programming language than a simple comparison of features. In the real world a number of practical considerations enter into the picture. They range from considerations about existing compilers to questions about the development tools for a particular language. This series of qualifications is

(continued)

COVER THE MARKETPLACE WITH THE WIDEST SELECTION OF IBM BLUE AVAILABLE.



OEMs: Let Systems Strategies help you cover the large, profitable marketplace of IBM[™] mainframe communications. Our software allows your computer system to emulate IBM terminals, workstations and printers.

EXPERIENCE: As the first to develop 3270 SNA and 3270 BiSync support under UNIX[™], Systems Strategies' experience can save you development time and money. Let us keep up with the changing shades of Big Blue as IBM communications evolve.

BROADEST PRODUCT RANGE: We have the broadest range of communications software available for UNIX and non-UNIX environments, allowing mini and micro computer systems to communicate with mainframes or networks using SNA/SDLC or BiSync. The CCITT X.25 interface is also available. Our family of products can serve your growing information access needs, now and in the future.

COMPLETE EMULATION: Systems Strategies provides a perfect match to Big Blue. Our products provide full SNA/3270, BSC/3270, SNA/RJE (3770) and BSC/RJE (2780, 3780, HASP) emulation. The integrated Applications Program Interface provides the capability for interactive transaction processing, file transfers and fully integrated applications across mainframe and workstation boundaries. No IBM host modification is required.

PORTABILITY: All of our software is written in 'C', using internal designs and architecture which make the communications and device emulation logic independent of the hardware and operating system, and thus easily portable. Call or write today for more information:

Systems Strategies Inc. 225 West 34th St. New York, NY 10001. (212) 279-8400.



Systems Strategies Inc.
An AGS Company

Experience... the main link in communications software

IBM is a trademark of International Business Machines Corp. UNIX is a trademark of AT&T Bell Laboratories.



Double your IBM PC's processing speed for under \$650.

AT speed for your IBM PC, with QuadSprint by Quadram.

Quadram introduces a rapid advancement in IBM PC performance. QuadSprint. The innovative expansion board that doubles the processing speed of your personal computer. Just plug the totally transparent QuadSprint into your system and watch **all** your PC programs (Lotus 1-2-3, dBASE III, Wordstar, and more*) run faster and more efficiently than ever before... without special commands or interface software.

But best of all, you can pick up QuadSprint without running up a huge bill. At less than \$650, QuadSprint is about half the price of other accelerator (turbo) cards and turns your PC into a machine that's virtually as fast as the new PC AT.

So make your own rapid advancement. To the Quadram dealer closest to you. And see how to double the processing speed of your IBM PC. With QuadSprint by Quadram.

QUAD*Sprint*TM

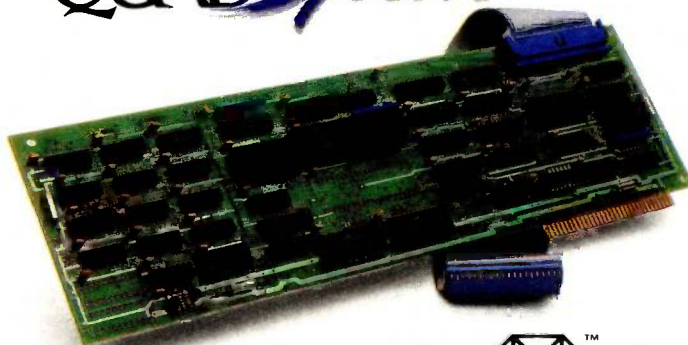

QUADRAM TM
An Intelligent Systems Company

4355 International Blvd./Norcross, Ga. 30093
(404) 923-6666/TWX 810-766-4915 (QUADRAM NCRS)

Inquiry 343

The Best Source Debugger for C

Interactive testing: enter any C expression, statement, or function call, and it is immediately executed and the result displayed. **Direct execution** allows fast and thorough testing, makes learning C a snap.

Run-time checking: execution stops upon exception, and source code displayed. Exceptions include array reference bounds, stack overflow arithmetic or floating point error, etc. Pointers are checked for null or out of range values.

Breakpoints: any number of breakpoints can be set *anywhere* in your program; breakpoints are set with screen editor, not by line numbers. Breakpoints may be conditional. Single-step by statement. Interrupt execution from keyboard. Breakpoint, exception, or interruption is always shown with source code. Examine and modify data, look at stack history. Even change your program and then resume execution!

Lint-like Compile-time checking: argument number and sizes are checked for consistency. Never mismatch source and object code.

The best feature of all: the *fastest* C interpreter is right there when you're debugging. Make changes in seconds with the integrated screen editor. Test the changes immediately, running your program at compiled speed. Save source code for your favorite compiler, or make stand-alone executable programs. Nothing else is needed. ***Instant-C* is the fastest way to get working, fully debugged C programs available today.**

"We sincerely feel that *Instant-C* can have a major positive impact on programmer productivity." *Computer Language*, Feb. 85, pp. 82-83.

Instant-C is only \$495. Money back for any reason in first 31 days.

Rational
Systems, Inc.

(617) 653-6194
P.O. Box 480
Natick, MA 07160

CHOOSING A LANGUAGE

used to further narrow the language choices based on real-world criteria.

How available is the language?

How popular is the language?

How many different compilers are available for this language? Are they compatible with each other? How hard is it to locate compilers for this language? Answers to these questions describe the availability of a language. Generally, the more available a language is, the safer it will be to use.

It is important to choose a language that has an established history and predictable future. Will the language you choose be around tomorrow or does it belong to the "Language of the Month" club? Brand-new languages may offer many desirable features. But the future of both the language and its new features can be uncertain. If it doesn't catch on, the language and its special features may die.

How do you learn the language?

What is the source of this information?

If the language chosen is not in your programming repertoire, you are going to have to learn it. How do you learn to program in the language? Are there good reference materials or outside help available to teach you the language? The best language in the world is no help to you if you can't figure out how to use it.

What are the characteristics of the compiler?

Is the code produced quick, compact, and predictable?

Theory and practice must merge in the creation of a compiler. The compiler should operate quickly and be reliable. It should not require a great deal of memory or disk space. Finally, the amount of support from the manufacturer is important.

Compilers translate high-level instructions into code that a particular computer can execute. The code that they produce must be efficient both in size and speed. Furthermore, the execution time and size of the code produced by the compiler should be reasonably predictable. That is, the compiler should be consistent in the

quality of the code it produces.

What hardware-development tools are available?

What software-development tools are available?

What kinds of software libraries are available?

The types of tools associated with a programming language are important considerations in that language's evaluation. Tools make you significantly more productive and ease your work load.

Tools come in many different forms. Hardware-development tools, such as an in-circuit emulator, are indispensable in the development of software-controlled products. The availability of this type of tool could easily alter a choice of a programming language.

Another form of tool is software-oriented. Software-development, debugging, and management tools are quite popular but not compatible with all programming languages. A good directory program for file maintenance is also a tool. The purpose of these tools is to make the job of programming as easy as possible.

One final type of tool is the software library. It is often more feasible to purchase a library of software functions than to write your own. Examples of software libraries include graphics and real-time control packages. The availability of good software libraries at low cost is an important practical consideration in the choice of a language.

LANGUAGE SUITABILITY

Now that you know how to describe the application, programming features, and practical considerations, the selection process can begin. The end result of this evaluation process is a list of from one to three languages that are ideally suited to your particular application. If you end up with more than one language on your list, then any one of these can be selected. This is the only point in the language-selection process where you can apply your own personal bias and not affect the quality of the final language choice. ■

Get your Mac to open up.

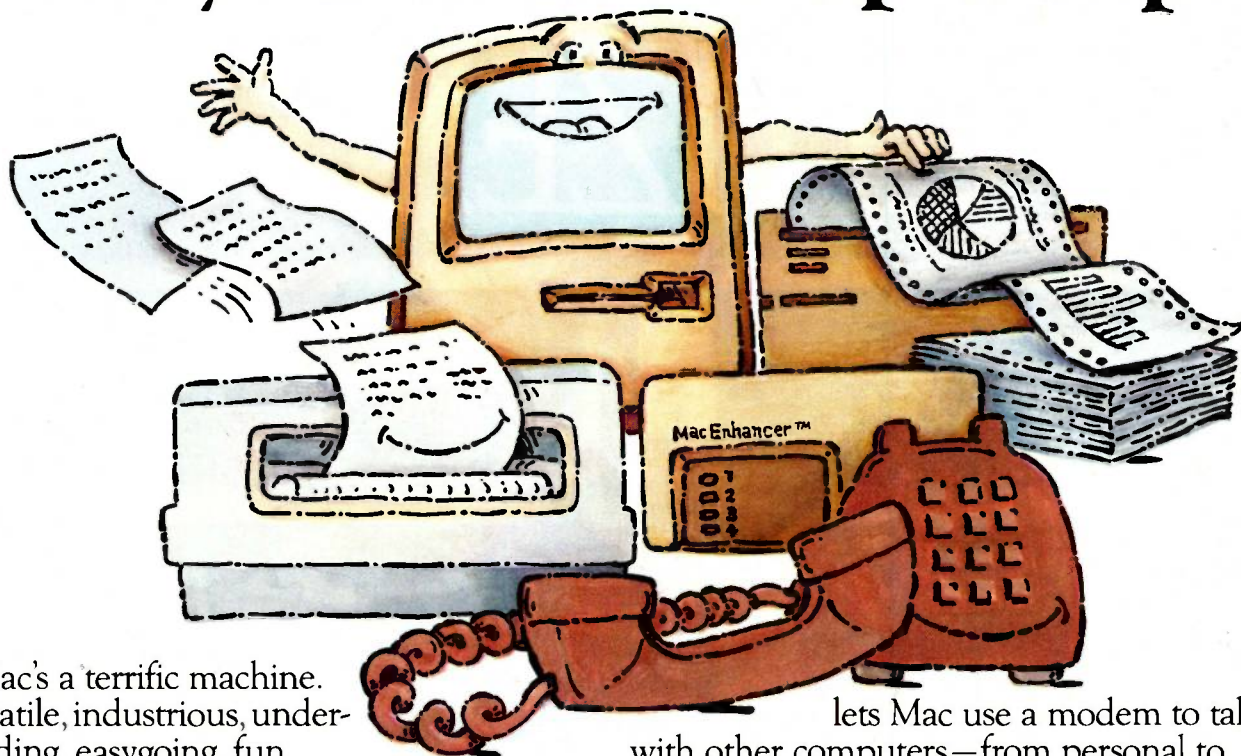

Mac's a terrific machine. Versatile, industrious, understanding, easygoing, fun.

Trouble is, Mac lives in a world of his own. He doesn't communicate well with his co-workers. Doesn't work well with them.

Now there's help.

The Microsoft® MacEnhancer™ expansion system can get him out of his shell. It'll open

lets Mac use a modem to talk with other computers—from personal to mainframes.

All without losing the loveable Mac personality. Just “point and click.”

Getting Mac to expand his horizons wasn't easy, but somebody had to do it. And

MICROSOFT
The High Performance Software™

who better than Microsoft? We've written more Macintosh™ programs than any other software company. Including Microsoft Word, Microsoft File. And Microsoft BASIC, Mac's first language.

For more information, or to free associate with your nearest Microsoft representative, call (800) 426-9400. In Washington State, Alaska, Hawaii and Canada, call (206) 828-8088.

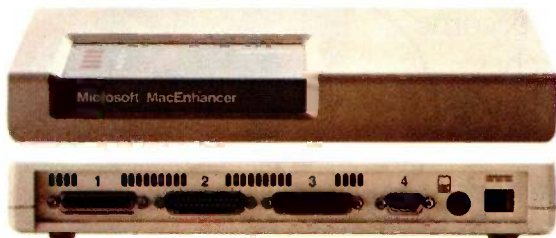

his communications channels. Expand his horizons.

MacEnhancer simply plugs into Mac's communication port. It lets you keep that original port while adding an IBM®-type parallel connector for your printer and two IBM-type serial connectors.

So now Mac can hobnob with even the finest letter quality printers. Cope with hyperactive dot-matrix printers.

And it comes with MacEnhancer terminal software. A communications program that

SOLID CITIZENS.

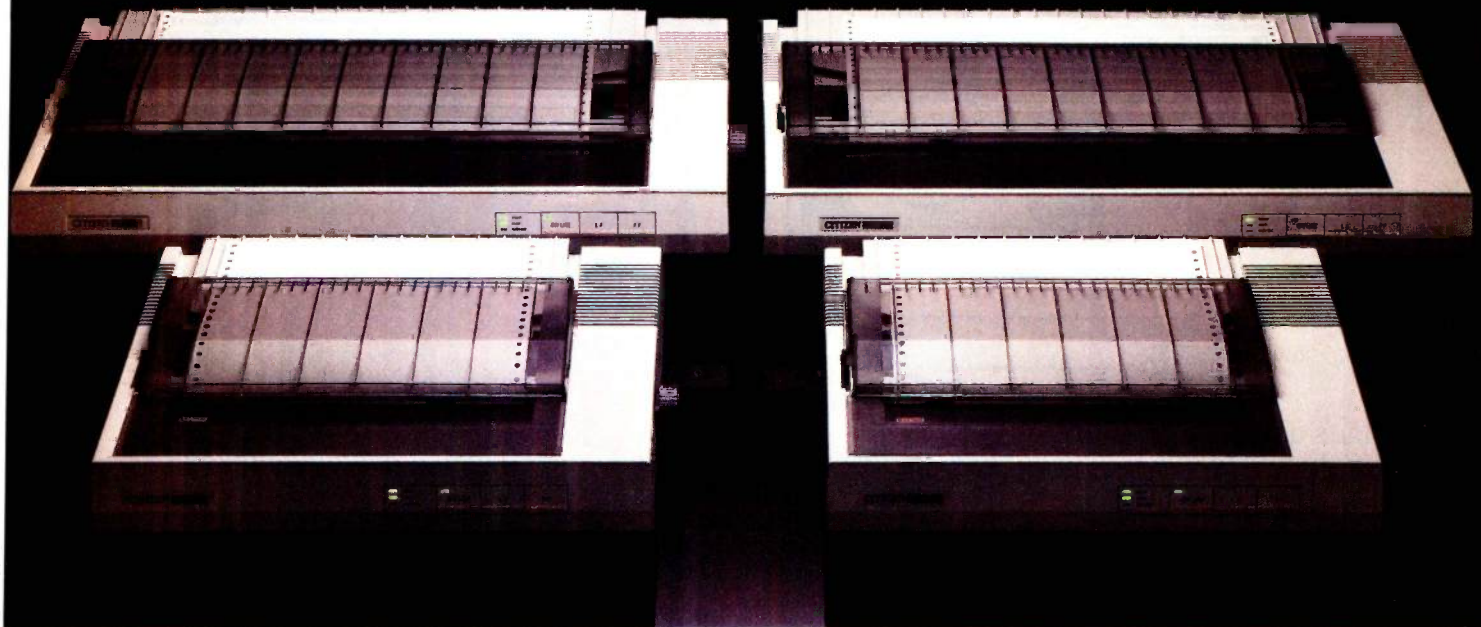

Presenting four upstanding Citizens who give faithful service above and beyond the call of duty. Citizen™ dot matrix printers, precision-engineered by the people who've become a wristhold word in fine, precision-engineered watches.

The Citizens are sleek, quiet, and reliable. They're extremely easy to use. And feature a unique push-feed paper system that makes paper loading a breeze. What's more, the Citizens are IBM® and Epson®-compatible. Can print graphics.

Can dash out output at 160 cps (40 cps correspondence-quality) or a blazing 200 cps (50 cps correspondence quality). And offer the industry's longest warranty—18 months on all parts and labor.

The Citizen MSP-10/15 and MSP-20/25. Four solid reasons to stop by your dealer.

And watch what the Citizens can do for you.

For more information, call 1-800-556-1234, Ext. 34.

In California, 1-800-441-2345, Ext. 34. Or write Citizen America Corporation,  **CITIZEN™**
2425 Colorado Avenue, Santa Monica, CA 90404.



STRUCTURING BASIC

BY ARTHUR HUSTON

Creating a library of subroutines

COUNTING ALL of its dialects, BASIC is now among the world's major languages. Even so, many programmers complain that it lacks features found in more structured languages. By creating a library of procedures and functions, however, you can compensate for some of the language's shortcomings and write more powerful programs in less time.

Most structured languages have two types of library routines: functions and procedures. In BASIC the former is a subroutine that returns only one value; the latter returns more than one, or none. It's not possible, however, to incorporate into BASIC the concept of local variables or to pass variables of different names into subroutines. And since BASIC requires line numbers, inserting a subroutine into a program could overwrite existing code.

For these reasons, BASIC programmers usually rename the variables and renumber the code when they reuse a subroutine in a new program or, worse, they only use subroutines to eliminate redundant code in one program. With some discipline, however, you can force BASIC to mimic true procedures and functions and thus

eliminate redundancy between programs as opposed to within a single program.

Newer dialects of BASIC, including recent versions of DEC VAX BASIC, the Microsoft Business BASIC Compiler, Better BASIC from Summit Technology, and True BASIC from True BASIC Inc., implement these concepts and bring much-needed structure and power to the language. I will concentrate instead on the garden-variety Microsoft BASIC interpreter and such offshoots as GW-BASIC, Applesoft BASIC, and Commodore 64 BASIC.

Mimicking more structured features requires that you invent a set of programming rules and adhere to them rigidly. You may find at first that the discipline required inhibits your programming, but consider the benefits of assembling a library. When you start a program you can concentrate on its purpose rather than worry about chores like menus and date manipulation. Your programs will have a consistent user interface, and entire sections of code will be thoroughly debugged before you start. Anyone familiar with your library can maintain your code, and porting your programs to a different computer will be

easier—you simply convert your library.

LINE-NUMBERING RULES

Without line-numbering rules, merging in a subroutine might mean overwriting existing code or require scanning programs for a free set of line numbers (and then loading, renumbering, and saving the subroutine, reloading the program, and finally merging in the subroutine). With line-numbering rules, you need only break a program into logical parts and assign line numbers to each part.

Programs always begin with initialization, or declaration. A set of remarks should tell you what the program does, and the early lines allocate string space and dimension all arrays. Ideally, you should initialize every variable with special meaning in the program code and add a remark that explains its function. Reserving line numbers 0-999 leaves more than enough room.

Some programmers like to put initialization at the end of the program

(continued)

Arthur Huston (154 Park St., Stoughton, MA 02401) is a programmer of financial software in Boston.

and call it with a GOSUB. I find such programs less readable; more important, they are incompatible with most compilers, which require that the code dimension arrays before referencing them.

Program code comes next. You will want to make judicious use of your subroutine library; this code simply calls the subroutines in the correct order and gives your program its uniqueness. Let's set aside lines 1000-9999.

Next are program subroutines, which are not part of your library but are of use only to the program in which they appear. Line numbers 10000-14999 should be enough.

Specific applications require application subroutines. A payroll system, for example, might use a routine to read employee names from a file; a stock portfolio might have a procedure to calculate which stocks to buy. Reserve lines 15000-24999.

Last are the system subroutines—your software library, which is useful in every program you write. Let's set aside the lion's share of your programming space, lines 25000-65000. You'll be surprised at how quickly you'll fill it up.

We can differentiate the system subroutines further into their logical functions. Lines 25000-29999 might handle user-interface routines such as menus; 30000-34999 could be reserved for file handling; 35000-59999 for all-purpose subroutines like data

handling and string manipulation; lines 60000-65000 for ON ERROR GOTO routines. See table 1 for a summary of these line-numbering rules.

In some versions of BASIC, placing the subroutines immediately after initialization results in faster program execution. The BASIC code stored in memory is simply a linked list, with each line pointing to the next one; it follows that lines near the beginning of a program will be found faster than those at the end. The current versions of Microsoft GW-BASIC, however, search for the line number the first time it is called and thereafter branch directly. The time saving is so minimal for this popular version of BASIC that I have not placed my subroutines at the beginning.

There are, however, a number of caveats to using this system. When you create your library, make sure there's no overlap from one routine to the next. If you must add features or debug a routine, insert new code between lines rather than extending the routine. Lastly, renumbering your programs in increments of 10 would render the entire scheme useless. You can, however, renumber the program code and program subroutines sections.

These line numbers are not cast in stone; the point is to predict how many lines each section of your code will require and then allocate them accordingly. You'll notice, for instance, that I gave the largest section to sys-

tem subroutines. Few of these are used in any one program, but all of them will be needed to accommodate your library.

Some programmers never begin subroutines with remarks because many compression programs delete the REMs, leaving undefined lines. I always reference remarks, but I use more sophisticated compression routines that avoid the conflict. Some of these packages include The BASIC Development System from SoftTool Systems on the IBM PC, GPLE from Beagle Bros. on the Apple, and the Snapp Utilities from Snapp Inc. on the TRS-80. All three packages contain other utilities to ease programming. Note that an alternative method would place remarks just prior to the referenced line (e.g., placing REMs on lines 5196-5199 for a subroutine beginning on line 5200).

NAMING RULES

Giving subroutines descriptive names certainly helps to explain their use, but the eight-character filename limit of many BASICs is severely restricting. For a naming convention, therefore, I suggest that the starting line number of the subroutine follow a two-character prefix (SS, for example, for your system subroutines). Application subroutines could assume the prefix from the application's name (PR for payroll, for example). Using this method, you can quickly identify the type of subroutine—application or system—and its line numbers. Rely on your written documentation to tell you what the subroutine does.

Variable-naming rules prevent "collisions;" or "side effects;" which occur when program code and a subroutine use the same variable for different purposes. For example, if the program code used the variable PR to record payroll and a subroutine used PR as a flag to see if the printer were on line, calling the subroutine would change the value of the variable.

To avoid the problem, you can simulate the concept of local variables by assigning groups of variables to logical sections of code. For example,

(continued)

Table 1: This line-numbering scheme is only a suggestion; the important thing to do is predict how many lines each section of your code will require. In addition, the initialization part should always be the first section of code. Note that in some versions of BASIC, placing the subroutines immediately after initialization will speed up program execution.

Code Section	Lines
Initialization (declaration)	0 - 999
Program code	1000 - 9999
Program subroutines	10000 - 14999
Application subroutines	15000 - 24999
System subroutines	25000 - 65000
—user interface	25000 - 29999
—file handling	30000 - 34999
—all-purpose routines	35000 - 59999
—ON ERROR GOTO	60000 - 65000

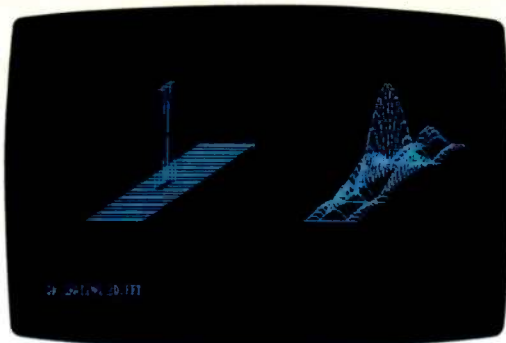

ASYST multiple windows permit side-by-side comparisons. The two-dimensional FFT routine, shown, is one of the many built-in functions.

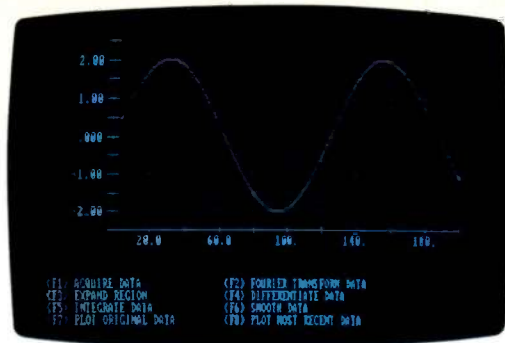

With ASYST, data acquisition and analysis routines can be combined to create powerful, menu-driven functions.

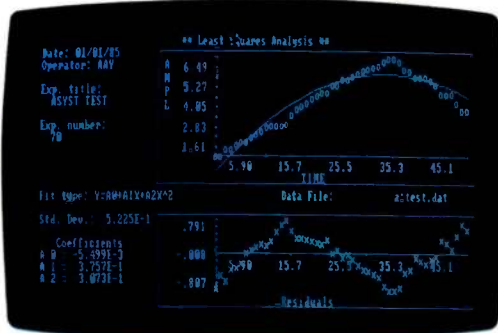

Least squares, polynomial, exponential, and logarithmic curve fitting routines fully integrate with other ASYST capabilities.

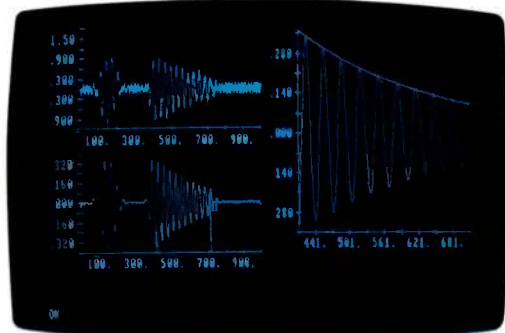

ASYST integrates analysis functions with graphics. On-screen cursors allow interactive selection of curve segments.

ASYST Scientific Software.

Acquisition, analysis and graphics capabilities turn your IBM PC into a powerful workstation.

ASYST and your IBM PC, XT,™ AT, or compatible put you in direct control. You can reduce data while collecting — displaying results as you proceed. Now for the first time you can pull information through the analytical process without timesharing delays or software bottlenecks. See why "scientists and engineers will rejoice at having such a versatile tool to turn their PC's into minis" — PC Magazine.

Get the speed and precision of a minicomputer — at a fraction of the cost.

- ASYST fully utilizes the PC's 8087 coprocessor for precision exceeding that of other micros — and many minis and mainframes.
- A 1024-point FFT with ASYST/IBM PC takes less than 3 sec. An optimum performance custom routine on a DEC 11/23 + minicomputer with FPF 11™ took 2 sec. — at five times the price.

ASYST is composed of three separate, but fully-integrated, modules:

Module 1: System/Graphics/Statistics establishes the environment. Includes data representation and storage; arith-

metic, trigonometric, hyperbolic and other mathematical and statistical functions; direct graphics output and display; array manipulation; control of vectors and matrices; automatic plotting; file manipulation; programming control structures; and a built-in text editor.

Module 2: Analysis reduces and analyzes data. Includes Eigenvalues, Eigenvectors, polynomials, least squares approximations, curve fitting, convolutions, integration, differentiation, smoothing, and Fast Fourier Transform.

Module 3: Data Acquisition allows interfacing with laboratory instruments. Commands such as "A/D.IN" allow data communication with standard interface boards. Includes A/D and D/A conversions, digital I/O, timing, and triggering. Commands can be combined for customized automatic acquisition and control.

- Module 1 works alone — or with either of the other two modules — allowing you to tailor the system to your specific needs.
- All functions are always available. You never have to leave the system to access any of its capabilities.

Built-in routines. Full programmability.

- Use straightforward, pre-programmed commands such as XY.DATA.PLOT and ARRAY.EDIT.
- Combine and modify commands to extend the system for your custom applications.

Take advantage of our 30-day no-risk offer. Call (800) 348-0033, today!

In New York state, call (212) 702-3241.

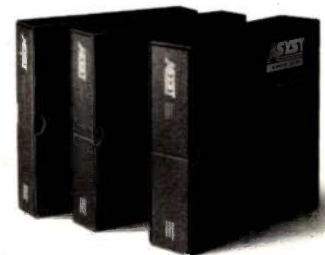

ASYST

MACMILLAN SOFTWARE CO.
An Affiliate of Macmillan Publishing Company
866 Third Avenue, New York, NY 10022

you can set aside variables beginning with A–H for program code and program subroutines, I–J for program code loops (following the programming convention started with FORTRAN), K–P for application subroutines, and Q–Z for system subroutines. Table 2 summarizes these variable-naming rules.

I suggest breaking variables down even further. Each section of code uses two sorts of variables: "throwaways," which are used in calculations and then discarded, and permanent

variables, which have a consistent meaning throughout a program or within a given application. Program variables, for instance, could use A–D as throwaways and E–H as permanent variables. In addition, you can break down the system variables according to the same logical functions as the corresponding line numbers.

When you call a subroutine, simply set the local variables required by the subroutine to the values you want to pass. On return, transfer the values you want to save into program vari-

ables before calling other subroutines, which otherwise might change the values.

I suggest using descriptive variables only in the program code, program subroutines, and application subroutines, and then only for permanent variables. Avoid using descriptive variables in system subroutines because that eliminates their usefulness elsewhere (exceptions are variables like *true* and *false* that always have the same definition. Be aware of potential conflicts in BASICs in which only the first two letters of the variable names are significant.

Table 2: Variable-naming rules give BASIC the ability to mimic local variables. They ensure that the variables in your subroutines will not collide with program variables and create bugs. You can differentiate variables further into throwaway and permanent variables. You can also organize system variables according to the logical functions of the system line numbers.

Code Section	Variable Name
Program code	A–H, I–J for FOR . . . NEXT loops
—Throwaway	A–D
—Permanent	E–H, descriptive variables
Program subroutines	A–H (shared w/program code)
—Throwaway	A–D
—Permanent	E–H
Application subroutines	K–P
—Throwaway	K–M
—Permanent	N–P
System subroutines	Q–Z
—Throwaway	Q–R
—Permanent user-interface variables	S–T
—Permanent file-handling variables	U–V
—Permanent all-purpose variables	W–X
—Permanent ON ERROR GOTO variables	Y–Z
—System variables like <i>true</i> , <i>false</i> , screen-control strings, etc.	

- Remarks to describe the purpose of the program
- DEFINT, DEFSTR, DEFSNG, DEFDBL, used to specify the data type of variables without constantly using the %, !, and \$ notation
- DIM statements, to dimension your arrays
- COMMON statements, used to pass variables between programs
- ON ERROR GOTO
- DEF FN, to define functions
- Declare program variables, e.g.,
 - 100 REM 100–199 Declare program variables
 - 110 REM Today's date, user name, # of items changed
 - 120 E0\$=DATE\$(0) : E1\$="" : E0=0

Figure 1: I recommend this initialization order, which is similar to those of more structured languages and will make your code compatible with most BASIC compilers.

STARTING YOUR LIBRARY

Now is the time to break your anti-documentation habit. To turn these programming conventions to your advantage, take the time to write them down systematically (napkins are out). Having written copies of your line-numbering, subroutine-naming, and variable-naming rules will make them easier to apply. Make copies for everyone who has to work with your code.

Once you have established your programming rules, create a skeleton program to use every time you start development. The first part could establish a simple order for the initialization process, to keep it logical and to ease compilation of your programs. Figure 1 contains a suggested order for this code. The second part of this program could contain a set of remarks describing where everything goes. Line 1000, for instance, might read 1000 REM MAINLINE CODE 1000–9999.

Before adding a routine to your library, ask yourself whether it is useful in many programs and whether it is general enough without losing functionality. If the answer to both questions is "Yes," you probably have a good candidate. Some examples are "Press < Return > to Continue," strip leading and trailing blanks from a string, evaluate a string to see if it's a valid numeric, and so on. More elaborate routines might include a classy menu operating with the cur-

(continued)

If you don't have a Hercules Graphics Card, you could end up looking like this:

"I know, because one day it happened to me . . .

"I was running some routine tests on a non-Hercules monochrome graphics card when I was struck by a severe case of *low resolutionitis*. I'm the president of Hercules and that's me exhibiting the symptoms of the disease in its advanced stages. Not a pretty sight, is it?

"What causes *low resolutionitis*? Experts point to ordinary monochrome graphics cards with coarse, hard-to-read graphics. A bad case of eyestrain may develop if action is not taken immediately.

"Fortunately for me, a Hercules Graphics Card was nearby. A quick change brought soothing 720 x 348 graphics. That's twice the resolution of ordinary 640 x 200 graphics cards.

"Which means better graphics for Lotus™ 1-2-3™, Symphony™, Framework™, pfs:Graph®, Microsoft® Chart and Word, SuperCalc3®, AutoCad™, and dozens of other programs.

"Including Microsoft Flight Simulator, now Hercules compatible!

"Oh, and don't forget that a parallel printer port is standard on the Hercules Graphics Card, not an extra cost option.

"Now, if you're worried about buying a new product that hasn't had all the bugs

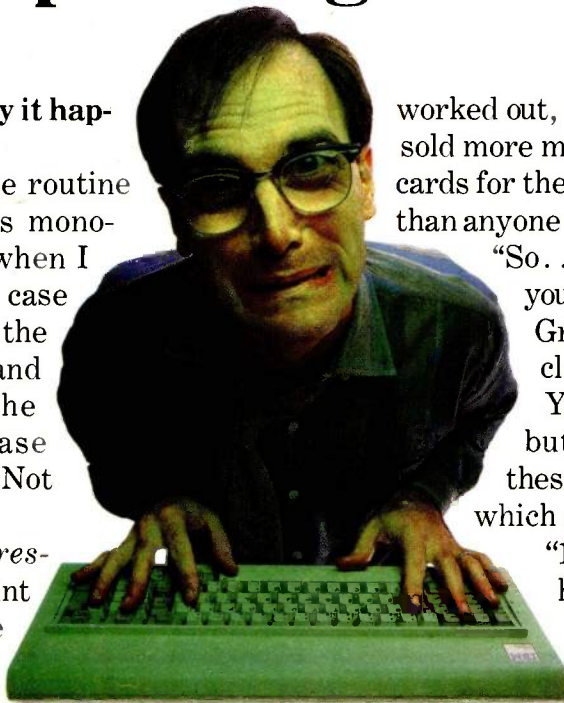

worked out, relax. Hercules has sold more monochrome graphics cards for the IBM® PC, XT™ and AT™ than anyone else in the world.

"So . . . you're convinced that you should buy a Hercules Graphics Card. Now, steer clear of cheap imitations. You may save a few bucks, but you won't get all of these five essential features which only Hercules has:

"1) A safety switch that helps prevent damage to your monitor, 2) the ability to keep a Hercules Color Card in your

system, 3) the ability to use the PC's BASIC to do graphics, 4) a Hercules designed chip that eliminates 30% of the parts that can go wrong, and 5) a two year warranty, because we think reliability is something you should deliver and not just talk about."

"Call 1-800-532-0600 Ext 408 for the name of the Hercules dealer nearest you and we'll rush you our free info kit.

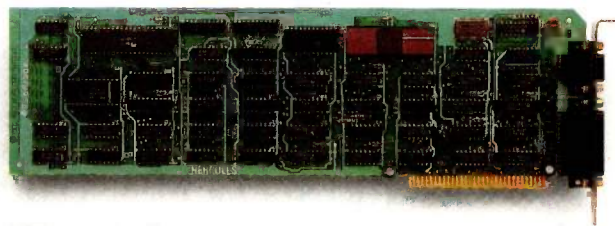

Hercules. We're strong on graphics.

STRUCTURING BASIC

sor and Return keys.

Use your imagination to put power into your programming. For instance, an input routine that takes a string from the keyboard up to a given number of characters would be even better if it allowed you to program the function keys, permitting messages like "Enter Search Code, <F1> to Go

Back, <F2> to Go Forward, <F3> to Quit."

You might create some subroutines with the DEF FN construct, allowing you to define functions similar to those of structured languages. Many versions of BASIC restrict you to a one-line equation, but even this would be handy for a function such as

centering messages on the screen.

Document your routines both in the code and on paper. The first three lines of each routine should list the purpose of the routine and both the required and returned variables. The written documentation will allow you to identify subroutines and will explain how to use them correctly. Figure 2 suggests a format for the documentation.

By providing everyday tools, the subroutine library allows you to concentrate on "the good stuff." Those interested in taking the concept a step further can assemble a library of utilities to handle large tasks like file management. It would be a simple matter to decide what variables you need to describe a file and its fields, to write subroutines to read the file descriptors and file into memory, and then to write a program to manage the file. ■

```
Subroutine Name = CT35510
Line #s = 35510-35550
Purpose = Compare a string to a list of valid passwords and return a
          flag on the result
Required Variables = Q$ = String to compare to password list
Returned Variables : QO = Number of the password, or zero if invalid

Notes: This subroutine requires that CT24340 (Input a string from keyboard) be
       present in the same program.
```

Figure 2: A subroutine documentation form should identify the purpose of the routine, the required and returned variables, the line numbers it occupies, and any other prerequisite subroutines.

MERCEDES - BENZ EUROPEAN DELIVERY



YOU CAN BRING DOWN THE COST OF EUROPE WHEN YOU BRING BACK A NEW MERCEDES-BENZ.

IF YOU PLAN on touring Europe this year, you can take overseas delivery of any 1985 Mercedes-Benz gasoline or diesel model you choose.*

Pick it up at the Stuttgart Delivery Center and enjoy a driving vacation unmatched for comfort, convenience and freedom. Avoid costly car rentals while saving on the price of your new Mercedes-Benz.

For details, get our free "European Delivery" color brochure. Just clip and send the coupon at right.

*Subject to availability.

Send coupon to:
Mercedes-Benz of North America, Inc.
Marketing Communications Division
One Mercedes Drive, Montvale, NJ 07645



Name _____

Address _____

City _____ State _____ Zip _____

©1985 Mercedes-Benz of N.A., Inc., Montvale, N.J.

MH-MA-85

Compare the Hercules™ Color Card to IBM's.

Five reasons why the Hercules Color Card is better.

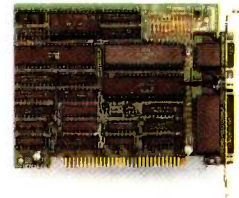
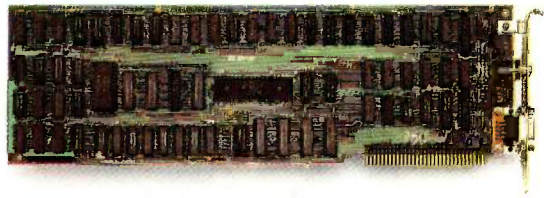

IBM Color Adapter \$244

Hercules Color Card \$245

1. Compatibility

Runs hundreds of graphics programs.

Runs the same hundreds of graphics programs. "The Hercules Color Card is so nearly identical to the IBM Color/ Graphics Card that it's almost uncanny." PC Mag.

2. Printer port.

None.

Standard. Our parallel port allows you to hook up to any IBM compatible printer.

3. Size.

13.25 inches. Limited to long slots.

5.25 inches. Fits in a long or short slot in a PC, XT, AT or *Portable*.

4. Flexibility.

Can't always work with a Hercules Graphics Card.

Always works with a Hercules Graphics Card by means of a software switch.

5. Warranty.

90 days.

Two years.

Any one of these five features is enough reason to buy a Hercules Color Card. But perhaps the most convincing reason of all is just how easy the Hercules Color Card is to use: "Right out of the box, the Hercules Color Card goes into an empty expansion slot, ready for you to plug in. . . and go to work—no jumpers, no software. For most applications, it's just that easy." PC Magazine.

Call 1-800-532-0600 Ext. 421 for the name of the Hercules dealer nearest you and we'll rush you our free info kit.

Hercules.

We're strong on graphics.

Inquiry 208



THE MAXWELL MODEM.

Racal-Vadic

Any modem can send and receive information. But what good is a modem if you can't communicate with it?

In plain English.

The Maxwell Modems and George,TM our communications software, let you do just that.

In fact, learning to use them is as easy as reading a menu. Instead of a manual.

All the features make sense.

Like auto-dialing directories. Automatic log-on. Auto-answer. Automatic error-checking. And complete unattended operation. Which means you can send and receive files late at night when the phone rates are lower. And you're asleep.

Plus, with single keystroke dialing, you can call a database faster than you can say Racal-Vadic. While the handy mes-

RACAL

FINALLY, A MODEM YOU CAN COMMUNICATE WITH.

sage editor makes jotting a quick message just that. Quick.

The Maxwell Modems are available in two versions, internal* or desktop. And, now, in three different speeds. 300, 1200 or 2400 bits-per-second. So there's bound to be one just right for you. And your personal computer.

Best of all, they're from

Racal-Vadic—the world's leading supplier of switched-network modems. The kind of modems data networks use to take calls from modems like yours.

Just as soon as you get one.

And the easiest way to do that is to call 800-4-VADICS for the name of the Maxwell Modem dealer nearest you.



THE MAXWELL MODEM.™

From Racal-Vadic

We don't have all the answers you need, but we'll do all we can to find them!

PC PROGRAMMERS CORNER

Borland	
Turbo Pascal.....	\$ 37
CompuView	
Vedit	\$130
Vedit+	179
Digital Research	
C Basic Comp	
(CB-86)	\$339
CP/M-86	45
Concurrent CP/M	
w/ Windows	119
Concurrent DOS....	179
Display Mgr.....	279
Fortran 77-DOS	
or CP/M.....	279
Personal Basic.....	99
Emerging Technology	
Edix (editor).....	\$139
Heritage	
Smartkey II+.....	\$ 75
Microsoft	
C Compiler	\$319
Pascal Comp	199
Basic Comp.....	249
Fortran Comp.....	259
Morgan Computing	
Prof Basic.....	\$ 79
Peter Norton	
Norton Util 3.0.....	\$ 59
Supersoft	
Fortran.....	\$209
Lifeboat	
Lattice Windows....	\$209
Run-C	99
Dr Halo (Graphics).	79
P Mate	189

IBM/PC SOFTWARE

Anderson Bell	
Abstat	\$289
Ashton-Tate	
Call	Call
Central Point	
Copy II PC.....	\$ 34
Connecticut Software	
Printer Boss	
NEW v. 5	\$ 99
Dow Jones	
Market Manager +....	\$189
Ecosoft, Inc.	
Microstat.....	\$239
Enertronics	
Energraphics.....	\$219
w/ plot option	279
Fox & Geller	
Grafox	\$159
dGraph	159
dUtil.....	58
Quickcode	159
Quickreport	159

Harvard Software	
Total Project Mgr	\$309
Lifetree	
Volkswriter Deluxe....	\$155
Volkswriter Scientific..	299
MDBS	
Knowledge Man	\$275
Micropro	
Pro Pak	\$255
Wordstar 2000+	295
Microrim	
Call	Call
Microsoft	
Flight Simulator	\$ 39
Project	169
Word	229
MuMath/MuSimp	179
Microstuf	
Crosstalk	\$ 99
Northwest Analytical	
Statpak	\$329
Open Systems	
Acct'g Modules.... ea	\$379
Samna Corp.	
Samna Word III	329
Sensible Designs	
dProgrammer	\$199

APPLE SOFTWARE

We have a vast selection of programs available for Apple II, IIe, IIc, and Macintosh.

CP/M SOFTWARE

All prices below are for 8" standard.

Digital Research	
C Basic Comp (CB-80)	\$289
SPP (86)	149
Display Mgr 80.....	239
Display Mgr 86.....	279
Pascal MT+ 80	199
Pascal MT+ 86	349
PL/I 86.....	399
Access Mgr 86.....	239
Fortran 77-86	199
Infocom	
All Games.....	Call
MicroPro	
ProPak	\$359
Others	Call
Microsoft	
Call	Call
Microstuf	
Crosstalk	\$ 99
Northwest Analytical	
Statpak	\$365
Supersoft	
Disk Doctor	\$ 74

APPLE BOARDS

ALS	
CP/M Card	\$269
Smartem II.....	119
Z-Engine	139
CCS	
7711 Asynch Serial....	\$ 99
Microtek	
Call	Call
Orange Micro	
Groppler +	\$119
Prometheus	
Versacard.....	\$159

IBM/PC BOARDS

AST Research	
Six Pak +	\$265
Orchid Technology	
Call	Call
Quadram	
Quadboard 384K	
w/64K	\$255
Other Products.....	Call
Tecmar	
Call	Call

MODEMS

Heyes	
Smartmodem 300.....	\$209
Smartmodem 1200	429
Smartmodem 1200B....	369
US Robotics	
S-100 Modem	\$379
Password M or F.....	325

PRINTERS

C. Itoh Electronics, Inc.,	
Diablo, Epson, NEC,	
Okidata, Quadram,	
Star Micronics	Call

MONITORS

Amdek	
300A Amber	\$149
310A	179
PGS	
HX12 RGB Clr	\$489
MAX 12	189
SR12 (690x480 Res) ...	639
Doublar Card.....	175
Quadram	
Call	Call
Zenith	
Call	Call

DISK DRIVES

FLOPPY DRIVES —	
CDC, Tandon, Half	
High Drives.....	Call
HARD DISKS —	
Corvus, Davong,	
I-Omega Bernoulli Box,	
Maynard Electronics,	
Mountain, Inc.....	Call

PC Jr ACCESSORIES

KeyTronic	
KB 5151 Jr.....	\$173
KB 5149 Numeric	
Keypad).....	89
Quadram	
Quad Jr	
Exp Chassis.....	Call
Quad Jr Exp Mem	
(for Chassis).....	Call

This is only a sample of the nearly 10,000 products we carry. If you're interested in something that is not listed, PLEASE CALL!

POLICY:

- ▶ Wisconsin residents add 5% for sales tax.
- ▶ Minimum \$4.00 for shipping, handling and insurance for orders to \$200.
- ▶ For orders over \$200, add 2 1/4% for shipping, handling and insurance.
- ▶ For cash prepayment of orders \$200 or more, add ONLY 2% for shipping, handling and insurance.
- ▶ Foreign — either add 15% handling & shipping (Int'l money order) or inquire.
- ▶ Prices are subject to change without notice.
- ▶ All items subject to availability.

WE WELCOME:

- ▶ Visa, MasterCard and American Express. (No charge for credit cards.)
- ▶ Corporate, government educational or volume purchasers, please ask for special accounts desk for additional discount.
- ▶ COD (Add \$2.00 per box/parcel. Cash or certified check required.)
- ▶ Checks. (Allow 1-2 weeks for clearing.)

WORKING HOURS:

Monday-Friday 8:30-6:00 : Saturday 10:00-2:00 : Central Time
For technical support, order status and customer service, call (715) 848-1374.

1 800 826-1589

WITHIN WISCONSIN **1 800 472-3535**

INT'L TELEX: 260101 ORYX SYS WAU

ORYX SYSTEMS, INC.
CRAFTSMEN OF THE NEW TECHNOLOGY

425 First St. • P.O. Box 1961 • Wausau, WI 54401



SUBROUTINE LIBRARIES IN PASCAL

BY BRUCE WEBSTER

*A look at some of the facilities available
for creating these libraries*

ONE PHRASE OFTEN USED in software development—indeed, in almost all aspects of computers—is “reinventing the wheel.” It’s what you often find yourself forced to do, over and over, with each new software project. Most programs need to perform certain functions, such as user I/O, file access, and specific types of computation. Fortunately, there’s one way you can avoid rewriting the same routines: Use subroutine libraries.

A subroutine library is basically a collection of useful, trustworthy routines that can be used by different programs. The advantages of using subroutine libraries are obvious. First, you can break programs into smaller chunks that are more easily edited. Second, you can do the job right once and then never worry about it again. It’s as if you are extending the language to meet your needs. Third, all of your programs will behave in predictable ways, at least as far as the library routines are concerned. Each program will carry out the same actions in the same way. This not only means that the user interface can be consistent but also makes it easier for

different programs to share resources and information. Fourth, subroutine libraries make group software projects easier. Effort isn’t duplicated by each person writing his or her own clear-screen routine.

To create a subroutine library, you gather together those routines that have general use. It makes little sense to create a library of routines so specialized that they will be used in only one program. Then you test the routines thoroughly to make sure that they are bulletproof. A subroutine that can blow up or otherwise produce poor results is a dangerous thing to place in a library. Finally, use the libraries as often as you can, improving and modifying them as errors and deficiencies show up. Amending your programs will give you better libraries and will give your programs a degree of consistency that will make them easy to maintain.

The original definition of Pascal does not contain any provisions for creating subroutine libraries beyond reusing the same routines in each program. However, most microcomputer implementations of Pascal contain at

least one of two extensions to aid in using libraries. The simplest involves include files, which are files of subroutines that can be pulled in during compilation. The second uses units to group related definitions and routines into precompiled chunks. Let’s take a look at each method.

INCLUDE FILES

Almost every version of Pascal that runs on microcomputers lets the user define include statements that direct the compiler to read and compile the contents of another file before continuing. These statements take the form of a compiler option giving the name of the file to be read. Figure 1 illustrates what a program containing an include statement might look like. When the compiler gets to the statement `{ $I utility.lib }`, it starts reading from the file `utility.lib`, just as if the

(continued)

Bruce Webster (6215 Thorn St., San Diego, CA 92115) is a consulting editor to *BYTE* and a charter member of the PMS Commando Team. His interests include programming, reading, weightlifting, go, war games, and exactly one attempt at skydiving.

SUBROUTINE LIBRARIES

contents of that file were present after the declaration of `Indx` and `Jndx` and before the start of the procedure `Test1`.

The technique is simple enough, but it has some problems. The most common is a conflict between identifiers in the library and identifiers in the program itself. (An identifier is the name given anything—a constant, a data type, a variable, a subroutine, and so on.) For example, if the file `utility.lib` contained a subroutine named `Initialize`, then the compiler would generate an error when it found the procedure `Initialize` in the program `TestLibrary`. Similar problems might arise if you were using more than one library and both libraries contained routines, variables, or data types with the same identifiers.

One solution to the conflicting identifier problem is to have a unique prefix precede the identifiers in a given library. For instance, all identifiers in `utility.lib` could start with the characters `Util`. The library routine `Initialize` would now become `Utilinitialize` and would not conflict with any routines in the main program. This

has the added advantage of reminding you from which library each routine used in your program came. There are some problems, though. First, typing the extra four characters for each identifier may become tiring after a while. Second, the version of Pascal that you are using has some limit on the number of "significant" characters in an identifier. If this limit is small—around eight characters, say—then the prefix may significantly reduce what you've got to work with.

Suppose you had two library routines, `ClearEOL` and `ClearEOS`, which cleared to the end of a line and the end of the screen, respectively. If you add the prefix `Util`, then the resulting identifiers are identical past the eight-character limit. Even if you reduce the prefix to `Ut`, you'll still have to shorten the names to something like `UtClrEOL` and `UtClrEOS`. This raises the third potential problem: Short identifiers with prefixes may lose some of their mnemonic value. `ClearEOS` explains itself more clearly than `UtClrEOS`.

Another solution is to forget about

the prefixes and keep a list of all identifiers within each library. You can do this at the start of the library file within comment statements. When you include a particular library file, you would then refer to its list to avoid identifier conflicts within the program using it. This, of course, is not without its drawbacks. It may be tedious to maintain the identifier list, especially for large libraries. And it doesn't solve the problem of similar routines with identical names in different libraries; you have to solve that by choosing distinct names for each.

A less common problem can occur if your library gets big. The compiler may not be able to handle all the additional identifiers, resulting in some sort of symbol-table overflow error during compilation. Or the program may compile fine, but the resulting code file may be too large for the available memory. If you have these problems, there's a good chance that your library contains unused or redundant subroutines. If that's the case, you have several options. First, you can create another library that contains only the routines you need for that specific program. Second, you can break the library up into two or three sublibraries; one could contain the most commonly used routines and the others could hold less-needed functions. Third, you may be able to replace a large group of specialized routines with a few routines that use parameters to choose the specific action. For example, instead of having separate routines to perform different screen actions—clear screen, clear line, clear to end of screen, clear to end of line, and so on—you might have a single routine, `DoScreen`, that performs all of those actions based on one or two parameters.

Yet another problem involves routines that use a nonstandard data type as a parameter or as a variable within the routines themselves. This might involve a specific example of a predefined data type (such as a set of characters or a string of a certain length), or it might require a user-

(continued)

```
program TestLibrary;
var
  Indx,Jndx : Integer;

{$I utility.lib} { pull in subroutine library}

procedure Initialize;
begin
.
.
end; { of proc Initialize }

procedure DoTest;
begin
.
.
end; { of proc DoTest }

begin { main body of program TestLibrary }
  Initialize;
  DoTest
end. { of program TestLibrary }
```

Figure 1: An illustration of how to include library routines in a Pascal program.

IT SCREAMS!

PCturbo 186™

"The PCturbo 186 is a sophisticated product, jam-packed with goodies... Lightning-like, indeed."
— Winn L. Rosch, PC Magazine

"PCturbo 186...speeds up your IBM PC something wonderful...no glitches, no problems, and it's fast, FAST, FAST!" — Jerry Pournelle, BYTE

ADVANCED 8MHz
80186 MICROPROCESSOR

UP TO 640K 16-BIT
ONBOARD RAM

WORKS WITH 8088
ALREADY IN YOUR PC FOR
100% IBM COMPATIBILITY

EASY TO INSTALL AND
TRANSPARENT TO USE

DISK CACHING AND
RAM DISK BUILT-IN

CUSTOM VLSI TECHNOLOGY
WITH TURBOBUS EXPANSION

EXTENDS THE LIFE OF YOUR COMPUTER ■ SPEEDS UP YOUR EXISTING PC ■ FINISHES JOBS FASTER

■ Now from Orchid Technology — PCturbo 186, the most practical solution to upgrading the performance of your existing IBM PC, XT or compatible. Based on the new generation 80186 processor, the PCturbo 186 runs your application programs, such as databases and spreadsheets 200% to 400% faster.

■ Plugged into your PC, the PCturbo works together with the computer power you already own today. Unlike less powerful imitations, the PCturbo works in tandem with the 8088 in your PC. It does not replace it. In this design, the 8088 handles all the peripheral I/O while the PCturbo runs your programs concurrently and more efficiently.

■ The PCturbo is a high speed system, with built-in software tools designed to increase all aspects of computer performance. Innovative software allowed Orchid to enhance the PCturbo with many powerful features, such as Mainframe style Disk Caching and high capacity RAM Disks, speeding up the reading and writing of files.

■ To help take advantage of those powerful software tools, the PCturbo allows you to add up to

640K of its own RAM on board. With PCturbo you can now have up to 1.28 Megabytes of RAM in one system — double the previous limit of the IBM PC! This frees the extra RAM in your PC to be used for increasing I/O performance.

■ With the PCturbo there are no new Operating System manuals to read, keyboards to learn, or special software versions to buy. When you plug the PCturbo board into your IBM PC or compatible PC, everything works just like it did the day before — only faster! The PCturbo was designed to be easy to install and transparent to the user. Installation does not void the warranty on your PC, as with some other offerings. Just plug it in, turn it on, and speed it up!

■ The PCturbo is a proven product, introduced in 1984. Since then, we've created a custom VLSI (Very Large Scale Integration) chip which improves the cost/performance ratio of the board even more. Our exclusive TurboBus Expansion capability allows you to add on new Turbo options such as the Serial Port Daughtercard. Continuing in our tradition, Orchid is first with the most in high performance PC enhancements.

PCturbo 186 is the most practical solution to making your operation more efficient and productive. Now isn't that what you bought a computer for in the first place?



ORCHID TECHNOLOGY
47790 Westinghouse Drive
Fremont, CA 94539
(415) 490-8586 Telex: 709289

PCturbo 186 is a trademark of Orchid Technology. IBM and IBM PC are trademarks of International Business Machines Corporation.

defined data type, such as a record of some sort. If the compiler allows free mixing of declarations and routines, as do Turbo Pascal and a few other implementations of Pascal, the appropriate declarations can be made as needed. However, if the order of declaration is more strict, then a second include file containing only dec-

larations (constants, data types, and variables) can be created and included at the proper spot (usually before all of the program's declarations).

Libraries based on include files can be used with almost every microcomputer-based Pascal available. However, a number of Pascal implemen-

tations have a more sophisticated mechanism for libraries, known as units. Let's take a look at these.

UNITS

The UCSD p-System pioneered the use of unit subroutine libraries. Units can also be found in the Apple and Microsoft (IBM) Pascal implementations. (An even more powerful form, the module, is found in the languages Modula-2 and Ada.) A unit is a subroutine library with two parts. The first part, the interface, is visible to the program using the unit. It contains all the declarations that the program needs to use in that unit. The second part, the implementation, holds the actual code of the routines declared in the interface as well as any other routines and/or declarations needed. Those other routines/declarations are invisible to the program using the unit and can be referenced only by the code found in the implementation. Hence, you can hide how the routines in the units are implemented.

The other great advantage of units is that they are compiled separately from the program. When a unit is compiled, the text of the interface is saved, but the implementation is converted to machine code (or, in the case of the p-System, p-code). The compiled unit is then placed in a library. When you compile a program using that unit, the compiler just reads the interface to get the declarations it needs; the implementation is not recompiled. This can save a lot of time, especially if the unit or units involved are large.

Since the unit isn't recompiled, the question of what happens to the code arises. The answer depends upon the particular implementation, but there are two basic approaches. The first involves code-based units (in Apple Pascal, this is known as a regular unit). The code from such a unit is directly copied from the library into the program's code file, either at compilation time or in a later linking step. This produces a single executable file with all the code needed to run. If several such programs occupy the same disk,

(continued)

You're in Good Company When You Program in BetterBASIC



All of these companies rely on BetterBASIC to write their software programs. They have found that BetterBASIC combines the features they need from BASIC, Pascal, C and Forth in one familiar environment. Some of these features include the following.

640K Now you can use the full memory of your PC to develop large programs.

STRUCTURED Create well organized programs using procedures and functions that are easily identified and understood and completely reusable in future programs.

MODULAR Use procedures and functions grouped together to form "library modules."

INTERACTIVE BetterBASIC acts like an interpreter, responding to the users' commands in an immediate mode. However, each statement is actually compiled as it is entered.

EXTENSIBLE Create your own BetterBASIC modules which contain BetterBASIC extensions (ideal for OEMs).

COMPILED Each line of the program is compiled as it is entered

into the computer's memory rather than interpreted at runtime. The optional Runtime System generates EXE files.

BetterBASIC Runs on IBM PC, IBM PC/XT and compatibles.

CALL 1-800-225-5800 Order Better BASIC now, or write Summit Software Technology, Inc.™, P.O. Box 99, Babson Park, Wellesley, MA 02157. Prices are listed below.

BetterBASIC: \$199 Runtime System: \$250
8087 Math Module: \$99

Still not convinced? Order the BetterBASIC sample disk which includes a demo, a tutorial, compatibility issues, 50 lines of BetterBASIC and more. Only \$10.

MasterCard, VISA, P.O. Checks, Money Order, C.O.D. accepted.

BetterBASIC is a registered trademark of Summit Software Technology, Inc.

IBM PC and IBM PC/XT are registered trademarks of International Business Machines Corp. Tandy is a registered trademark of Tandy Corp. Illustrated above are registered trademarks of the following companies: Mobil Oil Corp.; A T & T; General Electric Co.; Westinghouse Electric Corp.; TRW, Inc.



ALSO AVAILABLE FOR THE TANDY 2000, 1200 AND 1000

EXPAND YOUR CAREER HORIZONS...



The CIE Microprocessor Trainer helps you to learn how circuits with microprocessors function in computers.

START WITH CIE.

Microprocessor Technology. Satellite Communications. Robotics. Wherever you want to go in electronics ... start first with CIE.

Why CIE? Because we're the leader in teaching electronics through independent study. Consider this. We teach over 25,000 students from all over the United States and in over 70 foreign countries. And we've been doing it for over 50 years, helping thousands of men and women get started in electronics careers.

We offer flexible training to meet your needs. You can start at the beginner level or, if you already know something about electronics, you may want to start at a higher level. But wherever you start, you can go as far as you like. You can even earn your Associate in Applied Science Degree in Electronics.

Let us get you started today. Just call toll-free 1-800-321-2155 (in Ohio, 1-800-362-2105) or mail in

Inquiry 84

the handy reply coupon or card below to:
Cleveland Institute of Electronics,
1776 East 17th Street, Cleveland, Ohio 44114.



Cleveland Institute of Electronics
1776 East 17th St., Cleveland, Ohio 44114

Please send your free independent study catalog.
For your convenience, CIE will try to have a representative contact you — there is no obligation.

Print Name _____

Address _____ Apt. _____

City _____ State _____ Zip _____

Age _____ Area Code/Phone No. _____

Check box for G.I. Bill bulletin on Educational Benefits

Veteran Active Duty

MAIL TODAY!

BY-03

each will have its own copy of the unit(s). In Apple Pascal, all units are code-based (regular) unless otherwise specified.

The second approach uses library-based units (known as intrinsic units in Apple Pascal). Such a unit remains in the library file until needed, which may be when the program using it is started or not until some routine in the unit is actually called. At this time, the unit is loaded into memory. This requires, of course, that the library file containing the unit be available (i.e., on a currently mounted disk and in a known location) when the program is executed. All units in UCSD Pascal (version IV.0 and later) are by default library-based: a utility known as the Librarian must be used to make them code-based.

A library-based scheme works best when several programs on the same disk use the same unit(s). One "real-

world" example is the computer game SunDog, of which I was the principal programmer. One side of the SunDog disk contains three code files—a demo program, a utility program, and the game itself—along with a library file containing seven intrinsic (library-based) units. All three code files use most of the units in the library. If the units' code had to exist in each program file, an additional 20K to 30K bytes of disk space would be needed—space that just isn't there.

Some of the problems mentioned with include files also exist for units, though usually to a lesser degree. There is the same potential for conflicts between identifiers, and the same solutions are available. Overtaxing the compiler becomes less likely, since only those identifiers absolutely needed by the program need be declared in the interface, and units can give you greater control over the

code size of the finished product. The problem of correct data types disappears altogether, since you can freely declare constants, data types, and variables in both the interface and the implementation sections. All in all, units tend to be easier and more flexible to work with.

Units represent a major step forward in subroutine libraries, but additional steps can yet be taken. Two newer, Pascal-derived languages have more powerful features for library creation. Modula-2, designed by Niklaus Wirth as a successor to Pascal, can be thought of loosely as a language using nothing but units, allowing an entire program to consist of separately compiled chunks. Ada, designed by the Department of Defense as a replacement for everything, also has units, which come in several flavors. (Both Modula-2 and

(continued)

This and \$1650 the PC

will get you you've dreamed of.

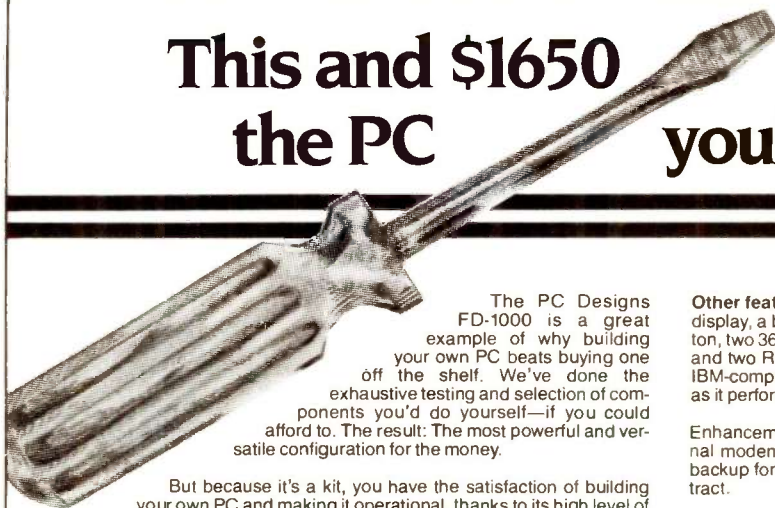

The PC Designs FD-1000 is a great example of why building your own PC beats buying one off the shelf. We've done the exhaustive testing and selection of components you'd do yourself—if you could afford to. The result: The most powerful and versatile configuration for the money.

But because it's a kit, you have the satisfaction of building your own PC and making it operational. Thanks to its high level of integration, the FD-1000 requires no soldering; just a screwdriver and about an hour and you're booting up.

Look at these performance features of the FD-1000:

SPEED: 8MHz clock speed (plus standard 4.77 MHz)

MEMORY: Up to 1 MB on-board memory (256K RAM included)

POWER: American-made 140-watt power supply (hard disk ready)

VERSATILITY: Five available IBM plug-compatible expansion slots

COMPATIBILITY: Supports a variety of popular operating systems, including PC-DOS (included with kit), MS-DOS, Concurrent DOS and Xenix. Runs popular software like Lotus 1-2-3, dBase III, Flight Simulator and more.

Other features include a Princeton Graphics MAX-12E amber monochrome display, a built-in clock/calendar with battery back-up, a hardware reset button, two 360K Shugart double-sided, double-density half-height floppy drives and two RS232 serial interfaces plus a parallel printer port. With its 84-key IBM-compatible keyboard and IBM-style case, your FD-1000 looks as good as it performs.

Enhancements available at extra cost include Graphics Capability, an internal modem, a 10 or 20 MB internal Winchester hard disk, an internal tape backup for the hard disk, a color monitor and an annual mail-in service contract.

All wiring and hardware is included, and easy-to-follow instructions make the FD-1000 a simple and practical project for the new or seasoned user seeking performance and reliability at low cost.

NO-RISK GUARANTEE: If you're not completely satisfied with your FD-1000, return it within 30 days for a full refund, including your mailing costs. Our one-year warranty on all components ensures your satisfaction.

For more information, or to order, call or write:

PC DESIGNS (918) 494-9765.
8238 South Gary Avenue,
Tulsa, Oklahoma 74137

MICROWAY'S 8087 RUNS 1-2-3™!

MicroWay is the world's leading retailer of 8087s and high performance PC upgrades. We stock a complete selection of 8087s that run at 5 and 8mhz. All of our coprocessors are shipped with a diagnostic disk and the best warranty in the business - 180 days! We also offer daughterboards for socketless computers such as the NEC PC and PCjr, and a board which increases the clock speed of the 80287 in the PC AT. Our new NUMBER SMASHER™ includes 512K ram. It will run the IBM PC at clock speeds up to 9.5mhz and achieves a throughput of .1 megaflops

with 87BASIC/INLINE, Intel Fortran, or Microsoft Fortran. Software reviewers consistently cite MicroWay software as the best in the industry! Our customers frequently write to thank us for recommending the correct software and hardware to meet their specific needs. They also thank us for our same day shipping! In addition to our own products which support the 8087 and 80287, we stock the largest supply of specialized software available anywhere. For information call us at

617-746-7341

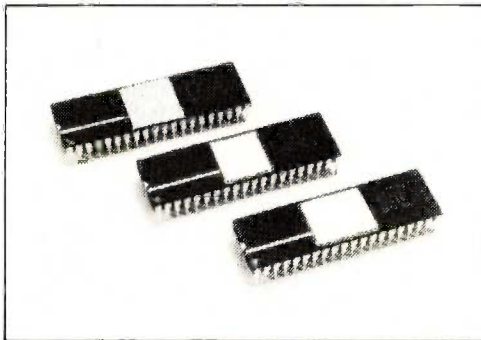

MicroWay® 8087 Support

For the IBM PC, PC XT, PC AT and Compatibles.

87FFT™ Written in assembly language, performs Forward and Inverse FFTs on real and complex arrays which occupy up to 512K bytes of RAM. Also does convolutions, auto correlations, hamming, complex vector multiplication, and complex to radial conversions. Callable from MS Fortran, 87MACRO or 87BASIC/INLINE. **\$150**

87FFT-2™ performs two-dimensional FFTs. Ideal for image processing. Requires 87FFT. **\$75**

MATRIXPAK™ manages a MEGABYTE! Written in assembly language, our runtime package accurately manipulates large matrices at very fast speeds. Includes matrix inversion and the solution of simultaneous linear equations. Callable from MS Fortran 3.2, 87MACRO, and 87BASIC/INLINE. each **\$150**

GRAPHICS PACKAGES

Grafmatic for MS Fortran or Pascal. **\$125**
Plotmatic for Grafmatic. **\$125**
MultiHalo (one language). **\$189**

DFixer™

A disk utility which thoroughly checks PC or AT hard disks for bad sectors and updates the MS DOS file allocation table accordingly. **\$149**

87DEBUG™ - a professional debugger with 8087 support, a sophisticated screen-oriented macro command processor, and trace features which include the ability to skip tracing through branches to calls and software and hardware interrupts. Breakpoints can be set in code or on guarded addresses in RAM. **\$150**

HARDSCOPE™ includes a version of 87DEBUG which interfaces a Breaker Box which makes it possible to reset your PC and break program execution independent of DOS. **\$249**

AST Advantage™ **\$439**

JRAM-2™ (ØK) **\$199**

JRAM™ AT (ØK) **\$229**

MAYNSTREAM™ 60 meg **\$1695**

87BASIC/INLINE™ converts the output of the IBM Basic Compiler into optimized 8087 inline code which executes up to seven times faster than 87BASIC. Supports separately compiled inline subroutines which are located in their own segments and can contain up to 64K bytes of code. This allows programs greater than 128K! Requires the IBM Basic Compiler and Macro Assembler. Includes 87BASIC. **\$200**

87BASIC™ includes patches to the IBM Basic Compiler and both runtime libraries for USER TRANSPARENT 8087 support. Provides super fast performance for all numeric operations including trigonometrics, transcendentals, addition, subtraction, multiplication, and division. **\$150**

87MACRO™ - our complete 8087 software development package. It contains a "Pre-processor," source code for a set of 8087 macros, and an object library of numeric functions including transcendentals, trigonometrics, hyperbolics, encoding, decoding and conversions. For the IBM Macro Assembler, Version 1.0 or 2.0. **\$150**

OBJ-ASM™ - a multipass object module translator and disassembler. Produces assembly language listings which include public symbols, external symbols, and labels commented with cross references. Ideal for understanding and patching object modules and libraries for which source is not available. **\$200**

RTOS - REAL TIME OPERATING SYSTEM
RTOS is a multi-user, multi-tasking real time operating system. It includes a configured version of Intel's iRMX-86, LINK-86, LOC-86, LIB-86, OH-86, and MicroWay's 87DEBUG. Runs on the IBM-PC, XT, PC-AT and COMPAQ. **\$400**

INTEL COMPILERS!

FORTTRAN-86. **\$750**
PASCAL-86. **\$750**
PL/M-86. **\$500**
87C (LATTICE/MICROWAY). **\$750**
ASM-86. **\$200**

*Requires RTOS or iRMX-86. All Intel compiler names and iRMX-86 TM Intel Corp.

FASTBREAK™

MicroWay's daughterboard turns on your 8087 during 1-2-3™ execution and extends DOS functionality. Recalculations run up to 36 times faster. Includes an 8087 chip. When used with the NUMBER SMASHER™ it can provide a total increase in 1-2-3™ execution speed of up to 79 to 1.

FASTBREAK™ 5mhz. **\$339**

FASTBREAK™ 8mhz. **\$479**

FASTBREAK™

for NUMBER SMASHER. **\$239**

FASTBREAK™ LOCK BOX. **\$60**

8087 5mhz **\$109**

Including DIAGNOSTICS and one-year warranty For IBM PC and compatibles.

8087-2 8mhz **\$195**

For Wang, AT&T, DeskPro, NEC, Leading Edge

80287-3 5mhz **\$250**

For the IBM PC AT

64K RAM Set **\$12**

256K RAM Set **\$72**

256K CMOS RAM Set **\$135**

128K RAM Set PC AT **\$169**

NUMBER SMASHER™ **\$1590**

9.54mhz 8087 coprocessor board with 512K

FORTRAN and UTILITIES

Microsoft Fortran 3.2. **229**

IBM Professional Fortran. **545**

Intel Fortran-86¹. **750**

FORLIB+. **65**

STRINGS and THINGS. **65**

C and UTILITIES

Lattice C. **299**

Microsoft C Version 3.0. **299**

C86. **299**

FLOAT87. **150**

BASIC and UTILITIES

IBM Basic Compiler. **270**

87BASIC. **150**

87BASIC/INLINE. **200**

Summit BetterBASIC™. **175**

Summit 8087 Module. **87**

MACRO ASSEMBLERS

IBM Assembler with Librarian. **155**

87MACRO. **150**

Microsoft Assembler V 3.0. **125**

PASCAL

Microsoft Pascal 3.2. **199**

Borland Turbo with 8087 and BCD. **85**

APL

STSC APL★PLUS/PC. **450**

Pocket APL. **85**

COSMOS Revelation. **750**

SPSS/PC. **595**

FASTBREAK and NUMBER SMASHER are trademarks of MicroWay, Inc. Lotus and 1-2-3 are trademarks of Lotus Development Corp.

MicroWay

P.O. Box 79
Kingston, Mass.
02364 USA
(617) 746-7341

**The World Leader
in 8087 Support!**

NEW AMBER CRT'S

- Eliminates strobe, flicker, and eye fatigue
- Made with Lead/Strontium impregnated glass that stops X-ray emission
- Available in slow decay green or medium decay "European Amber" (the standard in Europe)
- High-contrast double dark face glass that also cuts U.V. radiation
- Tube face is etched to stop glare
- Ideal for word processing and programming, yet fast enough for games and graphics
- Warranted for one full year against manufacturing defects or tube failure

- Comes with a 30 day money back guarantee
- Easily installed (comes with pre-mounted hardware)



Your new amber CRT is easily installed with a screwdriver and a socket.

Now, you can easily upgrade your monitor to exceed European standards for persistence and color with the installation of a Langley-St.Clair Soft-View™ CRT! Available for the TRS-80™ TeleVideo™ Kaypro™ Heath™ DEC™ Zenith™ IBM PC™ Apple III™ and a wide variety of other monitors.

Call now to order your Soft-View™ CRT from Langley-St.Clair—\$99.95

Plus \$7 for packing and UPS Shipping (\$17 for Overseas, Parcel Post, or UPS Blue Label). Add sales tax where applicable. Visa/MasterCard orders welcomed.

Langley-St.Clair

Instrumentation Systems, Inc.
132 W. 24th St., New York, NY 10011
In New York call 212 989-6876

TO ORDER: CALL 800 221-7070

**IBM AT THE OFFICE
APPLE AT HOME**

NO PROBLEM!

A "Wireless file transfer" package for the IBM PC® to Apple II and back. **APPLE TURNOVER™** is a firmware board which fits into any slot in the IBM PC and some compatibles. NO modems, NO serial links, NO hassles, NO problems. **APPLE TURNOVER™** will format Apple CP/M® and Apple DOS 3.3 disks. Leave your IBM and Apple computers where they are. Simply bring your Apple disk to work and transfer your file to a PC-DOS disk. Allows for modifications to text and data files. It's a simple, inexpensive, high performance alternative to complicated serial links and modems.

"NEW!" **APPLE TURNOVER™** version 2.0 will read, write and format PRO-DOS and Apple P-System Too.

See your dealer or call
for information:

(213) 938-0857

Vertex
systems inc.

Innovation in microcomputer products 6022 W. Pico Blvd., Los Angeles, CA 90035

SUBROUTINE LIBRARIES

Unit subroutine libraries allow for information hiding and separate compilation.

Ada started with Pascal, but the two went in opposite directions, Modula-2 toward a simple language definition, Ada toward a complex one. It will be interesting to see which proves to be more successful.)

UPDATING LIBRARIES

Like all other portions of your programs, your libraries will change with time. You will find and fix bugs, add and delete features, and generally improve your libraries. But if they change, what of your programs that use them?

For include files and code-based units, the answer is the same: If you want the changes reflected in your programs, you'll have to recompile the programs. (For code-based units, you'll have to recompile the units first.) As a rule it is probably best that you recompile all programs using a given library after each major change to that library. This maintains consistency and predictability for each of your programs.

Library-based units are another story altogether. If you make changes to the interface portion of a library-based unit, then you must recompile all programs using the library file where that unit resides. Failure to do so could cause the programs to crash or behave erratically. Why? Because the interface that the unit now has and the interface that the program "remembers" are no longer the same. All sorts of problems may arise, due to changes in data structures, differences in variable addresses, and relocations of subroutines.

On the other hand, if you change only the implementation portion, you don't need to recompile anything except the unit itself. This is the real vir-

(continued)

MICRO CAP and MICRO LOGIC put your engineers on line... not in line.



MY OWN WORKSTATION

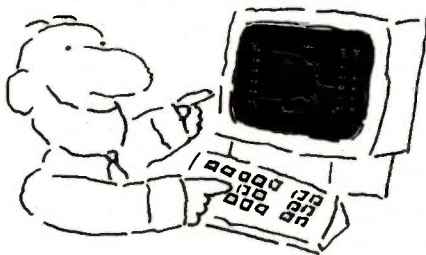

How many long unproductive hours have you spent "in line" for your simulation? Well, no more. MICROCAP and MICROLOGIC can put you on line by turning your PC into a productive and cost-effective engineering workstation.

Both of these sophisticated engineering tools provide you with quick and efficient solutions to your simulation problems. And here's how.

MICROCAP: Your Analog Solution

MICROCAP is an interactive analog circuit drawing and simulation system. It allows you to sketch a circuit diagram right on the CRT screen, then run an AC, DC, or Transient analysis. While providing you with libraries for defined models of bipolar and MOS devices, Opamps, transformers, diodes, and much more, MICROCAP also includes features not even found in SPICE.

MICROCAP II lets you be even more productive. As an advanced version, it employs sparse matrix techniques for faster simulation speed and larger net-

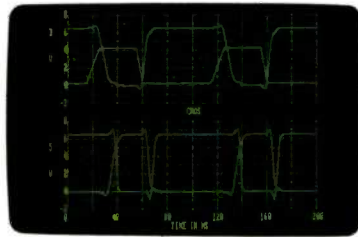

"Typical MICROCAP Transient Analysis"

works. In addition, you get even more advanced device models, worst case capabilities, temperature stepping, Fourier analysis, and macro capability.

MICROLOGIC: Your Digital Solution

MICROLOGIC provides you with a similar interactive drawing and analysis environment for digital work. Using standard PC hardware, you can create logic diagrams of up to 9 pages with each containing up to 200 gates. The system automatically creates the netlist required for a timing simulation and will handle networks of up to 1800 gates. It provides you with libraries for 36 user-defined basic gate types, 36 data channels of 256 bits each, 10 user-defined clock waveforms, and up to 50 macros in each network. MICROLOGIC produces high-resolution timing diagrams showing selected waveforms and associated delays, glitches, and spikes—just like the real thing.

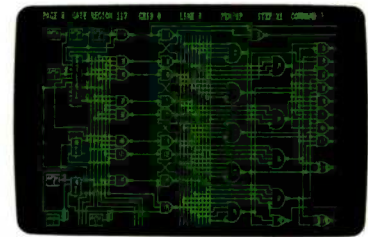

"Typical MICROLOGIC Diagram"

Reviewers Love These Solutions

Regarding MICROCAP... "A highly recommended analog design program" (PC Tech Journal 3/84). "A valuable tool for circuit designers" (Personal Software Magazine 11/83).

Regarding MICROLOGIC... "An efficient design system that does what it is supposed to do at a reasonable price" (Byte 4/84).

MICROCAP and MICROLOGIC are available for the Apple II (64k), IBM PC (128k), and HP-150 computers and priced at \$475 and \$450 respectively. Demo versions are available for \$75.

MICROCAP II is available for the Macintosh, IBM PC (256k), and HP-150 systems and is priced at \$895. Demo versions are available for \$100.

Demo prices are credited to the purchase price of the actual system.

Now, to get on line, call or write today!

Spectrum Software

1021 S. Wolfe Road, Dept. B
Sunnyvale, CA 94087
(408) 738-4387

Inquiry 384

TOUGH LOCAL NETWORK PROBLEM:

"How can our department get our six computers and three printers to work together efficiently? We also want to be able to access outside data services and our future company LAN."

SIMPLE \$2995* SOLUTION: NetCommander

NetCommander is a smart, small Local Area Network manager. It lets you link from four to 40 computers and peripherals — in any mix of models and makes. A 50K buffer (expandable to 250K) makes sure that productivity is high — keeping fewer printers humming — while computer and PC users do their thing, without waiting for a printer, modem, or shared disk. Those devices can be specified with names defined by users — and allocated on the basis of availability and capability. And NetCommander handles multiple protocols and different baud rates simultaneously — without modifications to hardware or software. It will also tie into your company's LAN. The latest in a family of products in use since 1979, NetCommander is a smart, small, efficient network manager.

For more information, call or write:

NetCommander

Digital Products Inc. • The Simple Network Solution Company
600 Pleasant Street • Watertown, MA • 02172
(617) 924-1680 • Outside Mass., call 1-800-243-2333
And check out our 30-day trial evaluation.

*For 16 ports

SUBROUTINE LIBRARIES

Subroutine libraries maintain consistency between programs.

ture of the "hidden" portion of a library-based unit: You can implement the unit however you want, and the program doesn't care as long as the interface remains the same. This can make a big difference when several large programs use the same library and recompilation might end up taking a few hours.

SAMPLE LIBRARIES

Two actual subroutine libraries are available for downloading from BYTENet Listings at (617) 861-9774. The first—an include file—is a rather extensive 56K-byte source text library designed for Turbo Pascal running under MS-DOS. I was unable to learn the author of this public-domain file; it was uploaded to my bulletin board, and a copy can be found on the BYTENet Listings bulletin board. The file is named TURBUTIL.PAS.

The second library, an intrinsic (library-based) unit designed for Apple Pascal, contains a number of routines for low-level manipulation of memory, variables, and pointers. The unit actually has two parts, one in Pascal, the other in 6502 assembly language. The first part must be compiled, the second assembled, and then the two are linked together. These files, too, are posted on BYTENet Listings and are named LOWLIB.PAS and LOWLIB.ASM, respectively.

CONCLUSIONS

Subroutine libraries save time, maintain consistency between programs, and speed up the entire software-development cycle. Their importance is evident in the large role they play in newer languages, such as Modula-2 and Ada. Take it from someone who spent over two years developing a large (20,000+ lines), complex set of Pascal programs: Libraries can be a real lifesaver. ■

The BASIC idea.

Now it's even better.

True BASIC™

A new, more powerful version of the world's most widely used programming language—created by the original developers of BASIC, John Kemeny and Thomas Kurtz.

True BASIC is still easy to learn and use yet offers the following advanced features:

- **STRUCTURE**—True BASIC allows you to write modular programs. It supports advanced control structures such as SELECT CASE, IF-THEN-ELSEIF, DO Loops, etc.
- **EXTERNAL PROGRAMS**—Increase your programming efficiency by storing frequently used functions and subroutines in user-defined libraries. True BASIC supports calls to assembly language subroutines.
- **FULL MEMORY**—With True BASIC you can use all the available memory in your computer.

- **SUPERIOR GRAPHICS**—Allow you to draw in your own coordinates, not in terms of pixels. Animation, sound and color are supported.
- **IMPROVED ERROR CHECKING**—Compiler reports syntax errors before running a program. The language incorporates user-defined error messages.
- **WINDOWS**—True BASIC allows you to program multiple screen windows, each with its own parameters.
- **SPEED**—Because True BASIC is compiled, it is faster than interpreted BASICs. Automatic 8087 support is standard.

Now available for the IBM PC, Apple Macintosh available Summer, 1985.

True BASIC.™

The BASIC idea made better.

★ **Addison-Wesley**

Reading, Massachusetts 01867

True BASIC is a trademark of True BASIC, Inc./IBM is a registered trademark of International Business Machines, Inc./Apple is a trademark of Apple Computer, Inc./Macintosh is a trademark licensed to Apple Computer, Inc.

Put your PC in PicturesSM

With PC-EYE™ your IBM PC can capture real-life pictures of people, products, drawings, text - anything a video camera can see. Add one or more of CHORUS' software packages and you can perform sophisticated graphic arts, data base management, security and long distance communications tasks.



Start with the PC-EYE™ video capture system. There are three models to choose from with up to 640 x 512 resolution — 16, 64, and 256 gray levels or color combinations. Then add one or more of the following software packages for your application.



PhotoBase™ - Integrates pictures with your data base
Compatible with dBase II, R:Base 4000 and the IBM Filing Assistant and others, PhotoBase lets you use your data base system as you now do. BUT, now you can add a quarter screen picture captured by a video camera or VCR and display data, pictures, and signatures on the screen simultaneously. Applications include real estate, bank security and signature verification, medical record keeping, product cataloging and more.



IMiGIT™ - Graphic Arts Capability
IMiGIT is icon driven and ideal for creating traditional or exotic illustrations using combinations of art, text and photos for slide presentations, video graphics, CAD, medical, advertising and publishing applications. IMiGIT PLUS delivers high quality true color graphics you can manipulate and edit with text, painting, air brushing, curve fitting, filled and unfilled circles, boxes and much more via mouse or digitizer pad.



PhotoMail™ - Two-way Communications using pictures, text and voice.

Transmit pictures over ordinary telephone lines to remote computers. Pictures of people, diagrams, text, houses, construction sites - anything you can capture with standard video equipment you can display and transmit at resolutions up to 640 x 400 x 16 levels of gray or color. You can edit pictures with text and labels. Dual cursors permit simultaneous pointing to common pictures. PhotoMail supports alternate voice and image transmission, disk storage, and hardcopy printout. File conversion is included to support "electronic mail" systems.



Great Value Added Opportunities
OEMs and software developers can incorporate high quality pictures into their products. Systems can be upgraded with PC-EYE digitizing expansion boards using an EIA RS-170 or RS-330 video source and PC-EYE imaging subroutines.

Call us about our other imaging products like Colorverter™, ScreenMaster™, and CompressIT™ to help meet your application needs. **1-800-OCHORUS** or **603-424-2900**. Or write for our "Seeing is Believing" comprehensive brochure.

TM: All are trademarks of CHORUS DATA SYSTEMS, INC.

*dBase II is a trademark of Ashton-Tate; R-Base 4000 is a trademark of Microrim, Inc.; IBM Filing Assistant is a trademark of International Business Machines Corporation.

CHORUS

Give us your staine your filthy dirty,

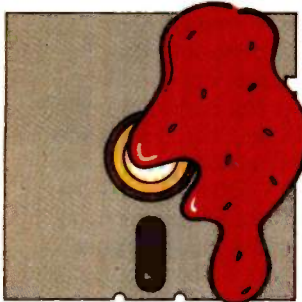

Aunt Molly's jam

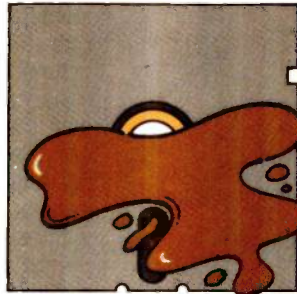

Regular coffee, two lumps

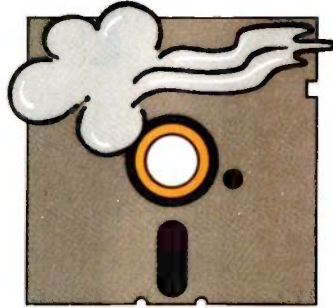

Clouds of smoke



Maria's liquid cover



The big chill

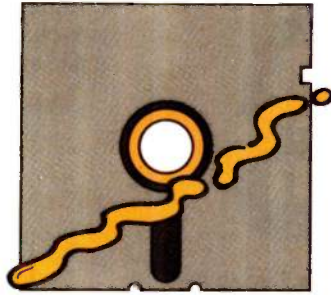

Hot dog mustard

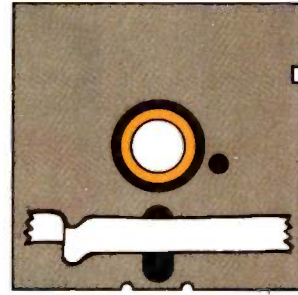

Tacky white tape

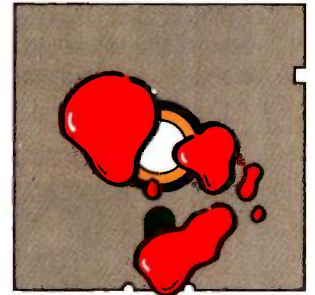

Lunchcounter ketchup

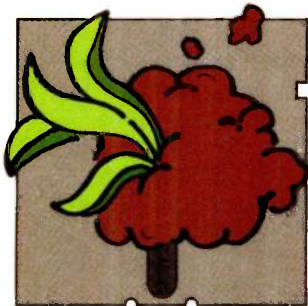

Potted plant—no pot

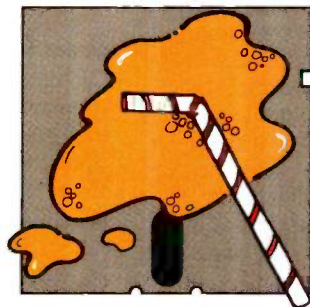

Fizzy orange soda

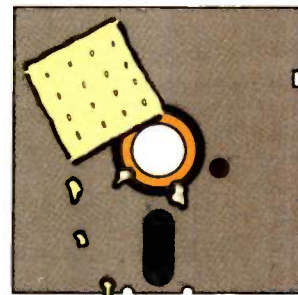

Cracker crumbs

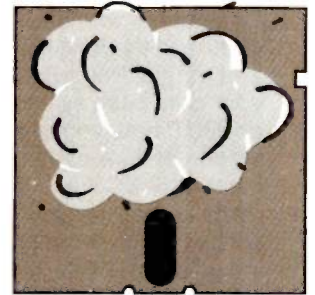

Dust (cough-cough)

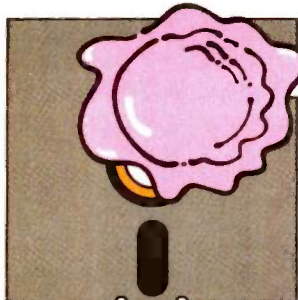

One scoop of ice cream



Sudsy soap bubbles



Chocolate fingerprints

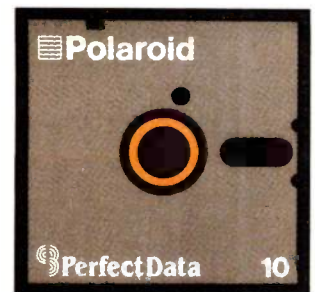

d, your dog-eared, your mistreated:

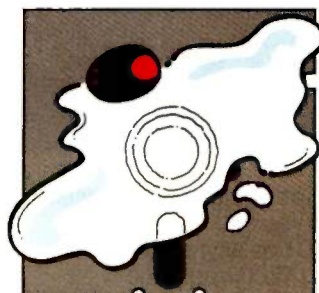

Dry martini, one olive

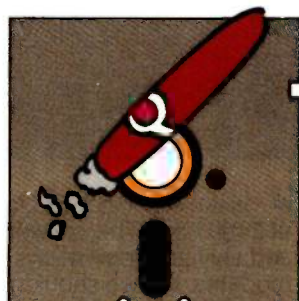

Boss's cigar ashes



Spilled milk

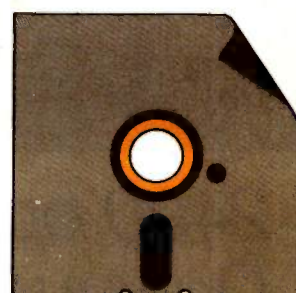

Dog-eared jacket

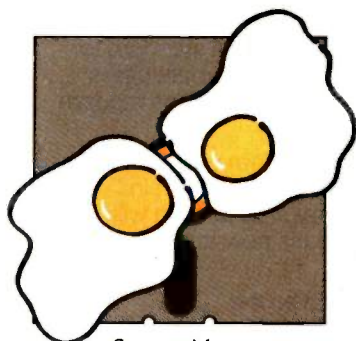

Sunny side up



Waterbased ink spots

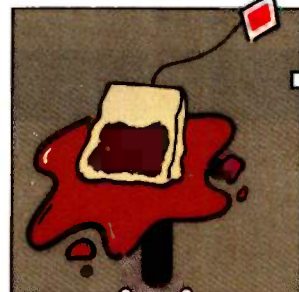

English breakfast tea

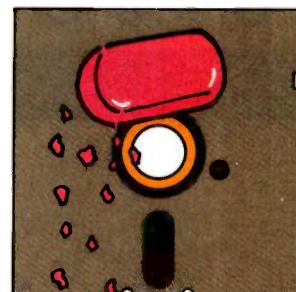

Eraser bits

If it's a Polaroid diskette, we'll fix it.

Accidents can be fatal to floppy disks. But now Polaroid introduces a free data recovery service.

So, if you spill coffee on a Polaroid Professional Quality Diskette, we can help recover your data. (And most other accidents, too.) Call 800-241-4403

and we will tell you how our service works.

These Polaroid floppy disks boast a 20-year guarantee and are certified 100% error-free. And only Polaroid offers a free data recovery service. Because accidents happen.

"Polaroid"® of Polaroid Corp.
"Perfect Data"™ of Perfect Data Corp.

Inquiry 331

 **Polaroid**

THE PROFESSIONAL QUALITY DISKETTE IN THE GRAY BOX.

PerfectData

©1985 Polaroid Corp.

JUNE 1985 • BYTE 265

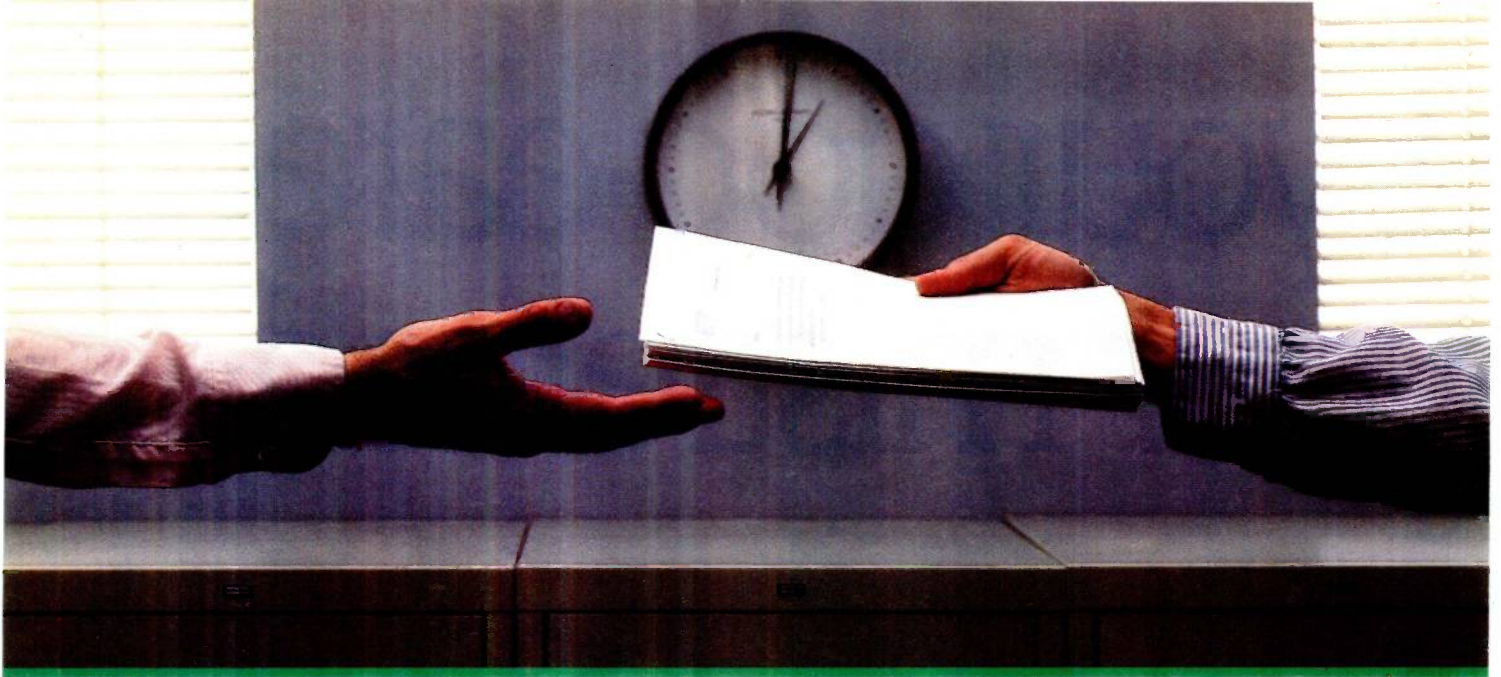

2400 bps modems: Do you Really need another speed?

- Is the shift from 300 to 1200 bps going to repeat itself at 2400 bps? The answer is both yes and no. There certainly are applications for 2400 bps asynch dial-up modems, but we shouldn't expect 1200 bps to die overnight.
- 2400 bps modems can improve throughput, thereby getting tasks done quicker and more economically. However, 1200 bps has become the virtual standard for professional dial-up communications, and most users are satisfied with it. So why consider a 2400 bps modem at all?
- One reason is flexibility. If the modem you select operates at all three speeds (300, 1200 & 2400) in accordance with accepted industry standards, it will serve virtually all dial-up applications now and in the foreseeable future.
- The modem you select should be the MultiModem224. It is Bell 212A and 103 compatible at 1200 and 300 bps, and CCITT V.22bis compatible at 2400. It is also 100% compatible with the Hayes command set, meaning that it will work with virtually all communications software packages, at all three speeds. Other features include both synchronous and asynchronous operation, full intelligence and a phone number memory.
- The MultiModem224 is available in both desktop and IBM PC™ internal card versions. (There is also a rack-mounted version for central sites.) And as a bonus, we provide free offers from ten of the most popular on-line information services, including CompuServe™, Dow Jones™ and The Source™.
- A 2400/1200/300 bps modem is just a plain good investment. Why not let the MultiModem224 provide your communications for both today and tomorrow?

Inquiry 300

MultiTech
Systems

The right answer every time.

82 Second Ave. S.E. New Brighton, MN 55112 (612) 631-3550. TWX: 910-563-3610

MultiTech
Systems

MultiModem 224
2400/1200/300 BPS Intelligent Modem

1200
300
2400

Ans



On

USING DATA FLOW FOR APPLICATION DEVELOPMENT

BY WAYNE P. STEVENS

This form of linkage results in functions that are easier to understand, develop, and maintain

DATA FLOW IS the technique of connecting functions only by flows of data. Data-flow diagrams, which depict the flows of data among functions, are a natural way to document and design applications. The resulting applications are much easier to develop, test, and maintain, and the various functions are easier to reuse than those connected in other ways.

The terms "data flow" and "data-flow diagrams" have gained popularity in the last 5 to 10 years. However, the concepts they represent have been used in the computer industry since its inception. Job steps are connected to each other by flows of data through the files and databases they reference. And systems flowcharts, the diagrams that depict the flows of data among job steps, are not flowcharts in the normal sense, but rather charts of data flow—data-flow diagrams (see figure 1).

KINDS OF CONNECTIONS

Almost all connections between functions in computer applications include the sharing of data. With data flow, only one function can access the

data at a time. Connections between functions can also include passing control or sharing a common data area, neither of which involves data flow. The following are various ways in which one function in an application can relate to another:

- follow or branch to another function in the same program
- do a source include or reference a macro
- perform or branch and link to another function in the same program
- call another function
- pass only data to another function

When functions follow each other in the same program, the computer automatically executes the second one after executing the first. The connection consists of passing control from the first to the second. While they are also connected by any variables they can both reference, there is no flow of data. The same is true if one function branches to the other.

Source includes, which bring a referenced function into the program at compile time, enable multiple programs to include a particular function.

However, once included, its connection to the functions around it is the same as above. It is connected by passed control and shared common data rather than by data flow.

A perform or branch and link to a function within the same program involves a more reusable routine. However, the connection between the functions is still one of passed control and shared common data.

When you package functions into separate modules, usually with a separate compile, you can pass data between them. A called function receives data from its caller, does its job, and can pass data back to its caller. The data passed is accessed only by the called routine until it returns control to the caller. This passing of control makes the functions more dependent on each other than those connected *only* by data flow.

(continued)

Wayne P. Stevens (IBM Corporation, 1241 East Main St., Stamford, CT 06904) works in IBM's Information Programming Services doing planning for future development tools. He has an M.S. in electrical engineering from MIT.

Pascal and C Programmers

Your programs can
now compile the
FirstTime™

FirstTime is an intelligent editor that knows the rules of the language being programmed. It checks your statements as you enter them, and if it spots a mistake, it identifies it. *FirstTime* then positions the cursor over the error so you can correct it easily. *FirstTime* will identify all syntax errors, undefined variables, and even statements with mismatched variable types. In fact, any program developed with the *FirstTime* editor will compile on the first try.

More than a syntax checker!

FirstTime has many unique features found in no other editor. These powerful capabilities include a zoom command that allows you to examine the structure of your program, automatic program formatting, and block transforms.

If you wish, you can work even faster by automatically generating program structures with a single key-stroke. This feature is especially useful to those learning a new language, or to those who often switch between different languages.

Other Features: Full screen editing, horizontal scrolling, function key menus, help screens, inserts, deletes, appends, searches, and global replacing.

Programmers enjoy using *FirstTime*. It allows them to concentrate on program logic without having to worry about coding details. Debugging is reduced dramatically, and deadlines are more easily met.

<i>FirstTime</i> for PASCAL	\$245
<i>FirstTime</i> for C	\$295
Microsoft PASCAL Compiler	\$245
Microsoft C Compiler	\$395
Demonstration disk	\$25

Get an extra \$100 off the compiler when it is purchased with *FirstTime*. (N.J. residents please add 6% sales tax.)

Spruce

Technology Corporation

110 Whispering Pines Drive
Lincroft, N.J. 07738

(201) 741-8188 or (201) 663-0063

Dealer enquiries welcome. Custom versions for computer manufacturers and language developers are available.

FirstTime is a trademark of Spruce Technology Corporation.



DATA FLOW

Functions connected by data flow are not dependent on adjacent functions. They simply do their jobs, sending and receiving data as available. This independence is what makes it easier to develop and maintain data-flow-connected functions.

Connections that pass control require that the functions be on the same computer at the same time, and many require that the functions be written in the same language.

In contrast, functions connected only by data flow, such as job steps, need not be on the same computer at the same time, or ever. For example, an independent job step can ex-

ecute as long as its input data is available and it can dispose of its output data. It is not dependent on whether the previous step is or was ever on the same machine, or even if it was accomplished on any machine—it may be a manual step. The only constraint is that the passed data be available.

Actually, most connections between functions are data flow. Job steps are data-flow-connected; so are commands in on-line development systems. Consider the commands that read in a file, sort it, and print. These commands operate independently and can be used to process the data

(continued)

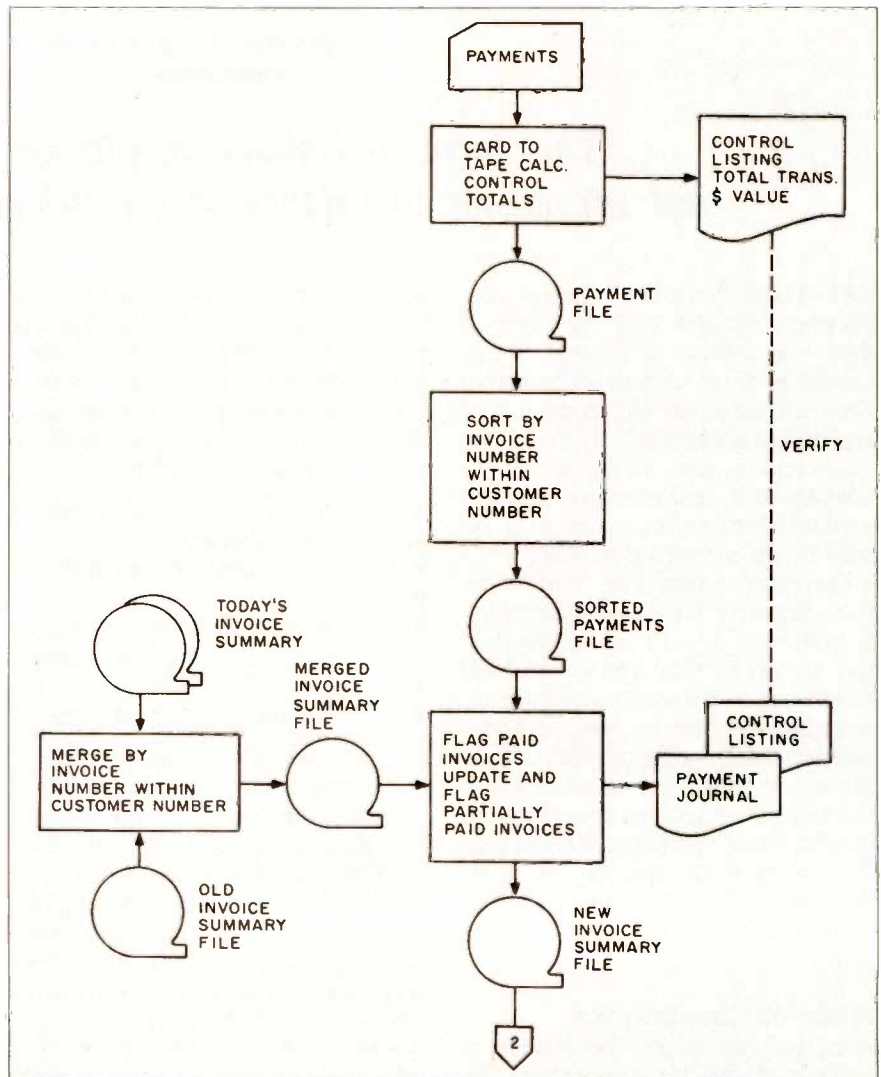

Figure 1: A systems flowchart—also a data-flow diagram.

DATAEASE™

The Corporate Database Standard.

DATAEASE

#1 with Corporate users.

Thousands of businesses, both large and small, use DATAEASE to solve their needs. Because DATAEASE, with its ideal combination of power and ease-of-use, allows you to gather, link, calculate and report information key to decision making — all without programming skills.

"We chose DATAEASE over dBASEII™ and Lotus 1-2-3™ because most of the programming was already done."

Joe Dane, Human Resources Director
MCI Telecommunications Corporation

"Office staff members with little to no computer experience are actively using DATAEASE to improve productivity in handling large amounts of information."

Louis M. Brigando, Senior VP,
MetPath, Inc.

"We switched from a \$250,000 mini system to a \$15,000 system of IBM PC's and DATAEASE. Now orders, inventory, sales ... everything is easier. All without the help of a programmer."

J.A. Fulmer
Robinson
Foundry, Inc.

DATAEASE

#1 with Reviewers

"I was very impressed with its overall performance and features."

Bill Jacobson
BYTE, October 1984

'DATAEASE is a true winner.'

Business Computer Systems
April 1984

DATAEASE was rated good or excellent in performance, documentation, ease-of-use, error handling, support...in all areas.

InfoWorld
March 25, 1985

"DATAEASE is perhaps the most effective blend of ease-of-use and performance available for PC users to date."

Data Decisions
January 1985

For information or the dealer nearest you call:

800-243-5123

DATAEASE

#1 in Corporate sales.

According to several recent best seller lists, DATAEASE is now the industry standard for corporate users who want a database that doesn't require programming:

DATAEASE tops dBASEII, R:BASE™ in Corporate Software sales.

Infosystems, March 1985
Corporate Best Seller List

DATAEASE outsold all other database management systems — ahead of dBASEIII™, Symphony™, Framework™ and R:BASE 4000.

MIS, Inc., September 1984
A leading supplier to Corporate America

DATAEASE ranked #3 on best sellers list; outselling Lotus 1-2-3™, R:BASE and Powerbase™.

Software News, March 1985
Corporate Best Sellers List

Why settle for less? Contact Software Solutions, Inc. for more information on DATAEASE, the #1 choice of Corporate America.

Software Solutions, Inc.

305 Bic Drive, Milford, CT 06460

203-877-9268

Telex: 703972

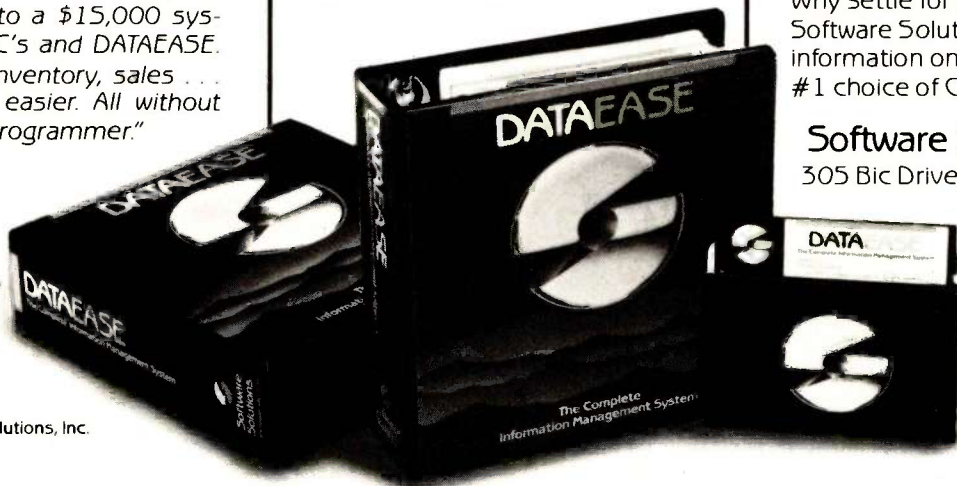

© 1985 Software Solutions, Inc.

Scandinavia
West Soft A/S, Alesund, Norway; (47) 71-41141

United Kingdom
Sapphire Systems, Essex; 01-554-0582

South Africa
Dataflex, Craighill; 11724-6355

West Germany, Austria
M&T Software Verlag, Munich; 089-4613-0

Switzerland, France
Softsource, S&A 1222 Vesenz, Switzerland; 022-3518-55

the previous command produced as output, that is, read, sort, and print the same file. Similarly, data flow connects the commands or transactions in on-line applications. The interfaces between computer applications and their users are also based on data flow. And functions in distributed applications operate independently, passing data to one another.

The various commands within text editors are also data-flow-connected. They do not call each other, they just act on the data in the file being edited. You can execute them in any order. And the text editors are data-flow-connected to the text processors that format and print the data. The UNIX shell can connect independent modules with data flow via *pipes*. IBM PC-DOS uses a similar technique to let programs pass data to generalized I/O (input/output) routines.

USING DATA FLOW

You and I use data flow every time we communicate with someone else,

pass a form or letter along, or enter data into a computer. In fact, it is hard to avoid using data flow. Let's apply this inherent knowledge to the process of developing applications.

The basic tool for utilizing data flow is the data-flow diagram. This is similar to a systems flowchart but with slightly different symbols. Data-flow diagrams do not indicate the medium on which the data will be passed (tape, disk, printer, etc.). Data-flow diagrams using the Gaine and Sarson notation (see reference 1) include five symbols (see figure 2). Functions are represented by rectangles, and flows of data among them by arrows. Files and databases are represented by a U-shaped symbol on its side (or just parallel lines). Squares represent external entities that are sources or targets for data (e.g., user departments). Small circles are used for off-page connectors. And typically, data flows from left to right in the diagrams.

One advantage of this notation is its

ability to include both the limited system name for a function or file and a longer, descriptive label. There are other notations (see figures 3 and 4), but the meaning is the same. They all show functions connected by flows of data to other functions, to files, and to external entities.

The key to developing data-flow diagrams that are easy to work with is to keep them to 7 ± 2 functions. Our short-term memory can handle only 7 ± 2 chunks easily and accurately. (This is why, for example, local telephone numbers were limited to 7 digits.) An $8\frac{1}{2}$ - by 11-inch piece of paper also contains approximately the amount of information we can easily handle at one time. It is no accident that data-flow diagrams kept to 7 ± 2 functions will fit on a single page.

You can represent larger numbers of functions without exceeding 7 ± 2 functions in any one diagram by using hierarchies (see figure 5). Any function on a data-flow diagram can represent

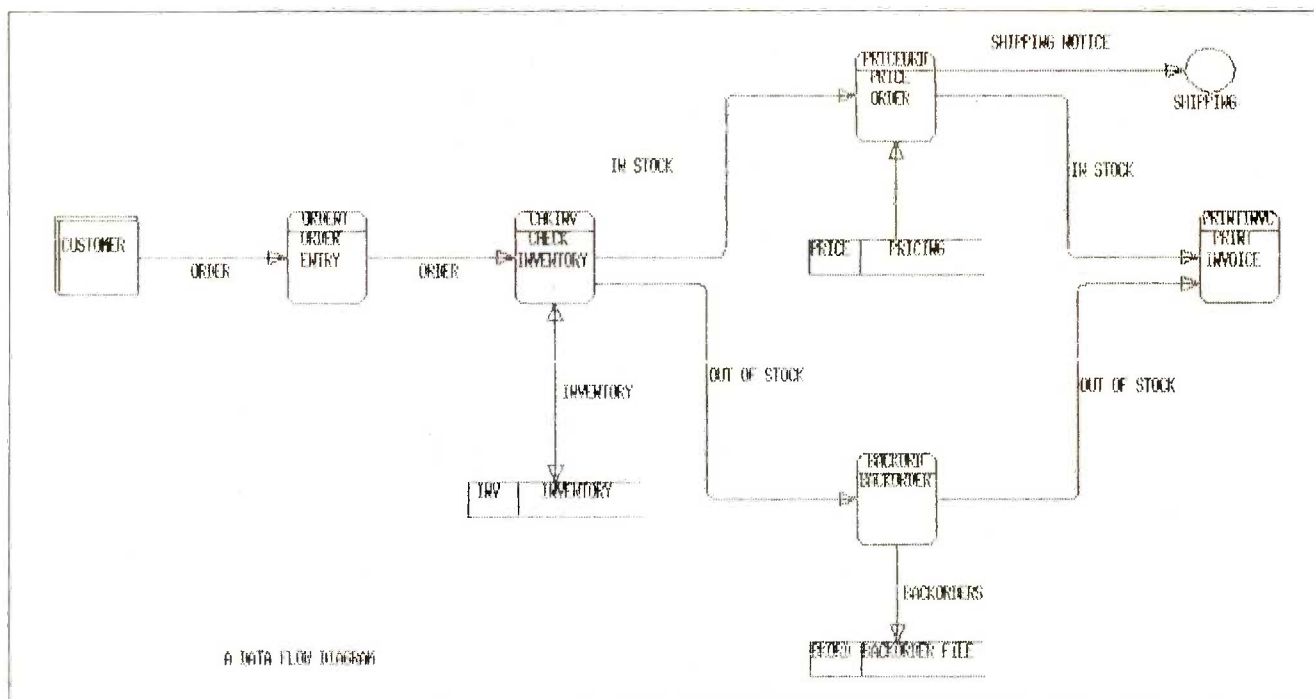

Figure 2: A data-flow diagram. Rectangles represent functions (notice that each rectangle contains a short description of the function and, above it, the name of the computer module that implements it), arrows represent flows of data, squares represent

external sources or destinations of the data, and sideways Us represent files or databases. This figure was drawn by EXCELERATOR, a program that manages and manipulates data-flow diagrams.

a lower-level data-flow diagram, and so on. The process stops when you are going to implement a function via a different technique, for example, as an individual module or as a hierarchy of called modules. It is not necessary to decompose all the functions at any given level in the hierarchy. Any one or more may be decomposed, while others in the same diagram can be bottom-level modules.

In hierarchies of data-flow diagrams, a function's lowest-level diagram must show the data flows into and out of it (see figure 5). However, higher-level diagrams can repeat files and external entities shown on a lower-level diagram or not, as desired. In fact, often the highest-level diagrams only show the major flows of data. The files are relegated to the lower-level diagrams. It is helpful, though, to show files shared between two functions on the highest-level diagram that contains the two functions.

How do you design the flows of data within a single diagram? If you are documenting an existing manual or automated application, you can do the following:

- Record existing functions and the data that flows among them.
 - Include existing files and external sources and targets for data.
 - Name each function, flow of data, file, database, and external entity.
- Note that functions *do* something to the data, and thus typically their descriptions start with a verb (e.g., READ THE SCREEN, EDIT THE DATA). Flows of data are objects. Their descriptions are usually nouns, often qualified by an adjective (e.g., MASTER RECORD, FORMATTED RESULTS, TRANSACTION). Files and databases typically have names that indicate their contents (e.g., PAYROLL, ORDERS, TRANSACTION LOG). An external entity can be a manual step, another application, input data, or an output report. Its name usually reflects the name of the user, application, data, or report.

Some approaches and tips that can help when you design a new data-flow
(continued)

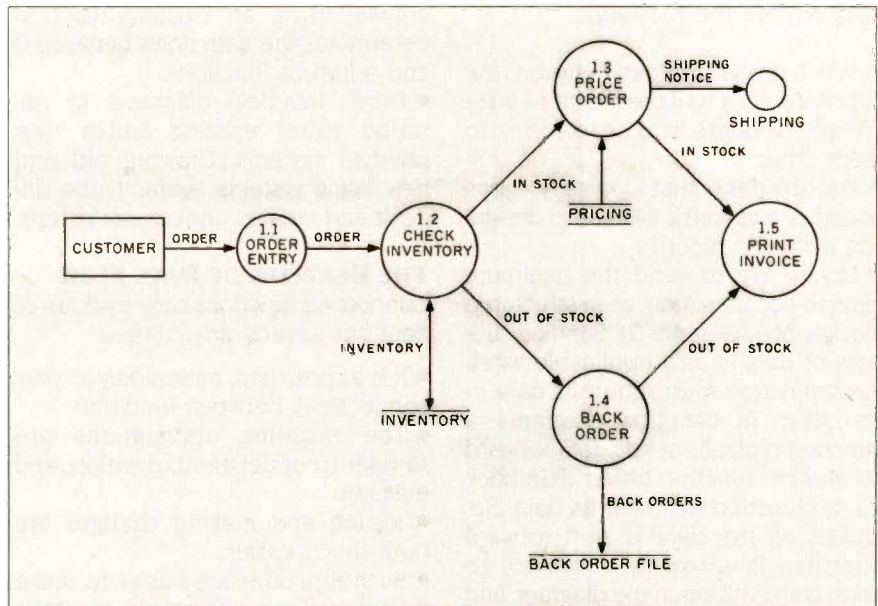

Figure 3: A Yourdon data-flow diagram. This diagram is equivalent to figure 2 but is in the notation used by Yourdon Inc.

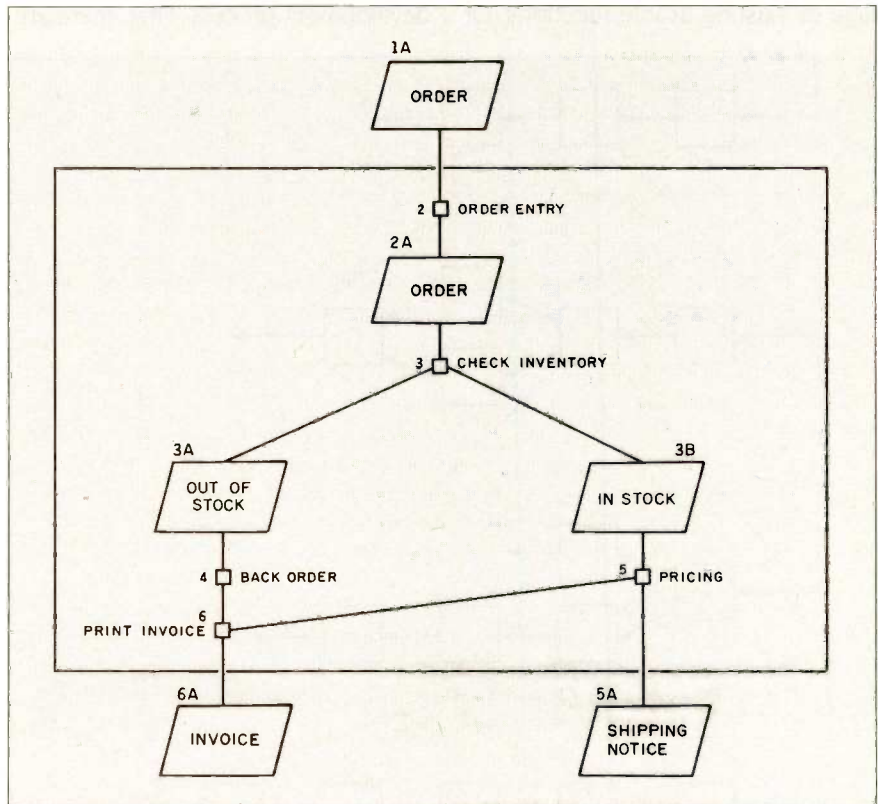

Figure 4: A data-flow diagram in Swedish notation. This diagram is equivalent to figures 2 and 3 but uses a different notation. Note: The large boxes are forms and the small ones are functions.

diagram are the following:

- When designing flows between new functions, do it as if the functions were people at desks who send forms to each other.
- Group data that logically goes together into forms (similar to designing a flat-file record).
- Do *not* try to send the minimum data to each function, as in structured design (see reference 2). Sending subsets of data is only applicable when each function must return its data to its caller. In data-flow diagrams, a function typically sends data forward to another function rather than back to the function that sent its data. So, unless all the data is sent forward together, it is usually necessary to reassemble it later in the diagram, and this is a complex and unnecessary task.
- Since a big advantage of data-flow connections is easy reuse, take advantage of existing usable functions. Of

course, using an existing function determines the data flows between it and adjacent functions.

- Draw data-flow diagrams to describe either existing and/or new physical systems. Drawing old and new *logical* systems seems to be difficult and creates unnecessary steps.

THE BENEFITS OF DATA FLOW

Connecting functions only by flows of data has several advantages.

- It is a consistent, natural way to view connections between functions.
- The resulting applications are simpler to understand, develop, and maintain.
- Testing and making changes are both much easier.
- Such functions are easier to reuse than functions connected in other ways.

Developing applications involves viewing them at several phases in the development process. First, there are

the manual applications that are being automated or to which an automated application must interface. You can describe manual applications with data-flow diagrams. In fact, data-flow diagrams may be the best way to picture many manual applications so that people not trained in data processing can easily understand and relate to them.

The development phases include application identification, analysis and design, implementation, and maintenance. The purpose of application identification is to determine the major functions to be performed and the flows of data among them. This is the information that data-flow diagrams depict. Structured analysis is the technique of using data-flow diagrams for the analysis and design phase. Most of the advantages of structured techniques come from the ability to consider part of the application relatively independently of the rest. The segmentation of structured programming, the modules of structured design, and the functions of HIPO (hierarchy plus input, process, output) provide the pieces we can consider separately. Hierarchies provide these advantages for data-flow diagrams.

Functions must share data in order to be part of the same application. Data-flow diagrams can picture the flows between many of the functions during implementation, for example, jobs, job steps, and on-line commands. And you can use the same diagrams for maintenance that you used for design and implementation. Often, applications in these various phases are seen differently. This requires translating between the different views as development proceeds, which adds complexity and introduces errors. However, you can use the data-flow view of an application in all phases of the development cycle.

There are significant advantages to using data flow as a consistent application view. First, you can include both manual and automated functions in the same diagram. Second,

(continued)

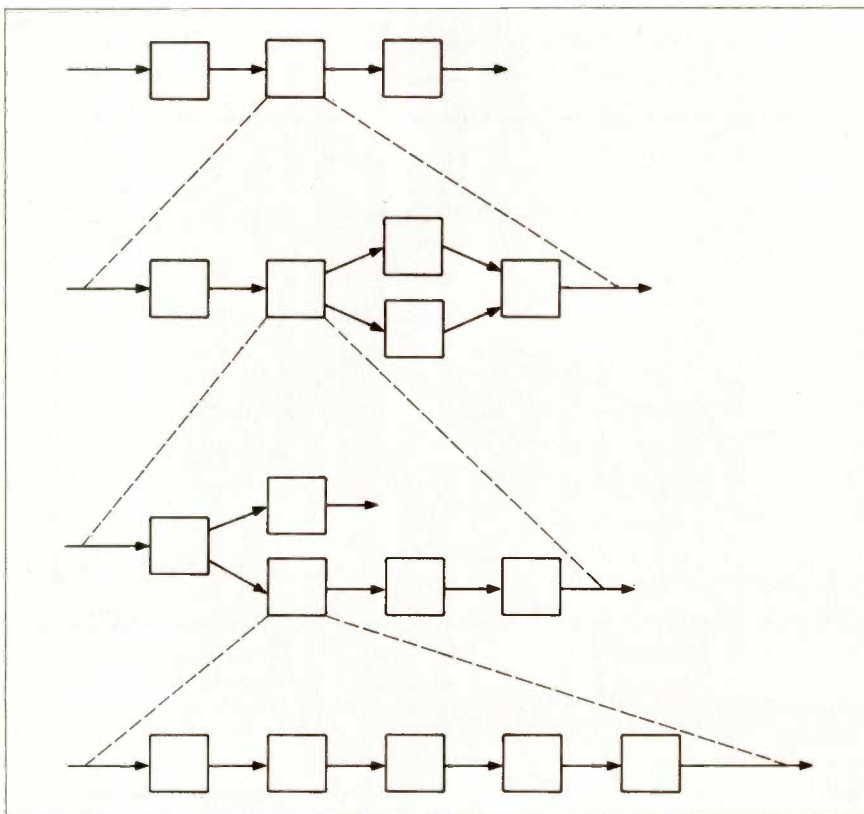

Figure 5: Skeleton hierarchies of data-flow diagrams.

Princeton Graphic Systems and Sigma Designs team up to give you a brighter, sharper display.

SR-12 and Color 400. A brilliant combination for super-high resolution graphics and a crisp character display. For a brighter,

sharper display with all your IBM PC-compatible software here's a team that can't be beat. The SR-12 super-high resolution RGB monitor from Princeton Graphic Systems and Color 400, the advanced color graphics adapter card from Sigma Designs.

Snap in Color 400. Begin by snapping Color 400 in to your IBM PC, XT, or AT. No switches to set. No cables to confuse. Color 400 gives you a razor sharp 640 x 400 display. It

**COLOR
400**

automatically *doubles* the number of lines on standard 200 line software. Watch your graphics come to life. Enjoy fully formed, monochrome-quality characters in text mode. Just turn on your PC and tune in a whole new world of vibrant color.

Turn on SR-12 for the impressive results. The SR-12 displays your Color 400 image with unmatched clarity and brilliant color. Because the SR-12 combines a .31mm dot pitch tube and a non-glare screen with an incredible 640 x 400 non-interlaced resolution, you get a flickerless image that's as crisp and clean as a personal computer can produce.



SR-12

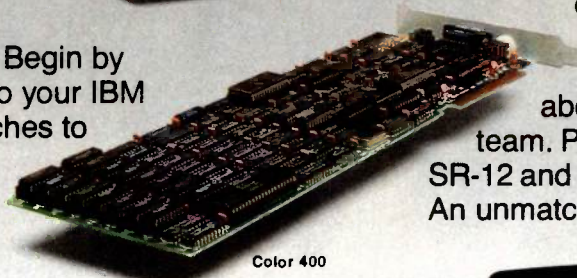

Color 400

See how impressive this state-of-the-art image can be on your own PC system. Visit your local retailer today and ask about this new color graphics team. Princeton Graphic System's SR-12 and Sigma Designs' Color 400. An unmatched, brilliant combination.



**SIGMA
DESIGNS**

SIGMA DESIGNS, INC., 2023 O'Toole Avenue, San Jose, CA 95131
(408) 943-9480 Telex: 171240

PRINCETON
GRAPHIC SYSTEMS
AN INTELLIGENT SYSTEMS COMPANY

Princeton Graphic Systems, 601 Ewing Street, Bldg. A, Princeton, N.J. 08540
(609) 683-1660, Telex: 821402 PGS PRIN, (800) 221-1490 Ext. 204

Graphic Screens courtesy Mouse Systems, Inc. and Forthright Systems, Inc.

IBM PC, PC XT, and PC AT are registered trademarks of International Business Machines, Inc.

2 Megabytes

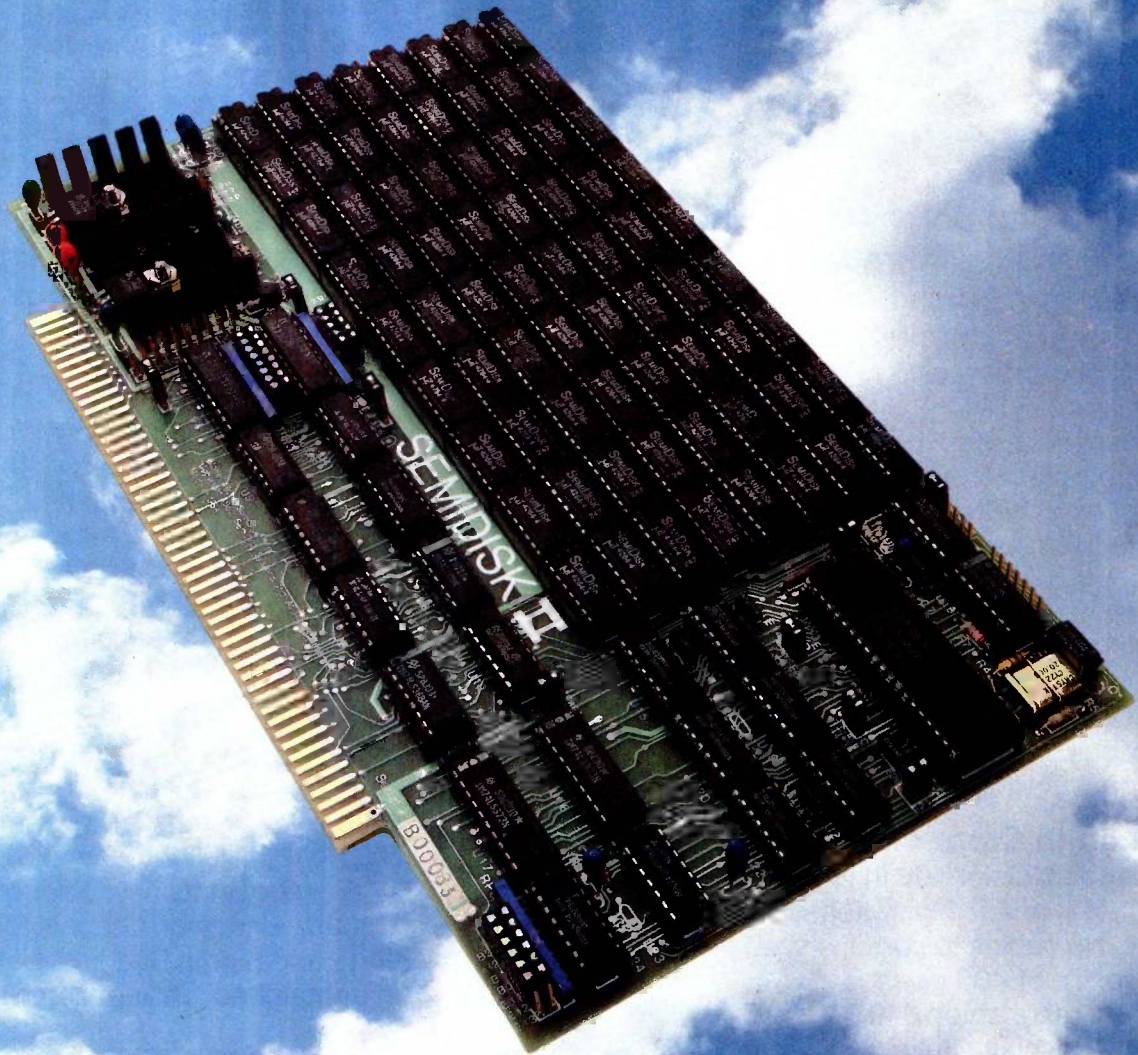

THE LARGEST CAPACITY DISK EMULATOR YOU HAVE EVER SEEN.

You know about disk emulators. They're fast semiconductor disk drives. Very fast. But until now, the most disk storage you could get on a single board was 1Mbyte. (That was from us, too.) Now we have news that'll really blow your socks off... 2 Megabytes on a single board. Available NOW. That's not a pie-in-the-sky promise.

That's enough storage for dozens of large programs and hundreds of kilobytes of data files. Enough for almost anything you want to do with a disk drive. But that's not all. With SemiSpool, our CP/M print spooler, you can implement a print buffer hundreds of kilobytes long in seconds. All in software. At no extra cost.

Another thing about disk emulators. Unless they're from SemiDisk Systems, they're probably afraid of the dark: Lose power or turn the computer off, and your valuable data goes to that big backup disk in the sky. But our Battery Backup Units keep SemiDisk data flying high while your computer is off, and up to 10 hours during a complete blackout.

So remember this: SemiDisk Systems has been building dedicated microcomputer disk emulators longer than anyone. And larger. And faster. And at a much lower cost. And that's not a lot of hot air.

AT A PRICE YOU NEVER THOUGHT YOU'D SEE

	<u>\$12K</u>	<u>1Mbyte</u>	<u>2Mbyte</u>
SemiDisk I, S-100	\$995	\$1795	
SemiDisk II, S-100	\$1295	\$2095	\$2549
IBM PC, XT, AT	\$945	\$1795	\$2499
QX-10, QX-16	\$799		\$2499
TRS-80 II, 12, 16	\$995	\$1795	\$2499
Battery Backup Unit	\$150		

SEMIDISK

SemiDisk Systems, Inc.
P.O. Box GG, Beaverton, Oregon 97075
503-642-3100



Call 503-646-5510 for CBBS/NW, 503-775-4838 for CBBS/PCS, and 503-649-8327 for CBBS/Aloha, all SemiDisk-equipped computer bulletin boards (300/1200 baud). SemiDisk, SemiSpool trademarks of SemiDisk Systems. CP/M trademark of Digital Research.

you can automate various functions within a diagram at different times without having to modify it. And third, cycling back for corrections is much easier since it doesn't require translating between various different application views.

Data flow is the natural way to connect functions because that is how people interact with each other. We go about our business independently until we exchange information with others by talking with them, passing along forms, etc. In the same way, application functions connected by data flow operate independently and interact with each other by exchanging data.

Data-flow diagrams can describe applications from the simplest to the most complex, whether on-line, batch, or distributed. With data flow, on-line applications differ from batch only by doing input and output to terminals rather than to readers and printers. Distributed applications are naturally data flow since they consist of functions that execute independently and send data to each other.

The complexity of developing applications rises exponentially as their size increases. For example, a two-page program is more than twice as hard to develop as a one-page program. Not only must each of the two pages be developed, but the connections between the two pages must also be handled, especially if different people developed the two pages. You can reduce this complexity if you can divide the application into parts that can be developed relatively independently. The more independent the pieces are, the simpler the development.

Hierarchies of data-flow diagrams have a significant advantage over call hierarchies. With data-flow diagrams, you can consider each level separately. But call hierarchies make sense only if two or three levels are viewed together. You must consider at least two levels of a call hierarchy in order to even see the relationships between functions. Data-flow connections, on the other hand, are between functions on the same level. Thus, you can con-

sider each level of a data-flow diagram independently, making them easier to work with and understand.

The most easily reusable functions are those you can use without having to understand their internals. It is easier to reuse modules that have been separately compiled so that you don't have to synchronize the local

variables and labels with those of the including module. However, modules in a call hierarchy have the definition of the hierarchy imbedded within them. Thus, it is difficult to reuse any but the bottom-level modules in another hierarchy without recoding them; obviously, recoding requires

(continued)

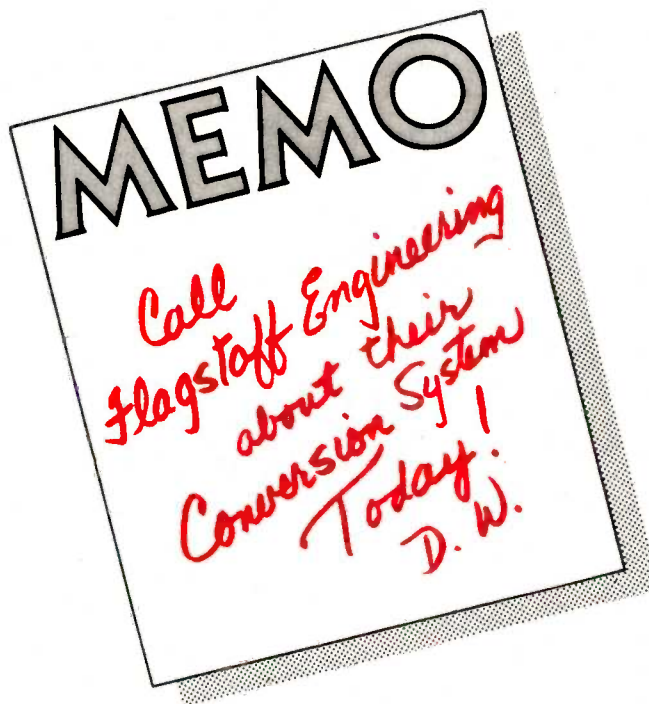

NEW SOLUTIONS for DATA/FILE CONVERSIONS

Our "FILE CONNECTION" programs provide 8" diskette file exchange between the IBM PC and most Micro-Mini-Main Frame computer systems.

Our "WORD CONNECTION" programs provide 8" diskette text document exchange between the IBM PC and many word processing systems.

Our "DISPLAYWRITER CONNECTION" programs transform documents from Textpack, Wordstar, Multimate, etc. to the new DisplayWrite 2 format. Also, conversion service is available upon request.



Flagstaff Engineering

P.O. Box 1970 • Flagstaff, AZ 86002 • (602) 774-5188 • TELEX 705609

Call Today!

Name _____
 Position _____
 Company _____
 Address _____

Yes! Please have someone call me!



Keep Your Computer Fit With CROSS-CHEX™

Cross-Chex is the complete menu-driven system of hardware diagnostics. It analyzes performance levels of Winchester and floppy disk drives, video display, RAM memory, video memory, ROM character generator and keyboard. Includes (1) Diagnostic Diskette (1) Cross-Chex Program Diskette (1) Users Manual. Let Cross-Chex keep your computer fit, ensure the performance of your computer, maximize your uptime and maintain the integrity of your data all for the low price of \$99.00.

Convert any CP/M to DOS with CROSSDATA®

Crossdata is the low-cost utility software that converts data/text file formats from CP/M to MS/PC-DOS and back again on any IBM PC/XT or clone.

It is a self-contained program, ready to run, that reads/writes CP/M and MS/PC DOS Diskettes using MS/PC-DOS 2.0, 2.1 or 3.0 and comes with 28 formats—plus you can add your own!

Solve your computer incompatibility problems fast with Crossdata, the proven conversion package, by ordering one today for only \$99.00.

Backup/Restore for Winchester under PC/MS-DOS, CP/M86 and CCPM with CROSSAVE™

Now you can back-up large data base files from a Winchester to a floppy for files that exceed the diskette capacity.

Crossave will save and/or restore a file or a selected group of files that have been updated. It also backs up and restores all of the files on the Winchester. It uses compression to reduce storage space requirements on the floppy and expands the file upon restoration. Requires IBM PC/XT or clone.

Reasonably priced at \$99.00.

No risk 10-day money back guarantee on all products

Don't delay. Call us today: (408) 395-2773 or write:



**AWARD
SOFTWARE,
INC.**

236 North Santa Cruz Ave.,
Los Gatos, CA 95030

All major credit cards accepted

DATA FLOW

RECOMMENDATIONS

1. Use data-flow diagrams to document all types of applications throughout the development process.
2. Obtain reference books on data flow (see references 1 and 3).
3. Keep data-flow diagrams to 7 ± 2 functions by constructing hierarchies.
4. Decompose functions to as small a module as your environment allows. If this is larger than one page of specifi-

5. Design flows of data as though the functions were being done manually and connected by flows of forms.
6. Obtain a good tool to help draw the diagrams, and one that captures the information for use later in the development cycle.

knowledge of their internals. Data-flow-connected modules don't even know the adjacent modules exist. This makes them more easily reusable.

AVAILABLE RESOURCES

Designers of data-flow diagrams have, up to now, struggled with several complications we no longer face, including lack of education and documentation and lack of adequate automated tools to help draw the diagrams. Today there are companies and consultants who teach data-flow concepts; you will probably find people in your own company who already use data flow. Good reference books include those by DeMarco (generally considered to be the father of structured analysis—see reference 3) and Gaine and Sarson (reference 1). The text listed as reference 4 provides a description of the advantages of data-flow mechanisms at the module level.

Several good products have emerged in the past year or so that automate the process of drawing and maintaining data-flow diagrams. Various personal computer software packages are adequate for drawing and maintaining data-flow diagrams. I recommend you look for several characteristics in such a tool. It should let you enter and change the diagram easily. It should enable you to construct hierarchies of data-flow diagrams and, preferably, to move between these hierarchies while drawing them. It should allow you to enter definitions of functions and data into a dictionary for later use in the development process. And it should allow

for selective input and output of such specifications so they can be shared with other people and used by other tools. One example of such a tool is EXCELERATOR, available from Index Technology Corp. (Cambridge, Massachusetts) for \$8400.

SUMMARY

Data-flow connections are the most prevalent connection between functions in computer applications. They exist among job steps, on-line transactions, manual processes, jobs in the same application, and distributed applications. You can describe them with data-flow diagrams (which are similar to systems flowcharts). These diagrams provide a natural way to describe applications. You can use them throughout the development process and for all sizes and types of applications. Since we naturally interface with each other in a data-flow manner, common skills are used to draw the diagrams. And applications constructed from data-flow-connected functions are easier to understand, develop, and maintain. ■

REFERENCES

1. Gaine, C., and T. Sarson. *Structured Systems Analysis: Tools and Techniques*. New York: Improved System Technologies, 1977.
2. Stevens, W. P. *Using Structured Design*. New York: John Wiley & Sons, 1981.
3. DeMarco, T. *Structured Analysis and System Specification*. New York: Yourdon, 1978, pages 1-125.
4. Stevens, W. P. "How Data Flow Can Improve Application Development Productivity," *IBM Systems Journal* 21, No. 2, 1982, pages 162-178.

COMPUTER HUT™

COMPARE
OUR
SERVICE & PRICE!

SPECIAL OF THE MONTH

IBM-PC, XT & AT
CALL FOR
PRICE

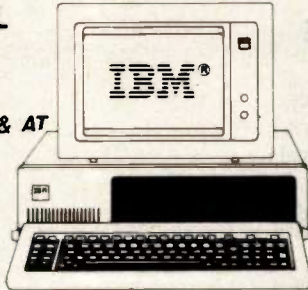

COMPAQ® CALL

DISK DRIVES

Tandon TM100-2 DS/DD	\$159
MATSUSHITA JA 551	\$139
TEAC FD-55B Slimline	\$139

HARD DISKS/TAPE

MAYNARD	
WSI	\$849 WS2 \$1049
IOMEGA	
Bernoulli Box 20 Meg	\$2695
EVEREX, SYSGEN	CALL

ME MAYNARD ELECTRONICS	
Floppy Disk Controller	\$129
FDC w/Par. Port or Ser Port	\$179/189

ADD-ON BOARDS

QUADRAM	
Quadboard 64K exp. to 384K	\$269
Quadcolor I & II	CALL
Quad 512+ 64K	\$239

AST RESEARCH	
SixPak Plus 64K	\$269
MegaPlus II 64K	\$279
I/OPlus II	\$129
Advantage	CALL

MICROLOG	
Baby Blue II 64K	\$489

TECMAR	
Graphics Master	\$489
MAESTRO	CALL

HERCULES	
Hi Res Mono Graphics	\$335
Color Graphics w/Par Port	\$189

PARADISE	
Modular Graphics	\$285
5-PACK	CALL

MODEMS

Hayes®	
Smartmodem 1200	\$429
Smartmodem 1200B	\$389
Smartmodem 2400	\$649
BIZCOMP	
PC Intellimodem	\$359
NOVATION	CALL
SmartCat	\$349

PRINTERS

EPSON	
FX-80+	FX-100+
RX-80 BEST	RX-100 BEST
JX-80 DEAL	LQ-1500 DEAL
LX80	

brother	
HR-15 XL	\$399
HR 35	\$839

DYNAX/FORTS	
DX-15 Par	\$399
DM40 NLQ	CALL

C-ITOH	
PROWRITER	CALL
STARWRITER F-10P	\$995

OKIDATA	
182P	
84P BEST	84S BEST
92P PRICES	92S PRICES
93P	93S

NEC	
Spinwriter 2050	\$699
3550	\$1449 8850 \$1949
Pinwriter P2	\$589 P3 \$795

TOSHIBA	
P1351	\$1299 P1340 \$649

DAISYWRITER	
2000 w/48K Buffer	\$849

DATAPRODUCTS	CALL
---------------------	------

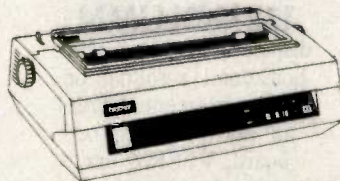

ASK ABOUT OUR
TRAINING & REPAIR
SERVICES.

MONITORS

AMDEK	
Video 300G	\$135 300A \$145
Video 310A \$179

PGS	
HX12 Hi Res RGB monitor BEST
MAX-12 Hi Res Mono PRICES
SR-12 Super Hi Res RGB	



SOFTWARE

WORDPROCESSING	
MS Word	\$239 Multimate \$269
Volkswriter Deluxe \$159
PFS: Write	\$89 PFS: Proof \$69
WordPerfect	\$269 WordStar CALL

DATABASE/INTEGRATED	
dBase III	CALL Quickcode III \$179
RBase 4000	\$279 Clout 2.0 \$169
LOTUS 1-2-3 & Symphony CALL
Framework	CALL

UTILITIES/COMPILERS	
Crosstalk	\$109 Smartcom II \$109
Sideways	\$49 Norton Utilities \$59
Sidekick	\$45 Turbo Pascal \$45
LIFEBOAT Lattice C \$299
MS Basic	\$259 MS Fortran \$239

BUSINESS	
MICROSOFT Project	\$159 Chart \$159
STAR Acct. Partner I & II	CALL
BPI SYSTEMS	CALL
PFS: File	\$89 PFS: Graph \$89
PFS: Plan	\$89 Multiplan \$139

OTHER	
Mastertype	\$35 Typing Tutor III \$39
Math Blaster \$39
Flight Simulator \$39
Managing your money \$135

AND LOTS MORE

ANY PRODUCT NOT
LISTED? CALL

EAST COAST

COMPUTER HUT
OF NEW ENGLAND INC.

101 Elm St. Nashua, NH 03060

(603) 889-0666

For Orders Only — (800) 525 5012

CANADA

MICROCONTEXT
AUTHORIZED DEALER

4847 Ave Du Parc
Montreal Que H2V4E7.

(514) 279-4595

MID-WEST

COMPUTER HUT INC.

524 S. Hunter
Wichita, Kansas 67207

(316) 681-2111

For Orders Only — (800) 572 3333

All products usually in stock for immediate shipment and carry full manufacturers' warranty. Price subject to change — this ad prepared two months in advance. You get the lowest price. We honor personal checks — allow 10 days to clear. COD up to \$300 add 2%. Visa, MasterCard add 2%. For shipping & insurance add 2% or \$6.00 min. for small items and \$12. min. for monitors, printers, etc. We accept company checks and P.O.'s from Fortune 1000 Companies.

IBM is a trademark of IBM Corp.

Return authorization and order status call information line

Inquiry 103

45

Let's get straight to the point. We think our VTERM software is the most powerful and versatile micro-to-mainframe link you can buy for an IBM PC or compatible. The fact is,

NO OTHER COMMUNICATIONS PROGRAM DOES SO MUCH.

VTERM is a single integrated package that combines terminal emulation, file transfer, mainframe graphics, and general communications capabilities. As a terminal emulator, VTERM is unsurpassed by other software. It

URNS YOUR PC INTO A VT100 OR TEKTRONIX 4010 TERMINAL.

The emulation is complete. Host software written for a VT100, VT52, VT101, VT102 or Tektronix 4010 will run without change using a PC and VTERM. You get throughput to 9600 baud, printer and plotter support, disk capture of graphics and text, easy-to-use setup screens, multiple setup files, programmable softkey macros, on-line help, automatic dialing, full keyboard emulation, and more.

FOUR ERROR-CORRECTING FILE TRANSFER PROTOCOLS

are supported by VTERM. They include our powerful VTRANS 7 and VTRANS 8 protocols. (VTERM comes with complete VTRANS host software for several host operating systems.) In addition, you get ASCII text file exchange and XMODEM, as well as the new micro-to-mainframe standard:

KERMIT. YES, KERMIT!

Kermit is a versatile error-correcting file transfer protocol developed at Columbia University. VTERM's Kermit supports wildcard transfers, server commands, data compression, command macros, and other advanced features. Kermit requires host software which is available at nominal cost from Columbia for many host operating systems.

THE VTERM HOT KEY

lets you switch instantly between DOS and VTERM, so you can run local programs without losing your terminal screen or link to your host.

132 COLUMN

display is emulated with horizontal scrolling or fully implemented with an optional adaptor board. VTERM can redisplay data that has scrolled vertically off the screen.

VTERM

is now available in two versions. VTERM 4010 has all the features described above. VTERM II has all the features of VTERM 4010 except Tektronix 4010 emulation. VTERM runs on the IBM PC, XT, AT, Portable, and compatibles.

Inquiry 87

JOIN US AT
**NEW YORK
COLISEUM
JUNE 17-19
1985**
BOOTH NO. 2012



Coefficient Systems Corporation
611 Broadway, New York, NY 10012
(212) 777-6707 ext. 201

DEBUGGING TECHNIQUES

BY GREGG WILLIAMS

*There are no magic formulas but there are tools,
and the most powerful one is your own brain*

NOBODY LIKES TO debug a program. It is tedious, time-consuming, and often maddening. Debugging your own code is bad enough, but debugging someone else's (often someone who is no longer available for questions) can be argued to be cruel and unusual punishment—nevertheless, it has to be done.

This article is a compilation of debugging techniques gathered from my personal experiences programming in a commercial environment, the experiences of other BYTE editors and programmers, and published texts. The news is not good: There are no magic techniques; debugging is accomplished mostly through the sustained use of a perceptive, disciplined mind. Still, you will find the techniques described here useful if you aren't already acquainted with them.

Although I have tried to make the article as general as possible, I'll assume that you are running a high-level language—BASIC, probably—and that you don't have access to any sophisticated debugging tools.

BEFORE DEBUGGING

If you are fortunate enough to be writing your own code, you can make

the debugging process easier. Here are some suggestions:

- Use structured programming. This does not mean that you have to give up GOTO statements, only that you not misuse them. You can use structured programming techniques with *any* computer language, not just so-called structured languages like Pascal and Modula-2. Structured programming is a discipline; adopting it will improve your programs more than anything else mentioned in this article. If you do not know much about it, you can find plenty of books and articles on the subject.
- Design your programs modularly. Consider the program diagrammed in figure 1 (each block is a module of code). If the program is considered as a monolithic whole, you will have to test the 30 ($3 \times 2 \times 5$) separate paths the program can go through to debug it properly. If you debug the modules separately, you must test 11 things—each of the 10 modules plus the containing program that glues them together.
- Program for clarity and optimize later. Write your code to be readable, not clever—the performance gain

from terse code is usually not worth the extra programming time that the code will consume over the life of the program. If you *must* optimize the program, get it working first, then examine it to determine where optimization will be the most effective.

- Avoid—or at least isolate and document—system-dependent code. This is more important if you are writing programs at work (where you may switch computers someday), but it never hurts to call attention to program behavior that is not determined solely by the code itself.

- Document your program well, using both program comments and printed documentation.

DEBUGGING THEORY

Too many of us go about debugging haphazardly and so spend more time at it than we need to. To be effective, debugging must be led by the "perceptive, disciplined mind" mentioned

(continued)

Gregg Williams is a senior technical editor at BYTE whose programming credentials include an M.S. in computer science and several years programming COBOL, BASIC, and APL. He can be reached at POB 372, Hancock, NH 03449.

above. But what discipline do we follow?

My experience leads me to say that debugging is best driven by a combination of the scientific method and

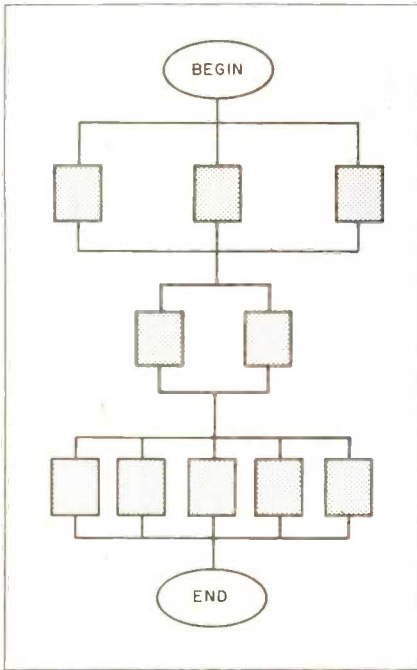

Figure 1: A modular program diagram. To test the program as a whole, you would have to test 30 ($3 \times 2 \times 5$) different paths.

hunch playing. The scientific method, which is the cornerstone of all scientific discovery, can be modified for debugging and described as follows:

1. Describe the error.
2. Gather data about the program's behavior.
3. Guess what caused the error (consistent with all the data gathered so far) and take steps to fix it.
4. Test your guess. (Does the program now work?)
5. If your guess does not fix the error, go to step 2; otherwise, you have just found and fixed the error.

Actually, confirming the error and fixing it may be two separate operations. You may confirm that a certain variable is causing the error by verifying that the variable contains an incorrect value at a certain point; in this case, fixing the error is a separate step.

In the scientific method, you are trying to find a hypothesis that fits all the facts. In debugging, your hypothesis is "x is causing this error," and you test this hypothesis by correcting x. If the error disappears, your hypothesis is correct and you have found and corrected the error. If it does not (and this is very important), you now have another piece of data—that is, "x does not cause this error"—and your next

hypothesis must be consistent with this added data.

ASSUMPTIONS IN DEBUGGING

An error (also called a bug) can come from several sources. It may be caused by errors in the syntax of the program, errors of logic that cause the computer to malfunction, errors of logic that cause the computer to give plausible but incorrect answers, and errors generated outside the program (by the software or hardware used).

Because of this, you must be careful not to eliminate any area that might contain the source of the error. On the other hand, computer hardware is *not* at fault 99.9 percent of the time, and system software (the operating system, language, and utilities) is not at fault 99 percent of the time. I have summarized these realities in the following three assumptions:

1. The computer is never at fault.
2. The system software is almost never at fault.
3. Everything except this rule is suspect (even assumptions 1 and 2, but at different levels of probability).

In other words, never rule out hardware or system software errors, but pursue these hypotheses only after extensive testing has failed to find all the more probable causes of error.

Table 1: An entry from my debugging log. Such entries may, in the future, help you debug later programs.

Environment: While debugging a Microsoft (binary version) BASIC 2.0 program on a 128K-byte Macintosh computer, I keep getting a "Type Mismatch" error on the execution of the SUB (subprogram) "get.field(new.item\$,1)" (get.field is defined as "SUB get.field(msg.string\$,button.pressed) STATIC"; new.item\$ can have any value (it goes in as a blank string), and 1 is a valid value for the second parameter (which can be either 1 or 2).

Debugging: I get the same error with any other value in the second place (2, 3, etc.). The program works fine when I assign the value to a variable and use a variable in the call, but I check the variable and determine that its value hasn't somehow changed. The program also works if I use "3/3" but not if I use "1 + 0". Why?

Cause: It turns out that "1" is of type "integer" and "button.pressed" is of type "single-precision real" in this version of BASIC. This caused the type mismatch when I used the constant but not when I used the variable. I suspect that "3/3" evaluates as a single-precision constant but that "1 + 0" remains an integer result.

Solution(s): (1) Pass values only through variables. (2) Change the dummy variable to an integer using DEFINT or by appending "%" to it (i.e., "button.pressed%"). (3) Change the constant to a single-precision real by typing it as "1.0" or "1!".

In the future: Be aware of variable types in Mac MBASIC 2.0.

DEBUGGING PRACTICE

Here are some collected notes on debugging:

- Keep an interactive, written record of your debugging. The form is irrelevant, but it should include a statement of the error being sought; hypotheses, their tests, and the results; unanswered questions; and whatever else comes to mind. (Table 1 shows an entry from my debugging log.)
- Equally important, always save a copy of your program before you add the latest "fix." If the fix makes things worse, don't try to undo the damage. Instead, revert to the previous version. You might also profit from keeping versions of the program at different stages of debugging.
- When you are reading a printed

listing, make sure it is current. To be safe, print a new listing periodically.

- Test multiple variations of the program, each of which changes *one* thing about it, and analyze the results carefully. The effects can then be attributed to the change itself. This may give you a clue to the nature of the error you are trying to correct.

- Learn from negative results—even tests that don't seem to tell you anything actually do.

- Don't ignore the possibility of rewriting the code rather than debugging it; this is especially valid when enough previous errors have been patched that the program is more patches than code. If the code is in bad enough shape, you may be able to rewrite it faster than you can debug it, and the resulting code will be easier to read and maintain.

- Be aware of the particular problems of the language being used (for example, inadvertently duplicated variable names in BASIC, misuse of pointers in C, the peculiar behavior of a register, flag, or instruction in assembly language).

- Watch out for often-confused symbols (the letters capital I, capital O, lowercase l, the numerals 0 and 1) and missing spaces and carriage returns.

- Develop literal (for reading code) and speculative (for hypothesizing causes) modes of thought and learn how to strengthen each and switch between the two.

DEBUGGING TECHNIQUES

I have divided these techniques into three broad categories: techniques for eliminating visible errors, finding hidden errors and verifying program correctness, and anticipating future errors. The sections that follow describe techniques that fall into these categories. The three categories begin with the headings "Indirect Methods," "Testing vs. Debugging," and "Preventive Debugging," respectively.

INDIRECT METHODS

Many program errors are quite visible—you know something's wrong because you can see it—but their

causes are not. One way to find the cause of an error is to *play computer*; in other words, with program listing and scratch paper in hand, you execute the program manually, keeping track of variable values on paper. This method is time-consuming and tedious, but it often catches subtle errors. However, you must know exactly what each program statement does, and you must be very literal in simulating code execution; otherwise, you will keep making the mistake that is the cause of the bug. (A variant of playing computer is explaining the error to someone else. Even if the other person doesn't know much about computers and can't offer a solution, you often discover the factor you've overlooked.)

You can sometimes find an error when you look at the structured pseudocode, flowchart, or whatever similar documentation you have.

Because this documentation is at a higher level than actual program code, it may be easier for you to see a logical error in the design of the program.

Finally, browse through your debugging notebook for ideas; you may realize that your current problem is similar to an error you have already fixed.

PRINT STATEMENTS

PRINT statements are probably the most often used debugging tool, but they are not often used effectively. They can be used to gather data about the program's behavior (i.e., "Is this variable doing anything unusual?"), to test a hypothesis ("Is this variable giving the incorrect value *x*?"), or to confirm the correct operation of the program ("Is this variable now giving the correct value *y*?").

(continued)

IBM protects disks in sleeves of TYVEK.



Here's why.

Quality disks deserve a quality sleeve. Sleeves of TYVEK® spunbonded olefin provide unsurpassed data protection because

1. TYVEK is strong—won't tear like paper.
2. TYVEK does not lint.
3. TYVEK is smooth, non-abrasive.
4. TYVEK is chemically clean, has a neutral pH.
5. TYVEK reduces static problems.
6. TYVEK is unaffected by water.

Take the first step to maximum disk data protection. Call 800-44 TYVEK for the names of manufacturers who rely on sleeves of TYVEK.

*TYVEK is DuPont's trademark for spunbonded olefin. DuPont makes TYVEK, not sleeves.



CAN THE JUKI® 6300 REALLY PRINT OVER 500 LETTERS IN 8 HOURS? STAND BACK AND WATCH!

Busy offices, take note: Our new letter-quality printer zips along at **40 characters per second** and sells for only **\$995**. Its 13" print line will handle your spreadsheets and every imaginable kind of correspondence—plus graphics! Quiet, too—less than 60 dbA. And the 3K buffer memory (expandable to 15K) lets you use your computer for other purposes while the JUKI is printing. Compatible with most computers. (You can even get an optional tractor feed and cut-sheet feeder for it!) Now you know why JUKI printers are humming in offices all over the world!



JUKI®
The worker.
JUKI OFFICE MACHINE CORP.

EAST COAST:

299 Market St., Saddle Brook, NJ 07662
(800) 932-0590

WEST COAST:

23844 Hawthorne Blvd., Suite 101, Torrance, CA 90505
(800) 325-6134 • (800) 435-6315 (California)

PRINT statements are most valuable when they are used effectively. Three factors are critical: *what* you are using the PRINT statement for, *what variables* are being examined, and *where* they are being examined. If you misjudge either of the last two factors, you will be gathering data that wastes your time and gives you no insight into your situation.

PRINT statements can be either unconditional, like this:

```
6808 PRINT "At 6808, X = ";X;
      " A$ = ";A$
```

or conditional:

```
6808 IF A$ = "" THEN PRINT
      "At 6808, A$ empty, X = ";X
```

The unconditional PRINT statement is the simplest to insert into a program, but it may cause a distracting number of relatively useless diagnostic statements—if, for example, line 6808 is in the middle of a triple-nested DO loop. The conditional PRINT statement is more useful because it displays itself only when some significant condition occurs (in the second example above, the programmer knows that A\$ is of interest only if it is empty).

Also remember that PRINT statements (and the print-oriented debugging techniques mentioned below) can go to at least three devices: screen, printer, or disk file. Video output gives you an interactive display of the relationship between cause (the printed variable's value) and effect (the effect on the program), but it may destroy the normal output to the screen. Printed output gives you a printed record that can be studied later along with the program code. Disk output is useful when you *must* generate a lot of PRINT statements; it is faster than printed output and can be searched and examined quickly using a word processor. It is your responsibility to choose the technique best suited to a given situation.

You will sometimes have a visible error and no idea of its cause. You can then use PRINT statements in a "divide and conquer" scheme. To do this, find a point in the program where

things are okay and another one where they are not. Then repeatedly place a PRINT statement between the two and decide which half contains the error. Eventually, you will have isolated the error to a small enough area that the number of possible causes is also small. (Here, you are advised to consider—and apply—Sherlock Holmes's famous statement, "When you have eliminated the impossible, whatever remains, *however improbable*, must be the truth.")

BREAKPOINTS

If you are able to stop your program, examine and change the values of variables, and resume execution at the point you stopped the program, you have *breakpoint* capability. You can do this in assembly language if you run your program along with some kind of debugger/monitor program. In most Microsoft BASICs, you can stop

a program with a Control-C from the keyboard or a STOP from the program, then examine and even change variable values and resume by executing the CONT (continue) statement. In many cases, you will want to print out the values of some variables before you stop the program.

Breakpoints let you debug your program interactively. They have most of the characteristics of PRINT statements: They can be executed conditionally or unconditionally; they can be used to gather data for your next debugging guess, to confirm a guess, and to pinpoint the location of an error; and their effectiveness depends on the forethought used in planning the breakpoint and evaluating its results. Many programmers use breakpoints as a mechanism through which to do an open-ended exploration of the program in the hope that they will

(continued)

DYSAN[®] protects disks in sleeves of TYVEK.



Here's why.

Quality disks deserve a quality sleeve. Sleeves of TYVEK[®] spunbonded olefin provide unsurpassed data protection because

1. TYVEK is strong—won't tear like paper.
2. TYVEK does not lint.
3. TYVEK is smooth, non-abrasive.
4. TYVEK is chemically clean, has a neutral pH.
5. TYVEK reduces static problems.
6. TYVEK is unaffected by water.

Take the first step to maximum disk data protection. Call 800-44 TYVEK for the names of manufacturers who rely on sleeves of TYVEK.

*TYVEK is DuPont's trademark for spunbonded olefin. DuPont makes TYVEK, not sleeves.
Dysan is a registered trademark of Dysan Corporation



Uplifting news.

Now we've got application software to support our data acquisition hardware for the IBM PC.[™]

Hold up a minute!

Now you can get all your analog I/O application software at the same place you get your IBM PC compatible hardware. Data Translation.[™]

We've got four application software packages that cover a broad range of capabilities, all compatible with the DT2801 series of seven analog I/O boards. So you'll never have to write a line of code again.

Take a look at these:

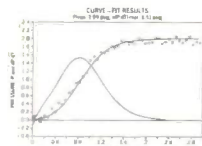

Graph Using Curve-Fit

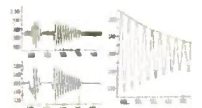

Analysis Functions with Multiple Window Display

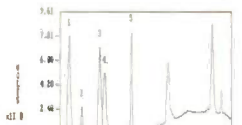

Peak Detection and Integration

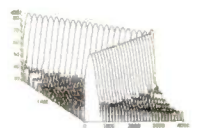

3-D Spectral Display

DT/NOTEBOOK

For the non-programmer. An easy-to-use menu-driven package for real-time data acquisition, process control, and data analysis that automatically interfaces to spreadsheet packages. Its menu-driven interface is ideal for users who aren't very familiar with computers.

ASYST

For the advanced user. A command-driven package for real-time data acquisition and control, advanced data analysis, and graphics display. For the user who requires more sophisticated graphics and analysis capabilities.

CHROMLAB

For the chromatography scientist. A menu-driven, scientific software package for chromatography and spectroscopy applications. For users who need to do real-time data collection/display, peak detection/integration, and report generation.

DT/LS-PC 1

For the signal processing scientist. Command-driven software for digital signal processing that supports data acquisition, waveform manipulation, design and use of digital filters, and spectral analysis. For users who need advanced analysis tools in both time and frequency domains.

Call us today. We'll help you choose the right package to give your data acquisition the boost it needs.



Fred Molinari,
President

Call for our new
576 pg. catalog/
handbook or see it
in Gold Book 1985.

Call (617) 481-3700

DATA TRANSLATION

World Headquarters: Data Translation, Inc., 100 Locke Dr., Marlboro, MA 01752 (617) 481-3700 Tlx 951 646.

European Headquarters: Data Translation, Ltd., 13 The Business Centre, Molly Millars Lane, Wokingham Berks, RG112QZ, England Tlx: 851849862 (#D)

International Sales Offices: Australia (61) 663-5289; Belgium (32) 2-7352135; Canada (416) 625-1907; Chile (56) 2-253689; China (408) 727-8222; Denmark (45) 2451822; England 0734-793838; Finland 0372-144; France (33) 6306839; Greece (30) 031-527039; (30) 01-3614-300; Hong Kong (852) 3-312607; India 231880; Israel (972) 3-324198; Italy (39) 2349751; Japan (81) 343-7571; (81) 348-8301; (81) 335-5111; Korea (82) 753-3101; Netherlands (31) 70996360; Norway (02) 567140; Portugal (351) 19545313; South Africa (27) 12118161782; Singapore (65) 2729412; Spain (34) 12502577; Sweden (46) 8289425; Switzerland (41) 17231410; Taiwan (86) 721-7864; (86) 531-2434; West Germany (49) 89806061.

DT/NOTEBOOK © 1984, Laboratory Technology Corp. ASYST © 1984 MacMillan Software Co. CHROMLAB © 1984, University of Southern California. DT/LS-PC 1 © 1984, Signal Technology Inc. IBM is a registered trademark of IBM Corp. Data Translation is a registered trademark of Data Translation, Inc.

stumble over some clue. This is usually unproductive and should be attempted only when you are at a complete loss as to what to do next.

Through breakpoints, you usually have access to the *state* of the machine—that is, all the data needed to completely recreate the computer's configuration at a given moment—even though you may not make use of it. Because of this, a breakpoint is a measure halfway between a PRINT statement and a snapshot, discussed below. Breakpoints and snapshots differ in two ways: Breakpoints are not always available, and snapshots are harder to use but more thorough.

SNAPSHOTS

A *snapshot* is a printed record of the state of the machine. Because a snapshot *completely* describes the program at the point it is taken, it is the final authority on what's "inside" the program at that instant. This is both good and bad—good because you have all the information you could possibly need, bad because you may not spot the data you need in the sea of data you have. A snapshot is also *printed* documentation of the program's state at a given point; because it can be referred to later, it may save you from having to recreate the situation. (In the darker moments of debugging, when your current results seem to contradict your memory of past results, a snapshot is often welcome verification that you are *not* going crazy.)

Snapshots are usually not used interactively (but they can be if you want to wait for the printout). They are usually used with a fresh listing of the program to hunt for clues about the cause of the error. Because snapshots are very long, they are also inconvenient to set up and take a long time to print out (in some cases, you might consider writing them to disk). For all these reasons, snapshots are usually used as a last resort.

For a high-level language snapshot, make a list of all the system and program variables (a cross-referencing program will help in this); then write a subroutine that prints these (prefer-

ably in alphabetic order). To use the snapshot, add a line to your program that prints some reference to itself and calls the snapshot subroutine—for example, in BASIC:

```
3305 PRINT "Snapshot at end of
input routine":GOSUB 9950
```

When debugging assembly-language programs, capture the contents of *all* memory and record the address of the snapshot and the values of the processor's flags and registers. If you can, store the contents of memory as a formatted dump that shows bytes as both hexadecimal numbers and ASCII (American Standard Code for Information Interchange) characters. You can make your snapshot shorter by not capturing certain areas (those containing video-display memory or system ROMs—read-only memories), but always keep in mind that you have left something out—occasionally, it

may be what you need to find the error!

TESTING VS. DEBUGGING

Before I can talk about finding hidden errors and verifying program correctness, I need to point out the difference between debugging and testing. *Debugging* is the process of correcting all the errors you find in a program; it ends when you can find no more bugs. *Testing* is a more deliberate, methodical process that attempts to prove that a program's behavior is correct in all cases; it ends after you have devised tests that reasonably justify the claim, applied them (with positive results), and documented your methods and results for current and future critics.

FORCING AND CHECKING

So you've found and corrected all the

(continued)

3M protects disks in sleeves of TYVEK.

Here's why.



Quality disks deserve a quality sleeve. Sleeves of TYVEK® spunbonded olefin provide unsurpassed data protection because

1. TYVEK is strong—won't tear like paper.
2. TYVEK does not lint.
3. TYVEK is smooth, non-abrasive.
4. TYVEK is chemically clean, has a neutral pH.
5. TYVEK reduces static problems.
6. TYVEK is unaffected by water.

Take the first step to maximum disk data protection. Call 800-44 TYVEK for the names of manufacturers who rely on sleeves of TYVEK.

*TYVEK is DuPont's trademark for spunbonded olefin. DuPont makes TYVEK, not sleeves.



HOW TO BUY SOFTWARE WHEN ALL THE ADS LOOK THE SAME.

We know it's hard to choose a software house. All the ads say the same thing—"Lowest prices," "fastest delivery," "best support," "biggest inventory."

Trouble is, although the claims are the same, the companies are very different. Which is why we want you to know some important facts about us:

1. 800-SOFTWARE is one of the oldest and most reputable firms in the industry. Our customers include Coca-Cola, GE, Hewlett-Packard, Xerox, AT&T, and thousands of other satisfied buyers.

2. Our National Accounts Program offers volume discounts and valuable services to large software users. We offer *incredibly* low prices on large bids!

3. We have a giant, \$1,000,000 inventory. Which means we can offer next-day delivery if needed.

4. With every product you get friendly, expert technical support. Have a question? You'll be glad you bought from 800-SOFTWARE!

5. We'll match our competitors' prices on most products. We *never* cut service.

6. We never charge extra for credit card purchases, nor do we process for payment until the product is shipped. (Our competitors don't make this claim!)

7. You'll automatically receive our Technical Support Newsletter—a great way to stay up-to-date.

8. We are members of the Better Business Bureau and the Direct Marketing Association.

9. We want your business. Which is why we work so hard to keep you happy. Give us a call and let us *prove* it!

CHECK OUT ALL OUR INCREDIBLE PRICES:

Wordstar 2000/2000 Plus CALL	PFS File/Graph/Write \$84	Okidata 92/93 \$389/\$629	Epson Printers CALL
RBase 4000 \$259	SuperCalc 2/3 CALL	Hercules Color/Graphic Card \$199/\$325	IUS Accounting \$299/mod.
SOFTWARE BORLAND SOFTWARE™ Sidekick CALL Turbo Pascal/8087 \$39/\$79 BDURBAKI™ Signmaster \$ 79 DECISION RESOURCES® Chartmaster \$249 Signmaster \$189 DIGITAL RESEARCH™ CALL FOX & GELLER™ CALL FUNK SOFTWARE™ Sideways \$ 49 HARVARD SOFTWARE™ Harvard Project Manager \$289 IMSI™ PC Paintbrush \$ 99 LIFEBOAT LATTICE C-COMPILER™ \$359 LIFETREE™ Volkswriter Deluxe \$179 MICROPRO® WordStar \$209 WordStar 2000/2000 Plus CALL WordStar Pro Package/P.P. Plus \$259/\$359 InfoStar CALL All Other Products CALL	MICROIM™ RBase 4000 \$259 MICROSOFT® Multiplan \$125 Fortran \$289 All Other Products CALL MICROSTUF™ Crosstalk \$ 95 MULTIMATE™ \$255 ROSESOFT™ Pro Key \$ 99 SOFTWARE PUBLISHERS™ PFS File/Graph/Write \$ 84 PFS Report \$ 75 SORCIM/IUS™ SuperCalc 2/3 \$159/\$195 EasyWriter II System \$185 IUS Easy Business Accounting \$299/mod. Super Project \$209 All Other Products CALL	HARDWARE, ETC AMDEK™ Monitors CALL AST™ Products CALL ATI™ & CDEX™ TRAINING CALL CODE-A-PHONE Tel-A-Modem \$479 EPSON™ PRINTERS FX 80, FX 100 & LQ 1500 CALL HAYES™ Smartmodems 1200/1200B CALL HERCULES™ Color Card \$199 Graphic Card \$325 MAXELL™ & MEMOREX™ DISKETTES CALL MEMORY CHIPS CALL OKIOATA™ PRINTERS 92 IBM \$389 93 IBM \$629 PRINCETON GRAPHICS™ MONITORS CALL QUADRAM™ CALL WESTERN UNION EASY LINK® FREE	

WE ALSO CARRY HUNDREDS OF OTHER PRODUCTS FOR THE IBM-PC® AND COMPATIBLES, MACINTOSH®, APPLE II® AND CP/M®!



800-SOFTWARE, INC.
940 Dwight Way
Berkeley, CA 94710

800-SOFTWARE

To order call toll-free:
800-227-4587 OR 415-644-3611

- Dealer inquiries welcome.
- Quantity discounts available through our National Accounts Program.
- Purchase orders accepted. Please call us in advance.
- Call for shipping charges. Overnight delivery available.
- We do not add surcharge for credit card purchases.
- Prices may change. Above prices are for IBM-PC and compatibles.
- International orders welcome. TELEX #751743 800SOFTWARE UD.

errors in your program—it's ready to go, right? Wrong. You've corrected all the *visible* errors; the program's been debugged, but it hasn't been tested. You can never be sure that a program is completely error-free, but you can test it to be reasonably certain that it works correctly. *Forcing* and *checking with sample data* are two methods used to find hidden bugs and verify program correctness.

Forcing involves simplifying the pro-

gram so that the relationship between input and output is known or is easily calculated; then you can exercise the program with test data and compare the predicted output with the actual output. In some cases, you can enter a set of data that is considerably simpler than other sets might be (for example, in a statistical-analysis package, you might enter 3 data items instead of 10 or 100). In other cases, you may need to change the program

so that, at some point, it uses constant values instead of calculated values in some places.

This second method is the type of forcing you'll use most often (this is a variation of the change-only-one-thing technique discussed above). By setting certain variables to constant values, you can observe the behavior of the program as it is influenced by the remaining variables. If you spot an

(continued)

A PROTOTYPE FOR YOUR PROTOTYPES



METHODS BY DIGITALK. A SMALLTALK PROGRAM DEVELOPMENT ENVIRONMENT FOR THE IBM PC. AN OBJECT-ORIENTED SPEED DEMON. AN EXCITING WAY TO PROGRAM.

Think about your problem. Browse the Methods Smalltalk source code. Select some building blocks like pop-up menus, windows, text-editors and dictionaries. Put them together. Try it. Oops, Methods tells you something is missing. No problem. Continue thinking, changing and trying. Now you're prototyping! Try out new ideas. Redefine your problem. And you don't have to throw this prototype away. Refine it until you like the finished product.

Methods by Digitalk. A new way to develop software for the PC. Use it for windowing, simulation and artificial intelligence applications. Use it by prototyping.

Methods is Smalltalk-80™ language compatible. It includes its own Smalltalk source code. You can extend it in Smalltalk and assembly language.

Methods operates on IBM PCs with 512K bytes RAM using MS-DOS or PC-DOS. Color and monochrome monitors are supported. No mouse is required. A Smalltalk language manual and an environment guide are included.

Smalltalk-80™ is a trademark of Xerox Corporation. IBM is a registered trademark of International Business Machines Corporation. MS is a trademark of Microsoft Corporation.

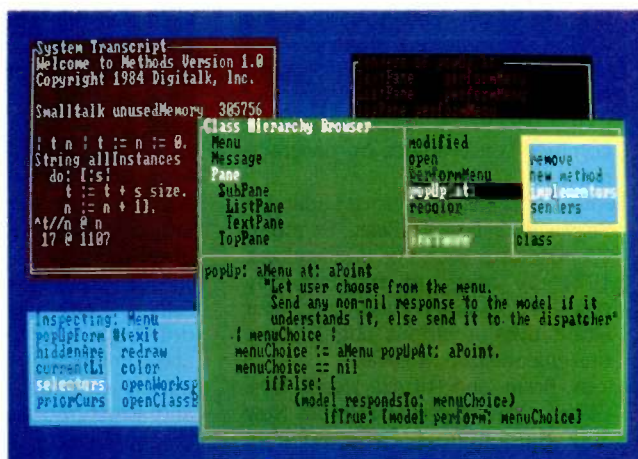

Available from Digitalk for \$250. Outside U.S. add \$15.00 for shipping and handling. California residents add 6% sales tax. Visa and MasterCard accepted. Educational and Dealer Discounts Available.

DIGITALK, INC.
5200 West Century Boulevard
Los Angeles, California 90045
(213) 645-1082

error in this way, you can use this observed relationship to infer which variables are causing the error. Once you have found them, force the other relevant variables to known values; then you should be able to find the error by studying the actual behavior of the system compared to its expected behavior.

Another use of this method is to force execution of a given section of a program. When a program has few enough alternate paths in it that you can afford to test each one manually, you can use forcing to ensure that you are in fact testing each section of code.

Forcing is a special case of *checking*

with sample data, a method that is used to rigorously verify the correctness of a program. The design and selection of test data heavily influences the validity of the testing process, so it should be done with great care.

A meaningful discussion of this subject is beyond the scope of this article, but I mention it to point out that the use of sample data is an important tool for even the most casual programmer. When you are working with a program that deals with a range of data, take the time to run the program with input data that is just inside, on, and just outside the range of valid data. For example, if your program computes the average of between 1 and 20 numbers, try it with 0, 1, 2, 19, 20, and 21 numbers. In general, you will be surprised at the number of times that your program fails to act correctly.

PREVENTIVE DEBUGGING

Two debugging techniques fall into the category of *preventive debugging*—that is, practices that will alert the future user to the occurrence of an error. The first is the simple technique of using “sleeping” debugging instructions, while the second is a little-known technique called firewalling. Both techniques are available to people who are coding the program they will later maintain, though they can sometimes be added to existing programs. They are most useful in a program where error detection and quick diagnosis and correction are important.

Sleeping debugging instructions are conditional diagnostic routines that execute only if a predefined abnormal condition wakes them up. These can be as simple as a PRINT statement that notifies the user that an error has occurred or as complicated as a subroutine that analyzes the state of the program and writes a file of useful debugging information to the disk.

The best time to add such instructions into a program is when you are writing (and, later, debugging) it, while you have the greatest insight into how the program works. Ask yourself ques-

(continued)

RECOMMENDED BOOKS

Much has been written about the theory and practice of design, coding, and debugging. Here is a selected list of especially useful books that I have on my bookshelf. Some are handy references, others challenge the very foundation of your beliefs on how one should write a program.

Bruce, Robert C. *Software Debugging for Microcomputers*. Reston, VA: Reston Publishing Company, 1980. A good catalog of debugging techniques.

DeMarco, Tom. *Structured Analysis and System Specification*. Englewood Cliffs, NJ: Prentice-Hall, 1979. A very good book on the design of large systems; it contains extended information on the use of the data-flow diagrams (DFDs) and data dictionaries.

Ledgard, Henry F. *Programming Proverbs*. Rochelle Park, NJ: Hayden Book Company, 1975. A book of good common-sense advice on programming.

Ledin, George Jr., and Victor Ledin. *The Programmer's Book of Rules*. Belmont, CA: Lifetime Learning Publications, 1975. A book of hierarchically ordered rules that remind you of your alternatives at various stages of the design/code/debug cycle.

Meeck, Brian, and Patricia Heath, eds. *Guide to Good Programming Practice*. New York: Halsted Press (division of John Wiley and Sons), 1980. A good collection of essays on various topics; the essays do not fit into an organized whole, but each has good information in it.

Page-Jones, Meilir. *The Practical Guide to Structured Systems Design*. New York: Yourdon Press, 1980. A detailed but pragmatic book on the proper decomposition of large systems into modular subtasks; it has good sec-

tions on data-flow diagrams and the factors that influence the effectiveness of a modular system or program.

Peters, Lawrence J. *Software Design: Methods and Techniques*. New York: Yourdon Press, 1981. An invaluable survey book that describes dozens of design methodologies, techniques, and notations—excellent for browsing to find the method that makes the most sense to you.

Smith, Truck. *Secrets of Software Debugging*. Blue Ridge Summit, PA: Tab Books, 1984. A well-written book that digs deeply into the psychology of debugging and illustrates its points with three chapter-long microcomputer examples; this is my favorite book on debugging.

Ward, Paul T. *Systems Development Without Pain*. New York: Yourdon Press, 1984. Describes a new design technique that emphasizes good communication between the designers and the users; the method modifies and simplifies the concept of structured analysis.

Yourdon, Edward Nash, ed. *Classics in Software Engineering*. New York: Yourdon Press, 1979. Contains reprints of and commentary about all the pivotal papers on structured programming and structured analysis, the debate among Dijkstra, Knuth, and others about GOTO statements, and many essays on structured programming.

Yourdon, Edward, and Larry L. Constantine. *Structured Design*. Englewood Cliffs, NJ: Prentice-Hall, 1979. This is the first major book on structured analysis; it uses data-flow diagrams but puts heavy emphasis on structure charts. It also contains several theoretical chapters that debate how best to modularize a program.

INTRODUCING THE MERLIN™ ELECTRONIC LETTERING SYSTEM. IT BEATS THE HELVETICA OUT OF KROY.®



At any price, the new Merlin electronic lettering system from Varitronics™ is a major achievement.

At a suggested retail price of only \$1,795, it's a minor miracle. That's less than half the cost of its nearest competitor, the Kroy 80K Editor,™ so you can save even more than you spend. But superior technology means more than a lower cost. In this case it means a much better system.

You'll find the Merlin to be significantly faster than any electronic lettering machine on the market, and more than five times faster than the old "spin-and-print" machines.

Loading and unloading the Merlin's supplies is clean and easy. The carbon ribbon simply snaps into place like film in an instant camera. And your hands never touch the actual ribbon.

You can interchange the color carbon at any time in the middle of a job to highlight a word or phrase.

And every lettering disc is the size of a 45 RPM record for easy storage, each one holding 101 upper and lower case letters and symbols, in a variety of styles and sizes ranging from 8 to 36 point.

Yet we managed to fit all these features, plus many more, in a package that weighs just 23 pounds and takes up considerably less desktop space than a comparable Kroy® machine.

Discover a world of ways the Merlin can work its magic to improve the look and effectiveness of your communications. Just call **1-800-MERLIN-1** (in Minnesota, call 1-800-742-5685, ext. 99). Or send in the coupon for more information, a sample of Merlin lettering and the name of a dealer in your area who's offering a substantial trade-in allowance on your present lettering system.

Suggested retail prices as of 2/1/85.

© Varitronic Systems, Inc., 1985

Kroy and Kroy 80K Editor are trademarks of Kroy Inc. Varitronics and Merlin are trademarks of Varitronic Systems, Inc.

At \$29.95 and the size of a 45 RPM record, the Merlin's lettering discs hold 101 letters and symbols. Kroy's discs cost \$44.95 and are the size of an LP, yet only hold 78 characters.



The Merlin's tape and carbon cartridges are clean, and easy to load and unload. And fully interchangeable in the middle of a job.



5 TIMES FASTER THAN SPIN-AND-PRINT

Due to its advanced technology, the Merlin is able to print more than five times faster than the old "spin-and-print" machines.

At 23 pounds, the Merlin is both light-weight and compact, and less than half the weight and size of the Kroy 80K Editor.

\$1795

The Merlin is the result of superior design. Yet we're offering it at less than half the price of the Kroy 80K Editor.

Inquiry 413



1-800-MERLIN-1
(IN MINNESOTA, 1-800-742-5685, EXT. 99)

- Please send me more information about Merlin and a free sample of Merlin lettering.
- I'd like a hands-on demonstration of Merlin.

Name/Title _____
 Telephone (____) _____
 Company _____
 Address _____
 City _____ State _____ Zip _____



One Board... One Family

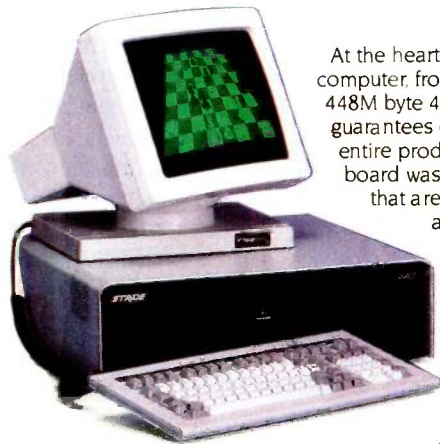

At the heart of every Stride 400 Series micro-computer, from the floppy-based 420 to the 448M byte 460, is an identical CPU board. This guarantees compatibility throughout the entire product family. And it means, our CPU board was designed with standard features that are either options or simply unavailable on other microcomputers:

- 68000 microprocessor (10 MHz with no wait states)
- VMEbus
- 256K bytes RAM
- 5¼" 640K byte floppy
- Battery-backed real time clock
- 4K CMOS RAM
- Four RS-232C serial ports (Stride multiuser BIOS)
- Centronics bi-directional parallel port
- Omninet Local Area Network (Liaison LAN software)

With this basic design, Stride is able to explore the full range of 68000 applications from an advanced multiuser, multi tasking BIOS to built-in local area networking. No other microcomputer offers the flexibility to run over a dozen different operating systems and more than 30 languages/compilers.

The basic design is backed by a rich option list:

- 12 MHz 68000 processor
- VMEbus (Eurocard) cage
- Low cost, high speed graphics
- NOD™ cursor control
- 12M bytes of RAM
- 448M bytes of hard disk storage
- 22 serial ports
- Floating point processor (NS16081)
- Cartridge streaming tape backup
- Memory Management Unit

CBASIC COBOL
Modula-2
Pascal FORTRAN
RM/COS Lisp
UNIX System V
Cp-System
CP/M68K



All this, and still the best price/performance ratios in the industry: from \$2900 to over \$60,000. But it begins with the powerful Stride CPU board, a standard feature of every 400 series system. It's what we call "Performance By Design."



Formerly Sage Computer

For more information on Stride or the location of the nearest Stride Dealer call or write us today. We'll also send you a free copy of our 32 page product catalog.

Corporate Offices:
4905 Energy Way
Reno, NV 89502
(702) 322-6868

Regional Offices:
Boston: (617) 229-6868
Dallas: (214) 392-7070

tions like these: "What's the most damaging thing that could happen while this program is running? What can the program do to spot it? What ranges of data will always be invalid? What could the user do that the program will have to guard against or correct?" With careful planning and design, you can add sleeping debugging instructions that will alert you to program errors and help minimize their effect.

FIREWALLING

Firewalling is a preventive debugging technique available to highly modular programs. If you have designed your modular program correctly, each module is completely self-contained and interacts with other modules only through a known list of variables. A fire wall is a special kind of sleeping debugging instruction that checks the validity of data as it comes out of a module. The idea behind firewalling is to ensure that, even if an error occurs, it is not allowed to spread from its origin to other modules. This method is most useful in large systems that pass data from one program to another, but you may find occasion to use it in smaller programs of your own.

CONCLUSIONS

As I said at the beginning of this article, there are no magic techniques—but there are tools, and the most powerful one is your own brain. Debugging is part technique, part art, part luck, and the most difficult part of it is to be *thinking hard* when the situation calls for it. I hope I have presented some useful tools; if you have any other useful techniques, I would enjoy hearing from you.

The temptation is to take it easy, to skip the hard parts, to keep rummaging through the program for more clues instead of thinking about the ones you already have—but all that is like the man who kept looking for his lost car keys under the streetlight because the light was better there. Although luck and intuition contribute in debugging, there is no substitute for thoughtful, sustained analysis. ■

"...compatibility has been a cruel hoax used to mislead the public."

[This is one of a series of design philosophy discussions with Rod Coleman, President of Stride Micro (formerly Sage Computer).]

RC: One of the biggest mistakes being made today is that many in this industry underestimate how much the public is willing to take. Today's micro-computer buyer is far more sophisticated than those who were buying systems just 24 months ago.

Q: How does that affect a manufacturer?

RC: In our case, I think it means

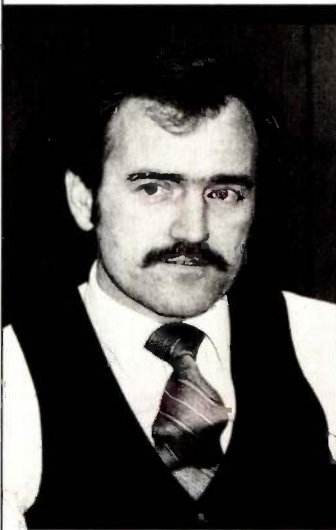

"... I'm often amazed that our competitors continue to introduce products that don't really relate to their own machines above or below them."

that our designers and engineers have to be more honest. By that I mean that you can't simply rely on clever marketing techniques to overcome hardware shortcomings.

Q: Give me an example.

RC: The best one I can think of is the overused buzzword of "compatibility." It has been a cruel hoax used to mislead the public. Indeed, dozens of these compatible machines are interchangeable with one another, but, in reality, users don't trade one system for another of the same capacity. Instead, they're looking to upgrade, link or expand their capabilities. That's when the so-called compatibility ends. One major manufacturer changes to a different CPU chip between entry-level and mid-range machines, and then changes again to move into a high capacity environment. Another competitor is only compatible until you decide you want multiuser or local area networking; at that point you've got to change operating systems and software.

Q: How has Stride approached this problem?

RC: From the start, we knew we had to select a microprocessor and basic system design that had enough power and flexibility to meet the needs on both ends of the spectrum. Without a capable CPU, your system will never be state-of-the-art. Thus all machines in the Stride 400 Series were designed to accommodate the same 68000-based CPU board. This board provides for all the standard features such as VMEbus, multiuser, LAN, etc. Then, when a customer decides to move up, it's a simple matter of providing more RAM, storage, backup devices, etc. Since every system in the family has a common CPU board, compatibility is guaranteed. The idea is so basic, that I'm often amazed that our competitors continue to introduce products that don't really relate to their own machines above or below them.

Q: Do most customers buy Stride machines for that flexibility to expand?

RC: Many do, but we are also getting a lot of response from those looking for a big system as the cornerstone to a growing network of smaller machines. This is where local area networks really shine, but the incompatibility between the large hard disk machines and the smaller workstations has prevented users from capitalizing on this technology. Again, since Stride's LAN is a standard feature of all systems, and they share a common board, this is a natural application.

Q: Is the 68000 microprocessor the key to that compatibility?

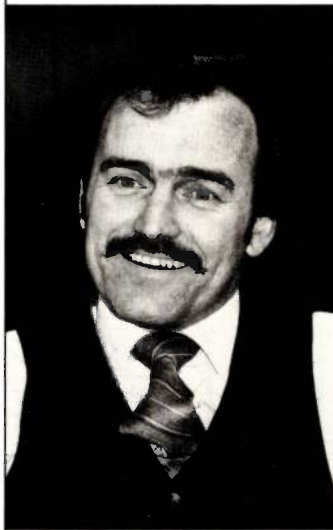

RC: To a large extent, yes. Although it's been on the market for some years, we feel this processor still holds a significant advantage over other architectures. When we evolved from Sage Computer to Stride Micro, we closely examined the state of the microprocessor market. We elected to remain with the 68000 family because it was the only proven product that would handle everything from our floppy-based 420 machine up to the top-of-the-line Stride 460 with

22 users, 12M bytes of RAM and 448M bytes of Winchester hard disk storage. An extra benefit of this is that we were able to boost the already-impressive performance of the Sages by increasing the clock speed from 8MHz to the Stride's standard 10MHz and optional 12 MHz without changing architectures. That would have been impossible with most other chips.

Q: Do you see others following your lead?

RC: Yes and no. The good signs are that more and more interest is being generated in portable languages and operating systems that work across a broad range of system capabilities. Yet, then I see an announcement from a leading hardware supplier that their newest multiuser machine is only compatible with the smaller systems when it's in single user mode. Overall, I think Stride will remain unique for some time to come.



STRIDE
MICRO

Formerly Sage Computer

For more information on Stride or the location of the nearest Stride Dealer call or write us today. We'll also send you a free copy of our 32 page product catalog.

Corporate Offices:
4905 Energy Way
Reno, NV 89502
(702) 322-6868

Regional Offices:
Boston: (617) 229-6868
Dallas: (214) 392-7070

Commodore® Accessories

RS232 Adapter for VIC-20 and Commodore 64

The JE232CM allows connection of standard serial RS232 printers, modems, etc. to your VIC-20 and C-64. A 4-pole switch allows the inversion of the 4 control lines. Complete installation and operation instructions included.

- Plugs into User Port
- Provides Standard RS232 signal levels
- Uses 6 signals (Transmit, Receive, Clear to Send, Request to Send, Data Terminal Ready, Data Set Ready).

JE232CM \$39.95

VOICE SYNTHESIZER FOR APPLE AND COMMODORE

Plug-In - Talking in Minutes!

JE520AP

JE520CM

• Over 250 word vocabulary - allows the formation of more than 500 words

• Built-in amplifier, speaker, volume control, and audio jack

• Recreates a clear, natural male voice

• Plug-In user ready with documentation and sample software

• Case size: 7 1/4" L x 3 3/4" W x 1-3/8" H

APPLICATIONS:

- Security Warning
- Teaching
- Instrumentation
- Telecommunication
- Handicap Aid
- Games

Part No.	Description	Price
JE520CM	For Commodore 64 & VIC-20	\$114.95
JE520AP	For Apple II, II+, and IIe	\$149.95

Computer Memory Expansion Kits

IBM PC, PC XT and Compatibles

Most of the popular Memory Boards (e.g. Quadram® Expansion Boards) allow you to add an additional 64K, 128K, 192K or 256K. The IBM64K Kit will populate these boards in 64K byte increments. The Kit is simple to install - just insert the 9-64K RAM chips in the provided sockets and set the 2 groups of switches. Complete conversion documentation included.

IBM64K (Nine 200ns 64K RAMs)..... \$19.95

IBM PC AT

Each kit comes complete with nine 128K dynamic RAMs and documentation for conversion.

IBM128K (Nine 250ns 128K RAMs).... \$174.95

APPLE IIe

Extended 80-Column/64K RAM Card. Expands memory by 64K to give 128K when used with programs like VisiCalc™. Fully assembled and tested.

JE864..... \$99.95

TRS-80 MODEL I, III

Each Kit comes complete with 8 ea. 4164N-20 (200ns) 16K Dynamic RAMs and documentation for conversion. Model I, 16K equipped with Expansion Interface can be expanded to 48K with 2 Kits. Model III: Can be expanded from 16K to 48K using 2 Kits. Each Kit will expand computer by 16K increments.

TRS-16K3 200ns (Model III)..... \$6.29
TRS-16K4 250ns (Model I)..... \$5.49

TRS-80 MODEL IV & 4P

Easy to install Kit comes complete with 8 ea. 4164N-20 (200ns) 64K Dynamic RAMs and conversion documentation. Converts TRS-80 Model IV computers from 16K to 64K. Also expands Model 4P from 64K to 128K.

TRS-64K-2..... \$17.95
 (Converts the Model IV from 16K to 64K or will expand the Model 4P from 64K to 128K)

TRS-64K2PAL (Model IV only)..... \$38.95
 (8-4164's with PAL Chip to expand from 64K to 128K)

TRS-80 COLOR AND COLOR II

Easy to install Kit comes complete with 8 ea. 4164N-20 (200ns) 64K Dynamic RAMs and documentation for conversion. Converts TRS-80 Color Computers with D, E, ET, F and NC circuit controls to 32K. Also converts TRS-80 Color Computer to 64K. Flex DOS or OS-9 required to utilize full 64K RAM on all computers.

TRS-64K-2..... \$17.95

INDUSTRIES

PROTECT YOURSELF... DATASHIELD® Surge Protector

Eliminates voltage spikes and EMI. 80% surge before it can damage your equipment or cause data loss. 6-mo warranty. Power dissipation (1000 microseconds): 2000 watts.

Model	DESCRIPTION	PRICE
Model 100		
Model 75	4 Sockets, On/Off Switch.	\$49.95
Model 85	6 Sock. Super Filters, On/Off Switch.	\$59.95
Model 100	6 Sock. Super Filters, Low Volt. Alarm.	\$69.95
Model 110AMS	6 Sockets, Super Filters, Auto Master Switch.	\$99.95

DATASHIELD® Back-Up Power Source

Protects your computer from black-outs, brown-outs, power surges and line noise. PTT's PC200 is designed for PCs with floppy disk memory, the XT300 for hard disk memory and the AT800 for multi-user systems. A typical compatible PC for each of these standbys will be supported for 15 to 28 minutes after power is lost. Weight (PC200: 24 lbs.) - (XT300: 37.5 lbs.) - (AT800: 83 lbs.)

PC200 (200 Watt Rating).....	\$299.95
XT300 (300 Watt Rating).....	\$399.95
AT800 (800 Watt Rating).....	\$699.95
AT800 (800 Watt Rating).....	\$799.95

*** SUMMER SPECIALS ***

PROMETHEUS

Intelligent 300/1200 Baud Telephone Modem with Real Time Clock/Calendar

The ProModem™ is a Bell 212A (300/1200 baud) intelligent stand-alone modem. Full featured expandable modem. Standard features include Auto Answer and Auto Dial, Help Commands, Programmable Intelligent Dialing, Touch Tone™ and Pulse Dialing & More. Hayes command set compatible plus an additional extended command set. Show w/alphabetic display option.

Part No.	Description	Price
PM1200	RS-232 Stand Alone Unit.....	\$319.95
PM1200A	Apple II, II+ and IIe Internal Unit.....	\$299.95
PM1200B	IBM PC and Compatible Internal Unit.....	\$239.95
PM1200BS	IBM PC & Compatible Internal Unit w/Mite Software.....	\$274.95
MAC PAC	Macintosh Package.....	\$369.95

(Includes PM1200, Cable, and ProCom-M Software)

OPTIONS FOR ProModem 1200

PM-COM	(ProCom Communication Software). Please specify Operating System.	\$79.95
PM-OP	(Options Processor).....	\$79.95
PMO-16K	(Options Processor Memory - 16K).....	\$ 4.50
PMO-32K	(Options Processor Memory - 32K).....	\$ 9.00
PMO-64K	(Options Processor Memory - 64K).....	\$18.00
PM-ALP	(Alphanumeric Display).....	\$79.95

PM-Special (Includes Options Processor, 64K Memory and Alphanumeric Display)..... \$169.95

KEYBOARDS

Mitsumi 54-Key Unencoded All-Purpose Keyboard

- SPST keyswitches
- 20 pin ribbon cable connection
- Low profile keys
- Features: cursor controls, control, caps (lock), function, enter and shift keys
- Color (keycaps): grey - Wt. 1 lb. - Pinout included

KB54..... \$14.95

New!

82-Key ASCII Cherry Keyboard

- 7-bit parallel ASCII
- 11-key numeric keypad
- Cursor keypad
- SPST mechanical keyswitches
- 4 illuminated keys
- 26-pin header connector
- Color: white
- Size: 18" L x 6 1/2" W x 1 1/4" H
- Spec included

KB8201..... (1700 avail.)... \$29.95

Apple Owners!

Apple Keyboard and Case for Apple II and II+

- Keyboard: 68 keys - 15-key keypad
- Direct connection with 16-pin ribbon connector
- 26 special functions
- Size: 14 1/2" L x 5 1/2" W x 1 1/2" H
- Case: Accommodates KB-A68
- Pop-up lid for easy access
- Fits power supply and motherboard too
- Size: 15 1/2" W x 18 D x 4 1/4" H

Part No.	Description	Price
KB-EA1	Apple Keyboard and Case (pictured above).....	\$134.95
KB-A68	68-Key Apple Keyboard only.....	\$ 79.95
EAEC-1	Expanded Apple Enclosure Case only.....	\$ 59.95

POWER SUPPLIES

Power/Mate Corp. REGULATED POWER SUPPLY

- Input: 105-125/110-250VAC at 47-63Hz
- Line regulation: ±0.05%
- Three mounting surfaces
- Overvoltage protection
- UL recognized
- CSA certified

Part No.	Output	Size	Weight	Price
EMA5/6B	5V@3A/6V@2.5A	4 1/4" L x 4" W x 2 1/4" H	2 lbs.	\$29.95
EMA5/6C	5V@6A/6V@5A	5 1/2" L x 4 1/4" W x 2 1/4" H	4 lbs.	\$39.95

KEPCO/TDK 4-OUTPUT SWITCHING POWER SUPPLY

- Ideal for disk drive needs of CRT terminals, microcomputers and video games
- Input: 115/230VAC, 50/60Hz
- Output: +5V @ 5 Amp, +12V @ 1.8 Amp, +12V @ 2 Amp, -12V @ 0.5 Amp
- UL recognized
- CSA certified
- Size: 7 1/4" L x 6-3/16" W x 1 1/4" H
- Weight: 2 lbs.

\$59.95 each or MRM 174KF..... 2 for \$99.95

Switching Power Supply for APPLE II, II+ & IIe™

- Can drive four floppy disk drives and up to eight expansion cards
- Short circuit and overload protection
- Fits inside Apple computer
- Fully regulated +5V @ 5A, +12V @ 1.5A, -5V @ .5A, -12V @ .5A
- Direct plug-in power cord included
- Size: 9 1/2" L x 3 1/2" W x 2 1/4" H
- Weight: 2 lbs.

KHP4007 (SPS-109)..... \$59.95

4-CHANNEL SWITCHING POWER SUPPLY

- Microprocessor, mini-computer, terminal, medical equipment and process control applications
- Input: 90-130VAC, 47-400Hz
- Output: +5VDC @ 5A, -5VDC @ 1A, +12VDC @ 1A, -12VDC @ 1A
- Line regulations: ±0.2%
- Ripple: 30mV p-p
- Load regulation: ±1%
- Overcurrent protection
- Adj: 5V main output - 10%
- Size: 6 3/4" L x 1 1/4" W x 4-15/16" H
- Weight: 1 1/2 lbs.

FCS-604A..... \$69.95

IBM PCXT EQUIVALENT 130 WATT POWER SUPPLY

UPGRADE YOUR PC!

- Input: 100V-130V/200V-260V selectable @ 47 to 63Hz
- Output: +5VDC @ 15A, -5VDC @ 0.5A, +12VDC @ 4.2A, -12VDC @ 0.5A
- Plug compatible connectors
- Fits into IBM PC
- Weight: 6 lbs.

IBM-PS..... \$159.95

\$10 Minimum Order - U.S. Funds Only CA Residents: Add 6% Sales Tax Spec Sheets - 30¢ each Shipping: Add 5% plus \$1.50 Insurance Send \$1 Postage for FREE 1985 Jameco Catalog Prices Subject to Change Send stamped, self-addressed envelope to receive a Monthly Sales Flyer - FREE!



1355 SHOREWAY ROAD, BELMONT, CA 94002 6/85 PHONE ORDERS WELCOME - (415) 592-8097 - Telex: 176043

Apple® Accessories

5 1/4" APPLE™ Direct Plug-In Compatible Disk Drive and Controller Card

The ADD-514 Disk Drive uses Shugart SA390 mechanics - 143K formatted storage - 35 tracks

- Compatible with Apple Controller & ACC-1 Controller
- The drive comes complete with connector and cable - just plug into your disk controller card
- Size: 6" L x 3 3/4" W x 8-9/16" D
- Weight: 4 1/2 lbs.

ADD-514 (Disk Drive)..... \$169.95
ACC-1 (Controller Card)..... \$ 49.95

More Apple Compatible Add-Ons...

APP-1	(Cooling Fan with surge protection).....	\$39.95
KHP4007	(Switching Power Supply).....	\$59.95
JE614	(Numeric/Aux. Keypad for IIe).....	\$59.95
KB-A68	(Keyboard w/Keypad for II & II+).....	\$79.95
MON-12G	(12" Green Monitor w/swivel stand).....	\$99.95
JE864	(80 Col. +64K RAM for IIe).....	\$99.95
ADD-12	(5 1/4" Half-Height Disk Drive).....	\$169.95

NEW!

ADDITIONAL APPLE™ ADD-ONS AVAILABLE

ARC-16K	(16K RAM Card for Apple II & II+).....	\$39.95
AEB-2	(EPROM Burner for Apple II, II+ & IIe) Allows copy of standard EPROMS 2716, 2732, 2764.....	\$69.95
A80-C	(80-Column Card w/Soft Switch).....	\$74.95
ADD-IIc	(5 1/4" Half-Ht. Disk Drive for Apple IIc).....	\$169.95

DISK DRIVES

Documentation Included

Best Buys!

MP151S	(MPI 5 1/4" SS full-ht.).....	\$ 89.95
RFD480	(Remex 5 1/4" DS full-ht.).....	\$109.95
TM100-2	(Tandon 5 1/4" DS full-ht.).....	\$159.95
FD55B	(Teac 5 1/4" DS half-ht.).....	\$149.95
SA45S	(Shugart 5 1/4" DS half-ht.).....	\$159.95
FDD100-8	(Siemens 8" SS full-ht.).....	\$119.95
PKC-5	(5 1/4" Power Cable Kit).....	\$2.95
PKC-8	(8" Power Cable Kit).....	\$3.95

UV-EPROM Eraser

8 Chips - 21 Minutes

1 Chip - 15 Minutes

Erases all EPROMs. Erases up to 8 chips within 21 minutes (1 chip in 15 minutes). Maintains constant exposure distance of one inch. Special conductive foam liner eliminates static build-up. Built-in safety lock to prevent UV exposure. Compact - only 9.00" L x 3.50" W x 2.60" H. Complete with holding tray for 8 chips.

DE-4 UV-EPROM Eraser..... \$74.95
UVS-11EL Replacement Bulb..... \$16.95

JE664 EPROM PROGRAMMER

See Our New IBM Communications Program!

24 & 28 PIN PACKAGES

8K to 64K EPROMS

REQUIRES NO ADDITIONAL SYSTEMS FOR OPERATION

Programs and validates EPROMs - Checks for properly erased EPROMs - Emulates PROMs or EPROMs - Loads data in RAM by keyboard - Changes data in RAM by keyboard - Loads RAM from an EPROM - 664 RAMs can be used for external microprocessor development - Compares EPROMs for content differences - Copies EPROMs - Input: 115VAC @ 60Hz - Assembled and tested - Size: 15 1/2" L x 8 1/4" W x 3 1/4" H - Wt: 5 1/2 lbs. - 2716 Module included

JE664-A EPROM Programmer..... \$995.00

JE664-RS232C INTERFACE OPTION - This option implements computer access to the JE664-A RAM, allowing computer to manipulate, store, and transfer EPROM data to and from the JE664-A. Sample program listing is supplied in MBASIC for CP/M computers. Documentation provided to adapt the software to other computers with an RS232C port. Specs: 3600 Baud, 8-bit word, auto parity with 2 stop bits. Assembled and tested - 2716 Module included

EPROM Programmer

JE664-ARS w/IE665 Option..... \$1195.00

JE664-ARS COMMUNICATION PROGRAM

FOR IBM-PC or XT and Compatibles

- Fast compiled BASIC program
- Easy to use, menu-driven
- Print hard-copy of EPROM data
- View data in HEX and ASCII
- NEW! The JE664-ARS Communication Program was written for quick interfacing between the JE664-ARS EPROM Programmer and the IBM-PC computer and compatibles. Menu-driven program allows user to Load and Save EPROM data to and from the computer or floppy disk. Data entered by the computer can be viewed in Hex & ASCII formats. Printed hard-copies are also displayed in both formats. Program is ideal for keeping archives of master EPROMs on disk. The program is compatible for all EPROMs listed with the JE664-A. Computer requirements: IBM-PC, XT (or eq.) with at least 128K RAM and one serial port. Optional: One parallel port for printer.

JE664-ARS-CP	\$49.95
JE664-ARS Communications Program (5 1/4" Disk and User's Instructions)	\$29.95
JE664-CP CABLE	\$29.95
Cable for IBM-PC to JE664-ARS Program (5 Shielded Cable Assembly)	\$29.95
JUMPER (PERSONALITY) MODULES - Jumper (Personality) Modules for 8K, 16K, 32K, and 64K EPROMs. Please specify EPROM and manufacturer.	\$14.95 each

WE START SERVICING YOUR PCs BEFORE WE EVER SEE THEM.



With Back-Up,[™] the service starts as soon as you call us.

Because we diagnose your malfunctioning equipment right over the phone. And before we hang up, we know what's wrong and what parts are needed before we arrive on site.

That way, we can service your equipment as quickly as possible without tying up your office for hours on end.

We specialize in servicing business PCs. Particularly IBM-PCs. (We've been servicing IBM equipment longer than any other national third-party maintenance company.)

And unlike most maintenance companies, we give you centralized support. So calling one number brings service to your company's PCs. Anywhere across the country.

Back-Up is just one of the ways we're using proven technology to solve computer maintenance problems worldwide. Call 1-800-346-6789 (in Minnesota 612/292-2209). Outside the U.S., call your local Control Data office. And find out how efficient we can be.

 CONTROL DATA

6502 TRICKS AND TRAPS

BY JOE HOLT

Tips for surviving 6502 assembly-language programming

WITH THE ADVENT of complex microprocessors whose operation codes (op codes) begin to resemble some high-level languages, the days of the 6502 seem numbered. Indeed, a microprocessor with only three 8-bit registers and a 64K-byte address space is apparently no match for a piece of silicon that can walk through 4 gigabytes of memory in 32-bit strides and work with hundreds of bits worth of registers. I won't try to fool you: The 6502 will *not* be around forever. But when the last of its species emerges from the forge, it will be joining an installed base of more than 3 million 6502-based computers. There is merit, therefore, in discussing the peculiarities of this dying breed, the ins and outs of this most nonorthogonal microprocessor.

The 6502 has three 8-bit registers (only one of which can be used in arithmetic and Boolean operations), a single-page (256-byte) fixed stack, and optimized performance when dealing with the first 256 bytes of memory. But what may be considered a tight architecture is befuddled by an instruction set full of inconsistency and seeming favoritism to certain combinations of addressing modes and op codes. Steve Wozniak even admitted that the only reason he put a 6502 in his Apple II was because it was cheap.

In order to gain the most benefit from the 6502, an assembly-language programmer must understand these idiosyncrasies and use them to his or her advantage.

PECULIARITIES

I will assume for the sake of brevity that you are already familiar with the 6502's architecture and operation codes (and assembly language in general) and perhaps have ac-

cess to an Apple or Atari with a decent assembler. If not, you might want to pick up a good reference book on the 6502 and sit down with an assembler and experiment. An intimate knowledge of your machine is the greatest boon to any programming task.

ZERO PAGE

The first two pages (512 bytes) of address space have special meaning to the 6502. The first page, called the Zero page, consists of memory addresses 0000 to 00FF [Editor's note: All addresses are in hexadecimal unless otherwise specified.] and is considered prime real estate for variable storage. Memory references to the Zero page by most op codes can be reduced to 1 byte because the 6502 has a special addressing mode strictly for this area of memory. Not only are programs that place variables on the Zero page shorter, but they also run faster because the microprocessor need only fetch 1 byte from the program to determine the memory address. The upper byte of the address (00xx) is supplied internally. For example, the following sequence assembles to 6 bytes and executes in eight clock cycles:

```
300:AD 80 03 LDA $380 ;get value
303:8D 81 03 STA $381 ;and stuff it elsewhere
```

The equivalent sequence using Zero-page variables assembles to only 4 bytes and executes in six clock cycles:

```
300:A5 80 LDA $80 ;get Zero-page value
```

(continued)

Joe Holt is a freelance technical writer. He can be reached at 476 West Main Rd., El Centro, CA 92243.

302:85 81 STA \$81 ;and stuff it elsewhere

Where speed and space are critical, there is no better solution than to put oft-used variables on the Zero page. But beware: Other programmers before you have done the same, so it's important not to alter Zero-page memory locations already used by your computer's ROM (read-only memory) routines or DOS (disk operating system).

THE STACK

The second page consists of memory addresses 0100 to 01FF and is the location of the 6502's stack. Because the entire stack can be addressed by 9 bits, the stack pointer is 8 bits wide with the upper bit (01xx) supplied internally. You can only set this 8-bit stack pointer via the X register; you must place the value in the X register and transfer it to the stack pointer with the TXS (transfer X register to stack pointer) op code. Because the stack grows downward, it is good practice to initialize the stack pointer at the beginning of any 6502 program with the following code:

```
300:A2 FF LDX #$FF ;set pointer to very top of stack
302:9A TXS
```

Conversely, the only way you can read the stack pointer is through the X register, with the TSX (transfer stack pointer to X register) op code. This instruction is handy for "locating yourself" in a relocatable program, a topic I'll describe later.

The stack never grows so low that it clobbers the Zero page. Instead, the stack pointer wraps from 0100 back up to 01FF, possibly causing confusion if you've already got a page full of variables or return addresses pushed onto the stack. This situation can be kept in check by limiting the use of recursive subroutines.

FLAGS

The 6502 is notorious for how it handles its flags, especially the Carry flag. Where most processors set the Carry flag when a borrow occurs from a subtract operation, the 6502 produces a *clear* Carry to indicate a borrow. The following is an illustration with the SBC (subtract with Carry) instruction:

```
300:38 SEC ;be sure the Carry's set
301:E9 01 SBC #1 ;decrement the
; accumulator
303:90 .. BCC BORROW ;a borrow occurred
```

You've probably noticed the lack of add and subtract op codes on the 6502 that do not include the Carry flag. This oversight necessitates setting (for SBC, as above) or clearing (for ADC—add with Carry) the Carry before performing one of these operations.

The backward Carry for subtract operations is not in itself confusing, that is, until you realize that compare operations (CMP, CPX, CPY) are actually subtracts in compares' clothing. Logical compares are accomplished within most

microprocessors by simply subtracting from the value being compared the value to compare with and tossing away the result. In other words, comparing 5 to 6 would be a matter of subtracting 6 from 5 and setting the appropriate status flags. In this situation (5 minus 6) a borrow would occur, indicated by a *clear* Carry. Therefore, after a compare operation, a clear Carry indicates less than, and a set Carry indicates greater than or equal. This is *backward* from the logic of all other popular microprocessors.

The other flag that you should be wary of is the Decimal flag. When set, all arithmetic operations are performed in BCD (binary-coded decimal). This is wonderful if you intend to perform BCD mathematics, but it can cause all kinds of unexplainable problems if not. Consequently, you should start any 6502 program with a CLD (clear Decimal flag) operation. Set the Decimal flag only when necessary and clear it immediately afterward.

The way the 6502 decides to set or clear its flags after different operations is not immediately obvious, and the logic behind this is somewhat different from that of most other microprocessors. For example, the Carry flag is only affected by arithmetic (ADC, SBC, and compares) and shift operations (ASL, LSR, ROL, and ROR), except when explicitly changed (with CLC, SEC, or PLP). Operations that affect the Carry flag on many other processors, such as Boolean operations (AND, EOR, and ORA), do not modify the Carry at all. Increment and decrement operations do not affect the Carry either, but this is only a problem when testing if a register or memory value was decremented past 0, in which case you have to execute an explicit comparison:

```
300:CA DEX ;count down
301:E0 FF CPX #$FF ;past zero?
303:F0 .. BEQ ROLLUNDER ;yes
```

The two flags that are set or cleared in conjunction with most operations are the Negative and Zero flags. The Negative flag reflects the state of the eighth (most significant) bit of the result of the operation, and the Zero flag is set whenever the result is equal to 0 (all bits cleared). All operations that work with a value set these flags, including the load (LDA, LDX, and LDY) and transfer (TAX, TAY, TSX, TXA, TXS, and TYA) op codes.

THE BIT INSTRUCTION

Although the 6502's instruction set includes no operations for bit manipulation (short of Boolean operations), a special instruction can be used to examine the eighth (most significant) and seventh bits of a value in memory. This is the BIT op code, and when used it will place the eighth bit of the memory referenced in the Negative flag and the seventh bit in the Overflow flag without affecting the contents of any register. This has the most benefit when you use it to test if a Boolean variable (that is, one that is either 00 or FF) is set or not:

(continued)

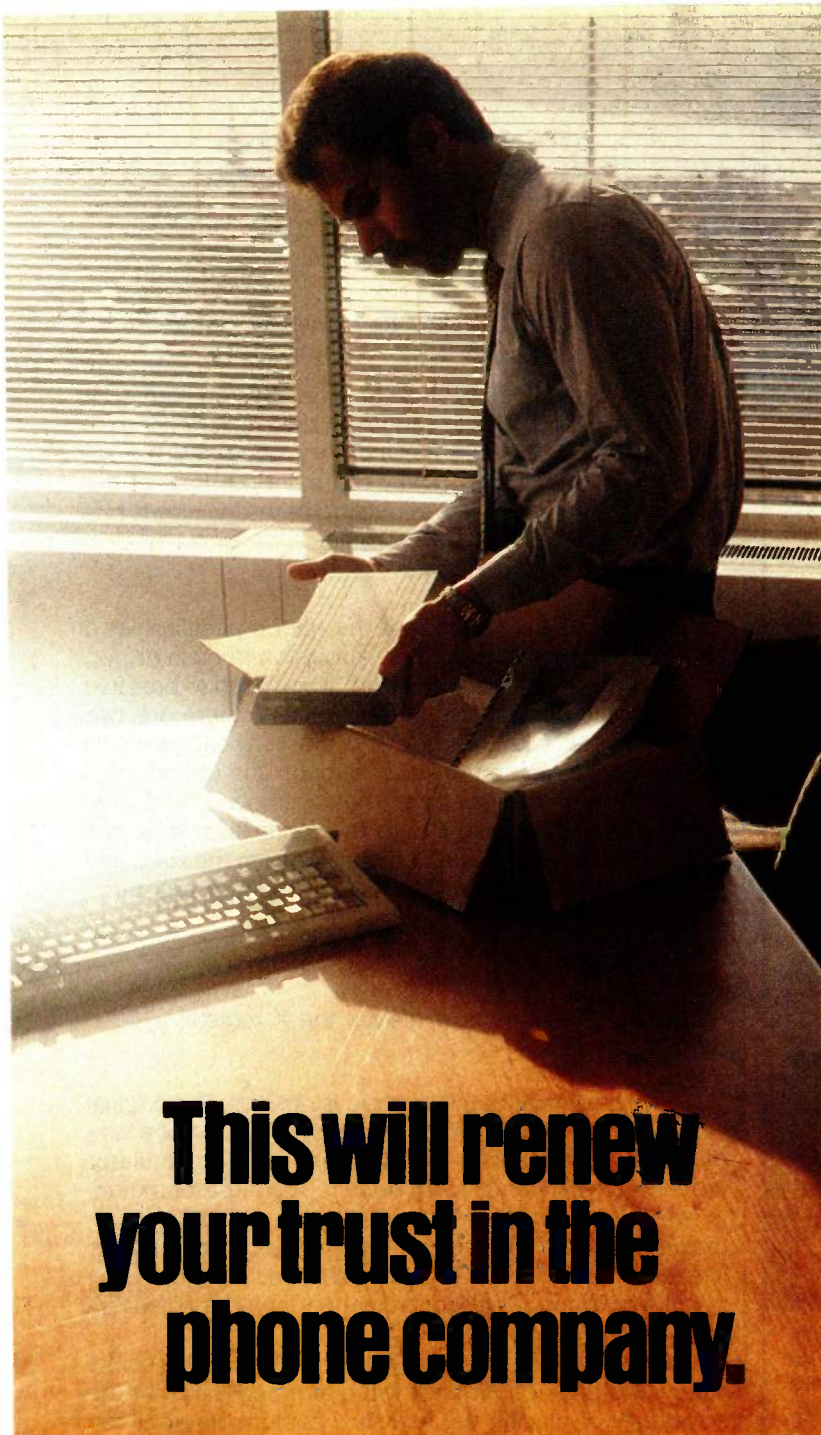

This will renew your trust in the phone company.

Anycbody who's ever sent data over phone lines knows the problems it can present.

Information gets mumble-jumbled. \$4,000 invoices become \$40,000 invoices. And soon your company's lost a pretty penny over some modem foul-up.

Well, now you can say good-bye to all that.

™MNP is a trademark of Microcom, Inc. ©Copyright 1985 Codex Corp.

Because Codex just came out with a modem that overcomes the inadequacies of phone line performance.

(Codex, as your friends in data processing will tell you, is the industry's acknowledged leader in state-of-the-art products, in service, in just about everything that has to do with networking.)

The Codex error-correcting pc modem is a serious business modem.

It gives you data transmissions more than 10,000 times more reliable than most other modems. Over anybody's phone lines.

A sophisticated error-correction system called MNP™ detects breakdowns in phone line performance and retransmits data. And the beauty is all this happens without you ever knowing it.

Just think. Data you can trust.

Now don't you feel better about those crazy phone lines?

If you're a data

communications manager responsible for purchasing modems, call **800-426-1212. Extension 225.**

Or write Codex Corporation, Department 707-225, 20 Cabot Boulevard, Mansfield, MA 02048.



codex





ZENITH data systems

THE QUALITY GOES IN BEFORE THE NAME GOES ON

PROFIT FROM ZENITH DATA SYSTEMS Z-150 PC DESKTOP OR Z-160 PC PORTABLE IBM COMPATIBLES!



OWN TOTAL PERFORMANCE
USE ZENITH'S PERSONAL COMPUTER SYSTEMS!

- 4 Open Expansion Slots
- Full Color*, Green*, or Amber Video
- Clearly Labeled, Easy-to-Use Keyboard
- Excellent Price/Performance Ratio
- Zenith Total Service, Technical and Training Support

*Z-150 PC ONLY - MONITOR NOT INCLUDED



ZENITH DATA SYSTEMS Z-160 PC PORTABLE SYSTEM

SAME AS Z150PC W/ 2 DRVS. 320K RAM, S, P, MS-DOS, WORD* AND MULTI-PLAN* SOFTWARE \$2,239 SAME AS ABOVE W/ 10.6Mb H.D \$2,849

*WHILE SPECIAL OFFER LASTS!

ZENITH DATA SYSTEMS Z-150 PC DESKTOP SYSTEM

2 DRIVES, 320K RAM, GAME, SERIAL & 2 PARALLEL PORTS. CLOCK-CALENDAR WITH BATTERY BACK-UP, FREE SOFTWARE TO INCLUDE MS-DOS, RAM-DISK, PRINT SPOOLER, MSWORD*, MS-MULTIPLAN* **\$1,899**

576K RAM OPTION **\$100**

1 FLOPPY & 10Mb DRIVES **\$2,399**

1 FLOPPY & 20Mb DRIVES **\$2,599**

EXTERNAL 25Mb TAPE **\$775**

*WHILE SPECIAL OFFER LASTS!

S=100™
(800) 528-3138

SEE PAGE 485 FOR MONITORS

6502 TRICKS AND TRAPS

```
300:24 80 BIT ALLDONE ;are we done?
302:30 BMI DONE ;yes
```

The BIT operation also has the side effect of setting or clearing the Zero flag depending on the result of a logical AND operator between the memory value and the accumulator. This feature (really the main purpose of the BIT operation) has little use outside of testing status bits in a memory-mapped I/O machine.

SAVING X AND Y

To complete the discussion of the 6502's peculiarities, I should mention that there is no provision to push or pop the contents of the X or Y registers. If you need to preserve the contents of either of these registers, there are two paths you can take. The first and most logical one is to save the contents on the stack, but you can only do this by transferring the register to the accumulator and then pushing the accumulator onto the stack. To restore the register, you must pop the accumulator from the stack and transfer its contents back to the appropriate register:

```
300:8A TXA ;save the X register
301:48 PHA
```

```
325:68 PLA ;now restore the X register
326:AA TAX
```

The disadvantage of this method is obvious: The original value in the accumulator is destroyed, and it is not a simple matter of pushing and popping the accumulator around each sequence to preserve it. You must temporarily save the contents of the accumulator either in the remaining register or in some memory location. Neither situation is desirable. (Of course, if the accumulator isn't holding anything of any consequence, then this disadvantage can be ignored.)

Your alternative is to store the register in memory somewhere and then load it back when required. This has the advantage of placing the register's content where it can be easily accessed (by LDX, STX, LDY, and STY op codes), but it forces you to set aside a specific location just for preserving a register. Things get really messy when this occurs in a recursive routine or if the location for saving the register is also used someplace else for the same purpose. In either case, havoc will ensue. The bottom line is that no solution is perfect, and you must examine the situation carefully to decide what will work best.

TRICKS

Tricks (or "hacks") are techniques that use a feature or deficiency in the programming environment to an advantage not anticipated by the system designer. If you use them with caution, they can result in faster, more compact object code.

In the 6502's case, there are dozens of these optimization tricks, each of which saves bytes and cycle time. Some

(continued)



SPECIAL DISKETTE OFFER

Dysan diskettes are the ultimate in quality flexible recording media for flexible disk drives. They are certified to be 100% error free on-track and between tracks. Diskettes are tested on-track as well as between tracks for missing pulse, extra pulse, and modulation. Quality is built into each diskette from the inside out. The ultra smooth disc surface is burnished on both sides to promote longer media life, longer head and load pad life, as well as better recording and playback performance. And to help introduce you to the Dysan quality standard we're running a special on their diskette product line.

PLUS! If you call, write, or utilize reader service in response to this ad—we'll send you our full-range catalog of computer supplies with Special Offers good for further savings on Dysan diskettes and many other quality products.

LYBEN COMPUTER SYSTEMS
1250-E Rankin Dr. • Troy, MI 48083 • Phone (313) 589-3440
Simply #1 in Service & Reliability

Dysan. The Finest Quality Diskettes Available.

Mirrored Hardware

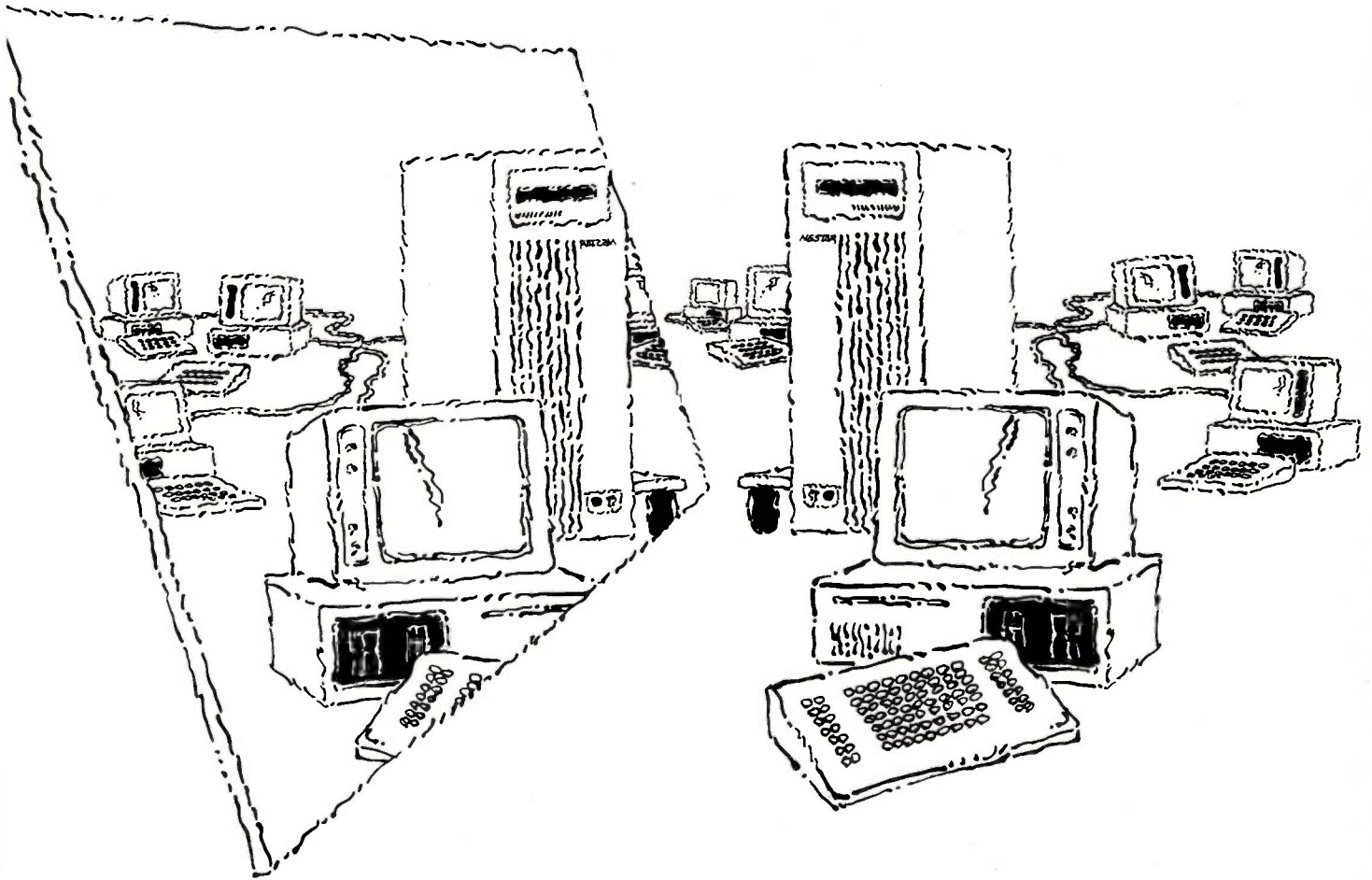

Unmatched System Reliability

A mirrored image of your data. Just what you need to assure yourself of reliable data reliably transmitted and reliably received. NESTAR's engineers ensure the reliability of your system—and your data—by designing into its products such features as tape backup for hard disk files, automatic check-sums on transmitted data, full duplexing, and mirroring of file servers.

Banks trade and transfer billions of dollars every day. They demand a network that stores, transfers, and retrieves data reliably. Banks trade and transfer their billions of dollars every day over NESTAR networks.

Call or write for your copy of:
"Executive Briefing"
2585 East Bayshore Road,
Palo Alto, CA 94303 • (415) 493-2223



Local Area Networks For Large Organizations

NESTAR™



WE'VE TAUGHT THE COMPETITION A LESSON IN ECONOMICS.



ERGO 200—the best
 Price/Performance terminal on the market today—offers total TeleVideo 925 compatibility at just \$399 (plus freight). In addition, ERGO 200 emulates the Lear Siegler ADM3A, DEC VT 52, Hazeltine 1410 and Micro-Term ACT-5A. These emulations, plus the following popular features make the ERGO 200 the best buy: • a built-in tilt mechanism • 7 x 9 character matrix • five emulations • 16 host-definable, user-programmable, downloadable function keys • optional Tektronix 4010 (Plot-10) graphics board • five video attributes in any combination • soft set-up mode • seven keyboard LEDs • 25th status line • two speeds of smooth-scroll • Non-glare green screen with screen saver • one-year warranty
 So, move over TeleVideo—Micro-Term's ERGO 200 goes to the head of the class.

MICRO-TERM

Call Toll-Free (800) 325-9056
 MICRO-TERM, INC., 512 Rudder Road, St. Louis County, MO 63026
 (314) 343-6515, TWX: 9107601662, MICROTERM, STL.
 TeleVideo 925, ADM3A, VT 52 and Hazeltine 1410 are registered trademarks.

Find the right word

THE WORD FINDER

(Synonym Finder)

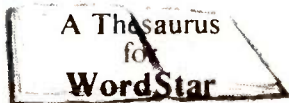

Multimate, Word Perfect

Improve your writing by finding the perfect word. Put your cursor on a word and call up a list of words with similar meaning. Pick one, and voila, your new word replaces your old word. No more fumbling for a book. It's so fast and easy you'll use it all the time. Special introductory offer, only \$79.95! (Regularly \$124.95.) Synonym Finder installs on most machines that run WordStar (3.3 or 3.0), Multimate, or Word Perfect. Specify word

proc., computer, operating system (MS/PC DOS or CP/M 80) and disk format. New database has 1/2 more words than Random House and uses 1/2 less disk space. Easy to install and operate. Highly rated by dozens of reviewers and users groups. Add \$2.50 shipping and NYS residents add sales tax. Okay! My check is enclosed for \$_____ (or charge my VISA/MC acct. # _____ expires _____ / _____).

Writing Consultants

Suite 348, 11 Creek Bend Drive - Fairport, NY 14450
 Orders only: 800-828-6293 Info: 716-377-0130
 dealers and distributors please call or write

6502 TRICKS AND TRAPS

of the tricks described here are not necessarily applicable just to the 6502 but are simply good programming practices. Nonetheless, they are essential to using the 6502's full potential.

BRANCHING

One of the glaring holes in the 6502's instruction set is the absence of an unconditional relative jump (or branch). This makes writing relocatable code difficult, and many times it seems a waste to have to use 3 bytes for a jump instruction just to skip over 1 or 2 bytes. One way you can get around this is by using a conditional branch when the state of a flag is guaranteed. For example, because a load operation always modifies the Negative and Zero flags, this type of sequence is possible:

```
300:C9 05    CMP #5           ;less than 5?
302:B0 ..    BCS NOTLESS    ;no
304:A9 01    LDA #1           ;yes, set to 1
306:D0 ..    BNE CONTINUE  ;-- always taken
```

Because the accumulator is loaded with 1, the Zero flag will always be clear, in which case the BNE (branch if not equal) will always be taken.

If you do not know the state of a flag for certain, but you must use a branch instead of a jump (perhaps you are writing some relocatable code), you can always force one of the flags to a known state and branch on that condition. Because the Overflow flag is seldom used, it finds itself the most likely candidate:

```
300:B8    CLV           ;clear overflow for branch
301:50 .. BVC SMORE    ;-- always taken
```

This sequence takes just as many bytes as an equivalent jump (JMP) instruction, with the one disadvantage common to all 6502 relative branches: They can only jump forward 127 bytes or back 128 bytes.

One other trick involves the misuse of the BIT operation. Because the BIT operation does not affect any registers and only the Zero, Negative, and Overflow flags, it can be put to good use as a "skip over the next 2 bytes" instruction. For example,

```
300:C9 05    CMP #5           ;less than 5?
302:B0 03    BCS NO           ;no
304:A2 FF    LDX #$$$      ;yes, set to true
306:2C      DFB $2C      ;-- BIT trick
307:A2 00 NO: LDX #0      ;no, set to false
309:86 80    STX AFLAG    ;save true/false status
```

If the condition is true (less than 5), the X register will be loaded with the value FF, then a nonsense BIT instruction occurs, after which execution continues. If the condition is false, NO will be branched to, which loads the X register with 00. In one sense, the operation immediately following the LDX #\$\$\$ is a BIT operation with memory address 00A2, but in another sense, that memory address operand (00A2) disassembles to the instruction LDX #0.

6502 TRICKS AND TRAPS

This trick of hiding code within the operand of other code is an old one but should nonetheless be used with caution.

This BIT technique can also be used to skip over 1 byte by using the Zero-page addressing mode for BIT, in which case the value for the DFB (define byte) pseudo-operation would be 24.

ADDING AND SUBTRACTING

Because of the lack of add and subtract operations that do not include the Carry, the sequences CLC, ADC and SEC, SBC are common ones. There is one way to avoid having to explicitly set or clear the Carry, but only if the Carry is in a known state. For example,

```
300:C9 05    CMP #5           ;less than 5?
302:B0      BCS NOTLESS     ;no
304:18      CLC
305:69 05    ADC #5           ;yes, put it above 5
```

Because the Carry flag will *always* be clear if the branch is not taken, the CLC before the ADC instruction is unnecessary. You must be careful to ensure that the condition of the branch does not change, however.

If the Carry flag is in the wrong (but known) state, it can still be used to your advantage if the operand for the ADC or SBC is immediate:

```
300:C9 05    CMP #5           ;less than 5?
302:90      BCC LESS        ;yes!
304:69 04    ADC #5-1       ;(or 4)
```

In this example, the ADC operation will still add 5 to the accumulator because the Carry will always be set and will therefore be added along with the 4.

INITIALIZATION

There are many places in a program where a number of variables must be set to certain values. Usually, the code looks like this:

```
300:A9 FF    LDA #$FF        ;set a few true/false vars
302:85 80    STA VAR1
304:85 81    STA VAR2
306:A9 00    LDA #0          ;clear this one
308:85 82    STA VAR3
30A:A9 01    LDA #1          ;and initialize another
30C:85 83    STA VAR4
```

If the X or Y register can be sacrificed, the fact that the values being stored are consecutive can be exploited:

```
300:A2 FF    LDX #$FF        ;set a few true/false vars
302:86 80    STX VAR1
304:86 81    STX VAR2
306:E8      INX              ;now we're up to 0
307:86 82    STX VAR3       ;clear this one
309:E8      INX              ;now we're up to 1
30A:86 83    STX VAR4       ;and initialize another
```

(continued)

IBM PC KEYBOARD IMPROVEMENT!

Plug in a better keyboard for your IBM PC or PC-XT. Our new keyboards feature conductive elastomer technology with "Maxi-Touch" tactile response. Low-profile design, three versions:

- Standard IBM layout
- Enhanced layout (improved Return, Enter, Left Shift and Slash positioning)
- Dvorak high-efficiency layout

Keyboard enclosure matches IBM, has comfortable palm rest. With coiled cord, connector. Only \$168.00 plus shipping. Available from stock.

Maxi is a leading OEM keyboard supplier.



(IBM PC AND PC-XT are trademarks of International Business Machines.)

THE *Maxi*-SWITCH CO.

9697 EAST RIVER ROAD • MINNEAPOLIS, MINNESOTA 55433
 Subsidiary of (612) 755-7660
 EECO Incorporated. TWX 910-576-2690



COMPUPRO USERS

SMD Acceleration Options

now for Concurrent DOS

SMD SUBSYSTEMS

Controller—Drive—Power Supply—Cables
 Desktop Cabinet / Concurrent DOS XIOS

600 MbMax	Concurrent DOS	XIOS
84 MBYTE	168 MBYTE	300 MBYTE
\$8,995.00	\$10,995.00	\$12,995.00

suggested list pricing

DATABANK ACCELERATED COMPUPROS

All systems with 5" & 8" floppy
 Concurrent DOS XIOS

130 MBYTE Internal SMD Disk Drive & Controller
 Standard Compupro System Specs and Enclosures

SUPER 816CH130 SMD	SUPER 816FH130 SMD
\$15,995.00	\$16,995.00

call for quote — any compupro system

SPECIAL

WHY SMD?

1.2 MB/SEC × controller-disk transfer rate
 20 MSEC average disk access time

130 MYBTE = \$7,495.00

Internal retrofit on your lower enclosure
 Prebooking Required
 Only 48 hrs. at our site

WHY DATABANK?

Authorized Compupro System Center
 Dunn & Bradstreet 05-204-9640

DATABANK 228 A WEST CARRILLO
 SANTA BARBARA, CALIFORNIA 93101
(805) 962-8489

Note that this only reduces the size of the code; there is no savings in speed (an INX op code takes just as many clock cycles as an LDA #).

LOCATING YOURSELF

Often it is necessary to know the location of code that is executing in a relocatable environment. If there is within the system the location of a known RTS instruction (perhaps in ROM), this can be accomplished by calling this RTS, then examining the remains on the stack. The following example will determine what page the executing code is on:

```
300:20 58 FF JSR KNOWNRTS ;get return address
                                on the stack
303:BA      TSX
304:BD 00 01 LDA $100,X      ;now get what
                                page we're on
```

There is a special consideration when using this type of code. If there is the possibility of a 6502 interrupt occurring (from a real-time clock or a communications device), the return address above the stack would be destroyed by the 6502's interrupt processing. It would be wise in this case to turn off interrupts before this bit of code (SEI), then reenable them immediately after the LDA \$100,X (CLI). *[Editor's note: These instructions are two more examples of the 6502's confusing mnemonics. At first glance, you would think that SEI would mean "set interrupts." However, SEI means "set interrupt disable flag"; its execution shuts off the 6502 interrupts. CLI means "clear interrupt disable flag," and a CLI instruction actually enables interrupts.]*

NONINDEXED INDIRECT

One of the nicest features of the 6502 is its abundance of addressing modes, but there are times when even these are not enough. A prime example is the situation when a nonindexed indirect reference must be made. Most of the time, the Y register is sacrificed in this way:

```
300:A0 00 LDY #0            ;index of zero
302:B1 80 LDA (POINTER),Y ;nonindexed
```

But if the Y register is already being used, a similar method involving the seldom (if ever) used preindexed indirect addressing mode can be used, at the expense of the X register:

```
300:A2 00 LDX #0            ;use some register
302:A1 80 LDA (POINTER,X)
```

Of course, you should take advantage of an index register that already contains 00.

INDIRECT JUMPING

Last but not least is a technique for branching to different routines depending on an index value. This can be used for interpreting keyboard commands or executing alternate parts of code based on a certain number. The only limitation is that all the routines must reside on the same

page in memory, but a little extra programming can overcome this. This technique uses an RTS instruction as a kind of indirect jump:

```
300:A9 03 LDA #HIPAGE      ;high byte of
                                address routines
                                are on
302:48    PHA              ;stick it on the
                                stack
303:BD 20 03 LDA ADDR TAB,X ;X contains the
                                function number
306:48    PHA              ;fake a 'return'
                                address
307:60    RTS              ;go to the routine
```

The table ADDR TAB would contain the low byte of each routine *minus one* due to the fact that the 6502's program counter is incremented after the address is obtained for the RTS. This portion of code expects the function number in the X register. First, the high byte of the routines' addresses is pushed onto the stack, then the low byte is obtained from the table and pushed onto the stack. At this point, the stack contains the address of a routine to execute just as if an instruction right before that routine had been a JSR (jump to subroutine; note: JSR actually stands for "jump and save return address"). When the RTS executes, it pulls the address off the stack, increments it, then continues program execution at that address.

THE 65C02

Just when you get used to the idea of having to use all these tricks and have plastered your wall with 6502 peculiarities (as I've done), along comes the 65C02. The 65C02 is a revision of the 6502 that is built into the Apple IIc, is offered as an upgrade to the Apple IIe, and solves many of the problems and voids many of the hacks described above. For example, the 65C02 includes a branch-always instruction, eliminating the need for the known-condition branching tricks. Also included are push and pop X and Y instructions, which eliminate the need for all the tricky register transfers or loading and storing. Another nice addition is the inclusion of increment- and decrement-accumulator instructions, so that it is no longer necessary to resort to arithmetic just for this. A few bugs within the 6502 have also been fixed in the 65C02.

THE FUTURE OF THE 6502

After all is said and done, has all this been purely academic? I think not. Despite its simplicity and peculiarities, the 6502 is still an attractive microprocessor for semi-dedicated machines (that is, game machines, low-priced home computers, etc.). It is a fast microprocessor with a very efficient design. And to tell you the truth, I enjoy programming the 6502 for the very quirks I've been complaining about. I believe there are others who feel the same way, and this if nothing else should guarantee a long and prosperous life for the 6502. ■

Dac-easy accounting

\$49.95

Introductory Price

The software revolution of the year!

All 7 complete modules on 1 disk! Compare our features with other packages costing thousands more!

General

- Menu Driven •Fully Integrated
- MS-DOS & PC-DOS
- RUNS ON PCjr, PC, XT, AT, AND COMPATIBLES
- Password Protection In All Programs
- Slipcased Binder
- OVER 300 DIFFERENT REPORTS!!
- OVER 90 ROUTINES!!
- File Capacity Limited Only By Disk Space
- Service Contract Available
- ONLY \$49.95 FOR ALL 7 MODULES
- Money Back Guarantee

General Ledger

- Double Entry •Unlimited # Of Accounts
- Multi-Level Accounting
- Unlimited Departments
- 3 Year Account History For CRT Inquiry
- Pencil & Pen Feature To Correct Mistakes Without Reverse Entries
- UNIQUE Budgeting Routine (See Forecasting)
- CRT Voucher Inquiry
- All Reports Compared to Last Year or Budget
- Unlimited Journals

Accounts Receivable

- Open Item or Balance Forward
- 7 Customized Columns For Aging Report
- Unlimited # Of Customers
- Mailing Labels With 4 Different Sorts
- Automatic Finance Charges
- Supports Partial Payments •Directories
- 3 Year Customer History for # Of Invoices, Sales, Costs, And Profits
- Customized Text On Statements
- Cash Flow Analysis •Sales Analysis
- Automatic Sales Forecasting By Customer, Salesman, Or Customer Type

Accounts Payable

- Check Printing •Automatic Allocation Of Available Cash To Payables
- Vendor Directories With Sorting By Vendor Code, Name, Or Territory
- Aging Reports With 7 Customized Columns
- Unlimited # Of Vendors
- Mailing Labels •3 Year Vendor History For CRT Inquiry And Printing
- Flexible Payment Calendar
- Automatic Forecasting of Purchases
- Unlimited Allocations Per Invoice
- Up To 10 Invoices Paid Per Check

Inventory

- Supports Average, Last Purchase, And Standard Costing Methods •Physical Inventory
- Accepts Any Measure Units Per Case Like Fractions/Dozens/Gross/Etc
- Automatic Changing Of Costing Methods
- Time And Product Inventory
- 3 Year Product History In Units, Dollars, Cost, And Profits
- Automatic Forecast Of Product Sales
- Automatic Pricing Assignments
- Alert And Activity Reports With 11 Sorts
- CRT Shows On-Hand/On-Order/Committed/Sales/Cost/Profit/Turns/GROI

Purchase Order

- Allows Up To 99 Lines Per Purchase Order
- Per Line Discount In %
- Purchase Order Accepts Generic Discounts/Freight/Taxes/Insurance
- Purchase Order Accepts Back Orders & Returns
- Purchase Journal
- Automatic Interfacing With General Ledger, Payables, And Inventory

Billing

- Invoicing On Plain Or Pre-Printed Forms
- Prints Sales Journal
- Automatic Updating Of Committed Products In Inventory
- Ability To Customize Invoice For Remarks
- Allows Return Credit Memo

- Interfaces With Inventory, Accounts Receivable And General Ledger

Forecasting

- Unique program that automatically forecasts using your 3 year history
- Forecast Revenue And Expense Accounts
- Forecast Vendor Purchases
- Forecast Customer Sales, Cost, And Profit By Customer Or Salesperson
- Forecast Inventory Item Usage By 4 Automatic Methods
- Forecast By Same As Last Year, Or % Base From Last Year, Or Trend, Or Least Square Trend Line Analysis Method

NOT COPY-PROTECTED

Minimum Hardware Requirements:

128K memory, one 5 1/4 DSDD floppy disk, 132 column printer in compressed mode, 80X24 CRT, MS-DOS, PC DOS 2.0 or later.

Runs on your: IBM (PCjr/PC/XT/AT), AT&T, EPSON, TANDY (1000/1200/2000), TI, COMPAQ, CORONA, SANYO, COLUMBIA, ETC.*

*Computer names are trademarks and/or trademarks of their respective manufacturers)

To Order Call Toll Free:

1-800-431-0800

ASK FOR OPERATOR 250

For More Info Call:

(214)458-0038

30 Day Money-Back Guarantee: Before you spend thousands of dollars on an accounting system, try **dac-easy accounting**, and if you are not fully satisfied, return it. For \$49.95 you owe it to yourself to find out that software doesn't have to be expensive to be the best.



dac software, inc. 5580 Peterson, Suite 130, Dallas, TX 75240

\$49.95 plus \$7.50 postage and handling Texas residents add 6 1/8 % sales tax (\$3.06) Credit card members can order by phone. Enclose check or money order with coupon. \$7.00 for C.O.D.

CHECK MONEY ORDER COD VISA MASTERCARD AMEX

ACCOUNT NO. _____ EXPIRES _____

Name _____

Address _____

City _____ State _____ Zip _____

Phone _____ Signature _____ B250

The TI Pro where no

Now you can have true CAD at an affordable price. Plus an out-of-this-world PC package for your unique computing needs.

High quality computer-aided design has usually meant working with highly expensive mainframes.

But now, with the TI Professional Computer and AutoCAD™ 2 software from Autodesk, Inc., you can put real CAD on your desk for under \$10,000. And you'll have a superior PC system for other computing needs – available in a package of hardware, service, training and support *no other PC offers.*

TI and AutoCAD 2 let you explore the outer limits of your imagination.

AutoCAD 2 gives you mainframe capabilities like multilayering and precise dimensioning, plus isometric design and piece part takeoff attributes. You can create your own symbol and parts libraries. Use bi-directional zoom to go from a full building elevation to the smallest bolt with trillion-to-one precision. And move, copy, rotate or delete any part of your drawing.

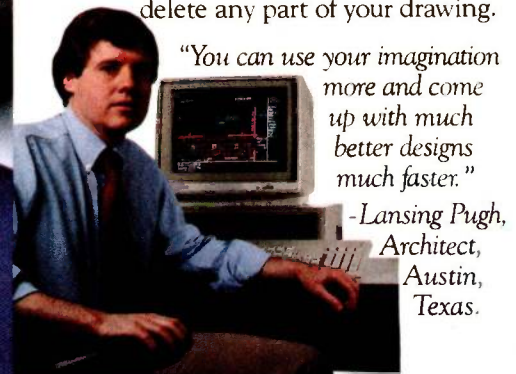

"You can use your imagination more and come up with much better designs much faster."

*-Lansing Pugh,
Architect,
Austin,
Texas.*

The perfect match of CAD and machine.

Running AutoCAD 2 on the TI Professional Computer can yield spectacular results. High resolution graphics (720 x 300 pixels) give you crisp characters, lines and curves. Unlike many PCs, TI shows up to 8

Professional Computer takes CAD PC CAD has gone before.

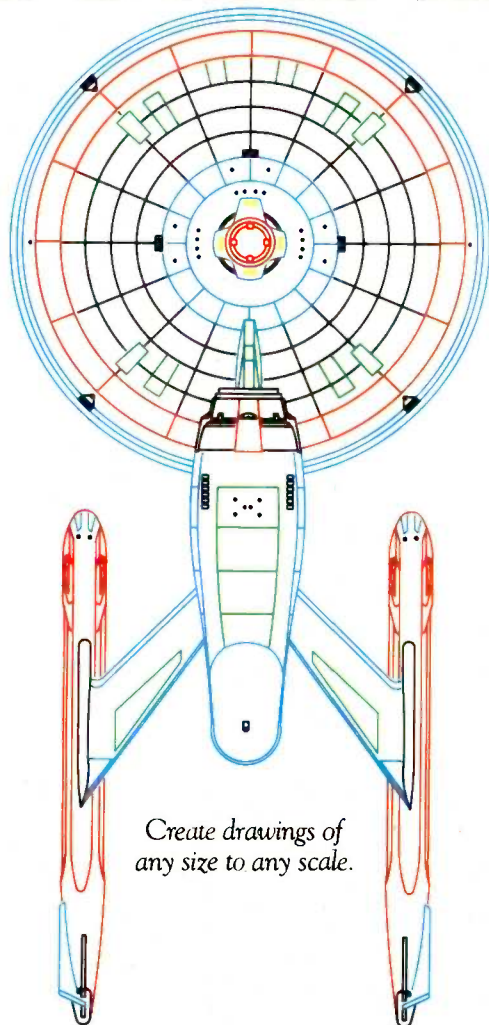

Create drawings of any size to any scale.

colors simultaneously. And lets you mix and display text and graphics at once.

The TI Professional Computer is part of a complete system that gives you better performance from the best-selling software for other applications, too. It's an uncommonly expandable system that works with a vast range of peripherals. It can all be configured to your own individual needs. And grow as you grow.

We also offer optional service and support packages unobtainable anywhere else. Like a 24-hour customer support line. Extended 1- or 5-year service and support programs. And regional training seminars to get you started.

Is this the right CAD system for you? TI has the answers.

You have your own special way of working, your own unique needs. If the answers below apply to you, the TI/AutoCAD 2 system is your best choice.

Q. Are your drawings dimensioned?

A. If they are, our system automatically computes them with a choice of linear, angular, aligned, circular and leader options.

Q. Do you often modify existing drawings?

A. We make it fast and simple, with a revised, plotted drawing that looks as good as the original. So, your productivity will be greatly improved.

Q. Are overlays useful to you?

A. If so, you can store information in unlimited, named layers, and turn them on or off for display or plotting in any color combination.

Q. Do you use standard symbols or parts?

A. AutoCAD 2 offers optional symbol libraries and lets you create your own.

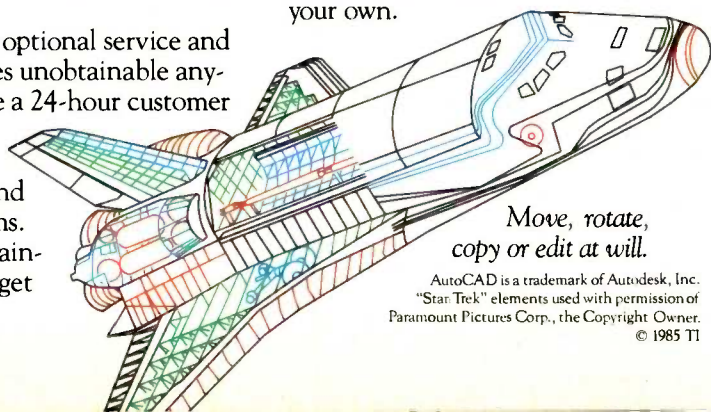

Move, rotate, copy or edit at will.

AutoCAD is a trademark of Autodesk, Inc. "Star Trek" elements used with permission of Paramount Pictures Corp., the Copyright Owner. © 1985 TI

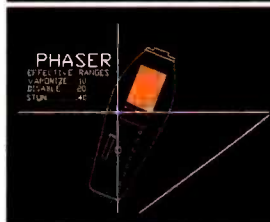
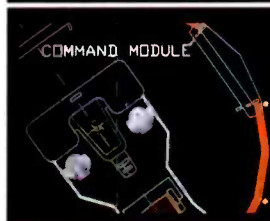
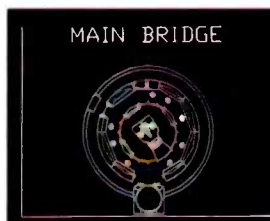

Beam down from the big picture to the smallest detail.

Q. What size drawings do you use?

A. Our system works with a wide variety of leading plotters for drawings from A-size (8½" x 11") to E-size (36" x 48").

Q. Do you have other PC needs?

A. The TI Professional Computer isn't just a dedicated CAD workstation. It runs over 1000 popular software programs for word processing, spreadsheets, accounting or other business needs.

Q. Is expandability important?

A. TI supports many expansion options, from communications to larger disks, printers, even to speech recognition, to improve your productivity.

Explore the possibilities.

Draw your own conclusions. For more details, or to arrange a demonstration at your nearest TI dealer, mail this coupon or call us at 1-800-527-3500. In Canada (416) 884-9181.

Name _____
Company _____
Address _____
City _____ State _____ Zip _____
Phone _____
Mail to: Texas Instruments Incorporated, P.O. Box 809063,
Dept. DCC052BY, Dallas, TX 75380-9063.

TEXAS INSTRUMENTS
Creating useful products and services for you.



For IBM-PC Add-On Users

In A Pinch? Give QIC The Inch Measure Us By The Standards We Set!

We Set The Standard On Price!

QIC-01 Internal Hard Disk Subsystem

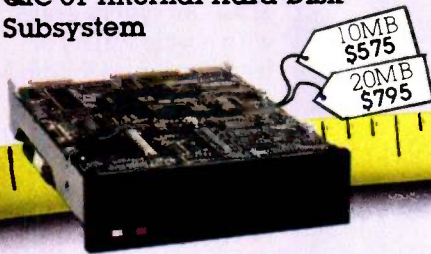

Comes complete with controller, cables, drive, easy instructions. Fits inside your floppy slot. Compatible with DOS 2.0, 2.1, and 3.0 without any patches. 20 MB half-height, \$795 ... 33 MB full-height, \$1,595 ... 20 MB Drive for the PC AT, \$895.

We set The Standard In Quality!

QIC-03 300/1200 Baud Modems

Our modems are fully Hayes compatible with features such as low heat dissipation, low power consumption, software volume control for the speaker, and large-scale-integration "Modem on a chip" for high reliability. It also comes with communications software which lets you emulate VT100 or IBM 3101. Both external and internal models are available.

We Set The Standard On Reliability!

QIC-05 Five-Function Card

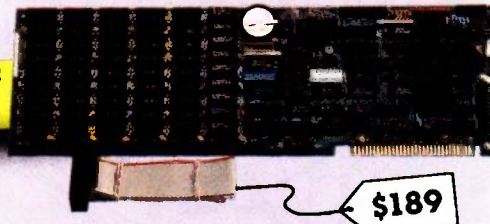

It gives you more than just added memory. It gives you reliable memory expansion (up to 384K), a serial port, a parallel port, a game port, and a battery back-up clock calendar. Includes RAM disk, print spooler, and clock utilities. (The 64K RAM set is only \$15.)



We Set The Standard On Performance!

QIC-02 Floppy Tape Drive

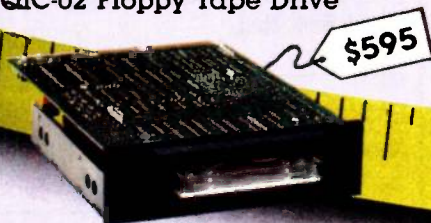

How's this for Performance? It backs up your 10 MB disk in only 5 minutes and performs both image and file-by-file back-up. This half-height drive will fit inside your floppy disk and connect to your floppy controller. (No need for an additional controller card.) ... All for a truly amazing low price.

Graphics Boards

Hercules, Color	\$185
Hercules Compatible, Mono	\$245
Paradise Graphics	\$295
Everex Graphics Edge	\$295

Back-up Tape Subsystems

45 MB Internal Streaming Tape for AT	\$895
45 MB Internal/External Streaming Tape for PC XT	\$950/\$1195
20 MB Internal/External Streaming Cassette	\$695/\$895
Expansion Chassis with I/O Slots	\$695
IBM PC, 256K, 2 Drives	CALL

...And

We Guarantee Satisfaction!

No Risk. All our products carry the manufacturer's warranty. And remember, if for any reason, you are not completely satisfied within 30 days, you can return it for a full refund.

Call Us Today!
(408) 942-8086

"We Set The Standards"

QIC RESEARCH
INCORPORATED

489 Valley Way
Milpitas, Ca 95035
Inquiry 342

SOFTWARE-ICS

BY LAMAR LEDBETTER AND BRAD COX

A plan for building reusable software components

THE SOFTWARE WORLD has run headlong into the Software Crisis—ambitious software projects are hard to manage, too expensive, of mediocre quality, and hard to schedule reliably. Moreover, all too often, software delivers a solution that doesn't meet the customers' needs. After delivery, if not before, changing requirements mean that systems must be modified.

We must build systems in a radically different way if we are going to satisfy tomorrow's quantity and quality demands. We must learn to build systems that can withstand change.

Some system developers are already building software much faster and of better quality than last year. Not only that, the systems are much more tolerant of change than ever before, as a result of an old technology called message/object programming. This technology, made commercially viable because of the cost/performance trends in hardware, holds the key to a long-awaited dream—software reusability. A new industry is developing to support the design, development, distribution, and support of reusable Software-ICs (integrated circuits). A forthcoming

series in *UNIX/World* will address message/object programming.

MESSAGE/OBJECT PROGRAMMING AND SOFTWARE-ICS

In this article we'll look at the concepts of message/object programming and how they support the building of "Software-ICs," as we call them, by satisfying the requirements for reusability.

A Software-IC is a reusable software component. It is a software packaging concept that combines aspects of subroutine libraries and UNIX filter programs. A Software-IC is a standard binary file produced by compiling a C program generated by Objective-C.

The notion of *objects* that communicate by *messages* is the foundation of message/object programming and fundamental to Software-ICs. An object includes data, a collection of procedures (*methods*) that can access that data directly, and a selection mechanism whereby a message is translated into a call to one of these procedures. You can request objects to do things by sending them a message.

Sending a message to an object is exactly like calling a function to operate on a data structure, with one

crucial difference: Function calls specify not *what* should be accomplished but *how*. The function name identifies specific code to be executed. Messages, by contrast, specify what you want an object to do and leave it up to the object to decide how.

REQUIREMENTS FOR REUSABILITY

Only a few years ago, hardware designers built hardware much as we build software today. They assembled custom circuits from individual electrical components (transistors, resistors, capacitors, and so on), just as we build functions out of low-level components of programming languages (assignment statements, conditional statements, function calls, and so on). Massive reusability of hardware designs wasn't possible until a packaging technology evolved that could make the hardware environment of a chip (the circuit board and adjoining electrical components) rela-

(continued)

Lamar Ledbetter is director of special projects and Brad Cox is vice president of Productivity Products International (27 Glen Rd., Sandy Hook, CT 06482), which produces Objective-C.

tively independent of the detailed workings of that chip. The IC quickly developed to the point that multiple chip vendors now vie to sell their hardware design effort in a market for reusable hardware designs.

One concept that stands out in hardware systems is that many of the components perform unique services. Services are provided upon request, and the requester need not be concerned with the internal methods or data used, only the result. The equivalent software concept, *encapsulation*, is fundamental to success in software reusability. Encapsulation defines a data structure and a group of procedures for accessing it. Users access the data structure only through a set

of carefully documented, controlled, and standardized interfaces.

The concept of *messaging* is also prevalent in the hardware world. It is through messaging that the loose coupling of components is achieved and the division of responsibility between the user and the supplier is defined and enforced.

The hardware industry has also achieved a high degree of reusability through the development of standards. There are standards for interconnection, power, and processing, for example. In contrast, in the software world standards for the syntax and semantics of only a few languages have been defined and adhered to across a range of hard-

ware. There have also been many unsuccessful attempts to define standards for the implementation of software algorithms and applications (such as GOTO-less programming, no global data, loose coupling, tight binding, and data hiding, among others). Stressing strict static "type checking" as a standard helps solve the problems of integration and debugging but does not change the basic operator/operand concept embodied in most languages; it only moves it to a higher level of abstraction. To reuse modules developed using the operator/operand concept, you have to hope that the output of one module is compatible with the "type" of the input of the receiver, redefine the type of the operands in either the receiver or sender, or transform the operands. Because of the complexity, there has been little progress in the definition of standards for reusability in the operator/operand model. In contrast, useful standards for reusability are in use or being developed in organizations that have embraced the message/object paradigm.

In the hardware world, the functions of standard components are well defined and identifiable. Given a knowledge of the functions available and a high level of standardization, hardware designers routinely integrate reusable hardware components into new systems. Standard functions are easy to identify because they map into the real-world model of hardware systems. In the software world, the definition of standard, identifiable functions is still a dream, even with our "standard" utility libraries. If software reusability is to become a reality, languages must support a more direct mapping from the model of the real-world functions to the implementation.

Hardware components are delivered in an unmodifiable form. That means that standard functions are protected. If Software-ICs are to become a reality, the languages and standards must support the delivery of components that operate as advertised and are immune to modification

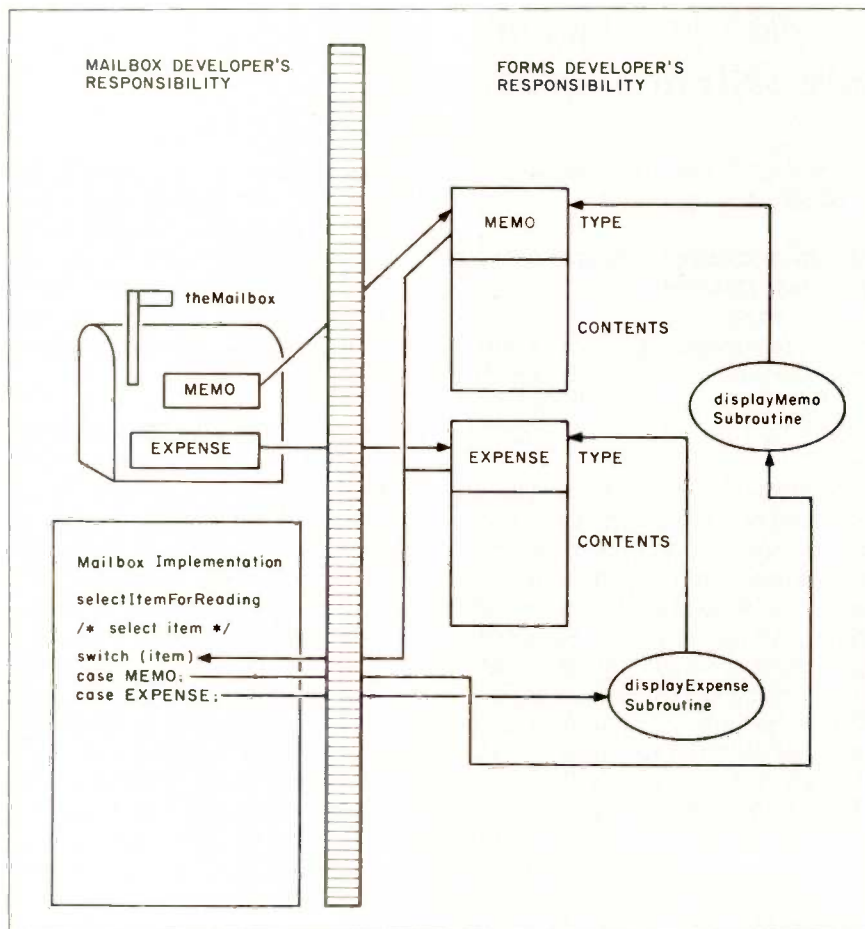

Figure 1: Mailbox using the operator/operand model. The Mailbox developer must specify how to display the form by checking the form type and calling the correct subroutine. As a result, every form type must be enumerated and the implementation changed as form types are added or deleted.

SOFTWARE-ICs

by the system builder. If the system builder wants different functions, he must go back to a Software-IC "foundry" for a new component.

Reusability can have several meanings in both the hardware and software worlds. A hardware designer would never think (as we do in software) of starting the design of a modification with a blank piece of paper or by looking at the design of all of the connecting components. A designer also doesn't worry about needing to modify the interfaces or components not affected by the change. Modified components "inherit" most of the previous implementation and contain only the changes necessary to provide the required new behavior. The inheritance of already-working methods by a new Software-IC has tremendous productivity implications.

WHY DIDN'T SOFTWARE-ICs EXIST BEFORE?

One of the main reasons Software-ICs didn't exist before is that the cost performance of hardware did not support the requirement that computer cycles must be used ("wasted") to enhance software reusability. The cycles were too expensive, and performance optimization was necessarily a primary goal. Strict implementations such as Smalltalk-80 consume orders of magnitude in performance. Less revolutionary implementations of the message/object paradigm, such as Objective-C, while paying some performance price, are viable for commercial systems and are in use today in companies building major software systems.

Most of us have been taught to think within the conceptual framework of operators and operands. That framework has led many to conclude that the complexity involved in re-using a software component far exceeds the possible benefits.

In order for Software-ICs to work, the manner in which systems evolve has to be fundamentally different. The concept of *inheritance*, discussed in detail later, is that fundamental difference. The concept of Software-ICs

Encapsulation is fundamental to success in software reusability.

also demands a level of standardization in system implementation that has not been feasible until recently. Finally, the market for Software-ICs is a recent reality created by the recognition that what I call the Software Crisis can be solved only by fundamental changes in the way we build systems. It is no longer competitively viable to ignore the products of previous development efforts if there is any way to reuse or reapply those products.

OBJECTS, MESSAGES, AND ENCAPSULATION

The distinction between specifying what should be done as opposed to how it should be done is subtle and often misunderstood. It is, however, a crucial one because, as has been demonstrated in the hardware world, it is central to reusability.

By way of example, imagine a programmer building an electronic mailbox in an electronic office system, and focus on the mailbox developer's role as a user of services provided by his supplier, the developer of the forms being mailed. The mailbox developer must provide a way to implement the intention to display the selected item. If he does this using the conventional operator/operand model and specifying how, not what, as depicted in figure 1, the code given in listing 1a results.

Notice the separation of responsibilities. Because the mailbox developer is responsible for deciding how to implement the function that is called `selectItemForReading`, the code must enumerate every data type the forms developers might provide. This results in code that is inherently nonreusable; the case labels explicitly

(continued)

Little Board™ \$349*

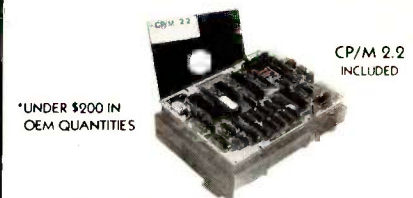

*UNDER \$200 IN
OEM QUANTITIES

CP/M 2.2
INCLUDED

- 4-MHz Z80A CPU, 64K RAM, Z80A CTC, and 2732 Boot ROM
- Mini/Micro Floppy controller (1-4 Drives, Single/Double Density, 1-2 sided, 40/80 track)
- Only 5.75 x 7.75 inches, mounts directly to a 5 1/4" floppy drive
- Two RS232C Serial Ports (75-9600 baud and 75-38,400 baud), 1 Centronics Printer Port
- Power Requirements: +5VDC at 0.75A; +12VDC at 0.05A/On-board -12V Converter
- CP/M 2.2 BDOS • ZCPR3 CCP
- Enhanced AMPRO BIOS
- AMPRO Utilities included:
 - Read/write to more than two dozen other formats (Kaypro, Televideo, IBM CP/M86...)
 - Format disks for more than a dozen other computers
 - Menu-based system customization
- BIOS and Utilities Source Code available

BOOKSHELF™ Series 100

AS LOW AS \$635 IN OEM QTY

MODEL	QTY	PRICE
121 1 400K DSDD Drive		\$ 895.00
122 2 400K DSDD Drives		995.00
142 2 800K DSDD Drives		1,095.00

- Little Board CPU
- Runs thousands of CP/M programs
- Enhanced Operating System including ZCPR3 CCP and FRIENDLY™ Integrated Operating Environment
- Word Processing, Electronic Spreadsheet, Database Management, Spelling Checker all included (complete T/maker Pkg.)
- 10 MB hard disk version available
- 6 1/2" high, 7 1/4" wide, 10 1/2" deep, 12 1/2" lbs.

SCSI/PLUS™ Adapter

Compatible with most Z80 Systems
(send \$10 for complete specifications)

- Mounts directly to Little Board
- Multi-Master high-speed parallel bus \$99
- SASI-SCSI compatible QTY 1
- General purpose I/O expansion bus
- Supports up to 64 bus devices
- Allows multi-Little Board Systems and resource sharing
- Little Board hard disk software/source \$79 QTY 1

DISTRIBUTORS

Argentina-Factorial, S.A.	1-41-0018
Australia-ASP Microcomputers	613-500-0628
Belgium-Centre Electronique Lempereur	041-23-45-41
Canada-Electronic Sales Assoc	(604) 986-5447
Denmark-Danbit	03-66-20-20
England-Quant Systems	01-534-3158
Finland-Symmetric OY	358-0-585-322
France-EGAL+	1-502-1800
Israel-Alpha Terminals	03-491695
Spain-Xenios Informatica	3-593-0822
Sweden-AB AKTA	08-54-20-20
USA:	CALL AMPRO

Z80A is a registered trademark of Zilog, Inc.
CP/M is a registered trademark of Digital Research.

AMPRO

COMPUTERS, INCORPORATED
67 East Evelyn Ave. • Mountain View, CA 94041
(415) 962-0230 • TELEX 4940302

Listing 1: Operator/operand versus message/object implementations. Listings 1a and 1b are, respectively, examples of portions of code that create an electronic Mailbox using conventional (operator/operand) and message/object models. Comparing the two illustrates the difference between the Mailbox developer specifying "how" versus "what."

(1a)

```
selectItemForReading(theMailbox) {
    .
    .
    .
    /* Select an item in theMailbox and . . . */
    /* check the item type flag */
    switch(item->type)
    /* Now call the appropriate display subroutine */
    {
        case MEMO:    displayMemo(item); break;
        case EXPENSE: displayExpense(item); break;
        .
        .
        default: error("unknown contents"); break;
    }
    .
    .
}
```

(1b)

```
selectItemForReading(theMailbox) {
    .
    .
    .
    /* Select an item in theMailbox and . . . */
    [item display]; /* Send item a message to display itself */
    .
    .
}
```

Listing 2: Using Software-ICs. This message/object program counts the unique words in a file using preexisting Software-ICs from the Objective-C library: Set and String.

```
// Reads words from stdin and counts unique ones main() {
extern id String, Set; /* Specify object (instance) factory ids
id uniqueWords, currentWord; /* Local object (instance) ids
char buf[MAXBUF]; /* Word buffer

uniqueWords = [Set new]; /* Create a new empty set instance
while (nextWord(buf) != EOF) { /* forEachWord . . .
    currentWord = [String str:buf]; /* Create a string instance for each word
    [uniqueWords filter:currentWord]; /* Store unique ones in set
}
printf("The number of unique words is %d \n", [uniqueWords size]);
}
```

state that this mailbox is useless except for memo and expense contents.

Now notice what happens in the re-written code (listing 1b) using messages and objects as depicted in figure 2. The message expression, `item display`, commands the object, `item`, to display itself, thus specifying only what the object is to do. How the object is to do it is decided by the forms developers so the mailbox code becomes independent of its contents.

The technical term for this is *dynamic binding*. Dynamic binding and encapsulation are at the root of the reusability provided by this variety of message/object programming.

Some modern programming languages (Ada, Modula-2, and CLU, for example) provide a different form of encapsulation by binding statically at compile time. While this certainly is an improvement over traditional languages like C and Pascal, it provides no new help in solving the reusability problem. The mailbox example coded in any of these languages would still need the switch statement.

The notion of a Software-IC, in which reusable code is built and tested by a supplier and then delivered to consumers in binary form, is not possible without dynamic binding.

USING SOFTWARE-ICs

We will demonstrate the use of Software-ICs by building a simple program that counts the unique words in a file. For the sake of comparison, we will discuss two different solutions based on reuse of existing software and then turn our attention to the Software-IC solution.

The subroutine-library solution would reuse library functions for managing files, printing results, and comparing strings. Custom software would be required for the word parser, hash function, hash table/collision handling, counting words in the hash table, and printing the formatted results. Much of the significant new development and debugging effort concerns algorithms that have been

implemented in many previous applications. Once working, however, the implementation should be fairly efficient.

A UNIX-style solution would consist of small "tools" connected by pipes. The off-the-shelf utilities that could be reused include `tr` (translate characters), `sort` (sorting utility), and `wc` (word-count utility). The programmer would have to custom-build a script for assembling the utilities. This particular problem requires a good working knowledge of applicable UNIX utilities but no custom software. The implementation would be noticeably slower than both the subroutine library and Software-IC solutions.

The Software-IC solution involves assembling two prefabricated Software-ICs from a library of com-

ponents. A `String` is used to hold words, and a `Set` can be used to hold the unique words. Both are standard components in the library released with Objective-C. The performance of the Software-IC solution would not be as good as the first solution, but it would certainly be acceptable and could be optimized by tuning. The full text for this solution, except for the small function `nextWord()`, which parses words from the input stream, is presented in listing 2.

The two external symbols `Set` and `String` identify a pair of *factory objects* whose function is to produce instances of their *classes* (Software-ICs). Each class defines behaviors and declares data for (a) its factory object and (b) its instances. The two local symbols `uniqueWords` and `current-`

The notion of a Software-IC is not possible without dynamic binding.

Word identify instances, which will be manufactured by `Set` and `String` at run time.

In this example, `String` responds to a `str:` message by allocating enough space to hold the characters in the message argument `buf`. The next statement commands the `set uniqueWords` to perform the filter: function on `currentWord`.

(continued)

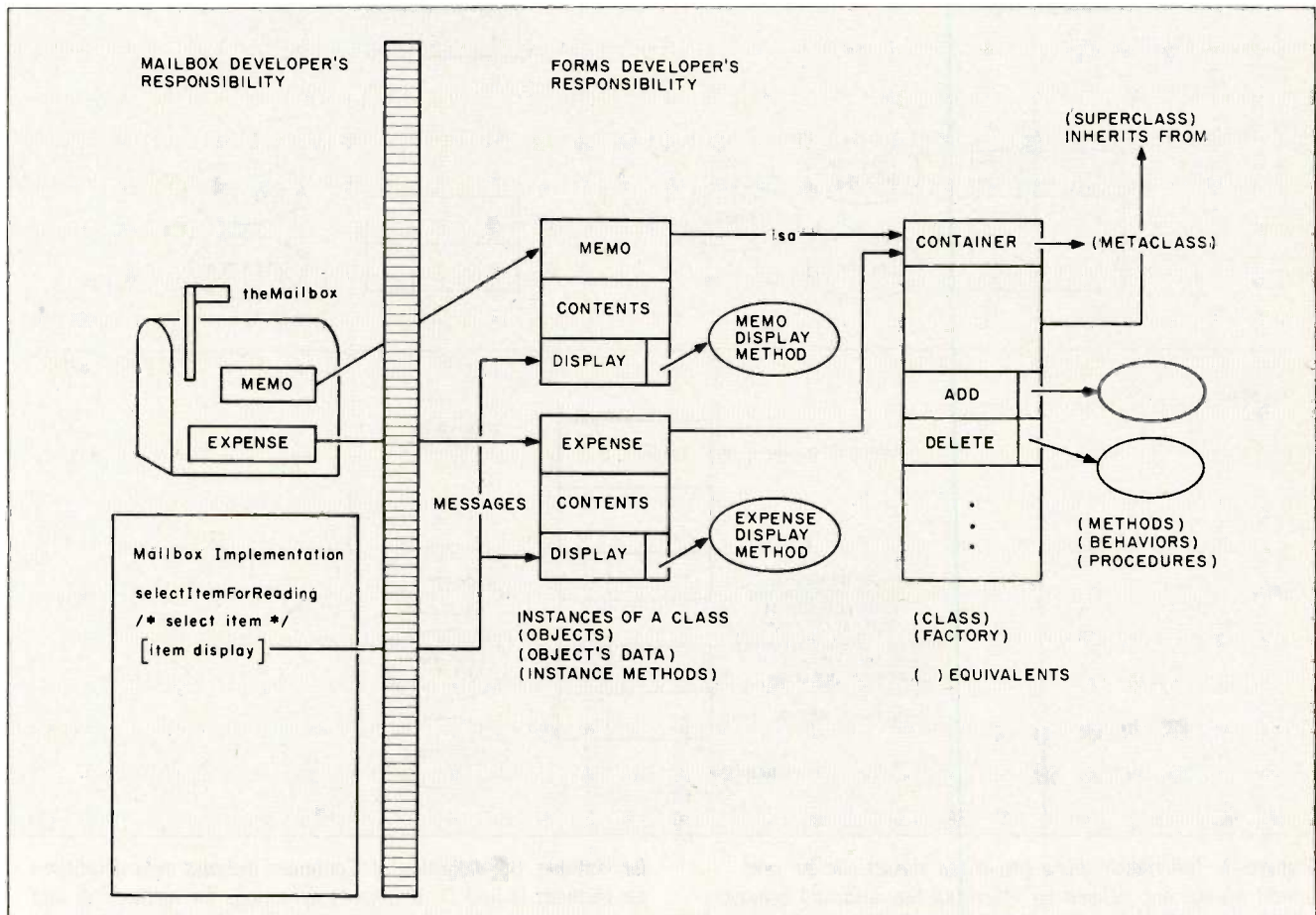
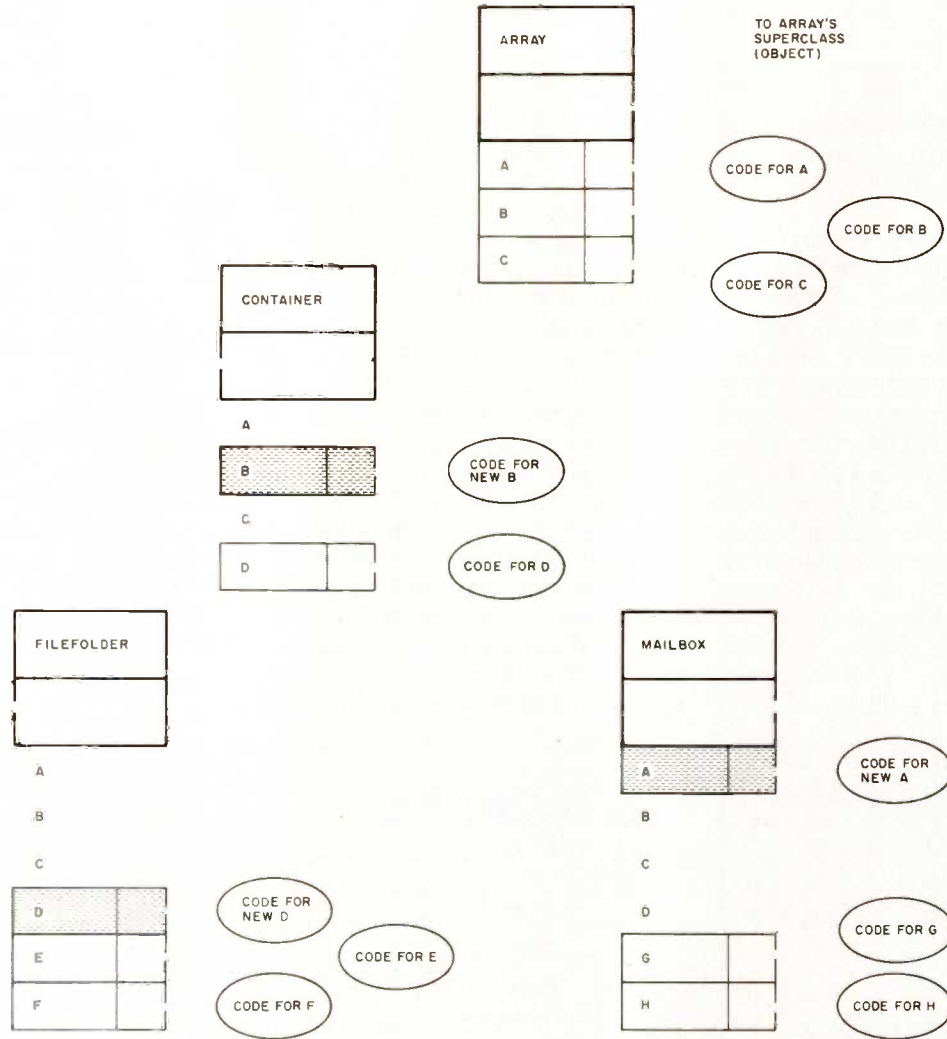

Figure 2: Mailbox using the message/object model. The Mailbox developer specifies what the form should do by sending it a

message to display itself. As a result, form types can be added or deleted without changing the Mailbox implementation.

(3a)



(3b)

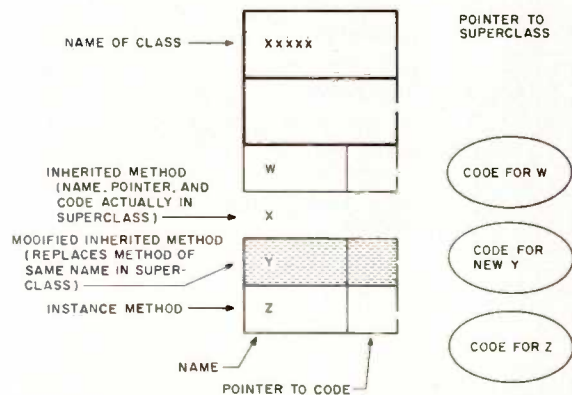

Figure 3: Inheritance. New specialized classes can be, and almost always are, defined by inheriting the data and behaviors of older generic classes, then specifying only how the new ones differ. Figure 3a shows how the classes Container, FileFolder, and Mailbox are created; 3b explains the notation used. Note that,

for example, the definition of Container includes only definitions for methods B and D. It inherits definitions for methods A and C from Array; these definitions do not need to be explicitly specified by the programmer, nor do they take any room in the definition of Container.

SOFTWARE-ICs

How are reusable sets possible, since they must work properly with many different kinds of contents? For example, the same Set code may need to compare strings, points, symbols, and so on, often within the same application. The answer is that dynamic binding allows the Set to legitimately consider equality testing, for example, none of its business. Instead, it pushes that decision back onto its contents. When it needs to test the equality of two items, it merely commands one of them to report whether it isEqual: to the other.

CLASSES, METHODS, AND INHERITANCE

So far we have focused primarily on encapsulation. This technology should be thought of as an aid to using the services in a system. It also provides some advantages for the suppliers (builders) of message/object systems as well. Consider the job facing the builders of three familiar components of an office-automation system: Mailbox, Envelope, and FileFolder.

At one level a Mailbox is very different from a FileFolder, but they are similar in that they are kinds of containers. Each will have some amount of code involved in managing collections of other objects.

Inheritance allows containment code to be built, stockpiled, and thereafter reused as often as needed. This is done by building a class

The manner in which systems evolve has to be fundamentally different.

named Container, whose methods support the operations we expect of containers: adding elements, removing them, expanding and shrinking their internal capacity as needed. Thereafter, specialized container classes like Mailbox, Envelope, and FileFolder are built by describing only how each subclass differs. They may differ by having additional private data fields or by having additional (or modified) behaviors. Figure 3 depicts a typical inheritance hierarchy.

To design a new capability, the programmer's thoughts turn immediately to "What do I already have that is most like the thing I need?" (see figure 4). For example, to develop an Envelope the programmer focuses on describing how Envelopes should differ from Containers. Envelopes differ from Containers by, for example, having additional data variables such as returnAddress, targetAddress, and stamp. Envelopes also differ by exhibiting additional behaviors (or methods), for example, mailTo:, open, and discard. Note that no methods

(continued)

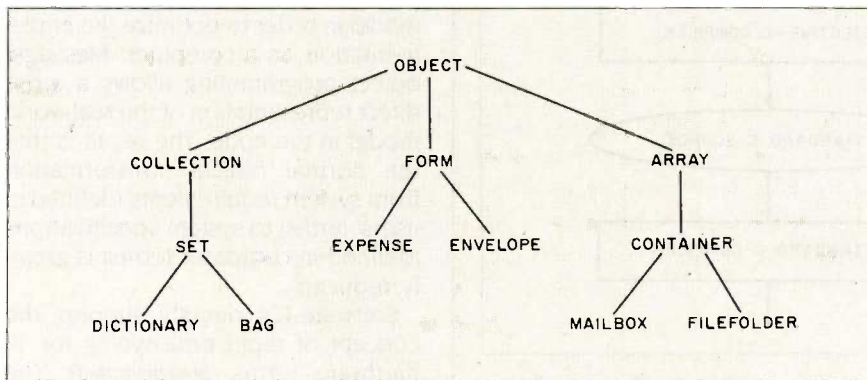

Figure 4: Opportunities to reuse work emerge. As the design proceeds, similarities to previously developed Software-ICs become apparent, and a large degree of reuse results.

1st PLACE

COMPUTER SYSTEMS
13422 N. CAVECREEK RD.
PHOENIX, AZ. 85022

OTHER INFORMATION: 602-867-9897



Send cashier's check or money order all other checks will delay shipping two weeks.
Prices & availability subject to change without notice.

CALL FREE
1-800-841-2748



Hi - I'm Joan,
Thanks again for keeping the orders coming. We really appreciate your business.

We try to keep our ad small & pass on the savings to you. We list only a few of the brands of hardware & software that we carry. If you don't see what you're looking for, give me a call, I'll be happy to help you.

Thanks again and God bless
Joan

COMPUTERS

ALTOS 580-20	\$3350
ALTOS 586-20	\$5350
IBM PC	\$CALL
LEADING EDGE PC	\$CALL
NEC 8201	\$319
SANYO 550-555	\$CALL
SANYO 775	\$CALL
WYSE PC	\$CALL
WYSE HD	\$CALL
TELEVIDEO 1605	\$CALL
ZENITH	\$CALL

PRINTERS

BROTHER HR 25P	\$649
DAISYWRITER 2000 48K	\$799
EPSON	\$CALL
STAR SG10	\$235
JUKI 6100	\$385
JUKI 6300	\$689
OKIDATA (LOW PRICES)	\$CALL
TOSHIBA 1340P	\$569

CITOH

8510	\$299	1550P	\$439
F10-40C PS	\$869	F1055	\$1019

DIABLO

801F	\$2369	630API	\$1029
------	--------	--------	--------

NEC

3550	\$1049	8830	\$1479
P2-P3	\$CALL	2030	\$599

TERMINALS - MONITORS

WYSE 50	\$445
WYSE 85	\$585
QUME 102G	\$399
TELEVIDEO	\$CALL
AMDEK 300A	\$129
PRINCETON MAX 12	\$165
PRINCETON HX12	\$459

DISK DRIVES & BOARDS

AST 6 PK	\$259
PARADISE MODGRAP	\$259
HERCULES COLOR BOARD	\$155
TALLGRASS 20MG	\$2289
TALLGRASS 3135	\$3689

MODEMS

PROMODEM 1200	\$309
PROMODEM 1200B	\$259
PROMODEM 1200A	\$299
HAYES SMARTMODEM 1200	\$389
HAYES SMARTMODEM 1200B	\$369

OBJECTIVE-C

Objective-C, a PPI product (Productivity Products International Inc., 27 Glen Rd., Sandy Hook, CT 06482), is a hybrid language that combines the reusability, modeling power, and complexity-reducing attributes of Smalltalk-80 with the portability, efficiency, compatibility, and access to machine details of the C language. As shown in figure A, the Objective-C compiler transforms the Objective-C language into standard C statements. The message/object code examples use the Objective-C syntax.

While Smalltalk-80 attempts to revolutionize programming, Objective-C seeks to change it through evolution. Objective-C provides a thin layer of new structure over its C substrate by adding classes, objects, messages, encapsulation, and inheritance. No C-language capabilities are eliminated,

and none are changed. The programmer can choose conventional C-language tools when efficiency and portability are paramount and message/object power tools when encapsulation, inheritance, and dynamic binding are needed to enhance reusability and reduce code bulk and complexity.

The hybrid approach of Objective-C does breach the purity of the message/object paradigm. This means that the design and implementation rules are not as clearly defined but must evolve through experience. The hybrid approach will also require more management diligence if the amount of reusable code is to be optimized. The criteria for choosing messages/objects or writing functions in C should be clearly defined and enforced. This will require standards and control.

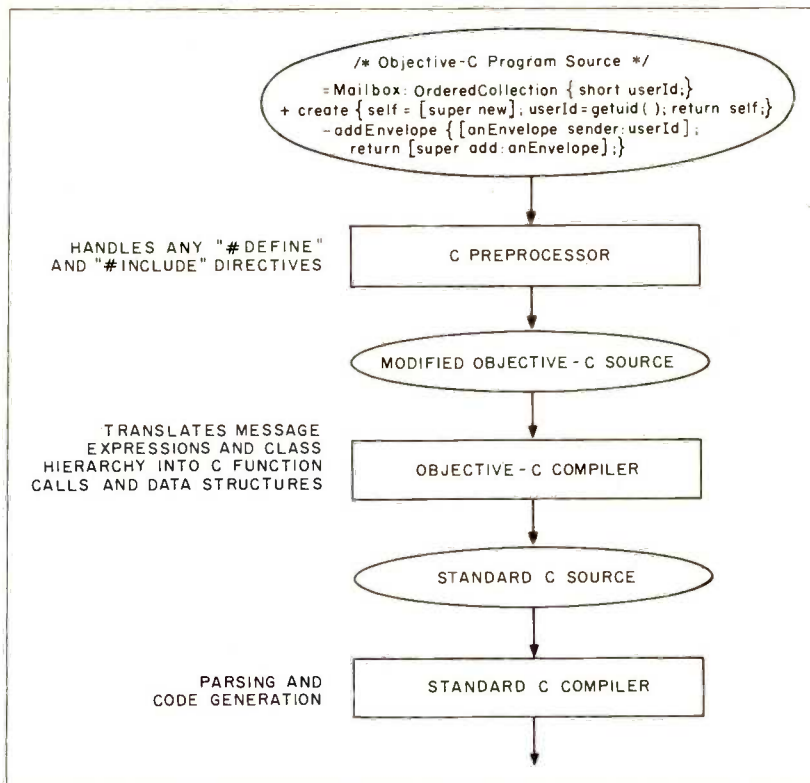

Figure A: Objective-C—a superset of the C language. Objective-C is actually a hybrid language whose message/object syntax is changed to standard C syntax by the Objective-C compiler.

Message/object

programming allows a more direct

representation of the

real-world model in

the code.

need be defined for adding and removing contents from envelopes because they, and the data variables that support them, are acquired automatically, or *inherited*, from Container.

FileFolders and Mailboxes will have their own distinctive implementations. However, only their differences from a Container need to be designed, coded, tested, documented, delivered, and maintained. Their containment abilities were developed once and thereafter reused. Containment is defined consistently, systemwide. You add a letter to a Mailbox in precisely the same manner as you add a letter to a FileFolder.

SYSTEM BUILDING WITH SOFTWARE-ICs

System requirements normally model data, data flow, and actions on data. In traditional system building, the system requirements must then be mapped into the operator/operand model in order to optimize the implementation on a computer. Message/object programming allows a more direct representation of the real-world model in the code. The result is that the normal radical transformation from system requirements (defined in users' terms) to system specifications (defined in computer terms) is greatly reduced.

Software-ICs directly support the concept of rapid prototyping (or, in hardware terms, *breadboarding*). The ability to demonstrate a subset of a system's final functionality (particularly the human interface) in a rapid pro-

(continued)

SOFTWARE-ICs

G & L Co.

Table 1: Software-IC specification sheets. This is a condensed version of the specification sheet for the Point Software-IC. The complete version contains 21 methods (versus the 9 shown).

Point

Instance variables: { short xLoc, yLoc; }

Inherits: Object

Inherited by:

Referenced by: Point Rectangle

Refers to: Geometry Point Primitive __Object__Object__csav msg fprintf lmul sqrt

Discussion

Points are vectors (i.e., coordinates) on a two-dimensional plane. When displayed on a graphics terminal, the origin is at the top left; the horizontal axis increases to the right . . .

Instance Variables

xLoc A short integer specifying the value for the horizontal axis (e.g., column).

yLoc A short integer specifying the value for the vertical axis (e.g., row).

Instance Creation

+x:(int)y:(int)

Replies a new point at coordinates (x@y).

+fromUser

Prompts the user to specify the coordinates for a new point. The default implementation is . . .

Instance Variable Access

Unless otherwise specified, these methods reply to the receiver.

-(int)x Replies the x-coordinate of the receiver.

-(int)y Replies the y-coordinate of the receiver.

-X:(int)y:(int)

Sets the coordinates of the receiver to (x@y).

Conditionals

In the following, words like "isAbove" or "isLeft" are with respect to a screen-oriented point of reference, not the numerical magnitudes of the coordinates. For example, the point (0, 0) is above and to the left of all other positive coordinates.

-(BOOL)isBelow:aPoint

Replies YES if receiver is below aPoint.

Equality Testing

-(int)hash

Replies xLoc ^ yLoc.

-(BOOL)isEqual:aPoint

The receiver and someObject are equal if and only if they are both points and have equal coordinates.

Printing

-printOn:(IOD)anIOD

Prints the receiver as: fprintf(anIOD,"%d@%d", xLoc, yLoc);

(continued)

P.O. Box 9096
ANAHEIM, CA 92802
IN CAL (714)758-8600,
774-3221
OUT CAL (800)523-8750

1-800-523-8750 Toll free hot line for tech support even if you don't purchase from us. If we don't have the product you want, we'll get it for you in 48 hrs. or less. Same day shipment.

1. TEAC 55B double sided double density 360Kb \$95.00
2. 135 watt power supply for IBM type's 110/220v W/5 power leads \$89.00
3. IBM type case 5 or 8 slot \$49.00
4. Chinon SS/DD drive for Apple II, IIe, IIc 40 track not just 35 \$109.00
5. 10mb & 20mb hard drive w/auto boot intelligent controller & cable \$549.00 \$599.00
6. IBM type turbo motherboard. 4.77 to 8 MHz 100% compatible 256K chip compatible up to 640 KB of memory on motherboard. 15 day satisfaction or money back. With 512 KB \$600.00
7. Panasonic DD/DS \$82.00

DON'T HURRY, WE HAVE PLENTY OF PRODUCTS

**WHY WAIT FOR
ANSWERS FROM YOUR
IBM PC/AT/XT
NOW THERE'S
MEGA-MATH™**

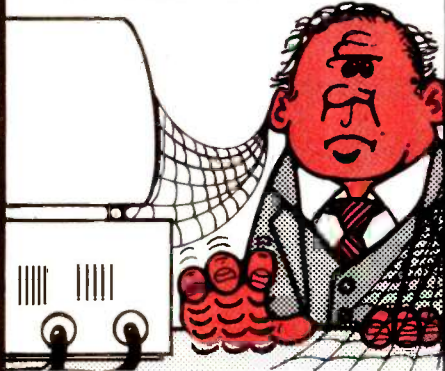

Engineers, scientists and statisticians are discovering the time saving capability of New "Mega Math" II. A library of over 45 assembly language subroutines for fast numeric calculations, up to 11 times faster than your present compiler.

The pretested routines use the 8087 or 80287 coprocessor for optimum performance. The routines reduce development time, code size and testing time.

"Mega Math" II Includes:

- MATRIX OPERATIONS**
- VECTOR OPERATIONS**
- VECTOR SCALAR OPERATIONS**
- STATISTICAL OPERATIONS**
- FAST FOURIER TRANSFORM**
- CONVOLUTION**
- SOLUTION OF LINEAR EQUATIONS**

The library is callable from Microsoft Fortran, Basic, "C" and Pascal compilers. Also IBM Professional Fortran and Macro Assembler.

Get "Mega Math" II Performance for only

\$299.00 (U.S.)

Also available is the "Mega Math" A.T. "Booster". A single PC board, designed to reduce execution time in numeric processing applications.

If your IBM AT is equipped with the 80287 coprocessor, the "Booster" will enhance its performance by up to 50%.

PRICE **\$349.00 (U.S.)**

For increased performance of Mega Math Routines, inquire about Micray's high performance floating point processor for the IBM AT or compatibles.

**MICRAY
ELECTRONICS LTD.**

(403) 250-1437
Bay 1, 4001A - 19 Street N.E.
Calgary, Alberta, Canada T2E 6X8



THESE INQUIRIES WELCOME

TRADEMARKS:

(IBM, PC/XT/AT)

INTERNATIONAL BUSINESS MACHINES
(MICROSOFT) MICROSOFT CORPORATION
(MEGA MATH) MICRAY

SOFTWARE-ICs

```

Declarations:Point.m
== Point:Object (Geometry, Primitive){
  short xLoc, yLoc;
}
+ x:(int)xy:(int)y
+ fromUser

- (int)x
    
```

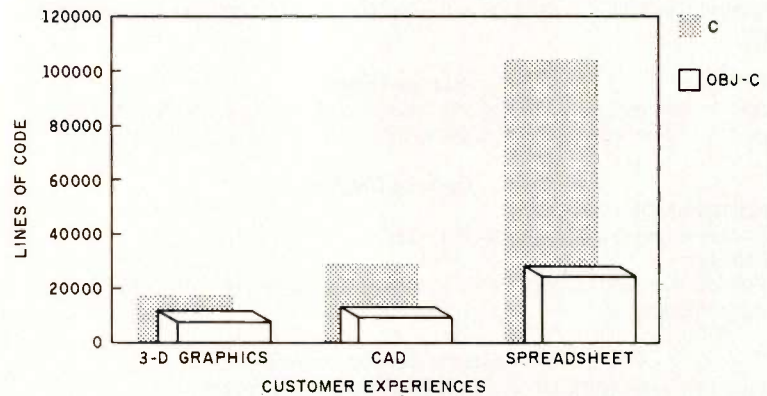

Figure 5: Productivity experiences. Actual decreases in lines of code experienced by PPI customers using Objective-C in three different application areas.

prototype helps ensure that the system built is the system needed.

No matter how well the delivered system satisfies the requirements, people usually have an immediate desire to change/evolve the system. Fortunately, as we have seen, it is possible to build changeable systems.

System builders using Objective-C employ a combination of aids to enhance the reusability of their Software-ICs. The standard libraries, for example, are documented using a catalog composed of Software-IC specification sheets. Table 1 summarizes the specification sheet for a Software-IC called Point.

CONCLUSIONS

The tools exist today in the software world to build Software-ICs. They are in use in a number of major com-

panies and have demonstrated (see figure 5) code bulk reductions of between 2.5-1 and 5-1.

As the use of Software-ICs spreads, productivity in the software world should improve much as hardware ICs improved productivity in the hardware world. The use of Software-ICs also will promote the evolution of optimized system-building methodologies and tools. Just as semiconductor foundries produce both standard and custom ICs, Software-IC foundries will do exactly the same in the software industry. ■

REFERENCES

1. Love, T. "Application Development in Smalltalk-80." Arlington, VA: *Proceedings of Softfair-83*.
2. *Objective-C Reference Manual*, Version 3.0, Sandy Hook, CT: Productivity Products International, December 1984.

Straight Talk.™

The information software that keeps you on course.

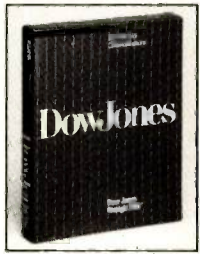

You don't go sailing without the right navigational instruments. And you don't make business decisions without the right information. Straight Talk and your Macintosh™ give you access to a world of timely information. Fast. So you have the information you need to make informed business decisions.

Here's what it gives you:

- Automatic log-on and log-off to major information services like, Dow Jones News/Retrieval,® The Source_{SM}, and CompuServe.
- The latest business information and financial news, plus airline schedules and fares, an encyclopedia, electronic mail and much more.
- Ability to review, save, edit and copy data received online *after* you hang up.
- Communication with other Macintosh computers via modem or networking.

And at \$95, Straight Talk is the least expensive, most diligent electronic know-it-all you'll ever come across.

Straight Talk is the precision instrument designed to make sure your ship comes in.

Special Offer!

For a limited time, order Straight Talk at \$95 and get 5 hours of **free time** on Dow Jones News/Retrieval (approximately \$100 value). To order, see your local computer dealer* or call:

1-800-257-5114, ask for John Austin.

(In New Jersey, Alaska, Hawaii and Canada, call 1-609-452-1511)

Please have your credit card information ready, including expiration dates. VISA, MasterCard, and American Express accepted.

Act now — Offer expires July 31, 1985.

*To redeem offer send proof of purchase to Dow Jones & Company, Inc., John Austin, P.O. Box 300, Princeton, N.J. 08540.

Straight Talk works with Apple® Macintosh™

Inquiry 152

Dow Jones™
Software
For Informed Decisions

"I think we turn left here."

Got a minute?

The folks who make very modern personal computers would have you accept a very old fashioned idea. Namely that you should buy everything else from them, too. Including their printers.

But IBM owners everywhere are finding that while the IBM PC may be the right tool for their business, the ideal tool for putting their business on paper is the all new Microline 192 from Okidata. And it isn't taking them long to find out.

First there's speed. The Microline 192 is twice as fast as the IBM Graphics Printer. But IBM PC owners are finding some other very remarkable features about the Microline 192 that the Graphics Printer doesn't have.

PRINTER COMPARISON

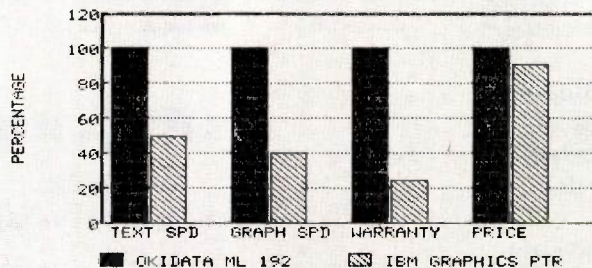

FEATURE	OKIDATA	IBM
SPEED	160 CPS	80 CPS
CORRESPONDENCE QUALITY	YES	NO
FREE FONT SOFTWARE	YES	NO
BIDIRECTIONAL GRAPHICS	YES	NO
MENU SELECT MODE	YES	NO
CUT SHEET FEEDER	OPTIONAL	NO
WIDE CARRIAGE MODEL	YES (ML-193 \$699)	NO
WARRANTY	1 FULL YEAR	90 DAYS
WEIGHT	9 LBS	13 LBS
SUGGESTED LIST PRICE	\$499	\$449

Oh, one other comparison worth repeating. In the minute and ten seconds it took the Microline 192 to print what you've just read, the IBM Graphics Printer wouldn't have told half the story.

OKIDATA, an OKI AMERICA company

OKIDATA MICROLINE 192

That's about all it takes to discover why Okidata's new printer beats the IBM® Graphics Printer.

The folks who make very modern personal computers would have you accept a very old fashioned idea. Namely that you should buy everything else from them, too. Including their printers.

But IBM owners everywhere are finding that while the IBM PC may be the right tool for their business, the ideal tool for putting their business on paper is the all new Microline 192 from Okidata. And it isn't taking them long to find out.

First there's speed. The Microline 192 is twice as fast as the IBM Graphics Printer. But IBM PC owners are finding some other very remarkable features about the Microline 192 that the Graphics Printer doesn't have.

PRINTER COMPARISON

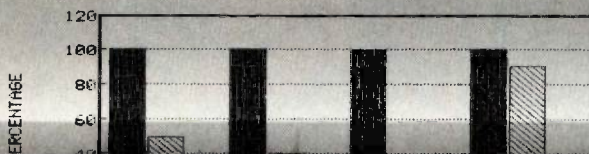

IBM Personal Computer Graphics Printer

OKIDATA
an OKI AMERICA company
Mt. Laurel, NJ 08054, 1-800-OKIDATA
Inquiry 320

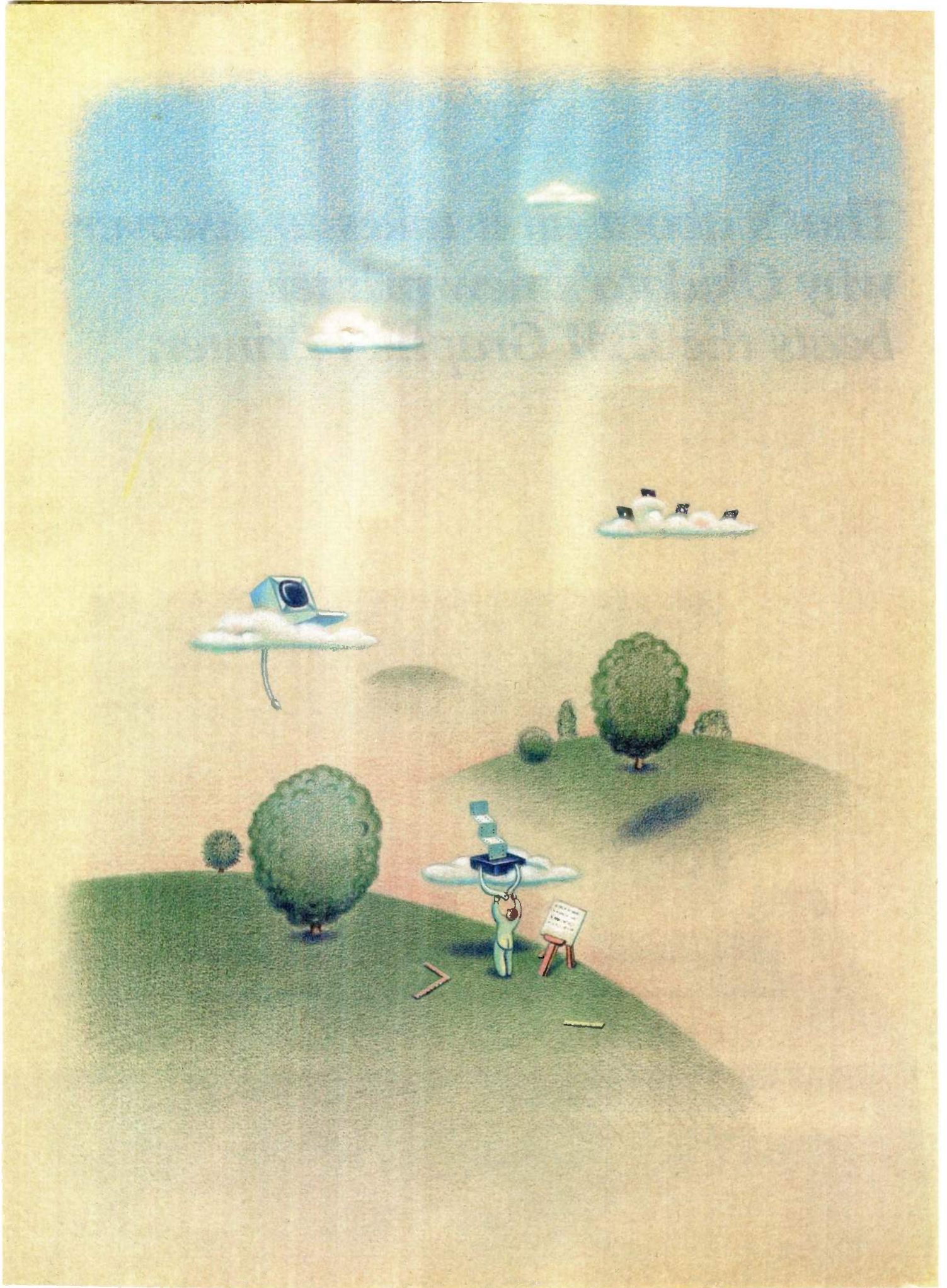

Reviews

REVIEWER'S NOTEBOOK <i>by Glenn Hartwig</i>	323
THE MINDSET PERSONAL COMPUTER <i>by Tom Wadlow</i>	324
IDEA PROCESSORS <i>by William Hershey</i>	337
CONVENIENCE SOFTWARE <i>by Mark J. Welch</i>	353
BUILDING EXPERT SYSTEMS WITH M.I <i>by Bruce D'Ambrosio</i>	371
HEWLETT-PACKARD'S HP 7475A PLOTTER <i>by Rich Malloy</i>	379
THE IBM QUIETWRITER PRINTER <i>by Jon R. Edwards</i>	385
THE WORD PLUS <i>by George Sheldon</i>	393
REVIEW FEEDBACK	401

SOME ARTISTS SPEND A LIFETIME trying to get their work displayed in a major gallery. The designers of the Mindset Personal Computer hit the big time with their first effort: This aesthetically appealing machine is part of the design collection of the Museum of Modern Art in New York. Although the Mindset is not as popular as Apple or IBM machines, its graphics capabilities, inspired by CAD/CAM minicomputers, deserve attention. We first looked at this IBM PC work-alike in a product preview last year. Tom Wadlow now gives us an updated report.

Idea processors, tools for organizing text and thoughts, are growing in popularity. William Hershey examines an outline arranger (ThinkTank), two index-card systems (Executive Writer/Executive Filer and THOR), and a package that can handle outlines and index cards (Framework). As Mr. Hershey points out, these tools are applied in as many ways as there are users.

Another type of package that seems to be appearing frequently is the memory-resident software that lets you interrupt your program in progress to write notes, calculate, or execute DOS functions. Mark Welch compares some of this "convenience software": Borland's SideKick, Software Arts' Spotlight, and Bellsoft Inc.'s Pop-Ups.

Bruce D'Ambrosio poses the question: Would anyone of sound mind pay \$12,500 for a software program? Before you assume the answer is no, read his review of M.I, a knowledge-engineering tool for the IBM PC from Teknowledge, a start-up company specializing in artificial intelligence.

Our two hardware reviews this month cover output devices. Our man in New York, Rich Malloy, plotted some graphs with Hewlett-Packard's HP 7475A and describes this six-pen graphics machine. Jon Edwards, one of our technical editors, reports on IBM's Quietwriter. Readers who think most letter-quality printers sound like chain saws might be glad to hear this unidirectional unit is neither loud nor slow. It's also not inexpensive.

Nothing can replace a good spelling teacher or proofreader, but according to George Sheldon, The Word Plus from Oasis Systems is the next best thing. This spelling-checker program includes a 45,000-word dictionary and runs on most CP/M and MS-DOS computers.

—Glenn Hartwig, Dennis Barker, and Lynne Nadeau, BYTE

Resource Technology — What's it all about?

IT'S ABOUT TIME!

...and Time is relative. In business, time is profitability!

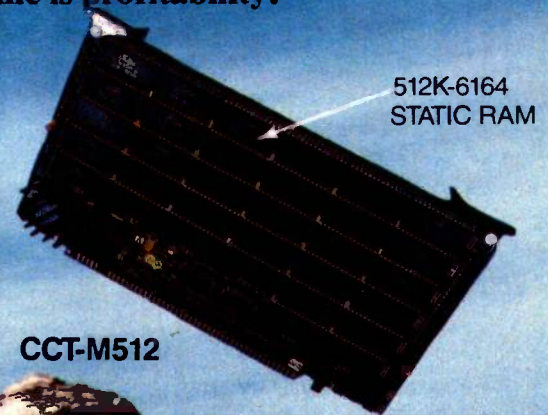
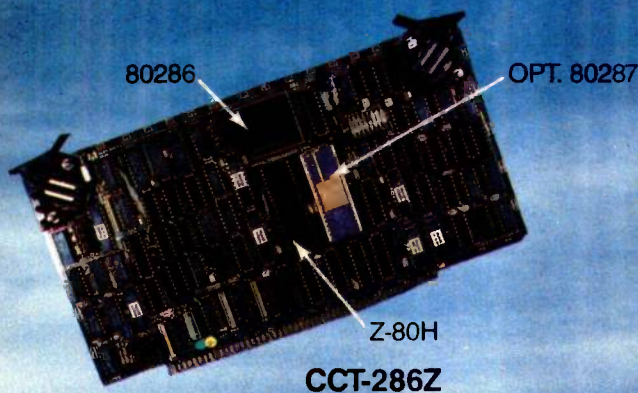

Given enough time, an end result of the desired quality may be finally attained - (see natural examples). In business, however, the bottom line is directly proportionate to the quality of, and the time consumed by, the tools employed - (see digital examples).

CCT teams up with MACROTECH to bring these ultimate speed and power tools to the serious business/scientific market. State-of-the-art processors, with super high-speed/high-density memory boards, form the basis for CCT machines with bottom-line computing power PCs can't touch.

CCT Implements Tomorrow's Technology Today!

Join some of the serious CCT clientele: U.S. Dept. of State, Uniroyal, Miles Labs, Univ. of Massachusetts, UCLA, Teledyne Semiconductor, UC Berkeley, U.S. EPA, Proctor & Gamble, MIT, Lockheed, Corps of Engineers, U.S. Navy, U.S. Coast Guard, Jet Propulsion Labs, Hallmark, McGraw-Edison, Sperry, International Paper, 3M, Beech Aircraft, ISI, Eastman-Kodak, Western Electric, Nat'l. Bureau of Standards, USC, Cornell University, British Cable and Wireless, USAF, and thousands more, worldwide.

For further details, see our technical ad on page 483 of this issue, or contact our technical staff at (602) 282-6299. For system quotations and ordering only, call our sales building at (800) 222-8686.

CUSTOM COMPUTER TECHNOLOGY / 1 CCT PLAZA / SEDONA, AZ 86340

Photograph: Sedona's famous Red Rock Crossing, taken with Nikon FE-2 and Nikkor 35-105mm lens, at 40mm, at F11-1/60th, with special Kodak 5294 movie film-ASA 320.

R·E·V·I·E·W·E·R'S N·O·T·E·B·O·O·K

TeleSoft (10639 Roselle St., San Diego, CA 92121) recently dropped the price of its Ada subset compiler for the IBM Personal Computer (PC) from \$3030 to \$1200, prompting us to take a look at it. The fact that TeleSoft's Ada compiler for the 68000 has been validated made it seem possible that the company's IBM PC compiler would outperform other efforts. When it arrived, the inclusion of an 850-page manual also seemed promising.

The manual, however, carried on the theme of the 68000 to such an extent that much of the information it contained was specific to that processor. Inaccuracies and a cryptic style further inhibited understanding.

TeleSoft's Ada needs either an IBM PC XT with 320K bytes of memory or an IBM PC with dual floppy-disk drives and at least 576K bytes of memory, much of which it uses as a RAM (random-access read/write memory) disk for its many system files. A call to TeleSoft was required to create the two working disks needed to run the compiler (from the 10 floppy disks provided); the manual's instructions were mislabeled. Another call was needed to decode and correct the manual to learn to format and initialize a disk using ROS (real-time operating system). TeleSoft's proprietary operating system. You have to use TeleSoft's screen editor to enter programs since ROS can't read text files and disks created with PC-DOS editors.

Once the system was ready, two more calls to TeleSoft were needed to compile a program; the system really expects a hard disk and requires special, undocumented efforts to run on a floppy-disk system. To its credit, TeleSoft provided extensive phone support.

Summarizing: The product costs

\$1200, has cryptic and sometimes inappropriate references in its documentation, requires numerous long-distance telephone calls, makes you learn a proprietary operating system and a new screen editor, and generates intermediate code that you can interpret only from within the proprietary operating system.

A copy of SongPainter version 1.00 for the Apple Macintosh came from Rubicon Publishing (La Costa Centre, 6300 La Calma Dr., Austin, TX 78752) with copyrights crediting Starcor J.V., also of Austin; the Regents of the University of California; and Apple Computer Inc. Given that its asking price is \$59.95, it has generated a lot of curiosity in most of those who've heard it.

SongPainter's promotional material says it's for experienced musicians or users with "virtually no knowledge of music." Basically, it lets you write a song by picking a note from a "tone window" and transferring it to one of four tracks in a "song window." Notes are labeled, and each is distinguished by its own visual pattern (dots, cross-hatching, stripes, in several varieties each). You can paint single notes or chords. You get a choice of 32 horns, woodwinds, strings, percussion instruments, keyboards, and synthesizer-type waveforms.

The documentation that came to us was a draft version, and the software itself was labeled "Not For Release" (although it is considered to be a full-fledged version 1.00). I certainly hope that the real documentation has an index.

When and if the manufacturer releases a production version of SongPainter, I hope it fixes a fairly obvious bug. Although you can copy SongPainter (at least version 1.00) onto a backup disk, trying to use the

help function on the backup crashes the system.

Isaw the Ericsson gas-plasma-screen laptop portable for the first time at the West Coast Computer Faire. I admit I was intrigued. Actually, it's a laptop transportable since it doesn't have batteries for truly independent operation. Still, it claims full IBM PC compatibility, weighs about 14 pounds, has 256K bytes RAM, uses 5¼-inch disks, has an 80-column by 25-line screen, and has a full-size, detachable keyboard. The whole package looks very nice except that it has only one disk drive. I'm looking forward to getting one for evaluation.

Another nice item that was demonstrated but wasn't ready for sale was a 2-megabyte Macintosh from Levco Enterprises in San Diego. At the time, Levco said it had all the bugs out and was just waiting for a reliable source of supply before setting a price and taking orders. However, the vendor was selling a Fat Mac upgrade kit for \$235. It wasn't surprising that the Levco booth looked pretty busy for most of the show.

We've gotten a number of requests for the operating-system patch that gives the NEC APC III partial compatibility with the IBM PC. It works with some packages but not with others (for example, it works with Perfect Writer, Filer, and Speller version 1.0 but not with version 2.0). We've put the program listing for that patch on BYTenet Listings, our electronic bulletin-board system. If you call (617) 861-9774, you can download the patch and try it out on as many packages as you like. An article detailing how the patch works is scheduled for an upcoming issue.

—Glenn Hartwig, *Technical Editor, Reviews*

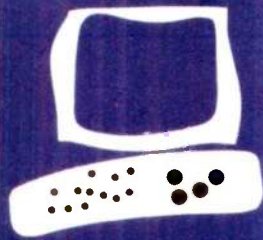

The Mindset Personal Computer

A high-performance graphics machine that runs IBM PC software

BY TOM WADLOW

IBM Personal Computer work-alikes, often called "clones" by the industry, are designed to duplicate as many of the IBM PC's features as possible. The reason they can compete in the marketplace lies in their differences, however. Clones usually have a lower price, a faster processor, or a better keyboard than the IBM PC.

The Mindset Corporation has chosen to enhance a different feature. The Mindset Personal Computer system (see photo 1) differs from the IBM PC primarily in the quality and speed of its graphics display. The Mindset machine has the ability to do some graphics operations in hardware rather than software. This makes some sophisticated and otherwise time-consuming graphics procedures run briskly on the Mindset PC. [Editor's note: Many IBM PC-compatible manufacturers, Mindset included, have recently had some financial trouble. However, the Mindset's extensive graphics capabilities deserve close examination.]

THE SYSTEM

As outlined in a BYTE Product Preview (see "The Mindset Personal Computer" by Gregg Williams, April 1984 BYTE, page 270), the Mindset comes in five basic pieces: the system unit, the expansion unit (disk drives), the keyboard, a mouse, and the display. Of these, the expansion unit and the mouse are optional. A full system with two disk drives and a monochrome display has a list price of about \$2900.

The system unit is the heart of the Mindset and contains the processor, 32K bytes of RAM (random-access read/write memory), two cartridge sockets, I/O (input/output) module sockets, and system indicator lights. The system unit also includes another 32K bytes of RAM specifically dedicated to the video display.

The Mindset uses the Intel 80186 microprocessor (with a 6-MHz clock speed), rather than the 8088 used by the IBM PC or the 8086 used by some of the other clone systems. Since the 80186 is upward-

compatible with the 8088 (meaning that it has all the same instructions as the 8088 and a few more as well), quite a lot of IBM PC software runs on the Mindset.

The cartridge sockets were designed to hold preprogrammed memory cartridges but none are available from Mindset. However, a programmable 8K-byte cartridge that Mindset calls an NVRAM (nonvolatile random-access memory) is available. You can store information in the cartridge, and it will retain this information when you turn off the power or remove the cartridge from the machine. This cartridge consists of low-power memory with its own battery.

Mindset originally intended that it would be possible to use the cartridge system in the same way as you would a floppy-disk-based system. The Mindset's operations guide gives the example of a cartridge containing BASIC in one socket, with an NVRAM cartridge in the other. Unfortunately, the BASIC cartridge is not available.

The rear of the system unit contains the connectors for an external video monitor and audio speaker. In addition, the Mindset has space for several I/O modules at the back of the unit.

Mindset has covered all three display options. The system unit has connectors for composite (NTSC) video, for RF (radio frequency) video on a regular television set, or for an RGB (red-green-blue) monitor. The composite-video output is suitable for taping on a videocassette recorder. The RF output can be seen on television channels 3 or 4. And the RGB output is compatible with the IBM PC-type RGB monitor.

The Sync signal for the RGB is split into separate horizontal and vertical drives. It is not difficult to convert these signals to composite sync, which is required by many non-IBM RGB monitors. A single NOR gate is all that is required. I used a 74LS02 to interface my Sanyo DMC6113 RGB monitor to the Mindset. This is not necessary if you have an IBM PC-compatible monitor.

You can add various interfaces to the

Tom Wadlow is an engineer and freelance writer living in the San Francisco Bay area. He can be reached at POB 2755, Livermore, CA 94550.

Mindset by plugging special I/O modules into three slots on the system unit's rear panel. Two of the slots can accommodate one double-width I/O module or two single-width modules. Mindset sells modules for an RS-232C interface, printer interface, and stereo sound. Each costs \$99. A 300-bps (bits per second) modem module takes up two slots and costs \$199. The Mindset has no internal IBM-type slots for expansion boards. Most of the capabilities that those boards provide are handled by the I/O modules.

The Mindset has three indicator lights on the front of the system unit: a red light indicating that power is on, and yellow and green lights that can be accessed by software. Not many of the Mindset programs use these lights. The lights on my review unit were visible only when the room lighting was off.

Since Mindset does not offer any cartridges, most users will need the expansion unit. Adding the expansion unit will bring the total amount of RAM to either 128K bytes or 256K bytes. Also, the expansion unit contains one or two 360K-byte floppy-disk drives. On the back of the expansion unit are three more slots for I/O modules.

The expansion unit sits on top of the system unit. The two are coupled together by a special connector that extends down from the expansion unit into a receptacle on the system unit. Other than the friction fit from this connector, there is no mechanical connection between the two boxes, as you will find out if you are careless in picking up a Mindset.

The Mindset keyboard (see photo 2) plugs directly into the front of the system unit, unlike the IBM PC keyboard, which plugs into the rear. The jacks on either end of the connecting cord resemble those modular plugs used for telephone connections.

On the left and right sides of the keyboard are connectors for a mouse or some other type of pointing device. A joystick is available, and some software can use a bit pad.

Only the mouse was available for review. Having two connectors for the mouse means that both left- and right-handed people will find the Mindset comfortable to use. The only people who will be inconvenienced are those who like to put the keyboard on their lap. Note that you cannot unplug the mouse and move it to the other port once a program (such as Lumena) has initialized it.

As is the case with any mouse, the Mindset mouse is useless unless a program knows how to access it. This means that the mouse may not be usable in many programs, such as spreadsheets or editors. Some mice for the IBM PC come with software patches that let you modify these programs so they can be used with a mouse. There is no reason why a similar approach could not be devised for the Mindset mouse, but Mindset does not provide such a patch.

The Mindset keyboard is slightly smaller than that of the IBM PC and somewhat lighter. The keys all have a solid feel to them

(continued)



Photo 1: The Mindset Personal Computer with optional expansion unit, two disk drives, and mouse.

with good tactile feedback. Though the Mindset is primarily a graphics machine, the keyboard is adequate for word processing or other applications that demand a lot of continuous typing.

A lot of thought went into the layout of this keyboard. Mindset did not make the mistake of duplicating the IBM PC's key layout that caused such an uproar among touch-typists. The keyboard has the same functionality as that of the IBM, retaining all the important keys. There is no numeric keypad, however, which may disturb some. In its place, Mindset has put an inverted-T cursor-control set and the IBM's special-purpose keys such as Ins, Del, PgUp, and PgDn. The 10 function keys are arranged across the top of the keyboard. Since there is no numeric keypad, the special Num Lock, plus, and minus keys on the IBM keyboard have not been duplicated on the Mindset. The scroll-lock and break functions, which share a single key on the IBM, are separate keys on the Mindset.

The Mindset power switch, by the way, is in an unusual place—the back of the keyboard. Certain parts of the Mindset are powered up as long as the unit is plugged into the wall. These include the on-board clock/calendar and the memory that holds the system-configuration information.

When you boot the system after it has been unplugged, a built-in configuration program is run. This program lets you reset the clock, specify the order in which the system checks the boot devices, inform the system of the particular display device you are using, and slightly modify the horizontal and vertical position of the screen display to compensate for your monitor. The program also displays the available amount of RAM and lets you turn the audible beeper on or off.

The configuration program is organized as a visible menu with currently selected options highlighted in color. Pressing the space bar cycles the current menu item through its possible settings. Pressing Return moves you to the next menu item. To finalize the configuration, you just reboot.

Although the Mindset has three different jacks for monitors, it has no way of determining which jack is in use. Some programs, such as Lumena, need to know whether composite video or RGB is in use, since certain color combinations do not work well on a composite monitor. Other video features, such as the limited anti-aliasing (blurring the jagged edges of a diagonal line so that it appears smoother) available on the Mindset, will not work on an RGB monitor. The configuration program lets you

specify which monitor will be used.

I was using an RGB monitor but I noticed a little interference between the RF output and my television. A visible but fuzzy copy of the system screen was ghosted on top of the program on channel 3, about 20 feet from the computer. An RCA plug with the center pin clipped out and the ground shield soldered across the back cleared up this problem.

When you select the TV option (composite video or RF-modulated video), the Mindset will start up in 40-character by 16-line mode. The monitor (RGB) option starts up in 80-character by 25-line mode.

It was a pleasant surprise to find that Mindset has designed a new typeface rather than adopting the ugly one used by IBM on its color display. The Mindset font is similar, but many of the irregularities, such as the shape of the lowercase letters, are smoothed out. The new font is pleasant to look at.

The Mindset can boot from either of the cartridge slots or drive A. If the first device on the priority list does not contain bootable code, it tries the next device, then the third. You can set the priority of each device in the configuration program. If none of the devices will boot, a picture of the Mindset logo appears and begins to rotate. This looks impressive and beats an error message.

SOFTWARE

The Mindset does not come with any software. The operating system, MS-DOS 2.0, is a \$60 option. The Mindset version of MS-DOS is specially written for it. In fact, the machine will not boot an off-the-shelf copy of PC-DOS. Newer versions of MS-DOS must be obtained directly from Mindset or its distributors. The DOS manual claims that this customization is necessary to let the operating system take advantage of the Mindset's 80186 processor. Although the DOS is a custom product, it can read and write disks from PC-DOS or other MS-DOS systems, and it uses much of the same applications software.

(continued)



Photo 2: The Mindset keyboard includes two connectors for a mouse or joystick. Note the inverted-T cursor-key arrangement. The Sys Config key calls up the Configuration program stored in ROM.

AT A GLANCE

Name

Mindset Personal Computer

Manufacturer

Mindset Corporation
617 North Mary
Sunnyvale, CA 94086
(408) 737-8555

Size

(with expansion unit) 16 by
12.2 by 5.5 inches

Components

Display: Connects to RGB, composite, or TV monitors
Text: 80 by 25 or 40 by 16
Graphics: 640 by 400 pixels by 2 colors, 320 by 400 by 4, 640 by 200 by 4, 320 by 200 by 16, plus IBM PC graphics modes

Keyboard: Detached, 84 keys

Processor: 16-/16-bit 80186, 6-MHz clock speed

Memory: (with expansion unit) 128K or 256K bytes

Storage: (with expansion unit) One or two 360K-byte, 5¼-inch floppy-disk drives, MS-DOS format

Interfaces: Joystick or mouse, cartridge slots

Options: 8K RAM cartridge (\$79), parallel port (\$99), serial port (\$99), 300-bps modem (\$199), mouse (\$149), joystick (\$39), Genlock circuitry (\$500)

Optional Software

MS-DOS (\$60), GW-BASIC (\$79), Lumena (\$399)

Price

With 256K, two drives, monochrome display, parallel and serial ports, MS-DOS, and GW-BASIC, \$2885

Comments

Well-built solid machine with good keyboard; much better graphics performance than IBM PC; recommended for artists, graphics enthusiasts

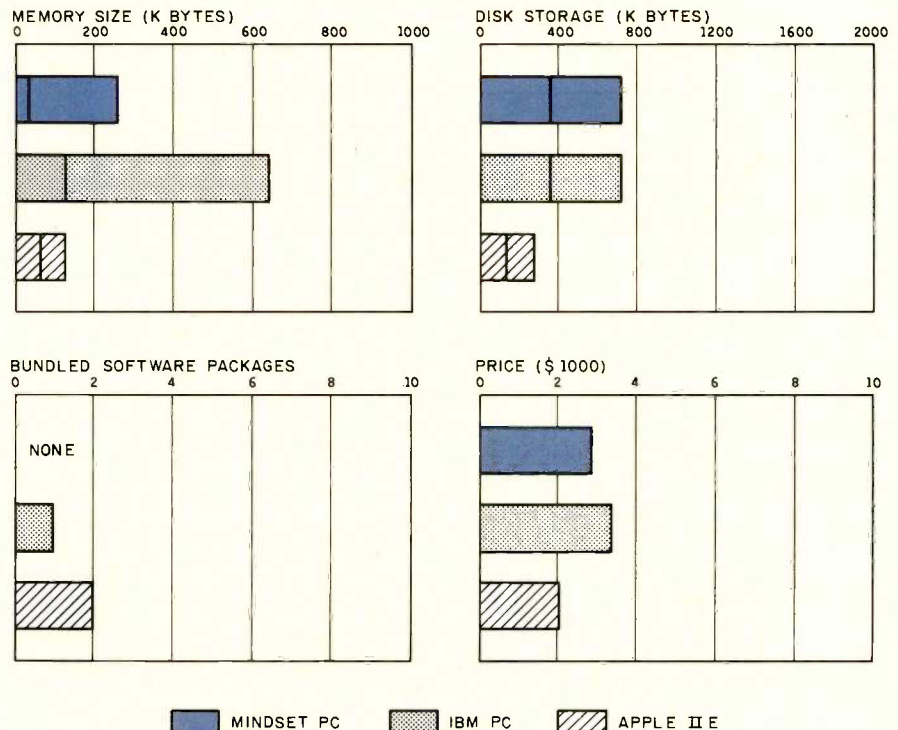

The Memory Size graph shows the standard and optional memory available for the computers under comparison. The Disk Storage graph shows the highest capacity for a single floppy-disk drive and the maximum standard capacity for each system. The Bundled Software Packages graph shows the number of

software packages included with each system. The Price graph shows the list price of a system with two disk drives, a monochrome monitor, a printer port and a serial port, 256K bytes of memory (64K bytes for 8-bit systems), and the standard operating systems and BASIC interpreter for the computers under comparison.

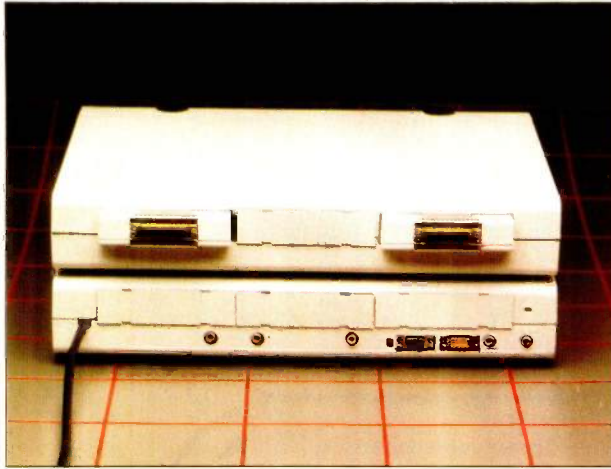

The rear panel of the Mindset system unit and expansion unit. Note the three slots on each for I/O modules.

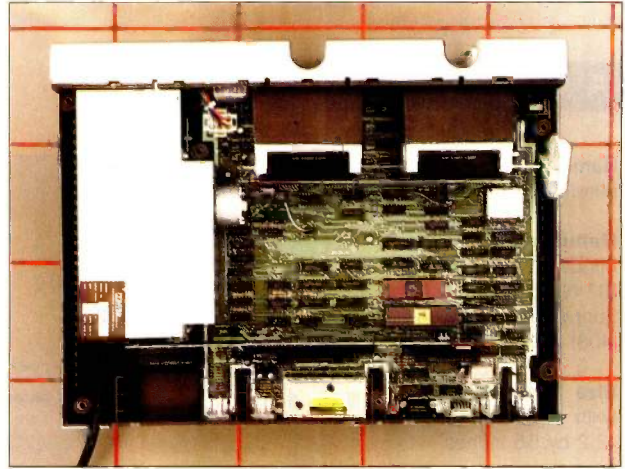

The inside of the Mindset Personal Computer.

DISK ACCESS IN BASIC (SEC)

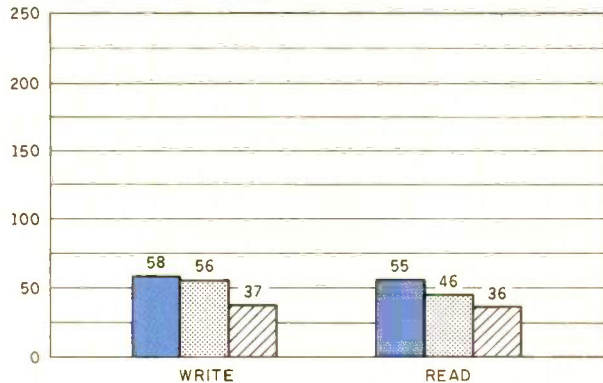

BASIC PERFORMANCE (SEC)

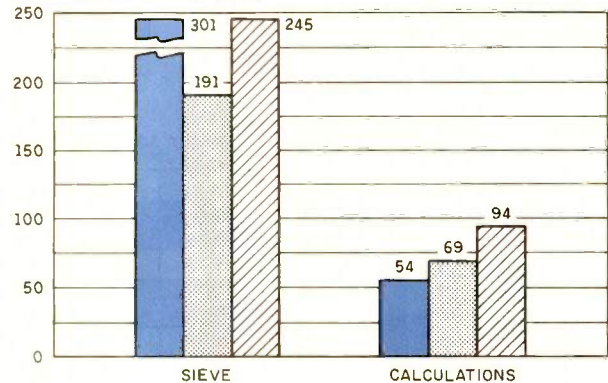

SYSTEM UTILITIES (SEC)

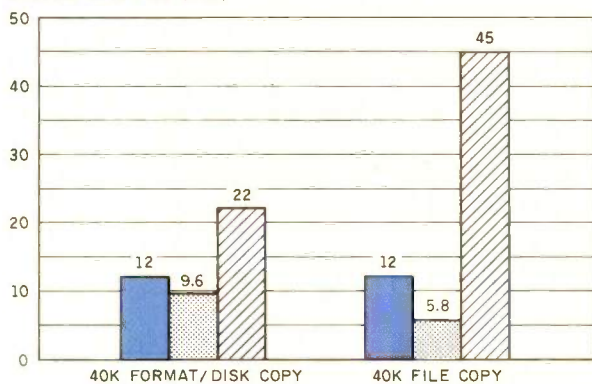

SPREADSHEET (SEC)

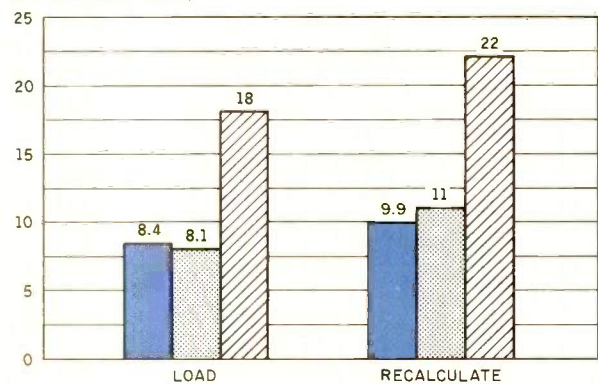

■ MINDSET PC ▨ IBM PC ▩ APPLE II E

The graph for Disk Access in BASIC shows how long it takes to write and to read a 64K-byte sequential text file to a blank formatted floppy disk. (For the program listings, see "The Chameleon Plus" by Rich Krajewski, June 1984 BYTE, page 327, and October 1984, page 33.) The Sieve column in the BASIC Performance graph shows how long it takes to run one iteration of the Sieve of Eratosthenes prime-number benchmark. The Calculations column shows how long it takes to do 10,000 multiplication and 10,000 division operations using single-precision numbers. The System Utilities graph shows how long

it takes to format and to copy a standard text file to disk (adjusted time for 40K bytes of disk data) and to copy a 40K-byte file using the system utility programs. The Spreadsheet graph shows how long it takes to load and recalculate a 25- by 25-cell spreadsheet where each cell equals 1.001 times the cell to its left. Microsoft Multiplan was the spreadsheet used. The tests for the Mindset used Mindset DOS 2.0 and GW-BASIC. Tests for the Apple IIe used ProDOS (except for the spreadsheet test, which was done with DOS 3.3). The IBM PC was tested running under PC-DOS 2.0.

Although the primary purpose is color graphics, Mindset claims that its machine can run a large number of IBM PC software packages. I have successfully run Multiplan, The Final Word, dBASE II, PC/FORTH, Kermit, Turbo Pascal, and Starcross. However, I did not exhaustively test all these packages (especially the Starcross game, which I haven't solved yet). One unfortunate failure was the Microsoft Flight Simulator, which I particularly wanted to see on this machine.

LUMENA

Two software packages that drive the Mindset graphics particularly well are Lumena and the special Mindset version of GW-BASIC. Lumena is a paint program, similar in principle but not in appearance to MacPaint. GW-BASIC is the familiar Microsoft BASIC clone package with special additions to use Mindset's display capabilities.

Lumena apparently runs on a wide variety of graphics machines, of which the Mindset is on the lower end. It was written by Time Arts Inc. of Santa Rosa, California, and it is a real tool for artists and illustrators. Time Arts sells a range of products based around Lumena, including special workstations, animation tools, and digitizers. On the appropriate hardware, you can create some truly spectacular artwork with this package.

A typical Lumena system uses a graphics screen with 512- by 512-pixel resolution and a choice of 256 simultaneous colors. The workspace available on the Mindset is limited to 320 by 200 pixels and only 16 simultaneous colors. While it is not possible to duplicate the efforts of the professional system on the Mindset, some interesting and useful work can be done with the Mindset/Lumena combination (see photos 3 and 4).

Lumena (from now on, I refer to the Mindset version) uses the graphics screen as a frame buffer to store an image the artist can work on. Most of the time the artist sees just his or her design with the Lumena cursor, a small white cross, superimposed. By bringing the cursor to the bottom of the screen, you get the Lumena com-

mand menu on the bottom third of the screen over part of the image. Moving the cursor out of the command menu causes the menu to

vanish, and the portion of the image that was covered reappears.

Lumena has a tree-structured menu

(continued)



Photo 3: An example of graphics produced by the Mindset using Lumena software and an IBM PC-compatible RGB monitor. The photo shows the Lumena control panel. This display is overlaid on your drawing when the cursor is moved through the bottom of the screen. Moving the cursor out of the control panel restores the screen to its original condition.



Photo 4: Another example of Lumena on the Mindset. This picture is courtesy of Rebecca Wilson.

interface. This means that some menu selections will bring up a submenu. You select an item by touching the appropriate menu entry with the cursor and clicking the left button on the Mindset mouse. The left button is consistently used to select or draw. The right button always repositions the cursor to the center of the screen.

Clicking a command such as Airbrush causes the cursor to act as such. Some commands, such as Shape, have many possible subcommands, such as Circle or Ellipse. Selecting these commands places you in a submenu. Selecting the Menu option (always the top left choice in each submenu) returns you to the next

higher menu on the tree. Selecting the "<" option takes you to the most recently used submenu, so you need not go up to the main menu and back down the other side of the tree.

The basic drawing implements of Lumena are brushes and pens. The differences between these two are slight. You can draw freehand with round circles, squares, and airbrushes (like spray paint). You can also draw straight lines by specifying the end points, circles by specifying the center and radius, ellipses by a center and two points on the circumference, and so on. All of this is done graphically. You do not have to enter numbers for size or position. You point and click.

With the exception of the Escape key, which is used to abort a command in progress, the keyboard remains untouched during a Lumena session.

In addition to pens and brushes, Lumena provides a wide selection of transformations that you can apply to a portion of the image. You can easily select a part of the display and enlarge, shrink, move, copy, make a mirror image in either direction, rotate, taper, or render it in perspective. You can even take a rectangular piece of the screen and use that as a paintbrush. The special graphics hardware in the Mindset makes these operations happen fast. You can use the mouse to select half the screen and move it around superimposed on the rest of the picture. Lumena can overlay an image using several logical operations, such as AND, OR, XOR, or their complements.

Like the Macintosh's MacPaint program, Lumena's command interface encourages playful exploration. It is easy to try out a function just to see what it does. This feature is the most addictive in the program. Even if you are not an artist, you can have hours of fun doodling on the screen. It is a very malleable medium and an easy one in which to correct your mistakes.

Having no artistic training myself, it seemed prudent to get an artist's opinion. I asked graphic artist Carolyn King to try the system. She was reluctant, having managed to avoid computers up to this point. After a brief introduction to Lumena, I left Carolyn alone with the machine. In an hour I returned to find her using sophisticated commands that she learned by playing with Lumena. After minimal training and an hour of experience, she was making real pictures without resorting to the manual. She could even correct some of my mistakes. That is the mark of a well-designed user interface (see the text box "An Artist Reacts to the Mindset" at left).

BASIC

A strong point of the Mindset version of GW-BASIC is animation. GW-BASIC

(continued)

AN ARTIST REACTS TO THE MINDSET

BY CAROLYN KING

Having been trained in the traditional arts and crafts, I have always tended toward an appreciation of handcrafted artwork and an apprehension about things technological. Using a computer was something I had avoided for years.

My training is mainly as a printmaker and painter. I have always felt that the visceral side of art-making can be as important as the art itself. Manipulating media such as clay, fiber, and paint can somehow set up a bridge between our awareness of ourselves and an awareness of the history behind the art. Although this account might seem quite familiar to other users of mouse-based systems, it is my way of underscoring how surprised I was by the outcome of working on the Mindset with Lumena.

I was surprised at how little time it took to learn how to use the mouse as a drawing tool. In just a few hours, I felt relatively comfortable with the mouse and the mechanics of the Lumena program.

I enjoyed the blend of sculpture and graphic arts used to create images. Bringing the image into view by

"sculpting" the negative space (i.e., using black or the background color to nibble away at the picture) is a wonderful addition to the usual technique of painting color on background.

I was surprised and relieved to find that, although the computer is not a "plastic" medium to the senses in the way that paint and clay are, I was able to slip into that "altered state" in which the images flow from me to the medium. This was an important discovery for me and eliminated most of my misgivings about the computer as an art tool.

Finally, as far as the mechanics of this particular unit go, the screen doesn't have good enough resolution, so the artist is limited in the ability to refine the image beyond a certain point.

On the whole, I have been convinced that the computer can be a tool the artist can use like any other. Working with a computer is full of a lot more surprises, however. I went into this with a lot of resistance and preconceived notions. I came away with a much wider view of the computer as a tool for the artist and the stirrings of a serious addiction to the mouse.

* ALL PC HARD DISKS
LOW POWER

THE WORLD OF PC UPGRADES

IS10	10 Mbyte Hard Disk with Controller	\$590
IS10R	10 Mbyte Removable Hard Disk/Controller	\$1295
IS20	20 Mbyte Hard Disk with Controller	\$790
IS30	30 Mbyte Hard Disk with Controller	\$1195
MT-10	10 Mbyte Micro Tape Backup "add it to your XT"	CALL
ISPS	Power Supply "Internal" (150 watts)	\$185
CC01	Floppy/Hard Disk Controller Card (1.6 Meg Floppy Compatible)	\$465
	when included in any of above Hard Disk Systems add	\$185

"FOR YOUR AT"

AT20	20 Mbyte Hard Disk for IBM AT	\$795
AT33	33 Mbyte Hard Disk for IBM AT	\$995

NOTE: The above pricing is for internal units. External units are available.
Micro Design International has been serving the Computer Industry for over 8 years.
Our products carry a one year warranty with a 30-day money back guarantee.

**NEW
LOW
PRICES"**

**MAGNETIC MEMORY
PRODUCTS FOR THE
IBM AT, XT/PC AND
COMPATIBLES...**

**NOW
FROM**

\$590

FREE

**WITH THE
PURCHASE
OF ANY
HARD DISK**

**COMMAND
ASSIST \$49.95**
(DOS manual on disk)
...as reviewed in P.C. Week

**CACHE
ASSIST \$49.95**
{For faster disk access}

AND

**TO ORDER CALL COLLECT
(305) 677-8333**

MasterCard/Visa/Check/or Money Order

Inquiry 276

Micro Design International Inc.

6566 University Boulevard, Winter Park, Florida 32792 (305) 677-8333 TELEX 332559 MDII ORL UD



lets you define "objects" and move them around the screen. During their journey, they may vary their appearance using up to eight different views. They may collide with other objects or perform a specific action upon arriving at a destination. Objects can also be clipped, which means that they can pass through a "window" on the screen, becoming partially, then fully visible as they move into view, and then gradually vanishing as they pass back out of view, much like a car moving past a window.

A simple yet impressive demonstration of the animation facilities comes with GW-BASIC. Across a background of words, a picture of a Saturn-like ringed planet slowly tumbles across the screen. As it hits the edge, it bounces off toward another part of the display. The power of this system becomes evident when you run this program in high-speed mode. Saturn becomes a streak, still bouncing and spinning but whipping across the screen faster than an IBM PC user would think possible.

As for non-graphics capabilities, GW-BASIC performs in the same ball-

park as the IBM PC. Mindset's GW-BASIC, together with some special video interfaces Mindset has designed, might provide the basis for some impressive video-production systems (see the text box "Update on Mindset" below).

PROBLEMS

Every system has some flaws, and the Mindset is no exception. One particular annoyance is the insistence of the operating system to look for its Command program (COMMAND.COM) only in the current drive. For example, if you are running Multiplan on drive B and you quit, the system will check only drive B for COMMAND.COM, never A. Fortunately, many applications will be unaffected by this, since they leave the resident copy of COMMAND.COM in memory while they are running.

A slight but annoying feature involves the mouse's design. The mouse cord is very thick, as big as the power cord for the system unit. The placement of the mouse connector on the side of the keyboard, combined with this monstrous cable, means that you

constantly readjust the cord to get it out of the way. A thin mouse cord with a connector on the system unit would have been appreciated.

A major problem with this system has to do with copy protection. Both Lumena and the disk-based version of GW-BASIC are copy-protected. You can copy each disk, but neither will run unless the original disk is in the default drive. I would be very hesitant about buying software that does not permit at least one working backup copy.

Lumena appears to have a bug in the way it writes to the disk. The Lumena manual says that the correct way to run the program is to keep the master disk in drive A with the working disk in drive B. Then you set B as the default drive and you enter A:LUMENA. Thus, you are running the program from drive A but writing by default to drive B. This does work and it is the only way that it works. Reversing the disks or running from drive A and using the Lumena command to change the current disk cause big problems. In particular, saving a file to drive B will eat up all the available space on that disk and Lumena will die. The disk can be fixed with the Recover program.

Lumena also seems prone to "Zero Divide" errors. These happen occasionally for no apparent reason. They cause Lumena to crash and return to DOS. Luckily, the Mindset frame buffer is not cleared on each invocation of Lumena, so it is sometimes possible to reenter the program and find your work retained in the graphics memory. Still, I would prefer to avoid the need for such error recovery.

CONCLUSIONS

All in all, the Mindset is a pleasant alternative to the IBM PC. If you have no need for graphics, you have no compelling reason to select this machine over many of the other IBM compatibles on the market. But if your application requires fast, easy-to-use, medium-resolution color graphics, and particularly if you want animation capability, the Mindset/Lumena combination is hard to beat. ■

UPDATE ON MINDSET

BY RICH MALLOY

Mindset has recently been aiming its machine away from the general consumer market and toward professional graphics designers. This is evidenced by the fact that consumer-oriented software such as games has not been developed for the machine, despite the fact that the Mindset's graphics hardware seems well suited for such applications. Instead, Mindset has made available some special video-related products that might be more at home in professional video studios.

A special version of the system unit includes Genlock circuitry to let it interact better with video equipment. There

is also an external video-production module that lets you mix the Mindset's computer-developed graphics with signals from standard cameras and recorders. According to Mindset, these options let you superimpose Mindset graphics on video images. In addition, you can fade graphics in and out. The special Genlock circuitry costs an additional \$500; the video-production module is \$799.

I have not tested this equipment, but Mindset claims that its system is already being used for graphics in a new television game show entitled "Catch Phrase," which should debut this fall.

SoftCard II[™] squeezes the most juice out of your Apple.

CP/M

Microsoft[®] SoftCard II is the latest high-performance CP/M[®] board that really juices the Apple[®] II, IIe and II+.

Hard facts on SoftCard.

The new SoftCard has a high speed (6MHz) Z-80 that runs CP/M programs up to three times faster than lesser boards. Plus 64K memory. And if that wasn't enough, we also support the Apple Profile hard disk.

Microsoft BASIC is included so it's compatible with more Apple CP/M software than any other board on the market. Thousands of the juiciest business programs including dBaseII[™], WordStar[®] and sophisticated Microsoft languages

like FORTRAN-80, COBOL-80 and BASIC Compiler.

Juicing up the performance of computers is nothing new for us. We invented the SoftCard and wrote Applesoft for the Apple II.

MICROSOFT[®]
The High Performance Software[®] In fact, our BASIC is the language spoken by nine out of ten microcomputers worldwide.

Get the Apple juicer from Washington. Call (800) 426-9400. In Washington State, Alaska, Hawaii and Canada, call (206) 828-8088 and ask for the name of your nearest Microsoft dealer.

MICRO SOFT

Microsoft is a registered trademark and SoftCard and The High Performance Software are trademarks of Microsoft Corporation. Apple is a registered trademark of Apple Computer, Inc. dBase II is a trademark of Ashton-Tate. WordStar is a registered trademark of MicroPro. CP/M is a registered trademark of Digital Research, Inc.

NINE THINGS TO CHECK GRAPHICS

Does the graphics software package you're about to buy (or the one you're using) give you all of these features?

		ENERGRAPHICS	OTHERS
1	PRESENTATION BUSINESS GRAPHICS	✓	
2	3-D OBJECT & SURFACE DRAWINGS	✓	
3	DRAWING CAPABILITY	✓	
4	STATISTICS	✓	
5	MAINFRAME LINK	✓	
6	PC COMPATIBILITY	✓	
7	SLIDE SHOW	✓	
8	CORPORATE USE	✓	
9	PRICE	✓	

EnerGraphics is a trademark of Enertronics Research, Inc.

Lotus 1-2-3, MultiPlan, Tel-A-Graf and Disspla, WANG, TI, GDDM, and IBM PC/XT/AT, 3270/PC are trademarks of Lotus Development Corp., Microsoft Corp., ISSCO, Wang Laboratories, Texas Instruments Corp., and IBM Corp., respectively.

ENERTRONICS

SEEING IS BELIEVING

WHEN YOU BUY BUSINESS SOFTWARE.



Presentation Business Graphics
EnerGraphics delivers pie charts, flowcharts, bar charts, line graphs and more with easy interface to Lotus 1-2-3, MultiPlan and other spread sheets. You'll learn it quickly because we're menu-driven.

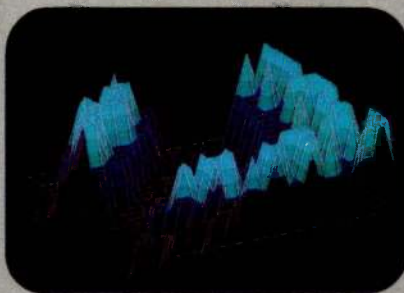

3-D Object & Surface Drawings
EnerGraphics gives you entry-level 3-D CAD features such as zoom, rotate and hidden line removal.

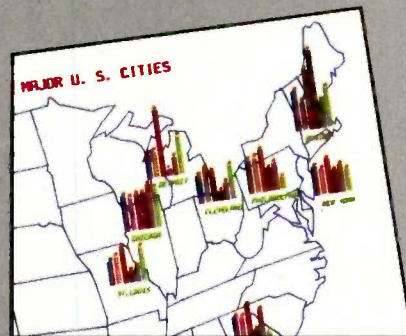

Drawing Capability With EnerGraphics, simple keystroke commands enable you to create text, flow, gantt, pert and organization charts with the capability to enlarge, reduce, rotate, draw, modify, duplicate and overlay.

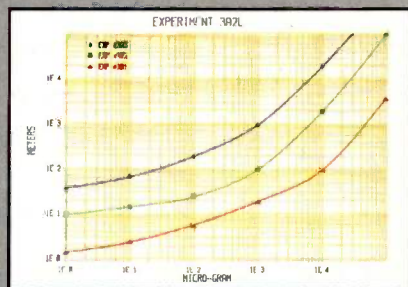

Statistics EnerGraphics enables you to analyze data using linear and log scales to do linear and polynomial regression. Statistical information can be represented in scatter graphs.

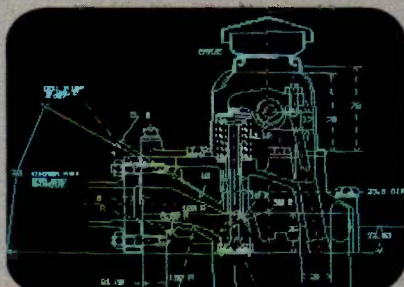

Mainframe Link Our new EnerConnect program allows you to combine PC-based graphics with mainframe graphics such as GDDM, ISSCO'S Tel-A-Graf® Disspla® and IGES data files.



PC Compatibility EnerGraphics can give you an almost unlimited number of graphics applications on Wang, TI, IBM PC/XT/AT, 3270/PC and compatibles.



Slide Show Any of our attractive graphics can be converted into color or b&w slides, or overhead or on-screen presentations using the Polaroid Palette.



Corporate Use You'll find EnerGraphics is the graphics software choice of over 100 leading corporations with more being added all of the time.



Price At a retail price of just \$350 (\$450 with plotter) EnerGraphics actually costs less than many packages that offer only a few of these features.

EnerGraphics. Brought to you by the specialists in graphics application software.

Find out why users rate us at the top among stand alone business graphic packages. Just check with your local EnerGraphics dealer today.



NUMBER SMASHER

Speeds Up Everything...Especially 1-2-3™!

The MicroWay NUMBER SMASHER triples the speed of all cpu bound software while doubling the speed of 8087 bound software. When combined with MicroWay's FASTBREAK™ it results in an increase in the speed of 1-2-3™ of up to 80 to 1! If you're tired of WAITing, the SMASHER is the card for you!

The heart of the NUMBER SMASHER is a 9.54 mhz 8086 working with a matched high speed 8087. The card comes standard with 512K of 16 bit RAM and can be expanded to 640K. It triples the throughput of your original 8088 by doubling the system clock speed and quadrupling the data bus bandwidth.

Software compatibility is guaranteed by the nature of our card. It does not augment the 8088, but replaces it with a special 8086 that runs as a true 16-bit processor in the first 640K of ram and as an 8-bit processor everywhere else.

Examples of software which show dramatic speed-ups include AUTOCAD, 1-2-3™ worksheets which depend heavily on financial or transcendental functions, and multi-user operating systems. Any program written with an MS-DOS compiler that supports the 8087, such as MS-FORTRAN or 87BASIC, will run on the NUMBER SMASHER at least a factor of 2.5 times faster! Software that comes with the card also increases the throughput of I/O bound programs and includes a disk cache routine, ram disk and print spooler.

The NUMBER SMASHER is an upgrade product for 8088 based PCs and compatibles. It works on the IBM-PC and XT, the COMPAQ and compatibles manufactured to the IBM-PC hardware standard. Contact MicroWay or your local MicroWay Installation Center for technical specifications and supporting benchmarks.

**Micro
Way**

The World Leader in 8087 Support

P.O. Box 79, Kingston, Mass. 02364 USA (617) 746-7341

NUMBER SMASHER and FASTBREAK are trademarks of MicroWay, Inc. LOTUS and 1-2-3 are trademarks of Lotus Development Corp.

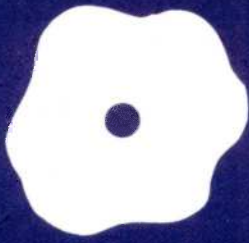

Idea Processors

ThinkTank

Executive Writer/

Executive Filer

THOR

Framework

BY WILLIAM HERSHEY

An idea processor is a tool for organizing blocks of text. Because text is a critical part of the final product, idea processors incorporate some type of text editor, even a full-blown word processor in some cases. So far the products that call themselves idea processors seem to fall into two classes: outline organizers and computerized index-card retrieval systems.

Like spreadsheets, these tools are applied in as many ways as there are users. I prefer outline processors to index-card systems. They are better at giving you a top-down view of things, which is supposed to be the best way to think. If you have a large amount of textual reference material to manage, an index-card system might better meet your needs. But keep in mind that it is easy to structure an outline to work like a deck of cards.

Idea processors are growing in popularity, and their range of capabilities varies widely. This review examines four. One program is an outline processor, two are index-card systems, and the fourth can be used both ways. All four packages are available for the IBM Personal Computer (PC) and compatibles; ThinkTank is also available for the Macintosh. I tested the IBM versions on a Compaq with 640K bytes of RAM (random-access read/write memory) and two floppy-disk drives.

THINKTANK

Billed by Living Videotext as the first idea processor, ThinkTank is a versatile outlining tool with a decent text editor. Since the program's introduction on the Apple II and III, reincarnations with varying capabilities have arrived for the Macintosh and the IBM PC. The command tree in the PC version is complex. But once you discover the shortcuts, you won't have any trouble using it. The version for the 128K-byte Macintosh, called ThinkTank 128, is like a sports car. It won't hold much, but it's fun to drive and gets you where you're going fast.

I first used and reviewed ThinkTank (on an Apple III) more than a year ago (see my review "ThinkTank" in the May 1984 BYTE, page 189). Now that the IBM PC and Macintosh versions have been on the market for a while, that review deserves an update. The IBM version is much improved over the first Apple versions. Disk accesses are reduced, paragraph capacity is dramatically increased, and editing is easier. But the commands for the PC version could confuse novices. The initial Macintosh version has limitations and design problems, but its simplicity and speed make it effective.

ThinkTank outlines have just a few key elements. You can enter headlines as long as 77 characters. Each headline can have any number of subheadings beneath it and, with the IBM PC version, a "paragraph" of up to 20,000 characters of text. You can break up ThinkTank's paragraphs into your own smaller paragraphs by inserting "hard" carriage returns. The subheadings can have more subheadings and paragraphs beneath them, up to as many as 10,000 levels.

A bar cursor highlights each headline as you scroll through the outline. You can "expand" a headline (using the plus-sign key on the PC's numeric keypad) to see the subheadings and paragraphs beneath it, or you can "collapse" it (using the minus-sign key) to hide all the subordinate levels. ThinkTank automatically precedes each headline with a plus or minus sign. A plus means that the headline has subordinate levels or paragraphs. A minus means that no deeper levels exist.

The ability to collapse or expand an outline at any headline level gives you many ways of viewing the ideas that make up your outline. This, combined with the ability to move headlines and insert new ones at any point, is the essence of idea processing, ThinkTank-style. ThinkTank 128 does not let you enter paragraphs under the headlines. That's a serious drawback, but the benefit is speed. With your whole outline in mem-

(continued)

William Hershey (MITRE Corp., 1820 Dolley Madison Blvd., McLean, VA 22102) is a systems engineer with a B.S. in engineering from Princeton and an M.A. in computer and communication sciences from the University of Michigan. He is also an instructor in computer literacy at the University of Maryland's University College.

*Except for the lack
of paragraphs,
ThinkTank 128's
biggest flaw is its
unconventional
user interface.*

ory and the mouse to guide you through the commands, the program is a joy to use. (ThinkTank 512, with enhanced capabilities that include paragraph and image handling, should be on sale by the time you read this but was not available for this review.)

In converting the program from the Apple III to the PC, Living Videotext made some commands easier to use by assigning them to the PC's function keys and the keys on the numeric keypad. Unfortunately, the company

left all the old commands intact and mixed function keys, the Insert and Delete keys, and single-letter commands in the same main command menu. This could make the command structure seem very complex to a first-time user. In some cases, there are as many as three paths to travel to perform a given operation. Once you have learned the program, of course, you avoid the long detours and take the express route. Replacing the old menu commands with function-key definitions at the bottom of the screen might simplify the process.

The editor works well. You can move through a paragraph quickly and easily by using the numeric keypad. Moving and copying text between paragraphs, however, is tedious. Once you leave a paragraph and go to another one beneath a different headline, you are effectively editing a different document. Selected blocks can't go with you. Whole paragraphs can be merged, but only if their parent headlines are adjacent.

Using ThinkTank 128 is quite easy because of the Mac's pull-down

menus and the use of the mouse. You control the position of an arrow on the screen with the mouse. When you click the mouse button, a box appears around the nearest headline. Double-clicking makes a headline's subordinate levels expand or collapse. Finer control with the mouse lets you put a vertical bar inside the boxed headline to set an insertion point for editing. Holding down the mouse button changes the sharp box around the headline to a fuzzy one, and you can then drag it along with all of its subheadings to a different spot in the outline (see photo 1). Here the Macintosh really outshines the PC. You can also move headlines the old way, using the keyboard. The keyboard commands are most useful for inserting new headlines.

The Macintosh Clipboard works as expected for some cut-and-paste operations, including sending all or part of your outline to another application like MacWrite. But drag selection for cutting and copying does not work within a headline; the Backspace key is your only deletion tool there. In fact, drag selection is not implemented anywhere in ThinkTank 128. Consequently, you cannot select groups of headlines for deleting, moving, or copying unless they all fall under a high-level headline.

Sorting of subheadings and searching for strings of text are available in another pull-down menu. They are easier to use here than in the PC version, which has them buried deep in the menu tree. Unfortunately, however, ThinkTank 128 has no Undo command as do many Mac programs. When you delete part of your outline or sort a set of subheadings in a way you don't like, you have no way to restore things to their previous condition.

Except for the lack of paragraphs, ThinkTank 128's biggest flaw is its unconventional user interface. Scrolling is one example. Instead of using the predefined "scroll bars" from the Macintosh's built-in routines, the Living Videotext programmers invented their own "hot" border surrounding the text window. It's the same gray

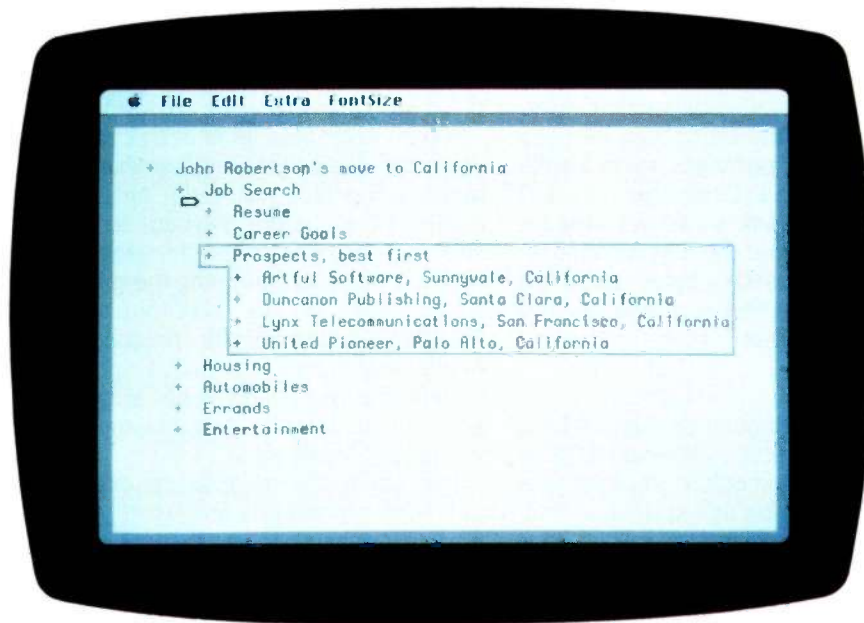

Photo 1: In the Macintosh version of ThinkTank, moving headlines and their subheadings is much easier than in the IBM PC version. When you hold the mouse button down, a fuzzy box appears around the headline and everything subordinate to it. You can then drag it where you want it.

AT A GLANCE

Name	ThinkTank	Executive Writer/ Executive Filer	THOR	Framework
Type	Idea processor	Idea processor	Idea processor	Integrated package
Manufacturer	Living Videotext 2432 Charleston Rd. Mountain View, CA 94043 (415) 964-6300	Paperback Software International 2612 Eighth St. Berkeley, CA 94710 (415) 644-2116	Fastware 200 Freeway Dr. East East Orange, NJ 07018 (800) 372-2345	Ashton-Tate 10150 West Jefferson Blvd. Culver City, CA 90230 (213) 204-5570
Computer	256K IBM PC, 128K and 512K Macintosh, 64K Apple II family, 96K Apple III, 384K Data General/One	192K IBM PC, 256K PCjr	128K IBM PC	384K IBM PC
Features	Outlining, text editing, formatting	Index-card retrieval and word processing	Index-card retrieval and text editing	Integrated outlining, word processor, database, spreadsheet, graphics, telecommunications
Documentation	User's manual	User's manual	User's manual	Tutorial, reference manual
Price	IBM PC, \$195; 128K Macintosh, \$145; 512K Macintosh, \$245; Apple II family, \$150; Apple III, \$150; Data General/One, \$195	Executive Writer, \$69.95; Executive Filer, \$49.95	\$295	\$700

pattern as the normal Mac desktop background. A press of the mouse button when the arrow is on one of the four borders causes the text to scroll away from that border. Clicking on the corners causes diagonal scrolling.

It sounds easy and it is. But Mac users are used to seeing scroll bars with arrows and a "thumb" that can be dragged to a relative position in the document. Giving them a non-standard alternative to what they already know is contrary to Apple's philosophy of keeping the Macintosh user interface consistent from one program to another. This is one of the few features I had to find in the manual before I could make full use of ThinkTank 128.

ThinkTank's diagonal scrolling is not available with standard Macintosh scroll bars. But how many times have you wished for diagonal scrolling? Another shortcoming is that you cannot drag or size the ThinkTank 128 outline window (at least not in the version I tried).

Even the IBM PC version of ThinkTank does not claim to be a word

processor. Although it lacks advanced editing and formatting features, it does a decent job of putting an outline on paper. For some features, the paragraph editor in the IBM PC version of ThinkTank is easier to use than Executive Writer (reviewed later), which does claim to be a full word processor. Neither program formats text on the screen as it will appear on paper, but at least ThinkTank reformats paragraphs automatically to end lines at word boundaries. Executive Writer requires the press of a function key for that.

ThinkTank lets you format output as DOS (disk operating system) text files (with hard carriage returns after each line) for polishing with your favorite word processor. WordStar users will appreciate the option that inserts WordStar formatting codes into the output file. ThinkTank's 17 format options include outline-specific information, such as the number of spaces for indentation of the various levels and the depth for printing headlines, paragraphs, and section numbers. ThinkTank will print a table of contents to the level you specify and automatical-

ly insert the page number where each section heading will appear. The version for the 128K-byte Macintosh, however, severely limits printing capabilities. You highlight a headline, and the program will print out that headline; all others become subordinate to it. You have no control over outline depth and no table of contents.

The IBM PC version comes with two manuals. The well-written user's manual combines a tutorial approach with a full account of how things work. The last 10 pages are reproduced as a separate quick-reference guide to help you keep track of commands. ThinkTank 128's documentation is of similar quality but takes a different approach. It has a tutorial section and two reference sections, covering the specific and the general. ThinkTank's simplicity on the Macintosh eliminates the need for a Mac quick-reference guide.

Both versions come with one disk that contains the program and sample outlines. Unlike the Apple III version that I reviewed earlier, the IBM

(continued)

and Macintosh disks are copy-protected. With the IBM version you can copy the program to your own disk (including hard disk) and execute it from there, but you must have the master disk in drive A when you start the program.

**EXECUTIVE WRITER/
EXECUTIVE FILER**

[Editor's note: Prior to January, Executive Writer and Executive Filer were marketed as one package, called The Idea Processor. The developer, Idea Ware, split the package and sold the two programs to Adam Osborne's Paperback Software International (PSI) for distribution. In its new incarnation, the product has been upgraded to version 2.0 and repackaged as Executive Writer and Executive Filer. Each package consists of a manual with a software disk inside the back cover. The

packages sell for \$69.95 and \$49.95, respectively. Version 2.0's reported improvements include on-screen formatting, horizontal scrolling, and enhanced speed. Steve Cook of PSI said that version 2.0 provides on-screen help, printing from within the editor, and many WordStar-like control-key sequences. Cook explained that the package is offered as separate modules because PSI wanted a word processor and felt that The Idea Processor's was a good one. Buyers who purchase both modules integrate them by using a routine provided by PSI that needs to be invoked only once. PSI provides all support for both packages.

Mr. Hershey initially reviewed The Idea Processor but has added material to reflect the capabilities of the new packages.]

Executive Writer and Executive Filer combine a flexible word processor with an indexed "cardfile" system that

lets you search for cards by keywords. You can shuttle blocks of text quickly between the cardfile and your document. Features include keyboard macros and the ability to store and recall graphics images for insertion into your text.

In The Idea Processor, as well as in Executive Writer and Executive Filer, the word processor and cardfile are integrated. The cardfile resides in a hierarchical system of "drawers" and "cabinets," making it easy to relate to the real world. Figure 1 shows an overview of the system's operation.

Unlike ThinkTank, Executive Writer and Executive Filer do not help you visualize the big picture. Your document consists of straight text, just as it would in any word processor. You have no tools to experiment with the overall structure of your work. The value of Executive Filer lies in finding large blocks of text by keyword. Especially if you keep a large amount of reference material on disk, this retrieval feature could save you time.

Even if you don't need the cardfile, Executive Writer might meet your word-processing needs. It has many features and is relatively easy to learn and use. When used with the Ctrl key, the cursor keys on the numeric keypad and the Insert, Delete, Backspace, and Tab keys position the cursor to the beginning or end of a line, to the top or bottom of the screen, or to the next or previous word. A status line near the bottom of the screen shows whether the insert, wordwrap, boldface, and underline features are on or off.

Function keys handle most of the other word-processing commands. An information line at the bottom of the screen labels them. They work alone or in combination with the Ctrl, Alt, and Shift keys to invoke 40 different operations. I found using the function keys cumbersome in some cases. Block operations, for example, use Ctrl with the function keys. Copying a block of text requires pressing Ctrl-F3 to begin the block, moving the cursor to extend it, Ctrl-F4 to end it, moving the cursor again to indicate where you want the copy, Ctrl-F7 to put it there,

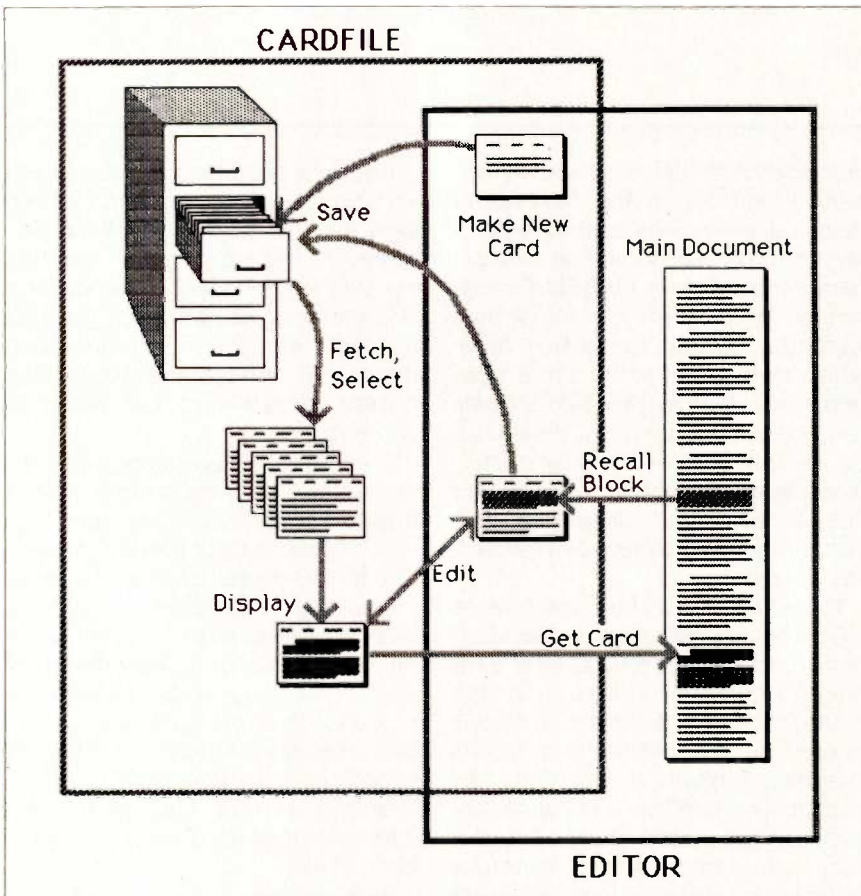

Figure 1: With Executive Writer and Executive Filer you can create and organize blocks of text on "cards." You can move text back and forth between the cardfile and a document in the editor.

and Ctrl-F5 to make the highlight on the original block disappear. Deleting and moving blocks requires similar finger contortions. Fortunately, shortcuts with the Ctrl, Alt, Backspace, End, and Delete keys make it easy to delete individual words or all or part of a line, eliminating the need to select a block for deletion.

Executive Writer's search and replace capabilities are flexible. The function keys work with the Shift key to activate them. You can define up to 10 keyboard macros with as many as 100 keystrokes each. They disappeared when you left The Idea Processor, but in Executive Writer you can save them along with margin and tab settings. You assign each a number from 0 to 9 and call them by pressing Ctrl and the appropriate number. You can nest macros within each other as long as you don't ask a macro to call itself. Macros work with the cardfile's editor, too.

Besides the minor complaints already noted, The Idea Processor's biggest shortcoming was the editor's inability to format text on the screen as it will appear on paper. Some format features like boldface and underlined text did appear on the screen, and Executive Writer adds on-screen margin control to these. Page breaks are still left to your imagination. Another annoyance that remains in Executive Writer is the need to press F2 periodically to reformat the current paragraph.

Each format command is a two-letter code. Pressing F6 generates a special "feather" symbol that precedes the code. There are 24 of them, giving you the usual formatting capabilities plus special features like even/odd logic in headings and footings, automatic numbering of footnotes, automatic counters anywhere in the text (for section numbers, etc.), and insertion of graphics images into text. A separate Print program prints your document. If your printer is not one of the standard ones supported, PSI supplies a utility to help you create the necessary printer-configuration file.

The Idea Processor lacked a

graphics editor, and so does Executive Writer, but the manual tells how to save screen images from other programs. Idea Ware publishes one called The Graphics Idea, which includes the SlideShow facility. The manual provides examples of others such as Lotus 1-2-3, VisiPlot, and dGRAPH II. The file format is the same used by the BSAVE command in BASIC. A SAVESCREEN utility lets you save the graphics images for access from the editor or cardfile. File operations, invoked with Alt and the function keys, let you save all or part of a document. After saving a document, The Idea Processor required you to leave the editor and reload the document to resume work on it. Executive Writer has an Update feature that avoids this extra step. Once a document is loaded, you can insert text from other files and from cards in the cardfile.

In the cardfile, provided by Executive Filer, you can peruse your indexed ideas for just the right one to insert in your document. Or you can take a highlighted block of text from the main document to store on a card for later use. You won't have a split screen or windows to keep your document in view while you examine cards, but switching between editor and cardfile screens is nearly instantaneous.

Instead of function keys the cardfile uses menus to help you organize cards. The first thing you do when accessing the cardfile is make or unlock a cabinet. Each cabinet holds up to eight drawers, which in turn hold thousands of cards (depending on the space available on your disk). Each card in the cardfile holds up to 8000 characters. You edit the card with the full set of commands used to edit

(continued)

Operate your office PC from home ...



Use the power of your office-bound PC at home or on the road ... all you need is REMOTE.

Whatever PC power you may need, spreadsheet, DBMS, word processor, can be yours. All you need is a portable computer or terminal and a modem. REMOTE provides password protection for each user.

Leave your PC in the office ... but pack the power to go. REMOTE.

REMOTE™

MICROSTUF®

1000 Holcomb Woods Parkway / Roswell, Georgia 30076

A NEW LEGEND BEGINS.



INTRODUCING NEW KODAK DISKETTES.

For as long as anyone can remember, the world has trusted Kodak film to capture its memories. Now the world can trust legendary Kodak quality to capture its computer data.

Introducing Kodak diskettes. And the beginning of a new legend.

We know you expect nothing less than extraordinary performance from a Kodak product. We didn't disappoint you.

These remarkable new diskettes are so thoroughly tested, they're certified error-free.

Every Kodak diskette is highly burished for optimum read-write accuracy. And every standard diskette is made to withstand at least 4½ million passes before significant wear occurs.

© Eastman Kodak Company, 1984

With accuracy and durability like that, we can offer this no-questions-asked replacement policy:

This KODAK Diskette will be free from manufacturing defects, or we will replace it.

Kodak diskettes for home and business PC use are available in standard 8- and 5¼-inch formats, high-density 5¼-inch diskettes, and 3½-inch micro diskettes in our HD 600 Series.

New Kodak diskettes. Because the only thing that can follow a legend is another legend.



KODAK.
The name says it all.



Inquiry 161

documents in Executive Writer. After creating the card, you specify which drawer it's to be stored in and enter a list of keywords to use in retrieval.

You can fetch a card or set of cards by specifying a keyword or pressing the tilde (~) as a wild card to fetch them all. Then you can browse through them one at a time. Once a card is displayed, you can modify the selection criteria by specifying Boolean operators (AND, OR, NOT) that combine the current list of keywords with others. With only these search mechanisms, Executive Filer lacks power as a database manager. But the keyword retrieval scheme is effective and simple and should meet most people's needs.

In addition to Executive Filer's obvious text-classification uses, the package can be useful to programmers. With wordwrap off and no boldface or underlined characters, files are standard ASCII (American Standard Code for Information Interchange) text files that can be read by compilers and interpreters. You can use the cards to organize and store subroutines.

The two extensive demonstration disks that came with The Idea Processor are not included with Executive Writer/Executive Filer. The new version does have a file illustrating a simple application. The new manuals have "quick courses" to get you started, and the Executive Filer manual has an "expert" section with tips on various ways to use the package. The new software requires you to have the master disk inserted when you start the program. After you register, you can get an unprotected copy for \$10.

Although it lacks ThinkTank's outlining and sorting capabilities, Executive Writer is a better word processor. Executive Filer's retrieval features are also more flexible than ThinkTank's, though limited in comparison with most database managers. It appears well suited to large writing projects that require the assembling and indexing of much information. The program would also be useful to reporters or authors who

want to keep a disk library of material for reference.

THOR

If you want a program that puts commands on the screen in color and gives you total control over the color and intensity of your text as you type, this one from Fastware is for you. THOR stands for "thought organizer." According to the manual, it "combines the free format facility of a word processor with the power of a database manager." Unfortunately, it doesn't perform either function very well. Commands are inconsistent with common sense, and the text editor is awkward to use.

For retrieval of text blocks, THOR works more like a conventional file-management program than Executive Filer, which provides search capability on up to 10 keywords for each record. THOR stores a block of text, which it

calls a "thought," with up to 5 categories or fields plus the date you entered the information. The total number of categories in a database of thoughts can be as many as 255, but any given thought can use only 5 of them.

Retrieval by category can occur at two levels. You can search your thoughts to find the ones that merely *have* a category or a set of categories. Or you can be more specific and search the contents of those categories. You can thus mix several types of records in the same database and still find what you want.

Two other selection criteria are available. You can search for thoughts created within a specified range of dates, and you can search for thoughts containing any of three specified strings of text. If you want to use combinations of the three

(continued)

PC power ... anywhere.

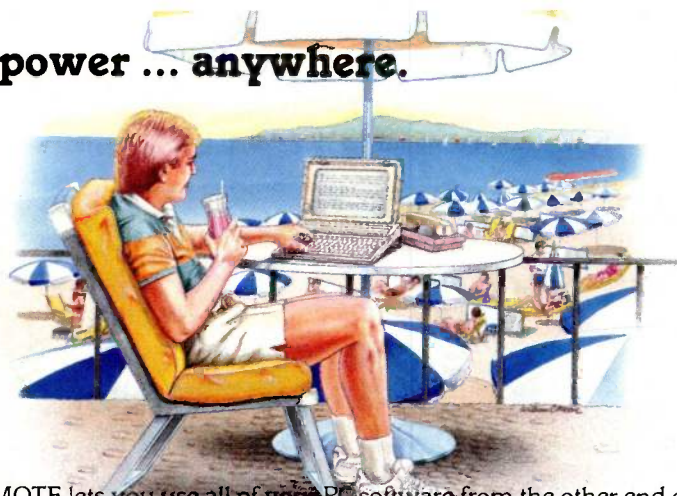

REMOTE lets you use all of your PC software from the other end of a telephone line ... wherever that might be!

All you need is a terminal or portable microcomputer, a modem, and a phone line. You can call into the host microcomputer, access it, and run most popular programs, including word processors, spreadsheets, and database managers. You'll see the program in operation just as if you were sitting in front of the host computer.

REMOTE's powerful electronic mail system rivals those found on mainframes, with full password protection. Why leave your PC power in the office ... when you can give it a call with REMOTE?

REMOTE™

MICROSTUF®

1000 Holcomb Woods Parkway / Roswell, Georgia 30076

types of selection criteria, they are automatically connected with AND operators—that is, a thought must meet all the criteria specified in order to be selected. Selection of thoughts is thus rather inflexible.

If I seem to be dwelling on the database aspects of this program, it is because the program authors have dwelled on them. The tutorial does not show how to classify and organize blocks of amorphous text, brimming with intertwining ideas. A real "thought organizer" should do that. Rather, the tutorial illustrates in detail how to work with a database of restaurants in New York City and select the French ones in midtown that serve duck (see photo 2).

The most annoying feature of THOR is not its limited capability but its terminology. As I've noted, a block of text is called a thought. This leads to the terms "thought maintenance," which you and I know as text editing; "thought categorization," which entails entering database fields and their values; and "thought review," which we normally call record selection. And it goes downhill from there.

Let's turn now to thought mainte-

nance (text editing). There are two editors—a "field editor" for fields and a "screen editor" for larger blocks of text. They work differently. The field editor works only with capital letters. No matter how you type them in, they appear as capitals. I suppose this is to facilitate "BRAINscanning" (retrieving records). The Delete key erases an entire field, not a single character as it does in the screen editor. However, fields are limited to 12 characters, so you won't have much to retype.

In the screen editor, the up and down arrows take you to the previous or next line. In the field editor, it all depends. If you have not made any changes to the field yet, these arrows take you to the previous or next field, respectively. Be careful using the up arrow, however; the manual warns, "Sometimes to insure data integrity, THOR will not allow you to do this and will tell you so with a beep." Using the down arrow in this situation, the manual states, "is similar to using the RETURN key except on some screens the down arrow key will jump over a group of subsequent fields." If you have made changes to the field, pressing either the up or the down arrow—

or the Esc key—replaces the changes with the original default value and moves the cursor to the beginning of the field.

Now that you have mastered the field editor, we can move to the screen editor. Unlike Executive Writer/Executive Filer, THOR does not focus on a single main document that can be assembled by the screen editor from smaller blocks of text. The only unit of organization for a THOR database is the thought. THOR's thoughts, however, can hold more than Executive Filer's cards. Fastware claims that thoughts can be as large as 40,000 characters, depending on your machine's amount of RAM.

THOR's screen editor has cut-and-paste commands, but they're not like the ones in most word processors. Cut breaks the current line into two lines at the cursor position. Paste reformats a paragraph from the cursor position, like Ctrl-B in WordStar or F2 in Executive Writer. There are no block move or copy commands, but you can save a block of text to a file and load it in again. The screen editor does not have a destructive backspace, but it has a typeover mode, called Edit mode.

Although I am not fond of this editor, it does have a feature not found in most word processors. In the upper right corner of the screen is the current attribute character, which shows the color, intensity, and other characteristics (like underlining, flashing, and reverse video) of the characters to be typed. By pressing the Alt key in combination with others, you can affect the way each character in your block of text will be displayed. The graphics attributes work only within THOR and cannot be saved with text files for use in other programs.

THOR provides limited on-screen formatting in the form of margin and tab settings. Print-formatting commands must be inserted into text and are confined primarily to page-length settings. The INCLUDE formatting command lets you string thoughts together as they are printed.

Like Executive Writer/Executive



Photo 2: THOR is pretty and colorful, but it lacks power in both its file-management and text-editing operations.

Filer, THOR can save and load straight ASCII text files. The jobs that THOR claims to handle best are some of the same ones cited by PSI for Executive Filer. THOR's manual was 44 pages of poorly written dot-matrix printout in a loose-leaf binder. Fastware claims to have improved the documentation. It still has no index.

FRAMEWORK

The real champion of idea processing is Framework. The top level is an outline organizer in the manner of ThinkTank but with more power and flexibility. It also offers screen-formatted word processing, a database manager that you can use as a cardfile, spreadsheets, graphics, and telecommunications with Macintosh-like pull-down menus and consistent, easy-to-use commands. Naturally, it's the most expensive offering, and it requires lots of memory (256K bytes minimum).

Framework's applications and capabilities extend far beyond those of the other programs in this review. The outline is the web that ties together all applications. As tempting as it is to dig into all of Framework's features, I will focus here only on the parts of Framework that are similar to other idea processors. (For more information, see the product preview of Framework in the August 1984 BYTE, page 121.)

Just as ThinkTank can create headlines with subordinate subheadings and paragraphs, Framework can create an outline with many levels. Commands for expanding and collapsing work on any part of the outline in much the same way they do in ThinkTank. Each line in the outline represents a "frame." A frame can remain empty or contain text, a database, a spreadsheet, a graph, or other frames.

To understand what Framework can do to help you process ideas, it is first important to understand how frames work. A frame is a box that you can resize and relocate anywhere on the screen. Frames overlay each other as you use them, but you can put them away at any time. The only limit to the number of active frames is the

amount of memory in your IBM PC.

There are five types of frames. Your title for each one goes into its border at the upper left. You can have a "container frame" that merely holds other frames. Each application also has its own type of frame: word processing, spreadsheet, database, and presentation graphics. The manual claims that a sixth type is the outline frame, but that's not quite right. Outlines are merely container frames displayed in "outline view."

When you decide to make an "empty/word" frame into a container frame, you can put only other frames into it. You cannot use it to store blocks of text unless they are inside other frames.

If the screen weren't green, you'd swear that Framework was running on a Macintosh. The pull-down menus appear quickly. The function keys have a single set of actions and

operate consistently throughout all applications.

The top of the screen has a line of nine menus. You will need most of them for idea processing. The Disk menu loads and saves files and gives you access to DOS and other programs. (When you are done, you return to Framework with a frame full of whatever DOS put on the screen. I even ran ThinkTank from within Framework to compare some features of the two programs.)

The Create menu makes empty frames. Creating an outline frame is the logical first step in beginning a project. The resulting container frame has empty section headings (each representing a frame) in a predetermined format. After you learn Framework, you'll probably prefer to create your own container frame with your desired outline format. The Edit

(continued)

System service by REMOTE control.



System troubleshooting's enough of a headache without adding travel to it. REMOTE can cut your service travel ... to nothing flat.

REMOTE lets you access and operate a distant system via modem. You can troubleshoot the system from top to bottom, update or revise software and data files ... all without leaving your office!

Boost your system support efficiency and your bottom line ... all you need is REMOTE!

REMOTE™

MICROSTUF®

1000 Holcomb Woods Parkway / Roswell, Georgia 30076

Framework outlines have a triangle in front of frames with subframes.

menu lets you choose Insert or Type-over mode and has an Undo command. The Locate command is for searching and replacing strings; it also has ascending and descending sort commands that sort sections in an outline as well as fields and columns in databases and spreadsheets.

The Frames menu has a number of commands unique to Framework (see photo 3). Normally when you add frames to an outline, the program puts one below another in "column" format. An alternative in the Frames menu is referred to as "Allow Free Dragging." A better term would be "allow vertical dragging" because you can always move frames horizontally on the screen. Only when you have allowed free dragging can you drag frames vertically.

Free dragging can come in handy

when polishing writing. If you have two alternative paragraphs you need to compare for the best wording of an idea, you can put them in frames and put the frames side by side. They will appear on the printed page in that arrangement until you decide which one to delete. This is also a great way to print multiple columns of text on a single page or print blocks of text scattered haphazardly over the page.

Although ThinkTank numbers the sections of your document and generates a table of contents with page numbers, these features are available only on the printed output. Framework lets you view them on the screen as you work. When you add a new frame to your outline, the section numbers are automatically adjusted to accommodate it. Both programs use a hierarchical numbering scheme (for example, 1, 1.3, 2.4.1, etc.).

Framework outlines have a triangle in front of frames with subframes. You have the option to "Reveal Type" for each frame. Frame types are empty/container, word, database, spreadsheet, and graph.

If you are writing a document with a block of text in each subframe of your outline, it is easy to see how well

you are progressing. Just check the number of frames marked (W), for word frame, against the ones still marked (E), for empty/container frame.

Two especially useful keys with Framework are F9 (Zoom) and F10 (View). When used with a typical document consisting of an outline and word frames, they can provide four different ways of looking at the document. The use of these keys can be confusing at first because where they take you depends on where you've been. I tend to stick with F9 most of the time to zoom back and forth between outline and full-screen views of text. The view accessible via F10 shows a nested set of frames with part of the text visible inside each one.

For linear narrative, in which one idea flows logically to the next, you may find the frames view unnecessary; the outline provides a better overview, with the full-document view providing the detail. The frames view lets you be very creative in using Framework's display to show logical or dependent relationships between frames of text. Framework can be a two-dimensional tool for writers, just as spreadsheet programs are for number crunchers.

Framework uses margin settings within frames so you can see roughly how your text will appear on paper. You can scroll horizontally to 255 columns, and paragraph reformatting is automatic when you insert new text into the middle of a paragraph. The Words menu at the top of the screen has a few key attributes to control margin, justification, and tab settings. It also has switches for boldface, underline, and italic attributes. You can also select combinations of these styles, and the type on the screen reflects your choice. For other formatting features, however, Framework uses formulas that you load into the frame border. These control paging, headers, footers, and the like.

The biggest formatting deficiency is the lack of page-break lines on the screen. Because a finished document is likely to be produced from a series



Photo 3: Framework's pull-down menus are fast and easy to use.

(continued)

MoneyCenter

ACTIVE TREASURIES				Symbol	Last	Change	High	Low
Issue	Maty	Price	Change	B-POUND	1.1030	+0.0120	1.1045	1.0960
3-MO	5-16	8.19-15	+0.02	D-MARK	0.3073	+0.0030	0.3075	0.3059
6-MO	8-15	8.27-23	+0.02	SU-FRNC	0.7305	+0.0144	0.7320	0.7200
11 1/4	2/15	99.01-04	-1.4	YEN	3913	+65	3916	3892
I Amer Telephone & Telegraph				SPH	TICK CHART		04:22P	

LA: 213/8	CG: +0 1/8
PV: 211 1/4	VL: -0
O1: 211 1/8	C1: -0
CH: -0	CL: -0

HI=183.65 LO=181.20 181.85ST -1.00

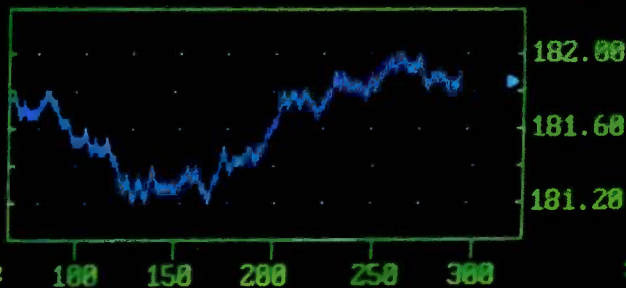

5616 05:19P Economist advises near-term caution in fixed-income markets
 5612 05:18P Kessler sees FOMC holding to a relatively accommodative mode

I LA: 213/8 CG: +0 1/8 OP: 0 PV: 211 1/4

MoneyCenter

8

Monitor colors simulated
 © 1985 AT&T Information Systems



ONCE KNIGHT-RIDDER CHOSE AT&T THE FINANCIAL PICTURE LOOKED BRIGHTER.

In the demanding world of financial markets, everything depends on getting the right information. Fast.

For over 30 years, America's leading futures dealers have relied on Knight-Ridder's Commodity News Services. Now, Knight-Ridder is introducing a new service and they're relying on AT&T.

Only AT&T could provide the complete system Knight-Ridder needed for MoneyCenter, one of the most comprehensive financial market information systems ever developed. The system features personal computers, printers, local area networks, and custom-tailored modems. All supported by an unparalleled national service organization.

For traders, just a few seconds can mean millions of dollars in either profit or loss. Knight-Ridder chose the AT&T PC 6300 because of its incredible speed. And also because its high resolution screen is easy on the eyes.

As Knight-Ridder's services expand, their AT&T system can too. Our unique open architecture assures that any AT&T system is flexible enough to meet changing needs and permits our products to work with other vendors' products as well.

To find out why an AT&T system is the right choice for your business, call AT&T Information Systems at 1-800-247-1212, Ext. 535.



AT&T

The right choice.

of frames, page-break lines would be understandably hard to implement. You can, however, use the "widow orphan tolerance" parameter in Frame-

work's configuration file to set the minimum number of lines allowed stranded as a widow or orphan when a paragraph is broken. You also can

preview a document before printing by saving the formatted version into a DOS text file and then loading that file as a new frame. Your printer-control codes will show up as IBM screen-graphics characters, which can be a big help in debugging printer-formatting problems. The spooling feature is nice, too. When you print your document, Framework writes it to a temporary disk file and prints it from there, so you can get back to work right away.

Framework far surpasses all the other idea processors for straight word processing. Cursor movements are clean, flexible, and fast. Selection of blocks for moving, copying, and deleting is simple and consistent with those operations in other Framework applications. When compared with other full-service word processors it stands up very well, and at the time of this writing it is the only one with outlining and other organizational capabilities.

As I stated earlier, Framework can help you organize text in the form of an outline much as ThinkTank does. But it can also be used as a cardfile system. The key lies in Framework's database capabilities. Each field in each record of a Framework database is a frame. This means, of course, that you can fill it with as much text as you like (up to the 32,000-character frame limit). The forms view of a database displays all field values of a given record inside their frames (see photo 4). You can arrange them on the screen however you like.

By constructing a database with fields for categories (like title, author, and keywords), plus a large frame for text, you can have a cardfile system with powerful retrieval capabilities. You can readily copy text from the text frames of your cards into larger documents that reside in non-database frames. You can also view a database in a table format that shows one line for each record. Here, you can see the keyword fields plus the first few words of each text block (see photo 5). (THOR provides a similar feature, but Executive Filer does not.) You can

(continued)



Photo 4: You can look at a Framework database in "forms view," which lets you set up a database as a cardfile system to manage blocks of text. Every field in every record is a frame.



Photo 5: An alternate view of the Framework cardfile database in photo 4 shows the first several words in each field and lets you scan through and sort your cards.



Networking Raised to a Greater Power

Advanced Technology. With it, IBM tripled the speed of the PC and increased its memory capacity five-fold. Nowhere is this increase in computing power more important than in networking situations. If the AT's technological advances have prompted you to look into a multi-user network, you owe it to yourself to take a closer look at MultiLink Advanced™ . . . a unique multi-tasking, multi-user networking system that runs programs under PC-DOS 3.0.

Eight Workstations for the Price of an AT. MultiLink Advanced™ represents the next generation in networking systems for IBM microcomputers. The system enables terminals, connected to a single AT, to emulate IBM-PC's having up to 448K of RAM (The PC-Shadow™ terminal, shown above, even has a PC look-alike, as well as work-alike keyboard and display).

This means that instead of spending \$3,000 per workstation for a PC with a Kilobuck "Network Interface Board," you can use inexpensive terminals . . . eight of which cost less than an IBM AT. Even if you need only one workstation connected to your AT, you'll realize significant savings.

MultiLink Advanced™ . . . Instant Access to All of Your Resources. Central to most multi-user situations is the need to coordinate a variety of printers. With what's been described by *PC-Tech Journal* as ". . . by far, the best print spooler for the IBM PC," MultiLink Advanced™ gives users the option to print either at their workstations, or at a central location. In addition, programs and files can be shared by multiple users locally or through use of a modem. Just think of it . . . having remote access to an AT with a lightweight terminal/modem.

Although designed to take advantage of the AT, MultiLink Advanced™ runs on all versions of PC-DOS, except 1.0, and certain implementations of MS-DOS. A wide range of leading programs are supported which include WordStar, dBASE III, Multimate, and Lotus 1-2-3.

Get the Advanced Story Today. Call The Software Link Today for complete details and the dealer nearest you. MultiLink Advanced™ is immediately available at the suggested retail price of \$495 and comes with a money-back guarantee. VISA, MC, AMEX accepted.

MultiLink[™]

ADVANCED



THE SOFTWARE LINK, INC.

8601 Dunwoody Place, Suite 336, Atlanta, GA 30338 Telex 4996147 SWLINK

CALL: 404-998-0700

Dealer Inquiries Invited

IBM, PC, AT, & PC-DOS are trademarks of IBM Corp. MS-DOS, WordStar, dBASE III, Lotus 1-2-3, and Multimate are trademarks of Microsoft Corp. MicroPro, Ashton-Tate, Lotus Development Corp. & Multimate International, respectively.

MultiLink Advanced™ & PC-Shadow™ are trademarks of The Software Link, Inc.

quickly sort all your cards or a subset of them on any category and scroll through them to get ideas.

Framework comes with well-written tutorial and reference manuals and was easy to learn despite all its power. It also has five disks, two of which are needed to start the program and run it. (The second drive remains free for

a data disk.) There is a backup copy of disk 1, the only one with copy protection. The two remaining disks contain a tutorial and utilities. As with ThinkTank, you can copy the program files onto your own disks. But you must have a system disk 1 in any drive for the program to start. A new copy-protection scheme should be ship-

ping with Framework by the time you read this. It will enable PC XT owners to install Framework on their hard disks and boot the program without the floppy system disk.

Framework's critics point out the program's thirst for memory. You must have 256K bytes, and 384K bytes if you install the telecommunications package. You will probably want more. Spreadsheets, especially, take a lot of RAM. And everything you do has to reside in memory. Framework has no automatic spooling of memory contents to disk files as WordStar and dBASE do. As a Framework document, the original manuscript of this review occupied about 95K bytes. As a straight ASCII text file, it reduced to about 56K bytes.

CONCLUSIONS

If you need a tool to organize blocks of text, whether for a doctoral dissertation or a collection of subroutines, one of the idea processors presented here could help you. Framework is by far the most capable; it gets my vote for most valuable program. It does everything the other three programs can do and more.

ThinkTank and Executive Writer/Executive Filer offer slightly different solutions to the problem of managing textual information. As an outline processor, ThinkTank presents a better way of organizing ideas into a structure for writing. Executive Filer has with its cardfile a more flexible retrieval system for large volumes of information, and Executive Writer is a more powerful word processor.

THOR offers some capabilities for organizing blocks of text, but its limitations and awkward implementation should eliminate it from serious consideration.

We obviously have not heard the end from developers of idea processors. As information continues to overwhelm us, we will have to use more tools like these to keep it all straight. ThinkTank, like VisiCalc, may have really started something by coming up with an easy way to do something for which pencil and paper are inadequate. ■



Software Tools for Serial Devices

Are you developing a C or Pascal program that will include functionality like this?

- ◆ **File transfer between computers**
- ◆ **Realtime data acquisition**
- ◆ **Printer/plotter control**

Blaise Computing Inc. has a set of tools for you. ASYNCH MANAGER™ is a library of software routines, including all source code, which will dramatically reduce the amount of time you need to get your applications working.

Using ASYNCH MANAGER™, you can control any hardware device employing the RS-232 interface on an IBM PC or operationally compatible micro computer. Moreover, your PC will be able to operate at fast speeds, since interrupt-

driven routines and flexible buffer sizes are featured.

As with other packages in our Programmer Productivity Series, there are no royalties for incorporating our routines into your systems. Other high-level language interfaces are planned. Contact us directly to order or to obtain additional specifications.

ASYNCH MANAGER™
\$175.00 includes the first language interface, second language \$75.00 additional.

Other products to speed your development projects in C and Pascal include: **TOOLS™** comprises a library of routines providing advanced string handling, forms utilities, screen handling and more. Features a general BIOS gate—\$125

TOOLS 2™ is a second library of routines focusing on DOS 2.0+ operating systems capabilities. Perform memory allo-

cation, program chaining, file and buffer handling from within your C or Pascal program—\$100

VIEW MANAGER™ is our screen development system which dramatically reduces programming required for screen displays. Block mode data collection, verification, overlays are all featured—\$275. Source Code for routine library—\$150

BLAISE COMPUTING INC.
2034 Blake Street Berkeley, CA 94704
(415) 540-5441

Now Showing In Black And White

If you own an IBM-PC or PC work-alike, Roland's new MB-142 monitor lets you show off your text and graphics in today's hottest colors—black and white. That's right! The MB-142 gives you black characters on a paper-white background—just like people have been reading for centuries. You can also have white characters on a black background with just the touch of a button.

Both of these black and white display formats are easier on the eyes and less fatiguing than the green or amber phosphor used in standard monochrome monitors. The MB-142's large 14-inch screen, combined with its ultra-high 720 x 350 resolution, can display characters that are larger and more legible than what you can get with ordinary monochrome monitors. Another great plus is that the MB-142 plugs directly into the monochrome board of your IBM or compatible—just like your present monochrome monitor, with nothing more to buy.

Because of the MB-142's advanced electronic circuitry, you even have the ability to mix graphics and text on the same display when using graphics and text boards from leading manufacturers such as Persyst, STB, Paradise, Hercules, AST and many others. What makes it all possible? The same sophisticated technology used in color monitors.

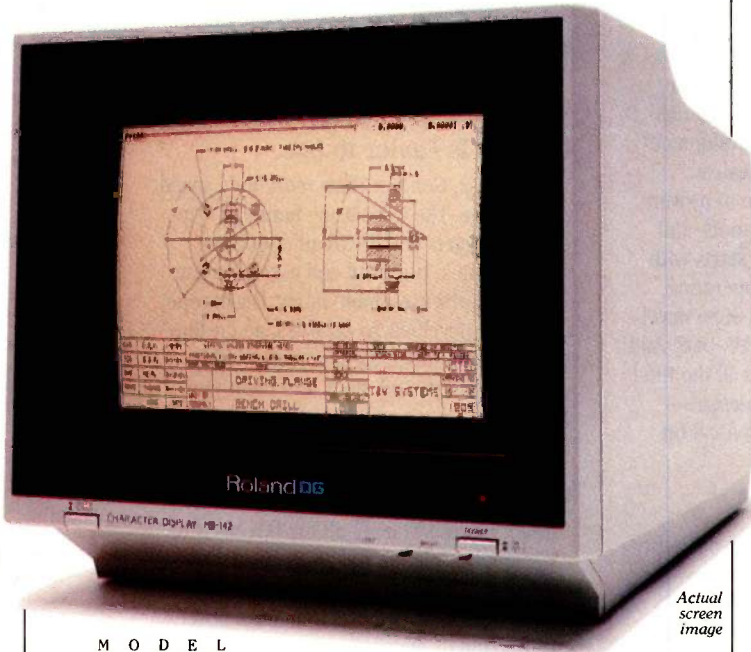

Actual screen image



Push a button for instant reverse screen

The MB-142 supports all the winning cards



For business, black and white makes more sense than green and black



The big difference is that the MB-142 monitor does the job for significantly less money. The MB-142 is designed to interface economically, too. Imagine seeing your favorite business graphics or CAD/CAM packages, such as Lotus 1-2-3, Energraphics, Chart-Master, AutoCAD, CADDraft and VersaCAD, in ultra-high resolution black and white. Also, take full advantage of your program's windowing capability using the large 14-inch screen.

Take a good look at the differences that set the MB-142 apart from the rest. No other monochrome monitor gives you the fatigue-free black and white viewing, text and graphics capabilities and easy interface. Naturally enough, the MB-142 is from Roland DG—the new computer peripherals company that's pointing the way to the future. Look for this and other Roland products at fine computer dealers everywhere.

For more information, contact: Roland DG, 7200 Dominion Circle, Los Angeles, CA 90040. (213) 685-5141.

The software programs listed are trademarks of the following companies: AutoCAD, AUTODESK, Inc.; CADDraft, Personal CAD Systems, Inc.; Chart-Master, Decision Resources, Inc.; Energraphics, Enertron Research, Inc.; Lotus 1-2-3, Lotus Development Corp.; VersaCAD, T&W Systems, Inc.

Roland DG

Put your blue box out to pasture.

Genesis Has Better Choices for Superior 8086 Designs.

Genesis development tools turn your IBM PC or compatible computer into the most flexible, comprehensive development system made for 8086-family designs. Genesis offers the widest choice of proven languages, superior debugging tools, and even in-circuit emulators. It all starts with ACCESS, the superior Genesis operating environment that allows Intel's 8086 development software to run under MS-DOS. And not only do we sell ACCESS and all the Intel languages for 8086 and 80186 designs — we also offer an ACCESS system for 8-bit designs as well.

Genesis Is Faster.

You get performance as well as flexibility with Genesis. For example, in our tests the ASM 86 assembler running under ACCESS on an IBM PC AT runs 4.7 times as fast as the assembler on a hard-disk based Series III and an incredible eleven times faster than a

floppy-disk based Intel system. The ASM 86 assembler we tested under ACCESS even ran 1.53 times faster than a VAX 11/782 running competing cross-software.

Genesis Is Easier to Use.

Of course, Genesis offers more than speed of execution. The GeneScope family of symbolic debuggers and in-circuit emulators share the most powerful and easiest to use human interface available today. GeneScope offers high-level macro facilities, an on-line symbolic assembler, alphanumeric and graphic support, and many more features that make Genesis tools a better solution than other systems.

Genesis Costs Less.

With Genesis you get all the flexibility of a personal computer and all the power of expensive dedicated development systems. You can get your products to market faster, at a fraction of the cost.

Is there really any reason to keep using obsolete, expensive equipment — when you can have Genesis instead? **Quit chewing your cud** — give us a call and find out how Genesis tools can make your life easier.



Genesis Has a Better Solution.



Genesis™
Microsystems

Genesis Microsystems Corporation
196 Castro Street
Mountain View, California 94041
Phone: (415) 964-9001
Telex: 4998093 GENMS UI

Inquiry 194

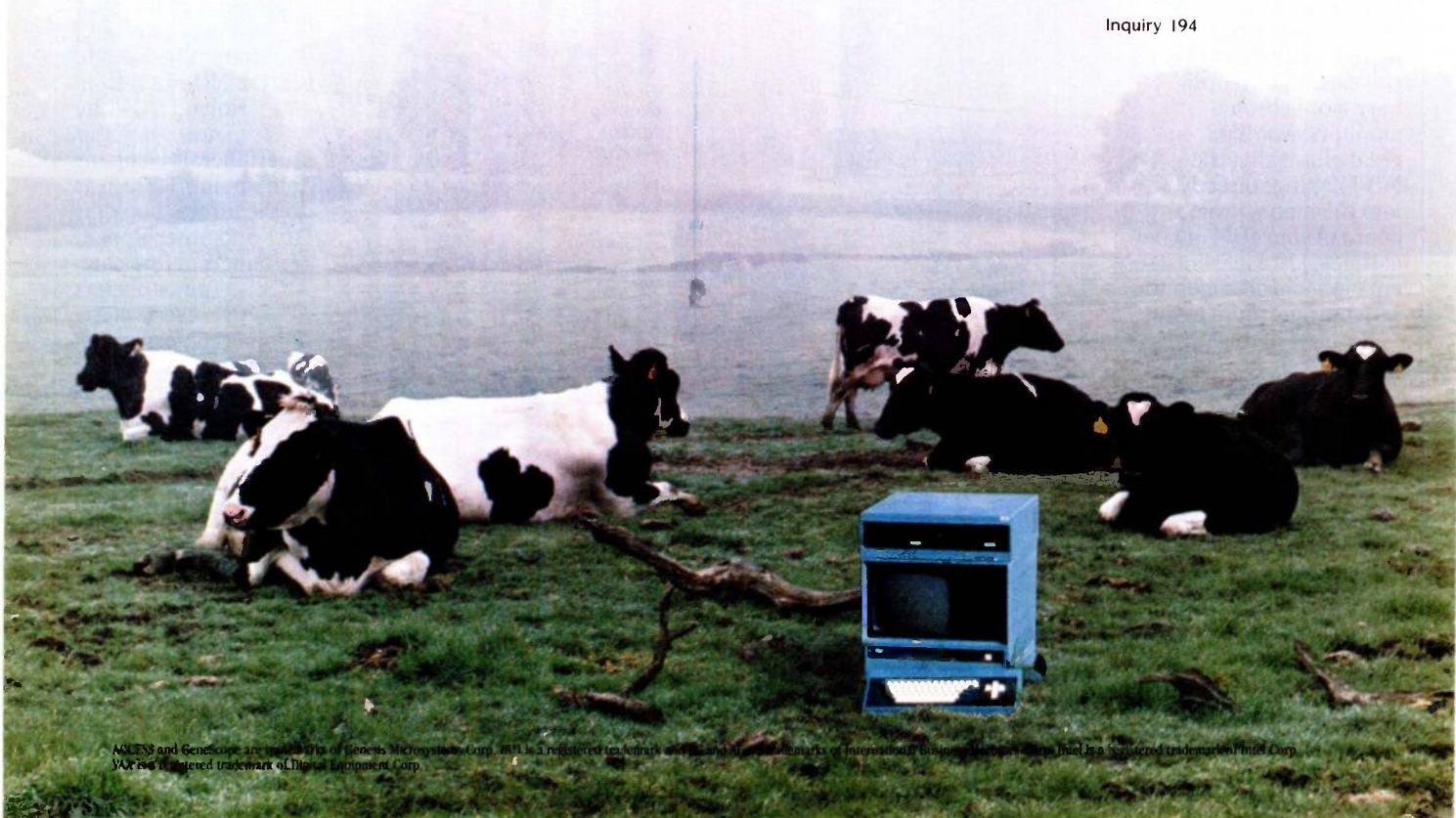

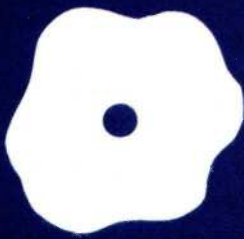

Convenience Software

The latest in pop-up programs

BY MARK J. WELCH

Editor's note: Bellsoft claims that Pop-Up and Pop-Ups are trademarks of Bellsoft Inc. In this article the author uses the lowercase term pop-up to refer to any memory-resident program that can be invoked at any time, including Spotlight and SideKick. Pop-Up refers to Bellsoft's specific programs.

Until recently, microcomputers usually handled spreadsheets, word processors, and database programs one at a time. Now that memory is relatively inexpensive, a number of programmers have developed software that lets the computer run more than one program concurrently or switch activities instantly. Some integrated software packages and operating systems let you load and run two or more standard applications at once. However, integrated programs are generally expensive in terms of money and memory.

Lately, several companies have introduced relatively inexpensive memory-resident pop-up programs that let you interrupt your current program to calculate, write notes, check an appointment calendar, look up a phone number and dial it, or execute DOS (disk operating system) functions.

Borland International's SideKick includes a programmer's calculator, a WordStar-compatible notepad, an appointment calendar, an auto-dialer, and an ASCII (American Standard Code for Information Interchange) table.

Software Arts, creator of the VisiCalc spreadsheet program, has introduced Spotlight, which includes an appointment book/ alarm, a DOS filer utility, a phone book, a notepad, a calculator, and an index-card file.

Bellsoft's Pop-Ups are 10 programs in eight packages, including an alarm clock, an appointment calendar, a calculator, a clipboard, a notepad, a DOS filer, an auto-dialer, a computer-use log, and a telecommunications program. Because the programs are sold separately, they are individually less expensive than SideKick or Spotlight and reserve less memory.

No two people have the same needs or preferences. In microcomputing, this has led to a wide variety of word processors, spreadsheets, and operating systems. The same applies to memory-resident pop-up programs. I began looking at the programs because I needed a pop-up phone directory. You might find a pop-up notepad more important. Others might think that no pop-up program is useful unless it includes a spreadsheet, a feature I haven't yet found.

I'll try to identify my personal preferences and distinguish them from more general performance problems. I'll also suggest what uses might be best for each program module. Rather than review each program separately, I'll give an overview of each, summarize major issues, and compare similar modules of each package.

SIDEKICK

SideKick is the oldest and, in my opinion, the simplest of the programs. SideKick costs \$50, which is less than comparable programs. It appears to be designed for programmers. The manual is good and includes an index and a "Quick Starter" chapter.

SideKick's ASCII table is a programming feature that isn't included in any other pop-up program. It is valuable for programming, but it isn't helpful in any other application.

SPOTLIGHT

Spotlight is easily the slickest, best-packaged program, and it features the best—and least necessary—manual. I found Spotlight to be the most intuitive program to use and the most attractive on screen. Its phone book and index-card file can each handle up to 36 directories with up to 500 entries each (disk space permitting).

Spotlight costs \$150, but it includes features SideKick doesn't have.

POP-UPS

Bellsoft chose not to bundle its programs together and instead sells eight separate

(continued)

Mark J. Welch is a staff writer for BYTE. He can be reached at McGraw-Hill Publications, 425 Battery St., San Francisco, CA 94111.

Pop-Up packages for \$19.95 to \$149.95 each. (Pop-Up Alarm Clock is available for \$5 shipping and handling and is bundled with each of the other programs.)

PopDOS (\$39.95) is a DOS utility. Pop-Up Notepad (\$39.95) includes separate notepad and clipboard programs (see photo 1). Pop-Up TeleComm (\$79.95) includes Modem, a

telecommunications program, and Voice, an auto-dialer. Pop-Up Calendar (\$19.95) and Pop-Up Calculator (\$39.95) are separate packages.

While SideKick and Spotlight feature professional, typeset manuals, the Pop-Up programs include shorter, typescript manuals. Also included with each program is a quick-reference card that duplicates its on-line

help function. All three programs had fairly good on-line help.

MEMORY USAGE

Money isn't the only price you pay for pop-up programs. You must also sacrifice part of your RAM (random-access read/write memory). If you use a 64K-byte IBM PC or compatible, beware: Few of the pop-up programs will function with another program running. While the programs can run in a 128K-byte machine, few applications will run simultaneously unless you have 192K or 256K bytes of RAM. A few programs might have problems even then. I used a 256K-byte IBM PC with two floppy-disk drives.

You can use more or less memory with each program, depending on your needs and available memory. Spotlight lets you reserve from 75K to 128K bytes; 75K bytes is the minimum necessary to run the program and with 128K bytes you can load all the Spotlight windows on screen simultaneously.

You can load SideKick in one of four versions: the full system (60K bytes), everything except the notepad (51K bytes), everything except the calculator (40K bytes), or just the calculator and ASCII table (23K bytes).

You load the Pop-Up programs separately. Each one uses up from 13K to 28K bytes. If you load all of them at once, 155K bytes are reserved (see table 1 for each program's memory allocation).

OTHER FACTORS

All three systems are designed for the IBM PC but will run on some compatibles. I tested all the software on my Seequa Chameleon and all the programs ran. However, Spotlight's copy-installation program didn't work, and scrolling fuzzy lines appeared whenever I invoked a Spotlight window. Software Arts says it is developing versions that will work properly on compatibles.

SideKick is copy-protected. To make backup copies or to install it on a hard disk, you must buy the unprotected version for \$79.95. Spotlight is also copy-protected, but the program lets

Table 1: Memory allocation for pop-up programs

Product	Programs	Memory Requirements
Spotlight	Full system	75K bytes (minimum) Users can reserve more (128K bytes is enough to have all applications on screen)
SideKick	Full system	60K bytes
	No calendar	51K bytes
	No notepad	40K bytes
	Only calendar and ASCII table	23K bytes
Pop-Ups	DeskSet Plus	155K bytes
	Notepad	20K bytes
	Clipboard	15K bytes
	Calendar	24K bytes
	Calculator	18K bytes
	Alarm Clock	13K bytes
	Modem	28K bytes
	Voice	15K bytes
	PopDOS	23K bytes

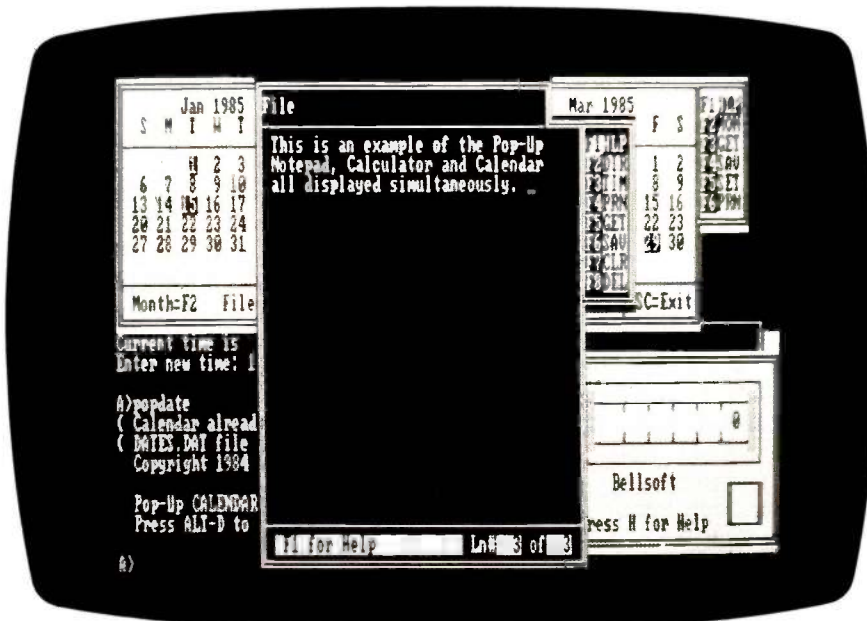

Photo 1: Bellsoft's Pop-Up programs are typical of the convenience software available.

AT A GLANCE

Name	Pop-Up Programs	SideKick	Spotlight
Manufacturer	Bellsoft Inc. 2820 Northup Way Bellevue, WA 98004 (206) 828-7282 (800) 862-6262	Borland International 4113 Scotts Valley Dr. Scotts Valley, CA 95066 (408) 438-8400 (800) 255-8008	Software Arts 27 Mica Lane Wellesley, MA 02181 (617) 431-6500
Features	Programs available separately	Calculator, notepad, auto-dialer, ASCII table, appointment calendar	Appointment book, DOS filer utility, phone book, notepad, index-card file, calculator
Computer	IBM PC or compatible with 64K bytes of memory, monitor, and one disk drive	IBM PC or compatible with 128K bytes of memory, one disk drive, and monitor; IBM PCjr, Seequa Chameleon, and BytecComterm Hyperion owners must buy unprotected version	IBM PC or compatible with 128K bytes of memory, one disk drive, and monitor
Price	Pop-Up Alarm Clock \$5 (or bundled with all programs) Pop-Up Calendar \$19.95 Pop-Up PopDOS \$39.95 Pop-Up Notepad \$39.95 (includes Pop-Up Clipboard) Pop-Up Calculator \$39.95 Pop-Up TeleComm \$79.95 (includes PopModem, PopVoice, Simplicity Modem, and Simplicity Voice) TaxLog plus Pop-Up Calendar \$39.95 Pop-Up DeskSet \$59.95 (includes Calendar, Notepad, Calculator, PopDOS, and Alarm Clock) Pop-Up DeskSet Plus \$129.95 (includes all of above plus TeleComm)	Copy-protected version \$49.95 Unprotected version \$79.95	\$150

you make up to three working copies from the master on either floppy or hard disks. Spotlight also lets you "uninstall" in case you want to reformat a hard disk or add a hard disk to a machine. The Pop-Up programs from Bellsoft are not copy-protected.

CALCULATORS

All three packages are supplied with standard four-function memory calculators. I found Bellsoft's Pop-Up Calculator to be the best for office work because it features a scrolling "paper tape" that you can echo to the printer. It also includes a 10-number memory; SideKick and Spotlight have a stan-

dard 1-number memory. Pop-Up Calculator also has a dollar mode; if you enter 4567 in this mode, the screen displays \$45.67.

For programmers, SideKick's calculator includes decimal, binary, and hexadecimal modes and can perform conversions and logical functions (XOR, AND, OR). It also lets you use parentheses to specify the order of calculations. SideKick's calculator keys are located all over the keyboard. For example, the C key clears all entries, E clears the last entry, and the bottom six function keys (F5 to F10) are for hexadecimal numbers A through F (the keyboard letters A through F

won't work as hexadecimal numbers).

Spotlight and Pop-Up Calculator let you paste (or feed) numbers into an application program. SideKick is a bit more obscure; it lets you program keys that insert the calculated value when hit. With SideKick's method, you can reposition the cursor and program multiple keys with values, but a key is unusable until deprogrammed.

ALARM CLOCK/ APPOINTMENT BOOK

The price of the Pop-Up Alarm Clock is certainly the best; it's available for

(continued)



AHH. IT'S LONELY AT THE TOP.

TWA's FIRST CLASS SLEEPER-SEAT™ TO EUROPE
AND THE AMERICAN EXPRESS® CARD PUT YOU
COMFORTABLY AHEAD OF THE CROWD.

Success has its rewards. And TWA's First Class and the American Express Card are two rather impressive examples.

In TWA's First Class you can select from a menu that includes caviar and champagne. Entrees like chateaubriand. And vintage wines like Puligny-Montrachet.

Then stretch out comfortably in a Sleeper-Seat, and sleep the flight away.

And as a First Class passenger, you'll be treated accordingly from the moment you first reach the airport. With a separate check-in desk for your convenience. And a special invitation to relax in TWA's Ambassadors Club® lounge before your flight.

And when you take the American Express Card along, you have an ideal travelling companion. Because it's known and welcomed all over the world.

So you can use it to pay for your TWA tickets, your hotel, rental car, meals — or just about anything else that strikes your fancy along the way.

And of course, when you carry the American Express Card, you carry all the cachet that comes with it. Don't leave home without it.*

And do take TWA's First Class on your next trip to Europe. It's in a class by itself.



TWA

LEADING THE WAY.™ TWA.

\$5 shipping and handling from Bellsoft, as a sort of "free sample." The program is quite limited; it only lets you program alarms for one day at a time. It's also not easy to figure out; even with the on-line help, I had to refer to the manual. Two problems: The alarm message is too short, and it is erased after the alarm rings and the window is put away.

Bellsoft also sells a separate Calendar program that lets you enter appointment information. The Calendar program is extremely difficult to understand and use. I quickly abandoned it because it has such limited message space per day. The separation of the daily alarm and the long-term calendar also reduced each program's usefulness.

The Alarm Clock includes an option to feed the current date and time to an application. It can also generate a "timed feed," which passes a series of keystrokes to an application at a certain time.

SideKick's calendar is much better; you can list appointments for each half hour. However, the message line is very short, and the daily calendar runs only from 8 a.m. to 8:30 p.m. The program does not have an alarm feature.

Spotlight's appointment book is my favorite. It contains an alarm option so Spotlight beeps 10 minutes before an appointment. It lets you set appointments far in advance. A weekly event (a staff meeting, for example) only needs to be programmed once. You can set the calendar to display appointments only or to show all appointments and every hour, half hour, or quarter hour. A vertical bar shows how long an appointment will last; bars also graphically show when more than one appointment is scheduled for the same time.

When a Spotlight alarm occurs, the program generates a unique tone (not too irritating) but doesn't display the appointment information. You have to invoke the appointment window to find out what caused the alarm. If an alarm sounds when you're not around, everyone else in the office

(continued)

How Do I Choose the Right Personal Computer Monitor?



Introducing the Most Powerful Business Software Ever!

TRS-80™ (Model I, II, III, or 16) • APPLE™ • IBM™ • OSBORNE™ • CP/M™ • XEROX™



The VERSABUSINESS™ Series

Each VERSABUSINESS module can be purchased and used independently, or can be linked in any combination to form a complete, coordinated business system.

VERSARECEIVABLES™ \$99.95
 VERSARECEIVABLES™ is a complete menu-driven accounts receivable, invoicing, and monthly statement-generating system. It keeps track of all information related to who owes you or your company money, and can provide automatic billing for past due accounts. VERSARECEIVABLES™ prints all necessary statements, invoices, and summary reports and can be linked with VERSALEDGER II™ and VERSAINVENTORY™.

VERSAPAYABLES™ \$99.95
 VERSAPAYABLES™ is designed to keep track of current and aged payables, keeping you in touch with all information regarding how much money your company owes, and to whom. VERSAPAYABLES™ maintains a complete record on each vendor, prints checks, check registers, vouchers, transaction reports, aged payables reports, vendor reports, and more. With VERSAPAYABLES™, you can even let your computer automatically select which vouchers are to be paid.

VERSAPAYROLL™ \$99.95
 VERSAPAYROLL™ is a powerful and sophisticated, but easy to use payroll system that keeps track of all government-required payroll information. Complete employee records are maintained, and all necessary payroll calculations are performed automatically, with totals displayed on screen for operator approval. A payroll can be run totally, automatically, or the operator can intervene to prevent a check from being printed, or to alter information on it. If desired, totals may be posted to the VERSALEDGER II™ system.

VERSAINVENTORY™ \$99.95
 VERSAINVENTORY™ is a complete inventory control system that gives you instant access to data on any item. VERSAINVENTORY™ keeps track of all information related to what items are in stock, out of stock, on backorder, etc., stores sales and pricing data, alerts you when an item falls below a preset reorder point, and allows you to enter and print invoices directly or to link with the VERSARECEIVABLES™ system. VERSAINVENTORY™ prints all needed inventory listings, reports of items below reorder point, inventory value reports, period and year-to-date sales reports, price lists, inventory checklists, etc.

VERSALEDGER II™ \$149.95
 VERSALEDGER II™ is a complete accounting system that grows as your business grows. VERSALEDGER II™ can be used as a simple personal checkbook register, expanded to a small business bookkeeping system or developed into a large corporate general ledger system **without any additional software.**

- VERSALEDGER II™ gives you almost unlimited storage capacity (300 to 10,000 entries per month, depending on the system),
- stores all check and general ledger information forever,
- prints tractor-feed checks,
- handles multiple checkbooks and general ledgers,
- prints 17 customized accounting reports including check registers, balance sheets, income statements, transaction reports, account listings, etc.

VERSALEDGER II™ comes with a professionally-written 160 page manual designed for first-time users. The VERSALEDGER II™ manual will help you become quickly familiar with VERSALEDGER II™, using complete sample data files supplied on diskette and more than 50 pages of sample printouts.

SATISFACTION GUARANTEED!

Every VERSABUSINESS™ module is guaranteed to outperform all other competitive systems, and at a fraction of their cost. If you are not satisfied with any VERSABUSINESS™ module, you may return it within 30 days for a refund. Manuals for any VERSABUSINESS™ module may be purchased for \$25 each, credited toward a later purchase of that module.

To Order: Write or call Toll-free (800) 431-2818 (N.Y.S. residents call 914-425-1535)

- * add \$3 for shipping in UPS areas
- * add \$5 to CANADA or MEXICO
- * add \$4 for C.O.D. or non-UPS areas
- * add proper postage elsewhere

Inquiry 202
 DEALER INQUIRIES WELCOME

All prices and specifications subject to change / Delivery subject to availability.



COMPUTRONICS

50 N. PASCACK ROAD, SPRING VALLEY, N.Y. 10977

* TRS-80 is a trademark of the Radio Shack Division of Tandy Corp. • *APPLE is a trademark of Apple Corp. • *IBM is a trademark of IBM Corp. • *OSBORNE is a trademark of Osborne Corp. • *CP/M is a trademark of Digital Research • *XEROX is a trademark of Xerox Corp.

must suffer through the noise without knowing where it's coming from. When Bellsoft's Pop-Up Alarm Clock sounds, it also pops up its window and highlights the current alarm, an approach I much prefer.

TELEPHONE OPTIONS

I must confess a bias; I can't live without Spotlight's phone directory. To find a number, I can locate a card alphabetically or search all cards for specific information (Joe Smith or (212) 555-1212), so I don't have to admit to callers that I don't remember them. The phone cards are the size and shape of Rolodex cards; I wish they were larger, perhaps even a full page. It would also be nice to have distinct fields so searching would be faster.

SideKick's auto-dialer is similar but it's designed with a very small single-line format, and you can edit information in the directory only by using the separate notepad. Of course, SideKick can auto-dial the number as well, something Spotlight can't do. SideKick's notepad lets you sort entries so the auto-dialer phone list can be in order. I prefer Spotlight's automatic alphabetizing and editing from within the phone book.

SideKick can include pauses in numbers. This is useful if you have a PBX or long-distance service and have to wait for a dial tone before continuing to dial. SideKick also required that I reset my modem DIP (dual in-line package) switches. More irritating, I had to "install" a modem on SideKick. This involves selecting the COM1: or COM2: ports. I think SideKick should use COM1: as the default port for a modem.

SideKick's documentation indicates that when you invoke the auto-dialer it reads a phone number at the cursor and can auto-dial it. I could not get this function to work.

Bellsoft's PopVoice, included in the Pop-Up TeleComm package, is a limited auto-dialer. When invoked, it dials a phone number located at the cursor; it also stores three most frequently dialed numbers. The limit of only

(continued)

Will It Work with My PC?

Before you can experience the full capabilities a high performance monitor offers, it has to work with your personal computer. That's why Princeton Graphic Systems makes high resolution monitors compatible with most popular brands of personal computers. IBM, Compaq, Corona, Apple and more. But we go one step further. By paying close attention to ergonomic detail, we make Princeton Graphic Systems monitors compatible with you, the computer system user...

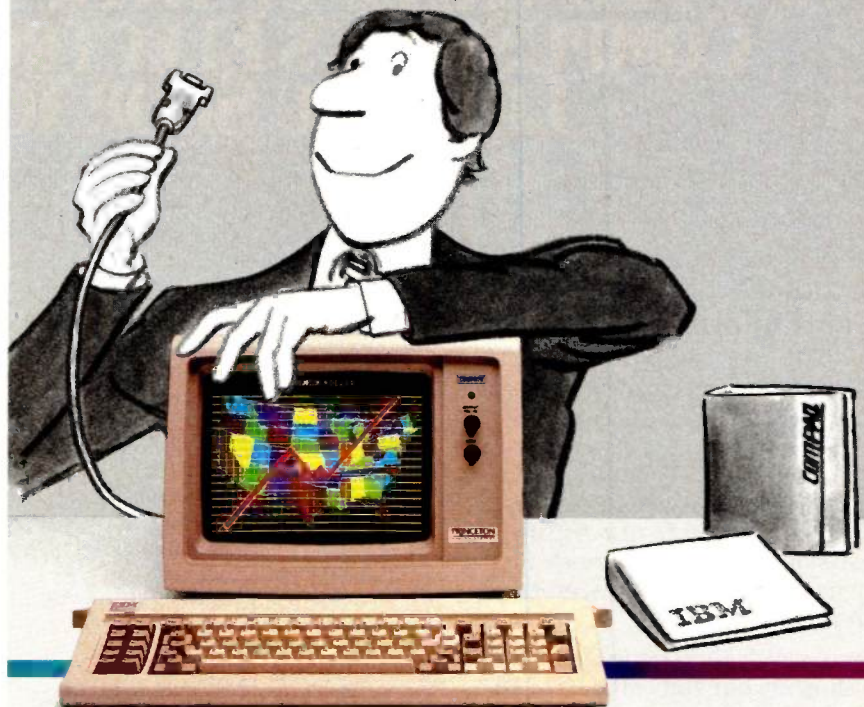



BY THE YEAR 2000, THE WORLD MAY CATCH UP WITH THE WAY COMPU SERVE'S ELECTRONIC MALL™ LETS YOU SHOP TODAY.

Presenting the computer shopping service that delivers discount prices, name-brand merchandise, and in-depth product information.

To make your computer even more useful, join CompuServe and shop in our Electronic Mall. Easy enough for beginners, it's open 24 hours a day, 7 days a week. And it offers a wide range of goods and services from nationally known stores and businesses including Bloomingdale's, Waldenbooks, American Express and Commodore.

CompuServe's Electronic Mall™ lets you shop at your convenience in all these departments:

The Auto Shop, Book Bazaar, Financial Mart, Leisure Center, Merchandise

Mart, Newsstand, On-line Connection, Personal Computer Store, Record Emporium, Specialty Boutique and Travel Agency.

Take the CompuServe Electronic Mall 15-Minute Comparison Test.

What you can do in 15 minutes shopping the Electronic Mall way.

- Access descriptions of the latest in computer printers, for instance.
- Pick one and enter the order command.
- Check complete descriptions of places to stay on your next vacation.
- Pick several and request travel brochures.
- Access a department store catalog and pick out a wine rack, tools, toys... anything!
- Place your order.

What you can do in 15 minutes shopping the old way.

- Round up the family and get in the car.

The Electronic Mall—A Valuable Addition to the Vast World of CompuServe.

CompuServe Information Services bring you information, entertainment, personal communications and more.

You can access CompuServe with almost any computer and modem, terminal or communicating word processor.

To buy a CompuServe Subscription Kit, see your nearest computer dealer. To receive our informative brochure, or to order direct, call or write:

CompuServe

Information Services, P.O. Box 20212,
5000 Arlington Centre Blvd., Columbus, OH 43220
800-848-8199
In Ohio call 614-457-0802

*A pop-up notepad
lets me save my ideas
and continue
without losing
my train of thought.*

three numbers is intolerable. Also included with TeleComm is Simplicity Voice, a stand-alone auto-dialer. It allows longer phone lists, but it isn't a pop-up program.

PopModem, also part of the TeleComm package, is a pop-up telecommunications program. It has one problem: Normally the Escape key stops PopModem's dialing, but not if other keys are stored in the keyboard buffer. Also, when PopModem gets no answer, it hangs up without any screen message.

I can't anticipate needing telecommunications from within another task, given the amount of time most on-line sessions take. Usually I find myself wanting a notepad when I'm on line, not the other way around.

Spotlight also includes an index-card program that is identical to the phone directory. I used it to keep a second address list from the Spotlight phone book. While you can select any of 26 separate lists for each of the two programs, I prefer to use the default file.

NOTEPAD/CLIPBOARD

When I'm using an application program such as a word processor, ideas often pop into my head completely unrelated to what I'm doing. A pop-up notepad lets me save my ideas and continue without losing my train of thought. In a similar vein, when telecomputing I often want to save something I see. I can use features in my telecommunications software to capture incoming text, or I can use a pop-up clipboard feature to "clip" information from a screen.

(continued)

Does It Give Me A Bright, Sharp Image?

Take a close-up look at the display. Bright, crisp characters and sharp, colorful graphics mean you're getting a high-quality image. The kind of image that comes with every Princeton Graphic Systems' monitor. Because Princeton Graphic Systems combines flicker-free technology, a fine dot pitch, and a nonglare screen to give you an image that *PC World's* World Class Survey rates number 1 . . .





SAN FRANCISCO JULY 22-26

85

S I G G R A P H



The combined efforts of many disciplines – academia, industry, science and art – are brought together in one conference.

SIGGRAPH '85 PRESENTS THE STATE OF THE ART IN COMPUTER GRAPHICS.

- ◆ TECHNICAL PAPERS
– original research results, formally reviewed
- ◆ PANELS
– lively exchange with leaders in the field
- ◆ COURSES
– new topics and old favorites, introductory and advanced
- ◆ FILM AND VIDEO SHOW
– computer animation for the connoisseur
- ◆ ART SHOW
– the synergy of art and technology
- ◆ EXHIBITION
– the state of the art in hardware and software tools
- ◆ PLUS
– technical proceedings, birds-of-a-feather groups, continuous animation screenings and social events at the Exploratorium and the Academy of Science.

All this, Silicon Valley and San Francisco too!
Register early for substantial savings and to ensure full participation.

TWELFTH ANNUAL CONFERENCE & EXHIBITION ON COMPUTER GRAPHICS AND INTERACTIVE TECHNIQUES.

SIGGRAPH '85
111 East Wacker Drive # 600
Chicago, IL 60601
(312) 644-6610

Inquiry 9

SIGGRAPH '85 is sponsored by the Association for Computing Machinery's Special Interest Group on Computer Graphics in cooperation with Eurographics and the IEEE Technical Committee on Computer Graphics.

Please send a copy of the SIGGRAPH '85 advance program to:

Name _____

Company _____

Address _____

City _____ State/Country _____ Zip _____

Telephone Number () _____

Members of ACM SIGGRAPH will automatically receive these materials in the mail in April and need NOT return this coupon. ◆◆◆◆◆

Spotlight features a simple eight-page notepad. I find the page size too small but still use it fairly regularly, even from within a word processor. Spotlight can print or save either one page or the entire notepad. It doesn't have any way to paste or feed information into an application or to capture it from a screen.

Bellsoft's Pop-Up Notepad is quite similar. It doesn't break its contents into pages; instead, it scrolls through a hundred 35-character lines. It can also print or save the information, though not a page at a time.

Also included in the Pop-Up Notepad package is Pop-Up Clipboard, which I find quite useful. Clipboard can capture any part of a text screen for editing and paste it back into an application. Clipboard can't save the text to disk or print it out, but the program can paste information into the Notepad to be saved or printed. The flaw in this approach is the 35-character line length in the notepad.

If you're including a list of numbers in a document, you can even use the Clipboard to feed the numbers into the Calculator, using plus signs to end each line, and then feed the Calculator's result back into the word processor. One problem with the Clipboard is that it can feed information to another application very quickly so it overloaded my word processor. However, when you load Clipboard, you can select the feed rate.

SideKick's notepad can also capture information from a screen, but it can't paste or feed information into an application. It can save information, but it has no print feature, which is quite frustrating. You can vary SideKick's notepad size to fill the whole screen or any part of it. SideKick's is more powerful than the notepads in Spotlight or Pop-Up Notepad, and it includes many WordStar features. It uses the WordStar command structure, which would be helpful to WordStar (or Turbo Pascal) users.

DOS FILER/UTILITY WINDOW

Spotlight includes a DOS filer that you can use to view text files or sorted

(continued)

How About Dependability?

You rely on your personal computer system to help get your work done. That's why it's important to choose a monitor built for reliability. Princeton Graphic Systems monitors are built under the highest quality control standards, backed by a full one-year warranty and supported by a nationwide service network.* The result: monitors that perform when you need them, day in and day out . . .

*Bell & Howell, Xerox, MAI Sorbus Service and Princeton Graphic Systems.

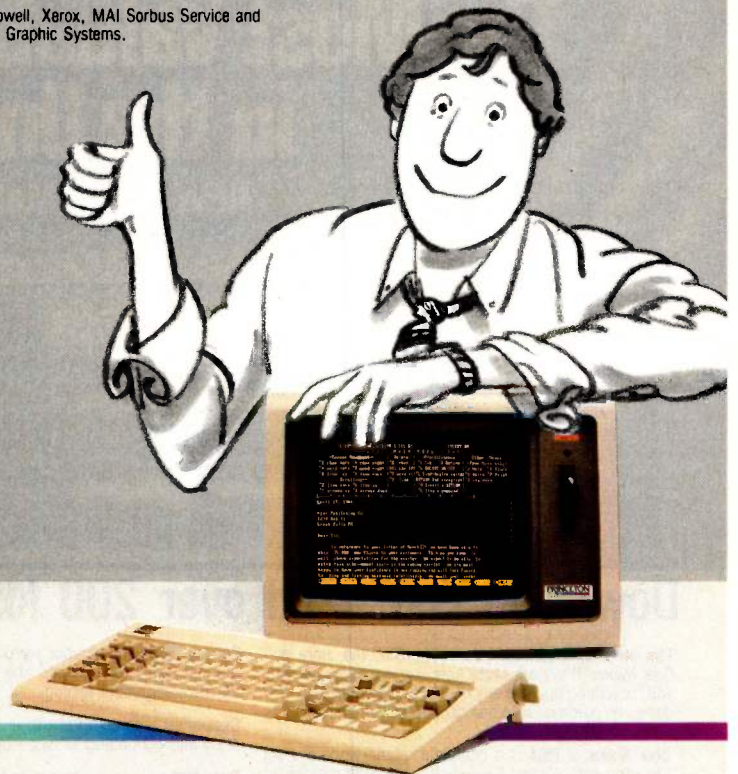

A problem might be the location of a pop-up window on your screen.

directories; to erase, copy, or rename files; to format a disk; or to change the current directory. It can also paste a selected filename, with drive and path information, into an application. I found the filer useful in checking files before uploading them and deleting files to make room on a disk during word processing.

PopDOS performs most of the same functions. When displaying a file, Spotlight pauses as the window fills each time; PopDOS requires that you use Control-S to pause. PopDOS adds

the ability to print a file, a time-saving feature I used several times. You can also use PopDOS to send control codes to the printer. If you have an IBM graphics printer, the program can select the typeface.

SideKick doesn't include a DOS utility, but it can view directories from within the notepad.

SOME CONSIDERATIONS

The pop-up programs must be user-invoked. Spotlight uses Shift-Alternate and a mnemonic key command. The Pop-Up programs use Alternate and a key. SideKick uses Control-Alternate to invoke its main menu. If for some reason your program is looking for these keystrokes (and I don't know of any that do), the invocation won't work.

Bellsoft's Pop-Ups use an Alternate-key combination (Alternate-N for Notepad, for example). This can

create problems, so Bellsoft lets you type the Alternate-key sequence twice. Then the Pop-Up program feeds the Alternate-key to the application program.

SideKick normally requires a two-step process to invoke a program. First, you must press Control-Alternate to bring up the SideKick menu. Pressing a particular letter key brings up a program, and the Escape key puts the program away. If you use one program a great deal, you can put it away with the Control-Alternate sequence; when you next type Control-Alternate, SideKick immediately restores the pop-up program you last used.

Another problem might be the location of a pop-up window on your screen. All the programs let you move the windows around the screen, but you can locate Bellsoft's Pop-Ups only

(continued)



Download fast, read over 200 formats easily, reformat rapidly

The more disk formats you work with, the more our Disk Maker™ system saves time and money by reading and/or writing disks in any of over 200 formats. No modems, no patches, no other special software necessary.

Disk Maker II Plus is a complete, stand-alone system featuring both 8" and 5 1/4" disk drives with options for 3 1/2" and IBM PCAT drives—up to 12 total drives. With its 6 MHz processor and RAM memory drive, Disk Maker II Plus is fast! Hardware options include a 15 or 20 Mb hard disk, an 8086 MSDOS coprocessor and memory expansion.

Optional software includes word processor and Compu-graphic typesetter formats and the MicroDrive Tester for drive alignment testing.

Supported with comprehensive manual, 6 month warranty and continuing software update program.

Disk Maker I is an alternative for existing S-100 systems (CompuPro, Zenith Z-100, North Star, etc.) to provide the same functions as Disk Maker II Plus.

Write or call today for information on how Disk Maker™ can save you time and money.

Jerry Pournelle wrote about Disk Maker™: "It's easy to install, easy to use, and darned near unique. If you need one, you need it bad." (BYTE, July 1984)

NEW GENERATION SYSTEMS
 1800 Michael Faraday Drive, Suite 206, Reston, VA 22090
 (703) 471-5598 Order Line: (800) 368-3359
 Dealer inquiries welcomed.

Meet The Princeton Graphic Systems Family.

The right monitor at the right price. Princeton Graphic Systems offers you a complete family of high performance personal computer monitors. Monitors that deliver the compatibility, resolution, and reliability you need for any application and any budget: from word processing to sophisticated business graphics.



HX-12. High resolution RGB monitor -690 x 240 lines noninterlaced - .31 mm dot pitch tube-Nonglare screen -**\$695**

HX-12E. High resolution RGB monitor -Compatible with IBM Enhanced Graphics Adapter -Nonglare screen -**\$785**



MAX-12. Amber monochrome -720 x 350 lines -Enhanced to interface with IBM color or monochrome adapter card -Nonglare screen -Can display 16 shades of amber -**\$249**



HX-9/9E. Nine inch, high resolution RGB monitor - .28mm dot pitch tube - 9E compatible with IBM Enhanced Graphics Adapter -Nonglare screen -Green/amber switch -Apple/IBM colors - Etched dark glass screen -**\$650/\$750 (9E)**



SR-12P. PGS's top of the line RGB monitor - Analog input allows for the display of 4,096 possible colors - Compatible with IBM Professional Graphics Adapter - Nonglare screen -**\$999**



SR-12. Super-high resolution RGB monitor -690 x 480 lines noninterlaced - .31 mm dot pitch tube - Nonglare screen - Requires interface card -**\$799**



Princeton accessory product line. Undergraduate tilt/swivel monitor base, ColorView card, Green/Amber switch, RGB-80 card and Scan Doubler card.

Princeton Graphic Systems. The only real choice.

For office or home use, Princeton Graphic Systems has a monitor that's right for you. Inquire at your local computer store about our complete line of high resolution color and monochrome monitors; monitors that live up to the Princeton Graphic Systems' tradition of quality, performance, and value. **Princeton Graphic Systems.** 601 Ewing Street, Bldg. A, Princeton, N.J. 08540. (609) 683-1660 Telex: 821402PGSPRIN (800) 221-1490. Ext. 504

PRINCETON[™]
GRAPHIC SYSTEMS
AN INTELLIGENT SYSTEMS COMPANY

IBM IBM Enhanced Graphics Adapter, and IBM Professional Graphics Adapter are trademarks of International Business Machines, Inc. Compaq is a trademark of Compaq Computer Corp. Corona is a trademark of Corona Data Systems, Inc. Apple is a trademark of Apple Computer Corp. PC World is a trademark of CW Communications, Inc.

in a limited number of locations. Spotlight loses track of your preferred location when you put a window away; the next time you invoke it, it appears in its original place.

Spotlight's disk must be present in the system at all times, since its programs and some data are stored on disk. SideKick also accesses the disk for data files. The Pop-Up programs never access the disk once loaded except to load or save a file at your request. The Pop-Up programs also pop up or go away more quickly. Spotlight can be installed on a hard-disk system, as can the Pop-Up programs; however, hard-disk users need to buy

an unprotected version of SideKick.

In my opinion, Spotlight's programs use the best mnemonics, since each matches an abbreviation. SideKick includes both a calculator and a calendar; rather than calling the calendar an "appointment book" as Spotlight does, SideKick uses the letter L (caLendar). Bellsoft chose the letter B for clipBoard, but I often tried Alternate-C and got the Calculator. Bellsoft calls its Calendar a Dates program, so the command is Alternate-D.

You might decide you like some features of one program and other features of a different program. It is possible to have Spotlight, SideKick,

and some Pop-Up programs resident at the same time. However, Spotlight can be interrupted by SideKick, but not by some Pop-Up programs. SideKick permits either Spotlight or a Pop-Up to interrupt it. The Pop-Up programs won't permit any other program to interrupt them. It was impossible to install all the pop-up programs simultaneously in a 256K-byte machine—they won't fit.

SUMMARY

Each of these programs has good features (for an update, see the text box "New Versions" at left). A programmer looking for an ASCII table or a calculator with hexadecimal and binary capabilities will want SideKick. If you want to keep track of your calculations, you'll prefer the Pop-Up Calculator's tape feature.

If you want a sophisticated phone directory, you will probably find Spotlight the most helpful of the three programs.

Users who need to be able to cut information from an application won't consider Spotlight. If they also need to paste the information back, they'll forget about SideKick in favor of Pop-Up Clipboard. I wish one pop-up program combined the Pop-Up Clipboard features with the ability to print and save to disk.

I've settled on a combination of Spotlight and Pop-Up Clipboard. My preference for Spotlight is based solely on its phone-book feature, which I need for work. At home, I prefer the Pop-Ups and SideKick, since I do programming in addition to activities where the Clipboard would come in handy.

Someone suggested to me that some of these programs shouldn't be necessary. The DOS utilities, for example, merely compensate for programs that can't take advantage of MS-DOS features. The calculator shouldn't be necessary within a word processor, since word processors would be better if they included a calculator option. But since everyone can't afford to own ideal software—even if it exists—it's good to be able to pop up a compromise. ■

NEW VERSIONS

Since BYTE originally received the software covered in this review, new products and improved versions of older products have appeared. Here's the latest information I have as this review was written.

POP-UPS

Bellsoft has combined all its programs into the Pop-Up DeskSet and the Desk-Set Plus (see the "At a Glance" page for a list of all the programs included). Another new package is TaxLog plus Pop-Up Calendar. The TaxLog program, resident on your work disk but not in RAM, lets you keep a daily log of your computer use.

SPOTLIGHT 1.1

Software Arts has released version 1.1 of Spotlight. Its major enhancement is the addition of an auto-dialer to the phone-book accessory program. Other changes include user-selectable colors for each accessory and support for MS-DOS 3.0 (including formatting IBM PC AT 1.2-megabyte disks) from the filer accessory. The company said it would send a free copy of the new program to every registered user of Spotlight 1.0. I had not yet received Spotlight 1.1 when I wrote this review.

PCWINDOW

PCwindow is a less sophisticated memory-resident program, but its price

makes it quite attractive: it's free. Its authors are distributing it using the "user-supported software" approach. You can copy the program freely, and the authors only ask that users send them a check for what they think PCwindow is worth (\$10 is suggested). Going a step beyond the usual user-supported software approach, the program's authors also offer a copy of the source code for \$30.

PCwindow is less sophisticated than the other programs reviewed. It has three components: a one-page notepad, an ASCII (American Standard Code for Information Interchange) table, and a clock/timer/alarm. The notepad lets you edit messages on a single 78-character by 12-line page. You can read notes from or save them to disk files (you print by "saving" to the MS-DOS file/device prn). The clock/timer/alarm includes an alarm that rings once at the designated time and a timer accurate to one second (if your PC keeps poor time, so will this program).

By the time you read this, PCwindow should be available through many users groups and other sources of public-domain and user-supported software. You can also get a copy of the program by sending a self-addressed, stamped, disk-mailing envelope and a formatted 5¼-inch disk to Creative Freeware Unlimited, POB 10047, Columbia, MO 65205.

Kimtron

MULTI-USER SOLUTION for IBM PC, XT, AT

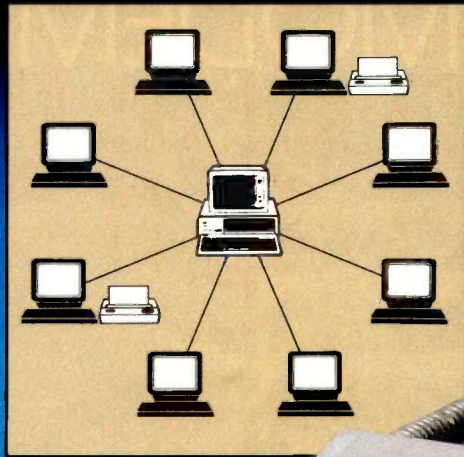

Compare the Solution!

The Multi-User Solution of the future is now available.

Convert your IBM PC, XT, AT or Compatibles to a true multi-user system while maintaining display, keyboard and software compatibility.

Since the KT-7/PC display is the same as your PC monochrome monitor, with its look-alike keyboard, operators will feel they're using an IBM PC and can also use the same software manual. Kimtron's multi-user solution includes file and record locking, shared data access, and communication between users. It is **the** intelligent alternative.

The KT-7/PC supports Time Sharing, Enhanced Time Sharing

and Multi-Processor implementation under PC DOS, MS DOS, UNIX, XENIX, CPM 86, Multilink, Concurrent PC DOS, and other compatible multi-user operating systems.

Kimtron's multi-user solution may be tailored for cost effectiveness; as low as \$1095 for an additional user, and for speeds more than ten times faster than LAN. You can add one or as many as 31 additional users per PC. Kimtron delivers the future now by allowing an ever-widening network of multi-user PC's.

The KT-7/PC may be complemented with one (or more) I/O Card, Memory Card, 8086 Speed

Enhancer Card, 80286 AT Card, 8088 Multi-Processor Card, 80186 Speed Enhancer Card, 68000 Card, and related software.

For more information about Kimtron's Multi-User Solution, or general video data terminals for other mini or micro multi-user systems, call your local computer dealers, distributors or Kimtron Corporation Today!

(408) 727-1510

NOTE: IBM PC, XT, AT, PC DOS, MS DOS, UNIX, XENIX, CPM 86, Multi-Link, Concurrent PC DOS are registered trademarks of IBM Corporation, Microsoft Corp., Bell Labs., Digital Research Inc., Software Link Inc. respectively.



1705 Junction Court
Building #160
San Jose, CA 95112

Kimtron

THE 24K... NEW FROM ARK...IS THE FIRST UNIVERSAL FDX 2400 DIAL MODEM...



* MNP is a proprietary product of MICROCOM, Inc.

MULTIPLE MODEMS IN ONE

THE ARK 24K HAS IT ALL!

MULTIPLE MODEMS IN ONE

Operational Modes

- State-of-the-ARK MODE: User friendly help commands, Sync/Async operation, DTE buffer to 9600 bps, Separate Sync/Async connectors, Extensive diagnostic capabilities, and much more.
 - ARQ Error Free Transmission based on MNP*
 - Hayes™ "AT" Mode Compatible
 - Front Panel Operation (Concord type)
- On-Site Service Nationwide

INTRODUCTORY OFFERS

The ARK 24K...multiple modems in one...
2400 bps FDX... **\$595⁰⁰†**
Quantity discounts available.

DEALER INQUIRIES INVITED

The ARK 1200 bps FDX Compatible Version...
NOW \$365.00. At a later date factory upgrade to 2400 bps—\$275.00

To order or for more information, call 800 228-0914 today or write ARK Electronic Products, Inc., Department A, 325 West Hibiscus Boulevard, P.O. Box 2169, Melbourne, Florida 32902-2169 for your brochure about the best modem on the market today.



† Offer expires July 31, 1985

No waiting!



The new compiler for dBase III®

EASE OF USE

dBIIICompiled code can use both dBASE II and dBase III data files, eliminating the need to convert from one format to another. And dBIIICompiler's unique design lets you concentrate on your dBASE program rather than complex memory management problems.

INDEPENDENCE

Buy dBIIICompiler once, and compile and distribute as many applications as necessary at no additional cost. WordTech imposes no license fees, and compiled applications will execute without dBASE III or RunTime.

PORTABILITY

Versions exist for MS-DOS, as well as for the IBM PC. Cross-environment linkers between versions enable you to run your dBASE III programs on most MS-DOS machines.

SPEED

Compiled applications run faster than under the dBASE III interpreter, and are more compact.

SECURITY

Compilation is the best way of protecting your program source code.

Suggested retail price: \$750; Cross-environment linkers: \$100 Special introductory offer (expires July 31, 1985); dBIIICompiler and one cross linker: \$750

Site licenses available

WORDTECH SYSTEMS

Tools for Thinkers since 1982

WORDTECH SYSTEMS, INC. P.O. Box 1747 Orinda, CA 94563 TX 503599 (415) 254-0900

dBASE III, dBASE II, dBASE, RunTime, Ashton-Tate, Inc. MS-DOS, Microsoft, Inc. IBM PC International Business Machines, Inc.

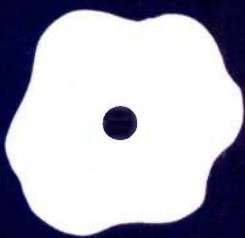

Building Expert Systems with M.I

A knowledge-engineering tool for the IBM PC

BY BRUCE D'AMBROSIO

Would anyone of sound mind and body pay \$12,500 for an IBM Personal Computer (PC) program? An individual, no—but a company, maybe. If the program helped to design and build expert systems, *maybe* becomes *might*. If the program also included a training course in knowledge engineering, *might* becomes *probably*. Teknowledge, a start-up artificial-intelligence (AI) company boasting that its founders constitute "one-third of the entire world's knowledge engineering expertise," hopes to convince companies anxious to explore knowledge engineering that its new product, called M.I, is worth such a hefty investment.

M.I is *not* just a program but a carefully crafted product that provides companies with a moderately priced alternative (compared to hiring an AI professional and buying a LISP machine) for exploring knowledge engineering. It consists of a one-week training course, an extensive set of training materials, and the M.I program itself. No one of these three items can be considered in isolation because the strength of the product comes from the design and integration of the entire package.

M.I clearly shows Teknowledge's expertise in all aspects of both knowledge engineering and the technology-transfer problem. At the same time, there are some disturbing flaws in the execution of the product, flaws that would be understandable in a \$200-\$300 package but are as out of place here as a door that won't close on a new Rolls Royce.

M.I—THE CONCEPT

Knowledge engineering is an outgrowth of a technology developed in AI labs in the late 1970s known as "expert systems." This technology's basic goal is to free the expert for other tasks or to transfer an expert's problem-solving skill to a computer-based knowledge system for easy application when the expert is unavailable. One problem with this approach is that building ex-

pert systems requires an extensive time commitment from an expert, typically six months to two full years.

The Teknowledge approach recommends that rather than attempt to build expert systems, knowledge engineers concentrate on "knowledge systems," systems that contain less rare, but no less useful, knowledge.

M.I is intended for what Teknowledge describes as a "structured selection" problem, one of the best-understood problems in AI. The signs of a structured selection problem, as described in the M.I course, are that it can be solved in a 20-minute phone consultation with an expert, it does not involve the use of diagrams or plans (such as circuit schematics), and the recommended solution is chosen from a small number of options (a few dozen at most). A goal of the course is to bring the knowledge-engineer trainee to the point where he understands this characterization of M.I's intended applicability well enough to recognize problems within his own company that meet these criteria. In this the course succeeds well. Indeed, the course is at its best when discussing the subtle issues of problem selection and design, and it shows Teknowledge's broad experience in this area.

But is this enough? Or is this so limited an area of applicability as to render M.I useful only for trivial problems? Here, Teknowledge's ambiguity regarding M.I is apparent. When asked directly whether or not M.I is capable of supporting knowledge systems complex enough to be worth fielding, the official Teknowledge answer seems to be "Yes, sort of, well, maybe..." Teknowledge can't really seem to decide whether M.I is a demonstration system intended for training and evaluation of the technology or a really useful tool in itself.

M.I is designed for the junior to mid-level technical professional, typically with at least one or two years of programming experience. There is another aspect to the ideal

(continued)

Bruce D'Ambrosio (555 Tulsa St., San Lorenzo, CA 94580) is studying for his Ph.D. in computer science at the University of California at Berkeley.

AT A GLANCE

Name

M.I

Type

Expert-system toolkit

Manufacturer

Teknowledge Inc.
525 University Ave.
Palo Alto, CA 94301

Format

4½-day course, three
documentation volumes, one
5¼-inch floppy disk

Computer

IBM PC, PC XT, and PC AT or
compatible

Features

Inference engine, debugging
tools, and sample knowledge
bases

Documentation

Reference manual, training
manual, descriptions of
sample knowledge systems

Price

\$10,000 for M.I software and
materials plus \$2500 for
course

Audience

Companies interested in
exploring expert-systems
technology and rapid
prototyping of expert systems

M.I trainee. M.I can be thought of as a programming language, but with reservations. In programming-language terms, M.I supports a *non-procedural* language. Teknowledge emphasizes that M.I knowledge bases have declarative, as well as procedural, semantics and must be consistent from both perspectives. Each statement must make sense by itself and express some "fact" that you could say to someone when teaching that person about the problem area. What all this means in terms of choosing candidates for the M.I training is that an extensive but narrow data-processing background may in fact be an impediment to learning some of the concepts embodied in M.I. A good, solid exposure to computer programming and computer science concepts, together with a general "liberal education," would be better. In particular, some exposure to the basics of mathematical reasoning and logic would be beneficial. M.I shows the best preparation for the future may *not* be a crash course in the current technology (for example, the "computer literacy" craze) but rather a sound education in the old-fashioned "basics."

M.I—THE COURSE

The course I attended (I actually attended only for a total of 12 hours) ran from Monday to Friday. It was about half lecture and half "hands-on" laboratory experience, with the lecture portion a mix of knowledge-engineering principles and M.I mechanics. The pacing was quite relaxed, and I rarely felt that I had less time than needed to complete the laboratory sections of the course. There were three trainers for the six attendees; the architect of M.I, Steve Hardy of Teknowledge, was the primary lecturer, and the two main programmers on the M.I development team served as laboratory assistants, guiding us through the exercises and answering any questions. Hardy has all the attributes to make a superb lecturer: flair for teaching, enthusiasm for his subject, and absolute command of his subject matter, both M.I in particular

and knowledge engineering in general. It was not clear that he would continue teaching the course (the session I attended was only the second time the course had been given), and I think it would be a loss should he delegate that task to others.

Each attendee had exclusive use of an IBM PC for the laboratory exercises. The course starts with a general discussion of M.I, what it is and what it can do, and then proceeds along two interwoven tracks. Lectures and exercises introduce increasingly complex features of M.I, and the remainder of the course covers various aspects of knowledge engineering, both theoretical fundamentals and practical wisdom. Both parts of the course are excellent.

The instructional component of the M.I product is by far its strongest. The material is organized and presented superbly, and there are many gems of wisdom scattered through every lecture. Anyone attending this course should take careful notes, or perhaps use a tape recorder (Teknowledge permitting), because the documentation for M.I does not meet these same standards.

The course clearly communicates the essence of knowledge engineering in a way I have seen no book do.

M.I—THE DOCUMENTATION

The M.I documentation comes in three 3-ring binders. The first contains the transparencies used during the lectures (about 250 slides) plus some discussion material. The second contains listings of five sample knowledge bases that are part of the M.I package. The third is the M.I reference manual. While the volumes are nicely bound, reproduction quality is poor (but not bad enough to seriously threaten the readability of the text).

The volume containing the slides serves as an outline to organize your notes around. It also provides a way to effectively reduce the cost of M.I. Once a trainee has completed the three-month training program, he can in turn train others. The slides provide a detailed record of topics and the order in which they were covered, and

the text of the exercises does a good job not only in describing each assignment but also in making clear what the student is supposed to be getting out of it.

The volume containing the five increasingly complex sample knowledge bases is also well done. This volume includes text describing each of the laboratory exercises done using the sample systems as well as a complete listing of each sample knowledge base.

The first is called Wine and is a simple wine advisor, criticized in prior reviews of M.I. The point of this system, however, is not sophistication but simplicity. It is the simplest possible system that could be written in M.I to serve as an introduction. Two variations of Wine follow, Vine and Cwine. They differ from Wine solely in their use of increasingly sophisticated features of M.I; they encode more or less the same knowledge about wine.

Next is a knowledge base called Banker. Banker represents the level of complexity the trainee is expected to be competent at upon completion of the three-month M.I program. It contains about 150 rules and facts and advises clients on banking services. At the end of a consultation, Banker recommends a combination of accounts most suitable for the particular client (for example, regular checking plus money-market savings).

The final sample system is an excerpt from Sacon, an early, landmark expert system. The most complicated of the sample systems, it serves as a benchmark demonstrating use of the most complex features of M.I.

These samples are crucial for understanding knowledge engineering and M.I, and they should be studied carefully. Effective utilization of M.I relies on the user developing an intuitive feel for proper style; some of the issues remain unclear until you actually encounter them in attempting to construct a system of your own. At that time it is invaluable to have a set of samples to refer to.

The M.I reference manual is adequate. One reason I suggest careful

note-taking is that not all features described in the course are clearly documented in the manual. Were M.I a \$500 product, I would praise the manual as quite adequate. However, as the price rises, so do expectations, and this manual does not meet them.

M.I—THE SOFTWARE

The software, while only one component of the total M.I product, is the most crucial. [Editor's note: A second version of M.I, called M.Ia, costs \$2000 and is a scaled-down version of the program; it's suitable for developing prototype M.I applications. M.Ia cannot interface to other software and is not suitable for developing complex systems.] Overall, the software is solid in concept. Again and again this product demonstrates Teknowledge's clear understanding of practical knowledge engineering. However, its execution has many minor flaws, as I will explain. In concept, it clearly owes much to EMYCIN, developed by the Heuristic Programming Project at Stanford

University and the first "productized" knowledge-engineering system. However, M.I incorporates many differences, and it certainly is not merely a straightforward implementation of EMYCIN for the IBM PC.

The major architectural components of M.I are a knowledge base, an inference engine, and a cache (see figure 1). The knowledge base is built by the knowledge engineer and contains the facts and rules needed for the specific application. The inference engine is the software that "reasons" using the facts and rules provided in the knowledge base. The cache is a memory-resident database in which conclusions are stored as they occur.

The knowledge representation (language for expressing rules and facts) in M.I is based on a subset of predicate logic. While this is hidden from the knowledge engineer by an easy-to-understand syntax, there are several consequences nonetheless.

(continued)

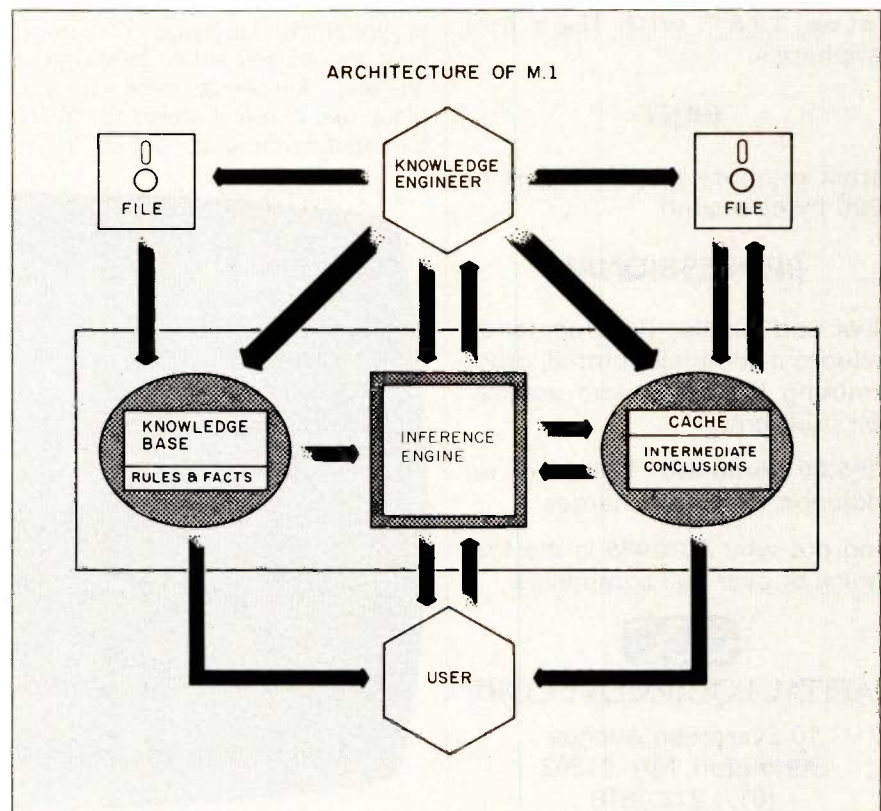
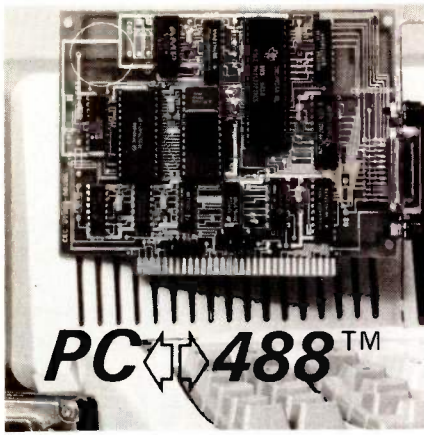

Figure 1: Block diagram of the components of M.I.



An IEEE-488 interface for all IBM-PC's and COMPATIBLES
VERSATILE

Easy-to-use commands for all IEEE-488 (GP-IB, HP-IB) functions.

Resident firmware supports **BASIC, Pascal, C, and FORTRAN.**

Emulates Hewlett-Packard controller functions and graphics language statements.

Supports Tektronix® Standard Codes and Formats.

Print listings, plot graphs, and use **Lotus 123™** with IEEE-488 peripherals.

FAST

Direct memory transfer rates to 800K bytes/second.

PROFESSIONAL

Clear and concise documentation includes a complete tutorial, programming examples, and application programs.

\$395.00 complete. There are no additional software charges.

Find out why **PC488** is the first choice of over 500 companies.



CAPITAL EQUIPMENT CORP.

10 Evergreen Avenue
Burlington, MA. 01803
(617) 273-1818

IBM is a trademark of International Business Machines Corp.
Lotus 123 is a trademark of Lotus Development.
Tektronix is a trademark of Tektronix, Inc.

REVIEW: M.I

Logic-based representations are known for completeness and rapid prototyping rather than speed of execution. M.I, true to this tradition, is slow: It can evaluate about one logical inference every 2 seconds (by my very crude estimates). But this is adequate for a typical consultation-style system; in the sample systems, I spent much more time thinking about answers to questions than I did waiting for program execution.

Another consequence of the logic basis of M.I is that knowledge structure is implicit rather than explicit. While this is a rather technical point, an important result is limitation of the system's ability to provide any knowledge-base construction tools to aid the knowledge engineer. This does not seem to concern Teknowledge, however. The company has made no attempt to provide construction tools of any kind (as I'll explain).

A very interesting feature of M.I is that the rule language has been extended to be a complete symbolic programming language. You never have to use any other language in building a knowledge base with M.I. Most rule-based systems (EMYCIN, for example) provide "hooks" to the

underlying language (LISP in the case of EMYCIN) so that you can code directly in that language any functions and tests that cannot be easily expressed in the rule language. This is unnecessary in M.I. Any internal computation that can be expressed in any programming language can be expressed directly in M.I's rule language.

M.I's rule language provides certainty factors using a modification of the "bounded sum" evidence-combination technique used in EMYCIN. Certainty factors are a standard technique for representing partial information within an expert system. (Here's an example. I usually prefer sweet wines, but I sometimes prefer a medium-dry wine. This could be expressed in M.I as: Sweet CF 75, Medium CF 30). One distinction between rule-based systems and more traditional methodologies, such as decision trees, is this ability to reason with partial or uncertain information. M.I's implementation of certainty-factor calculations is fairly straightforward and intuitive. One potential problem is the handling of negation (if the client does not like sweet wine, then...). Negation is handled in a



Photo 1: The windowed screen display of M.I.

REVIEW: M.1

way that generates discontinuous results and is likely to produce conclusions unexpected by the knowledgeable engineer.

M.1 has a set of debugging tools including an "instrument panel," a set of four windows that appears at the top of the screen (see photo 1) and displays the current activity of the system. One window shows the goal the system is currently trying to achieve, a second shows the rule currently being considered, a third shows the conclusions the system has reached, and a fourth shows the legal responses that can be made to the current question. The instrument panel is a wonderful idea, but it's somewhat limited in its utility by the small size of the windows. Teknowledge strongly recommends use of a color display, and the panels do look nice in color, but they also work perfectly well on the monochrome screen of my Corona PC. In addition to the instrument panel, a set of inquiry commands is available once a rule base is loaded into M.1. The WHY command displays the rules leading to a conclusion, the SHOW command interrogates the cache (the place where conclusions are stored), the USES command displays all rules that reference a particular fact, and the LIST command lists entries in the rule base. There are some minor inconsistencies in the arguments these commands take and when they can be used, but nonetheless they are quite handy. Also, you can save the current state of a consultation on disk and retrieve it later, helpful in interrupted debugging sessions as well as in saving test cases.

You can make small changes to the rule base using a simple add/delete/replace facility within M.1. However, the utility of this facility is limited by two things. First, only entire rules can be added, deleted, or replaced. M.1 sample systems contain many rules of 5 to 15 lines in length, an awkward amount to key in simply to make a minor change. But even worse, these changes are made only to the copy of the rule base in memory. The only way to update the file copy of a rule

base is to exit from M.1, start up your text editor, and edit the file. In defense of M.1, it would be almost impossible to write a knowledge-base editor that more than two people would like. Nevertheless, the lack of effort in this area seems to be a major weakness of M.1.

Another deficiency I find in M.1 is not being able to add any documentation that can appear during a consultation. Rules are displayed in the form in which they were entered by the knowledge engineer. Teknowledge claims the rule syntax is so flexible that self-documenting rules can be written. (The same claim was once made for COBOL.) Similarly, you can ask *why* a question is being asked (and see the rule that is being considered), but there is no mechanism for providing you with more information about *what* is being asked. (For example, M.1 asks for the client's preference in wine "body." What if the client doesn't know what body is?)

[Editor's note: The latest version of M.1 provides an OPTIONS command that prompts the user with a list of acceptable answers to a question. This version also provides a method to call M.1 from high-level languages like C so that knowledge bases can be integrated with existing applications to add intelligence to databases or spreadsheets. M.1's most recent version also can generate executable knowledge systems for distribution.]

CONCLUSION

M.1 is a fascinating product. The course, the sample systems, and the software combine to form an excellent introduction to the capabilities of rule-based systems. For those with the money to spend, M.1 provides guidance to ensure that the knowledgeable-engineer trainee does not spend months or even years in a blind alley due to a misunderstanding of the nature or purpose of rule-based systems. Nonetheless, serious deficiencies in the current software lead me to conclude that M.1, at least in its present state, is best considered an evaluation and training tool and not a product for developing knowledge-based systems that can be put in the hands of naive users. ■

Shopper's Guide

for ELECTRONIC & COMPUTER

RS-232 DATA LINE MONITOR

A miniature Data Line Monitor determines the status of the seven key signals of the RS-232 data path. All 25 pins wired through, and dedicated red LED's report the status of: Transmit Data, Receive Data, Request to Send, Clear to Send, Data Set Ready, Data Carrier Detect, Data Terminal Ready, LED's glow at 3 Volts.



MODEL	GENDER	1-9	10-24
DLMS	M-F Shielded	37.35	33.99
	Deluxe Monitor now available with red/green LED's to indicate a hi, low or open condition. Metal shield.		
DLMS-2	M-F Shielded	46.95	42.72

DATA LINE GENDER CHANGERS

Needed when connectors won't mate. Choice of shielded, unshielded, or Centronics.



RS-232 Gender Changers

DG-25F	(F-F) Unshielded	16.95	15.42
DG-25M	(M-M) Unshielded	16.95	15.42
DGS-25F	(F-F) Shielded	18.65	16.97
DGS-25M	(M-M) Shielded	18.65	16.97

Centronic Gender Changers

DGS-36F	(F-F) Unshielded	36.95	33.62
DGS-25M	(M-M) Shielded	36.95	33.62

RS-232 DATA JUMPER BOX ADAPTER

Used to customize RS-232 interfaces. All 25 pins terminate to 25 solder pads. The PC board is already wired to the D-Subs. Includes 25 stripped leads for custom wiring. Many interfaces could be built. Null Modems, Pin Reversers, etc. Metal snap-on covers, hardware supplied.



DJBS	(M-F) Shielded	21.95	19.97
DJBS-M	(M-M) Shielded	21.95	19.97
DJBS-F	(F-F) Shielded	21.95	19.97

RS-232 DO IT YOURSELF KIT

Allows the creation of many RS-232 variations. The following components are included in the assortment: two 25-pin D-Sub Connectors, two metal Snap-on half covers, 1 set Hardware.



DIYS	(M-F) Shielded	12.95	11.78
DIYS-M	(M-M) Shielded	12.95	11.78
DIYS-F	(F-F) Shielded	12.95	11.78

RS-232/CENTRONICS ADAPTER BOX

Used to customize printer adapters. The DB-25 has 25 flying leads, ready to be soldered to any of the 36 pin female Centronics.



DJBA	(M-F) Shielded	24.95	22.70
------	----------------	-------	-------

RS-232 SURGE PROTECTOR

Guard against voltage spikes entering your RS-232 ports. Metal varistors on lines 2, 3 & 7 clamp surges above 25 volts without affecting normal operation. This compact protector mounts in series. All 25 lines are wired through. DSP (Male-Female) 24.95 22.70



TOLL FREE ORDERING • ADD \$4.50 Ship. & Hand. 800-343-1455 MA & Technical Calls 617-682-8936

DATA TRANSFER SWITCH BOXES

- Sturdy Aluminum Cases
- RFI Safety Proof
- Light Tan Color
- High Grade Rotary Switch
- Size: 2.25" x 7.25" x 5"
- 6 LED Hi-Lo Monitor (Optional)



RS-232 12 Lines Switched

DT2512-2	2 Way (1In-2Out)	99.00	94.05
DT2512-3	3 Way (1In-3Out)	115.00	109.25

Switches-Lines: 2, 6, 8, 15, 17, 20, 24, 25

RS-232 All 25 Lines Switched

DT2525-2	2 Way (1In-2Out)	115.00	109.25
DT2525-3	3 Way (1In-2Out)	130.00	123.50

Optional 6 LED (Hi-Lo) Monitor Add \$30.00

Centronics 25 Lines Switched

DT3625-2	2 Way (1In-2Out)	155.00	147.25
DT3625-3	3 Way (1In-2Out)	175.00	166.25

Switches: 1-16, 18, 31-36, 19-30

DATA TRANSFER SWITCH BOXES

- Sturdy Steel Cases
- RFI Safety Proof
- Dark Tan Color
- Molded Rotary Switch
- Size: 3.2" x 6" x 5.9"
- Unconditionally Guaranteed



RS-232 12 Lines Switched

DB2512-2V	2 Way (1In-2Out)	99.00	94.05
DB2512-3V	3 Way (1In-3Out)	115.00	109.25
DB2512-4V	4 Way (1In-4Out)	135.00	128.25
DB2512-X	Crossover	120.00	114.00

Switches: 2, 6, 8, 15, 17, 20, 22, 24, & 25

RS-232 All 25 Lines Switched

DB2525-2V	2 Way (1In-2Out)	120.00	114.00
DB2525-3V	3 Way (1In-3Out)	140.00	133.00
DB2525-4V	4 Way (1In-4Out)	165.00	156.75
DB2525-X	Crossover	150.00	142.50

Centronics 25 Lines Switched

CN3625-2V	2 Way (1In-2Out)	155.00	147.25
CN3625-3V	3 Way (1In-3Out)	175.00	166.25
CN3625-4V	4 Way (1In-4Out)	195.00	185.25
CN3625-X	Crossover	180.00	171.00

Switches: 1-16, 18, 31-36, 19-30

Centronics All 36 Lines Switched

CN3625-2V	2 Way (1In-2Out)	170.00	161.50
CN3625-3V	3 Way (1In-3Out)	195.00	185.25
CN3625-4V	4 Way (1In-4Out)	225.00	213.75
CN3625-X	Crossover	205.00	194.75

Lcom DATA PRODUCTS
1755 Osgood St. Rte 125
No. Andover MA 01845



Scrolling down Fifth Avenue.



Step beyond the limits of personal computing, and through the doors of the world's finest stores. Or right into the action on Wall Street. Browse, buy, sell or trade. Stocks, information, Maine lobster, Oregon seedlings, Italian luggage, airline tickets. Without leaving your chair.

With an Avatex™ modem, your personal computer can take you wherever you want to go, on your schedule. As far, as fast, as often as you like, at a price that won't stop you in your tracks.

Avatex gives you the power, speed and intelligence of a serious piece of communications equipment, streamlined so anyone can use it easily and productively. Immediately.

So with Avatex the possibilities are astronomical, but the price of owning one is not: Avatex 300—\$64.95*, Avatex 600—\$99.95*, Avatex 1200—\$299.95*

For the name of the Avatex dealer nearest you, call 800-4-AVATEX.

Avatex™ Modems

The next step in personal computing.



Avatex™ is a trademark of E+E DataComm. U.L./C.S.A. & FCC Part 15 and 68 approved. Copyright 1985 by E+E DataComm. *Suggested retail price.

WordPerfect is just that.

PC World

At SSI, we face a monumental challenge; living up to the name we gave our word processing software. After all, with a name like WordPerfect, the product had better measure up. Obviously it's doing just that. For good reason.

Simplicity.

Most WordPerfect functions require only one keystroke, a simple press of a finger. And comprehensive, well-written documentation makes learning a breeze.

Speed.

With WordPerfect's document orientation, you never have to wait between pages of

text. No matter how fast you type, WordPerfect won't slow you down.

Features.

In addition to standard word processing functions, WordPerfect includes several comprehensive, useful features not found on many word processors. Like a 100,000-word phonetic dictionary; multi-page footnoting capability; table of contents and index generation; automatic outlining and paragraph numbering; and a network version of WordPerfect.

Get the word processor that's living up to its name. WordPerfect. For more information, see your dealer.

Or call or write:

SSI Software
288 West Center Street
Orem, Utah 84057
Information: (801) 224-4000
Order Desk: 1-800-321-4566
Toll-free



SSI Software
Reaching for perfection.

There is very little this program WordPerfect can't do."

InfoWorld

even a beginner can soon master WordPerfect's most difficult functions, such as

PC World



Hewlett-Packard's HP 7475A Plotter

An accurate
and versatile
graphics
machine

BY RICH MALLOY

Hewlett-Packard's six-pen plotter, the HP 7475A, can plot not only on the familiar 8½- by 11-inch paper but also on 11- by 17-inch paper. The 7475A has a suggested list price of \$1895 (the original price of its two-pen predecessor, the HP 7470A, which now has a suggested price of \$1095). It's about the same size as a wide-carriage dot-matrix printer and is somewhat lighter. Paper is driven in and out of the plotter by special rollers having a high-friction surface. This paper movement in and out of the plotter forms one dimension of pen movement. Moving the pen across a track above the paper surface forms the second dimension.

The plotter is available with either of two interfaces. The one we received has an RS-232C serial interface with a DB-25 connector that's very easy to reach. Right next to the connector is a group of eight tiny switches used to control the serial parameters and some of the plotter defaults. The HP 7475A is also available with a connector for the HP Interface Bus (HP-IB) for direct connection to other HP computers and devices. The model with this connector costs the same as the serial version.

On the right side of the plotter is a series of push buttons to control the plotter. Several of these buttons are used to move the pen position. Others change paper size and move the pen up or down manually. Two indicator lights signal error conditions. On the left side of the plotter is the *pen carousel*, a spool-like unit that has slots for six pens, which are loaded in much the same way as bullets into an old Colt .45 revolver. The carousel gets its name because it rotates to place a new pen into the moving pen holder.

Each pen slot has a rubber pen cover to keep the ink from drying out. You can easily remove the carousel to make quick pen changes. And you can buy extra carousels and load them up with pens of other colors.

Speaking of pens, Hewlett-Packard sent us

two types. Both types had felt tips. One kind was fairly fine (0.4 mm) and came in a variety of colors (black, red, green, blue, violet, etc.). The other kind was broader (0.7 mm) and came only in black.

PLOTTING

The HP 7475A is controlled by a series of commands in the Hewlett-Packard Graphics Language (HP-GL). All HP plotters use this control language, although the low-end units may not be able to execute all of the commands.

An HP-GL command consists of a two-letter verb usually followed by a numeric argument or two. For example, the sequence

```
PA 100,300
PD
PA 400,700
PU
```

draws a line from point 100,300 to point 400,700. PA stands for "move to absolute point," and PD and PU mean "pen down" and "pen up," respectively.

The coordinate system is very large and easy to use. On an 8½- by 11-inch page, you can access any point within a 10,080 by 7520 matrix. In addition, you can scale these points to match your requirements. For example, instead of a coordinate system of 10,080 by 7520, you can set up a matrix of 640 by 200 to match your computer's video screen. Also, you can use relative coordinates.

The HP-GL commands can be generated fairly easily on your computer with simple BASIC commands. After a little experimentation, you can draw circles, arcs, dotted lines, and boxes filled with various textures (see figure 1).

PERFORMANCE

Watching the HP 7475A draw a picture is just short of fascinating. The pen is fast, and

(continued)

Rich Malloy is a senior technical editor for BYTE. He can be contacted at BYTE, 43rd Floor, 1221 Avenue of the Americas, New York, NY 10020.

AT A GLANCE

Name

HP 7475A Plotter

Manufacturer

Hewlett-Packard
9606 Aero Dr.
San Diego, CA 92123
(619) 279-3200

Size

5 by 22.4 by 14.5 inches; 16 pounds

Price

\$1895

Computer Needed

Any computer with serial or HP-IB interface

Features

Six pens, fast pen speed, high-quality character set

Paper Sizes

8½ by 11 inches; 11 by 17 inches

pen changes are made quickly and accurately. A moderately complex graph takes about 1 to 3 minutes.

There are a few things I would improve on the HP 7475A, however. It can be quite noisy even when it's not doing anything. Also, I would like a key for aborting a bad plot. For example, suppose you forgot to put the right color pens in the carousel; you could probably stop your graphics software, but the plotter would continue until it emptied its input data buffer.

TEXT

With a plotter, of course, you can draw any text character you want, but this requires a bit of programming. To make things easy, most low-cost plotters (including the two-pen HP 7470A) are programmed to be able to produce the standard ASCII (American Standard Code for Information Interchange) characters. Unfortunately, to save memory space, most of these characters look fairly crude; for example, the numeral 0 may look like an octagon.

One of the nice features of the HP 7475A is its high-quality character set

(see figure 1). These characters can be drawn at any height, width, or inter-character spacing.

If I had more time with this plotter I would write a BASIC program that prints text characters in a flowing script font. This would let me print a handwritten note—or a close facsimile thereof. Well, I didn't have enough time to program all the characters in a script font, but I did create a short program using the preprogrammed characters. This program, in effect, turned the plotter into one of the slowest printers around (about 3 characters per second). But the quality of the characters was very close to that of a daisy-wheel printer, and I could print them any size I wanted.

COMPATIBLE SOFTWARE

In the very likely event that you do not have enough time to write your own software, you need not despair. A large amount of software should be available to drive the HP 7475A. Because of the popularity of the older HP 7470A plotter, almost every graphics program written for micro-computers comes with a driver for it. Since the 7475A is compatible with the 7470A, it too can use this software (of course, this software cannot take advantage of the 7475A's extra capabilities). Hewlett-Packard, however, has been very successful in getting the major graphics-software houses to write drivers especially for the 7475A.

OTHER FEATURES

Although I did not get to try this, the HP 7475A can be used as a digitizer of sorts. Instead of holding a pen, the pen holder can grip a set of cross hairs equipped with a magnifier. You can then insert a map, for example, into the plotter and, using the arrow keys on the control panel of the plotter, move the pen holder to a specific point of interest. If you have your computer set up to give the plotter a certain command, it will respond with the coordinates of that point.

Another feature I have not tried is the ability to use a wide variety of pens. The HP felt-tip pens are fairly

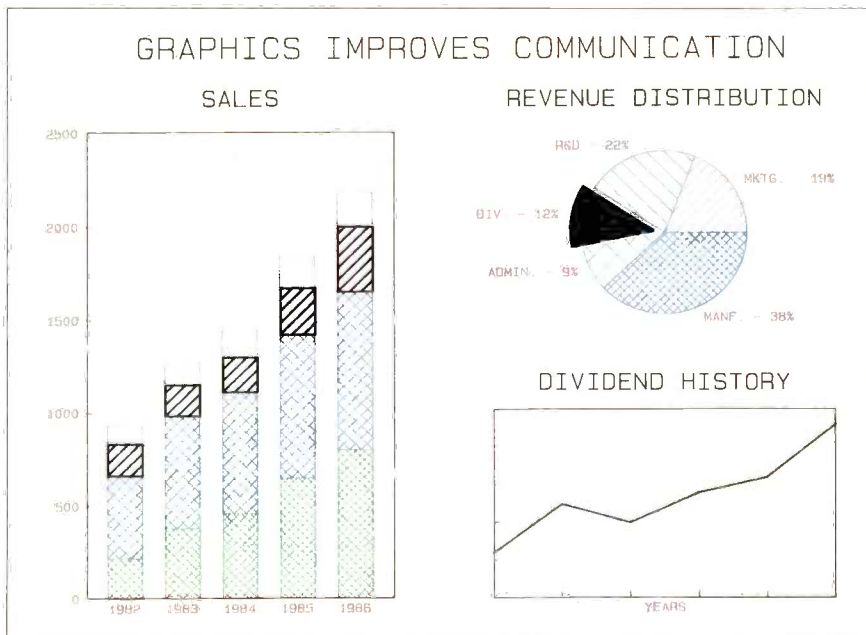

Figure 1: Graphs and text produced by the HP 7475A. This test plot is automatically produced by a ROM (read-only memory) chip in the plotter.

REVIEW: HP 7475A

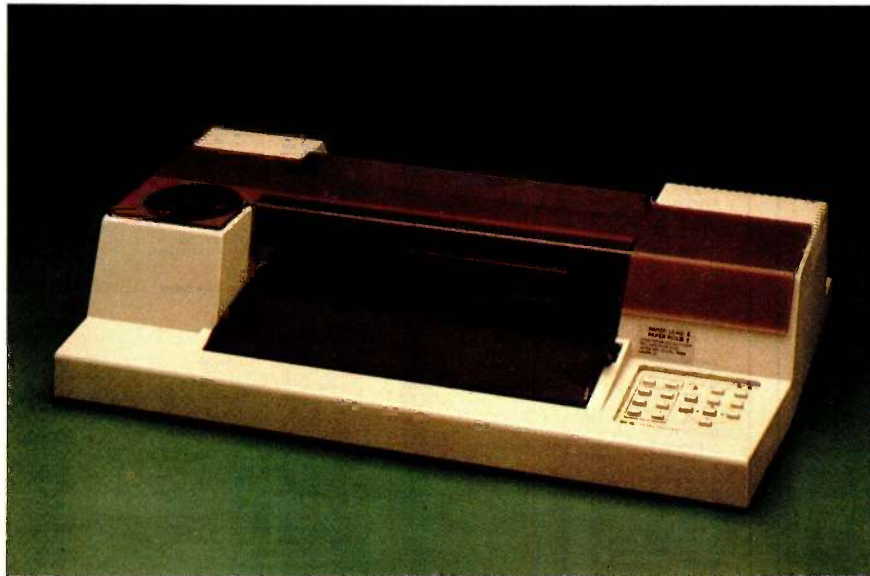

Photo 1: Hewlett-Packard's six-pen plotter, the HP 7475A.

good, but they do not produce a line of sufficient quality to be used in a magazine, for example. HP claims, however, that certain art stores sell adapters that enable you to attach technical pens to the pen holder. These pens are the same as those used by graphic artists, and when used at a slow speed on the plotter, they should produce high-quality lines.

INTERFACING

The HP 7475A comes in two versions: one with an RS-232C serial interface and one with an HP-IB daisy-chain-type interface. I didn't use the HP-IB version of the plotter, but I tested the serial version with the IBM Personal Computer and the Tandy Model 100. It worked fairly well with both systems. For the IBM, there's a special null modem cable that switches pins 2 and 3 and 6 and 20. The plotter uses pin 6 to signal when its input buffer is full (which happens very quickly).

Unfortunately, the Model 100 doesn't read pin 6 or 20 and keeps right on sending information to the plotter even when the buffer is full, causing some strange-looking plots. The only way I could get the plot to come out right was to slow down my homegrown graphics program with

frequent pauses. According to the plotter's documentation, it can use the XON/XOFF protocol to signal when its buffer is full, but I couldn't get this to work.

DOCUMENTATION

By computer standards, the HP 7475A's documentation is good. It covers all aspects of the plotter, its organization is coherent and logical, and the presentation is professional. My only complaint has to do with the chapters on interfacing. A few more examples and some simplified phrasing would have helped immensely.

The documentation includes instructions for interfacing the plotter with all the major personal computers (except the Tandy Model 100).

CONCLUSIONS

The HP 7475A six-pen plotter is a powerful, accurate, versatile, and affordable graphics machine. It is well designed and well built. Its performance is practically flawless, and it seems to be expandable.

I wish the plotter had a key for aborting a bad plot. Another nice addition would be an automatic paper feeder—but for that you'll have to buy the new HP 7550A plotter for a significantly higher price, about \$3900. ■

CENTECH

The Colorful Solution to Data Organization™

SS-DD	DS-DD
\$120 — 5 1/4" QTY. 50 — \$149	
	BULK
\$149 — 5 1/4" QTY. 20 — \$199	
	BOXED
\$230 — 96 TPI — \$289	

TIMELESS WARRANTY

COLOR DISKETTES—LOWEST PRICE EVER!
100% error-free and free of manufacturing defects or we will replace it at no charge. Available in 13 useful colors. Double density and reinforced hubs. Includes tyvek sleeves, user ID labels, write-protect tabs. As an introductory offer we will send a **FREE LIBRARY CASE** with each order of boxed diskettes.

***FREE 3M Flip 'n' File™ Offer...**



SS-DD	DS-DD
\$152 — 5 1/4" QTY. 20 — \$205	
\$228 — 96 TPI — \$284	
\$288 — 3.5" 135 TPI	

Factory fresh and pre-packaged with a **Free Flip 'n' File™** for every 50 3M diskettes order. Includes tyvek sleeves, reinforced hubs, user ID labels and write-protect tabs.

3M Headcleaning Kit \$7.95

ECONOMICAL PRICE American-Made EXCELLENT QUALITY

BULK DISKETTES

LIFETIME WARRANTY

SS-DD	DS-DD
90¢ — 5 1/4" QTY. 50 — 98¢	

Includes white tyvek sleeves, reinforced hubs, user ID labels and write-protect tabs. Every track, every sector, every diskette tested at 163% of industry standards. Certified 100% error-free and free of all manufacturing defects or we will replace it at no charge. American made by a leading manufacturer of magnetic media to surpass the best the world has to offer.

DISK STORAGE

Amaray Media Mate 50	\$9.95
Disk Minder II-75	\$11.95
Micro Disk Minder-36	\$8.75

PRINTER RIBBONS

Epson MX 70/80	\$3.53
Epson MX-100	\$4.90
Okidata 80, 82, 83, 92, 93	\$1.45
Okidata 84	\$3.50

PRICE PROMISE: We will better any lower delivered price on the same products and quantities advertised nationally.

TERMS: FREE USE OF VISA & MASTERCARD. American Express also accepted. C.O.D. orders add \$3.00. **Shipping:** Add \$3.00 per 100 diskettes or fraction thereof. Other items add \$2.00 for disk storage or headcleaning kit or each multiples of 8 ribbons. P.O. accepted. Utah residents add 5 1/4% sales tax. Minimum order \$30.00.

TOLL FREE ORDER LINE:

1-800-233-2477
(1-800-AFFAIRS)
INFORMATION AND INQUIRIES:
1-801-942-6717

Computer Affairs, Inc. 2028 E. FT. UNION BLVD., #105 SALT LAKE CITY, UTAH 84121 CALL 1-800-AFFAIRS HOURS: 8AM-5PM M-F (Mtn. Time)

PC NETWORK

BUY HARDWARE AND SOFTWARE AT WHOLESALE + 8%, AND GET 14-30 DAY SOFTWARE RENTALS†...

In just the last few months, *The NETWORK* has saved its members more than \$24,000,000 and processed over 100,000 orders.

Listed below are just a few of the over 20,000 products available at our EVERYDAY LOW PRICES! All software below is priced in IBM-PC format.

The nation's largest corporations depend on PC NETWORK!

On our corporate roster are some of the nation's largest financial industrial and professional concerns including some of the most important names in the computer industry:

AT&T	General Motors
Barclays Bank	Gillette
Bell & Howell	Hewlett Packard
Citibank	Hughes Aircraft
Columbia University	IBM
Data General	ITT
Exxon	Kodak
Farm Bureau Insurance	Multimate
Frontier Airlines	United Nations
General Mills	Yale University
General Electric	Veteran's Administration

plus thousands of satisfied consulting firms, small businesses, user groups, municipalities, government agencies and value-wise individuals ACROSS THE NATION! Their buyers know that purchasing or renting from PC NETWORK saves them time, money and trouble. They also count on us for product evaluation, professional consultation and the broadest spectrum of products and brands around.

CALL TOLL FREE 1-800-621-S-A-V-E

In Illinois call (312) 280-0002
Your Membership Validation Number: B365

You can validate your membership number and, if you wish, place your first money-saving order over the phone by using your VISA, MASTERCARD or AMERICAN EXPRESS. Our knowledgeable service consultants are on duty Mon-Fri 8 AM to 7 PM, SAT 9 AM to 5 PM CST.

PERSONAL COMPUTER NETWORK
320 West Ohio
Chicago, Illinois 60610

Call now... Join the PC NETWORK and start saving today!

PC NETWORK • MEMBERSHIP APPLICATION

YES! Please enroll me as a member in the PC NETWORK™ and rush my catalog featuring thousands of computer products, all at just 8% above DEALER WHOLESALE PRICES. I will also periodically receive "THE PRINTOUT", a special up-to-date on merchandise at prices BELOW even those in my wholesale catalog, and all the other exclusive, money-saving services available to Members.

365

I am under no obligation to buy anything. My complete satisfaction is guaranteed. Please check (✓) all boxes that apply.

- | | |
|---|---|
| Basic Membership
With 14 Days Rental
<input type="checkbox"/> One-year membership for \$8
<input type="checkbox"/> Two-year membership for \$15 (SAVE \$1)
<input type="checkbox"/> Business Software Rental Library for \$25 add'l. per year—with 14 day rentals
<input type="checkbox"/> Games Software Rental Library for \$10 add'l. per year | Special V.I.P. Membership
With 30 Days Rental.
<input type="checkbox"/> One-year membership for \$15
<input type="checkbox"/> Two-year membership for \$25 (SAVE \$5)
<input type="checkbox"/> BOTH Business and Game Software Rental Libraries for \$30 add'l. per year—with 30 day rentals
*VIP members receive advance notice on limited quantity merchandise specials |
|---|---|

Bill my credit card: VISA MasterCard American Express

Account Number: _____
Exp. Date: _____
mo. year

Check or money order enclosed for \$ _____

Name _____ Apt. No. _____
Address _____
City _____ State _____ Zip _____
Telephone () _____
My computer(s) is: IBM PC IBM-XT IBM-AT Apple II
 Macintosh Other _____

Signature _____
(Signature required to validate membership)
Copyright © 1984, PC NETWORK, INC.

GAMES & EDUCATIONAL SOFTWARE

(Please add \$1 shipping and handling for each title ordered from below.)

	Wholesale	Wholesale	
Bluebush Chess (Your Toughest Opponent)	\$ 34.00*	Sierra On-Line King's Quest	\$ 27.00*
Bluechip Millionaire/Oil Baron or Tycoon	31.75*	Sierra On-Line Crossfire	18.00*
Broderbund Logo Runner	19.75*	Sublogic Night Mission Pinball	23.00*
CBS Goren-Bridge Made Easy	45.00*	Spinnaker Alphabet Zoo	15.97*
CBS Mastering the SAT	81.00*	Spinnaker Delta Drawing	24.97*
Hyden Sargon III	26.97*	Spinnaker Face Maker	15.97*
Infocom Zork or Witness	20.50*	Spinnaker Hey Diddle Diddle	15.97*
Infocom Deadline, or Suspended	27.00*	Spinnaker Kinder Comp	15.97*
Microsoft Flight Simulator	27.00*	Spinnaker Rhymes & Riddles	15.97*
Mouse Systems PC Paint-Turn your PC into A Color Macintosh!	59.95*	Spinnaker Story Machine	15.97*
Scarborough Mastertype	27.00*	Spinnaker Most Amazing Thing	20.77*
		Virtual Combinatics Micro Cookbook	21.00*

BUSINESS SOFTWARE

(Please add \$2.50 shipping and handling for each title ordered from below.)

ATI How to use Multimate	\$ 42.00*	Micro Pro Wordstar 2000	\$222.00*
ATI How to use Microsoft Word	42.00*	MicroRim RBase 4000	219.00*
ATI How to use Lotus 1-2-3	42.00*	Microsoft C Compiler	275.00*
Ashton-Tate Database III	310.00*	Microsoft Windows (Latest Version 2.0)	205.00*
Ashton-Tate Finestwerk	310.00*	Microsoft Multiplan	105.00*
Ashton-Tate Friday!	151.00*	Monogram Dollars & Sense	102.00*
Borland Side Kick (Protected)	26.00*	Multimate (Multiple Latest Version)	232.00*
Central Point Copy II PC	20.00*	Oasis The Word Plus	90.00*
Conceptual Instruments Desk Organizer	157.00*	Open Systems P/D Sales AIR/INV G/L AP Team Mgr	325.00* ea.
Digital Research CP/M-86	33.00*	Real World G/L AIR/PIR or OE/INV	387.50*
Digital Research DR Logo	57.00*	Rosoft Prokey Version 3	74.00*
Digital Research P/D Compiler	389.00*	Ryan McFarland RM COBOL (Dev. System)	570.00*
Digital Research Energraphics with Plotter Option	235.00*	Samna Most Amazing Thing	270.00*
FunK Software Sideways	34.00*	Satellite Software WordPerfect	209.00*
Harvard Business Project Manager	185.00*	Softcraft Fancy Fonts	125.00*
Howardsoft Tax Preparer 1988	177.00*	Software SET-EX	35.00*
Hayes Smartmodem - New VT 100 Emulator	68.00*	Software Publishing PFS: File	72.00*
Human Edge The Management Edge	137.50*	Software Publishing PFS: Report	64.00*
Human Edge The Sales Edge	137.50*	Software Publishing PFS: Write	72.00*
Human Edge The Word Processor	267.75*	Software Publishing PFS: Graph	72.00*
Human Edge Development Lotus 1-2-3	265.00*	The Software Group Enable	417.00*
Lotus Development Symphony	385.00*	TCS Total Ledger	440.00*
MDBS KnowledgeMan	245.00*	Verbatim Disk Drive Analyzer	25.00*

HARDWARE

(Please add shipping and handling charges found in italics next to price.)

Apple Macintosh Base System	CALL	Apparat 256K Memory Board with 64K	\$ 81.00* (1.75)
Apple Apple IIc	CALL	Apparat Combo II w/serial/port/game!	115.00* (2.48)
Apple Apple IIe	CALL		
Columbia Desktop & Portable Systems	CALL	Apparat AT Ram Expansion card	136.00* (2.50)
COMPAQ Hard Disk Portable	\$2,511.50* (54.24)	AST Six-Pack Plus with 64K	222.00* (2.50)
Compaq Hard Disk 2 Drive/256K	CALL	AST IO Plus II	120.00* (2.50)
DATA General DG ONE	1,999.00* (43.20)	AST Advantage for AT	CALL
128K/1 Drive "The Real Portable"	CALL	EVEREX Magic Card 64K	160.00* (2.50)
IBM PC Base System 20SD/PC/256K	1,495.02* (32.35)	Everex Magic Card 128K	CALL
IBM PC AT Base System 20SD/PC/256K	1,926.62* (42.87)	Everex Magic Card 256K	CALL
IBM PC/AT All Configs	CALL	ORCHID BIOS/GM W/64K	200.00* (2.50)
Sayno MBC 550 "Lowest Cost Compatible"	620.00* (13.39)	Quadram Improved Quadboard w/OK	199.00* (2.50)
Sayno MBC 775 Color Portable IBM Clone	1,775.00* (38.00)	Tezmar Captain Multifunction Card OK	146.00* (2.50)
2 Drives/Color Monitor/256K			
Texas Instruments Professional	CALL		

COMPLETE SYSTEMS

PC Network 10MB INTERNAL 1.2 Height	\$ 459.00* (9.92)
Autoboot Drive, New lower price	
Maxtor 140MB External Auto Booting Drive with Controller for PC	4,900.00* (106.00)
Maynard Mainstream 20MG Tape Backup	950.00* (20.52)
Maynard Floppy Disk Controller	92.00* (2.50)
Maynard WS-1 10MB Internal Hard Disk	770.00* (18.15)
Maynard WS-2 same as WS-1 but with Sandstar Floppy Controller (uses 1 slot)	930.00* (20.30)
Maynard Floppy Controller/Serial Port	145.00* (2.50)
Parasonic Half Height Hard Drive Pair	145.00* (3.10)
PC Network Half Height Drive Pairs	145.00* (2.48)
Our Volume Lets us Import These Name Brand Drives Direct from the Source	
Tandon TM 100 Full Height DSD/Drive	93.00* (2.20)
Tallgrass 25MB External/Hard Disk with 80MB Tape Backup	2,445.00* (46.44)
Teac FD 55-B Half Height DSD/Drive Pair	180.00* (3.39)
Western Digital Cobra Hard Disk Controller	175.00* (2.50)

DISK DRIVES & CONTROLLERS

64K Memory Upgrade Kits (9 chips)	\$ 13.05* (1.00)
64K Dynamic Ram Chips (Each)	1.45* (1.00)
256K Dynamic Ram Chips (Each)	5.75* (1.00)
128K AT Mother Board Chips (Each)	13.50* (1.00)
Anchor Mark XII	\$ 230.00* (5.00)
Anchor Volksmodem 300	47.00* (1.00)
Hayes Smartmodem 2400	568.00* (5.00)
LAT-EST IN COMMUNICATION TECHNOLOGY!	
Hayes Smartmodem 1200B with new Smartcom II VT 100 Emulator	325.92* (2.50)
Hayes Smartmodem 1200	361.25* (5.00)
Prometheus Promodem 1200	279.00* (5.00)
External 100MB Hard Disk Compatible	
U.S. Robotics Password 1200BPS "LWES" PRICE	215.00* (4.65)
U.S. Robotics Courier 2400BPS Modem	525.00* (5.00)

MEMORY CHIPS

64K Memory Upgrade Kits (9 chips)	\$ 13.05* (1.00)
64K Dynamic Ram Chips (Each)	1.45* (1.00)
256K Dynamic Ram Chips (Each)	5.75* (1.00)
128K AT Mother Board Chips (Each)	13.50* (1.00)

MODEMS

Amdex Video 300G Composite Green	\$ 110.00* (3.00)
Amdex Video 300G Composite Amber	120.00* (3.00)
Amdex Video 310A IBM Type Amber	130.00* (3.00)
Amdex Color 300 (NEW) Composite	215.00* (4.64)
Amdex Color 600 (NEW) High Res RGB	395.00* (8.53)
Amdex Color 700 (NEW) Ultra High Res	455.00* (9.83)
Amdex Color 710 (NEW) 700 w/Non Glare/Long Phosphor	485.00* (10.48)
Princeton HK-12 RGB Monitor	CALL
Princeton MAX-12 IGB Mono	CALL
Princeton SR-12 Ultra High Res RGB	CALL
Quadram Quadchrome - NEW! (800x600 RGB w/14" Screen)	370.00* (8.21)
Samsung 12" TTL IBM Type Amber	89.50* (5.00)
Taxan 420 Super High Res RGB Monitor	380.00* (8.21)
Taxan 440 Highest Res RGB (720x400)	525.00* (11.34)
Zenith ZVM-123 Green High Res (Consumer Reports Rated Best Buy!)	76.00* (2.50)

MONITORS

Hercules Color Card w/Parallel Port	\$ 145.00* (3.20)
Hercules Monochrome Graphics Cards	273.00* (2.50)
Paradise New Modular MultiDisk Card	244.00* (2.50)
Persyst Bob Card Ultra High Res Color Card with Mono Quality Text in Color	365.00* (2.50)
STB Graphics Plus II NEW! (Simultaneous Mono Graphics & Color)	235.00* (5.00)
Brand Name DSD Diskettes	\$ 14.00* (1.00)
Guaranteed for Life! Not Generic	
Duritas PC Pedestal II	32.50* (2.50)
PC Network Replacement 130 Watt IBM PC Power Supply - Gives your PC (Old or New) the same capacity as an AT Good for late in tape drives (without need for a piggyback unit) and large capacity disk drives.	9.99* (1.00)
SMA PC Document, Keyboard Templates for Lotus/DBASE/Multimate and others (Each)	17.00* (10.00)
WP Printer Paper 2600 Sheets Microline Perfs (invisible when torn)	

MULTIFUNCTION CARDS

Apparat 256K Memory Board with 64K	\$ 81.00* (1.75)
Apparat Combo II w/serial/port/game!	115.00* (2.48)
Apparat AT Ram Expansion card	136.00* (2.50)
AST Six-Pack Plus with 64K	222.00* (2.50)
AST IO Plus II	120.00* (2.50)
AST Advantage for AT	CALL
EVEREX Magic Card 64K	160.00* (2.50)
Everex Magic Card 128K	CALL
Everex Magic Card 256K	CALL
ORCHID BIOS/GM W/64K	200.00* (2.50)
Quadram Improved Quadboard w/OK	199.00* (2.50)
Tezmar Captain Multifunction Card OK	146.00* (2.50)

PRINTERS

Citizen MPS-10 NEW	\$ 310.00* (6.70)
180CPS/80COL/Fnc+Trac	
Citizen MPS-15 NEW	455.00* (9.83)
180CPS/80COL/Fnc+Trac	
Citizen MPS-20 NEW	440.00* (9.50)
200CPS/80COL/Fnc+Trac	
Citizen MPS-25 NEW	575.00* (12.42)
200CPS/80COL/Fnc+Trac	
C. Itoh F1040 Starwriter 40 CPS LQ	875.00* (18.90)
C. Itoh Prowriter 8510 AP	285.00* (6.16)
Comex CR-240 420 CPS DP/ILQ Printer From the Epson Organization	1,533.00* (33.12)
Epson LX 80 100CPS 80 COL LQ Mode	219.00* (4.73)
New Model!	
Epson FX 100	319.00* (6.90)
Epson FX 100+	453.00* (9.80)
Epson LQ1500	CALL
Epson IBM-to-EPSON Parallel Cable	21.00* (1.00)
NEC 180 180CPS LQ Parallel	615.00* (13.10)
NEC 2050 20CPS Letter Quality Printer	615.00* (13.10)
NEC 3530 35CPS LQ Parallel	1,125.00* (24.30)
NEC 3550 35CPS Letter Quality Printer	1,222.00* (27.22)
Okidata ML 102 NEW 1200CPS LQ	200.00* (4.33)
Okidata ML 192 NEW Sleek Design! 160CPS LQ Mode Fnc-IBM Graphics	340.00* (7.35)
Okidata NEW! Color 2060CPS/100+ Colors LG Mode IBM Graphics + More! Requires Interface	109.00* (2.35)
Okidata NEW! IBM Interface for Okidata, Color 20	69.00* (1.50)
Okidata ML/BP 200CPS 132 Col	620.00* (13.40)
Okidata ML/93P 160 CPS Wide Platen	550.00* (11.88)
Okidata 2410P Packmark 350CPS	1,640.00* (35.42)
Quime Sprint 1140 40CPS Letter Quality	1,155.00* (24.00)
Quime Sprint 1190 90CPS Letter Quality	CALL
New! Fastest Daisywheel Out!	
Quime IBM Cable and Interface (required)	72.00* (1.00)
Silver Reed EXP 400 10CPS Letter Quality	230.00* (4.99)
Silver Reed EXP 500 18CPS Letter Quality	280.00* (6.05)
Texas Instruments 855 DP/ILQ/Tractor	679.00* (14.70)
Toshiba P-1340 80 Col Version of P-1351	530.00* (11.45)

VIDEO CARDS

Brand Name DSD Diskettes	\$ 14.00* (1.00)
Guaranteed for Life! Not Generic	
Duritas PC Pedestal II	32.50* (2.50)
PC Network Replacement 130 Watt IBM PC Power Supply - Gives your PC (Old or New) the same capacity as an AT Good for late in tape drives (without need for a piggyback unit) and large capacity disk drives.	9.99* (1.00)
SMA PC Document, Keyboard Templates for Lotus/DBASE/Multimate and others (Each)	17.00* (10.00)
WP Printer Paper 2600 Sheets Microline Perfs (invisible when torn)	

*PC NETWORK Members pay just 8% above the wholesale price, plus shipping. All prices reflect a 3% cash discount. Minimum shipping \$2.50 per order. Personal checks please allow 10 working days to clear.

†RENT BEFORE YOU BUY — Members are eligible to join The NETWORK's Business and Game Software Rental Libraries and evaluate products for a full 14 (Regular) or 30 (VIP) days to see if it meets your needs. And The NETWORK's rental charges are far less than other software rental services—JUST 20% OF THE MEMBER WHOLESALE PRICE. We feature over 1,000 available titles in IBM/Apple/MAC and CP/M Formats. Hardware prices highlighted by ► reflect recent major price reductions.

COMPLETE IBM™ PC SYSTEMS

IBM PC BASE SYSTEM IBM PC w/256K

\$1,495.02* (32.55)

Floppy Drive Controller
2 Double Sided Double Density 320/360K Disk Drives
Your lowest cost starting point for the system of your choice. Combine it with any of the monitors, video cards, multifunction cards and accessories listed in this ad, and prove The NETWORK can't be beat.

IBM PC PROFESSIONAL HARD DISK SYSTEM IBM PC w/256K

\$1,906.62* (42.87)

Floppy Drive Controller
1 Double Sided Double Density 320/360K Disk Drive
w/Half Height Disk Subsystem.
Half Height 10MB Drive Allows Room
for Addition of Tape Backup in PC!
1½ times faster than XT
Automatic Hard Disk Boot Feature.

Increase productivity in any business or professional situation. The 10MB hard disk eliminates cumbersome floppy disk changes, simplifies operations and dramatically speeds program execution time. The NETWORK's buying power provides you with better than XT performance at a price lower than you'd expect to pay for a standard PC.

*PC Network Members pay just 8% above this wholesale price plus shipping. These prices have been prepared in April, 1985 and may have been changed with new product announcements. Call for latest prices.

CALL FOR
LATEST IBM
ANNOUNCEMENTS
CUSTOM
CONFIGURATIONS
WELCOME

COMPAQ™ HARD DISK SYSTEM (+)

PORTABLE HARD DISK SYSTEM w/256K/Floppy/10MB Hard Disk

\$2,511.50* (54.24)

FEATURED PRODUCTS!

64K MEMORY EXPANSION KITS.....\$ 13.05*

Set of 9 chips Guaranteed for Life. Quantity Discounts Available.

LOTUS 1-2-3 265.00*

DBASE III or FRAMEWORK Best Price!!! . 310.00*

INTERNAL PC 10MB HARD DISK..... 459.00*

Low Power Automatic Boot works on standard PC's. Includes drive/controller/cables/mounting hardware & instructions. Full one year warranty!

We use our clout with Brand Name suppliers like COGITO/MMI/Tandon/Fujitsu/Miniscribe/Shugart and others to bring you the best products at the Lowest Price in the Business! Call on the brand of your choice.

½ HEIGHT DS/DD DISK DRIVES.....145.00* (pr)

2 drives w/mounting hardware & complete instructions.

Just like our hard disks featured above. The Network buy's direct and makes fantastic deals with manufacturers like MPI/Tandon/CDC/Shugart/Qume/TEAC and others to bring you fantastic prices and Name Brand drives for your PC/AT/XT or Jr/or Compatible. Yes, this price is for two drives!!

EPSON PRINTERS Unbelievable Low Prices!!!

LX-80 80COL/100CPS219.00*

FX-80 80COL/160CPS319.00*

FX-100 132COL/160CPS453.00*

AST SIX-PACK PLUS w/64K 222.00*

Fantastic Price!!!

EVEREX MAGIC CARD/64K 160.00*

Full six Pack Features—Game Port included Extra Software
Fantastic Price!!!

HAYES 1200B 325.92*

with new Smartcom II/VT100 Emulator

BRAND NAME DISKETTES14.00*

DS/DD Box of 10 Guaranteed for Life Not Generic

TANDON TM100-2 FULL HEIGHT DRIVE 93.00*

AMDEK V310A IBM TTL AMBER 130.00*

STB GRAPHIX PLUS II235.00*

Both Mono and Color Card w/printer port. Run either Monitor type or both at once!
Gives 16 Colors w/Lotus.

*NETWORK members pay just 8% above these wholesale prices plus shipping

CALL TOLL FREE 1-800-621-S-A-V-E (orders and memberships only)

In Illinois call (312) 280-0002 validation code B365

TM—Registered trademark of IBM and COMPAQ

PC NETWORK

... WITH THESE 15 UNIQUE BENEFITS

1 COST + 8% PRICING—The NETWORK purchases millions of dollars in merchandise each month. You benefit in receiving the lowest price available and all at just 8% above published dealer wholesale price.

2 OUR 600 PAGE WHOLESALE CATALOG—Members receive our 600 page wholesale catalog containing over 20,000 hardware and software products for the IBM PC, APPLE and over 50 other popular computer systems. THE NETWORK'S CATALOG IS THE LARGEST SINGLE COMPILATION OF PERSONAL COMPUTER PRODUCTS AVAILABLE TODAY. NOW UPDATED QUARTERLY!

3 IN-STOCK INSURED FAST HOME DELIVERY—The NETWORK maintains a giant multi-million dollar inventory of most popular products, allowing us to ship many orders from stock. Non-stock items are typically maintained in local warehouses just days away from The NETWORK and YOU. We pay all insurance expenses on your shipment. EMERGENCY OVERNIGHT SERVICE IS AVAILABLE ON REQUEST.

4 10 DAY RETURN POLICY—If you are not satisfied, for any reason with any hardware component purchased from The NETWORK within 10 days of receipt, we will refund your entire purchase (less shipping) with no questions asked.

5 MEMBERSHIP SATISFACTION GUARANTEE—If for any reason you are not satisfied with your membership within 30 days, we will refund your dues IN FULL.

6 EXPERIENCED CONSULTANTS—The NETWORK hires consultants, not order takers, to aid you in product selection. Our consulting staff possesses in excess of 150 man years of personal computer product experience. We back our consultants with our money back guarantee: IF ANY PRODUCT RECOMMENDED BY OUR CONSULTING STAFF FAILS TO PERFORM AS PROMISED—WE WILL TAKE IT BACK AT OUR EXPENSE FOR A 100% REFUND.

7 FREE TECHNICAL SUPPORT—The NETWORK supports every product it sells. Our qualified TECH-SUPPORT staff will help you assemble your system, interpret vendor documentation and get your software and hardware to work. WE WILL GIVE YOU ALL THE HELP YOU NEED, WHEN YOU NEED IT—FREE!

8 OPTIONAL BUSINESS RENTAL LIBRARY—All members can join our BUSINESS RENTAL LIBRARY featuring over 1000 available titles for just \$25 PER YEAR above the base membership fee. This entitles you to rent business software AT JUST 20% of the DISCOUNT PRICE FOR A 14 DAY PERIOD. If you decide to keep the software, the entire rental fee is deducted from the purchase price. VIP MEMBERS GET A FULL 30 DAYS for just \$30 above the V.I.P. base fee. This also includes the game library privileges for a \$5 combination savings.

9 OPTIONAL GAME SOFTWARE RENTAL LIBRARY—The Game Rental library is available to members for just \$10 PER YEAR and permits evaluation (or just enjoyment) of any game or educational software product as above.

10 SPECIAL SAVINGS BULLETINS—THE PRINTOUT—Issued Quarterly at no charge to Network members only! The Printout contains all the New Product listings and price changes you need to keep your Catalog up to date. Also, we buy excess dealer inventories, and store bankruptcy closeouts, which we turn around and make available to our members at fantastic savings via THE PRINTOUT.

11 DISCOUNT BOOK LIBRARY—Working with numerous publishers and distributors, The NETWORK has assembled a library of over 1000 computer related books and manuals at savings of up to 75% from the normal store price.

12 MEMBERSHIP REFERRAL BONUS—Our most valuable source of new members is you! To date almost 40% of our members have been referred by word of mouth from other satisfied members. For those of you who refer new members, The NETWORK will credit a cash bonus to your account applicable to any future purchase.

13 CORPORATE ACCOUNT PROGRAM—Almost 50% of The NETWORK's members are corporate buyers and users (see opposite page left). The NETWORK can establish open account status and assign designated account managers to expedite orders, and coordinate multiple location shipments.

14 QUANTITY DISCOUNTS—For large corporations, clubs, and repeat or quantity buyers The NETWORK can extend additional single order discounts, when available to us from our manufacturers and distributors.

15 PRICE PROTECTION—The PC Industry is crazy!! Prices change not yearly or monthly or even weekly but often day by day!! These changes are sometimes up but are mostly down!!! THE NETWORK GUARANTEES THAT IN THE EVENT OF A PRODUCT PRICE REDUCTION, BETWEEN THE TIME YOU PLACE YOUR ORDER AND THE TIME THE PRODUCT SHIPS YOU WILL ONLY PAY THE LOWER AMOUNT!!

Here's The Savvy-est True Dual Trace 10 MHz Digital Storage Scope You Ever Saw ... At The Saving-est Price. Only \$595.

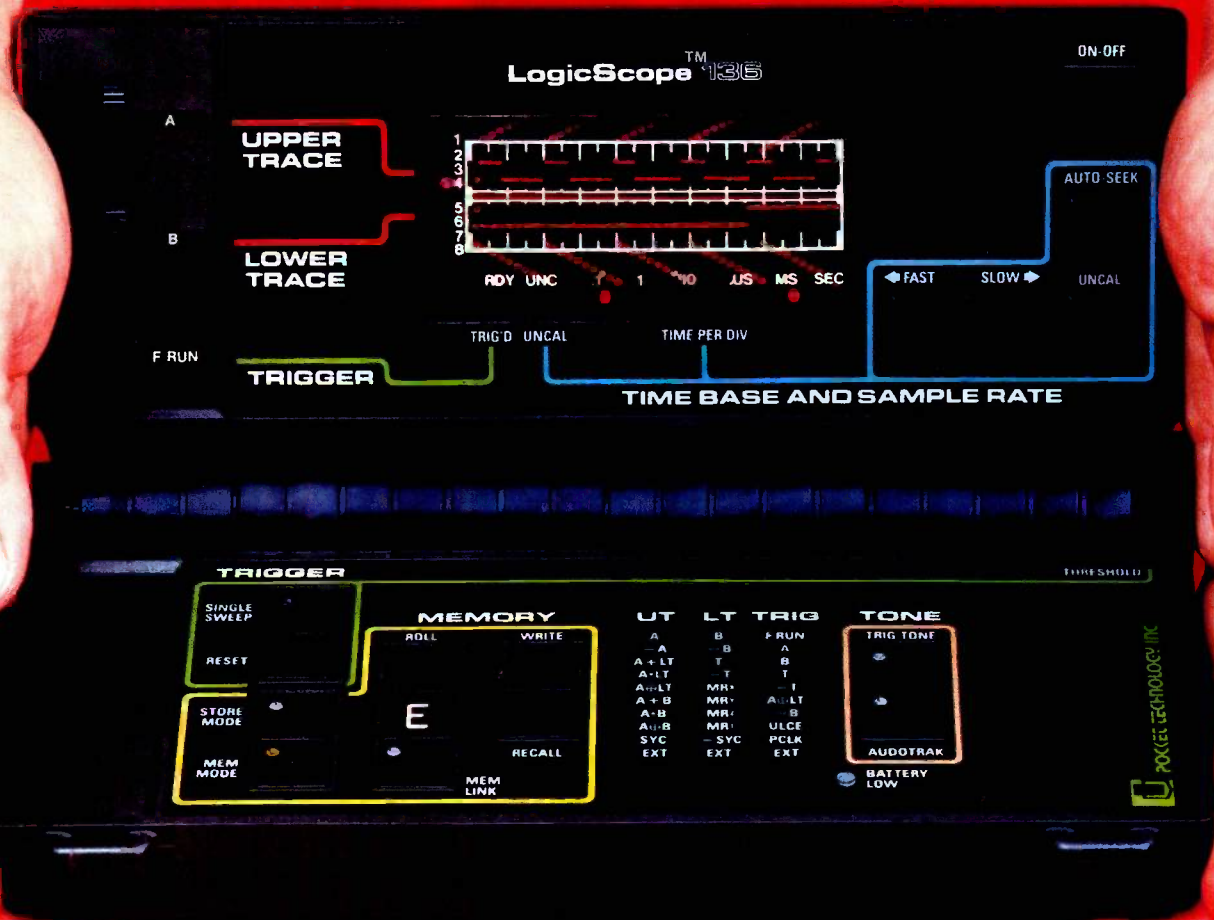

The Handy New LogicScope™ 136

True Dual Trace • 10 MHz Real Time Bandwidth • 3 Input Channels • I/O Port
 Digital Waveform Storage • Boolean Waveform Operations • Audio Functions
 8.0 (L) x 4.5 (D) x 1.75 (H) Inches • 1.25 Pounds • 9 Volt Battery/AC Operation

Consider the LogicScope 136

- The LogicScope 136 is the next logical step in test instrumentation for you. It combines many of the features and capabilities of sophisticated logic analyzers and oscilloscopes . . . and it fits in your hand. Never before has so much technology been available in so small an instrument, at such a low price.
- The pocket-sized LogicScope 136 is made possible by a patented breakthrough in display technology. The conventional CRT has been replaced by a unique array of 400 LED's that permits simultaneous display of two digital waveforms.
- The 136 can be used for viewing single shot events, or repetitive waveforms. It can be operated in real time mode, or in memory mode which permits acquisition and storage of up to 50-100 bit waveforms. These can be recalled, logically compared (AND, OR, EXCLUSIVE OR) to other input waveforms, or output to an external device via an I/O port. This I/O port will also accept future add-on 136 Modules.
- Its very low cost, convenience and ease-of-use make the LogicScope the ideal instrument, for designing, troubleshooting or repairing digital systems. Made in U.S.A.

Consider its Engineering & Field Service Applications:

- On microprocessor-based systems, check the timing relationship of various parameters relative to the system clock and other key events. Its storage capability allows visual and logical comparison of non-repetitive waveforms to known reference signals. Output in the start-up of the digital device can be compared to reference signals to determine the operating state of the device. Questionable waveforms can be stored for analysis.
- Its light weight and small size make the LogicScope convenient to take on every service call. The 136 provides much more information for trouble shooting a digital system or peripheral than a logic probe or digital counter without having to lug an oscilloscope or logic analyzer along.

Contact us for the name of your local distributor



POCKET TECHNOLOGY, INC.

7320 Parkway Drive, Hanover, MD 21076 U.S.A.
 301-796-3300 TELEX 908207
 Division of Renaissance Technology Corp.

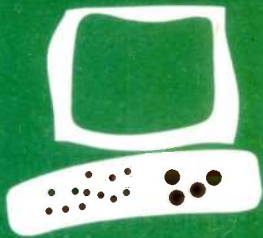

The IBM Quietwriter Printer

Quietly
elegant
output

BY JON R. EDWARDS

Most letter-quality printers I have used are slow, loud, and expensive. IBM's new Quietwriter printer (see photo 1) is not inexpensive at \$1395, but it is neither slow nor loud.

The unidirectional printer uses an innovative thermal-transfer process to simulate letter-quality printing while maintaining excellent font flexibility, acceptable speed, and a conspicuously quiet performance that justifies its name. For some users, the printer's most important feature will be the cartridge-based fonts, each of which can generate letter-quality output of the entire IBM character set.

DESCRIPTION

The IBM Quietwriter is large, solid, and well constructed. It measures 21 by 6 by 14½ inches and weighs 22 pounds without the optional pinwheel form feeder. The housing is an off-white, high-impact plastic. The front of the unit includes five membrane keys, five LEDs (light-emitting diodes) to indicate the status of the printer, and 10-, 12-, and 15-character-per-inch (cpi) rulers. The on/off lever is on the top left. To the right are the paper-release lever and the paper bail.

The Quietwriter, which comes with a standard Centronics-compatible parallel interface, uses unidirectional printing with friction paper feed and a special IBM Quiet noncorrecting ribbon. The maximum printing width is 13 inches. The Quietwriter has no option for a serial interface.

Unlike other thermal-transfer printers with print heads that apply heat to the ribbon, the Quietwriter applies an electrical current to the ribbon, which heats internally. The technique, which IBM calls a resistive-ribbon thermal transfer, apparently speeds the printing because the print head does not need to cool between characters.

The print head contains 40 vertical circuits that form characters in a dense matrix as the carrier assembly moves across the page (see photo 2). In 10 pitch, the matrix is 36 by 40; in 12 pitch, it is 30 by 40; and in 15

pitch, it is 24 by 40. The print head presses against the ribbon, selectively forcing the four-layer ribbon to release ink in response to pinpoints of current. A polymer material heats up in the pinpointed areas. A metallic conducting layer then melts a third layer (another polymer), which releases the fourth layer, the film of ink. The technology allows for correcting ribbons, although the age of word processing does not require them.

The printing process is amazingly quiet. Carriage returns are the loudest part of the operation, save for the three warning beeps that occur when the printer runs out of ribbon, runs out of paper, or cannot sense the font. The beeps effectively gain the user's attention, but I'd prefer a quieter warning more in keeping with the printer's name.

The five membrane keys on the front of the printer are easy to read and use. The Stop and Start buttons control on-line and off-line status. The other front buttons (Paper Up, Paper Down, and Form Feed) function when the printer is off line. Also, when the printer is off line, the Stop button becomes a Code button that provides a second, related function when used in conjunction with the other buttons; Paper Up and Paper Down work incrementally (rather than continuously), and Form Feed becomes Form Feed Set.

All the keys work properly and easily. However, the only way to clear the buffer, which holds about a page of text, is to turn the printer off and then on again.

Technically, the Quietwriter is a dot-matrix printer but its characters appear as clear and clean as most letter-quality output (see figure 1). All the characters are well formed; the dense matrix permits pleasant fonts with impressive curved detail on many characters.

Currently, IBM offers four fonts for the Quietwriter: Prestige (15-cpi), Prestige Elite (12-cpi), Courier (10-cpi), and Bold-face (12-cpi), which provides proportional

(continued)

Jon R. Edwards is a technical editor for BYTE. He can be contacted at POB 372, Hancock, NH 03449.

spacing. It's simple to insert the fonts, which come in matchbox-size cartridge form, and you can switch between two installed fonts with a command from the computer. The printer has two font holders; even when not in use, the second font holder provides handy storage. The printer gives visual and audible warnings if fonts are improperly installed.

Printing speed depends upon the font. Benchmark tests, which involved printing 4000 characters (50 lines of 80 As each; see "The Art of Benchmarking Printers" by Sergio Mello-Grand, February 1984 BYTE, page 193), gave results of 25.2 characters per second (cps) for the 10-pitch font, 29.4 cps for the 12-pitch font, and 33.7 cps for the 15-pitch font. The times are well below press announcements of 40 to 60 cps, but the speeds are acceptable.

When you need to change the rib-

bon or if there are problems in the ribbon mechanism, the printer again gives audiovisual warnings, goes off line, and gives you a chance to change or fix the ribbon. The \$12 ribbons are encased in sturdy plastic.

At first I had some small problems with the ribbon, which tended to form a crease at the top and occasionally cut off the tops of letters. I quickly became proficient in loading the ribbon properly and keeping it taut during installation, but I noted that the creased ribbon did not activate the ribbon warning. Changing the ribbon, at first a chore, now is quick and simple.

The paper bail rolls the paper into the printer quickly and easily, but I miss having a roller knob to give me more direct control over the platen. The addition of the optional pinwheel form feeder would obviate the need to load paper before every use.

This is the COURIER font (10 pitch)
 This is the PRESTIGE ELITE font (12 pitch)
 This is the PRESTIGE font (15 pitch)
 This is the BOLDFACE font (12 pitch)

Figure 1: Samples of printout from the IBM Quietwriter using the four available cartridge fonts.

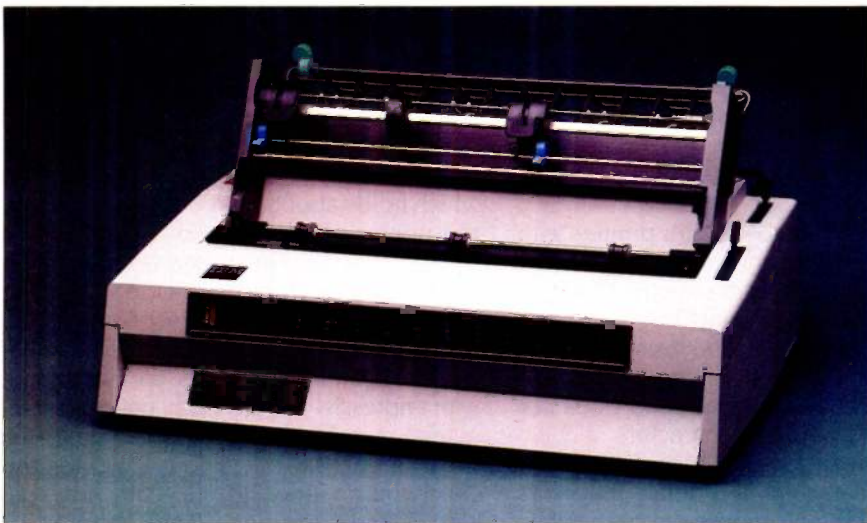

Photo 1: The IBM Quietwriter with the optional pinwheel form feeder attached.

The printer offers a contrast control switch with three settings to allow for changes in paper, ribbons, or climate (see photo 3). I got the best results with the contrast control set in the highest position. In the lower positions, using standard white printer paper, characters were unevenly thin or thick, and parts of some characters occasionally did not print. In the highest setting, I experienced the same problems but quite rarely. The final output was always very good. Note that different contrast settings have no effect on the benchmark times for each font.

IBM claims that print-head life is optimized on the lower contrast settings, and that the higher position causes the print head to wear out sooner. The latter might be the price users have to pay for acceptable printer output. New print heads cost \$20. IBM recommends using its Quiet cleaning cartridge to preserve the head's life, which IBM rates in excess of 4,000,000 impressions.

Through the use of printer control codes, the printer allows switching between fonts, superscripting and subscripting, setting and clearing of horizontal and vertical margins and tab stops, and variable line feeding. I had no difficulty subscripting, superscripting, or underlining using PC-Write. To print in boldface, you have to use the appropriate control code to switch to the separate boldface font (available only in 12 pitch).

Without the optional pinwheel form feeder, printing multipage documents is likely to require the auto-stop function, which stops the printing at the end of every page. You only order the function once; it remains active until the computer resets the printer or you turn it off.

OPTIONS

Serious office use will require the Quietwriter's optional pinwheel form feeder (\$75), which supports forms with widths between 3 and 15 inches. The form feeder is easy to install and use. It locks directly onto the platen shaft and has a cable that plugs into

(continued)

AT A GLANCE

Name

IBM Quietwriter printer

Manufacturer

IBM National Distribution
Division
1000 Westchester Ave.
White Plains, NY 10604
(800) 426-2468

Type

Dot-matrix printer with letter-quality output

Size

21 by 6 by 14½ inches

Weight

22 pounds

Computer

IBM Personal Computer or compatible with a Centronics-type parallel interface

Features

The printer buffer holds 1800 characters. All four cartridge fonts, including Courier (10 pitch), Prestige Elite (12 pitch), Prestige (15 pitch), and Boldface (12 pitch) print the entire IBM character set. Ribbons have an approximate capacity of 160,000 characters depending on pitch used. Supports underlining, subscripting, and superscripting

Documentation

120-page guide to operations

Price

\$1395

Options

Pinwheel form feeder \$75
Additional fonts \$50 each
Additional ribbons \$12 each
Additional print heads \$20 each

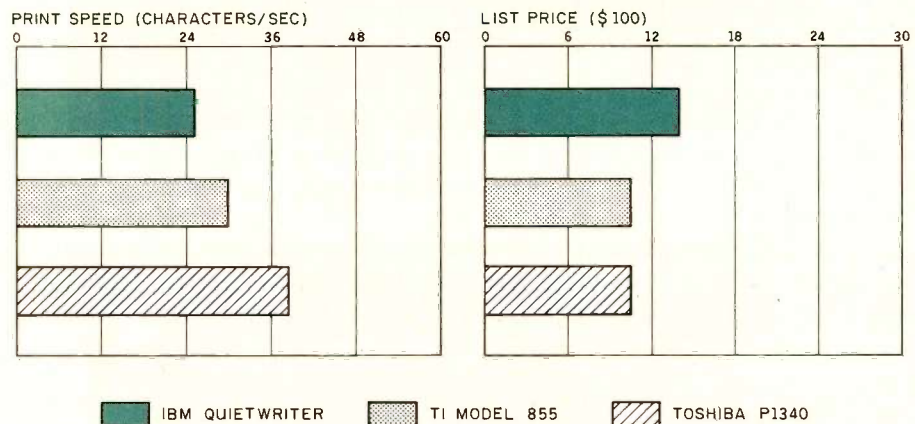
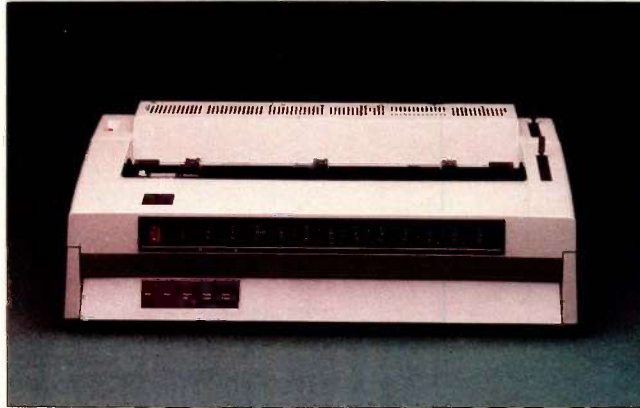

This is the IBM QUIETWRITER printer.

This is the Texas Instruments Omni 800/

This is the Toshiba P1340 in high-quality

A comparison of the Quietwriter printer with the Texas Instruments Omni 800/Model 855 printer (see January BYTE, page 345 for review) and the Toshiba P1340 printer, both in letter-quality mode. The pitch for all the printers is 10 characters per inch. The print speeds were

determined by timing how long it took the printers to print 50 lines of 80 As each. The prices shown are list prices. The price for the Quietwriter does not include the optional pinwheel form feeder.

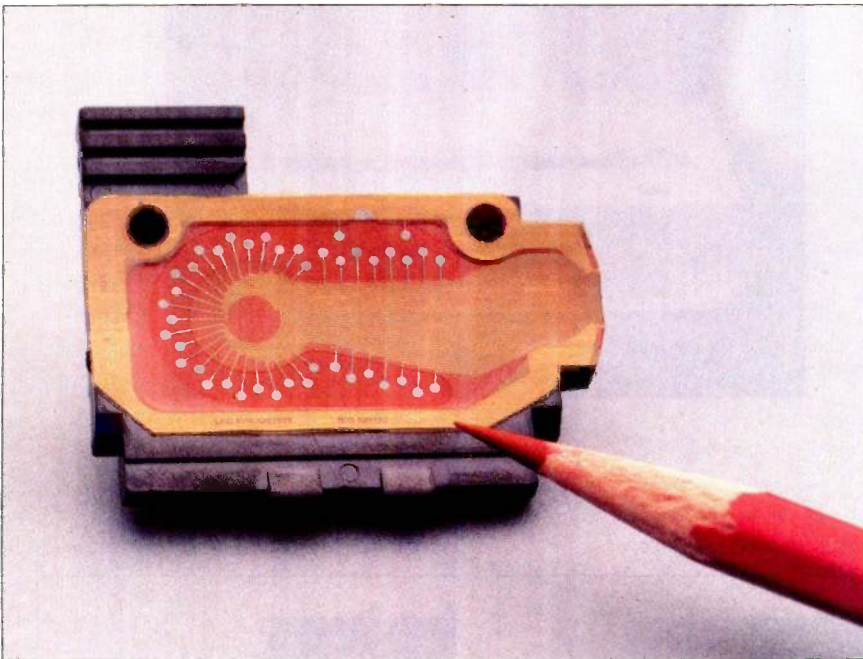

Photo 2: A close-up of the IBM Quietwriter print head; 40 circuits press against the ribbon to form a dense matrix as the carrier assembly moves across the page.

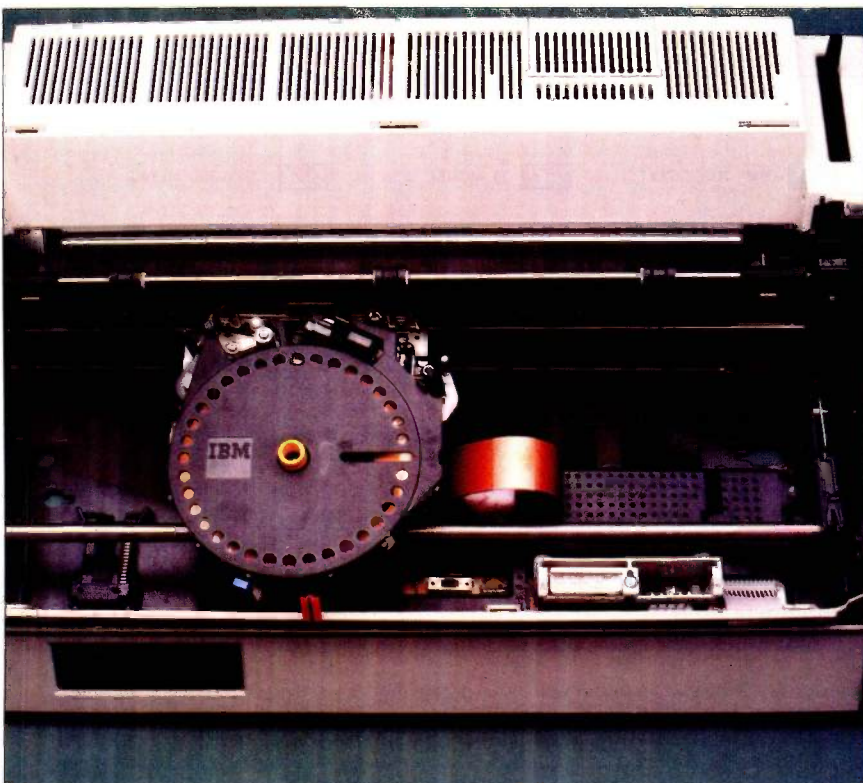

Photo 3: The inside of the IBM Quietwriter. The fonts are at the lower right. The contrast control and DIP switches are in the middle.

a connector on the rear of the printer.

You must use the Paper Up key and not the paper bail to move paper with the form feeder, but there are easy-to-follow instructions for inserting paper. It is important to follow the instructions carefully. For example, if the paper-release bail remains shut, paper will gradually pull and tear off of the pinwheels. The manual, however, contains proper cautions. IBM says it will provide a cut-sheet feeder for the printer in the second quarter of 1985. Its estimated cost is \$350.

With the optional pinwheel form feeder attached, a light warning comes on when the printer senses the end of continuous form paper. The printer beeps loudly, goes off line, and waits for more paper.

The documentation is adequate, with simple, well-illustrated instructions for unpacking and assembling the printer. There are adequate sections on most aspects of printer operation. A "Problem Determination Procedures" section helps you diagnose problems. An appendix lists all the printer control codes, the escape codes used by word processors to engage the printer's functions. To engage these functions from a BASIC program, use LPRINT with the required escape character codes.

There are easy instructions for changing the DIP-switch settings to accommodate, for example, paper length and width. The switches are conspicuously located left of the font holders, but I would prefer a larger switch to regulate paper width. The printer's self-test, in addition to printing the entire font, prints out the DIP-switch settings—a useful feature.

CONCLUSIONS

The Quietwriter's main strength is its combination of acceptable letter-quality print, reasonable speed, and merciful quiet. Undoubtedly, many offices could not sacrifice one of the three. Others might welcome letter-quality output of the entire IBM character set. Those who require letter-quality printouts of program listings might find an answer in the IBM Quietwriter. ■

Able to leap tall buildings...



Standard unit:

	A Leading Brand	Basic Time BT/AT
Microprocessor	Intel 6 MHz 80286	Intel 6 MHz 80286
User memory	512 Kb RAM [enhanced model]	640 Kb RAM
System expansion	8 I/O/ slots	8 I/O slots
Floppy disk drive	1.2 Mb [read only 360 Kb]	1.2 Mb [read/write 360 Kb]
Hard disk drive	20 Mb [enhanced model]	44 Mb
Serial ports	1	2
Parallel ports	2	2
Keyboard	84 keys	84 keys
List price	\$5795	\$4495

Options:

128 Kb RAM	\$350	included
Monochrome/printer adapter text/graphics [720 x 348]	250	included
Monitor [12" green]	275	included
Tilt/swivel base	69	included
MS-DOS Software	65	included
Total price	\$6804	\$4495

Basic Time AT Enhancements

BT70 (70 Mb) internal hard disk
 BT60 Streamer (60 Mb) tape backup
 Color/graphics adapter card.
 AT4X4 Plus Multifunction Board

Dealer/Reseller Hotline

Inside California
(800) 841-2474
 Outside California
(800) 323-8437

basic time

3350 SCOTT BLVD • BLDG 52 • SANTA CLARA • CA 95054

(408) 727-0877

WHAT'S FAIR DINKUM VALUE?

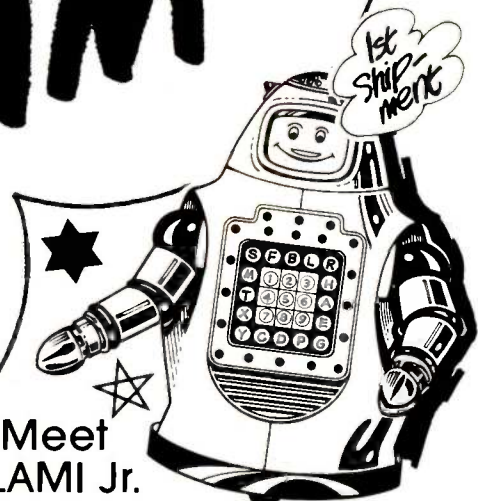

Meet ELAMI Jr.

Latest Robotic Technology Amazing Low Price

Elami Jr. can be happy, sleepy, angry or sad. He has a 190 word english vocabulary - you can program words and sentences. He'll move left, right, forward and backward in a series of programmed moves. 12" tall with blue eyes, an individual security code makes him just yours to command. Cat Y-2000

ONLY \$149⁰⁰

For the technically minded
8 bit microcomputer, custom designed, built-in 2K ROM and 1/2 K of RAM for storing and operating of programs, plus 16K of ROM and 1/2 K of ROM, for speech processor.

Now's the time to get into satellite TV!

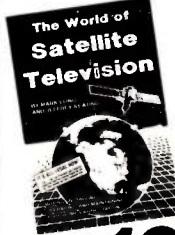

\$10⁹⁵

THE WORLD OF SATELLITE TV

Tells you all you need to know about selecting, installing and trouble shooting a system. Complete with maps, charts and satellite 'foot prints' so you'll know what's up there and how to find it. Mark Long and Jeffery Keating. 224 pages. Cat B-1842

HOME SATELLITE TELEVISION

Is home satellite TV worthwhile? What about equipment, cost and legal restrictions? This book will answer all your questions and be a valuable source system. Cook & Vaughan. 326 pages. Cat B-1840

\$13⁵⁰



When Australians say 'Fair Dinkum' about something, they mean; that's it, the genuine article, true blue, ridgy didge, absolutely true. It could refer to a story, or a person; like a 'fair dinkum mate' is a true friend or, as in our case, the value you get when you buy from Dick Smith Electronics. Fair dinkum value because:

- You will be served by dedicated electronics enthusiasts
- We buy directly from the manufacturer so save agents' and middle-man commissions.
- We have thousands of exciting new and unique products
- We keep our overhead costs down and pass it on in lower prices to you

IT'S FAIR DINKUM VALUE!



MOTORCYCLE INTERCOM

BIKERS - No more shouting against the wind

This intercom fits snugly under your helmet and detaches instantly in case you are separated from your partner. Communicate in comfort while you ride.

Cat F-1000 **ONLY \$39⁹⁵**

AMAZING LOW PRICE

DICK SMITH'S FUNWAY INTO ELECTRONICS GIFT PACK

NO SOLDERING REQUIRED

Contains the famous introductory Funway Into Electronics Vol. 1 which starts off from the very basics of electronics and shows you how to make 20 different projects, including Transistor Tester, Beer Powered Radio, Light/Dark Indicator, Electronic Siren, Radio Receivers, Music Maker and many more. Book and all components included. Cat K-2605



ONLY \$24⁹⁵

Like what you see? Our new catalog (out in June) will have 1000's more fascinating products.

Mail this coupon today along with \$2.00 for the catalog and \$1.00 for shipping and handling and be among the first to receive our massive, goody packed, 132 page ELECTRONICS ENTHUSIASTS' CATALOG and ask about the draw for a TRIP TO THE LAND DOWNUNDA FOR 2 PEOPLE FLYING QANTAS

Name.....

City..... State..... Zip.....

Mail to: Dick Smith Electronics, Inc.
PO Box 2249 Redwood City CA 94063

A quality LCD Multimeter that measures capacitance as well 3 1/2 digit display

ONLY \$99⁹⁵



Very high accuracy full range digital multimeter. Complete with test leads, carry case and full instruction manual. Cat Q-1460

LOOK AT OUR PRICES FOR A PRO QUALITY SHOTGUN MIC

Use with your video or movie camera for high quality sound. Super directional response pattern allows you to pick out specific sound sources. Switch from super cardioid to uni-directional for long or short range. Cat C-1069

\$59⁹⁵



WHY PAY MORE?

20 more fun projects to build in **FUNWAY 2** VOLUME 2

Building the projects in Funway 2 will teach you how to solder onto PCB's and use a multimeter. All useful projects too. Cat B-2605

ONLY \$6⁹⁵

Now your into IC's **FUNWAY 3** VOLUME 3

When you've worked your way through Volumes 1 & 2 you're ready for the more complex projects described in full detail in this book. Then you could be ready for a job in electronics. Cat B-2610

ONLY \$6⁹⁵

DICK SMITH ELECTRONICS

INCORPORATED IN THE STATE OF CALIFORNIA



AMAZING VALUE!

ALMOST A COMPLETE TEST BENCH

Dick Smith **MULTITESTER**

ONLY \$69 No wonder this is our best selling multimeter! A 100k/ohm per volt, high sensitivity, full range multimeter with TRANSISTOR AND CAPACITANCE CHECKER. Strongly made for field work as well as service bench or lab. Cat Q-1140

CHECK OUT OUR FULL RANGE



LISTEN TO THIS! **AUDIBLE CONT. TESTER DICK SMITH MULTIMETER**

\$19⁹⁵ A compact, reliable multimeter with the added bonus of a built-in buzzer for convenient continuity testing! PLUS battery checker and 100C range - not usually found on low priced meters. • 19 ranges plus dB • 20k ohm/volt sensitivity and large banana plugs for sure contact. Cat Q-1022

The high internal resistance of these meters means that they won't load the circuit you are testing.

OUR MOST POPULAR METER

MAKE YOUR OWN PCB'S & PANELS

EXCLUSIVELY FROM DICK SMITH ELECTRONICS

SAVE \$10

QUALITY ELECTRIC CAR AN TENNA

WILL BE \$24⁹⁵

SPECIAL \$14⁹⁵

Cat A-7360

CHECK OUR PRICES!

26 WAY IDC UNIVERSAL CABLE

We buy this cable by the mile direct from the manufacturer to get the lowest possible price so check our prices before you buy.

46¢/ft Cat W-2750 Also 34 way Cat W-2752 60¢/ft

DON'T RISK DROPOUTS! XIDEX Precision flexible disks

This new range of XIDEX precision disks offers you a level of quality and reliability previously unknown. An extra 18 critical tests ensure that all disks easily exceed the ANSI specs for 96 TPI high density recording.

Cat X-3512 Box of 10 single sided, double density SOFI/S \$39.95 ea
BUY BULK AND SAVE - 10 boxes \$29.95 ea
Cat X-3514 Box of 10 double sided, double density SOFI/S \$49.95 ea
BUY BULK AND SAVE - 10 boxes \$39.95 ea

BIG 10" X 12" SHEETS

PHOTOSENSITIVE FILM

Use to reproduce PC patterns, dial scales etc. Use with photo resist or SCOTCHCAL™ aluminium panels. Cat H-5690 \$4.95

PHOTOSENSITIVE ALUMINIUM SHEET

Self adhesive aluminium sheet with either red or black emulsion. Make your own professional panels.

Red Cat H-5692 \$6.95 per sheet
Black Cat H-5694 \$6.95 per sheet
Scotchcal Developer for use with either film or aluminium sheet Cat H-5696 .95¢

Lost your keys again? JUST WHISTLE!

That's right, with one of these little beauties next time you misplace your keys just whistle and it will beep right back at you. A great conversation starter too! Cat Y-1070

ONLY \$17⁵⁰

LOOK AT OUR AMAZINGLY LOW PRICE! **GAMMA™ FD100C FLOPPY DISK DRIVE** FOR APPLE® IIC COMPUTERS

Media: Standard 5.25" single sided floppy diskette • Track Density: 48 lpi
Tracks/Diskette: 40 • Sectors/Track: 16 • Bytes/Sector • Capacity: 160K bytes
Disk Rotation Speed: 300 rpm • Track to track access time: less than 12msec.

LIST PRICE \$199
PRICE \$129

ONLY \$129

• Low cost
• Precise band positioner
• Track00 sensor design eliminates recalibrate noise
• Reliable data read/write
• 42 msec track to track access time
• 160K bytes storage capacity

APPLE® is a registered trademark of Apple Computer Inc. GAMMA™ is a registered trademark of Video Technology Ltd.

Here's how to find us

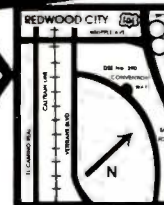

FAIR DINKUM VALUE

EVERYTHING FOR THE ELECTRONICS ENTHUSIAST

MAIL ORDER CENTER AND SHOWROOM:

390 Convention Way, Redwood City CA 94063

PO Box 2249, Redwood City CA 94063

Telephone: (415) 368 8844

Order Hotline: (415) 368 1066

Mail Order Customers: please use Cat No., product description and price when ordering. This ensures we get what you want out to you as fast as possible.

IF YOU'LL AGREE - IT'S FAIR DINKUM VALUE!
ORDER NOW
(415) 368 1066
Californian residents add 6 1/2 %

CORVUS INTRODUCES SHARED STORAGE. FOR THE REST OF THE OFFICE.



Without mass storage that every Macintosh can access, your networked office won't have a prayer.

Because you'll still have to share data by swapping floppies.

And just consider

how fast a floppy disk fills up with an entire workgroup compiling data.

To share information, you have to get those floppies neatly stacked, sorted and cataloged.

Something your computer should do for you.

Which is why we've introduced OmniTalk software. It lets you network your Macintosh Office and LaserWriter printer with an OmniDrive hard disk. So you can store all your files in one place. And share information whenever you want, with whomever you want.

Without turning your floppies into little frisbees. Several people can even access the same information at once—something

a floppy could never do. With OmniDrive and OmniTalk, your Macintosh Office has faster access to software and data, greater storage capacity, even easier back-up

capability. Plus, you get three levels of protection to keep your files safe. And with the Corvus 126MB hard disk, it all costs less per megabyte than any other system. You see, Corvus has more experience networking than anyone else. No one offers more, because no one can.

So take it from us. If you're going to add people to your new Macintosh Office, add the mass storage system that every-

one can use. OmniDrive from Corvus. Then your Macintoshes can really start talkin' business.

For more information, call (800) 4-CORVUS.



Macintosh is a trademark licensed to Apple Computer, Inc. LaserWriter is a trademark of Apple Computer, Inc. OmniDrive and OmniTalk are trademarks of Corvus Inc.



The Word Plus

An
easy-to-use
spelling
checker

BY GEORGE SHELDON

A spelling-checker program cannot replace a stern spelling teacher. But The Word Plus, from Oasis Systems, is the next best thing. This program, which sells for \$150, contains a 45,000-word dictionary. It is one of the older spelling checkers on the market. The Word Plus is available for most CP/M, CP/M-86, and MS-DOS computers in both 5¼-inch and 8-inch disk formats, and it is compatible with WordStar and most other major word processors. For this review I used it on my Kaypro 2.

The very idea of a spelling checker may seem to some people to be an unnecessary option. Most people who use a word processor are satisfied enough with the formatted text and easy editing their chosen software offers. For them, adding an electronic dictionary is like extra icing on a cake.

But owning a word processor and not using a spelling checker is like buying a brand new automobile without shock absorbers: You can use the car to get where you want to go, but getting there could be a whole lot smoother.

TWO TYPES OF SPELLING ERRORS

All electronic dictionaries, including the one incorporated in The Word Plus, have their limitations. This is caused by the fact that there are two types of spelling errors.

First, a word is simply misspelled because either the writer did not know how to correctly spell the word or the word was mistyped. With the determination of a bloodhound on a fox hunt, The Word Plus will search out and locate these kinds of errors.

Second, a word may be misused. This occurs with words like *there* and *their*. Both are spelled correctly but are misspelled when used in the wrong context. Unfortunately, a spelling checker cannot help with these types of errors. The reason is obvious: The word, according to the electronic dictionary, is spelled correctly. You are on your own to locate and correct these types of errors.

The Word Plus measures up to what is ex-

pected of a spelling checker. Not only does it find spelling errors, it helps to correct them. It works fast, and unlike other dictionaries, it checks spelling in one sweep of the document. This feature is what puts The Word Plus ahead of many other spelling checkers.

FOUR COMPONENTS

The package's strongest point is its modular design. Instead of being one large spelling checker, The Word Plus is made of four separate tools: Spell, Review, MarkFix, and TW.

Spell finds spelling errors. Review shows them to you and helps you correct them (more on this in a moment). MarkFix makes the corrections within the document. TW is similar to a batch program; Oasis Systems describes it as the "orchestra leader." It directs the other three programs to do the work. TW is a real time-saver, and you seldom run the programs individually.

Learning to use The Word Plus is as easy as operating it. The user's guide is 48 pages and fairly well organized, though it could be clearer. The instructions are complete enough so that a novice computer user could quickly operate the program.

Within seconds after you enter the program it asks the name of the file to check. It then begins the task of checking your document file against the contents of its master dictionary and also any special dictionary you may have created.

The Word Plus does seem to take a long time to check spelling, but in reality it is fairly fast. On my Kaypro 2, The Word Plus checked a 22-page, 5500-word chapter in 3 minutes 15 seconds. I doubt even a spelling teacher could work that fast.

As soon as Spell has completed its scrutiny of your document, TW brings the Review program onto your screen. Review presents each misspelled word along with a 10-option menu. Selections include the following: show the misspelled word in the

(continued)

George Sheldon is a freelance writer whose interests include country music and personal computers. He can be reached at POB 228, Hershey, PA 17033.

Now IBM AT Compatible

THE BRIEFCASE DATA BASE.

CARTRIDGE DATA MANAGEMENT COMES OF AGE.

Today's business microcomputers have generated an information explosion that today's data storage devices—including the highly-touted, high-capacity Winchester—have been ill-prepared to contain.



With one notable exception. The Bernoulli Box™ from IOMEGA. Available for the IBM PC, XT, AT, most compatibles, the TI Professional, and Apple's Macintosh™, the Bernoulli Box delivers unparalleled data base dynamics. Thanks to its removable 10-megabyte cartridges (5-megabyte for the Macintosh) and its proprietary removable disk technology.

And that, more and more, is what your business needs today. Not centralized, monolithic banks of information, but data

bases defined by job function and software application. Data bases that give people the versatility to work more productively.

But there is more. More performance and reliability. Transfer rates and access times faster than most Winchester. No head crashes ever. And cost per megabyte that Winchester cannot touch.

The Bernoulli Box's cartridge capacity, portability, and absolute interchangeability give your business more options. You can easily build primary data bases. You can package individualized data bases, software and all—for payroll, accounting, marketing—in convenient, dedicated cartridges. You can secure them quickly and economically in backup. And you can pack all of the data into a briefcase, an interoffice envelope, or even a file drawer.

For the dealer nearest you, call 1-800-556-1234 ext. 215. In California call 1-800-441-2345 ext. 215.

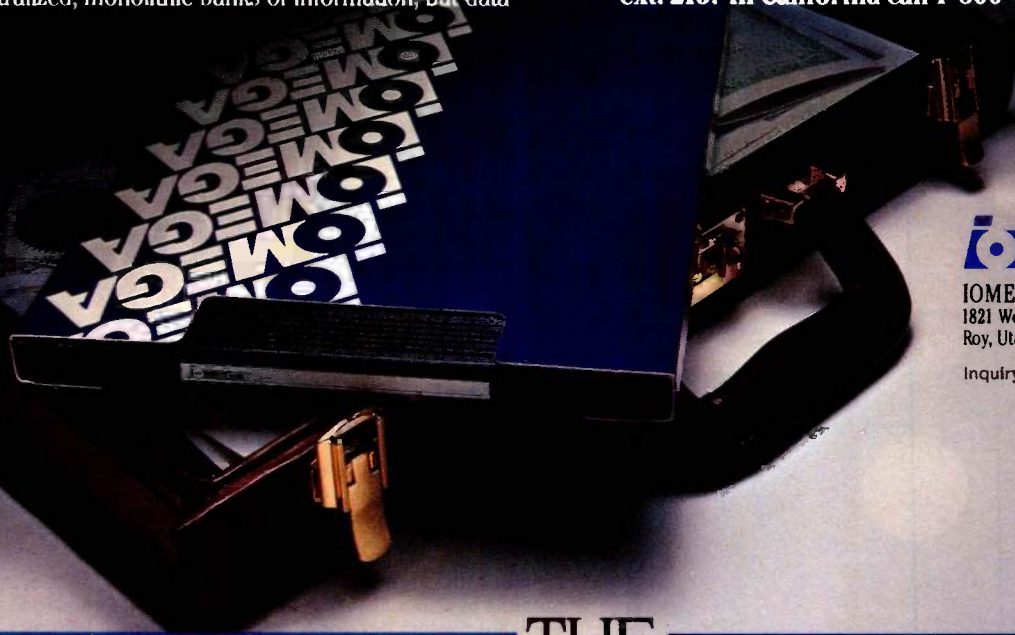

IOMEGA

IOMEGA Corporation
1821 West 4000 South
Roy, Utah 84067

Inquiry 226

THE
BERNOULLI
BOX™

*Often The Word Plus
sent me scrambling
to the dictionary to
check plural forms
I thought were correct
and found they were.*

aries, including one that has a limited vocabulary. This is ideal for a writer working on books for juveniles, where only a certain grade-level of words can be used.

PROBLEMS

There are, however, several things about The Word Plus that I do not like.

Its dictionary of a mere 45,000 words is small in comparison with other spelling checkers. I dislike the way the dictionary does not know the plural forms of some words. Often the program sent me scrambling to *Webster's Collegiate* to check plural forms I thought were correct and found that they were.

Also, there is a homonym helper that does not seem very useful. First you have to review a long list of homonyms: words like *to, two, too; capital, capitol; waiver, waver*. You then delete those words you know how to spell and use correctly. The program will then search your text and mark those words that cause confusion. Unfortunately, by the time you delete all the homonyms you know how to use, there are so few words on the list that running the program is useless. And, if you are having that much trouble with a certain homonym, you will

either learn how to use the word correctly or avoid it in your writing.

CONCLUSION

The Word Plus is compatible with several word-processing packages, including WordStar, PeachText, Word Master, Electric Pencil, and Perfect Writer. It operates on almost any 8080-, Z80-, or 8086-based computer and runs under MS-DOS or CP/M, as well as most variations of CP/M.

Although I've never admitted it, the real reason I bought my computer was for the spelling checker. I like The Word Plus. It's easy to use and easy to learn, and it *does* catch spelling errors. For a serious word-processor user, it will become as important as the word-processing software itself. For anyone who wants to make a finished document as perfect as possible, The Word Plus is worth the investment. ■

TESSy



\$19500

Corporate discounts available.
Price includes 12 month
updating service.

TERMINAL EMULATION SOFTWARE SYSTEM

VT100 4010
TM

- **FREE SOFTWARE UPDATES**
- Double height / double width, VT102™ support
- ANSI / ISO color command support
- Convenient help screens
- ASCII file transfers
- IBM / EPSON graphics printer support
- HERCULES, HAYES and KEYTRONICS support
- Monitor mode for data stream debugging
- "Smart" key assignments
- Extensive setup support

Enhance through-put of your IBM PC, XT™ AT™ or portable by using TESSY... the first Terminal Emulation Software System developed and optimized by a leading graphics terminal house. Unparalleled user productivity... 2 to 10 times faster than other emulators... data buffering from host while doing local processing... and much more.

ORDER TESSY NOW... CALL 1-800-633-2252, Ext 680

Satisfaction guaranteed or return within 30 days for full refund. Visa, Mastercard or C.O.D. accepted and we pay shipping.

Trademarks: VT-100 is a trademark of Digital Equipment Corp.
4010 is a product of Tektronix Corp.
IBM is a registered trademark of International Business Machines

ID SYSTEMS

CORPORATION
6175-W Shamrock Court • Dublin, Ohio 43017

All for one...





or one for all.



Presenting the IBM PC Network.

Now there's a way to tie your IBM PCs, PC/XTs, Portable PCs and IBM Personal Computer ATs together. So that everyone in the office can share information and hardware resources like printers and disk storage devices. Or simply send a message. To one or to all.

It's an economical solution.
And it's from IBM.

The pleasure of networking.

The IBM PC Network can support a wide variety of powerful programs. Better still, it can save both time and money.

It can cut down trips to the file room because the files are now electronic and on-line.

It can save time waiting for the copier or the interoffice mail, because messages can be sent from PC to PC.

It means you won't have to buy a printer or fixed disk storage device for every PC.

It's a good investment in a more efficient office.

The do-it-yourself connection.

It's an easy solution, too. Because the IBM PC Network comes in kits.

The kit you buy depends on how many IBM Personal Computers you want to connect (2 to 72) and how far apart they are. The cable in this local area network is the broadband type, virtually identical to that used for cable television.

So you don't have to be a technician to install the IBM PC Network. No fancy tools, no special experience needed.

And best of all...

As you grow, so grows your network.

Make your decision now.

And grow.

As your business expands and more people need to share information, you can add cable and connectors as you add more PCs to the network.

IBM PC Network Specifications

Adapter	with IBM cabling
16-bit 80188 microprocessor	Supports 256 stations within a
16-bit 82586 controller	1000-foot radius of translator
2 megabit RF transmission speed	with custom cabling
CSMA/CD access protocol	Cabling Components
5 kilometers maximum distance	75-ohm coaxial cable
to translator unit	1000 feet from translator unit
1000-station maximum network	maximum
16 active aliases per station	4 cable segments: 25 feet, 50 feet,
32 active sessions per station	100 feet, and 200 feet
6 MHz transmit/receive channels	Supports connection of up to 64
40 KB ROM, 16 KB RAM	additional IBM PCs
Translator	Operating System
Connection for 8 IBM PCs	DOS 3.1 required
Expansion capability	User Interface
Supports 72 stations within a 1000	IBM PC Network Program
foot radius of translator	SNA 3270 emulation

You can even set up the IBM PC Network to communicate with an IBM mainframe, using your PCs as terminals.

To start building your network, see your Authorized IBM PC Dealer, IBM Product Center or IBM marketing representative.

For more information on where to see the IBM PC Network, call 1-800-447-4700. In Alaska and Hawaii, call 1-800-447-0890.

IBM[®]



THE FLOPLESS FLOPPY

That's right. A StorageMaster® diskette is the one you can count on again and again for consistent performance. Because it's made beyond the standards by one of the world's largest manufacturers of storage media.

So if you won't settle for anything

less than extraordinary performance every time, reach for the flopless one. Reach for a StorageMaster diskette. For the location of your nearest distributor, see your local Yellow Pages or call toll-free 1-800-232-6789 ext. 370.

5018 Copyright © 1985 Control Data Corporation.

CONTROL
DATA

SUPPORT FOR SYMPHONY

I enjoyed reading a review as thorough and fair as the one written by Dick Pountain on Lotus's Symphony (January, page 317). With products of this complexity, a few inaccuracies creep in that might leave false impressions on the reader. I would like to point these out.

The Search/Replace functions of the word-processing window are case-sensitive only when you enter uppercase characters in the search string. Thus, the user has the choice. The user also can disable automatic rejustification.

Indented numbered or lettered subparagraphs are handled such that Symphony recognizes the characters (like a) b) c) or 1. 2. 3.) automatically and puts them to the left of the margin setting provided there is enough space. This is a very handy feature, and the user can always overrun and control it by using hard spaces.

While it is true that a number of features usually found in word-processing programs (like hyphenation) are missing, other features (like speed search with the End key or when selecting a block of text) were incorporated that make working with Symphony's word-processing windows very pleasant.

You cannot enter all Extended ASCII characters. Instead, Symphony uses its own extended character set called LICS (Lotus International Character Set). LICS does not contain the IBM PC's graphics characters, but it contains many characters found in different foreign languages. Symphony goes a long way to establish the correct telephone-book collating sequence and to materialize the characters on screen and paper. If necessary it even switches character sets between two characters on a dot-matrix printer.

The inability to display color graphs and high-resolution text on the same screen lies entirely within the Color Graphics Adapter. (Lotus recently hinted that it will provide a driver for the new IBM Enhanced Graphics Adapter.)

The communication function does provide a mainframe protocol. Symphony emulates an ANSI-compatible terminal so a PC running Symphony acts like a VT-100 or similar terminal. Thus, it is easy to in-

terface to a host providing ANSI signals (e.g., DEC mainframes or any other host with a suitable protocol converter) while at the same time filing transfers in both directions without the need to install any special software.

Symphony does use a rectangular "active area" beginning at the upper left cell A1. Whenever you enter something into the spreadsheet outside this area it automatically and invisibly expands to cover the newly used cell. When you erase such cells, the active area does not shrink. However, the spreadsheet is shrunk to its minimum required size whenever you save it to disk. It is not normally necessary to use XTRACT.

Be aware that even an erased cell can keep your active area expanded if it contains formatting information or an allow-changes setting. (To find the lower right corner of your active area, press the End and Home keys.)

While "sparse matrix" storage methods would certainly save some memory under certain circumstances, Lotus's method contributes to the program's speed. Note that it outruns nearly all its competitors, often by a factor of three or more.

HANS-GEORG MICHNA
Munich, West Germany

HP'S THINKJET

Your article on the HP ThinkJet printer by Mark Haas (January, page 337), while well done, left out some information a prospective buyer should know. I've owned one and used it heavily for four months.

Mr. Haas perhaps misleads your readers about the paper required by the ThinkJet, saying "the ink will bleed on paper that is too absorbent—roughly equivalent to writing with a fountain pen on tissue paper." This implies that the special HP paper isn't very absorbent. The exact opposite is true. If you write on HP paper with a medium- or wide-line pen, you can see the ink bleed through. The back of the HP paper should be, but isn't, treated to resist such wicking.

The ThinkJet cannot print acceptably on any paper that is not highly absorbent. From trials, I conclude that the tiny globules of ink expelled by the ThinkJet must

spread by absorption to form a legible character. If the globules come to rest on a relatively impermeable surface, they remain at original size—much too tiny to form characters of acceptable width.

I agree with Mr. Haas that the ink cartridge is reliable even if not used for a week or more. HP apparently employs ethylene glycol to keep its ink from evaporating. Unfortunately, the glycol creates a serious problem: The ink is not fast and it remains forever water-soluble.

Next, I cannot print mailing labels successfully. All commercial labels are treated to resist staining from handling so they are not absorbent. Labels printed with normal output are faint and illegible. Those in boldface smear either going through the printer or when handled.

Because the ThinkJet has no platen, you cannot use paper less than 7½ inches wide (the two friction rollers that substitute for a platen are set this distance apart). Therefore, you cannot print postcards, notes, or any small form unless it is made up in special absorbent paper and is several forms wide. No such forms are now commercially available.

The paper-loading arrangement in the ThinkJet is cumbersome. I don't mind this when loading the first sheet of fanfold, but I gave up on loading cut paper. It takes longer to load a sheet than to print it.

Last, my ThinkJet has a paper-feed problem. After fanfold paper sits overnight, the top of the sheet takes on a permanent curve. The next document then catches on the paper separator, folds into a V, and arches the middle of print lines upward. Although a simple modification to the paper guide prevents this, HP should have caught it on the prototype.

In sum, the ThinkJet does a fast, reliable job for quick drafts. It definitely isn't a general-purpose printer. If your readers want one printer to handle everything, I'd advise they look elsewhere.

DICK BARNES
Hatteras, NC

BASIC STRING VARIABLES

I write in response to Robert S. Hunter's query on page 356 of Review Feedback
(continued)

REVIEW FEEDBACK

(January) about how to use the OPEN statement in BASIC with a string variable for the filename.

In any BASIC program it is possible to substitute a variable for a string when it is not acceptable to the BASIC interpreters by leaving blank spaces within the quotation marks that need the string, then POKeIng the string variable into the blanks character by character. This works in any variation of any BASIC.

Most BASICs store keywords like OPEN, CLOSE, and GOTO as a 1-byte token in-

stead of correctly spelling the keyword. This saves memory and speeds searches for the correct routine to execute the command. Some versions of Microsoft BASIC use 153 as the token for OPEN. The numbers are usually above the highest printing ASCII codes (above 127) and appear as graphics characters if you PEEK into the spot where the OPEN token is stored. If you loop through the computer's memory looking for the OPEN command's token, you will locate the line of code that needs to have the variable

POKEd into the blanks between the quotation marks. In other words, you tell the computer to look through its memory starting at the beginning of your program and find the line you need by searching for OPEN.

You need to look at a memory map of your computer to find out the address of the pointer that stores the address of the start of a BASIC program. The BST variable in line 200 of listing 1 is the address that points to the start of the BASIC program area, sometimes referred to as the BASIC buffer. BEND is the variable found by PEEKing the address of the start of the variables found in the pointer table. Some BASICs do not use a pointer to the end of your program; the end is simply defined by a series of zeros when the program is entered. You should find both BST and BEND before running the subroutine by PEEKing at the table of pointers and using the appropriate math. You can find them during program execution if you know the pointers for sure.

If you do not have a memory map and do not know what the token for OPEN is, loop through the entire memory looking for a dummy line of text, then branch out of the loop and get the address where the dummy text was found (see listing 2).

Listing 1 POKEs FL\$ into the filename after OPEN in line 110. This whole section is treated as a subroutine and is exited after the CLOSE statement in line 130. More string manipulation could be done to check for a filename extension in FL\$ instead of truncating FL\$ when it is too long and forcing the extension to DAT, BST, BEND, and FL\$ must be initialized before entering the subroutine.

After you run this program, get a listing and see how line 110 is changed with FL\$ in place of the blank spaces.

Listing 2 should be run independently of the first program and run several times using different characters in the remark statement in line 10, and in lines 50 and 110 to be certain there isn't a felonious group of Xs. After finding the start of BASIC, you find the end by adding the available memory in an empty buffer to the start address.

JEROME P. CIGNA
Rochester, NY

NEWWORD

I must take you to task for John Heilborn and Nanci Reel's review of NewWord (February, page 291). The reviewers make it sound as though the installation procedure is a terribly long process. To me,

Listing 1: Program to POKe FL\$ into a filename.

```
105: GOSUB200
110: OPEN"0"#1," /DAT"
120: PRINT#1,"SOME DATA"
130: CLOSE#1
140: RETURN
200: FOR A = BST TO BEND
205: REM BST & BEND ARE START AND END OF BASIC BUFFER
210: IF PEEK(A)=(TOKEN FOR "OPEN") THEN 250
215: REM LINE 210 BRANCHES AT THE OPEN TOKEN
220: NEXT A:RETURN
250: IF PEEK(A + 1) = 34 THEN 280
260: REM LINE 250 CHECKS CHARACTER AFTER OPEN
265: REM AND BRANCHES AT CHR$(34) OR " SIGN
270: NEXT A:RETURN
280: IF PEEK(A + 2) = ASC("0") THEN 310
290: REM LINE 280 IS SECOND REDUNDANCY CHECK
300: NEXT A:RETURN
310: FL = 8:IF LEN(FL$) < > 8 THEN GOSUB 500
320: REM LINE 310 BRANCHES TO PADDING ROUTINE TO
325: REM BRING LENGTH OF FL$ TO 8 CHARACTERS
330: C = 0:FOR B = A + 9 TO A + 9 + FL
340: C = C + 1:POKE B,ASC(MID$(FL$,C,1))
350: NEXT B:NEXT A:RETURN
500: IF LEN(FL$) > 8 THEN 550
510: FOR PAD = LEN(FL$) TO 7
520: FL$ = FL$ + " "
530: NEXT PAD:RETURN
550: FL$ = LEFT$(FL$,8):RETURN
```

Listing 2: Program to find the start address of the BASIC buffer and the token for OPEN.

```
10: REM XXXXXXXXXXXXXXXXXXXX
20: OPEN"0"#1,"DUMMY"
30: CLOSE#1
40: FOR X = 0 TO 65536
50: IF PEEK(X) = ASC("X") THEN 100
60: NEXT X:END
100: FOR Y = X TO X + 16
110: IF PEEK(Y) < > ASC("X") THEN 60
120: NEXT Y:PRINT"START ADDRESS OF BASIC IS";X - 8
130: FOR Y = X TO X + 25
140: IF PEEK(Y) = 34 THEN 200
150: NEXT Y
200: PRINT"TOKEN FOR OPEN COMMAND IS";PEEK(Y - 1)
```

REVIEW FEEDBACK

this is the strength of the program. Versions of WordStar prior to the 3.3 release allowed little flexibility—they didn't even let you set the help level until you were into the file on which you were working.

Further, the price of NewWord is about half that of WordStar and includes Mail-Merge. NewWord's powerful printing drivers are especially useful in an office environment with several different printers.

The support offered by Rocky Mountain Software is excellent. If one must find fault, one should complain that NewWord will not support the Random House Thesaurus program, or that there should be a way to delete the printing drivers one doesn't require from the working copy to make additional disk space.

NewWord's few shortcomings are minor compared with its power, flexibility, and price. I feel your reviewers should have given far more plaudits to this outstanding and relatively inexpensive program.

HAL REMMES
Hyde Park, MA

THE MT 160

In the review by Mark J. Welch of the Mannesmann Tally MT 160 printer (February, page 325), there is one important bit of misinformation.

Mannesmann Tally does not provide end-user support. Service-department personnel insist that you direct your question only to your dealer. My dealer was incredulous about this policy and refused to call for an answer to my question about how to configure WordStar with this printer.

My question was how to obtain superscripts. The answer (which I was forced to discover on my own) might be of interest to others. Using WordStar's Install program, select the Epson MX-80 printer option; you can then change the printer name to Mannesmann Tally if you care to. Enter 1B, 53, 00 (hexadecimal) for ^PT. Enter 1B, 53, 01 (hexadecimal) for ^PV. Finally, enter 1B, 54 for ^PR. If you type the last time. ^PT1 ^PT ^PR

in WordStar, a superscript 1 will follow the word time.

The printer has been reliable and the print quality in correspondence mode is better than that of most other printers in a similar mode (although the quality of print in draft mode is below average). What I especially like is that the characters are of normal typewriter size. However, the lack of user support makes the printer unsuitable for anyone inexperienced in con-

figuring software and printers.

RICHARD WAGNER
Tallahassee, FL

for any inconvenience this may have caused our readers. ■

CORRECTION

We have been informed that the \$7.95 price paid by Mr. Dobson (November Review Feedback, page 352) for a Juki daisy wheel was erroneous. We apologize

REVIEW FEEDBACK is a column of readers' letters. We welcome responses that support or challenge BYTE reviews. Send letters to Review Feedback, BYTE Publications, POB 372, Hancock, NH 03449. Name and address must be on all letters.

Here are 70 reasons to buy at Elek-Tek, not to mention the fastest delivery anywhere.

PRINTER ACCESSORIES

- | | |
|--|---------|
| 1. FR 192
Epson 80 col. ribbon | \$ 3.50 |
| 2. FR 193
Epson 132 col. ribbon | 5.00 |
| 3. FR 153A
OKI & Gemini Ribbon | 2.50 |
| 4. FF 7353
80 col. printer stand (metal) | 15.00 |
| 5. FF 7354
132 col. printer stand (metal) | 18.00 |
| 6. CB 5609
IBM PC to Epson cable, 8 ft. | 20.00 |

IBM PRODUCTS

- | | |
|--|--------|
| 24. Amdek 310A
Amber Monitor | \$ 160 |
| Other Amdek Monitors | CALL |
| 25. Sakata Monitors | CALL |
| 26. AST Six Pak +
Multifunction Board, 64K | 265 |
| 27. AST Megapius II
Multifunction Board, 64K | 270 |
| 28. AST I/O Plus II
Multifunction Board, OK | 125 |
| 29. Quadram Quadboard
Multifunction Board, OK | 210 |
| 30. Quadram Quadboard
Multifunction Board, 64K | 270 |
| 31. Quadcolor I
Graphic Board | 210 |
| 32. Paradise
Modular Graphics Card | 290 |
| 33. Hercules
Monochrome Card | 329 |
| 34. Hercules Color
Color Graphic Card | 170 |
| 35. Novation 4905911
Modem w/software | 320 |
| 36. Novation 4905921
Internal Modem w/software | 320 |
| 37. Hayes 1200B
Internal modem w/software | 389 |
| 38. Hayes 1200
External modem | 425 |
| 39. Anderson-Jacobson 1212-2C01
Internal modem w/crossstalk | 360 |
| 40. Anderson-Jacobson 1212-2C02
Modem w/crossstalk, 2nd ser. port | 400 |
| 41. TEAC FD55B
1/2 ht. DSDD Disk Drive | 129 |
| 42. Switchcraft Keyboard
13 prog. keys, heavy duty | 175 |

Save 30% to 43%
off Manufacturer Suggested Ret. prices on
EPSON • Okidata • Gemini • NEC
• TOSHIBA • COMREX • TTX

- | | |
|------------------------|--------|
| EPSON® | |
| 7. RX 80/RX 80 FT. | CALL |
| 8. RX 100 | \$ 350 |
| 9. FX 80 + | 345 |
| 10. LX 80 | CALL |
| 11. FX 100 | 550 |
| 12. LO 1500 par | 1090 |
| 13. Comrex II Comriter | 360 |
| STAR | |
| 14. SG 10 | CALL |
| 15. SD 10/15 | CALL |
| 16. SR 10/15 | CALL |
| OKIDATA | |
| 17. OkI 84 | CALL |
| 18. OkI 92 | CALL |
| 19. OkI 93 | CALL |



EPSON
FX 80+

OTHER PRINTERS

- | | |
|-------------------|--------|
| 20. TTX 1014 | \$ 360 |
| 21. SCM D200 | 350 |
| 22. Toshiba P1351 | 1290 |
| 23. Toshiba P1340 | 730 |

DISKETTES

Call for Quantity pricing for 10 boxes or more.

- | | | |
|------------------------------------|-------|--|
| maxell Box of 10 | | |
| 43. MF1
3 1/2" SSDD | \$ 27 | |
| 44. MF2
3 1/2" DSDD | 37 | |
| 45. MD1
5 1/4" SSDD | 16.50 | |
| 46. MD2
5 1/4" DSDD | 21.50 | |
| 47. MD2DD
5 1/4" DSDD/96 TPI | 35 | |
| 48. MD2HD
5 1/4" DSDD/IBM AT | 45 | |
| 49. FD1
8" SSDD | 32 | |
| 50. FD2
8" DSDD | 37 | |
| 3M | | |
| 51. 3M3SS
3 1/2" SSDD | 34 | |
| 52. 3M3DS
3 1/2" DSDD | CALL | |
| 53. 3M5SSDD
5 1/4" SSDD | 16.50 | |
| 54. 3M5DSDD
5 1/4" DSDD | 21.50 | |
| 55. 3M5DSD96
5 1/4" DSDD/96 TPI | 31 | |
| 56. 3M8SSDD
8" SSDD | 21 | |
| 57. 3M8DSDD
8" DSDD | 29 | |
| Dysan | | |
| 58. Dys 12
5 1/4" SSDD | 19 | |
| 59. Dys 22
5 1/4" DSDD | 25 | |
| 60. Dys 33
5 1/4" DSDD/96 TPI | 45 | |
| 61. Dys 24
5 1/4" DSDD/IBM AT | 50 | |
| 62. Dys 8128
8" SSDD | 27 | |
| 63. Dys 8228
8" DSDD | 32 | |
| wabash | | |
| 64. WAB 1111
5 1/4" SSDD | 11 | |
| 65. WAB 1212
5 1/4" SSDD | 12 | |
| 66. WAB 2222
5 1/4" DSDD | 13 | |

DISKETTE ACCESSORIES

- | | |
|--|------|
| 67. RSI 600
5 1/4" Head Cleaning Kit (30 Cleanings) | \$ 6 |
| 68. F 320
3 1/2" Head Cleaning Kit (20 cleanings) | 25 |
| 69. MM 5
Media Mate-Holds 50 5 1/4" disks | 10 |
| 70. MM 3
Media Mate-Holds 30 3 1/2" | 9 |

CALL TOLL FREE 800-621-1269 EXCEPT Illinois, Alaska, Hawaii Inquiry 165

Corp. Accts. Invited. Min. Ord. \$15.00. Visa or MasterCard by Mail or Phone. Mail Cashier's Check, Mon. Ord., Personal Check (2 wks. to clear) Add \$4.00 1st item. (AK, HI, PR, Canada add \$10.00 first item) \$1.00 ea. add'l ship. & handl. Shipments to IL address add 7% tax. Prices subj. to change. WRITE for free catalog. RETURN POLICY: Defective Only: Most products replaced within 30 days of purchase with identical merchandise only. Computer and large peripherals replaced only when defective on arrival within 3 work days of delivery. Other problems covered by mfr. warranty. ALL ELEK-TEK MERCHANDISE IS BRAND NEW, FIRST QUALITY AND COMPLETE. Delivery subject to availability.

ELEK-TEK, inc.

6557 N. Lincoln Ave., Chicago, IL 60645
(312) 631 7800 (312) 677 7660



Finally A Video Board That Leaves The Confusion Behind.

On an IBM™ monochrome monitor (or equivalent), STB's Chauffeur displays color/graphics software in full-screen format and no software modifications are necessary.

Of course, we built the Chauffeur to work with the family of IBM PCs and compatibles. Our new video board is software compatible with the IBM Color/Graphics Adapter, as well as hardware and software compatible with the IBM Monochrome/Printer Adapter.

No More Confusion

No more mixing and matching hardware with software. The

Chauffeur converts graphics display into a format compatible with the IBM monochrome monitor.

For you, that means no more worries about preboot software. Best of all, you don't have to deal with those drivers anymore.

Follow The Leader

STB's Chauffeur is clearly the leader in video boards. It converts colors to a 16 level grey scale, and gives you a graphics display that fills a monochrome screen.

For graphics, the Chauffeur supports the same resolutions as the IBM Color/Graphics Adapter.

For text, our board produces a high quality monochrome character set.

STB's Chauffeur includes a parallel port, an optional clock/calendar and our exclusive PC Accelerator™, for print spooling and high speed disk emulation. You also get our one year warranty and an illustrated manual with thorough instructions.

Relax And Enjoy The View

Buy the Chauffeur now. Put it in your system and enjoy watching graphics on your monochrome monitor.



Avoid The Crazy Drivers In The Graphics Jam With STB's ChauffeurTM

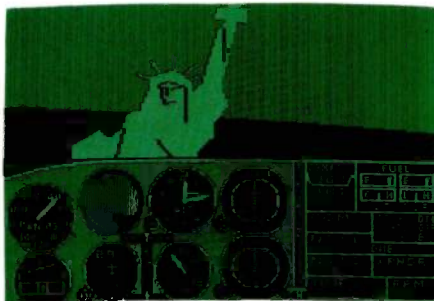

Flight Simulator™



PC Paintbrush™



Keep
Life
Simple

Finally you can buy the most popular IBM color/graphics software with no worries about hardware compatibility. STB's Chauffeur video board produces monochrome display without preboot software or those crazy drivers.

Write For A Free Info Pack Today.
STB Systems, Inc., 601 North Glenville, Richardson, Texas 75081

Inquiry 389

STB
STB Systems, Inc.

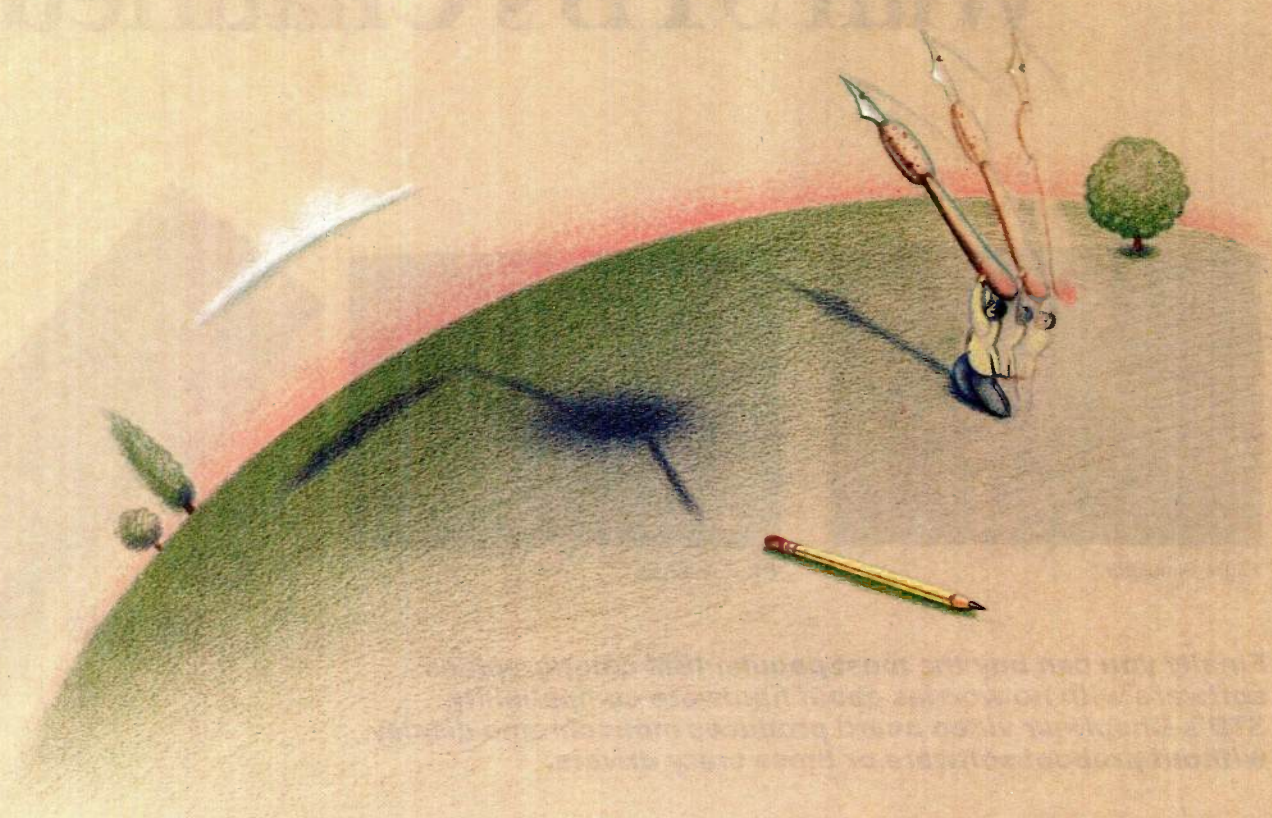
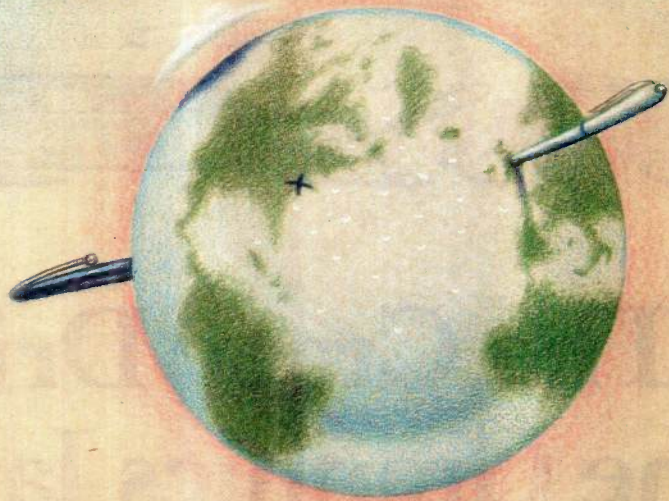

Kernel

COMPUTING AT CHAOS MANOR: FROM THE LIVING ROOM <i>by Jerry Pournelle</i>	409
CHAOS MANOR MAIL <i>conducted by Jerry Pournelle</i>	435
BYTE U.K.: TELEPHONE COMPUTERS <i>by Dick Pountain</i>	439
BYTE JAPAN: NEW NECs AND A CARTRIDGE DISK <i>by William M. Raïke</i>	451
BYTE WEST COAST: A GEM SEMINAR <i>by John Markoff and Phillip Robinson</i>	455
CIRCUIT CELLAR FEEDBACK <i>conducted by Steve Ciarcia</i>	461
BYTELINES <i>conducted by Sol Libes</i>	468

CHAOS MANOR'S RENOVATION continues and likewise do Jerry Pournelle's impressions of sundry hardware and software products. First, though, he discovers why reliable ol' Zeke at last needed some attention, then proceeds with this month's offerings. Finally, as usual, he finds time to answer some of his mail.

From London, BYTE U.K.'s Dick Pountain takes a look at International Computers Ltd.'s One Per Desk telecomputer. This interesting piece of equipment is built around the Sinclair QL and uses a real multitasking operating system to expand computing and communicating capabilities.

Bill Raïke muses about the continuing introduction of interesting new computer products in BYTE Japan. In this installment, he takes a look at three significant upgrades to NEC computers, an impressive hard-disk-cartridge system, and the escalating use of PCs as tour guides.

The troops at our BYTE West Coast outpost spent some of their time this month at a Digital Research seminar on GEM, a Macintosh-like environment available for non-Macs. Our intrepid editors also comment on a Macintosh disassembler and technological advances in disk controllers.

In Circuit Cellar Feedback, Steve Ciarcia also finds time to share some of his correspondence with readers who have built his projects.

Longtime BYTE readers will notice that Sol Libes's BYTELINES has returned. Sol offers us his perspective on the happenings in the personal computing world with news and speculation on a wide variety of topics.

—Gene Smarte, *Managing Editor*

MACROTECH—STILL THE S-100 PERFORMANCE PACESETTER



MI-286. Our 80286/Z80H Dual CPU Board is at least twice as fast as Compupro's 8085/88 and it's a direct replacement. The MI-286 has already become the standard by which other 80286 based systems are measured. Ask us for a complimentary Benchmark Report.

ADIT. There's nothing else like it on the market. It's an Intelligent I/O Board with its own real time firmware that lets you control up to 16 different terminals, modems or printers all from a single slot. ADIT is the performance standard in environments such as Alpha Micro where I/O speed is critical.

V-RAM. High performance Static CMOS system memory/virtual disk in either quarter or half megabyte configurations. With its on-board battery and power-fail logic, the V-RAM sets a new performance standard at conventional static memory prices. When accessed through I/O port channels, the half megabyte V-RAM becomes M Drive compatible with true non-volatile solid-state disk capability.

MSR. High performance and reliability in a memory so fast you won't believe it's a dynamic ram product. Compatible with all popular S-100 environments, the MSR's low power consumption and 120 nanosecond ram devices set a new standard for dynamic memory products. The MSR is available in quarter, half, one and two megabyte configurations at the lowest prices in the industry.



Dealers:

Gifford Computer Systems	(415) 895-0798
Custom Computer Technology	(800) 222-8686
Priority One Electronics	(800) 423-5922
John D. Owens & Associates	(212) 448-6298
In England; Fulcrum (Europe) Ltd.	(0621) 828763

Macrotech dealers also include most Compupro Systems Centers, Heathkit Electronic Centers and Alpha Micro Dealers.



MACROTECH International Corp.
9551 Irondale Ave.
Chatsworth, CA 91311
(800) 824-3181 • in Calif. (818) 700-1501
Telex: 9109970653

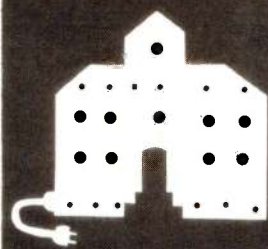

C·O·M·P·U·T·I·N·G A·T· C·H·A·O·S M·A·N·O·R

From the Living Room

Reconstruction

Cleaning Zeke II

Z-100 Video Memory

Dysan's Interrogator

Zenith Z-160

HP LaserJet Fonts

Macrotech and Gifford

SPUZ

Mini/Micro Show

Hercules Color Board

More on Mac

More on Valdocs

Eagle

BY JERRY POURNELLE

Readers sometimes ask if Chaos Manor is *really* as disorganized as all that. They wouldn't if they'd been here this last month. Just today the contractors got a roof on my house; for the past week we have been naked to the stars. I am at present writing this in the living room because my office has no ceiling. The stairway to the new upstairs suite goes through the old office—and although the upstairs now has a roof, it has no walls.

It's February, and even in Los Angeles it gets cold at night. I can put on enough sweaters and vests to make it nearly endurable, but it's impossible to write with gloves on, so after two nights of stiff fingers I gave up. I've promised Mrs. Pournelle that the computers will be out of her living room Real Soon Now. . .

CLEANUP

Zeke II, the Viasyn CompuPro Z80 I do nearly all my writing on, hasn't been opened for two years. If it ain't broke, don't fix it; but without a ceiling my office is effectively broke, so we had to move Zeke. I brought him out to the living room, set him up, and turned him on.

There was a sharp click as he tried to access the disk, then blooey: a screen full of garbage. Resetting didn't help. Zeke just wasn't communicating.

I have a lot of computers, and I'm not usually nervous about opening them up; but one reason for my nonchalance is that no matter what might happen to any of the other machines, I could always go back to good old superreliable Zeke to get my work done. Now, with all my other machines covered with plastic, my office two inches deep in sawdust and powdered plaster, and nearly everything I own packed away in boxes, Zeke wasn't working.

"Don't panic." I told myself that several times, then opened the cover.

Zeke was full of dust and dirt. Dog hair, dust balls, you name it. The dust filter had obviously died years ago. First thing, then,

was to use the vacuum cleaner. He still didn't work, so next I removed all the boards, flexed them a bit, pushed the chips into their sockets, and put them back. This time he booted up fine, and I was able to get some work done. Next day, though, when I tried to connect up the printer, we got more garbage.

Up to then I'd hoped to solve the problem myself, but I had no more time. What with the new construction, plus a trip to New York to promote my new book, plus the Mini/Micro show in Anaheim this week, Stride Faire this coming weekend, and a trip to Texas Instruments next week—I'm scheduled to go directly from Reno to Dallas Sunday without ever coming home—there was no way to lose any more time and still meet the deadline for the column. Nothing for it: I called Tony Pietsch, who built Zeke.

"Dust," he said. "Dust and dirt."

"But it worked fine—"

"While it was just sitting there. Moving it moved the dirt. These machines aren't maintenance-free, you know."

"Tell me what to do—"

"Just stay there. I'll come over. You watch."

JUST ROUTINE. . .

He had a box of solvents. The most important one is called DE-OX-IDE. There was also a standard tuner cleaner, a bottle of alcohol, a can of compressed air, and a can of Instant FD Zero Residue Cleaner, which contains mostly trichlorotrifluoroethane. Some computer stores carry these, but most don't; a big electronics supply house is a more reliable source.

What Tony calls routine maintenance consists of using common sense and solvents. Tony knows what he's doing, but if I were working alone, I'd start by making a chart of every cable and board; it's amazing how easily you can forget which way things are hooked up. Then disconnect everything that's easy to disconnect, remove all boards, and start in, using compressed air, solvents,

(continued)

Jerry Pournelle holds a doctorate in psychology and is a science-fiction writer who also earns a comfortable living writing about computers present and future.

"Pop-Ups take the Sidekick idea one step further."

—InfoWorld
January 14, 1985



Independent reviewers everywhere agree. When it comes to a showdown on capabilities and ease of use, the winner is Bellsoft's Pop-Up DeskSet™

That's because DeskSet gives you more. Like standard *and financial* calculators. A clip-board for "cutting and pasting" information from one program to another. An alarm clock that displays the time of day. On screen. In any program. And instant access to DOS commands for checking directories and copying or deleting files.

Not to mention a 120 year calendar. A handy notepad. And *Pop-Up Anything* that lets you turn your word processor, spreadsheet or application program into an instant, on screen Pop-Up.

DeskSet is everything Sidekick could have been.

But isn't.

All at a price that puts the competition to shame. Only \$69.95* and it's non-copy protected. (Or \$129.95* for DeskSet Plus that includes our powerful telecommunications software.)

Buying Pop-Up DeskSet is as easy as it is to use. It's at the best software retailers nationwide. Or you can order DeskSet directly from Bellsoft by calling:

1-800-44-Pop-Up
(1-800-447-6787)

BELLSOFT

2820 Northup Way
Bellevue, WA 98004
(206) 828-7282

Pop-Ups run great on the IBM PC, XT, AT, PCjr, 3270PC and compatibles. Pop-Up, Pop-Ups and DeskSet are trademarks of Bellsoft, Inc. Sidekick is a trademark of Borland International.

*Plus \$5.00 shipping and handling.

CHAOS MANOR

paper towels, and tissue paper. Be sure to clean all cable connectors, board connectors, sockets, and anything else that comes apart easily and makes electrical connection. First use solvent, then the DE-OX-IDE.

You probably want to open a window when you do, unless your office happens to have no roof like mine.

Before replacing the boards, lay them down on a flat surface and carefully push each socketed chip firmly in place. Then put the boards in as they were, replace the cables—

We did all that to Zeke. Tony, being confident that there was nothing actually wrong with the machine, put the cover back on before testing it. The universe generally punishes me for such arrogance, but it works for Tony. We fired up the machine and everything ran. Indeed, the letters on my screen seem somehow steadier and crisper, although that may be over-enthusiastic imagination.

JAZZING UP ZORRO

I'm told those with late-model Z-100 machines don't need to do this.

Zorro, our Z-100, was one of the first that Zenith made. The Z-100 comes with a color board. The early model used 32K-bit memory chips. A 32K-bit chip is really a 64K-bit chip with problems on one side of it. When 64K-bit chips first came out, the yields were low and the chips were expensive. It made sense to use the partly defective ones. The result was acceptable color resolution, but only half of what the machine was capable of.

There are two ways to find out if you have the older model with 32K-bit chips. The complicated way is to disassemble the Z-100 and look at the jumper on the video board. (The video board is the small upper upside-down board you see after you remove the disk drives.) The jumper has three positions: 32K-bit upper bank, 32K-bit lower bank, and 64K-bit. If it's set for 64K-bit, you have a newer machine.

You can also find out by running one of the tests built into the Z-100 ROM (read-only memory); just boot the machine without a disk, and when

you get the "hand prompt" device error message, type H for help, and on the menu that follows, type S for system information. The machine will tell you what kind of video it has. [Editor's note: Early versions of the Z-100 ROMs do not have this feature.]

Ours had the 32K-bit variety. Omnitrend's Universe game is designed to work with an IBM PC color board or a full 64K-bit Z-100 color system. I blush to say that after three years of putting up with the 32K-bit video, the Universe game was what finally induced me to buy enough chips—24 of them—to bring Zorro up to full video strength. We used 4164-type 150-nanosecond parts. Replacing the 32K-bit chips and changing the jumper takes about a half hour.

We had problems afterward, but it wasn't Zorro's fault. One wants to be careful when putting the Z-100 back together; it's fairly easy to crimp a keyboard cable or jam one of the keys so that it binds on the case. The keyboard simply sits on foam in the case, so it's not surprising that it happens. The result isn't a disaster, but it seemed like one until we opened the machine and reassembled it with a bit more care.

Alas, after all that I discovered that I don't yet have Z-DOS II for the Z-100, so I still haven't seen how Universe looks on Zorro. I have Zenith disks marked "MS-DOS 2.0 for the Z-100 PC"; it seemed reasonable to suppose that would work with Zorro, but "Z-100 PC" refers only to Z-150 and Z-160 machines.

DYSAN'S INTERROGATOR

One way to be sure your machine is in good shape is to run diagnostic programs. You generally get a set of them with a DOS (disk operating system), but to really check out disk drives you can't beat the Dysan diagnostics programs. The Dysan Interrogator comes in both Z-100 (including Z-110 and Z-120) and IBM PC versions. The IBM PC variety will work with the IBM PC and the Zenith Z-150 and Z-160 machines; I presume it works with other PC-compatibles. The

(continued)

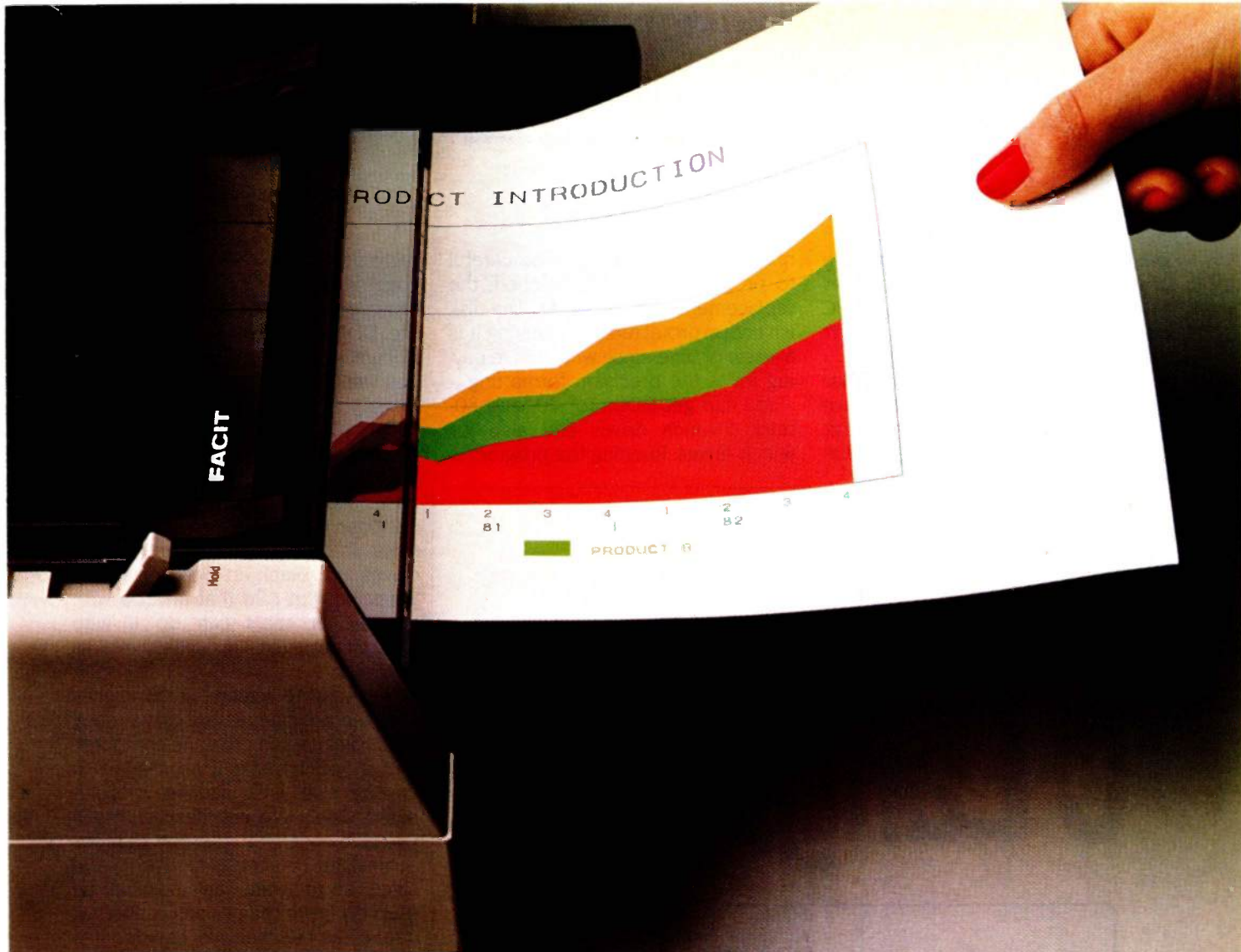

GET THE PICTURE WITH FACIT 6-PEN PLOTTERS

Multicolour graphics on paper and overhead transparency film are now a reality at a price every computer owner can afford – with the new Facit 4550 and Facit 4551 Pen Plotters.

The 6-pen cassette design provides instant colour changes with a multitude of colour set-ups. Longlife ballpoint for paper, oil-based fiber-tip for transparencies and water-based ceramic pens for high-quality CAD drawings are available with 8 to 12 different colours. Two pen-cassettes can be stored in pockets on top of the casing. The pens are securely sealed to prevent drying.

Business graphics, CAD, CAE, science and engineering plottings are handled with a character resolution as high as 10×10 elements per character. Facit 4550 accepts media sizes ISO A4 or 8 1/2 × 11", while Facit 4551 takes media up to ISO A3 or 11 × 17".

FRIENDS WITH ALL MAJOR COMPUTERS

With HP-Graphic Language emulation and serial/parallel interfaces, the plotters easily make friends with all major computer models on the market. Software packages include Lotus 1–2–3,

Symphony, Fast Graphs, DR Draw/Graph, BPS, etc.

Got the picture? Get it at your nearest Facit representative!

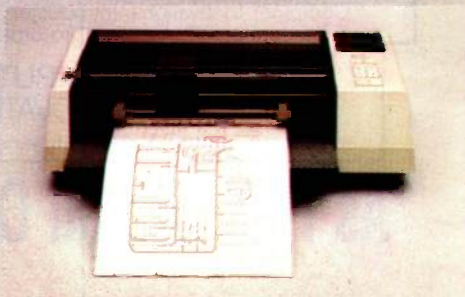

FACIT

Inquiry 177

only reason it wouldn't would be if the computer used a disk controller radically different from what the PC uses, and anything that does that isn't likely to be PCompatible.

The Interrogator comes in two disks: the Interrogator disk, which you boot up, and the Digital Diagnostic disk (DDD). The DDD is a *very* precisely for-

matted disk. You want to be careful to protect it. If it gets lunched, the replacement costs 50 bucks. The disk isn't copy-protected, but copying it is a waste of time, since what you're paying for is the precision formatting.

You can get DDDs for 40- and 80-track 5¼-inch drives and also for 8-inch drives. Running the program is

extremely simple: boot the Interrogator disk, and when prompted, remove the Interrogator and put in the DDD. The test program is self-documented with on-screen help. If you want to test for write-error problems, you'll need scratch disks; the program will tell you when to insert them.

Dysan also makes an Analog Diagnostic disk (ADD), which, used with an oscilloscope, allows drive realignment. In my opinion, realigning disk drives is a black art best left to experts, but I'm told that anyone with the proper tools can do it with enough patience. I'm unlikely ever to find out.

The software agreement that comes with the program says that you may use it on one and only one computer, and if you transfer the program to anyone else, your license is terminated. One supposes that the person you give or sell it to thereby acquires some kind of license to use it; and since the program can't possibly be used on more than one computer at a time—as I said above, copying it is an exercise in futility—I can't see what would prevent a club from buying a copy, selling it to a member, and repurchasing it after the member is finished. The Dysan Interrogator is a tool you won't need often, but when you do need it there's no real substitute.

HAVE A CARE . . .

Just after they removed my roof, I (sensibly, I thought) took Mrs. Pournelle to New York. The ostensible reason for the trip was to tape some promotional materials for the latest Niven and Pournelle novel (*Footfall*, Ballantine Books), but Roberta knew better. The *real* reason we went was to get away from the hammering and sawing, and besides, the Metropolitan Opera was in season. (We saw *Ariadne auf Naxos*, which was good only if you like mountainous sopranos and superegotistical tenors, and *Tales of Hoffmann*, which was just plain wonderful no matter what you like.)

Of course I worried: it doesn't often

(continued)

Learn the C Language*

Introducing
C

C LANGUAGE TRAINING SOFTWARE
IBM PC-DOS 2.0 +

INTRODUCING C is a C language interpreter and learning guide that teaches the fundamentals of C programming. You'll learn program structure, syntax, and all about libraries - QUICKLY and EASILY. Join the C revolution with INTRODUCING C - from Computer Innovations. Introductory price \$95.

For further information or to order call 800-922-0169.

 **COMPUTER
INNOVATIONS, INC.**

980 Shrewsbury Avenue, Tinton Falls, NJ 07724 • (201) 542-5920

*As Fast As You Can Learn BASIC

NEW FROM VAULT: THE LOADING PRO.

Vault Corporation introduces the *Proloader™ Automatic Diskloading Machine*, an engineering breakthrough. Vault is the worldwide market leader in computer security disk technology and is the developer and producer of Prolok™ software protection, Filelok™ data security and Telelok™ telecommunication security.

The first of its kind, Proloader is designed equally for office and factory environments both functionally and aesthetically. It has an attractive, sturdy, high quality outer shell with an easy to read and operate control panel and a footprint of only 23" X 7 7/8", small enough for the desktop next to your PC.

Proloader works in conjunction with any IBM® PC 2.00 or later, or compatible micro-computer with a minimum of 256K.

Proloader will process 150 5 1/4" diskettes unattended accommodating any jacket weight, with an audible alarm for jams. It automatically verifies each disk upon completion and rejects disks with bad sectors.

Proloader provides instant in-house disk loading, processing, formatting and duplicating, as well as providing software protection and data security options.

Proloader is built with high quality components, time-tested fully internal pneumatic disk handling and modular construction for easy service and replacement. It is fully automatic leaving you and your staff free to attend to other duties.

Using Prolok software protection diskettes and Proloker software from Vault, you can protect your software as you duplicate the disks. Most other protection schemes are compatible with Proloader as well.

Proloader is the least expensive and most efficient office size automatic diskloading machine on the market. The complete Proloader package consists of Proloader, the Proloker Master Diskette, a supply of Prolok or blank diskettes, according to preference, operating manuals, and a 90 day warranty on parts and labor. Call Vault for a demonstration of how Proloader can improve your productivity at \$3,495, the lowest diskloading price in the market place.



2649 Townsgate Road, Suite 500
Westlake Village, California 91361
(805) 496-6602
(800) 445-0193 (US)
(800) 821-8638 (CA)

PROLOADER.™

FORMATS · DUPLICATES · VERIFIES · PROTECTS.

IBM® is a registered trademark of International Business Machines Corporation. Price is in U.S. Currency, F.O.B. Factory. Made in U.S.A. Proloader™, Prolok™, Filelok™ and Telelok™ are trademarks of Vault Corporation.

rain in Los Angeles, but anything can happen in February. Sure enough, during one of Roberta's calls to check up on the kids, I heard what I'd feared: it was raining, the contractors hadn't got the plastic covering put up in time, and the office ceiling was dripping. Fortunately, nothing was spoiled except the newest version of Cygnus's Star Fleet I, and I have backup copies.

Alas, that wasn't the entire story. The disk had been thoroughly wetted. The boys dried it out. When it was dry, not knowing where the backup copy was, they put it into the IBM PC. The result was a real disaster: media came off the disk, and no amount of cleaning would restore the disk drive. We've had to replace it. It may be repairable, but I have my doubts.

The moral of the story is clear: if the disk is ruined, it's ruined. Trying to salvage a \$2 disk can be pretty expensive. Don't. For that matter, it doesn't

hurt to *look* at disks once in a while; if they look like they have crud on them, you want to think hard about using them.

COLOR AND CABLES AND LUGGABILITY

We're becoming increasingly fond of the Zenith Z-160. It's as PCompatible as the Z-150, has the same great keyboard, contains the same wonderful ROM-based diagnostics as the Z-150, has four totally empty slots, and, while not portable, it's luggable. The disk drives pop down, the keyboard snaps into place, and there's a handle. You won't *quite* get a sprained back from carrying it; indeed, when we had our big Space Conference at Larry Niven's house, we discovered just how easily moved the Z-160 could be. Everyone liked it.

Do understand what we mean by movable: it weighs about the same as

a PC, but it does fold up, has no sharp corners, and has a handle. A nice *big* handle. There are also some funky little compartments into which you stuff keyboard and power cables. They're covered with little sliding doors. Rachel Klau, one of the Zenith software gurus, claims they're for toast. . . .

The amber screen is a bit small for me, but it's 9 inches, as big as any portable, and it will do. I managed to write 10 pages or so with it and play Universe for days. Universe requires a color system for your IBM, and I don't have color in Lucy Van Pelt, our fussy budget genuine IBM PC. The Z-160 doesn't care. Colors are shown as shades on the amber screen.

There are also composite and RGB (red-green-blue) color outputs on the back of the Z-160. When we first tried to hook up the color, it didn't work, even though we were using Zenith monitors. I couldn't figure that one out. I should have: we also have an STB color board for the PC, and we couldn't get *that* to work with the Zenith monitor. I didn't figure it out, though, and asked Zenith's technical gurus for help. They didn't quite laugh at me.

As it happens, it's no wonder we couldn't get the monitors to work: we were trying to hook up the Z-160 (and the IBM PC) with a Z-100 monitor cable. The Z-100 and PCompatible cables have exactly the same connectors, but the Z-100 uses different pin-outs from the Z-150 and Z-160. This is presumably because the Z-100 was designed before the IBM PC came out, and the Z-150 and Z-160 were intended to be as PCompatible as possible. I can't think Zenith *enjoys* having to stock two identical-appearing video cables. Anyway, if you use the wrong cable, you get video, but the vertical won't lock and the horizontal is in the wrong place. Alex thinks you could probably reset the Z-100 pin-outs—the Zenith technical documents set new standards for what we mean by *complete*—but I'd think that more work than it's worth. The cables appear identical, but they do have different

(continued)

© 1985 Best Western International

World Wide Reservations 1-800-528-1234



Make reservations at any Best Western,
see your travel agent, or call
1-800-528-1234.

"World's largest chain of independently owned and
operated hotels, motor inns, and resorts"

THE PROGRAMMER'S SHOP™

helps compare, evaluate, find products. Straight answers for serious programmers.

SERVICES

- Programmer's Referral List
- Compare Products
- Help find a Publisher
- Evaluation Literature free
- BULLETIN BOARD - 7 PM to 7 AM 617-826-4086
- Dealer's Inquire
- Newsletter
- Rush Order
- Over 700 products

Free Literature - Compare Products

Evaluate products Compare competitors Learn about new alternatives. One free call brings information on just about any programming need. Ask for any "Packet" or Addon Packet ADA, Modula A1 BASIC C COBOL Editors FORTH FORTRAN PASCAL UNIX/PC or Debuggers, Linkers, etc.

RECENT DISCOVERIES

SMALL TALK for PCDOS - "Methods" has objects, windows, browser, inspector. PCDOS \$239

ARTIFICIAL INTELLIGENCE

EXSYS - Expert System building tool. Full RAM, Probability, Why, Intriguing, serious. PCDOS \$275

GC LISP - "COMMON LISP", Help, tutorial, co-routines, compiled functions, thorough. PCDOS Call

INSIGHT 1 - Expert Sys. Dev't, decent PCDOS \$95

M Prolog - full, rich, separate work spaces. MSDOS \$725

PROLOG-86 - Learn fast, Standard, tutorials, samples of Natural Language, Exp. Sys. MSDOS \$125

TLC LISP - "LISP-machine"-like, all RAM, classes, turtle graphics 8087. CP/M-86, MSDOS \$235

Expert System front-ends for PROLOG: APES (\$275), ES/P (\$895)

Other solid alternatives include: MuLISP-86 (\$189), WALTZ LISP for CPM (\$159), MicroPROLOG (\$275)

EDITORS FOR PROGRAMMING

BRIEF Programmer's Editor - undo, windows, reconfigurable, macro programs, powerful. PCDOS \$195

VEDIT - well liked, macros, buffers, CPM-80-86, MSDOS, PCDOS \$119

MACINTOSH

We evaluate, carry every available programmers product. Ask.

C LANGUAGE

C Terp by Gimbel, full K & R, .OBJ, ASM interface, 8087. MSDOS \$275

INSTANT C - Interactive development - Edit, Source Debug, run. Edit to Run - 3 Secs. MSDOS \$495

"INTRODUCING C" - Interactive C to learn fast. 500 page tutorial, examples, graphics. PCDOS \$95

MEGAMAX C - native Macintosh has fast compile, tight code, K&R. toolkit, .OBJ, DisASM MAC \$275

C ADDONS

APPLICATION TOOLKIT by Shaw - Complete: ISAM, Screen, Overlay mgmt, report gen, Strings, String math. Source. CPM, MSDOS \$495

COMMUNICATIONS by Greenleaf (\$159) or Software horizons (\$139) includes Modem7, interrupts, etc. Source. Ask for Greenleaf demo.

C SHARP Realtime Toolkit - well supported, thorough, portable, objects, state sys. Source MANY \$600

PRE-C - LINT, full, enhanced, all Cs. MSDOS \$345

DEBUGGERS

PERISCOPE DEBUGGER - load after "bombs", symbolic, "Reset box", 2 Screen, own 16K. PCDOS \$279

SOURCE PROBE by Atron for Lattice, MS C, Pascal. Windows single step, 2 screen, log file. \$395

FORTRAN LANGUAGE

DR/Fortran-77 - full ANSI 77, 8087, overlay, full RAM, big arrays, complex NUMS., CPM86, MSDOS \$249

MacFORTRAN - full '77, '66 option, toolbox, debugger, 128K or 512K, ASM-out option MAC \$375

Ask about Microsoft, Supersoft, others.

OTHER LANGUAGES

ASSEMBLER - ask about FASM-86 (\$95), ED/ASM (\$100) - both are fast, compatible, or MASM (\$125), improvements.

BetterBASIC all RAM, modules, structure. BASICA - like \$185

HS/FORTH - '79 & '83 Standards, full RAM, ASM, BIOS, interrupts, graph, multi-task, optimizer MSDOS \$250

MBP COBOL has screen control, strong doc, '74 interm., fast. MSDOS \$680

SUPPORT PRODUCTS

BASIC DEVELOPMENT SYSTEM - (BDS) for BASICA; Adds Renum, crossref, compress. PCDOS \$115

CODESMITH - visual, interactive debugger. Symbolize, modify code \$129

FASTER C - Lattice users eliminate Link step. Normal 27 seconds. Faster C in 13 sec. MSDOS \$95

PLINK-86 for Overlays, most lang., segment control. MSDOS \$325

"C" LANGUAGE

	OUR PRICE
MSDOS C86-8087, reliable	call
Instant C - Inter., fast, full	495
Lattice C - the standard	call
Microsoft C 3.0 - new	279
Williams, debugger, fast	call
CPM80: EcoPlus C - faster. SLR	275
BDS C - solid value	125
MACINTOSH: Hippo II	375
Megamax - optimizer, full	275
Consular's MAC C	275
Compare, evaluate, consider other Cs	

BASIC

	RUNS ON	PRICE
Active Trace-debug	86/80	75
BASCOM-86 - MicroSoft	8086	279
BASIC Dev't System	PCDOS	115
BetterBASIC - 640K	PCDOS	185
CB-86 - DRI	CPM86	419
Prof. BASIC Compiler	PCDOS	89
CADSAM-Full Btree, source	MSDOS	150
SCREEN SCULPTOR	PCDOS	115

Ask about ISAM, other addons for BASIC

SERVICE

ALL PRODUCTS - We carry 700 products for MSDOS, CP M 86, CP M 80, Mac-Intosh and key products for other micros

EDITORS Programming

	RUNS ON	OUR PRICE
BRIEF - Intuitive, flexible	PCDOS	195
C Screen with source	86/80	75
Epsilon - like EMACS	PCDOS	195
FINAL WORD-for manuals	86/80	215
PMATE-powerful	8086	185
VEDIT-full, liked	86/80	119
XTC - multitasking	PCDOS	95

COBOL

	MSDOS	PRICE
Dig. Res-decent	MSDOS	500
Macintosh COBOL-Full	MAC	1850
MBP-Lev. II, native, screen	MSDOS	885
Micro Focus Prof.-Full	PCDOS	call
Microsoft-Lev II, no royal	MSDOS	500
Ryan McFarland-portable	MSDOS	695

LANGUAGE LIBRARIES

	MSDOS	PRICE
GRAPHICS: Graphic-source in C	MSDOS	219
GRAPHMATIC-3D FTN. PAS	PCDOS	125
HALO-fast, full-all lang.	PCDOS	139
FILE MGMT: BTree-retrieve-all lang.	MSDOS	215
Cindex + -source, no royal.	86/80	369
CTree-source, no royal	ALL	369
dBC ISAM by Lattice	8086	229
dB VISTA "Network" Structure	MSDOS	465
PHACT-up under UNIX, addons	MSDOS	225
DITHER: CUtil by Essential	MSDOS	129
Greenleaf - 200 +	MSDOS	159
CSharp - Real-Time	MSDOS	600
PORTABLE C to PC, Mac, II	Many	125
SOFT Horizons - Blocks I	PCDOS	139
SCREEN: CURSES by Lattice	PCDOS	125
CView - input, validate	PCDOS	195
MetaWINDOW - icons, clip	PCDOS	139
PANEL - many lang. term	MSDOS	249
ProScreen - windows, source	PCDOS	415
Windows for C	MSDOS	175

FORTRAN

	RUNS ON	OUR PRICE
MS FORTRAN-86 - Impr	MSDOS	\$ 239
DR Fortran-86 - full '77		8086 249
PolyFORTRAN-XREF. Xtract	PCDOS	165

OTHER PRODUCTS

	PRICE	PRICE
Assembler & Tools - DRI	8086	159
Atron Debugger for Lattice	PCDOS	395
cEnglish - dBase to C	MSDOS	750
C Helper: DIFF, xref, more	86/80	135
CODESMITH-86 - debug	PCDOS	139
MacASM-full, fast, tools	MAC	115
MBP Cobol-86 - fast	8086	885
Modula 2 for MAC	PCDOS	90
Micro: SubMATH-FORTRAN full	86/80	250
Microsoft MASM-86	MSDOS	125
MSD Debugger	PCDOS	119
Multilink - Multitasking	PCDOS	265
PC FORTH + - well liked	MSDOS	219
PFX-86 Debugger	MSDOS	169
PL 1-86	8086	495
PolyIlorarian - thorough	MSDOS	95
PolyMAKE	PCDOS	95
PROFILER by DWB - flexible	MSDOS	109
Prolog-86-Learn, Experiment	MSDOS	125
SYMD debugger-symbols	PCDOS	119
TRACE86 debugger ASM	MSDOS	115

Call for a catalog, literature, and solid value

800-421-8006

THE PROGRAMMER'S SHOP™

128-1 Rockland Street, Hanover, MA 02339

Visa Mass. 800-442-8070 or 617-826-7531 MasterCard 8517

Note: All prices subject to change without notice. Mention this ad. Some prices are specials. Ask about COD and POs. All formats available.

names marked on the connector ends. Do beware of the fact that to Zenith a Z-100 is *not* a "Z-100 series PC."

The only complaint I have about the Z-160 is that the disks pop up out of the top at an angle that makes it very difficult to figure out where to put an external monitor. I'm having the car-

penters make a gizmo that's open in front to give access to the disk drives and sits above them so that the Zenith ZM-135 color monitor is level when put above the machine. I suspect that anyone who gets a Z-160 will need something like that, and it's a pity that Zenith doesn't furnish a neat plastic thing made for the purpose.

Other than that, the Z-160 is a compact and luggable version of the Z-150. If you're in the market for a PC or PCompatible, I recommend either of these Zenith machines in preference to the genuine IBM PC.

FONTS

Unless this is the first time you've encountered this column, you have to know that I love the Hewlett-Packard LaserJet printer. Last month it got even better: HP sent me four different font cartridges. You plug the cartridge in, send the printer a hideously complex sequence of codes preceded by the escape character, and voilà! With proper controls you can make the LaserJet print on legal-size paper, print sideways—that is, across the long dimension of the paper—do *italics* and **boldface**, change from Gothic to Helvetic typeface, etc.

There is a catch. You have to figure out the HP documentation for the fonts. I couldn't. When the HP people called me to discuss the new fonts, I read them their own documents and asked what they meant. The result was interesting: an engineer who already knew how to do everything got confused when I read him the instructions. He had to forget what I'd read him before he could recall how you really do it.

They claim they're going to rewrite the instruction sheets that come with the fonts. I hope so. I've also suggested that they come up with a new font cartridge that contains a complete font set: normal uppercase and lowercase, boldface, italic, small capitals, a symbol set, and the other stuff that you find in a standard case of type. The LaserJet isn't really up to book standards. It is, however, more than good enough for newsletters, manuals, manuscripts, and correspondence; it looks better than anything the Diablo or NEC Spinwriter ever produced.

Tony Pietsch has borrowed my new type fonts; within a week or so he'll bring them back, along with a new version of WRITE (my favorite text editor) that makes use of them. I'll

(continued)

PICTURE THIS.

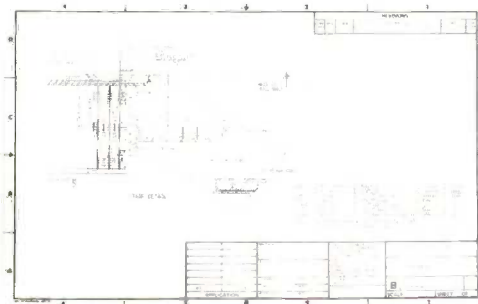

Thanks to our electronic digitizing scanner, you can capture images in high resolution. Then manipulate, convert, store, retrieve, or print them.

But what's truly amazing is the range of other applications for Datacopy scanners. Such as generating technical manuals including text, drawings and pictures. Catalogs. Personnel or doc-

Until now, your PC wasn't giving you the full picture. Because no matter how you look at it, it takes both time and money to convert old drawings to your new CAD system.

But Datacopy's new graphic scanners change all that.

Convert old drawings to your PC CAD system. Quickly.

This remarkable peripheral enables you to move images from paper to your CAD database. Without painstaking manual digitizing.

When used with AutoDesk's CAD/camera™ and AutoCAD™, Datacopy's scanners can convert images to vector form for drawings or symbol libraries. Or convert CAD drawings to raster format for complex documents.



ument files. Or whatever you decide.

All you need to get in the picture is an IBM XT, AT, or compatible. Our friendly, yet powerful, Word Image Processing System™ software is included in your purchase.

The result is a visionary achievement: the power to draft information, not just drawings; to publish information, not just data. All for a surprisingly low cost.

But seeing is truly believing. Which is why you should call our toll-free number today for more information—1-800-821-

2898 or in California 415-965-7900. Or

write Datacopy Corporation, 1215 Terra Bella Avenue, Mountain View, CA 94043. Telex: 701994 DATACOPY UD.

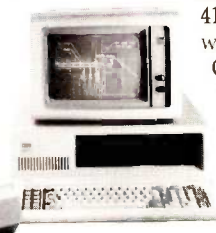

DATACOPY

The Eye of the Computer™



Your Career Is Our Business- Catch Our Magazine

Grab the brass ring through McGraw-Hill's **COMPUTER CAREERS**

McGraw-Hill's **COMPUTER CAREERS** magazine will be published in May 1985. This McGraw-Hill publication, focusing on career development, will be edited for computer specialists working in leading edge areas such as computer graphics, communications and robotics, as well as mainstream design and application of computer technology.

You are only eligible to receive a free subscription if you graduated between 1978-1985 with a:

Computer Engineering/Science major or Electrical/Electronic Engineering major with computer related curriculum, and/or

Are actively involved in computer technology in your job function.

To receive this free subscription to **COMPUTER CAREERS**, fill in one of the attached postcards which will trigger an application form for you to complete. We must have your home address only. If both cards are missing, send your request to: Violet Frey, Circulation Manager, McGraw-Hill's **COMPUTER CAREERS**, McGraw-Hill Publications Company, 1221 Avenue of the Americas, New York, NY 10020.

COMPUTER CAREERS editorial content will focus on interests and concerns of the computer science/engineering specialist. Articles will sift through the maze of computer-related jobs to show you what and where the opportunities are...tell you how to weigh them now and in the future...offer expert advice that will help you move successfully ahead in your career...identify areas where you can build your personal attributes to enrich your career. In addition, the reader has available a Resume Forwarding Service in each issue.

McGraw-Hill's
**Computer
Careers**



then be able to send in book manuscripts that greatly resemble the final printed work.

RESOLVED...

The new Apple printer has 300 dots/inch resolution. That means 90,000 dots per square inch. Multiply that by the 8½ x 11 inches of a standard sheet of paper, and you'll see why Apple needed so much memory in its new printer. The HP LaserJet is character-oriented. It needs more memory if it's going to do graphics. I'm sure HP will do something about that.

Real typesetters consider 300 dots/inch to be far too little; but give the micro world a couple more years and nearly anyone will be able to typeset a book.

MACROTECH AND GIFFORD

In my review of the Macrotech 80286/Z80 board for S-100 systems, I said

that the CompuPro people have been concerned about using the "B-step" revision of Intel's 80286 chip for multi-user systems because the B-step has known bugs. On the other hand, Macrotech's engineers believe they have compensated for the chip's problems. Certainly I never had a problem while using the Macrotech board in my otherwise all-CompuPro system with CompuPro single-user software.

The Macrotech board was designed to drop into an existing CompuPro 8/16 system, replacing the processor but leaving the CompuPro Disk Controller, Hard Disk, System Support Board, memory boards, and communications equipment intact; and the Macrotech system ran on 8/16 software as obtained from CompuPro. When CompuPro (well, Viasyn; I'll get used to using the new name one day) began changing over to Concurrent

DOS and the SPUZ concept (see below), they made significant changes in their software. Their latest stuff won't work with the Macrotech board. I'm a CompuPro test site, and what with all the construction here I didn't have room to set up two S-100 systems, so in order to test the new CompuPro software I switched back from the Macrotech board to my older CompuPro 8085/8088 processor. I wasn't too happy with the change; the Macrotech was significantly faster.

I've now heard from the people at Gifford Engineering. They have multi-user software for the Macrotech board, and they say they have never had any problems with what they're shipping; they don't hesitate to recommend the Macrotech system to customers. Gifford has done a lot of work with CompuPro equipment and software and has a deservedly high

(continued)

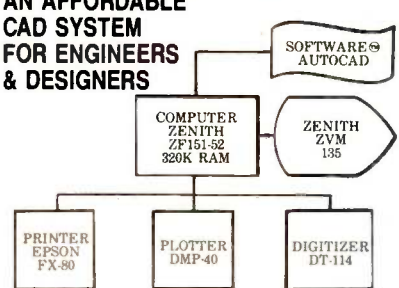
<p>Come visit us in our Long Island Showroom 226 Sherwood Ave. Farmingdale, NY 11735</p>				<p style="text-align: right;">Se Habla Español 1-800-331-3341 Cable: COMSYSTEC NEWYORK Telex: CSTNY 429418</p>	
<p>OUR SPECIALTY: IBM COMPATIBLE PRODUCTS, GRAPHICS, DATABASE, 68000 UNIX, EXPORT</p>					
<p>NEW UNDER \$4000 COMPLETE CASH REGISTER—COMPUTER—POINT OF SALE—COMBINATION SYSTEM—CALL! ALSO — SYSTEMS FOR MULTI-USER ACCOUNTING, LEGAL, MEDICAL, DENTAL, PHARMACY, CHIROPRACTIC, WHOLESALERS, RETAILERS, WAREHOUSES, BUSINESS, DATABASES, COMMUNICATION, NETWORKS</p>		<p style="text-align: center;">ACCESSORIES</p> <p>3 COM NETWORKING ETHERLINK \$650 IBM PC 1 or 2 to XT upgrade ROM BIOS ... 119 TAVA and PC COMPATIBLES 2.0 UPGRADE ROM 85 5¼ DSDD DISKETTES—\$1.49 ea. 10 MEG HARD DISK WITH CONTROLLER \$795 IN CASE WITH POWER SUPPLY, CABLES, ETC. 1095 PRINTERS—CALL FOR OTHERS C. ITOH • F10-40P • \$947.70 OKIDATA • 82A • \$324.00</p>		<p>AN AFFORDABLE CAD SYSTEM FOR ENGINEERS & DESIGNERS</p> 	
<p>IBM AT ADD ONS—Latest and best CMI 20 and 40 M-Byte Drives Multifunction board—to 4 Meg RAM, 4 serial ports, parallel, game ports—Call AT 1.2 Meg Diskettes—\$6.45 ea.</p>		<p>NETWORKS—MULTIUSER SYSTEMS New High Resolution, Quality Font and Graphics Laser Printer \$6500</p>		<p>\$5,800.00 DT114 DIGITIZER 780, DT11—\$725 DMP 40—\$795, DMP 41 or 42—\$2450 DMP 51 and 52—\$3850 HP 7470A—\$940 HP 7475—\$1650 Zenith ZVM 136 PRINCETON GRAPHICS SR12, HI-RES COLOR—CALL</p>	
<p>Cromemco NEW 68000 BASED VIDEO COMPUTER</p>		<p>NEW — Sanyo IBM Compatible Internal Color CRT Portable, 2 Drives, Serial, Parallel Ports, Comp. Video, and RGB Output \$1995</p>		<p>SYSTEM CONFIGURATION We assemble systems at special prices, including software, special operating systems, shells etc. Call us for business systems, CAD systems, networking, LANS, graphics, mainframe links, interfacing, application integration. MULTI USER SOFTWARE USING MS-DOS FORTUNE 1,500,000 COMPANIES— LET US SOLVE YOUR SYSTEM NEEDS!</p>	
<p>Primages 45CPS Daisy Wheel Printer with Pagemate Sheet Feeder and 14" Paper Width—Super Quality at \$839</p>		<p>Polaroid Diskettes 5¼" DSDD with Dial A File \$30/Box</p>		<p>CLEARANCE: EPSON QX10—\$1299</p>	
<p>Qume 101 Terminal Special \$329</p>		<p>Apple Compatible Oki 92 with Cable \$349 Silver Reed Letter Quality \$279</p>		<p>Columbia, Eagle, NEC PC 8021, ZENITH, DUAL TELEVIDEO, COMPAQ, CORONA, SANYO, IBM PC/AT, APPLE, ETC... CALL TERMINALS, PRINTERS, MODEMS, PLOTTERS, DIGITIZERS</p>	
<p>Prices subject to change. American Express, Visa/Mastercard add 3%. F.O.B. point of shipment. 20% restocking fee for returned merchandise. Personal checks take 3 weeks to clear. COD on certified check only. N.Y. residents add sales tax. Manufacturers' warranty only. International customers, please confirm price before order. Accept P.O. from Fortune 500, schools and gov't.</p>		<p>Computer Channel 226 Sherwood Ave. Farmingdale, NY 11735 For information CALL (516) 420-0142 To order CALL 1-800-331-3341</p>		<p>TELEX: 429418 CSTNY</p>	

The C Compiler Thousands Rely On

C-86™

NEW-IMPROVED Version 2.2 Compiles 25% Faster
IBM-PC AT Support

When the going gets tough, Optimizing C86 comes through time and time again. C86 is a highly dependable C compiler that has been optimized through the years to provide the best combination of reliability, speed, and performance.

FAST, IN-LINE 8087/80287 SUPPORT

Now you can take full advantage of 8087/80287 capabilities, allowing your programs to run many times faster than possible with other C compilers. Plus the source code to all routines is included, so you have complete control over all functions.

MORE OF THE FEATURES YOU WANT

- **SOURCE** is provided to all libraries for total programming control. The source includes a set of standard UNIX routines plus many DOS specific functions.
- **SPECIAL IBM-PC LIBRARY** including communication, screen, and keyboard handling functions.

- **COMPATIBLE WITH WIDELY AVAILABLE LIBRARIES** such as HALO screen graphics and many, many others (call for list).
- **TOPVIEW SUPPORT LIBRARY** provides windowing capabilities.
- **SPEED OPTIMIZATION** — there's always room to tighten your code, and Computer Innovations has the tools to help. For example, *PROFILER-86* helps identify key areas for optimization.

TECHNICAL SUPPORT, NOBODY DOES IT BETTER

Computer Innovations has earned a reputation for providing customer support that is **unequaled** in the industry. This includes a user's group, an on-line bulletin board, and a user's newsletter.

JOIN THE THOUSANDS OF PROGRAMMERS WHO TRUST AND RELY ON C86

For Further Information Call 800-922-0169.
Technical Assistance Call (201) 542-5920.
Computer Innovations features a full line of C products including **C-to-dBase** (dBase development tool) and **Introducing C** (C Interpreter Language Learning System). Call or write for a product profile.



**COMPUTER
INNOVATIONS, INC.**

980 Shrewsbury Avenue, Tinton Falls, NJ 07724

© 1984 Computer Innovations, Inc.

For Further Information Call
800-922-0169

Technical Assistance Call (201) 542-5920

Inquiry 104

reputation for delivering quality systems. They will continue to provide software support for the Macrotech board.

I'm no great fan of multiuser systems. I continue to believe that "one user, at least one processor" is the motto to follow. The multiuser system I use is the CompuPro C-10, better known here as Shirley. Each user has a Z80 board and a block of memory, with yet another processor to network them together and do traffic management for access to common files and common equipment like the hard disk and printer. However, in my opposition to timesharing I may be bucking a trend: the IBM PC AT is supposed to offer multiuser capabilities (although the last I heard there have been some problems), and Gifford reports good success with multiple users on the Macrotech 80286/Z80 board.

Anyway, I want to make it clear that I liked the Macrotech board a lot; I never had any problems with their final version; and I haven't heard from anyone who did have problems. I've still got mine, and when things settle down here I intend to set up two S-100 8/16 systems—one based on the Macrotech, the other on Viasyn's latest 80286 plus Z80H SPUZ—and flog the daylight out of them.

THE SPUZ IS HERE

While I was down at the Mini/Micro show my new 80286 and Z80H boards arrived from Viasyn. Alas, I have to go to the Stride Faire tomorrow morning, and this has to get out tonight; Tony came over for an hour to set things up. It didn't take him more than about 5 minutes; Viasyn's documentation and installation instructions are steadily improving, partly in response to my carping.

Anyway, I was able to use the new system for spelling checking and sending this to New Hampshire on BYTEnet, but I haven't had time to do more extensive testing. On the other hand, Tony has been running his CompuPro 80286 and Z80 for nearly three months, so no one anticipates any problems—but we'll see. I often find glitches no one else does, which is one reason that Viasyn uses me as a test site.

Unlike the Macrotech 80286/Z80 board, the new CompuPro 816/286 system uses two different boards. The 8-MHz Z80H board is a SPUZ, which is CompuPro shorthand for Slave Processor Unit Z80. (There will be other SPU boards, such as an 80186.) The 80286 processor boasts the newest "C-step" revision 80286 chip from Intel. Together, they make up a super-fast system with true concurrent operations: the Z80 SPUZ can be doing one job while the 80286 is doing another.

In fact, you don't need the 80286 board to run the Z80 as a SPUZ. Before we installed the new 80286 processor, we dropped the SPUZ into my existing 8085/8088 system and installed the new Switch! (that's generally pronounced "switch-bang!") software that comes with the SPUZ, after which all my 8-bit software (such as WRITE) ran on the newer and faster Z80H. The 8085 aboard the 8085/8088 Dual Processor board is awakened on power-up, then immediately told to go to sleep; after that, the SPUZ handles all 8-bit operations. So long as you stick to 8-bit stuff, the system is just as fast with a Dual Processor and SPUZ as it is with the 80286 processor; meaning that you can upgrade a Dual Processor in stages, if you don't want to pop for everything at once.

The 80286 runs 16-bit operations, like directory sorts, and PIP, and assemblies, and disk accesses, at surprisingly noticeable higher speeds. I haven't tested the CompuPro 80286 against the Macrotech. They're both fast.

The SPUZ without the 80286

(continued)

INSIGHT™

EXPERT SYSTEMS

"INSIGHT is essentially the equivalent or better than any other tool available for the personal computer."

Paul Harmon, author of Expert Systems, Artificial Intelligence in Business

Turn your PC into an expert.

Give it Insight, or give it Insight 2. Both let you create knowledge base systems using any PC-compatible text editor.

Insight not only simplifies access to lots of information, it analyzes and offers solutions. For entry-level operators it's a perfect procedural training package to help build and implement knowledge base software.

Insight 2 is more than just an "expert." It's a knowledge base engineering tool with application capabilities. It can call up Pascal programs, read and write dBASE II® files, and its decision-making process can tie in directly to your existing databases. Run-only versions also can be developed and distributed.

Two unique packages from the same expert idea.



**Level
Five
Research, Inc.**

*Insight™ (\$95) and Insight 2™ (\$485)
run on the IBM®PC, DEC® Rainbow, and
Victor® 9000.*

4980 South A-1-A

Melbourne Beach, Florida 32951

(305) 729-9046

What every Apple II+ and IIe user should ask before buying the "Sider" 10 MB hard disk:

When a company offers a superior quality 10 megabyte Winchester hard disk for only \$695, it's bound to raise a few eyebrows...and a lot of questions. The fact is, you're probably already wondering "Can I really get a 10 megabyte hard disk that's *reliable* for only \$695?" The answer is: ABSOLUTELY...when you choose the Sider from First Class Peripherals.

What's so great about the Sider?

For starters, the Sider lets you boot your *Apple II+* or *IIe* directly off the hard disk—unlike some other Winchester subsystems. Rebooting is also trouble-free. And the disk is partitionable, allowing you to allocate space to four operating systems on the same disk. The Sider supports: Apple DOS 3.3; Pro DOS™; Apple Pascal; and CP/M®.

What's more, a small "footprint" lets you incorporate the compact Sider into your existing computer set-up with ease.

In addition, with the Sider, you not only pay far less for the subsystem, you also save money on installation. Because, unlike other 10 MB systems that require the purchase of expensive "extras," the Sider is *plug and play*. Everything you need is provided, including cables, host adaptor, installation software and manual.

What makes it so reliable?

To start, the Sider is manufactured, and sold exclusively, by First Class Peripherals, an innovative computer company which is backed by Xebec. The computer industry's leading manufacturer of disk controllers, Xebec has over a decade of experience serving customers like IBM, Toshiba, Texas Instruments and Hewlett Packard. It's this kind of expertise that helps assure the Sider's performance.

Special design features further enhance reliability. The Sider's controller is the field-proven, industry standard Xebec SI410A. And Xebec's 3200 drive tester, the

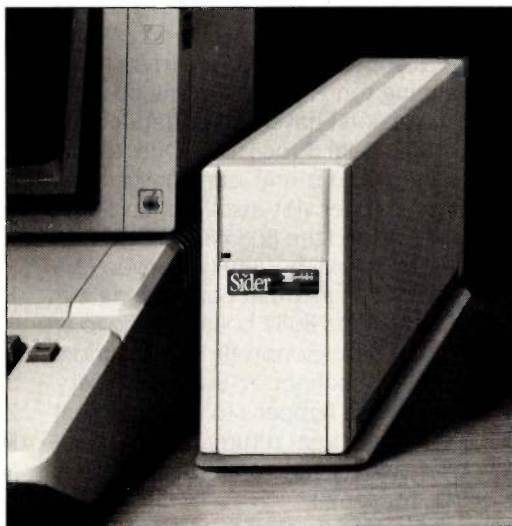

"Only \$695?"

toughest in the industry, ensures that the Sider will operate reliably. One more assurance of the \$695 Sider's quality: it's UL Approved and FCC Class B rated.

But why is it only \$695?

You pay less for the Sider than for other 10 MB hard disks simply because you're paying for the superior quality components inside the unit, not for a lot of retail overhead costs. Since First Class Peripherals sells direct, you avoid dealer and dis-

tribution expenses, and pay only for the product.

What about a guarantee?

Like many experienced Apple users, you may be reluctant to buy a hard disk priced at only \$695 without first seeing for yourself how it performs. That's why First Class Peripherals offers you a reassuring, money-back guarantee that eliminates any risk on your part. Simply order the Sider and use it for 15 days. Then, if you're not entirely satisfied, return it and receive a full refund—no questions asked.

The Sider also comes with a full one-year limited warranty. Plus, there's a convenient, toll-free hotline you can call anytime you have a technical or service question, or need help.

Don't delay. Order the Sider now.

To receive the Sider 10 megabyte Winchester hard disk subsystem for only \$695, simply order using the coupon below. For faster service, order by phone and charge to your VISA, MasterCard or American Express. (You can also call us if you have any questions or technical concerns about the Sider. We'll see you get the help you need.) Call toll-free:

1 800 538-1307
Extension 205

Yes, please send me the Sider, including half-height 10 megabyte Winchester hard disk drive, Apple adaptor board, cable, complete installation software and documentation.

I prefer to pay as follows:

- I've enclosed my check or money order for \$695* + \$15 shipping and handling, payable to First Class Peripherals.
- Please bill the following credit card account for \$695* + \$15 shipping and handling:
- VISA MasterCard American Express

Card # _____ Exp. Date _____

Signature _____
*Residents of CA, NV and PA, please add appropriate sales tax.

Name _____

Address _____

City _____

State _____ Zip _____

Telephone (area code) _____

Mail to:

FIRST CLASS PERIPHERALS 3579 Highway 50 East
Carson City, NV 89701

Apple and Pro DOS are trademarks of Apple Computer, Inc. CP/M is a registered trademark of Digital Research, Inc.

*I saw little of
interest at this year's
Mini/Micro show.
All the exhibits
were in two large
rooms of the
Disneyland Hilton.*

speeds up 8-bit operations something wonderful. WRITE blazes along; indeed, the system drives the TeleVideo 950 (connected up at 19,200 bits/second) almost as fast as Zeke II works with memory-mapped video. I guess it won't be long before I abandon my ancient VDM (video-display module) memory-map board. That will sever my last link with Zeke I, my friend who happened to be a Z80 computer. The VDM board we use at present is not the same one that we had in Zeke I, but the character-generator chips in the board are.

WAITING...

What we're waiting for is the first production run of the CompuPro PC-Video board. You drop that into an S-100 system and connect up either a color or a high-resolution monochrome monitor (both are combined on the PC-Video board), after which your 80286/SPUZ, Dual Processor, or 8086 system can be made to think it's an IBM PC AT. Tony designed the PC-Video board to work with any PC-compatible keyboard, so I'll use the Wico Smartline Smartboard. My system will then run under Concurrent DOS; meaning that I'll have available, on one computer system, the whole world of 8-bit CP/M software (such as WRITE, The Word Plus, and Calendar/1); all of my CP/M-86 16-bit software, including all the 8-bit stuff I wrote in CBASIC and recompiled with CBASIC-86; and about 98 percent of the IBM PC software, including SideKick, Lotus

1-2-3, ThinkTank, Flight Simulator, and WordStar 2000. Moreover, I'll be able to run 8-bit programs, such as WRITE, simultaneously with 16-bit, such as long compilations.

I'd hoped to get Concurrent DOS running tonight, but it turns out that the version I have is intended for use with a Dual Processor. Due to my bouts with flu and our construction orgy it never got installed, and now we've retired the 8085/8088 Dual Processor board, hopefully forever. (Actually, of course, that board, along with Jim Hudson's 8087 board, will go to an educational nonprofit organization, such as a school or the L-5 Society. That's what happens to all equipment that doesn't get returned to the supplier. We try not to let anything stay idle for long.)

I'd hoped to change to Concurrent DOS because I wanted to send this at 1200 baud. (I know, I know; the modern convention is to say "bits/second" rather than baud, and technically that's a bit more accurate; but I learned the older terminology, and "baud" is much simpler and shorter to write. After all, we say "hertz" rather than "cycles per second.") Alas, this goes off at 300 baud. A story goes with that.

I'm writing this column on Zeke II, a plain vanilla Z80 system. When I get done, I transfer the text (with a 1-megabyte 8-inch floppy disk) to the new 80286/SPUZ machine for spelling checking. (I've got to find out that machine's name; 80286/SPUZ is clumsy.) After that, it gets transmitted to New Hampshire via BYTEnet. What I'd hoped to do was use Concurrent DOS to output the text onto a 5¼-inch disk in IBM PC-DOS format. I could then take that disk over to the Zenith Z-160, which has our OmniTel Encore 1200-baud modem, and squirt the files off at 1200 baud. Alas, the only modem I had for the Dual Processor (and thus the only one I have for his successor, the 80286/SPUZ) is an ancient PMMI (Potomac Micro Magic Inc.) 300-baud system; it works fine, but I never knew how *slow* it was until I started fooling around with the OmniTel Encore at 1200. Now, though,

I'm anxiously awaiting Concurrent DOS, because even with all that monkey motion it would be worth the extra effort to communicate at 1200.

Of course, I could break down and get another modem. Tony tells me he no longer recommends an internal modem for S-100 systems. Fortunately, the people at OmniTel have sent me their Hayes-compatible external 300/1200 modem. That will run MITE just fine.

HOW FALLEN ARE THE MIGHTY

The Mini/Micro show used to be combined with WESCON. I remember it as large and exciting. I first saw the Zenith Z-100 at a Mini/Micro. The DEC Rainbow was introduced at another Mini/Micro. I first saw Modula-2 in action, and got Modula-2 and a Sage II to run it on, at a Mini/Micro show.

This year there was nothing. At the last Mini/Micro in Anaheim, WESCON filled the Anaheim Convention Center, and Mini/Micro completely filled two floors of exhibit space at the Disneyland Hilton. This year, all of the Mini/Micro exhibits were contained in two large rooms of the Disneyland Hilton. One of those rooms was the ballroom in which we held the ice-cream social, Meet the Pro's, at last year's World Science Fiction Convention; and indeed, the World Con had considerably higher attendance than Mini/Micro.

I saw little of interest at Mini/Micro. There were about 20 booths exhibiting VME and Multibus stuff, which may or may not be a portent of the future. I saw for the first time a Motorola 68000 computer intended as a development system for 68000 software; it has some of the finest high-resolution color graphics I've ever seen. Otherwise, nothing new, and little to grab my attention.

PRICE GOUGING?

One thing I was looking for at Mini/Micro was an expansion box for our IBM PC. Lucy Van Pelt is *full*, and we have lots of new boards for her, including two Hercules boards (see below), modem boards, hard disk (we

(continued)



With Network Revelation,[®] you're not alone.

Span the void that separates you from other PC's. Be as one with a universe of data. Be a true network with Network Revelation.[®]

Network Revelation is more than a relational database management system. It's a complete applications environment for most microcomputer networks. That's not dreaming about the future. It's low-key raving about a capability of the present.

With Network Revelation, you can send and receive data on local area networks and remote file servers. Rev's data dictionaries let you add or restructure

fields at will, saving ages of programming time. And our menu-driven applications generator and procedural language are eons ahead of other databases.

The possibilities are infinite. Distributed processing systems linking worlds. Accounting, inventory and order entry systems connected for instant access to data by a galaxy of users. And your data is secure with complete file or record locking.

REVELATION co-exists with MS-DOS.[™] So you can transport Lotus 1-2-3,[™] Multiplan[®] or other data from

PC to PC—using popular routes like Novell, Ethernet or 3 Com.[™] You can even evolve files from primitive, single-user databases into a powerful Rev application.

Encounter the future of distributed data processing today. Revelation costs just \$950.00.* Network Revelation starts at only \$1495.00* for a complete four-user system. So call us and we'll arrange for an unforgettable demonstration with a Cosmos rep in your area.

MS[™] and Multiplan[®] of Microsoft Corporation.
1-2-3[™] of Lotus Development Corporation. 3 Com[™]
of 3 Com Corporation.
*Suggested U.S. list price.

Cosmos, Inc., 19530 Pacific Highway S.

COSMOS[™]

Seattle, WA 98188, 206-824-9942



\$549

10 MEG H.D. INT.

\$79 \$669

HH DRIVE JUKI 6300

WAREHOUSE EXPRESS

\$229 | **\$149** | **\$1049**
 WS PRO | 5 PACK | MAC 10 MEG

PRINTERS • PLOTTERS

C. ITOH (Riteman, Epson Exacts)	CALL
EPSON (All Models)	CALL
ENTER (Sweet-P 6 Pen Plotter, HP)	\$729
JUKI	
6100	\$372
6300	669
LEGEND (Square Dot, EPSON Compatible)	
880	LOW
1080	\$229
1380 160cps (IBM)	289
1385 160cps 17" (IBM)	LOW
SILVER REED	
EXP400	\$229
EXP500	274
EXP550	389
EXP770 36cps	669
TOSHIBA	
1340	\$544
1351	1179

MODEMS • MONITORS • DRIVES

ANCHOR AUTOMATION	
Volksmodem 12 (1200 Baud)	\$169
Mark XII (1200 Baud)	225
Express 1200 (HAYES Exact)	CALL
HAYES (1200, 1200B)	CALL
NOVATION (HAYES Compatible)	
Smart Cat + 2400 IBM & MAC	\$499
Smart Cat + 1200 w/Mite & Cable IBM & MAC	295
TAXAN	
116 Amber	\$115
122 Amber	131
420 RGB IBM HI-RES w/cable	379
425 RGB IBM HI-RES	399
440 RGB IBM ULTRA HI-RES	513
PRINCETON GRAPHICS	
DRIVES (E-Z Install)	
5.25 hh/ds/dd IBM	\$ 89
Controller Card (w/drive only)	69
10 Meg HD PC	549
20 Meg HD PC	699
20 Meg HD AT	599
Macintosh 10 Meg HD	1049
3.5 do/dd MAC Drive Ext.	350

COMPUTERS • CARDS • CHIPS

PC's SYSTEMS		CALL
LEADING EDGE		CALL
MAC's		CALL
NEC		
APC III	CALL	
8401	LOW	
8201 w/Modem	\$299	
AC or BATTERY Adaptor	17	
RAM 32K	199	
PANASONIC (SR. Partner)		CALL
PARADISE		
Modular Graphics Card	\$259	
5-Pack	149	
Parallel or Serial Port	65	
RAM 64K 150 NSEC	\$ 19	

SOFTWARE • DISKETTES

AUTO CAD (Software, Digitizers, Plotters)	CALL
CPA+ (For LOTUS 1-2-3) GL, AP, AR, PR	\$350
ENABLE	\$350
1-2-3	\$289
SYMPHONY	\$390
MICROPRO	
WordStar	\$169
WordStar Professional	229
WordStar 2000	235
WordStar 2000+	285
MAXELL & OTHERS (100 QTY) IBM, MAC, HP	LOW

Please make checks payable to: **M.H.I.**
 5021 N. 20th Street #10261
 Phoenix, AZ 85064

ORDER LINE 1-800-428-7979

Other Information: **(602) 890-0596**



Prices reflect 3-5% Cash Discount. Shipping on most items \$8.00. Prices and availability subject to change without notice. Send cashier's check or money order. All other checks delay shipping 2 weeks. ADD #185

CHAOS MANOR

*A lot of software,
 including many
 spreadsheet programs,
 has special code
 to make use of the
 graphics capabilities
 of the Hercules board.*

still have the bubble-memory hard-disk emulator), and such like. There was only one manufacturer of PC expansion boxes at Mini/Micro (or at least I saw only one, and I was looking). They want about \$850 for a 6-slot box with power supply. This seems unreasonable.

After all, I can get a CompuPro 21-slot S-100 box with the splendid CompuPro boat-anchor power supply (that power is so well regulated that we've actually had the power cord unplugged by the kitten and got it plugged back in in time to avoid any glitches; I don't recommend you do that, but it did happen to us)—I can get that system for considerably less than \$850. What is there about the PC bus and power supply that makes it worth so much?

Anyway, I'm still looking for an expansion box. One day I suppose I'll gulp hard and pay the money, but I sure hate to.

HERCULES BOARD

One thing I want to install in the PC is the Hercules color board. The other day, quite out of the blue, there arrived two Hercules boards: the color board and the high-resolution graphics monochrome board. The monochrome board installs in place of the IBM high-resolution monochrome board, so we put that one in almost instantly. For some software the PC doesn't know the difference, and neither will you: text and such like are crisp and steady, but then they were

with the IBM board, too.

However, a lot of software, including many spreadsheet programs, has special code to make use of the graphics capabilities of the Hercules board. The result is a dramatic improvement.

The Orchid Technology PCTurbo 186 board we're so fond of can also take advantage of the Hercules board. Alas, I've mislaid my PCTurbo 186 manual. It isn't lost; I'm sure it has been packed in one of the innumerable boxes that fill the office extension. After all, I've mislaid almost everything else I own . . .

More on the Hercules boards next month; so far I like them.

A MACWARNING

This comes from the ARPANET Mac-Enthusiasts.

The Macintosh Reset button (also called the "Programmer's button") does not reset memory, nor does it cause the system to reboot. If used to bail out of certain kinds of system crashes, it can cause the Macintosh to trash disks.

The safest thing to do is to turn the machine off and make it reboot. Don't use the Programmer's button unless you really know what you're doing. Because it doesn't cause the system to reboot, it can, of course, save time; but the cost can be high. I was taught always to open the disk-drive doors before doing anything as radical as turning the machine off, or even resetting it, but of course you can't do that with the Macintosh, since there's no simple mechanical way to make it eject disks; either you must plead with the Macintosh to get it to give your disks back or use a hairpin on the drive mechanism. As long as the disk is in the Macintosh it can be written on, and the Mac writes on disks a lot. The present Finder is pretty dumb and doesn't check the disk directory before writing on the disk; the Reset operation can get the Finder pretty thoroughly confused. It's safer all around simply to turn the machine off, count five, and turn it back on again. [Editor's note: A hardware engineer at Apple reports that the Reset button does

(continued)

Introducing the MIX Editor

(with Split Screen - both horizontal and vertical)

A Powerful Addition To Any Programmer's Tool Box

Full Screen Editing
WordStar Key Layout
Custom Key Layouts
Terminal Configuration
Help Files
Backup Files

Introductory Offer
Only

2995

30 Day Money Back Guarantee

Programmable
Macro Commands
Custom Setup Files
Mnemonic Command Mode
Multiple File Editing
Split Screen Editing

For PC DOS/MSDOS (2.0 and above/128K) • IBM PC/Compatibles, PC Jr., Tandy 1000/1200/2000, & others
For CPM80 2.2/3.0 (Z80 required/64K) • 8" SSSD, Kaypro 2/4, Osborne 1 SD/DD, Apple II, & others

Great For All Languages

A general purpose text processor, the MIX Editor is packed with features that make it useful with any language. It has auto indent for structured languages like Pascal or C. It has automatic line numbering for BASIC (255 character lines). It even has fill and justify for English.

Terminal Configuration

A utility for defining terminal features (smart features included) allows the editor to work with any terminal. Over 30 of the most popular terminals are built-in.

Custom Key Layouts

Commands are mapped to keys just like WordStar. If you don't like the WordStar layout, simply change it. Any key can be mapped to any command. You can also define a key to generate a string of characters, great for entering keywords.

Split Screen

You can split the screen horizontally or vertically and edit two files simultaneously.

Macro Commands

The MIX Editor allows a sequence of commands to be executed with a single keystroke. You can define a complete editing operation and perform it at the touch of a key.

MIX software
2116 E. Arapaho
Suite 363
Richardson, Tx 75081
(214) 783-6001

MSDOS is a trademark of Microsoft
PCDOS is a trademark of IBM
CPM80 is a trademark of Digital Research
WordStar is a trademark of MicroPro

Custom Setup Files

Custom keyboard layouts and macro commands can be saved in setup files. You can create a different setup file for each language you use. The editor automatically configures itself using a setup file.

Command Mode

Command mode allows any editor command to be executed by name. It is much easier to remember a command name versus a complicated key sequence. Command mode makes it easy to master the full capability of the editor. Frequently used commands can be mapped to keys. Infrequent commands can be executed by name.

Editor Commands

The editor contains more than 100 commands. With so many commands, you might think it would be difficult to use. Not so, it is actually extremely simple to use. With command mode, the power is there if you need it, but it doesn't get in your way if you don't. Following is a list of some of the commands.

Cursor Commands

Left/Right/Up/Down
Tab Right/Tab Left
Forward Word/Backward Word
Beginning of Line/End of Line
Scroll Up/Scroll Down
Window Up/Window Down
Scroll Left/Scroll Right
Top of File/Bottom of File
•••

Block Commands

Copy/Move/Delete
Read/Write
Lower Case/Upper Case
Fill/Justify
Print

File Commands

Directory (with wild cards)
Show File/Help File
Input/Output File
Delete File/Save File

Other Commands

Split Screen/Other Window
Find String/Replace String
Replace Global/Query Replace
Delete Line/Undelete Line
Delete Word/Undelete Word
Insert Mode/Overwrite Mode
Open Line/Join Line
Duplicate Line/Center Line
Set Tab/Clear Tab
•••

To Order: Call Toll Free 1-800-622-4070, (Illinois only 1-800-942-7317)

Mix Editor ___ \$29.95 + shipping (\$5 USA/\$10 Foreign) Texas residents add 6% sales tax

Visa ___ MasterCard ___ Card # ___ Exp. Date ___

COD ___ Check ___ Money Order ___ Disk Format ___

Computer ___ Operating System: MSDOS ___ PC DOS ___ CPM80 ___

Name: _____

Street: _____

City/State/Zip: _____

Country: _____

Phone: _____

MIX software
2116 E. Arapaho
Suite 363
Richardson, Tx 75081
Dealer Inquiries Welcome
Call (214) 783-6001

Cure development headaches with our \$105* Controller

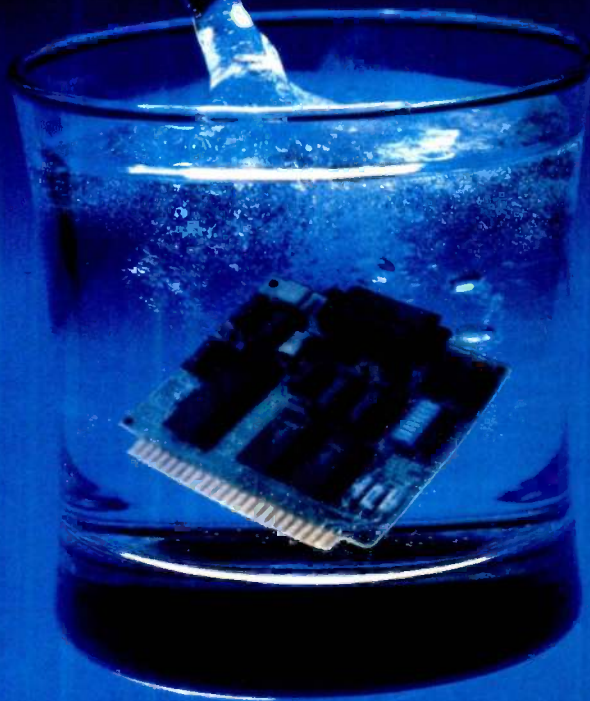

* BCC11 100 quantity or qualified buyers' price.

At \$105, Micromint's System Controller is a dirt cheap development tool without equal.

It'll turn your IBM PC into a design laboratory that saves your company thousands of dollars and months of evaluation. You'll save headaches, too. When you tell your boss the first phase of your pet project is only going to cost \$105, watch the relief begin.

Micromint's Z8 System Controller, the tiny computer on a board, is the cornerstone of an entire family of integrated, intelligent products from AC/I/O to smart terminals. Able to speak three languages (BASIC, FORTH and Assembly), this tiny 4" x 4 1/2" computer supports 6K bytes of EPROM or 4K bytes of RAM, two parallel ports and an RS-232 serial port.

If learning a new language isn't in your future, no problem. **WRITE YOUR PROGRAMS IN BASIC AND TRANSLATE THEM INTO FORTH WITH A SINGLE KEY STROKE.** Our specially masked chip will let you know in an instant whether your program is operational. You'll be building before the competition is de-bugging.

For OEM Orders and Customer Assistance Call Our Toll Free Line

1-800-635-3355



Call or write for a complete product line brochure. Or order our complete set of 12 fully detailed owners' and technical reference manuals for only \$29.95. This set includes all of the following manuals:

- Z8 FORTH System Controller
- Z8 BASIC System Controller
- BASIC/Debug Software Reference
- Z8 Microcomputer Assembly Language/Hardware Technical Reference
- Memory and I/O Expansion
- EPROM Programmer
- Analog to Digital Converter
- 16K Memory Expansion
- Serial I/O Expansion
- RS-232/20mA Converter
- Smart Video Terminal
- AC/DC Power I/O

ORDER PRODUCT CODE BCC99.

Micromint, Inc.

Dept. 14, 25 Terrace Drive, Vernon, CT 06066

in fact connect to the 68000's RESET pin and will cause the system to reboot.]

LAUNCH A THOUSAND SLIPS...

I reported in March on Mike Lehman's Fast Finder, which substitutes for the regular Finder program in the Macintosh operating system. We still like it, and anyone who writes programs for the Mac would be well advised to get it. It is, however, pretty well a hacker's tool. There are very few built-in safeguards.

It also uses Macintosh hacker terminology. In particular, there's the term *launch*.

So far as I know, launch is a term peculiar to the Macintosh and perhaps the Lisa. The Macintosh operating system allows you to access programs that aren't really programs; that is, if you "double-click" a text file created with MacWrite, the Finder is smart enough to know that what you

really want is to load (launch) MacWrite and have MacWrite read in the text file so you can edit it.

Lehman's Fast Finder program gives you another alternative. Fast Finder will ask you if you want to launch your text file. The first time I was asked that, I thought, "Well, of course I want to," and said yes; whereupon Fast Finder dutifully tried to run the text file as if it were a command file. The result wasn't pretty, and I could recover only by turning the machine off. It turns out that launch is a MacTechnical term meaning "run independent of anything else." To launch a file means to treat it as a command file. If it isn't one—if it's a MacPaint file or a document file—the result is unlikely to be what you wanted.

Fast Finder is a really convenient program, but it does give you the opportunity to really screw things up. Fortunately, there's always a way out:

*Fast Finder is
pretty well a
hacker's tool.*

one option under Fast Finder is to launch the old Finder program.

SICK JOKES

Another bit of information I got from the ARPANET: be careful what you put into your machine. There is out there making the rounds of the remote bulletin boards a program called VDIR.COM. It's a little hard to tell what the program is supposed to do.

What it actually does is trash your system. It writes garbage onto any disk it can find, including hard disks.

(continued)

6 TIMES FASTER!

SuperFast Software Development Tools

INCREASE YOUR PROGRAMMING EFFICIENCY

with high-performance software development products from SLR Systems.

No other tools approach the speed or flexibility of the SLR Systems line.

"Z80ASM is an extraordinary product...",
Robert Blum, Sept. 84 DDJ

"...in two words, I'd say speed & flexibility",
Edward Joyce, Nov. 84 Microcomputing

ASSEMBLERS

- RMAC/M80 macros
- Nested INCLUDES & conditionals
- 16 char. labels on externals
- Built in cross-reference
- Optional case significance
- Phase/dephase
- Math on external words and bytes
- Define symbols from console
- Generate COM, HEX, SLR-REL, or Micro-soft-REL files
- Time & Date in listing
- Over 30 configure options

LINKERS

- Links SLR & M80 format files
- Output HEX or COM file
- Three separate address spaces
- Load map and SID/ZSID .SYM file
- SLRINK+ includes:
 - All tables overflow to disk
 - HEX files do not fill unused space
 - Intermodule cross-reference
 - EIGHT separate address spaces
 - Works with FORTRAN & BASIC
 - Generate PRL & SPR files
 - Supports manual overlays
 - Full 64K output

- Z80ASM -full Zilog Z80 \$125
- NEW! Z80ASM+ -all tables virtual \$195
- NEW! SLRMAC -full Intel 8080, with Z80.LIB extensions internal \$125
- NEW! SLRMAC+ -all tables virtual \$195

- SLRINK -fastest memory based \$125
 - NEW! SLRINK+ -full featured virtual \$195
- Combo Paks available from \$199. - \$299.

Z80 CPU. CP/M compatible, 32K TPA required.

For additional information contact SLR Systems

1-800-833-3061, in PA (412) 282-0864
1622 N. Main St., Butler, PA 16001 • Telex 559215

"Z80ASM...a breath of fresh air...",
Computer Language, Feb. 85



C.O.D., Check or Money Order Accepted

SLR Systems

and flashes up various messages telling you what it's doing. It's a time bomb: once run, you can't be sure what will happen next because it doesn't always do anything immediately. At a later time, though, it can crash your system. Does this remind you of some of the imbecilic copy-protection schemes threatened by companies such as Vault and Defendisk? Anyway, you'd do well to avoid VDIR.COM. I expect there are a couple of harmless—perhaps even useful—public-domain programs floating

about with the name VDIR; and, of course, anyone warped enough to launch this kind of trap once can do it again. Be careful about untested "free" software.

EEEEEEK!

One more tip, which comes from, alas, practical experience: when you load a telephone number into a modem disk file, double-check the number. I gave Alex the local ARPANET access number to record for the 1200-baud modem and inadvertently transposed

two numbers. Alex dutifully put it into the system. Then we tested it. Each time we'd see the number come up, hear it ring, be answered, hear our own carrier—then no communications. Nothing.

Eventually I listened on an extension. To my horror I heard an exasperated lady answer the telephone. Naturally all she would hear would be the high-pitched whine of our carrier. Since we'd "tested" the number five times (at 0300, alas!), she was rapidly losing patience. I can't blame her. Since then I've checked all the modem access number files three times.

VALDOCS 2.0

Just before going to Mini/Micro I had a talk with Jim Bell of SemiDisk, the people who make RAM-disk hardware for S-100, IBM PC, and Epson computers. Jim tells me he has been talking to Roger Amidon of Rising Star, the outfit that is supposed to be supplying the Valdocs operating system for the Epson QX-10 computer line. Amidon says that Rising Star is working on SemiDisk drivers for Valdocs 1.19, which is, I guess, the currently supplied version of Valdocs. (The last one I have is 1.18, and I suspect that I don't *really* have 1.18. That, however, is another story.)

Anyway, Rising Star promises that you'll be able to use SemiDisk with Valdocs 1.19 "within a week," which, given the track record of Rising Star, translates to Real Soon Now.

Rising Star also assures SemiDisk that the drivers to make use of SemiDisk are already built into Valdocs 2.0. Alas, SemiDisk doesn't yet have a copy of 2.0, nor, to the best of my knowledge, does anyone else.

Interestingly enough, there was an Epson America dealer at Mini/Micro; he had large posters proclaiming the virtues of Valdocs 2.0.

"When will it be done?" I asked.

"It's done now."

"You mean I can buy it?"

"Yes."

"Can I take a copy home with me?"

"No, we're quoting 60 to 90 days

(continued)

ITEMS DISCUSSED

COMPUPro Z80H SPUZ \$695 Viasyn 3506 Breakwater Court Hayward, CA 94545 (415) 786-0909	LASERJET PRINTER \$3495 Hewlett-Packard 19447 Pruneridge Ave. Cupertino, CA 95014 (800) 367-4772
EAGLE COMPUTERS Eagle 1600 from \$4495 Spirit XL \$4795 Eagle Computer 7100 Chapman Ave. Garden Grove, CA 92641 (408) 395-5005	MACROTECH MI-286 BOARD \$1395 Macrotech International 20630 Lassen St. Chatsworth, CA 91311 (818) 700-1501
FAST FINDER \$100 Tardis Software 2817 Sloat Rd. Pebble Beach, CA 93953 (408) 372-1722	MULTIUSER SYSTEMS MP/M 8/16 \$695 Multiuser Concurrent DOS . . \$695 Gifford Engineering 2446 Verna Court San Leandro, CA 94577 (415) 895-0798
HERCULES BOARDS color board \$245 high-resolution graphics monochrome board \$499 Hercules 2550 Ninth St. Berkeley, CA 94710 (415) 540-6000	NORTON UTILITIES, VERSION 3.0 . . \$100 Peter Norton 2210 Wilshire Blvd. Santa Monica, CA 90403 (213) 399-3948
INSTANT FD ZERO RESIDUE CLEANER \$5.90 Tech Spray POB 949 Amarillo, TX 79105 (806) 372-8523	UNIVERSE \$98.50 Omnitrend POB 3 West Simsbury, CT 06092 (203) 658-6917
INTERROGATOR \$139 Dysan 1244 Reamwood Ave. Sunnyvale, CA 94089 (800) 551-9000	ZENITH COMPUTERS Z-100 \$2899 Z-150 from \$2199 Z-160 from \$2399 Zenith Data Systems 1000 Milwaukee Ave. Glenview, IL 60025 (312) 391-8865

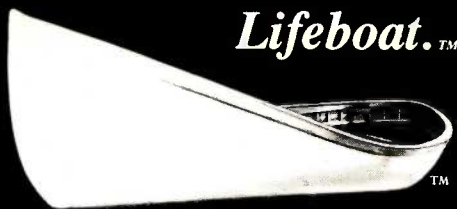

Lifeboat.™

C is the language.
Lifeboat™ is the source.

Productivity Tools from the Leading Publisher of C Programs.™

The Lattice® C Compiler

The cornerstone of a program is its compiler; it can make the difference between a good program and a great one. The Lattice C compiler features:

- Full compatibility with Kernighan and Ritchie's standards
- Four memory model options for control and versatility
- Automatic sensing and use of the 8087 math chip
- Choose from the widest selection of add-on options
- Renowned for speed and code quality
- Superior quality documentation

"Lattice C produces remarkable code... the documentation sets such a high standard that others don't even come close... in the top category for its quick compilation and execution time and consistent reliability."

Ralph A. Phraner, *Byte Magazine*

Lattice Library source code also available.

Language Utilities

Pfix 86/Pfix 86 Plus — dynamic and symbolic debuggers respectively, these provide multiple-window debugging with breakpointing capability.

Plink 86 — a two-pass overlay linkage editor that helps solve memory problems.

Text Management Utilities — includes GREP (searches files for patterns), DIFF (differential text file comparator), and more.

LMK (UNIX "make") — automates the construction of large multi-module products.

Curses — lets you write programs with full screen output transportable among all UNIX, XENIX and PC-DOS systems without changing your source code.

BASTOC — translates MBASIC or CBASIC source code directly to Lattice C source code.

C Cross Reference Generator — examines your

C source modules and produces a listing of each symbol and where it is referenced.

Editors

Pmate — a customizable full screen text editor featuring its own powerful macro command language.

ES/P for C — C program entry with automatic syntax checking and formatting.

VEDIT — an easy-to-use word processor for use with V-PRINT.

V-PRINT — a print formatting companion for VEDIT.

CVUE — a full-screen editor that offers an easy way to use command structure.

EMACS — a full screen multi window text editor.

Fast/C — speeds up the cycle of edit-compile-debug-edit-recompile.

Graphics and Screen Design

HALO — one of the industry's standard graphics development packages. Over 150 graphics commands including line, arc, box, circle and ellipse primitives. The **10 Fontpack** is also available.

Panel — a screen formatter and data entry aid.

Lattice Window — a library of subroutines allowing design of windows.

Functions

C-Food Smorgasbord — a tasty selection of utility functions for Lattice C programmers; includes a binary coded decimal arithmetic package, level 0 I/O functions, a Terminal Independence Package, and more.

Float-87 — supports the 8087 math chip to boost the speed of floating-point calculations.

The Greenleaf Functions — a comprehensive library of over 200 routines.

The Greenleaf Comm Library — an easy-to-

use asynchronous communications library.

C Power Packs — sets of functions useful for a wide variety of applications.

BASIC C — This library is a simple bridge from IBM BASIC to C.

Database Record Managers

Phact — a database record manager library of C language functions, used in the creation and manipulation of large and small databases.

Btrieve — a sophisticated file management system designed for developing applications under PC-DOS. Data can be instantly retrieved by key value.

FABS — a Fast Access Btree Structure function library designed for rapid, keyed access to data files using multipath structures.

Autosort — a fast sort/merge utility.

Lattice dB-C ISAM — a library of C functions that enables you to create and access dBase format database files.

Cross-Compilers

For programmers active in both micro and mini environments we provide advanced cross-compilers which product Intel 8086 object modules. All were developed to be as functional — and reliable — as the native compilers. They are available for the following systems:

VAX/VMS, VAX/UNIX, 68K/UNIX-S,
68K/UNIX-L

Also, we have available:

Z80 Cross-Compiler for MS- and PC-DOS — produces Z80 object modules in the Microsoft relocatable format.

New Products

Run/C — finally, a C interpreter for all levels of C Programmers.

C Sprite — a symbolic debugger with breakpoint capability.

Inquiry 249

Call LIFEBOAT: 1-800-847-7078. In NY, 1-212-860-0300.

YES! Please rush me the latest FREE Lifeboat™ catalog of C products.

Name _____ Title _____

Company Name _____ Business Phone _____

Address _____

Please check one of the following categories:

Dealer/Distributor End User Other _____

Return Coupon to: Lifeboat™ Associates
1651 Third Avenue, New York, NY 10128

1985 Lifeboat Associates

BY

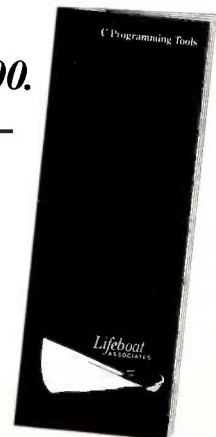

**LOW COST UNIVERSAL
E (K) PROM PROGRAMMER**

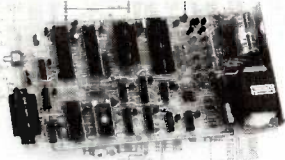

- * SUPPORTS: (EPROMS) 2516 THRU 64, 2716 THRU 512, 27C16 THRU 128, 68732 THRU 66 (EEPROMS) 52N13 THRU 33, 2816A THRU 64A (MICROS) 8741 THRU 49H
 - * NO PERSONALITY MODULES, ONBOARD POWER SUPPLY
 - * HS232C INTERFACE, XON-XOFF, RTS, CTS, DTR
 - * ACCEPTS KEYBOARD ENTRY WITH LINE EDITING
 - * ACCEPTS ASCII, INTEL, AND MOTOROLA FORMATS
 - * USER FRIENDLY MONITOR FOR I/O DEBUGGING
 - * FAST PROGRAMMING SUPPORTED: 2764 UNDER 3 MIN.
 - * LOW/HIGH BYTE PROGRAMMING FOR 16 BIT DATA PATH
 - * BYTE, BLOCK, OR CHIP ERASE (EEPROMS ONLY)
 - * LIST IN INTEL OR MOTOROLA HEX FORMAT
 - * VERIFY PROGRAM AND VERIFY BLANK COMMANDS
- * 1409-01: 4K FIRMWARE, PCB, XFORMER, DOC \$90.00
 - * 1409-02: 1409-01 + FULL SET OF PARTS \$200.00
 - * 1409-03: ASSEMBLED AND TESTED UNIT \$300.00
 - * 1409-11: 8K FIRMWARE, PCB, XFORMER, DOC \$125.00
 - * 1409-12: 1409-11 + FULL SET OF PARTS \$250.00
 - * 1409-13: ASSEMBLED AND TESTED UNIT \$350.00
 - * COMMUNICATION DRIVERS FOR MOST PCs \$35.00

B&C MICROSYSTEMS
6322 MOJAVE DR, SAN JOSE, CA 95120
Tel: (408)997-7685, TWX 4996363

NEC PRINTERS

2050	\$ 625
3550	\$ 990
8850	\$1400
2010/15/30	\$ 625
3510/15/30	\$ 990
8810/15/30	\$1400
Elf 360	\$ 399
Pinwriter P-2	\$ 490
(w/Interface & Tractor)	
Pinwriter P-3	\$ 690
(w/Interface & Tractor)	

Terms: **PREPAID — FREE FREIGHT!!**

QUALITY PRINTERS
8415 Cement City Rd.
Brooklyn, Michigan 49230
Phone: 517-592-3749

Inquiry 345

AWESOME
TECHNOLOGY, INC.

Poor Man's TopView™

"MULTIPLE CHOICE" Provides:

- A) Screen switching under DOS
- B) Up to 8 programs in memory
- C) Efficient memory use - run 123 with WordStar in 256K
- D) Data transfer screen snapshot
- ✓E) All of the above available NOW

Multiple Choice is only \$64 and runs on IBM PC/XT/AT/clones

For Information, Call (408) 646-1384

AWESOME TECHNOLOGY, INC.
177 Webster St. Ste. A-416
Monterey, CA 93940

Order Toll Free (VISA/MC)
Outside CA (800) 548-2255 Ext 803
Inside CA (800) 624-2644 Ext 803

TopView is a trademark of IBM Corporation

Inquiry 44

CHAOS MANOR

delivery time."

"Wait," says I. "You mean I can order it now, but it will be 60 to 90 days before you'll deliver it to me?"

"Yes."

In other words, Valdocs 2.0 will be available Real Soon Now. I sure wouldn't hold my breath. If they ever get things set up to use SemiDisk with Valdocs in any form whatever, I advise all Valdocs users to take advantage of the opportunity. Valdocs with a RAM disk would be both simple to learn and conveniently fast; I'm amazed that Rising Star hasn't done something about the situation already.

EAGLE FLIES?

They didn't have an exhibit, but I did meet Gary Kappenman, CEO of the newly reorganized Eagle Computer, at Mini/Micro. Eagle went through some hard times. As a result, they offered reviewers the opportunity to buy their review machines at good discounts. I bought both of mine, the Eagle 1600 (a very fast 8086 machine) and the Spirit XL, an IBM PC XT work-alike that's about 99 percent PC-compatible.

Alex promptly borrowed the Spirit XL. The Spirit runs PC-DOS 2.0, which allows tree-structured disk directories. Working late at night Alex managed to erase an entire disk directory. He makes backup copies, of course, but he'd made the last backup just before his most productive hour of the week. When he realized he'd erased everything, he left the machine running and locked up the room so no one would touch it. The next morning he called Eagle and explained his problem.

"Norton Utilities," the Eagle people said. "Go buy them."

He went out and got Norton Utilities 3.0; the program took care of his problem. Alex says the Norton Utilities are self-prompting, very easy to use, and let him completely recover from his blunder.

We're still fond of the Eagle Spirit XL. I am told I will get Eagle's newest machine, the Turbo, within a week or so. I'm looking forward to it; I've heard good things about the machine.

Eagle always did have excellent hardware. The problem was that their

software was never complete and their documentation was wretched. Gary Kappenman tells me they had too many bright people: before they would get one development completely finished, the hackers would rush off to invent yet another marvel.

"As technology improvement that was a great way to go," Kappenman says. "As a way to generate marketable products it wasn't such hot procedure."

According to Kappenman, Eagle has stacks and stacks of excellent new technology on the shelf; they've cut way back on personnel and expenses; and they intend to concentrate on bringing their on-shelf technology to market, one *finished* product at a time.

I always did like their hardware and their protechnology attitude. I wish them well.

WINDING DOWN

It's 0200, and I have to catch a plane to Reno at 1000. The guest of honor at the Stride Faire this year is Niklaus Wirth, and I confess I'm greatly looking forward to meeting him. Stride Micro also promises a remarkable new human/computer interface system based on cursor control through eye and head movement. It sounded like a good idea when they told me about it last year; and people I respect at Stride Micro are enthusiastic, so that's something else I want to see.

After Reno I go to Dallas to see some late developments at TI. My Chrysler LeBaron convertible talks to me through a TI Speech Synthesizer chip; I confess that one thing I'd like to get from TI is a way to program my car so that it will say outrageous things at the touch of a hidden button. Things like "Beep Beep Beep: Your passenger is stupid;" or "Beep Beep Beep: Passenger should prepare for extreme lateral acceleration;" or even "Beep Beep Beep: Ejection seat is armed;" I'd also like to have a way to connect the voice to the security system so that it might say "Warning: Lethal gas now being released into driving compartment." I don't sup-

(continued)



**There's a good chance
that a computer in
your future will
come with
Microware software.**

**People who can't wait for the
future have Microware
software now.**

Right now, many of the biggest names in the business have their next-generation personal computers on the drawing boards. These advanced systems will have capabilities that will go far beyond what's available today. Many of these exciting new products will feature high-performance system software by Microware.

Operating systems and programming languages are the foundations upon which all other applications are built. Microware's OS-9 operating system is the ideal base for innovative fourth-generation application packages. It provides many advanced capabilities including true multitasking, a universal file and I/O system, modular construction, powerful graphics, unlimited communications gateways, and real-time response. And it's so versatile it can be used on almost any size system — from inexpensive personal computers all the way up to large multiuser systems.

Microware also has outstanding versions of the most popular programming languages. For example, Microware's extended, structured Basic is friendlier than an interpreter, yet it runs as fast as a compiler. And it's so smart that it actually reports bugs as programs are typed in. Or consider Microware's full-feature C Compiler. It can recompile almost any Unix application program to be much smaller and faster than the Unix equivalent. You can also choose Fortran and Pascal compilers of equal calibre.

Software like this doesn't happen by accident. Microware software is specifically designed to **unleash the full potential of the extraordinary**

68000 and 6809 microprocessor families. Microware works in close cooperation with the people who actually design the systems and silicon in order to achieve maximum integration and performance. That's why Microware software has already made a big impact within the scientific, engineering, and industrial communities.

Affordable, powerful personal computers with Microware software are available *now* at most Tandy/Radio Shack retail locations, and through Fujitsu and Hitachi in Japan. Plus over a hundred innovative manufacturers worldwide offer a veritable banquet of professional systems and software for VME, Multibus, STD, and most other popular standard bus architectures. If you're technically oriented, you can even get a reasonably priced Microware PortPak™ and install OS-9 on your own custom 68000 system.

Some things change, others can't. Will Unix ever become affordable and understandable enough for you? How long can MS-DOS keep up with new technology? You can wait and find out, or you can step into the future today. Contact us today and we'll send you complete information.



MICROWARE®

MICROWARE SYSTEMS CORPORATION
1866 N.W. 114th Street • Des Moines, Iowa 50322
Phone 515-224-1929 • Telex 910-520-2535

MICROWARE JAPAN, LTD.
41-19 Honcho 4-Chome, Funabashi City • Chiba 273,
Japan • Phone 0474-22-1747 • Telex 298-3472

OS-9 is a trademark of Microware and Motorola. Unix is a trademark of Bell Laboratories. VAX is a trademark of Digital Equipment Corporation. Multibus is a trademark of Intel Corporation.

PROFESSIONAL PROGRAMMER'S BULLETIN:

Be Productive, Be

BRIEF™

The Programmer's Editor

TRY BRIEF RISK-FREE
FOR 30 DAYS WITH
OUR MONEY-BACK
GUARANTEE!

BRIEF's power and flexibility provide dramatic increases in programming productivity. BRIEF's ergonomically designed human interface becomes a natural extension of your mind, allowing you to eliminate tedium and concentrate on creativity.

- WINDOWS
- Full UNDO (N Times)
- Compile within BRIEF
- Keystroke Macros
- Exit to DOS inside BRIEF
- Programmable Macro Language
- Multiple files, unlimited size
- "Regular Expression" search
- Reconfigure keyboard
- Language sensitive user controllable features (such as Auto-Indent for C)

AVAILABLE FOR PC-DOS, IBM-AT,
AND COMPATIBLE SYSTEMS

ONLY \$195.

DEMO AVAILABLE FOR ONLY \$10
(applicable to future purchase)

CALL TOLL FREE
800-821-2492

for "Technical Description" or to order.

**Solution
Systems™**

335-B Washington St., Norwell, MA 02061
617-659-1571

BRIEF is a trademark of UnderWare.
Solution Systems is a trademark of Solution Systems

PROLOG-86™

Become Familiar in One Evening

Thorough tutorials are designed to help learn the PROLOG language quickly. The interactive PROLOG-86 Interpreter gives immediate feedback. In a few hours you will begin to feel comfortable with it. In a few days you are likely to know enough to modify some of the more sophisticated sample programs.

Sample Programs are Included like:

- an EXPERT SYSTEM
- a NATURAL LANGUAGE INTERFACE
(it generates a dBASEII "DISPLAY" command)
- a GAME (it takes less than 1 page of PROLOG-86)

PROTOTYPE Ideas and Applications QUICKLY

1 or 2 pages of PROLOG is often equivalent to 10 or 15 pages in "C" or PASCAL. It is a different way of thinking.

Describe the FACTS and RULES without concern for what the computer will have to do. Maybe you will rewrite in another programming language when you are done.

Programming Experience is **not** required but a logical mind is. PROLOG-86 supports the de facto STANDARD — in "Programming in Prolog" by Clocksin & Mellish.

AVAILABILITY: PROLOG-86 runs on MSDOS, PCDOS or CPM-86 machines. We provide most formats. The price of PROLOG-86 is **only \$125.**

Full refund if not
satisfied during
first 30 days.
800-821-2492

**Solution
Systems**

335-B Washington St.,
Norwell, Mass. 02061
617-659-1571

CHAOS MANOR

pose I'll really be able to do that, but I can dream.

The game of the month is Universe by Omnitrend. I've put far too much time into it, despite the fact that the game is completely menu-driven, which makes it very easy to learn and very hard to use; I long to write a long command string, then go have coffee while the machine executes each command in turn. The fact that I'm still playing despite the tedious menu command system should say volumes about the game's complexity and inherent interest factor.

The book of the month is by Michael Crichton (author of *The Andromeda Strain*), *Electronic Life* (Ballantine, 1984, \$3.95). Dr. Crichton has managed to pack a great deal of useful information, philosophy, and common sense into 250+ pages. Recommended for almost anyone; even experienced hackers will find parts interesting and can then keep the book around to lend to beginners.

Next month I should have Concurrent DOS and the PC-Video board. Tony ought to have the software to make use of all the new type fonts for the LaserJet. I also have a Hewlett-Packard 150 computer, which hasn't even been uncrated; alas, I do not think my upstairs suite will be finished, so I may not have a place to set it up. There's a strong possibility that I'll have the new HP portable as well; I'm looking for a good portable to carry about on trips. I'll also have more on the Hercules boards.

Seneca once said of relocating that "two removes are equal to one fire." I find that rebuilding requires shifting things about like Chinese checkers, so that we get the equivalent of *three* removes. I make no doubt it will all be wonderful when it's finished. It's a great life if you don't weaken. ■

Jerry Pournelle welcomes readers' comments and opinions. Send a self-addressed, stamped envelope to Jerry Pournelle, c/o BYTE Publications, POB 372, Hancock, NH 03449. Please put your address on the letter as well as on the envelope. Due to the high volume of letters, Jerry cannot guarantee a personal reply.

COMPUTER CRIME PAYS.

An estimated \$3 billion plus annually.

What's more, there's practically no risk. Computer data thieves rarely get caught. And when they do, inadequate laws and the fear of publicity keep most victims from taking legal action.

Don't assume that just because you're not involved in anything top-secret, nobody's interested in your data files.

Computer thieves know that someone's always willing to pay a handsome price to get confidential corporate and professional information. Or pay to get it back.

AND THEY KNOW JUST WHAT TO LOOK FOR:

- ACCOUNTING RECORDS
- PRODUCT DESIGN DATA
- RESEARCH DATA
- MARKETING PLANS
- CUSTOMER LISTS
- PRIVILEGED CLIENT DATA
- BANK FILES
- CREDIT INFORMATION

Clearly, it's you vs. them. And the time to do something about it is now.

The Federal Government has spelled out the solution in no uncertain terms. It's called the Data Encryption Standard. And it's the basis for the DES 2000™ computer security system.

MAXIMUM PROTECTION WITH THE DES 2000

The DES 2000 protects your data files by encrypting transmitted and/or stored information—rendering it totally unintelligible without the proper access code.

DES 2000™ DATA ENCRYPTION SYSTEM



The code—one of 72-quadrillion possible 16-digit key combinations—is required at all times to command the DES 2000 to decipher the encrypted data.

So whether there's an intrusion from the outside via modem or phone line tap...or from the inside through a terminal or by outright disk theft...no key, no information.

You can't buy better protection than that.

ALSO THE MOST COST-EFFECTIVE SOLUTION

Equally important, the DES 2000 for the first time makes this level of security truly cost-effective. Priced under \$500, it offers the same protection, the same reliability as systems now in use by banking institutions and costing upwards of \$15,000.

Considering how well computer crime pays off these days, the DES 2000 is the most effective way to make sure your company's data doesn't become someone else's profit.

For more information on computer crime and the DES 2000 Data Encryption System—call (818) 991-8200 or Toll Free outside California 1-(800) 641-0814.

from: **PRACTICAL™
PERIPHERALS**

31245 La Baya Drive, Westlake Village, CA 91362 • (818) 991-8200 • TWX 910-336-5431

**ORDER
LINE
800-354-7330**

SILICON SPECIALTIES

COMPUTERS

NEC	
PC-8201 Computer	\$315
PC-8401A	Save
8201 & 8401 Accessories	Save
Sanyo MBC-775 Portable	
MBC-555 Series	Save
MBC-885	Save
Wyse	
Wyse pc Dual	Save
Wyse pc 10 Meg	Save
Zenith	
Z-150 Single Drive	Save 25%
Z-150 Dual Drive	Save 25%
Z-150 W/10 Megabyte	Save 25%
Z-160 Single Drive	Save 25%
Z-160 Dual Drive	Save 25%

DISK DRIVES

Alpha Omega Turbo 10	
Turbo 20	\$689
Turbo 30	\$1019
	\$1379
Haba Habadisk for Macintosh	
	\$329
Imega Bernoulli Box for IBM	
10 Megabyte	\$1799
20 Megabyte	\$2499
20 Megabyte Plus	\$2660
5 Megabyte for Macintosh	\$1459
Rana Elite I	
Elite II	\$179
Elite III	\$339
Elite III	\$405
Elite 10H/Apple	\$1080
Controller (W/Drive Only)	\$69
1000 W/DOS for Atari	\$175
Tallgrass TG-3020	
TG-3135	\$2289
TG-4060	\$3689
Controller	\$1469
	\$119

BOARDS

AST Six Pack Plus	
	\$259
Hercules Color Card	
Graphic Card	\$145
	\$295
Paradise Modular Graphic 06-1	
Five Pak	\$259
	\$159
Quadram Quadboard EX Ok	
E Ram 80	\$219
Quadlink	\$89
	\$329
Tec Mar	
Graphics Master	\$449
128K Dynamic Memory	\$225
256K Dynamic Memory	\$299
Captain 128K	\$299
Captain 256K	\$399

PRINTERS

Anadex	
9625B	\$1089
WP6000	\$2039
DP6500	\$2179
Brother	
HR-15XL	\$345
HR-25	\$649
HR-35	\$875
Canon	
LBP-8A1	Call
C-Itch	
A-10-30	\$469
F-10 Parallel or Serial	\$869
55 CPS Serial or Parallel	\$1035
8510 Parallel (Prowriter)	\$295
8510 SP	\$385
8510 SCP	\$465
8510 BPI	\$315
Citizen	
MSP-10	\$329
MSP-15	\$509
MSP-20	\$469
MSP-25	\$639

Comrex	
CR-2E	\$364
CR-4	Save
420	Save
DaisyLaser	
PR101	Save
Datasouth	
DS180	\$1089
DS220	\$1315
DS-PP#1	\$449
DS-PP#2	\$635

Diablo	
D-25	\$609
630 API	\$1484
630 ECS	\$1669
630 ECS/IBM	\$1669
Other Printer Models	Save
Epson All Printer Models	
	Save

Inforunner	
Riteman w/Tractor	\$244
Riteman 15	\$499
Riteman Blue w/Tractor	\$299

Juki	
5500	Save
6000	\$199
6100	Save
6300	Save

NEC	
2010, 2015, 2030, 2050	\$629
3510, 3515, 3530, 3550	\$1009
8810, 8815, 8830, 8850	\$1349
P2, P3	Save

Okidata All Printer Models	
	Save
Panasonic	
1091	\$265
1092	\$349
1093	\$519
KXP3151	\$459

Siemens	
PT/88 InkJet	Save
PT/89 InkJet	Save

Star Micronics All Printer Models	
	Save

Silver Reed	
EXP400 Parallel	\$235
EXP500 Parallel or Serial	\$379
EXP550 Parallel or Serial	\$399
EXP770 Parallel or Serial	\$699
Toshiba P1340 Parallel or Serial	
P351 Parallel or Serial	\$549
	\$1165

DISKETTES

Maxell MD-1 (Qty 100)	
	\$149
MD-2 (Qty 100)	\$189
Nashua	
S/S D/D (Qty 100)	\$125
D/S D/D (Qty 100)	\$135

KEYBOARDS

Keytronics 5151	
5151 Jr.	\$179
	\$179

MONITORS

Amdek All Monitors	
	Save
Princeton Graphic HX-12	
	\$479
Sanyo CRT-36	
	\$149
Taxan	
121 Green	\$125
122 Amber	\$134
420 RGB	\$399
425 RGB/Green	\$410
440	\$549
Zenith	
ZVM-122 Amber	\$95
ZVM-123 Green	\$89
ZVM-124	\$129
ZVM-130	Save
ZVM-133 Color/RGB	\$410
ZVM-135 Color/RGB W/Audio	\$459
ZVM136	\$575

PLOTTERS

Enter Sweet-Pe00	
	\$780
Epson HI-80	
	Save

ZENITH-SS/EPSON
Zenith Z-150 Dual Drive 320K Ram
Zenith Green or Amber Monitor
\$1899
Includes Cables

EPSON LX 80 Printer
Above System with Z-160 Dual Drive Portable (No monitor)
\$1999

VIDEO TERMINALS

Altos	
Smart II	\$769
Qume	
QVT 102 Green	\$449
QVT 102 Amber	\$469
Wyse 50	
75	Save
Wyse 85	\$565
	Save
Zenith Z-22	
Z-29	\$469
Z-49	\$599
	Save

MODEMS

Anchor Automation	
Anchor Express	Save
Mark XII	\$239
Hayes Smartmodem 300 Baud	
Smartmodem 1200 Baud	\$189
Smartmodem 1200B (IBM)	\$379
Smartmodem 2400 Baud	\$359
Micromodem IIE (Apple)	Save
	\$219
Novation Smart Cat Plus	
	\$315
Prometheus All Models	
	Save
Racal-Vadic All Models	
	Save
US Robotics Password 1200	
	\$209

Inquiry 369 for MS DOS Products. Inquiry 370 for all others.

Prices reflect 3% to 5% cash discount. Product shipped in factory cartons with manufacturer's warranty. Please add \$9.00 per order for UPS ground shipping. Orders 10 lbs. and under you pay for ground service; receive air service at no extra charge. Available on orders 11-20 lbs. \$15 for air service. Orders 21-30 lbs. \$20 for air service. Prices & availability subject to change without notice. Send cashier's check or money order...all other checks will delay shipping two weeks.



SILICON SPECIALTIES
2034 WEST SOUTHERN
MESA, ARIZONA 85202
602-969-0909

GERMAN QUERIES

Dear Jerry,

As I sit here blinking at the screen of my computer, the screen is blinking right back. There was a time when I had no such problem, but then I had a voltage-regulating gizmo. It was about the size of a husky paperback novel and had two sockets. It set me back some, but it was worth it, I guess. When Uncle Sam sent me to Germany, I left the voltage regulator in the States—the juice here, after all, is 220 V; I figured I would get one in a local computer store.

But that has not been easy. Do you know anyone back there who sells a small, lightweight one for 220 V?

Another question. My thinking machine is an Actrix with CP/M. It cost me a fortune, but I am a linguist, and a computer is the ideal thing for translations and for memorizing vocabulary. Unfortunately, all the languages I speak use diacritical marks, and Russian uses an entirely different alphabet. The questions: Is there a word-processing program available in Russian? German? Italian? Is there a program I can hook into (with BASIC or Pascal) that will display foreign characters on the monitor?

Thanks.

PETER A. KISS
18th MI Bn
APO NY 09108

Alas, this sounds like a job for Super Garcia!

As to part two, I can't help, but perhaps one of the readers can.—Jerry

LEAD TIME

Dear Jerry,

I must agree with Mr. Penner (Chaos Manor Mail, September 1984) that the six-month lead time for your wonderful column is outrageous. In your response to his letter, you itemized the ordeal a BYTE article undergoes. It seems to me that the editors of a magazine like BYTE could devise a more high-tech method for handling the column.

First, you could submit the column electronically over the phone. The technical editor and copy editor could edit the copy

on their terminals and transmit it back to you for corrections and approval. Once finalized, it could be proofread and typeset by computer. Meanwhile, the layout people can reserve a fixed space for the column in each issue and paste it in as soon as it is typeset. The entire process above could be done in a week, it seems.

I am by far no expert in publishing, but what I suggest seems completely possible. I believe BYTE could halve the lead time by making fuller use of the technology they describe so well each month. What say you?

CLAUS BUCHHOLZ
New York, NY

P.S. I hope to find out what the lead time is for a letter to Chaos Manor Mail.

We are reducing the time. We can't use telephones, because the phone lines to New Hampshire are, uh, interesting even in good weather; but we can send disks Federal Express.

A week is too short a cycle time; but we are getting it down to about six weeks, which is pretty good for a magazine this size!

As to the letter cycle times, that depends on the phase of the moon . . .

—Jerry

Editor's note: We hope to have an integrated electronic-publishing system installed before the end of 1985. The money is budgeted. The only question is how soon the vendor can deliver what we need.
—Phil Lemmons

CHINESE MATTERS

Dear Jerry,

I am writing to you concerning a small inaccuracy on page 350 of your column in February. It concerns your incorrect dating for Confucius. You said, "The *I Ching* or *Book of Changes* has been around a long time; Confucius thought it was old at the time of Christ. It is supposed to have been composed about the time of the Trojan War." While I found the syntax of your sentence about Confucius and Christ a little perplexing, I assume you mean that Confucius lived around or after the time of Christ. This is not true. While dates for

Confucius are not accurate, he is generally thought (by sinologists) to have lived from 551 to 479 B.C. Dates for the *I Ching* are also not very accurate, but sinologists generally accept that the book dates from at least 1123 B.C.—the beginning of the Chou dynasty (the book's other name is the *Chou I*).

It was a book of divination. Confucius is supposed to have done some editing work on the book, writing the 10 wings, or appendixes, to it, but his authorship has been disputed by Chinese scholars since the Sung dynasty (960–1123, 1125–1279 A.D.), especially in the works of Ou-yang Hsiu. Most Chinese classics were destroyed in a massive book-burning and censorship campaign carried out by the first Ch'in emperor, Ch'in shih-huang-ti, in 213 B.C. The *I Ching* was one of the few books to have survived intact, and its line of transmission from the pre-Ch'in era has been documented in at least one source.

I know that the above is probably more than you need or want to know, but my scholarly training and perhaps a bit of leucitis compels me to run off at the keyboard.

Thank you for your kind attention. I thoroughly enjoy your columns and opinions; it is one of the reasons I get BYTE.

RONALD GANS
New York, NY

I'm no sinologist, but the Encyclopaedia Britannica gives the same dates for Confucius as you do. Perhaps I meant old before the time of Christ? The Trojan War is traditionally supposed to have happened about 1150 B.C., so that part was right.

*I gather there is considerable dispute regarding the proper use of the *I Ching*; divination can mean "prediction," but it can also mean "determine the godly thing to do," which is the way many people use the book. Thank you for the details on the *I Ching's* history.—Jerry*

COPY-PROTECTION SOLUTION

Dear Jerry,

For some time you and your readers have been frustrated by software copy

(continued)

protection. I gather numerous software producers believe they will lose their investment without it. Some time ago you said you did not know a solution. I think I might have one. As a user, you should continue to have access to the program once you have bought it, unless you willfully destroy or lose your disk. How can we accomplish this and still protect the software producer?

My suggestion is simplicity itself. The terms of the sale should include duplicate disks of the software, each protected if the producer wishes. It should also include a guarantee by the producer to replicate the protected program on either of these disks if their magnetic program becomes unworkable. In this way, both interests should remain protected.

There are, of course, operational details. The program would be replaced on an identifiable disk originally supplied by the software producer. The postage (if needed) might be borne by the buyer, the cost of duplication by the producer or his agent. It seems gratuitous to fix the maximum number of duplicates unless this proves necessary. It should surely be 10 or more to that unlucky user.

I get the impression that a similar procedure is already followed by some companies, which update their software either free or for some fixed fee. Obviously, replacement would not automatically entitle one to an update, but then some users might be tempted to update at the time of duplication if the price is right. There should be no obligation to do so.

FRANCIS MARBURG
Falls Church, VA

Your plan certainly seems viable. My colleague John Dvorak argues that any kind of copy protection is economically counterproductive: most software can't take off unless it is adopted by a lot of old-time users, and the old-timers already have software that they're reasonably happy with. They won't buy expensive new packages unless they're really good. However, if they try a free copy of something new and like it enough, they will not only buy that but influence a lot of others to do likewise.

I think I agree with him.—Jerry

TECHNICAL-SUPPORT SOLUTION

Dear Jerry,

Your December 1984 column discussed the support problem. I have a suggestion that may solve the problem, and I have my own story to relate.

A year ago I decided to buy a computer. My dad and I have shared a TRS-80 Model I since 1978, and I had pretty much outgrown it. I had to get a new machine in a hurry—my parents were moving—because I wanted to transfer all my source files by an RS-232C interface, and I did not want to type all the files in again.

I chose an Advanced Digital Super 6 single-board computer. It is S-100-based, has all the I/O I need for now, and supports CP/M 3.0. Priority One's price for the computer was steep, about \$1000. I figured that before I sent away for a computer that I knew little about, I should at least send away for the manual. (The ads looked great, but I wondered what kind of nightmare I would find when I actually fired the thing up.) I visited a local dealer who gave a price of \$1100. My first reaction was, "That's okay because if I need any help in bringing it up they could at least help and make sure the board worked." I asked about the high price, compared to Priority One, and they said they might cut it to \$1000. However, the bottom line on support was that I could get it only if I spent \$3500 on a complete system from them! The complete system was a 12-slot mainframe and supply, two 8-inch drives, and the processor card. This I could not handle.

I ended up buying the board from American Square Computers for \$555 and CP/M 3.0 for \$350. My total outlay for the processor, software, an 8-inch drive, a mainframe, and a Qume terminal was less than \$2400.

All I wanted was that the dealer sell me CP/M and the board and make sure it would boot on a Shugart 801. I could get no answer from the manager as to what the cost of this onetime support would be. I was willing to pay \$100 for it, figuring that's a cheap way to find out if all the hardware is going to work.

I had to sweat a few details. The manual on the disk drive did not match the drive that Priority One sent—all the jumpers were different when they made a printed-circuit-board change for a semicustom VLSI chip. The drive would not fit in the mainframe without a slight amount of metalworking in the cabinet. The Super 6 manual had a few errors, too.

The fact is, I got it all going in plenty of time, and I am very happy with the machine. The only software that I purchased at the time was Turbo Pascal, on your recommendation, and I am truly impressed.

What should the computer stores do? The one I went to lost a sale because they

could not handle the case of the knowledgeable customer who did not want to blindly buy their package. I was not willing to spend an additional \$1000 for a system integration, which they had done hundreds of times before.

The computer store should determine what kinds of support they can provide, to whom they will provide it, and what it will cost. Then tell their prospective customers. The companies that do the mail-order business should state the same in their ads. The computer-buying public will likely follow the lead if they know that a discount house will have limited service and that a full-service computer dealer will service only its legitimate customers.

CLYDE R. SHAPPEE
Walpole, MA

Priority One would have sent you the proper manual if you'd asked; at least they tell me they would, and I believe them.

*You do know what you're doing.
Best.—Jerry*

NEWMEDIA

Dear Jerry,

Why did you describe the Newmedia program in the February issue ("Small Disks!," page 352) and then list it as "not available" in the "Items Discussed" box? I have a Cromemco Z80 system with no software support and need a program like that.

BILL PINKERTON
Palm Bay, FL

When I put together the information for the "Items Discussed" box I try to include prices and telephone numbers, but I don't always have them. In those cases our intrepid and hardworking BYTE editors have a go. They're usually successful. Sometimes, though, they simply can't find anyone who'll answer the question, or a company won't have a firm price at press time; in which case you'll find "not available" in the slot where you'd hope to see the price.

In the case of Newmedia, alas, the program is available only as part of the CompuPro 8/16 software-support package. I doubt that it would run on your Cromemco. My first computer was a Cromemco Z-2, so I have considerable sympathy for you, but I fear there's little we can do: Newmedia was written especially to run on a CompuPro 8/16 using a CompuPro Disk Controller.

Wish I could be more help.—Jerry ■

Back, by popular demand.

Just a few years ago, illegal hunting and encroaching civilization had all but destroyed the alligator population in the south. They were added to the official list of endangered species in the United States.

Now alligators have made a comeback.

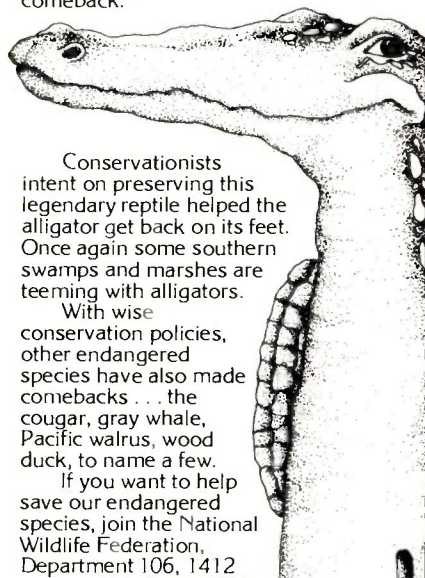

Conservationists intent on preserving this legendary reptile helped the alligator get back on its feet. Once again some southern swamps and marshes are teeming with alligators.

With wise conservation policies, other endangered species have also made comebacks . . . the cougar, gray whale, Pacific walrus, wood duck, to name a few.

If you want to help save our endangered species, join the National Wildlife Federation, Department 106, 1412 16th Street, NW, Washington, DC 20036.



**POSTURE
SUPPORT**

THE BACK CHAIR ON SALE FROM \$29⁹⁵



Sit, work for hours without back and neck pain with The Back Chair. Now available in 3 models.



The ORIGINAL Genuine Oak Chair
SALE PRICE: \$29.95!

Made from hardwood layers with a final layer of oak.



New 3-Position Adjustable Chair
ON WHEELS: \$49.95

Made from solid hardwood with beautiful oak finish.

Chocolate Brown pads on original and adjustable chairs

Reduce the effect of gravity on your back. Sit comfortably and more relaxed with your spine in perfect alignment.

NEW SWIVEL BACK CHAIR ON WHEELS. Sleek, modern appearance with oak veneer base: \$89.95



Grey 100% Wool Knit

Full 360° Swivel

Height Adjustability

Oak Base

Especially recommended for office and institutional use

SHOP FASTER BY PHONE 1-805-966-7187

Or send a check or your credit card # (Diner's Club, VISA, MasterCard, American Express) for the BACK CHAIR (Standard Model, \$29.95 ea.; Adjustable Model, \$49.95 ea.; Swivel Model, \$89.95 ea. — please indicate below) plus \$9.95 shipping (Canadian orders, \$13.00 shipping). CA residents add 8% sales tax. Sorry no C.O.D. If not satisfied return within 15 days for refund (less shipping).

ITEM NO.	QUAN.	ITEM	PRICE EA.	SHIPPING	TOTAL
838		Stand. BACK CHAIR	\$29.95		
808		Adj. BACK CHAIR	\$49.95		
807		Swivel BACK CHAIR	\$89.95		

STARSHINE GROUP

816 B State Street, Dept. BC347, Santa Barbara, California 93101
America's Premium Direct Mail House Now In Our 9th Year

- 384KB of socketed RAM.
- Serial port supporting asynchronous communications to 9.6 KBaud.
- Parallel printer port with bidirectional capability.
- Full modem support.
- Parity checking and error reporting.
- Calendar/clock with 5-year battery.
- Insta-Drive RAM disk emulation software.
- Wait-Less Printing print spooler software.
- Optional game port.

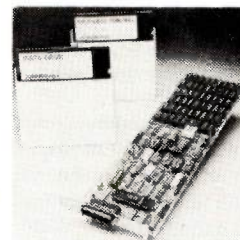

Get IBM PC* maximum memory and save expansion slots with the Emulex/Persyst SB 384 board.

Save \$300 on this multifunction/memory board that lists for \$895. Now \$595 at MTI.

Emulex is one of the most respected manufacturers of add-in boards in the industry, and offers a 2-year warranty on the SB 384 board. MTI carries their entire line of communications products. Call today.



A SUBSIDIARY OF DUCOMMUN INCORPORATED

Computer & Data Communications Equipment Sales / Leasing / Service / Systems Integration

Digital Equipment Corp., Intel, Texas Instruments, AT&T, ADDS, Qume, HP* Dataproducts, Diablo, Epson, Lear Siegler, Esprit, Wyse, Link, C. Itoh, PCI, Racal-Vadic, MICOM, Ven-Tel, Develcon, Control Data, Emulex, U.S. Design.

New York: 212/226-2337
New Jersey: 201/227-5552
Ohio: 216/464-6688
Kentucky: 502/499-6656
Pennsylvania: 513/891-7050
California: 818/883-7633
518/449-5959 412/931-9351 *Franchised areas only.

All other areas: 800/645-6530

* Or PC-compatible. IBM PC is a registered trademark of International Business Machines.

We work in The Macintosh Office.

Control Room

This office is real. You can order it now.*

It is brought to you by Odesta Helix.

The data-based system solution for people who take care of business.

What is Odesta Helix™?

Helix is a data-based information management & decision support system. It provides a data-based "pool" into which you may put all kinds of information --text, numbers, pictures, or ASCII data-communications (via MacTerminal™) --without having to know a programming language or battle with command codes, modes, or imposed structure.

A System Solution--Once & For All.

Once information is entered, it is then just as easy to examine from any angle, and use in any application. From reports, lists, and mail merge letters to analyses and interactive searches. All within Helix. And all without having to learn a query language, spread-sheet formulae, report formatting or data-base algebra.

Bridging the Gap & Closing the Circle.

If you manage resources or information, you are probably already asking the next question:

"Since Helix lets us build applications on top of a flexible data-based foundation, can we share that information within our business or department?"

Yes. Now you can have direct access to the real operational pulse of your organization--its contracts, orders, shipments, research or inventory. Information that you can easily query and evaluate with visual tools so innovative that they should be seen rather than described. That let you schedule projects and allocate resources based on historical data--and then re-formulate tactics and plans as conditions change.

And that let you close the circle by embedding your own flags in the system to give direction to others, and to manage by exception rather than rule.

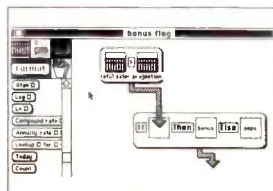
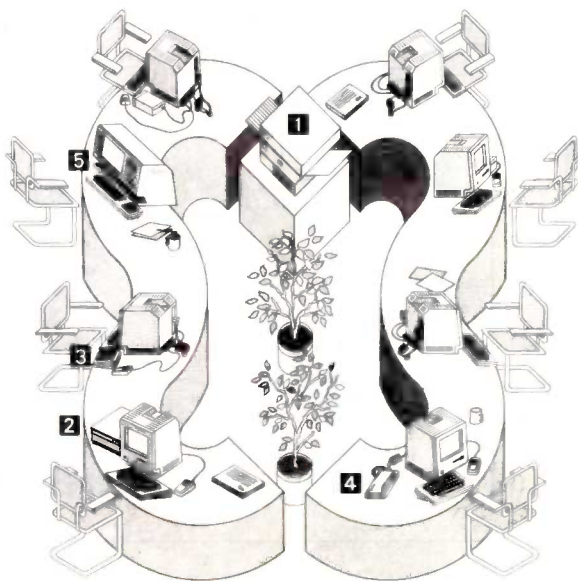

One of the acclaimed innovations of Helix is the way you can visually manipulate powerful concepts and calculations almost as easily as you can say them. A manager may now build or specify applications using his or her own expertise -- instead of having to learn programming or rely on a programmer.

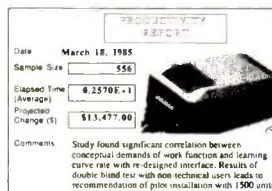

Since numbers, words, and pictures communicate more meaning when seen in context, Helix lets you work with them in any combination. Illustrated price lists, personnel documentation, training materials, competitive analysis research...

How Real is Real?

Visit a dealer who can demo Helix and The Macintosh™ Office. Take a seat and make it real for yourself. Or call us at 1-800-323-5423 (Illinois: 1-312-498-5615) or send us the coupon to get a free copy of our "Control Room" brochure, including samples of actual LaserWriter output.

* Available at any Businessland™ Center or Moore Business Center. For the name of other Helix dealers near you, call Softsel at 1-800-556-2283.

Room With a View

Ask someone about Helix who is using it, and you will understand why it has been a best selling business program since it began shipping January 11, 1985. Then combine its dynamic flexibility and personal control with the concept of shared resources, and you may decide that our version of The Macintosh Office warrants your serious consideration.

Interior Design

As a manager, you practice the art of hitting a moving target. The success of your aim depends on knowing where you stand. That is specifically what Odesta Helix is designed to provide, and what The Macintosh Office offers as a cost-effective vehicle. Existing mainframes, minis, and personal computers are either too unresponsive, inflexible, or limited to provide you with the hour to hour, day by day answers you require. And since these two types of systems are so different, and serve such different sets of needs, we suggest that parallel installations will develop naturally, and complement one another.

Knobs & Buttons

1 Odesta Helix drives the LaserWriter with many Macintoshes at once, producing publication-ready reports, documents with numbers, text, and picture data, and irresistible mail-merge letters. 2 With the Corvus OmniDrive™ and OmniTalk™ Helix uses shared mass storage and supports sequentially shared files. 3 By fully supporting the keypad, Helix makes numeric data entry completely independent of keyboard and mouse. 4 Modem based data-communication for remote Helix file transfers, as well as for ASCII file Dump & Load to other programs and machines. 5 Helix supports the Macintosh XL (and Lisa™ under MacWorks™), using its full screen and running unfettered on its hard disk (as well as such 3rd party hard disks as the Corvus™ HyperDrive™ and Quark™).

Control Room

Odesta Corp.
3186 Doolittle Dr., Northbrook, IL 60062

- Please send me your Control Room Brochure.
- Please have a Salesperson call.

Name _____

Company _____

Address _____

City _____

State _____ Zip _____

Phone _____

© 1985 Odesta Corp. Odesta Helix is a trademark of Odesta Corporation. The Apple logo, MacTerminal, MacWorks, and Lisa are trademarks of Apple Computer, Inc. Macintosh is a trademark licensed to Apple Computer, Inc. Corvus, OmniDrive, and OmniTalk are trademarks of Corvus Systems, Inc. Quark is a trademark of Quark Peripherals, Inc. HyperDrive is a trademark of General Computer Co. Businessland is a trademark of Businessland, Inc.



B·Y·T·E U.K.

Telephone Computers

A look at the One Per Desk telecomputer

BY DICK POUNTAIN

Of the areas in which nontechnical people use personal computers, telecommunications has the most potential for expansion and improvement. In the industrialized countries at least, more people own telephones than computers.

For the person with a computer at home, teleshopping, telebanking, and remote database access seem more productive than filing the stamp collection or storing recipes.

Telecommunications can be advantageous for businesspeople in the same way. So much of the business day is spent on the phone that much time can be saved by simplifying the processes of establishing contact and transferring information.

The quality of telecommunications facilities on general-purpose microcomputers still falls somewhere between highly technical and positively hair-raising. Even with an auto-dial modem, you are exposed to more of the nasty details of the RS-232C interface than is necessary or wise. Mindful of these facts, a number of manufacturers have recently turned their attention to producing dedicated "telephone computers"—personal computers with built-in telephone hardware, tightly integrated telecommunications software, and general-purpose desktop computer facilities.

Two such machines have just been introduced in the U.S. by Rolm Corporation. One of the machines is a peripheral for the IBM Personal Computer (PC). Perhaps a harbinger of the growing importance of this technology, IBM has bought the company outright.

International Computers Ltd. (ICL), the U.K.'s largest national mainframe computer company, has just produced an interesting and innovative *telecomputer* called the One Per Desk (OPD). The name is suggestive of ICL's marketing strategy, namely, to get one of these machines onto every executive's desk in the large corporations that ICL currently services.

ICL, like many mainframe companies,

came fairly late into the personal computer arena and then made its entrance by "badge engineering" products from established U.K. personal computer firms using industry-standard software. (Badge engineering means buying a product and re-labeling it with your own "badge" for resale.) The first ICL offerings were 8-bit multiuser systems running MP/M; more recently, 8088- and 8086-based IBM compatibles have been added.

The OPD, however, represents quite a new departure. It was largely designed in-house by ICL, though it uses the processor board, microdrives, and custom gate arrays from the Sinclair QL, which is based around the Motorola 68008 8-/32-bit central processor. ICL has written its own truly multi-tasking operating system for the OPD that permits telecommunication to take place while running business-application programs. Such an investment of corporate energy suggests that the OPD is closer to what ICL thinks businesspeople need on their desks than a conventional personal computer; the purchase of Rolm by IBM suggests that at least one other large computer corporation may agree.

The OPD differs, however, from the Rolm offerings in an important way. It's cheap by business computer standards (starting price £1200, approximately \$1450 at the current exchange rate), and it works on ordinary phone lines, not special PBX (private branch exchange) systems. In other words, it comes close to what you need for a domestic telecomputer.

FUNCTIONS

The OPD is capable of acting as a sophisticated automatic telephone and as quite a powerful desktop computer and calculator. It also contains a battery-backed clock and calendar.

In its role as a telephone, it allows direct dialing of calls, storage and retrieval of telephone numbers for automatic dialing,

(continued)

Dick Pountain is a technical author and software consultant living in London, England. He can be contacted c/o BYTE, POB 372, Hancock, NH 03449.

monitoring of the cost of phone calls, and a limited form of automatic answering. It also contains a twin-standard modem (300 bits per second [bps] and the 1200/75 bps used for Viewdata systems in the U.K.) that can access remote computers using all the above automatic facilities.

When making ordinary phone calls, you can switch on an internal loudspeaker to monitor the progress of your call, but there is no internal microphone. Therefore, upon connection, you must revert to the telephone handset. The OPD remembers the last 10 numbers dialed and allows single-key redialing by selecting one of them from the screen.

A built-in voice synthesizer acts as a simple answering machine. You can choose two different messages for appropriate times of day (e.g., hours spent in and out of the office), but the OPD can't record messages from callers.

When using the OPD as a terminal for data communications, you can create a directory of frequently used services and have them automatically dialed, complete with appropriate log-on procedures. In addition, the OPD can auto-answer a data call.

ICL is also developing an optional

message system, a ROM (read-only memory)-based application that allows electronic mail to be sent between OPDs with full auto-answer capability. It wasn't ready at the time of this test.

Since an OPD can control two phone lines (plugging straight into the wall sockets), you can make a voice call simultaneously with a data transmission. In general, you can always make or receive a voice phone call, regardless of whatever else you are doing on the OPD, and then when you hang up, return to where you left off.

THE HARDWARE

The OPD bears no external resemblance whatever to the Sinclair QL. It's packaged as two units: a console unit containing the keyboard, telephone receiver, central processor, and two microdrives; and a VDU (visual-display unit), which contains the power supply as well as a 9-inch high-definition black-and-white monitor (see photo 1).

The VDU is small and neat, only slightly larger than that of the Apple IIc. It has only two controls, a slider to adjust the contrast and the main power switch. The black-and-white-monitor tube is of very high definition

and has two display modes: 26 lines by 80 characters and 26 lines by 40 characters. It can display a gray scale, with two shades of gray in 80-column mode and six shades in 40-column mode, which lets you create nice screen designs.

The OPD can support internally all the colors and font sizes of the Sinclair QL, and ICL does offer an optional color monitor; however, it is much larger than the black-and-white unit, and the company feels that most business users will prefer the lower cost and smaller size of the latter.

The bottom two lines of the screen are dedicated to the *notice-board*, a status area where various messages—as well as date and time—are displayed. And when you dial a phone number—either manually or automatically—the digits of the number appear in this area as they are dialed.

The console unit has a removable sloping cover over the microdrives, which you must remove to install the dry-cell backup battery. The rear of the case contains huge slots to receive the ROM mounting module and the telephony module, which are supplied separately. The advantage of this arrangement is that you can substitute a new telephony module when the OPD is sold in different national markets; it contains the modem as well as the connectors for two telephone lines.

The keyboard has typewriter-style keys of normal pitch and feel and is quite suitable for word processing. The separate numeric keypad differs in function from that on an ordinary computer; rather than being a mere supplement to the top-row numeric keys, it is a telephone-dialing pad. Special keys surrounding the pad perform functions like last-number-redial and select-the-internal-loudspeaker.

The telephone handset sits to the left of the main keyboard in a cradle with a conventional receiver-rest switch. Lifting the receiver interrupts the computer and prompts you to dial a number; the call is disconnected by replacing the receiver or through software.



Photo 1: *The One Per Desk* from International Computers Ltd.

(continued)

At last — an expert system that's easily affordable

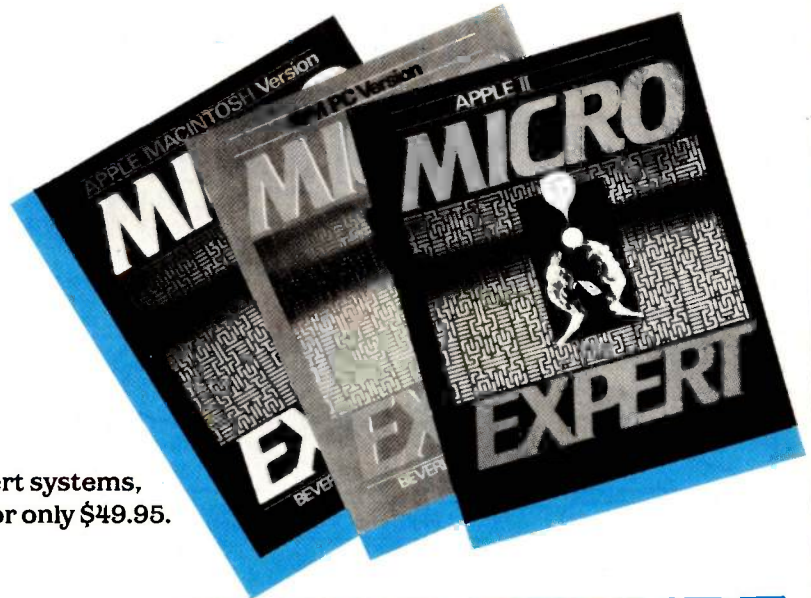

Now you can explore the world of expert systems, creating your own knowledge bases, for only \$49.95.

Expert systems — programs that can make logical inferences from a database of rules — are among the hottest developments in software today. They greatly simplify complicated problem solving for a wide variety of professionals . . . from the engineer troubleshooting complex machinery to the investor making critical financial decisions. But they ordinarily cost thousands of dollars, which is too much for most individual users to pay.

Here for the first time is a full, open expert system at a fraction of the usual cost. MICRO EXPERT, running on Apple or IBM PC, gives you the problem-solving capabilities of systems costing thousands . . . for less than \$50!

Among its many useful features . . .

- it provides a complete expert system with rule-generating capabilities — has the capacity to store and use up to 400 rules
- it contains complete source codes and descriptions of program designs for easy modifications
- it overlooks nothing — makes the cross connections that people miss unless they work through every possible combination of the facts and all possible relationships
- it allows you to include calls to Pascal procedures within rules
- it lets you trace inferences, find out why any given inference was made
- it lets you find out how questions are asked and how any given inference was made

An invaluable *affordable* aid to every professional who must solve problems in situations where there are a lot of possibilities, the MICRO EXPERT package includes a 64-page guide with detailed instructions on everything from starting the system to developing and writing rule bases.

Machine Specifications:

Apple II (all models), 64K RAM, one or more disk drives, printer optional
 IBM PC, 128K RAM, one or more disk drives, printer optional
 Apple Macintosh, 128K RAM, one or more disk drives, printer optional



MICRO EXPERT

by Beverly and William Thompson

MasterCard and Visa holders,
 call 1-800-628-0004
 (In New York call 212-512-2999)
 Or use this handy coupon . . .

McGraw-Hill Book Company

P.O. Box 400, Hightstown, NJ 08520

YES, I want to order MICRO EXPERT, the unique new computer program that provides a complete expert system at an easily affordable price.

- APPLE II (852110-6) \$49.95
 IBM PC (852109-2) \$49.95
 APPLE MACINTOSH (852139-4) \$49.95
 (available August 1985)

- My check (including local sales tax) is enclosed
 Charge my order to: VISA MasterCard

Card # _____ MC Bank # _____

Expiration Date _____

Signature _____

Orders must include payment. Make checks payable to McGraw-Hill Book Company. Disks are not returnable. Order subject to acceptance by McGraw-Hill.

Name _____

Firm _____

Address _____
(No P.O. box, please)

City _____ State _____ Zip _____

In Canada, available from McGraw-Hill Ryerson, Ltd., 330 Progress Avenue, Scarborough, Ontario M1P 2Y5. Prices slightly higher outside the U.S. 23-D238-1000-3

TOLL FREE
ORDERS ONLY! **800-631-0962**
(INSIDE CALIFORNIA) **800-521-6162**

Customer Service **HOTLINE**
(408) 559-6555

GUARANTEED the LOWEST!

OUR PRICE GUARANTEE - It's Simple! We'll beat any ad in this magazine - same terms - call TOLL FREE for details!

DCC

DISCOUNT COMPUTER CENTERS

OUR CUSTOMER SATISFACTION GUARANTEE: If for any reason your DCC purchase fails to meet manufacturers specifications within 30 days of purchase, please return it to us for a full refund or exchange of your choice! Sorry, software excluded due to copyright laws.

EPSON all models!
RX/FX and LQ1500
also NEW JX80
(7 colors)

PRINTER SALE!!!

OKIDATA

models 82/83/84 and 92/93!!
also 2410 (350 cps!)

IBM PC \$1650
or 2 drives/256K,
10 mg hard disk

IBM XT \$3395
10 mg. hard disk
256K, 1-360Kb drive only

new models!!

HR-15 XL \$359
BROTHER
LETTER QUALITY
High Speed 36 cps
7K Buffer

HR-35

COMPUTERS

IBM PC & XT See special above!!!
PC with 1 drive/64K 1395
PC with 2 drives/256K 1650
XT with 10 mg HD/128K 3350
XT with 2 drives/10MG 3475

Call for details - Compatible brand portables and desktops

MONITORS

IBM MONOCHROME 249
COLOR 569
AMDEK 300G 135
300A 145
310A 165
COLOR 600 419
COLOR 710 NEW 515
TAXAN 12" Green 114
12" Amber 117
420 RGB 439
PRINCETON HX-12 459
SR-12 649
MAX-12 168
ZENITH 122 - 12" G 93
12" A 93
124 MONO - IBM 169
135 RGB COMP 475
POLO 16 COLOR RGB!! 350

MODEMS

HAYES 300 195
1200 459
1200B IBM INTERNAL 389
MICROMODEM II E 209
ANCHOR MARK XII 244

AST \$229
SIX PAK PLUS
w/64K RAM **\$249**

10 MG ^{1/2} Hi Internal \$665
HARD DISK
SPECIAL
w/controller card and cables!!!
\$1099 20 MG ^{1/2} Hi Internal

WORDSTAR 2000
All new-easy to use
"Windows"
Footnotes
Spell Checker
Much, much more

\$259

mouse systems
w/PC PAINT **\$124**

MOUSE \$129
micro-soft

Color graphics
card **\$165**

HERCULES \$309
Mono graphics card

PRINTERS

****DOT MATRIX****
EPSON RX 80 100 cps 235
RX 80 F/T 100 cps 279
RX 100 100 cps, 132 col. 399
FX 80 or JX 80 best price
FX 100 160 cps, 132 col. in
LQ 1500 200 cps NEW! magazine
OKIDATA 82A/83/84 Save
92P All
93P Models
2410 Drastically Reduced!!!
GEMINI 10-X 239
15-X 349
DELTA 10 or 15 Special
RADIX 10 or 15 \$Call

****DAISY WHEEL****
PRIMAGE I 55 cps, SER/PARR 1395
w/Cut Sheet Feeder 1695
BROTHER DAISY WHEEL
HR-15 XL 359
HR-25 599
HR-35 (36 cps) 799
JUKI 6100 389
JUKI 6300 724
DIABLO 620 829
630 1276
DYNAX DX-15 1689
NEC all models 359
QUME all models \$Call

DRIVES

IBM 360 KB 219
TANDON 100-2 360KB 165
APPLE DRIVES Sale 135

TEAC 1/2 HI-360 KB 119
SHUGART 1/2 HI-360 KB 109
COGITO 10 MG H.D. W/CONTROL 665
ATARI INDUS GT 349

IBM SOFTWARE

****SPREADSHEET****
FRAMEWORK Monthly Special 355
FRIDAY 195
SUPERCALC 3 228
MULTIPLAN 136

****IBM WORDPROCESSORS****
WORDSTAR PRO PACK 249
MULTIMATE 84
WORD W/MOUSE 249
VOLKSWRITER DELUXE 269
PFS PROOF 159

****IBM DATA BASE****
dBASE II 284
dBASE III 355
PFS FILE 84
CONDOR III 84
R-BASE 4000 249
R-BASE CLOUT 279

****IBM MISC****
SIDEKICK 39
COPY II PC 29
THINKTANK 129
PROKEY 3.0 79
HARVARD PROJECT MGR 245
SIDEWAYS 45
NORTON UTILITIES 45
PFS REPORT 55
DOW JONES ANALYST 79
SET FX + 219
****IBM GAMES****
FLIGHT SIMULATOR 34

IBM - BOARDS

HERCULES GRAPHICS 305
HERCULES COLOR New! 165
AST SIX PAK W/64K 249
MEGAPLUS 259
STB GRAPHIX PLUS 309
EVEREX GRAPHIC EDGE 379
H.D. CONTROLLER 299
MAGIC CARD 199
QUADRAM QUADBOARD W/64K 269
QUADLINK 449
IBM MONOCHROME 249
COLOR GRAPHICS 219
PLANTRONICS COLOR PLUS 375
TECMAR GRAPHICS MASTER 475
PARADISE COLOR 279

IBM ACCESSORIES

64K RAM CHIPS 200ns 35
150ns 35
IBM KEYBOARDS 159
KEYTRONICS 5151 NEW! 179
5150 159
MICRO-SOFT MOUSE 129
MOUSE SYSTEM-MOUSE 124
KOALA PAD 85
JOYSTICKS - KRAFT/HAYES 45

PINBALL 39
MATHBLASTER 45
FROGGER 28
ULTIMA III 35
ZAXXON 35
GATO SUB SIMULATOR 35

APPLE - BOARDS

ORANGE MICRO GRAPPLER + 113
BUFFERED w 64K 168
MICROMAX GRAPHMAX 99
VIEWMAX 80 139
VIEWMAX 80E W/64K 189
MAC DISKETTES 48
IIC PRINTER INTERFACE 59
SUPER COOLING FAN 49

ACCESSORIES

PRINTER RIBBONS all makes Low!!!
64K RAM chips SALE 35
VERBATIM SS-DD diskettes 21
DS/DD diskettes 27
DYSAN SS/DD diskettes 26
DS/DD diskettes 34
DISK MINDER-PLEXI (75) 19
DISK MINDER WKEY (100) 24
SURGE PROTECTOR Compugard 59
PTI POWER BACK-UP 200 w 275
300 w 355

ATARI/C-64

ACCESSORIES low, low CALL!!
C-64 CARDCO + G 79
ATARI MP1150 94
APE FACE 69
GRAPPLER CD COMMODORE 99

DCC DISCOUNT COMPUTER CENTERS

an established mail order/retail distribution network

BUYER FRIENDLY TERMS! • DELIVERY We ship immediately! Most orders delivered within 5 days! Add 3% (15^{min}) for UPS shipping, handling, insurance. Calif. residents add 6.5% sales tax. 2nd day UPS available at extra charge. • PAYMENT Visa, M/C, cashiers checks, money orders, personal checks accepted. (Allow 10 business days for personal/company checks to clear). WE NEVER CHARGE EXTRA FOR CREDIT CARDS! C.O.D.'s welcome (20% p/p deposit) with cash, certified check or money order. • WARRANTY All items shipped are new, include FACTORY WARRANTY and are GUARANTEED TO WORK. DCC is an AUTHORIZED DEALER and SERVICE CENTER for most major brands. • RETURNS Must be accompanied by RMA number (supplied by DEALER) and may be subject to a 20% restocking fee. Prices and availability subject to change without notice. All items limited to stock on hand. • MAIL ORDER PRICES NOT VALID AT RETAIL OUTLETS DUE TO REGIONAL PRICING RESTRICTIONS. Minimum order \$50.

FREE - VISA/MC!



1707 S. BASCOM AVE • CAMPBELL, CA 95008 • (408) 559-6555
1243 W. EL CAMINO • SUNNYVALE, CA 94087 • (415) 965-4494
1341 FULTON AVE • SACRAMENTO, CA 95825 • (916) 971-3503

VISIT OUR DISCOUNT SHOWROOMS!

If you should hear a modem whistling at the other end of the line when you pick up the receiver, the Auto button will switch that line over to data auto-answer, while the Hold key holds a voice or data call and switches you to the other line.

The OPD is principally a ROM- and RAM (random-access read/write memory)-based computer, with the tape-cartridge microdrives serving only as backup devices. The machine should be left connected permanently to a main power supply and *not* switched off at the end of the day. To save wear and tear on the VDU, the screen blanks itself when not used for 10 minutes and is restored either by an incoming call or by pressing any key. There's no power switch on the console unit; the one on the VDU lets you switch the monitor off (over weekends or holidays) but leaves the console energized.

The machine comes with 128K bytes of RAM and an expansion box at the rear of the console that accepts ROM capsules containing the operating system and optional application programs. Telephone numbers and other data used in telephone communication are stored in RAM most of the time. Obviously, it's essential to make a microdrive backup to guard against power failure. (An internal battery ensures that the telephone part of the OPD will function even in the event of a power failure.) Some applications require more data than

RAM can hold (word processing, for instance), and you can store less frequently used telephone directories on the microdrives to save RAM space.

ICL's idea is that the average user does not want to be involved with operating systems, files, and mass-storage devices, and it's a sound idea. Most of the time the OPD behaves like a telephone that remembers things; in other words, it behaves like a consumer appliance rather than a computer. When the microdrives *must* be used, the filing system is of a fairly rudimentary and obvious sort that merely dumps a memory image to tape, driven by menu selections.

Apart from considerations of operational simplicity, this RAM-based way of working overcomes most of the objections to the Sinclair QL microdrives; namely, their relatively slow access speed and questionable long-term reliability. (ICL has made some internal modifications that it claims have improved reliability.) In normal use you might only use the microdrives once or twice a day.

You can also connect a serial printer to the OPD. Pressing the Print key prints the current screen contents; continuous print is available when you are using the word processor or monitoring a remote computer session.

SYSTEM SOFTWARE

The ROM-based operating software of the OPD is controlled by a combination of screen menus and dedicated

keys. Its design looks rather staid in these days of overlapping windows and icons, but it is nevertheless well thought out and easy to use with few exceptions.

The three fundamental control keys—Start, Resume, and Review—are situated on the main keyboard. Pressing Start brings up the top-level menu, which is the starting point for all activities.

The OPD operating system is fully multitasking and distinguishes two types of applications called *transient* or *extended*, respectively. Transient applications stop dead when you press the Start key and can only be rerun by selecting them again from a menu.

Extended applications, on the other hand, will, if possible, go into the background when you press Start and continue running there. For example, if you were connected to a remote database and downloading data to the OPD, this activity would continue even if you pressed Start to do something else. Some extended applications (e.g., a word processor or spreadsheet) require the use of the keyboard and screen, however. These are *suspended* rather than put into the background and can be restarted where they left off by pressing the Resume key. If there are several suspended applications, Resume presents a screen menu of them so you can choose which one to restart.

The top-level menu provides access

(continued)

GRAPHS WITHOUT GRAPHICS?

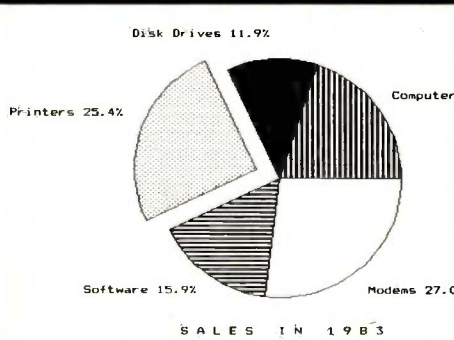

No need for color monitor or graphics board.
Make graphs on dot matrix printers.

Easy to Use. No Programming.
CP/M 2.2, 3, 80, or 86, MS-DOS or PC-DOS.
Excellent Manual. Most disk formats.

DataPlotter™

Line Graphs & Scatterplots . . . \$69
Bar Graphs & Pie Charts . . . \$69
Both for \$99

Lark Software™
131 N. Leverett Rd.
Leverett, MA 01054

(Prices include manual)
Add \$3 shipping,
\$8 outside US and Canada.
Specify type of Printer.
(413) 773-8687 Visa, M/C

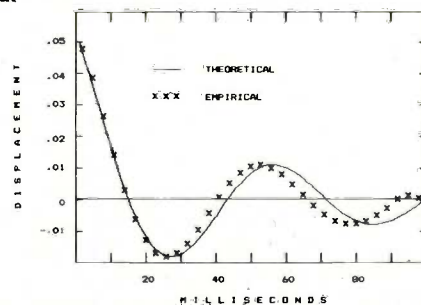

to the telephone directory, BASIC, a desk calculator, and submenus that control voice and data automated-call facilities, the microdrive utilities, and ROM applications software.

The telephone directory is a built-in database that acts as an electronic phone book. In addition to the name, phone numbers (both voice and data, and extension numbers for PABX [private-area branch exchange]), and a descriptive comment for each person or firm, you may store a *shortcode* and a telephone *charge band*. The *shortcode* is a three-letter abbreviation used for ultraquick dialing, while the *charge band* permits the OPD to calculate the cost of calls made to this number.

You can display the directory on the screen as a list of single-line entries. A keypress expands these to give more information (e.g., the identifying comment) or to retrieve a whole

record for amendment. You can dial a number by selecting it from this list in one of two ways, either by moving a block cursor to the appropriate entry or by using a search command that can match words or parts of words anywhere in a record.

To dial numbers using a *shortcode*, lift the receiver and type the code; you don't have to access the directory at all.

The telephone-control submenu permits you to set up voice auto-answer messages and to inspect the total cost of calls made in all the different charge bands. You can set the attributes call-timing and auto-answer on or off for a particular telephone line with this menu.

The voice synthesizer integrates nicely into the system. Answer messages are named and stored in a library. You can create a new one with an editor that offers a screen display

of all the words available. (The words will more than fill the screen, so it can be scrolled.) You compose your message from this vocabulary by typing it on the input lines at the foot of the screen. Once it's entered, a single press of the key makes the OPD speak the message so you can see how it sounds and edit it immediately. The vocabulary contains most of the words you need to compose polite business-type messages, plus all the letters of the alphabet, the digits, the numbers up to 59, the suffixes "ing" and "s" (hard and soft), and "breath" pauses. The speech quality is clear and intelligible but somewhat expressionless.

You may select a message from the library and assign it to a telephone line. By specifying a start and finish time, it's possible to allocate two different messages for different times of

(continued)

RAM BOARDS, DISK DRIVES, FILTERS and MONITORS

QUALITY PRODUCTS AT LOW PRICES ...
1 YR. WARRANTIES, SHIPPED WITHIN 48 HOURS!

Short-Slot Ram Expansion (Memory) Boards for IBM-PC and PC-Compatibles	
64K (Expandable to 256K)	\$149.00
256K (Expandable to 1MEG)	245.00
RAM (1st Quality, Name Brand, Factory Direct, 150NS)	
64K (9 PCS)	17.95
256K (9 PCS)	79.95
5¼" Disk Drives for IBM-PC and PC-Compatibles	
TEC FB-503, ½ Height, 360K (DS, DD)	99.00
Line Filters (Filters Out Line Surges and Spikes)	
Filter FS-1 (Single Outlet)	49.00
Filter FL-6 (6 Outlets)	69.00
Monitors	
Panasonic Computer Display, Non-Glare	129.00
(Model TR-120M1PA, P-31 Green Phosphor)	
Twix Victor JVC Computer Display, Non-Glare	139.00
(Model MIC-120EU1C, P-31 Green, Tilt and Swivel)	
Twix Victor JVC Computer Display, Non-Glare	149.00
(Model MIC-120JU1C, Orange, Tilt and Swivel)	

We accept American Express, Master Charge, Visa, Certified Checks, Money Orders, COD (w/ deposit), and Wire Transfers. All orders shipped within 48 hrs., most next day. We ship UPS, Federal Express, and Emery. Minimum shipping charge \$3.50. All prices are subject to change w/o notice. Some items may be subject to back-order. All returns must be authorized within 10 days of purchase (Please call for R/A No.) and are subject to a 15% restocking charge. Texas residents please add 6% sales tax.

CUSTOMER SERVICE LINE (214) 341-4886
TOLL FREE ORDER LINE (800) 437-6677

SWISTEC SWISTEC COMPUTER
9555 Crestedge Drive • Dallas, TX 75238

a message to our subscribers

From time to time we make the BYTE subscriber list available to other companies who wish to send our subscribers material about their products. We take great care to screen these companies, choosing only those who are reputable, and whose products, services, or information we feel would be of interest to you. Direct mail is an efficient medium for presenting the latest personal computer goods and services to our subscribers.

Many BYTE subscribers appreciate this controlled use of our mailing list, and look forward to finding information of interest to them in the mail. Used are our subscribers' names and addresses only (no other information we may have is ever given).

While we believe the distribution of this information is of benefit to our subscribers, we firmly respect the wishes of any subscriber who does not want to receive such promotional literature. Should you wish to restrict the use of your name, simply send your request to the following address.

BYTE Publications Inc.
Attn: Circulation Department,
70 Main St., Peterborough, NH 03458

Subscription Problems?



We want to help!

If you have a problem with your BYTE subscription, write us with the details. We'll do our best to set it right. But we must have the name, address, and zip of the subscription (new and old address, if it's a change of address). If the problem involves a payment, be sure to include copies of the credit card statement, or front and back of cancelled checks. Include a "business hours" phone number if possible. We'll respond A.S.A.P.

BYTE
Subscriber Service
P.O. Box 328
Hancock, NH 03458

Brainy Buffer.

Do you press "print" and wait? And wait? And wait?

HanZon's 64K Universal Data Buffer is the only self-configuring intelligent device that gives you uninterrupted use of your personal computer.

With four standard interface ports, now you can share output devices with two micro systems. Just plug them in and you're ready to go. And it's expandable up to 256K.

Call HanZon today for more information and the name of your nearest dealer: 206-487-1717.



Suggested retail price: \$385.

BYTE Back issues for sale

	1976	1977	1978	1979	1980	1981	1982	1983	1984	1985
Jan.				\$2.75	\$3.25	\$3.25		\$3.70	\$4.25	\$4.25
Feb.			\$2.75	\$2.75	\$3.25	\$3.25	\$3.70	\$3.70	\$4.25	\$4.25
March			\$2.75		\$3.25		\$3.70	\$3.70	\$4.25	\$4.25
April			\$2.75	\$2.75	\$3.25	\$3.25	\$3.70	\$3.70	\$4.25	\$4.25
May		\$2.00	\$2.75	\$2.75	\$3.25		\$3.70	\$3.70	\$4.25	\$4.25
June		\$2.00	\$2.75	\$2.75	\$3.25		\$3.70	\$3.70	\$4.25	
July	\$2.00	\$2.00	\$2.75	\$2.75	\$3.25		\$3.70	\$4.25	\$4.25	
Aug.		\$2.00	\$2.75	\$2.75			\$3.70	\$4.25	\$4.25	
Sept.		\$2.75	\$2.75	\$2.75	\$3.25		\$3.70	\$4.25	\$4.25	
Oct.			\$2.75	\$2.75	\$3.25	\$3.25	\$3.70	\$4.25	\$4.25	
Nov.				\$3.25		\$3.25	\$3.70	\$4.25	\$4.25	
Dec.		\$2.75	\$2.75	\$3.25	\$3.25	\$3.25	\$3.70	\$4.25	\$4.25	

Special BYTE Guide to IBM PC's — \$4.75

Prices include postage in the US. Please add \$.50 per copy for Canada and Mexico; and \$2.00 per copy to foreign countries (surface delivery).

Check enclosed

Payments from foreign countries must be made in US funds payable at a US bank.

VISA

MasterCard

Card # _____

Exp. _____

Signature _____

Please allow 4 weeks for domestic delivery and 12 weeks for foreign delivery.

NAME _____

ADDRESS _____

CITY _____

STATE _____ ZIP _____

Circle and send requests with payments to:
BYTE Back Issues
P.O. Box 328
Hancock, NH 03449

day, e.g., hours you are in and out of your office.

The computer-access submenu contains another database similar to the telephone directory, to hold phone numbers of remote computer services. An entry is much like a telephone-directory entry except that it contains a field for the profile, a

named file of communications parameters (parity, stop bits, etc.) and log-on information. The system provides two skeleton profiles, one for a 300-bps "glass Teletype" and one for a Viewdata terminal to the U.K. Prestel standard; other types will become available later as ROM capsules. By editing these skeletons, you can

create and store profiles for specific sources; you can apply a single profile to more than one source.

Data captured from a remote source can be stored in the page store, which is yet another database holding numbered, screen-size pages of data. It can store up to 99 pages for later inspection or printing.

Logging on to a remote source is not quite fully automatic. The OPD dials the number automatically, but you must manually press a function key to send the log-on sequence stored in its profile once connection is established—hardly an onerous task.

The last option on the top-level menu is Housekeeping, which covers all the utilities, such as setting the date and time, saving and loading memory images to the microdrives, and viewing a directory of the RAM contents. This latter option shows how many 512-byte blocks each memory file occupies and allows manual deletion of files to free up space.

THE OPD AS A COMPUTER

In the rare moments when you are not using the OPD as a telephone, it can serve as a desktop calculator and computer.

You access the calculator from the top-level menu; it has a full-screen display that emulates a printing desk calculator whose printout shows the last 16 results, complete with memory operations.

BASIC, also accessible from the top-level menu, is Sinclair's SuperBASIC, a superior but rather slow structured dialect, which I examined in some detail in my September 1984 BYTE U.K. column (page 415).

Although the OPD derives some of its components (especially the custom gate arrays that handle analog control of the microdrives) from the Sinclair QL, it uses a completely different operating system and therefore, in general, it cannot run QL software. By choosing to implement SuperBASIC in full, ICL hopes to provide a high-level language bridge to QL compatibility; BASIC programs written for the

(continued)



dBASE-III POWER TOOLS

FOX&GELLER

QUICKREPORT™ dBASE Report Writer

A full featured report writer for any job—simple or complex:

- Connect up to 6 databases per report
- No programming required
- Draw reports on screen
- 16 levels of sorting
- 16 levels of totalling
- Use bold, underlining
- Print forms
- Date, arithmetic
- Up to 255 columns wide
- Generate dBASE programs automatically
- Programs are commented and bug-free
- Data Entry Programs/Forms
- Data validation programs
- Computed fields
- Multi-page forms
- Menu Generator

Now you can create database applications in minutes without programming.

**POWERFUL,
YET
SIMPLE**

QUICKCODE-III dBASE-III Program Generator

Also Available:

dGRAPH-III—Quality graphics for dBASE-III
 dUTIL-III—Programming utility for dBASE-III
NEW QUICKINDEX—Index Files up to 90% faster than dBASE

Available from your local dealer.

800-221-0156

IN NJ (201) 794-8883

VISA, MASTER CARD accepted

FOX & GELLER
604 MARKET ST.
ELMWOOD PARK,
NEW JERSEY 07407



FOX&GELLER

dBASE™ Ashton-Tate Quickreport and QuickCode™ of Fox & Geller

COMPUTER WAREHOUSE

CALL TOLL FREE **1-800-528-1054**

PRINTERS

Anadex	
9625B	\$1089
WP6000	\$2039
DP6500	\$2179
Brother	
HR-15XL	\$345
HR-25	\$599
HR-35	\$809
Canon	
LBP-8A1	Call
C-Itoh	
A-10-30	\$469
F-10 Parallel or Serial	\$869
55 CPS Serial or Parallel	\$1035
8510 Parallel (Prowriter)	\$295
8510 SP	\$385
8510 SCP	\$465
8510 BPI	\$315
Citizen	
MSP-10	\$329
MSP-15	\$509
MSP-20	\$469
MSP-25	\$639
Comrex	
CR-2E	\$364
CR-4	Call
420	Call
DaisyLaser	
PR101	Call
Datsouth	
DS180	\$1089
DS220	\$1315
DS-PP#1	\$449
DS-PP#2	\$635
Diablo	
D-25	\$555
630 API	\$1484
630 ECS	\$1669
630 ECS/IBM	\$1669
Other Printer Models	Call
Epson All Printer Models	Call
Inforunner	
Riteman w/Tractor	\$244
Riteman 15	\$499
Riteman Blue w/Tractor	\$299
Juki	
5500	Call
6000	\$199
6100	Call
6300	Call
NEC	
2010, 2015, 2030, 2050	\$629
3510, 3515, 3530, 3550	\$1009
8810, 8815, 8830, 8850	\$1349
P2, P3	Call
Okidata All Printer Models	Call
Panasonic	
1091	\$259
1092	\$349
1093	\$519
KXP3151	\$459
Siemens	
PT/88 InkJet	Call
PT/89 InkJet	Call
Star Micronics All Printer Models	Call
Silver Reed	
EXP400 Parallel	\$235
EXP500 Parallel or Serial	\$279
EXP550 Parallel or Serial	\$399
EXP770 Parallel or Serial	\$699
Toshiba P1340 Parallel or Serial	\$549
P351 Parallel or Serial	\$1165

MONITORS

Amdek All Monitors	Call
Princeton Graphic HX-12	\$479
Sanyo CRT-36	\$149
Taxan	
121 Green	\$125
122 Amber	\$134
420 RGB	\$399
425 RGB/Green	\$410
440	\$549
Zenith	
ZVM-122 Amber	\$95
ZVM-123 Green	\$89
ZVM-124	\$129
ZVM-130	Call
ZVM-133 Color/RGB	\$410
ZVM-135 Color/RGB W/Audio	\$459
ZVM136	\$575



"FREE"

* * * * *

Air Express Shipping

See Details Below



SOFTWARE

IBM PC and 100% Compatibles

Crosstalls 16 \$95	Smart System \$449
D Base III Call	Super Calc 3 (ver. 2)	... \$159
Enable \$265	Word Perfect 4.0 \$209
Framework Call	Wordstar 2000 \$239
Multimate 3.3 \$239	Wordstar Professional	.. \$239

We do not guarantee computer compatibility.

MODEMS

Anchor Automation	
Anchor Express	\$274
Mark XII	\$239
Hayes Smartmodem 300 Baud	\$189
Smartmodem 1200 Baud	\$379
Smartmodem 1200B (IBM)	\$359
Smartmodem 2400 Baud	\$609
Micromodem IIE (Apple)	\$219
Novation Smart Cat Plus	\$315
Prometheus All Models	Call
Racal-Vadic All Models	Call
US Robotics Password 1200	\$209

BOARDS

AST Six Pack Plus	\$259
Hercules Color Card	\$145
Graphic Card	\$295
Paradise Modular Graphic 06-1	\$259
Five Pak	\$159
Quadram Quadboard EX Ok	\$219
E-Ram 80	\$89
Quadlink	\$329
Tec Mar	
Graphics Master	\$449
126K Dynamic Memory	\$225
256K Dynamic Memory	\$299
Captain 128K	\$299
Captain 256K	\$399

COMPUTERS

NEC	
PC-8201 Computer	\$315
PC-8401A	Call
8201 & 8401 Accessories	Call
Sanyo MBC-775 Portable	\$1859
MBC-555 Series	Call
MBC-885	Call
Wyse	
Wyse pc Dual	Call
Wyse pc 10 Meg	Call
Zenith	
Z-150 Single Drive	Save 25%
Z-150 Dual Drive	Save 25%
Z-150 W/10 Megabyte	Save 25%
Z-160 Single Drive	Save 25%
Z-160 Dual Drive	Save 25%

KEYBOARDS

Keytronics 5151	\$179
5151 Jr.	\$179

VIDEO TERMINALS

Altos Smart II	\$769
Qume	
QVT 102 Green	\$449
QVT 102 Amber	\$469
Wyse 50	\$429
75	\$565
Wyse 85	Call
Zenith Z-22	\$469
Z-29	\$599
Z-49	Call

DISKETTES

Maxell MD-1 (Qty 100)	\$149
MD-2 (Qty 100)	\$189
Nashua	
S/S D/D (Qty 100)	\$125
D/S D/D (Qty 100)	\$135

PLOTTERS

Enter Sweet-P600	\$780
Epson HI-80	Call

DISK DRIVES

Alpha Omega Turbo 10	\$689
Turbo 20	\$1019
Turbo 30	\$1379
Haba Habadisk for MacIntosh	\$329
Iomega Bernoulli Box for IBM	
10 Megabyte	\$1799
20 Megabyte	\$2499
20 Megabyte Plus	\$2660
5 Megabyte for MacIntosh	\$1335
Rana Elite I	\$179
Elite II	\$339
Elite III	\$405
Elite 10H/Apple	\$1080
Controller (W/Drive Only)	\$69
1000 W/DOS for Atari	\$175
Taligrass TG-3020	\$2289
TG-3135	\$3689
TG-4060	\$1469
Controller	\$119

COMPUTER WAREHOUSE

Order Processing & Order Line: 1-800-528-1054
Other Information: 602-954-6109

2222 E. Indian School Rd.
Phoenix, Arizona 85016

Inquiry 109 for MS DOS Products. Inquiry 110 for all others.



Store Hours: Mon-Fri 10-5:30 Saturday 9-1
Order Line Hours: Mon-Fri 8:30-5:30 Saturday 9-1



Prices reflect 3% to 5% cash discount. Product shipped in factory cartons with manufacturer's warranty. Please add \$9.00 per order for UPS ground shipping. Orders 10 lbs. and under you pay for ground service, receive air service at no extra charge. Available on orders 11-20 lbs. \$15 for air service. Orders 21-30 lbs. \$20 for air service. Prices & availability subject to change without notice. Send cashier's check or money order. All other checks will delay shipping two weeks.

SUMMER SALE

Order either option #1 or #2 before July 15th and receive a **FREE LQP PRINTER VIVITAR TRANSTAR 120 RETAILS FOR \$599.⁰⁰**

- 14 CPS Daisy Wheel
- 10, 12, 15 Pitch Selectable
- Friction Feed
- Selectable Baud to 9600
- Easy Change Ribbon Cartridge

OPTION #1

MSDOS/CPM86



EAGLE PC-2

FEATURES:

- 128Kb RAM expandable to 512Kb
- (2) 320Kb Floppy Disks
- Monochrome Monitor
- Eagle Writer, Eaglecalc MS-DOS, CP/M-86
- One Year Warranty

List: \$3,495.⁰⁰ **SALE \$1488.^{00*}**

*INCLUDES FREE LQP PRINTER

OPTION #2

CPM PORTABLE



TELEVIDEO TPC-1

FEATURES:

- 64K Ram (Expandable to 128K)
- Dual 5¼" Floppy Disk Drive (368.6K per drive)
- 9" Amber Graphic Monitor
- Low Profile Keyboard with 10 function keys
- TeleWrite, TeleCalc, TeleChart CP/M

List: \$1,995.⁰⁰ **SALE \$850.^{00*}**

*INCLUDES FREE LQP PRINTER

ORDER #1 OR #2

800-624-2001
716-325-5530

EXSEL INC.®

OFFICE EQUIPMENT BROKERS
215 ALEXANDER STREET
ROCHESTER, NEW YORK 14607



BYTE U.K.

latter should run, although I was unable to get hold of any samples to test this.

The OPD can be optionally supplied with Psion's Xchange suite of applications in ROM. This is based on the four-program suite supplied with the Sinclair QL, but is, in fact, a later version that is more integrated and features a limited form of multitasking (in addition to that provided by the OPD operating system).

The QL versions are bedeviled by slowness caused by their heavy use of overlays from the microdrives; running from ROM on the OPD renders a significant improvement, though the screen updating in Quill (its word processor) is still irritatingly slow.

The four component programs, Quill, Archive (database manager), Abacus (spreadsheet), and Easel (business graphics), are run from an executive program called Xchange, which allows you to create named tasks. For example, you could have two Quill tasks in existence at once with different names. These tasks are, strictly speaking, interruptible rather than truly multitasking; a single keypress suspends the current task and returns you to Xchange, from which you can enter another task. Xchange also facilitates the exchange of data between different applications, e.g., from a spreadsheet to the word processor.

Xchange applications can use files that reside either in memory or on the microdrives. However, the program isn't fully integrated with the OPD operating system, in the sense that its applications can use only Xchange-created files and cannot access the memory files used by, for instance, the telephone directory or the page store.

OVERVIEW

Having to revert to a boring ordinary telephone after several weeks with the OPD came as somewhat of a shock to me. It seems so right that my telephone should be part of my computer, or vice versa. Certainly, it's possible to buy fancy phones that do last-number-redial and store a few numbers, but to call up a remote data-

base with a single keystroke and then return immediately to where you left off typing a document is something else.

ICL has aimed the OPD at the business market, where its small size—don't forget it can replace two telephone receivers as well as a personal computer—could make it an attractive purchase for managers and executives whose desks have begun to resemble a TV studio floor.

There are some things that the OPD lacks that I would eventually like to see in such a product. In particular, I should like to download documents from a remote source and incorporate them directly into a word-processing document, which requires a text editor that is more fully integrated into the system. Also, given that its RAM-based way of working is very effective, it could use more RAM.

The lack of an industry-standard operating system could be perceived as a weakness, but ICL is adamant that the OPD is not aimed at computer buffs, nor at those with sophisticated computing requirements; the supplied ROM software should provide all that's needed in its intended market.

Such doubts apart, playing with the OPD has convinced me that it's as much of a milestone in personal computing in its own way as the Macintosh. It's hard to imagine how a future personal computer can avoid having integral telephone facilities; plug-in modems and acoustic couplers suddenly seem very clumsy.

With post-Macintosh user interfaces and possibly video as well as voice channels, the personal computers of the future could at last become truly useful in the home as well as the office. Remote banking and shopping are already with us in a limited way. Downloading books and pictures (maybe movies, too?) from the world's libraries could soon follow, as could wholly electronic mail (with photographs as well as text).

The OPD will be available in the U.S.—with a suitable U.S. telephony module—probably in the latter half of this year. ■

Byte Book Club™

POWERFUL TOOLS! POWERFUL SAVINGS!

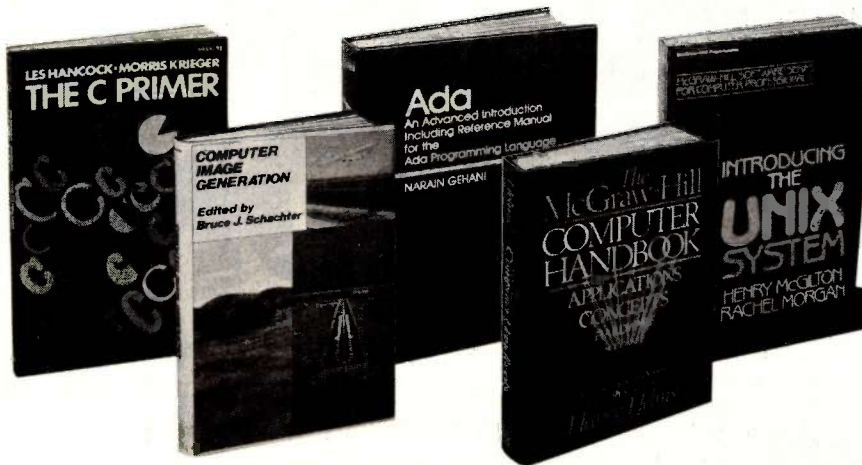

**Take any 3 books
for \$1.00
only each
(Values up to \$84.50)**

If you join now for a trial period and agree to purchase three more books—at handsome discounts—during your first year of membership. (Publishers' prices shown)

SYSTEMS PROGRAMMING FOR SMALL COMPUTERS By D. H. Marcellus
582937-1B \$28.95
(Counts as 2 of your 3 books)

CONSTRUCTION OF DATA PROCESSING SOFTWARE By J. Elder
582953-3 \$22.95

ADA: AN ADVANCED INTRODUCTION INCLUDING REFERENCE MANUAL FOR THE ADA PROGRAMMING LANGUAGE By N. Gehani
583037-XB \$28.95
(Counts as 2 of your 3 books)

BUSINESS INFORMATION PROCESSING WITH BASIC By G. Struble
582360-8 \$17.95

BOWKER'S 1985 COMPLETE SOURCEBOOK OF PERSONAL COMPUTING By R. Bowker
583155-4 \$19.95

APPLIED CONCEPTS IN MICROCOMPUTER GRAPHICS By B. Artwick
582875-8B \$27.95
(Counts as 2 of your 3 books)

USING dBASE II By C. Townsend
583038-8 \$18.95

ASSEMBLY LANGUAGE PROGRAMMING FOR THE IBM PC By D. J. Bradley
583050-7 \$19.95

PASCAL FOR FORTRAN PROGRAMMERS By R. Perrott & D. Allison
582989-4 \$18.95

COMPUTER IMAGE GENERATION By B. J. Schachter
583065-5B \$29.95
(Counts as 2 of your 3 books)

MICROCOMPUTER GRAPHICS AND PROGRAMMING TECHNIQUES By H. Katzan, Jr.
582576-7 \$22.50

PRINCIPLES OF INTERACTIVE COMPUTER GRAPHICS, 2/e By W. M. Newman & R. F. Sproull
463/387B \$41.95
(Counts as 2 of your 3 books)

GRAPHICS PROGRAMS FOR THE IBM PC By R. J. Traister
582928-2 \$14.95

MINICOMPUTER AND MICROPROCESSOR INTERFACING By J. C. Cluley
582585-6B \$27.50
(Counts as 2 of your 3 books)

THE C PRIMER By L. Hancock
259/81X \$17.95

THE MCGRAW-HILL COMPUTER HANDBOOK By H. Helms
279/721A \$84.50
(Counts as 3 of your 3 books)

INTRODUCING THE UNIX SYSTEM By H. McGilton
450/013 \$19.95

PROGRAMMING ASSEMBLER LANGUAGE By P. Abel
583088-4B \$26.95
(Counts as 2 of your 3 books)

TROUBLESHOOTING AND REPAIRING PERSONAL COMPUTERS By A. Margolis
582890-1 \$21.95

HANDS-ON BASIC: For the IBM Personal Computer By H. Peckham
491/78X \$19.95

Introducing The MACINTOSH By C. Duff
180/245 \$14.95

GUIDE TO THE IBM PERSONAL COMPUTER By W. Sikonowicz
574/847 \$19.95

THE MASTER HANDBOOK OF HIGH-LEVEL COMPUTER LANGUAGES By C. Taylor Jr.
583096-5 \$21.95

Why YOU should join the Byte Book Club now!

- **Best and newest books from ALL publishers!** Books are selected from a wide range of publishers by expert editors and consultants to give you continuing access to the best and latest books in your field.
- **Big savings!** Build your library and save money too! Savings range up to 30% or more off publishers' list prices—usually 20% to 25%.
- **Bonus books!** You will immediately begin to participate in our Bonus Book Plan that allows you savings up to 70% off the publishers' prices of many professional and general interest books!
- **Convenience!** 14-16 times a year (about once every 3-4 weeks) you receive the Club Bulletin FREE. It fully describes the Main Selection

and alternate selections. A dated Reply Card is included. If you want the Main Selection, you simply do nothing—it will be shipped automatically. If you want an alternate selection—or no book at all—you simply indicate it on the Reply Card and return it by the date specified. You will have at least 10 days to decide. If, because of late delivery of the Bulletin you receive a Main Selection you do not want, you may return it for credit at the Club's expense.

As a Club member you agree only to the purchase of three additional books during your first year of membership. Membership may be discontinued by either you or the Club at any time after you have purchased the three additional books.



Fill out the card and mail today! If the card is missing, write to:

BYTE BOOK CLUB™, P.O. Box 582, Hightstown, New Jersey 08520

THIS IS COMPUTER PROTECTION.

To safeguard your computer against mysterious errors and costly servicing, not just any surge and noise suppressor will do. *Serious computer problems demand serious computer protection...* DATAGARD® by SL WABER.

For more information about DATAGARD and our complete line of Computer Accessories, call or write today.



WABER

Inquiry 371

A Division of SL Industries, Inc.

Computer Accessories Group
300 Harvard Avenue
Westville, NJ 08093
Toll-free (800) 257-8384
In NJ (609) 456-5400

Nobody does it better. Nobody can.

バイト

New NECs and a Cartridge Disk

PC-8801 Mk II SR

Mr. PC

PC-6001

Tomas drives

Shoppers' guides

Readers' queries

BY WILLIAM M. RAIKE

I'm always impressed by the pace of introductions of new computer products here; not a month goes by without at least one noteworthy new computer or peripheral device appearing under exhibition spotlights or on dealers' shelves. This month's newcomers include three substantial upgrades of NEC computers and an impressive new cartridge hard-disk system from Tomas. In this month's *BYTE Japan* I'll also comment on a growing application area here: computers as neighborhood guides.

NEW TRIO FROM NEC

Japan's leading personal computer manufacturer, NEC, recently introduced, of all things, three 8-bit personal computers. The first is an upgrade of its PC-8801 Mk II, based on NEC's version of the Z80 microprocessor and now more than a year old. The older version of the PC-8801 Mk II is still selling well at the major computer outlets in Tokyo's madhouse Akihabara electronics district, with discount prices in the under-\$800 range.

The new version is called the PC-8801 Mk II SR. It's a mystery why NEC didn't simply call it the Mk III; I'm not even sure I want to know what the "SR" stands for.

Like its predecessor, the SR comes in three versions (with zero, one, or two floppy-disk drives) and has 64K bytes of user RAM (random-access read/write memory), plus an extra 48K bytes of graphics video RAM. The SR also has the same multiple personality as the earlier PC-8801 systems, which allows it to maintain compatibility with its ancestors all the way back to the PC-8001 computer that first appeared almost six years ago. In addition to its 64K bytes of N88-BASIC ROM (read-only memory), the SR also has the older N-BASIC ROM; you select one bank of ROM or the other by an external DIP (dual-inline package) switch.

The SR isn't identical to the plain old Mk II model, though. For one thing, it offers a

3000-plus-character kanji ROM as standard. This feature is currently almost universal; even the low-priced MSX machines (now in the \$100 to \$350 range) offer some kanji support. The SR also has a switch that lets you select between two different versions of N88-BASIC.

The SR handles graphics several times faster than the old Mk II and supports additional color graphics features. In either the 640-by-200-dot (low-resolution) or 640-by-400-dot (high-resolution) mode, each dot can assume any of eight colors. You can select the eight colors on a character-by-character basis from a total of 512 colors. Finally, the computer includes a programmable sound synthesizer with an eight-octave range, offering piano, brass, and percussion effects along with insect sounds, bird calls, and others.

There's very little software to run on the SR, except for the Japanese-language word-processing packages from outside vendors that also run on the older versions of the PC-8801 with optional kanji boards installed. I can't imagine anywhere except Japan where hardware of this caliber would be sold completely unsupported by corresponding graphics software (except for BASIC), leaving it up to the hobbyists to figure out whether they can do anything useful with their \$1000 new computer. Judging from the rapid turnover in used computers, many users discover that they're limited to buying commercial games or keying in thousands of lines of BASIC coding for public-domain games that appear in computer magazines every month. (There's only one magazine here that's published on disk as well as paper.)

It's revealing that, with all the hype surrounding the graphics and sound-synthesizer features of this computer, including extensive magazine advertising, there is absolutely no mention of an operating system. Having owned an earlier PC-8801, I know it can run CP/M, but there's not much in the

(continued)

William M. Raikes, who has a Ph.D. in applied mathematics from Northwestern University, has taught operations research and computer science in Austin, Texas, and Monterey, California. He holds a patent on a voice scrambler and was formerly an officer of Cryptext Corporation in the U.S. In 1980, he went to Japan looking for 64K-bit RAMs. He has been there ever since as a technical translator and a software developer.

The Tomas drives are quieter, offer more capacity than a floppy-disk drive, and provide a reasonable way to maintain backup storage.

way of vendor support for users who want access to that software base.

MR. PC

Another NEC entry is apparently designed to attract people who want a system one step above the low-priced MSX machines. It's called the Mr. PC, and advertising for the machine is directed toward young people; magazine ads and brochures feature people dressed in the latest teen-age fashions and bill the Mr. PC as the Roppongi *pasocom* (personal computer), a reference to one of the more bustling disco and nightlife districts of central Tokyo. The computer comes in either red or black. A major feature is its cordless keyboard, doubtless also designed for people who want to dance with the keyboard. The list price is just under \$600, although 20 or even 30 percent discounts are almost universal at most of the major Akihabara computer department stores.

The Mr. PC is an enhancement of the NEC PC-6601 computer I talked about in the September 1984 BYTE Japan ("Show Time," page 407). It comes with one 320K-byte 3½-inch microfloppy-disk drive and 64K bytes of RAM as standard; you can add another drive for about \$150 extra. There are five banks of ROM, including two versions of BASIC, a ROM for the sound synthesizer (which isn't quite as elaborate as the one in the PC-8801 Mk II SR), and a 1024-character kanji ROM. Even without any separate graphics video RAM, the

color graphics capabilities are adequate: 320 by 200 dots, with a 15-color palette.

The main processor is a μ PD780C, equivalent to a Z80, and runs at 3.58 MHz. The Mr. PC also uses three sub-processors: one 8049 for controlling cassette and RS-232C serial I/O (input/output) (the RS-232C board is a \$25 option), one 80C49 for a timer and television controller (a video superimpose feature is standard), and another 80C49 used as a keyboard controller.

This machine's software situation is only marginally better than that of the PC-8801 Mk II SR; the Mr. PC comes with a Japanese-language word processor, a music software package called Musicwriter, and a game. The computer stores are jammed with games for the PC-6601, all of which run on the Mr. PC.

PC-6001 UPGRADED

Although NEC doesn't have an entry in the MSX market (there are over two dozen competing MSX machines now), it recently upgraded its slow-selling PC-6001 computer; the result is the PC-6001 Mk II SR. Similar to the Mr. PC but without a disk drive, it offers 80-column display capability and accepts almost all of the Mr. PC peripherals and options. It costs about \$350, the same price as the top-of-the-line MSX computers. Since it doesn't accept MSX software cartridges, though, it's hard to imagine this machine finding much acceptance.

CARTRIDGE HARD-DISK SYSTEM

A new disk system from a small company called Tomas Electronics has really big potential. The Tomas cartridge-disk system incorporates the best features of floppy-disk systems and hard disks. Most floppy disks are limited to about a megabyte (although the new Hitachi 6.5-megabyte 5¼-inch floppy-disk drives I talked about in the February BYTE Japan ["Disks and Printers," page 367] should start appearing before long); as density increases, manufacturing quality control and the sensitivity of the disk to dust

contamination and wear become increasingly serious problems. And the idea of keeping a box or more of floppy disks as backup for a hard-disk system deserves to become obsolete.

Besides being quieter and offering more capacity than a floppy-disk drive, the Tomas drives offer a reasonable way to maintain backup storage. The Tomas disk cartridges consist of a 3.9-inch Winchester-type hard disk enclosed in a protective cartridge; the cartridges are about ½ inch thick and about 4½ inches square. The rigidity of the cartridge allows the drives to use a fast rotational speed (just over 3500 revolutions per minute) and a high recording density (12,000 bits per inch). The cartridge also protects the sensitive magnetic surface from contamination or careless handling.

The individual cartridges plug into the front of the Tomas drives (single- and dual-cartridge drives are available), giving the same flexibility and ease of backup as floppy-disk drives. Each cartridge holds 5 megabytes when formatted; the average time to access a track is only 90 milliseconds, and the high rotational speed and high recording density combine to give a data-transfer rate of 5 megabits per second. According to Tomas, a carbon-coating technique and improved manufacturing facilities contribute to making the system highly reliable.

The price of the system is comparable to the price of a hard-disk system of similar capacity; the list prices for the single- and dual-drive versions (the RX-0600 and RX-0606) are about \$1750 and \$2450, respectively. An individual 5-megabyte cartridge, called a Q-Pak, sells for about \$80; that's more than floppy disks on a per-byte basis, but Tomas claims the life of a Q-Pak is several times longer than the life of a floppy disk, and the speed advantage more than offsets the price difference.

The drives have built-in controllers; from the computer's point of view, they work just like conventional hard-disk units. According to Tomas, you can connect either the single- or dual-disk drive to an IBM Personal Com-

puter (PC) or PC XT with a hard-disk interface, as well as to the NEC PC-9800 series computers (running under CP/M or MS-DOS), the IBM 5550, the Oki iF800 series, and the DEC LSI-11 (running under the RT-11 operating system). The company says a Fujitsu version will be out soon; I'd welcome the chance to try one on my own system.

ON THE STREET

As still another sign of the diffusion of personal computers into everyday life in Japan, video-display units are starting to appear on Tokyo sidewalks, used as directories and guides to local services and businesses. They are usually found in relatively sheltered locations near subway stations or major shopping districts. The hardware, based on standard personal computer technology, is usually housed in protective plexiglass, and the weather has dictated the use of sealed membrane-type keyboards or touchpads. Other than that, the systems have no particular anti-vandalism or security precautions. The software is all menu-driven; it allows you to select from categories such as "restaurants," "shopping," "services," "entertainment," etc., and then to request more detailed information about particular listings. Color graphics are both eye-catching and informative, and the systems usually provide maps to guide the user to individual establishments, an essential feature in view of Tokyo's sometimes chaotic street addresses. Some systems are free, others are coin-operated; I don't know what it costs an establishment to be included in the directory.

These high-tech directories aren't limited to Tokyo; for example, I saw a particularly handy system in Matsumoto, a scenic city in north central Japan. Installed next to the main downtown train station, the system didn't have a video display; instead, a menu with a hundred or so three-digit codes was posted on a large board, similar to the type of building directory used in most large office buildings. When I keyed in my desired

code, the system produced a one-page information brochure, including maps and other graphics. It was printed on a high-speed 24-pin dot-matrix kanji printer. This particular service was free, and I noticed that over a period of 20 minutes or so many of the system's users were children, some obviously in the process of showing their parents how to use the directory.

ANSWERS

I get a number of questions from BYTE readers, but it's impossible for me to answer all of them personally. One question that comes up repeatedly is whether you can get a board for the IBM PC that will let it handle Japanese characters. According to the president of the local IBM PC users group, the answer is no, although it is rumored that Chinese-language systems exist in Taiwan. The

language gap is not surprising in view of the many technologically superior Japanese personal computers that sell for a fraction of the price of the IBM PC and the computers sold by IBM Japan Ltd. that have Japanese-language capability. As I've mentioned before, the IBM PC and compatibles are not in widespread use in Japan.

If you have a question about the Japanese personal computer world, or comments or suggestions about past and future topics for the BYTE Japan column, you can write to me c/o BYTE, POB 372, Hancock, NH 03449. I'll try to reply to as many queries as possible here in the column.

NEXT MONTH

In the July BYTE Japan I'll tell you about the new Silver-Reed EB50, a battery-powered, lap-size, four-color printer/plotter/typewriter, the ongoing battle of memory chips, and more. ■

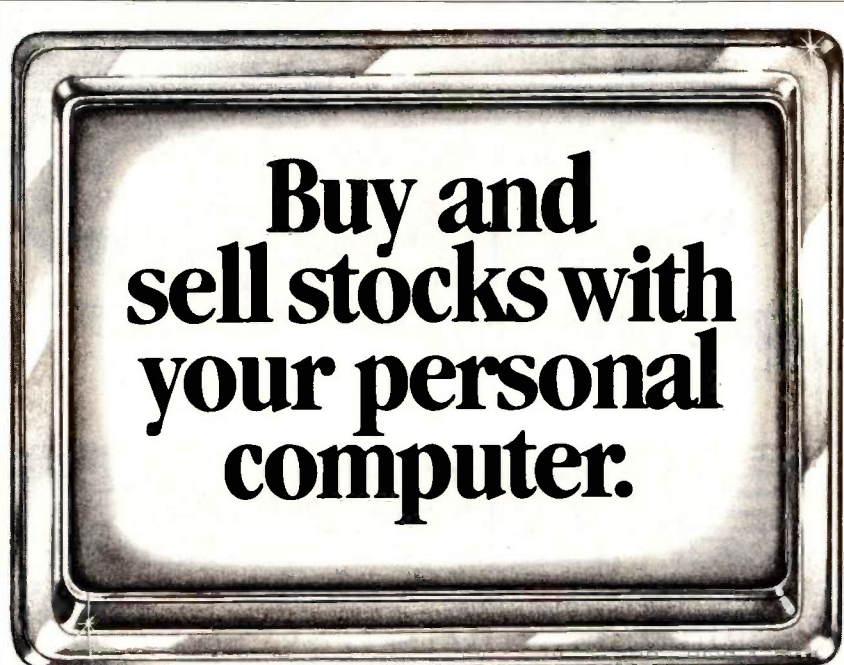

**Buy and
sell stocks with
your personal
computer.**

Now use your own personal computer to place stock and option orders 24 hours a day, seven days a week. Get quotes, review your portfolios and more. And save up to 75% on brokerage commissions*. For more information, call toll free today:

1-800-544-6666.

In Mass., call collect (617) 523-1919

*As compared with full-cost brokerage firms. Minimum commission is \$30.00. KQB060185

FIDELITY
INVESTORS PRESS

FIDELITY BROKERAGE SERVICES, INC.
Member NYSE. SIPC.

A COMPUTER PROGRAM THAT SPEAKS YOUR LANGUAGE



The Computer Chronicles, a half-hour weekly television series brings you news and information from Silicon Valley and around the world. Correspondent Stewart Cheifet and Gary Kildall, creator of CP/M cover today's headlines and the stories behind them. Find out what is, what was and what will be, with the only computer program you're ever going to need. **The Computer Chronicles**, every week on a public television station near you. (Check local listings for time and channel.)

Produced by KCSM, San Mateo, CA and WITF, Harrisburg, PA with funding from McGraw-Hill's **BYTE** and **POPULAR COMPUTING** magazines.





A GEM Seminar

Also, a Mac
disassembler
and advances
in disk-
controller
technology

BY JOHN MARKOFF
AND PHILLIP
ROBINSON

In the March BYTE West Coast (page 355) we mentioned GEM (Graphics Environment Manager), a new program from Digital Research (DR) that gives a computer a Macintosh-like face of icons, windows, multiple fonts, and pull-down menus. In February we attended the GEM Seminar in Monterey, California, where DR began teaching programmers to adapt their software to the GEM environment. What began as an interesting and impressive technical presentation gave way to a marketing brouhaha, which in turn led to a demonstration of DR's flexibility.

Why is GEM so important? DR's John Hiles claims that personal computers with GEM will not only reach the people who read *PC*, *MacWorld*, and *Scientific American* but also will reach those who read *Time* and *TV Guide*. Those people will be more at ease with GEM than with standard operating-system interfaces. DR, the company that once ruled the microcomputer roost with its CP/M operating system for 8-bit microcomputers, hopes to set a new standard with GEM. The Digital Research folks want to provide the advantages of the Mac (and more, such as color displays) to people with other computers. Although the new Atari Inc. under Jack Tramiel (former head of Commodore) is the only company that has committed itself to building GEM into its computers, DR is clearly hoping to penetrate the software-rich, business-standard world of the IBM Personal Computer (PC).

To do this, DR has to do two things. First, it must convince people to use GEM, to build it into hardware and to adapt software to it. Second, DR must teach hardware and software developers how to do those things. Programs will not automatically run on a computer that is equipped with GEM; special files must be added, icons must be designed, and program connections must be developed. (By the way, the bindings for GEM are written in C, though Pascal will be added later. If you want to work with GEM,

you certainly should learn C.)

DR decided to begin its education effort with seminars. The one we attended in Monterey was followed by one in London. The seminars had three goals: to continue to pitch GEM, to demonstrate some of the fundamentals of GEM programming (and hand out a software toolkit full of programming utilities and sample code), and to show doubters that GEM is real. That last goal may seem unnecessary, but the fate of Desq, Visi On, and Windows seems to show that such software environments have been jinxed. Visi On disappeared and almost took one of yesterday's largest microcomputer software firms (VisiCorp) with it. Desq has lapsed into limbo, and Microsoft Windows, from one of today's largest software companies, has been repeatedly delayed. In fact, because GEM competes with Windows as much as it does with the Macintosh, DR was clearly happy to be handing out kits and discussing a real product when Microsoft was still months away from its planned summer release of Windows.

To stress the importance of the seminar, DR handed out a list of the attending companies. These were broken into three groups: software houses, original equipment manufacturers (OEMs), and the press. In all, more than 200 people from 30 OEMs and 105 people representing various software firms were there. However, not everyone came with firm intentions to adapt to GEM. In fact, many would only admit coming to have a look at it or check it out. The list of firm commitments is short but substantial. Atari, ACT (makers of the Apricot computers), Commodore, Northern Telecom, and Texas Instruments have all bought licenses to use GEM. Atari has already employed the license to put GEM in its new ST series of computers. We've heard rumors that Atari isn't alone. The software companies—known at the seminar as ISVs (independent software vendors)—who have announced that they will write to GEM

(continued)

BYTE West Coast is prepared monthly by BYTE's editors and staff in San Francisco and Palo Alto. Correspondence should be addressed to BYTE West Coast, BYTE Magazine, 425 Battery St., San Francisco, CA 94111.

*MacNosy is a
sophisticated
disassembler written
by veteran
compiler designer
Steve Jasik.*

are Blue Chip, Chang Labs, Hayden, Lifetree, Matrix/Systems Group, Pro-Vue, Quadratron Systems, Schoenburg and Hoxie, Software Products, Spinnaker, and Thorn EMI.

Most of the two-day seminar was devoted to explaining GEM architecture and to walking through GEM program code. Throughout the sessions, the DR team demonstrated GEM running on a variety of IBM machines including a PC AT, a PC XT, and an IBM PC with two floppy-disk drives and 256K bytes of memory. (The PC AT used IBM's advanced graphics adapter with the 640- by 200-pixel resolution.)

A description of GEM's VDI (virtual device interface), which allows programs to think they have control of the terminal when they are in fact being handled by GEM, was followed by a short discussion of fonts. As Lee Lorenzen, senior software engineer for DR, explained, DR is only providing a sans-serif font called Swiss (which looks like Helvetica) and a serif font (which looks like Times-Roman) but is encouraging third-party fonts. In fact, the folks from DR started referring to IFVs (independent font vendors).

Tom Rolander of DR explained some of the tough technical stuff, walking through the code of a sample GEM application he had written (a simple paint program). Then DR's Tim Oren began a detailed overview of the RCS (resource construction set). On Friday morning we completed the RCS overview and then quickly learned how to use the Icon Editor

from Greg Morris of DR (he wrote the editor). Rolander returned to walk us through some more C listings for a simple desk accessory.

Friday afternoon's discussion of marketing set off a small explosion. Have you ever seen a room loaded with loud, hostile, and sometimes profane programmers? Except in software project-status meetings, of course. We witnessed one after the DR marketing team presented the licensing facts about GEM. Basically, we were told that there will be two ways for software developers to work with GEM. They can develop GEM-compatible applications and sell them to people who already have GEM on their computers. That's no market at all right now: No one has GEM. Or they can pay DR a license fee that will allow them to sell the application and GEM in a bundle. This license costs \$1000 per product per year (with no guarantee that it won't rise)—so far, not so bad. But then DR mentioned that GEM would only run on IBM (PC, PC AT, and PC XT) equipment. It wouldn't even run on compatibles like the Compaq. Why? Because DR didn't want it to. DR deliberately wrote GEM—crippled it—so it wouldn't run on clones. Again, why? Because DR wanted hardware manufacturers to pay OEM license fees to have GEM run on their computers. All OEMs except IBM, that is.

DR didn't mention this until the final hours of the seminar. In fact, the DR marketing people didn't hand out the sheets detailing licensing until just before this session. Did they anticipate the attendees' reactions? The software developers certainly didn't anticipate having to support different GEM versions of their applications for every compatible and clone. What had seemed up until then a crowd of programmers willing to give GEM a shot quickly changed. While not everyone objected to the IBM constraint, there were a number of hostile questions from the audience. In fact, when one person asked how many thought GEM's inability to run on the Compaq was a serious limitation, 50 to 60 percent of the attendees raised

their hand. DR responded that it has to make some money on the product and OEM fees are a place to do so. While some developers felt this was reasonable, many others seemed to think they'd been bushwhacked.

Gary Kildall, the president and founder of DR, tried to calm the attendees. Discussions after the conference centered on the marketing plans and what a pain they were. Things looked black for GEM.

Then DR changed its mind. In late February, the folks in Monterey decided to change the code in GEM that checks for machine type. Now, GEM will run on IBM compatibles and clones. Imagine, a sizable software company that really pays attention to its developers and makes major changes because of what it hears.

We were impressed by GEM, as were a number of the developers at the seminar. Everyone went home with two big binders full of some useful information and some fluff, a lot of C code, an invitation to a CompuServe GEM support group, a toolkit disk, and a list of toolkit bugs. While GEM had been in beta test for a couple of months, the toolkit had just reached the beta-test stage and had a number of bugs. For instance, in a certain circumstance, if you tried to drag something out of a menu and then accidentally dropped it on a divider line, the entire computer system would hang and have to be reset.

GEM lets you have the same kind of fun as working with a Macintosh and yet lets you step back into the IBM PC world with a quick exit instruction. GEM even has a limited multitasking facility (it can handle some background processes). It is reasonably quick and thorough, but it does have limitations. For example, it has some arbitrary limits, such as a maximum of four open windows at a time and no more than six desk accessories (and a memory-limit size for those).

At press time DR was planning to release its own GEM applications, including GEM Draw (April), GEM Write and GEM Paint (June), and GEM Graph and GEM Wordchart (July).

How will GEM impact the micro-computer world? Right now that depends mainly on DR, Atari, and Apple. Can DR convince developers to work in a GEM world? Will Atari be able to produce huge numbers of inexpensive GEM machines, as Tramiel claims? And finally, how will Apple respond? If people can have the Macintosh juice in a cheaper computer, or on an IBM PC-compatible, will they continue to buy Macs? Does Apple have the next evolution or revolution (like a cheaper or more powerful Mac) up its sleeve? If so, the Cupertino Corps may well find that GEM's imitation has confirmed Mac ideas and put Apple out in front of the microcomputer race. If Apple isn't ready to take the next step, it may be run over by a horde of "Macalikes" egged on by a smiling DR.

MACNOSY: "A DISASSEMBLER FOR THE REST OF US"

Better software-development tools have become available for the Macintosh during the past half year. Currently there are a number of C programming languages, several assemblers, several BASICs, LISP, Logo, FORTH, Modula-2, and an interpretive Pascal to name just a few. Add a licensed version of Xerox Smalltalk-80, which Apple is rumored to have in the works for release soon, and the Macintosh becomes a reasonable programming environment.

For those who want to go further, programming editors and a variety of debugging tools are now readily available. Possibly one of the ultimate Macintosh "exploring" tools is MacNosy, a sophisticated disassembler written by veteran compiler designer Steve Jasik.

Jasik has written compilers for Control Data Corporation for a number of years and is best known for his work developing a global optimizing FORTRAN compiler for the Control Data Cyber 170 system. While attempting to gain a clearer understanding of the Motorola 68000 and the Macintosh operating system, he grew frustrated with the poor quality of the documentation and the general lack of source

COMPANIES MENTIONED

DIGITAL RESEARCH INC.
POB DRI
60 Garden Court
Monterey, CA 93942
(408) 649-3896

JASIK DESIGNS
343 Trenton Way
Menlo Park, CA 94025
(415) 322-1386

SUNOL SYSTEMS
1187 Quarry Lane
Pleasanton, CA 94566
(415) 484-3322

listings. So he decided to write MacNosy.

Jasik considers his program to be as much a "decompiler" as a disassembler. MacNosy, which consists of more than 7000 lines of Pascal code and about 300 lines of assembly-language code, contains many features associated with compilers including a table manager, symbol-table enter/lookup routines, a reference map, and global flow analysis.

MacNosy runs on either a 512K-byte Macintosh or a 1-megabyte Lisa under the Workshop operating system or the MacWorks environment. It is capable of disassembling the resource fork of an application, ROM (read-only memory), or various resource types in the system file (DRVr, PACK, INIT, CDEF, WDEF, etc.).

A partial list of MacNosy features also includes symbol dictionaries of the ROM names and global symbols (0 to hexadecimal B00) with value-to-symbol substitution, selective listing of procedures in a file by procedure name or substring, the ability to search a program file for references to selected addresses, ROM calls, resource-type references, constant or string references, a full or selective listing of the resources in a file in a format similar to that of the Macin-

tosh Resource Mover, and the ability to translate the segment-relative address of an instruction to the disk-file relative address for code-patching purposes. MacNosy also records its input on a text format .jrn1 file for later playback. A future program addition will be a built-in mini-editor for viewing and modifying files while in MacNosy.

Jasik claims that MacNosy is set apart from other disassemblers because it treats a program as a tree of procedures. It begins at the main entry point and does a tree walk to mark the program areas that are procedures. Areas not included are considered data. Currently the program doesn't reconstruct enough information about data areas that are actually code (procedures passed as addresses), and programmer intervention is needed to decode these areas.

In addition to its use as an educational tool and as a tool for developers who want to examine the Macintosh ROM to find out what the ROM routines are doing and for those who want to learn advanced 68000/Macintosh programming techniques by examining others' code, MacNosy has a more controversial use. Advanced programmers can use it to remove copy-protection schemes from commercial software. Jasik takes the position that he is not opposed to copy protection as long as it is not "obnoxious" in the sense that it prohibits the user from booting an application from a hard disk without having to insert a key disk each time. He is also critical of Apple's decision not to make more information about its ROM-based operating system available for the Macintosh.

FASTER AND FATTER WINCHESTERS

Personal computer hardware designers are constantly confronted with the task of squeezing increased performance from limiting standards. Particularly in the area of mass storage, personal computers are bumping up against I/O (input/output) bottlenecks imposed by existing floppy-disk and

(continued)

An RRL data-encoding technique improves on traditional techniques because it represents a given bit stream using significantly fewer flux reversals.

Winchester fixed-disk technology.

To at least partially get around these restrictions it is possible to design new disk controllers that extract more performance out of current-generation Winchester disks. Large performance gains will soon be made by a new generation of disk controllers that offer higher data-transfer rates and greater storage capacity based in part on new data-encoding techniques.

One interesting example of this trend is a new two-chip mass-storage controller set recently announced by Sunol Systems of Pleasanton, California. The DC1001 disk-controller chip plus the RB1002 RAM (random-access read/write memory) buffer support chip are based on CMOS (complementary metal-oxide semiconductor) custom gate-array technology and can be designed into a

single controller card that will handle a hard-disk drive, a floppy-disk drive, and even a file-addressable tape back-up system. Because it is fabricated in CMOS technology, the chip set will consume far less power than other commercial controllers. Each chip consumes just 100 megawatts when operated from a 5-volt power supply.

The chip set implements the ST506 5¼-inch, the ST412 buffered-seek, and the ST412HP high-performance hard-disk interfaces, the SA 5¼-inch, SA800, and SA850 8-inch floppy-disk interfaces, as well as the ESDI (enhanced small-disk interface) file-addressable tape, and the QIC 36 streaming-tape interface.

The new controller set is addressable in a fashion similar to other popular controllers such as the NEC µPD765. It is simply necessary to send a byte sequence through a host central processor or a local control microprocessor.

The key feature that lets the Sunol controller set achieve increased capacity and faster transfer rates than standard Winchester and floppy-disk controllers is the use of an RLL (run-length limited) data-encoding technique that offers significant advantages over traditional MFM (modified frequency modulation) or FM (frequency modulation) methods.

RLL improves on traditional techniques because it represents a given bit stream using significantly fewer flux reversals. According to Dr. Robert McCullough, Sunol's founder, RLL

permits recording up to 60 percent more bits than MFM and can transfer data 50 percent faster.

FM is a self-clocking encoding technique that is used to record bit-serial data on magnetic media. Clocking is done by first writing a flux reversal to define the leading edge of a bit cell. If the value of the cell is 1, a second flux change will occur midway through the cell, however, if the value of the cell is 0, a second flux reversal will not take place until the leading edge of the next bit cell.

MFM keeps the flux reversals for 1s but removes the clock bits except those between two consecutive logic 0s. Rather, the MFM bit cell is defined by an external phase-locked oscillator synchronized with the data-bit stream.

In contrast, in RLL encoding there is nothing that can be identified separately as a "clock bit" or a "data bit." Instead there are only data patterns and corresponding code patterns. Each binary data string can be represented as an RLL encoded data pattern. A minimum and maximum number of 0s are inserted between flux transitions. McCullough claims that RLL offers the best trade-off available between flux-reversal density and bit density.

Ultimately, this will translate into significant performance increases. When used as part of a newer high-performance interface standard such as the ST412HP, for example, RLL encoding can permit a 15-megabit-per-second data throughput. ■

THE \$2995 DEVELOPMENT SYSTEM

Turns any personal computer into a complete micro-computer DEVELOPMENT SYSTEM. Our integrated control/display program runs under MS-DOS, CP/M, ISIS, or Apple and controls the UDL via an RS-232 port.



Up to 128K bytes of **EMULATION ROM** (8K standard) allows you to make program patches instantly. Since the target ROM socket connects data and address lines to both the analyzer and the emulator, no expensive adaptors or personality modules are needed.

The powerful **BUS STATE ANALYZER** features four-step sequential triggering, selective trace, and pass and delay counters. Symbolic trace disassemblers and debuggers are available for Z-80, 8048, 6500, 6800, 8031, 8085, Z-8, 1802, 8088/80188, 8086/80186, R65 and 68000.

PROM PROGRAMMER also doubles as a **STIMULUS GENERATOR**.

For further information, call or write:
ORION Instruments
 702 Marshall St., Suite 614
 Redwood City, CA 94064
(415) 361-8883

Structural Analysis Software for Micros

A book/disk pkg that shows how to write structural analysis software. Uses the 'direct stiffness' method of analysis with Gauss Jordan sol'n of eqn's. Eleven programs show how to plot 3D structures, rotate in 3D, store on disk, analyze with force and moment loads. Handles linear and non-linear structures (plastic mat'ls, large displacements) via incremental solution strategy. Can be used for professional analysis of small structures. Book with theory, operating instructions. Disk with BASIC source code.

- IBM version \$96
- Apple version \$96
- Z-100 version \$96

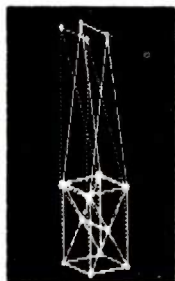

S/SAM

3D truss and frame analysis with graphics. Easy method of describing structure via keyboard input, store structure on disk, recall and modify. Loadings include forces and moments at nodes, prescribed node displacements and rotations, thermal loads. S/SAM gives node translations and rotations, member forces and moments in global and member coordinate systems. Handles up to 150 degrees of freedom. Graphics shows original structure in 3 dimensions with deflected shape superimposed in color (dotted lines is b&w), scale deflections up or down, rotate in 3D. Features stress post-processor which does accurate stress analysis on members, material properties and beam cross section disk catalogs, multiple load case analysis. Source code in BASIC on disk. Manual. Demo kit available.

- IBM S/SAM \$385
- Apple S/SAM \$385
- Z-100 S/SAM \$385
- IBM dem kit \$35
- Apple demo kit \$35
- Z-100 demo kit \$35

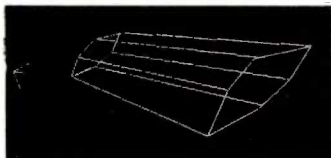

Designer^{3D}

A 3-dimensional CAD program. Interactively create 3D drawings on screen via keyboard commands. Position points, connect by lines, fit curves through points with B-spline routine, scale, rotate in 3D, translate, view in perspective, store on disk, recall up to 5 drawing simultaneously. Move each independently. Move a point and all lines, curves move with it. Input data is in terms of real physical dimensions such as inches or millimeters. Drawings automatically scaled to fit on screen. Attach physical data to drawing elements such as weight, resistance, etc. Use disk files as input to your own applications software. *...inexpensive, versatile, a very powerful design package...can do things Autocad can't.* -Boatbuilder Magazine. Programs on disk in BASIC fully documented. Manual.

- IBM version \$85
- Apple version \$85
- Z-100 version \$85

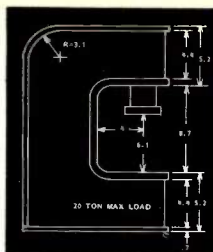

CAD-BASIC

A professional quality CAD program with source code in BASIC fully documented. Use keyboard commands to create any 2D drawing, store on disk, recall, store standard shapes, scale, rotate, automatic curve fitting, semi-automatic dimensioning. Perfect low-cost CAD system for professionals, software hobbyists, educators. Screen dump or plotter versions available.

- Screen Dump CAD-BASIC \$120
- For Houston Instruments Plotter \$120
- For Hewlett-Packard Plotter \$120

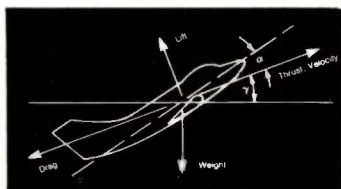

BASIC Aircraft Performance

A system of 8 programs to estimate the performance of aircraft on prescribed missions and in maneuvering flight at prescribed conditions. Features state-of-the-art drag prediction program, thrust/fuel input and evaluation program, simple method of describing complex missions. This system will take you from a 3-view drawing of an aircraft to a completed performance envelope and a mission performance description. Use of thrust/fuel flow tables permit any engine type - turboprop, turbojet, etc. All programs in BASIC, source code on disk, 240 pg manual with theory, operating instructions.

- IBM version \$120
- Apple version \$120
- Z-100 version \$120

Engineering Software for Micros

A collection of programs for engineering applications of micros. CAD graphics, mechanisms, Fourier Series, Fourier Transforms, Gauss Jordan sol'n of eqn's, Monte-Carlo optimization. Emphasis on graphics. BASIC source code on disk.

- IBM version \$50
- Apple version \$50
- Z-100 version \$50

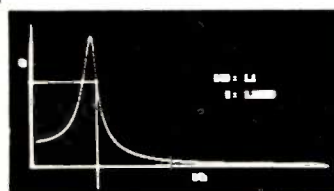

Visual Vibrations

Solves 1 and 1 degree of freedom damped oscillator problems with emphasis on graphics. Response to applied harmonic force, foundation motion, impulse and step loading, response spectra, log plots, complete description of system including natural frequencies, time constants, damping factors, etc. Book reviews theory with operating instructions. BASIC source code on disk.

- IBM version \$75
- Apple version \$75
- Z-100 version \$75

Visual Statistics

Statistical analysis with emphasis on graphics. Create data files interactively thru keyboard. See x,y data points on screen as entered. Add, delete, move points, store on disk, recall and merge data files. Customize plots - define axes, flash point numbers, define grids, connect point with lines, bar charts, sort, percent between limits, running average, x-mean, y-mean, weighted x-mean, standard deviation, Z-values, correlation coeff', coeff' of determination, linear regression thru specified point. BASIC source code on disk. Manual.

- IBM version \$65
- Apple version \$65
- Z-100 version \$65

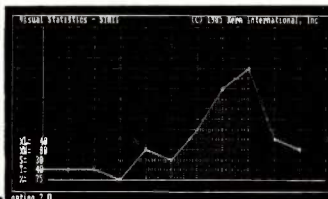

Statistics Software for Micros

19 programs for statistical analysis: summary statistics, binomial and normal probabilities, chi-square test, 1 and 2 sample hypothesis testing and confidence intervals, multi-factor ANOVA, comparison procedures, latin squares, cross-over designs, repeated measures design, simple and multi-linear regression, regression thru origin, logistic response analysis, graphics with profile of means, scatter plots, residual plots, histograms. Numerous example problems. 320 pg manual, BASIC source code on disk.

- IBM version \$62
- Apple version \$62
- Z-100 version \$62



Graphics for the IBMpc, Apple, Z-100

64 programs that show how to write graphics software. They advance from elementary graphics to advanced concepts in small steps. Shows how to create 2D and 3D shapes, rotate, translate, scale, stretch, store on disk, view in perspective, clip, window, remove hidden lines. Applications to CAD/CAM, business, games. Named 'the best book on microcomputer graphics' -Creative Computing Magazine. Book with BASIC source code on disk.

- IBM version \$50
- Apple version \$50
- Z-100 version \$50



Sections

Calculates properties of composite or uniform beam cross-sections. They can have any shape, regions of different material properties, reinforcing rods and holes. Properties calculated: area, wgt/unit length, centroid coord's, bending and polar inertias, principal angle, inertias about principal axes, axial stiffness, bending stiffness, torsional stiffness, distance to outermost fibers. Create shapes via keyboard input using real physical dimensions, plot section on screen with principal axes, outermost fiber shown in color or b&w, store on disk, recall and modify. BASIC source code on disk. Manual.

- IBM version \$65
- Apple version \$65
- Z-100 version \$65

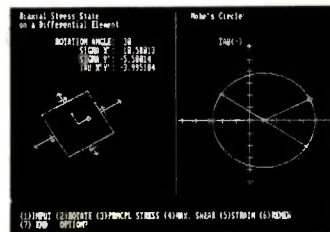

Stress & Strain

Solves 2 and 3 dimensional combined stress problems. In 2D case, specify stresses, program draws stress element with Mohr's circle. Rotate element, new stresses are calculated, Mohr's circle is redrawn, stress vectors drawn to scale on rotated element. Also get principal stresses, strains, principal angle, max shear. 3D case is similar but no Mohr's circle. Principal stresses found via matrix iteration. BASIC source code on disk. Manual.

- IBM version \$85
- Apple version \$85
- Z-100 version \$85

C Graphics

A collection of programs that show how to write graphics software in C on an IBMpc. Learn how to turn on the graphics mode and place a point on the screen at x,y coordinates with assembly language, then develop SCREEN, PSET and LINE functions in C. Develop C functions to create 2D and 3D shapes, rotate, scale, translate in 3D, store drawings on disk. Build your own graphics language. Book with C and BASIC source code plus compiled modules on disk.

- IBM version \$66

KERN

INTERNATIONAL, INC
433 Washington Street, Po Box 1029
Duxbury, MA 02331 (617)934-0445

To Order: Add \$4 for first item, \$2 each additional item for UPS shipping in US; \$12 and \$6 Europe; \$6 and \$3 Canada, Cent'l and S. America; \$14 and \$7 elsewhere. Use check drawn on US bank, int. money order or VISA/MC number with expiration date. Returns allowed in 10 days if disk envelope is not opened. Shipping must be prepaid. Mass. residents add 5% sales tax. Use this form or call for faster delivery.

Name _____
Address _____
VISA/MC No _____ Exp Date _____

LOSE WAIT.

OUR MODULA-2 SOFTWARE DEVELOPMENT SYSTEM TURNS "WAIT TIME" INTO "WORK TIME."

When Modula-2 was introduced as the programming language of the future, it no doubt whet your appetite for greater efficiency.

A vast improvement over Pascal, the language is modularly designed for greater ease of large program development. With built-in error control features that can save you up to 30% on editing time.

Today, there's a complete Modula-2 programming environment: SDS-XP.

REDUCE YOUR WAIT. There's no time like real time. And that's about how fast the SDS-XP compiler works. It turns up to 100 lines of Modula-2 text into native machine code in less than five seconds.

Our intelligent, syntax-directed editor can save up to 90% on typing time. It lets you enter full statements with a single keystroke, gives on-line help to correct undefined variables or syntax errors and formats your program automatically. So you spend less time debugging and less time recompiling.

There are also multiple editor windows that let you refer to one file while you edit another. And that can add even more hours of creative, productive time to your day.

BUILD UP PROGRAMS. SDS-XP lets you create programs using your computer's full capabilities. With extensive libraries, you can develop several, linkable components that can be assembled automatically. You can also access exclusive link-and-run modules for direct calls to the operating system, sound, 8087 and color graphics.

Our compiler turns 100 lines of typical Modula-2 text into optimized machine code in under five seconds.

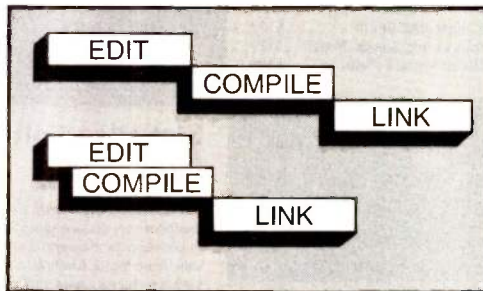

It not only has a faster compiler, it also saves time by compiling while you edit.

SDS-XP runs on the IBM® PC family or any 100% compatible computer. The system is non-copy protected. And any programs you develop using it, you own.

TWO TRIM PRICES: \$249 OR \$80.88. Best of all, there are two Modula-2 software development systems to choose from. So you can fit your needs, and your budget.

For \$249 you can get SDS-XP with foreign object importer, module tool box and the option to add a debugger

for even greater programming capability.

Or, for just \$80.88, there's M2SDS with our editor, compiler and linker. It, too, is a complete programming environment and it's specially designed for those who want easy-to-learn, easy-to-use programming capabilities.

Both SDS-XP and M2SDS include a comprehensive language text/user's manual and telephone support from Interface Technologies.

Call us today to order the programming environment that's best for you. Get the future of programming efficiency. And the sure way to lose wait fast.

Work faster and easier with multiple editor windows.



WE ACCEPT CHECKS, MASTERCARD, VISA AND AMERICAN EXPRESS. Price does not include shipping and handling. Texas residents add 6.125% Sales Tax. International orders add \$30.

**INTERFACE
TECHNOLOGIES**

3336 Richmond, Suite 200, Houston, TX 77098

IF YOU'RE TIRED OF WAITING ON YOUR COMPILER AND WANT TO LOSE WAIT,

CALL 1-800-922-9049

(IN TEXAS, CALL 713/523-8422.)

C·I·R·C·U·I·T C·E·L·L·A·R F·E·E·D·B·A·C·K

Conducted by Steve Ciarcia

OFFER EXTENDED

Dear Circuit Cellar Project Builders,

In my November 1984 article on the Lis'ner 1000 voice-recognition board, I offered the software separately to Circuit Cellar project builders for \$17 through March 1, 1985. Requests have poured in throughout the offering period, but the majority of foreign mail has just started to arrive. To give everyone time to properly evaluate the project and respond, I am extending the availability of the software through August 1, 1985. Thanks for your support.—Steve

TRUMP CARD QUESTIONS

Dear Steve,

I recently read your articles in BYTE about the Trump Card, and I am considering the purchase of the board. However, I have several questions I would like to have answered before I make such an investment.

You mentioned that there are a few minor differences between IBM BASICA and TBASIC. What are these differences? Does TBASIC support the 8087 math coprocessor? How long can I expect Trump Card to take to compile very large and complicated programs? Our IBM PC system has an expansion unit. Can Trump Card be placed in the expansion unit, or must it be put in the system unit as is the case with the monochrome monitor adapter and some other cards? Is it possible that some IBM software will not run properly when Trump Card is in the system? Is it possible that some of the other cards we have in our system will interfere with Trump Card?

GRIEG A. OLSON
Tucson, AZ

The Trump Card manual supplies a listing of the IBM BASIC statements, functions, variables, and commands that are either fully supported, supported with some differences, or not supported by TBASIC. The items not supported by TBASIC generally comprise the special PC BASIC commands associated with input/output control. For example, some of the items not supported by TBASIC are DEFUSR, DELETE, KEY, LLIST, MERGE, MOTOR, PEN, STICK, TRON, and

TROFF. In some cases, the item is not supported because it is handled in a different manner by TBASIC. For example, items like DELETE, LLIST, and MERGE are handled by the built-in EE editor that comes with TBASIC and are not needed by the TBASIC compiler. A chapter on the EE editor is included in the TBASIC manual.

TBASIC does not support the 8087 math coprocessor. However, the increase in speed acquired by using TBASIC is remarkable without the 8087 coprocessor.

The compilation time for large programs is still quite fast. A 25K-byte BASIC program will compile in about 8 seconds.

The Trump Card should be able to be placed in an expansion unit, since the memory associated with the Trump Card is on the Trump Card itself.

The Trump Card should not affect the operation of any IBM software packages, and the Trump Card should not interfere with any of the other cards in your system. At least, it has never interfered with any of my hardware or software.

—Steve

BRITISH SWEET TALKER II

Dear Steve,

I thoroughly enjoyed the article that you wrote in the March 1984 BYTE regarding the new Sweet Talker II.

I am a beginning computer enthusiast, and I have just ordered this board to begin experimenting with a number of projects.

One of the more involved projects is to create a computer-generated British voice. While I will be experimenting with the Sweet Talker II to learn a lot of the basics and further understand that the chip can be best utilized by programming it with an assembly language to take advantage of its many features, I am wondering whether it will be possible to get a British accent out of its synthesized voice.

GEORGE E. HANDLEY
Shawnee Mission, KS

It may be possible to obtain a British accent from the Sweet Talker II, but I have not tried to do so. The Apple II text-to-speech algorithm generates some words that have a distinct (though un-

intentional) Irish brogue, and some phoneme changes might produce the British accent. It would be strictly a trial-and-error approach, however.

Each of the methods of speech synthesis is a compromise. The phoneme approach allows an unlimited vocabulary at the expense of accuracy. The linear-predictive-coding (LPC) method offers accurate speech reproduction, but the vocabulary is limited, since the coding for each word must be computed. The adaptive differential pulse-code modulation (ADPCM) method, described in my June 1983 Circuit Cellar article, may represent an acceptable solution, but it uses large amounts of memory. As the 256K- and 1024K-byte memory chips become available in quantities to drive the price down, this may be a cost-effective approach to your application.—Steve

AUDIO DOWN-CONVERTER

Dear Steve,

I am an avid reader of your articles in BYTE, although I'm not quite a project builder. Your recent articles on "talkers" and "listeners" prompted me to write to you regarding my friend's hearing problem. It has seemed to me that her hearing could be enhanced by some of the technology that goes into your projects.

Her problem is that she hears only sounds below 700 cycles. It seems to me (quite possibly because of my lack of knowledge) that it might be possible to build a device that would take in all noise and shift it to a frequency where she can hear. Do you have any suggestions? Thanks.

RALPH M. CARLSON
Poulsbo, WA

Though the Lis'ner 1000 (November 1984, page 110) has the capability to extract filter coefficients from speech in real time and also synthesize speech, the routines required to lower the frequency spectrum make it impossible to do in real time. The speech would have to be received, analyzed, and synthesized in chunks. Also, it would not be very portable.

A technique that might work was

(continued)

described in "Listen to a New World of Sounds with an Ultrasonic Detector" in the July 1978 issue of Popular Electronics. Though the circuit described would not work for your particular frequencies, the technique of heterodyning might be applied. If you have had any trigonometry, you have seen this identity: $(\sin x)(\sin y) = \frac{1}{2} \cos(x-y) - \frac{1}{2} \cos(x+y)$. Multiplying a signal of constant frequency (y) by a signal of varying frequency (x) produces two signals having a frequency equal to the sum and difference of the input signals. If you choose 1000 Hz as frequency y, all frequencies in the signal x would be increased and decreased by 1000 Hz. The component that is increased in frequency would be rejected by your friend's ears, leaving only the lower frequencies.

The resulting signal would not be the same as playing a record at half speed, because that process divides all frequencies by two. In fact, the resulting signal may be less intelligible than the original. By changing the frequency and filtering the results, some intelligible signal may be produced.

Books on operational-amplifier circuits are available from advertisers in BYTE. One such book, Design of Op-Amp Circuits, with Experiments by Howard M. Berlin (Howard W. Sams & Co., 1978), gives a circuit for multiplying two signals together using two logarithmic amplifiers, a summing amplifier, and an antilogarithmic amplifier. A hitch in using the circuit is that a DC offset must be added to the two signals before they can be multiplied, since you can't take the log of a negative number. It is easy to add the offset, but the resulting signal will have components of x, y, and x+y left, which may need to be filtered out. —Steve

WHITHER SIGNALS?

Dear Steve,

I enjoyed your article about the Trump Card (May and June 1984). Your system interests me because it improves BASIC execution time, supports CP/M-80, and provides development tools. It also is a direct demonstration of how to build quality hardware.

I am interested in using the Trump Card to run real-time data analysis in electrophysiology. But before I can I need to know several things. First, what is the exact meaning of the connecting symbols in the schematic? Second, I had trouble following the signals in the schematic. Can you tell me their origins and destinations? The

signals are HOLD, HOLDPC, LAI-LA11, MRF5H, R/W, Z, AD8-AD15, BIOR, CAS, INC, INTOP, SPIO, MREQ, MUX, and RESET.

F. MARION
Paris, France

The connecting symbol notation used in my articles is as follows:

An arrow with a line emitting from its point means that a connection to that point comes from some other point in the schematic.

An arrow with a line entering the flat side means that signal goes somewhere else in the schematic.

An arrow with a number in it means the connection comes from or goes to an external connector.

A double-pointed arrow denotes an intersheet connection.

Now that the connecting notation is explained, let's address your list of Trump Card signals.

The HOLD line that goes to IC24, IC31, and IC10 is generated at pin 3 of IC10 and is shown on page 48.

The HOLDPC line is generated at pin 8 of IC35 and goes to pin 2 of IC10 on page 48.

The LAI through LA11 signals are generated by IC5 and IC6 on page 45.

The MRF5H signal is generated at IC11 pin 6. It does not come from another source, as indicated on page 46. Also, the line shown between pins 10 and 12 of IC20 should not be there, and the MRF5H signal should also be connected to pin 10 of IC20.

The R/W signal is generated at pin 30 of IC1 and connects to pin 1 of IC23.

The Z signal is generated at pin 10 of IC13 and connects to pin 9 of IC31 and to pin 3 of IC32.

The AD8 through AD15 lines are the upper data lines of the Trump Card and connect to all locations with the same labels on pages 45 and 47.

The BIOR line is not used in the Trump Card.

The CAS signal is generated at pin 3 of IC33 and connects to pin 4 of IC15 and pin 4 of IC16 (the arrows on ICs 15 and 16 are reversed).

The INC, INTOP, and SPIO lines are not used.

The MREQ line is used only as shown on page 46. It does not go anywhere else in the circuit.

The arrow on pin 1 of IC17 should be reversed. The MUX line is generated at pin 5 of IC19.

The RESET signal is generated at pin

13 of IC9 on page 49.

I hope these comments will make constructing your Trump Card a little easier. —Steve

TRUMP CARD USERS GROUP

Dear Steve,

As one of the original users of the Trump Card, I'd like to take this opportunity to bring you up to date on current developments.

We have a Trump Card Users Group (TRUG) in San Jose, California, and we are in the early stages of setting up a Trump Card software exchange on my BBS. I have chosen what I believe is the best BBS software, Tom Jennings's Fido system. The BBS is Fido #13. With the support of Sweet Micro Systems, much of the software that comes with the Trump Card is available for downloading. Also, one of the charter members of TRUG, Lloyd Zusman of Master Byte Software, has written some nice C utilities and enhancements to the C library that you can download as well.

Currently, we are running version 1.6 of Zoom, the operating system that comes with Trump Card. It supports context switching on the Trump Card itself, but as of this writing, it doesn't yet support concurrent processing between the Z8000 and the 8088. We are slowly working on that capability and we hope to have it in the near future.

We'd like to invite any and all Trump Card users to call in and download what we have. Also, we'd like to invite any of you who are interested to help us develop a nice repertoire of software for this nice processor. We are ultimately looking for a bunch of UNIX-like utilities to make the Zoom system appear closer to UNIX, but feel free to upload anything you'd like.

Call Fido #13 at (408) 923-5565, 300/1200 bps, 8 bit, 1 stop, no parity. Or you can drop a line to TRUG, 3152 Penitencia Creek Rd., San Jose, CA 95132.

VERNON CRAWFORD
San Jose, CA ■

Over the years I have presented many different projects in BYTE. I know many of you have built them and are making use of them in many ways.

I am interested in hearing from any of you telling me what you've done with these projects or how you may have been influenced by the basic ideas. Write me at Circuit Cellar Feedback, POB 582, Glastonbury, CT 06033, and fill me in on your applications. All letters and photographs become the property of Steve Ciarcia and cannot be returned.

LycO Computer Marketing & Consultants



SAVE ON THESE IN STOCK PRINTERS



AXION	
GP 550 AT (Atari)	249
GP 550 CD (C-64)	249
GP 550 PC (IBM)	239
GP 550 AP (Apple)	279
GP 700 AT (Atari)	459
GP 700 AP (Apple)	459
Elite 5CD (C-64)	329

CARDCO	
LQ1	369
LQ3	279

EPSON	
RX-80	225
FX-80 FT	279
FX100*	579
JX 80	529
LQ 1500 P	1099
LQ 1500 S	1149
Hi-80 Color Plotter	399

MANNESMANN TALLY	
Spirit 80	255
MTL-160L	549
MTL-180L	739

PANASONIC	
	189
	259
	399
	589
	459

BLUE CHIPS	
M12010	\$275
M12010 C-64	\$275

CITIZEN	
MSP-10	329
MSP-15	499
MSP-20	479
MSP-25	649

JUKI	
Juki 6100	379
RS 232 Serial Board	55
Tractor	119
Sheet Feeder	209
Juki 6300	769

NEC	
NEC 8025	\$699
NEC 8027	\$359

Smith Corona	
Fastext 80	189.00
O100	219.00
D200	399.00
D300	519.00
L1000	339.00

C. ITOH	
Prowriter 8510 AP	279
8510 BC2	389
8510 BP1	319
8510 SP	379
8510 SR	429
8510 SCP	459
8510 SCR	479
7500 AP	205
7500 AP	245
1550 P	449
1550 BC2	489
A-10-20-P	459
F 10 40 PU or RDU	888
F10 SSSPU or RDU	1069

COMREX	
CR-II-EC Comriter IIE Parallel	359
CR-II-ES Comriter II E Parallel	379
CR-IV-C Comriter IV Parallel	689
CR-IV-S Comriter IV Serial	689

LEGEND	
880	219
1080	239
1200	249

OKIDATA	
Okimate 10	179
82A	295
84	645
92	349
93	565
92 Imagewriter	425
92 IBM Version	349

STARMICRONICS	
SG-10	219
SG-15	379
SD-10	339
SD-15	445
SR-10	489
SR-15	585
Powertype	309
Gemini 10X	CALL
Gemini 15X	CALL
SB-10	CALL

Corona	
LP300 Laser Printer	2699
200361 Toner Cartridge	89

DIGITAL DEVICES	
16K printer buffer	99 75
32K printer buffer	119 75
64K printer buffer	169 95

★ **PRINTER** ★
INTERFACING
Available

OLIVETTI	
DY 250 Parallel	739
DY 250 Serial	729
DY 450 Parallel	1099
DY 450 Serial	1079

MONITORS

MODEMS

AMDEK	
300 Green	125
300 Amber	139
310 Amber IBM	155
Color 300 Audio	245
Color 500 Composite	369
Color 600	429
Color 700	495
Color 710	569

SAKATA	
SC-100 Color	219
STS1 Stand	29
SG 1000 Green	99
SA 1000 Amber	109

GORILLA	
12" Green	78
2" Amber	84

TAXAN	
210 Color RGB	249
115 Green	119
116 Amber	125
400 Color RGB	275
410 Color RGB	339
420 Color IBM	429
121 Green IBM	139
122 Amber IBM	145

NEC	
JB-1260 Green	95
JB-1201 Green	135
JC 1215 Color	235
JC 1216 RGB	375
JC 1460 Color	265
JB-1205 Amber	139

X-TRON	
Comcolor I Composite Green	199

PANASONIC	
DT 1300 RG1 composite	329

ZENITH	
ZVM 122A Amber	84
ZVM 123G Green	75
ZVM 124 Amber IBM	129
ZVM 131 Color	275
ZVM 133 RGB	389
ZVM 135 Composite	449
ZVM 136 Hi Res Color	589

PRINCETON GRAPHICS	
MAX-12 Amber	189
HX-12 RGB	475
SR-12 RGB	599

MICROBITS	
MPP 1000 E (Atari)	99.00
MPP 1064 (C-64)	69.95

TELE LEARNING	
CM-250 (C-64)	65.00
AP-250 (Apple)	109.95
IB-250 (IBM)	109.95

HAYES	
Smartmodem 300	189
Smartmodem 1200	459
Smartmodem 1200B	389
Micromodem IIE	249
Micromodem 100	289
Chronograph	179
Smart Com II	75

CARDCO MOD-1 (C-64)	
NESTRIDGE (C-64)	CALL
MITEY MO (C-64)	CALL
1660 AUTO MODEM (C-64)	85
COMPUSERVE	23.95

DISK DRIVES

INDUS	
GT Atari	\$219.00
GT Commodore	\$249.00

MSD	
SD1 Drive	\$229.00
SD2 Drive	\$469.00

DISKETTES

IBM-PC COMPATIBLE

MAXELL	
5 1/4" MD-1	16.99
5 1/4" MD-2	23.75
(Box 10)	

SKK	
5 1/4" SKK-SSSD	10.99
5 1/4" SKK-SSDD	13.99
5 1/4" SKK-DSDD	15.99

ELEPHANT	
5 1/4" SSSD	13.99
5 1/4" SSDD	15.99
5 1/4" DSDD	19.99

CORONA	
PPC 22A	
Portable 256K-Amber	1699
PPC 22G	
Portable 256K-Green	1699
PPCXTA	
Portable 256K-10Meg	2899
CORI 28K 128K RAM	1599

Zenith	
Z-150	Call

Leading Edge	
PC Compatible	Call

*LOTUS	
Lotus 1-2-3	309 00
Symphony	439 00

*PARADISE	
5-Pak Multifunction	179.00
Modular Graphics	289.00
Modular Graphics Card	315.00

SUPER SAVINGS!

LOWEST PRICES!

TOLL FREE 1-800-233-8760

Inquiry 259



TO ORDER



CALL TOLL FREE

800-233-8760

Customer Service 1-717-327-1825 Jersey Shore PA 17740

or send order to
LycO Computer
P O Box 5088

RISK FREE POLICY

In-stock item shipped within 24 hours of order. No deposit on C.O.D. orders. Free shipping on prepaid cash orders within the Continental U.S. PA residents add sales tax. APO, FPO, and International orders add \$5.00 plus 3% for priority mail service. Advertised prices show 4% discount for cash, add 4% for Master Card or Visa. Personal checks require 4 weeks clearance before shipping. All items subject to change without notice.

For your protection, we check for stolen credit cards.

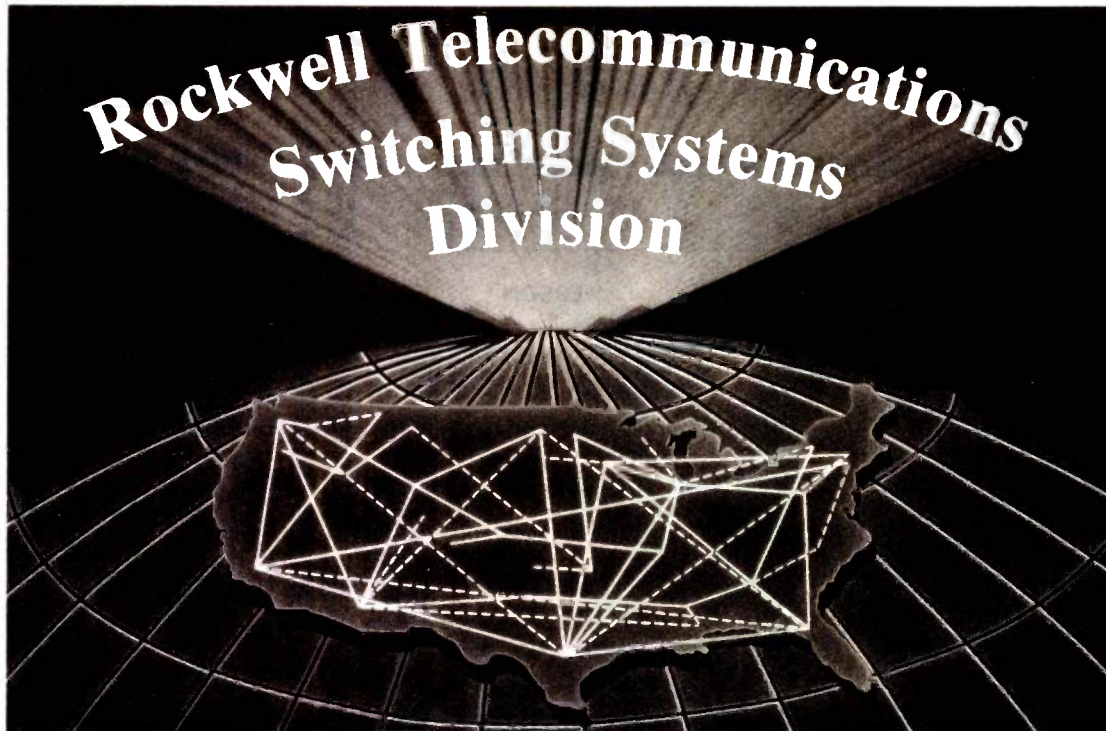

OUR GROWTH CONTINUES!

Rockwell International's Switching Systems Division is entering into a phase of rapid expansion due to increasing Market acceptance of our microprocessor controlled digital switching systems for commercial, corporate, specialized common carrier and Telco's.

As a recognized leader in the design and manufacture of switching systems it is important to maintain our balance of key technologies, strategic business strength and leadership. As a growing business we need to attract additional talented employees who will help us meet tomorrow's challenges.

The following new positions exist at various levels of experience within the division:

CAD/CAM Supervisors

- BSEE or Equivalent Experience
- CAD/CAM Experience (Computervision CADD5 4X Preferred)
- Supervisory Experience

Software Development Engineers

- BS/MS CS/EE/Math
- Unix* and C, Pascal, ADA
- Call Processing, Data Communication or Maintenance Software Experience

*TM Bell Labs

System Engineers

- BSEE/MSEE, BSCS/MSCS
- High Level Project Planning, Systems Architecture
- Product Leadership Responsibility

CAE Engineers

- BSEE/MSEE
- Digital Circuit Simulation
- Gate Array Design
- Test Vector Design
- Schematic Capture
- CAE Tool Selection

Project Engineers

- BSEE, MSEE
- Experience In Data Communications/Transmission/Signaling

Software Tool Developers

- BSCS/MSCS
- Unix and C
- Data Communications
- Networking Applications

Unix System Administrators

- Unix and C
- Graphics Applications
- Group Leadership Exposure

Sales Account Executives

- BS, MBA
- Telco Sales
- Key/Major Accounts Experience

Telecommunications Futurists

- MSEE/MSCS/MSCE/PhD
- Telecommunications Experience
- Systems Architecture

Hardware Development Engineers

- BSEE/MSEE
- Digital Signal Processing
- LSI/Microprocessor Technology
- CMOS/TTL Digital Filters, Digital Tone Detection, Gate Array

Senior Designers

- Interactive CAD/CAM Design Experience (Computervision CADD5 4X Preferred)

Engineering Managers

- BSEE, MSEE, MBA
- Telephony Experience
- Supervisory Experience

Marketing Professionals

- BS Business/BSEE or Equivalent
- Telecommunications Marketing Experience

Rockwell International employees benefit from exciting challenges and outstanding rewards. We offer an excellent salary and complete benefits package including company-paid life, medical and dental insurance for employee and dependents. We also offer a choice of 2 HMO's as an alternative to our medical insurance. In addition, the program includes 100% tuition reimbursement (including IITV on-site courses), 12 paid holidays and a generous vacation plan. Also provided is a company-paid pension program and a 75% matching savings plan and stock ownership plan.

We encourage you to use our toll free number
1-800-835-5567
 between 9am — 4pm (CST) for more information.

If you are interested in any of the positions listed above, please send resume in complete confidence to: **Employment Manager, Section B685, Rockwell International, Switching Systems Division, 1431 Opus Place, Downers Grove, Illinois 60515. Equal Opportunity Employer M/F.**



Rockwell International

... where science gets down to business

B.O.O.K.S R.E.C.E.I.V.E.D

- THE ABCS OF LOTUS 1-2-3, Bill Kling. Glenview, IL: Scott, Foresman and Co., 1985; 432 pages, 21 by 23 cm, spiral-bound. ISBN 0-673-15996-5, \$18.95.
- ADA SOFTWARE TOOLS INTERFACES. Peter J. L. Wallis, ed. Lecture Notes in Computer Science #180. New York: Springer-Verlag, 1984; 168 pages, 16.5 by 24 cm, softcover. ISBN 0-387-13878-1, \$13.
- APPLE SOFTWARE FOR PENNIES. Bertram Gader and Manuel V. Nodar. New York: Warner Books, 1985; 320 pages, 13.5 by 20.5 cm, softcover. ISBN 0-446-38206-X, \$9.95.
- APPLE IIE. Vincent Kassab. Englewood Cliffs, NJ: Prentice-Hall, 1985; 238 pages, 17.5 by 23.5 cm, softcover. ISBN 0-13-039421-1, \$16.95.
- APPLIED CALC RESULT. Erik Fagerland. Mount Laurel, NJ: handic Software, 1984; 176 pages, 17 by 23 cm, softcover. ISBN 91-7880-001-5, \$19.95.
- APPLIED PROGRAMMING TECHNIQUES IN C. Terry A. Ward. Glenview, IL: Scott, Foresman and Co., 1985; 368 pages, 19 by 23.5 cm, softcover. ISBN 0-673-18050-6, \$19.95.
- ARTIFICIAL INTELLIGENCE: HOW MACHINES THINK. F. David Peat. New York: Baen Enterprises, 1985; 384 pages, 13 by 21 cm, softcover. ISBN 0-671-55933-8, \$8.95.
- BASIC BASIC PROGRAMS FOR THE ADAM. Timothy Orr Knight and Darren La Batt. Blue Ridge Summit, PA: Tab Books, 1984; 124 pages, 18.5 by 23.5 cm, softcover. ISBN 0-8306-0716-1, \$8.25.
- BASIC STATISTICS: AN INTRODUCTION TO PROBLEM SOLVING WITH YOUR PERSONAL COMPUTER. Jerry W. O'Dell. Blue Ridge Summit, PA: Tab Books, 1984; 462 pages, 13 by 21 cm, softcover. ISBN 0-8306-1759-0, \$15.95.
- BEFORE YOU BUY WORD PROCESSING SOFTWARE. Dona Z. Meilach. New York: Crown Publishers, 1984; 208 pages, 15 by 22.5 cm, softcover. ISBN 0-517-55340-6, \$8.95.
- BUSINESS APPLICATIONS FOR THE APPLE II & IIE UNDER CP/M. Steven Zimmerman, Leo Conrad, and Donald Smith. Bowie, MD: Brady Communications, 1985; 272 pages, 17.5 by 23.5 cm, softcover. ISBN 0-89303-354-5, \$15.95.
- C: AN ADVANCED INTRODUCTION. Narain Gehani. Rockville, MD: Computer Science Press, 1985; 352 pages, 15.5 by 23.5 cm, hardcover. ISBN 0-88175-053-0, \$29.95.
- CHILDREN'S PROGRAMS FOR THE COMMODORE 64. Susan Sutphin. Englewood Cliffs, NJ: Prentice-Hall, 1985; 190 pages, 17.5 by 23 cm, softcover. ISBN 0-13-132499-3, \$12.95.
- COCO LOGO FOR THE TRS-80 COLOR COMPUTER. Dale Peterson, Don Inman, and Ramon Zamora. New York: John Wiley & Sons, 1985; 136 pages, 21 by 28 cm, softcover. ISBN 0-471-87921-5, \$12.95.
- THE COMPLETE INVESTMENT BOOK. Richard Bookstaber. Glenview, IL: Scott, Foresman and Co., 1984; 416 pages, 19.5 by 23.5 cm, softcover. ISBN 0-673-15952-3, \$19.95.
- COMPUTATION AND PROOF THEORY. M. M. Richter, E. Börger, W. Obershelp, B. Schinzel, and W. Thomas, eds. Lecture Notes in Mathematics #1104. New York: Springer-Verlag, 1984; 488 pages, 16.5 by 24 cm, softcover. ISBN 0-387-13901-X, \$22.50.
- COMPUTER AND MICROCOMPUTER SYSTEMS FOR SMALL BUSINESSES. Russell E. Wilcox. Phoenix, AZ: Oryx Press, 1984; 256 pages, 15.5 by 23.5 cm, hardcover. ISBN 0-89774-131-5, \$27.50.
- COMPUTER CULTURE: THE SCIENTIFIC, INTELLECTUAL, AND SOCIAL IMPACT OF THE COMPUTER. Heinz R. Pagels, ed. Annals of the New York Academy of Sciences, Volume 426. New York: The New York Academy of Sciences, 1984; 300 pages, 15 by 23 cm, softcover. ISBN 0-89766-245-8, \$66.
- COMPUTER SOFTWARE. *Scientific American*. New York: W. H. Freeman and Co., 1985; 132 pages, 21 by 28 cm, softcover. ISBN 0-7167-1712-3, \$13.95.
- CRACKING THE "PEANUT": YOUR IBM PCjr COMPANION. Hank Mishkoff. Plano, TX: Wordware Publishing, 1984; 248 pages, 19 by 23.5 cm, softcover. ISBN 0-13-188319-4, \$16.95.
- DATA ADMINISTRATION. William R. Durell. New York: McGraw-Hill, 1984; 222 pages, 16 by 23.5 cm, hardcover. ISBN 0-07-018391-0, \$32.95.
- DATA AND COMPUTER COMMUNICATIONS. William Stallings. New York: Macmillan Publishing, 1985; 608 pages, 18.5 by 26 cm, hardcover. ISBN 0-02-415440-7, \$38.50.
- DATA COMMUNICATIONS: A USER'S GUIDE, 2nd ed., Kenneth Sherman. Reston, VA: Reston Publishing, 1985; 464 pages, 18.5 by 24 cm, hardcover. ISBN 0-8359-1226-1, \$32.95.
- DATABASE FOR THE IBM PC.
- Sandra L. Emerson and Marcy Darnovsky. Reading, MA: Addison-Wesley, 1984; 336 pages, 19 by 23.5 cm, softcover. ISBN 0-201-10483-0, \$14.95.
- DIGITAL LOGIC DESIGN: TUTORIALS AND LABORATORY EXERCISES. John F. Passafiume and Michael Douglas. New York: Harper & Row, 1985; 128 pages, 21 by 28 cm, softcover. ISBN 0-06-045028-2, \$17.50.
- EFFECTIVE DESIGN OF CODASYL DATA BASE. George T. Fadok. New York: Macmillan Publishing, 1985; 160 pages, 16 by 24 cm, hardcover. ISBN 0-02-949530-X, \$29.95.
- THE FFT: FUNDAMENTALS AND CONCEPTS. Robert W. Ramirez. Englewood Cliffs, NJ: Prentice-Hall, 1985; 192 pages, 18 by 24 cm, hardcover. ISBN 0-13-314386-4, \$26.95.
- FIRST NIBBLES OF THE APPLE COMPUTER. Melba Bennett. Bowie, MD: Brady Communications, 1985; 288 pages, 21.5 by 28 cm, softcover. ISBN 0-89303-456-8, \$17.95.
- THE FORTRAN COOKBOOK, 2nd ed., Thomas P. Dence. Blue Ridge Summit, PA: Tab Books, 1984; 238 pages, 18.5 by 23.5 cm, softcover. ISBN 0-8306-1737-X, \$11.95.
- FROM BASIC TO FORTRAN. Alfred J. Bruey. Blue Ridge Summit, PA: Tab Books, 1984; 144 pages, 18.5 by 23.5 cm, softcover. ISBN 0-8306-1753-1, \$9.95.
- FUNDAMENTALS OF OPERATING SYSTEMS, 3rd ed., A. M. Lister. New York: Springer-Verlag, 1984; 176 pages, 15 by 23 cm, softcover. ISBN 0-387-91251-7, \$13.95.
- GETTING STARTED WITH MICROSOFT WORD. Janet Rampa. Bellevue, WA: Microsoft Press, 1984; 312 pages, 19 by 23.5 cm.

THIS IS A LIST of books received at BYTE Publications. It is not meant to be exhaustive; its purpose is to acquaint BYTE readers with recently published titles in computer science and related fields. We regret that we cannot review all the books we receive; instead, this list is meant to be a monthly acknowledgment of these books and the publishers who sent them.

(continued)

Votrax Announces

VOTALKER IB & AP

New Industry Standards For Talking Personal Computers. Exclusively for IBM PC and XT, Apple II, and Compatibles. From Votrax, The Pioneer in Synthetic Speech Systems.

Give your IBM PC and XT and Apple II the Power of Speech

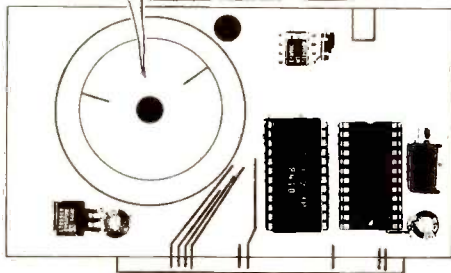

Until Votalker IB and AP, synthetic speech systems for personal computers were like a piano with 50 keys, an eagle with a broken wing, and a singer with a two-octave range. When Votrax developed the SCO2 speech synthesis chip, it was the classic case of advanced technology in need of support systems to unlock its dormant powers. Now, Votalker introduces a revolutionary family of text-to-speech translators — the key to the lock. First members of the family are the Votalker IB for IBM PC and XT and the Votalker AP for Apple II, Apple IIe, and Apple Plus. With Votalker these units play the piano with all 88 keys. Soar through unlimited vocabulary, using 32 inflections and 4,100 pitch settings. Sing in five octaves, and generate sound effects in 16 amplitudes.

A Newly Designed Circuit Board includes:

- SCO2 chip • speaker • audio amplifier
- volume control • external speaker jack.

The board operates in the host computer slot, eliminating the need for serial ports and cable hookups. Internal editing and smoothing ensure clarity and integrity of speech.

The Text-To-Speech Translator sets Votalker above all other synthetic voice products. Text is generated through programs or keyboard and translated directly into spoken language. The sophisticated software on a diskette offers:

- unlimited vocabulary
- little use of system memory
- exception table that stores and accurately pronounces difficult words.

Other Votrax Products — the stand-alone Personal Speech System and Type 'N Talk — are currently used in thousands of applications.

Votalker Prices Begin at \$179

Call Votrax at (800) 521-1350*



VOTRAX, INC.
1394 Rankin
Troy, Michigan 48083
(313) 588-2050

*In Michigan, Call Collect
(313) 588-0341

BOOKS RECEIVED

softcover, ISBN 0-914845-13-6, \$16.95.

A HANDBOOK OF SOFTWARE DEVELOPMENT AND OPERATING PROCEDURES FOR MICROCOMPUTERS. Paul Holliday. New York: Macmillan Publishing, 1985; 208 pages, 16 by 24 cm, hardcover, ISBN 0-02-949510-5, \$24.95.

THE HEWLETT-PACKARD SOFTWARE CATALOG, Summer 1984. Hewlett-Packard. New York: John Wiley & Sons, 1984; 384 pages, 17.5 by 23 cm, softcover, ISBN 0-471-81912-3, \$9.95.

THE HUMAN FACTOR IN COMPUTER CRIME. Julia Van Duyn. Princeton, NJ: Petrocelli Books, 1985; 168 pages, 16 by 24 cm, hardcover, ISBN 0-89433-256-2, \$24.95.

THE ILLUSTRATED MS/PC-DOS BOOK. Russell A. Stultz. Dallas, TX: Wordware Publishing, 1985; 224 pages, 19 by 23.5 cm, softcover, ISBN 0-915381-53-2, \$15.95.

INC. MAGAZINE'S DATABASICS: YOUR GUIDE TO ONLINE BUSINESS INFORMATION. Doran Howitt and Marvin I. Weinberger. New York: Garland Publishing, 1984; 638 pages, 15.5 by 23 cm, softcover, ISBN 0-8240-7287-1, \$16.95.

INTERACTIVE MEDIA. Diane Gayeski and David Williams. Englewood Cliffs, NJ: Prentice-Hall, 1985; 240 pages, 17.5 by 23.5 cm, softcover, ISBN 0-13-469131-8, \$12.95.

INTERFACING YOUR MICROCOMPUTER TO VIRTUALLY ANYTHING. Joseph J. Carr. Blue Ridge Summit, PA: Tab Books, 1984; 336 pages, 13 by 21 cm, softcover, ISBN 0-8306-1890-2, \$13.95.

INTRODUCTION TO COMPUTER ENGINEERING. Franco P. Preparata. New York: Harper & Row, 1985; 336 pages, 16 by 24 cm, hardcover, ISBN 0-06-045271-4, \$37.95.

INTRODUCTION TO LOGIC PROGRAMMING. Christopher John Hogger. APIC Studies in Data Processing #21. Orlando, FL: Academic Press, 1984; 296 pages, 15.5 by 23.5 cm, hardcover, ISBN 0-12-352090-8, \$46.

INTRODUCTION TO ROBOTICS: A SYSTEMS APPROACH. James Rehg. Englewood Cliffs, NJ: Prentice-Hall, 1985; 240 pages, 18 by 24 cm, hardcover, ISBN 0-13-495581-1, \$29.95.

INTRODUCTION TO SIMULATION AND SLAM II, 2nd ed., A. Alan B. Pritsker. New York: John Wiley & Sons, 1984; 638 pages, 19.5 by 24 cm, hardcover, ISBN 0-480-20087-1, \$29.50.

INTRODUCTORY THEORY OF COMPUTER SCIENCE. E. V. Krishnamurthy. New York: Springer-Verlag, 1985; 224 pages, 15.5 by 23.5 cm, softcover, ISBN 0-387-91255-X, \$15.

THE KAYPRO PLAIN & SIMPLE. William Houze and David Lenfest. Blue Ridge Summit, PA: Tab Books, 1984; 208 pages, 18.5 by 23.5 cm, softcover, ISBN 0-8306-1802-3, \$12.95.

LEARNING BASIC ON THE IBM PCjr. Thomas C. Barte. New York: Harper & Row, 1985; 384 pages, 18.5 by 23 cm, softcover, ISBN 0-06-040521-X, \$14.95.

LOGO FUN. Pat Parker and Teresa Kennedy. New York: Scholastic, 1985; 118 pages, 20.5 by 27.5 cm, softcover, ISBN 0-590-33243-0, \$5.95.

MAC MULTIPLAN. David Lenfest and Linda K. Woods. Blue Ridge Summit, PA: Tab Books, 1984; 272 pages, 18.5 by 23.5 cm, softcover, ISBN 0-8306-1851-1, \$16.95.

MAKING MS-DOS & PC-DOS WORK FOR YOU. The Human Connection. Blue Ridge Summit, PA: Tab Books, 1984; 222 pages, 18.5 by 23.5 cm, softcover, ISBN 0-8306-1848-1, \$13.95.

MASTERING THE COMMODORE 64. Mark Greenshields. Englewood Cliffs, NJ: Prentice-Hall, 1984; 208 pages, 15 by 22.5 cm, softcover, ISBN 0-13-559535-5, \$12.95.

MASTERING YOUR MACINTOSH. William Skyvington. Englewood Cliffs, NJ: Prentice-Hall, 1984; 272 pages, 17 by 23 cm, softcover, ISBN 0-13-559527-4, \$15.95.

MICROCOMPUTER PROGRAMMING IN BASIC WITH BUSINESS AP-

BOOKS RECEIVED

PLICATIONS, 2nd ed., George Tsu-Der Chou. New York: Harper & Row, 1985; 316 pages, 18.5 by 23.5 cm, softcover, ISBN 0-06-041298-4, \$18.95.

MICROCOMPUTERS IN EDUCATION CONFERENCE: LITERACY PLUS+, Ruth A. Camuse, ed. Computer Science Press, 1984; 480 pages, 15.5 by 23.5 cm, hardcover, ISBN 0-88175-077-8, \$35.

MORE FROM YOUR MICRO. Charles Platt. New York: Avon Books, 1985; 192 pages, 10.5 by 17.5 cm, softcover, ISBN 0-380-89529-3, \$2.50.

NEW COMPUTER ARCHITECTURES, I. Tiberghien, ed. International Lecture Series in Computer Science. Orlando, FL: Academic Press, 1984; 304 pages, 15 by 23.5 cm, hardcover, ISBN 0-12-690980-6, \$28.50.

OMNI COMPLETE CATALOG OF COMPUTER HARDWARE AND ACCESSORIES, Owen Davies, ed. New York: Macmillan Publishing, 1984; 352 pages, 21 by 28 cm, softcover, ISBN 0-02-008300-9, \$13.95.

OMNI ONLINE DATABASE DIRECTORY 1985, Owen Davies and Mike Edelhart. New York: Macmillan Publishing, 1984; 336 pages, 21 by 27.5 cm, softcover, ISBN 0-02-079920-9, \$14.95.

1001 THINGS TO DO WITH YOUR APPLE, Mark R. Sawusch and Tan A. Summers. Blue Ridge Summit, PA: Tab Books, 1984; 256 pages, 18.5 by 23.5 cm, softcover, ISBN 0-8306-1816-3, \$9.95.

1001 THINGS TO DO WITH YOUR MACINTOSH, Mark R. Sawusch and Tan A. Summers. Blue Ridge Summit, PA: Tab Books, 1984; 250 pages, 18.5 by 23.5 cm, softcover, ISBN 0-8306-1846-5, \$9.95.

PC TELEMART/VANLOVES IBM SOFTWARE DIRECTORY, Xerox Corporation. New York: R. R. Bowker Co., 1984; 966 pages, 21.5 by 27.5 cm, softcover, ISBN 0-8352-1969-0, \$24.95.

POWERFUL PROJECTS WITH YOUR TMEX/SINCLAIR, Jim Stephens. Glenview, IL: Scott, Foresman and Co., 1985; 238 pages, 19 by

23 cm, softcover, ISBN 0-673-18038-7, \$12.95.

PRACTICAL PROGRAMMING IN PASCAL, Kent Porter. New York: New American Library, 1984; 272 pages, 18.5 by 23.5 cm, softcover, ISBN 0-452-25568-6, \$14.95.

PROBLEM SOLVING WITH FORTRAN, Richard W. Dillman. New York: Holt, Rinehart and Winston, 1985; 368 pages, 16 by 23.5 cm, softcover, ISBN 0-03-063734-1, \$22.95.

READY TO RUN ACCOUNTING WITH LOTUS 1-2-3 & SYMPHONY, William Urschel. Sherman Oaks, CA: Alfred Publishing Co., 1984; 226 pages, 21.5 by 27.5 cm, softcover, ISBN 0-88284-330-3, \$39.95. Includes floppy disk.

RESUMES FOR COMPUTER PROFESSIONALS, Arthur R. Peil and George Sadek. New York: Simon & Schuster, 1984; 128 pages, 21 by 28 cm, softcover, ISBN 0-671-50338-3, \$7.95.

ROBOTICS AND ARTIFICIAL INTELLIGENCE, M. Brady, L. A. Gerhardt, and H. F. Davidson, eds. New York: Springer-Verlag, 1984; 722 pages, 17 by 24.5 cm, hardcover, ISBN 0-387-12888-3, \$62.50.

SCHOOL & HOME GUIDE TO THE IBM PCjr, E. Murdock and S. Sudbury. Englewood Cliffs, NJ: Prentice-Hall, 1985; 208 pages, 18 by 24 cm, hardcover, ISBN 0-13-793654-0, \$21.95.

SOFTWARE LIFECYCLE MANAGEMENT: THE INCREMENTAL METHOD, William C. Cave and Gilbert W. Maymon. New York: Macmillan Publishing, 1984; 192 pages, 16 by 24 cm, hardcover, ISBN 0-02-949210-6, \$27.95.

SOLVING ELLIPTIC PROBLEMS USING ELLPACK, John R. Rice and Ronald F. Boisvert. New York: Springer-Verlag, 1985; 512 pages, 16 by 24 cm, hardcover, ISBN 0-387-90910-9, \$46.50.

TECHNIQUES OF EDP PROJECT MANAGEMENT: A BOOK OF READINGS, Alan E. Brill, ed. New York: Yourdon Press, 1984; 312 pages, 17.5 by 25.5 cm, softcover, ISBN 0-917072-42-1, \$29.

TIM HARTNELLS EXECUTIVE

GAMES FOR THE IBM PC & XT, Tim Hartnell. New York: Ballantine Books, 1984; 312 pages, 15 by 22.5 cm, softcover, ISBN 0-345-31940-0, \$9.95.

USING AND PROGRAMMING THE ADAM, Timothy Orr Knight. Blue Ridge Summit, PA: Tab Books, 1984; 128 pages, 18.5 by 23.5 cm, softcover, ISBN 0-8306-1706-X, \$7.95.

USING SMALL COMPUTERS TO MAKE YOUR BUSINESS STRATEGY WORK, Richard M. Koff. New York: John Wiley & Sons, 1985; 408 pages, 15 by 23 cm, softcover, ISBN 0-471-87502-3, \$19.95.

VISI-CALC MADE SIMPLE, Thomas M. O'Donovan. New York: John Wiley & Sons, 1984; 168 pages, 16.5 by 24.5 cm, softcover, ISBN 0-471-90457-0, \$18.95.

THE WILEY SCIENCE CALENDAR, 1985. New York: John Wiley & Sons, 1985; 168 pages, 20.5 by

26 cm, hardcover, ISBN 0-471-87849-9, \$16.95.

WORD PROCESSING ON THE IBM DISPLAYWRITER, J. M. Williford. New York: John Wiley & Sons, 1984; 144 pages, 21 by 28 cm, softcover, ISBN 0-471-88256-9, \$14.95.

WORD PROCESSING ON WANG SYSTEMS, J. M. Williford. New York: John Wiley & Sons, 1984; 130 pages, 21 by 28 cm, softcover, ISBN 0-471-88258-5, \$14.95.

WORD PROCESSING ON THE XEROX 860, J. M. Williford. New York: John Wiley & Sons, 1984; 112 pages, 21 by 28 cm, softcover, ISBN 0-471-88257-7, \$14.95.

WORKING WITH 1-2-3 ON THE IBM PC AND COMPATIBLES, Richard Startz. New York: Harper & Row, 1985; 144 pages, 18.5 by 23.5 cm, softcover, ISBN 0-06-046426-7, \$14.95. ■

DISKETTES

CALL TOLL FREE West of Rockies **1-800-621-6221**
Central & East **1-800-654-4058**

Dysan 5 1/4" Disks S-SIDE D-DEN. 1695 D-SIDE D-DEN. 2195 S-SIDE 96TPI 2895 D-SIDE 96TPI 3895 HIGH DEN. 5195	maxell 5 1/4" Disks S-SIDE D-DEN. 1495 D-SIDE D-DEN. 1995 S-SIDE 96TPI 2495 D-SIDE 96TPI 3095 HIGH *DEN. 3995 3 1/2" Disks S-SIDE 2895 D-SIDE 4295 8" Disks S-SIDE S-DEN. 2195 S-SIDE D-DEN. 2395 D-SIDE D-DEN. 2795	BONUS Disks -10 pk \$9.95 per box SS DD Verbatim Kits 4.95 Refills 8.95 Media Mate 895 ea. *2.95 Shipping 100 Disk Bulk Pack 89.00 SS DD 112.00 DS DD	3M 5 1/4" Disks S-SIDE D-DEN. 1495 D-SIDE D-DEN. 1995 S-SIDE 96TPI 2495 D-SIDE 96TPI 3095 3 1/2" Disks S-SIDE 2895	Verbatim Datalife 5 1/4" Datalife S-SIDE D-DEN. 1495 D-SIDE D-DEN. 1995 S-SIDE 96TPI 2495 D-SIDE 96TPI 3095 3 1/2" Datalife S-SIDE 2795
		8" Disks S-SIDE S-DEN. 1995 S-SIDE D-DEN. 2495 D-SIDE D-DEN. 2895	8" Datalife S-SIDE S-DEN. 1995 S-SIDE D-DEN. 2295 D-SIDE D-DEN. 2695	

1-800-621-6221
1-800-654-4058

TERMS: Minimum 20 disks or \$35.00 — VISA or MasterCard accepted
 COD orders add 2.95 for special handling. SHIPPING: 3 1/2" & 5 1/4" Diskettes; Add 3.95 for every 100 Diskettes or any fraction thereof. 8" Diskettes; Add 4.95 for every 100 Diskettes or any fraction thereof. We ship UPS; orders requiring other delivery methods add shipping, plus 2% of total order.

Conducted by Sol Libes

Watch out Commodore and Atari. IBM is rumored to be working on a low-end consumer computer to be sold as a mass-market machine. It is believed to be Z80-based; employ the Microsoft MSX operating system; and include ROM application packages, a built-in disk drive, and a port for a read-only laser-disk unit. IBM is reportedly aiming at a \$300 list price. . . . Ashton-Tate is reported to be working on a Macintosh version of its Framework integrated software package, which might be out by the time you read this. . . . Zenith is said to be negotiating with Morrow Inc. to distribute the portable Pivot IBM PC-compatible computer under its own name. . . . Expect IBM to bring out a System/36 board for the PC AT and call the system the AT/36. The System/36 is IBM's lowest-cost office minicomputer system. The pricing of the AT/36 is expected to be in the \$10-15,000 area. . . . Intel is expected to finally start shipping "samples" of its 80386 32-bit microprocessor in August, more than a year behind Motorola (68020) and National Semiconductor (32000). . . . The 64K-bit RAM chips, which were selling in the \$3 range, now cost less than \$2 in quantity as IBM canceled orders for more than 1.5 million chips. . . . Zilog has pushed back introduction of its Z800 microprocessor (an upgraded Z80) to this summer. The company had announced the unit about three years ago. Hurry up, the window is closing fast! And don't expect Zilog's Z80000 32-bit microprocessor to be released until the fall, at the earliest. . . . Boeing is reportedly testing pilot-voice command recognition, instead of switches, for the 747. . . . Digital Equipment Corporation is rumored to be testing the desktop Microvax III, an eight-chip version of the VAX-11/780 (its big system) for introduction next year. . . . Prices of 1200-bps modems are dropping as the market reaches the saturation point and 2400-bps units begin arriving. Many purchasers are holding off, waiting to see if the 2400-bps units take hold. . . . Texas Instruments and Radio Shack are reported to be getting ready to implement Digital Research's GEM (Graphics Environment Manager) on systems they will be announcing soon. Atari and ACT have already declared their intention to use it on

new systems. GEM creates a color Macintosh-like environment.

OSBORNE AND FRANKLIN EXIT CHAPTER II

Hurrah! With the way IBM and Apple have been pushing competitors out of the business, it is terrific to see two companies return from bankruptcy proceedings. Osborne and Franklin were both reorganized, have straightened out their operations, worked out arrangements with their creditors, and got some financing. Both are now active and in there competing again. Give them three cheers and some support.

Osborne has released two new systems, which reportedly are selling well, primarily overseas. Franklin is promising to release a new system shortly.

IT WAS A VERY GOOD YEAR

For many manufacturers, 1984 was a very good year. Future Computing, a Texas-based market research firm, reports the following sales for the 15 industry leaders (reported in millions of dollars):

IBM	\$2750
Apple	710
Tandy	420
Compaq	300
Hewlett-Packard	260
Wang	250
DEC	240
Zenith	210
Kaypro	110
Sperry	90
Altos	90
TeleVideo	90
Texas Instruments	90
Corona	80
Epson	80

If someone had told me five years ago that in 1984 one company would do \$2.75 billion in personal computer sales, I would have said they didn't know what they were talking about. Boy, would I have been wrong.

IBM UPDATE

IBM has begun cracking down on dealers who resell PCs to nonauthorized dealers—the so-called "gray market." In an effort to control this practice, IBM canceled 40 of

its value-added retailers and instituted a policy of prohibiting lateral shipping among dealers without its approval. The net effect will no doubt be a decrease in selling of systems at discount prices by non-IBM dealers.

IBM was blamed for stimulating the gray market by forcing dealers to order large volumes of machines with lead times that many dealers call ridiculous.

IBM is expected to reduce the prices of the IBM PC and IBM PC XT once again as some reports indicate that IBM has warehouses full of these products. In the meantime, an enhanced version of the PC AT is expected in the late summer. IBM has begun shipping XENIX (UNIX System III), which turns the PC AT into a three-user timesharing system. Several companies are introducing plug-in cards that allow XENIX with a 40-megabyte disk to handle up to 16 users.

COMPUTERS FOR VISION-IMPAIRED USERS

Maryland Computer Services, Forest Hill, MD, reports that it has taken a Hewlett-Packard HP 150 and enhanced it for use by blind computer users. The computer now speaks any information appearing on its screen, allowing blind users to create and manipulate material. The system was created with the aid of several blind engineers and programmers. A separate keypad enables the user to review material a word, line, or screen at a time; change the speech rate; and even announce screen enhancements such as underlining and boldface. An optional braille printer and software for blind users are also available.

NEC has also introduced a version of its personal computer in Japan that operates as a Japanese-language word processor with braille output. (This computer is distributed by the Y.D.K. Co. and the Vocational Development Center for the Blind in Tokyo.)

APPLE BYTES AND PITS

Word is that sales of the Macintosh have flattened out and that even Apple's offering to lend a Mac overnight to prospective purchasers was not a tremendous success. Looks like people are waiting for the

software that will take advantage of the Mac's hardware and operating system. At the end of 1984, Apple claimed that there were some 300 Mac software packages, but many of these existed only in demo form, as far as I can tell.

Apple shipped about 275,000 Macs in its first year, less than was promised, but more than IBM shipped in the first year of the PC (fewer than 100,000). But by the end of IBM's first year with the PC, several hundred software packages were available. This was due mainly to the fact that IBM had three different operating systems for the PC (PC-DOS, CP/M-86, and the p-System) that already had application software available or that could be easily translated from 8-bit versions of the operating systems.

The Mac being such a radical departure from preceding products and its being a very powerful and sophisticated programming environment have delayed software developers. Apple's promised stand-alone development software is still not available, and the 3½-inch 800K-byte double-sided floppy disk announced last year has still not appeared.

The street price of the Mac has already dropped to less than \$1400 for 128K bytes and less than \$1900 for 512K bytes. More price cuts are expected shortly.

Also, reports have surfaced of interface problems encountered by outside vendors attempting to connect hard-disk drives to the Mac. The problem appears to be in the Mac's ROM, and there is talk of a new version of the ROM for systems using hard-disk drives.

There are rumors of the "SuperMac" in development, based on the 68020, Motorola's true 32-bit chip. It should have true DMA capability, multitasking ability, a color screen, and a bus for plug-in components. There are also rumors of the "FlatMac," a portable Mac using a CMOS 68000 chip, flat display, 3½-inch drive, and internal battery. Expect at least one of these products to be announced at the next Apple stockholders meeting in January. Apple is known to be evaluating a new 5-megabyte 3½-inch Sony floppy-disk drive for use on the Mac that can also read and write the present 400K-byte disk format.

The Apple IIe is also due for an upgrade to use the same internal circuitry as the IIc with 128K bytes (expandable to 512K bytes) of RAM. This will soup up its operation. An 8-/16-bit microprocessor chip is expected as an option. The case should remain essentially the same. Expect it to be promoted as an office machine, and

the cost of the IIe and IIc machines should be cut.

Almost a year after Apple announced and demonstrated the flat display for the IIc, it began shipping the unit. This display, in effect, converts the IIc into a portable machine, if you also buy the carrying case. Just one problem—Apple does not have battery power for the IIc. However, you can buy battery units for the IIc from the following two companies: Power Systems, Wayzata, MN, and Discwasher of Columbia, MO.

While on the subject of the Apple, it is reported that it sold 430,000 IIs in the first quarter of fiscal 1985 and that the II accounts for nearly 85 percent of Apple's hardware sales. Also, some rumors say that Apple will change to 3½-inch drives on the II later this year. The company is expected to offer both single- and double-sided quad-density drives storing up to 800K bytes per drive. Apple hopes that this will put the II in a "business product" class.

IS THE PC WINDOW REALLY OPEN?

Windowing software for the IBM PC is available, but acceptance in the marketplace still appears to be far off because of a lack of application software to utilize windows. The problem is that software developers are unsure of which way to go and a huge investment in time and money to develop windowing versions of their software is required. IBM's Topview is out but of limited capability, and rumors say that Topview-II is just around the corner. Digital Research has decided not to directly market its powerful Macintosh-like GEM package but will rather sell it to OEMs. GEM software-development packages were delivered to software developers in February. Microsoft has been demonstrating Windows for nearly two years and has also shipped software-development packages. The final product is expected to be out this month.

Once software developers make a decision on how to proceed, it generally takes them a year to create a product, debug it, and get it to the marketplace. Since Topview, GEM, and Windows are all different from the software developers' point of view, many are sitting on the fence waiting to see which product will succeed. By this time next year, we should all know the answer.

THE HOUSEKEEPING COMPUTER

Mitsubishi and General Electric will shortly introduce home-management computers.

The Mitsubishi machine, using a proprietary bus, will link sensors, appliances, telephone, alarm, temperature control, and entertainment systems to a distributed programmable microprocessor control system. The Mitsubishi home-management system is already being sold in Japan and is expected to reach our shores next year.

GE will soon introduce a system based on the BSR X-10 wireless system (which has been out since 1979, sans computer). Although not as powerful as the Mitsubishi system, it will control lights, appliances, heating, and cooling. GE has added graphics software and circuitry to use a television as a monitor and a handheld remote-control unit to control devices.

BSR already sells a software package to enable the Radio Shack Color Computer to communicate with the X-10 system. PCjr, Apple IIc, and Commodore 64 packages are expected to appear within a short period of time.

And the Electronics Industry Association has a committee working on the development of a consumer electronics bus (CEB), with participation from approximately 50 companies.

RANDOM BITS

The Commerce Department recently released a competitive impact study on the world software market that found the U.S. in very good shape vis-à-vis foreign competition. They found that the U.S. held about 70 percent of the world's software market with a dollar volume 10 times greater than either Japan or France, its nearest competitors. . . . Future Computing contends that 50 percent of all personal computer software has been pirated (unauthorized use of backup copies). This is based on 45,000 responses from a mailing to 70,000 households. . . . AT&T is promising initial shipments of 1-megabit memory chips early next year. IBM, Toshiba, NEC, and Fujitsu are also working on 1-megabit devices with production promised for 1987. ■

BYTELINES, news and speculation about personal computing, is conducted by Sol Libes, the author of numerous books and articles on computers. He is the founder of the Amateur Computer Group of New Jersey and a coorganizer of the Trenton Computer Fair. He edits and publishes Micro/Systems Journal, a bimonthly publication for system programmers and integrators. He can be contacted do BYTE, POB 372, Hancock, NH 03449.

NEW SYSTEMS



The FD-1000 kit for building an IBM PC XT-compatible computer.

PC XT-Compatible in a Kit

PC Designs' FD-1000 kit lets you build a computer that is compatible with the IBM PC XT. The FD-1000 uses an 8088-2 microprocessor with a 4.77- or 8-MHz clock speed. It features up to 1 megabyte of on-board RAM, one parallel and two serial ports, a clock/calendar with battery backup, a hardware reset button, Princeton Graphic Systems' amber monochrome monitor, and all necessary cables. Two 360K-byte floppy-disk drives and a built-in floppy-disk controller are standard.

The FD-1000 supports PC-DOS, MS-DOS, CP/M-86, Concurrent DOS, and an optional 8087-2 math copro-

cessor. It also has five expansion slots and 52K bytes of user-definable ROM for custom applications. Available enhancements include a 10-megabyte low-power internal Winchester disk drive, the internal tape backup for the hard disk, and a color monitor.

The FD-1000 costs \$1650 in its standard configuration and \$2250 with an internal 10-megabyte Winchester drive. Contact PC Designs, 8238 South Gary, Tulsa, OK 74137, (918) 481-1734. **Inquiry 615.**

Kaypro's 16

Kaypro recently introduced the IBM PC XT-compatible model 16. The Kaypro 16 uses an 8088 processor. It comes with 256K bytes of RAM (expandable to 640K bytes), a 10-megabyte hard-disk drive, a 360K-byte floppy-disk drive, and a green-phosphor monitor.

Several software packages come bundled with the Kaypro 16, including WordStar, MailMerge, InfoStar+, CalcStar, MITE telecommunications, MS-DOS with utilities, and GW-BASIC.

The Kaypro 16 is priced at \$3295. Contact Kaypro Corp., POB N, Del Mar, CA 92014, (619) 481-4300. **Inquiry 616.**

MultiUser-16 Computer System

Inner Access Corporation's MultiUser-16 has time-sharing and multitasking capabilities. It uses the Motorola 68000 processor running at a clock speed of 8 MHz; the 68010 processor is also available as an option. The system supports 8 users but expands to

accommodate 64 users.

The MultiUser-16 has 2.76 megabytes of floppy-disk storage and ½ megabyte of memory expandable to 16 megabytes. You can expand the standard 40 megabytes of hard-disk storage with voice-coil seek to 1 gigabyte. The motherboard has eight slots. Included with the system is the Mirage multi-user, multitasking operating system.

Suggested retail price for the MultiUser-16 is \$13,495. Contact Inner Access Corp., 517K Marine View, Belmont, CA 94002, (415) 591-8295. **Inquiry 617.**

DEC Offers Rainbow 190

Digital Equipment Corporation's Rainbow 190 is compatible with the rest of the Rainbow family. It includes a 10-megabyte hard-disk drive, 640K bytes of memory, a monochrome monitor, and a DEC Gold Key keyboard. The 190's technical character set ROMs contain 96 letters and symbols for scientists and engineers.

Three software packages come with the Rainbow 190: MS-DOS 2.11, WPS-Plus/Rainbow, and Rainbow Office Workstation. WPS-Plus/Rainbow is compatible with the word processors offered on DECmate and VAX systems. Rainbow Office Workstation integrates Rainbow functions with VAX and All-in-1 environments.

Single-quantity price for the Rainbow 190 system is \$6495. The manufacturer expects the system to be available in July. Contact Digital Equipment Corp., Maynard, MA 01754, (800) 344-4825. **Inquiry 618.**

NEW SYSTEMS

KTX-1350N Videotex Workstation

The KTX-1350N from Sony lets you interface with NAPLPS and ASCII databases. In addition, you can use the unit to display composite-video signals such as output from video cameras, videodisc players, and videocassette recorders, as well as high-quality RGB signals from computer graphics systems.

This videotex system features a built-in NAPLPS decoder, a 13-inch diagonal Trinitron color monitor, two standard RS-232C communication ports, Centronics and Video/Graphic Printer ports, dual 3½-inch microfloppy-disk drives, and a full-size

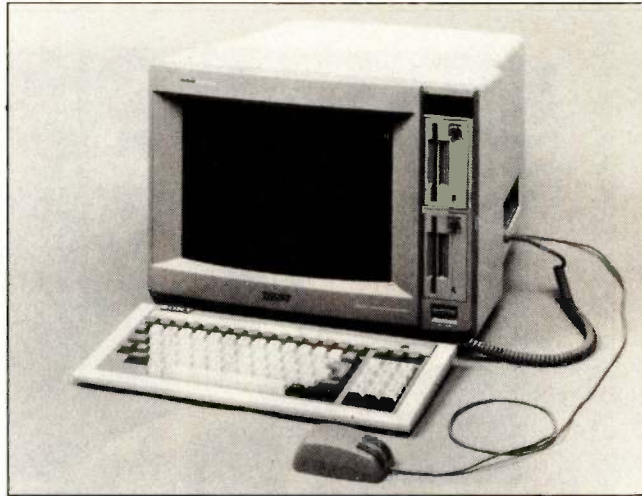

Sony's KTX-1350N videotex system.

detachable keyboard. The KTX-1350N's setup and operation are menu-driven.

You can select a system communication rate from 75 to 19,200 bps.

Graphics on the workstation are 256 by 210 pixels. The display can use up to 16 colors simultaneously from a 2048-color palette. You can also choose a split-screen display feature.

MS-DOS and a 25-pin connector for RGB superimpose capability come with the KTX-1350N. CP/M-86 is an option. The KTX-1350N is designed to work with Sony's MDM-1200 Telephone Modem and UP-103 Video/Graphic Printer.

Suggested list price for the KTX-1350N Videotex Workstation is \$3750. Contact Sony Communications Products Co., Sony Corp. of America, Sony Dr., Park Ridge, NJ 07656, (201) 930-6432. Inquiry 619.

PERIPHERALS

UDS Series of FasTalk Modems

Universal Data Systems has bundled SignOn communications software with its line of FasTalk modems. The models available include FasTalk 300, a stand-alone 300-bps modem; FasTalk 1200, a stand-alone 300/1200-bps modem; and FasTalk 1200PC, a 300/1200-bps plug-in card modem for the IBM PC and compatibles.

All models are Hayes-compatible. The modems feature auto-dial/auto-answer, automatic selection of pulse- or tone-dialing modes, a talk/data toggle, a built-in audio speaker, and true call-progress detection.

The list price for FasTalk 300 is \$345; FasTalk 1200 and FasTalk 1200PC are \$525 each. Contact Univer-

sal Data Systems, 5000 Bradford Dr., Huntsville, AL 35805-1953, (205) 837-8100. Inquiry 620.

Priam Hard Disk for the AT

InnerSpace is a 5¼-inch add-in disk-drive kit that enhances the IBM PC AT's storage capacity. The kit includes hardware, cables, installation software, instruction manual, and reference guide. InnerSpace is available in the ID40-AT version, a 43-megabyte drive, and the ID60-AT version, a 60-megabyte drive. Both models access data at about 30 milliseconds.

InnerSpace protects data by providing automatic defect management and guards against data loss with a dedicated head-landing zone, shock mounts, and spindle and head locks.

The ID40-AT is priced at

\$2195, and the ID60-AT costs \$2595. Contact Priam Corp., 20 West Montague Expressway, San Jose, CA 95134, (408) 946-4600. Inquiry 621.

IEEE-488 Interface for the Macintosh

Iotech's Mac488A can communicate at up to 57,600 bps. It lets you interface more than 4000 different instruments to the Macintosh. The unit is compatible with all languages that can access the Mac's serial port.

Bus commands and protocol for the Mac488A are the same as those used by Hewlett-Packard computers. High-level commands are sent from the Macintosh serial port to the Mac488A.

The interface unit's micro-processor interprets the commands and controls the bus.

With the power supply, manual, and 12-foot cable, the Mac488A costs \$595. Contact Iotech Inc., POB 21204, Cleveland, OH 44121, (216) 831-8646. Inquiry 622.

HP-Compatible Series 8000 Disk Subsystems

Bering Industries' Series 8000 line of hard disks comprises 12 models with storage capacities from 10.4 to 70.4 megabytes. A 3½-inch double-sided floppy-disk drive with a formatted capacity of 788K bytes is available as a built-in option.

The Series 8000's Opt. 7xx multiport configurations let two or three computers access a common disk drive

(continued)

PERIPHERALS

and share files. A dedicated and a shared disk area at each port support the basic features of a local-area network. The configuration is set up by using standard HP-IB/GPIB cables in a cluster.

This disk subsystem implements HP's CS/80 and Subset/80 disk-drive command sets. It works with HP technical and business computers, development systems, and personal computers such as the Touchscreen, Portable, and Integral.

Prices for the Series 8000 range from \$1790 for a 10-megabyte subsystem to \$6090 for a 70-megabyte subsystem. The floppy-disk option costs \$300. A two-port disk-sharing option is \$980 and a three-port option is \$1280. Contact Bering Industries Inc., 1400 Fulton Place, Fremont, CA 94539, (415) 651-3300. Inquiry 623.

MicroTouch Screen with Glass Sensor

MicroTouch Systems uses a solid glass sensor as the basis for its continuous touchscreen. The MicroTouch Screen has a resistive coating bonded to the surface of its glass overlay. The glass surface allows transmission of up to 85 percent of the display light.

The MicroTouch Screen has a resolution of 256 by 256 touch points. An intelligent controller transmits touch data over an RS-232C serial line to the host computer.

The manufacturer produces the screen in 12-, 13-, and 19-inch sizes. Single-quantity cost for the 13-inch size is \$995. Contact MicroTouch Systems Inc., 400



The MicroTouch Screen.

West Cummings Park, Woburn, MA 01801, (617) 935-0080. Inquiry 624.

Tandy 1000 Hard-Disk Upgrades

Osicom has introduced a line of hard-disk upgrade products for the Tandy 1000. Fixed-disk drives for internal installation come in 10- and 20-megabyte configurations. External drives are available with 10-, 20-, and 30-megabyte capacities.

Each upgrade package contains the drive hardware, a controller card, cables, and the manual. After in-

stallation, your 1000 will boot directly from the hard-disk drive once you load DOS from a floppy disk.

Suggested list price for the internal drives is \$999 for 10 megabytes of storage and \$1199 for 20 megabytes. The external drives cost \$1009 for the 10-megabyte version, \$1229 for 20 megabytes, and \$2239 for 30 megabytes. Contact Osicom Inc., Suite 300, 18 Bank St., Morristown, NJ 07960, (800) 922-0881; in New Jersey, (201) 540-0144. Inquiry 625.

40-Megabyte Hard Disk for AT&T UNIX PC

Bell Technologies has developed the B40, a

40-megabyte hard-disk drive for AT&T's UNIX PC system. The B40 fits inside with no modifications. It has an average access time of 85 milliseconds.

Users can trade in their existing drives for a \$300 refund for 10-megabyte units and \$500 for 20-megabyte units. The B40 sells for \$2995. Contact Bell Technologies Inc., POB 8323, Fremont, CA 94537, (415) 792-3646. Inquiry 626.

Multi-User Disk Server for IBMs and Apples

The Multi-User Disk Server from Space Coast Systems lets Apple II+, IIe, and III, IBM PC, and PC XT users share the same hard-disk subsystem. With this unit, eight computers can use a 10- to 84-megabyte Space Coast Systems Storage Module. An extender unit allows connection of eight more computers.

The Multi-User Disk Server requires no communications software and is compatible with several multiuser software packages, including Great Plains accounting software, WOSbase database, Omnibus 1-2-3, and SunData bulletin-board communications systems.

Retail pricing for the Multi-User Disk Server is under \$2000. Contact Space Coast Systems Inc., 301 South Washington Ave., PO Drawer 2767, Titusville, FL 32781-2767, (305) 268-0872. Inquiry 627.

ADD-INS

Solderless Breadboard

The HB-7215 Titan solderless breadboard from Handy Products has enough space for you to build a complete computer. It features a 63 14-pin IC capacity of 48 distribution strips and 5680 plug-in tie points.

When your paper design is complete, you don't need soldering to insert ICs, diodes, transistors, DIP switches, LED/LCD displays, capacitors, resistors, and other components. Board markings code the component positions. You interconnect components with #22-24 AWG solid hookup wire, and you can test the board by plugging in your oscilloscope, power supply, frequency meter, signal generators, and so on.

The HB-7215 Titan is available for \$129.95. Contact Handy Products, 7 Business Park Dr., POB 699, Branford, CT 06405, (800) 344-2639. Inquiry 628.

ATI-1000 AT-Compatible Motherboard

ATronics International's ATI-1000 motherboard is compatible with the IBM PC AT. It has up to 640K bytes of main memory expandable to 16 megabytes; 1 megabyte of on-board memory is optional. Its 64K bytes of system ROM/EPROM is expandable to 128K bytes.

Other hardware features include the Intel 80286 processor (the 80287 is optional), eight I/O slots, three programmable timers, a 6- to 8-MHz clock, seven-channel direct memory access, an on-board battery, and a speaker attachment.

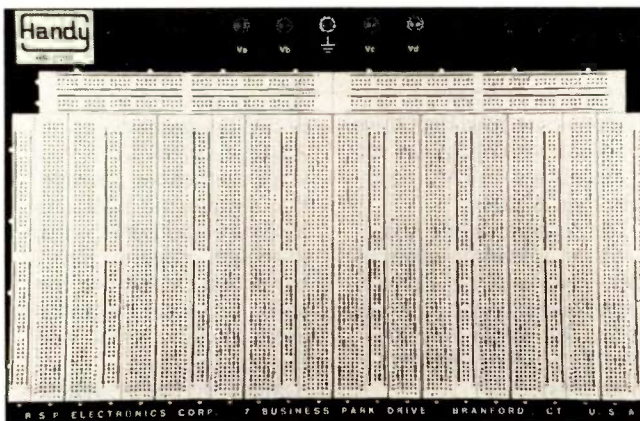

The HB-7215 Titan solderless breadboard.

Suggested retail price for the ATI-1000 is \$1995. Contact ATronics International Inc., POB 296, Mount Eden, CA 94557-0296, (415) 538-2844. Inquiry 629.

Multifunction Memory Card for Tandy 1000

The 4N1-1000 card from Micro Mainframe lets you add up to 512K bytes of memory to your Tandy 1000, provides DMA capability, and includes an RS-232C serial card. The 4N1-1000 also accepts optional real-time clock and mouse modules. This multifunction card uses only one of the Tandy 1000's expansion slots.

You can purchase the basic 4N1-1000 with 0K bytes for \$259.95, with 128K bytes for \$309.95, with 256K bytes for \$469.95, or with 512K bytes of RAM for \$649.95. Contact Micro Mainframe, 11285-E Sunrise Gold Circle, Rancho Cordova, CA 95670, (916) 635-3997. Inquiry 630.

3 Megabytes of RAM on the IBM PC AT

Emulex's Mega Memory board provides up to 3 megabytes of RAM for the IBM PC AT. It fits into any of the AT's 16-bit slots. The board has a total of six banks, representing 12 rows, that you can populate with 64K- or 256K-byte chips depending on your AT's configuration.

Mega Memory comes standard with two software packages: Wait-Less Printing, a print spooler, and Insta-Drive, a RAM-disk emulator.

List price for Mega Memory ranges from \$395 for 0K bytes of RAM to \$5495 for 3 megabytes. Contact Emulex Corp., 3545 Harbor Blvd., POB 6725, Costa Mesa, CA 92626, (714) 662-5600. Inquiry 631.

Controller for Floppy- and Hard-Disk Drives

The Xebec S1220 single-board controller eliminates the need for separate floppy- and hard-disk controllers. It plugs into a full-length I/O slot in the IBM PC, XT, and compatibles.

The unit will support up to two 5¼-inch floppy-disk drives or two 5¼-inch fixed-disk drives. It has a drive transfer rate of 5 megabits per second.

The S1220 has a microprocessor-based architecture, full-sector buffer, and automatic seek and position verification. Its programmable features include sector interleave, sector size, and auto-initialize on power-up or restart for floppy and hard drives.

The S1220 Integrated Hard/Floppy Disk Controller costs \$295. Contact Xebec, 3579 Highway 50 E, Carson City, NV 89701, (800) 982-3232. Inquiry 632.

Color Computer Data-Acquisition System

The Data Gatherer from Green Mountain Micro is a 16-channel, 12-bit data-acquisition system with an on-board clock/calendar and parallel printer port. The system is designed for use with Tandy's TRS-80 Color Computer, TDP-100, or Color Computer 2.

A ROM-based operating system lets you program in Extended Color BASIC. The Data Gatherer is intended for economical testing and measurement, sensing, monitoring, robotics, laboratory control, and music synthesis.

The Data Gatherer sells for \$330 assembled and \$220 in kit form. The manual is available separately for \$15. Complete with 64K-byte computer, the system costs \$550. Contact Green Mountain Micro, Bathory Rd., Roxbury, VT 05669, (802) 485-6112. Inquiry 633.

(continued)

Graph Numeric Data on the Macintosh

With Engineering Tool Kit (ETK), you can use a Macintosh to record numeric engineering data, translate this data into graphics forms, and generate statistical reports. The types of graphs you can make include trend charts, scatter plots, and histograms (with optional best-fit curves). You can plot a maximum of 200 points and print out the statistics that go with those graphs.

Functions provided are multiple linear regression and analysis of variation reports (correlation coefficients, standard error of estimate, F-ratio, degrees of freedom, standard deviation, and other statistics). ETK also has a scientific calculator with logarithmic, arithmetic, and trigonometric computation capabilities.

The Engineering Tool Kit runs on either the 128K or 512K Mac with single or dual drives. Microsoft BASIC 2.0 is required. List price is \$99. An Apple II version lists at \$59. Contact Soft-Tools, POB 8751, Boise, ID 83702, (208) 343-1437. Inquiry **634**.

LISP Development Environment for Mac

Available as a complete workstation or a stand-alone software package, ExperLisp brings a LISP environment to the Macintosh 512K. The program, a complete implementation of LISP, provides access to the Mac toolbox, compiles directly to MC68000 machine code, and has three-dimensional and spherical graphics capabilities.

An ExperLisp Workstation includes the software and a Macintosh XL with up to 4 megabytes of RAM and a 10-megabyte hard-disk drive. Workstations configured with 2 megabytes of RAM cost less than \$7000.

The software alone costs \$495. You need an external disk drive to run it. Contact ExperIntelligence Inc., 559 San Ysidro Rd., Santa Barbara, CA 93108, (805) 969-7874. Inquiry **635**.

Demographics on a Disk

What's the ratio of women to men in Baltimore? How many Vietnam veterans live in New Hampshire? How many people voted against the winner of the 1980 Presidential election?

Answers to these questions, as well as other demographic data, are available from People in Places, an information program for the Macintosh. The package contains figures from the 1980 U.S. Census relating to population, income, employment, housing, businesses, and vital statistics. You can have information listed or displayed on maps or graphs. Data is presented for each state and region, urban counties and rural areas, and the Census Bureau's metropolitan statistical areas. Some subjects have comparative data from 1970 and 1960.

People in Places sells for \$35. Contact Data & Information Software Co., Suite 1633, 235 Montgomery St., San Francisco, CA 94104, (415) 391-7670. Inquiry **636**.

Talking Apple II

For less than \$40, you can give voice to your BASIC programs on an Apple II. Speak Up is a voice-synthesizer package that requires no additional hardware and packs a text-to-speech converter into 7K bytes. You can embed the utility into your programs or use it alone to pronounce the text you type.

Speak Up has a suggested retail price of \$39.95. For details, contact Educational Micro Inc., 1926 Hollywood Blvd., Hollywood, FL 33020-4524, (305) 920-2222 ext. 620.

Inquiry **637**.

Mac Communications Package

Dow Jones Information Services and Prentice Corporation have developed a complete communications package for the Macintosh. Called M125, the package includes Straight Talk, a POPCOM X100 modem, phone cables, and a modem-to-Mac cable.

Straight Talk communicates with Macs and provides access to Dow Jones News/Retrieval, The Source, CompuServe, and other services. It also supports MacWrite, MacPaint, and other Mac conventions.

The POPCOM modem has a feature that automatically sets modem switches, determines which cables to use, and locates the proper phone network. The modem also has an auto-voice feature.

M125 retails for \$495. For more information, contact Prentice Corp., 266 Caspian Dr., POB 3544, Sunnyvale, CA 94088-3544. Inquiry **638**.

Mac Cross-Compiler

Pterodactyl Software's PCMacBASIC cross-compiler creates Macintosh programs from BASIC source code using the Pascal Workshop and Mac Supplement on a Lisa. The programs run on a Mac or Mac XL. Two configuration tables in the Resource file, one for each machine type, control memory allocation and screen parameters. They can adjust for screen and memory size and compensate for rectangular pixels.

Features include multiple windows that update automatically, Dialog and Alert boxes configured in the Resource file, sequential or random disk files, and an extended CALL statement that accesses Pascal procedures and functions.

PCMacBASIC includes a run-time license and sells for \$1000.

Pterodactyl has also released PC BASIC Compiler, which has a syntax compatible with BASICA on the IBM PC but also includes extensions. It generates assembly language and an EXEC file to automatically assemble and link. You can call Pascal, assembly-language, and Quickdraw subroutines from BASIC. The compiler is available for the Lisa in several versions. A protected compiler (unprotected run time for one machine) is \$250. With a run-time license, the price is \$750. A cross-compiler that runs on the Lisa and creates programs for the Mac costs \$1000, including a run-time license.

Contact Pterodactyl Software, 200 Bolinas Rd. #27, POB 538, Fairfax, CA 94930, (415) 485-0714. Inquiry **639**.

SOFTWARE • APPLE

Mockingboard Enhancements

Sweet Micro Systems has released three packages for its Mockingboard synthesizers. These programs let Mockingboard users create customized speech, speak in three European languages, and access these capabilities through BASIC.

Speech Development System (SDS) lets you add or delete phonemes and manipulate the six variables associated with each phoneme. These variables

include inflection, rate of speech, amplitude, filter frequency, rate of articulation transition, and rate of inflection transition. SDS costs \$39.95.

Foreign Language Rule Tables (FLRT) provides the basis for converting text into speech. The vendor has developed a set of rules that, when used with the Text to Speech Algorithm, enables the computer to speak in French, German, or British English. You can use these rules alone or incorporate them into programs

that teach foreign languages or are used for translation purposes. FLRT, which can be used in conjunction with SDS, retails for \$24.95.

Developers' Toolkit contains utility programs to facilitate development of music, sound, and speech software. Rule Editor lets you print the rule table on any printer. It works with Mockingboards B, C, and D. A new version of the Text to Speech Algorithm accesses a rule table located above the normal 48K-byte memory, giving you more room

in which to place other program code. It also works with Mockingboards B through D. Ampermock is an ampersand utility designed to simplify incorporation of sound and speech in BASIC programs. It works with Mockingboards A through D. The toolkit, which retails for \$29.95, contains five other programs.

Contact Sweet Micro Systems Inc., 50 Freeway Dr., Cranston, RI 02920. (401) 461-0530. **Inquiry 640.**

SOFTWARE • CP/M/MS-DOS

Program for Programmers

FABS (Fast Access B-tree Structure) Plus is an assembly-language program module designed to maintain key files for quick data retrieval in large files. The package has an auxiliary program that lets you construct tightly packed index files directly from a data file; the program extracts keys from the nondeleted records, sorts them, and packs them into the B-tree.

FABS Plus does not support paths to files when using MS-DOS 2.0. Files to be accessed must be in the current directory. The program reportedly has special commands that permit its use in a network or multi-user environment. Features include generic searches, multilevel sequencing, and support of duplicate keys (as well as ASCII or integer key types).

The vendor claims access times of less than 1 second on a floppy disk and less than 1/2 second on a hard disk.

Suggested retail price is \$195. Contact Computer Control Systems Inc., 298 21st Terrace SE, Largo, FL 33541. (813) 586-1886. **Inquiry 641.**

Development System Under RM/COBOL

C/Script II is designed to automate applications development under Ryan-McFarland's COBOL environment. You can use the system to specify all data, screen descriptions, and program-specific information. RM/COBOL source-code programs are produced through the use of maintainable skeleton files, a data dictionary, and three source-code generators.

You can access applications produced with C/Script II through the Variable Menu System. Menu options are arranged in a logical, hierarchical structure. A security

system interactively monitors all terminals and allows reporting of operator activities. The package reportedly lets you enter an unlimited amount of code to customize generated programs.

C/Script II runs on all IBM PCs and compatibles and other MS-DOS or UNIX machines supporting RM/COBOL version 2. Prices range from \$1540 to \$5385, depending on environment. Contact C. S. Laboratories Inc., 459 North Dean Rd., Auburn, AL 36830. (800) 626-0381; in Alabama, (205) 821-1133.

Inquiry 642.

PIP Utility

A system utility for interfacing to microcomputer operating systems, XPIP combines functions of many operating-system commands with additional capabilities. Once you've selected a command and options, XPIP displays the correct command-line syntax before executing the command.

XPIP lets you display directories with file attributes, file size, and creation date and time sorted by name, extension, or size; search a set of files for the occurrence of a string; perform arithmetic in any base from 2 through 16; and execute a list of XPIP commands in a text file. You can have any file displayed, 128 bytes at a time, in hexadecimal and ASCII. XPIP uses English messages.

XPIP for MS-DOS or PC-DOS 1.1 or later requires 128K bytes of memory and at least one disk drive. XPIP for CP/M requires version 2.2 or later and at least 44K. Both versions cost \$29.95. Contact System Facilities Inc., POB 7079, Charlottesville, VA 22906. (804) 977-5245. **Inquiry 643.**

(continued)

Local Network on a Disk

LANLink is a software-driven local-area network (LAN) for IBM PCs and compatibles. Instead of requiring you to install network interface boards in your computer, LANLink uses RS-232C ports for all network communications. The logic that normally resides on boards is on LANLink's server and satellite disks.

The Software Link explained that it has programmed the 8250 universal asynchronous receiver/transmitter (UART) chip, standard on serial ports, to handle the same tasks assigned to controller chips on network boards. Using these ports, the company has realized a data-transfer rate of more than 115,000 bps.

The program is capable of linking multiple servers for hard-disk backup. It also provides R-LAN, a remote-access feature that lets you interact with the network through a modem in real time to work with files, programs, and peripherals.

LANLink runs on all PC-DOS machines and some MS-DOS compatibles. A starter kit that includes modules for both a server and a satellite is \$495. Additional satellite modules cost \$195. Contact The Software Link Inc., Suite 336, 8601 Dunwoody Place, Atlanta, GA 30338, (404) 998-0700. Inquiry **644**.

Expert-Systems Shell

An AI package designed for commercial users, TESS (The Expert System Shell) lets you build expert systems on an IBM PC or

compatible. You don't need to know Prolog or LISP to create a TESS system; what you need are facts, rules, and probabilities.

TESS is a Bayesian-inference shell that can also offer some Prolog features. You can load large batches of rules into the shell from sequential files. The package is written in C.

The program includes modifiable windows and help facilities and comes with tutorials and descriptions of techniques used to make expert systems. Minimum hardware configuration is a PC with monochrome display, two 360K-byte disk drives, and 256K bytes of memory. TESS sells for £650. Contact Helix Expert Systems Ltd., 11 Ludgate Circus, London EC4M 7LQ, England; tel: 01-248 1734; Telex: 296119.

In North America, the package is marketed as Expert Edge and costs \$795. Contact Human Edge Software Corp., 2445 Faber Place, Palo Alto, CA 94303, (415) 493-1593. Inquiry **645**.

GPIB Utility

Tektronix has developed a toolkit designed to simplify integration of an IBM PC into a GPIB instrument system. Called GURU (GPIB Users Resource Utility), the package consists of

a GPIB interface board with self-test and diagnostics, a shielded GPIB cable, and a tutorial manual.

GURU's support software includes a tool that lets you generate a program for executing a prescribed test sequence without writing any code. You can call and use interactively a BASIC library of 16 subroutines for instrument selection and setup, range and tolerance tests, waveform acquisition and storage, and waveform graphs and statistics.

Tektronix plans to establish an application program library for GURU users.

GURU costs \$600. Contact Tektronix Inc., Marketing Communications Dept., POB 1700, Beaverton, OR 97005, (800) 547-1512; in Oregon, (800) 452-1877. Inquiry **646**.

Debug dBASE

A utility program designed to help dBASE programmers debug code by locating control-statement errors, dFLOW graphically illustrates program loops, IF...ELSE conditionals, and case constructs. The package produces correctly indented listings for individual files and for entire applications systems. dFLOW also cross-references all modules in a full system and compiles a variable concordance.

dFLOW works with dBASE II and III on an IBM PC, PC XT, PC AT, and most compatibles. Suggested retail price is \$129. Contact WallSoft Systems Inc., Suite 869, 233 Broadway, New York, NY 10279, (212) 406-7026.

Inquiry **647**.

ATLAS Helper

Developed to help train engineers and technicians in the generation of ATLAS (Abbreviated Test Language for All Systems) code, ATLAS Tutor eliminates the need for a test station or compile facility. The menu-driven program-generation tool produces code that's in accordance with IEEE Standard 716.

The tutor leads you step-by-step through the statement-generation process. Each ATLAS statement you construct is stored in a user-defined file so that the statements are linked into a test program. Proper punctuation is inserted automatically.

Examples in the user's manual are organized by ATLAS verbs. The manual includes references to comments about the verbs and references to other structure elements.

ATLAS Tutor runs on an IBM PC or compatible with two disk drives (360K bytes per disk) or one floppy-disk drive and one hard-disk drive. The price is \$400, which gets you the program and manual and a copy of the document "IEEE Standard 716 C/ATLAS Test Language." Contact Dubert International Inc., 8858 Glenhaven St., San Diego, CA 92123, (619) 277-4700. Inquiry **648**.

WHERE DO NEW PRODUCT ITEMS COME FROM?

The new products listed in this section of BYTE are chosen from the thousands of press releases, letters, and telephone calls we receive each month from manufacturers, distributors, designers, and readers. The basic criteria for selection for publication are: (a) does a product match our readers' interests? and (b) is it new or is it simply a reintroduction of an old item? Because of the volume of submissions we must sort through every month, the items we publish are based on vendors' statements and are not individually verified. If you want your product to be considered for publication (at no charge), send full information about it, including its price and an address and telephone number where a reader can get further information, to New Products Editor, BYTE, POB 372, Hancock, NH 03449.

Micro Products International
714/898-0840

We accept Visa, M/C, Pre-Pay by Check or Money Order. COD's are accepted by Telephone & Mail. COD Terms are: Cashier's Check for first time orders over \$1000.
Fax: 714/897-3363 Tlx: 887841 XORDATA HTB

Flower Specials

TEAM New Hayes SmartModem Compatible! TEAM

Finally a price breakthrough on a Hayes compatible, external 300/1200 baud modem. This low price is without driver software, but if you need it add \$25.00. Call for a 26 page catalog of our special deals. Look in this spot every month for Hot, New Items sure to catch your interest!



- Hunts me popular Hayes communications software
- FCC approved for direct RJ-11 connection
- All cables & power supply included for this one low price.

MOD-8100-00 **\$279.00**

IBM PC-XT SELECTRIC KEYBOARDS

Our volume purchase of these excellent Selectric type keyboards will bring the features you have been wanting down to a price you can't resist. So many features you'll love!!!!

- Single key reset
- Separate numeric keypad
- Separate "Arrow" keypad
- Dimple marked "5", F, & J keys



KEY-1051-00 Selectric **\$129.00**
KEY-1050-00 Standard **89.00**

ADD-ON POWER SUPPLY



Power Supply with Fan and Power Filter. Uses 140 watts, runs Hard Disk & Tape Back-Up. IBM Replacement type for Hard Disk.

New High Velocity Fan!
New Low Price!
POW-1040-00 **\$99.00**

IBM STYLE MOTHERBOARD

Micro Products announces a powerful new IBM XT type motherboard. 4 layers for superior reliability & speed. Turbo mode allows 75% higher thru-put by increasing system clock to 7.0MHz under software control. Designed to use new 256K RAM chips or 64K chips. 640K memory expansion does not require use of valuable card slots. Many outstanding features combined with our new 7 PAK Multifunction board make previously expensive options standard features at a LOW LOW Cost.



BOA-6068-00 Supplied with OK **\$349.00**

SUPER 12 PAK MULTI-FUNCTION

This one is really loaded! Features: One Parallel Port, One RS232-C Serial Port, One Game Port, Real-Time Clock / Calendar with Battery Back-up, Expandable to 384K of Parity-checked Memory, Supplied OK Memory, all cables, PrintSpooler and RAM Disk Software.

BOA-6335-00 **\$199.95**
*Additional (9) 64K Memory Chips **\$ 15.00**
KIT-8000-00 **\$ 15.00**

We Cater to IBM™ Dealers
★ Hardware ★ Software
★ Training Tapes ★
Call for our Catalog now!

Do it Yourself!

Think of this System as a "Do it Yourself" System. Start by choosing 8 Slots. Some of the standard Features: • 64K RAM expandable 256K • 4 DMA Channels • Runs MS-DOS™ and CP/M-86™ (software not included) • Multi-function Keyboard & Cable • Hard Disk Ready Power Supply • And MORE!
S-8000-00 **Only \$525*/695**



1 type Case only
Slot CAB-3065-00 **\$65*/99**
Slot CAB-3068-00 **\$65*/99**

OEM'S 1245-Single'S 1495

Complete System! XPC Turbo!

NEW Features!

- RAM Disk
- Game Port
- 640K cpcy
- PrintSpooler
- Turbo mode!
- 4.77MHz to 7.00MHz!
- Ser, Par
- Clock

*OEM Qty 12 +



10 Meg H.D. Complete System!
\$1995**

20 Meg Color Complete System!
\$2550**

40 Meg w/Tape Complete System!
\$3035**

- Software**
- XWORD
 - XBASIC
 - XBASE
 - XCALC
 - XCOM

Check These Standard Features:

- Full-Size, Feather-Touch, Capacitance Keyboard, 10 Function Keys, Calculator-Type Numeric Keypad
- Parallel & Serial I/O • Real Time Clock • Game Port • 2-Slimline 5 1/4" DS/DD 48 TPI 360K Drives
- 8 IBM expansion slots • RAM Disk • Print Spooler • 4 DMA & 3 Timer channels
- Full 640K capacity on-board • 8088 16-bit CPU • Monochrome Video Card
- Up to 32K of EPROM (full 8K supplied) • Supports PC-DOS - MS-DOS - CP/M-86
- Power Supply Hard-Disk-Ready, no need to add-on additional power
- High resolution 12" Monitor, Green Screen, 22 MHz bandwidth

Add-On H.D. & Tape



10 Megabyte Irwin on the top, your choice of Hard Disk on the bottom. Super appearance! Requires one slot in your PC for SASI interface and an extension connector on the floppy card. Everything else is supplied by us.

10 Meg	\$1295	40 Meg	\$1995
20 Meg	\$1395	105 Meg	\$4395
26 Meg	\$1595	140 Meg	\$4995

Add-On Hard Disk

Two ways to go. The Internal system is cheaper because it does not need a P/S & Chassis. The same P/S & Chassis can be used for a 10 Meg Tape Back-up on your XT!

10 Megabyte	\$595 Int*/895 ext	40 Megabyte	\$1295 Int*/1595 ext
20 Megabyte	\$795 Int*/1095 ext	105 Megabyte	\$3795 Int*/3995 ext
26 Megabyte	\$995 Int*/1295 ext	140 Megabyte	\$4395 Int*/4695 ext

Add-On 10 Meg Tape



If your IBM-XT needs a little help in the Back-up category, you won't be able to beat this price! Cables, software and everything!

SUB-8300-00 **\$495*/695**

Not enough room here - Call for Catalog

MITS MultiMedia Interactive Training Systems

INTERACTIVE

Video or Audio Tape Training! That's Right!

Learn at home - at your own pace -

Lotus 1-2-3™ Framework™ WordStar™
IBM-PC DOS™ dBase II™ Symphony™
SuperCalc™ BusinessMaster™

At last! An inexpensive, convenient means of learning how to use a Computer and Software. With his System you sit comfortably in front of your Computer, watch a demonstration, and then, the Tape system (Audio or Video) actually INTERACTS with you! Telling you what keys to strike, waiting for you to do the exercises at your own rate. As much practice time as You want. A pace that you set. Some classes 10 hours in length! Fantastic detail and tips! Call us for more information and practical demonstrations. Nothing like it anywhere else!

The following are registered Trademarks and their Companies: 1-2-3, Symphony - Lotus Development Company; MS-DOS, PC-DOS, Flight Simulator - Microsoft; dBase II - Ashton-Tate; WordStar - MicroPro International Corp.; SuperCalc - Sorcim, Inc.; VisiCalc - VisiCorp, Inc.; CP/M-86 - Digital Research Inc.; IBM, IBM PC, IBM PC XT - International Business Machines.

POWER BACK-UP

Protect your Data! Datashield® is a battery operated Power Generator which instantly supplies even, uninterrupted AC Power to a Microprocessor in the event of a Power Drop or Outage. Also provides Surge Protection, which filters and eliminates voltage spikes (surges) above 140 VAC.



200 watts POW-2000-00 **\$299.00**
300 watts POW-2050-00 **\$399.00**

INTERNATIONAL ORDERS

Micro Products is ready to serve your needs in several countries. Each Office has Sales Literature, Local Pricing, Inventory and Technical Service available to support your needs. There are no problems with U.S. Export Forms.

HEAD OFFICE
Darryl R. Green
15392 Assembly Lane, Unit A
Huntington Beach, CA 92649
Phone: 714 / 898-0840
Telex: 887841 XORDATA HTB

AMSTERDAM OFFICE
Cynthia Clark
Building 70, 4th Floor
1117 ZH Schiphof-East
Amsterdam, The Netherlands
Phone: (020) 45 26 50
Telex: 18306

AUSTRALIAN OFFICE
8 Irwin Street, Bellevue
W. Australia 6056
Phone: 274-3701

TAIPEI OFFICE
William Wang
Suite 605, Worldwide House
686 Min Sheng E. Rd.
Taipei, Taiwan, R.O.C.
Tel: (02) 712-8877 Tlx: 21405

MARACAIBO OFFICE
Jim Stevens
Av. 3F Esq. Calle 81
Centro Com. Maeliga - Local #5
Maracaibo, Venezuela 4001-A
Phone: 061913328
Telex: 62344 PEMIN

CANADIAN OFFICE

-- PENDING --

PROM LASER

This is the One! Our PROM Burner allows reading, storing-to-disk, recalling, and burning. Hi-speed algorithms burns 2764 in 45 seconds! Also handles 2716, 2732, 27128, 27256. Features: Zero insertion force sockets; On-board Voltage Generator; No interference with normal computer operations.



BOA-8640-00 **\$199.00**

MISCELLANEOUS \$\$\$ SAVERS

7 PAK Multifunction Floppy, RTC, 2 Serial, 1 Parallel, Game, RAM Disk
BOA-6250-00 **\$189.00**
64K Memory Chips (9) NEC for IBM KIT8000-00 **\$ 15.00**
256K DRAM Memory Chips (8) = 256K KIT9000-00 **\$ 81.00**
Add-On Memory, (up to 512K) supplied OK BOA-6350-00 **\$ 99.00**
Floppy Controller, Controls up to four drives, 5 1/4" 4896 TPI
BOA-6100-00 **\$ 95.00**
Monochrome Graphics Card (Hercules type) (1-2-3 compatible) 720h x 348v
BOA-6150-00 **\$175.00**
Color Graphics Card, 320 x 200 Res. Color, 640 x 200 Monochrome
BOA-6200-00 **\$145.00**
Clock Calendar Board, fits in "short slot" w/battery Back-up
BOA-6375-00 **\$ 55.00**
Hard Disk Controller, standard ST-506 interface for DOS 1.1 & 2.0
BOA-8050-00 **\$245.00**
300 / 1200 Baud Modem Internal w/PC Talk III Communications Software
BOA-8725-00 **\$239.00**
Monochrome Monitor, 22MHz bandwidth, composite input or TTL
MON-1725-00 Green/Comp **99.00** MON-1700-00 Amber/Comp **104.00**
MON-1775-00 Green/TTL **104.00** MON-1750-00 Amber/TTL **109.00**

Inquiry 278

Micro Products • 15392 Assembly Lane • Huntington Beach, CA 92649 • 714/898-0840



SUNTRONICS CO., INC.

12621 Crenshaw Blvd., Hawthorne, CA 90250

1-800-421-5775 (Order Only)
 (213) 644-1140 (CA Order & Info.)
 STORE HOURS
 Mon-Fri 9 a.m. to 6 p.m.
 Sat 10 a.m. to 5 p.m.

TERMS: VISA MASTERCARD C.O.D. (Cash or Certified Check Required) Check (Allow 2-3 Weeks for Clearing) Shipping & H.C. \$3.00 for 3 Lbs. plus 50¢ for each add. Lb. Calif. residents add Calif. Sales Tax \$10.00 Minimum Order IBM and Apple are registered trademarks of IBM & Apple.

IBM® XT Compatible Products

CPU Board (w/128K)	\$350.00
Computer Cabinet	\$69.00
83 Key Full-Function Keyboard	\$85.00
Monochrome Graphic Card (w/parallel printer port)	\$175.00
135 Watt Power Supply	\$129.00
150 Watt Power Supply	\$135.00
Color Graphic Card	\$129.00
FDD Controller Card	\$179.00
Parallel Printer Card	\$49.00
ASYNC & RS232 Card	\$69.00
360KB DSDD (Slimline) Disk Drive, TEAC	\$99.00
IBM Parallel Cable	\$19.00
IBM Prototype Board	\$9.00
Apparat EPROM Blaster	\$129.00
MicroLog Z-80B Baby Blue II Co-Processor, Multi-Function (Run CP/M Software, Require 64K RAM)	\$499.00
IBM Up-Grade Kit (4164-150NS)	12.50 per kit
IBM Up-Grade Kit (41256-150NS)	\$65.00 per kit
10MB Hard Disk (w/Controller)	\$595.00
Hard Disk Drive Controller (10MB & 20MB)	\$229.00
IBM PC Mouse	\$147.00
Koala Graphics Table (w/Software)	\$105.00
Keyboard Extension Cable	\$9.00
Multi-Function (384K w/64K RAM, 1 Serial & Parallel, Clock Calendar)	\$169.00
Multi-Function (FDC, Serial & Parallel, Clock Calendar, Game Port)	\$199.00

Apple Compatible Products

Sun Z80 Card (w/o Software APPLE II & II+ only)	\$49.00
Sun 80 Column Card (w/Soft Switch)	\$85.00
Power Supply (5 Amp)	\$59.95
Cooling Fan	\$42.00
Floppy Disk Controller	\$42.00
16K RAM Card	\$49.00
128K RAM Card	\$159.00
Parallel Printer Card	\$49.00
Serial Printer Card	\$89.00
RS232 Card for Modem	\$99.00
EPROM Programmer (2716, 32, 64)	\$75.00
Apple Disk Drive (Full height)	\$159.00
Apparat EPROM Blaster	\$119.00
Grappler	\$75.00

SPECIAL SALE ITEMS

S-100 Single Board Computer (Z80A)	B/B \$49.00
S-100 Clock Calendar	B/B \$42.00
S-100 64K Static Memory Board (w/o RAM)	B/B \$49.00
S-100 Prototype Board (Sun-721)	\$9.95
12" Amber TTL Hi-Res Monitor (20mHz) (for IBM)	\$115.00
12" Green TTL Hi-Res Monitor (20mHz) (for IBM)	\$109.00
12" Green Composite Hi-Res Monitor (22mHz) (IBM & Apple)	\$85.00
14" Super Color Monitor (RGB 654(H) x 490(V))	\$385.00
SKC DS/DD 5 1/4" Diskette	\$13.95 per 10

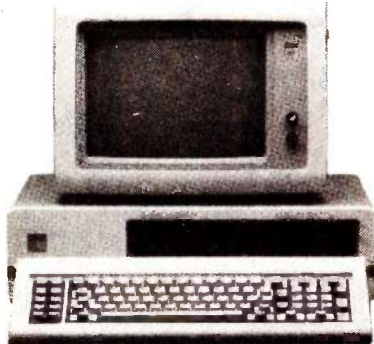

IBM PC, 256 K, One Half Height 320 K Disk Drive DS/DD, Persyst Color Card, Taxan Green Monitor, DOS 2.1 PLUS a 10MB Hard Disk Sub System all for:

\$2690.00

IBM PC, 256 K, Two Half Height Drives DS/DD, Persyst Color Card, Taxan Green Monitor, DOS 2.1, 130 Watt Power Supply PLUS a 10MB Hard Disk Sub System all for:

\$2980.00

IBM PC, 256 K, Two Half Height Drives DS/DD, Persyst Color Card, Taxan Green Monitor, DOS 2.1, 130 Watt Power Supply, 10MB Hard Disk Sub System, PLUS 10MB Tape Back Up System all for:

\$3579.00

IBM PC, 256 K, Two Half Height Drives DS/DD, Persyst Color Card, Taxan Green Monitor, DOS 2.1, 130 Watt Power Supply, 20MB Hard Disk Sub System all for:

\$3380.00

IBM PC, 256 K, Two Half Height Drives DS/DD, Persyst Color Card, Taxan Green Monitor, DOS 2.1, 130 Watt Power Supply, 20MB Hard Disk Sub System PLUS 10MB Tape Back Up System all for:

\$3979.00

(We configure and test the system for you at no extra cost.)

SOMEBODY Has To Have The Lowest Prices!

MONITORS	
AMDEK 300	\$135.00
PGS HX-12	\$475.00
PGS MAX-12	\$190.00
PGS SR-12	\$625.00
TAXAN GREEN COMPOSITE	\$125.00
TAXAN AMBER COMPOSITE	\$135.00
TAXAN GREEN W/TTL PLUS	\$149.00
TAXAN AMBER W/TTL PLUS	\$159.00
IBM MONOCHROME DISPLAY	\$260.00
IBM COLOR DISPLAY	\$590.00

PRINTERS	
EPSON FX 80	\$425.00
EPSON FX 100	\$625.00
EPSON RX 80	\$245.00
EPSON RX 80FT	\$295.00
OKIDATA 82A	\$299.00
OKIDATA 83A	\$569.00
OKIDATA 92P	\$399.00
OKIDATA 93P	\$625.00
OKIDATA 84P	\$759.00
OKIDATA 2410P	\$1959.00
TOSHIBA P1351	\$1295.00
NEC SPINWRITER 3550	\$1595.00
NEC PINWRITER 80 COL	\$699.00
NEC PINWRITER 136 COL	\$899.00
BROTHER HR-25	\$699.00
BROTHER HR-35	\$925.00

(Accessories on NEC & OKIDATA printers available)

DRIVES	
TANDON TM-100-2	\$179.00
SLIMLINE - TOSHIBA	\$155.00
SLIMLINE - TEAC 55B	\$155.00

MULTIFUNCTION BOARDS	
AST I/O+1 SER & 1 PAR	\$179.00
AST SIX PACK 64K, 1 SER & 1 PAR	\$269.00
QUADBOARD 64K	\$269.00
IBM COLOR GRAPHIC ADAPTER	\$225.00

IBM MONO PRINTER ADAPTER	\$230.00
PERSYST COLOR ADAPTER	\$190.00
PERSYST MONO PRINTER ADAPTER	\$210.00
HERCULES GRAPHIC ADAPTER	\$349.00
HERCULES COLOR CARD	\$210.00
STB GRAPHIX PLUS II	\$375.00

MODEMS	
HAYES SMART MODEM 1200	\$469.00
HAYES SMART MODEM 300	\$209.00
HAYES 1200B PLUG IN CARD	\$429.00
QUBIE PC 212A/1200 INT	\$275.00
QUBIE PC 212E/1200 EXT	\$299.00

HARD DISKS	
10MB SUB SYSTEM INT	\$850.00
10MB SUB SYSTEM EXT	\$1025.00
10MB TAPE BACK UP	\$599.00

GENERAL	
CONTROL DATA DISKETTES	\$25.00/box
KEYTRONIC KB5151	\$189.00
PARALLEL CABLES	\$25.00
64K RAM UPGRADE KIT	\$50.00
128K RAM UPGRADE KIT (For AT)	\$199.00
IBM PC POWER SUPPLY (Original) 63.5 Watts	\$89.00
IBM KEYBOARD FOR PC (Original)	\$109.00



(714) 838-7530
 2640 Walnut Avenue, Unit K,
 Tustin, California 92680
 (Prices & availability subject to change without notice—
 IBM is a registered trademark of IBM Corporation.)

What the world really needs is a 99 cent Double Sided, Double Density Diskette with a LIFETIME WARRANTY!

And DISK WORLD! has it.

Introducing Super Star Diskettes: the high quality diskette with the lowest price and the best LIFETIME WARRANTY!

In the course of selling more than a million diskettes every month, we've learned something: higher prices don't necessarily mean higher quality.

In fact, we've found that a good diskette manufacturer simply manufactures a good diskette...no matter what they charge for it. (By way of example, consider that none of the brands that we carry has a return rate of greater than 1/1,000th of 1 percent!)

In other words, when people buy a more expensive diskette, they aren't necessarily buying higher quality.

The extra money might be going toward flashier advertising, snazzier packaging or simply higher profits.

But the extra money in a higher price isn't buying better quality.

All of the good manufacturers put out a good diskette. Period.

How to cut diskette prices ...without cutting quality.

Now this discovery posed a dilemma: how to cut the price of diskettes without lowering the quality.

There are about 85 companies claiming to be "diskette" manufacturers.

Trouble is, most of them aren't manufacturers. Rather they are fabricators or marketers, taking other company's components, possibly doing one or more steps of the processing themselves and pasting their labels on the finished product.

The new Eastman Kodak diskettes, for example, are one of these. So are IBM 5 1/4" diskettes. Same for DYSAN, Polaroid and many, many other familiar diskette brand names. Each of these diskettes is manufactured in whole or in part by another company!

So, we decided to act just like the big guys. That's how we would cut diskette prices...without lowering the quality.

We would go out and find smaller companies to manufacture a diskette to our specifications...specifications which are higher than most...and simply create our own "name brand" diskette.

Name brand diskettes that offered high quality at low prices.

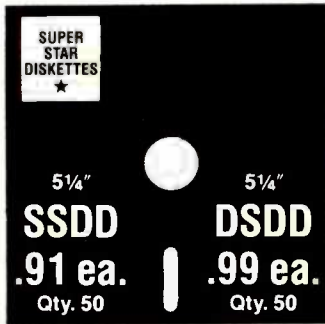

Super Star diskettes are sold in multiples of 50 only. Diskettes are shipped with white Tyvec sleeves, reinforced hubs, user ID labels and write-protect tabs.

Boy, did we get lucky. Our Super Star Diskettes are the same ones you've been using for years...without knowing it.

In our search for the low priced, high quality diskette of our dreams, we found something even more interesting.

We found that there are several manufacturers who don't give a hoot about the consumer market for their diskettes. They don't spend millions of dollars in advertising trying to get you, the computer user, to use their diskettes.

Instead, they concentrate their efforts on turning out the highest quality diskettes they can...because they sell them to the software publishers, computer manufacturers and other folks who (in turn) put their name on them...and sell them for much higher prices to you!

After all, when a software publisher or computer manufacturer or diskette marketer puts their name on a diskette, they want it to work time after time, everytime. (Especially software publishers who have the nasty habit of copy-protecting their originals!)

Super Star Diskettes. You already know how good they are. Now you can buy them...cheap.

Well, that's the story.

Super Star diskettes don't roll off the boat from Pago-Pago or emerge from a basement plant just east of Nowhere.

Super Star diskettes have been around for years...and you've used them for years as copy-protected software originals, unprotected originals. Sometimes, depending on which computer you own, the system master may have been on a Super Star diskette. And maybe more than once, you've bought a box or two or more of Super Star diskettes without knowing it. They just had some "big" company's name on them.

Super Star Diskettes are good. So good that a lot of major software publishers, computer manufacturers and other diskette marketers buy them in the tens or hundreds of thousands.

We buy them in the millions.
And then we sell them to you.
Cheap.

When every little bit counts, it's Super Star Diskettes.

You've used them a hundred times...under different names.

Now, you can buy the real McCoy, the same diskette that major software publishers, computer manufacturers and diskette marketers buy...and call their own.

We simply charge less.

Super Special!

Order 50 Super Star Diskettes and we'll be happy to sell you an Amaray Media-Mate 50 for only \$8.75, shipping included...a lot less than the suggested retail price of \$15.95.



Regular DISK WORLD! price: \$10.95 ea.
+ \$2.00 Shpng.

DISKETTE STORAGE CASES

PERFECTDATA DIAL 'N FILE
Terrific! Holds 10 5 1/4" diskettes. Just flip the lever and they all slide up for easy access and identification. Grey with smoked plastic front.

\$2.75 Ea. + .35 Shpng.

DISK CADDIES
The original flip-up holder for 10 5 1/4" diskettes. Beige or Grey only.

\$1.65 ea. + .20 Shpng.

DISKETTE 70 STORAGE
Dust-free storage for 70 5 1/4" diskettes. Six dividers included. An excellent value.

\$11.95 ea. + \$3.00 Shpng.



HOW TO ORDER:

ORDERS ONLY:
1-800-621-6827
(In Illinois: 1-312-944-2788)

INQUIRIES:
1-312-944-2788

FOR FASTEST SERVICE, USE NO-COST MCI MAIL: Our address is DISK WORLD!. It's a FREE MCI MAIL letter. No charge to you. (Situation permitting, we'll ship these orders in 24 hours or less.)

SHIPPING: 5 1/4" & 3 1/2" DISKETTES—Add \$3.00 per each 100 or fewer diskettes. **OTHER ITEMS:** Add shipping charges as shown in addition to other shipping charges. **PAYMENT:** VISA, MASTERCARD and Prepaid orders accepted. **COD ORDERS:** Add additional \$3.00 special handling charge. **APD, FPD, AK, HI & PR ORDERS:** Include shipping charges as shown and additional 5% of total order amount to cover PAL and insurance. We ship only to United States addresses, except for those listed above. **TAXES:** Illinois residents, add 8% sales tax.

MINIMUM ORDER: \$35.00 or 20 diskettes.

The Super Star LIFETIME WARRANTY!

Super Star Diskettes are unconditionally warranted against defects in original material and workmanship so long as owned by the original purchaser. Returns are simple: just send the defective diskettes with proof of purchase, postage-paid by you with a short explanation of the problem, and we'll send you the replacements. (Incidentally, coffee stained diskettes and diskettes with staples driven through them don't qualify as "defective".)

**WE WILL MEET OR BEAT ANY NATIONALLY
ADVERTISED PRICE
ON THE SAME PRODUCTS AND QUANTITIES
SUBJECT TO THE SAME TERMS AND CONDITIONS.**

HOURS:
Human: 8AM-6PM Central Time, Monday through Friday
Answering Machine: 6PM-8AM, All Times
MCI MAIL: 24 hours a day.

DISK WORLD!, Inc.

Suite 4806
30 East Huron Street
Chicago, Illinois 60611

NEW!!

MEGA-CASE™

NEW!!

**IDEAL FOR OEM MANUFACTURERS, UNIVERSITIES,
RESEARCH LABS ETC.**

THE ULTIMATE PC COMPATIBLE ENCLOSURE

**IDEAL FOR MEGA-BOARD™ XT OR ANY IBM-PC PC-XT
COMPATIBLE BOARDS**

**OEM AND DEALER
QUANTITY DISCOUNTS AVAILABLE**

EASY ACCESS!!

**FLIP-TOP-CASE™
OPENS FOR EASY
ACCESS TO INSIDE!!**

**EXCLUSIVE
FLIP-TOP-CASE™**
Overcomes Problems
With PC Case

Bus Expansion Slot

Allows External
Access To PC Bus

POWER SUPPLY

Blank Label Inset
For Your Company Or
University Name Here

Mounts Standard
Half or Full Height
Floppy Disk
or Hard Disk Drives

Rugged Heavy Gauge Steel Construction

**ONLY
\$99⁹⁵**

COMPLETE

ADVANCED KEYBOARD

- FEATURES:**
- Horizontal Return Key
 - Caps Lock and Num. Lock Indicators
 - Enter Key for Numeric Keypad



Full PC Compatibility

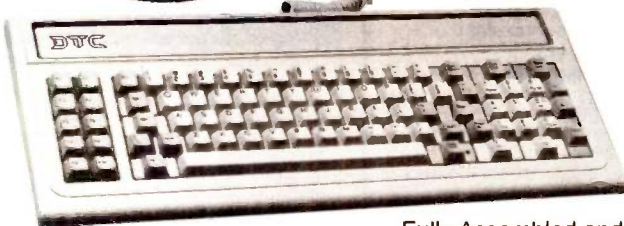

Fully Assembled and Tested with One Year
Limited Warranty

**ONLY
\$149⁹⁵**

DTC™ DISPLAY
TELECOMMUNICATIONS
CORPORATION

4100 SPRING VALLEY ROAD
SUITE 400
DALLAS, TX 75234
(214) 991-1644

TERMS: We accept cash, checks,
money orders, or purchase orders from
qualified firms and institutions. Prices
and availability subject to change without
notice. Shipping and handling charges
extra.

MEGA-BOARD™ XT

#1 CHOICE OF MAJOR OEM MANUFACTURERS, UNIVERSITIES, RESEARCH LABS ETC. A THOROUGHLY FIELD PROVEN DESIGN. HIGH VOLUME PRODUCTION ENGINEERED.

- FULL IBM PC-XT* COMPATIBILITY!
- FULL MEGA-BYTE RAM CAPACITY ON MOTHERBOARD!

THOUSANDS SOLD WORLD WIDE!

DEALERS AND OEM MANUFACTURERS QUANTITY DISCOUNTS AVAILABLE

Standard Key-board Interface
(Full PC compatible)

Hardware Reset
(Overcomes reset flaw in PC)

Eight Compatible I/O Interface Connectors
(Full PC compatible)
(compatible with all IBM-PC* plug-in cards)

Power Connector
(Full IBM* pinout compatible)

8088 Processor
(Same as PC)

Special J1 Interface
(Allows horizontal mounting of compatible expansion cards for easy bus expansion and custom configuring) (Board has 62 pin gold plated compatible connector)

8087 Numeric Processor
(Same as PC)

Peripheral Support Circuits
(Same as PC)

Extended ROM Capability
(Runs all compatible PC ROMS) (Jumper programmable to accommodate all popular 8K, 16K, 32K and 64K ROM chips and NEW EE ROMS! VPP power pin available for EP ROM burning!) (External VPP voltage required)

Configuration Switches
(Same as PC)

Speaker/Audio Port
(Same as PC)

Wire Wrap Area
To facilitate special custom applications!

Full Mega-Byte Ram Capacity! On board!
(With parity)
 256K Bytes using 64K chips
 1 Mega Bytes using 256K chips

ONLY! \$499⁹⁵

Mega-Board™ Triple-tested, fully socketed and assembled with IC's.

Includes highest quality PC board with gold plating, silk screen, solder mask

Board Size 10.5 inch X 13.5 inch

- MEGA-BOARD™ — XT
 - BARE BOARD KIT \$ 99.95
 - ASSEMBLED AND TESTED SOCKET KIT (LESS IC'S) (FULLY SOCKETED) \$199.95
 - ASSEMBLED AND TESTED — COMPLETE (INCLUDES USERS MANUAL AND MEGA-BIOS ROM) \$499.95
- USERS MANUAL WITH THEORY OF OPERATION, SCHEMATICS, BLOCK DIAGRAM, APPLICATION NOTES \$ 19.95
- MEGA-BIOS™ ROM (2764) FULLY XT COMPATIBLE, MS-DOS, PC DOS \$ 29.95
- HARD TO GET PARTS CALL

FREE OFFER

FREE! Displaytel™ Exclusive. Our Commitment to Microcomputer Education!

FREE Intel 8088 Data Book with each Mega-Board™ Order!

ORDER NOW!!! Fast, friendly service

CALL 214-991-1644



Immediate shipment! Most instock items shipped same or next day!

10 Day money back guarantee if not completely satisfied!

DTC™ DISPLAY TELECOMMUNICATIONS CORPORATION

4100 SPRING VALLEY ROAD SUITE 400 DALLAS, TX 75234 (214) 991-1644

TERMS: We accept cash, checks, money orders, or purchase orders from qualified firms and institutions. Prices and availability subject to change without notice. Shipping and handling charges extra.

CCT-4 SYSTEM SERIES

The latest CCT implementation of the new generation Intel 16-Bit Processor technology. This means extreme speed, unequalled power, and the ultimate in reliability, and of course, the innovators at CCT behind it.

This series in the CCT line exploits the speed and power of the Intel 80286 and Zilog Z-80H (8MHz), on the 286Z CPU board. This combination, along with CompuPro DMA controllers and I/O boards, yields a dramatic improvement in system throughput speeds, from basic CP/M operation, up to large powerful multi-user/multi-tasking machines. The CCT-4 represents the most advanced hardware presently available in a microcomputer to run the thousands of CP/M type software programs on the market, and with CONCURRENT DOS 8-16 and the CompuPro PC Graphics board (when available), all software written for the IBM PC machines. This series is for the serious business/scientific user.

CCT-4A State-of-the-art power in it's basic form. Consists of CCT-286Z CPU board and CCT-M256 (256K), along with CompuPro: Enclosure 2 Desk (21 slot MF), Disk 1A, System Support 1, Interfacer 4, the CCT-2.4 floppy drive system, and CP/M 80 and CP/M 86, and with SF-200 surge suppressor system. **\$5,495.00**

CCT-4B Single-user/hard disk power. As the 4A, except priced without the CCT-2.4, to add in your choice of CCT hard/floppy combination drive subsystem, at the published pricing. **\$4,375.00**
 (Example: CCT-4B Mainframe with CCT-10/1 = \$6,548.00) Plus cost of selected drive subsystem

CCT-4C Multi-user/hard disk power. As the 4B, with the CCT-M512 (512K static RAM board) instead of M256; Interfacer 3 instead of Interfacer 4; SF-400 instead of SF-200, plus Concur. DOS 8-16 O.S. (6 user system) **\$6,075.00**
 (Example: CCT-4C Mainframe with CCT-40/1 = \$9,248.00) Plus cost of selected drive subsystem

NEW RAM BOARD

Limited Time Offer - FREE Supercalc 86 with any CCT-4

The above systems include all necessary cabling, assembly, testing, minimum 20 hour burn-in, and the CCT unconditional 12 month direct warranty.

CCT-M512 CCT introduces it's 512K static RAM board. IEEE Standard 12MHz. 512K in one slot! **Introductory Price: \$1,899**
CCT-M256 256K version of M512 upgradeable to full 512K. Perfect 256K RAM board for any CompuPro system **\$979**

CUSTOM COMPUTER TECHNOLOGY / BOX 4160 / SEDONA, ARIZONA 86340
TOLL FREE ORDERING: 800-222-8686 / For technical support / service: 602-282-6299

WE LOCALLY DEVELOP & MANUFACTURE

SWITCHING POWER SUPPLIES

WITH ONE YEAR WARRANTY & PROMPT LOCAL SERVICE



ITEM	FOR	+5V	-5V	+12V	+12V	-12V	+24V	+8V	±16V	W x D x H in.	TERMINALS	PRICE
SW40W	TERM. & 2 ALPS DRIVES	2.5A	-	2/2.5A pk.	-	.3A	-	-	-	6.3 x 3.9 x 1.9	MOLEX 5051	\$ 49.95
SW70W	APPLE II*, II+	7A	.3A	2.5/3.5A pk.	-	.3A	-	-	-	9.6 x 4 x 2.4	MOLEX 126-P1	59.95
SW80W	PC WITH SOFT DRIVES	8A	.3A	3/4A pk.	-	.3A	-	-	-	7.4 x 4.5 x 2.3	MOLEX 2139	74.95
SW138	IBM PC-XT* P/S RPLCMNT.	15A	1.0A	4/6A pk.	-	1.0A	-	-	-	9.5 x 5.6 x 4.6	MOLEX, AMP.	129.95
XT200W	XT W/2 HARD DISKS	20A	1.0A	7/9A pk.	-	1.0A	-	-	-	SAME AS SW138	MOLEX, AMP.	189.95

SPECS. OF ABOVE SWITCHERS: 117/220 VAC SELECTABLE, INPUT 90-132 VAC/180-275 VAC, EFFIC. 75% TYPICAL, LINE REGUL. 0.3%, LOAD REGUL. 1% ON +5V, 5% ON OTHER VOLTAGES, 6.2 OVP SETTING ON +5V, OVERLOAD & SHORT CIRCUIT PROTECT, LOW OUTPUT RIPPLE & NOISE, 1% MAX, 50,000 HRS. MTBF RELIABILITY, UL, FCC & VDE SAFETY & NOISE STANDARDS.

S ₃	FOR S-100, 10 SLOTS	5A	1A	*	-	-	5/7A pk.	12A	3A	10 x 6 x 5	SOLDER POST	\$105.95
S ₄	FOR S-100, 6 SLOTS	4A	1A	*	-	-	4/5A pk.	8A	2.5A	8.4 x 5 x 4.8	SOLDER POST	89.95
R ₁	2 FLOPPY DRIVES	3A	.5A	*	-	-	3/4A pk.	-	-	8 x 4 x 3.4	SOLDER POST	44.95
R _{1A}	APPLE II PC*	3A	.5A	3/4A pk.	-	.5A	-	-	-	8 x 4 x 3.4	SOLDER POST	46.95
C ₆₄	COMPATIBLE TO COMMODORE C64 (OR C+4)*	POWER SUPPLY: +5V/1.7A, 9 VAC/1A & 117 VAC IN, POTTED, U/L & CSA.										19.95

*: +24V CAN BE CHANGED TO +12V BY FACTORY, PLEASE SPECIFY WHEN YOU ORDER.
 THE ABOVE 5 LINEAR P/S ARE WITH 3% LOAD REGUL., OVP ON +5V, FUSED: INPUT & OUTPUTS.

UNINTERRUPTIBLE A.C. POWER SUPPLY: UPS-90W @ \$299.95 & UPS-200W @ \$399.95 EA.

SAVES YOU FROM LOSING DATA DURING A.C. POWER LINE FAILURES OR TRANSIENT OVER VOLTAGES CAUSED BY OFFICE EQUIPMENT, HOME APPLIANCES, LIGHTNING, ETC., SPECS: CUT-IN VOLTAGE, 102V; TRANSFER BACK TO LINE, 106V; BATTERY BACKUP IN 4 MS TYPICAL, OUTPUT VOLTAGE 102-132V STEPPED SINE WAVEFORM, BATTERY OPERATING PERIOD; 5 MIN. AT FULL LOAD & 15 MIN. AT HALF LOAD, EXTERNAL 12V BATTERY TERMINALS, ALARM ALERT, FULL PROTECTIONS ONE-YEAR WARRANTY, UPS-90W IDEAL FOR APPLE'S PC WITH MONITOR; UPS-200W IDEAL FOR IBM PC/XT/AT WITH MONITOR.

SHIPPING \$16.00 EA.
 SIZE: 4H x 6W x 9L



UPS-90W



UPS-200W

OEM WELCOME!

C64



SHIPPING:

FOR EA. POWER SUPPLY: \$6.00 IN CALIF.; \$8.00 IN OTHER STATES; \$18.00 IN CANADA. FOR EA. TRANSFORMER: \$6.00 IN ALL STATES; \$12.00 IN CANADA. CALIF. RESIDENTS ADD 6.5% SALES TAX.

MAILING ADDRESS:
 P.O. BOX 4296
 TORRANCE, CA 90510
 TELEX: 182558



SUNNY INTERNATIONAL
 IN BUSINESS SINCE 1975
 (213) 328-2425 MON-FRI 8:30-5:30



SHIPPING ADDRESS:
 22129 1/2 S. VERMONT AVE.
 TORRANCE, CA 90502

**TOLL-FREE
ORDERING:
800-222-8686**

**FOR TECHNICAL SUPPORT/
SERVICE / IN ARIZONA:
602-282-6299**

CCT[®] CUSTOM COMPUTER TECHNOLOGY

1 CCT PLAZA — P.O. BOX 4160 — SEDONA, ARIZONA 86340

Purchase your Hardware and Software directly from an OEM / Systems Integrator. Take advantage of our buying power! We stock a full line of Board Level Components, Software and Peripherals. Call for your needs. We'll give you the Lowest Prices, and the Technical Support and Know-How we are quickly becoming well-known for. Satisfied Customers Nationwide. The Nation's Custom Systems House for Business, Education and Science. Call for a system quote. CCT implements tomorrow's technology today!

• FOREMOST QUALITY • ADVANCED SUPPORT • REASONABLE COST •

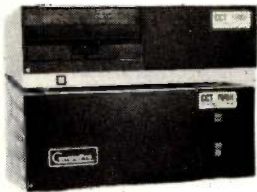

80286 NOW!

□ **CCT-286Z** is our model designation for the **MI-286** dual processor board from **Macrotech**. It features the super high speed combination of Z-80H and 80286, with provision for the 80287 math chip. Directly replaces 8085/88 and 8086 CPUs running CP/M, MP/M Concurrent DOS, and MS-DOS, at throughput increases of 3X to 5X!

SPECIAL PRICE - \$995
80287 Option - Installed - \$250

**SEE THE CCT-4 SERIES
USING THIS BOARD
DETAILED ON THE FACING PAGE**

NEW—TRUE IBM PC INTERFACE ULTRA HI-RES GRAPHICS!

CCT S-100/PC is a break-through for the Science/Business user. Mini-enclosure accepts PC & compatible boards and directly connects to your S-100 system, running PC-DOS or Concurrent DOS. Hercules™ Graphics System—Coming this May!
!! THE BEST OF BOTH WORLDS !!

LIBERTY TERMINALS

• Superior Reliability •

110-14" GREEN-80/132 Column \$499
110-14" AMBER \$519
200-14" GREEN-80/132 Super Deluxe \$569
200-14" AMBER \$589

OKIDATA PRINTERS - Top Quality

82 - 80 Col. \$329 83 - 132 Col. \$619
92 - 80 Col. \$429 93 - 132 Col. \$659
84 - 132 Col./200cps—Top of the Line \$799
For Serial Interfaces — Add \$100

TOSHIBA P351 - 288 CPS/24 PIN - \$1499

DIABLO — Letter Quality Series

Model 620 .. \$969 Model 630 .. \$1799

WE HAVE ALL SOFTWARE—CALL

\$ ACROSS THE BOARD PRICE REDUCTIONS \$

**INDUSTRIAL GRADE
SUPERIOR QUALITY**

CCT DISK DRIVE SYSTEMS

**ROLLS ROYCES OF
THE INDUSTRY**

S-100 HARD DISK SUBSYSTEMS

Professionally engineered ST-506 type systems for the business market S-100 Computer user. Includes industry top quality drives, CompuPro Disk 3 DMA controller, all cabling, A&T, formatted, burned-in. Provisions for up to two hard disks in each system. We include operating system update. CP/M 80, CP/M 86, CP/M 8-16, MP/M 8-16, CP/M 68K. (/1 Systems are CCT innovated hard/floppy combinations, with Mitsubishi DSDD 8" drive.) 12 month warranty.

CCT-10 (11 + MEG)	\$1499	CCT-10/1	\$2049
CCT-20 (22 + MEG)	\$2019	CCT-20/1	\$2569
CCT-40 (36 + MEG)	\$2499	CCT-40/1	\$3049
CCT-60 (58 + MEG) (New)	\$3699	CCT-60/1	\$4249
CCT-90 (87 + MEG) (New)	\$4909	CCT-90/1	\$5459
CCT-125 (123 + MEG) (New)	\$6099	CCT-125/1	\$6649

NEW 10 MEG REMOVABLE CARTRIDGE DRIVE SYSTEM
for hard disk back-up — DMA using Disk 3 controller.
Super fast/Ultra reliable — Available April

FLOPPY SYSTEMS

CCT-2.4 • Dual 8" DSDD

Mitsubishi 2.4 Megabyte in Extra Heavy horizontal enclosure, removeable filter air system, all cabling, A&T, Burned in. The fastest system available: \$1229

CCT-5 • 5 1/4" DSDD

IBM Compatible Tandon 320K. Extra Heavy Cabinet accommodates two drives, hard or floppy. All cabling, A&T, Burned-in. Perfect for our PC-DOS Package \$399

CCT-8/5 • FULL IBM COMPATIBILITY

One Mitsubishi 8" DSDD (1.2 Meg)/One 5-1/4" DSDD (360K) IBM Drive
Both 3ms step rate — For Concurrent DOS and PC DOS \$1029

★ SUPER PRICES ★ COMPUPRO COMPONENTS ★ IN STOCK ★

CPU-Z - \$229 • Disk 1A - \$399 • Disk 1A w/CP/M - \$499 • CPU 8086/10 - \$359 • SPU-Z - ?
CPU 8085/88 - \$229 • CPU 286 - \$849 • CPU 68K - 10Mhz - \$359
PC Graphics - \$399 • Disk 3 - \$459 • RAM 22 (256K) - \$1179 • RAM 23/64K - \$309/128K - \$579

NEW — M-Drive/H - 512K - \$599 / 2 Meg - \$2099

Enclosure 2 Desk - \$699/Rack - \$749 • Interfacer 3 - \$409 • Interfacer 4 - \$289 • System Support 1 - \$299
Concurrent DOS 8-16 (CCTCMX) - \$309 • CP/M 80 (CCTHMX) - \$125 • CP/M 86 (CCTTMX) - \$175
CP/M 8-16 (CCTTMX) - \$199 • CP/M 68K (CCTCX) - \$279 • Operating System Updates/Remakes - \$30

16 Bit Upgrade Kit: CP/M 86, RAM 23, System Support 1, Cable \$729 □ CP/M 8-16 - Kit - \$753

CCT-1 — ENTRY LEVEL S-100 BUSINESS SYSTEM

- Enclosure 2-Desk-21 Slot Mainframe •
- CPU 8085/88 - 6Mhz 8085/8Mhz 8088 •
- Disk 1A - DMA Floppy Disk Controller •
- RAM 23 - 64K Static RAM - 12Mhz •
- Interfacer 4 - 3 Serial/2 Parallel I/O •
- CCT-2.4-Dual 8" Mitsubishi DSDD Drive System - 2.4 Megabytes •
- CP/M 80 - 2.2 HMX - CCT Modified •
- All Cabling, Complete CCT Assembly, Testing, and Minimum 20 Hour Burn-in •

**SPECIAL PRICE
\$3,375**

RUNS ALL STANDARD 8" CP/M SOFTWARE - INCLUDES OUR EXCLUSIVE 12 MONTH DIRECT WARRANTY

Prices & availability subject to change. All products new, and carry full manufacturer's warranties. Call for catalog. Free technical help to anyone. All products we sell are CCT individually tested and set up for your system - Plug-In & Go! Arizona residents add sales tax. **CCT[®]** Trademark — Custom Computer Technology; **MS-DOS[®]** Trademark — Microsoft; **IBM[®]** Trademark — International Business Machines; **CompuPro[®]** Trademark — W.J. Godbout; **CP/M[®]** **MP/M[®]** Trademarks — Digital Research; **HERCULES[™]** Trademark — Hercules ComputerTechnology

100% GUARANTEED ICs - MONEY BACK!

1-800-245-2235

SPECIALS*

4164	250ns	.75
4164	200ns	9/11.50
41256	150ns	7.50

That's right! . . . 100% money-back guaranteed ICs at prices never before possible! Krueger Technology's unique patented IC removal process is the key to our ability to sell so low. The fact is, it costs less to retrieve and refurbish an IC from an obsolete PC board than manufacture a new one. Since we maintain an inventory in excess of six million ICs and process over 100,000 ICs per day (over thirty million in the past ten years) we can supply you with most, if not all of your IC needs.

Until this year our vast inventory of ICs was available to only manufacturers and distributors. The phenomenal growth of the catalog market has allowed us to open our inventory to you. You can now buy direct and cut out all middlemen.

Call today and discover what seven of the ten largest computer manufacturers already know . . . "The Krueger Alternative". Don't forget, you get an additional 30% discount on orders over \$500!

SPECIALS*

27128	450ns	5.00
Z80ASIO/O		3.75
FDC1793		5.00
68000G8		18.00

MISCELLANEOUS

DS0026	1.50	8155	2.00
AY5-1013	1.50	81C55	3.25
AY3-1015	1.50	8185	7.00
MC1408	1.00	8202	14.00
PR1472	2.00	8216	1.00
MC1488	.50	8224	3.00
MC1489	.50	8228	3.00
TR1602	2.00	8237	3.00
WD1691	5.25	8238	2.50
FD1771	6.50	8243	1.50
FD1791	10.00	8250	4.00
FD1795	10.00	8251	2.00
FD1797	10.00	8253	2.00
BR1941	2.50	8254	6.00
WD2143	5.25	8255	2.00
SY2158	1.75	8257	2.00
XR22XX	1.00	8259	2.00
INS2651	4.00	8272	4.00
COM2661	4.00	8273	10.00
CA3XXX	.50	8274	9.00
D3232	1.00	8275	9.00
D3242	4.00	8276	15.00
MC3470	1.50	8279	3.50
MC4024	2.00	8281	7.50
MC4044	2.00	8283	5.50
LF412	3.00	8284	2.00
CRT5027	5.00	8288	4.00
CRT5037	5.00	8291	20.00
TMS5501	12.00	8292	21.00
IM6402	2.00	DP8303	3.00
D7201	4.50	8304	1.75
SN754XX	.25	MC8501	15.00
SN76477	2.00	MC8504	2.00
SN76489	3.50	DM8556	3.00
D765	4.00	8741	10.00
Z8001	7.50	8748	10.00
8031	5.00	8755	19.00
8035	2.00	88XX	.50
8039	2.00	8TXX	.50
8050	2.00	8X300	6.00
8060	2.00	AY3-8910	2.00
8080A	1.50	AY3-8912	2.00
8085	2.00	AY5-9200	2.75
8086	4.00	FDC9229	4.00
8087-3	99.00	9517	3.00
8088	7.50	9602	.75
COM8116	5.00	96L02	1.50
DM8131	2.25	96LS02	1.50
DM8136	4.00	96S02	1.50

ADC/DAC*

ADC08XX	3.50
DAC08XX	1.50
DAC08	1.00
DAC80	8.00
1408	1.50

DYNAMIC RAMS

64K	150ns	1.50
64K	200ns	1.35
32K	(4332)	3.00
16K	120ns	1.00
16K	150ns	.75
16K	200ns	.50
16K	250ns	.35

STATIC RAMS

64K		6.00
(64Kx1, 16Kx4, 8Kx8)		
16K		2.00
(16Kx1, 4Kx4, 2Kx8)		
8K		2.00
2147, 2148, 2149		2.00
2114, 4044, 5257		.50
ECL RAMS, 93XXX		3.00
ALL OTHERS		1.00

30% DISCOUNT ON \$500 ORDERS

EPROMS

27128	300ns	6.00*
27128	250ns	7.00*
2764	450ns	2.50
2764	300ns	3.00
2764	250ns	3.50
68766		6.00
68764		6.00
2732	450ns	2.50
2732	300ns	3.00
2732	250ns	3.50
2716	650ns	1.35
2716	450ns	2.00
2716	350ns	2.25
2708		2.00
68708		4.00

CMOS

ANY 4000 SERIES	.25
ANY 4500 SERIES	.50

ECL

ANY 10K LOGIC	1.00
ANY 100K LOGIC	5.00

Z80 SERIES

2.5 MHZ	
CPU, CTC, PIO	1.00
DMA, DART, SIO	3.00
4.0 MHZ (A)	
CPU, CTC, PIO	2.00
DMA, DART, SIO	4.50
6.0 MHZ (B)	
CPU, CTC, PIO	3.00
DMA, DART, SIO	9.00

TMS 9900 SERIES

9901	1.50
9918	20.00
9980	10.00

ALL OTHER 99XX
3.00

*30% Discount does not apply

74 SERIES

74XX	.25	74SXX	.35
741XX	.35	74S1XX	.45
742XX	.50	74S2XX	.60
743XX	.50	74S3XX	.60
74LSXX	.25	74ALSXX	.35
74LS1XX	.35	74ALS1XX	.45
74LS2XX	.50	74ALS2XX	.60
74LS3XX	.50	74ALS3XX	.60
74FXX	.35	74HCXX	.35
74F1XX	.45	74HC1XX	.45
74F2XX	.60	74HC2XX	.60
74F3XX	.60	74HC3XX	.60
74HCTXX	.35		
74HCT1XX	.45		
74HCT2XX	.60		
74HCT3XX	.60		

6500/6800 SERIES

ANY 65XX	2.00
ANY 65XXA	2.50
ANY 65XXB	3.00
ANY 68XX	2.00
ANY 68AXX	2.50
ANY 68BXX	3.00
6810	.75

OUR POLICY

Delivery: Orders normally shipped within 2 business days. Add \$3 for UPS ground-5# & under. Add \$4 for UPS blue (air), 2# & under; for each additional air pound add \$1. Arizona residents add 6% sales tax.

Payment: Visa, MC, cashiers check, certified check, money order, personal check accepted (Allow 10 days for personal checks to clear.) No surcharge on credit card orders. CODs welcome with cash, certified check, cashiers check or money order. Add \$3 COD handling charge.

Pricing: Minimum order \$20. 30% discount on orders over \$500. Prices subject to change without notice. All items limited to stock on hand.

We reserve the right to limit quantities.

KRUEGER Technology, Inc.

2219 South 48th Street • Tempe, AZ 85282

800-245-2235

In Arizona 602-438-1570

HOURS: 7 a.m. - 5:30 p.m.
(MOUNTAIN TIME)
Monday Thru Friday





S-100 DIV./696 CORP.
14455 NORTH 79th ST.
SCOTTSDALE, AZ 85260
 Inquiry 359 for End-Users.
 Inquiry 360 for DEALERS ONLY.

SALES 800-528-3138
CUST. SERVICE/TECH. 602-991-7870
TELEX 9103806778 SONEHUND

Computer Systems

Please call w/ your System Requirements so that we may quote the configuration that best fits your needs.

- ADVANCED DIGITAL Call for Custom Configurations**
COMPUPRO 816/C-H40 w/ 5 1/4" x 8" FLPY'S \$6,795
COMPUPRO 816/10-H40 w/ Two 5 1/4" FLPY'S \$5,395
CALL FOR OTHER SYSTEM CONFIGURATIONS
CROMEMCO 10MHz 68000 UNIX-5 Systems
CS-100H50X20E 2Mb ECC RAM 50Mb H.D. \$13,849
CS-300H50X20E 2Mb ECC RAM 50Mb H.D.-Can Expand To 16 Users w/ 16Mb ECC RAM \$16,295
INTERCONTINENTAL MICRO SYSTEMS 12 User Hi-Speed 16 Bit System. Includes 1Mb Automatic Cache Buffer, Dual 8" Floppies, 25Mb Fixed and 25Mb Removable Hard Disk (Complete Back-Up in 5-10 Min.), 256K Ram Per User, Turbodos 1.41, NewWord Word Processor, w/ Spelling Checker & Merge Print \$19,095
MORROW PIVOT 256K RAM, PC-Compatible, Back-Lit Screen, Dual 5 1/4" DSDD DRVS., Modem, MS-DOS, NewWord, Etc. Etc. CALL
MORROW PIVOT 640K RAM CALL
MORROW MD3, MDT70 Terminal & HR15-XL Printer and all Bundled Software \$1,845
MORROW MD5, MDT70 Terminal & HR15-XL Printer and all Bundled Software \$2,025
MORROW MD11, MDT70 Terminal & HR35-XL Printer and all Bundled Software \$2,979
MOTOROLA 16 User MEGAFRAME with Parallel Processing, UNIX System 5 & VAX 750 PWR. CALL
ZENITH 150-PC COMPATIBLE SEE PAGE 298

S-100 Bus Boards

- If you purchased before calling us, you probably paid too much! We stock **ACKERMAN DIGITAL, ADVANCED DIGITAL, CCS, COMPUPRO/VIASYN, CROMEMCO, ELECTROLOGICS, HUDSON, INTERCONTINENTAL MICRO SYSTEM, KONAN, MORROW, MULLEN COMPUTER, NORTH STAR, PICKLES & TROUT, SYNTECH DATA, TARBELL, TECMAR, TRANSEND**
 A Few Of This Month's SPECIALS Are:
COMPUPRO/VIASYN RAM 23, 128K STATIC \$495
COMPUPRO/VIASYN RAM 22, 256K STATIC \$1,090
COMPUPRO/VIASYN PC-VIDEO BOARD \$395
ELECTROLOGIC 64K CMOS STATIC RAM BD. \$175
ELECTROLOGIC QUASI-DISK 2Mb RAM-DISK \$995
SYNTECH DATA SYS. XRAM-IV EDC 256K \$1,295

PC-Slave Boards

ADVANCED DIGITAL PC-SLAVE W/256K, 8 MHz 8088 CPU, 2 S Ports, RTNX S/W-For Multi-User PC \$750

PC-Multifunction Boards

- We Have a Good Selection of Multifunction and Memory Boards for PC, XT, AT, JR, AT&T, and PC Portables.
STB RIO PLUS II/PC & XT 384K \$369
STB BIG BYTE 384K \$269
STB GRANDE BYTE/PC-AT 2.5Mb \$1,419
STB RIO GRANDE/PC-AT 1.5Mb, 2 S, P, & G \$1,095
TECMAR CAPTAIN 384K w/Treasure Chest \$259
TECMAR JR. CAPTAIN 128K w/Treasure Chest \$269
TECMAR RGB Long Persist Phos. 640x480 \$525
TECMAR WAVE 256K Fits XT Short Slot \$219
TECMAR MAESTRO 2.5Mb \$675
TECMAR EXPANSION CHASSIS w/8 Slots \$649
TECMAR DYNAMIC MEMORY 256K \$99

PC-Video/Graphics Boards

- STB GRAPHICS PLUS II w/ Paral. PRT Port \$269**
STB MONO PLUS II w/ Paral. PRT. Port \$169
STB SUPER RES 400 16 Color Hi-Res \$399
TECMAR GRAPHICS MASTER 16 Color Hi-Res \$439
TECMAR GRAPHICS TENDER RGB/PRT. PORT \$195

PC-Scientific/Industrial Boards

- TECMAR IEEE-488 Board \$259**
TECMAR DADIO D To A Up to 24 Devices \$259
TECMAR VIDEO VAN GOGH with Software to Digitize TV Images \$275
TECMAR E+EEPROM PROGRAMMER/READER \$309
TECMAR E+EEPROM EXPANSION 192K Ext. \$375
TECMAR E+EEPROM SOFTWARE \$59
TECMAR BASE BOARD 96 Digital I/O Lines \$225
TECMAR LABMASTER w/ TM40 Option \$685

PC-Data Security

WESTERN DIGITAL WD200 w/ Encrypt-Decrypt S/W - Absolute Security For Stored or Transmitted Files. Can Be User Transparent & Automatic. \$139

Floppy Disc Drives

- TANDON 100-24 \$125**
SANYO BF5-540D \$99.95
TEAC FD55B & MITSUBISHI 4851 \$99.95
MITSUBISHI 2896, QUME 242, TANDON 842-E \$369
MITSUBISHI 2894 & QUME 842 STD. 8" \$395

Hard Disc Subsystems

Using **AMCODYNE, MAXTOR, MITSUBISHI, QUANTUM & RODIME** Drives. **SEE PAGE 60**

Chips

We Have Some of the **LOWEST PRICES** in the Nation!!
INTEL 8087, 80287 MATH CO-PROC. CALL
64K and 256K RAM CHIPS CALL

Modems

- PROMETHEUS PROMODEM 1200** Hayes Compatible w/ Built-In PWR Supply-RS232 Stand Alone Unit \$295
OPTIONS FOR PROMODEM 1200 ARE:
OPTION: PROCESSOR \$75
OPTION: 64K MEMORY \$35
OPTION: ALPHANUMERIC DISPLAY \$79
PROMETHEUS 1200A Apple II, II+, IIe Card w/Terminal Software in ROM \$295
PROMETHEUS 1200B Card for PC Compatibles with Promcom Software \$265
PROMETHEUS 1200M Stand Alone MAC Modem with Cable and Communications Software \$348
U.S. ROBOTICS PASSWORD 1200 \$235
U.S. ROBOTICS AUTO DIAL 212A CALL
U.S. ROBOTICS S-100 BOARD 300/1200 \$295
U.S. ROBOTICS PC MODEM W/Telpac Software \$249
U.S. ROBOTICS PC MULTI-FUNCTION MODEM with Clock-Cal Battery Back-Up, Printer Port, 64K-256K RAM, Telpac Software \$459
U.S. ROBOTICS COURIER 2400 Baud Modem \$499
HAYES SMART MODEM 1200, RS-232 \$449
HAYES SMART MODEM 2400, Universal \$669

Monitors & Terminals

- AMDEK 300G/300A \$129/\$139**
AMDEK 310 AMBER For PC w/ 3 Yr. Warranty \$159
AMDEK 710 Ultra Hi-Res RGB Color \$595
TATUNG CM-1322 640X400 RGB Monitor - SAMEAS THEY MAKE FOR IBM \$395
TATUNG CM-1360 RGB w/ GRN./AMB Switch \$419
TATUNG CM-1370 720X480 31.5KHz Scan RGB Monitor with Green Switch \$499
TAXAN MONITORS Call for Low Prices
TECMAR 640X480 RGB w/ Green Switch \$519
ZENITH ZVM122A AMBER Non-Glare \$89
ZENITH ZVM123A GREEN Non-Glare \$85
ZENITH ZVM135 HI-RES RGB w/ Green Switch \$459
LIBERTY TERMINALS w/Variable Scrolling, Green, Amber, 14", DEC Compatibility Extra Pages of Memory, and Graphics Options in Stock at Unbeatable Prices
TATUNG TVT-7210 Terminal 14" GRN. EMUL. TVI924 & LSI ADM31 w/ Prog.Keys & ERGO Design \$569
TATUNG TVT-7220 Same Features But DEC VT220, 100 & 50 Compatible \$599
WYSE 50 / 75 TERMINALS In Stock \$489/\$649
ZENITH Z29/Z49 TERMINALS \$649/\$895

Printers & Plotters

- EPSON LX80, RX100+, FX80+, FX100+, LQ1500 \$249**
OKIDATA New 182 Quiet 120 CPS & 60 CPS
 We Also Stock OKIDATA 92, 93 & Accessories
COMREX 425 420 CPS DATA to 107CPS NLQ CALL
BROTHER HR-15-XL 17CPS Daisywheel S or P \$365
BROTHER HR-35 36 CPS Daisywheel S or P \$849
BROTHER HR-10 12CPS Daisy w/ TRAC., S&P \$299
BROTHER 2024L 24 PIN TOSHIBA TYPE PRT. \$935
BROTHER M1009 50CPS Dot Matrix 6.6 Lbs. \$195
BROTHER Tractor & Cut-Sheet Feeders CALL
TEXAS INSTRUMENTS 800 SERIES CALL
NEC DATASOUTH DIABLO Available Upon Request
HOUSTON INST. PLOTTERS & DIGITIZERS CALL

Printer Buffers

- JOHNATHON FREEMAN UPB 64K FORMERLY TTX** in and/or Out Serial and/or Parallel \$169
PRACTICAL PERIPH. MICROBUFFER 64K CALL

Testing Devices & Software

- DATACOM TRI-STATE RS232 V.24 Breakout \$175**
RID-DYMEK FLYP DRV DIAGNOSTIC DISKETTE \$25
FLUKE 77 DVM w/ Holster \$119

Networking & Switch Boxes

- STANDARD DATA STANDARD NET LAN** for PC's Includes Manual 10' Cable & Board \$598 ea.
INTERCONT. MICRO SYS LAN-PC w/o RAM \$469
INTERCONT. MICRO SYSTEMS LANS-100 \$359
COMPUPRO/VIASYN NET 11 For 816/10 Sys. \$425
COMPUPRO/VIASYN NET 101-96 For S-100 Bus \$425
GILTRONIX MANUAL AND AUTOMATIC SWITCHING UNITS To Fit all of Your SHARED Printer, Terminal, Modem and Other Peripheral Needs. **From \$79**

Software

We Have Access to all Well Known Brands - **ORDER CORRECTLY - SOFTWARE IS NOT RETURNABLE!**

Accounting

- REAL WORLD GL, AP, AR, PR, OE, INV, SA \$425**
STAR SOFT'S Accounting Partner CP/M80 \$235

Spreadsheets & Integrated Pkgs.

- ASHTON-TATE Framework CALL**
MICROSOFT Multiplan \$129
MDBS Knowledgegerman \$319
SORCIM Supercalc-3 Better Than 1-2-3!!! \$209

Operating Systems & Utilities

- DIGITAL RESEARCH Complete Line up to 35% Off**
COMPUPRO/VIASYN CPM at Affordable Prices
CENTRAL POINT SOFTWARE Copy II PC \$35
CROMEMCO COMPLETE LINE at GOOD ECONOMIES

Languages And Tools

- DIGITAL RESEARCH Most Products in Stock CALL**
MICROSOFT Complete Line CALL
BD SOFTWARE "C" Compiler 8" SS SD \$95
LATTICE "C" Compiler (Ask About Options) \$299
COMPUTER INNOVATIONS C-86 "C" Compiler \$299
COMPUIVIEW Vedit-86/Vedit-MSDOS \$150/\$120

Data Base Managers

- DATA ACCESS Dataflex Multi-User BEST PRICE**
ASHTON-TATE dBase II & III \$275/\$385

Graphics And CAD

- VECTRIX Graphics Systems Utilize 9 Bit Planes and have 384K RAM to Operate Independently of Host Video Controller and RAM Memory**
VECTRIX VX/PCA BD. SET - 512 Colors \$1,995
VECTRIX VX384A Stand Alone RS232 Co-proc. \$3,395
VECTRIX VX1307 13" RGB Analog Monitor \$1,295
VECTRIX VX/PCB 512 \$2,595
VECTRIX VXTB 11"x11" Graphics Tablet \$895
DIGITAL RESEARCH DR. GRAPH AND DRAW \$189
MICROPRO CHARTSTAR CALL

Communications

- MYCROFT LABS MITE AND MITE PLUS From \$79**
MICROSTUF CROSS TALK XVI \$98

Word Processors

- NEWSTAR NEWWORD w/ Money Back Guar. \$95**
MICROPRO PROPAK 8" CP/M86 \$239
OASIS THE WORD PLUS Spelling Checker \$49

Power Solutions

- SOLA MINI UPS 750 Watt Sine Wave HIGH INRUSH (4500 Watt) CALL**
TRIPPLITE LC-1800 Conditioner/Stabilizer \$215
TRIPPLITE BC-425-FC 425 Watts 15-20 Minutes \$449
TRIPPLITE SB-400 Watt w/ 30 Min. Back-Up \$459
TRIPPLITE ISOBAR Line Suppressor-Filters from \$40

Mainframe & Drive Enclosures

- INTEGRAND 2915 - 2 5/4" Winchester DRVS \$144**
INTEGRAND 1100 7 Slots and 2 X 8" Drives \$475
PARA DYNAMICS 2810 MINI-PRONTO \$798
PARA DYNAMICS 3820S PRONTO \$1,150
PARA DYNAMICS 4500D To 4 Sequenced H.D. \$675
MESA POWER SYSTEMS 5401 5 1/4" Hard Disk \$209
MICROWARE 511001 Dual Hor. 1/4 Ht. 5 1/4" FIPY \$75

Diskettes & Cartridges

- DYSAN Hard Disk Cartridges 5 1/4" & 8" \$99/\$145**
DYSAN DISKETTES Low Prices From \$19.50
FUJI FILM FLOPPY DISKS Low Prices From \$18.50
3M TAPE CARTRIDGES 300XL & 600A in Stock \$29.95

FULL DEALER SUPPORT
VISIT OUR SHOWROOM
HRS. 8:30 AM - 5:00 PM M-F

All merchandise new. Advertised prices are cash prepaid only. MC, Visa & P.O.'s from qualified firms - add 3%. Wires, COD's (\$5 min. fee) with Cashiers Check/MO., & APO's accepted. Shipping: minimum \$4 first 3 lbs. Tax: AZ RES ONLY add 5% sales tax. All returns subject to 20% restocking fee. Retail prices slightly higher.



THE CLASSIC

BYTE T-SHIRT

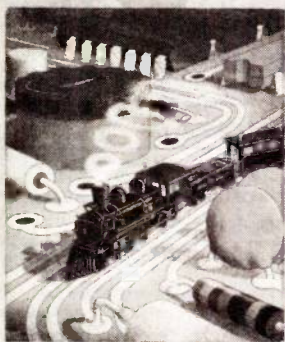
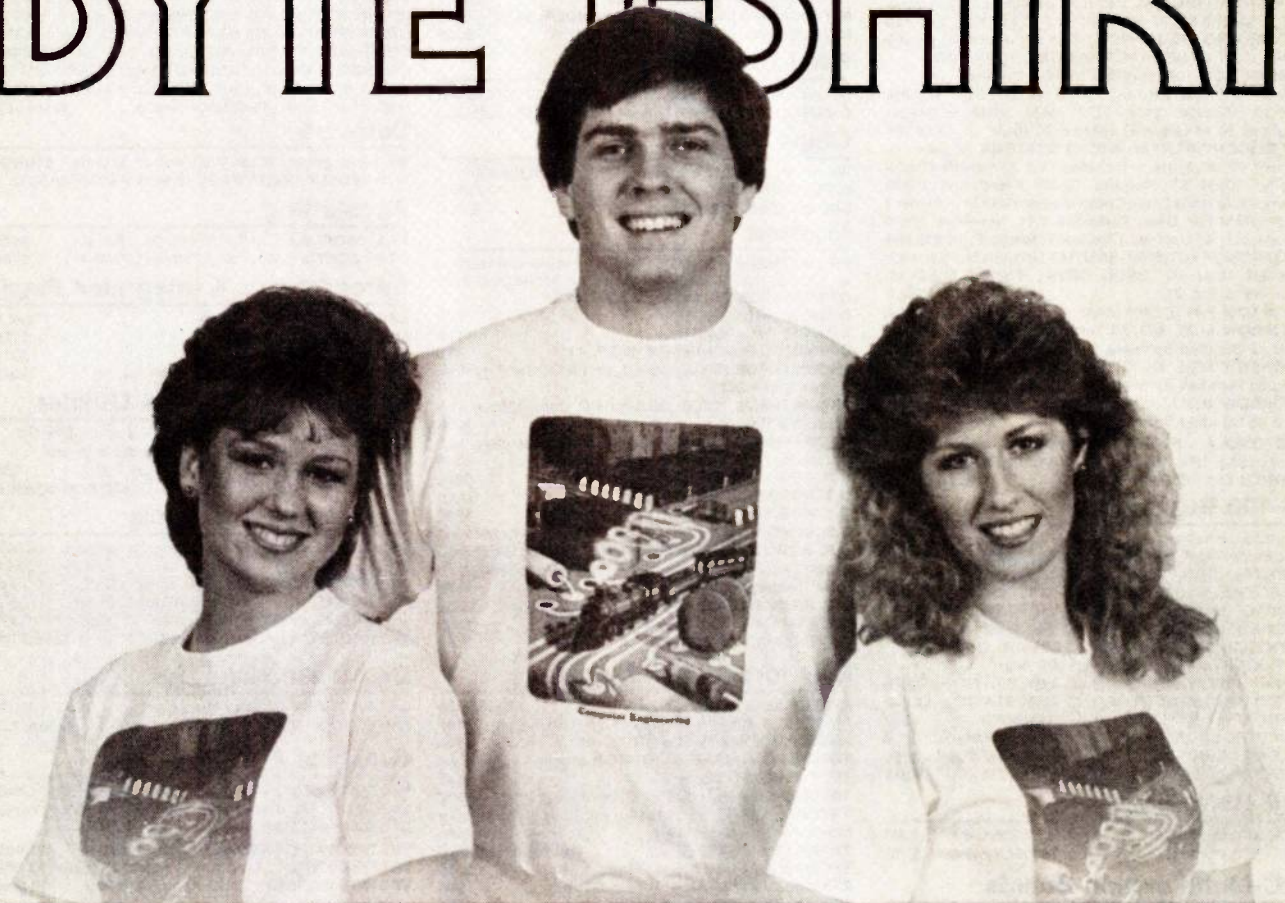

"COMPUTER ENGINEERING" – July 1977 Byte Cover

One of the truly classic Byte covers —and boy, does it look great on a T-shirt! The vivid colors really jump out. But don't mistake this for one of those rubbery patches that crack and peel off after a few washings. This is true four-color process: the inks are silk-screened into the fabric of the shirt, resulting in a beautiful, full-color image that lasts.

You'll also appreciate the shirt itself: a real heavyweight made of 50% cotton, 50% polyester. You'll enjoy cotton comfort in a tough shirt that keeps its crisp, fresh look through many washings—with almost no shrinking! The price for each Byte Classic T-Shirt is only \$9.50 (\$8.50 each for 3 or more). Your order will be shipped within a week.

Please send me the following T-shirt(s) at \$9.50 each, or \$8.50 each for 3 or more. I have included \$2.00 for shipping and handling.

Qty.	Size	Amount
_____	Adult—Extra Large	\$ _____
_____	Adult—Large	\$ _____
_____	Adult—Medium	\$ _____
_____	Adult—Small	\$ _____
_____	Child—(sizes 10-12)	\$ _____
	Shipping and Handling	\$2.00
	(Overseas add \$3.00)	\$ _____

TOTAL \$ _____

I have enclosed check or money order.

VISA MasterCard Send Dealer Info.

Card #: _____

Exp. Date: _____

Ship my T-Shirt(s) to:

Name: _____

(Business): _____

Address: _____

City: _____

State: _____ Zip: _____

Mail this coupon to:

Robert Tinney Graphics
1864 North Pamela Dr.
Baton Rouge, Louisiana
70815

For VISA or MasterCard Orders
or for more information
Call 1-504-272-7266



SINCE 1977

Computer Discount Products

Monthly Mail-Order Listing
For Apple, IBM & Macintosh Users

Retail Showrooms In California:
San Jose • San Mateo • San Francisco

WE PAY SHIPPING*
Get The Details Below!!

UTILITIES & ENHANCEMENTS

Ap	BEAGLE D/Code/GPLE	ea29.99
Ap	Dos Boss	15.99
Ap	Fat Cat	21.99
Ap	EASTSIDE Wildcard 2	111.99
Ap	VIDEX Enhancer II	99.99
Ap	Function Strip	31.99
Ap	Hardswitch	14.99
Ap	PSIO	145.99
Ap	Soft Video Switch	25.99
Ap	Ultraterm	229.99
Ap	VideoTerm w/Softsw.	175.99
IBM	GET ORGANIZED	149.99
IBM	NORTON UTILITIES	55.99
IBM	SIDEKICK	35.99
IBM	SIDEWAYS	39.99
IBM	QUADRAM Quadink	399.99
IBM	PCjr Expans. Chassis	549.99
IBM	Quadsprint	499.99
IBM	Quadvue Monochrome	299.99
Ap/IBM	BORLAND Turbo Pascal	35.99
Ap/IBM	Toolbox/Tutor	ea29.99
	Copy II + /PC/MAC	25.99

GRAPHICS

Ap	BEAGLE Graphics	35.99
Ap	Triple Dump	27.99
Ap	BRODERBUND Dazzle Draw	44.99
Ap	Graphics Library	18.99
Ap	Print Shop	29.99
Ap	FONTRIX	59.99
Ap	PENGUIN Complete Graphics	49.99
Ap	Graphics Magician	37.99
IBM	FONTRIX	99.99

THE NEWSROOM - Ap 39.99

APPLE PREBOOTS

Apple Writer	14.99
Apple Writer for Ultraterm	23.99
Visicalc	39.99
Expansion	66.99
Visicalc for Ultraterm	54.99

Home & Business SOFTWARE

Ap	ASCII Express	84.99
Ap	CONTINENTAL Hm. Acct.	44.99
Ap	Tax Advantage	139.99
Ap	FINANCIAL COOKBOOK	39.99
Ap	MONOGRAM Dollars/Sense Ile	69.99
Ap	Forecast	49.99
Ap	PFS Rept, File, Graph, Write	ea79.99
IBM	ASCII Express Pro	139.99
IBM	ASHTON-TATE dBase II	289.99
IBM	dBase III/Framework	389.99
IBM	CONTINENTAL FCM	71.99
IBM	Home Accountant +	84.99
IBM	Tax Advantage	45.99
IBM	LOTUS 1-2-3	299.99
IBM	MONOGRAM Dollars & Sense	109.99
IBM	PFS Rept, File, Graph, Write	ea89.99
Ap/IBM	MICROSOFT MULTIPLAN	169.99
Mac	CONTINENTAL Hm. Acct.	63.99
Mac	FILE VISION	139.99
Mac	MICROSOFT Basic	94.99
Mac	Chart	74.99
Mac	File/Multiplan	ea129.99
Mac	MONOGRAM Dollars & Sense	94.99
Mac	Forecast	59.99
Mac	PFS File or Report	ea79.99
Mac	File AND Report	155.99
Mac	THINK TANK 128K	115.99

WORD PROCESSING

Ap	BANK STREET Write/Spell	ea43.99
Ap	KENSINGTON Format II	99.99
Ap	MICROPRO Wordstar	189.99
Ap	Wordstar Pro w/CP-M	265.99
Ap	SENSIBLE SPELLER	79.99
Ap	SIERRA HomeWord	44.99
Ap	Screenwriter II	89.99
IBM	BANK STREET Writer	49.99
IBM	LIFETIME Volkswriter Deluxe	159.99
IBM	MICROSOFT Word w/Mouse	289.99
IBM	MICROPRO Wordstar 2000	259.99
IBM	Wordstar 2000 Plus	325.99
IBM	Wordstar PCjr	149.99

PRINTERS & MONITORS

TAXAN

#115 Green 12" - Apple	129.99
#116 Amber 12" - Apple	139.99
#121 Green 12" - IBM	149.99
#122 Amber 12" - IBM	159.99
#220 Color Composite	289.99
#420 Hi-Res RGB 12"	399.99
#425 RGB With Audio 12"	459.99
#440 Ultra Hi-Res 12"	599.99
#555 RGB Card For #440	299.99

OKIDATA 92 with Plug/Play 459.99

EPSON

FX-80 + 160 CPS	375.99
FX-100 + 160 CPS - Wide Carriage	559.99
LX-80 100 CPS - Near Letter Quality	249.99
FINGERPRINT for EPSON	44.99

PGS

HX-12 Hi-Res RGB 12"	459.99
MAX-12E Amber 12"	179.99
SR-12 Super Hi-Res RGB 12"	599.99
Scan Doubler	299.99

USI Pi 4 Apple Amber 99.99

EDUCATIONAL

Ap	BARONS SAT	59.99
Ap	CBS SAT	94.99
Ap	DLM Alien Add/Minus Mis.	ea21.99
Ap	Alligator/Dragon Mix	ea21.99
Ap	HLS Crossword Magic	39.99
Ap	LEARNING CO. Rocky Boots	31.99
Ap	Robot Odyssey	31.99
Ap	SPINNAKER Grandma	19.99
Ap	Kids On Keys/Kidwriter	ea19.99
Ap	Sum Ducks/Trains	ea24.99
Ap/IBM	LEARNING CO. Add. Magic	27.99
Ap/IBM	Magic Spell/Number Stump	25.99
Ap/IBM	Moptown/Reader Rabbit	ea25.99
Ap/IBM	SPINNAKER Facemaker	19.99
Ap/IBM	Presidents Choice	25.99
Ap/IBM	Snooper Troops	28.99

ENTERTAINMENT

Ap	CHAMPION Lode Runner	24.99
Ap	SIR TECH Knight of Diamond	34.99
Ap	Wizardry	34.99
IBM	GATO	29.99
IBM	MASTERTYPE	32.99
IBM	SIR TECH Wizardry	44.99
Ap/IBM	BRODERBUND Lode Run.	24.99
Ap/IBM	ELECTRONIC ARTS Archon	29.99
Ap/IBM	Pinball/Music/Skylox	ea29.99
Ap/IBM	FLIGHT SIMULATOR	35.99
Ap/IBM	SARGON III	31.99
Ap/IBM	TRILLIUM/Rama/Fahrenheit	25.99
Ap/IBM	ULTIMA II or III	ea44.99
Ap/IBM	WINDHAM Swiss Fam. Robin	18.99
Mac	BRODERBUND Lode Runner	27.99
Mac	MAC FUN PAK	31.99
Mac	MAC VEGAS	47.99
Mac	SIERRA Frogger	29.99
Mac	TRIVIA FEVER Vol. 2	19.99

INFOCOM - Ap, IBM & MAC

Hitchhiker	
Cutthroats	
Seastalker	ea27.99

HARDWARE

Ap	CDP 16K Ram Card	39.99
Ap	Parallel Interface w/Cable	39.99
Ap	DAN PAYMAR Lower Case 1	25.99
Ap	Lower Case 2, Rev 7	19.99
Ap	EXTENDED 80 Col. Card-Ile	129.99
Ap	JOYSTICK Kraft or TG	39.99
Ap	KENSINGTON System Saver	65.00
Ap	KOALA Touch Pad	75.99
Ap	MICRO-SCI A-2 Drive	195.99
Ap	MOCKINGBOARD Sound	79.99
Ap	Speech Chips	79.99
Ap	Sound AND Speech - Ile	145.99
Ap	Sound AND Speech - Ilc	145.99
Ap	ORANGE MICRO Grappler +	99.99
Ap	Buffered Grappler	159.99
Ap	THUNDERCLOCK	109.99
Ap	TITAN Accelerator Ile	219.99
Ap	Neptune 64K	199.99
IBM	AST Six Pack Plus 64K	245.99
IBM	KENSINGTON PC Saver	29.99
IBM	Masterpiece	100.00
IBM	KOALA Touch Pad	89.99
IBM	PLANTRONICS Color + Board	375.99
IBM	QUADRAM 512 + 64K	229.99
IBM	ERam 80	129.99
IBM	Microfazer 8K-All Config.	139.99
IBM	Quadboard I or II-No K	219.99
IBM	Quadboard I	195.99
IBM	Quadcolor Upgrade to II	199.99
IBM	TEAC 1/2 Height Drive #58B	159.99

VIDEO 7

RGB 80/64 Ile	189.99
Slot 7 RGB Card II + e	109.99
RGB Adapter Ilc	149.99
Mapper Connector	39.99

MODEMS

HAYES 300 Baud	209.99
1200 Baud	474.99
1200B for IBM	359.99
Micromodem Ile	239.99
NOVATION Appletalk II 300 Bd.	198.99
Expansion Module	29.99
JCat	104.99

DISKETTES - STORAGE & MORE

DYSAN 5 1/4" SS/DD	24.99	LIBRARY CASE Holds 10	1.99
5 1/4" DS/DD	31.99	PRINTER STAND - Regular	24.99
MAXELL 5 1/4" SS/DD	18.99	Tilted	29.99
VERBATIM 5 1/4" SS/DD	21.99	PRINTER STAND - Large	29.99
5 1/4" DS/DD	27.99	Tilted	32.99
3 1/2" For MAC	32.99	RIBBONS Epson MX/FX80	4.99
AMARAY 5 1/4" Disk Bank System	22.99	Epson MX/FX100	7.99
5 1/4" Disk Bank Singles	4.99	Oki 82,83,92,93 & Gemini	2.99
Media Mate 50-5 1/4" Original	14.99		
Media Mate 30-3 1/2"	11.99		
FLIP 'n FILE 50-5 1/4" Original	14.99		
50-5 1/4" With Lock	25.99		

\$CALL

For Diskette Case PRICING!!

Computer Discount Products

860 So. Winchester Bl., San Jose, CA 95128

(408) 985-0400 FROM 8AM PST

Inquiry 101

Purchase Order Prices Differ - Call First • Prices Subject To Change • Software Sales Final
Please Allow Time For Personal Checks To Clear - ★ We Reserve The Right To Charge For Freight On Orders Less Than \$100
U.S. Mail - \$10 Minimum Chg. • Hardware Shipping - \$CALL

**ALL SOFTWARE SHIPPED
FREIGHT FREE***
No Charge For Credit Cards
Guaranteed Fair Pricing

ORDER # B-6

IBM AT 3Mb COMBO CARD WITH LIFETIME WARRANTY*



The AT Multifunction Card that can give you up to 3Mb of added memory plus added I/O features.
 Expandable from 128K to 3Mb. Add memory as you need it. • IBM AT Compatible • Parallel Port • Serial Port • Spooler • Supports IBM VDISK • User Upgradeable • Parity Checking Standard • Split Memory Addressing.
 Complete with 128K RAM, Serial and Parallel Port **\$449**
 AT RAM Expansion Card (0K) **\$129**
 Additional RAM available at our low prices. **OTHER ADD ONS 384K:**
 RAM: Clock, 512K RAM Card, Spoolers, RAM Cards for PPCs and more.



4401 So Tamarac Parkway / Denver, CO 80237 / 303/741-1778
 ORDERING AND DEALER INFORMATION
 800/525-7674
 Stores in Denver & Chicago / *On all cards sold after June 1, 1984

Inquiry 31

"KING OF THE ELECTRONICS JUNGLE"



LEO ELECTRONICS, INC.
 P.O. Box 11307
 Torrance, CA 90510-1307
 Tel: 213/212-6133 800/421-9565
 TLX: 291 965 LEQ UR
 FAX: 213/212-6106

MEMORY EXPANSION CHIPS

RANDOM ACCESS MEMORY			
	PRICE EACH	SET OF 8	SET OF 9
4164-150ns	1.90	\$14.40	\$ 16.20
4164-200ns	1.80	\$15.20	\$ 17.10
4128-150ns (IBM/AT)	13.65	—	\$122.85
41256-150ns 256K	7.50	\$60.00	\$ 67.50
HM6116P-3	3.50	\$28.00	—

EPROMS	PRICE
2716	\$ 2.80
2732	\$ 3.50
2764	\$ 4.50
27128	\$ 7.00
27256	\$15.00

WE NOW CARRY:
 Disk drives, Power supplies,
 384K Multifunction boards,
 Colorgraphic boards, and
 more.
CALL FOR BROCHURE

We accept checks, Visa, MasterCard. Purchase Orders from qualified firms and institutions. U.S. funds only. Call for C.O.D. California residents add 6% tax. Shipping is UPS. Add \$2.00 for ground and \$3.00 for air. All major manufacturers. All parts 100% guaranteed. Pricing subject to change without notice. Call for volume pricing.

Inquiry 246

DISKS AS LOW AS 72¢ SS/DD BULK

Made by top USA makers, not "low-end" or "cut-rate". Our suppliers won't allow us to reveal their names, but when you receive them you'll recognize them as disks that sell for much, much more! **Certified, guaranteed 100% error free. MONEY BACK SATISFACTION GUARANTEE!** Full one year replacement warranty!
RFS Z80A99 211450 4164-150 1.44
 112 Z80A-PID 1.50 270877 8251 2.50
ICS UP0765 9.99 2716 (5v) .99 8235 2.50
 210750 4116-200 .34 50256 9.99

Pay by MC/Visa/Amex, CDD, or send check with order. We charge **all** UPS/Postal shipping, no handling charge on **all** orders. Include daytime phone number and STREET address. Minimum order \$15.
Money-back 30 day satisfaction guarantee!
(800)343-0472 IN MASS: (617)UNT-TECH*
UNITECH 203 HURLEY ST. CAMBRIDGE, MA 02141
 Send for FREE CATALOG listing 1000's of items!

Inquiry 412

5 1/4" FLOPPY MOTORS

Now Buehler OEM replacement spindle motors for all major 5 1/4-inch, full-height floppy disk drives are available for fast delivery. Built to exact OEM size, performance and quality standards. Pulleys included.

For details and prices, contact:



Buehler Services, Inc.
 P.O. Box A, Hwy 70-E
 Kinston, NC 28501
 Phone: 919/522-4300

Inquiry 31

RAM Memory Expansion Kit 4264/4164 Compatible Fits Major PC Brands



Free Shipping! FACTORY DIRECT HIGHEST QUALITY!

MICRON DRAMS	LIST	OUR PRICE!
9 64K DRAMS	\$ 25.	\$ 20.
9 128K DRAMS	\$359.	\$125.
9 256K DRAMS	\$369.	\$149.

150 ns Access Time

MICRON TECHNOLOGY, INC. Marketing Department
 2805 E. Columbia Rd.
 Boise, Idaho 83706

(208) 386-3900 TWX 901-970-5973
IMMEDIATE SHIPPING!
 VISA, MasterCard, Certified Check, COD & Money Orders

Inquiry 282



Sure it's insured?

SAFWARE® Insurance provides full replacement of hardware, media and purchased software. As little as \$39/yr. covers:
 • Fire • Theft • Power Surges
 • Earthquake • Water Damage • Auto Accident
 For information or immediate coverage call:
1-800-848-3469
 In Ohio call 1-614-262-0559



SAFWARE, The Insurance Agency Inc.

Inquiry 362

TAPE WORLD

1-800-245-6000

maxell.		Dysan	
It's Worth It			
MD-1	5 1/4" SSDD	1.39	104/1D 5 1/4" SSDD 1.89
MD-2	5 1/4" DSDD	1.99	104/2D 5 1/4" DSDD 2.69
FD-1	8" SSDD	2.69	3740/1D 8" SSDD 2.69
FD-2	8" DSDD	3.29	3740/2D 8" DSDD 3.29
MF-1	3 1/2" MICRO	2.99	
MD2-HD	5 1/4" DSHD	4.99	
MEMOREX			
	5 1/4" SSDD	1.69	
	5 1/4" DSDD	1.99	
BASF			
	5 1/4" SSDD	1.34	
	5 1/4" DSDD	1.54	
VERBATIM			
	5 1/4" SSDD	1.69	
	5 1/4" DSDD	2.39	
SCOTCH			
	5 1/4" SSDD	1.49	
	5 1/4" DSDD	1.99	
ELEPHANT			
	5 1/4" SSDD	1.59	
	5 1/4" DSDD	2.19	

WE WILL BEAT ANY PRICE BY 3%
 Factory Sealed. Shipping 3.75 any size order.
 Pre-paid, COD, or credit card. COD add 1.95
SCHOOLS & GOVT. ON PO.
 Also, TDK, and Maxell audio and video cassettes.
 220 SPRING ST. BOX 361 BUTLER, PA 16001
 412-283-8621 M-Fri. 8:30-5:00

Inquiry 400

Microprocessor Software Development on VAX or PDP-11.



You can develop software for Z80, 8080, 8085, NCS800, and 8086 using native mode compilers and assemblers.
 Use low-cost cross tools for other microprocessors. Interface in-circuit emulators perfectly. You can run Intel development tools under ISIS or UDI.
 Our plug-in processor cards let you run CP/M-80, CP/M-86, or MS-DOS from any terminal on your VAX or PDP-11 system.
 Prices start at just \$1295. Ask for our FREE catalog of 350 development and cross development tools.

Decmation 3375 Scott Blvd., Suite 236
 Santa Clara, CA 95054
 (408) 980-1678
 Registered Trademarks: VAX, VAX-Digital Equipment Corporation, CP/M-80, 80, Digital Research, MS-DOS-Microsoft Corporation, ISIS, UDI-Intel
 We are not connected with Digital Equipment Corporation.

Inquiry 135

Verbatim®

Data Life Diskettes
 Lifetime Warranty

	Catalog #	Box of 10
5 1/4" SSDD	18158	\$15.50
5 1/4" DSDD	18188	\$19.95
5 1/4" DSDD	18239	\$28.50

Minimum Quantity 100
Disk Drives
 5 1/4" 1/2 heights

TEAC 55B	\$119
Panasonic/Shugart	\$109
3 1/2" SS Shugart SA 300	\$110 limited quantity

Kimtron KT-7* Terminal

Compatible to Televideo® 925 5545
 Also carry complete line of computer products
MICROSCRIBE, INC.
 3350 Scott Blvd., Bldg. 15 Santa Clara, CA 95054
 Call M-F 8:00 - 5:00 (408) 748-1333

Inquiry 284

Sav-On Computers 800-345-7100

ORDERS INSIDE CALIF — 213-675-2115

CUSTOMER SERVICE & TECHNICAL HELP — 213-675-2382

WE HAVE THE LOWEST PRICES IN BYTE — WE HAVE MOST ITEMS IN STOCK AND WE WILL BEAT ANY ADVERTISED PRICE ON THE SAME TERMS!

DISK DRIVES TEAC 55B ½ HIGH DRIVE \$95.00 55A 169.00 55F CALL	DISK DRIVES TANDON 100-2 FULL HEIGHT FOR PC \$109.00 101-4 CALL	DISK DRIVES MPI FULL HEIGHT FOR PC \$75.00 ½ HIGH CALL	DISK DRIVES MICRO SCI A2 FOR APPLE \$179.00 OTHERS CALL	DISK DRIVES RANA DRIVE CONTROLLER \$85.00 RANA DRIVES CALL
DISK DRIVES IBM CONTROLLER HANDLES 4 DRIVES \$69.00 MANY MORE CALL	DISK DRIVES OTHER DRIVES AVAILABLE CALL	IBM MEMORY 64K \$12.00 128K \$20.00 DEALERS CALL	IBM IBM PC CALL FOR BEST PRICE	IBM IBM XT \$2095.00 BARE BONE
IBM IBM PC \$1549.00 W / 2 DR & 256K	IBM TO PRINTER \$15.95 OTHER CABLES AVAILABLE CALL	IBM MONO CARD \$219.00 CALL FOR MONITORS NOT LISTED BELOW	IBM IBM PC 2 DRIVES & 256K SAVON COLOR CARD AND AMBER MONITOR \$1699.00	COMPUTERS COMPAQ DESK PRO 2 \$2295.00 WITH MONITOR
COMPUTERS SANYO 555-2 W/MON. & SOFTWARE \$1099.00 SANYO PARTS AVAIL.	COMPUTERS COMPAQ PORT. 2 DRIVES & 256K \$1995.00 WOW	COMPUTERS APPLE PRO SYSTEM \$1249.00 WHILE THEY LAST	COMPUTERS APPLE MAC 1 DRIVE & 256K \$2095.00 FATMAC AVAILABLE	COMPUTERS CALL FOR OTHER CPU's
MODEMS HAYES 1200B INTERNAL W/S.W. \$345.00 ALL HAYES AVAILABLE	MODEMS ANCHOR MARK XII \$219.00 ALL ANCHOR AVAILABLE	MODEMS VOLKS MODEM \$199.00 WHILE THEY LAST	SOFTWARE LOTUS 1-2-3 \$299.00 WHILE THEY LAST	SOFTWARE SYMPHONY \$399.00 WHILE THEY LAST
PRINTERS OKIDATA FOR IBM \$345.00	PRINTERS JUKI 6100 (18cps) \$379.00 CALL FOR 6300 AND TRACTORS	PRINTERS EPSON FX80T \$379.00 CALL FOR LQ-80 LOW LOW PRICE	PRINTERS GEMINI SG-10 \$229.00 SG-15 \$379.00	PRINTERS BROTHER HR15XL \$389.00
HARD DISK CAL PEK 10 MEG HARD DRIVE W/CONTROLLER 120 DAY WARRANTY \$729.00	MONITORS AMDEK 310A MONOCHROME \$165.00	MONITORS PRINCETON HX12 \$439.00 SR-12/SCAN DOUBLER MAX-12 ALL AVAILABLE	COLOR CARD HERCULES COLOR W/PARALLEL PORT \$179.00 MONO CARD \$315.00	EXPANSION CARD DATA PLUS 256K EXP CARD FOR PC / COMPATIBLES \$169.00

FINANCING AVAILABLE—with approved credit

DEALERS: Open Accounts available, call for applications

TERMS: We accept VISA, MASTERCARD, COD's, and Wire Transfers. UPS, Federal Express and Emery shipping available. California residents please add 6½% sales tax to order. Prices are subject to change without notice. Not responsible for typographical errors.

Sav-On Computers, Inc.

12595 Crenshaw Blvd., Hawthorne, CA 90250

OPEN: 7:30am till 6:00pm Monday-Friday and 9:00am till 2:00pm Saturday

ICs PROMPT DELIVERY!!!

SAME DAY SHIPPING (USUALLY)

OUTSIDE OKLAHOMA: NO SALES TAX

INCREASE XT MOTHERBOARD TO 640 Kbyte CONSUME NO EXPANSION SLOTS! \$110.00

QUANTITY ONE PRICES SHOWN

DYNAMIC RAM			
256K	256Kx1	150 ns	\$ 5.00
128K	128Kx1	150 ns	10.99
64K	64Kx1	120 ns	2.10
64K	64Kx1	150 ns	1.40
EPROM			
27C256	32Kx8	250 ns	\$20.99
27256	32Kx8	250 ns	13.95
27128	16Kx8	250 ns	4.48
27C64	8Kx8	200 ns	7.85
2764	8Kx8	250 ns	3.45
2732A	4Kx8	250 ns	3.95
2716	2Kx8	450 ns	2.95
STATIC RAM			
6264LP-15	8Kx8	150 ns	\$8.15
6116LP-3	2Kx8	150 ns	2.50

OPEN 6 1/2 DAYS: WE CAN SHIP VIA FEDEX ON SAT.

MasterCard VISA or UPS CASH COD
Factory New, Prime Parts
 MICROPROCESSORS UNLIMITED
 24,000 S. Peoria Ave.
 BEGGS, OK 74421 (918) 267-4961

Prices shown above are for April 29, 1985

Please call for current prices. Prices subject to change. Please expect higher or lower prices on some parts due to supply & demand and our changing costs. Shipping & insurance extra. Cash orders prices shown. Orders received by 5 PM CST can usually be shipped to you by the next morning via Federal Express Standard Air @ \$6.00 or Priority One @ \$11.50

Inquiry 283

DOS UTILITIES

Attrib* - set/reset file attributes
 Crypt - file encryption
 DSort - sort directory files
 Find* - find strings in files
 Log - log computer usage for IRS
 Move* - rename across directories
 Tree - disk/file usage statistics
 * supports DOS wildcards

SEE - Full screen editor:
 supports optional microsoft mouse;
 block pick, put, cut, paste; search
 1000 wps; single & global replace;
 multiple windows & files; center,
 justify; spell check, correct 300 wps
 from supplied + user dictionary;
 32000 lines/file, 32000 chars/line;
 Instruction course included.

\$49 for all 8 programs
 \$79 unprotected
 Visa/MC - CA add 6% sales tax

California Scientific Software
 25642 Hazelnut, El Toro, CA 92630
 (714) 581-7654

Inquiry 69

CENTROID

controls up to 4 motors from any CRT, terminal or computer

STEPPING MOTOR CONTROLLER

- powerful 5 amps/ winding
- acceleration deceleration
- RS232 interface
- 1-4 axis moves

Standard Version with BASIC \$985
 16K BASIC with Battery Backup \$1335
 CNC VERSION \$1950
 Stepping Motor Tips Cookbook \$8
 CNC Manual \$12

CENTROID (814) 237-4535
 Box 739, State College, PA 16804

Inquiry 79

IBM PC/VT100

EM100 for IBM PC, XT, AT, JR.

- VT102 emulation
- File Transfer
- 132 Column modes
- Color Support

■ EM100-4010

- Tektronix 4010 emulation
- VT102 emulation
- Picture files
- High resolution hardcopy
- Supports IBM, IBM Enhanced, Hercules and Tecmar graphics cards.

Multicopy discounts

Diversified Computer Systems, Inc.
 100 Arapahoe, Boulder, CO 80302
 (303) 447-9251

Trademarks: VT100 - Digital Equipment; IBM PC, XT - IBM Corp; Hercules - Hercules Computer Technology.

Inquiry 150

NOW C HERE!

CROSS SOFTWARE for the NS32000

Also Available for IBM PC

INCLUDES:

- * Cross Assembler *
- * Cross Linker *
- * Debugger *
- * N.S. ISE Support *
- * Librarian *
- * Pascal Cross Compiler *
- * C Cross Compiler *

U.S. prices start at \$500

SOLUTIONWARE

1293 Mt. View-Alvino Rd.
 Suite B
 Sunnyvale, Calif. 94089
 408/745-7818 • TLX 4984264

Inquiry 381

VT100 or D200 on your PC, jr, XT, AT or compatible

ZSTEMpc-VT100 Smart Terminal Emulator
 132-col. by windowing - no addit. hardware
 Double High Double Wide Characters
 Full VT100 line graphics. Smooth scrolling
 2-way file transfers incl. XMODEM
 Full keyboard softkeys/MACROS
 Speeds to 38.4KB. High Throughput
 NOW both Color/graphics and Monochrome Support
 ZSTEMpc-VT100 \$150. ZSTEMpc-D200 \$125.
 30 day money back guarantee. MC/VISA.

KEA SYSTEMS LTD.
 #412 - 2150 W. Broadway
 Vancouver, B.C. CANADA V6K 4L9
 Support (604) 732-7411
 Orders (800) 663-8702

Zstem by KEA SYSTEMS

Inquiry 427

AFFORDABLE M-68000 COMPUTER SYSTEM

M68KCPU 6-10 MHz CPU, 20K static RAM, 16K EPROM, on board monitor, two RS-232 serial ports, 16-bit parallel port, 5 timer/counters expansion bus.
 Bare board \$ 99.95
 Complete Kit \$595.00

MD512K 128-512K static RAM, floppy disk controller & hard disk interface Bare board \$ 99.95
 Complete Kit (128K) \$725.00

M68KE Enclosure with power supply, fan, filter, 4 slot card cage \$249.00

M68KASM M68000 Macro Cross Assembler for CP/M80, IBM PC, TRS-80 and Apple II computers \$199.00
 UPS shipping & handling \$ 4.00
 COD orders add \$ 3.00
 Foreign orders add \$20.00
 California residents add 6.5% tax

EMS Educational Microcomputer Systems
 (714) 854-8545
 P.O. Box 16115 • Irvine, CA 92713

Inquiry 163

DATAFLEX™

- Multi-user Database!
- Powerful!
- Multiple Operating System Compatibility!
- Attractive Dealer Pricing!
- Full Dealer Support!

Dataflex is a trademark of Data Access
 Dealer Inquiries Invited

COGITATE

24000 Telegraph Road
 Southfield, Michigan 48034 USA
 (313) 352-2345

Inquiry 88

American Semiconductor

Computers, Components, Hardware & Software

4164	HIT/MDT OKI/NAT	1.17
128K	FORAT	7.99
41256	MOS/OKI NATHIT	5.75

DSDD DRIVES 89.
10mb TAPE BACKUP 569.
IBM-PC 1350
A.T. UPGRADE KIT CALL
10 mb Winchester 699
AT-20mb Winchester 799
8087 Math Coprocessor 125
AST-6 Pack+ 269

800-237-5758
 Sales Ext. 266

Vendor Line
 813-949-3193 Add 3%

Inquiry 28

SUPER SUMMER CLEARANCE SALE

COMPUTER CONNECTION
TOLL FREE ORDER LINE

PRINTERS

OKIDATA	
ML182P 120 cps	229
ML182 IBM Graphics Comp	229
ML182S 10" Carriage	279
ML83A, 15" Para. & Ser.	545
ML192P, 160 cps	375
ML192 IBM Graphics Comp	375
ML192S, 160 cps	449
ML193P, 160 cps	559
ML193 IBM Graphics Comp	559
ML193S, 160 cps	559
ML84P, 200 cps	669
ML84 IBM	669
ML84S, 200 cps	769
STAR MICRONICS	
SG-10, 120 cps, 2K buffer	\$ 249
SG-15, 120 cps, 2K buffer	399
SD-10, 160 cps, 10" carriage	369
SD-15, 160 cps, Corr. Qual.	479
SB-10 Draft & NLQ 24 wire pinthead	799
C. ITOH	
7500 AP w/tractor (better than RX80)	\$ 225
Prowriter 8510 AP +, 120 cps	335
Prowriter 8510 BC2, 120 cps	389
Prowriter 8510 SP, 180 cps	399
8510 BPI (IBM Compatible)	335
Prowriter II 1550 P, 15" 120 cps	449
Prowriter II 1550BCD, 15" 120 cps	499
1550 EP (IBM Compatible)	445
1550 SP, 180 cps	525
Starwriter F10-40PU, 40 cps	949
Starwriter A10-30	499
Printmaster F10-55PU, 55 cps	1029
BROTHER	
HR25, 25 cps	\$ 669
HR35, 36 cps	839
DYNAX	
DX15XL, 20 cps By Brother	\$ 379
JUKI	
6100, L.Q. 18 cps w/proportional spc.	399
6300	699
TOSHIBA	
P1340 P	\$ 595
P1340 S	595
P351 P, Faster than 1351	1229
P351 P/S, Faster and More Versatile	1299
PANASONIC	
1091 w/Tractor, 120 cps, 1 yr. war.	\$ 279
1092	439
1093	669
LEGEND	
880, 80 cps, FT & Graphics	\$ 229
1080, 120 cps, FT & Graphics	275

DISK DRIVES

TANDON	
TM100 2 for IBM PC	\$ 114
ALPHA OMEGA	
10 Meg w/Controller Card	\$ 699
20 Meg w/Controller Card	Call
33 Meg w/Controller Card	Call
TEAC	
55B Double Sided 360K	\$ 99
Quad Density	169
MPI	
55S Dbl/Dbl for IBM	\$ 80
Drives For Apple & Franklin	
RANA SYSTEMS	
Elite I	\$ 199
Elite II	339
Elite III	389
Controller Add	75
MICRO-SCI	
A-2	\$ 169
A-5C for IIc w/cable	189
A-5 1/2 height for IIe	199
Controller Add	59

PRINTER ACCESSORIES

ORANGE MICRO	
Grappier +	\$ 89
Buffered Grappier +, 16K exp. 64K	155
TOSHIBA	
Bi-Directional Tractor	\$ 149
Font Disk for Down loading P1351	50
MICROTEK	
Dumpling GX (same as Grappier +)	\$ 69
Dumpling GX w/16K buffer	135
Dumpling GX w/32K buffer	147
Additional Buffering 16K	12
FOURTH DIMENSION	
Par. Card & Cable for Apple	\$ 47
OKIDATA	
Plug and Play for IBM	\$ 49
Okigraph I for 82A/83A	49
Tractor for 82A & 92	49
JUKI	
Bi-Direc. Tractor for 6100/6300	\$ 125/135
Serial Interface	65
CABLES	
IBM PC to Parallel Printer	\$ 18
Serial Cable	18

DISPLAY MONITORS

QUADRAM	
Amber chrome IBM compatible	\$ 165
AMDEK	
V300G	\$ 125
V300A	135
V310A for IBM PC	159
Color 500 Color Composite	339
Color 600 RGB Hi-Res	429
Color 710 Super Hi-Res	545
TAXAN	
IBM Green Monochrome #121	\$ 139
IBM Amber Monochrome #122	145
RGB IBM w/Cable #420	419
RGB Super Hi-Res. #415	393
RGB Super Hi-Res. #440	499
RGB/Comp. Med. Res. #210	259
PRINCETON GRAPHICS	
HX-12 for use with IBM PC	\$ 455
Max 12E Amber for IBM	179
SR 12 Super Hi-Res	565
Scan Doubler	185
X-TRON	
AG-12, 1000 x 450 Hi-Res w/lt. swvl.	\$ 130
AA-12, 1000 x 450 Hi-Res w/lt. swvl.	135

SIZZLING SPECIALS!!

IBM PC
2 Drives, 256K
\$1639

135 WATT
POWER SUPPLY
\$139

CC MULTIFUNCTION
CARD
Par., Ser., C/C w/384K
\$249

APPLE PROF.
SYSTEM
\$1345

CC COLOR
GRAPHICS CARD
\$139

ML192P
\$379

CC MONO
GRAPHICS CARD
\$179

TOSHIBA 351
\$1229

MICRO-SCI A2
100% Apple Comp.
\$169

IBM PC ACCESSORIES

IBM	
IBM Dos 3.0	\$ 69
IBM Tech Ref. for PC	85
PARADISE	
Modular Graphics Card	\$ 269
Module A	79
Module B	120
5-Pak	175
64K MEMORY UPGRADE	
64K (9 chips) 200ns	\$ 17
PERSYST BOARD	
Bob Hi-Res Display Adaptor	\$ 399
QUADRAM	
Quad Color 1 Board	\$ 199
Exp. Quadboard w/64K & Game Port	239
Quadlink 3000 Run Apple sft on IBM	359
VUTEK (2 yr. war.)	
Vutek - CPS Board, RGB & Composite	w/Par. & Ser. Ports, 2 Yr. War. \$ 239
Color Card (Herc. comp.)	175
Monographic Card (Herc. comp.)	275
AST RESEARCH	
Six Pak + w/64K	\$ 239
Preview	Call
KEYTRONICS	
KB5151	\$ 189
MICROTEK	
Monochrome Text Par. & Ser.	\$ 195
Color Graphics Card	165
DATA PLUS	
384K Mem. Board w/OK	\$ 119
XT Short Card, 384K Mem.	185

APPLE & FRANKLIN ACCESSORIES

ACCESSORIES	
Kensington System Saver	\$ 69
Fan for Apple II & IIe w/surge	37
MICROMAX	
Viewmax 128K extended 80 col. card	
for Apple IIe w/64K	\$ 124
80 col. card for Apple II & II+	139
ADVANCED LOGIC SYSTEMS	
Z Engine 2.2	\$ 119
APPLE	
Super Serial Card	\$ 135
ASTAR	
RF Modulator	\$ 17
MICRO-SCI	
64K, 80 Col. Card	\$ 85

GIVE US A CHANCE TO BEAT THE COMPETITION'S ADVERTISED PRICE. IF YOU SEE IT ADVERTISED FOR LESS, CALL COMPUTER CONNECTION FIRST FOR LOWEST QUOTE!

MAIL ORDER:

17121 S. Central Avenue, Unit L
Carson, California 90746



NO SURCHARGE FOR CREDIT CARDS

We accept VISA, MasterCard, COD (w/deposit), Certified Checks or Wire Transfers. Minimum Shipping Charge \$4.00. Some items subject to back order. California Res. add 6 1/2% Sales Tax. All returns are subject to a 15% restocking charge and must be authorized by store manager within 10 days. Prices subject to change without notice. This Ad supersedes all others.

PERSONAL SYSTEMS

APPLE	
Professional Sys. incl. Apple IIe w/128K & 80 col., tilt mon., duo disk w/con't kit	\$1345
Apple IIc Lightweight Portable	Call
IBM	
IBM PC Bare w/con. & keyboard	\$1370
IBM PC 64K, 1 Drive	1499
IBM PC 64K, 2 Drives	1599
IBM PC, 2 Drives w/256K	1639
IBM XT, 10 Meg, 360K Dr. w/256	3195
IBM AT Base	Call
IBM AT Enhanced	Call
Call About All "AT" Systems	

SANYO	
MBC 550-2 w/1 320K Drive & sftwr.	\$ 895
MBC 555-2 w/2 320K Drives & more software	999
Portable	Call
Serial Port for Sanyo	79
TAVA	
TAVA PC1 Par. & 1 Ser. Ports, 128K, 2-320K Drives, Color Card & Monitor	\$1499
COMPAQ	
256K, w/2 320K Drives	\$1945
Desk Top Model 1	1725
Desk Top Model 2	2150
Desk Top Model 3	Call
Desk Top Model 4	4495

SOFTWARE

LOTUS DEVELOPMENT CORP.	
Lotus 1-23	\$ 295
Symphony	437
ASHTON TATE	
D Base II	\$ 329
D Base III	419
PRINTER SWITCH BOX	
EXPONENT	
Centronics Two Switch	\$ 84
Centronics Four Switch	110
Serial Two Switch	75
Serial Four Switch	99

MODEMS

ANCHOR	
Mark XII	\$ 219
Volksmodem XII	185
Anchor Express	Call
HAYES MICRO	
300 Baud Smart Modem	\$ 189
1200 Baud Smart Modem	369
1200 B for IBM PC	379
2400 Baud Modem	645
Micro Modem IIe	259
Chronograph	189
300 For Apple IIc w/Sftwr	Call

DISKETTES

PC DISKETTES	
Sgl./Dbl. (Box of 10)	\$ 16
Dbl./Dbl. (Box of 10)	18
COMPUTER CONNECTION	
Dbl./Dbl. (Box of 10)	\$ 16
Sgl./Dbl. w/Disk Container (10)	20
Dbl./Dbl. w/Disk Container	20
Bulk 50 & Up - Dbl./Dbl.	1.35 ea.
5 yr. warranty	

ORDER LINE
(800) 732-0304

(Outside California)
[213] 635-2809
(Inside California)

Mon.-Fri. 7 a.m. to 6 p.m.
Saturday 11 a.m. to 3 p.m.

CUSTOMER SERVICE:
(213) 635-5065
Mon.-Fri. 9 a.m. to 3 p.m.

COMPUTER CONNECTION



maxell



PERSONAL COMPUTER PRODUCTS

The floppy disks that meet or exceed every standard of quality.

MD1-D 5 1/4" SINGLE SIDE DOUBLE DENSITY SOFT SECTOR \$1.59

MD2-D 5 1/4" DOUBLE SIDE DOUBLE DENSITY SOFT SECTOR \$2.09

SOLD IN BOXES OF TEN ONLY

tremendous selection of software books, accessories and supplies

UP TO 50% OFF!

Software for IBM PC

dBase III	349	Multimate	269
Framework	349	Symphony	419
Home Acct. Plus	89	Wordstar 2000	279
w/Ultrafile	149	Wordstar Pro Pac	249

ADDITIONAL SOFTWARE AVAILABLE IN OTHER FORMATS. CALL FOR AVAILABILITY AND PRICE.

Minimum shipping and handling \$2.00. California residents add 6% sales tax. Prices subject to change without notice. Write for our free catalog.

ABC data products

3311 ADAMS AVE. SAN DIEGO, CA 92116

619-283-5488 800-854-1555

Inquiry 8

6809 Single Board Computer

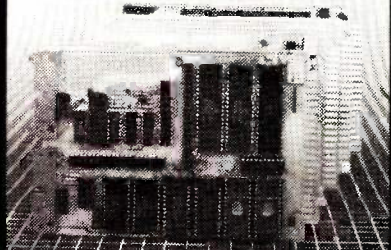

6809 MPU; 2 serial ports, 4 parallel ports; RAM, EPROM, real-time clock, watchdog timer, 44-pin 4.5" x 6.5" PCB
EXPANSION MODULES: RAM, EPROM, CMOS RAM/battery, analog I/O, serial I/O, parallel I/O, counter/timer, IEEE-488, EPROM programmer, floppy disks, cassette, breadboard, keyboard/display.



Wintek Corp
1801 South Street
Lafayette, IN 47904
317-742-8428

Inquiry 424

PRINTER RIBBONS

	PRICE	PER RIBBON	PER DOZEN
ANADEX 9500	10.50	10.50	109.80
APPLE DMP	5.50	5.50	58.80
BROTHER HR-15/25 MS	5.95	5.95	68.40
C. ITOH PROWRITER	5.50	5.50	58.80
COMMODORE MPS-801	8.00	8.00	90.00
EPSON MX-FX 70/80	5.00	5.00	48.00
EPSON MX-FX 100	6.95	6.95	75.00
EPSON LQ-1500	9.75	9.75	111.00
GEMINI 10-10X-15-15X	2.50	2.50	23.40
IBM/IDS 4-COLOR	15.75	15.75	180.00
IDS MICROPRISM-480	5.75	5.75	58.80
NEC - 3500 M/S Non Flip	6.25	6.25	69.00
NEC - 3500 NYLON	9.00	9.00	96.00
NEC - 8023A	5.50	5.50	58.80
OKIDATA 80/82/83/92	2.50	2.50	23.40
RADIO SHACK DMP-2100	7.50	7.50	87.00
RADIO SHACK LP VI & VIII	5.75	5.75	58.80
RITEMAN	8.50	8.50	96.00
SILVER REED EX 550 M/S	8.50	8.50	90.00
SILVER REED EX 550 NYLON	6.95	6.95	75.00
TALLY SPIRIT - 80 M/S	7.50	7.50	84.00
TALLY - MT-160	8.00	8.00	90.00
TALLY - MT-180	8.50	8.50	96.00
TOSHIBA - 1350/1351	7.50	7.50	87.00

Add \$3.00 Ship. & Hand. — To Order Call
Toll Free 1-800-742-1122
In MI (313) 569-3218 or Write for our Catalog
DWIGHT COMPANY, INC.
15565 Northland Drive - West Tower
Southfield, Michigan 48075-6496

Inquiry 156

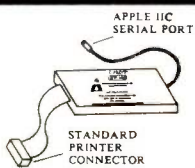

MW-100 232-C SERIAL TO CENTRONICS PARALLEL PRINTER INTERFACE FOR ALL MAJOR CENTRONICS PRINTERS INTERFACES THE APPLE IIC, EPSON FX8, AND HX20 TO STANDARD PARALLEL PRINTERS

\$99

MW-200 UNIVERSAL INPUT-OUTPUT BOARD BOARD FOR IBM PC

16 EIGHT BIT ANALOG INPUTS
14 HI VOLTAGE/CURRENT OUTPUTS
BASIC DEMO PROGRAM INCLUDED
1 ANALOG OUTPUT -- PROTOTYPING AREA
10 PROGRAMMABLE DISCRETE INPUTS/OUTPUTS

\$265

MW-201 UNIVERSAL SERIAL I/O BOARD WITH RS-232 INTERFACE

16 EIGHT BIT ANALOG INPUTS
14 HI VOLTAGE/CURRENT OUTPUTS
ONE ANALOG OUTPUT
APPLE-IBM-KAYPRO-COMPATIBLE
TALKS TO ANY SERIAL RS-232 PORT
MICROPROCESSOR CONTROLLED - 6510
AUTO BAUD RATE SEEKING - AUTO DATA LOGGING

\$385

Micro World Electronix, Inc.
3333 S. Wadsworth Blvd., #C105,
Lakewood, CO 80227
(303) 987-9531 or 987-2671



Inquiry 279

ZENITH/Heath Users

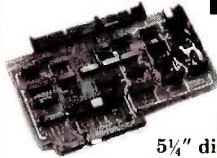

Double Your 5 1/4" disk storage capacity without adding a drive.

Get twice as much from your H88 or H89 microcomputer. Our FDC-880H floppy disk controller, in conjunction with your 5 1/4" drives, for example, expands memory capacity from 256 bytes to 512 bytes per sector.

And it handles single and double-sided, single and double-density, 8" and 5 1/4" drives — simultaneously.



C. D. R. Systems Inc.

Controlled Data Recording Systems Inc.
7210 Clairmont Mesa Blvd., San Diego, CA 92111
(619) 560-1272

Inquiry 77

3M Diskettes Lifetime Warranty

TIRED OF WAITING FOR SERVICE AND PRICE? 9 out of 10 SURVEYED DISK BUYERS PREFERRED

NORTH HILLS #1 IN SERVICE AND PRICE 1-800-328-3472

Formatted and hard sectored disks in stock-Dealer inquiries invited. COD, VISA, MASTERCARD All orders shipped within 24 hrs.



NORTH HILLS CORP. INTERNATIONAL
3564 Rolling View Dr.
White Bear Lake, MN. 55110
MN. call collect—612-770-0485

Scotch® Diskettes

Rely on Scotch® diskettes to keep your valuable data safe. Dependable Scotch diskettes are tested and guaranteed error-free. The low abrasivity saves your read/write heads. They're compatible with most diskette drives.

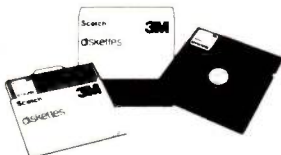

(800)235-4137

VISA

Dealer Inquiries Invited

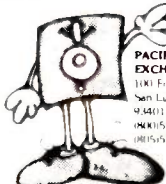

PACIFIC EXCHANGES
1101 Foothill Blvd.
San Luis Obispo, CA
94401 In Cal call
(805)542-5435 or
(805)543-1117

Inquiry 319

The Statistician

CPM IBM-PC TRS-DOS XENIX

- * Multiple Regression
- * Stepwise Ridge
- * All Subsets
- * Backward Elimination
- * Time Series Analysis
- * Descriptive Statistics
- * Transformations
- * Survey Research
- * Nonparametrics
- * XY Plots
- * ANOVA
- * Random Samples
- * Data Base
- * Search & sort
- * Hypothesis tests

Please call **TOLL FREE 1-800-334-0854 (Ext. 814)**



for more information or write: Quant Systems Box 628 Charleston, SC 29402 VISA/MC Accepted

Inquiry 346

HARD DISK BOOT + DATA SECURITY

FiXT ends boot hassles, stops data thieves—

DATAMAC, DAVONG, GREAT LAKES, IOMEGA, XEBEC, ZOBEX, others.

No-Slot Installation for IBM PC, COMPAQ, COLUMBIA \$70 + \$95 + tax/shpp



GOLDEN BOW SYSTEMS
Box 3039 San Diego CA 92103 619/298-9349

Inquiry 198

ADVANCED COMPUTER PRODUCTS, INC.

64K UPGRADE \$24.95

SINCE 1976

1985 CATALOG Send \$1.00

APPLE COMPATIBLE PERIPHERALS

AT RAM	\$24.95	BUFFERED GRAPPLER	\$189.95
256K RAM	15.95	GRAPPLER SUPER SERIAL	SALE \$119.95
64K RAM SET	24.95	VIDEO 7 RGB EXT. I/O	199.95
COEX PAR. PRINTER CARD (w/cable)	49.95	APPLE II SERIAL CABLE	36.95
COEX 80 COL. EXT. 64K CARD	99.95	APPLE II Keyboard	49.95
6LS CPM 3.0 PLUS CARD	\$299.00	APPLE II Disk Controller	49.95
COEX 10K RAM EXT. w/cable	39.95	APPLE II File Power Supply	49.95
COEX 80 COL. EXT. 64K CARD	99.95	APPLE II Keyboard	49.95
IS PRASO I/O (I/O)	139.95	APPLE II Keyboard	49.95
KENNINGTON SYSTEM SAVER	69.95	APPLE II Keyboard	49.95
KENNINGTON PC SAVER	39.95	APPLE II Keyboard	49.95
KRAFT JOYSTICK	36.95	APPLE II Keyboard	49.95
MOUSE SPEED DEMON	249.95	APPLE II Keyboard	49.95
MICROSOFT 2.80 SOFTCARD	247.95	APPLE II Keyboard	49.95
GRAPPLER PLUS	99.95	APPLE II Keyboard	49.95

FARADAY IBM PC

CPU Board w/486 MS DOS Compatible
\$299.95

RDCKWELL AIM

6502 Single Board Computer
\$249.00

IBM PC - HARDWARE

AST "COMPOLUS" 64K	\$199.00	KEYBOARD S15051	158 000 199.00
SIGMA "MAXIMIZER" 64K	249.95	MOUSE SYSTEMS MOUSE W/SW	149.00
SIGMA DISK CONTROLLER	189.95	QUADBOARD W/4K	263.00
HARD DISK CONTROLLER	249.95	TECHNAR GRAPHICS MASTER	499.00
10 MB INTERNAL HARD DISK	698.00	TECHNAR CAPTAIN	319.00
10 MB EXTERNAL HARD DISK	869.00	CURTIS PC PEDESTAL	9.00
15 MB INTERNAL HARD DISK	849.00	PGS or QUAD-CORNER ADAPTOR	36.00
15 MB EXTERNAL HARD DISK	1049.00	TILT and SWIVEL STAND	21.00
40 WATT BOOSTER SUPPLY	149.95	RAM BOARD	21.00
130 WATT IBM SUPPLY	159.95	EXTENSION CABLE IBM MONO	38.00
PC COMPATIBLE KEYBOARD	99.00	KEYBOARD EXTENSION CABLE	28.00
IBM PC CHASSIS	129.95	SURGE SUPPRESSORS	39.00
FLANTRONICS "COLORPLUS"	389.95	RAM (ONLINE)	49.00
10 MB INT. TAPE STREAMER	1150.00	EMERALD II	49.00
PERYSYST MONO CARD	199.00	SHAPPIRE (IPEX)	59.00
PARADISE MONO/COLOR	409.95	TRIP (ORANGE)	109.00
HERCULES MONO CARD	389.00	COEX 384K MULTICARD W/IO	169.00

INTERSL STD-BUS BOARDS

IBS3100 Z80 CPU	LIST \$69.95	ACP \$29.95
IBS3101 286 CPU	200 69.95	
IBS3110 8085 CPU	200 79.95	
IBS3218 18K CACDS RAM	610 99.95	
IBS3218 18K CACDS RAM	200 39.95	
IBS3320 18K CMOS RAM	160 119.95	
IBS3330 Z80 PIO (D. Matting)	210 49.95	
IBS3333 Universal PIO	210 49.95	
IBS3340 Opto Para. Input	300 119.95	
IBS3400 Floppy Controller	215 79.95	
IBS3510 SASI (DMA) W/Int. Int.	610 99.95	
IBS3500 TACT	215 99.95	
IBS3510 Opto Iso Input	270 119.95	
IBS3520 SPIST Relay	150 69.95	
IBS3521 OPT Relay	180 69.95	
IBS3600 Arithmetic	375 149.95	
IBS3610 EPROM Programmer	260 79.95	
IBS3700 Synchronizer	245 69.95	
IBS3711 CPU, Synchronizer	245 69.95	
IBS3720 REMOVCDS	315 149.95	
IBS3800 12 Bit AD	720 269.95	

MONITORS

AMDEK 300G (GREEN)	\$139.95
AMDEK 300A (AMBER)	149.95
AMDEK 310A (IBM AMBER)	169.95
CALL FOR COLOR & NEW MODELS	
PGS-HX-12 (IBM COLOR)	469.95
PGS-SR-12 (H RES)	599.95
PGS-HX-12 (IBM GREEN)	149.95
PGS DOUBLER BOARD	227.00
TAXAN 420 (IBM IBM)	399.00
2114-2 (H2124)2X5	309.95
GENITH 20M11115	159.95
SANYO 6500 (MED-RES)	279.00
SANYO 7500 (H-RES)	379.00
SANYO (LOCAL AREA) 12" AMBER SALE	74.95

MODEMS

BIZCOMP "PC INTELLMOD" (INT)	\$349.95
HAYES SMARTMODE 1200 (EXT)	469.95
HAYES SMARTMODE 1200B (INT)	399.95
HAYES SMARTMODE 300 (EXT)	206.95
MICROMODEM APPLE II	249.95
PROMETHEUS 1200M (PC EXT)	469.95
PROMETHEUS 1200 (PC EXT)	389.95
CA1 COMMUNICATIONS SYSTEM	419.95
APPLE COMP. LOW COST MODEM (300)	49.95

HARD DISKS

SEAGATE ST506 5MB	\$269.00
SEAGATE ST418 (15MB)	449.00
SEAGATE (10MB) ST412	449.00
CM1 10, 15,	

MAIL ORDER PRICING ONLY

6800U					
68000	\$48.95	6810	\$ 2.85	6850	\$ 3.25
68000.10	69.95	6820	3.75	6852	5.65
6800	2.90	6831	2.90	6862	7.90
6602	7.75	6828	14.50	6875	6.75
6803	18.95	6840	12.75	6880	2.20
6809E	14.50	6845	14.95		

6501U					
6502	54.50	6504	\$6.75	6522	\$6.75
6502A	6.90	6507	7.75	6532	9.50
6502B	9.50	6520	4.25	6551	11.50

8000U					
8035	\$ 5.75	8214	\$ 3.75	8259	\$ 6.75
8039	5.75	8218	1.95	8271	6.85
8030A	2.95	8224	2.20	8275	26.95
8005A	4.90	8226	.95	8279	7.90
80C85A	9.95	8228	.30	8282	6.25
8086	24.50	8237	12.75	8283	6.25
8087	29.95	8237.5	18.95	8284	5.50
8088	29.50	8238	4.25	8286	6.45
8089	88.95	8243	3.95	8287	6.45
8155	6.75	8250	10.50	8288	14.95
8156	6.75	8251	4.25	8289	44.95
8185	26.95	8251A	6.95	8292	12.95
8202	23.95	8253	6.75	8741	27.95
8203A	37.95	8255	4.25	8748	24.50
8205	3.25	8255A	6.95	8749	24.50
8212	1.95	8257	5.75	8755A	34.95

Z-80					
Z80-CPU	2.95	4.35	8.50		
Z80-GTC	3.75	4.75	12.25		
Z80-OART		9.50	17.95		
Z80-DMA	12.95	11.95	17.95		
Z80-INT	2.95	12.95	12.50		
Z80-SIO/0	11.25	12.25			
Z80-SIO/1	11.95	12.75			
Z80-SIO/2	11.95	12.75			
Z80-SIO/3	11.95	12.75			

Z-80					
Z8030	\$34.95	Z8001	\$34.95	Z8132	\$36.95
Z8530	34.95	Z8002	34.95	Z8671	37.95

DISK CONTROLLERS

UP0785	\$24.95	1797	\$26.95	6843	\$32.95
		2791	49.95		
		1791	24.75	2793	49.95
		1793	26.50	2795	49.95
		1795	26.50	2797	29.95

CRT CONTROLLERS

6645	\$14.95	8275	\$28.50	TM99118	\$39.50
68845	15.95	7220	39.95	8350	39.95
68847	11.50	5027	17.95	6345	14.95
46505	14.75	5037	21.95	8002	19.95
66047	24.50	NEC7220	Graphics	36.95	

UARTS/UARTS

1002B	\$3.95	2350	\$ 9.95	UM6403	\$ 8.75
1013A	3.95	8250	10.50	TM55001	14.95
1015A	6.75	UM6402	7.75	2851	8.95

EPROMS

1702 (1M5)	\$ 3.90	2732A (4K50NS)	\$ 6.80
2704 (405NS)	3.65	2732A (250NS)	8.95
2758 (10K)	5.50	2732A (200NS)	12.50
2758 (405NS)	2.75	2758 (4K50NS)	6.80
2716 (350NS)	5.50	2774 (200NS)	7.50
2518 (5V)	5.50	2784 (200NS)	7.50
TM52716	7.50	TM52864 (405NS)	12.95
TM42930	14.50	MC68016 (405NS)	24.95
2732 (405NS)	4.60	MC68076 (350NS)	39.95
2732 (200NS)	8.25	27128 (300NS)	21.50
2732 (200NS)	10.95	27128 (250NS)	22.95

STATIC RAMS

2101 (450NS)	\$2.29	Mk4118	\$4.95
2102 (450NS)	.99	TM20016 (200NS) x10	10.00
2102 (450NS)	1.39	TM20016 (150NS) x10	9.95
2102 (200NS)	1.00	TM20018 (100NS) x10	11.00
2111 (450NS)	2.75	MH6118B (200NS) x7.5	21.00
2112 (450NS)	2.75	MH6118B (150NS) x9.5	21.00
2114 (450NS)	1.45	69500 (200NS) x9.5	21.00
2118 (450NS)	1.89	MH6118L (4 LP) x9.0	9.00
2114L (300N)	1.78	MH6118L (2 LP) x9.0	6.78
2114L (200N)	1.89	69500 (200NS) x9.5	21.00
2147 (55NS)	5.50	26132 (300NS)	32.95
4044 (450NS)	3.25	MEM264P (15/150) 32.95	
4044 (300NS)	3.75	MEM264L (15/150) 36.95	
4044 (200NS)	4.75	74S188 (80NS)	8.85
UP0410 (100NS)	3.75	93415 (50NS)	3.95
5101 (CMOS)	3.50	83426 (50NS)	3.95

DYNAMIC RAMS

68000	\$48.95	6810	\$ 2.85	6850	\$ 3.25
68000.10	69.95	6820	3.75	6852	5.65
6800	2.90	6831	2.90	6862	7.90
6602	7.75	6828	14.50	6875	6.75
6803	18.95	6840	12.75	6880	2.20
6809E	14.50	6845	14.95		

NOW LIQUIDATING GAVILAN COMPUTER CALL FOR GAVILAN 8/16 LINE COMPUTERS See Below - GAVILAN SPECIALS

Corporate Buyers ... Call For Volume Quotes!

IF YOU DON'T SEE IT HERE CALL TOLL FREE

LINEAR

LM1084H	\$3.95	NE590	\$2.45	LM3099	98
LM3099	5.95	NE592	2.70	LM3099	98
LM3099.1	3.5	LM7099	5.5	LM3099	98
LM3099.1	1.89	LM7099.1	9.00	LM3099	98
LM3099.5	9.5	LM710	98	LM3099	98
LM3099.4	7.75	LM711	75	LM3099	98
LM3070A	40	LM715	3.95	LM3099	98
LM3062N	65	LM723N	5.5	LM3099	98
LM3102N	1.65	LM723H	.75	LM3099	98
LM3120N	62	LM733	98	LM3099	98
LM312H	1.75	LM739	1.85	LM3099	98
LM3182N	1.45	LM741CN	33	LM3099	98
LM3194	1.85	LM742	2.65	LM3099	98
LM3194.1	1.10	LM741N	29	LM3099	98
LM320	1.50	LM747	.65	LM3099	98
LM320.5	5.5	LM749	.55	LM3099	98
LM320.5	1.15	LM741	1.15	LM3099	98
LM3300	1.50	LM741	1.15	LM3099	98
LM3300.5	1.75	LM741	1.15	LM3099	98
LM3300.5	1.75	LM741	1.15	LM3099	98



Now, the lowest prices ever on

3M Scotch® DISKETTES

LIFETIME WARRANTY!

\$149^{ea.} 5 1/4" SSDD Qty. 50 **\$199**^{ea.} 5 1/4" DSDD Qty. 50

5 1/4" SSDD-96TPI → **\$2.29** ea. 5 1/4" DSDD-96TPI → **\$2.85** ea.
SOFT SECTOR ONLY! MINIMUM ORDER: 20 DISKETTES

ADD 3% FOR ORDERS UNDER 50!

FREE! FLIP 'N FILE 15 w/10 DISKETTES. (Exp. Thru 5/30/85)

These are factory-fresh 3M diskettes packed in boxes of 10 with Tyvek sleeves, reinforced hubs, identification labels and write-protect tabs.

3.5" MICRO-DISKETTES—SS-135 TPI → **\$2.89** ea.

LIFETIME WARRANTY ON ALL 3M SCOTCH DISKETTES!

HOURS: 8AM-5PM Central Time, Monday-Friday

WE WILL BEAT ANY NATIONALLY ADVERTISED PRICE ON THE SAME PRODUCTS AND QUANTITIES!

DISK WORLD!, Inc.

Suite 4806 • 30 East Huron Street • Chicago, Illinois 60611

DISK WORLD!

Authorized Distributor
Information Processing
Products



FANTASTIC LOW PRICES ON



BASF QUALIMETRIC DISKETTES!

LIFETIME WARRANTY!



\$129^{ea.} 5 1/4" SSDD Qty. 20 **\$149**^{ea.} 5 1/4" DSDD Qty. 20

5 1/4" SSDD-96TPI — **\$1.46** ea. 5 1/4" DSDD-96TPI — **\$1.75** ea.

PACKED IN CARDBOARD CASES!

BASF QUALIMETRIC DISKETTES have a LIFETIME WARRANTY with Tyvek sleeves, reinforced hubs, user identification labels and write-protect tabs.

SOFT SECTOR ONLY! MINIMUM ORDER: 20 DISKETTES

BASF 3.5" MICRO-FLOPPIES BASF 5 1/4" HIGH DENSITY FOR IBM PC-AT

SSDD-135 TPI — **\$2.50** ea. DSDD-HD — **\$4.91** ea.

FOR ORDERS ONLY: INFORMATION & INQUIRIES:

1-800-621-6827 **1-312-944-2788**

(In Illinois: 1-312-944-2788) (In Illinois: 1-312-944-2788)

HOURS: 8AM-5PM Central Time, Monday-Friday

WE WILL BEAT ANY NATIONALLY ADVERTISED PRICE ON THE SAME PRODUCTS AND QUANTITIES!

DISK WORLD!

Authorized Reseller
Information Processing
Media



Incredible value!

Nashua™ Diskettes

LIFETIME WARRANTY!

\$105^{ea.} 5 1/4" SSDD Qty. 50 **\$115**^{ea.} 5 1/4" DSDD Qty. 50

These are poly-bagged diskettes packaged with Tyvek sleeves, reinforced hubs, user identification labels and write-protect tabs. NASHUA Corporation is a half-billion dollar corporation and a recognized leader in magnetic media.

SOFT SECTOR ONLY! Sold in multiples of 50 only!

FOR ORDERS ONLY: INFORMATION & INQUIRIES:
1-800-621-6827 **1-312-944-2788**

(In Illinois: 1-312-944-2788)

HOURS: 8AM-5PM Central Time, Monday-Friday

WE WILL BEAT ANY NATIONALLY ADVERTISED PRICE ON THE SAME PRODUCTS AND QUANTITIES!

DISK WORLD!, Inc.

Suite 4806 • 30 East Huron Street • Chicago, Illinois 60611

DISK WORLD!

Authorized Distributor
NASHUA MAGNETIC MEDIA

BETTER MODEMS AT LOWER PRICES!

...and get 24-hour shipping on your DISK WORLD! orders

1200/300 Baud Avatex Modem 300 Baud Avatex Modem

\$189.95 ea. **\$59.95** ea.

Avatex Modems have everything. They're inexpensive, Hayes-compatible, Auto Dial, Auto Answer and high quality (backed by a one-year warranty).

Best of all, our combination includes a One-Year FREE subscription to MCI MAIL and special communications software for placing TOLL-FREE orders with DISK WORLD!

Orders received via MCI MAIL are shipped within 24-hours (subject to product availability). (Cables are not included.)

FOR ORDERS ONLY: INFORMATION & INQUIRIES:
1-800-621-6827 **1-312-944-2788**

(In Illinois: 1-312-944-2788)

HOURS: 8AM-5PM Central Time, Monday-Friday

WE WILL BEAT ANY NATIONALLY ADVERTISED PRICE ON THE SAME PRODUCTS AND QUANTITIES!

DISK WORLD!, Inc.

Suite 4806 • 30 East Huron Street • Chicago, Illinois 60611

DISK WORLD!

Authorized Distributor



DISK WORLD! Ordering & Shipping Instructions

Shipping: 5 1/4" & 3.5" DISKETTES—Add \$3.00 per each 100 or fewer diskettes. Other Items: Add shipping charges as shown in addition to other shipping charges. Payment: VISA and MASTER-CARD accepted. COD Orders: Add additional \$3.00 Special Handling charge. APO, FPO, AK, HI & PR Orders: Include shipping charges as shown and additional 5% of total order amount to cover PAL and insurance. Taxes: Illinois residents only, add 8% sales tax.

Prices subject to change without notice.

This ad supercedes all other ads.

Not responsible for typographical errors.

MINIMUM TOTAL ORDER: \$35.00

FOR ORDERS ONLY: INFORMATION & INQUIRIES:
1-800-621-6827 **1-312-944-2788**

(In Illinois: 1-312-944-2788)

HOURS: 8AM-5PM Central Time

Monday-Friday

WE WILL BEAT ANY NATIONALLY ADVERTISED PRICE ON THE SAME PRODUCTS AND QUANTITIES!

DISK WORLD!, Inc.

Suite 4806 • 30 East Huron Street • Chicago, Illinois 60611

DISK WORLD!

Authorized Distributor

DISK WORLD!

ATHANA DISKETTES The great unknown!

99¢^{ea.} 5 1/4" SSDD Qty. 50 **\$109**^{ea.} 5 1/4" DSDD Qty. 50

You've used these diskettes hundreds of times...as copy-protected originals on some of the most popular software packages. They're packed in poly-bags of 25 with Tyvek sleeves, reinforced hubs, user identification labels and write-protect tabs.

LIFETIME WARRANTY!

SOFT SECTOR ONLY! Sold in multiples of 50 only.

FOR ORDERS ONLY: INFORMATION & INQUIRIES:
1-800-621-6827 **1-312-944-2788**

(In Illinois: 1-312-944-2788)

HOURS: 8AM-5PM Central Time, Monday-Friday

WE WILL BEAT ANY NATIONALLY ADVERTISED PRICE ON THE SAME PRODUCTS AND QUANTITIES!

DISK WORLD!, Inc.

Suite 4806 • 30 East Huron Street • Chicago, Illinois 60611

DISK WORLD!

Authorized Distributor
ATHANA MAGNETIC MEDIA

Nail down great prices on

DISKETTE

PRINTERS

PRINTER RIBBONS

CALL 1-800-847-7676
3A604 (5Mb) 149.95
REMOVABLE Call

CALL FOR QUOTE ON HIGHER
CAPACITY HARD DRIVES!

SUPER SAVER

SHUGART SA604 HARD DISK

5Mb \$129.95

NEW FACTORY DIRECT Qty 10 119.95
Qty 100 109.95

DISK DRIVES

TEAC 55B	\$129.95
MITSUBISHI 4851	149.95
SHUGART 455	124.95
TANDON TM100 2	189.95

8" DISK DRIVES

SHUGART 801R	\$269.95
SIEMENS FDD100-8	129.95
SIEMENS FDD200-8 DS/DD	195.00
MITS M2894	439.95
MITS M2896 1/2 HI	439.95
TANDON 848E 1/2 HI	389.95
QUIME 242 1/2 HI	399.95

DRIVE CABINETS

5 1/2" CASE POWER SUPPLY	\$69.95
5 1/4" DUAL 1/2 HI w/POWER SUPPLY	79.95
8" DUAL CASE w/POWER SUPPLY	279.95
8" THINLINE DUAL w/POWER SUPPLY	199.95
5 1/4" HARD DISK w/POWER SUPPLY	199.95
5 1/4" 1/2 HIGH HARD DISK	199.95

APPLE DISK DRIVES

APPLE II/IIe COMPATIBLE	\$174.95
APPLE II/IIe COMPATIBLE 1/2 HIGH	184.95
MICROSCI APPLE IIc DRIVE	219.95
APPLE II to APPLE IIc ADAPTOR	19.95
APPLE II/IIe DISK CONTROLLER	49.95

NOTICE TO DEALERS — We Will Pay
Top Dollar For Your Excess Inventory

D-SUBMINIATURE

DB25S (Female)	\$3.10	\$2.90
DB25P (Male)	2.40	2.29
Hood \$1.25	Mtg H/W \$.99	
DE37S (Female)	\$5.95	\$5.75
DE37P (Male)	5.25	5.10
Hood \$1.75	Mtg H/W \$.99	
DD50S (Female)	\$8.95	\$8.65
DD50P (Male)	6.00	5.75
Hood \$3.25	Mtg H/W \$.99	

(OTHER STYLES IN CATALOG)

CENTRONICS

IDC 36 Pin Male	\$8.95
IDC 36 Pin Female	9.49
Solder 36 Pin Male	7.49
Solder 36 Pin Female	8.95

(CALL TOLL FREE FOR IDC'S)

IC SOCKETS

SOLDERTAIL	1-99	100
MACHINED HIGH RELIABILITY SOCKET	8 Pin ST/LP \$ 13	\$ 10
SALE CALL FOR SPECIAL RATES	14 Pin ST/LP 15	11
	16 Pin ST/LP 17	12
	18 Pin ST/LP 20	17
	20 Pin ST/LP 28	26
	22 Pin ST/LP 29	27
	24 Pin ST/LP 29	27
	26 Pin ST/LP 39	32
	36 Pin ST/LP 45	38
	40 Pin ST/LP 48	42
	64 Pin ST/LP 3.95	3.25

WIREWRAP (GOLD)



	1-99	100
8 Pin WW/3L	\$.49	\$.40
14 Pin WW/3L	.82	.49
18 Pin WW/3L	65	55
18 Pin WW/3L	88	77
20 Pin WW/3L	99	96
22 Pin WW/3L	1.19	1.13
24 Pin WW/3L	1.25	1.17
26 Pin WW/3L	1.49	1.39
40 Pin WW/3L	1.89	1.75

TEXTOOZIF ZERO INSERTION

18 Pin \$8.75	24 Pin \$7.85	28 Pin \$8.95
---------------	---------------	---------------

(We Stock All Types of Sockets)

4027 (250ns)	\$1.29	TMS4416 (150ns)	\$9.75
1103 (300ns)	.79	41256-150 (150n)	17.95
4118N-2 (150ns)	1.80	41258-200 (200n)	15.95
4118N-3 (200ns)	1.65	TMS4050 (300ns)	1.85
4118N-4 (250ns)	1.45	TMS4060 (300ns)	1.85
4164N-150 (150n)	5.95	MMS280 (300ns)	1.85
4164N-200 (200n)	4.95	UPD411 (300ns)	1.85
4184N-120 (120ns)	8.49	MM5298 (250ns)	1.85
TMS4164 (150ns)	5.95		

GAVILAN SPECIALS

8 or 16 LINE COMPUTERS	Call
16 LINE BY 80 LCD DISPLAY	\$79.95
8 LINE BY 80 LCD DISPLAY	39.95
THERMAL PRINTER MECHANISM	24.95
GAVILAN/IBM KEYBOARDS	14.95
8 1/2 x 11 THERMAL PAPER (500 sht)	2.99
PASCAL SOFTWARE w/MANUAL	99.00
12V Ni-CAD BATTERY PACK	18.95
20 MHz CRYSTAL OSCILLATOR	3.98

SUPER SAVER

IBM PC[®]
Comp. DS/DD Disk Drive
\$89⁹⁵

HI-TECH SPECIALS

AMD7910
300 BAUD MODEM IC
\$29⁹⁵

DATA ACQUISITION

ADC0800 \$14.95	ADC0617 \$9.75	1408L8 \$1.95
ADC0804 3.45	DAC0800 4.75	1408L8 2.85
DAC0806 1.90	DAC0808 2.85	DAC100 7.95
ADC0809 4.45	DAC1020 7.95	DAC08 7.95
ADC0816 14.25	DAC1022 5.85	DAC01 6.95
AD7523JN 1.99	LF353N 1.99	LF13201N 1.99

TOLL FREE

800-854-8230

TWX
910-595-1565

Inquiry 13

EXPANSION MEMORY
64K UPGRADE (Set of 9) \$24.95
256K RAMS (256Kx1) \$15.95

CABLES/ACCESSORIES

IBM PARALLEL (Shielded)	\$29.95
IBM SERIAL (Shielded)	24.95
KEYBOARD EXTENSION	9.95
RS232 GENDER CHANGER Male-Male	14.95
RS232 GENDER CHANGER Female-Female	14.95
NULL MODEM ADAPTOR	14.95

SPECIALS OF THE MONTH

8087 — 80287 SALE	Call
AB PRINTER SWITCHBOX (Parallel)	\$69.95
TELEDATA MODEM VIC 20/64	42.95
APPLE IIe KEYBOARD	49.95
IBM COMPATIBLE KEYBOARD	99.95
POTTER POWERLINE MODULE	5.99
CALL FOR DEC RAINBOW BLOW-OUT	
NEC8201 PORTABLE	369.95
NEC8027 PORTABLE PRINTER	369.95
ZENITH Z151PC COMPUTERSALE	1995.00
IBM PC, 256K 2 w/DRIVES	1795.00
IBM PORTABLE	1850.00
COMPAQ PORTABLE	2195.00

4018 .35	4046 .80	4082 .95	4556 .95
4017 .65	4047 .88	4085 .95	4566 1.35
4018 .79	4048 .99	4086 .95	80C95 1.50
4019 .39	4049 .35	4033 .45	80C97 .49
4020 .69	4050 .34	4094 2.95	MC14408 12.95
4021 .69	4051 .75	4098 1.90	MC14409 12.95
4022 .69	4052 .75	4099 1.85	MC14410 9.95
4023 .25	4053 .75	4501 .69	MC14411 11.95
4024 .59	4055 3.95	4502 .95	MC14412 12.95
4025 .25	4056 2.95	4503 .49	MC14419 4.95
4027 -.45			CALL FOR 74HC

74S00/PRDMS'

74S00 \$3.35	74S74 5.55	74S158 \$ 9.99	74S260 \$1.19
74S02 .35	74S85 1.89	74S160 2.49	74S280 1.95
74S03 .35	74S86 5.55	74S161 1.89	74S287* 1.95
74S04 .45	74S112 5.55	74S174 1.19	74S288* 1.95
74S05 .45	74S113 5.55	74S175 1.19	74S373 2.09
74S08 .39	74S114 5.55	74S188* 1.49	74S374 2.09
74S09 .39	74S142 8.99	74S194 1.49	74S387* 1.95
74S10 .35	74S132 1.39	74S195 1.49	74S471* 5.95
74S11 .35	74S133 4.5	74S196 1.49	74S472* 4.95
74S15 .35	74S134 5.0	74S240 1.99	74S473* 4.95
74S20 .35	74S135 6.9	74S241 1.99	74S474* 4.95
74S22 .35	74S136 1.39	74S242 1.99	74S475* 4.95
74S30 .35	74S138 8.9	74S243 1.99	74S570* 2.95
74S32 .45	74S139 8.9	74S244 1.99	74S571* 2.95
74S38 .89	74S140 5.5	74S251 1.19	74S572* 4.95
74S40 .39	74S151 9.9	74S253 1.19	74S573* 4.95
74S51 .35	74S153 9.9	74S257 1.19	74S940 2.49
74S64 .39	74S157 9.9	74S258 1.19	74S941 2.49
74S65 .39			CALL FOR 74HC

74C00

74C00 \$3.35	74C74 \$ 6.65	74C161 \$1.15	74C373 \$2.35
74C02 .35	74C85 1.89	74C175 1.15	74C374 2.35
74C04 .29	74C90 1.15	74C240 1.89	74C901 5.99
74C08 .35	74C93 1.15	74C244 1.89	74C922 4.45
74C10 .35			MORE 74C IN STOCK — ALSO IN CATALOG

TERMS: We accept VISA MC MO. Cashiers and Personal checks. School and Company PO's. We do not charge your card until we ship. Personal checks require drivers license and credit card #. No Surcharge Added on VISA or MC. COD's over \$500 require 20% deposit with order. Add 3% shipping and handling for UPS. We offer same day shipment. Prices subject to change without notice. We reserve the right to substitute manufacturer. We are not responsible for typographical errors. Min. Order \$10.00 Retail Sale Prices May Vary

MAIL ORDER PRICING ONLY

STORAGE CASES

AMARAY MEDIA-MATE 50: A REVOLUTION IN DISKETTE STORAGE



Every once in a while, someone takes the simple and makes it elegant! This unit holds 50 5¼" diskettes, has grooves for easy stacking, inside nipples to keep diskettes from slipping and several other features. We like it!

\$10.95 ea. + \$2.00 Shpng.

DISKETTE 70 STORAGE: STILL A GREAT BUY.

Dust-free storage for 70 5¼" diskettes. Six dividers included. An excellent value.

\$11.95 + \$3.00 Shpng.



DISK CADDIES

The original flip-up holder for 10 5¼" diskettes. Beige or grey only.

\$1.65 ea.

+ 20¢ Shpng.

FOR ORDERS ONLY:
1-800-621-6827

(In Illinois: 1-312-944-2788)

INFORMATION & INQUIRIES:
1-312-944-2788

HOURS: 8AM-5PM Central Time, Monday-Friday

WE WILL BEAT ANY NATIONALLY ADVERTISED PRICE ON THE SAME PRODUCTS AND QUANTITIES!

DISK WORLD!, Inc.

Suite 4806 • 30 East Huron Street • Chicago, Illinois 60611

DISK WORLD!

The value leader in Computer supplies And accessories.

RIBBONS.

at extraordinary prices!

Brand new ribbons, manufactured to Original Equipment Manufacturer's specifications, in housings. (Not re-inked or spools only.)

LIFETIME WARRANTY!

Epson MX-70/80 . . . **\$3.58** ea. + 25¢ Shpng.

Epson MX-100 . . . **\$4.95** ea. + 25¢ Shpng.

Okidata Micro83 . . . **\$1.48** ea. + 25¢ Shpng.

Okidata Micro84 . . . **\$3.66** ea. + 25¢ Shpng.

FOR ORDERS ONLY:
1-800-621-6827

(In Illinois: 1-312-944-2788)

INFORMATION & INQUIRIES:
1-312-944-2788

HOURS: 8AM-5PM Central Time, Monday-Friday

WE WILL BEAT ANY NATIONALLY ADVERTISED PRICE ON THE SAME PRODUCTS AND QUANTITIES!

DISK WORLD!, Inc.

Suite 4806 • 30 East Huron Street • Chicago, Illinois 60611

DISK WORLD!

MEMOREX

diskettes!

LIFETIME WARRANTY!

\$128 ea.
Qty. 20

5¼" SSDD

\$170 ea.
Qty. 20

5¼" DSDD

MEMOREX DISKETTES come with heavy, lintless paper sleeves, reinforced hubs, write-protect tabs and user ID labels.

3 5" MICRO-FLOPPIES
SSDD-135TPI

\$2.44 ea.

SOFT SECTOR ONLY!

MINIMUM ORDER: 20 DISKETTES
INFORMATION & INQUIRIES:
1-312-944-2788

5¼" DSDD-HD
FOR IBM PC-AT
\$3.89 ea.

HOURS: 8AM-5PM Central Time
Monday-Friday

WE WILL BEAT ANY NATIONALLY ADVERTISED PRICE ON THE SAME PRODUCTS AND QUANTITIES!

DISK WORLD!, Inc.

Suite 4806 • 30 East Huron Street • Chicago, Illinois 60611

DISK WORLD!

PRIORITY ONE ELECTRONICS

1 **PRIORITY ONE ELECTRONICS**

9161 Deering Ave., Chatsworth, CA 91311-5887

WHY SHOULD YOU BUY FROM A DIRECT MAIL MERCHANT?

Special trips to hole-in-the-wall stores in quest of shallow promises? Limited brand choices within each product category? Shelves sparingly stocked? Sales clerks who make you wait while they finish their game of space invaders — and then make you wish they'd go back to their game because they know less about the products than you do!

Are any of these reminiscent of your last shopping trip to a local computer store? Deciding which computer component you want to buy is complicated enough without the added frustrations you often face when shopping in a store.

Maybe, its time you tried a better way to shop. It's nothing new — millions do it every day with surprising satisfaction. It's called direct merchandising, catalog selling, or simply shopping by mail order.

Direct mail retailers allow you to shop from the convenience of your home or office, and more often, can provide products faster than if you had ventured out to hunt them down by yourself. Shopping by mail (or better still by phone) saves you gas, parking fees, and most important — your valuable time. In addition, you'll have access to thousands of items you may never find in your local store.

Priority One Electronics did not invent this method of selling, but we have invested over \$1,000,000.00 refining it to better serve you. The efficiencies of our direct mail marketing are passed along to you in the form of better service, more support, and lower prices.

How much can you save? Plenty! Our unequalled purchasing power assures you of the lowest possible price. Also, you don't have to pay the 10% franchising fee that is passed along by your local chain store.

Our customers range from companies, like IBM purchasing the latest, state-of-the-art disk drives; to individuals buying add-ons for their own IBM-PCs. We have earned the confidence of our customers by thoroughly testing and evaluating each new product before it is added to our line. If we wouldn't use it ourselves, then we're not going to try and sell it to you!

We publish a colorful, 'Catalog of Values' every six weeks. Each new Flyer, resembling a 30 or 40 page newspaper, is certainly not 'junk mail'. Our hundreds of thousands of satisfied customers look forward to receiving the next edition — and then take the time to read it carefully. It is your direct link to our new products, special promotions, and sale items. If you are receiving these mailings, take the time to review each page. Or you may miss the 'deal of the year'!

If you're among those who haven't yet discovered how easy and secure it can be to buy by phone or mail — give us a chance to prove ourselves to you. Just fill out the coupon below and we'll mail you our next Sales Flyer.

Better still, give us that chance today. If you are about to make a purchase of any computer related product, call us now — Toll Free (800) 423-5922 — and ask one of our courteous, well trained, sales professionals for a price quotation. We are here to serve you.

The Sensible Way To Shop In Today's World



Call For
**DEALER'S
ADVANTAGE**

Add-on Products for IBM PC®

10 Mb Hard Disk Kit (with controller)	\$550.00
20 Mb Hard Disk Kit (with controller)	\$650.00
Floppy Controller Card	\$50.00
Hard Disk Controller Card	\$170.00
Color Graphics Card (RGB and NTSC Comp.)	\$95.00
Monochrome Graphics Card	\$100.00
Memory Card With 256K	\$150.00

MINIMUM OF TEN BOARDS

* IBM is a registered trademark of International Business Machines, Inc.

CRANE Associates, Inc
3928 S. Sepulveda Blvd., Ste. 12
Culver City, CA 90230
(213) 390-9840

Inquiry 121

**Erases Most Eproms
in 3 Minutes**

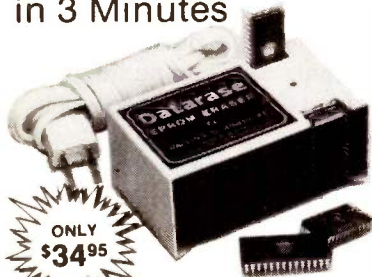

ONLY
\$34.95

Solid State 2-8 Min.
Timer Version \$54.95

For all 24 or 28 pin devices—2 at a time
90 DAY WARRANTY SHIPPING & HANDLING \$2.50
DEALERS WELCOME AZ RESIDENTS ADD 6% TAX

WALLING CO.

4401 S. JUNIPER • TEMPE, AZ 85282 • (602) 838-1277

Inquiry 420

*IBM® PC/XT/AT Compatible



*4164-120/150/200	129
*128K-150/200 for AT	995
*256K-150	599
*Teac half-height for AT	119.00
*20 Mb Hard disk for AT	695.00
8087-3	119.00
Apple Drives — half heights	124.00
*Tandon/CDC full height drives	109.00
*CDC/Teac half height drives	109.00
*Micro Science 20 Mb kit for PC/XT	839.00
*10 Mb Hard Disk System	649.00
*20-100 Mb Hard Disk Drives Lowest Prices/Call	
*Everex Magic Card 0-384 expansion	179.00
*Everex Magic Card w/384K RAM populated	259.00
*Everex Graphic Edge Color Cards	339.00
*Drive Installation Kits	Call

Add \$3.95 shipping to all orders • Prices subject to change • P.O.'s on approval • C.O.D. OK • All new, no surplus, no seconds.
QUANTITY DISCOUNTS • Corporate accounts invited
3310 West Main St. Tampa, FL 33607
In FL and for info, call 813-875-0299

FOR ORDERS ONLY, 800-237-8910



TELEX 330690

FAX LINE: 813-876-7194

Inquiry 323

Verbatim
flexible disks

Call Free **(800) 235-4137** for prices and information. Dealer inquiries invited. C.O.D. and charge cards accepted.

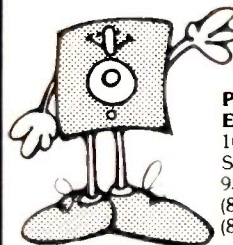

VISA

PACIFIC EXCHANGES
100 Foothill Blvd.
San Luis Obispo, CA 93401. In Cal. call (800) 592-5935 or (805) 543-1037.

Inquiry 319

DOUBLE THE OPTION CAPACITY
OF YOUR IBM PERSONAL COMPUTER

PC XTRA

- DIRECT EXTENSION OF IBM PC BUS
- NO SOFTWARE CHANGES
- NO HARDWARE MODIFICATION
- STYLING CONSISTENT WITH IBM

Add all those special options that you've been wanting without worrying about filling your plug-in and back panel space

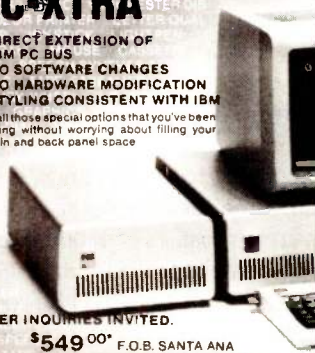

DEALER INQUIRIES INVITED.

\$549.00* F.O.B. SANTA ANA
*CALIFORNIA RESIDENTS ADD 6% SALES TAX

P C HORIZONS, INC.

1701 E. Edinger, Ste. A6, Santa Ana, CA 92680
(714) 953-5396

Inquiry 317

MARYMAC INDUSTRIES INC.

800-231-3680

**Radio Shack TRS-80's
Epson Printers**

People you Trust to give you the very best!



- Lowest Discount Prices
- Reliable Service
- Quality Products

"World's largest volume TRS-80 dealer."

22511 Katy Fwy., Katy (Houston) Texas 77450
(713) 392-0747 Telex 774132

Inquiry 264

Contact us for other low prices on hardware and software.

Next Day Air Extra

FREE SHIPPING. NO SURCHARGE FOR OR .

Call for latest prices.

10, 20, 33 AND 42 MEG INTERNAL AND EXTERNAL HARD DISK SYSTEMS

 Microscience
International
Corporation.



Quantity 1
Quantity 10

	10 MEG	20 MEG	33 MEG	44 MEG
Brand of Hard Disk	Microscience (Half Height)	Microscience (Half Height)	Rodime	Rodime
Internal	\$529	\$679	\$1195	\$1495
	\$519	\$669	\$1095	\$1395
External	\$729	\$879	\$1295	\$1595
	\$719	\$869	\$1195	\$1495

RODIME



Externals mounted with independent power supply and fan. Fully DOS 2.1 or 3.0 compatible. Both Internals and Externals boot from Hard Disk. 33 and 44 Meg Internal Disks include extender power supply. The system comes complete and ready to install with the Hard Disk, Controller, Cables, Manual, Software, and Mounting Hardware. One Year Warranty.

10, 20, and 33 Meg Hard Disks are available with combined Floppy/Hard Disk Controller Card for additional \$75.

COMPAQ

\$2595

256K, 1/360K drive,
10 Meg Internal



Functional equivalent to a Compaq Plus™

Now using 3 1/2" shock-mounted Winchester drives. The same as used in the Compaq Plus™. Also available with 2 half-height drives and 10 MEG HD-\$2795.

Quantities of 10 or more \$2395 each
Or upgrade your Compaq to a Compaq Plus™ equivalent with our 3 1/2" shock-mounted Winchester disk kit. Includes Hard Disk, Controller, Cables, Manual, software, and Mounting Hardware. One year warranty.

Quantities of 10 or more \$545 each

\$595

COMPAQ

It simply works better. **DESKPRO™**

640K, One 360K Drive,
One 10 Meg Internal Hard Drive
Tape Backup Unit.

\$3495

Includes Monitor



With 20 Meg Internal Hard Drive--\$3641
With 33 Meg Internal Hard Drive--\$4141
With 44 Meg Internal Hard Drive--\$4541

Compaq is a registered trademark and Compaq Plus and Compaq Deskpro are trademarks of Compaq Computer Corporation.

IBM AT™
CALL

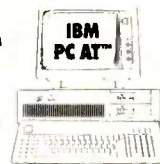

IBM PC™
CALL

IBM is a trademark of IBM Corp.

Call us for competitive prices on larger quantities of RAM chips.

64K RAM

Set of 9 chips, 200 or 150 Nanoseconds

\$14

per set
Quantities of 10 or more \$12 per set
Quantities of 50 or more \$10 per set

256K RAM 1-9 sets \$69 per set
10-49 sets \$59 per set
50 or more sets \$49 per set

AST SixPak Plus™



w/64K \$249
w/384K \$319

One Year Warranty

- Upgradeable to 584K
- Clock/Calendar
- Software included

**PC'S LIMITED
Six Function Card**



w/OK \$149
w/384K \$233

Two Year Warranty

- Parallel Port
- Serial Port
- Optional Game Port, \$25

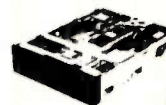

TEAC
55-B, Half-Height, DS/DD
\$99

DISK DRIVES

MITSUBISHI

(Japan's Best)
Half-Height, DS/DD

\$89
10 or more \$79

**INTEL 8087
Math Co-processor**



10 or more chips
\$89 each

\$99

SOLVE YOUR POWER PROBLEM.

XT™ POWER 135W



\$95

Fully XT™ compatible.
One Year Warranty.
Directly Replaces Power Supply in PC™.
10 or more \$85

**IBM PC AT™
PRODUCTS**



128K RAM set \$89
20 MEG Internal Hard Disk \$649
32 MEG Internal Hard Disk \$995

Fully compatible w/IBM PC AT™ Disk Controller, DOS 3.0 or 3.1
These are high-performance disk drives,
well-suited for the AT™.
IBM is a trademark of IBM Corp.

**IRWIN™
MAGNETICS**

TAPE BACKUP SYSTEM

\$595

10 or more \$495 each
• Uses Floppy Controller Card • Half Height
• 10.55 Meg Formatted Capacity • Low Power
• Used in Compaq Deskpro.

Prices shown are low prices and assurance that all merchandise is new, unused product, all sales are final. Call technical support for return authorization number on all warranty repairs. Any unauthorized return subject to a 10% restocking fee. Prepaid checks, money orders, VISA, MasterCard, American Express, or approved company purchase orders are accepted. No surcharge for VISA or MasterCard 3% surcharge for American Express.

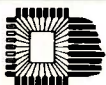

PC'S LIMITED

OUTSIDE TEXAS, ORDERS ONLY, CALL 1-800-IBM-5150

7801 N. Lamar, #E-200, Austin, Texas 78752

All calls for technical support and inside Texas,
call (512) 452-0323.

Telex No. 9103808386 PC LTD



Ad number 406

TALL TREE JRAM-2 2 MEGABYTE

Multi-Function Board for your
IBM, PC, XT, AT

WITHOUT MEMORY **\$199⁹⁵**

- Up to 2 megabytes of RAM
- Optional Parallel, Serial & Clock
- Free Jet Drive/J Spool Software
- Uses only 1 slot
- No loose cables!

	LIST	JADE
J RAM-2 without memory	\$219	\$199 ⁹⁵
J RAM-2 with 1 megabyte	\$519	\$449 ⁹⁵
J RAM-2 with 2 megabytes	\$819	\$699 ⁹⁵
Serial/Parallel/Clock module	\$180	\$149 ⁹⁵
Serial/Serial/Clock module	\$269	\$229 ⁹⁵
J RAM-AT without memory	\$569	\$479 ⁹⁵
J RAM-AT with 1 megabyte	\$869	\$749 ⁹⁵
J RAM-2 with 2 megabytes	\$130	\$119 ⁹⁵
AT Serial/Parallel module	\$130	\$119 ⁹⁵
AT Serial/Serial module	\$130	\$119 ⁹⁵
Jet Drive/J Spool Software	\$120	\$99 ⁹⁵

New! from JADE IBM Multifunction Card

Up to 384K, parallel printer port, RS-232 serial port, serial cable, clock/calendar, RAM disk/spooler and diagnostic software package.

	LIST	JADE
OK	\$349	\$198 ⁹⁵
64K	\$449	\$219 ⁹⁵
256K	\$549	\$269 ⁹⁵
384K	\$649	\$299 ⁹⁵

AST for IBM PC

	LIST	JADE
Six Pak Plus 64K	\$395	\$249 ⁹⁵
Six Pak Plus 256K	\$695	\$319 ⁹⁵
Six Pak Plus 384K	\$945	\$349 ⁹⁵
Mega Plus 64K	\$395	\$269 ⁹⁵
Mega Plus 256K	\$665	\$349 ⁹⁵
Mega Plus 512K	\$1095	\$699 ⁹⁵
I/O Plus	\$165	\$119 ⁹⁵
Preview	\$399	\$309 ⁹⁵

135 WATT
Drop-in replacement
POWER SUPPLY
For your IBM PC
\$129⁹⁵
List Price \$199

PRICE WAR!

Name Brands, Fast Service, & Satisfaction Guaranteed

GET YOUR IBM PC-AT THE AST Advantage

- Up to 3 Megabytes of RAM
- Uses standard 64K or 256K chips
- Has PAL for split-addressing
- Low power, IBM-AT high speed bus
- One parallel & one serial port
- 2nd serial or game port optional

	LIST	JADE
128K, 1 serial, 1 parallel	\$595	\$479 ⁹⁵
512K, 1 serial, 1 parallel	\$1395	\$679 ⁹⁵
1.5 MB, 1 serial, 1 parallel	\$2195	\$989 ⁹⁵
3.0 MB, 1 serial, 1 parallel	\$4145	\$1689 ⁹⁵

New Products to Expand Your PCjr.

AST 512K JrCombo w/128K	\$395	\$299 ⁹⁵
512K Multifunc. Card w/OK	\$295	\$229 ⁹⁵
External 360KB Disk Drive	\$499	\$369 ⁹⁵
Parallel Printer Port	\$120	\$94 ⁹⁵
8087 Co-Processor Card	\$199	\$149 ⁹⁵
Light Pen System	\$299	\$229 ⁹⁵
Simultaneous Disk/Keyboard	\$59	\$44 ⁹⁵
AST-PCnet IIjr LAN	\$495	\$399 ⁹⁵
TECMAR CAPTAINjr. w/128K	\$499	\$349 ⁹⁵

HAYES SMARTMODEM

YOUR CHOICE **\$169⁹⁵**

HAYES Smartmodem 300
HAYES Micromodem IIe
HAYES Smartmodem IIc

SAVE UP TO \$200!

Expansion Boards for Your IBM-AT

	LIST	JADE
JADE AT-Expando Plus	\$495	\$395 ⁹⁵
AT-Memory Master plus	\$495	\$429 ⁹⁵
AST Advantage-AT	\$595	\$479 ⁹⁵
STB Rio Grande 128K to 1.5M	\$495	\$359 ⁹⁵
STB Grande Byte 128K to 2.5M	\$395	\$299 ⁹⁵
Quadport-AT 1S, 1P	\$154	\$139 ⁹⁵
4 Serial Port Option	\$195	\$179 ⁹⁵
Quadmeg-AT 1 MEG	\$2465	\$1995 ⁹⁵
Quadmeg-AT 2 MEG	\$3495	\$2995 ⁹⁵
Quadmeg-AT 4 MEG	\$7490	CALL
128K Upgrade Kit	\$395	\$129 ⁹⁵
20 Megabyte Hard Disk	\$1790	\$895 ⁹⁵
360K Disk Drive for AT	\$395	\$119 ⁹⁵

IBM Video Boards

	LIST	JADE
Hercules Color	\$245	\$189 ⁹⁵
Hercules Graphic	\$499	\$339 ⁹⁵
Plantronics Color Plus	\$549	\$379 ⁹⁵
AST Preview	\$399	\$309 ⁹⁵
AST Monograph Plus	\$595	\$449 ⁹⁵
Tecmar Graphics Master	\$699	\$499 ⁹⁵
Quadcolor I	\$295	\$209 ⁹⁵
Quadcolor II	\$275	\$209 ⁹⁵
PC Peacock	\$299	\$239 ⁹⁵
Paradise Graphics Card	\$395	\$319 ⁹⁵
Paradise Module A	\$95	\$87 ⁹⁵
Paradise Module B	\$275	\$239 ⁹⁵
Everex Graphics Edge	\$599	\$349 ⁹⁵

JADE 1200 BAUD MODEM

Hayes Smartmodem compatible, 1200 BAUD modem at a fraction of the price. FCC approved.

JADE 1200 BAUD MODEM	\$399	\$299 ⁹⁵
----------------------	-------	---------------------

10 Megabyte Hard Disk for Your IBM PC \$599⁹⁵

Plug-n-run, ready to go, complete with controller card, data cable, and mounting hardware, totally PC/XT compatible, faster than XT, handles 4 different operating systems, streamer tape back-up available. External model includes cabinet & power supply. Full one year manufacturers warranty.

	LIST	JADE
10 MEGABYTE Internal 1/2 High	\$1350	\$599 ⁹⁵
10 MEGABYTE External	\$1585	\$799 ⁹⁵
15 MEGABYTE Internal	\$1765	\$879 ⁹⁵
15 MEGABYTE External	\$1897	\$1049 ⁹⁵
20 MEGABYTE Internal	\$1800	\$999 ⁹⁵
20 MEGABYTE External	\$2060	\$1199 ⁹⁵
33 MEGABYTE Internal	\$3298	\$1569 ⁹⁵
33 MEGABYTE External	\$3388	\$1799 ⁹⁵
10 MEGABYTE Half-High Tape	\$1000	\$579 ⁹⁵
20 MB Disk with 10 MB Tape	\$2980	\$1799 ⁹⁵

KEYTRONICS



	LIST	JADE
5150 Improved IBM Keyboard	\$209	\$159 ⁹⁵
5151 Deluxe IBM Keyboard	\$299	\$199 ⁹⁵

HAYES Smartmodems



Sophisticated direct-connect auto-answer/auto dial modem, touch tone or pulse dialing RS232 interface programmable

	LIST	JADE
HAYES Smartmodem 2400	\$899	\$629 ⁹⁵
HAYES Smartmodem 1200	\$699	\$389 ⁹⁵
HAYES 1200B w/o Smartcom II	\$539	\$339 ⁹⁵
HAYES 1200B for IBM PC	\$599	\$359 ⁹⁵
HAYES Smartmodem 300	\$289	\$169 ⁹⁵
HAYES Chronograph	\$249	\$199 ⁹⁵
HAYES Micromodem 100	\$399	\$299 ⁹⁵
HAYES Micromodem IIe	\$299	\$169 ⁹⁵
HAYES Smartmodem IIc	\$399	\$169 ⁹⁵
HAYES PLEASE Software	\$395	\$299 ⁹⁵
HAYES Smartcom II	\$149	\$99 ⁹⁵

PROMODEMS from PROMETHEUS

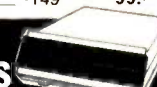

	LIST	JADE
1200B ProModem for IBM PC	\$399	\$289 ⁹⁵
1200 RS-232 ProModem	\$495	\$299 ⁹⁵
1200A ProModem for Apple	\$449	\$349 ⁹⁵
1200 ProModem for Macintosh	\$495	\$349 ⁹⁵
Alpha/num Display Option	\$99	\$79 ⁹⁵
Options Processor	\$99	\$79 ⁹⁵
64K Mem Expansion for Above	\$99	\$19 ⁹⁵

Mouse by MOUSE SYSTEMS

	LIST	JADE
PC MOUSE with Pop-ups	\$195	\$139.95
PC MOUSE with Paint	\$220	\$159.95
FIELD MOUSE (male or female)	\$175	\$129.95
PC PAINT Software	\$99	\$69.95
MOUSE WINDOW Software	\$150	\$109.95
POP-UP MENU Software	\$50	\$39.95

64K RAM Upgrade Kits for Your IBM PC **\$1795**

High speed RAM upgrade kit with FREE! parity (error detection) and one year warranty. We ship thousands of these kits to satisfied customers every week.

	LIST	JADE
128K RAM Chip Kit for AT	\$359	\$129.95
256K RAM Chip Kit	\$495	\$78.95

QUADRAM for IBM PC

	LIST	JADE
Quadboard No RAM	\$269	\$234.95
Quadboard 64K	\$395	\$275.95
Quadboard 128K	\$495	\$319.95
Quadboard 256K	\$595	\$399.95
Quadboard 384K	\$795	\$469.95
Quadlink	\$680	\$349.95
Quadcolor I	\$295	\$209.95
Quadcolor II	\$275	\$209.95

TEAC 55B 360K Disk Drive for IBM PC **\$999.95**



Double-sided, double density

	LIST	JADE
TANDON 100-2	\$299	\$119.95
TEAC 55B	\$249	\$99.95
CDC 1/2 Height	\$279	\$139.95
CDC Full Height	\$299	\$149.95

SHUGART 8" Disk Drives

SHUGART SA 801A SS/DD (Limited Supply)	
LIST \$502	\$399.95 ea. 2 for \$389.95 ea.
SHUGART SA-851R DS/DD	
LIST \$605	\$459.95 ea. 2 for \$454.95 ea.

MICROSOFT for IBM PC

	LIST	JADE
Mouse with Word	\$495	\$319.95
Microsoft Word	\$249	\$339.95
Mouse a la carte	\$199	\$129.95

HIGH RESOLUTION
640 x 260, .38 Dot Pitch

TAXAN

RGB COLOR

MONITOR

LIST PRICE \$699
For cable add \$19.00 **\$299.95**

High Resolution Video Monitors



	LIST	JADE
Amdek 300G	\$179	\$139.95
Amdek 300A	\$199	\$149.95
Amdek 310A	\$230	\$179.95
Amdek Color 300	\$349	\$269.95
Amdek Color 500	\$525	\$399.95
Amdek Color 600	\$650	\$449.95
Amdek Color 710	\$799	\$589.95
PGS MAX-12	\$269	\$179.95
PGS HX-12 640x240	\$699	\$449.95
PGS SR-12 720x480	\$799	\$629.95
PGS Scan-Doubler	\$299	\$199.95
14 inch Quadchrome II	\$599	\$499.95
Taxan 440 Ultra Hi-res RGB	\$799	\$599.95
Taxan 210 RGB/Composite	\$349	\$289.95
Taxan TV Tuner for RGB Monitor	\$99	\$89.95

PERSYST Boards

	LIST	JADE
Mono display adapter	\$225	\$189.95
Mono display adapter w/parallel	\$250	\$199.95
BoB Hi-res display adapter	\$595	\$469.95
Time Spectrum SB 384 w/64K	\$395	\$299.95

High Speed 8087 APU

LIST PRICE \$293	SALE PRICE \$139.95
------------------	---------------------

ISO-BAR



These industrial quality ISO-BARs look like a standard multi-outlet power strip but contain surge suppression circuitry and built-in noise filters plus a 15 amp circuit breaker.

	LIST	JADE
4 Receptacle Iso-Bar	\$89	\$59.95
8 Receptacle Iso-Bar	\$99	\$69.95

UNINTERRUPTABLE POWER SUPPLY

Emergency back-up power to save your computer system and your valuable data. A must for every computer system

200 Watt UPS	\$359	\$279.95
425 Watt UPS	\$539	\$459.95
1000 Watt UPS	\$1179	\$995.95

Disk Drive for Your Apple IIc **\$1299.95**

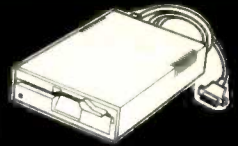

	LIST	JADE
Disk Drive for Apple IIc	\$249	\$129.95
Full Height Disk Drive	\$299	\$139.95
Half Height Disk Drive	\$249	\$129.95
ALS Z Engine	\$299	\$145.95
16K RAM Card	\$99	\$39.95
64K 80 Column Card for IIc	\$219	\$119.95
Best 80 Column Card II/II+	\$219	\$139.95
Printer Card & Cable	\$109	\$49.95
Fan with Surge Protection	\$99	\$59.95
Grappler Plus	\$175	\$99.95
64K Buffered Grappler+ w/16K	\$275	\$149.95

JADE XPC IBM PC

- ▶ 256K of RAM Expands to 640K on Main Board
- ▶ 140 Watt Power Supply
- ▶ 4.77 or 7 MHz Clock
- ▶ 8 Expansion Slots
- ▶ Deluxe Keyboard
- ▶ 90 Day Warranty



- ▶ 256K of RAM Maximum on Main Board
- ▶ 63 Watt Power Supply
- ▶ 4.77 MHz Clock
- ▶ 5 Expansion Slots
- ▶ IBM Keyboard
- ▶ 90 Day Warranty

256K of RAM, Two 360K Disk Drives, & Disk Controller
\$1295

OPTION #1

- 256K of RAM
- Two 360K Drives
- Hercules Card
- Amdek 300

IBM PC ___ \$1995
JADE XPC ___ \$1695

OPTION #3

- 256K Expands to 640K
- 10 Megabyte Hard Disk
- One 360K Drive
- 130 Watts of Power
- Multifunction Card
- Hercules Card
- Amdek 300

IBM PC ___ \$2995
JADE XPC ___ \$2695

\$1695

OPTION #2

- 256K of RAM
- Two 360K Drives
- Hercules Card
- PGS HX-12 Monitor

IBM PC ___ \$2395
JADE XPC ___ \$2095

Place Orders Toll Free!



Continental U.S.A. Inside California Los Angeles Area
(800) 421-5500 (800) 262-1710 (213) 973-7707

JADE

Computer Products

4901 West Rosecrans Ave. Hawthorne, California 90250

NEW! EPSON LX-80



EPSON LX-80 100 cps, NLQ
 EPSON RX-100F/T+ 100 cps
 EPSON JX-80+ 160 cps, Color
 EPSON FX-80FT+ 160 cps
 EPSON FX-100F/T+ 160 cps
 EPSON LQ-1500 200 cps, NLQ
 EPSON HI-80 4 Pen Plotter
 EPSON/COMREX 420 cps \$2495 \$1995.95
 2K Serial Board for RX/FX \$149 \$99.95
 NLQ Board for RX/FX \$219 \$179.95
 LetterWriter NLQ Kit for FX \$75 \$59.95
 LX-80 Tractor \$59 \$29.95
 FX-80 Tractor \$59 \$39.95
 LQ-1500 Tractor \$89 \$49.95
 LQ-1500 Sheet Feeder \$499 \$399.95

Save up to \$400.00
 Call for Low Price

NEW! OKIDATA PRINTER MICROLINE 192 \$349.95

160 CPS, Near Letter Quality, & Graphics

	LIST	JADE
OKIMATE 20 Color printer	\$150	\$139.95
PLUG-N-PRINT for OKI 20	\$75	\$69.95
OKI 182 120 cps, graphics	\$299	\$259.95
OKI 192 160 cps, graphics	\$499	\$349.95
OKI 193 160 cps, 15" paper	\$699	\$549.95
OKI 92 160 cps, graphics	\$599	\$349.95
OKI 93 160 cps, 15" paper	\$995	\$599.95
OKI 84 200 cps, parallel	\$1399	\$799.95
OKI 84 200 cps, serial	\$1499	\$949.95
Tractor for OKI 192	\$50	\$44.95
Tractor for OKI 92	\$89	\$54.95
2K Serial Board for 192/193	\$99	\$69.95
2K serial Board for 92/93	\$120	\$99.95
Extra-Ribbon	\$9	\$4.95

Data Switches

	LIST	JADE
SERIAL A-B Switch	\$129	\$99.95
PARALLEL A-B Switch	\$129	\$99.95
SERIAL A-B-C-D Switch	\$175	\$139.95
PARALLEL A-B-C-D Switch	\$175	\$139.95

A-B Printer Switch

Fully bi-directional switch allows your computer to run either of two printers, or allows two computers to share one printer, standard parallel switch box.

	LIST	JADE
Printer Switch	\$149	\$89.95
Extra Cable	\$40	\$29.95

Continental U.S.
800-421-5500

Inside California
800-262-1710

For Technical Inquires
 or Customer Service call:
213-973-7707

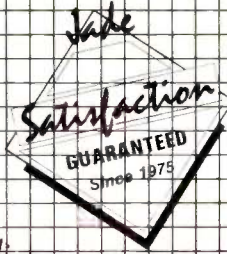

CITIZEN Printers

Best Near-Letter-Quality printers for under \$1000!!!

	LIST	JADE
CITIZEN MSP-10 FT 160 cps	\$499	\$349.95
CITIZEN MSP-15 FT 160 cps	\$749	\$529.95
CITIZEN MSP-20 FT 200 cps	\$699	\$489.95
CITIZEN MSP-25 FT 200 cps	\$949	\$669.95
CITIZEN Serial Option	\$60	\$49.95

Printer Accessories

	LIST	JADE
IBM PC style cable	\$54	\$19.95
Standard parallel cable	\$40	\$19.95
Dual Printer Switch Box	\$149	\$89.95
Apple Card & cable	\$109	\$49.95
RS-232C serial cable	\$30	\$24.95
Ribbons	as low as	\$4.99
Apple IIC cable	\$39	\$19.95

DOUBLE-SIDED DOUBLE-DENSITY DISKETTES

99¢ EACH In Bulk Packages of 125 pcs.
 Includes envelopes & labels

	LIST	JADE
Single-sided, double-density	\$34	\$16.50
Double-sided, double-density	\$42	\$19.50
Double-sided, 1.2 MB for AT	\$69	\$49.50
3 1/2" Single-sided for Mac	\$69	\$39.50
3 1/2" Double-sided for DG/1	\$89	\$49.50
Bulk Diskettes as low as		90¢

WHY PAY \$1149 FOR A C. ITOH

STARWRITER F-10

When Our 40 CPS Letter-Quality Daisywheel
 From The Same Manufacturer

IS ONLY **\$499.95**

C. ITOH Printers

C. Itoh's best-selling ProWriter and StarWriter printers are now available with parallel interfaces for Apple & IBM, or a serial interface for Apple IIC, Macintosh, Data General, etc. Full one year manufacturers warranty.

	LIST	JADE
ProWriter 7500 FT 105 cps	\$289	\$209.95
ProWriter 8510 AP 120 cps	\$429	\$299.95
ProWriter II 1550 FT 120 cps	\$619	\$439.95
StarWriter Y10-20 20 cps	\$489	\$359.95
StarWriter A10-30 29 cps	\$669	\$479.95
StarWriter F10-40 40 cps	\$1199	\$899.95
StarWriter F10-55 58 cps	\$1449	\$1089.95
StarWriter F10 Tractor	\$249	\$159.95
StarWriter A10 Tractor	\$199	\$139.95

Letter Quality Printers On Sale!

	LIST	JADE
JUKI 6100 18 CPS	\$599	\$399.95
JUKI 6300 40 CPS	\$995	\$849.95
COMREX CR-11e 20 CPS	\$599	\$399.95
NEC 3550 33 CPS	\$2250	\$1399.95
DIABLO 630 40 CPS	\$2340	\$1569.95
TOSHIBA P1340 180 CPS	\$995	\$599.95
TOSHIBA P1351 180 CPS	\$1895	\$1249.95
TOSHIBA P351 288 CPS	\$1850	\$1299.95
T.I. 855 150 CPS	\$935	\$689.95
T.I. 865 150 CPS	\$1299	\$949.95

STAR Printers

	LIST	JADE
SG-10 120 CPS	\$299	\$239.95
SG-15 120 CPS	\$499	\$399.95
POWERTYPE 18 CPS	\$499	\$359.95

The LITTLE BOARD with FREE! CP/M 2.2

Miniature single board CP/M computer designed to mount directly on top of a 5 1/4" floppy disk drive (7.75" x 5.75"). Contains Z80A, CPU, 64K RAM, Boot EPROM, terminal port, modem port, parallel printer port, floppy disk controller, and CP/M 2.2 included FREE!

	LIST	JADE
Little Board with CP/M	\$400	\$339.95
Support Package	\$59	\$48.95
Serial Cable	\$13	\$11.95
Diskless Monitor Eprom	\$30	\$24.95
SCSI/Plus I/O Adapter	\$99	\$89.95

QUADRAM MICROFAZER Buffers



Expandable to 64K (parallel model expands to 512K)

8K Parallel in/Parallel out	\$169	\$139.95
64K Parallel in/Parallel out	\$225	\$164.95
128K Parallel in/Parallel out	\$445	\$269.95
8K Serial in/Parallel out	\$199	\$169.95
64K Serial in/Parallel out	\$260	\$199.95
8K Parallel in/Serial out	\$199	\$169.95
64K Parallel in/Serial out	\$260	\$199.95
8K Serial in/Serial out	\$199	\$169.95
64K Serial in/Serial out	\$260	\$199.95

PRACTICAL PERIPHERAL MICROBUFFERS

Stand alone Microbuffers for Printers & Modems

	LIST	JADE
32K Parallel in/Parallel out	\$299	\$229.95
64K Parallel in/Parallel out	\$349	\$249.95
32K Serial in/Serial out	\$299	\$229.95
64K Serial in/Serial out	\$349	\$249.95
64K Add-on Board	\$179	\$149.95

We accept cash, checks, credit cards, or purchase orders from qualified firms and institutions.
Minimum prepaid order \$15.00 California residents add 6 1/2% tax. Export customers outside the US or Canada please add 10% to all prices. **Prices and availability subject to change without notice.** Shipping and handling charges via UPS Ground 50¢/lb. UPS Air \$1.00/lb. **minimum charge \$3.00**

JADE Computer Products



Apple II + Paper Tape I/O Is This Easy
 10101011010001010.....
 01010101010010100.....
 One minute you're without, the next you're up and running! Just plug into your **APPLE II PLUS**. A neat and complete package.

- Model 600-1 Punch — 50cps, rugged
- Model 605 Reader — 150cps
- Parallel Interface Board/Cable
- Data Handling Program

Code conversion available. **TRS-80** package soon. **ADDMASTER CORP.** 416 Junipero Serra Dr., San Gabriel, CA 91776 * 213/285-1121.

Inquiry 12

SAVE TIME AND MONEY WITH LOW COST PI-SWITCH BOXES.

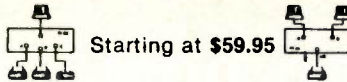

Starting at \$59.95

- Quickly shares your computer among multiple terminals, printers, modems, etc. with just a flick of the wrist.
 - Compact black & beige aluminum enclosure features a high quality rotary switch with rear mounted connectors.
 - Serial RS-232 Models have fem. 25-Pin Conn. (Lines 1-7 & 20)
- | | |
|-------------------------------|---------|
| PI-02-S switches 2 to 1 | \$59.95 |
| PI-03-S switches 3 to 1 | 79.95 |
| PI-05-S switches 5 to 1 | 109.95 |
- Parallel models have fem. 36-Pin cent. conn.
- | | |
|-------------------------------|--------|
| PI-02-P switches 2 to 1 | \$4.95 |
| PI-04-P switches 4 to 1 | 154.95 |
- Dealers, schools & custom inquiries welcome.
 - One Year Warranty. COD, VISA, M/C.
 - Shipping UPS \$2.00/ea. AIR \$4.00/ea.

SAB LINK
 7301 NW 41 St.
 MIAMI, FL 33166
 (305) 592-6092

Inquiry 361

Electronic Circuit Analysis

- New release
- Transient, AC, DC analysis
- Full nonlinear
- Over 200 nodes
- Full editing
- Macro circuits
- Worst case, Monte-Carlo
- Temperature effects
- Frequency dependent parts
- Time dependent parts

For MS-DOS. 128k minimum.
 \$395.00

Tatum Labs
 P.O. Box 698
 Sandy Hook, CT 06482
 (203) 426-2184

Inquiry 401

PC EXPANSIONS

Gume 142A	\$189
Teac FD55B	\$129
Tandon TM100-2	\$129
Tandon TM101-4	\$239
CDC 9409	\$129
Maynard Disk Controller	\$114
Sandstar Series	\$call
Internal 10MB HD systems: WS1	\$769
WS2	\$929
MaynStream tape backup	\$1229
Quadboard (64K)	\$254
Quadboard (384K)	\$349
Quadcolor I	\$199
AST SixPakPlus (64K)	\$259
SixPakPlus (384K)	\$354
MegaPlus (64K)	\$269
Advantage	\$419
I/O Plus	\$129
PCnet - starter kit	\$809
HERCULES graphics board	\$339
Color Card with PP	\$169
HAYES Modems: 300	\$199
Smartmodem 1200	\$429
Smartmodem 1200B	\$389
Set of 9 chips (64K)	\$19
256K chips (each)	\$36
8087 chip	\$139
Verbatim Datalife disks (20)	\$49

VLM Computer Electronics
 10 Park Place • Morristown, NJ 07960
 (201) 267-3268 Visa, MC, Check or COD

Inquiry 419

WHY YOUR FLOPPY DISK SHOULD BE A BASF FLEXY DISK



- Lifetime warranty.
- Certified 100% error-free.
- Special self-cleaning jacket and unique two-piece liner.
- Center hole more accurate than industry standard.
- Bi-axially oriented polyester substrate.
- Cross-linked oxide coating.
- Double lubrication.

PLUS BASF Special Offer
 Call, write, or utilize reader service — we'll send you our full-range catalog of computer supplies with a special offer enclosed.

LYBEN COMPUTER SYSTEMS
 1250-E Rankin Dr., Troy, MI 48083
 Phone: (313) 589-3440
Simply #1 in Service & Reliability

Authorized Reseller
 Information Processing Media



Inquiry 258

NEW I/O BUS FOR DATA ACQUISITION & CONTROL

Now available for IBM PC, XT, AT & Apple II.

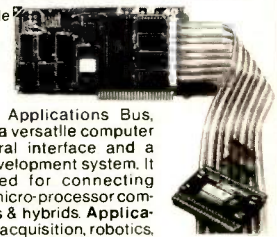

The Local Applications Bus, **LAB 40**, is a versatile computer to peripheral interface and a product development system. It is optimized for connecting directly to micro-processor compatible I.C.s & hybrids. **Applications:** data acquisition, robotics, instrumentation, control, conventional peripherals. **Capabilities:** access up to 64 sixteen bit ports, 8 interrupts, DMA speeds more. Presently available Applications modules include 8 & 12 bit high speed A/D w/programmable gain. Prices for the LAB 40 developers kit (circuit, software & manual) start at \$200.

Computer Continuum

75 Southgate Ave., Suite 6
 Daly City, CA 94015 (415) 755-1978

Hyperon Software

Specializing in innovative programming tools

- Complete documentation and C-source provided (presently DOS only).
- Reasonable prices.
- High quality and good performance.

Products currently available:

C Preprocessor. Features include variables and expressions, loops, and full macros. Price — \$39.95
 General purpose editor. Line oriented commands with a screen oriented submode. Command window. Price — \$29.95

Order from:

HYPERON SOFTWARE
 P.O. Box 3349
 Costa Mesa, CA 92628

Enclose check or money order. California residents add 6%
 2532 Orange Ave. Costa Mesa, CA

Inquiry 214

maxell DISKS
 LIFETIME WARRANTY

TIRED OF WAITING FOR SERVICE AND PRICE? 9 out of 10 SURVEYED DISK BUYERS PREFERRED

NORTH HILLS #1 IN SERVICE AND PRICE 1-800-328-3472

Formatted and hard sector disks in stock-Dealer inquiries invited.
 COD, VISA, MASTERCARD
 All orders shipped within 24 hrs.



NORTH HILLS CORP. INTERNATIONAL
 3564 Rolling View Dr.
 White Bear Lake, MN. 55110
 MN. call collect—612-770-0485

DATA ACQUISITION TO GO INTERFACE FOR ANY COMPUTER

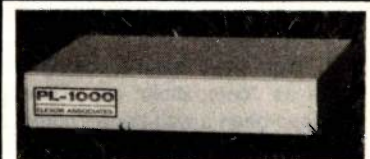

Connects via RS-232. Built-in BASIC. Stand alone capability. Expandable. Battery Option. Basic system: 16 ch. 12 bit A/D, 2 ch. D/A, 32 bit Digital I/O. Expansion boards available. Direct Bus units for many computers.

SPECIALISTS IN PORTABLE APPLICATIONS
(201) 299-1615

P.O. Box 246, Morris Plains, NJ 07950

ELEXOR

Inquiry 166

I*U*CO™ is the best thing to happen to personal computing since the invention of the personal computer!

I*U*CO is an idea whose time has come.

I*U*CO is the International Union of Computer Owners, an organization designed to protect the interests of personal computer owners and users against those who would take their money...and then deliver less than they promised.

Here's an overview of some of the vital services I*U*CO provides:

1. Access to the lowest priced, reputable vendor for nearly every computer related need; and,
2. Protection from the rip-off artists, vaporware specialists, false advertisers and other creepy, crawly creatures who have been attracted to the computer industry by the scent of your money; and,
3. Constantly updated information on software, hardware and peripheral releases, upgrades, bug reports, bug fixes, reviews, letters to the editor and other data individually tailored to your needs through the exclusive I*U*CO COMPUTER REGISTRY™; and,
4. Finally, a chance to get even with those characters out there who promised a lot, took your money...and then delivered less than they promised.

**I*U*CO™:
a lynch mob
with a purpose.**

Every computer owner has been ripped off at least once.

Or maybe a dozen times or more might be a more appropriate number.

In any event, we've all been victimized by the computer industry.

And it wasn't accidental.

Today's computer industry is filled with hypesters, rip-off artists, vaporware specialists and others whose sole function in life is to part you from your money by delivering a little less than you bargained for...or by charging you more than you would otherwise have to pay.

The rip-off might have been a computer that wasn't quite as "compatible" as advertised. Or it could have been a well-known computer that was to be delivered at the same time that "hundreds" of programs would be available with it...if you consider the same time to be a year-and-a-half later.

Or the rip-off might be in the form of measures taken by certain manufacturers and software publishers to limit sales of their products through "authorized" dealers only.

This is, of course, designed (they say) to get you better service.

But it's also a neat way to keep prices

artificially high by restricting competitive forces in the market place.

The number of ways you're being ripped off grow everyday, as greed becomes the major motivating factor in the computer marketplace.

Possibly, you've been had by a software manufacturer who continuously upgrades their software...charging you a pretty penny for the elimination of bugs which shouldn't have been there in the first place!

In a few cases, it's nothing more complex than a vendor who takes your money and simply takes their time in delivering.

If they ever get around to delivering at all.

In any event, the computer industry just isn't the friendly place it used to be, when everyone was trying to help each other learn about their machines.

Today's computer market has been an invitation to be ripped off.

**Until now, that is,
I*U*CO**

means protection.

I*U*CO™ subscribes to some very ancient wisdom: there's strength in numbers.

Labor unions learned the lesson a long time ago.

The individual worker had no clout.

But when the workers organized, they got a lot of power.

Even automobile owners learned the lesson a long time ago. Back when the early drivers got tired of dirt roads, they organized the American Automobile Association...and that's part of the reason the United States is laced with an incomparable highway and street system today.

Needless to say, the computer industry knows the value of organization as well.

Computer manufacturers, software publishers and others eager to get as much as they can from you have formed various associations to achieve such lofty goals as making sure that they can't be held responsible when their products don't work or to prevent you from copying the software you "licensed" from them...so they can sell you a back-up disk.

In short, everyone seems to have learned the benefits of getting organized and gaining power.

Except the personal computer owner and user.

And that's why there has to be an I*U*CO™.

I*U*CO™ is designed to be what every collective organization is: a means to protect the special interests of its own members!

And, in this case, the members are the victims...the people who own and use personal computers.

The people who until now have been powerless.

**First of all,
I*U*CO™**

means low prices.

The first benefit an I*U*CO™ member gets is the opportunity to save money.

Lots of it.

While certain manufacturers of software, peripherals and hardware are trying hard to crack down on what they call the "grey market" (thus keeping prices higher than they should be), I*U*CO™ will maintain a database of every mail-order advertisement that appears in the major national computer magazines. A similar database will also be kept for selected major retail markets, so you can take advantage of special sales and the like.

When you want the lowest price on something, just (electronically) mail your shopping list to I*U*CO™.

Within a day, you'll get the three lowest and most recently quoted prices...and, quite possibly, special prices that haven't been advertised anywhere!

I*U*CO™ protects you.

Of course, buying by mail or from a supplier you don't know can get you more than low prices.

It can get you problems in delivery, service and general dissatisfaction with the product you bought.

So, along with the low price quotations, you also get I*U*CO™ member evaluations of the product and the vendor and a bibliography of reviews, letters to the editor, articles and other information that just might convince you not to spend the money in the first place.

(Remember, most sellers are pretty restrictive about returns, particularly software returns.)

So, as an I*U*CO™ member, you get:

1. The lowest possible prices.
2. An assessment of both the product and the vendor.
3. Information on the actual use value of the product. (An awful lot of products sound better in their advertising than they are in reality. That's why so few companies offer a money-back guaranty.)

**Continuing protection
from I*U*CO™:**

the Computer Registry™.

As an I*U*CO™ member, you can also become part of our exclusive Computer Registry™.

You simply register the appropriate information about all the hardware, software and peripherals you own with I*U*CO™.

Then, as updates are announced, bugs discovered or fixed and so on, you automatically get this information as part of a customized and individualized monthly bulletin.

No more finding out a year after the fact that you're still using Version 1.00 and everyone else has Version 9.4! Or, you might find out that the problem you thought was yours alone is actually widespread.

(As a personal note, you'll find that this I*U*CO™ service is invaluable.)

In the past few weeks, I found out that a) the ROMS in my Anadex printer have been upgraded, b) there's at least one undocumented bug in running MacPaint with the 512K upgrade, c) the ROMS in my IOMEGA Bernoulli Box were upgraded, and d) [best of all] MicroPro knew of a bug in Infostar 1.6 which they didn't tell anyone about for 18 months!)

In none of these instances did the manufacturer tell the consumer.

As an I*U*CO™ member, you could get this information on a customized and individualized basis, each and every month for every piece of hardware, software and peripheral equipment you own or acquire.

**I*U*CO™:
the iron fist.**

The best part of I*U*CO™ has been saved for last.

Yes, I*U*CO™ will help you get the lowest prices on everything you want to buy for your computer.

And I*U*CO™ will give you solid information on the integrity of products and vendors.

Finally, if you choose to become a part of I*U*CO's™ exclusive Computer Registry™, you can also stay current with the products you own or acquire.

**But with I*U*CO™,
you also get power!**

But, more importantly, your membership in I*U*CO™ gives you the power of belonging to a community...a community of personal computer owners and users who need to protect their rights.

For instance, a group of software publishers managed to get the Louisiana legislature to pass a law "legalizing" the non-warranties they provide with their software. (You know, "this software is sold without any guaranty that it will work." Just pay your money and take your chances.)

**I*U*CO™
will fight for you!**

I*U*CO™ will fight that kind of nonsense by lobbying against it, organizing PAC's and, in general, by doing what every other special interest group does: fight for its own special needs and interests.

As one person, there is little you can do when you're ripped off by a vendor. The powers that be...such as the FTC...don't pay much attention to one person.

But when a special group like I*U*CO™ has a lot of members which can be translated into publicity and political pressure, you'd be surprised what can be done.

There's a lot more to the I*U*CO™ story.

More than we can afford to tell here.

Complete information costs only \$1.00.

So, fill in the coupon below.

Free! A guide to your legal rights as a personal computer owner!

Send a dollar for more information on I*U*CO™ membership and we'll include FREE a guide to your legal rights (and obligations) as a personal computer owner.

This synopsis, written by an attorney who also happens to be an electrical engineer will give you helpful information on questions such as using copy programs for making your own back-up copies, how to complain effectively and other issues which affect you as a personal computer owner.

It's a slim volume, to be sure, because unless you're both rich and tough, you're going to learn that you haven't got all that many rights.

International Union of Computer Owners, Inc.
30 East Huron Street
Chicago, Illinois 60611

YES, I'm tired of being ripped off. Enclosed is \$1.00. Please send information on I*U*CO™. I understand that I am under no obligation to enroll as a member.

Please print all information!

Name _____
Company _____
Address _____
City _____ State _____ ZIP _____
Make of computer: _____

DoKay

COMPUTER
PRODUCTS,
Inc.

ORDER TOLL FREE

(800)
538-8800

(CALIFORNIA RESIDENTS)

(800)
848-8008



STATIC RAMS

2101	256 x 4	450ns	1.90	
2102	1K x 1	450ns	.79	
2102L-4	1K x 1	450ns	.89	
2102L-2	1K x 1	250ns	1.29	
2111	256 x 4	450ns	2.29	
2112	256 x 4	450ns	2.29	
2114	1K x 4	450ns	.99	
2114-25	1K x 4	250ns	1.10	
2114L-4	1K x 4	450ns	1.20	
2114L-3	1K x 4	300ns	1.30	
2114L-2	1K x 4	200ns	1.40	
2147	4K x 1	55ns	3.95	
5101	256 x 4	450ns	3.90	CMOS
TMS4044-4	4K x 1	450ns	2.95	
TMS4044-3	4K x 1	300ns	3.45	
TMS4044-2	4K x 1	200ns	3.95	
MK4118	1K x 8	250ns	8.95	
TMM2016-20	2K x 8	200ns	2.49	
TMM2016-15	2K x 8	150ns	2.99	
TMM2016-10	2K x 8	100ns	4.49	
HM6116-4	2K x 8	200ns	2.49	CMOS
HM6116-3	2K x 8	150ns	2.99	CMOS
HM6116-2	2K x 8	120ns	5.49	CMOS
HM6116LP-4	2K x 8	200ns	2.99	CMOS
HM6116LP-3	2K x 8	150ns	3.49	CMOS
HM6116LP-2	2K x 8	120ns	6.49	CMOS
Z-5132	4K x 8	300ns	29.95	
HM6264P-15	8K x 8	150ns	9.95	CMOS
HM6264LP-15	8K x 8	150ns	8.95	CMOS
HM6264LP-12	8K x 8	120ns	10.95	CMOS

DYNAMIC RAMS

TMS4027	4K x 1	250ns	1.45	
UP0411	4K x 1	300ns	1.95	
MMS280	4K x 1	300ns	1.95	
MK4108	8K x 1	200ns	.49	
MMS298	8K x 1	250ns	.49	
4116-20	16K x 1	200ns	.79	
4116-15	16K x 1	150ns	.99	
4116-12	16K x 1	120ns	1.49	
2118	16K x 1	150ns	3.96	5v
4164-25	64K x 1	250ns	5.150	5v
4164-20	64K x 1	200ns	5.175	5v
4164-15	64K x 1	150ns	5.200	5v
41256-20	256 x 1	200ns	7.95	
41256-15	256 x 1	150ns	8.95	

EPROMS

1702	256 x 8	1 us	3.95	
2708	1K x 8	450ns	2.49	
2758	1K x 8	450ns	5.90	
2716	2K x 8	450ns	5.95	5v
2716-1	2K x 8	350ns	5.95	5v
TMS2516	2K x 8	450ns	5.95	5v
TMS2716	2K x 8	450ns	6.95	
TMS2532	4K x 8	450ns	5.95	5v
2732	4K x 8	450ns	5.95	5v
2732 A-4	4K x 8	450ns	21v	3.95
2732 A-35	4K x 8	350ns	21v	3.95
2732 A	4K x 8	250ns	21v	5.95
2732 A-2	4K x 8	200ns	21v	8.95
2764	8K x 8	450ns	5v	4.25
2764-25	8K x 8	250ns	5v	4.95
2764-20	8K x 1	200ns	5v	7.95
TMS2564	8K x 8	450ns	5v	9.95
MCM68764	8K x 8	450ns	5v	17.95
MCM68766	8K x 8	350ns	5v	19.95
27128-45	16K x 8	250ns	5v	8.95
27128-30	16K x 8	300ns	5v	9.95
27128-25	16K x 8	250ns	5v	10.95
27256-25	32K x 8	250ns	14v	24.95

74LS00

74LS00	.23	74LS125	.48	74LS260	.58
74LS01	.24	74LS126	.48	74LS266	.54
74LS02	.24	74LS132	.58	74LS273	1.45
74LS03	.24	74LS133	.58	74LS275	3.30
74LS04	.23	74LS136	.38	74LS279	.48
74LS05	.24	74LS137	.98	74LS280	1.95
74LS08	.27	74LS138	.54	74LS283	.68
74LS09	.28	74LS139	.54	74LS290	.88
74LS10	.24	74LS145	1.15	74LS293	.88
74LS11	.34	74LS147	2.45	74LS295	.98
74LS12	.34	74LS151	1.30	74LS298	.88
74LS13	.44	74LS153	.54	74LS299	1.70
74LS14	.58	74LS154	.85	74LS323	3.45
74LS15	.24	74LS154	1.85	74LS324	1.70
74LS20	.34	74LS155	.68	74LS352	1.25
74LS21	.28	74LS156	.68	74LS353	1.25
74LS22	.24	74LS157	.64	74LS363	1.30
74LS26	.28	74LS158	.58	74LS364	1.90
74LS27	.28	74LS160	.68	74LS365	.48
74LS28	.34	74LS161	.64	74LS366	.48
74LS30	.24	74LS162	.68	74LS367	.44
74LS32	.28	74LS163	.64	74LS368	.44
74LS33	.54	74LS164	.68	74LS373	1.35
74LS37	.34	74LS165	.94	74LS374	1.35
74LS38	.34	74LS166	1.90	74LS377	1.35
74LS40	.24	74LS168	1.70	74LS378	1.13
74LS42	.48	74LS169	1.70	74LS378	1.30
74LS47	.74	74LS170	1.45	74LS385	1.85
74LS48	.74	74LS173	.68	74LS386	.44
74LS49	.74	74LS174	.54	74LS390	1.15
74LS51	.24	74LS175	.54	74LS393	1.15
74LS54	.28	74LS181	2.10	74LS395	1.15
74LS55	.28	74LS189	8.90	74LS399	1.45
74LS63	1.20	74LS190	.88	74LS424	2.90
74LS73	.38	74LS191	.88	74LS447	.36
74LS74	.34	74LS192	.78	74LS490	1.90
74LS75	.38	74LS193	.78	74LS624	3.95
74LS76	.38	74LS194	.68	74LS640	2.15
74LS78	.48	74LS195	.68	74LS645	2.15
74LS83	.59	74LS196	.78	74LS668	1.65
74LS85	.68	74LS197	.78	74LS669	1.85
74LS86	.38	74LS221	.88	74LS670	1.45
74LS90	.54	74LS240	.94	74LS674	9.60
74LS91	.88	74LS241	.98	74LS682	3.15
74LS92	.54	74LS242	.98	74LS683	3.15
74LS93	.54	74LS243	.98	74LS684	3.15
74LS95	.74	74LS244	1.25	74LS685	3.15
74LS96	.88	74LS245	1.45	74LS688	2.35
74LS107	.38	74LS247	.74	74LS689	3.15
74LS109	.38	74LS248	.98	74LS783	23.95
74LS112	.38	74LS249	.98	81LS95	1.45
74LS113	.38	74LS251	.58	81LS96	1.45
74LS114	.38	74LS253	.58	81LS97	1.45
74LS122	.44	74LS257	.58	81LS98	1.45
74LS123	.78	74LS258	.58	25LS2521	2.75
74LS124	2.85	74LS259	2.70	25LS2569	4.20

We will try to BEAT
All Competitor's Prices
CALL for Quote!

DISC CONTROLLERS

1691	6.90	2795	38.90
1771	14.90	2797	38.90
1791	22.90	6843	33.90
1793	22.90	8272	19.90
1795	22.90	M88876	22.90
1797	22.90	M88877	22.90
2143	6.90	MC3470	4.90
2791	38.90	MC3470	4.90
2793	38.90	UP0765	19.90

CRT CONTROLLERS

6845	11.90	CRT5027	18.90
6847	10.90	CRT5037	28.90
68047	23.90	OP8350	38.90
68845	18.90	HD46505	11.90
7220	38.90	MC1372	6.90
8275	28.90	TMS9918A	38.90

UV ERASERS

QUV-T8/1 \$49.95
ECONOMY Model



- Erases 15 EPROMS in 20 minutes
- Plastic Enclosure

6500 6500 A

6502	4.90	6502A	5.90
6504	6.90	6520A	5.90
6505	8.90	6522A	9.90
6507	9.90	6532A	10.90
6520	4.30	6545A	12.90
6522	4.90	6551A	10.90
6532	9.90		
6545	9.90		
6551	9.90	6502B	7.90

6800 68800

6800	2.90	68800	9.90
6802	7.90	68802	11.90
6803	17.90	68809	11.90
6808	12.90	68809E	11.90
6809E	8.90	68810	5.90
6809	8.90	68821	5.90
6810	2.90	68840	18.90
6820	4.30	68845	18.90
6821	2.90	68850	5.90
6828	13.90		
6840	11.90		
6843	33.90		
6844	24.90		
6845	11.90		
6847	10.90	68000-8	34.90
6850	2.90	68047	23.90
6852	5.90	68488	18.90
6860	7.90	68652	14.90
6862	10.90	68661	8.90
6875	6.90	68764	17.95
6880	1.90	68764	17.95
6883	21.90	68766	19.95

8000

8031	14.90	8253	6.90
8035	5.90	8253-5	7.90
8039	5.90	8255	4.45
INS-8060	16.90	8255-5	4.90
INS-8073	29.90	8257	7.90
8080A	3.90	8257-5	8.90
8085	4.90	8259	5.90
8085A-2	11.90	8259-5	6.90
8086	24.90	8271	69.90
8087-3 (5 MHz)	159.90	8272	19.90
8087-2 (8 MHz)	279.90	8274	28.90
8088	19.90	8275	28.90
8089	59.90	8276	6.90
		8279-5	7.90
		8282	6.45
		8283	6.45
		8284	6.45
		8286	6.45
		8287	12.90
		8288	44.90
		8292	12.90

8100

8131	2.90	8286	6.45
8155	6.90	8287	6.45
8155-2	7.90	8288	12.90
8156	6.90	8289	44.90
8185	28.90	8292	12.90
8185-2	38.90		

8200

8202	23.90	8303	2.90
8203	38.90	8304	1.90
8205	2.90	8307	2.90
8212	1.75	8308	2.90
8214	3.75	8311	3.90
8216	1.75		
8224	2.20		
8226	1.75		
8228	3.45		
8237	12.90		
8237-5	14.90		
8238	4.45		
8243	4.45		
8250	9.90		
8251	3.90		
8251A	4.45		

8300

8741	28.90
8748	19.90
8749	28.90
8755	23.90

8700

80186-6	99.90
80188	89.90

80000

80186-6	99.90
80188	89.90

Z-80

Z80-CPU	1.95	Z80A-DMA	8.95
Z80-CTC	1.95	Z8	

ROBOT KITS! PEPPY



2-way sensor detects noise or solid objects in its path. When front sensor contacts an obstacle or hears a loud noise (hand-clap), Peppy automatically turns to the left.

Uses 2 AA and 1 9V battery (not included)

MV-916 \$24.95

RESISTORS

CARBON FILM 1/4 WATT 5%
ALL STANDARD VALUES

25 PCS	.75
50 PCS	1.25
100 PCS	2.00
1,000 PCS	15.00

RIBBON CABLE

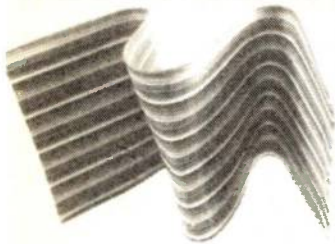

Size	Solid Color		Color Coded	
	1 ft.	10 ft.	1 ft.	10 ft.
10	.17	1.55	.78	7.20
16	.27	2.45	.95	8.70
20	.35	3.15	1.15	10.90
25	.45	4.00	1.22	11.50
26	.45	4.00	1.27	11.50
34	.60	5.35	1.55	14.40
40	.70	6.35	1.82	16.70
50	.88	7.40	2.40	21.90



Checkmate
Technology,
Inc.

APPLE IIe Special
Extended 80-Col.
VIDEO CARD
\$69.95

★ 64K to 128K ★
MULTIVIEW 80/160 249.00

0-160 columns with any monitor!

- Screens: 80x24, 80x32, 80x48, 96x24, 132x24, 132x30, 160x24
- On-screen BOLD and Underline
- Reverse scrolling
- Easy-to-read Wide-angle mode
- Apple II and IIe compatible
- Prompt lines
- Upper & lowercase letters



APPLE & IBM ACCESSORIES

APPLE ACCESSORIES

Parallel Printer Card	49.95
80-Col. card for Apple II+	149.95
80-Col. card for Apple IIe	129.95
Checkmate 80-Column Card	69.95
Serial Card (communication)	69.95
Clock Calendar card	79.95
Cooling Fan	38.95
Power Supply	69.95
Joystick	29.95
Joystick Adapter Apple Iic	14.95
RF Modulator	13.95
Disk Drive Full Height	169.95
Disk Drive 1/2 Height	169.95
Controller Card	49.95
Apple Paddles	5.95
16K Card	39.95
16K Bare Board	13.95
Extend-A-Slot	34.95
Paddle Adapple	29.95
Koala Touch Pad	99.00
Magic Touch Pad w/Joystick	79.95
Keytronic Keyboard	219.00
Apple Keyboard (Taiwan)	149.95

micromax
INNOVATORS IN MICRO-COMPUTER TECHNOLOGY

VIEWMAX-80 149.95

The right 80-column card for your
Apple II+

- Soft video switch
- Built-in inverse video
- Shift key support
- 2 year parts & labor warranty



VIEWMAX-80e 129.95

Most advanced 80-column
extended video card for
Apple IIe

- Expands memory up to 192K
- Double high resolution
- 2 year parts & labor warranty



DISK DRIVES Apple and IBM compatible

Apple full height	159.95
Apple half height	129.95
Teac 55B	115.95
Tandon TM100-2	149.95

APPLE or IBM JOYSTICK

\$29.95

Compatible for either:

APPLE II and APPLE IIe

OR

IBM-PC, JR., & IBM-XT

MULTIFUNCTION CARD



- 64K to 384K RAM
- Parallel Port
- Serial Port
- Clock Calendar
- Software Included
- 1-Year Warranty

\$199.00

MEMORY CARD



- Expandable to 512K
- Fully compatible with IBM software
- Fully compatible w/IBM diagnostic utilities
- Serial Port Available
- 1-Year Warranty

\$149.00

MEMORY EXPANSION KIT



4164 200ns
9 for \$15.75

DISKETTES 5 1/4"

**ATHANA: (SOFT SECTOR
w/HUB RING)**
25 per package

SS/DD..... 29.75 or 1.19 ea.
DS/DD..... 34.75 or 1.39 ea.

LIFETIME WARRANTY
ON ALL ATHANA DISKETTES

**NO LABEL: (SOFT SECTOR
w/HUB RING)**
25 per package

SS/DD..... 24.75 or .99 ea.
DS/DD..... 29.75 or 1.19 ea.

2-YEAR WARRANTY
ON ALL BULK DISKETTES

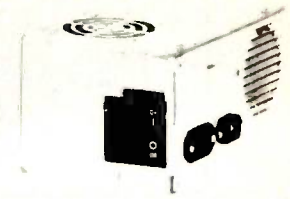

IBM SWITCHING POWER SUPPLIES

130 Watt IBM PC XT..... 139.95
200 Watt IBM PC AT..... 179.95

Reg. Power Supply Model 4A/PS (99/4)

3 DC Outputs:

12V @ .4A, +5V @ 1.1A
-5V @ .2A Highly Filtered

6.95



KEYBOARD (99/4)

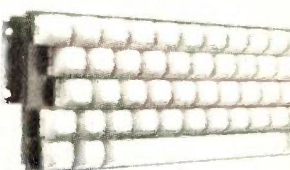

48 keys 4" x 10" **6.95**

TERMS: Minimum order \$10.00
For shipping and handling include
\$2.50 for UPS ground or \$3.50 for
UPS Blue (air). For each additional
air pound, add \$1.00. California
residents must include 6% sales
tax; L.A., S.F., S. Cruz & S. Mateo
counties include 6.5% sales tax
and Santa Clara include 7% sales
tax. All items subject to availability
and prices are subject to change.
Typographical errors are not our
responsibility.

No additional charge for Master-
card or Visa. We reserve the right
to substitute manufacturers and
to limit quantities.

CALL for VOLUME Quotes

NEW HOURS: M - F 7:30 am - 5:00 pm

VISIT OUR RETAIL STORE
2100 De La Cruz Blvd.
Santa Clara, CA 95050
(408) 988-0697

**ALL MERCHANDISE IS
100% GUARANTEED**

Telex: 756440

DoKay

COASTLINE COMPUTERS



800-228-4615

Please call collect if 800 number not in service.

213-329-4828

213-324-8087

1956 W. 153 St., Gardena, CA 90247

COASTLINE COMPUTERS GUARANTEES THE BEST OF SERVICE WITH EXPERIENCED SALES PEOPLE, LOWEST PRICES AND FAST DELIVERY!

IBM PC

- 2 ½ High Drives, 256K
- 10 Meg Hard Disk
- Mono Card & Monitor

\$2499

IBM PC

- IBM PC w/256K
- 2 Half High Drives
- 256K Memory
- Coastline Computer Color Card w/Parallel Port
- 12" Green Monitor

\$1699



IBM XT

- 1 Drives 128K Memory
- 10 Meg Hard Disk

\$3295

IBM PC

- 2 Full Height MPI Drives
- 512K, Okidata 192P
- Monitor & Interface

\$2499

IBM PC

- IBM PC w/256K
- 2 Teac 55B ½ High Drives
- 256K Memory
- AST SixPac Plus with 64K bringing system up to 320K
- Gemini SG 15 Printer

Price Too Low - Call

WE WILL BEAT ANY PRICE (same terms)!!!

<p>COMPAQ PORTABLE 2 Drives & 256K \$1995.00</p>	<p>AST SIXPAC + Comes with 384K Expandable Clock Calendar, Par/Ser Port Plus Software \$359.00</p>	<p>PRINCETON GRAPHICS HX-12 Color Monitor \$439.00</p>
<p>IBM CABLE Computer to Par Printer 6 Foot Long \$14.50</p>	<p>BMC 13" Amber Monitor \$89.00</p>	<p>IBM DOS 2.1 IBM PC & XT Operating System \$54.99</p>
<p>QUANTITY ORDERS Call for Bigger Discounts Corporate & School Accts Call for Information Dealer Programs Avail - P.O.s Expedited</p>	<p>Star Micronics GEMINI SG-10 Printer Lowest Price - Call</p>	<p>Other Product Lines Available from Coastline Amdek • Princeton Graphics • Techmar • Teac Hercules • Compaq • Tandon • NEC • Intel Okidata • Quadram • Hayes • Alpha Omega Anchor • Bizzcomp • Juki • Epson • Plus More!</p>
<p>CAL DEK 10 Meg INTERNAL HARD DISK For PC or Compatible Comes w/Drive Controller \$695.00 (120 day warranty)</p>	<p>OKIDATA 192P 160 cps for IBM PC \$369.00</p>	<p>CALL FOR NEW PRICING ON . . . STAR MICRONIC GEMINI'S</p>

Mail Orders To: 1956 W. 153 St., Gardena, CA 90247. Terms: Visa, Mastercard, COD;s and Wire Transfers. No surcharge for credit cards. UPS, Federal and Emery shipping available. Calif. residents add 6½% sales tax. Prices subject to change without notice. Not responsible for typos.

BLOW OUT SPECIALS YOU WONT BELIEVE

HAYES MODEM 1200 Baud Internal Modem w/SmartCom 1 Software \$339.00 2400 Baud \$639.00	ANCHOR MODEM Mark 12 External 1200 Baud Modem \$219.00	ANCHOR MODEM Volksmodem 12 300 - 1200 Baud Modem \$189.00
AMDEK MONITOR Color 710 Superior RGB Resolution \$559.00	AMDEK MONITOR 310A Monochrome \$159.00	PRINCETON GRAPHICS HX-12 (Hi Res Color) \$439.00 MAX-12 (Monochrome) \$169.00 SR-12 & Scandouble Call
BMC MONITOR Color Monitor \$189.00	TAXAN MONITOR Model 122 \$139.00	GORILLA MONITOR Green Monitor \$89.00
DRIVES (IBM Compatible) TEAC 55B \$99.00 MPI B-52 \$89.00 TANDON 100-2 \$139.00	DISKETTES DYSAN DS/DD \$29.95 COASTLINE DS/DD \$19.95	DISK CLEANERS HEAD CLEANERS CALL
OKIDATA PRINTER 192P (160cps) Streamline, Near Letter Quality \$369.00	GEMINI PRINTER SG 15 (100cps) \$389.00	JUKI PRINTER 6100 (18cps) \$389.00 Juki Tractor \$129.00
MEMORY UPGRADES 64K \$10.00 128K \$20.00	DEALERS NOTE 1000 pcs 4164 \$.95 ea. 5000 pcs 4164 \$.90 ea.	HERCULES Color Card w/Par. Port \$169.00 Monocard \$309.00
INTERFACE Techmar Graphics Master \$449.00 Quadram \$199.00	AST SIXPAC Par./Ser. Port Exp to 384K \$239.00	QUADBOARD with Game and 64K \$249.00
MATH COPROCESSOR Intel 8087-3 \$119.00	VOLT GUARD Surge Protector \$39.00	LOTUS 1-2-3 \$289.00
IBM PC's Quantity Orders Welcome CALL	IBM PC's Barebone Available CALL	CALL FOR LATEST PRICE CHANGES

The Only Friend You need When Buying a New PC
Is Coastline Computers. Call Today!

COASTLINE COMPUTERS



800-228-4615

Please call collect if 800 number not in service.

213-329-4828

213-324-8087

1956 W. 153 St., Gardena, CA 90247

JUNE 1985 • B Y T E 507

VT102/TEK 4010

For the IBM PC, XT, AT, PCjr, and Compatibles

PC102 precisely emulates DEC VT102, 101, 100, and VT52 terminals.

PC4010 includes all PC102 features plus Tektronix 4010 graphics

A few reasons why thousands of customers—including GE, Dow, Raytheon, Westinghouse, and Stanford University—prefer our products

- Complete keyboard and screen emulation w/line graphics (optional 132-columns)
- ANSI color, local printer, bidirectional file transfer support
- Guaranteed compatibility with all DEC applications including EDT, WORD-11, ALL-IN-ONE, DEC-CALC, UNIX v1
- New DOS shell key, ten programmable softkeys, plus full DOS 2.X-3.X path names
- Written in C and ASM up to 384 KB

PC102-JR	\$69.00	\$69.00
PC102	\$139.00	\$89.00
(for PC, XT AT ONLY)		
PC4010	\$179.00	\$139.00

Prepaid C.O.D. Mastercard VISA

30-DAY
money back
guarantee!
CALL
TODAY!

TERMINAL EMULATION SALES

gms
6440 Flying Cloud Dr.
Suite 205
Minneapolis, MN 55344

GENERAL
MICRO
SYSTEMS

(612) 944-0593

Inquiry 192

MEMOREX FLEXIBLE DISCS

WE WILL NOT BE UNDER-SOLD! Call Free (800)235-4137 for prices and information. Dealer inquiries invited and C.O.D.'s accepted.

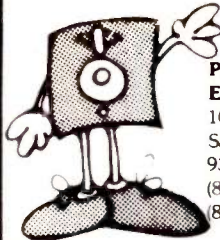

PACIFIC EXCHANGES
100 Foothill Blvd.
San Luis Obispo, CA
93401. In Cal. call
(800)592-5935 or
(805)543-1037

Inquiry 319

DISK DRIVES

Half Height
IBM Compatible

**ONE YEAR
WARRANTY**

40 tr. DS/DD \$115.00
80 tr. DS/DD \$139.00
1.2 meg. floppy CALL

Enclosures and mounting kits
Special bracketed pair pricing

IN STOCK * 2 DAY SHIP



ALLIED MICRO DEVICES

2809 Boardwalk, Ann Arbor, MI 48104
(313) 996-1282; TX 2907707 AMEL

*Manufactured by SANYO

Inquiry 19

EPROM PROGRAMMER

APROTEK 1000
ONLY

\$249.95

COMPLETE WITH
PERSONALITY
MODULE



117 AC POWER-RS232
-6 BAUD RATES - HANDSHAKE TO HOST
ALLOWS READ, WRITE, VERIFY & COPY

Comes complete with CPM & BASIC Driver
Program Listings for most small micros

Full 1 Year Warranty

Programs the following: 5 Volt 24 or 28 pin
devices: 27xx series through 27256,
25xx series, 68766 plus others
Specify Personality Module desired with order.
Additional Personality Modules only \$15.00 ea.

TO ORDER: CALL OR WRITE

APROPOS TECHNOLOGY

1071-A AVENIDA ACASO Add
CAMARILLO, CA 93010 \$4.00 Shipping-USA
(805) 482-3604 VISA or MC Add 3%

Inquiry 34

BIG DISCOUNTS ON LITTLE BOARDS™ & ACCESSORIES

- **AMPRO LITTLE BOARD™**—64K, Z80a CPU, CTC, DART, 1 parallel port, 5 1/4 controller supports four 48tpi and/or 96tpi drives w/CP/M 2.2 and ZCPR3 (A & T) \$329
 - **SYSTEM SUPPORT PKG**—Manuals, source code schematics, connectors & cables \$99
 - **SCSI PLUS**—DMA Hard disk interface \$159
 - **TEAC 55B DSDD 48tpi 1/2 ht drive** \$189
 - **TEAC 55F DSDD 96tpi 1/2 ht drive** \$179
 - **INTEGRAND** Custom two drive cabinet with 5 amp power supply & power cables \$229
 - **TERM-MATE**—Cabinet for 2 1/2 ht + LITTLE BOARD w/all cables & supply SCALL
 - **AMPRO SERIES 100** complete systems
- VISA & MASTER CHARGE. Personal Checks.
Please allow 2 weeks. Shipped via UPS.
Prices F.O.B. Prairie View, IL.
For additional information write or call:
DISKS PLUS • 15945 West Pope Blvd. • Prairie View, IL
60069 • (312) 537-7888

DISKS PLUS
DIVISION OF SOLARONICS, INC.

Inquiry 146

Quelo™ 68000 Software Development Tools

68000/68010 Assembler Package

Assembler, linker, object librarian and extensive indexed typeset manuals.

Conforms to Motorola structured assembler, publication M68KMASM[4]. Macros, cross reference and superb load map, 31 character symbols.

Optimized for CP/M-80, -86, -68K, MS-DOS, PC-DOS \$595
Portable Source written in "C" \$1495

**Complete 68000 Development Package
for MS-DOS**

Lattice 68000 "C" Compiler and
Quelo 68000 Assembler Package \$1095

68200 Assembler Package

Assembler and linker for Mostek MK68200.

Optimized for CP/M-80, MS-DOS, PC-DOS \$ 595

For more information contact

Patrick Adams

COD, Visa, MasterCard

Quelo Inc.

2464 33rd W. Suite #173

Seattle, WA 98199

Phone (206) 285-2528

telex 11 (TWX) 9103338171

CP/M, TM, DRI, MS-DOS™ Microsoft, PC-DOS™ IBM.

Inquiry 350

DATA ACQUISITION and control for ANY computer

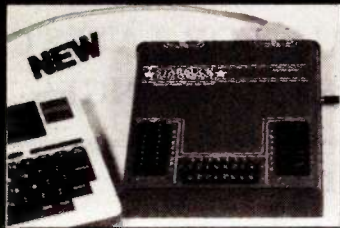

The Model 1232 communicates via RS-232, and has 8 analog inputs (± 4 VDC; 12 bits), 8 digital inputs and outputs, and a 2000 point buffer. Suitable for field data logging or lab use, the 1232 costs only \$690. The 8-bit system (0-5 VDC) is \$490. Detailed manual, \$6. Phone our applications engineer at 617-899-8629 or write:

★ ★ **STARBUCK DATA COMPANY** ★ ★

225 Crescent St., Waltham, MA 02154

Inquiry 388

OH → WINDOWS (for C)

OH → WINDOWS is a complete program library of window presentation and manipulation functions for use in C programs.

- Over 60 powerful primitives available to create, fill, move, save and print windows with single calls as simple as using Print! and Scan!
- Full color control and conversion for B&W displays
- 65 windows on four pages
- Detailed manual which fully describes all of the available functions (examples provided)
- Runs on IBM, PC, XT, AT and all Compaq models under DOS 1.1, 2.X, and 3.0
- Minimum system overhead (4K-10K bytes)
- Works with Microsoft, Lattice, and C86 C compilers.

\$74.95 (Visa, MC accepted)

Demo available \$5.00

Call or Write **SofTron, Inc.**
109 E. Scenic Dr.
Pass Christian, MS 39571
(800) 824-3609

Developed by
CAB Concepts

Inquiry 375

Macintosh™



512K
Includes drive.
\$1995

Macintosh is a trademark licensed to Apple Computer, Inc.

Call for prices on other Macintosh products.

PC'S LIMITED

OUTSIDE TEXAS, ORDERS ONLY, CALL 1-800-426-5150.

7801 N. Lamar, #1-200, Austin, Texas 78753

All calls for technical support and inside Texas,

call (512) 457-0323.

Max. cal. 9102000 24 HOURS Ad number 406 A

Call technical support for return authorization number on all warranty repairs. Any unauthorized return subject to a 10% restocking fee. No surcharge for Visa or MasterCard. 3% surcharge for American Express.

Inquiry 451

DISK DRIVES



We Will Beat ALL Competitor's Pricing

Teac 55B

- ★ 360K Half Height
- ★ 1 Year Warranty

\$93

Tandon TM100-2

- ★ 360K Full Height
- ★ The "IBM" Drive
- ★ Tested

\$100

MPI B-52

- ★ 360K Full Height
- ★ PC Compatible

\$70

10 Meg Hard Disk

- ★ For IBM
- ★ W/Hard Disk Controller

\$590

Apple Full Height

- ★ Drive w/Cable
- ★ Ready to go

\$130

Drive for Apple

- ★ 1/2 Height for II or IIC

\$140

Apple Compatible Drives

	QUANTITY		
	1	2	10
Micro Sci			
A-2 or A-20 Full HT Controller	\$160	\$155	\$150
	65	60	50
Rana Systems			
Elite I	\$195	\$195	\$190
Elite II, Dbl. Head	335	330	325
Elite III, Quad Density	380	380	375
Controller Controls 4 Drives	75	75	70
CCU Half Height			
FD525A Slimline w/cable	\$140	\$135	\$130
FD525C for IIC	140	135	130
CCU Full Height			
FD555A w/cable	\$130	\$125	\$120
Hard Disk			
10 Meg w/controller	\$590	\$580	\$570

**CCU
YOUR LARGEST
DISK DRIVE
SUPPLIER**

5 1/4" Disk Drives

	QUANTITY		
	1	2	10
Teac			
FD55A, 160K	\$100	\$100	\$100
FD55B, 360K	93	93	93
FD55F, Quad Density	130	125	120
All Teac's are Half Heights			
Tandon			
TM100-1, 160K	\$150	\$140	\$130
TM100-2, 360K	100	100	100
TM101-4, Quad Density	280	270	260
TM65-2, 360K 1/2 Height	185	180	175
MPI			
B-52, 360K PC Compatible	\$ 70	\$ 70	\$ 70
Shugart			
SA400, 160K	\$190	\$180	\$170
SA455, 360K 1/2 Height	89	89	89
SA465, Quad Den. 1/2 Height	200	190	180
Mitsubishi			
4851, 1/2 Height	\$130	\$130	\$130
4853, Quad Den. 1/2 Height	140	140	140
Control Data Corp.			
CDC 9409, 360K	\$170	\$165	\$160

8" Disk Drives

	QUANTITY		
	1	2	10
Siemens			
FDD-100-8	\$129	\$120	\$111
FDD-200-8	180	170	160
Shugart			
801R, Sgl./Dbl.	\$350	\$340	\$330
851R, Dbl./Dbl.	480	470	460
Tandon			
TM848-1E, Sgl./Dbl. 1/2 Ht.	\$270	\$265	\$260
TM848-2E, Dbl./Dbl. 1/2 Ht.	370	360	350
Mitsubishi			
M2894-63, Dbl./Dbl.	\$400	\$390	\$380
M2896-63, Dbl./Dbl. 1/2 Ht.	400	390	380
5 1/4" & 8" Power Supply & Cabinets			
	QUANTITY		
	1	2	10
JMR 5 1/4"			
Single Cabinet w/ pwr	\$ 70	\$ 60	\$ 50
Dual Thinline Cab w/ pwr	80	70	60
Dual Cabinet & Power	80	70	60
All have 6 month Warranty			
JMR 8"			
Sgl. Cabinet w/ pwr & fan	\$220	\$210	\$200
Dual w/ pwr for 2 thinline	230	220	210
Dual w/ pwr & fan	270	260	250

**CALL TOLL FREE
(800) 847-1718**

**Computer
Components
Unlimited**

A California Corporation

Inquiry 92

RETAIL STORES:
11976 Aviation Blvd.
Inglewood, CA 90304

16129 Hawthorne Blvd., Suite E
Lawndale, CA 90260

MAIL ORDER:
P.O. Box 1936
Hawthorne, CA 90250

**Customer Service & Technical
(213) 618-0487**

**Sales Desk
(800) 847-1718**
Outside California

(213) 618-0477
Inside California

PRINTERS



We Will Beat ALL Competitor's Pricing

Epson Fx-80

- ★ 160 cps ★ Friction Feed
- ★ Letter Quality Mode
- ★ IBM & Apple Roms

\$349

PRINTERS Epson

LX-80
RX-80 (120 cps)
RX-80FT
RX-100 +
FX-80 +
FX-100 +
LQ1500
JX-80

We Will
Beat ALL Pricing

We are an Authorized Dealer

Okidata	
OKI 182	\$ 229
OKI 83A	535
OKI 84P	669
OKI 84S	749
OKI 192	349
OKI 193	585
OKI MATE20 Color Printer	129

Call for other Models
FREE Plug 'n Play Roms w/ 92 & 93

JUKI	
6100, 18 cps Ltr. Quality	\$ 398
6300, 40 cps "New" w/3K Buffer	
Letter Quality	795

Brother Dist. by Dynax	
HR15XL, 12 cps	\$ 359
HR25, 25 cps	625
HR35, 36 cps	835

Panasonic	
1091, 120 cps w/ tractor	\$ 259
1092, 180 cps	429

C. ITOH	
8510AP	\$ 299
F10, 40 cps	895
Printmaster F1055pu	1050

Toshiba	
P1351, 196 cps	\$1219
P1340, 180 cps	639

A B SWITCHBOX

Par. or Ser.	\$ 69
--------------	-------

PRINTER INTERFACES

Fourth Dimension	
Card & Cable (For Apple)	\$ 45

Microtek	
Dumpling CX (Grappler Compatible)	\$ 75
Dumpling GX exp to 64K	145
Dumpling CX 16K w/ 16K exp to 64K	160

Okidata Options	
Tractor for 82 & 92	\$ 55
Serial Interface	85

Orange Micro	
Grappler +	\$ 84
Grappler + w/ 16K	174

Epson Accessories	
Epson Serial Interface	\$ 99
Letter Writer NCQ Kit	59
Lx-80 or Fx-80 Tractor	39

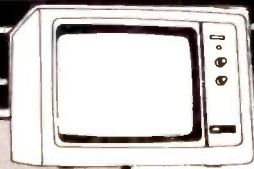

MONITORS

Taxan 425

- ★ RGB Hi-Res Color or Green
- ★ PGS Hx12 Compatible

\$399

MONITORS

Amdek	
300G, Hi-Res Green	\$ 125
300A, Hi-Res Amber	134
310A, Monochrome Amber	158
300 Hi-Res Color Comp.	275
500 RGB Composite	399
DVM Board for Apple RGB	119

Taxan	
425 Color RGB	\$ 399
440 Ultra Hi-Res	539

Stand	
Tilt & Turn Stand	\$ 19

Princeton Graphics	
MAX12, Monochrome Amber	\$ 169
HX12, RGB Color	449
SR-12 w/ Doubler Board	775

IBM	
Monochrome Green	\$ 219
Color Hi-Res	559

Zenith	
ZVM122	\$ 95
ZVM123	95

BMC	
12AUW Hi-Res Green	\$ 79
9191 Color Composite	199



MODEMS

U.S. Robotics

- ★ 1200 Baud
- ★ Hayes Compatible

\$219

MODEMS

Hayes	
Micro Modem IIE	\$ 229
300 Baud	195
1200B Internal	359
1200	385
2400 Baud	639

Anchor Automation	
Mark For TI	\$ 59
Mark VI 300 Baud IBM	79
Mark XII, 1200 Baud	219
Mark X, 300 Baud Stand alone	149
Express 1200 Baud	269

Prometheus	
Promodem	\$ 289
Pro 1200A Apple Int w/ sw	329
Pro 1200B IBM Int w/ sw	299
Pro Mac w/ cable & sw	329
No. C Cable	12
Alpha Disp.	89
Options Proc.	89

U.S. Robotics	
Password	\$ 219

**Computer
Components
Unlimited**
A California Corporation

Inquiry 93



No Surcharge For Credit Cards
All Prices Reflect a Cash,
Pre-Paid Discount
Thjs Ad Supersedes All Others

Customer Service & Technical

(213) 618-0487

**Sales Desk
(800) 847-1718**

Outside California

(213) 618-0477

Inside California

SYSTEMS

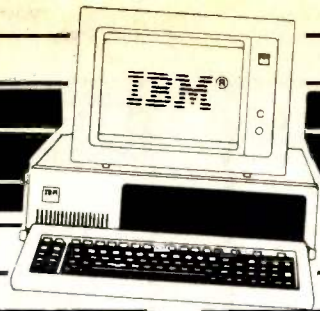

IBM PC System

- ★ 256K Memory
- ★ Two 360K Disk Drives

\$1499

Add \$50 for configuration & testing

New Version

IBM XT

- ★ w/10Meg
- ★ 360K Drive

\$2895

IBM PC System

- ★ 256K, Two 360K Drives
- ★ Hercules Clr. Graphics Card
- ★ Taxan Hi-Res Gr. Monitor
- ★ Epson LX-80 Printer / cable & NLQ Mode

\$2127

Apple	
IIE cpu	\$ 790
Macintosh	1895
IIC Portable	899

Compaq	
Portable (PC Compatible) 2, 360K Drives	
256K of Memory	\$1950
Compaq + w/10Meg	3700
Deskpro 1	1640
Deskpro 2	2250
Deskpro 3	3900
Deskpro 4	Call

Sanyo	
MBC 550-2	\$ 699
MBC 555-2	999
Optional Serial Port	69
Optional 360K Drive	129

Kaypro	
Kaypro II	Call
Kaypro 4	Call
Kaypro 10	(In Retail Stores Only) Call
Kaypro IIX	Call

IBM	
PC 256K, 2 Drives	1499
XT w/ 10 Meg, 256K	2895
Additional Memory 64K	10 ³⁰
AT Standard Config.	Call
AT w/20 meg	Call
Add \$50 for Configurations & Testing	

Tava	
PC Compatible w/Monitor	\$1100

IBM & APPLE ACCY'S



We Will Not Be Beat On 64K Upgrade Prices

- ★ Nine 4164, 200ns
- ★ 1 Year Warranty

\$10³⁰

APPLE EXTRAS

ALS	
ZEngine	\$ 119
CPM 3.0 Card	240
CCU	
RF Modulator	\$ 9
Fan w/Surge	34
CCU	
16K Mem. Card 1 yr war	\$ 45
Micro Max	
Viewmax 80, 80 col. card	\$ 135
Viewmax 80E (F for IIE) 64K	120
Micro Soft	
Mouse	\$ 139
Premium Soft Card IIE	369
Multiplan	149
Soft Card (280) w/64K	279
Micro Tek	
Serial Interface	\$ 89

IBM EXTRAS

Ast Research	
Six Pack + w/384K	\$ 299
Mega +	265
Add on Ports	49
Hercules	
Color Card	\$ 149
Graphics Card	304
Hard Disk	
10 Meg. External w/power supply	\$999
IBM	
Monochrome Adapter	\$ 219
Color Card	225
Paradise Systems	
Multi-display Card	\$ 329
New Modular Card	260
Module A	74
Module B	175
S Pack Multifunction	160
Quadram	
Quad Color Card	\$ 199
Quadlink	349
64K Upgrade	
64K of Memory	\$ 10 ³⁰
AT Upgrade	
Upgrade 200 ns	\$ 89
PC Products	
PC Peacock Color Card w/Par. Port	\$ 175
Ports	
Parallel	\$ 79
Serial	79
CCU	
Color Graphics Card	\$ 119

CCU Multifunction Card

Par. & Ser. Ports w/64K cyp 384K	
Clock Calendar & Software & Manuals w/384K	\$ 160
Everex	
Graphics Edge	\$ 329
8087's	
8087-2	\$ 149
8087-3	104
8087-6	95
5 1/4" DISKETTES	
CCU	
Sgl/Dbl reinforced hub	\$11 100 for 100
Dbl/Dbl reinforced hub	13 100 for 110
Not Bulk Packed	
Dysan	
Sgl/Dbl	\$33 100 for 300
Dbl/Dbl	39 100 for 370
Verbatim	
Sgl/Dbl	\$26 100 for 240
Dbl/Dbl	36 100 for 340
8" DISKETTES	
Dysan	
Sgl/Sgl	\$34 100 for 320
Dbl/Dbl	\$3 100 for 480
Verbatim	
Sgl/Sgl	\$30 100 for 280
Dbl/Dbl	40 100 for 360
DISK ACCESSORIES	
Verbatim	
8" or 5 1/4" Head Cleaning Kit	\$ 9
Flip Tub	
5 1/4" Holds 60 disks, plexiglass	\$ 6

Inquiry 93

RETAIL STORES:
11976 Aviation Blvd.
Inglewood, CA 90304

16129 Hawthorne Blvd., Suite E
Lawndale, CA 90260

MAIL ORDER:
P.O. BOX 1936
Hawthorne, CA 90250

Retail Hours:

10 a.m. - 6 p.m. Mon.-Fri.
10 a.m. - 3 p.m. Sat.

All merchandise new. We accept MC, Visa, Wire Transfer, COD Call, Certified Check, P.O.'s from qualified firms, APO accepted. Shipping: Minimum \$4.50 first 5 pounds. Tax: California Res. Only add 6 1/2% sales tax. All returns subject to 15% restocking charge. Advertised prices for Mail Order only. Retail prices slightly higher.
Prices Subject to Change.

Customer Service Hours:

10 a.m. - 4 p.m. Mon.-Fri.

John Aurentz
(213) 618-0487

Mail Order Hours:

8 a.m. - 6 p.m. Mon.-Fri.
10 a.m. - 3 p.m. Sat.

(800) 847-1718 (213) 618-0477
(Outside California) (Inside California)

64K & 256K DRAMS 8087-3 8087-2

BITTNER
BE
ELECTRONICS

1287 CLIFF DRIVE
SUITE ONE
LAGUNA BEACH, CA 92651
(714) 497-4910

Inquiry 53

• BAR CODE READER •



- IBM PC/XT COMPATIBLE (AND MOST CLONES)
- CONNECTS BETWEEN KEYBOARD AND THE PC
- NO CARD SLOT REQUIRED/SIMPLE INTERCONNECT
- NO CUSTOM SOFTWARE DRIVERS REQUIRED
- HIGH FIRST READ RATE
- READS DOT MATRIX & PRINTED BAR CODE LABELS
- CODE 3 OF 9, INTERLEAVED 2 OF 5, UPC
- AUTOMATIC BAR CODE SELECTION
- AUDIO AND VISUAL INDICATORS
- READS HIGH, MED, AND LOW DENSITY LABELS
- SWITCH SELECTABLE OPTIONS
- SELF-TEST DIAGNOSTICS

\$495 ea.

AMERICAN MICROSYSTEMS
P.O. BOX 830551, RICHARDSON, TX. 75080
(817) 834-9659
MASTERCARD AND VISA ACCEPTED

Inquiry 27

PAL, EPROM PROGRAMMERS & UV ERASERS FROM \$49.95

LOGICAL DEVICES INC.

*Where Reliability and
Customer Support
is of utmost Importance*

SEE OUR AD ON PAGE 24



**ORDER TOLL FREE
1-800-EEL-PROM
(1-800-331-7766)**

Inquiry 255

Uniforth™

!! FREE !!

FLOATING-POINT FORTH

Interested in having a FORTH-83 implementation with a video editor and an assembler, that will do floating-point arithmetic?

Now you can have such a system for your IBM PC or Z80 CP/M computer for **free!**

Look for the public domain UNIFORTH Sampler on your local BBS, or send us just \$35 for the latest disk version in your format. The Sampler is a subset of our more powerful Professional Series (available for most processor/operating system combinations)

It won't cost you a penny to try UNIFORTH and see for yourself the power of the FORTH language!

Call or write for our free 20-page catalog.

UNIFIED SOFTWARE SYSTEMS
P.O. Box 2644, New Carrollton, MD 20784
(301) 552-9590

Inquiry 410

NOW MAKE SOLID CONNECTIONS... Male or Female

RS-232 GENDER REVERSERS

\$18.95
each



Order either two male or two female connectors with all 25 pins interconnected. Order Now. Only **\$18.95**. All cash orders postpaid (IL res. add 6% sales tax). MC, Visa accepted.

Ask for Free Catalog. Phone: (815) 434-0846.



B&B electronics
MANUFACTURING COMPANY
P.O. Box 1008B, OTTAWA, IL 61350

Inquiry 45

FOR THE BEST OF US... THE CYPHER™

A COMPLETE 68000 & Z80A SINGLE BOARD COMPUTER SYSTEM WITH ULTRA-HIGH-RES GRAPHICS!!



- 68000 & Z80A DUAL PROCESSORS BEST OF BOTH WORLDS! OPTIONAL Z8011
- 256Kb x 8 MEMORY RESISTOR 4K164 GB 4754
- 16Kb x 8 MEMORY FLOPPY DISK CONTROLLER 4F
- 16Kb x 8V AND 256Kb
- DMA CONTROLLER FOR FAST IMAGE TRANSFER TO TV
- 1700K VIDEO RESOLUTION (640 X 480)
- 2 BIT PLANAR DISPLAY BUFFER
- 4 LAYER PCB (1.5" x 1.5")
- FULLY COMPATIBLE WITH IBM PC/XT/AT/PS/2
- FULL 68000 EXPANSION BUS (80 PIN HEADER SUPPORTED)

- ULTRA-HIGH RESOLUTION GRAPHICS: 68000 PROGRAMMABLE UP TO 1700 x 1200 RESOLUTION REC. 1700 GREAT FOR CAD SYSTEMS
- REAL TIME CLOCK AND DATE CONTROLLER
- PROGRAMMABLE 256Kb x 8V AND 256Kb x 16V MEMORY
- 16Kb x 8V AND 256Kb x 16V MEMORY
- PROGRAMMABLE & BUILT-IN RATE DEVIATOR
- PARALLEL ASCII & RS232C SUPPORT
- FULL 68000 EXPANSION BUS (80 PIN HEADER SUPPORTED)

LOWER PRICED NOW! 16847111 CYPER AVAILABLE

MOTOROLA INTEL
MOTEL COMPUTERS LIMITED
174 BETTY ANN DRIVE, WILLOWDALE,
TORONTO, ONTARIO, CANADA M2N 1X6
(416) 221-2340

Inquiry 298

I.B.M. Compatible

Case	\$ 65.00
Motherboard (256K RAM space, RAM not included)	280.00
Color Graphic Adapter	150.00
Floppy Disk Driver Controller Card	75.00
Plotter (4 colors)	495.00
Computer (2 DD Drivers, Color Graphic Adapter, 256K RAM Case, Keyboard and 135 W Power Supply)	1,500.00
Keyboard	700.00

APPLE Compatible

Z 80 Card	40.00
80 Column Card	50.00
I.C. Tester	125.00
Pal Writer Card	299.00
Graphic Pad Card (includes graphic program)	220.00
Prom 8200 Programmer (Fast Universal Type Eprom & Prom Programmer)	

For Eprom: 2716-27512; 2516-25512; (No Adapter Needed)
For Prom: 63xx, 745xx, 145xx, 185xx, 245xx, 285xx, 825xx, 875xx,
Include RS232 Interface

CALL NOW (312) 280-7610
Telex 280208 HFFMN INT CGO

HOFFMAN INT'L
600 N McClurg Ct. Ste. 309A
Chicago, Illinois 60611

Inquiry 212

CHIPS 'n DIPS

QUANTITY ONE PRICES

8087-3	\$99.00
8088	29.00
256K DRAM	6.00
64K DRAM 150 ns	1.35
64K DRAM 200 ns	1.35
128K DRAM	
Mostek 150 ns	18.00
5 1/4" Diskettes	1.75

FREE UPS SHIPPING

All parts in stock, first quality.
No seconds or surplus.
Same day shipping!

CHIPS 'n DIPS
P.O. Box 2517 • The Mall
Duxbury, MA 02331

617-934-2414

Inquiry 81

MetalICE-31



Powerful Real Time 8031 Emulator
That Runs on your IBM PC

The MetalICE series of emulators provide full speed, real time, transparent in-circuit emulation capability for either the 8031, 8032 or 8344. Many unique features are provided including over 16,000 hardware breakpoints. MetalICE emulators simply connect to your IBM PC or compatible through an RS232C interface. Each MetalICE emulator includes an advanced menu driven host interface. Prices start at under \$1,500.00. A Demonstration Package is available for \$35.00. Call toll free for more information: 1-800-METAICE.

MetaLink Corp.
33 W Boxelder Place
Chandler, AZ 85224
1-800-METAICE In AZ (602) 926-0797

Inquiry 272

California Digital

17700 Figueroa Street • Carson, California 90248



Fully IBM/PC Compatible? XEROX

When the June Issue of Byte went to press we were in the process of negotiating for the purchase of 5000 Xerox Computers. The units were manufactured by Toshiba and were to be marketed under the Xerox Label. At press time we had not received sample units and consequently was unable to have an actual photograph of the computer.

The Xerox Computer is purported as being 100 per cent IBM/PC Compatible. Obviously without having an actual unit to test, California Digital is unable to substantiate this fact. The Computer is supplied with two double sided disk drives and 256K of memory.

Also available, are about 1000 of the same machine which include a 10 Megabyte Winchester hard disk and a floppy drive.

By the time this Issue reaches your desk we should have the Xerox Computers in our warehouse and be able to provide more information. Please telephone for additional details.

\$995

Fujitsu 1935D 2400 BAUD

\$519



An exciting new modem from the telecommunication experts at Fujitsu. Reliable 2400 BPS communication over public phone lines. Automatically selects 2400 or 1200 baud depending incoming terminal speed. Integral speaker allows monitoring call progress. Will work in full and half duplex as well as simplex modes. Both Synchronous and Asynchronous communication protocols are available. Switch selectable test modes available for digital loopback, analog loopback, as well as remote loopback. Four microprocessor design assures reliable operation over noisy phone lines at both 1200 and 2400 baud. Switch selectable Bell 212A or CCITT V.22 compatible. Sleep mode can be enabled through the use of the DTR line. This effectively turns the modem off between calls. The Fujitsu 1935D is an excellent choice for upgrading bulletin boards to the higher speed operation. MEX overlays are currently being written and will be available shortly.

WINCHESTER SUBSYSTEM

For
IBM/PC

\$519



The California Digital Winchester subsystem provides over 10 megabytes of memory for only \$519. This low cost external hard disk systems is supplied with controller card and operating software.

Other features include telephone number storage, send / receive text as well as everything you need to install this Winchester on your IBM/PC is included with the subsystem kit. And at only \$519, this is by far the best value that has ever been offered in a hard disk system.

ANCHOR AUTOMATION MODEM

\$69



The Anchor Automation Mark VI is direct connect modem that plus into any port of your IBM/PC. This modem supports auto answer and auto dial capabilities. Other features include telephone number storage, send / receive text as well as single key-stroke dialing along with many other functions provided on the Mark VI was originally priced at over \$350.

FREE

Plastic library case supplied with all diskettes purchased from California Digital.

Soft Sector Ten Sector Sixteen Each box 10 Boxes 100 Boxes

FIVE INCH DOUBLE SIDED DOUBLE DENSITY			
5.25" DIGITAL	CAL-551 CAL-561 N/A	19.95	18.75 17.85
5.25" NOTCH	MMM-745/0 MMM-745/10 MMM-745/16	29.95	27.95 24.75
5.25" VERBATIM	VRB-550/01 VRB-550/10 VRB-550/16 NXL-MD2/96	29.95	27.95 23.75

MAXELL / HD CALL			
5.25" MAXELL	DYS-104/2D DYS-107/2D DYS-105/2D	42.50	40.50 35.50
5.25" MAXELL / 96	DYS-204/2D N/A	49.95	47.95 45.75

Other diskettes available include 3 1/2" and all 8" formats. Please phone for prices.

DUAL TEAC SUBSYSTEM

\$289



The dual Teac 56F subsystem features two 96 track per inch 5 1/4" double sided disk drives. Also supplied with the subsystem is 50 watt power supply and a four foot shielded signal cable.

TELETYPE \$595

MODEL
40



The Teletype Model 40 printer is continuous heavy duty communication equipment that have recently come off lease from a Cado Computer customer. It is seldom that California Digital becomes involved in the marketing of reconditioned equipment but we felt that this printer represented such an exceptional value that we had to offer this equipment to our customers.

The four character chain printer is capable of printing text in excess of 300 lines per minute. This printer, long used in high speed mini-computer applications, will provide the small business user with good quality multi-part printouts at speeds that can not be attained by dot matrix printers.

This unit also has a four channel vertical forms feed controller that allows for quick change of various form lengths. The Teletype Model 40 printer has a proprietary serial Teletype S31 interface and DIP switches are provided for setting baud rates to 9600. An optional RS-232 serial interface is available please phone for details.

western union EasyLink

EasyLink gives any personal computer access to over 1.5 million Western Unions World Wide terminals. With EasyLink service you can send Telex, Telegrams and Mailgrams from your own computer. Through the use of the "Mailbox" messages can be received even when your computer is turned off, and "picked up" at your convenience.

Joining the World of Western Union's EasyLink is FREE of charge and there is no monthly service fee. Sending a domestic Telex is about \$1.75 and a Mailgram has an average cost of \$2.50. Western Union does require a minimum usage of \$25 per month. Call California Digital to receive your EasyLink subscriber number.

BAR CODE READER For IBM/PC

\$589

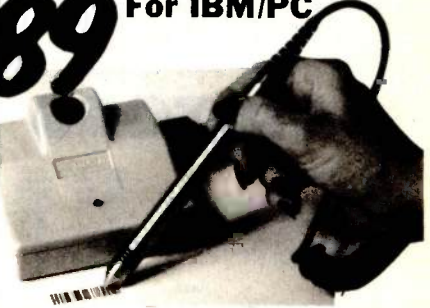

The DataLogic bar code reader plugs directly between the keyboard and the mainframe of your IBM/PC. All instructions are supplied in firmware built into the reader device. By the flip of a dip switch this bar code reader is capable of reading eight different formats of code including UPC, 2/5 and many more. Bar code is suitable for inventory control, freight and invoice records, personal records and other application limited only by imagination.

Other DataLogic bar code readers are designed for the Apple II and RS-232 serial terminals. Please phone for list of other bar code products available.

DIGIGRAPHICS \$179 MULTIFUNCTION

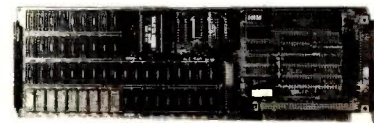

The Digigraphic 384M multifunction card is a work-a-like to the over priced AST Sixpack Plus but at a much more attractive price.

Memory is expandable to 384K/byte, battery backed up clock/calendar, fully programmable RS-232 communication port, centronics parallel port, and game port as standard equipment making this card an outstanding value. Software is also provided for clock/calendar functions. RAM-Disk up to 360K, print spooler for up to 3 printers, as well as diagnostic memory tests. \$179.00 no memory DGC-384/0; \$219.00 64K/byte memory DGC-384/64.

CONNECTORS DB25P



RIBBON CONNECTORS		"D" TYPE	
DB25P male	CND-r25P	DE9P male	CND-9P
DB25S female	CND-25F	DE9S female	CND-9S
57-30360 male	CNC-136P	DE hood	CND-9H
57-30360 male	CNC-36S	DA15P male	CND-15P
20 pin edge	CNI-DE20	DA15S female	CND-15S
20 pin socket	CNI-DS20	DC37P male	CND-37P
26 pin edge	CNI-DE26	DC37S female	CND-37S
26 pin socket	CNI-DS26	DC37 hood	CND-37H
34 pin edge	CNI-DE34	DS50P male	CND-50P
34 pin socket	CNI-DS34	DS50S female	CND-50S
50 pin edge	CNI-DE50	DS50 hood	CND-50H
50 pin socket	CNI-DS50	Hardware 2/set	CND-2HS



Shipping: First five pounds \$3.00, each additional pound \$.50.
Foreign orders: 10% shipping, excess will be refunded.
California residents add 6 1/2% sales tax. • COD's discouraged.
Open accounts extended to state supported educational institutions and companies with a strong "Dun & Bradstreet" rating.

**TOLL FREE ORDER LINE
(800) 421-5041
TECHNICAL & CALIFORNIA
(213) 217-0500**

California Digital

17700 Figueroa Street • Carson, California 90248

NEC RGB COLOR MONITOR \$259



The NEC JC-1401D is a 13" medium/high resolution RGB monitor suitable for use with the Sanyo MBC-550/555 or the IBM/PC. The monitor features a resolution of 400 dots by 240 lines. Colors available are Red, Green, Blue, Yellow, Cyan, Magenta, Black and White. These monitors are currently being used in applications far more critical than microcomputers. The NEC monitor carries the Litton-Monroe label and was originally scheduled for use in their "Office of the Future" equipment. A change in Monroe's marketing strategy has made these units excess inventory which were sold to California Digital. We are offering these prime "new" RGB monitors at a fraction of their original cost. Sanyo compatible NEC-1401/S; IBM/PC Computer compatible NEC-1401/PC

MONITORS

BMC 12A green phosphor 15 Mhz. composite video	BMC 12A	78.95
BMC 12 high resolution 20Mhz	BMC-12EN	119.00
Amdek 300G 12 green phosphor	AMK-300G	128.95
Amdek 300A 12 amber phosph. hi resolution	AMK-300A	138.95
Amdek 310A designed for IBM/PC, amber	AMK-310A	158.95
Zenith ZVM/22 Amber Phosphor 12" 40/80 column switch	ZTH-122	89.95
Zenith ZVM/23 green phosphor 12" 40/80 column switch	ZTH-123	89.95
NEC JB1201 green phosphor 18 Mhz. composite video	NEC-JB1201	159.00
NEC JB1260 commercial grade composite	NEC-JB1260	119.00
Conrac 9" open frame requires horiz sync. & 12v. supply.	CON-9W	59.00

NEC JC-1401D Medium/High 13" RGB	NEC-1401X	259.00
BMC AU1919IU Color composite video with sound	BMC-9191M	379.00
BMC 9191M RGB designed for use with the IBM computer	NEC-1203	699.00
NEC JC-1203DM RGB color monitor	NEC-JC1215	339.00
NEC JC-1215 color composite	ZTH-215	475.00
Zenith ZVM135 RGB & composite suitable for IBM PC	AMK-100	299.00
Amdek Color 11 13" composite video	AMK-200	419.95
Amdek Color III 13" RGB hi resolution	AMK-300	359.95
Amdek Color III 13" RGB medium resolution	PRN-HX12	478.95
Princeton HX-12 RGB IBM/PC compatible		

PRINTERS

MATRIX PRINTERS

Star Gemini-10X 120 char/sec	STR-G10X	249.00
Star Gemini-15X 100 char./sec. 15 paper	STR-G15X	365.00
Star Gemini Delta 10 160 Char/sec	STR-D10	359.00
Coshiba P1351 180 char/sec. letter quality	POS-1351	1495.00
Okidata 82A serial & parallel 9 1/2" paper	OKI-82A	279.00
Okidata 92A parallel interface, 160 char/sec.	OKI-92A	379.00
Okidata 83A & parallel 15" paper	OKI-83A	549.00
Okidata 84A & parallel 15" paper	OKI-84A	929.00
Epson RX-80 10" 120 Char/sec.	EPS-RX80	239.00
Epson RX-80-FT friction & tractor	EPS-RX80FT	279.00
Epson FX80FT 10" 160 char./sec. with graphitrac	EPS-FX80	399.00
Epson FX100FT 15" 160 char./sec. with graphitrac	EPS-FX100	599.00
Epson LX80 Color printer	EPS-LX80	1079.00
Printer 8510 parallel 9 1/2" paper	PRO-8510P	329.00
Printer II parallel 15" paper, graphics	PRO-2P	559.00
Dataproducts B-600-3, band printer 600 LPM	DBS-B600	6995.00
Printronix P300 high speed printer 300 lines per minute	PTX-P300	3995.00
Printronix P600 ultra high speed 600 lines per minute	PTX-P600	5795.00

WORD PROCESSING PRINTERS

Siewriter F10 parallel, 40 char/sec	PRO-F10P	499.00
NEC8810 55 char/second, serial interface	NEC-8810	1659.00
NEC8830 55 char/sec. par I interface	NEC-8830	1659.00
NEC2550 popular printer designed for the IBM/PC	NEC-2550	1599.00
NEC2050 designed for IBM/PC 20 char/sec. par I	NEC-2050	689.00
Silver Reed EXP500, 14 char/sec. par I interface	SRD-EXP500	319.00
Silver Reed EXP550 17 Char/sec. par I interface	SRD-EXP550	399.00
Diablo 630 40 char./sec. serial	DBL-630	1569.00
Diablo 620 proportional spacing, horiz & vert tab 20 cps	JUK-100	399.00
Juki 6100 18 char./sec	JUK-6300	699.00
Juki 5300 40 char./sec	CRX-CR2P	395.00
Comrex CR2, 5k buffer, proportional spacing, par I		

TERMINALS

Freedom 100, split screen, detachable keyboard	LIB-F100	495.00
Qume 102 green phosphor terminal	QUM-102	539.00
Amplex Dialogue 125 green screen	APX-D125A	675.00
Amplex Dialogue 175 amber screen, two page, func. keys	APX-D175A	715.00
Wyse 50, 13" green phosphor	WYS-50	595.00
Wyse 300, 8 1/2" color display, split screen	WYS-300	1159.00
Zenith 29 terminal, VT52 compatible, detachable keyboard	ZTH-229	765.00
Televideo 910 Plus, block mode	TVI-910P	575.00
Televideo 925, detachable keyboard, 22 function keys	TVI-925	759.00
Televideo 950, graphic char. split screen, 22 func.	TVI-950	950.00
Televideo 970, 14" green, 132 column, European	TVI-970	1095.00

COMPUTER PLOTTER

\$219

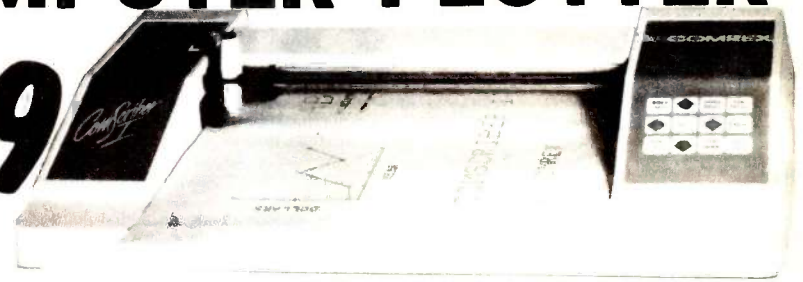

The Comrex Comscriber I is the ideal solution to make short work of translating financial and numeric data into a graphic presentation.

Many ready to run programs such as Lotus 1-2-3, Visi-on and Apple business graphics already support this plotter.

The Comscriber I features programmable paper sizes up to 8 1/2" by 120 inches, 6 inch per second plot speed and 0.004" step size.

Easy to implement Centronics interface allows the Comscriber I immediate use with the printer port of

most personal computers.

The Comscriber I is manufactured for Comrex by the Enter Computer Corporation. The plotter is marketed by Heath Kit and also sold under Enters own "Sweet P" Label. This is your opportunity to purchase a graphic plotter which was originally priced at \$795 for only \$219.

Also available is a support package which includes demonstration software, interface cable, amulticolor pen assortment and a variety of paper and transparency material.

1200 BAUD MODEM

The Team 212A offers all the features of the Hayes Smart Modem 1200 for a fraction of the price. Now is your opportunity to purchase a 1200 baud modem at the price of a 300 baud modem. California Digital is so confident of your complete satisfaction that we will allow the return the Team 212A and apply the full credit towards the purchase of any other 1200 baud modem. TEM-SM1200



\$229

PROMETHEUS ProModem 1200

\$319

The Prometheus ProModem 1200 is best value that we have seen in a 300/1200 baud modem. This Hayes compatible modem features completely unattended operation, auto answer/auto dial and even includes "redial number when busy" Internal diagnostics makes the ProModem 1200 an easy modem to install. Help commands, real time clock and internal speaker add to the ease of use of this unit.

An optional processor accessory allows battery back up, extra memory space for storing additional phone numbers, messages received, and can act as a transfer buffer when exchanging programs. The Alphabetic display option allows messages saved to be displayed when they were received, diagnostic test results, numbers in the directory, as well as modem status.

MODEMS

Team 1200 Hayes Compatible	TEM-SM1200	229.00
CTS 212AH 1200 baud, auto dial	CTS-212AH	299.00
Terminal software for CTS 212AH	CTS-212SFT	35.00
Prometheus 1200 super features	PRM-P1200	319.00
Prometheus 1200B internal PC	PRM-P1200B	279.00
Signalman Mark 12, 1200 baud, Hayes compatible	SGL-MK12	239.00
Signalman Mark 1, direct connect with terminal cable	SGL-MK1	75.00
Hayes Smart Modem 1200 baud, auto answer, auto dial	HYS-212AD	429.00
Hayes 1200B for use with the IBM/PC, 1200 baud	HYS-1200B	399.00
Hayes Smartmodem, 300 baud only, auto answer, auto dial	HYS-103AD	229.00
Hayes MicroModem II, 103 Apple direct connect	HYS-MM2	279.00
Hayes Chronogram, time & date	HYS-CHR202	199.00
U.S. Robotics 212A 300-1200 baud, auto dial, answer	USR-212A	439.00
Penn 300/1200 industrial quality	PEN-12AD	495.00
Universal Data 103LP, line power, answer & originate	UDS-103LP	169.00
Universal Data 202, 1200 baud, full duplex only	UDS-202LP	219.00
Universal Data 212LP, full 1200 baud duplex, line power	UDS-212LP	359.00
Novation J. Cal, direct connect, auto answer	NOV-JCAT	115.00



EAGLE \$895

The Eagle II/2 Computer features a 12" non-glass green phosphor CRT, typewriter style keyboard with separate numeric cluster. This unit provides two 5 1/4" drives for a combined storage capacity of 780 K/Byte. The computer contains a 4Mhz Z-80A DMA disk interface, two RS-232C serial ports, Centronics printer interface, along with an auxiliary parallel port. Software included consists of ULTRACALC electronic spread sheet, SPELLBINDER word processor, CBASIC2, CP/M 2.2, and an exclusive Eagle menu driven utility package. These units are all "factory new" and are being offered far below their suggested price of \$2495. This is your opportunity to purchase a complete CP/M system for only \$895.

Return of a Smash Hit Sellout DRAGON \$99



Compatible with most Radio Shack Color Computer software. The world famous Dragon computer is now available in the United States. Manufactured by the Tano Corp. under license of the British Broadcasting Company. The Dragon comes complete with 64K Byte of memory, serial modem port along with a Centronics printer interface. This unique micro-computer features Motorola's advanced 6809E microprocessor and comes standard with Microsoft Color Basic, data base manager, and a complete word processing package. The computer outputs color composite video along with R.F. video that allows the unit to be used in conjunction with any color television. This is the ideal low cost computer to be used with any dial up information system such as the Source, Western Union's EasyLink or any other time share service.

TOLL FREE ORDER LINE (800) 421-5041

TECHNICAL & CALIFORNIA (213) 217-0500

California Digital

17700 Figueroa Street • Carson, California 90248

F10 DAISY WHEEL PRINTER

\$499

LETTER QUALITY



The TEC F-10 Daisy Wheel printer is the perfect answer to a reasonably priced 40 character word processing printer. While this printer is "extremely" similar to C.Itoh's F-10/40 Starwriter printer. Legal counsel for the C.Itoh Company have advised us that we should refrain from referring to the TEC printer as a Starwriter.

This 40 character per second printer auto installs with Wordstar and Perfect Writer. Features extensive built-in word processing functions that allow easy adaptability and reduced software complexity. Industry standard Centronics interface provides instant compatibil-

ity with all computers equipped with a parallel printer port. The TEC F-10 accepts paper up to 15 inches in width.

These printers were originally priced to sell at over \$1400. Through a special arrangement California Digital has purchase these units from a major computer manufacturer and is offering these printers at a fraction of their original cost.

Options available include tractor feed, buffered memory and an assortment of printer cables for a variety of computers.

10 MEGABYTE WINCHESTER SPECIAL

California Digital has recently purchased several thousand 10 Megabyte Winchester disk drives. The manufacturer has asked us not to advertise their name. Please telephone for details

\$319



Your Choice

TEAC 55B 55F 48TPI-96TPI

One Two Ten

Five Inch Double Sided Drives

TEAC FD55B half height	119	115	109
TEAC FD55F 96 TPI, half ht.	119	115	109
CONTROL DATA 9409 PC	169	159	155
SHUGART SA455 Half Height	119	115	109
SHUGART SA465 1/2 Ht. 96TPI	119	115	109
TANDON 100-2 full height	149	145	139
TANDON 101-4 96TPI full ht.	299	289	279
MITSUBISHI 4851 half height	139	135	129
MITSUBISHI 4853 96/TPI 1/2 Ht.	155	149	139
MITSUBISHI 4854 8" elec.	295	285	275
QUME 142 half height	219	205	199

Eight Inch Single Sided Drives

SHUGART 801R	159	159	154
SIEMENS FDD 100-8	119	115	109
TANDON 848E-1 Half Height	369	359	349

Eight Inch Double Sided Drives

SHUGART SA851R	495	485	475
QUME 842 "QUME TRACK 8"	319	319	313
TANDON 848E-2 Half Height	459	447	435
REMAX RFD-4000	219	219	209
MITSUBISHI M2896-63 1/2 Ht.	459	449	409

MEMORY

4164 DYNAMIC MEMORY 150ns



\$1.35

Quantity 100

DYNAMIC MEMORY

4164 150ns. 64K 128 refresh	ICM-4164150	1.31	32 +	100 +
41256 150ns. 256K	ICM-41256150	2.29	1.99	1.35
4116 150ns. 16K	ICM-4116150	8.95	8.50	7.25
4116 200ns. 16K	ICM-4116200	1.75	1.65	1.45
4128 for IBM/AT	ICM-4128150	1.75	1.65	1.45
DP8409 dynamic controller	ICT-8409	8.95	8.75	8.35
		39.00	35.00	29.00

STATIC MEMORY

21L02 200ns. 1K static	ICM-21L02200	1.49	1.29	1.15
21L02 450ns. 1K static	ICM-21L02450	1.29	1.15	.99
2112 450ns. 2K static	ICM-2112450	2.99	2.85	2.75
2114 300ns. 1K x 4	ICM-2114300	4.50	1.85	1.75
4044TMS 450ns. 4K x 1	ICM-4044450	3.49	3.25	2.99
5257 300ns. 4K x 1	ICM-5257300	2.50	2.25	1.99
6116 P4 200ns. 2K x 8	ICM-6116200	3.95	3.85	3.70
6116 P3 150ns. 2K x 8	ICM-6116150	4.55	4.35	4.15

EPROMS

2708 450ns. 1K x 8	ICE-2708	4.95	4.75	4.55
2716 450ns. 2K x 8	ICE-2716	4.50	4.25	3.97
2716TMS 450ns. Tri-voltage	ICE-2716TMS	7.95	7.65	7.25
2732 450ns. 4K x 8	ICE-2732	4.50	3.75	3.55
2764 350ns. 8K x 8	ICE-2764	5.95	5.75	6.25
27128 350ns. 16K x 8	ICE-27128	7.95	7.35	6.95

Shugart 604 WINCHESTER



\$99

These 6.7 Megabyte drives are new units recently released by the Shugart division of Xerox. The Shugart 604 is fully 506 industry compatible. Each drive is tested before shipment and is supplied with a 90 day warranty. SHU-604

Five Inch Winchester Hard Disk Drives

FUJITSU M2235AS 27 Meg.	899	859
RODIME RO-208 53 Meg.	1589	1493
MAXTOR XT10140 140 Meg.	3895	3785
SHUGART 712 13 Meg. 1/2 Ht	495	465
SHUGART 604 6.7 Meg.	99	89
TANDON 502 10 Meg.	419	395
TANDON 503 19 Meg.	695	675
SEAGATE 225 25 Meg.	695	625

Shipping: First five pounds \$3.00, each additional pound \$.50. Foreign orders: 10% shipping, excess will be refunded. California residents add 6 1/2% sales tax. • COD's discouraged. Open accounts extended to state supported educational institutions and companies with a strong "Dun & Bradstreet" rating.



★ **PRICE WAR** ★ **CALL US LAST** WITH YOUR BEST QUOTES ★

PRINTERS

EPSON FX-80 +	\$349	FX-100 +	\$479
LQ-1500 Parallel	\$939	Serial	\$989
JX-80 160 cps, dot-matrix/7 color graphics			\$479
HI-80 4 Pen Plotter			\$369
LX-80 draft (100 cps) & NLQ modes			\$239
OKIDATA 92P/92-IBM			\$339
93-P/93-IBM	\$549	84-P/84-IBM	\$649
OKIMATE 20-IBM Parallel with Plug & Print			\$219
182-IBM Parallel Personal Printer			\$239
92 Tractor	\$70	84 Sheet Feeder	\$390

TOSHIBA 1340P (80 column)			\$549
TOSHIBA 351P (132 column)			\$1149
Tractor	\$170	Sheet Feeder	\$799

JUKI 6100 (18 cps), 13" wide			\$379
JUKI 6300 (40 cps), 16" wide			\$699
Tractor 6100/6300			\$130/\$140

BROTHER HR-15 XL (20 CPS)	\$339	\$349	
HR-15 Tractor/Keyboard/Sheet Fdr.	\$110/\$160	\$190	
HR-25 (23 CPS)	\$559	HR-35 (36 CPS)	\$769
Tractor/Sheet Feeder for HR-25/35			\$120/\$200
TWINRITER 5			CALL
2024L LQ/Graphics - 24 pin, 160/80 cps			\$999
2024L Cutsheet Feeders - Narrow	\$220	Wide	\$290

C. ITOH 8510-BPI	\$299	8510-SEP	\$369
8510-SCEP	\$429	1550-EP	\$419
1550-P	\$429	1550-SEP	\$509
Y10-20-P	\$409	A10-30-P	\$459
F-10-40-P	\$849	F-10-55-P	\$999

QUME LETTERPRO 20P - 20 cps			\$399
20P Tractor/Sheet Feeder			\$140/\$380
SPRINT 1140 +	\$1299	SPRINT 1155 +	\$1419
INTERFACE MODULE IBM Parallel			\$80
SPRINT Tractor/Sheet Feeder			\$210/\$690

PANASONIC KX-P3151 LQ 22 cps			\$479
KX-P1090/91/92/93	\$199/\$269/\$399/\$589		

STAR MICRONICS NEW 10" & 15" MODELS			
SG-10/15 120 CPS			\$229/\$379
SD-10/15 160 CPS			\$339/\$449
SR-10/15 200 CPS			\$489/\$599

NEC P-2	\$499	P-3	\$699
NEW ELF 360 (19 CPS)			\$449
2050	\$649	3550	\$999
8850			\$1399
Spinwriter Tractor/Sheet Feeder			\$190/\$790

DIABLO 630 ECS/IBM	\$1699	630 API	\$1529
Advantage D-25	\$549	Series 36	\$1199

DATA PRODUCTS Makers of IBM color printer			
SPG 8051 (Same as IBM Color Printer)			\$1349
SPG 8071 (Same as 8051 at twice the speed)			\$1699

DISPLAY CARDS

EVEREX Graphics Edge			Best Price Ever
AST Monograph Plus w/clock, Par & Ser Ports			\$399
PERSYST BoB Board			CALL
Short-Port Color	\$159	Mini-Mono	CALL
Color Combo: Multifunction & Color Adapter			from \$349
Mono Combo: Multifunction & Mono Adapter			from \$349
MYLEX Chairman			\$429
PARADISE Modular Brd	\$259	Modules	CALL
INTELLIGENT B-450 Mono/Color/printer			\$249
TECMAR Graphics Master w/PC Paintbrush			\$449
HERCULES MonoGraphics	\$289	Color	\$149
GENOA Spectrum Multi Display Card			CALL
IBM Color Card	\$229	Generic	\$129
QUADRAM QuadColor I or II	\$199	Both	\$390

EXCLUSIVELY FOR IBM PC

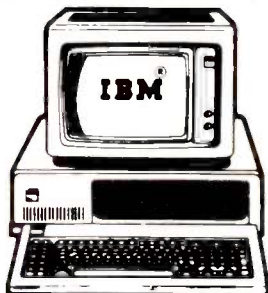

CALL FOR LATEST SYSTEM PRICES

FLOPPY/HARD DISKS

TEACH Half Ht FD 55B - DSDD	REDUCED \$95
(Warranted for IBM PC only) 10 +	CALL
TANDON 100-2 Full Ht - DSDD	\$99
IBM Full Ht - DSDD	\$129

HARD DISKS/BACKUP for IBM PC	
10 MB HD Int w/Controller	\$489
20 MB HD Int w/Controller	REDUCED \$599
Call for larger size Hard Disk/Backup CALL	

TALL GRASS NEW PC/T FORMAT DRIVES/BACKUP			
25 MB w/60 MB	\$2699	35 MB w/45 MB	\$3499
50 MB w/60 MB	\$4399	80 MB w/60 MB	\$5599
Controller	\$140	Cartridge(60 MB)	\$35
QUBIE 10/20 MB Internal or External			CALL
All Qubie Hard Drives include 1 Dir software			

MAYNARD 10MB/WS-1 \$799 10MB/WS-2 \$899			
20MB/WS-1	\$1099	20MB/WS-2	\$1199
30MB/WS-1	\$1699	30MB/WS-2	\$1779
Gemini WS-1	\$1019	Gemini WS-2	\$1129
The "Gemini" includes 10MB Hard Disk & Half Ht. floppy			
MaynStream System 20	\$999	Data Cassette 20	\$30
MaynStream System 60	\$1299	Cartridge 600	\$50

EVEREX 10MB Int	\$599	20 MB Int	\$799
EXCEL 4500-PC Internal 45MB Tape Backup			\$949
EXCEL 4500 External 45MB Tape Backup			\$999

IRWIN MAGNETICS			
10 MB Internal Tape Backup			\$569
10 MB External Tape Backup			CALL

★ **SUPER SPECIALS** ★

\$1000 + SINGLE ORDER ENTITLES YOU TO THESE SPECIAL PRICES

JUKI 6100/6300			\$369/\$679
OKIDATA 92P/93P/84P			\$329/\$535/\$635
BROTHER HR-15/25/35			\$329/\$539/\$749
PGS MAX-12E	\$159	HX-12	\$399
HAYES 1200B w/sft	\$335	1200 Ext	\$365
PROMETHEUS 1200B/1200 Ext			\$249/\$279
TECMAR Graphics Master w/PC Paintbrush			\$429
AST SIXPAK 384k	\$309	QUADBOARD 384k	\$293
ORCHID Blossom 384k	\$259	BT 6 Plus 384k	\$269
PARADISE 5-Pk 384k	\$233	TECMAR Captain 384k	\$253

COMPANY POLICY: Min. order \$100. Prices & availability subject to change. We ship UPS only. Shipping/handling charges vary. COD requires cashiers check. All merchandise sold is new and all sales are final. Products shipped in factory cartons come with manufacturer's warranty. For others, including IBM PC, call tech. support for return auth # for warranty repair. Non-defective items returned as defective subject to 10% service charge (Min. \$50). Not responsible for hardware or software compatibility of any product. No open acct. PD's or foreign orders. No showroom, demonstrations or walk-in sales. For advance payment (personal/company checks take 3 weeks to clear) or PICKUP. Please call first for workorder #.



COD NO SURCHARGE: VISA & MC 3%, AMEX 5%

MODEMS

MICROCOM ERA-2 Int. w/sft			\$339
HAYES 1200 B Internal w/software			\$345
1200 Standalone w/o software			\$375
NEW 2400 Baud Ext			CALL
POPCOM C-100/X-100			Special Low Prices
PROMETHEUS PROMODEM 1200 Ext			\$285
PROMODEM 1200 B Internal w/software			\$255
NOVATION SmartCat w/sft - Int or Ext			\$365
QUBIE Standalone	\$309	Internal	\$279
Ven-Tel Half Card w/Crosstalk XVI			\$359
1200 Plus External w/o software			\$329

MONITORS

PGS MAX-12E	\$169	HX-12	\$429
SR-12	\$599	Scan Dblr	CALL
TAXAN COMPOSIT 115 Green/116 Amber			\$129
MONO 121 Green/122 Amber (1000x360)			\$139
COLOR 411 (510x260)	\$349	425 (640x262)	\$449
COLOR 440 (720x400)	\$529	W/Persyst BoB Brd	\$899
SAKATA SG 1000 Green Composi			\$119
COLOR MONITORS			CALL
AMDEK 300G/300A/310A (M)	\$139/\$149	CALL	
COLOR 600 (640x240)	\$429	710 (720x480)	\$539
QUADRAM AMBERCHROME (720x350)			CALL
QUADCHROME II (640x240) Color Graphics & Text			\$429
TECMAR Color Monitor			\$529
ROLAND MB-142 14" Mono B/W			CALL

MULTI-FUNCTION CARDS

AST SIXPAK w/64k	\$239	Exp to 384k	\$329
QUADBOARD 0-k	\$209	Exp to 384k	\$313
ORCHID Blossom 0-k	\$175	Exp to 384k	\$279
BT 6 PLUS w/64k	\$199	Exp to 384k	\$289
IDS B-512 0-k	\$199	Exp to 512k	\$339
P/S/G/ Ports, Clock/Cal, disk emulation & Sockets for 512k			
PARADISE 5-Pack 0-k	\$149	Exp to 384k	\$253
TECMAR Captain 0-k	\$169	Exp to 384k	\$273
PERSYST Display & Multifunction Brds.			from \$349

MISC. ADD ONS

64K RAM Set	\$14	10 + Sets	\$13	50 +	\$12
8087-3/8087-6					\$125/\$95
ORCHID PCTurbo w/128k			\$699	640k	\$999
QUADRAM QUADsprint					\$499
CABLE Parallel, 6 ft	\$20	Parallel, 8 ft.	\$25		
Keyboard Extension, 6 ft.	\$10	Serial, 6 ft.	\$25		
MAXELL MD-1 SSDD Box	\$20	10 + Boxes	\$17		
(10 per box) MD-2 DSDD Box	\$25	10 + Boxes	\$22		
IBM Floppy Controller			\$115	Generic	\$75
PC Mouse & Micro Systems Mouse					CALL
QUBIE Keyboard 5150	\$119	5151	\$149		
KEYTRONIC Deluxe Keyboard KB 5151					\$165
QUADRAM Microfazer 8k to 384k					CALL
COMPUTER ACCESSORIES P2 (5)					\$99
POWER DIRECTOR P22 (4)	\$75	P12 (6)	\$139		
KENSINGTON Master Piece (5 Outlets)					\$89
PC Keyboard Storage Drawer					\$89
STANDBY PWR SUPPLY w/surge protection					
200 Watts	\$279	300 Watts	\$379	800 Watts	\$779
KOALA Touch Tablet w/software					\$79
KENSINGTON Universal Stand					\$20
CURTIS Surge Protectors & Accessories					CALL
TILT/SWIVEL Monitor Pedestal					\$30

COMPU

805-987-7015

406-C CONSTITUTION AVE., CAMARILLO, CA 93010

WHEN ORDERING PLEASE REFER TO AD #B799

Maxell Floppy Disks

The Mini-Disks
with maximum quality.



Dealer inquiries
invited. C.O.D.'s
accepted. Call
FREE (800) 235-4137.

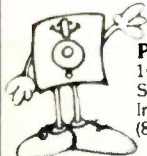

PACIFIC EXCHANGES
100 Foothill Blvd., San Luis
San Luis Obispo, CA 93401.
In Cal. call (800) 592-5935 or
(805)543-1037.

Inquiry 319



NEW!

SafeSkin

KEYBOARD PROTECTOR

Remains in place during keyboard use.
Prevents damage from liquid spills, dust,
ashes, etc. Fits like a second skin, excellent
feel. Homerow and numeric locators.
Available for: IBM-PC, Apple IIe, Radio
Shack Model 100, Commodore 64.
Send \$29.95, check or M.O., Visa & MC
include exp. date. Specify computer type.
Dealer inquiries invited. Free brochure
available.

MERRITT Computer Products, Inc.
2925 LBJ, #180 / Dallas, Texas 75234
(214) 942-1142

Inquiry 271

Monitor Mover Gives Back the Desk



\$159.95

- Models to fit most CRT's
- Rotates 360° on base
- Adjustable height
- Support tray swivels and tilts
- Holds up to 50 lbs
- Clamp, screw and wall mountings

Lirtek

P.O. Box 8056
Grand Rapids, MI 49508
(616) 241-4040

Inquiry 250

A New Text Editor for the DEC® Rainbow® and IBM® PC

- Edit many files at once
- Memory mapped video display
- Buffered input
- Context sensitive help
- Undo deletions
- Create, edit & save scratch buffers
- Powerful buffer operations
- Keystroke macros
- Easily reconfigurable
- Fast, Small for its power (38K)
- Utilizes all memory available
- Not copy protected
- Much more

Also included: A speller with a 25000+ word
expandable dictionary, and a text formatter
redefinable to familiar commands.

DEC: Both MS-DOS® & CP/M®, manual
IBM & compatibles: MS-DOS version, manual

\$49.95 M/C. Visa accepted

Plus \$3 shipping. IA res add 4% sales tax.

Orders: 1-800-227-2400 ext 975

1-800-772-2666 ext 975 (within CA)

College Software • 911 Clark Avenue

Ames, IA 50010 • (515)233-4023

Inquiry 89

**NOW INCLUDES
TINY BASIC
FORTH AVAILABLE**

SIBEC 51

8051/52 DEVELOPMENT BOARD

8051-Based Single-Board Computer with
Monitor/Debugger

- 28-pin byte-wide sockets; monitor will program EEPROMS.
- Perfect for System Development and Educational Applications

\$335

Binary Technology

P.O. BOX 67 • MERIDEN, NH 03770 • 603/469-3232

Inquiry 52

DATAMASTER™

One-of-A-kind Data Management Program Developed Especially for You.

\$175.00

STOP thinking about any other programs
STOP worrying about custom programming
START saving time and money
START being your own MASTER

California **(800) 423-0320**
Outside **(800) 482-DATA**

C.D.A. INTERNATIONAL SOFTWARE CORP.
(818) 986-3233 Telex: 215666

Inquiry 76

DATA ACQUISITION



RS 232C VOLTMETER FOR YOUR PC

B channel, 4 1/2 digit AC/DC voltmeter & controller.
SENSATROL talks your computer's language! Sensors
hook up easily to differential inputs providing 15
bits of 100uV. Special tri-state serial output allows
networking. Includes seven binary control outputs.
Uses simple PRINT and INPUT with BASIC. Detailed
manual starts amateurs in sensor hookup & applica-
tions. **\$385 COMPLETE!**

DEALER INQUIRIES WELCOME.
603-588-3746

BOX 33, FRANCESTOWN, NH 03043

DATA WORLD PRODUCTS

Inquiry 130

Two Dollars SALE

Each book from this ad is two Dollars! Buy all 12 books for only \$19.95!
Incredible savings — Mail your order today!

BOOKS FOR THE COMMODORE 64

The Great Book of Games
48 games, 144 pages
Order-No. 182 was \$ 9.95 now \$ 2.-
More on the Sixtyfour
Machine Language Programs for the
advanced user.
Order-No. 183 was \$ 9.95 now \$ 2.-

Machine Language Programming on
the C-64
Order-No. 184 was \$ 12.95
now \$ 2.-

Commodore 64 Tune-up
Hardware expansions, I/O program-
ming, A/D conversion.
Order-No. 185 was \$ 12.95
now \$ 2.-

Small Business Programs for the C-64
Order-No. 186 was \$ 12.95
now \$ 2.-

29 Programs for the C-64
Order-No. 55 was \$ 9.95 now \$ 2.-

The programs from the books are also available on disk. Each disk is \$ 9.95.

ELCOMP PUBLISHING, INC.
2174 West Foothill Blvd., Unit E
Upland, CA 91786
Phone: (714) 952-4477, Telex: 29 81 91

SUPER BOOK FOR THE APPLE II

The APPLE in your Hand
Advanced BASIC programs, intro-
duction into machine language,
FORTH, Tips & Tricks (220 pages).
Order-No. 178 was \$ 12.95
now \$ 2.-

BOOKS FOR ATARI 800 XL

Games for the ATARI
112 pages full of super games.
Order-No. 182 was \$ 7.95 now \$ 2.-

ATARI BASIC—Learning by Using
Order-No. 164 was \$ 7.95 now \$ 2.-

ATARI Machine Language
Programming
Order-No. 169 was \$ 9.95 now \$ 2.-

Hacker-book for the ATARI
Order-No. 172 was \$ 9.95 now \$ 2.-

BASIC in 60 Minutes — a day
Order-No. 36 was \$ 7.95 now \$ 2.-

The programs from the books are also available on disk. Each disk is \$ 9.95.

Inquiry 164

**Q. Business Systems
Consulting?**

A. Masterbyte.

MASTERBYTE COMPUTERS OF NEW YORK, INC.
Ste. 815, 19 W. 34 St., N.Y., NY 10001 • (212) 760-0341
SERVING BUSINESSES SINCE 1984

Inquiry 265

Lotus™ User?

Free Mail Order Catalog for Lotus Software users, includes:

- Lotus Programs
- Lotus Enhancement Software
- Books and Training Aids
- Hardware and Utilities

We are a unique mail order company specializing in Lotus related products.

4-5-6 WORLD
Dept. A-108
P.O. Box 22657
Santa Barbara, CA 93121
(800) 524-5678 Toll Free
(805) 564-2424 In California



Your definitive Lotus enhancement source

Inquiry 2

FORTRAN PROGRAMMERS

Discover why you should be using F77L

the complete implementation of the ANSI FORTRAN 77 Standard for the IBM PC and compatibles.

If you are serious about your FORTRAN programming, you should be using F77L.

\$477



Lahey Computer Systems, Inc.

31244 Palos Verdes Drive West, Suite 243
Rancho Palos Verdes, California 90274
(213) 541-1200

Serving the FORTRAN community since 1969

Inquiry 241

Computer System Sale

Lowest Price Computer System in the U.S.A.

\$449⁰⁰

Includes Atari 800XL 88K Computer, 127K Disk Drive, 20 CPS Letter Quality Printer, Beginners Basic Book, and more. List \$852.90.

All for only \$449⁰⁰

152K System \$499⁰⁰

312/ 382-5050

• Over 1000 programs available • free catalog

COMPUTER DIRECT

22292 N. Pepper Rd., Barrington, IL 60010

We Love Our Customers

Inquiry 341

8051 SIMULATOR \$199

for the IBM-PC or Z80 CP/M UC

SIM51 is a screen oriented program that simulates the Intel 8051 family of single chip microcomputers. It accepts Intel HEX files (produced by most cross assemblers) and features both a menu and a command driven user interface. Call today for complete information.

HiTech Equipment Corporation

9560 Black Mountain Road
San Diego, CA 92126

For Immediate Action Call:
(619) 566-1892

Inquiry 211

THE WORLD'S FASTEST S-100 Z-80 SLAVE PROCESSOR

TurboSlave I

- 8 Mhz Z-80H
- Data transfers to 1 mbyte/second
- S-100 IEEE-695 compatible
- 4k Monitor ram
- Low parts count
- No paddle boards
- 128k Ram with parity
- 2 RS-232 Ports 50-38 k baud
- F I O communications
- On board diagnostics
- Low power consumption
- TurboDOS compatible
- **GUARANTEED COMPATIBLE WITH ALL S-100 SYSTEMS RUNNING TURBODOS**

INTRODUCTORY PRICE \$495

Includes TurboDOS drivers (a \$100 value) and TurboSlave I with 128k ram



EARTH COMPUTERS

P.O. Box 8067, Fountain Valley, CA 92728
TELEX: 910 997 6120 EARTH FV

FOR MORE INFORMATION AND QUANTITY DISCOUNTS CALL: (714) 964-5784

Registered trademarks Z-80H, Zilog Inc., TurboDOS Software 2000, Inc.
*** IBM PC VERSION COMING SOON ***

Inquiry 160

PERCON® E-Z-READER™ BAR CODE READERS



\$595 QUANTITY ONE

QUALITY, PERFORMANCE, PRICE

IBM® PC/XT KEYBOARD COMPATIBLE VERSION
Works with most compatibles

Hooks up in seconds without changing software
—OR— RS 232C SERIAL VERSION

READS UPC A/E, CODE 39, CODABAR, ABC, 1 2 OF 5
DECODES BOTH DOT MATRIX & HIGH DENSITY PRINTED LABELS ACCURATELY

MS/PC DOS Bar Code Printing Software \$99



503/344-1189
2190 W. 11th St.
Eugene, OR 97402

1 Year Limited Warranty Units in Stock VISA, M/C or COD

Inquiry 325

SL-MICRO

STATISTICAL LANGUAGE for MICROCOMPUTERS

- features
- | | |
|--------------|-----------------|
| FREQUENCIES | FULL LABELING |
| CROSSTABS | TRANSFORMATIONS |
| PEARSON CORR | DATA EDITOR |
| REGRESSION | CONDESCRIPTIVE |
| * ANOVA | * BREAKDOWN |
- * = new

Only \$250. Manual \$15
Available for IBM PC, CP/M,
MS-DOS or CP/M-86.

QSC BOX 778
E. LANSING, MI 48823
(517) 641-4428

Inquiry 351

GDC Clearance Sale New Modems



- | | |
|---|------------------|
| 208 Micro-processor
4800 bps | \$500.00 |
| 201C
2000 or 2400 bps | \$429.00 |
| 212A 1200 bps full duplex
synch. or asynch.
300 bps asynch. | \$299.00 |
| 9600 Point-to-Point | \$1395.00 |

Various other models also available.

Call Toll Free 1-800-842-3672
Connecticut residents call
203-758-1811 ext. 7535

General DataComm

Middlebury, CT 06762-1299

Add \$5.00 shipping and handling. Conn. res. add sales tax.

Inquiry 191

DATA BROKERS
1-800-833-2600
in Ohio (513) 561-0099
FREE SHIPPING
NO EXTRA CHARGES!
MODEMS

HAYES 1200	\$399
HAYES 1200B	\$379
VOLKSMODEM 1200	\$189
ANCHOR MARK XII	\$225
MARK X 300	\$ 99
PASSWORD 1200	\$229
COURIER 2400	\$479
CERMETEK 1200	\$439
CERMETEK 1200PC	\$349
CERMETEK 2400	\$489
CERMETEK SECURITY	\$599

3535 Roundbottom Rd. Cinti., OH 45244

Inquiry 174

UNBELIEVABLE PRICES!

MODEM \$69⁹⁵

FOR APPLE OR IBM

INCLUDES ASCII PRO-EZ™ MENU DRIVEN SOFTWARE
(AT LEAST A \$100 VALUE IN ITSELF!)

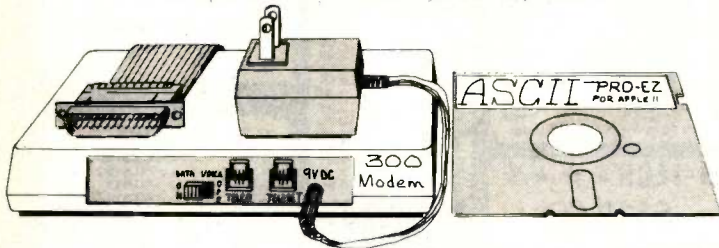

- * FCC APPROVED
- * BELL SYSTEM 103 COMPATIBLE
- * 300 BAUD
- * AUTO-DIAL/AUTO-ANSWER
- * DIRECT CONNECT
- * INCLUDES AC ADAPTOR

SPECIFY IBM OR APPLE WHEN ORDERING

TAXAN MODEL 415

RGB

VISION III MONITOR

ORIGINALLY MADE FOR ACORN COMPUTER SAME SPECS AS THE TAXAN 420

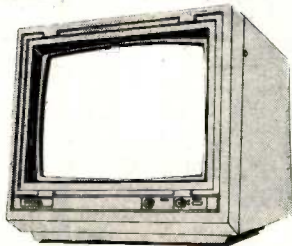

- * 18 Mhz BANDWIDTH
- * 640 x 262 PIXEL RESOLUTION
- * 16 COLORS WITH INTENSITY CONTROL
- * 12" BLACK MATRIX
- * IBM AND LOTUS COMPATIBLE

\$299⁹⁵

RGB MONITOR CABLE FOR IBM \$15.95

IBM

COMPATIBLE INTERFACE CARDS

MADE IN THE USA BY INTERSIL SYSTEMS

COLOR/GRAPHICS

- * SUPPORTS COMPOSITE OR RGB MONITOR
- * OPERATES IN ALPHANUMERIC OR ALL-POINTS-ADDRESSABLE GRAPHICS MODE **\$129⁹⁵**
- * SUPPORTS 16 COLORS
- * CONTAINS LIGHT PEN INTERFACE

MONOCHROME DISPLAY ADAPTOR

- * 720 x 350 PIXEL SCREEN (80 CHARACTERS x 25 LINES)
- * CHARACTER ATTRIBUTES: BLINK, UNDERLINE, REVERSE VIDEO, INTENSIFIED **\$149⁹⁵**
- * STANDARD TTL OUTPUT

JDR Microdevices

1224 S. Bascom Avenue, San Jose, CA 95128

800-538-5000 • 800-662-6279 (CA) • (408) 995-5430

FAX (408) 275-8415 • Telex 171-110

© Copyright 1985 JDR Microdevices

RETAIL STORE - 1256 S. BASCOM AVENUE
HOURS: M-W-F, 9-5 TU-TH, 9-9 SAT, 10-3

PLEASE USE YOUR CUSTOMER NUMBER WHEN ORDERING

TERMS: Minimum order \$10.00. For shipping and handling include \$2.50 for UPS Ground and \$3.50 for UPS Air. Orders over 1 lb. and foreign orders may require additional shipping charges - please contact our sales department for the amount. CA. residents must include 6% sales tax. Bay Area and LA residents include 6 1/2%. All merchandise is warranted for 90 days unless otherwise stated. Prices are subject to change without notice. We are not responsible for typographical errors. We reserve the right to limit quantities and to substitute manufacturer. All merchandise subject to prior sale.

4164 64K DYNAMIC 200ns 9/14.95

41256 256K DYNAMIC 200ns 5.95

STATIC RAMS

2101	256x4 (450ns)	1.95
5101	256x4 (450ns)(cmos)	3.95
2102-1	1024x4 (450ns)	.89
2102L-1	1024x1 (450ns)(LP)	.99
2102L-2	1024x1 (250ns)(LP)	1.45
2125	1024x1 (45ns)	2.95
2111	256x4 (450ns)	2.49
2111L	256x4 (450ns)(LP)	2.95
2112	256x4 (450ns)	2.99
2114	1024x4 (450ns)	8/9.95
2111-25	1024x4 (250ns)	8/10.95
2114L-4	1024x4 (300ns)(LP)	8/12.95
2114L-3	1024x4 (450ns)(LP)	8/13.45
2114L-2	1024x4 (200ns)(LP)	8/13.95
2114L-15	1024x4 (150ns)(LP)	8/19.95
TC5514	1024x4 (650ns)(cmos)	4.95
2141	4096x1 (200ns)	2.95
2147	4096x1 (55ns)	4.95
2148	1024x4 (70ns)	4.95
TMS4044-4	4096x1 (450ns)	3.49
TMS4044-3	4096x1 (300ns)	3.99
TMS4044-2	4096x1 (200ns)	4.49
TMS4044-1	4096x1 (200ns)(LP)	4.95
UPD410	4096x1 (100ns)	3.95
MK4118	1024x8 (250ns)	9.95
TMM2016-200	2048x8 (200ns)	3.25
TMM2016-150	2048x8 (150ns)	3.75
TMM2016-100	2048x8 (100ns)	4.75
HM6116-4	2048x8 (200ns)(cmos)	3.69
HM6116-3	2048x8 (150ns)(cmos)	3.95
HM6116-2	2048x8 (120ns)(cmos)	5.95
HM6116L-4	2048x8 (200ns)(cmos)(LP)	3.95
HM6116L-3	2048x8 (150ns)(cmos)(LP)	4.25
HM6116L-2	2048x8 (120ns)(cmos)(LP)	6.95
TC5516	2048x8 (250ns)(cmos)	9.95
TMS4016	2048x8 (200ns)	6.95
Z-6132	4096x8 (300ns)(Qstat)	34.95
HM6264P-15	8192x8 (150ns)(cmos)	10.25
HM6264LP-15	8192x8 (150ns)(cmos)(LP)	10.95
HM6264LP-12	8192x8 (120ns)(cmos)(LP)	12.95

LP=Low power Qstat=Quasi-Static

DYNAMIC RAMS

TMS4027	4096x1 (250ns)	1.99
2107	4096x1 (200ns)	1.95
MMS280	4096x1 (300ns)	1.95
TMS4050	4096x1 (300ns)	1.95
UPD411	4096x1 (300ns)	1.95
TMS4060	4096x1 (300ns)	1.95
MK4108	8192x1 (200ns)	.49
MMS298	8192x1 (250ns)	.49
4116-300	16384x1 (300ns)	8/6.95
4116-250	16384x1 (250ns)	8/6.95
4116-200	16384x1 (200ns)	8/8.95
4116-150	16384x1 (150ns)	8/10.95
4116-120	16384x1 (120ns)	8/12.95
2118	16384x1 (150ns)(5v)	4.95
MK4332	32768x1 (200ns)	9.95
4164-200	65536x1 (200ns)(5v)	9/14.95
4164-150	65536x1 (150ns)(5v)	9/16.95
4164-120	65536x1 (120ns)(5v)	3.95
MCM6665	65536x1 (200ns)(5v)	4.95
TMS4164-20	65536x1 (200ns)(5v)	4.25
TMS4164-15	65536x1 (150ns)(5v)	4.95
4164-REFRESH	65536x1 (150ns)(5v)(REFRESH)	8.95
TMS4416-20	16384x4 (200ns)(5v)	8.95
TMS4416-15	16384x4 (150ns)(5v)	9.95
41128-150	131072x1 (150ns)(5v)	13.95
41256-200	262144x1 (200ns)(5v)	5.95
41256-150	262144x1 (150ns)(5v)	6.45

5v=Single 5 Volt Supply REFRESH=Pin 1 Refresh

EPROMS

1702	256x8 (1us)	4.50
2708	1024x8 (450ns)	3.95
2758	1024x8 (450ns)(5V)	5.95
2716-6	2048x8 (650ns)	3.95
2716	2048x8 (450ns)(5V)	3.95
2716-1	2048x8 (350ns)(5V)	4.95
TMS2516	2048x8 (450ns)(5V)	4.95
TMS2716	2048x8 (450ns)	7.95
TMS2532	4096x8 (450ns)(5V)	4.95
2732	4096x8 (450ns)(5V)	4.25
2732A-4	4096x8 (450ns)(5V)(21V PGM)	4.95
2732A-35	4096x8 (350ns)(5V)(21V PGM)	4.95
2732A	4096x8 (250ns)(5V)(21V PGM)	6.95
2732A-2	4096x8 (200ns)(5V)(21V PGM)	10.95
2764	8192x8 (450ns)(5V)	4.95
2764-250	8192x8 (250ns)(5V)	5.25
2764-200	8192x8 (200ns)(5V)	8.95
TMS2564	8192x8 (450ns)(5V)	10.95
MCM68764	8192x8 (450ns)(5V)(24 pin)	24.95
MCM68766	8192x8 (350ns)(5V)(24 pin)	42.95
27128-45	16384x8 (450ns)(5V)	7.50
27128-30	16384x8 (300ns)(5V)	7.75
27128	16384x8 (250ns)(5V)	7.95
27256	32768x8 (250ns)(5V)	19.95

5V=Single 5 Volt Supply 21V PGM=Program at 21 Volts

CRYSTALS

32.768 KHz	1.95
1.0 MHz	3.95
1.8432	2.95
2.0	3.95
2.097152	2.95
2.4576	2.95
3.2768	2.95
3.579545	2.95
4.0	2.95
4.032	2.95
5.0	2.95
5.0688	2.95
5.185	2.95
5.7143	2.95
6.0	2.95
6.144	2.95
6.5536	2.95
8.0	2.95
10.0	2.95
10.738635	2.95
14.31818	2.95
15.0	2.95
16.0	2.95
17.430	2.95
18.0	2.95
18.432	2.95
20.0	2.95
22.1184	2.95
24.0	2.95
32.0	2.95

CRYSTAL OSCILLATORS

1.0MHz	7.95	8.0	7.95
1.8432	7.95	10.0	7.95
2.0	7.95	12.0	7.95
2.4576	7.95	15.0	7.95
2.5	7.95	16.0	7.95
4.0	7.95	18.432	7.95
5.0688	7.95	20.0	7.95
6.0	7.95	24.0	7.95
6.144	7.95		

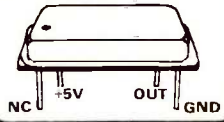

74LS00

74LS00	.24	74LS189	8.95
74LS01	.25	74LS190	.89
74LS02	.25	74LS191	.89
74LS03	.25	74LS192	.79
74LS04	.24	74LS193	.79
74LS05	.25	74LS194	.69
74LS08	.28	74LS195	.69
74LS09	.29	74LS196	.79
74LS10	.25	74LS197	.79
74LS11	.35	74LS221	.89
74LS12	.35	74LS240	.95
74LS13	.45	74LS241	.99
74LS14	.59	74LS242	.99
74LS15	.35	74LS243	.99
74LS20	.25	74LS244	1.29
74LS21	.29	74LS245	1.49
74LS22	.25	74LS246	.75
74LS26	.29	74LS248	.99
74LS27	.29	74LS249	.99
74LS28	.35	74LS251	.59
74LS30	.25	74LS253	.59
74LS32	.29	74LS257	.59
74LS33	.55	74LS258	.59
74LS37	.35	74LS259	2.75
74LS38	.35	74LS260	.59
74LS40	.25	74LS261	2.25
74LS42	.49	74LS266	.55
74LS47	.75	74LS271	1.99
74LS48	.75	74LS275	3.35
74LS49	.75	74LS279	.49
74LS51	.25	74LS280	1.98
74LS54	.29	74LS283	.69
74LS55	.29	74LS290	.95
74LS63	1.25	74LS293	.89
74LS73	.39	74LS295	.99
74LS74	.35	74LS298	.89
74LS75	.39	74LS299	1.75
74LS76	.39	74LS322	5.95
74LS78	.49	74LS329	1.55
74LS83	.60	74LS324	1.75
74LS85	.69	74LS348	2.50
74LS86	.39	74LS352	1.29
74LS90	.55	74LS353	1.29
74LS91	.89	74LS361	1.35
74LS92	.55	74LS364	1.95
74LS93	.55	74LS365	.49
74LS95	.75	74LS366	.49
74LS96	.89	74LS367	.45
74LS107	.39	74LS368	.45
74LS109	.39	74LS373	1.39
74LS112	.39	74LS374	1.39
74LS113	.39	74LS375	.95
74LS114	.39	74LS377	1.39
74LS122	.45	74LS378	1.18
74LS123	.79	74LS379	1.35
74LS124	2.90	74LS385	3.90
74LS125	.49	74LS386	.45
74LS126	.49	74LS390	1.19
74LS132	.59	74LS393	1.19
74LS133	.59	74LS395	1.19
74LS137	.34.95	74LS399	1.89
74LS137	.99	74LS399	1.49
74LS138	.55	74LS424	3.95
74LS139	.55	74LS447	.95
74LS145	1.20	74LS490	1.95
74LS147	2.49	74LS584	3.20
74LS148	1.35	74LS541	1.95
74LS151	.55	74LS624	3.99
74LS153	.55	74LS640	2.20
74LS154	1.90	74LS645	2.20
74LS155	.69	74LS668	1.69
74LS156	.69	74LS669	1.89
74LS157	.65	74LS670	1.49
74LS158	.59	74LS674	14.95
74LS160	.69	74LS682	3.20
74LS161	.65	74LS683	3.20
74LS162	.65	74LS684	3.20
74LS163	.65	74LS685	3.20
74LS164	.69	74LS688	2.40
74LS165	.95	74LS689	3.20
74LS166	1.95	81LS95	1.49
74LS168	1.75	81LS96	1.49
74LS169	1.75	25LS218	4.13
74LS170	1.49	25LS252	2.80
74LS173	.69	25LS258	3.74
74LS174	.55	25LS259	2.80
74LS175	.55	26LS31	2.19
74LS181	2.15	26LS32	2.19

GENERATORS BIT RATE

MC14411	11.95
BR1941	11.95
4702	12.95
COM5016	16.95
COM8116	10.95
MMS307	10.95

FUNCTION

MC4024	3.95
LM566	1.49
KR2206	3.75
8038	3.95

CRT CONTROLLERS

6845	12.95
68B45	19.95
6847	11.95
68047	24.95
HD46505SP	15.95
MC1372	6.95
8275	29.95
7220	39.95
CRT5027	19.95
CRT5037	34.95
TMS9918A	39.95
DP8350	49.95

DISK CONTROLLERS

1771	15.95
1791	23.95
1793	23.95
1795	23.95
1797	23.95
2791	39.95
2793	39.95
2795	39.95
2797	39.95
6843	34.95
8272	19.95
MB8876	29.95
MB8877	34.95
1891	7.95
2143	7.95

KEYBOARD CHIPS

AY5-2376	11.95
AY5-3600 STD	11.95
AY5-3600 PRO	11.95

CLOCK CIRCUITS

MMS314	4.95
MMS369	1.95
MMS369 EST	1.95
MMS375	4.95
MMS8167	8.95
MMS8174	11.95
MMS832	3.95

★★★HIGH-TECH★★★

8087-6 \$119.00

★ 4.87 MHz VERSION OF 8087 MATH COPROCESSOR
★ IBM-PC COMPATIBLE
★ RUNS TURBO PROGRAMS AS MUCH AS 100 TIMES FASTER THAN 8088 ALONE

★★★SPOTLIGHT★★★

ORDER TOLL FREE

800-538-5000

800-662-6279

(CALIFORNIA RESIDENTS)

Z-80

2.5 MHz

Z80-CPU	2.49
Z80-CTC	2.95
Z80-DART	7.95
Z80-DMA	8.95
Z80-PIO	2.95
Z80-SIO/0	9.95
Z80-SIO/1	9.95
Z80-SIO/2	9.95
Z80-SIO/9	9.95

6500

1.0 MHz

6502	4.95
65C02(CMOS)	12.95
6504	6.95
6505	8.95
6507	9.95
6520	2.95
6522	5.49
6532	9.95
6545	9.95
6551	9.95

6800

HM6264P-15 8Kx8 STATIC 150ns

SSI263 SPEECH SYNTHESIZER 39.95

74S00

74500	.32	745135	.89	745244	2.20
74502	.35	745138	.85	745251	.95
74503	.35	745139	.85	745253	.95
74504	.35	745140	.85	745257	.95
74505	.35	745151	.95	745258	.95
74508	.35	745153	.95	745260	.79
74509	.40	745157	.95	745273	2.45
74510	.35	745158	.95	745274	19.95
74511	.35	745161	1.95	745275	19.95
74515	.35	745162	1.95	745280	1.95
74520	.35	745163	1.95	745283	3.29
74522	.35	745168	3.95	745287	1.90
74530	.35	745169	3.95	745288	1.90
74532	.40	745174	.95	745289	6.98
74565	.40	745188	1.95	745317	.95
74538	.85	745180	11.95	745301	6.95
74540	.35	745181	3.95	745373	2.45
74551	.35	745182	3.95	745374	2.45
74564	.40	745185	16.95	745381	7.95
74565	.40	745187	1.95	745387	4.95
74574	.50	745189	6.95	745399	2.95
74585	1.99	745194	1.49	745412	2.98
74586	.50	745195	1.49	745470	6.95
745112	.50	745196	1.49	745471	6.95
745113	.50	745197	1.49	745472	4.95
745114	.50	745198	6.95	745474	4.95
745124	2.75	745225	7.95	745570	2.95
745132	1.24	745226	3.99	745571	2.95
745133	.45	745240	2.20	745573	9.95
745134	.50	745241	2.20	875181	16.25
				875185	16.95

CMOS

4000	.29	4531	.95
4001	.25	4532	1.95
4002	.25	4538	1.95
4006	.89	4539	1.95
4007	.29	4541	2.64
4008	.95	4543	1.19
4009	.39	4553	5.79
4010	.45	4555	.95
4011	.25	4556	.95
4012	.25	4558	2.45
4013	.38	4560	4.25
4014	.79	4569	3.49
4015	.39	4581	1.95
4016	.39	4582	1.95
4017	.69	4584	.75
4018	.79	4585	.75
4019	.39	4511	12.95
4020	.75	4072	12.95
4021	.79	4724	1.50
4022	.79	74C00	.35
4023	.29	74C02	.35
4024	.65	74C04	.35
4025	.29	74C08	.35
4026	1.65	74C10	.35
4027	.45	74C14	.59
4028	.69	74C20	.35
4029	.79	74C30	.35
4030	.39	74C32	.39
4034	1.95	74C42	1.29
4035	.85	74C48	1.99
4040	.75	74C73	.65
4041	.75	74C74	.65
4042	.69	74C76	.80
4043	.85	74C83	1.95
4044	.79	74C85	1.95
4046	.85	74C86	.99
4047	.95	74C89	4.50
4048	.69	74C90	1.19
4049	.35	74C93	1.75
4050	.35	74C95	.99
4051	.79	74C150	5.75
4052	1.95	74C151	2.25
4053	.79	74C154	.25
4056	.89	74C157	1.75
4057	.39	74C160	1.19
4058	.39	74C161	1.19
4059	.29	74C162	1.19
4060	.29	74C163	1.19
4061	.29	74C164	1.19
4062	.29	74C165	2.00
4063	.29	74C173	.79
4064	.29	74C174	1.19
4065	.29	74C175	1.19
4066	.29	74C182	.99
4067	.29	74C192	.99
4068	.29	74C193	1.49
4069	.29	74C195	1.39
4070	.29	74C200	5.75
4071	.29	74C221	1.75
4072	.29	74C24	2.25
4073	.29	74C27	2.45
4074	.29	74C37	2.45
4075	.29	74C37A	2.45
4076	.29	74C37B	2.45
4077	.29	74C37C	2.45
4078	.29	74C37D	2.45
4079	.29	74C37E	2.45
4080	.29	74C37F	2.45
4081	.29	74C37G	2.45
4082	.29	74C37H	2.45
4083	.29	74C37I	2.45
4084	.29	74C37J	2.45
4085	.29	74C37K	2.45
4086	.29	74C37L	2.45
4087	.29	74C37M	2.45
4088	.29	74C37N	2.45
4089	.29	74C37O	2.45
4090	.29	74C37P	2.45
4091	.29	74C37Q	2.45
4092	.29	74C37R	2.45
4093	.29	74C37S	2.45
4094	.29	74C37T	2.45
4095	.29	74C37U	2.45
4096	.29	74C37V	2.45
4097	.29	74C37W	2.45
4098	.29	74C37X	2.45
4099	.29	74C37Y	2.45
4100	.29	74C37Z	2.45

HIGH SPEED CMOS

A new family of high speed CMOS logic featuring the speed of low power Schottky (8ns typical gate propagation delay), combined with the advantages of CMOS: very low power consumption, superior noise immunity, and improved output drive.

74HC00

74HC: Operate at CMOS logic levels and are ideal for new, all-CMOS designs.

74HC00	.59	74HC175	.99
74HC02	.59	74HC193	1.25
74HC04	.59	74HC194	1.04
74HC08	.59	74HC195	1.09
74HC10	.59	74HC238	1.35
74HC11	.59	74HC240	1.89
74HC14	.79	74HC241	1.89
74HC20	.59	74HC242	1.89
74HC27	.59	74HC243	1.89
74HC30	.59	74HC244	1.89
74HC32	.59	74HC245	1.89
74HC36	.59	74HC251	.89
74HC51	.59	74HC257	.85
74HC74	.75	74HC259	1.39
74HC85	1.35	74HC273	1.89
74HC86	1.35	74HC289	4.95
74HC93	1.19	74HC367	.95
74HC125	1.19	74HC373	2.29
74HC132	1.19	74HC374	2.29
74HC138	.99	74HC393	1.39
74HC139	.99	74HC4017	1.99
74HC150	.99	74HC4020	1.39
74HC153	.89	74HC4024	1.59
74HC154	2.49	74HC4040	1.39
74HC157	.89	74HC4049	.89
74HC161	1.15	74HC4050	.89
74HC162	1.25	74HC4060	1.25
74HC166	2.95	74HC4511	2.39
74HC174	.99	74HC4538	2.29

74HCT00

74HCT: Direct, drop-in replacements for LS TTL and can be formed with 74LS in the same circuit.

74HCT00	.69	74HCT175	1.09
74HCT02	.69	74HCT193	1.39
74HCT04	.69	74HCT194	1.19
74HCT08	.69	74HCT195	1.29
74HCT10	.69	74HCT238	1.49
74HCT11	.69	74HCT240	2.19
74HCT14	.89	74HCT241	2.19
74HCT20	.69	74HCT242	2.19
74HCT27	.69	74HCT243	2.19
74HCT30	.69	74HCT244	2.19
74HCT32	.69	74HCT245	2.19
74HCT36	.69	74HCT251	1.09
74HCT51	.69	74HCT257	.99
74HCT74	.85	74HCT259	1.59
74HCT85	1.49	74HCT273	2.09
74HCT86	1.49	74HCT289	5.25
74HCT93	1.29	74HCT367	1.09
74HCT125	1.29	74HCT373	2.49
74HCT132	1.29	74HCT374	2.49
74HCT138	1.15	74HCT393	1.59
74HCT139	1.15	74HCT4017	2.19
74HCT150	1.39	74HCT4020	1.59
74HCT153	1.05	74HCT4024	1.79
74HCT154	2.99	74HCT4040	1.59
74HCT157	.99	74HCT4049	.99
74HCT161	1.29	74HCT4050	.99
74HCT162	1.39	74HCT4060	1.49
74HCT166	3.05	74HCT4511	2.69
74HCT174	1.09	74HCT4538	2.59

VOLTAGE REGULATORS

TO-220 CASE PACKAGE

7805T	.75	7905T	.85
7808T	.75	7908T	.85
7812T	.75	7912T	.85
7815T	.75	7915T	.85
7824T	.75	7924T	.85

TO-3 CASE PACKAGE

7805K	1.39	7905K	1.49
7815K	1.39	7915K	1.49
7824K	1.39	7924K	1.49

TO-92 CASE PACKAGE

78L05	.69	79L05	.79
78L12	.69	79L12	.79
78L15	.69	79L15	.79

OTHER VOLTAGE REGS

78M05C	5volt	1/2amp	TO-220	3.35
LM323K	5volt	3amp	TO-3	.49
LM338K	Adj.	5amp	TO-3	3.95
78H05K	5volt	5amp	TO-3	9.95
78H12K	12volt	5amp	TO-3	9.95
78P05K	5volt	10amp	TO-3	14.95
UA78540	FAIRCHILD	DIP	1.95	

LINEAR

LM301	.34	NE570	3.95
LM301H	.79	NE571	2.95
LM307	.45	NE590	2.50
LM308	.69	NE592	.99
LM308H	1.15	LM709	.59
LM309H	1.95	LM710	.75
LM309K	1.25	LM711	.79
LM310	1.75	LM723	.49
LM311	.64	LM724	.55
LM311H	.89	LM733	.98
LM312H	1.75	LM741	.35
LM313K	3.95	LM741H-14	.35
LM317T	1.19	LM741H	.40
LM318	1.49	LM747	.69
LM318H	1.59	LM748	.59
LM319H	1.90	LM1014	1.19
LM319	1.25	LM1303	1.95
LM320	7900	LM1310	1.49
LM322	1.65	MC1330	1.69
LM323K	4.95	MC1349	1.69
LM324	.59	MC1350	1.19
LM329	.65	MC1358	1.69
LM331	3.95	MC1372	6.95
LM334	1.19	LM1414	1.59
LM335	1.40	LM1450	2.50
LM336	1.75	LM1488	.69
LM337T	1.95	LM1489	.69
LM337K	3.95	LM1496	.85
LM338K	3.95	LM1558H	3.10
LM339	1.95	LM1717	2.37
LM340	7800	LM1812	6.25
LM349	.99	LM1830	3.50
LM350K	4.95	LM1871	5.49
LM350T	4.60	LM1872	5.49
LM358	.89	LM1877	3.52
LM359	1.75	LM1878	5.99
LM376	3.75	LM1896	1.75
LM377	1.95	ULN2003	1.29
LM378	2.50	XR2206	3.75
LM379	4.50	LM2877	2.05
LM380	1.50	LM2882	2.25
LM380H-8	1.10	LM2900	.85
LM381	1.60	LM2901	1.00
LM382	1.60	MPQ2907	1.95
LM383	1.95	LM2917	2.95
LM384	1.95	MC3487	2.95
LM386	1.95	LM386	1.95
LM389	1.35	LM3909	.89
LM390	1.95	LM3911	2.25
LM392	.69	LM3914	3.95
LM393	1.25	LM3915	3.95
LM394H	4.60	LM3916	3.95
LM399H	5.00	MC4024	3.95
NE531	2.95	MC4044	4.50
NE555	.34	RC4136	1.25
NE556	.65	RC4151	3.95
NE558	1.50	LM1815	1.95
NE584	.29	LM4500	3.25
LM565	.95	RC4558	.69
LM566	1.49	LM13600	1.49
LM5			

DB25S RS232 FEMALE SOLDER CUP 2.25

DB25P RS232 MALE SOLDER CUP 1.90

BARGAIN HUNTERS CORNER DYNAMIC RAMS

4164 200ns **\$.99** ea.
100 PIECE MINIMUM

41256 150ns **\$5.99** ea.
27 PIECE MINIMUM

SPECIALS END 7/31/85

HARD TO FIND "SNAPABLE" HEADERS

Can easily be snapped apart to make any size header, all with .1" centers

1x40	STRAIGHT LEAD	.99
1x40	RIGHT ANGLE	1.49
2x40	STRAIGHT LEAD	2.49
2x40	RIGHT ANGLE	2.99

SHORTING BLOCKS

SPACED AT .1" CENTERS
IDEAL FOR DISK DRIVES
OR ANY .1" HEADER

5/1.00

DIP SWITCHES

4 POSITION	.85
5 POSITION	.90
6 POSITION	.90
7 POSITION	.95
8 POSITION	.95
10 POSITION	1.29

36 PIN CENTRONICS

IDCEN36	RIBBON CABLE MALE	8.95
IDCEN36/F	RIBBON CABLE FEMALE	8.95
CEN36	SOLDER CUP MALE	7.95

RF MODULATOR (ASTEUM1082)

QUANTITIES LIMITED

- PRESET TO CHANNEL 3
- USE TO BUILD TV-COMPUTER INTERFACE
- +5 VOLT OPERATION



\$6.95

EMI FILTER

• MAJOR MANUFACTURER
• LOW COST
• FITS LC-HP BELOW

\$4.95

LINE CORDS

LC-2	2 CONDUCTOR	6 ft	.39
LC-3	3 CONDUCTOR	6 ft	.99
LC-HP	3 CONDUCTOR WITH STANDARD FEMALE SOCKET	6 ft	1.43
LC-CIR	CIGARETTE LIGHTER PLUG WITH 6 FOOT CORD		2.95

MUFFIN FANS

4.68" SQUARE	14.95
3" SQUARE	14.95

RESISTORS

1/4 WATT 5% CARBON FILM
ALL STANDARD VALUES
FROM 1 OHM TO 10 MEG OHM

50 PIECES SAME VALUE	.025
100 PIECES SAME VALUE	.02
1000 PIECES SAME VALUE	.015

EDGECARD CONNECTORS

S-100 ST	S-100	3.95
S-100 WW	S-100	4.95
72 PIN ST		6.95
72 PIN WW		7.95
62 PIN ST	IBM PC	4.95
50 PIN ST	APPLE	4.95
44 PIN ST		2.95
44 PIN WW		4.95

BYPASS CAPS

.01 µf DISC	100/\$6.00
.01 µf MONDLITHIC	100/\$12.00
.1 µf DISC	100/\$8.00
.1 µf MONDLITHIC	100/\$15.00

DIODES

1N751	5.1 VOLT ZENER	.25
1N759	12.0 VOLT ZENER	.25
1N4148	(1N914) SWITCHING	25/1.00
1N4001	50PIV 1A	12/1.00
1N4004	400PIV RECTIFIER	10/1.00
1N5402	200PIV 3A	.25
KBPO2	200PIV 1.5A BRIDGE	.45
KBPO4	400PIV 1.5A BRIDGE	.55
MDA801	50PIV 12A BRIDGE	1.39
MDA980-1	50PIV 12A BRIDGE	1.95
MDA980-2	100PIV 12A BRIDGE	2.25
VM48	DIP BRIDGE	.35

CAPACITORS TANTALUM

1.0 µf	15V .40	.47 µf	35V .50
6.8	15V .70	1.0	35V .45
10	15V .80	2.2	35V .65
22	15V 1.35	4.7	35V .85
22	35V .40	10	35V 1.00

DISC

10 µf	50V .05	560	50V .05
22	50V .05	680	50V .05
25	50V .05	820	50V .05
27	50V .05	.001 µf	50V .05
33	50V .05	.0015 µf	50V .05
47	50V .05	.0022 µf	50V .05
56	50V .05	.005	50V .05
68	50V .05	.01	50V .07
82	50V .05	.02	50V .07
100	50V .05	.05	50V .07
220	50V .05	.1	12V .10

MONOLITHIC

.01 µf	50V .14	.1 µf	50V .18
.047 µf	50V .15	.47 µf	50V .25

ELECTROLYTIC

1 µf	25V .14	1 µf	50V .14
2.2	35V .15	4.7	16V .14
4.7	50V .15	10	16V .14
10	50V .15	10	50V .16
47	35V .18	22	16V .14
100	16V .18	47	50V .20
220	35V .20	100	15V .20
470	25V .30	100	35V .25
2200	16V .60	220	25V .30
		330	16V .40
		500	16V .42
		1000	16V .60
		2200	16V .70
		6000	16V .85

COMPUTER GRADE

44,000 µf 30V 3.95 6000 16V .85

LED DISPLAYS

HP5082-7760	CC	.43"	1.29
MAN-72	CA	.3"	.99
MAN-74	CC	.3"	.99
FND-357(359)	CC	.375"	1.25
FND-500(503)	CC	.5"	1.49
FND-507(510)	CA	.5"	1.49
TIL-311 4x7 HEX W/LOGIC	Z70"	.270"	9.95

DIP CONNECTORS

DESCRIPTION	ORDER BY	CONTACTS								
		8	14	16	18	20	22	24	28	40
HIGH RELIABILITY TOOLED ST IC SOCKETS	AUGATxxST	.99	.99	.99	1.69	1.89	1.89	1.99	2.49	2.99
HIGH RELIABILITY TOOLED WW IC SOCKETS	AUGATxxWW	1.30	1.80	2.10	2.40	2.50	2.90	3.15	3.70	5.40
COMPONENT CARRIES (DIP HEADERS)	ICCxx	.49	.59	.69	.99	.99	.99	.99	1.09	1.49
RIBBON CABLE DIP PLUGS (IDC)	IDPxx	---	.95	.95	---	---	---	1.75	---	2.95

FOR ORDERING INSTRUCTIONS SEE IDC CONNECTORS BELOW

HEAT SINKS

T0-220	SCREW ON	.35
T0-220	CLIP ON	.35
T0-3	SCREW ON	.95
T0-220	INSULATOR	10/1.00
T0-3	INSULATOR	10/1.00

SWITCHES

SPDT MINI-TOGGLE ON-ON	1.25
DPDT MINI-TOGGLE ON-ON	1.50
DPDT MINI-TOGGLE DN-OFF-DN	1.75
SPST MINI-PUSHBUTTON N.O.	.39
SPST MINI-PUSHBUTTON N.C.	.39
BCO DUT 10 PSDITION 6 PIN DIP	1.95

DIFFUSED LEDS

JUMBO RED	T1 1/4"	1.99	100-up
JUMBO GREEN	T1 1/4"	.18	.09
JUMBO YELLOW	T1 1/4"	.18	.15
MOUNTING HDW	T1 1/4"	.10	.09
MINI RED	T1	.10	.09
MINI GREEN	T1	.18	.15
MINI YELLOW	T1	.18	.15
RECT RED	2x5mm	.25	.22
RECT GREEN	2x5mm	.30	.27
RECT YELLOW	2x5mm	.30	.27

D-SUBMINIATURE

DESCRIPTION	ORDER BY	CONTACTS					
		9	15	25	37	50	
SOLDER CUP	MALE	DBxxP	1.19	1.59	1.90	2.85	4.25
	FEMALE	DBxxS	1.50	1.85	2.25	3.90	5.25
RIGHT ANGLE PC SOLDER	MALE	DBxxPR	1.65	2.20	3.00	4.83	---
	FEMALE	DBxxSR	2.18	3.03	3.00	6.19	---
WIRE WRAP	MALE	DBxxWW	1.69	2.56	3.89	5.60	---
	FEMALE	DBxxSww	2.76	4.27	6.84	9.95	---
IDC RIBBON CABLE	MALE	IDBxxP	2.95	3.90	4.75	6.95	---
	FEMALE	IDBxxS	3.25	4.29	5.25	7.95	---
HOODS	BLACK	HOOD-B	---	---	.99	---	---
	GREY	HOOD-xx	.89	.99	.99	1.09	1.19

MOUNTING HARDWARE-\$1.00

FOR ORDERING INSTRUCTIONS SEE IDC CONNECTORS BELOW

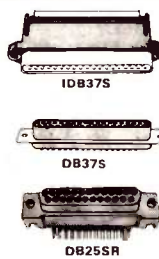

TEXTTOOL ZERO INSERTION FORCE SOCKETS AND RECEPTACLES

TYPE	CONTACTS				
	14	16	24	28	40
ECONO ZIF	---	4.95	6.75	7.75	9.95
ZIF SOCKET	4.95	4.95	5.95	6.95	9.95
ZIF RECEPTACLE	8.25	8.75	3.75	10.50	12.75

IDC CONNECTORS

DESCRIPTION	ORDER BY	CONTACTS					
		10	20	26	34	40	50
SOLDER HEADER	IDHxxS	.82	1.29	1.68	2.20	2.58	3.24
RIGHT ANGLE SOLDER HEADER	IDHxxSR	.85	1.35	1.76	2.31	2.72	3.39
WW HEADER	IDHxxW	1.86	2.98	3.84	4.50	5.28	6.63
RIGHT ANGLE WW HEADER	IDHxxWR	2.05	3.28	4.22	4.45	4.80	7.30
RIBBON HEADER SOCKET	IDSxx	.79	.99	1.39	1.59	1.99	2.25
RIBBON HEADER	IDMxx	---	5.50	6.25	7.00	7.50	8.50
RIBBON EDGE CARD	IDExx	1.75	2.25	2.65	2.75	3.80	3.95

ORDERING INSTRUCTIONS: INSERT THE NUMBER OF CONTACTS IN THE POSITION MARKED "xx" OF THE "ORDER BY" PART NUMBER LISTED. EXAMPLE: A 10 PIN RIGHT ANGLE HOLDER STYLE WOULD BE IDH10SR

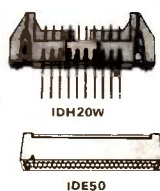

RIBBON CABLE

CONTACTS	SINGLE COLOR		COLOR CODED	
	1'	10'	1'	10'
10	.18	1.60	.83	7.30
16	.28	2.50	1.00	8.80
20	.36	3.20	1.25	11.00
25	.45	4.00	1.32	11.60
26	.46	4.10	1.32	11.60
34	.61	5.40	1.65	14.50
40	.72	6.40	1.92	16.80
50	.89	7.50	2.50	22.00

RETAIL STORE - 1256 S. BASCOM AVENUE
HOURS: M-W-F, 9-5 TU-TH, 9-9 SAT, 10-3

PLEASE USE YOUR CUSTOMER NUMBER WHEN ORDERING

TERMS: Minimum order \$10.00. For shipping and handling include \$2.50 for UPS Ground and \$3.50 for UPS Air. Orders over 1 lb. and foreign orders may require additional shipping charges - please contact our sales department for the amount. CA. residents must include 6% sales tax. Bay Area and LA residents include 6 1/2%. All merchandise is warranted for 90 days unless otherwise stated. Prices are subject to change without notice. We are not responsible for typographical errors. We reserve the right to limit quantities and to substitute manufacturer. All merchandise subject to prior sale.

JDR Microdevices

1224 S. Bascom Avenue, San Jose, CA 95128

800-538-5000 • 800-662-6279 (CA) • (408) 995-5430

FAX (408) 275-8415 • Telex 171-110

IBM PC PROTOTYPE CARD WITH DECODING CIRCUITRY \$29.95

WIRE WRAP PROTOTYPE CARDS

FR-4 EPOXY GLASS LAMINATE WITH GOLD-PLATED EDGE-CARD FINGERS



IBM-PR2

IBM

BOTH CARDS HAVE SILK SCREENED LEGENDS AND INCLUDES MOUNTING BRACKET

IBM-PR1	WITH +5V AND GROUND PLANE	\$27.95
IBM-PR2	AS ABOVE WITH DECODING LAYOUT	\$29.95

S-100

P100-1	BARE - NO FOIL PADS	\$15.15
P100-2	HORIZONTAL BUS	\$21.80
P100-3	VERTICAL BUS	\$21.80
P100-4	SINGLE FOIL PADS PER HOLE	\$22.75

APPLE

P500-1	BARE - NO FOIL PADS	\$15.15
P500-3	HORIZONTAL BUS	\$22.75
P500-4	SINGLE FOIL PADS PER HOLE	\$21.80
7060-45	FOR APPLE IIe AUX SLOT	\$30.00

GENERAL PURPOSE

22/44 PIN EDGE-CARD (.156" SPACING)

P441-1	BARE - NO FOIL PADS 4.5" x 6.0"	\$9.45
P441-3	VERTICAL BUS 4.5" x 6.0"	\$13.95
P441-4	SINGLE FOIL PADS 4.5" x 6.0"	\$14.20
P442-1	BARE - NO FOIL PADS 4.5" x 9.0"	\$10.40
P442-3	VERTICAL BUS 4.5" x 9.0"	\$14.20
P442-4	SINGLE FOIL PADS 4.5" x 9.0"	\$13.50

36/72 PIN EDGE-CARD (.1" SPACING)

P721-1	BARE - NO FOIL PADS 4.5" x 6.0"	\$9.45
P721-3	VERTICAL BUS 4.5" x 6.0"	\$13.25
P721-4	SINGLE FOIL PADS 4.5" x 6.0"	\$14.20
P722-1	BARE - NO FOIL PADS 4.5" x 9.0"	\$10.40
P722-3	VERTICAL BUS 4.5" x 9.0"	\$14.20
P722-4	SINGLE FOIL PADS 4.5" x 9.0"	\$15.15

BARE GLASS BOARDS

EXTENDER CARDS

NO EDGE-CARD FINGERS OR FOIL

P25x45	2.5" x 4.5"	\$2.40	IBM	\$45.00
P45x65	4.5" x 6.5"	\$4.70	APPLE	\$45.00
P45x85	4.5" x 8.5"	\$6.20	MULTIBUS	\$86.00
P45x170	4.5" x 17.0"	\$11.35		
P85x170	8.5" x 17.0"	\$18.95		

WIRE WRAP WIRE PRECUT AND STRIPPED

Note: 1 inch of insulation is stripped on each end. A 3.5" wire has only 1.5" of insulation.

LENGTH (INCHES)	100	QUANTITY	500	1000
2.5	1.60	4.70	8.20	
3	1.60	4.70	8.20	
3.5	1.65	5.00	8.90	
4.5	1.75	5.40	9.60	
4.5	1.80	5.75	10.30	
5	1.85	6.10	11.00	
5.5	1.90	6.50	11.75	
6	2.00	6.85	12.50	
6.5	2.30	7.80	14.30	
7	2.40	8.20	15.05	
7.5	2.50	8.55	15.85	
8	2.60	8.95	16.60	
8.5	2.65	9.30	17.40	
9	2.70	9.80	18.15	
9.5	2.80	10.00	18.95	
10	2.90	10.50	19.70	

PRECUT ASSORTMENT IN ASSORTED COLORS \$27.50

100ea: 5.5", 6", 6.5", 7"
250ea: 2.5", 4.5", 5", 5.5"
500ea: .3", 3.5", 4"

SPOOLS

100 feet	\$4.30	250 feet	\$7.25
500 feet	\$13.25	1000 feet	\$21.95

Please specify color:
Blue, Black, Yellow or Red

GE NICKEL-CADMIUM RECHARGABLE BATTERIES

NI-CAD CHARGER PACKAGE PRICE INCLUDES CHARGER (WALL PLUG), BATTERIES, & MODULAR BATTERY HOLDER

AAA CELLS	QTY. 2	\$11.71
AA CELLS	QTY. 2	\$11.71
C CELLS	QTY. 2	\$13.21
D CELLS	QTY. 2	\$13.21
9 VOLT	QTY. 1	\$13.21

BATTERIES ONLY

AAA CELLS	PKG. 2	\$6.07 ea.
AA CELLS	PKG. 1	\$3.33 ea.
C CELLS	PKG. 1	\$3.78 ea.
D CELLS	PKG. 1	\$3.78 ea.
9 VOLT	PKG. 1	\$7.57 ea.

DISK DRIVES

TANDON

TM 100-1 5 1/4" (FOR IBM) SS/DD	\$139.95
TM 100-2 5 1/4" (FOR IBM) DS/DD	\$159.95

MPI

MPI-B52 5 1/4" (FOR IBM) DS/DD	\$109.95
--------------------------------	----------

TEAC

FD-55B 1/2 HEIGHT DS/DD	\$119.95
FD-55F 1/2 HEIGHT DS/QUAD	\$139.95

SHUGART

SA 400L 5 1/4" (40 TRACK) SS/DD	\$199.95
SA 460 5 1/4" (80 TRACK) DS/QUAD	\$199.95

8" DISK DRIVES

FD100-8 BY SIEMENS, SHUGART 801 EQUIV. SS/DD	\$129.00
FD200-8 BY SIEMENS, SHUGART 851 EQUIV. DS/DD	\$180.00

JFORMAT-2 \$49.95 SUPPORT FOR QUAD DENSITY DRIVES FROM ALL TREE SYSTEMS

PLEASE INCLUDE SUFFICIENT AMOUNT FOR SHIPPING ON ABOVE ITEMS



TEAC FD-55B

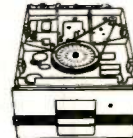

TANDON TM100-2

DISK DRIVE CABINETS

CABINET #1 \$29.95
• Fits one full height 5 1/4" disk drive
• Color matches Apple

CABINET #2 \$79.00
• Fits one full height 5 1/4" disk drive
• Complete with power supply, switch, line cord, fuse and standard power connector

• Please specify Grey or Tan

CABINET #3 \$89.95
• Fits two half height 5 1/4" disk drives
• Complete with power supply, switch, line cord, fuse and standard power connectors

8" DISK DRIVE CABINETS ALSO AVAILABLE-PLEASE CALL

PLEASE INCLUDE SUFFICIENT AMOUNT FOR SHIPPING ON ABOVE ITEMS

SWITCHING POWER SUPPLIES



PS-IBM \$159.95

- FOR IBM PC-XT COMPATIBLE
- 130 WATTS
- +5V @ 15A, +12V @ 4.2A
- -5V @ 5A, -12V @ 5A
- ONE YEAR WARRANTY

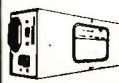

PS-A \$49.95

- USE TO POWER APPLE TYPE SYSTEMS
- +5V @ 4A, +12V @ 2.5A
- -5V @ 5A, -12V @ 5A
- APPLE POWER CONNECTOR



PS-3 \$39.95

- AS USED IN APPLE III
- +5V @ 4A, +12V @ 2.5A
- -5V @ .25A, -12V @ .30A,
- 15.5" x 4.5" x 2", .884 LBS.



PS-ASTEC \$19.95

- CAN POWER TWO 5 1/4" FD DS
- +5V @ 2.5A, +12V @ 2A
- -12V @ 1A
- +5V @ 5A IF +12V IS NOT USED
- 6.3" x 4.0" x 1.9"

OK INDUSTRIES

EX-1 IC EXTRACTION TOOL

- ONE PIECE METAL CONSTRUCTION
- EASILY EXTRACTS 8-24 PIN DEVICES
- LOW COST \$2.19



EX-1

EX-2 IC EXTRACTION TOOL

- EXTRACTS 24-40 PIN DEVICES
- HEAVY DUTY METAL CONSTRUCTION
- GROUND LUGS FOR MOS EXTRACTIONS
- EASY ONE HAND OPERATION \$12.74

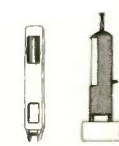

INS-1416 INS-2428

IC INSERTION TOOLS

INS-1416	for 14-16 pin IC's	\$5.15
MOS-1416	for 14-16 pin IC's	\$10.92
MOS-2428	for 24-28 pin IC's	\$10.92
MOS-40	for 40 pin IC's	\$12.43

MOS series insertion tools have metal construction and include grounding lug for CMOS applications.

BW-630 WIRE WRAP GUN

- BATTERY POWERED-USES 2 NI-CAD C CELLS (NOT INCLUDED)
- POSITIVE INDEXING
- ANTI-OVERWRAP DEVICE \$41.55



BW-630

WSU-30 WIRE WRAP TOOLS

- WRAPS, STRIPS, AND UNWRAPS
- WSU-30M WRAPS AN EXTRA TURN OF INSULATION

WSU-30 \$8.84 / WSU-30M \$10.14

WIRE WRAP TERMINALS

WWT-1	SLOTTED	25/\$7.06
WWT-2	SINGLE SIDED	25/\$4.25
WWT-3	IC SOCKET	25/\$7.06
WWT-4	DOUBLE SIDED	25/\$2.80
INS-1	INSERTION TOOL	\$3.64



WSU-30/30M

WIRE DISPENSER

- WITH 50' ROLL OF WIRE
- BUILT IN PLUNGER CUTS WIRE
- BUILT IN STRIPPER STRIPS 1"
- REFILLABLE

WD-30 \$6.50 WD-30TRI \$9.50

Specify Blue, White, Yellow or Red. With 50' of each.

SOCKET-WRAP I.D.™

- SLIPS OVER WIRE WRAP PINS
- IDENTIFIES PIN NUMBERS ON WRAP SIDE OF BOARD
- CAN WRITE ON PLASTIC, SUCH AS IC #

PINS	PART#	PCK. OF	PRICE
8	IDWRAP 08	10	1.95
14	IDWRAP 14	10	1.95
16	IDWRAP 16	10	1.95
18	IDWRAP 18	5	1.95
20	IDWRAP 20	5	1.95
22	IDWRAP 22	5	1.95
24	IDWRAP 24	5	1.95
28	IDWRAP 28	5	1.95
40	IDWRAP 40	5	1.95

PLEASE ORDER BY NUMBER OF PACKAGES (PCK. OF)

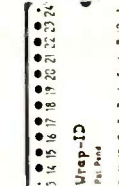

Wrap-ID Pin Pins

TRANSFORMERS FRAME STYLE

12.6V AC	2 AMP	4.95
12.6V AC CT	2 AMP	5.95
12.6V AC CT	4 AMP	7.95
12.6V AC CT	8 AMP	10.95
25.2V AC CT	2 AMP	7.95

PLUG CASE STYLE

12V AC	250ma	3.95
12V AC	500ma	4.95
12V AC	1 AMP	5.95
12V AC	2 AMP	6.95

DC ADAPTER

6, 9, 12V DC SELECTABLE WITH UNIVERSAL ADAPTER 8.95

MICROCOMPUTER HARDWARE HANDBOOK

Over 800 pages of manufacturers' data sheets on the most commonly used IC's

- TTL - 74, 74LS & 74F
- CMOS
- Voltage regulators
- Memory - RAM, ROM, EPROM
- CPU'S - 6800, 6800, Z80, 8080, 8085 & 8088/8
- MPU Support & Interface, 6800, 6500, Z80, 8200, etc.

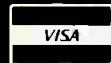

ORDER TOLL FREE
800-538-5000
800-662-6279
(CALIFORNIA RESIDENTS)



20 MHz DUAL TRACE OSCILLOSCOPE

- UNSURPASSED QUALITY AT AN UNBEATABLE PRICE
- BAND WIDTH- DC: DC TO 20MHz (-3db)
 - AC: 10Hz TO 20MHz (-3db)
 - SWEEP TIME - 2 μSEC TO 5 SEC / DIV ON 20 RANGES
 - VERT. HDRZ, DEFLECTION: 5mV TO 20V / DIV ON 20 RANGES
 - COMPLETE MANUAL AND HIGH QUALITY
 - HOOK-ON PROBES INCLUDED
 - INPUT IMPEDANCE: 1 MEG OHM
 - TV VIDEO SYNC FILTER
 - X, Y AND Z AXIS OPERATION
 - 110/220 VOLT 50/60Hz OPERATION
 - COMPONENT TESTER
 - LP CONSUMPTION-19 WATTS
 - BUILT IN CALIBRATOR
 - AUTOMATIC DR TRIGGERED TIMEBASE

\$399.95
WITH PROBES

FULL ONE YEAR WARRANTY

MULTIMETER PEN



AUTO RANGING, POLARITY & DECIMAL!

- LARGE 3 1/2" DIGIT DISPLAY
- DATA HOLD SWITCH FREEZES READING
- FAST, AUDIBLE CONTINUITY TEST
- LOW BATTERY INDICATOR
- OVERLOAD PROTECTION
- ONLY 1 1/4" x 6 1/4" x 3/4"
- DC VOLTS .1mV-500V
- AC VOLTS 1mV-500V
- 1 OHM-20 MEG OHMS
- WEIGHS ONLY 2.3 OUNCES
- LOW PARTS COUNT-CUSTOM 80 PIN LSI INSURES RELIABILITY
- INCLUDES MANUAL, BATTERIES, SOFT CASE, 2 PROBE TIPS, AND ALLIGATOR CLIP

ONLY \$49.95

TEAC-FD55B DS/DD 1/2 HT. FOR IBM PC **119.95**

MPI-B52 DS/DD FULL HT. FOR IBM PC **109.95**

EPROM PROGRAMMER
FOR APPLE COMPUTERS



RP525
\$79.95

- * DUPLICATE OR BURN ANY STANDARD 27xx SERIES EPROM
- * EASY TO USE MENU-DRIVEN SOFTWARE INCLUDED
- * MENU SELECTION FOR 2716, 2732, 2732A, 2764 & 27128
- * HIGH SPEED WRITE ALGORITHM
- * LED INDICATORS FOR ACTIVITY
- * NO EXTERNAL POWER SUPPLY REQUIRED

DISK DRIVES FOR IBM

TEAC
FD55B
\$119.95

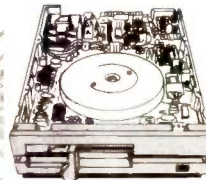

TANDON
TM100-2
\$159.95

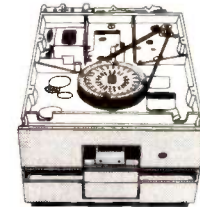

MPI
MODEL B52
\$109.95

IBM ACCESSORIES

- MAXIMIZER SIGMA MULTIFUNCTION CARD **\$259.95**
- HAYES SMARTMODEM 1200B FOR IBM **\$419.95**
- PRINTER CABLE PARALLEL 6' SHIELDED CABLE **\$19.95**
- KRAFT JOYSTICK **\$39.95**

DISKETTE FILE

\$8.95 IF PURCHASED WITH 50 DISKETTES OR MORE

\$9.95 IF PURCHASED ALONE

HOLDS 70 5 1/4" DISKETTES, WITH ROOM TO SPARE



DISK DRIVES

FOR APPLE COMPUTERS



BAL-525
\$139.95

- * 1/2 HEIGHT-ALPS MECHANISM
- * 100% APPLE COMPATIBLE
- * FULL 1 YEAR WARRANTY

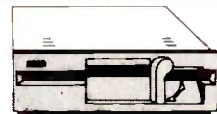

BAL-500
\$159.95

- * TEAC MECHANISM- DIRECT DRIVE
- * 100% APPLE COMPATIBLE
- * FULL 1 YEAR WARRANTY

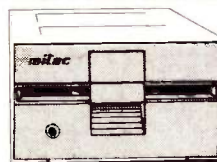

MITAC
AD-1
\$149.95

- * FULL HT. SHUGART MECHANISM
- * DIRECT REPLACEMENT FOR APPLE DISK II
- * SIX MONTH WARRANTY

DISK DRIVE ACCESSORIES

- DISK CONTROLLER CARD **\$49.95**
- APPLE IIc ADAPTOR CABLE **\$19.95**

NEW FOR APPLE IIc

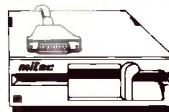

MITAC
AD-3C
\$139.95

- * 100% APPLE IIc COMPATIBLE, READY TO PLUG IN W/ SHIELDED CABLE & MOLDED 19 PIN CONNECTOR
- * FAST, RELIABLE SLIMLINE DIRECT DRIVE
- * SIX MONTH WARRANTY

BMC MONITOR STAND

MODEL PA-900

TILTS AND SWIVELS TO PROVIDE OPTIMUM VIEWING ANGLE, REDUCES OPERATOR FATIGUE



FACTORY SPECIAL \$14.95

ORDER TOLL FREE
800-538-5000
800-662-6279 (CA)

16K RAM CARD \$39.95

- BARE PC CARD AND INSTRUCTIONS **\$9.95**
- * 2 YEAR WARRANTY
- * EXPAND YOUR 48K APPLE TO 64K
- * USE IN PLACE OF APPLE LANGUAGE CARD

APPLE ACCESSORIES

- VIEWMAX-80 **\$159.95**
- VIEWMAX-80e **\$129.95**
- GRAPHMAX **\$129.95**
- THUNDERCLOCK **\$129.95**
- KRAFT JOYSTICK **\$39.95**
- POWER SUPPLY **\$49.95**

NASHUA DISKETTES

5 1/4" SOFT SECTOR DS/DD WITH HUB RINGS

BULK PACKAGED IN FACTORY SEALED BAGS OF 50. INCLUDES DISKETTE SLEEVES AND WRITE PROTECT TABS. IDEAL FOR SCHOOLS, CLUBS, AND USERS GROUPS. THIS IS A SPECIAL PURCHASE, SO QUANTITIES ARE LIMITED. THERE IS A 5 YEAR WARRANTY.

\$1.39ea. QTY 250 **\$1.49ea.** QTY 100 **\$1.59ea.** QTY 50

NASHUA DISKETTES WERE JUDGED TO HAVE THE HIGHEST POLISH AND RECORDED AMPLITUDE OF ANY DISKETTES TESTED. (SEE "COMPARING FLOPPY DISKS", BYTE 9/84)

VERBATIM DATALIFE DISKETTES

- SS/DD SOFT SECTOR **\$29.95**
- SS/DD 10 SECTOR HARD **\$29.95**
- DS/DD SOFT SECTOR **\$34.95**

IBM COMPATIBLE POWER SUPPLIES

130 WATT \$159.95

XT COMPATIBLE

- * +5V @ 15A, +12 @ 4.2A, -5 @ .5A, -12 @ .5A
- * UPGRADE YOUR PC, POWERS HARD DISK
- * POWER CABLES FOR 4 FDDs
- * ONE YEAR WARRANTY
- * SWITCH ON SIDE (FITS IBM CASE)



100 WATT \$99.95

- * SWITCH ON REAR
- * FOR USE IN OTHER IBM TYPE MACHINES
- * AVAILABLE IN 100W OR 130W VERSIONS
- * 90 DAY WARRANTY



130 WATT MODEL \$129.95

JDR Microdevices

1224 S. Bascom Avenue, San Jose, CA 95128

800-538-5000 • 800-662-6279 (CA) • (408) 995-5430

FAX (408) 275-8415 • Telex 171-110

RETAIL STORE - 1256 S. BASCOM AVENUE
HOURS: M-W-F, 9-5 TU-TH, 9-9 SAT, 10-3

PLEASE USE YOUR CUSTOMER NUMBER WHEN ORDERING

TERMS: Minimum order \$10.00. For shipping and handling include \$2.50 for UPS Ground and \$3.50 for UPS Air. Orders over 1 lb. and foreign orders may require additional shipping charges - please contact our sales department for the amount. CA. residents must include 6% sales tax. Bay Area and LA residents include 6 1/4%. All merchandise is warranted for 90 days unless otherwise stated. Prices are subject to change without notice. We are not responsible for typographical errors. We reserve the right to limit quantities and to substitute manufacturer. All merchandise subject to prior sale.

U·N·C·L·A·S·S·I·F·I·E·D A·D·S

WANTED: Apple IIe public-domain software or information on programs to help teach non-English-speaking six-year-old Korean boy English, math, or any basic learning material. David Harbour, Route 4, Box 49, Ava, MO 65608. (417) 683-5201.

WANTED: Inner-city school needs donation of IBM, Apple, or compatibles plus peripherals in exchange for tax-deductible donation verification. Donation will enable students to receive hands-on experience otherwise not available. Rama Lahori, Chicago Vocational High School, 2100 East 87th St., Chicago, IL 60617. (312) 978-1600.

WANTED: Nonprofit agency needs word-processing equipment to expose Austrian older youth to the media and develop employable skills. Tax-deductible. The Institute for Cultural Affairs, Lilienbrunn-gasse 15/8, Wien, Austria, tel: (433-222) 24-69-234.

WANTED: College computer club looking for tax-deductible donation of computer with word-processing. Florence V. Ward, John Jay College Computer Club, 445 West 59th St., New York, NY 10019.

WANTED: Donation of disk-based computer system (IBM PC, IBM-compatible, or CP/M) with programming tools (assembler, compiler, etc.) for effort to help blind people understand programming and to develop learning tools for them. Piotr Bednarski, ul. Ryemonta 10m92, 01-842, Warsaw, Poland.

NEEDED: Hardware reference manual and operator's manual for Intel's Intellex 8/80 system (no longer available). Will pay postage. R. Hu, 1467 Bortolotti Crescent, Gloucester, Ontario K1B 5C1, Canada.

NEEDED: Information, schematics, etc. for Infoton I-100 terminal manufactured about 1979. Also same for Vector Graphic S-100 Z80 Rev. 3 board. Jim Wolfe, POB 6601, Torrance, CA 90504. (213) 376-2931.

WANTED: If you have had problems (corrected or not) with your Pixel computer or if your service contract has not been honored, send details to S. E. Rudlin, 4600 Grove Ave., Richmond, VA 23226.

FOR SALE: Columbia VP portable, amber screen, 128K to 512K, extras: \$1600. Also, TRS-80 Model 100, 24K, brand new, modem, cable, AC adapter: \$500. Dan Gammon, (301) 946-7370.

FOR SALE: 8K RAM module for Radio Shack PC-2 or Sharp PC-1500 pocket computer: asking \$50. Need 16K RAM module with battery backup for the Radio Shack PC-2 or Sharp PC-1500. Also, would like to form users group for pocket computers. Robert Lerner, 23 Mayed Dr., Suffern, NY 10901.

WANTED: One AIM 65 micro, two (or more) BTK 32K Banker boards, one MTU card cage (or backplane only), one MMS Inc. Mach-9 6809 adapter for AIM, and one 2031 (or 4040) Commodore IEEE disk drive. Don Lewis, 606 Hazel Ave., Folsom, PA 19033, (215) 622-5495 or 586-5212.

FOR SALE: BYTE, all volume 3; volume 2, numbers 2, 5, 6, 7, 9-12; volume 4, numbers 1-4, 6, and 9; and issue 14 (October 1976). Also Commodore PET 8K with original keyboard and ROM. Best offer. Prefer local buyer. Shigeki Misawa, 37 Penwood Dr., New Providence, NJ 07974, (201) 464-1359.

FOR SALE: 1979 through 1984 of BYTE, *Creative Computing*, *Microcomputing*, *Interface Age*, and *Personal Computing*. Will sell volumes or single copies. Wanted: BYTE, October and November 1977 issues. Jim Reeb, 8392 East Inspiration Dr., Parker, CO 80134.

FOR SALE: Sweet Talker computer speech synthesizer, cabinet, built-in speaker, power supply, and ribbon cable for parallel interface, plus schematics and documentation: \$95. Mike Hagerman, 1704 Mars Ave., Loves Park, IL 61111, (815) 633-3382.

WANTED: Help in finding a BBS public-domain or individually written program for an Atari 800 with Microperipheral modem, model UM-1, one disk drive, and 820 printer. Jim Klein, 48 102nd Ave. NW, Coon Rapids, MN 55433.

WANTED: Schematics and parts list for an Ithaca Audio (Intersystems), EPROM burner board, part number IA-1200. Need same information for the front-panel board. Paul Detzel, 22635 Southwest 65th Way, Boca Raton, FL 33428, (305) 487-4222.

FOR SALE: Hewlett-Packard 86A with 12-inch monitor, 5¼-inch disk drive, auto-dial modem, 82905B printer, I/O, ADV, and more. All manuals. Retail value \$4900. Best offer. Winston Chung, 702 Harvey Rd., Claymont, DE 19703, (302) 792-2921.

WANTED: International computer hobbyists to correspond with in English, French, and German. Exchange information on microcomputer applications, engineering, robotics, R/C electric model planes, travel, national cultures, etc. Bob Saxer, 704 East Cedar Ave., St. Charles, IL 60174.

FOR SALE: CompuPro IEEE-696 CP/M system. Enclosure power supply and 21-slot motherboard, 6-MHz Z80, AMD 9511 floating-point board, dual Qume 842 disk drives and power supply, and more: \$1800. TeleVideo 910+ terminal: \$300. David A. Danello, POB 784, Dahlgren, VA 22448, (703) 775-4915 or (814) 643-3387.

WANTED: New Zealand University student would like to correspond with others who have an interest in Apple II computers and the expansions and languages available for them. Sean Fennell, 15 Buckley Rd., Epsom, Auckland 3, New Zealand.

FOR SALE: IBM film ribbons, stock number 1136108, for Selectric typewriters. Clear spool, not gray cartridge. Expired in 1976-1977; all 24 only \$20. Fred Robinson, 7580 Honeysuckle, Orchard Lake, MI 48033.

FOR SALE: SD Systems RAM Disk-256, never used: \$500. D. Boone, POB 330, Valley Mills, TX 76689.

FOR SALE: Never used 1983 Cromemco System HD3, DPU, 256K bytes of RAM, 20-megabyte hard disk, TU-Art, Cromix 68000, C-language compiler: \$10,000 or best offer. Dr. Jeppesen, POB 270, Oak View, CA 93022.

FOR SALE: Fidelity Electronics Elite A/S Chess Challenger, USCF rating 1850, upgradable to latest model, like new: \$300. Also, Novag Constellation chess computer, USCF rating 1800+, perfect condition: \$150. John A. Henderson, 526 South Division St., #9, Ann Arbor, MI 48194, (313) 995-4106.

FOR SALE: CompuPro 85/88 S-100 system, complete and working. Includes 15-slot Integrand chassis, 128K-byte RAM, PMMI modem, two Shugart 851s, Wyse 100 terminal, and more. Asking \$3000. David Langman, 2900 Connecticut Ave. NW, Washington, DC 20008, (202) 232-7999.

WANTED: High-school student seeks correspondence with people interested in computer graphics and simulation in Pascal, C, and assembly language. Mariusz Jarzebowski, ul. Wilanowska 364 m 81, 02-655, Warsaw, Poland.

FOR SALE: Computer Continuum A/D, D/A board with box, Timex computer, various Z80 and Timex books: \$150 or best offer. Rob Forbes, POB 4826, Boulder, CO 80306.

FOR SALE: IBM 160K-byte disk drive (TM100-1): \$95. BIOS ROM and 8088 from IBM PC: \$45. Joe Gunter, RR 2, Box 823, Lot 125, Pompano Beach, FL 33067, (305) 421-6301.

WANTED: Manual for IMSAI S-100 board. Will pay all copy and mail expenses. Steven McClain, 10428 Mull Ave., Riverside, CA 92505, (714) 354-6979.

WANTED: California Computer Systems boards for an S-100 bus as follows: Z80 processor board 2820-0001 and floppy-disk controller board 2411-0001 rev. B. Lee D. Miller, 932 North Lakeshore Dr., Lincoln, NE 68528, (402) 435-3864.

FOR SALE: Sanyo 12-inch green monitor, new: \$85. Smith-Corona TP-1 daisy-wheel printer (like new) with serial interface, two extra ribbons: \$250. Network hardware to connect up to eight Commodore 64s to single disk and printer: \$125. Other equipment available. Mike Schary, 110 Bel Air Lane, Fairfield, CT 06430, (203) 333-6034.

UNCLASSIFIED ADS MUST be noncommercial, from readers who have computer equipment to buy, sell, or trade on a onetime basis. All requests for donated computer equipment must be from nonprofit organizations. Programs to be exchanged must be written by the individual or be in the public domain. Ads must be typed double-spaced, contain 50 words or less, and include full name and address. This is a free service; ads are printed as space permits. BYTE reserves the right to reject any unclassified ad that does not meet these criteria. When you submit your ad (BYTE, Unclassified Ads, POB 372, Hancock, NH 03449), allow at least four months for it to appear.

FOR SALE: Micromint MPX-16 single-board computer system, MPX-17 IBM keyboard interface, and MPX-30 BIOS EPROM set for PC-DOS/hardware, unused in box: \$900. Lee W. Sorensen, 6555 Lawndale Lane, Maple Grove, MN 55369, (612) 420-2425.

FOR SALE: Apple II+ with GE good resolution 12-inch TV/RF modulator, shift modification, 64K RAM total, Apple disk drive, working well. Price: 60 percent of cost. Newt Steers, (301) 320-5820.

FOR SALE: New Apple-compatible disk drives, Teac (red) half-height, direct drive, one-year warranty: \$195 or best offer. Saturn 32K card: \$75 or best offer. Hayes Micromodem II: \$175 or best offer. Also, need inexpensive Apple IIe. W. Ostlund, 140 Oakview, Pittsburgh, PA 15218, (412) 242-5688.

FOR SALE: Xebec model S1410 hard-disk controller with manual, new, never powered up: \$295. Philip Nunn, 201 Netherfield, Comstock Park, MI 49321, (616) 784-5732.

FOR SALE: Atari 800 with 48K, 850 interface module, cassette player, paddles, joysticks, *Analog* and *Antic* magazines, over 25 books. Send SASE for complete list. Robin Japins, POB 472, Olathe, KS 66061-0472.

FOR SALE: OSM ZEuS-4 multiuser computer with 6.3-megabyte hard disk and 8-inch floppy-disk drive. Heath terminal, manuals, and more: \$4500. R. P. Perkins, M.D., OB/GYN, 2211 Lomas Blvd. NE, Albuquerque, NM 87106, (505) 277-4158.

FOR SALE: North Star Horizon 18-megabyte hard disk, complete with North Star and Soroc terminals: \$4200 or best offer. B. Tooley, (806) 655-7121.

FOR SALE: LA34 terminal, tractor option included, mint condition: \$400. Robert Lund, 34 Lorna Dr., Auburn, MA 01501, (617) 832-2611.

WANTED: Apple II+, IIe, or IIc computer. Include list of peripherals and cards. Indicate age, condition, asking price. Ken Hamel, Route 5, Box 162, Watertown, WI 53094.

FOR SALE: Hewlett-Packard HP 85a computer with 32K bytes of RAM, I/O ROM, case, and more. Must sell, make offer. John M. Uber, 1154 North Howard St., Akron, OH 44310, (216) 923-2074.

FOR SALE: Seattle Computer RAM+ expansion board for the IBM PC: \$100 (RS-232, 256K maximum, no memory included). Dane Laun, 14052 Southwest Stampfer Rd., Lake Oswego, OR 97034.

FOR SALE: Netronics 64K S-100 memory board with 16K: \$100. One Vector 11-slot S-100 motherboard: \$100. One solid-state music I/O board, two parallel/two serial, partially populated: \$50. Ron Rogers, Apt. 2028, 6525 South Gessner, Houston, TX 77036, (713) 541-3208.

FOR SALE: DEC PDP-8A-500 classic configuration. Dual 8-inch single-density floppy drives with controller, CPU card, MM card, two 8K core boards, DKC8A option card, serial card, plotter controller card, VT50AA terminal, manuals, and more. Working, \$600 plus shipping or best offer for part or all. Don Taylor, 12270 Southwest Center St. #63, Beaverton, OR 97005, (503) 627-0231.

WANTED: BYTE issues 1 through 12, and pre-1984 issues of *Microsystems*. Send list with prices. Barney Flusche, 98-825A Iho Place, Aiea, HI 96701, (808) 488-3259, evenings.

WANTED: Anyone wishing to trade public-domain software for the Apple II series. Send name, address, and a list of programs. Enclose SASE. Jason Pilnock, 5930 South 5th St., Pocatello, ID 83204.

WANTED: Computer science student seeks information for project concerning computer music synthesis and computers/synthesizer interfacing. Also, looking for others interested in starting a computer music group. Jeffrey Ring, 519 Shook, San Antonio, TX 78212, (512) 737-2387, evenings and weekends.

WANTED: Spectravideo owner seeks correspondence with other SV owners. R. Fortune, 46 West 17 St., New York, NY 10011.

FOR SALE: Cromemco C-10 SP with two 390K disk drives, Novation J-CAT, and more: \$1000. Ronald Gans, 350 West 55th St. #2-E, New York, NY 10019, (212) 957-8361.

FOR SALE: TI TM990 board-level computer, 16-bit 9900-based, 8-slot card cage, 100M and 101MA CPU boards, 64K memory, 303 floppy controller, much digital and analog I/O, manuals, and more. Will sacrifice. Dwight Aussieker, Varna, IL 61375, (309) 463-2318.

B·O·M·B

BYTE'S ONGOING MONITOR BOX

ARTICLE#	PAGE	ARTICLE	AUTHOR(S)	ARTICLE#	PAGE	ARTICLE	AUTHOR(S)
1	9	Microbytes	staff	16	267	Using Data Flow for Application Development	Stevens
2	39, 470	What's New	staff	17	279	Debugging Techniques	Williams
3	48	Ask BYTE	Ciarcia	18	295	6502 Tricks and Traps	Holt
4	65	Book Reviews	Martinez, Avila, Hinshaw, Lowans, Campbell, Alexander	19	307	Software-ICs	Ledbetter, Cox
				20	324	The Mindset Personal Computer	Wadlow
				21	337	Idea Processors	Hershey
				22	353	Convenience Software	Welch
5	108	Interactive Audio in a Videodisc System	Lawler, Hairsine, Miller	23	371	Building Expert Systems with M.I.	D'Ambrosio
6	121	Ciarcia's Circuit Cellar: Build the Home Run Control System, Part 3: The Software	Ciarcia	24	379	Hewlett-Packard's HP 7475A Plotter	Malloy
7	147	SALT	Fenster, Ford	25	385	The IBM Quietwriter Printer	Edwards
8	169	The SUM: An AI Coprocessor	Robinson	26	393	The Word Plus	Sheldon
9	185	Inside AppleTalk	Ushijima	27	409	Computing at Chaos Manor: From the Living Room	Pournelle
10	205	The Expert Mechanic	Fichtelman	28	439	BYTE U.K.:	
11	221	Switch	Grunbaum	29	451	Telephone Computers	Pountain
12	228	Two's-Complement Numbers Revisited	Bronson, Lyon			BYTE Japan: New NECs and a Cartridge Disk	Raike
13	235	Choosing a Programming Language	Elfring	30	455	BYTE West Coast: A GEM Seminar	Markoff, Robinson
14	243	Structuring BASIC	Huston			BYTELINES	Libes
15	253	Subroutine Libraries in Pascal	Webster	31	468		

March BOMB Results

THE BEST BARGAINS

Steve Ciarcia wins first place in the March issue for the first of several home-control projects from Ciarcia's Circuit Cellar. Aply entitled "Build the Touch-Tone Interactive Message System," this article tells you how your answering machine can do a whole lot more. In second place is Computing at Chaos Manor; and this month Jerry Pournelle composed it while "On the Road: Hackercon and COMDEX." John Markoff and Ezra

Shapiro's "Public-Domain Gems" wins third in the lineup. Fourth place goes to Richard S. Shuford, author of "Two Flat-Display Technologies." And winner of the \$100 prize is Laine Stump, for his fifth-place theme article, "The Kit Solution." His was the first nonstaff-written article to appear in the BOMB. So Peter Rice, whose article "Arithmetic on Your PC" placed sixth, wins the second-place bonus of \$50. Congratulations.

BYTE ADVERTISING SALES STAFF:

J. Peter Huestis, Advertising Sales Manager, 70 Main Street, Peterborough, NH 03458, tel. (603) 924-9281

NEW ENGLAND

ME, NH, VT, MA, RI
Paul McPherson Jr. (617) 262-1160
McGraw-Hill Publications
575 Boylston Street
Boston, MA 02116

ATLANTIC

NY, NYC, CT, NJ (NORTH)
Dick McGurk (212) 512-3588
Leah Goldman (212) 512-2096
McGraw-Hill Publications
1221 Avenue of the Americas—
39th Floor
New York, NY 10020

EAST

PA (EAST), NJ (SOUTH),
MD, VA, W.VA, DE, D.C.
Daniel Ferro (215) 496-3833
McGraw-Hill Publications
Three Parkway
Philadelphia, PA 19102

SOUTHEAST

NC, SC, GA, FL, AL, TN
Maggie M. Dorvee (404) 252-0626
McGraw-Hill Publications
4170 Ashford-Dunwoody Road—
Suite 420
Atlanta, GA 30319

MIDWEST

IL, MO, KS, IA, ND, SD, MN, WI, NB, IN
Bob Denmead (312) 751-3740
McGraw-Hill Publications
Blair Building
645 North Michigan Ave.
Chicago, IL 60611

GREAT LAKES, OHIO REGION

MI, OH, PA (ALLEGHENY), KY,
EASTERN CANADA
Mike Kisseberth (313) 352-9760
McGraw-Hill Publications
4000 Town Center—Suite 770
Southfield, MI 48075

SOUTHWEST, ROCKY MOUNTAIN

UT, CO, WY, OK, TX, AR, MS, LA
Dennis Riley (214) 458-2400
McGraw-Hill Publications
Prestonwood Tower—Suite 907
5151 Beltline
Dallas, TX 75240

SOUTH PACIFIC

SOUTHERN CA, AZ, NM, LAS VEGAS
Jack Anderson (714) 557-6292
McGraw-Hill Publications
3001 Red Hill Ave.
Building #1—Suite 222
Costa Mesa, CA 92626

Karen Niles (213) 480-5243, 487-1160
McGraw-Hill Publications
3333 Wilshire Boulevard #407
Los Angeles, CA 90010

NORTH PACIFIC

HI, WA, OR, ID, MT, NORTHERN CA,
NV (except LAS VEGAS), W. CANADA
David Iern (415) 362-4600
McGraw-Hill Publications
425 Battery Street
San Francisco, CA 94111

Bill McAfee (415) 964-0624
McGraw-Hill Publications
1000 Elwell Court—Suite 225
Palo Alto, CA 94303

WEST COAST SURPLUS AND RETAIL ACCOUNTS

Tom Harvey (805) 964-8577
3463 State Street—Suite 256
Santa Barbara, CA 93105

Post Card Mailings

National
Bradley Browne (603) 924-6166
BYTE Publications
70 Main Street
Peterborough, NH 03458

International Advertising Sales Representatives:

Mr. Hans Csokor
Publimedia
Reisnerstrasse 61
A-1037 Vienna, Austria
222 75 76 84

Mrs. Gurit Gepner
McGraw-Hill Publishing Co.
PO Box 2156
Bat Yam, 59121 Israel
3 866 561 321 39

Mr. Fritz Krusebecker
McGraw-Hill Publishing Co.
Liebigstrasse 19
D-6000 Frankfurt/Main 1
West Germany
69 72 01 81

Mrs. Maria Sarmiento
Pedro Teixeira 8, Off. 320
Iberia Mart I
Madrid 4, Spain
1 45 52 891

Mr. Andrew Karnig
McGraw-Hill & Associates
Finnbodavagen
S-131 31 Nacka, Sweden
8-44 0005

Mr. Jean Christian Acis
McGraw-Hill Publishing Co.
17 rue Georges Bizet
F 75116 Paris
France
1 720 33 42

Mr. Arthur Scheffer
McGraw-Hill Publishing Co.
34 Dover St.
London W1X 3RA
England 01 493 1451

Mr. Savio Pesavento
McGraw-Hill Publishing Co.
Via Flavio Baracchini 1
20123 Milan, Italy
011 86 90 656

Seavex Ltd.
400 Orchard Road, #10-01
Singapore 0923
Republic of Singapore
Tel: 734-9790
Telex: R535539 SEAVEX

Seavex Ltd.
503 Wilson House
19-27 Wyndham St.
Central, Hong Kong
Tel: 5-260149
Telex: 60904 SEVEX HX

Hiro Morita
McGraw-Hill Publishing Co.
Overseas Corp.
Room 1528
Kasumigaseki Bldg.
3-2-5 Kasumigaseki,
Chiyoda-Ku
Tokyo 100, Japan
3 581 9811

R·E·A·D·E·R S·E·R·V·I·C·E

Inquiry No.	Page No.	Inquiry No.	Page No.	Inquiry No.	Page No.	Inquiry No.	Page No.
429	313	84	257	161	342	*	260
2	518	86	506, 507	162	163	244	443
3	286	*	297	163	490	245	198
4	19	87	278	164	517	246	488
5	19	88	490	165	403	247	420
6	172	89	517	166	501	248	18
7	173	90	138	*	189	249	429
8	492	92	509	167	334, 335	250	517
9	362	93	510, 511	170	61	444	143
11	262	94	94	171	61	251	82
12	501	95	96	173	64	252	91
13	495	96	96	175	112	253	102
15	26	*	516	176	448	254	24
16	26	97	360	177	411	255	512
17	55	98	381	178	222	256	237
18	60	199	417	179	453	257	298
19	508	99	418	180	421	258	501
20	95	*	454	181	275	259	463
21	190	428	491	182	275	260	245
22	156, 157	*	501	185	446	261	408
24	207	341	518	186	494	262	53
27	512	101	487	189	215	263	75
28	490	102	208	190	315	264	494
29	52	103	277	191	518	265	517
30	309	104	419	192	508	266	7
31	488	105	412	193	180	267	301
*	CII, 1	106	92, 93	194	352	268	15
32	165	107	36, 37	195	162	269	441
33	202, 203	109	447	196	5	270	96
34	508	110	447	197	234	*	248
*	97	111	66	198	492	271	517
*	368	112	78	200	98	272	512
36	369	113	182, 183	201	70	273	77
37	164	114	182, 183	202	358	297	424
38	164	115	182, 183	203	118, 119	274	316
39	227	116	400	454	445	318	52
40	347	117	294	204	102	275	161
41	49	119	392	242	166, 167	276	331
158	376, 377	120	423	205	67	277	72, 73
42	171	121	494	207	247	278	477
43	276	122	163	208	249	279	492
44	430	123	322	209	199	438	159
45	512	124	482	210	201	439	159
*	430	125	483	211	518	281	59
46	120	126	228, 229	212	512	*	426
349	389	127	303	214	501	403	300
47	23	128	301	215	212	282	488
48	71	174	518	216	396	283	490
49	71	129	284	217	175	284	488
50	410	130	517	218	62, 63	441	478
51	68	131	416	*	397	442	184
*	414	132	22	436	398, 399	443	184
52	517	133	80, 81	434	88	*	151
53	512	134	146	435	88	*	153
54	350	135	488	220	190	*	155
55	41	136	76	221	190	*	79
56	41	137	391	222	54	*	241
57	43	138	262	223	194	*	333
58	43	139	101	225	460	288	341
59	45	141	217, 218, 219	224	502, 503	289	343
60	45	142	74	226	395	290	345
61	46, 47	143	287	227	498, 499, 500	291	100
62	46, 47	*	442	227	498, 499, 500	292	431
*	488	145	467	433	292, 293	293	94
65	83	118	100	229	519	294	259
*	449	146	508	230	520, 521	295	336
*	445	147	479	231	522, 523	172	226
*	444	148	496	232	524	296	34
*	445	149	480, 481	233	282	*	425
66	68	150	490	234	142	298	512
*	206	151	504, 505	427	490	299	437
67	38	152	317	235	459	300	266
68	38	153	281	236	177	303	98
*	513, 514, 515	154	283	237	367	304	142
71	139	155	285	238	484	305	137
69	490	156	492	239	375	306	111
72	179	157	210, 211	240	200	307	299
74	374	160	518	241	518	308	364
76	517					309	168
77	492					455	200
78	103					*	492
79	490					*	501
80	30					310	438
81	512					320	318, 319
82	263					311	50
83	242					312	220

TO GET FURTHER information on the products advertised in BYTE, either pick up your touch-tone telephone and use TIPS (if you are a subscriber), or fill out the reader service card. Either way full instructions are provided following this reader service index which is provided as an additional service by the publisher, who assumes no liability for errors or omissions. *Correspond directly with company.

ONLY PINWRITER DOT MATRIX PRINTERS CAN SAY ALL THIS.

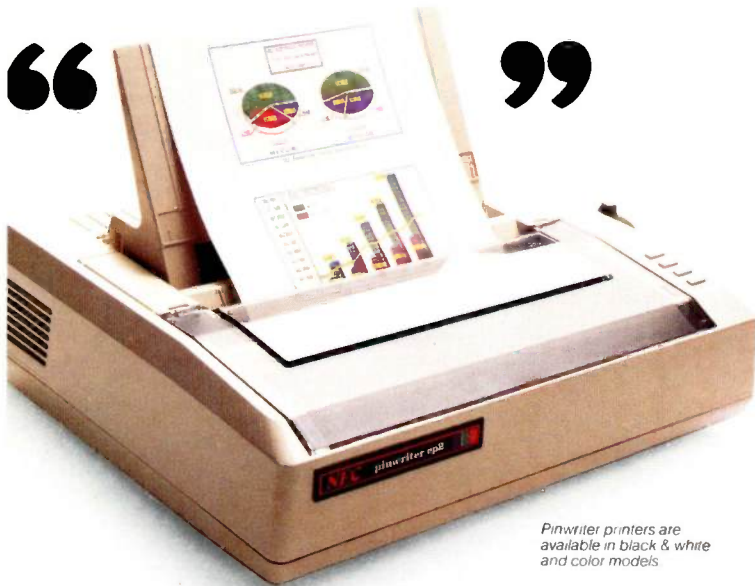

Pinwriter printers are available in black & white and color models.

The reason most people buy a dot matrix printer is for versatility.

And that's exactly why you should buy an NEC Pinwriter™ printer.

Pinwriters are the final word in versatility.

The Pinwriter lets you do more than any other dot matrix printer. Three different speeds cover all your needs—300, 900 or 1800 words per minute.

Pinwriter printers also let you create

unbelievably clear graphics. In black and white. Or in seven crisp colors.

But that's not all. Every Pinwriter gives you a choice of 8 different type styles. Plus, you can choose from a wide range of easy-to-use NEC forms handlers.

With Pinwriter, you can change spacing, type pitch, and speed with one finger.

Pinwriter is a trademark of NEC Corp.

And to make things even easier, Pinwriter printers work with the most popular PCs and software packages.

All the controls at your fingertips.

The Pinwriter is also much easier to use than any other dot matrix printer.

Press a button and you can change typefaces. Or speeds. Even spacing and pitch selection. And that's a refreshing change.

Of course, you can do it through your software, too.

I CAN PRINT PICA HIGH SPEED.
OR PICA CORRESPONDENCE QUALITY
OR PICA NEAR LETTER QUALITY
OR ELITE CORRESPONDENCE QUALITY
OR ELITE NEAR LETTER QUALITY
OR PROPORTIONALLY SPACED CORRESPONDENCE
OR PROPORTIONALLY SPACED NEAR LETTER QUALITY
OR CONDENSED
OR ANY PROGRAMMABLE TYPEFACE

The Pinwriter prints in 8 different typefaces at the touch of a button.

See your dealer for a quote.

For all this versatility, you might expect to pay a bundle for a

Pinwriter printer. Not so. Pinwriter prices are also easy to handle.

For more information, call 1-800-343-4418 (in MA call 617-264-8635). And find out why more and more PC owners are saying, "NEC and me."

NEC AND ME

NEC Information Systems, Inc.

1414 Massachusetts Ave.
Department 1610
Boxborough, MA 01719
Inquiry 306

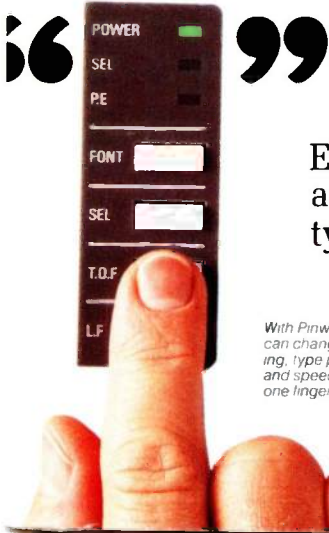
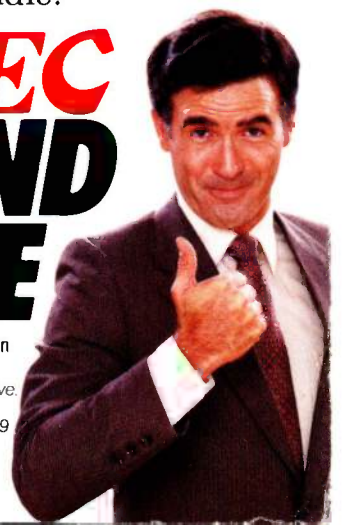

OUR IBM® PC XT "MIRROR IMAGE" HAS JUST BEEN CUT \$1000

The Tandy 1200 HD is now only \$1999

Get PC XT Power for a Fraction of the Cost

How would you like a system that does everything an IBM PC XT does—but costs thousands less? Now the Tandy 1200 HD is only \$1999 (was \$2999 in Cat. RSC-14). That's \$2396 less than the XT!

Expand Affordably

If you're already using an IBM PC, the Tandy 1200 HD lets you expand for less—and you can continue using the same software designed for the PC. The Tandy 1200 HD is compatible with expansion boards designed for the PC, too.

The Features You Demand

The Tandy 1200 HD (25-3000) comes with 256K RAM, a built-in 360K floppy drive and an internal 10-megabyte hard disk. That means you get the same performance, expandability and features as the IBM PC XT . . . but for a lot less.

Stop by your local Radio Shack Computer Center today. We invite comparison. The Tandy 1200 HD is Clearly Superior!

Available at over 1200
Radio Shack Computer Centers and at
participating Radio Shack stores and dealers.

Radio Shack® COMPUTER CENTERS

A DIVISION OF TANDY CORPORATION



Tandy 1200 HD prices apply at Radio Shack Computer Centers and at participating stores and dealers. IBM/™ International Business Machines Corp. Savings based on manufacturer's pricing as of 3/1/85.

Inquiry 352